

**can-am**<sup>TM</sup>



# 2014 Operator's Guide

Includes  
**Safety, Vehicle  
and Maintenance Information**  
(All countries except Canada/United States)

# DS 250<sup>TM</sup>

## **WARNING**

Read this guide thoroughly. It contains important safety information.  
Minimum recommended operator's age: 16 years old. Keep this Operator's Guide in the vehicle.

2 1 9 0 0 1 1 8 5

 **WARNING**

**YOUR VEHICLE CAN BE HAZARDOUS TO OPERATE.** A collision or rollover can occur quickly if you fail to take proper precautions, even during routine maneuvers such as turning and driving on hills or over obstacles. For your safety, understand and follow all the warnings contained in this Operator's Guide and the labels on your vehicle. **Failure to follow these warnings can result in SEVERE INJURY OR DEATH!** Keep this Operator's Guide with the vehicle at all times.

 **WARNING**

Disregarding any of the safety precautions and instructions contained in this Operator's Guide, *SAFETY DVD* and on-product labels could result in an injury including the possibility of death!

The following trademarks are the property of Bombardier Recreational Products Inc.:

Can-Am™

DS 250™

XPST™

---

# FOREWORD

Congratulations on your purchase of a new Can-Am™ ATV. It is backed by the BRP warranty and a network of authorized Can-Am dealers ready to provide the parts, service or accessories you may require.

Your dealer is committed to your satisfaction. He has taken training to perform the initial setup and inspection of your vehicle as well as completed the final adjustments before you took possession. If you need more complete servicing information, please ask your dealer.

At delivery, you were also informed of the warranty coverage and signed the *PREDELIVERY CHECK LIST* to ensure your new vehicle was prepared to your entire satisfaction.

## Know Before you Go

To learn how to reduce the risk for you or bystanders being injured or killed, read this Operator's Guide before you operate the vehicle.

Also, read all safety labels on your ATV and watch your *SAFETY DVD* video.

Failure to follow the warnings contained in this Operator's Guide can result in **SERIOUS INJURY** or **DEATH**.

## Age Recommendation

This vehicle is a category G, always follow this age recommendation:

- A person under the age of 16 should never operate this vehicle.

## Training Course

Never operate this vehicle without proper instruction. **Take a training course.** All operators should receive training from a certified instructor.

**FOR MORE INFORMATION ABOUT ATV SAFETY**, contact an authorized Can-Am dealer to find out about available training courses nearest you.

## Safety Messages

The types of safety messages, what they look like and how they are used in this guide are explained as follows:

The safety alert symbol  indicates a potential injury hazard.

 <b>WARNING</b> Indicates a potential hazard, if not avoided, could result in serious injury or death.
--

 **CAUTION** Indicates a hazardous situation which, if not avoided, could result in minor or moderate injury.

**NOTICE** Indicates an instruction which, if not followed, could result in severely damaged vehicle components or other property.

## About this Operator's Guide

This Operator's Guide has been prepared to acquaint the owner/operator of a new vehicle with the various vehicle controls, maintenance and safe operating instructions. It is indispensable for the proper use of the product.

Keep this Operator's Guide in the vehicle so that you can refer to it for things such as maintenance, troubleshooting and instructing others.

Note that this guide is available in several languages. In the event of any discrepancy, the English version shall prevail.

If you want to view and/or print an extra copy of your Operator's Guide, simply visit the following website **www.operatorsguide.brp.com**.

The information contained in this document are correct at the time of publication. However, BRP maintains a policy of continuous improvement of its products without imposing upon itself any obligation to install them on products previously manufactured. Due to late changes, some differences between the manufactured product and the descriptions and/or specifications in this guide may occur. BRP reserves the right at any time to discontinue or change specifications, designs, features, models or equipment without incurring any obligation upon itself.

This Operator's Guide and the *SAFETY DVD* should remain with the vehicle when it's sold.

While reading this Operator's Guide, remember that:

 **WARNING**

Indicates a potential hazard that, if not avoided, could result in serious injury or death.

---

# TABLE OF CONTENTS

<b>FOREWORD</b> .....	<b>1</b>
Know Before you Go .....	1
Safety Messages .....	1
About this Operator's Guide .....	1

## ***SAFETY INFORMATION***

<b>GENERAL PRECAUTIONS</b> .....	<b>8</b>
Avoid Carbon Monoxide Poisoning .....	8
Avoid Gasoline Fires and Other Hazards .....	8
Avoid Burns from Hot Parts .....	8
Accessories and Modifications .....	8
<b>SPECIAL SAFETY MESSAGES</b> .....	<b>9</b>
<b>OPERATION WARNINGS</b> .....	<b>12</b>
<b>RIDING THE VEHICLE</b> .....	<b>38</b>
Pre-Ride Inspection .....	38
Clothing .....	40
Carrying a Passenger .....	41
Carrying Loads .....	41
Working with your Vehicle .....	42
Recreational Riding .....	42
Environment .....	43
Design Limitation .....	43
Off-Road Operation .....	44
General Operating and Safety Precautions .....	44
Riding Techniques .....	46
<b>IMPORTANT ON PRODUCT LABELS</b> .....	<b>53</b>
Hang Tag .....	53
Vehicle Safety Labels .....	54
Compliance Labels .....	57
Technical Information Label .....	58

## ***VEHICLE INFORMATION***

<b>CONTROLS/INSTRUMENTS/EQUIPMENT</b> .....	<b>60</b>
1) Throttle Lever .....	61
2) RH Brake Lever .....	61
3) LH Brake Lever .....	61
4) Parking Brake .....	62
5) Transmission Lever .....	62
6) Multifunction Switch .....	63

<b>CONTROLS/INSTRUMENTS/EQUIPMENT (cont'd)</b>	
7) Indicator Lamps .....	65
8) Ignition Switch.....	66
9) Fuel Valve .....	66
10) Brake Pedal.....	67
11) Tool Kit .....	67
12) Seat Latch .....	68
13) 12-Volt Power Outlet .....	68
<b>FUEL.....</b>	<b>70</b>
Fuel Requirements.....	70
Fueling Procedure.....	70
<b>BREAK-IN PERIOD.....</b>	<b>72</b>
Operating During Break-In.....	72
<b>OPERATING INSTRUCTIONS.....</b>	<b>73</b>
Starting the Engine.....	73
Shifting the Transmission.....	74
Stopping the Engine .....	74
<b>TUNE YOUR RIDE .....</b>	<b>75</b>
Suspension Adjustment.....	75
<b>VEHICLE TRANSPORTATION.....</b>	<b>76</b>

## **MAINTENANCE**

<b>BREAK-IN INSPECTION .....</b>	<b>78</b>
Break-In Inspection Chart .....	78
<b>MAINTENANCE SCHEDULE .....</b>	<b>80</b>
<b>MAINTENANCE PROCEDURES .....</b>	<b>83</b>
Air Filter .....	83
Air Filter Housing.....	85
Engine Oil.....	86
Oil Strainer.....	88
Radiator .....	88
Engine Coolant .....	89
Spark Arrester .....	92
Air Injection Valve .....	92
Drive Belt .....	93
CVT Cover .....	93
Gearbox Oil .....	93
Throttle Cable .....	94
Spark Plug .....	96
Battery .....	97

**MAINTENANCE PROCEDURES (cont'd)**

Fuses..... 97

Lights..... 98

Drive Chain and Sprockets ..... 99

Tires and Wheels ..... 101

Wheel Bearing..... 102

Suspension ..... 103

Brakes..... 103

Frame ..... 104

**VEHICLE CARE ..... 105**

Post-Operation Care ..... 105

Vehicle Cleaning and Protection ..... 105

**STORAGE AND PRESEASON PREPARATION ..... 106**

***TECHNICAL INFORMATION***

**VEHICLE IDENTIFICATION ..... 108**

Vehicle Identification Number Location ..... 108

Engine Identification Number Location ..... 109

**EC DECLARATION OF CONFORMITY ..... 110**

**SPECIFICATIONS ..... 111**

***TROUBLESHOOTING***

**TROUBLESHOOTING GUIDELINES ..... 116**

***WARRANTY***

**BRP INTERNATIONAL LIMITED WARRANTY: 2014 CAN-AM™ ATV ..... 122**

**BRP LIMITED WARRANTY FOR THE EUROPEAN ECONOMIC AREA, THE COMMONWEALTH OF THE INDEPENDENT STATES AND TURKEY: 2014 CAN-AM™ ATV ..... 127**

***CUSTOMER INFORMATION***

**PRIVACY INFORMATION ..... 134**

**CHANGE OF ADDRESS/OWNERSHIP ..... 135**





# ***SAFETY INFORMATION***

---

## GENERAL PRECAUTIONS

### **Avoid Carbon Monoxide Poisoning**

All engine exhaust contains carbon monoxide, a deadly gas. Breathing carbon monoxide can cause headaches, dizziness, drowsiness, nausea, confusion and eventually death.

Carbon monoxide is a colorless, odorless, tasteless gas that may be present even if you do not see or smell any engine exhaust. Deadly levels of carbon monoxide can collect rapidly, and you can quickly be overcome and unable to save yourself. Also, deadly levels of carbon monoxide can linger for hours or days in enclosed or poorly ventilated areas. If you experience any symptoms of carbon monoxide poisoning, leave the area immediately, get fresh air and seek medical treatment.

To prevent serious injury or death from carbon monoxide:

- Never run the vehicle in poorly ventilated or partially enclosed areas such as garages, carports or barns. Even if you try to ventilate engine exhaust with fans or open windows and doors, carbon monoxide can rapidly reach dangerous levels.
- Never run the vehicle outdoors where engine exhaust can be drawn into a building through openings such as windows and doors.

### **Avoid Gasoline Fires and Other Hazards**

Gasoline is extremely flammable and highly explosive. Fuel vapors can spread and be ignited by a spark or flame many feet away from the engine. To reduce the risk of fire or explosion, follow these instructions:

- Use only an approved red gasoline container to store fuel.

- Strictly adhere to instructions in *FUELING* subsection.
- Never start or operate the engine if the fuel cap is not properly installed.

Gasoline is poisonous and can cause injury or death.

- Never siphon gasoline by mouth.
- If you swallow gasoline, get any in your eye(s) or inhale gasoline vapor, see your doctor immediately.

If gasoline spills on you, wash with soap and water and change your clothes.

### **Avoid Burns from Hot Parts**

Certain components become hot during operation. Avoid contact with those parts during and shortly after operation to avoid burns.

### **Accessories and Modifications**

Do not make unauthorized modifications, or use attachments or accessories that are not approved by BRP. Since these changes have not been tested by BRP, they may increase the risk of a crash or injury, and can render the vehicle illegal.

See your authorized Can-Am dealer for available accessories for your vehicle.

---

## SPECIAL SAFETY MESSAGES

### **THIS VEHICLE IS NOT A TOY AND CAN BE HAZARDOUS TO OPERATE.**

- This vehicle handles differently from other vehicles including motorcycles and cars. A collision or rollover can occur quickly if you fail to take proper precautions, even during routine maneuvers such as turning and driving on hills or over obstacles.

**SEVERE INJURY OR DEATH** can result if you do not comply with the following instructions:

- Read this Operator's Guide and all on-product safety labels carefully and follow the operating procedures described. Watch and pay attention to the *SAFETY DVD* video before operating the vehicle.
- Always follow this age recommendation: A person under 16 years old should never operate this vehicle.
- Never take place on this vehicle without wearing an approved helmet that fits properly. You should also wear eye protection (goggles or face shield), gloves, boots, long sleeved shirt or jacket, and long pants.
- Never carry a passenger on this vehicle. Passenger(s) affect balance and steering, and increase risk of losing control.
- Never operate this vehicle on any paved surfaces, including sidewalks, drive-ways, parking lots and streets.
- Never operate this vehicle on any public street, road or highway, even a dirt or gravel one.
- Never use this vehicle if you are tired, ill, or with drugs or alcohol. Your reaction time and judgement is greatly affected under these conditions.
- Never operate at excessive speeds. Always go at a speed that is proper for the terrain, visibility, and operating conditions, and your experience.
- Never attempt wheelies, jumps, or other stunts.
- Always inspect your vehicle each time you use it to ensure it is in a safe operating condition. Always follow the inspection and maintenance procedures and schedules described in this Operator's Guide.
- Always keep both hands on the handlebars and both feet on the footpegs of the vehicle during operation.
- Always go slowly and be extra careful when operating on unfamiliar terrain. Always be alert to changing terrain conditions when operating this vehicle.
- Never operate on excessively rough, slippery or loose terrain until you have learned and practiced the skills necessary to control this vehicle on such terrain. Always be especially cautious on these kinds of terrain.
- Always follow proper procedures for turning as described further in this Operator's Guide. Practice turning at low speeds before attempting to turn at faster speeds. Do not turn at excessive speed.
- Never operate this vehicle on hills too steep for the vehicle or for your abilities. Practice on smaller hills before attempting larger hills.

- Always follow proper procedures for climbing hills as described further in this Operator's Guide. Check the terrain carefully before you start up any hill. Never climb hills with excessively slippery or loose surfaces. Shift your weight forward. Never open the throttle suddenly or make sudden gear changes. Never go over the top of any hill at high speed.
- Always follow proper procedures for going down hills and for braking on hills as described further in this Operator's Guide. Check the terrain carefully before you start down any hill. Shift your weight backward. Never go down a hill at high speed. Avoid going down a hill at an angle that would cause the vehicle to lean sharply to one side. Go straight down the hill where possible.
- Always follow proper procedures for crossing the side of a hill as described further in this Operator's Guide. Avoid hills with excessively slippery or loose surfaces. Shift your weight to the uphill side of the vehicle. Never attempt to turn the vehicle around on any hill until you have mastered the turning technique described in this Operator's Guide on level ground. Avoid crossing the side of a steep hill if possible.
- Always use proper procedures if you stall or roll backwards when climbing a hill. To avoid stalling, use proper gear and maintain a steady speed when climbing a hill. If you stall or roll backwards, follow the special procedure for braking described in this Operator's Guide. Dismount on the uphill side or to a side if pointed straight uphill. Turn the vehicle around and remount, following the procedure described further in this Operator's Guide.
- Always check for obstacles before operating in a new area. Never attempt to operate over large obstacles, such as large rocks or fallen trees. Always follow proper procedures when operating over obstacles as described further in this Operator's Guide.
- Always be careful when skidding or sliding. Learn to safely control skidding or sliding by practicing at low speeds and on level smooth terrain. On extremely slippery surfaces, such as ice, go slowly and be very cautious in order to reduce the chance of skidding out of control.
- Never operate this vehicle in fast flowing water or in water deeper than that specified in this Operator's Guide. Remember that wet brakes may have reduced stopping ability. Test your brakes after leaving water, mud or snow. If necessary, apply them several times to let friction dry out the pads.
- Always keep in mind that braking distance is readily affected by but not limited to; weather and terrain conditions, braking system and tire conditions, vehicle speed and attitude, and vehicle load including towing. Remember to adjust your driving accordingly.
- Always be sure there are no obstacles or people behind the vehicle when you operate in reverse. When it is safe to proceed in reverse, go slowly.
- BRP recommends sitting on your ATV when operating in reverse. Avoid standing up. Your weight could shift forward against the throttle lever causing an unexpected acceleration and loss of control.
- Always use the size and type tires specified further in this Operator's Guide. Always maintain proper tire pressure as described further in this Operator's Guide.

- Never modify this vehicle through improper installation or use of accessories. Use only BRP's approved accessories. NEVER install passenger a seat.
- Any load carried on the vehicle will affect the stability and control of the vehicle. Never exceed the stated load limits for this vehicle including operator, all other loads and added accessories. Cargo should be properly distributed and securely attached. Always make sure the load is secured and cannot interfere with your proper control. Always be aware that the "load" may slide or fall off and create an accident. Avoid loads that may protrude sideways and get snagged or caught in brush or other obstacles. Avoid covering and obstructing the headlights or taillight with cargo. Reduce speed and allow greater distance for braking.

## OPERATION WARNINGS

The following warning and their format have been requested by the United States Consumer Product Safety Commission and are required to be in the Operator's Guide for all ATVs.

**NOTE:** The following illustrations are general representations only. Your model may differ.

### WARNING



#### **POTENTIAL HAZARD**

Operating this vehicle without proper instruction.

#### **WHAT CAN HAPPEN**

The risk of an accident is greatly increased if the operator does not know how to operate this vehicle properly in different situations and on different types of terrain.

#### **HOW TO AVOID THE HAZARD**

Beginners and inexperienced operators should complete a training course. They should then regularly practice the skills learned during the course as well as the operating techniques described in this Operator's Guide.

For more information about the training course, contact an authorized Can-Am dealer.

**⚠ WARNING**

V00A01Q

**POTENTIAL HAZARD**

Failure to follow the age recommendations for this vehicle.

**WHAT CAN HAPPEN**

A lack of respect for this age recommendation can lead to severe injury or death of the child.

Even though a child may be within the age group for which this vehicle is recommended, he may not have the skills, abilities, or judgment needed to operate this vehicle safely and may be involved in a serious accident.

**HOW TO AVOID THE HAZARD**

No one under 16 should operate this vehicle.

**⚠ WARNING**



**POTENTIAL HAZARD**

Carrying a passenger on this vehicle.

**WHAT CAN HAPPEN**

Greatly reduces your ability to balance and control this vehicle.

Could cause an accident, resulting in harm to you and/or your passenger.

**HOW TO AVOID THE HAZARD**

Never carry a passenger. Even with a long seat that provides unrestricted operator movement, it is not designed nor intended to carry passenger(s).



**⚠ WARNING****POTENTIAL HAZARD**

Operating this vehicle on paved surfaces.

**WHAT CAN HAPPEN**

The tires are designed for off-road use only, not for use on pavement. Paved surfaces may seriously affect handling and control of this vehicle, and may cause the vehicle to go out of control.

**HOW TO AVOID THE HAZARD**

Never operate this vehicle on any paved surfaces, including sidewalks, driveways, parking lots and streets.

**⚠ WARNING**



**POTENTIAL HAZARD**

Operating this vehicle on public streets, roads or highways.

**WHAT CAN HAPPEN**

You can collide with another vehicle.

**HOW TO AVOID THE HAZARD**

Never operate this vehicle on any public street, road or highway, even a dirt or gravel one. In many states or provinces it is illegal to operate this vehicle on public streets, roads or highways.

**⚠ WARNING****POTENTIAL HAZARD**

Riding this vehicle without wearing an approved helmet, eye protection and protective clothing.

**WHAT CAN HAPPEN**

The following items concern all ATV's operator:

- Riding without an approved helmet increases the chances of a severe head injury or death in the event of an accident.
- Riding without eye protection can result in an accident and increases the chances of a severe injury in the event of an accident.
- Riding without protective clothing increases the chances of severe injury in the event of an accident.

**HOW TO AVOID THE HAZARD**

Always wear an approved helmet that fits properly. You should also wear:

- Eye protection (goggles or face shield)
- Gloves and boots
- Long sleeved shirt or jacket
- Long pants.

**⚠ WARNING**



V00A07Q

**POTENTIAL HAZARD**

Using this vehicle with drugs or alcohol.

**WHAT CAN HAPPEN**

- Could seriously affect your judgment.
- Could cause you to react more slowly.
- Could affect your balance and perception.
- Could result in an accident or death.

**HOW TO AVOID THE HAZARD**

Never use drugs or alcohol before or while riding this vehicle.

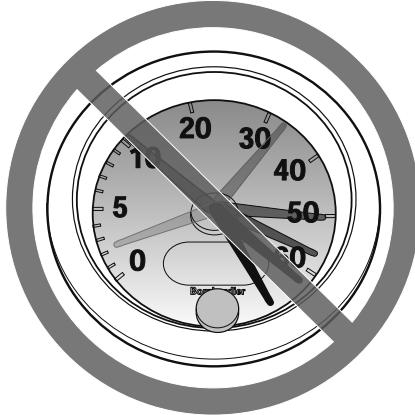
**⚠ WARNING**

V00A08Q

**POTENTIAL HAZARD**

Operating this vehicle at excessive speeds.

**WHAT CAN HAPPEN**

Increases your chances of losing control of the vehicle, which can result in an accident.

**HOW TO AVOID THE HAZARD**

Always travel at a speed which is proper for the terrain, visibility and operating conditions, and your experience.

**⚠ WARNING**



**POTENTIAL HAZARD**

Attempting wheelies, jumps and other stunts.

**WHAT CAN HAPPEN**

Increases the chance of an accident, including an overturn.

**HOW TO AVOID THE HAZARD**

Never attempt stunts, such as wheelies or jumps. Do not try to show off.

**⚠ WARNING**

**POTENTIAL HAZARD**

Failure to inspect the vehicle before operating.

Failure to properly maintain the vehicle.

**WHAT CAN HAPPEN**

Increases the possibility of an accident or equipment damage.

**HOW TO AVOID THE HAZARD**

Always inspect your vehicle each time you use it to make sure the vehicle is in safe operating condition.

Always follow the inspection and maintenance procedures and schedules described further in this Operator's Guide.

**⚠ WARNING****POTENTIAL HAZARD**

Riding on frozen waterways.

**WHAT CAN HAPPEN**

Severe injury or death can result if the vehicle and/or operator break through the ice.

**HOW TO AVOID THE HAZARD**

Never ride this vehicle on a frozen surface before you are sure the ice is thick enough and sound enough to support the vehicle and its load, as well as the force that is created by a moving vehicle.

**⚠ WARNING****POTENTIAL HAZARD**

Removing hands from handlebar or feet from the footrests during operation.

**WHAT CAN HAPPEN**

Removing even one hand or foot can reduce your ability to control the vehicle or could cause you to lose your balance and fall off the vehicle. If you remove a foot from the footrests, your foot or leg may come into contact with the rear wheels, which could injure you or cause an accident.

**HOW TO AVOID THE HAZARD**

Always keep both hands on the handlebar and both feet on the footrests during vehicle operation.

**⚠ WARNING**



**POTENTIAL HAZARD**

Failure to use extra care when operating this vehicle on unfamiliar terrain.

**WHAT CAN HAPPEN**

You can come upon hidden rocks, bumps, or holes, without enough time to react.

Could result in the vehicle overturning or loss of control.

**HOW TO AVOID THE HAZARD**

Go slowly and be extra careful when operating on unfamiliar terrain.

Always be alert to changing terrain conditions when operating the vehicle.



**⚠ WARNING****POTENTIAL HAZARD**

Failure to use extra care when operating on excessively rough, slippery or loose terrain.

**WHAT CAN HAPPEN**

Could cause loss of traction or vehicle control, which could result in an accident, including an overturn.

**HOW TO AVOID THE HAZARD**

Do not operate on excessively rough, slippery or loose terrain until you have learned and practiced the skills necessary to control this vehicle on such terrain.

Always be especially cautious on these kinds of terrain.

**⚠ WARNING**



**POTENTIAL HAZARD**

Turning improperly.

**WHAT CAN HAPPEN**

Vehicle could go out of control, causing a collision or overturn.

**HOW TO AVOID THE HAZARD**

Always follow proper procedures for turning as described further in this Operator's Guide. Practice turning at low speeds before attempting to turn at faster speeds.

Do not turn at excessive speed.

**⚠ WARNING****POTENTIAL HAZARD**

Operating on excessively steep hills.

**WHAT CAN HAPPEN**

The vehicle can overturn more easily on extremely steep hills than on level surfaces or small hills.

**HOW TO AVOID THE HAZARD**

Never operate this vehicle on hills too steep for the vehicle or for your abilities.

Practice on smaller hills before attempting larger hills.

**⚠ WARNING**



**POTENTIAL HAZARD**

Climbing hills improperly.

**WHAT CAN HAPPEN**

Could cause loss of control or cause vehicle to overturn.

**HOW TO AVOID THE HAZARD**

Always follow proper procedures for climbing hills as described further in this Operator's Guide.

Always check the terrain carefully before you start up any hill.

Never climb hills with excessively slippery or loose surfaces.

Shift your weight forward.

Never open the throttle suddenly or make sudden gear changes. The vehicle could flip over backwards.

Never go over the top of any hill at high speed. An obstacle, a sharp drop, or another vehicle or person could be on the other side of the hill.

**⚠ WARNING****POTENTIAL HAZARD**

Going down a hill improperly.

**WHAT CAN HAPPEN**

Could cause loss of control or cause vehicle to overturn.

**HOW TO AVOID THE HAZARD**

Always follow proper procedures for going down hills as described further in this Operator's Guide.

**NOTE:** A special technique is required when braking as you go down a hill.

Always check the terrain carefully before you start down any hill.

Shift your weight backward.

Never go down a hill at high speed.

Avoid going down a hill at an angle which would cause the vehicle to lean sharply to one side. Go straight down the hill where possible.

**⚠ WARNING**



**POTENTIAL HAZARD**

Improperly crossing hills or turning on hills.

**WHAT CAN HAPPEN**

Could cause loss of control or cause vehicle to overturn.

**HOW TO AVOID THE HAZARD**

Never attempt to turn the vehicle around on any hill until you have mastered the turning technique as described further in this Operator's Guide on level ground. Be very careful when turning on any hill.

Avoid crossing the side of a steep hill if possible.

***When crossing the side of a hill:***

Always follow proper procedures as described further in this Operator's Guide.

Avoid hills with excessively slippery or loose surfaces.

Shift your weight to the uphill side of the vehicle.

## ⚠ WARNING

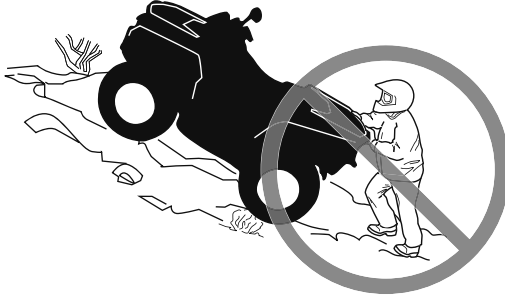

### POTENTIAL HAZARD

Stalling, rolling backwards or improperly dismounting while climbing a hill.

### WHAT CAN HAPPEN

Could result in vehicle overturning.

### HOW TO AVOID THE HAZARD

Use proper gear and maintain steady speed when climbing a hill.

#### ***If you lose all forward speed:***

Keep your weight uphill. Never open the throttle suddenly or make sudden gear changes. The vehicle could flip over backwards.

Apply the brakes.

Lock parking brake after you are stopped.

Dismount on uphill side, or to a side if pointed straight uphill.

#### ***If you begin rolling backwards:***

Keep your weight uphill. Never open the throttle suddenly or make sudden gear changes. The vehicle could flip over backwards.

Never apply the rear brake when rolling backwards.

Apply the front brake gradually.

When fully stopped, apply rear brake as well and lock parking brake.

Dismount on uphill side, or to a side if pointed straight uphill.

Turn the vehicle around and remount, following the procedure described further in this Operator's Guide.

**⚠ WARNING**



**POTENTIAL HAZARD**

Improperly operating over obstacles.

**WHAT CAN HAPPEN**

Could cause loss of control or a collision.

Could cause the vehicle to overturn.

**HOW TO AVOID THE HAZARD**

Before operating in a new area, check for obstacles.

Never attempt to ride over large obstacles, such as large rocks or fallen trees.

When you go over obstacles, always follow proper procedures as described further in this Operator's Guide.



**⚠ WARNING****POTENTIAL HAZARD**

Skidding or sliding improperly.

**WHAT CAN HAPPEN**

You may lose control of this vehicle.

You may also regain traction unexpectedly, which may cause the vehicle to overturn.

**HOW TO AVOID THE HAZARD**

Learn to safely control skidding or sliding by practicing at low speeds and on level smooth terrain.

On extremely slippery surfaces, such as ice, go slowly and be very cautious in order to reduce the chance of skidding or sliding out of control.

**⚠ WARNING**



**POTENTIAL HAZARD**

Operating this vehicle through deep or fast flowing water.

**WHAT CAN HAPPEN**

Tires may float, causing loss of traction and loss of control, which could lead to an accident.

**HOW TO AVOID THE HAZARD**

Never operate this vehicle in fast flowing water or in water deeper than that specified further in this Operator's Guide.

Check water depth and current before you attempt to cross any water. Water should not go above footrests.

Remember that wet brakes may have reduced stopping ability. Test your brakes after leaving water. If necessary, apply them several times to let friction dry out the pads.

**⚠ WARNING****POTENTIAL HAZARD**

Improperly operating in reverse.

**WHAT CAN HAPPEN**

You could hit an obstacle or person behind the vehicle, resulting in serious injury.

**HOW TO AVOID THE HAZARD**

When you select reverse gear, make sure there are no obstacles or people behind the vehicle. When it is safe to proceed, go slowly.

**⚠ WARNING**



**POTENTIAL HAZARD**

Operating this vehicle with improper tires, or with improper or uneven tire pressure.

**WHAT CAN HAPPEN**

Use of improper tires on this vehicle, or operation of this vehicle with improper or uneven tire pressure, may cause loss of control, tire blow outs, tire to move around on its rim and increases the risk of an accident.

**HOW TO AVOID THE HAZARD**

Always use the size and type of tires specified further in this Operator's Guide for this vehicle.

Always maintain proper tire pressure as described further in this Operator's Guide.

Always replace wheels or tires that are damaged.

**⚠ WARNING****POTENTIAL HAZARD**

Operating this vehicle with improper modifications.

**WHAT CAN HAPPEN**

Improper installation of accessories or modification of this vehicle may cause changes in handling which in some situations could lead to an accident.

**HOW TO AVOID THE HAZARD**

Never modify this vehicle through improper installation or use of accessories. All parts and accessories added to this vehicle should be approved by BRP and should be installed and used according to instructions. If you have questions, consult an authorized Can-Am dealer.

**NEVER** install passenger seat or use the racks to carry a passenger.

Modification of the vehicle to increase speed and performance may violate the terms and conditions of your vehicle limited warranty. In addition, certain modifications including the removal of engine or exhaust components are illegal under most laws.

**⚠ WARNING**



**POTENTIAL HAZARD**

Overloading this vehicle, carrying or towing cargo improperly.

**WHAT CAN HAPPEN**

Could cause changes in vehicle handling which could lead to an accident.

**HOW TO AVOID THE HAZARD**

Never exceed the stated load capacity for this vehicle including operator, as well as other loads and added accessories.

Cargo should be properly distributed and securely attached.

Reduce speed when carrying cargo or pulling a trailer. Allow greater distance for braking.

Always follow the instructions in this Operator's Guide for carrying cargo or pulling a trailer.

**⚠ WARNING**

V03M01Q

**POTENTIAL HAZARD**

Transporting flammable or dangerous material can lead to explosions.

**WHAT CAN HAPPEN**

This can cause serious injury or death.

**HOW TO AVOID THE HAZARD**

Never transport flammable or dangerous material.

---

# RIDING THE VEHICLE

To fully appreciate the pleasures and excitement of riding this vehicle, there are some basic rules and tips that you **MUST** follow. Some may be new to you while others may be common sense or obvious. Nonetheless, we ask that you take a few minutes to read this Operator's Guide completely before you operate this vehicle.

Even though a child may be within the age group for which this vehicle is recommended, he may not have the skills, abilities, or judgment needed to operate this vehicle safely and may be involved in a serious accident.

Individuals with cognitive or physical impairments or who are high risk takers have an increased exposure to overturns or collisions which may result in injury including death.

Not all vehicles are the same. Each has its own unique performance characteristics, controls and features. Each will ride and handle differently.

Become completely familiar with the operational controls and the general operation of the vehicle before venturing into off road conditions. Practice driving in a suitable area free of hazards and feel the response of each control. Drive at low speeds. Higher speeds require greater experience, knowledge and suitable riding conditions.

Riding conditions vary from place to place. Each is subject to weather conditions which may radically change from time to time and from season to season.

Riding on sand is different than riding on snow or through forests or marshes. Each location may require a greater degree of awareness and skills. Show good judgement. Always proceed with caution. Please do not take any unnecessary risks that could leave you stranded or possibly injured.

Never assume that the vehicle will go everywhere safely. Sudden changes in terrain caused by holes, depressions, banks, softer or harder "ground" or other irregularities may cause the vehicle to topple or become unstable. To avoid this, slow down and always observe the terrain ahead. If the vehicle does begin to topple or tip-over, it is usually the best advice to immediately get off... AWAY from the direction of the tip-over!

## Pre-Ride Inspection

### **WARNING**

Perform a pre-ride inspection before each ride to detect any potential problem that could occur during operation. The pre-ride inspection can help you monitor component wear and deterioration before they become a problem. Correct any problems that you discover to reduce the risk of a breakdown or crash. See an authorized Can-Am dealer as necessary.

Before using this vehicle, the operator should always perform the following pre-ride inspection check list.



## Pre-Ride Inspection Check List

### What to Do Before Starting the Engine (Key OFF)

ITEMS TO BE INSPECTED	INSPECTION TO PERFORM	✓
Fluids	Check fuel, engine oil and coolant levels	
Leaks	Check for any leaks under vehicle	
Steering	Check if steering operates freely by completely turning it from side to side	
Throttle lever	Activate throttle lever several times to ensure it operates freely. It must return to idle position when released	
Parking brake	Apply parking brake and ensure it operates properly	
Tires	Check tire pressure and condition	
Wheels	Check wheels for damage and if lug nuts are tightened	
Radiator	Check cleanliness of the radiator	
Drive chain and sprockets	Inspect sprockets for wear or damages	
	Check drive chain and slider for proper adjustment and lubrication	
Seat	Ensure operator seat is properly installed and latched	
Cargo	If you transport a cargo, respect the load capacity. Ensure cargo is properly secured to the racks	
Service and storage compartments	Check if service and storage compartments are properly latched	
Chassis and suspension	Check underneath vehicle for any debris on chassis or suspension, properly clean chassis and suspension	

### What to Do Before Starting the Engine (Key ON)

ITEMS TO BE INSPECTED	INSPECTION TO PERFORM	✓
Indicator lamps	Check operation of engine temperature indicator lamp (during first few seconds of key ON)	
	Ensure the N (neutral) and R (reverse) indicator lamps come ON as applicable to transmission lever selection	

ITEMS TO BE INSPECTED	INSPECTION TO PERFORM	✓
Lights	Check operation and cleanliness of headlights and taillight	
	Check operation of high and low beam	
	Check operation of brake light	
Engine	Ensure fuel valve is selected to the ON position	

### What to Do After the Engine is Started

ITEMS TO BE INSPECTED	INSPECTION TO PERFORM	✓
Indicator lamps	Ensure engine temperature indicator lamp is off (shut engine off if light remains on)	
Transmission lever	Check operation of transmission lever (F, N and R)	
Brakes	Drive forward slowly a few feet and apply both brake levers and the brake pedal individually. The brakes must fully apply. Lever and pedal must fully return when released.	
Emergency engine stop switch	Check that the emergency engine stop switch is working properly	
Ignition switch	Check if ignition switch is working properly by restarting and stopping the engine	

## Clothing

Actual weather conditions should help you decide how to dress. Always dress for the coldest weather expected. Thermal underwear next to the skin provides good insulation. It is important that the operator always wear the appropriate protective clothing and apparel, including an approved helmet, eye protection, boots, gloves, long sleeved shirt and pants. This type of clothing will provide you protection from some of the minor hazards you may encounter en route. Operator must never wear loose clothing such as a scarf that may get entangled in the vehicle or on tree branches and shrubs. Depending on conditions, antifogging goggles or sun glasses may be required. Different colored lenses available for goggles or sunglasses help you distinguish terrain variations. Sunglasses should only be worn during the daytime.

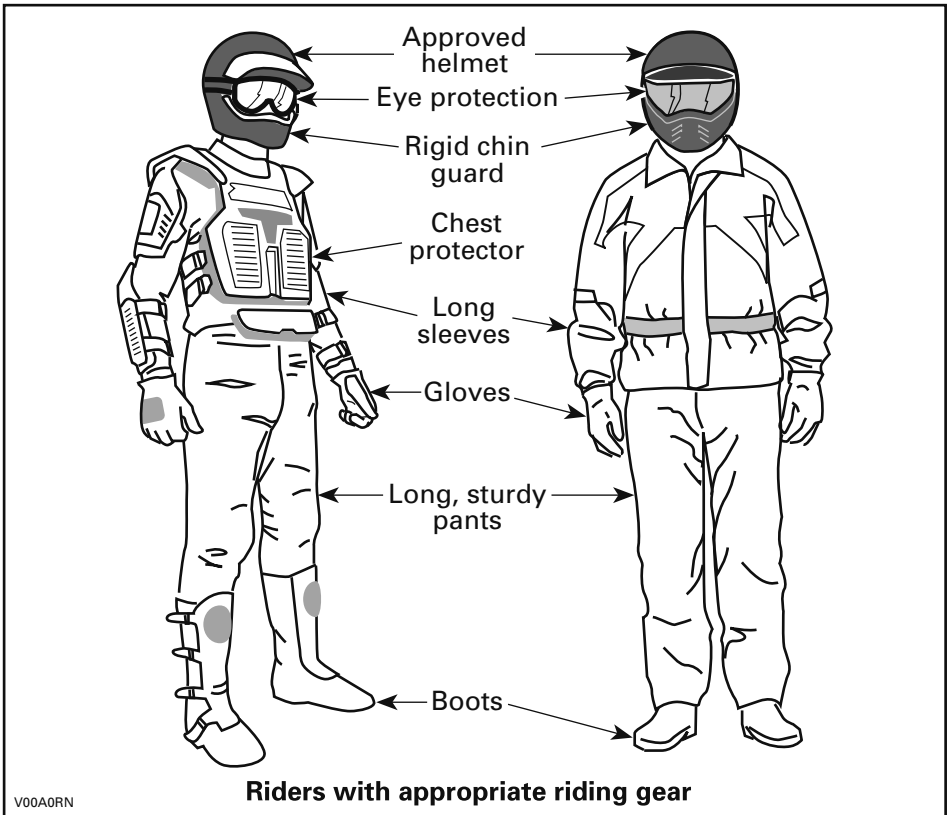

## Carrying a Passenger

This vehicle is designed specifically to carry an operator only. Even with a long seat, this vehicle is not designed nor intended to carry passenger(s). Carrying passenger(s) may affect the stability and your control of the vehicle.

## Carrying Loads

Any load carried on the vehicle will affect the handling, stability and braking distance of the vehicle. For this reason, do not exceed the load limits of the vehicle's manufacturer (see following table). Always make sure the load is secured, properly distributed and cannot interfere with your proper control, and avoid hills and rough terrain. Always be aware that the "load" may slide or fall off and create an accident. Avoid loads that may protrude sideways and get snagged or caught in brush or other obstacles. Avoid covering and obstructing the headlights or taillight with the cargo.

Safely reduce speed according to terrain conditions when carrying cargo or pulling a trailer. Allow greater distance for braking. Always secure cargo as low as possible on the rack(s) to reduce the effect of a higher center of gravity.

<b>MAXIMUM LOAD</b>		
<b>TOTAL LOAD ALLOWED</b>	150 kg (330 lb)	Includes operator, all other loads and added accessories

## **Working with your Vehicle**

Your vehicle can help you perform some LIGHT tasks. A variety of accessories are available from your authorized Can-Am dealer. However, always respect the load and capacities of the vehicle. Overloading of the vehicle can overstress the components and cause failure. To prevent possible injury, it is equally important to follow the instructions and warnings that accompany the accessory. Avoid any physical exertion through lifting or pulling of heavy loads or manhandling the vehicle.

## **Recreational Riding**

Respect the rights and limitations of others. Stay away from areas designated for other types of off road use. This includes snowmobile trails, equestrian trails, cross country ski trails, mountain bike trails etc. Never assume there are no other users on the trail. Always stay to the complete right of the trail and do not zig zag to one side of the trail then the other. Be prepared to stop or pull off to the side if another trail user appears in front of you.

Join a local ATV club. They will provide you with a map and advice or inform you where you can ride. If a club does not exist in your area, help start one. Group riding and club activities provide a pleasurable, social experience.

Always keep a safe distance from other riders. Your judgment of speed, terrain conditions, weather, mechanical condition of your vehicle and the "trust in judgment" you have in others around you will help you make a better choice of appropriate safe distance. This vehicle, like any other motorized vehicle, cannot stop "on a dime".

Before you ride, tell someone where you are planning to travel and your expected time of return.

Depending on the length of your ride, carry additional tools or emergency equipment. Find out where you can get additional gasoline and oil. Be prepared for the possible conditions you may encounter.

First aid kit	Adjustable wrench
Mobile phone	Knife
Friction tape	Flashlight
A rope	Colored lens goggles
Spare light bulbs	Trail map
Provided tool kit	Snack

## Environment

One of the benefits of this vehicle is that it can take you off the beaten path away from most communities. However, you should always respect nature and the rights of others to enjoy it. Do not ride in environmentally sensitive areas. Do not drive over forest crops or shrubs... nor cut down trees or take down fencing nor spin your wheels and destroy the terrain. "Tread Lightly".

This vehicle can cause OHV wildfires if debris builds up near the exhaust or other engine hot spots and ignites then falls off into dry grass. Avoid riding in wet areas, through muskeg or tall grass, where debris can build up. Should you ride in those areas, inspect and remove all debris from your engine and hot spots.

Chasing wildlife is in many areas illegal. Wildlife can die of exhaustion after being chased by a motorized vehicle. If you encounter animals on the trail, stop and observe quietly and with caution. It will be one of the better memories of your life.

Observe the rule... "what you take in, carry out". Do not litter. Do not start campfires unless you have permission to do so... and then only... away from dry areas. The hazards you may create on the trail may cause injury to others or yourself, even at a later date.

Respect farm lands. Always obtain the permission of the landowner before riding on private land. Respect crops, farm animals and property lines. If you come to a closed a gate, close it again after yourself.

Finally, do not pollute streams, lakes or rivers and do not modify the engine or exhaust system, or remove any of its components.

## Design Limitation

Although the vehicle is exceptionally rugged for its class, it is still a light vehicle by definition and its operation must be restricted to its proper purpose.

The addition of weight to any part of the vehicle changes its gravitational stability and modifies its performance.

## **Off-Road Operation**

The very nature of off-road operation is dangerous. Any terrain, which has not been specially prepared to carry vehicles, presents an inherent danger where angularity, terrain substance and exact steepness are unpredictable. The terrain itself presents a continual element of danger, which must be knowingly accepted by anyone venturing over it.

An operator who takes a vehicle off-road should always exercise the utmost care in selecting the safest path and keeping close watch on the terrain ahead of him. On no account should the vehicle be operated by anyone who is not completely familiar with the driving instructions applicable to the vehicle, nor should it be operated on steep or treacherous terrain.

## **General Operating and Safety Precautions**

Care, caution, experience and driving skill are the best precautions against the hazards of vehicle operation.

Whenever there is the slightest doubt that the vehicle can safely negotiate an obstacle or a particular piece of terrain, always choose an alternate route.

In off-road operation, power and traction, not speed, are important. Never drive faster than visibility and your own ability to select a safe route permit.

Constantly watch the terrain ahead for sudden changes in slopes or obstacles, such as rocks or stumps, that may cause loss of stability, resulting in tip-over or rollover.

Never operate the vehicle if the controls do not function normally.

When operating in reverse, check that the path behind the vehicle is free of people or obstacles. Proceed slowly and avoid sharp turns.

BRP recommends that you remain seated on your ATV when operating in reverse. Avoid standing up. Your weight could shift forward against the throttle lever causing an unexpected acceleration and loss of control.

When stopped or parked, always apply the parking brake. This is especially important when parking on a slope. On very steep inclines or if the vehicle is carrying cargo, the wheels should be blocked using rocks or bricks. Remember to set transmission lever to the FORWARD position and to turn the fuel valve to the closed position when vehicle is not being operated for a prolonged period of time or when transported.

## **Uphill Driving**

Due to configuration, this vehicle has excellent climbing ability, so much so that it is possible to tip over before traction is lost. For example, it's common to encounter terrain situations where the top of the hill has eroded to a point that the hill peak rises very sharply. The vehicle can readily negotiate such a condition, however, in doing so, when the front of the vehicle is driven to a point that the vehicle's balance moves rearward, a tip over can occur.

The same situation may apply if an embedded object causes the front of the vehicle to climb more than desired. If such a situation occurs take an alternate route. Be aware of side hilling dangers when doing so.

It is also wise to know the terrain condition on the other side of the hill or bank. All too often there exists a sharp drop-off that is impossible to negotiate or descend.

### **Downhill Driving**

This vehicle can climb slopes that are steeper than it can safely descend. Therefore, it is essential to ensure that a safe route exists to descend a slope before you climb it.

Decelerating while negotiating a slippery downhill slope could "toboggan" the vehicle. Maintain steady speed and/or accelerate slightly to regain control.

### **Side Hilling**

Whenever possible, such operation should be avoided. If necessary, do so with extreme caution. Side hilling on steep inclines could result in rollover. In addition, slippery or loose surfaces could result in uncontrollable side sliding. Do not attempt to turn the vehicle downhill with the slide. Avoid all objects or depressions that will intensify the raising of one side of the vehicle higher than the other, thus causing rollover.

### **Drop-Offs**

This vehicle will "bottom-out" and usually stop if either the front or rear wheels are driven over a drop-off. If the drop is sharp or deep, the vehicle will nose dive and tip-over.

## **WARNING**

**Avoid negotiating drop-offs. Reverse and select an alternate route.**

### **Riding on Snow Covered Surfaces**

When performing the pre-ride inspection, pay special attention to locations on the vehicle where snow and/or ice accumulations may obstruct visibility of the tail lamp, clog ventilation openings, block the radiator and fan, and interfere with the movement of the control levers, switches and brake pedal. Before starting with your ATV check the steering, throttle and brake lever and pedal controls for interference free operation.

Whenever an ATV is ridden on a snow covered drive path the tire grip is generally reduced causing the vehicle to react differently to control inputs from the operator. On low grip surfaces, the steering responses are not as crisp and precise, stopping distances are lengthened and acceleration becomes sluggish. Slow down and do not "gun" the throttle. This will only result in spinning of the tires and possibly in an over steering slide of the vehicle. Avoid hard braking. This will possibly result in a

straight line slide of the vehicle. Again, the best advice is to safely reduce speed in anticipation of a maneuver so to give yourself time and distance to regain total vehicle control before it spins out of your control.

As you drive your ATV over a loose snow covered surface, snow dust will be picked up in the wake turbulence of the moving vehicle and transported to contact and accumulate or melt on some exposed components including rotating parts like brake discs. Water, snow or ice may affect the response time of the brake system of your ATV. Even when not required to reduce vehicle speed apply brakes frequently to prevent ice or snow accumulation and to dry brake pads and discs. While doing so in low risk driving situations you will test for grip level and keep yourself alerted to how the vehicle reacts to your control inputs. Always keep the brake pedal, footrests, brake and throttle levers free of snow and ice. Frequently wipe snow off seat, handgrips, headlights and taillight.

The depth of the snow cover may hide rocks, tree stumps or other objects and if it is wet may totally impede the drivability as the vehicle becomes bogged down or completely loses traction in slushy snow. Look far ahead and always be watchful of any visible clues that might indicate the presence of such obstacles. In doubt steer clear. Avoid driving on any frozen body of water before checking that the ice will safely support the ATV, its riders and its load of cargo. Remember that a given thickness of ice may be sufficient to support a snowmobile but not an ATV of an identical weight because of the smaller load bearing surface of the four tire contact patches as compared to that of a snowmobile track and skis.

To maximize comfort and avoid frostbite, always wear clothing and ATV protective equipment appropriate for the weather conditions you will be exposed to during your ride.

At the end of each ride it is a good practice to clean the vehicle body and all moving components (brakes, steering components, drivelines, controls, radiator fan etc.) from any snow or ice accumulations. Wet snow will turn to ice during the shut down period and become more difficult to remove at the next pre-ride inspection.

## **Riding Techniques**

Riding your vehicle too fast for your skills or the conditions may result in injury. Apply only enough throttle to proceed safely. Statistics show that high speed turns usually result in mishaps and injury. Always remember that this vehicle is heavy! Its pure weight alone may entrap you should it fall and pin you down. Always use proper riding techniques to avoid vehicle overturns on hills, rough terrain, and in turns.

This vehicle is not designed for jumping nor can it fully absorb the high impact energy generated during manoeuvres such as jumping which, can be passed on to you, the operator. Performing "wheelies" can cause the vehicle to flip over onto you. Both practices have a high risk for you and should be avoided at all times.

To maintain proper control it is strongly advised that you keep your hands on the handlebar and within easy reach of all controls. The same holds true for your feet. To minimize the possibility of a leg or foot injury, keep your feet on the footrests



at all times. Do not direct your toes outwards nor extend your feet out to assist in turning as they can be hit or get snagged by passing obstacles, or may come into contact with the wheels.

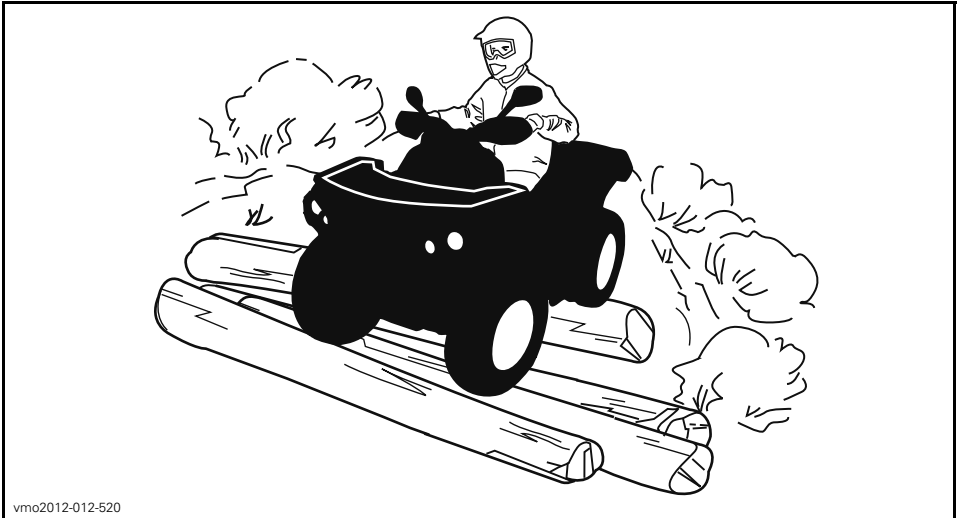

Even though there is an adequate suspensions system on this vehicle there are “washboard” or rough terrain conditions that will make you feel uncomfortable and can even cause back injuries. “Posting” or riding in a crouched position will often be required. Slow down and allow your flexed legs to absorb part of the impact.

This vehicle is not designed for riding on roads or highways. (In most places it is an illegal practice). Riding your vehicle on roads or highways could cause a collision to occur with another vehicle.

The tires on this vehicle are not suited for paved road use. Also, this vehicle is not equipped with a rear differential (rear wheels are always turning at the same speed). For these reasons, pavement may seriously affect the handling and control of the vehicle.

Riding on roads or soft shoulders may confuse other road users, especially if your lights are on.

If you have to cross a road, the lead driver should get off his vehicle, then observe and give directions to the other riders. The last person to cross, then assists the lead driver to cross. Do not travel on sidewalks. They are designated for pedestrian use.

Water can be a unique hazard. If it is too deep the vehicle may “float” and topple. Check the water depth and current before you attempt to cross any water. Water should not go above the footrest. Be wary of slippery surfaces such as rocks,

grass, logs, etc., both in the water and on its banks. A loss of traction may occur. Do not attempt to enter the water at high speed. The water will act as a brake and could throw you.

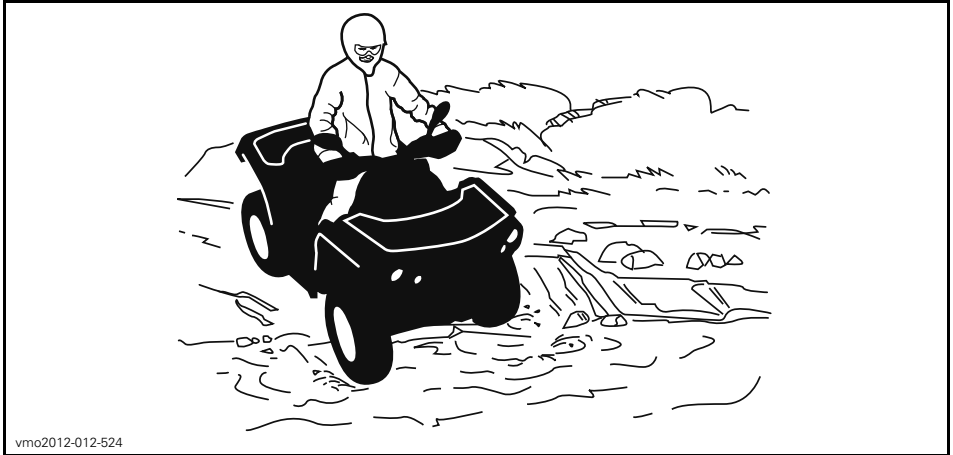

Wet brakes will affect the braking ability of your vehicle. Make sure you dry the brakes by applying them several times after the vehicle leaves the water, mud or snow.

Mud or marsh lands may be encountered near water. Be prepared for sudden "holes" or changes in depth. Similarly so, be watchful of hazards such as rocks, logs, etc., partially covered by vegetation.

If your route crosses frozen waterways, make sure the ice is thick enough and sound enough to support the total weight of yourself, the vehicle and its load. Be ever watchful of open water... it is a sure indication that the ice thickness will vary. If in doubt, do not attempt to cross.

Ice will also affect control of the vehicle. Slow down and do not "gun" the throttle. This will only result in spinning of the tires and the vehicle may possibly tip over. Avoid rapid braking. This again can result in an uncontrolled slide and the vehicle may possibly tip over. Slush should be avoided at all times since it could block the operation or controls of the vehicle.

Riding in snow may affect the brakes stopping capability. Safely reduce speed and allow greater distance for braking. Snow projection may cause ice build up or snow accumulation on brake components and controls. Apply brakes frequently to prevent ice or snow accumulation. Refer to General Operating and Safety Precautions in this subsection for more detailed information regarding riding on snow Covered surfaces.

Riding on sand, sand dunes, or on snow is another unique experience but there are some basic precautions that should be observed. Wet, deep or fine sand/snow may create a loss of traction and cause the vehicle to slide, drop off or become "bogged" down. If this occurs look for a firmer base. Again, the best advice is to slow down and be watchful of the conditions.

When riding in sand dunes it is advisable to equip the vehicle with an antenna type safety flag. This will help make your location more visible to others over the next sand dune. Proceed carefully should you see another safety flag ahead. Since the antenna type safety flag can snag and rebound on your body if caught, do not use it in areas where there are low hanging branches or obstacles.

Riding on loose stones or gravel is very similar to riding on ice. They will affect the steering of vehicle... possibly causing it to slide and tip-over especially at high speeds. In addition, braking distance may be affected. Remember that "gunning" the throttle or sliding may cause loose stones to be ejected rearwards into the path of another rider. Never do it deliberately.

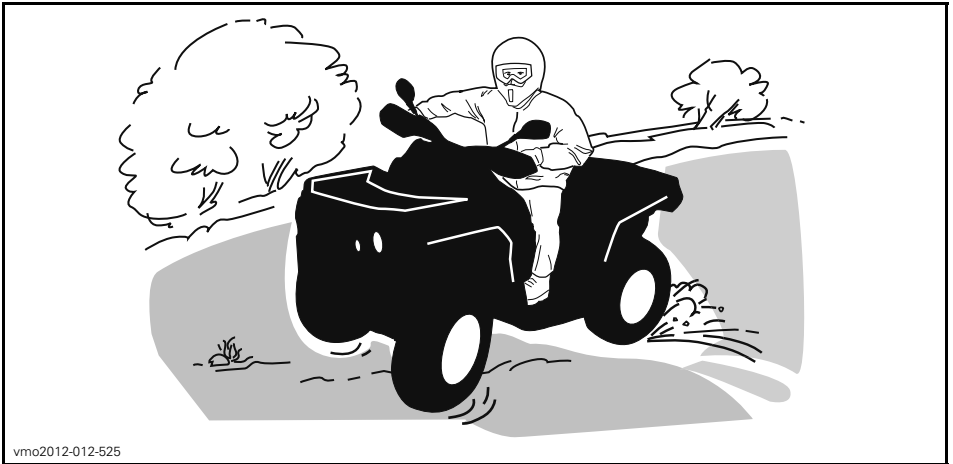

If you do get into a slide or skid, it may help to turn the handlebar into the direction of the skid until you regain control. Never jam the brakes and lock the wheels.

Respect and follow all posted trail signs. They are there to help you and others.

Obstacles in the "trail" should be traversed with caution. This includes loose rocks, fallen trees, slippery surfaces, fences, posts, and embankments and depressions. You should avoid them whenever possible. Remember that some obstacles are too large or dangerous to cross and should be avoided. Small rocks or fallen trees may be safely crossed... approach at a 90° angle. Stand on the footrests while keeping your knees flexed. Adjust speed without losing momentum and do not "gun" the throttle. Hold handlebar firmly. Place your body weight rearwards and proceed. Do not try to lift the vehicle front wheels off the ground. Be aware that the object may be slippery or may move while crossing.

When driving on hills or slopes two things are highly important... be prepared for slippery surfaces or terrain variations and obstacles and... use proper body positioning.

When stopped or parked always apply the parking device. This is especially important when parking on a slope. On very steep inclines or if the ATV is carrying a cargo, the wheels should be blocked using rocks or bricks.

## Uphill

Before trying to climb a hill, keep these things in mind. Hill Climbing should only be attempted by experienced operators. Start on shallow slopes. Always drive straight uphill and keep your body weight forward towards the top of the hill. Keep your feet on the footrests, shift your ATV into a lower gear and accelerate before you start to climb. Try to keep a steady speed and go easy on the throttle to avoid acceleration. Abrupt slope or terrain variation or rolling one wheel over an obstacle could have a big impact on the stability as it will lift the front of the vehicle increasing the risk of tipping over. Some hills are too steep to safely stop or recover from after an unsuccessful climbing attempt. Try to avoid steep inclines. If you're not careful, you could tip over when going up hills. If the hill is too steep and you cannot proceed or the vehicle begins to roll backwards, apply the brake, being careful not to slide. Dismount then use the "K" turn (while walking back, next to the vehicle on the up hill side and with a hand on the brake lever, slowly back the rear of the vehicle toward the top of the hill then drive downhill). Always walk or dismount on the upside of the slope while keeping clear of the vehicle and its rotating wheels. Do not try to hold on to the vehicle if it begins to topple. Stay clear. Do not ride over the crest of the hill at high speed. Obstacles, including sharp drop-offs, may exist.

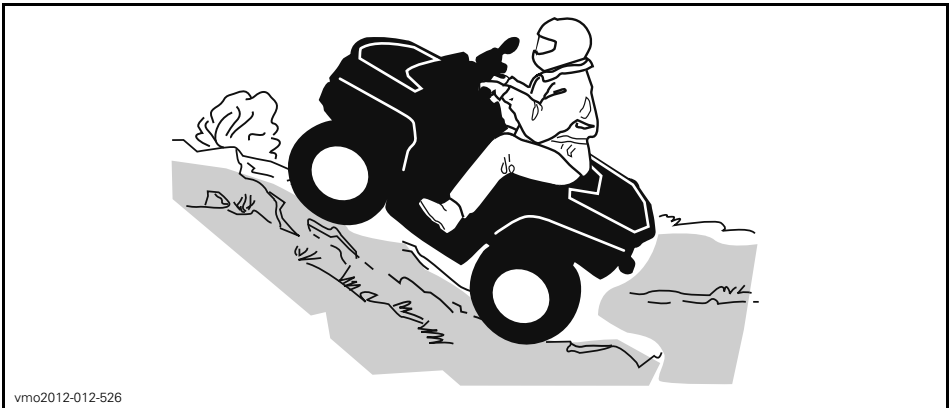

## Downhill

Keep your body weight rearwards. Apply the brake gradually to prevent skidding. Do not "coast" down the slope using solely engine compression or in neutral gear. Try to avoid steep inclines. If you're not careful, you could tip over when going down hills.

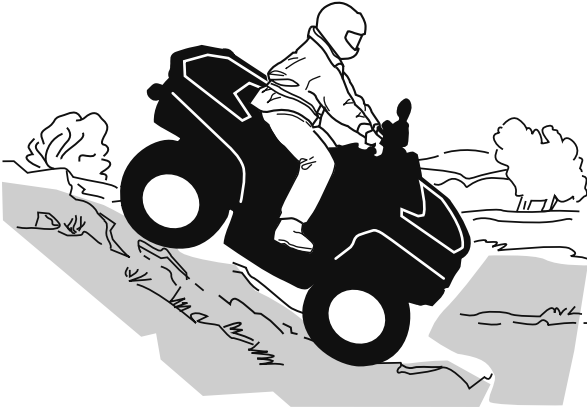

vmo2012-012-523

## Side Hilling

This is one of the **most risky** types of riding since it may drastically change the balance of the vehicle. It should be avoided wherever possible. However, if it is necessary to do so, it is important that you **ALWAYS** keep your body weight on the up-side of the slope... and be prepared to dismount on that side should the vehicle begin to topple. **Do not try to stop or save the vehicle from damage.**



vmo2012-012-527

While reading this Operator's Guide, remember that:

### **WARNING**

Indicates a potential hazard that, if not avoided, could result in serious injury or death.

# IMPORTANT ON PRODUCT LABELS

## Hang Tag

This vehicle comes with hang tags and labels containing important safety information.

Any person who rides this vehicle should read and understand this information before riding.

### **WARNING**

- Locate and read operator's guide.
- Improper ATV use can result in SEVERE INJURY or DEATH. Follow all instructions and warnings.
- Always wear ear protection.
- Always use an approved helmet and protective gear.
- Never use on public roads.
- Never carry passengers.
- Never use with drugs or alcohol.

**G**  
**GENERAL USE MODEL**

THIS ATV IS FOR  
RECREATIONAL USE OR UTILITY USE

**OPERATOR ONLY-NO PASSENGERS**

**NO OPERATOR UNDER AGE 16**

---

TRAINING COURSES TO TEACH ATV RIDING SKILLS  
ARE AVAILABLE. FOR INFORMATION CONTACT  
YOUR DEALER.

---

CHECK WITH YOUR DEALER TO FIND OUT ABOUT  
STATE OR LOCAL LAWS REGARDING ATV  
OPERATION.

**THIS HANGTAG IS NOT TO BE REMOVED BEFORE SALE.**

704903930



704903930A

## Vehicle Safety Labels

Read and understand all the safety labels on your vehicle.

These labels are affixed to the vehicle for the safety of the operator or bystanders.

The safety labels on your vehicle should be considered permanent parts of the vehicle. If missing or damaged, they can be replaced free of charge. See an authorized Can-Am dealer.

**NOTE:** The number on the vehicle illustrations refer to the safety label sequence number. In the event of any discrepancy between this guide and the vehicle, the safety labels on the vehicle have precedence over the labels in this guide.



vmo2010-001-104\_c

LEFT FRONT FENDER LABELS



vmo2008-009-002\_c

LEFT REAR FENDER LABELS

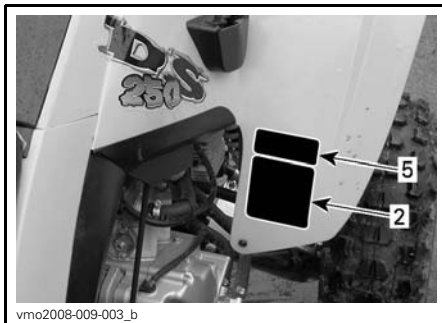

vmo2008-009-003\_b

RIGHT FRONT FENDER LABELS

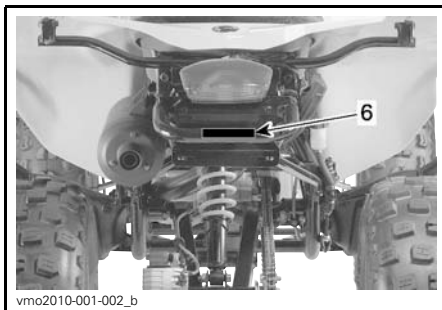

vmo2010-001-002\_b

REAR BUMPER LABEL



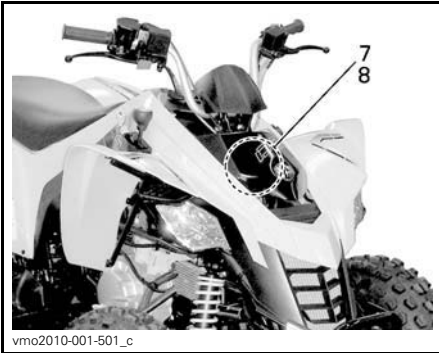

FRONT FENDER ACCESS PANEL

*Label 1*

**⚠ WARNING**

- Locate and read operator's guide.
- Improper ATV use can result in SEVERE INJURY or DEATH. Follow all instructions and warnings.
- Always wear ear protection.
- Always use an approved helmet and protective gear.
- Never use on public roads.
- Never carry a passenger.
- Never use with drugs or alcohol.

*Label 2*

**⚠ WARNING**

Operating this ATV if you are under the age of 16 increases your chance of SEVERE INJURY or DEATH. NEVER operate this ATV if you are under age 16.

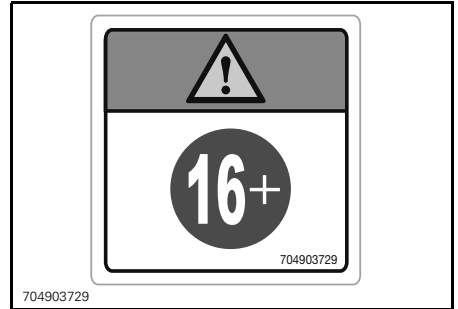

LABEL 2

*Label 3*

**⚠ WARNING**

- Locate and read operator's guide.
- NEVER carry a passenger.

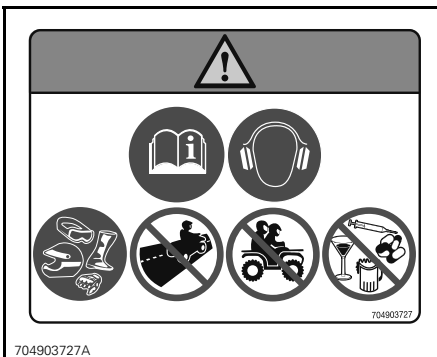

704903727A

LABEL 1

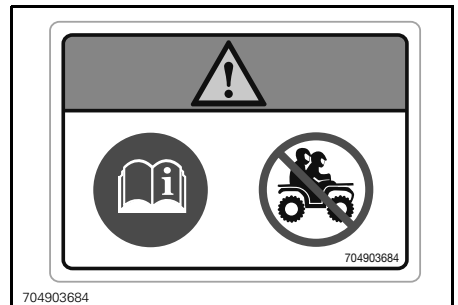

704903684

LABEL 3

Label 4

**⚠ WARNING**

- Locate and read operator's guide.
- Improper overloading or tire pressure can cause loss of control, resulting in SEVERE INJURY or DEATH.
- ALWAYS maintain proper tire pressure as shown.
- NEVER exceed the load capacity of 150 kg (330 lb) including weight of operator, cargo, accessories, and trailer tongue weight.

**⚠**

**< 150 kg MAX. (330 lb)**

**kPa**

<b>MAX: 34 kPa (5 psi)</b>	<b>MAX: 34 kPa (5 psi)</b>
<b>MIN: 26 kPa (3.8 psi)</b>	<b>MIN: 26 kPa (3.8 psi)</b>

704903811

LABEL 4

**NOTICE**

- **ATV MUST be stopped before shifting lever.**
- **Always apply foot brake to shift from Neutral (N).**

704901192A

704901192A

LABEL 5

Label 6

**⚠ WARNING**

NEVER attach here or on the luggage rack to pull a load. This can cause the vehicle to tip over. ALWAYS use the trailer hitch or the recovery hook to pull a load.

**⚠**

704903955A

704903955

LABEL 6

DO NOT OPEN WHEN HOT

**WARNING**

**1.1**

ATTENTION

NE PAS OUVRIR A CHAUD

vmo2010-010-100\_a

LABEL 7

Label 8



LABEL 8

Compliance Labels

These labels indicate vehicle's compliance.



LOCATION: RIGHT FRONT LOWER TUBE OF THE FRAME

ENGINE FAMILY	CBCXX2492GC	FAMILLE DE MOTEUR	<p><b>RENSEIGNEMENTS SUR LE DISPOSITIF ANTIPOLLUTION</b>                  CE VÉHICULE EST CERTIFIÉ POUR FONCTIONNER À L'ESSENCE SANS PLOMB ET IL RÉPOND AUX NORMES [2012] DE L'EPA ET RÉGLEMENTATIONS CALIFORNIENNES POUR LES VTT À MOTEUR SI.</p> <p><b>EMISSION CONTROL INFORMATION</b>                  THIS VEHICLE IS CERTIFIED TO OPERATE ON UNLEADED GASOLINE AND MEETS TO [2012] U.S. EPA AND CALIFORNIA REGULATIONS FOR ATV SI ENGINES.                  SEE OPERATOR'S GUIDE FOR MAINTENANCE SPECIFICATIONS                  VOIR GUIDE DU CONDUCTEUR POUR LES SPÉCIFICATIONS D'ENTRETIEN</p>	
PERMEATION FAMILY	CBCXPP404B53	FAMILLE DE PERMEATION		
CERTIFICATION STANDARD (FEL)	134 g/kW-hr HC+NOx 400 g/kW-hr CO	LIMITES DES ÉMISSIONS DE LA FAMILLE		
ENGINE DISPLACEMENT	249.4 cm <sup>3</sup>	CYLINDRÉE		
EXHAUST EMISSION CONTROL SYSTEM	EM	SYSTÈME DE CONTRÔLE DES ÉMISSIONS		
<p><b>BOMBARDIER RECREATIONAL PRODUCTS INC.</b></p>				

704902863

LOCATION: UNDERNEATH REAR FENDER

## Technical Information Label

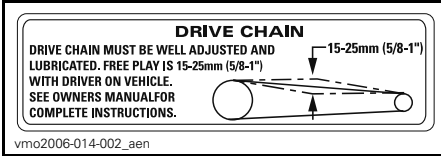

### DRIVE CHAIN ADJUSTMENT LABEL

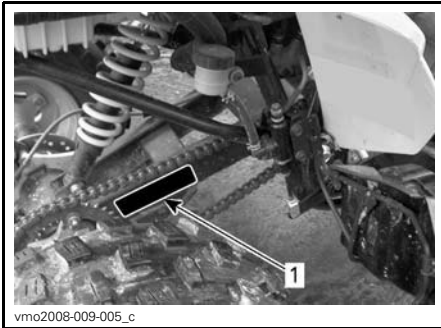

1. Location of drive chain adjustment label

# ***VEHICLE INFORMATION***

# CONTROLS/INSTRUMENTS/EQUIPMENT

NOTE: Some controls/instruments/equipment are optional.

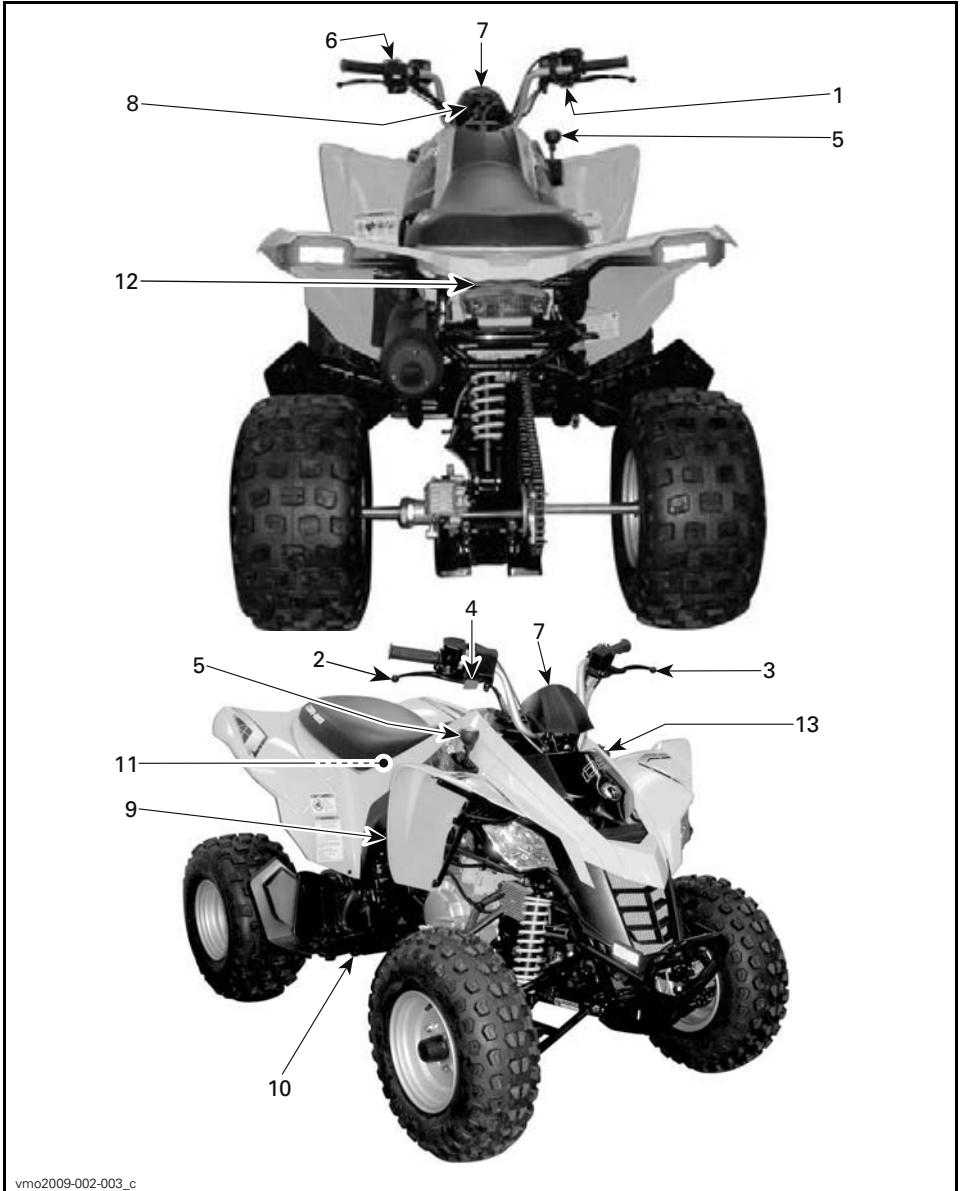

vmo2009-002-003\_c

**NOTE:** This section provides basic information on the functions of the various controls, instruments and equipment available on your vehicle. Illustrations used in this Operator's Guide may not be exact representations, your model may differ. For more details of how to operate a control in conjunction with some others, refer to *OPERATING INSTRUCTIONS* further in this section.

## 1) Throttle Lever

The throttle lever is located on the RH side of the handlebar.

When pushed forward, it increases the engine speed that allows the engagement of the transmission on the selected gear.

When released, the engine speed should automatically return to idle and the vehicle gradually slow down.

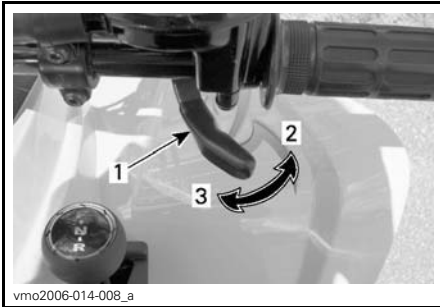

1. Throttle lever
2. To accelerate
3. To decelerate

## **⚠** WARNING

Check throttle lever operation before you start the engine. If the throttle lever does not function smoothly, check for the cause. Correct the problem before riding the vehicle. Consult your authorized dealer if you can't find or solve the problem yourself.

## 2) RH Brake Lever

The RH brake lever is located on the RH side of the handlebar.

When pulled in, the front brakes are applied. When released, it should automatically return to its original position. Braking effect is proportional to the force applied on the lever.

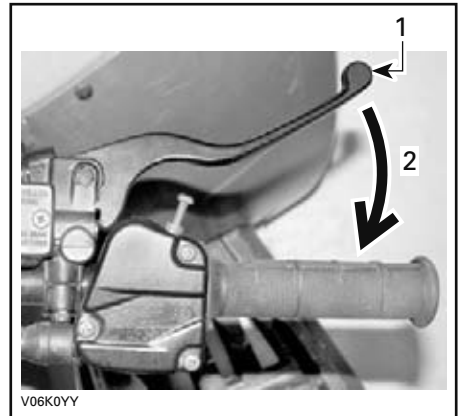

### TYPICAL

1. Brake lever
2. To apply brake

## 3) LH Brake Lever

The LH brake lever is located on the LH side of the handlebar.

When pulled in, the rear brake is applied. When released, it should automatically return to its original position. Braking effect is proportional to the force applied on the lever.



**TYPICAL**

1. Brake lever
2. To apply brake

#### 4) Parking Brake

The parking brake is located on the RH side of the handlebar.

When applied, it prevents the vehicle from moving. Useful when the brake needs to be locked such as when executing a K-turn, during transportation or when the vehicle is not in operation.

**⚠ WARNING**

Always use the parking brake and engage the the transmission in **FORWARD** gear when the vehicle is not in operation.

**⚠ WARNING**

Make sure the parking brake is fully disengaged before operating the vehicle. Riding the vehicle with a continuous pressure on the brakes may cause damage to the brake system and a loss of braking capacity and/or fire.

**To engage the parking brake mechanism:** Squeeze the RH brake lever and engage on the brake lever lock with a finger. The brake lever remains pulled in, applying rear brakes.

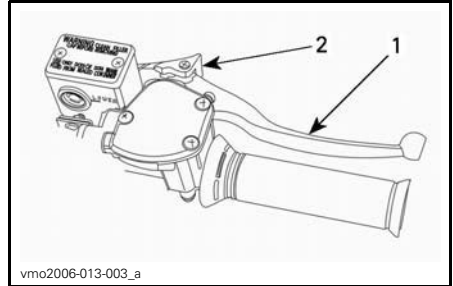

1. RH brake lever
2. Press to apply parking brake

**To release mechanism:** Squeeze brake lever. Lever lock should automatically return to its original position. Brake lever should return to rest position. Always release parking brake before riding.

#### 5) Transmission Lever

A 3 position transmission lever is located on the RH side of the vehicle near the steering column.

**NOTICE** Always completely stop the vehicle and apply the brakes prior to moving the transmission lever.

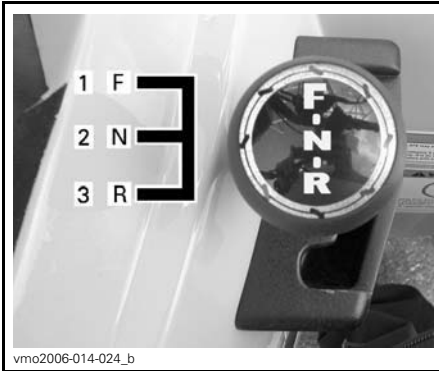

**TRANSMISSION LEVER PATTERN**

1. Forward (F)
2. Neutral (N)
3. Reverse (R)

To change the transmission lever position, completely stop vehicle, apply brakes, then move lever to the desired position. Do not force lever.

**NOTE:** Any shifting attempt at high RPM or without brakes applied will stop engine.

**R: Reverse**

This allows the vehicle to go backwards. This vehicle is equipped with a reverse speed limiter system. Refer to *OVERRIDE BUTTON* for more information.

## ⚠ WARNING

Before operating the vehicle in reverse, ensure the path behind is clear of obstacles or bystanders. BRP recommends that you remain seated. Avoid standing up. Your weight could shift forward against the throttle lever causing an unexpected acceleration and loss of control.

**N: Neutral**

This position disengages the transmission to allow manual vehicle movement or towing.

**F: Forward**

It is the normal driving range. It allows the vehicle to reach its maximum speed.

**6) Multifunction Switch**

The multifunction switch is located on the LH side of the handlebar.

The controls located on the multifunction switch are:

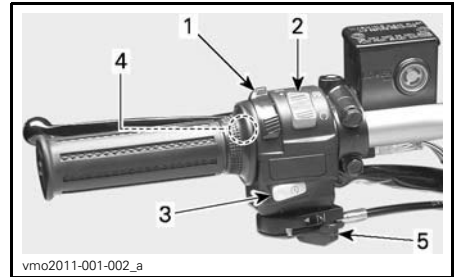
**TYPICAL — MULTIFUNCTION SWITCH**

1. Headlights switch
2. Emergency engine stop switch
3. Engine start button
4. Override button
5. Choke lever

**Headlights Switch**

This is a 3 position switch that controls the taillight and headlights simultaneously however, it has no effect on the brake light.

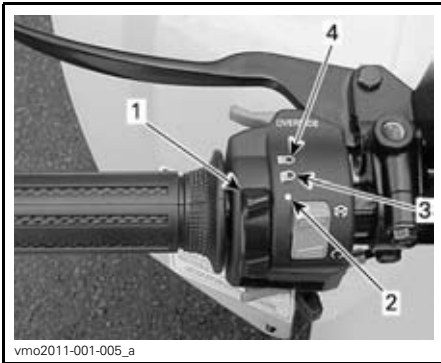

**TYPICAL — HEADLIGHTS SWITCH FUNCTIONS**

1. Headlights switch
2. Low beam and taillight
3. High beam and taillight
4. OFF position

**Emergency Engine Stop Switch**

This switch can be used to stop the engine and as an emergency control.

**NOTE:** While the engine can be stopped by turning the ignition key to the OFF position, we recommend the engine be stopped using the emergency engine stop switch.

To stop the engine, fully release throttle lever, then set the emergency engine stop switch to the STOP position.

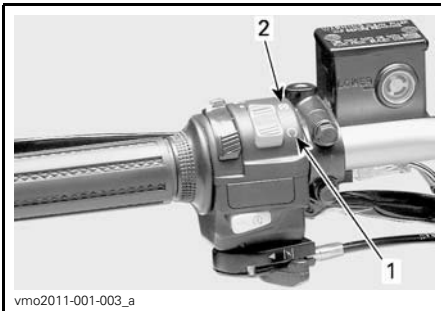

**TYPICAL - EMERGENCY ENGINE STOP SWITCH**

1. RUN position
2. STOP position

**Engine Start Button**

To start engine, set the emergency engine stop switch to RUN position.

Press and hold the engine start button, release immediately after engine is started.

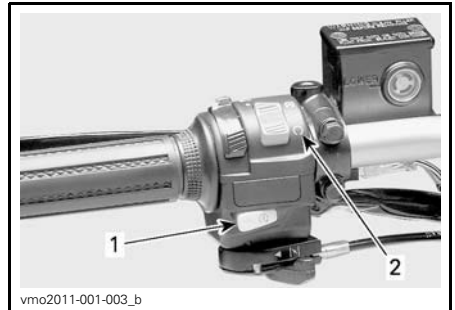

**TYPICAL**

1. Engine start button
2. Emergency engine stop switch (RUN position)

**NOTE:** The engine will not crank if the emergency engine stop switch is turned to STOP position.

**Override Button**

This button is used to override the reverse speed limiter system when backing up. Press and hold the override button, then push the throttle lever gradually forward.

**⚠ WARNING**

Never activate the override button if the throttle lever is not fully released as a loss of control may result.



vmo2011-001-005\_b

**TYPICAL**

1. Override button

**Choke Lever**

This device features a variable position lever used to ease starting a cold engine.

The OFF position is used when the engine is warm.



V06F0QY

**CHOKE LEVER IN THE FULL CHOKE POSITION**

The other positions between OFF and FULL will be used depending on engine temperature.

**7) Indicator Lamps**

The indicator lamps are located in the middle of the handlebar.



V06F0PY

**CHOKE LEVER IN THE OFF POSITION**

The full choke position is used when the engine is cold.

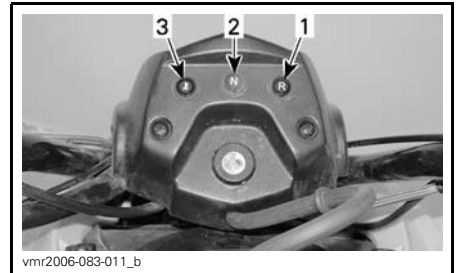

vmr2006-083-011\_b

1. Reverse lamp (RED)
2. Neutral lamp (GREEN)
3. Engine temperature (RED)

While reading this Operator's Guide, remember that:

**⚠ WARNING**

Indicates a potential hazard that, if not avoided, could result in serious injury or death.

## Engine Temperature (RED)



This light comes ON every time the ignition switch is turned ON, and remains ON for approximately 1 second.

When this indicator light is ON during engine operation, it indicates the engine is overheating.

If the engine overheats, refer to *ENGINE OVERHEATS* in *TROUBLESHOOTING*.

**NOTICE** If the light does not turn off right after engine starting, stop engine. See an authorized Can-Am dealer. Do not use the vehicle until repaired.

## Reverse Lamp (RED)



When lit, it indicates the transmission is in reverse position.

## Neutral Lamp (GREEN)



When lit, it indicates the transmission is in neutral position.

## 8) Ignition Switch

The ignition switch is located in the middle of the handlebar.

It is a key-operated 2 position switch; OFF and ON (with lights).

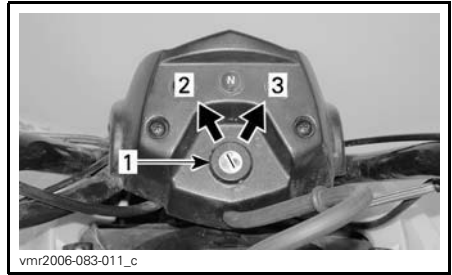

**TYPICAL — IGNITION SWITCH POSITIONS**

1. Ignition switch
2. OFF
3. ON with lights

Insert key in switch and turn to ON position. To remove key, turn key to OFF position then pull it out.

Remember that having the lights on without the engine running discharges the battery. Always turn ignition to OFF position after engine has been stopped.

**NOTE:** While the engine can be stopped by turning the ignition key to OFF position, we recommend the engine be stopped using the emergency engine stop switch.

## 9) Fuel Valve

The fuel valve is located on the RH side of the vehicle near the engine.

This is a 3 position rotary valve; OFF, ON, RES (reserve). Rotate the valve to align its pointer to the desired position.

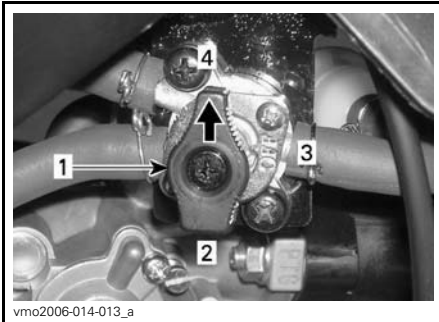

vmo2006-014-013\_a

1. Align the pointer toward the desired position
2. RES. (reserve)
3. OFF
4. ON

## OFF

Stops fuel supply to carburetor.

**NOTICE** Turn fuel valve to OFF position when vehicle is not being operated for a prolonged period of time or when transporting.

## ON

Allows fuel to flow to carburetor. This is the normal position for operation of the vehicle.

## RES (RESERVE)

When the normal supply of fuel in the tank is used up (ON position), an emergency supply of fuel is available by turning the valve to RES. The reserve contains approximately 10% of the fuel tank capacity. Use the RES position only when the ON supply is empty.

When in reserve, refuel as soon as possible. be sure to turn the valve back to the ON position after refuelling.

**NOTICE** Improper opening of fuel valve will restrict the flow of fuel. Make sure valve is fully opened while running.

## 10) Brake Pedal

The brake pedal is located on the RH side of the vehicle near the engine.

When pressed, the rear brake is applied. When released, it should return to its original position. Braking effect is proportional to the force applied on the pedal.

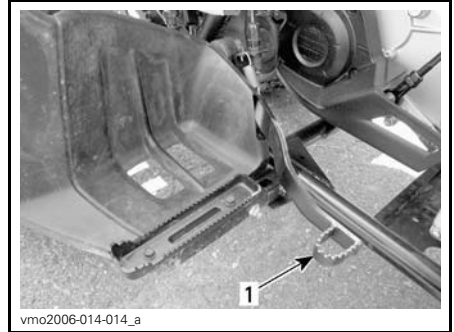

vmo2006-014-014\_a

1. Rear brake pedal

## 11) Tool Kit

The tool kit is located in the service compartment underneath the seat, it contains tools for basic maintenance.

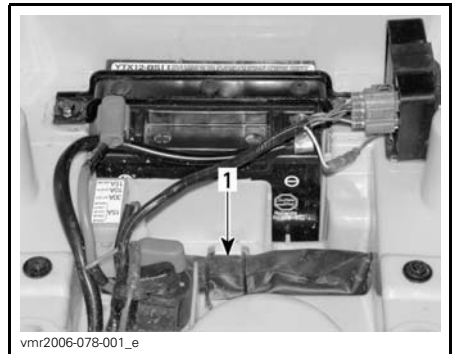

vmr2006-078-001\_e

**SERVICE COMPARTMENT UNDERNEATH SEAT**

1. Tool kit

## 12) Seat Latch

Located underneath the rear fender, it allows the removal of the seat to gain access to the service compartment.

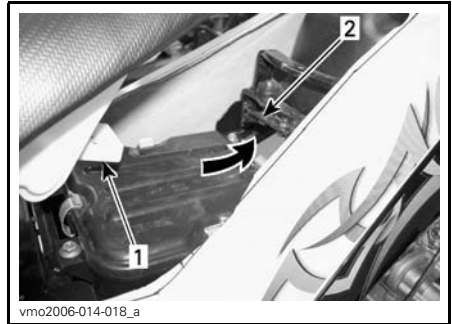
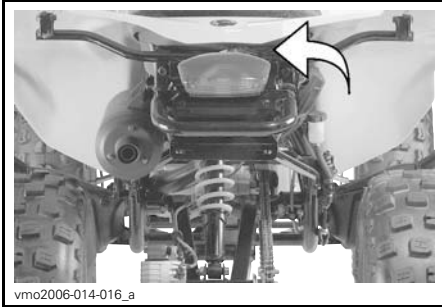

1. Tab
2. Hook

### **⚠ WARNING**

Make sure seat is securely latched before riding.

## Seat Removal

Unlock seat using latch lever.

Gently lift rear of seat while pulling rearward to release.



1. Seat latch

## Seat Installation

Insert seat tab into frame hook.

When seat rests in its position, firmly push seat down to latch.

**NOTE:** A distinctive snap will be felt. Double check that the seat is secure by giving it a tug to confirm proper latching.

## 13) 12-Volt Power Outlet



### TYPICAL

1. 12 Vdc power outlet location

Convenient for handheld spotlight or other portable equipment.

Remove protective cap to use. Always reinstall it after use to protect against weather.

Do not exceed the rating capacity. See *TECHNICAL SPECIFICATIONS*.

An auxiliary supply is available to connect additional accessories. Two wires are hidden in the wiring harness at the rear of vehicle. See an authorized Can-Am dealer for details.

While reading this Operator's Guide, remember that:

 **WARNING**

Indicates a potential hazard that, if not avoided, could result in serious injury or death.

---

# FUEL

## Fuel Requirements

**NOTICE** Always use fresh gasoline. Gasoline will oxidize; the result is loss of octane, volatile compounds, and the production of gum and varnish deposits which can damage the fuel system.

Alcohol fuel blending varies by country and region. Your vehicle has been designed to operate using the recommended fuels, however, be aware of the following:

- Use of fuel containing alcohol above the percentage specified by government regulations is not recommended and can result in the following problems in the fuel system components:
  - Starting and operating difficulties.
  - Deterioration of rubber or plastic parts.
  - Corrosion of metal parts.
  - Damage to internal engine parts.
- Inspect frequently for the presence of fuel leaks or other fuel system abnormalities if you suspect the presence of alcohol in gasoline exceeds the current government regulations.
- Alcohol blended fuels attract and hold moisture which may lead to fuel phase separation and can result in engine performance problems or engine damage.

## Recommended Fuel

Use common unleaded gasoline with an AKI (R+M)/2 octane rating of 87, or an RON octane rating of 92.

**NOTICE** Never experiment with other fuels. Engine or fuel system damages may occur with the use of an inadequate fuel.

## Fueling Procedure

### WARNING

- Always stop engine before refueling. Open cap slowly.
- If a differential pressure condition is noticed (whistling sound heard when loosening fuel tank cap) have vehicle inspected and/or repaired before further operation.
- Fuel vapors are flammable and explosive under certain conditions.
- Never use an open flame to check fuel level.
- Never smoke or allow a flame or spark in the vicinity.
- Always work in a well-ventilated area.
- Never top up the fuel tank before placing the vehicle in a warm area. As temperature increases, fuel expands and may overflow.
- Always wipe off any fuel spillage from the vehicle.

**NOTICE** Never place anything over the fuel tank cap, the vent on top of the cap can become blocked and the engine could misfire.

1. Stop engine.
2. Do not allow anyone to remain seated on the vehicle while filling.
3. Unscrew fuel tank cap counter-clockwise to remove it.



4. Insert the spout in the filler neck.
5. Pour fuel slowly to allow time for the air in the tank to escape and prevent fuel flow back. Be careful not to spill fuel.
6. Stop fuelling when the fuel reaches the bottom of filler neck. **Do not overfill.**
7. Fully tighten fuel tank cap clockwise.



1. Fuel tank cap

While reading this Operator's Guide, remember that:

**⚠ WARNING**

Indicates a potential hazard that, if not avoided, could result in serious injury or death.

---

# BREAK-IN PERIOD

## Operating During Break-In

A break-in period of 10 operating hours is required before running the vehicle at sustained full throttle.

After the break-in period, the vehicle should be inspected by an authorized Can-Am dealer. Refer to *MAINTENANCE INFORMATION*.

## Brakes

### **WARNING**

New brakes will not perform to their maximum efficiency until their break-in is complete. Use extra caution.

## Engine

**NOTICE** Never mix oil with fuel. This vehicle has a 4-stroke engine. Oil must be added to engine base only.

During the break-in period:

- Avoid full throttle operation.
- Maximum throttle should not exceed 3/4.
- Avoid sustained accelerations.
- Avoid prolonged cruising speeds.
- Avoid engine overheating.

However, brief accelerations and speed variations contribute to a good break-in.

## Belt

A new belt requires a break-in period of 50 km (30 mi).

During the break-in period:

- Avoid strong accelerations and decelerations
- Avoid pulling a load
- Avoid high speed cruising.

# OPERATING INSTRUCTIONS

## Starting the Engine

### Conditions Required for Engine Starting

1. Transmission lever must be set to NEUTRAL.
2. Emergency engine stop switch set to RUN position.
3. Key in ignition switch and turned to the ON position.
4. Engine start button pressed in.

### Initial Cold Starting

Insert key in ignition switch and turn to ON position.

**NOTE:** Do not forget, place the emergency engine stop switch to RUN position and apply brakes (front or rear).

In weather colder than 0°C (32°F), place the choke lever to full choke position.



V06F0QY

*FULL CHOKE POSITION*

Press the engine start button and hold until engine starts.

**NOTICE** Do not hold the engine start button more than 10 seconds. A rest period should be observed between cranking cycles to allow starter cool down. Pay attention not to discharge battery.

**NOTE:** Throttle assist may be used to help start the engine faster. Press the throttle lever slightly. If too much throttle is used, the choke system will not be activated.

Release the engine start button immediately after the engine has started.

After a few seconds, move the choke lever from full choke position to an intermediate position until the optimal engine RPM is achieved.

**NOTE:** Overusing the choke may flood the engine and make it hard to start. Refer to *TROUBLESHOOTING* if it occurs.

When the engine is warm, set the choke lever to OFF and release brakes.



V06F0PY

*CHOKE LEVER IN THE OFF POSITION*

### Warm Engine Starting

Start the engine as explained above but without the choke. If the engine does not start after two 5-second attempts with the electric starter, set the choke lever between the FULL and

OFF position. Start the engine without activating the throttle lever. After a few seconds, set the choke lever to OFF position.

## Shifting the Transmission

Let engine idle to warm up.

Apply brakes and set the transmission selector lever to "F" (forward), or "R" (reverse).

Release brakes.

### WARNING

Make sure the parking brake is fully disengaged before operating the vehicle.

Gradually press the throttle lever to increase engine speed and thus engage the continuously variable transmission (CVT).

When the throttle lever is released, the engine speed decreases.

**NOTICE** When changing from forward to reverse, or vice-versa, always completely stop the vehicle and apply the brake prior to moving the transmission lever.

**NOTE:** The engine will stop if any shifting is done at high RPM.

## Using Reverse Override

When the transmission lever is in the REVERSE position, engine RPM is limited thus limiting the reverse speed that can normally be commanded using the throttle lever.

### WARNING

If driving downhill in reverse, gravity can increase the vehicle speed above the set limited reverse speed.

To engage the override function, press and hold the override button, then gradually press the throttle lever to increase engine power.

### WARNING

Never activate the override button if the throttle lever is not fully released as a loss of control may result.

## Stopping the Engine

### WARNING

Avoid parking vehicle on a slope.

Release throttle and completely stop the vehicle.

Apply the parking brake.

Set transmission lever to the FORWARD position.

Set the emergency engine stop switch to STOP position.

Turn ignition key to OFF position.

Remove key from ignition switch.

# TUNE YOUR RIDE

## Suspension Adjustment

### **WARNING**

Adjust both front springs to the same length. Uneven adjustment can cause poor handling and loss of stability and/or control, and increase the risk of an accident.

Spring preload may vary from rider to rider according to weight. Preload can be changed by setting both preload cams up or down to compress the springs to different lengths.

Shorten the springs for a firmer ride and rough road conditions.

Lengthen the springs for a light load and a smooth road conditions.

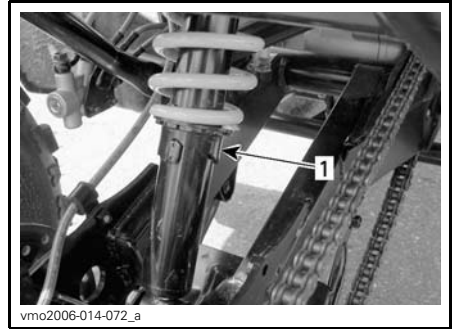

**REAR SUSPENSION**  
1. Preload cam



**FRONT SUSPENSION**  
A. Same length on both sides

While reading this Operator's Guide, remember that:

### **WARNING**

Indicates a potential hazard that, if not avoided, could result in serious injury or death.

# VEHICLE TRANSPORTATION

When transporting this vehicle, secure it to a trailer or in pickup box using suitable tie-downs. The use of ordinary ropes is not recommended.

## **⚠ WARNING**

Do not tow this vehicle behind a car or other vehicle. Use a trailer. Never tip this vehicle on end when transporting it. This vehicle must be transported in its normal operating position (on all 4 wheels) and facing towards the front of the transporting vehicle.

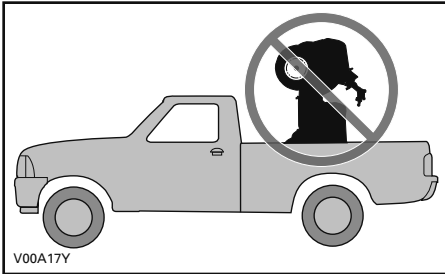

*FRONT BUMPER STRAP LOCATIONS*

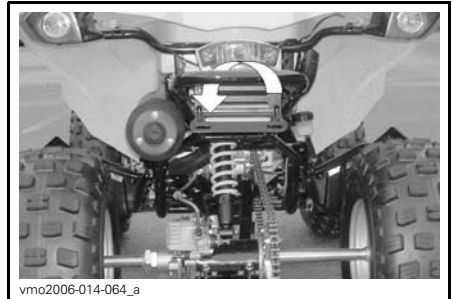

*REAR BUMPER STRAP LOCATION*

Set the fuel valve to the OFF position.

Set the transmission selector lever to the FORWARD position and apply the parking brake.

Secure the front of the vehicle by the front bumper and the rear of the vehicle by the rear bumper.

**NOTICE** Securing vehicle at other locations may damage the vehicle.

# ***MAINTENANCE***

# BREAK-IN INSPECTION

BRP suggests that after the first 10 hours or 300 km (200 mi) of operation, whichever comes first, your vehicle be inspected by an authorized Can-Am dealer. The break-in inspection is very important and must not be neglected.

**NOTE:** The break-in inspection is at the expense of the vehicle owner.

We recommend that this inspection be signed by an authorized Can-Am dealer.

---

Date of inspection \_\_\_\_\_ Authorized dealer signature \_\_\_\_\_

---

Dealer name \_\_\_\_\_

## Break-In Inspection Chart

BREAK-IN INSPECTION CHART	REPLACE					
	ADJUST					
	TIGHTEN					
	LUBRICATE					
	CLEAN					
	INSPECT					
<b>ENGINE</b>						
Engine oil						X
Engine oil strainer		X				
Valve Clearance	X				X	
Exhaust system	X					
Engine seals	X					
Engine mounting fasteners	X					
<b>COOLING SYSTEM</b>						
Radiator cap/cooling system pressure test	X					
<b>FUEL SYSTEM</b>						
Fuel filter	X					
Fuel lines, connections, and fuel tank pressure test	X					
Throttle lever and cable	X				X	
Carburetor					X	
Choke	X					



<b>BREAK-IN INSPECTION CHART</b>	<b>REPLACE</b>					
	<b>ADJUST</b>					
	<b>TIGHTEN</b>					
	<b>LUBRICATE</b>					
	<b>CLEAN</b>					
<b>INSPECT</b>						
<b>ELECTRICAL SYSTEM</b>						
Spark plug	X				X	
Ignition timing	X					
Battery	X					
Wiring harnesses and cables	X					
<b>CVT TRANSMISSION</b>						
CVT air inlet/outlet ducts	X	X				
<b>GEARBOX</b>						
Gearbox oil	X					
<b>DRIVE SYSTEM</b>						
Drive chain and sprockets	X					
<b>WHEEL/TIRES</b>						
Wheel nuts/studs	X					
<b>STEERING SYSTEM</b>						
Handlebar fasteners	X					
Steering system (column, bearing, etc.)	X					
Tie rod ends	X					
Front wheel alignment	X					
<b>BRAKES</b>						
Brake fluid	X					
Parking brake cable	X				X	

# MAINTENANCE SCHEDULE

Maintenance is very important for keeping your vehicle in safe operating condition. Proper maintenance is the owner's responsibility. The vehicle should be serviced as specified in the maintenance schedule.

The maintenance schedule does not exempt the pre-ride inspection.

## WARNING

Failure to properly maintain the vehicle according to the maintenance schedule and procedures can make it unsafe to operate.

### MAINTENANCE SCHEDULE

PART/TASK	25 h or 500 km (300 mi)					LEGEND
	50 h or 1 000 km (600 mi)					
100 h or 1 year or 2 000 km (1,200 mi)						
200 h or 2 years or 4 000 km (2,500 mi)						
To be performed by						
PART/TASK						LEGEND
<b>ENGINE</b>						
Engine oil			R		Dealer	(1) More often under dusty conditions. Refer to <i>AIR FILTER</i> in <i>MAINTENANCE PROCEDURES</i> .
Engine oil strainer		C			Dealer	
Valve clearance				I, A	Dealer	
Air filter	I, C <sup>(1)</sup>		R <sup>(1)</sup>		Customer	
Air injection valve filter	I, C <sup>(1)</sup>				Customer	
Exhaust system			I		Dealer	
Muffler spark arrester			C		Customer	
Engine seals			I		Dealer	
Engine mounting fasteners			I		Dealer	
<b>COOLING SYSTEM</b>						
Engine coolant			I <sup>(2)</sup>	R	Customer	(2) Every 100 hours, check coolant strength.
Radiator cap/cooling system pressure test				I	Dealer	
<b>GEARBOX</b>						
Gearbox oil				R	Dealer/ Customer	—

MAINTENANCE SCHEDULE						
A: Adjust C: Clean I: Inspect L: Lubricate R: Replace	25 h or 500 km (300 mi)					
	50 h or 1 000 km (600 mi)					
	100 h or 1 year or 2 000 km (1,200 mi)					
	200 h or 2 years or 4 000 km (2,500 mi)					
	To be performed by					
PART/TASK					LEGEND	
<b>CVT TRANSMISSION</b>						
Drive belt			I		Dealer	—
Drive and driven pulleys			I, C		Dealer	
CVT air inlet/outlet duct		I, C			Dealer	
<b>FUEL SYSTEM</b>						
Fuel filter			I	R	Dealer	—
Fuel lines, connections and fuel tank pressure test			I		Dealer	
Carburetor			A		Dealer	
Throttle lever and cable		I, A, L			Customer	
Choke			I, A		Customer	
<b>ELECTRICAL SYSTEM</b>						
Spark plug <sup>(3)</sup>			R		Customer	(3) Make sure the spark plug is correctly gapped.
Ignition timing		I			Dealer	
Battery		I			Customer	
Wiring harnesses, cables			I		Dealer	
<b>DRIVE SYSTEM</b>						
Drive chain sprockets			I		Customer	—
<b>WHEELS</b>						
Wheel bearings			I		Customer	—
Wheel nuts/studs	I				Customer	

MAINTENANCE SCHEDULE						
A: Adjust C: Clean I: Inspect L: Lubricate R: Replace	25 h or 500 km (300 mi)					
	50 h or 1 000 km (600 mi)					
	100 h or 1 year or 2 000 km (1,200 mi)					
	200 h or 2 years or 4 000 km (2,500 mi)					
	To be performed by					
PART/TASK						LEGEND
<b>STEERING</b>						
Handlebar fasteners			I		Dealer	(4) More often under severe use such as dusty area, sand, snow, wet or muddy conditions.
Steering system (column, bearing, etc.) (4)			I		Dealer	
Tie rod ends	I				Dealer	
Front wheel alignment			I		Dealer	
Ball joints	I				Dealer	
<b>SUSPENSION</b>						
Swing arm			I		Customer	—
Shock absorbers		I			Customer	
A-arms		I			Customer	
<b>BRAKE</b>						
Brake fluid	I			R (5)	Customer	(5) Brake fluid replacement or any brake system repairs must be performed by an authorized Can-Am dealer. (6) More often under severe use such as in dusty areas, sand, snow, wet or muddy conditions.
Parking brake cable (5)	I, A				Customer	
Brake pads (5)	I (6)				Customer	
Brake system (discs, hoses, etc.) (5)			I		Customer	
<b>BODY/FRAME</b>						
Frame			I		Dealer	—
Body/frame fasteners		I			Customer	

# MAINTENANCE PROCEDURES

This section includes instructions for basic maintenance procedures. If you have the necessary mechanical skills and the required tools, you can perform these procedures. If not, see your authorized Can-Am dealer.

Other important items in the maintenance schedule that are more difficult and require special tools are best performed by your authorized Can-Am dealer.

## **⚠ WARNING**

Turn off the engine and follow these maintenance procedures when performing maintenance. If you do not follow proper maintenance procedures you can be injured by hot parts, moving parts, electricity, chemicals or other hazards.

## **⚠ WARNING**

Should removal of a locking device be required (e.g. lock tab, self-locking fastener, etc.), always replace it with a new one.

## Air Filter

### Air Filter Maintenance Guideline

As with any ATV, air filter maintenance is critical to ensure proper engine performance and life span.

Air filter maintenance should be adjusted according to riding conditions.

Air filter maintenance must be increased in frequency for the following dusty conditions:

- Riding on dry sand
- Riding on dry dirt covered surfaces
- Riding on dry gravel roads or similar conditions.

**NOTE:** Riding in a group in these conditions increases even more the air filter maintenance and replacement requirement.

### Air Filter Removal

**NOTICE** Never remove or modify any component in the air filter housing. The engine is calibrated to operate specifically with these components. Otherwise, engine performance degradation or damage can occur.

Remove seat.

Release clamps and remove air filter housing cover.

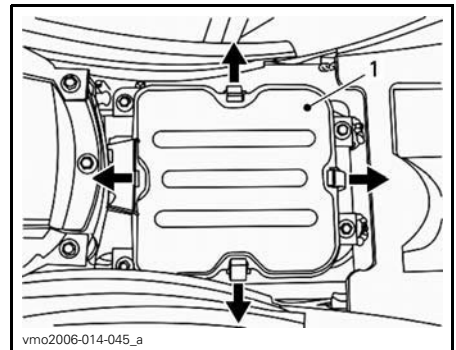

1. Air filter housing cover

Loosen clamp and remove retaining screw, then remove air filter.

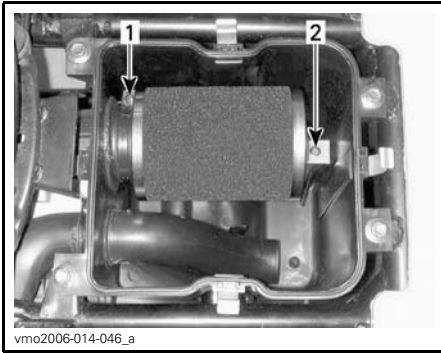

1. Clamp
2. Retaining screw

### Air Filter Cleaning

1. Spray the foam filter element inside and out with AIR FILTER CLEANER (P/N 219 700 341).



AIR FILTER CLEANER (P/N 219 700 341)



TYPICAL - SPRAY FOAM ELEMENT INSIDE AND OUT

2. Let stand for 3 minutes.
3. As stated on air filter cleaner (UNI) container, rinse with plain water.
4. Dry the foam element completely.

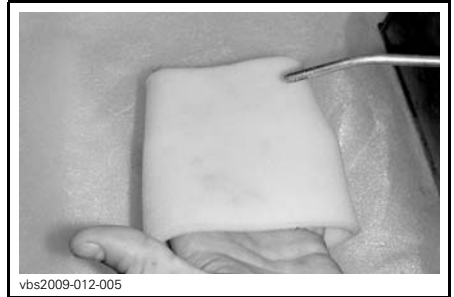

TYPICAL - DRY

**NOTE:** A second application may be necessary for heavily soiled elements.

5. When the filter is dry, re-oil it using AIR FILTER OIL (P/N 219 700 340) or an equivalent.



219700340

AIR FILTER OIL (P/N 219 700 340)

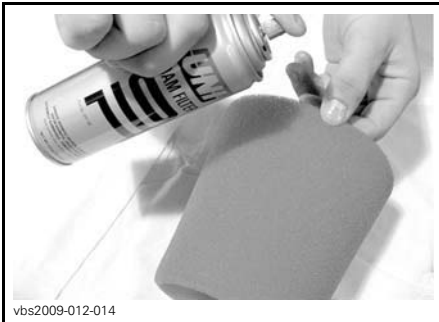

vbs2009-012-014

TYPICAL - OIL FOAM FILTER ELEMENT

**NOTICE** Engine performance degradation or severe damage can occur if the air filter is not properly maintained and/or if it is not well oiled.

### Air Filter Installation

Properly reinstall removed parts in the reverse order of their removal.

**NOTE:** Make sure that air filter housing cover is properly installed.

## Air Filter Housing

### Air Filter Housing Draining

**NOTICE** Never remove or modify any component in the air filter housing. The engine carburation is calibrated to operate specifically with these components. Otherwise, engine performance degradation or damage can occur.

Periodically inspect air filter housing drain tube for liquids or deposits.

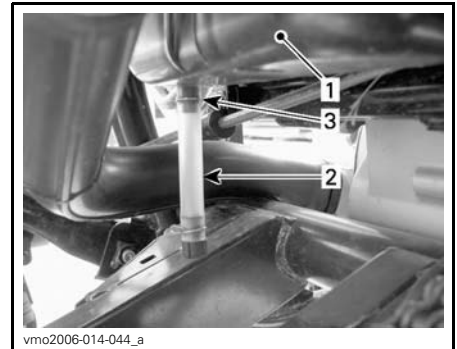

vmo2006-014-044\_a

#### TYPICAL

1. Air filter housing
2. Drain tube
3. Clamp

If liquid/deposits are found, squeeze and remove the clamp. Pull drain tube out and empty it.

**NOTICE** Do not start engine when liquid/deposits are found in the drain tube.

When liquid/deposits are found, the air filter must be inspected, dried, and possibly replaced depending on its condition.

## Engine Oil

### Recommended Engine Oil

For the summer season, use XPS 4-STROKE SYNTH. BLEND OIL (SUMMER) (P/N 293 600 121).

For the winter season, use XPS 4-STROKE SYNTHETIC OIL (ALL CLIMATE) (P/N 293 600 112).

If not available, use 4-stroke SAE 5W30 engine oil that meets or exceeds the requirements for API service classification SM, SL or SJ. Always check the API service label on the oil container, it must contain at least one of the above standards. Refer to the viscosity chart for details.

### Engine Oil Viscosity Chart

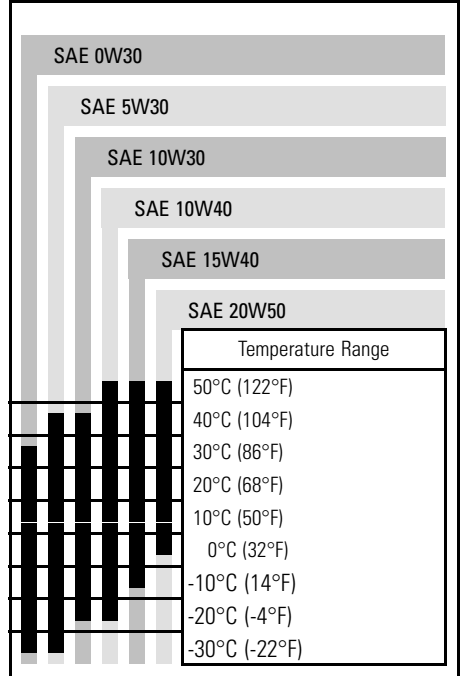

### Engine Oil Level

**NOTICE** Check level frequently and adjust as necessary. **Do not overfill.** Operating the engine with an improper level may severely damage engine. Wipe off any spillage.

**NOTE:** While checking the oil level, visually inspect engine area for leaks.

While reading this Operator's Guide, remember that:

### WARNING

Indicates a potential hazard that, if not avoided, could result in serious injury or death.



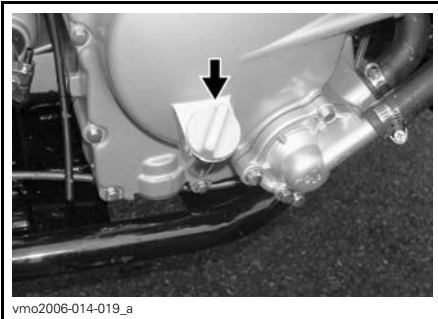

vmo2006-014-019\_a

**RH SIDE OF ENGINE**

With vehicle on a level surface and engine cold, not running, check the oil level as follows:

1. Unscrew dipstick then remove it and wipe clean.
2. Reinstall dipstick (do not screw it in).
3. Remove and check oil level. It should be near or equal to the upper mark.

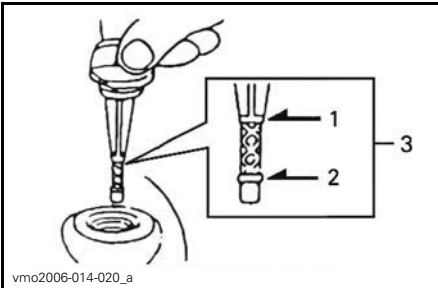

vmo2006-014-020\_a

1. Full
2. Add
3. Operating range

To add oil, remove dipstick.

Place a funnel into the dipstick tube to avoid spillage.

Add a small amount of recommended oil and recheck oil level.

Repeat the operation until oil level reaches the dipstick's full mark. **Do not overfill.**

Properly tighten dipstick.

**Engine Oil Change**

The oil change should be carried out on a warm engine.

**CAUTION** Engine oil can be very hot. In order to avoid potential burns, do not remove the engine drain plug or the oil strainer cover if the engine is hot. Wait until the engine oil is warm.

Ensure vehicle is on a level surface.

Remove dipstick.

Clean the drain plug area.

Place a drain pan under the engine drain plug area.

Unscrew drain plug.

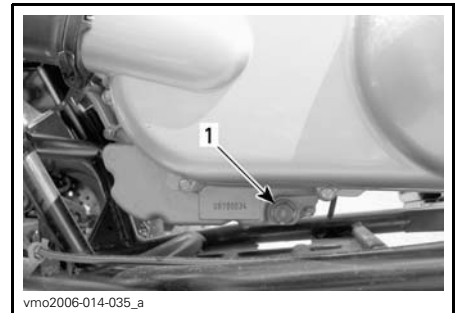

vmo2006-014-035\_a

**LH SIDE UNDERNEATH CVT COVER**

1. Oil drain plug

Allow sufficient time for all the oil to flow out of the engine.

Clean oil strainer, refer to *OIL STRAINER* in this subsection.

Clean drain plug washer and check it's condition, replace it if necessary.

Clean engine and drain plug contact surfaces, then reinstall drain plug and washer, torque to  $39 \text{ N}\cdot\text{m} \pm 3.9 \text{ N}\cdot\text{m}$  ( $29 \text{ lbf}\cdot\text{ft} \pm 3 \text{ lbf}\cdot\text{ft}$ ).

Refill engine with the specified quantity of the recommended engine oil. Refer to *TECHNICAL SPECIFICATIONS* for capacity.

**NOTE:** Engine oil quantity is also written on the dipstick.

Start engine and let idle for a few minutes. Ensure oil strainer and drain plug are not leaking.

Stop engine. Wait a few minutes to allow the oil to flow down into the crankcase, then recheck oil level. Adjust oil level as necessary.

Dispose of the used oil as per your local environmental regulations.

## Oil Strainer

### Oil Strainer Cleaning

Unscrew the oil strainer cover.

Allow enough time for oil to flow out of oil strainer hole.

Remove oil strainer and spring.

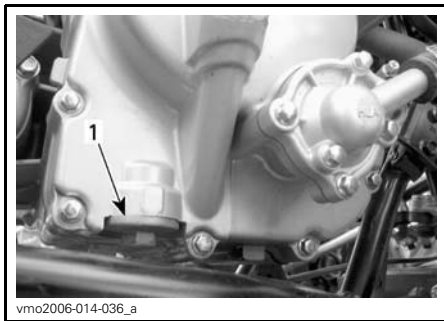

*RH SIDE OF ENGINE*  
1. Oil strainer cover

To clean oil strainer, use a solvent then dry using compressed air.

**⚠ CAUTION** Always wear appropriate skin and eye protection. Chemicals can cause a skin rash and eye injuries.

**NOTE:** Check cover O-ring and replace it if necessary.

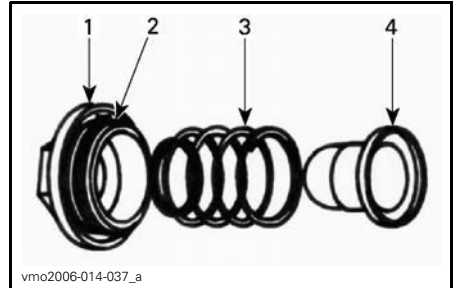

**TYPICAL**  
1. Cover  
2. O-ring  
3. Spring  
4. Strainer

Wipe off any oil spillage on engine.

Reinstall oil strainer, spring, and O-ring.

Install and torque cover to  $15 \text{ N}\cdot\text{m} \pm 1.5 \text{ N}\cdot\text{m}$  ( $133 \text{ lbf}\cdot\text{in} \pm 13 \text{ lbf}\cdot\text{in}$ ).

## Radiator

### Radiator Inspection

Before each ride, check the radiator area for cleanliness.

Inspect radiating fins. They must be clean, free of mud, dirt, leaves and any other deposit that would prevent the radiator to cool properly.

### Radiator Cleaning

Remove as much debris as you can with your hands. If water is available in proximity, try rinsing the radiating fins.

If available, use a garden hose to rinse the radiating fins.

**⚠ CAUTION** Never clean radiator with your hands when it is hot. Let the radiator cool down before cleaning.

**NOTICE** Be careful not to damage the radiating fins when cleaning. Do not use any object/tool that could damage the fins. The fins are purposely thin to allow efficient cooling. **WHEN HOSING, USE LOW PRESSURE ONLY. NEVER USE A HIGH PRESSURE WASHER.**

If engine is overheating even with a clean radiator, see an authorized Can-Am dealer.

## Engine Coolant

### Recommended Engine Coolant

Always use ethylene-glycol antifreeze containing corrosion inhibitors specifically formulated for internal combustion aluminum engines.

Cooling system must be filled with BRP PREMIXED COOLANT (P/N 219 700 362) or with distilled water and antifreeze solution (50% water, 50% antifreeze).

### Engine Coolant Level

Coolant reservoir is located under the RH front fender.

#### **⚠ WARNING**

Check coolant level with engine cold. Never add coolant in cooling system when engine is hot.

**NOTICE** Do not operate vehicle with a low coolant level. Overheating could occur causing extensive engine damage.

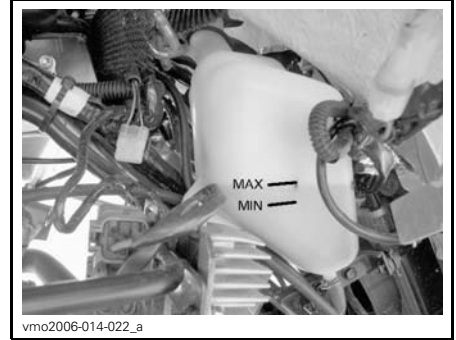

### COOLANT LEVEL

With vehicle on a level surface, coolant should be between MIN. and MAX. level marks of coolant reservoir.

**NOTE:** When checking coolant level at a temperature lower than 20°C (68°F), it may be slightly lower than MIN. mark.

To gain access to coolant reservoir, remove front fender access cover.

Pull up on rear portion of cover to remove tabs from rubber grommets.

Pull cover forward, then up to release lower tabs from front fender.

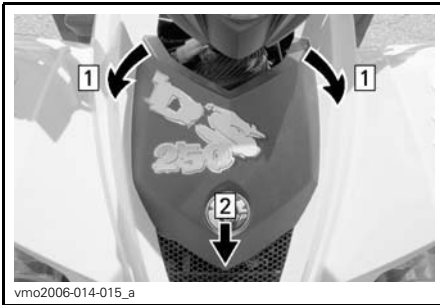

Step 1: Pull front tab from grommets  
Step 2: Pull cover forward then lift to remove

Add coolant up to MAX. mark if required. Use a funnel to avoid spillage. **Do not overfill.**

Properly reinstall and tighten filler cap.  
Reinstall front fender access cover.

If the coolant is added in the coolant reservoir, check the level in the radiator too. Add coolant if necessary.

**⚠ WARNING**

**In order to avoid potential burns, do not remove the radiator cap if the engine is hot.**

**NOTE:** A cooling system that frequently requires coolant is an indication of leaks or engine problems. See an authorized Can-Am dealer.

To gain access to the radiator, remove front fender access cover (see procedure above).

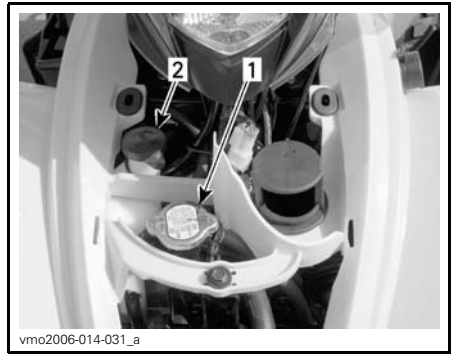

**TYPICAL**

1. Radiator cap
2. Coolant reservoir cap

**Engine Coolant Replacement**

**⚠ WARNING**

**In order to avoid potential burns, do not remove the radiator cap or loosen the coolant drain plug if the engine is hot.**

Remove front fender access cover.

Turn the radiator cap counterclockwise and remove it.



1. Radiator cap

Unscrew the cooling system drain plug located on the right side of engine and drain the coolant into a suitable container.

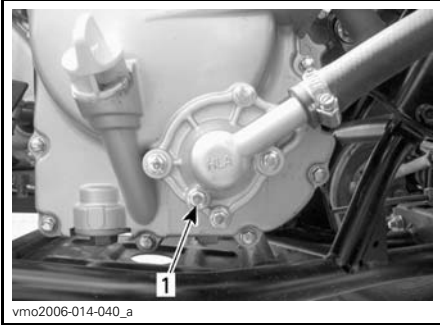

vmo2006-014-040\_a

1. Cooling system drain plug

Disconnect the by-pass hose from the top of the thermostat housing.

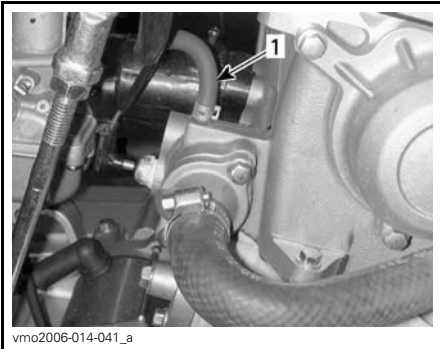

vmo2006-014-041\_a

1. By-pass hose

Drain the system completely and reinstall the drain plug.

Pinch hose between radiator and thermostat housing with a LARGE HOSE PINCHER (P/N 529 032 500).

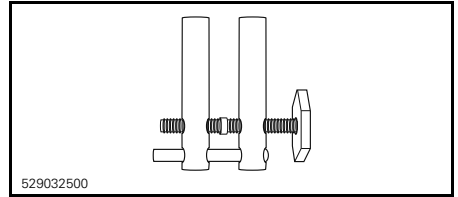

529032500



vmo2006-014-043\_a

**HOSE PINCHER LOCATION**

Lift the front of the vehicle sufficiently to raise the front wheels off the ground.

Fill the radiator until coolant comes out of the fitting of the thermostat housing by-pass hose.

Install the by-pass hose, then remove the hose pincher.

**NOTE:** If no coolant comes out of the by-pass hose fitting, squeeze the lower radiator hose several times until coolant comes out.

Completely fill the radiator.

Check the level in the coolant reservoir and adjust level if necessary.

Run engine at idle with the radiator cap off. Slowly add additional coolant if necessary.

At this point, wait until engine reaches normal operating temperature. Apply throttle two or three times; then add coolant if required.

Install radiator cap. Inspect all connections for leaks and check coolant level in the reservoir.

Install access cover.

## Spark Arrester

### Spark Arrester Cleaning

The muffler must be periodically purged of accumulated carbon.

#### **⚠ WARNING**

Never perform this operation immediately after the engine has been run because exhaust system is very hot. Wear eye protection and gloves. Respect all applicable laws and regulations.

Set the transmission lever to the FORWARD position and apply parking brake.

Remove the spark arrester from the muffler.

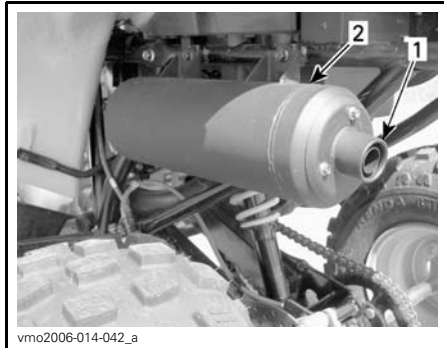

#### TYPICAL

1. Remove muffler end
2. Muffler

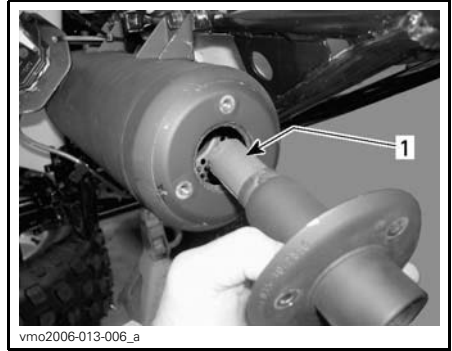

#### TYPICAL

1. Spark arrester

Remove carbon deposits from the spark arrester using a brush.

**NOTE:** Use a soft brush and be careful to avoid damaging spark arrester.

Reinstall the spark arrester in muffler.

## Air Injection Valve

### Air Injection Valve Filter Cleaning



#### LH SIDE OF ENGINE

1. Air injection valve

Disconnect hoses from air injection valve.

Remove air injection valve from its support.

While holding one half of the valve, turn the other half counterclockwise to open it.

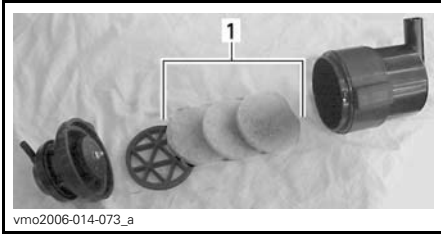

vmo2006-014-073\_a

1. Filters

Pour AIR FILTER CLEANER (P/N 219 700 341) or an equivalent into a bucket. Put filters in to soak.

While the filters soak, clean inside the air injection valve.

Rinse filters with warm water until all cleaning solution disappears, then let filters dry completely.

**NOTE:** If air filters are still dirty, replace them with new ones.

When finished, properly reinstall removed parts in the reverse order of their removal.

### Drive Belt

See an authorized Can-Am dealer to inspect and/or replace the drive belt.

While reading this Operator’s Guide, remember that:

## ⚠ WARNING

Indicates a potential hazard that, if not avoided, could result in serious injury or death.

## CVT Cover

### CVT Cover Draining

Whenever you suspect that water has entered the CVT cover, drain the CVT housing by removing the drain tube.

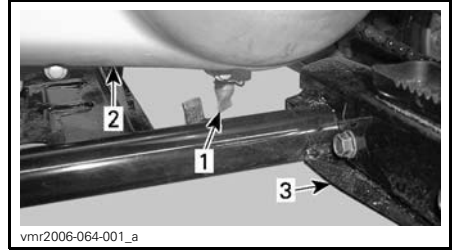

vmr2006-064-001\_a

1. CVT cover drain tube
2. CVT cover
3. LH footrest

## Gearbox Oil

### Recommended Gearbox Oil

Use 800 ml (27 U.S. oz) of XPS CHAIN-CASE OIL (P/N 415 129 500) or an equivalent SAE 75W90 chaincase oil.

**NOTICE** Do not use other types of oils when servicing the gearbox.

### Gearbox Oil Level

There is no dipstick provided with this vehicle, the gear box oil level cannot be checked.

The only way to ensure the level is correct is to drain gearbox and refill it with the specified quantity of the recommended gearbox oil. Refer to *GEAR-BOX OIL CHANGE* for procedure.

## Gearbox Oil Change

Place the vehicle on a level surface.  
Remove the drive chain protector.

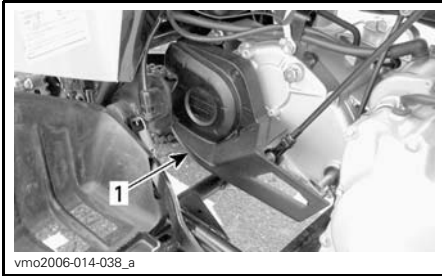

1. Drive chain protector

Clean fill and drain plug areas.  
Remove gearbox fill plug and washer.  
Place a drain pan under the gearbox drain plug area then remove the drain plug.

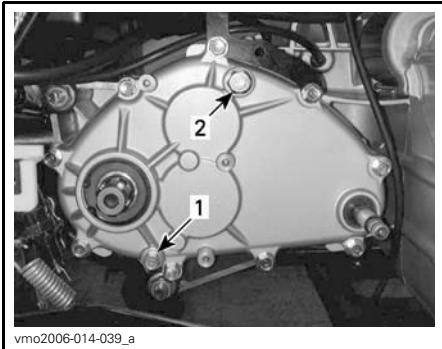

1. Gearbox drain plug  
2. Gearbox fill plug

**NOTE:** To completely drain the gearbox, place a jack stand under the left footpeg and tilt the vehicle toward the right side.

When the gearbox is empty, install and torque the drain plug with a new washer to  $9\text{N}\cdot\text{m} \pm 0.9\text{N}\cdot\text{m}$  ( $80\text{ lbf}\cdot\text{in} \pm 8\text{ lbf}\cdot\text{in}$ ) and remove the jack stand from under LH foot peg.

**NOTICE** There is no dipstick provided with this vehicle to check gearbox oil level. Be sure gearbox is completely drained before replenishing it with the specified amount of recommended oil.

Refill gearbox, using 800 ml (27 U.S. oz) of XPS CHAINCASE OIL (P/N 415 129 500) or an equivalent SAE 75W 90 chaincase oil.

**NOTE:** Gearbox oil quantity is also written on the gearbox cover.

**NOTICE** Do not use other types of oil when servicing the gearbox.

Reinstall and torque oil fill plug to  $39\text{N}\cdot\text{m} \pm 3.9\text{N}\cdot\text{m}$  ( $29\text{ lbf}\cdot\text{ft} \pm 3\text{ lbf}\cdot\text{ft}$ ).

## Throttle Cable

### Throttle Cable Inspection

Inspect throttle cable for excessive wear, kinking or fraying. Ensure cable moves freely.

**⚠ WARNING**

The throttle cable must be replaced if any signs of wear, fraying or other damage are found.

### Throttle Cable Lubrication

Lubricate the throttle cable using CABLE LUBRICANT (P/N 293 600 041) or an equivalent silicone cable lubricant.



**⚠ WARNING**

Always use a silicone-based lubricant. Using another lubricant (such as a water-based lubricant) could cause the throttle lever/cable to stick or become stiff.

Open the throttle lever housing.

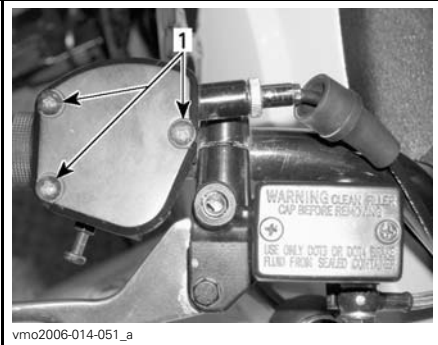

1. Remove screws

Slide the rubber protector to expose the cable adjuster.

Unscrew the lock nut of the cable adjuster then screw in the adjuster to release the cable tension.

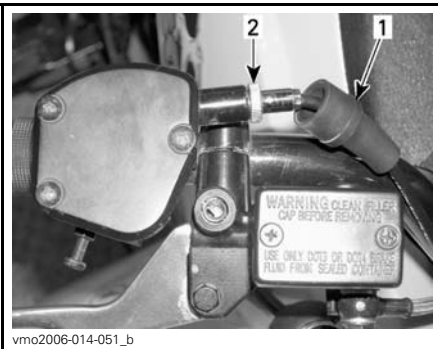

1. Rubber protector  
2. Cable adjuster

Remove the cable from the throttle lever.

**NOTE:** Slide the cable through the clip slot and remove the end of cable from clip.

Remove the carburetor cap on top of the carburetor.

Move the carburetor cap away from the carburetor body and place a rag under the cap to absorb excess lubricant.

Install the CABLE LUBER (P/N 529 035 738) on the cable.



Insert the needle of spray can in the cable luber hole.

**⚠ CAUTION** Always wear eye protection and gloves when you lubricate a cable.

**NOTE:** Place a rag around the cable luber to prevent lubricant splatter.

Add lubricant until it runs out at the carburetor end of the throttle cable.

Let the cable hang during approximately 15 minutes or until no lubricant flows out of cable.

Reinstall carburetor cap.

Reinstall and adjust the cable.

**Throttle Cable Adjustment**

Check throttle lever free-play, adjust if necessary.

**NOTE:** If correct adjustment is unattainable, see an authorized Can-Am dealer.

The normal throttle free-play is 1 mm to 3 mm (.039 in to .118 in).

**NOTE:** Measure throttle free play at the tip of throttle lever.

To adjust cable, slide rubber protector back to expose throttle cable adjuster.

Loosen lock nut, then turn the adjuster to obtain correct throttle lever free play.

Tighten lock nut and reinstall protector.

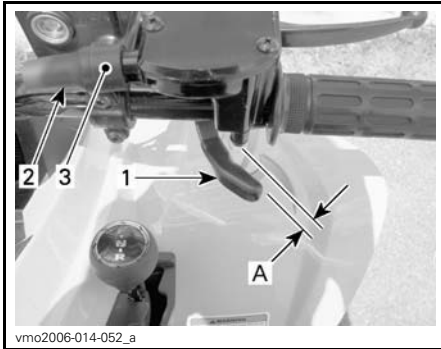

**THROTTLE LEVER FREE PLAY ADJUSTMENT**

1. Throttle lever
2. Protector
3. Cable adjuster

A. 1 mm to 3 mm (.039 in to .118 in)

With the transmission lever set to NEUTRAL position, start the engine.

Check if the throttle cable is adjusted correctly by turning handlebar fully to the right then fully to the left. If the engine RPM increases, readjust the throttle lever free play.

Ensure throttle cable is properly routed and not binding on anything when the handlebar is turned.

## Spark Plug

### Spark Plug Removal

**⚠ CAUTION** Always wear safety goggles when using pressurized air.

Disconnect spark plug cable from spark plug.

Unscrew spark plug one turn.

Clean spark plug and cylinder head with pressurized air if possible.

Unscrew spark plug completely and remove it from the engine.

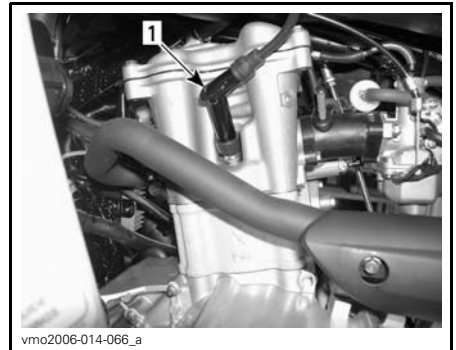

**LH SIDE OF ENGINE**

1. Spark plug

### Spark Plug Installation

Prior to installation, make sure the contact surface of the cylinder head and spark plug is free of grime.

Using a feeler gauge, set the spark plug gap to 0.8 mm (.031 in).

Apply anti-seize lubricant over spark plug threads to prevent a possible seizure.

Screw spark plug into cylinder head by hand and tighten with a torque wrench and a proper socket.

Torque spark plugs  
to 11 N•m ± 1.1 N•m  
(97 lbf•in ± 10 lbf•in).

## Battery

To access the battery, remove the seat.

### Battery Maintenance

**⚠ CAUTION** Never charge a battery while installed in vehicle.

These vehicles are equipped with a VRLA battery (Valve Regulated Lead Acid). It is a maintenance-free type battery, there is no need to add water to adjust electrolyte level.

**NOTICE** Never remove the battery sealing cap.

### Battery Inspection

Inspect battery connections for tightness and cleanliness.

Inspect battery support.

### Battery Removal

**NOTICE** Always disconnect the BLACK (-) battery cable first.

Disconnect BLACK (-) cable.

Disconnect RED (+) cable.

Remove the holding strap.

Remove battery from vehicle.

### Battery Cleaning

Clean battery, battery casing, cables and battery posts using a solution of baking soda and water.

Remove corrosion from battery cable terminals and battery posts using a firm wire brush. Battery top should

be cleaned using a soft brush and any grease-cutting soap or baking soda solution.

Apply DIELECTRIC GREASE (P/N 293 550 004) or an equivalent on battery posts to protect against oxidation.

### Battery Installation

Reinstall battery in vehicle.

**NOTICE** Always reconnect RED (+) cable first, then the BLACK (-) cable.

### Fuses

The electrical system is protected by fuses.

If a fuse is open circuit (or burnt, replace it by one of the same rating.

**NOTICE** Do not use a higher rated fuse as this can cause severe electrical system component damage.

Fuses are located underneath the seat in the service compartment. Remove the seat to access the fuse holder.



1. Fuse holder

To remove fuse from holder, unclip and remove holder cover then pull fuse out. Check if filament is melted.

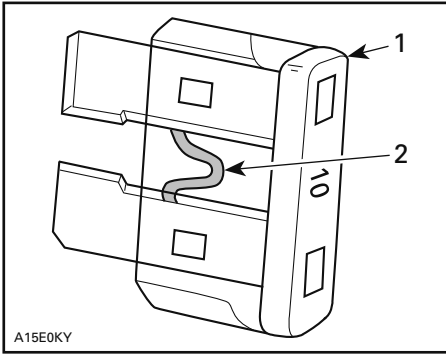

A15E0KY

1. Fuse
2. Check if melted

**NOTE:** The fuse rating and the circuit it protects is illustrated on the fuse holder cover.

## Lights

### Headlights

#### Headlight Bulb Replacement

**NOTICE** Never touch the glass portion of a halogen bulb with bare fingers, it shortens its operating life. If the bulb glass is touched, clean it using isopropyl alcohol, it will not leave a residue on the bulb.

**NOTE:** In the following illustrations, the headlight housing has been removed from the vehicle for a better comprehension.

To replace a headlight bulb, proceed as follows.

Ensure the ignition switch is in the OFF position.

Remove rubber protector over headlight housing.

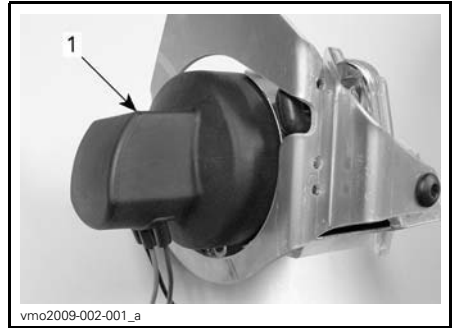

vmo2009-002-001\_a

#### TYPICAL

1. Rubber protector

Disconnect electrical connector from headlight.

Push the retaining clip round ends forward, then outwards to unlock headlight bulb.

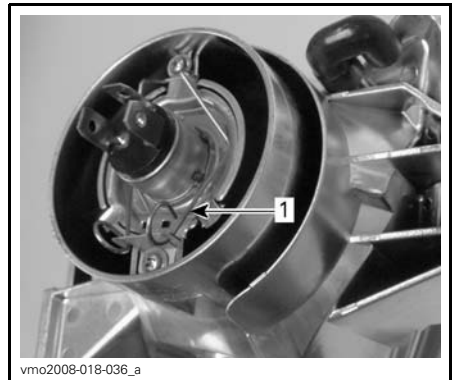

vmo2008-018-036\_a

#### TYPICAL

1. Retaining clip

Lift and hold the retaining clip then remove the bulb.



TYPICAL

Instal new bulb, do not touch the glass portion of the new bulb with bare fingers.

Check light operation after bulb replacement.

Properly reinstall removed parts in the reverse order of their removal.

### Beam Aiming Adjustment

To adjust the headlight beam, proceed as follows.

Loosen the screws shown in the following illustration, but do not remove them.



1. Screws to be loosened

Adjust headlight housing angle by hand.

Adjust both headlights evenly.

Tighten bolts when proper adjustment is obtained.

### Taillight Bulb Replacement

Ensure the ignition switch is in the OFF position.

Unscrew lens screws and remove lens to expose bulb.

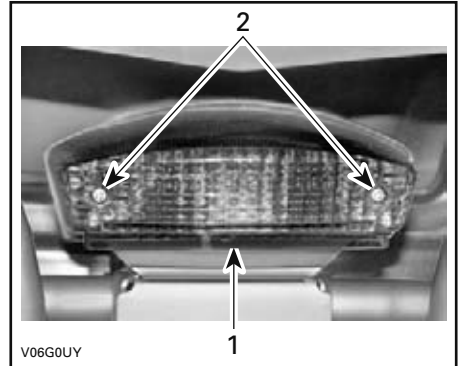

1. Lens
2. Screws

Push bulb in and hold as you turn it counterclockwise to release it from the socket.

Install the new bulb by first pushing and holding it in as you turn it clockwise to lock it in the socket.

Check light operation after bulb replacement.

Reinstall lens.

### Drive Chain and Sprockets

**NOTICE** Check drive chain for proper adjustment and lubrication before each use.

**⚠ CAUTION** Ensure the engine is OFF and the parking brake is engaged before checking, adjusting or lubricating the drive chain.

**NOTICE** Never operate this vehicle with the drive chain too loose or too tight as severe damage to the drive components can occur.

### Drive Chain and Sprocket Inspection

This vehicle is equipped with O-ring sealed, permanently greased, pins and rollers. Before operating the vehicle, always inspect the drive chain.

Check the free play of the drive chain and adjust if necessary.

Check for damaged or missing O-rings or and rollers.

Check the sprocket axle and pinion for distortion, excessive wear or other damage.

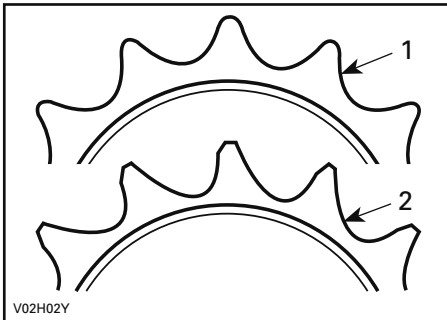

1. Good
2. Replace

**NOTICE** Replace the chain and sprockets together to prevent rapid chain and sprocket wear. Install a new retaining ring each time the engine sprocket is removed.

### Drive Chain Lubrication

**NOTICE** Never wash the chain with a high pressure washer or gasoline. Damage to the O-rings will result, causing premature wear and drive chain failure.

Clean the side surfaces of the chain using a dry cloth.

**NOTE:** Do not brush chain.

Lubricate only with an approved O-ring chain lubricant. Other commercial chain lubricants may contain solvents that could damage the O-rings.

### Drive Chain Adjustment

**NOTE:** Adjust the drive chain with the driver (or an equivalent weight) seated on the vehicle.

Select a level surface and set the transmission lever to NEUTRAL.

Loosen chain tensioner lock bolts.

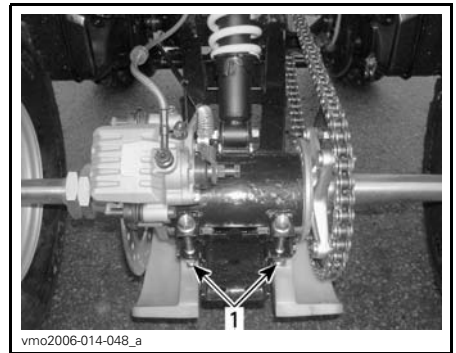

#### TYPICAL

1. Chain tensioner lock bolts

Loosen caliper support bolt.

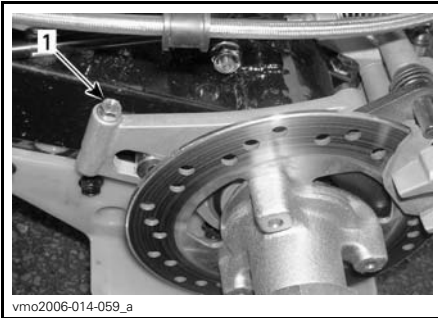

1. Caliper support bolt

Insert adjuster lock through sprocket hub and into chain tensioner.

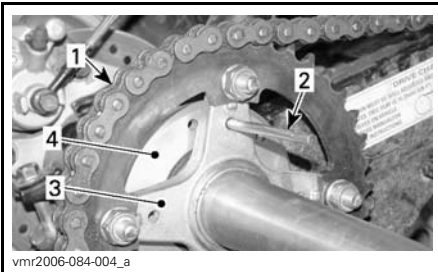

1. Drive chain
2. Adjuster lock
3. Sprocket hub
4. Chain tensioner

Adjust chain deflection by slowly moving the vehicle forward or backward.

The deflection on the top of the chain should be between 15 mm and 25 mm (.6 in and 1 in).

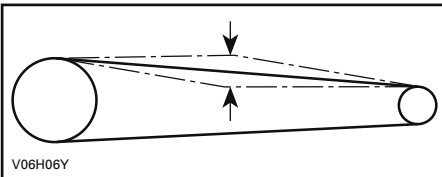

**DRIVE CHAIN DEFLECTION BETWEEN 15 MM AND 25 MM (.6 IN AND 1 IN)**

Tighten the chain tensioner lock bolts to  $62 \text{ N}\cdot\text{m} \pm 6 \text{ N}\cdot\text{m}$  ( $46 \text{ lbf}\cdot\text{ft} \pm 4 \text{ lbf}\cdot\text{ft}$ ) and caliper support bolt to  $12 \text{ N}\cdot\text{m} \pm 1.2 \text{ N}\cdot\text{m}$  ( $106 \text{ lbf}\cdot\text{in} \pm 11 \text{ lbf}\cdot\text{in}$ ).

**NOTICE** Never operate this vehicle with the drive chain too loose or too tight as severe damage to the drive components can occur.

When the adjustment is done, repeat the above procedure to check the deflection several times at different spots on the chain.

## Tires and Wheels

### Tire Pressure

**⚠ WARNING**

Tire pressure greatly affects vehicle handling and stability. Under-pressure may cause tire to deflate and rotate on wheel. Overpressure may burst the tire. Always follow recommended pressure. NEVER set tire pressure below minimum. It could cause the tire to dislodge from the rim. Since tires are low-pressure types, a manual pump should be used.

Check pressure when tires are cold before using the vehicle. Tire pressure changes with temperature and altitude. Recheck pressure if one of these conditions has changed.

For your convenience, a pressure gauge is supplied in the tool kit.

TIRE PRESSURE		
UP to 150 kg (330 lb)	FRONT/REAR	
	MAX.	34 kPa (5 PSI)
	MIN.	26 kPa (3.8 PSI)

Although the tires are specifically designed for off-road use, a flat may still occur. Therefore, it is recommended to carry a tire pump and a repair kit.

### Tire and Wheel Condition

Check tire for damage and wear. Replace if necessary.

Do not rotate tires. The front and rear tires have a different size. The tires are directional and their rotation must be kept in a specific direction for proper operation.

Occasionally, wheel nuts should be removed to apply anti-seize lubricant on studs to ease future removal. This is particularly important when the vehicle is used in a salt-water environment or in mud.

Remove one nut at a time, lubricate it, then install and retorque it to 50 N•m ± 5 N•m (37 lbf•ft ± 4 lbf•ft).

### Wheel Removal and installation

Slightly loosen wheel nuts then, lift vehicle.

Place a support under vehicle.

Remove wheel nuts then remove wheel.

At installation, it is recommended to apply anti-seize lubricant on the stud threads. Gently tighten nuts in a criss-cross sequence then apply a final torque of 50 N•m ± 5 N•m (37 lbf•ft ± 4 lbf•ft).

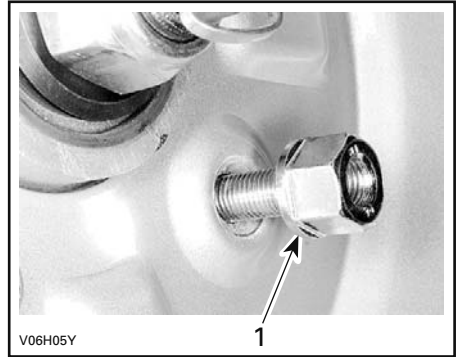

TYPICAL  
1. Taper side of nut

WHEEL NUT TORQUE	
Front and rear	50 N•m ± 5 N•m (37 lbf•ft ± 4 lbf•ft)

**NOTICE** Always use the recommended wheel nuts. Using a different nut could cause damage to the rim.

### Wheel Bearing

#### Wheel Bearing Condition

Push and pull on each wheel to check for free play. See an authorized Can-Am dealer if any free play is felt.

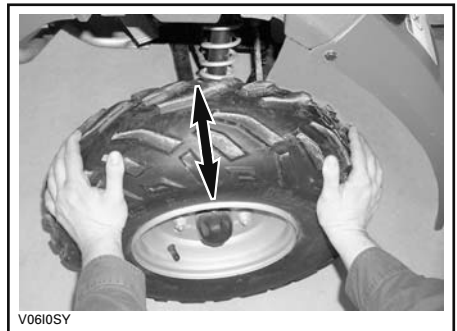

TYPICAL



## Suspension

### Suspension Lubrication

#### Swing Arm

Lubricate swing arm pivots. Use synthetic SUSPENSION GREASE (P/N 293 550 033) or an equivalent.

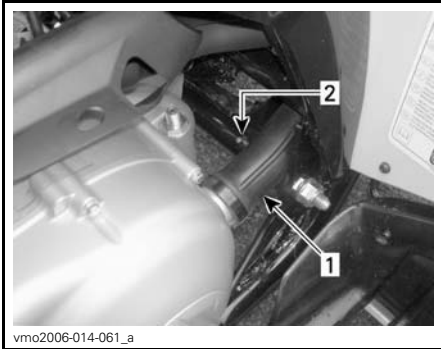

#### LH SIDE OF VEHICLE

1. CVT duct
2. Grease fitting

### Suspension Inspection

#### Shock Absorbers

Inspect shock absorbers for oil leaks and fasteners for tightness. See an authorized Can-Am dealer as necessary.

#### Swing Arm

Check swing arm for distortion, cracks or bending. See an authorized Can-Am dealer if any problem is detected.

#### A-Arms

Check A-arms for cracks, bending or other damage. See an authorized Can-Am dealer as necessary.

## Brakes

### **⚠ WARNING**

New brakes will not perform to their maximum efficiency until after their initial break-in is complete. Use extra caution.

### Recommended Brake Fluid

Always use brake fluid meeting the DOT 4 specification only.

**NOTICE** To avoid serious damage to the braking system, do not use fluids other than the recommended fluid, nor mix different fluids for adjusting the level.

### Brake Fluid Level

With vehicle on a level surface, check brake fluid in reservoirs for proper level. They should be above MIN. mark.

Add fluid as required. **Do not overfill.**

Clean filler cap before removing.

**NOTICE** Use only DOT 4 brake fluid from a sealed container. Do not use brake fluid taken from old or already opened containers.

**NOTE:** A low fluid level may indicate leaks or worn brake pads. See an authorized Can-Am dealer.

### Brake Fluid Reservoirs (at Handlebar)

Turn handlebar in the straight-ahead position to ensure reservoirs are leveled. Check the brake fluid level, the reservoir is full when the fluid reaches of the top of window.

Visually inspect lever boot condition. Check for cracks, tears, and other damage. Replace if damaged.



TYPICAL — LH REAR BRAKE FLUID RESERVOIR

### Rear Brake Fluid Reservoir

With vehicle on a level surface, brake fluid should be between MIN. and MAX. level marks.

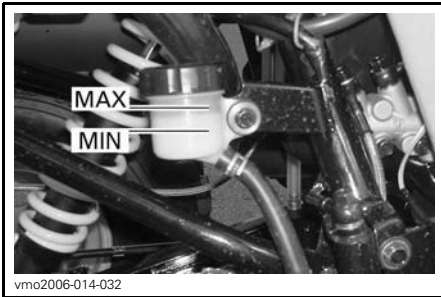

UNDERNEATH RH REAR FENDER

### Brake Fluid Replacement

**⚠ WARNING**  
 Brake fluid replacement should be performed by an authorized Can-Am dealer.

### Brake Inspection

**⚠ CAUTION** The brakes can be very hot after prolonged use of the vehicle and can cause burns. Wait for the brakes to cool down.

The braking system is a hydraulic type and no adjustment is required.

Check the following to keep the brakes in a good operating condition:

- Brake fluid level
- Brake system for fluid leaks
- Brake cleanliness
- Brake for spongy feel
- Brake discs for excessive wear and surface condition
- Brake pads for wear, damage or looseness.

SERVICE LIMITS	
BRAKE PAD THICKNESS	2 mm (.08 in)
BRAKE DISC THICKNESS	2 mm (.08 in)
MAXIMUM DISC WARPAGE	0.15 mm (.006 in)

See your authorized Can-Am dealer if a problem is detected concerning the brake system.

**⚠ WARNING**  
 Brake system maintenance and repairs should be performed by an authorized Can-Am dealer.

### Frame

#### Frame Fasteners

Check fastener condition and tightness on the vehicle. Retighten as required.

---

# VEHICLE CARE

## Post-Operation Care

When the vehicle is used in a salt water environment, rinsing the vehicle with fresh water is necessary to preserve the vehicle and its components. Lubrication of metal parts is highly recommended. Use XPS LUBE (P/N 293 600 016) or an equivalent. This must be performed at the end of each operating day.

When the vehicle is operated in muddy conditions, rinsing the vehicle is recommended to preserve vehicle and its components and to keep lights clean. See *VEHICLE CLEANING AND PROTECTION*.

## Vehicle Cleaning and Protection

**NOTICE** Wash vehicle with warm water and soap. Never use a high pressure washer to clean the vehicle. **USE LOW PRESSURE ONLY** (such as a garden hose). The high pressure can cause electrical or mechanical damage.

Painted parts which are damaged should be properly repainted to prevent rust.

When required, wash the body parts using warm water and a mild detergent. Apply a non-abrasive wax.

**NOTICE** Never clean plastic parts with strong detergent, degreasing agent, paint thinner, acetone, etc.

While reading this Operator's Guide, remember that:

### **WARNING**

Indicates a potential hazard that, if not avoided, could result in serious injury or death.

---

## STORAGE AND PRESEASON PREPARATION

### **WARNING**

Have an authorized Can-Am dealer inspect the fuel system integrity as specified in *MAINTENANCE SCHEDULE*.

When a vehicle is not in use for a period of four months, proper storage is a necessity.

See an authorized Can-Am dealer for proper procedures.

When using your vehicle after storage, a preparation is required. See an authorized Can-Am dealer for proper procedures.

# ***TECHNICAL INFORMATION***

# VEHICLE IDENTIFICATION

The main components of your vehicle (engine and frame) are identified using different serial numbers. It may sometimes become necessary to locate these numbers for warranty purposes or to trace your vehicle in the event of loss. These numbers are also required by the authorized Can-Am dealer to complete warranty claims properly. No warranty will be allowed by BRP. If the engine identification number (EIN) or vehicle identification number (VIN) is removed, mutilated, or altered in any way. We strongly recommend that you take note of all the serial numbers on your vehicle and supply them to your insurance company.

## Vehicle Identification Number Location



MANUFACTURED BY / FABRIQUÉ PAR : SANYANG INDUSTRY CO., LTD

MADE IN/  
FABRIQUÉ A :  
TAIWAN

MFD. DATE FAB: **12/2003**

MODEL: **1234**

VIN / NIV: **2BPS1234X2V000123**

THIS VEHICLE CONFORMS TO ALL APPLICABLE STANDARDS PRESCRIBED UNDER THE CANADIAN MOTOR VEHICLE SAFETY REGULATIONS IN EFFECT ON THE DATE OF MANUFACTURE/CE VÉHICULE EST CONFORME À TOUTES LES NORMES QUI LUI SONT APPLICABLES EN VERTU DU RÉGLEMENT SUR LA SÉCURITÉ DES VÉHICULES AUTOMOBILES DU CANADA EN VIGUEUR À LA DATE DE SA FABRICATION.

704 8011 19

1  
2

vmo2006-014-004\_a

### TYPICAL

1. Model
2. VIN (Vehicle Identification Number)

## Engine Identification Number Location



vmo2006-014-005\_a

The EC-Declaration of Conformity does not appear in this version of the Operator's Guide.

Please refer to the printed version that was delivered with your vehicle.



# SPECIFICATIONS

VEHICLE MODEL		DS 250
<b>ENGINE</b>		
Type	4-stroke. Single overhead camshaft engine, liquid cooled	
Number of cylinders	Single cylinder	
Number of valves	4 valves with mechanical lifters (adjustable)	
Displacement	249.4 cm <sup>3</sup> (15.2 in <sup>3</sup> )	
Bore	71 mm (2.8 in)	
Stroke	63 mm (2.5 in)	
Starting system	Electric starter	
Compression ratio	10.6:1	
Lubrication	Forced circulation and splashing	
Air filter	Sponge wet type	
<b>TRANSMISSION</b>		
Transmission	Continuously Variable Transmission (CVT) HI range (F), neutral and reverse	
<b>COOLING</b>		
Type	Liquid cooled	
Radiator	Front mounted	
<b>CARBURETION</b>		
Carburetor	Type	KEHIN PTG-23
Choke	Variable manual choke	
Idle speed	1700 ± 100 RPM	

<b>VEHICLE MODEL</b>		<b>DS 250</b>
<b>ELECTRICAL SYSTEM</b>		
Magneto generator	Type	338 W @ 5000 RPM
Ignition type		CDI (Capacitor Discharge Ignition)
Ignition timing		Not adjustable
Spark plug	Make	NGK
	Type	CR8E
	Gap	0.8 mm (.031 in)
	Quantity	1
Battery	Type	Wet type battery
	Volt	12 volts, 10 A•h (Ampere hour)
Starting system		Electric start
Headlight bulbs		2 x 35 W
Taillight bulb		1 x 5/21 W
Indicator lamps		1.7 W
Fuses	Fan motor	10 A
	Headlights	15 A
	Other lights	15 A
	Main fuse	30 A
<b>DRIVE SYSTEM</b>		
Rear axle		Chain driven/solid axle
<b>STEERING SYSTEM</b>		
Turning radius		3.5 m (11.5 ft) at low speed
<b>SUSPENSION</b>		
Front	Type	Independent suspension — double A-arm, 2 shock absorbers (oil)
	Travel	140 mm (5.5 in)
Rear	Type	Rigid swing-arm, 1 shock absorber (oil)
	Travel	170 mm (6.7 in)

VEHICLE MODEL		DS 250
<b>TIRES</b>		
Pressure	Front	Maximum: 34 kPa (5 PSI) Minimum: 26 kPa (3.8 PSI)
	Rear	
Size	Front	22 x 7–10
	Rear	20 x 11–9
<b>WHEELS</b>		
Size	Front	AT 10 x 5.5
	Rear	AT 9 x 8
Wheel nut torque		50 N•m ± 5 N•m (37 lbf•ft ± 4 lbf•ft)
<b>BRAKES</b>		
Front		Hydraulic, 2 discs
Rear		Hydraulic, 1 disc
Parking device		RH brake lever includes a parking brake
<b>WEIGHT AND LOADING CAPACITY</b>		
Dry weight		195 kg (430 lb)
Total vehicle load allowed		150 kg (330 lb) (includes operator, all other loads and added accessories)
<b>DIMENSIONS</b>		
Overall length		183 cm (72 in)
Overall width		103 cm (40.6 in)
Overall height		110.5 cm (43.5 in)
Seat height		80 cm (31.5 in)
Wheelbase		118.7 cm (47 in)
Ground clearance	Center of vehicle	26 cm (10.2 in)

<b>VEHICLE MODEL</b>		<b>DS 250</b>
<b>FLUIDS</b>		
Engine oil		For the summer season, use XPS 4-STROKE SYNTH. BLEND OIL (SUMMER) (P/N 293 600 121). For the winter season, use XPS 4-STROKE SYNTHETIC OIL (ALL CLIMATE) (P/N 293 600 112). Refer to <i>OIL VISCOSITY CHART</i>
Gearbox oil		XPS CHAINCASE OIL (P/N 415 129 500) or an equivalent 75W 90 chaincase oil
Coolant		Ethylene-glycol/water mix (50% coolant, 50% distilled water). Use BRP PREMIXED COOLANT (P/N 219 700 362) or an equivalent coolant specially designed for aluminum engines
Fuel	Type	Regular unleaded gasoline
	Octane	87 Pump Posted AKI (92 RON) - Refer to <i>FUEL REQUIREMENTS</i>
Brake fluid		DOT 4 brake fluid
<b>CAPACITIES</b>		
Fuel tank		12.5 L (3.3 U.S. gal.)
Engine		1.2 L (1.3 qt (U.S. liq.)) (oil change)
Gearbox oil		800 ml (.8 qt (U.S. liq.)) (oil change)
Coolant		850 ml (.9 qt (U.S. liq.)) (engine and radiator)
<b>NOISE EMISSION AND VIBRATION VALUES<sup>1</sup></b>		
Noise	Sound pressure ( $L_{pA}$ )	80 dB @ 3250 RPM (Uncertainty ( $K_{pA}$ ) 3 dB)
Vibration	Hand-arm system	<2.5 m/s <sup>2</sup> @ 3250 RPM
	Whole body at seat	<0.5 m/s <sup>2</sup> @ 3250 RPM
<sup>1</sup> : Noise emission and Vibration values are measured in accordance with Standard EN 15997:2011 on a paved surface, at Neutral.		

# ***TROUBLESHOOTING***

---

# TROUBLESHOOTING GUIDELINES

---

## ENGINE DOES NOT CRANK

---

1. **Ignition switch is in the OFF position.**
  - *Place switch to the ON position.*
2. **Emergency engine stop switch.**
  - *Make sure the emergency engine stop switch is in the RUN position.*
3. **Transmission is not set to NEUTRAL.**
  - *Set transmission either in NEUTRAL or press the brake lever.*
4. **Burnt fuse.**
  - *Check main fuse condition.*
5. **Weak battery or loose connections.**
  - *Check charging system fuse.*
  - *Check connections and terminals condition.*
  - *Have the battery checked.*
  - *Contact an authorized Can-Am dealer.*

## ENGINE TURNS OVER BUT FAILS TO START

---

1. **Mixture not rich enough to start cold engine.**
  - *Check fuel tank level and starting procedure for a cold engine, particularly use of the choke.*
2. **Flooded engine (spark plug wet when removed).**
  - *Turn ignition switch to ON position and ensure choke is not applied.*
  - *Ensure the transmission lever is set to NEUTRAL position.*
  - *Fully depress throttle lever and hold while starting the engine.*
  - *As soon as the engine starts, release throttle lever. Do not race engine.*
  - ***If the engine still does not start:*** *clean the spark plug cap area then remove it.*
  - *Remove the spark plug (tools are supplied in tool kit), refer to SPARK PLUG REMOVAL further in this guide.*
  - *Crank engine several times.*
  - *Install new spark plug if possible or clean and dry removed spark plug.*
  - *Start engine as explained above. If engine continues to flood, see an authorized Can-Am dealer.*
  - *Ensure to there is no fuel in the engine oil due to engine flooding, if so, replace engine oil.*
3. **No fuel to the engine (spark plug dry when removed).**
  - *Check fuel tank level; turn fuel valve to ON (also try on RES.). A failure of the fuel pump or carburetor may have occurred.*
  - *Contact an authorized Can-Am dealer.*

---

**ENGINE TURNS OVER BUT FAILS TO START (cont'd)**

---

**4. Spark plug/ignition (no spark).**

- *Check main fuse condition.*
- *Remove spark plug from engine and reconnect it to the spark plug cap.*
- *Ensure the ignition switch is set to ON and the emergency engine stop switch is set to the RUN position.*
- *Start engine with spark plug grounded to the engine away from spark plug hole. If no spark appears, replace spark plug.*
- *If trouble persists, contact an authorized Can-Am dealer.*

**5. Engine compression.**

- *Crank engine, you should feel a pulsation due to the compression cycle of the engine. If no pulsed resistance is felt, it suggests a major loss of compression.*
- *Contact an authorized Can-Am dealer.*

---

**ENGINE LACKS ACCELERATION OR POWER**

---

**1. Fouled or damaged spark plug.**

- *Check item ENGINE TURNS OVER BUT FAILS TO START.*

**2. Lack of fuel to engine.**

- *Check item ENGINE TURNS OVER BUT FAILS TO START.*

**3. Carburetor adjustments.**

- *Contact an authorized Can-Am dealer.*

**4. Engine is overheating.**

- *Check ENGINE OVERHEATS.*

**5. Air filter/housing clogged or dirty.**

- *Check air filter and clean if necessary.*
- *Check deposits in air filter housing drain.*
- *Check the position of the air intake tube.*

**6. CVT dirty or worn, including belt.**

- *Contact an authorized Can-Am dealer.*

**7. Parking brake is applied.**

- *Disengage parking brake.*

**8. Improper valve adjustment.**

- *Contact an authorized Can-Am dealer.*

---

**ENGINE OVERHEATS**

---

**1. Low coolant in cooling system.**

- *Check ENGINE COOLANT in MAINTENANCE INFORMATION.*

**ENGINE OVERHEATS (cont'd)**

---

**2. Dirty radiator fins.**

- *Clean radiator fins, check RADIATOR in MAINTENANCE INFORMATION.*

**ENGINE BACKFIRE**

---

**1. Exhaust system leakage.**

- *Contact an authorized Can-Am dealer.*

**2. Engine is running too hot.**

- *See ENGINE LACKS ACCELERATION OR POWER.*

**3. Ignition timing is incorrect or there is an ignition system failure.**

- *Contact an authorized Can-Am dealer.*

**4. Improper carburetor setting.**

- *Contact an authorized Can-Am dealer.*

**5. Fouled/damaged/worn spark plug.**

- *Clean/verify spark plug and heat range. Replace as required.*

**6. Antipollution system failed.**

- *Contact an authorized Can-Am dealer.*

**ENGINE MISFIRE**

---

**1. Fouled/damaged/worn spark plug.**

- *Clean/verify spark plug and heat range. Replace as required.*

**2. Water in fuel.**

- *Drain fuel system and refill with fresh fuel.*

**UNUSUAL ENGINE NOISE**

---

**1. Valve adjustment.**

- *Contact an authorized Can-Am dealer.*

**2. Chain tensioner.**

- *Contact an authorized Can-Am dealer.*

**3. Timing chain wear.**

- *Contact an authorized Can-Am dealer.*

**4. CVT contamination.**

- *Contact an authorized Can-Am dealer.*

**VEHICLE CANNOT REACH FULL SPEED**

---

**1. Engine.**

- *See ENGINE LACKS ACCELERATION OR POWER.*



---

**VEHICLE CANNOT REACH FULL SPEED (cont'd)**

---

- 2. Parking brake.**
  - *Ensure brake lever lock is completely disengaged.*
- 3. Air filter/housing clogged or dirty.**
  - *Check air filter and clean if necessary.*
  - *Check deposits in air filter housing drain.*
  - *Check the position of the air intake tube.*
- 4. CVT dirty or worn, including belt.**
  - *Contact an authorized Can-Am dealer.*

---

**TRANSMISSION LEVER IS HARD TO MOVE**

---

- 1. Transmission gears are in a position that prevents the transmission lever engagement in a different selection.**
  - *Rock the vehicle back and forth to move the gears in the transmission and allow the transmission lever to be set.*
- 2. Engine idle speed is set too high.**
  - *Adjust the idle speed. Refer to the TECHNICAL SPECIFICATIONS.*
- 3. CVT dirty or worn.**
  - *Contact an authorized Can-Am dealer.*

---

**THE RPM INCREASES BUT THE VEHICLE DOES NOT MOVE**

---

- 1. The transmission is in NEUTRAL position.**
  - *Set transmission in REVERSE or FORWARD.*
- 2. CVT is defective.**
  - *Contact an authorized Can-Am dealer.*
- 3. Water in the CVT housing.**
  - *Refer to CVT TRANSMISSION in MAINTENANCE INFORMATION.*



# ***WARRANTY***

---

# **BRP INTERNATIONAL LIMITED WARRANTY: 2014 CAN-AM™ ATV**

## **1) SCOPE OF THE LIMITED WARRANTY**

Bombardier Recreational Products Inc. (BRP)\* warrants its 2014 Can-Am ATV sold by Can-Am ATV distributors or dealers authorized by BRP to distribute Can-Am ATVs ("Can-Am ATV Distributor/Dealer") outside of the United States of America (USA), Canada, members states of the European Economic Area (which is comprised of the states of the European Union plus Norway, Iceland and Liechtenstein) ("EEA"), member states of the Commonwealth of the Independent States (including Ukraine and Turkmenistan) ("CIS") and Turkey), from defects in material or workmanship for the period and under the conditions described below.

All genuine Can-Am ATV parts and accessories, installed by an authorized Can-Am ATV Distributor/Dealer at the time of delivery of the 2014 Can-Am ATV, carry the same warranty as that of the Can-Am ATV.

This limited warranty will become null and void if: (1) The ATV was used for racing or any other competitive activity, at any point, even by a previous owner; or (2) the ATV has been altered or modified in such a way so as to adversely affect its operation, performance or durability, or has been altered or modified to change its intended use.

## **2) LIMITATIONS OF LIABILITY**

TO THE EXTENT PERMITTED BY LAW, THIS WARRANTY IS EXPRESSLY GIVEN AND ACCEPTED IN LIEU OF ANY AND ALL OTHER WARRANTIES, EXPRESSED OR IMPLIED, INCLUDING WITHOUT LIMITATION ANY WARRANTY OF MERCHANTABILITY OR FITNESS FOR A PARTICULAR PURPOSE. TO THE EXTENT THAT THEY CANNOT BE DISCLAIMED, THE IMPLIED WARRANTIES ARE LIMITED IN DURATION TO THE LIFE OF THE EXPRESS WARRANTY. INCIDENTAL AND CONSEQUENTIAL DAMAGES ARE EXCLUDED FROM COVERAGE UNDER THIS WARRANTY. SOME JURISDICTIONS DO NOT ALLOW FOR THE DISCLAIMERS, LIMITATIONS AND EXCLUSIONS IDENTIFIED ABOVE, AS A RESULT, THEY MAY NOT APPLY TO YOU. THIS WARRANTY GIVES YOU SPECIFIC RIGHTS AND YOU MAY ALSO HAVE OTHER LEGAL RIGHTS WHICH MAY VARY FROM COUNTRY TO COUNTRY. (FOR PRODUCTS PURCHASED IN AUSTRALIA SEE CLAUSE 4 BELOW).

Neither the Can-Am ATV Distributor/Dealer nor any other person has been authorized to make any affirmation, representation or warranty regarding the product, other than those contained in this limited warranty, and if made, shall not be enforceable against BRP.

BRP reserves the right to modify this warranty at any time, being understood that such modification will not alter the warranty conditions applicable to the products sold while this warranty is in effect.

### **3) EXCLUSIONS – ARE NOT WARRANTED**

The following are not warranted under this limited warranty under any circumstances:

- Normal wear and tear;
- Routine maintenance items, tune ups, adjustments;
- Damage caused by negligence or failure to provide proper maintenance and/or storage, as described in the Operator's Guide;
- Damage resulting from removal of parts, improper repairs, service, maintenance, modifications or use of parts or accessories not manufactured or approved by BRP which in its reasonable judgement are either incompatible with the product or adversely affect its operation, performance and durability, or resulting from repairs done by a person that is not an authorized servicing Can-Am ATV Distributor/Dealer;
- Damage caused by abuse, abnormal use, neglect, racing or operation of the product in a manner inconsistent with the recommended operation described in the Operator's Guide;
- Damage resulting from accident, submersion, fire, snow or water ingestion, theft, vandalism or any act of God;
- Operation with fuels, oils or lubricants which are not suitable for use with the product (see the Operator's Guide);
- Damage resulting from rust, corrosion or exposure to the elements;
- Incidental or consequential damages, or damages of any kind including without limitation towing, storage, transportation expenses, telephone, rental, taxi, inconvenience, insurance coverage, loan payments, loss of time, loss of income; or time missed for downtime experience due to service work.

### **4) WARRANTY COVERAGE PERIOD**

This warranty will be in effect from (1) the date of delivery to the first retail consumer or (2) the date the product is first put into use, whichever occurs first and for a period of:

SIX (6) CONSECUTIVE MONTHS for private use or commercial use.

The repair or replacement of parts or the performance of service under this warranty does not extend the life of this warranty beyond its original expiration date.

Note that the duration and any other modalities of the warranty coverage are subject to the applicable national or local legislation in the customer's country.

### **FOR PRODUCTS SOLD IN AUSTRALIA ONLY**

Nothing in these Warranty terms and conditions should be taken to exclude, restrict or modify the application of any condition, warranty, guarantee, right or remedy conferred or implied under the Competition and Consumer Act 2010 (Cth), including the Australian Consumer Law or any other law, where to do so

would contravene that law, or cause any part of these terms and conditions to be void. The benefits given to you under this limited warranty are in addition to other rights and remedies that you have under Australian law.

Our goods come with guarantees that cannot be excluded under the Australian Consumer Law. You are entitled to a replacement or refund for a major failure and for compensation for any other reasonably foreseeable loss or damage. You are also entitled to have the goods repaired or replaced if the goods fail to be of acceptable quality and the failure does not amount to a major failure.

## **5) CONDITIONS TO HAVE WARRANTY COVERAGE**

This warranty coverage is available **only** if **each** of the following conditions has been fulfilled:

- The 2014 Can-Am ATV must be purchased as new and unused by its first owner from a Can-Am ATV Distributor/Dealer authorized to distribute Can-Am ATVs in the country in which the sale occurred;
- The BRP specified pre-delivery inspection process must be completed and documented;
- The product must have undergone proper registration by an authorized Can-Am ATV Distributor/Dealer;
- The 2014 Can-Am ATV must be purchased in the country or union of countries in which the purchaser resides; and
- Routine maintenance outlined in the Operator's Guide must be timely performed in order to maintain warranty coverage. BRP reserves the right to make warranty coverage contingent upon proof of proper maintenance.

BRP will not honour this limited warranty to any private use owner or commercial use owner if one of the preceding conditions has not been met. Such limitations are necessary in order to allow BRP to preserve both the safety of its products, and also that of its consumers and the general public.

## **6) WHAT TO DO TO OBTAIN WARRANTY COVERAGE UNDER THIS WARRANTY**

The customer must cease using the ATV upon the appearance of an anomaly. The customer must notify a servicing Can-Am ATV Distributor/Dealer within two (2) days of the appearance of a defect, and provide it with reasonable access to the product and reasonable opportunity to repair it. The customer must also present to the authorized Can-Am ATV Distributor/Dealer proof of purchase of the product and must sign the repair/work order prior to starting the repair in order to validate the warranty repair. All parts replaced under this limited warranty become the property of BRP.

Note that the notification period is subject to the applicable national or local legislation in customer's country.

## **7) WHAT BRP WILL DO**

To the extent permitted by law, BRP's obligations under this warranty are limited to, at its sole discretion, repairing parts found defective under normal use, maintenance and service, or replacing such parts with new genuine Can-Am ATV parts without charge for parts and labour, at any authorized Can-Am ATV Distributor/Dealer during the warranty coverage period under the conditions described herein. BRP's responsibility is limited to making the required repairs or replacements of parts. No claim of breach of warranty shall be cause for cancellation or rescission of the sale of the Can-Am ATV to the owner. You may have other legal rights which may vary from country to country.

In the event that service is required outside of the country of original sale, the owner will bear responsibility for any additional charges due to local practices and conditions, such as, but not limited to, freight, insurance, taxes, license fees, import duties, and any and all other financial charges, including those levied by governments, states, territories and their respective agencies.

BRP reserves the right to improve or modify products from time to time without assuming any obligation to modify products previously manufactured.

## **8) TRANSFER**

If the ownership of a product is transferred during the warranty coverage period, this warranty shall also be transferred and be valid for the remaining coverage period provided BRP or an authorized Can-Am ATV Distributor/Dealer receives a proof that the former owner agreed to the transfer of ownership, in addition to the coordinates of the new owner.

## **9) CONSUMER ASSISTANCE**

1. In the event of a controversy or a dispute in connection with this limited warranty, BRP suggests that you try to resolve the issue at the Can-Am ATV Distributor/Dealer level. We recommend discussing the issue with the authorized Can-Am ATV Distributor/Dealer's service manager or owner.
2. If further assistance is required, the Can-Am ATV Distributor/Dealer service department should be contacted in order to resolve the matter.
3. If the matter still remains unresolved then contact BRP by writing at the address listed below.

**For countries within Middle East and Africa please contact our European office:**

**BRP EUROPE N.V.**

Customer Assistance Center

Skaldenstraat 125

9042 Gent

Belgium

Tel.: + 32 9 218 26 00

**For all other countries, please contact your local Can-Am ATV Distributor/Dealer (visit our website at [www.brp.com](http://www.brp.com) for contact information), or contact our North American office at:**

**BOMBARDIER RECREATIONAL PRODUCTS INC.**

Customer Assistance Center 75 J.-A. Bombardier Street  
Sherbrooke QC J1L 1W3

Canada

Tel.: 1 819 566-3366

\* For the territory covered by this limited warranty, products are distributed and serviced by Bombardier Recreational Products Inc. or its affiliates.

© 2013 Bombardier Recreational Products Inc. All rights reserved.

™ Trademark of Bombardier Recreational Products Inc. or its affiliates.



---

# **BRP LIMITED WARRANTY FOR THE EUROPEAN ECONOMIC AREA, THE COMMONWEALTH OF THE INDEPENDENT STATES AND TURKEY: 2014 CAN-AM™ ATV**

## **1) SCOPE OF THE LIMITED WARRANTY**

Bombardier Recreational Products Inc. (BRP)\* warrants its 2014 Can-Am ATVs sold by distributors or dealers authorized by BRP to distribute Can-Am ATVs ("Can-Am ATV Distributor/Dealer") in member states of the European Economic Area (which is comprised of the member states of the European Union plus Norway, Iceland and Liechtenstein) ("EEA"), in member states of the Commonwealth of the Independent States (including Ukraine and Turkmenistan) ("CIS") and Turkey from defects in material or workmanship for the period and under the conditions described below.

All genuine Can-Am ATV parts and accessories, installed by an authorized Can-Am ATV Distributor/Dealer at the time of delivery of the 2014 Can-Am ATV, carry the same warranty as that of the ATV.

This limited warranty will become null and void if: (1) The ATV was used for racing or any other competitive activity, at any point, even by a previous owner; or (2) the ATV has been altered or modified in such a way so as to adversely affect its operation, performance or durability, or has been altered or modified to change its intended use.

## **2) LIMITATIONS OF LIABILITY**

TO THE EXTENT PERMITTED BY LAW, THIS WARRANTY IS EXPRESSLY GIVEN AND ACCEPTED IN LIEU OF ANY AND ALL OTHER WARRANTIES, EXPRESSED OR IMPLIED, INCLUDING WITHOUT LIMITATION ANY WARRANTY OF MERCHANTABILITY OR FITNESS FOR A PARTICULAR PURPOSE. TO THE EXTENT THAT THEY CANNOT BE DISCLAIMED, THE IMPLIED WARRANTIES ARE LIMITED IN DURATION TO THE LIFE OF THE EXPRESS WARRANTY. INCIDENTAL AND CONSEQUENTIAL DAMAGES ARE EXCLUDED FROM COVERAGE UNDER THIS WARRANTY. SOME JURISDICTIONS DO NOT ALLOW FOR THE DISCLAIMERS, LIMITATIONS AND EXCLUSIONS IDENTIFIED ABOVE, AS A RESULT, THEY MAY NOT APPLY TO YOU. THIS WARRANTY GIVES YOU SPECIFIC RIGHTS AND YOU MAY ALSO HAVE OTHER LEGAL RIGHTS WHICH MAY VARY FROM COUNTRY TO COUNTRY.

Neither the Can-Am ATV Distributor/Dealer nor any other person has been authorized to make any affirmation, representation or warranty regarding the product, other than those contained in this limited warranty, and if made, shall not be enforceable against BRP.

BRP reserves the right to modify this warranty at any time, being understood that such modification will not alter the warranty conditions applicable to the products sold while this warranty is in effect.

### **3) EXCLUSIONS – ARE NOT WARRANTED**

The following are not warranted under this limited warranty under any circumstances:

- Normal wear and tear;
- Routine maintenance items, tune ups, adjustments;
- Damage caused by negligence or failure to provide proper maintenance and/or storage, as described in the Operator's Guide;
- Damage resulting from removal of parts, improper repairs, service, maintenance, modifications or use of parts or accessories not manufactured or approved by BRP which in its reasonable judgement are either incompatible with the product or adversely affect its operation, performance and durability, or resulting from repairs done by a person that is not an authorized servicing Can-Am ATV Distributor/Dealer;
- Damage caused by abuse, abnormal use, neglect, racing or operation of the product in a manner inconsistent with the recommended operation described in the Operator's Guide;
- Damage resulting from accident, submersion, fire, snow or water ingestion, theft, vandalism or any act of God;
- Operation with fuels, oils or lubricants which are not suitable for use with the product (see the Operator's Guide);
- Damage resulting from rust, corrosion or exposure to the elements;
- Incidental or consequential damages, or damages of any kind including without limitation towing, transportation expenses, storage, telephone, rental, taxi, inconvenience, insurance coverage, loan payments, loss of time, loss of income or time missed for downtime experience due to service work.

### **4) WARRANTY COVERAGE PERIOD**

This warranty will be in effect from (1) the date of delivery to the first retail consumer or (2) the date the product is first put into use, whichever occurs first and for a period of:

TWENTY-FOUR (24) CONSECUTIVE MONTHS for private use.

SIX (6) CONSECUTIVE MONTHS for commercial use or rental use.

The product is used commercially when it is used in connection with any work or employment that generates income during any part of the warranty period. The product is also used commercially when, at any point during the warranty period, it is licensed for commercial use.

The repair or replacement of parts or the performance of service under this warranty does not extend the life of this warranty beyond its original expiration date.

Note that the duration and any other modalities of the warranty coverage are subject to the applicable national or local legislation in the customer's country.

## **5) CONDITIONS TO HAVE WARRANTY COVERAGE**

This warranty coverage is available **only** if **each** of the following conditions has been fulfilled:

- The 2014 Can-Am ATV must be purchased as new and unused by its first owner from a Can-Am ATV Distributor/Dealer authorized to distribute Can-Am ATVs in the country in which the sale occurred;
- The BRP specified pre-delivery inspection process must be completed and documented;
- The product must have undergone proper registration by an authorized Can-Am ATV Distributor/Dealer;
- The 2014 Can-Am ATV must be purchased within the EEA by an EEA resident, in the CIS for residents of the countries comprised in such area and in Turkey for residents of Turkey; and
- Routine maintenance outlined in the Operator's Guide must be timely performed in order to maintain warranty coverage. BRP reserves the right to make warranty coverage contingent upon proof of proper maintenance.

BRP will not honour this limited warranty to any private use owner or commercial use owner if one of the preceding conditions has not been met. Such limitations are necessary in order to allow BRP to preserve both the safety of its products, and also that of its consumers and the general public.

## **6) WHAT TO DO TO OBTAIN WARRANTY COVERAGE UNDER THIS WARRANTY**

The customer must cease using the ATV upon the appearance of an anomaly. The customer must notify a servicing Can-Am ATV Distributor/Dealer within two (2) months of the appearance of a defect and provide it with reasonable access to the product and reasonable opportunity to repair it. The customer must also present to the authorized Can-Am ATV Distributor/Dealer, proof of purchase of the product and must sign the repair/work order prior to starting the repair in order to validate the warranty repair. All parts replaced under this limited warranty become the property of BRP.

Note that the notification period is subject to the applicable national or local legislation in customer's country.

## **7) WHAT BRP WILL DO**

To the extent permitted by law, BRP's obligations under this warranty are limited to, at its sole discretion, repairing parts found defective under normal use, maintenance and service, or replacing such parts with new genuine Can-Am ATV parts without charge for parts and labour, at any authorized Can-Am ATV Distributor/Dealer during the warranty coverage period under the conditions described herein. BRP's responsibility is limited to making the required repairs or replacements of parts. No claim of breach of warranty shall be cause for cancellation or rescission of the sale of the Can-Am ATV to the owner. You may have other legal rights which may vary from country to country.

In the event that service is required outside of the EEA, CIS or Turkey, the owner will bear responsibility for any additional charges due to local practices and conditions, such as, but not limited to, freight, insurance, taxes, license fees, import duties, and any and all other financial charges, including those levied by governments, states, territories and their respective agencies.

BRP reserves the right to improve or modify products from time to time without assuming any obligation to modify products previously manufactured.

## **8) TRANSFER**

If the ownership of a product is transferred during the warranty coverage period, this warranty shall also be transferred and be valid for the remaining coverage period provided BRP or an authorized Can-Am ATV Distributor/Dealer receives a proof that the former owner agreed to the transfer of ownership, in addition to the coordinates of the new owner.

## **9) CONSUMER ASSISTANCE**

1. In the event of a controversy or a dispute in connection with this limited warranty, BRP suggests that you try to resolve the issue at the Can-Am ATV Distributor/Dealer level. We recommend discussing the issue with the authorized Can-Am ATV Distributor/Dealer's service manager or owner.
2. If further assistance is required, the Can-Am ATV Distributor/Dealer service department should be contacted in order to resolve the matter.
3. If the matter still remains unresolved then contact BRP at the address listed below:

**For countries within EEA, CIS or Turkey, except Scandinavian countries, please contact our European office:**

**BRP EUROPE N.V.**

Customer Assistance Center

Skaldenstraat 125

9042 Gent

Belgium

Tel.: + 32 9 218 26 00

**For Scandinavian countries, please contact our Finland office:**

**BRP FINLAND OY**

Service Department

Isoaavantie 7

FIN-96320 Rovaniemi

Finland

Tel.: + 358 16 3208 111

You can find your Can-Am Distributor/Dealer's coordinates on [www.brp.com](http://www.brp.com).

\* In the EEA, products are distributed and serviced by BRP European Distribution S.A. and other affiliates or subsidiaries of BRP.

© 2013 Bombardier Recreational Products Inc. All rights reserved.

™ Trademark of Bombardier Recreational Products Inc. or its affiliates.

## **ADDITIONAL TERMS AND CONDITIONS FOR FRANCE ONLY**

The following terms and conditions are applicable to products sold in France only:

The seller shall deliver goods that are complying with the contract and shall be responsible for defects existing upon delivery. The seller shall also be responsible for defects resulting from packaging, assembling instructions or the installation when it is its responsibility per the contract or if accomplished under its responsibility. To be compliant with the contract, the good shall:

1. Be fit for normal use for goods similar thereto and, if applicable:
  - Correspond to the description provided by the seller and have the qualities presented to the buyer though sample or model;
  - Have the qualities that a buyer may legitimately expect considering the public declarations of the seller, the manufacturer of its representative, including in advertising or labeling; or
2. Have the characteristics mutually agreed upon as between the parties or be fit for the specific use intended by the buyer and brought to the attention of the seller and which accepted.

The action for failure to comply is prescribed after two years after delivery of the goods. The seller is responsible for the warranty for hidden defects of the good sold if such hidden defects are rendering the good unfit for the intended use, or if they diminish its use in such a way that the buyer would not have acquired the good or would have given a lesser price, had he known. The action for such hidden defects shall be taken by the buyer within 2 years of the discovery of the defect.

# ***CUSTOMER INFORMATION***

---

## PRIVACY INFORMATION

BRP wishes to inform you that your coordinates will be used for safety and warranty related purposes. Furthermore, BRP and its affiliates may use its customer list to distribute marketing and promotional information about BRP and related products.

To exercise your right to consult or correct your data, or to be removed from the addressee-list for direct marketing, please contact BRP.

**By E-mail:**    [privacyofficer@brp.com](mailto:privacyofficer@brp.com)

**By mail:**        BRP  
Senior Legal Counsel-Privacy Officer  
726 St-Joseph  
Valcourt QC  
Canada  
J0E 2L0



---

## **CHANGE OF ADDRESS/OWNERSHIP**

If your address has changed or if you are the new owner of the ATV, be sure to notify BRP by either:

- Mailing one of the change of address cards on the following pages
- Notifying an authorized Can-Am dealer.

In case of change of ownership, please join a proof that the former owner agreed to the transfer.

Notifying BRP, even after the expiration of the limited warranty, is very important as it enables BRP to reach the ATV owner if necessary, like when safety recalls are initiated. It is the owner's responsibility to notify BRP.

**STOLEN UNITS:** If your personal ATV is stolen, you should notify BRP or an authorized Can-Am dealer. We will ask you to provide your name, address, phone number, the vehicle identification number and the date it was stolen.

### **Scandinavian countries**

#### **BRP FINLAND OY**

Service Department  
Isoaavantie 7  
FIN-96320 Rovaniemi

### **Other countries in the world**

#### **BRP EUROPEAN DISTRIBUTION**

Warranty Department  
Chemin de Messidor 5-7  
1006 Lausanne  
Switzerland

***This page is  
intentionally blank***

CHANGE OF ADDRESS

CHANGE OF OWNERSHIP



VEHICLE IDENTIFICATION NUMBER

Model Number

Vehicle Identification Number (V.I.N.)

OLD ADDRESS  
OR PREVIOUS OWNER:

NAME

NO. STREET APT

CITY STATE/PROVINCE ZIP/POSTAL CODE

COUNTRY TELEPHONE

NEW ADDRESS  
OR NEW OWNER:

NAME

NO. STREET APT

CITY STATE/PROVINCE ZIP/POSTAL CODE

COUNTRY TELEPHONE

E-MAIL ADDRESS

V00A2F

CHANGE OF ADDRESS

CHANGE OF OWNERSHIP



VEHICLE IDENTIFICATION NUMBER

Model Number

Vehicle Identification Number (V.I.N.)

OLD ADDRESS  
OR PREVIOUS OWNER:

NAME

NO. STREET APT

CITY STATE/PROVINCE ZIP/POSTAL CODE

COUNTRY TELEPHONE

NEW ADDRESS  
OR NEW OWNER:

NAME

NO. STREET APT

CITY STATE/PROVINCE ZIP/POSTAL CODE

COUNTRY TELEPHONE

E-MAIL ADDRESS

V00A2F







**ATV MODEL No.** \_\_\_\_\_

**VEHICLE IDENTIFICATION NUMBER (V.I.N.)** \_\_\_\_\_

**ENGINE IDENTIFICATION NUMBER (E.I.N.)** \_\_\_\_\_

**Owner:** \_\_\_\_\_

NAME

No.

STREET

APT

CITY

STATE/PROVINCE

ZIP/POSTAL CODE

**Purchase Date** \_\_\_\_\_  
YEAR MONTH DAY

**Warranty Expiry Date** \_\_\_\_\_  
YEAR MONTH DAY

To be completed by the dealer at the time of the sale.

DEALER IMPRINT AREA

V00A2IL

Please verify with your dealer to ensure your vehicle has been registered with BRP.

While reading this Operator's Guide, remember that:

 **WARNING**

Indicates a potential hazard that, if not avoided, could result in serious injury or death.

 **WARNING****THIS VEHICLE CAN BE HAZARDOUS TO OPERATE.**

A collision or rollover can occur quickly, even during routine maneuvers such as turning and driving on hills or over obstacles, if you fail to take proper precautions.

**SEVERE INJURY OR DEATH** can result if you do not follow these instructions:

- **BEFORE YOU OPERATE THIS VEHICLE, READ THIS OPERATOR'S GUIDE AND ALL ON-PRODUCT SAFETY LABELS.**
- **NEVER OPERATE THIS VEHICLE WITHOUT PROPER INSTRUCTIONS.** Complete a certified training course.
- **NEVER CARRY A PASSENGER.** You increase your risk of losing control if you carry a passenger.
- **NEVER OPERATE THIS VEHICLE ON A PAVED SURFACE.** You increase your risk of losing control if you operate this vehicle on pavement.
- **NEVER OPERATE THIS VEHICLE ON PUBLIC ROADS.** You can collide with another vehicle if you operate this vehicle on a public road.
- **ALWAYS WEAR AN APPROVED HELMET,** eye protection, and protective clothing.
- **NEVER RIDE UNDER THE INFLUENCE OF ALCOHOL OR DRUGS.** They slow reaction time and impair judgment.
- **NEVER OPERATE THIS VEHICLE AT EXCESSIVE SPEEDS.** You increase your risk of losing control if you operate this vehicle at speeds too fast for the terrain, visibility conditions, or your experience.
- **NEVER ATTEMPT WHEELIES, JUMPS, OR OTHER STUNTS.**

219 001 185

OPERATOR'S GUIDE, DS 250 / ENGLISH  
GUIDE DU CONDUCTEUR, DS 250 / ANGLAIS

FAIT AU / MADE IN CANADA

U/M:P.C.