

ski-doo®



MXZ 120

OPERATOR'S GUIDE

Includes Safety,
Maintenance and
Use Information



2025

⚠ WARNING

Minimum recommended operators age under adult supervision:

- 6 years old

Read this operator's guide thoroughly. It contains important safety information. Adult supervision is required for the proper understanding of the risks involved with the usage of these vehicles.

Review and explain the content of this operator's guide with the young operator and make sure that the young operator understands the proper safe operation of the vehicle.

Keep this operator's guide handy for reference at all times.

520003295

**Original
Instructions**

CALIFORNIA PROPOSITION 65 WARNING

WARNING

Operating, servicing and maintaining an off-road vehicle can expose you to chemicals including engine exhaust, carbon monoxide, phthalates, and lead, which are known to the State of California to cause cancer and birth defects or other reproductive harm. To minimize exposure, avoid breathing exhaust, do not idle the engine except as necessary, service your vehicle in a well-ventilated area and wear gloves or wash your hands frequently when servicing your vehicle. For more information go to www.p65warnings.ca.gov/products/passenger-vehicle.

In Canada, products are distributed and serviced by Bombardier Recreational Products Inc. (BRP).

In the USA, products are distributed and serviced by BRP US Inc.

In the European Economic Area (which is comprised of the member states of the European Union plus the United Kingdom, Norway, Iceland and Liechtenstein), the Commonwealth of the Independent States (including Ukraine and Turkmenistan) and Turkey, products are distributed and serviced by BRP European Distribution S.A. and other affiliates or subsidiaries of BRP.

For all other countries, products are distributed and serviced by Bombardier Recreational Products Inc. (BRP) or its affiliates.

TM® Trademarks of BRP or its affiliates.

This is a non-exhaustive list of trademarks that are the property of Bombardier Recreational Products Inc. or its affiliates:

SKI-DOO®

MXZ®

XPS®

All rights reserved. No parts of this Operator's Guide may be reproduced in any form without the prior written permission of Bombardier Recreational Products Inc. ©Bombardier Recreational Products Inc. (BRP) 2024

This vehicle can be hazardous to operate.

Never accelerate rapidly or drive at high speed beyond the limits of visibility or without being totally familiar with the terrain and what lies in front of you. Obey speed limits and never operate at speeds that do not allow adequate maneuvering and stopping distances. Read and study the entire Operator's Guide and Snowmobile Safety Handbook.

Failure to follow this warning could result in personal injury to yourself or others. For your safety, understand and follow all the warnings contained in this Operator's Guide and on the labels on this vehicle.

Keep this Operator's Guide handy for future reference. If you lose your guide, an electronic printable version is available on www.operatorsguides.brp.com or visit your authorized dealer for a hard copy replacement. The safety labels should be considered permanent parts of the vehicle. If a safety label comes off or becomes hard to read, contact your authorized dealer for a free replacement.

FAILURE TO FOLLOW THE WARNINGS CONTAINED IN THIS GUIDE CAN RESULT IN SERIOUS INJURY OR DEATH.

The Operator's Guide, Snowmobile Safety Handbook, and Snowmobile Decals display important information:



The Safety Alert Symbol means ATTENTION! BE ALERT! YOUR SAFETY IS INVOLVED.



WARNING

WARNING identifies personal safety-related information. Follow the directive because it deals with the possibility of serious personal injury or even death.



CAUTION

CAUTION indicates a hazard situation which, if not avoided, could result in minor or moderate injury.

CAUTION

CAUTION, without the safety alert symbol, identifies unsafe practices. Follow the directive because it deals with the possibility of damaging part or parts of the snowmobile.

■ **NOTE:**

A NOTE identifies supplementary information worthy of particular attention.

Personal Injury

- To avoid injury to yourself and others, NEVER operate the snowmobile without first reading and understanding this guide and the Snowmobile Safety Handbook; then follow the instructions and heed the warnings given.
- USE COMMON SENSE.
- DON'T DRINK and DRIVE.
- STAY IN CONTROL at ALL TIMES.
- TELL YOUR FRIENDS. If you see a friend operating a snowmobile recklessly, at excessive speeds, while intoxicated, or in other unsafe ways, don't wait until it is too late to warn of the consequences of snowmobile misuse. Such conduct endangers everyone. TAKE AN ACTIVE ROLE IN THE SAFETY OF YOURSELF AND OTHERS.

Table of Contents

Foreword.....	3	Maintenance	20-28
U.S. Consumer Product Safety Commission (CPSC) Children's Product Certificate (U.S. Only)	4	Engine Oil.....	20
Snowmobile Safety Rules	5	Carburetor	21
Hangtags.....	6-8	In-Line Fuel Filter	22
Warning Labels & Information	9	Air Cleaner/Filter	22
Declaration of Conformity (EU)	10	Spark Plug.....	22
Declaration of Conformity (UK)	11	Brake.....	23
Emissions Regulation 2016/1628 (EU models).....	12	Drive Chain	23
Reporting Safety Defects	13	Drive Chain Tensioner	24
Preparing to Safely Operate the MXZ 120...	14	Track Tension	24
Operating the MXZ 120	15	Track Alignment	25
General Information	16-17	Adjusting Front Ski Shock Springs.....	26
Control Locations	16	Adjusting Rear Spring Tension	26
Snowmobile Identification	16	Ski Alignment	27
Gasoline — Oil	16	Ski Wear Bar.....	27
Engine Break-In	17	Recoil Starter Air Vents.....	28
Muffler	17	Lights.....	28
Operating Instructions	18	Maintenance Records	29
Starting and Stopping Engine	18	Preparation for Storage.....	34
Periodic Maintenance/Tune-Up Chart	19	Preparation after Storage	35
		Specifications	36
		Warranty.....	37
		Customer Information.....	49
		Contact Us	51
		Change of Address/Ownership.....	52

Foreword

The MXZ 120 Snowmobile is intended to be a learning/recreational snowmobile for a responsible child at least 6 years of age and under adult supervision. This snowmobile is intended to be ridden by the operator only; there should be no passenger. Also, this snowmobile is intended for daylight use in restricted off-road areas, primarily on snow. Use of this snowmobile on public streets, roads, and highways can be hazardous and is prohibited by law in most cases. As a parent or guardian, one must accept the responsibility of training the child in the safe operation of the snowmobile. Teach all operators the basic principles of operation, snowmobile rules and regulations, and especially how to stop the snowmobile in case of an emergency. Impress upon the child a sense of snowmobile courtesy and responsibility.

This snowmobile is a quality product designed, engineered, and assembled to give dependable service. Be sure, as the owner, to become thoroughly familiar with its basic operation, maintenance, and storage procedures. Read this guide and the accompanying Snowmobile Safety Handbook to ensure safe and proper use of the snowmobile.

This guide is divided into sections. The sections “Preparing to Safely Operate the MXZ 120” and “Operating the MXZ 120” must be read and explained to the child/operator. The other sections are for the owner/parent/guardian and contain information on snowmobile identification, safe operating instructions, lubrication, maintenance, storage, and after-storage preparation. If repair or service is ever required, contact an authorized BRP Snowmobile dealer for professional service.

At the time of publication, all information and illustrations were technically correct. No retroactive obligation is incurred.

This Ski-Doo Operator’s Guide should be considered a permanent part of the snowmobile and must remain with the snowmobile at time of resale.

Every BRP snowmobile meets or exceeds the standards of the Snowmobile Safety and Certification Committee and displays the SSCC decal. BRP endorses and encourages the safe use of all snowmobiles. Always wear a helmet and eye protection. Drive with caution, observe all state and local laws, and respect the rights of others. International Snowmobile Manufacturers Association (ISMA) members like BRP do their part to improve trails, sponsor events, and generally support the sport of snowmobiling. As a member of the National Snowmobile Foundation, BRP promotes snowmobiling through education, charity, and research programs.

© **Bombardier Recreational Products Inc. (BRP) 2024**

Printed in U.S.A.

**U.S. Consumer Product Safety Commission
(CPSC)
Children's Product Certificate
(U.S. Only)**

1. Identification of the product covered by this certificate:

Youth Snowmobile; Model: 2025 MXZ 120.

2. Citation to each CPSC product safety regulation to which this product is being certified:

This product is exempt from total lead content testing under 15 USC §1278a pursuant to Public Law 112-28.

This product meets the requirements of the ban of lead-containing paint under 16 CFR Part 1303.

This product meets SSCC/11 requirements, which requires third-party review, certification, and periodic audits.

3. Identification of the importer or domestic manufacturer certifying compliance of the product:

Arctic Cat (a division of Textron Specialized Vehicles)
601 Brooks Ave. S.
Thief River Falls, MN 56701
218-681-9799

4. Information for the individual maintaining records of test results:

Anna Hutchison, Compliance Engineer
Arctic Cat
601 Brooks Ave. S.
Thief River Falls, MN 56701
218-681-9799, ext. 2746
aconnelly@textron.com

5. Date and place where this product was manufactured:

The date of manufacture is located on the Vehicle Identification Number (VIN) label on the product.

Manufacturing Location:

Arctic Cat
601 Brooks Ave. S.
Thief River Falls, MN 56701









6. Date and place where this product was tested for compliance with the regulation(s) cited above:

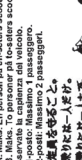



This product is exempt from total lead content testing under 15 USC §1278a pursuant to Public Law 112-28.

There are not any federally mandated testing requirements for children's snowmobiles. Arctic Cat certifies to SSCC/11 requirements, Class II-Children's Snowmobile. For a more detailed definition, see SAE J1038. This certification requires a third-party review, which is performed by:

SGS North America Inc.
291 Fairfield Ave.
Fairfield, NJ 07004

Snowmobile Safety Rules

<p>6 Beware of trees and other hazards. Do not drink and drive. Sit up for full control of the snowmobile. Wear safety in multi-weather. Always sign alerts at all diversal occasions.</p> <p>木や障害物に用心すること。</p> 	<p>7 Always use a solid hitch for towing. Always use proper tieing technique. Always use proper tieing technique. Always use proper tieing technique. Always use proper tieing technique.</p> <p>牽引にはしっかり 1点ロープをかけること。</p> 	<p>8 Observe proper rider capacity. Respect the number recommended by the manufacturer. Do not exceed the weight limit. Do not exceed the weight limit. Do not exceed the weight limit.</p> <p>乗客数を厳守すること。二人乗りには一人だけ。</p> 	<p>9 Obey all local laws and regulations. Obey all local laws and regulations. Obey all local laws and regulations. Obey all local laws and regulations.</p> <p>運転 標の要請に従って 注意していただくこと。</p> 	<p>10 Read and understand your Operator's Manual. Read and understand your Operator's Manual. Read and understand your Operator's Manual. Read and understand your Operator's Manual.</p> <p>オーナーマニュアルを熟読し、よく理解すること。</p> 
<p>5 Don't ride after midnight. Do not drink and drive. Do not drink and drive. Do not drink and drive. Do not drink and drive.</p> <p>真夜中以後は乗らないこと。</p> 	<p>11 Read and understand your Operator's Manual. Read and understand your Operator's Manual. Read and understand your Operator's Manual. Read and understand your Operator's Manual.</p> <p>オーナーマニュアルを熟読し、よく理解すること。</p> 	<p>12 Obey all local laws and regulations. Obey all local laws and regulations. Obey all local laws and regulations. Obey all local laws and regulations.</p> <p>運転 標の要請に従って 注意していただくこと。</p> 	<p>13 Obey all local laws and regulations. Obey all local laws and regulations. Obey all local laws and regulations. Obey all local laws and regulations.</p> <p>運転 標の要請に従って 注意していただくこと。</p> 	<p>14 Obey all local laws and regulations. Obey all local laws and regulations. Obey all local laws and regulations. Obey all local laws and regulations.</p> <p>運転 標の要請に従って 注意していただくこと。</p> 

<p>SNOWMOBILE SAFETY RULES</p> <p>SHI-DOO endorses and encourages the safe use of all snowmobiles. Always wear your seat belt. Always wear your seat belt. Always wear your seat belt. Always wear your seat belt.</p> <p>RÈGLEMENTS DE SÉCURITÉ EN MOTONEIGE</p> <p>SHI-DOO approuve et encourage l'utilisation sécuritaire de toutes motoneiges. Respectez toujours ces règlements qui vous permettront de profiter de votre plaisir. Respectez toujours ces règlements qui vous permettront de profiter de votre plaisir. Respectez toujours ces règlements qui vous permettront de profiter de votre plaisir.</p> <p>SÄKERHETSREGLER VID SNÖSKOTERKÖRNING</p> <p>SHI-DOO stöttar och uppmuntrar till säkerhetskörning. Följ alltid dessa regler när du är ute och kör. Följ alltid dessa regler när du är ute och kör. Följ alltid dessa regler när du är ute och kör.</p> <p>MOOTTORIKELKAN TURVASÄÄNNÖT</p> <p>SHI-DOO korostaa ja kannustaa moottorikelkkojen turvallista käyttöä. Käytä aina turvasäätintä. Käytä aina turvasäätintä. Käytä aina turvasäätintä.</p> <p>SIKKERHETSREGLER FOR BRUK AV SNØSKOOTER</p> <p>SHI-DOO støtter og oppmuntre alle til å bruke sikkerhetsregler ved bruk av snøscooter. Følg alltid disse reglene når du er ute og kjører. Følg alltid disse reglene når du er ute og kjører.</p> <p>NORME DI SICUREZZA PER LE MOTOSLITTE</p> <p>SHI-DOO sostiene ed incoraggia la sicurezza delle motoslitte. Per un divertimento continuo di questo sport sempre rispettare le suddette norme. Per un divertimento continuo di questo sport sempre rispettare le suddette norme.</p> <p>スノーモービルの安全運転ルール</p> <p>SHI-DOO は、すべてのスノーモービルを安全に楽しむことを奨励し、安全運転ルールを推奨しています。必ず安全運転ルールを守ってください。必ず安全運転ルールを守ってください。必ず安全運転ルールを守ってください。</p>	<p>1 Don't drink and ride. No booze, no foreleg, you control. Sit up for full control of the snowmobile. Wear safety in multi-weather. Always sign alerts at all diversal occasions.</p> <p>飲酒運転はしないこと。</p> 	<p>2 Always wear a helmet. Properly adjust your seat. Buckle up and use your seat belt. Buckle up and use your seat belt. Buckle up and use your seat belt.</p> <p>常時、ヘルメットを着用すること。</p> 	<p>3 Watch out for thin ice/water. Sit up for full control of the snowmobile. Wear safety in multi-weather. Always sign alerts at all diversal occasions.</p> <p>薄氷や水に注意すること。乗客数を厳守すること。</p> 	<p>4 Use caution when crossing road/train tracks. Do not drink and drive. Do not drink and drive. Do not drink and drive. Do not drink and drive.</p> <p>道路や線路を横断するときには注意すること。</p> 
--	---	---	--	--

Hangtags

This vehicle comes with hangtags containing important safety information. Anyone who rides the vehicle should read and understand this information before riding.

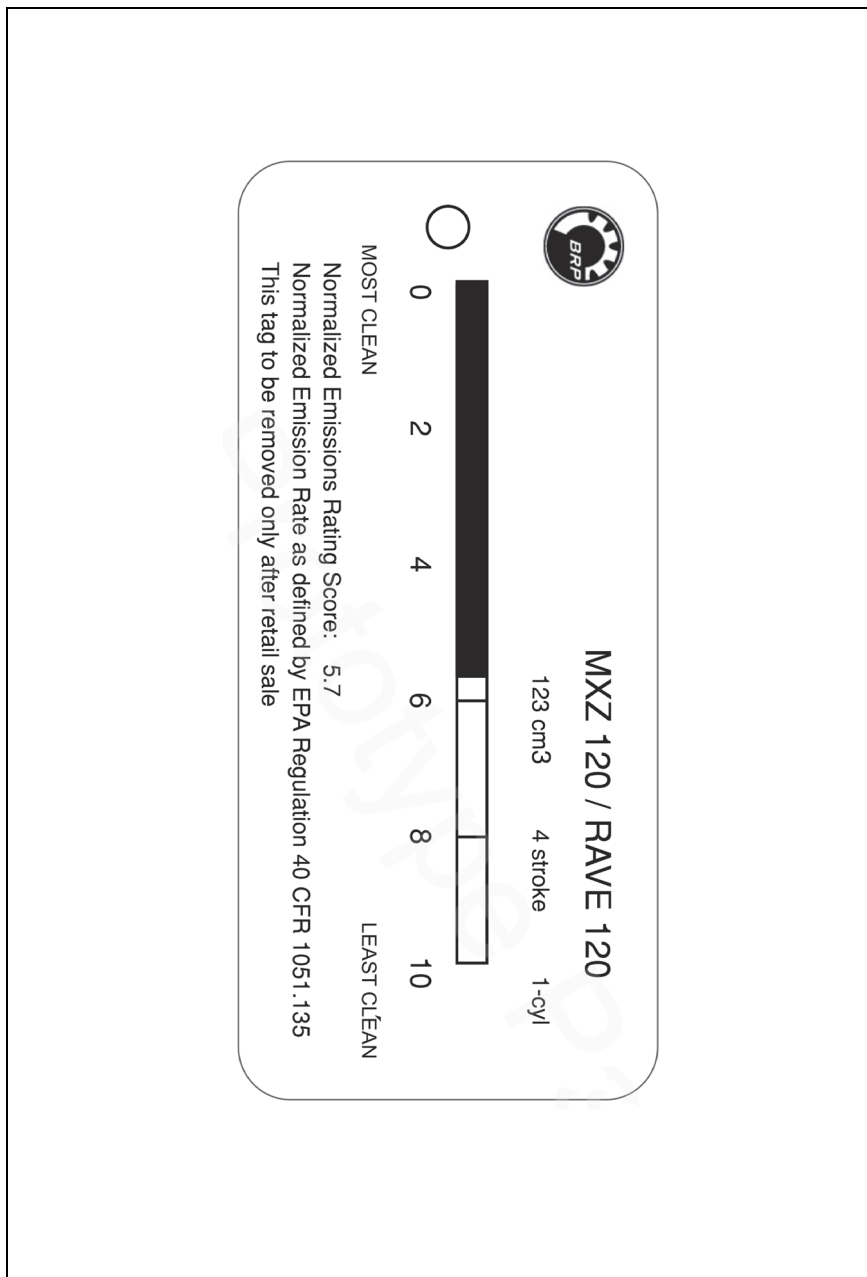

Hangtags

This vehicle comes with hangtags containing important safety information. Anyone who rides the vehicle should read and understand this information before riding.

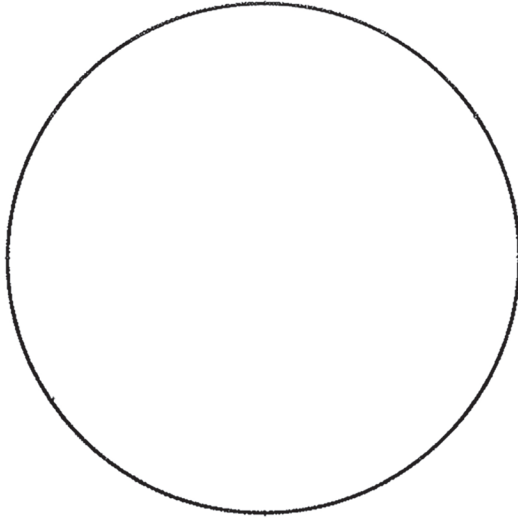

• **CAUTION** •

**4 CYCLE ENGINE
DO NOT USE
MIXED GAS!**

1655-318

Hangtags

This vehicle comes with hangtags containing important safety information. Anyone who rides the vehicle should read and understand this information before riding.

	
SNOWMOBILE SAFETY AND CERTIFICATION COMMITTEE	
SOUND RATING	73/78
<p>THE SOUND EMISSION OF THIS MODEL SNOWMOBILE HAS BEEN MEASURED IN ACCORDANCE WITH SOCIETY OF AUTOMOTIVE ENGINEERS SOUND EMISSION TEST PROCEDURES J1161 AND J192 AT FIFTY FEET (15.2m) AND DOES NOT EXCEED 73 dB (A) TRAVELING AT 15 MILES PER HOUR (24 km/h). NOR 78 dB (A) AT WIDE OPEN THROTTLE. A 2dB (A) TOLERANCE IS PROVIDED IN THE TEST PROCEDURES FOR VARIATIONS IN TESTING CONDITIONS.</p>	
<p>THIS LABEL IS NOT TO BE REMOVED PRIOR TO PURCHASE</p>	<p>THIS LABEL MAY ONLY BE AFFIXED TO A SNOWMOBILE WHICH ALSO BEARS AN SSCC SAFETY CERTIFICATION LABEL.</p>
<p>1655-766</p>	

Warning Labels & Information

This vehicle comes with labels containing important safety information. Anyone who rides the snowmobile should read and understand this information before riding. The labels should be considered as permanent parts of the snowmobile. If a label comes off or becomes hard to read, contact your authorized dealer for a replacement.

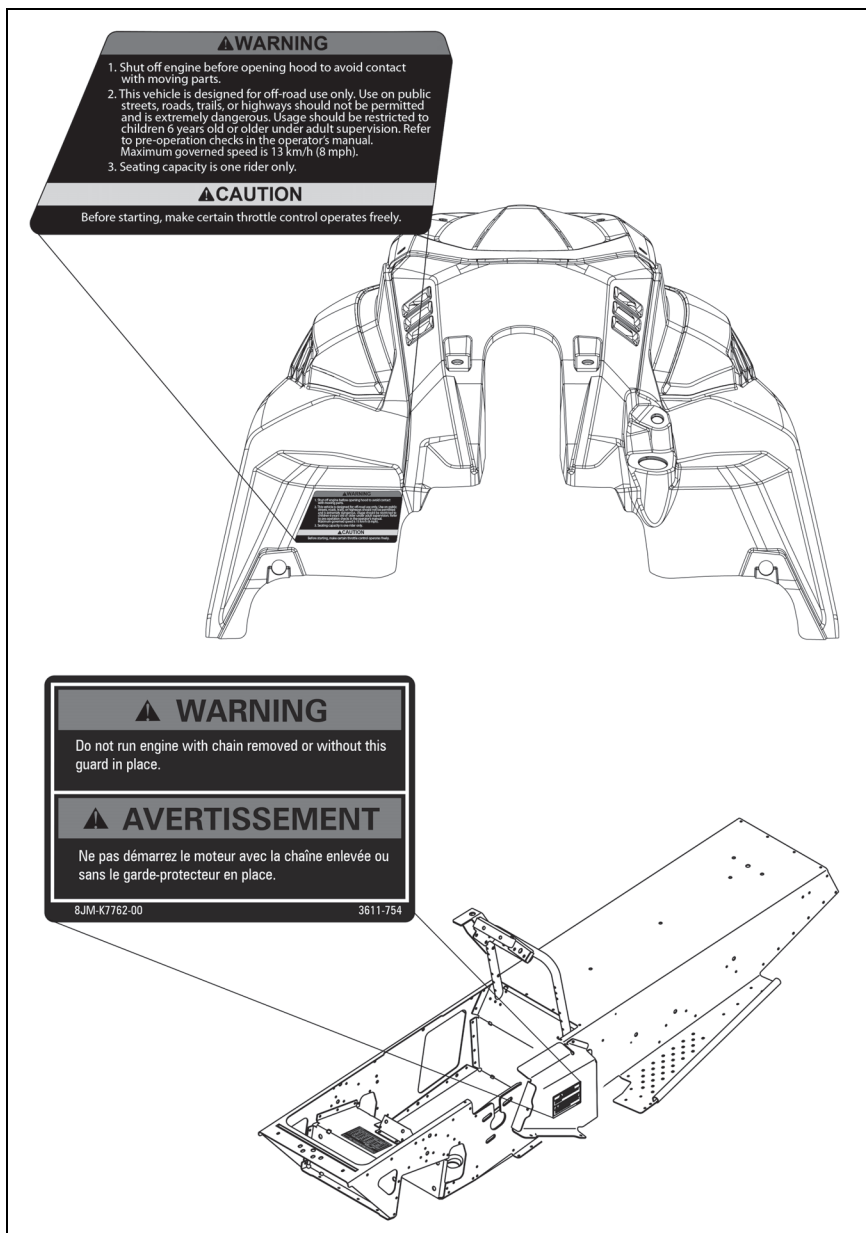

Declaration of Conformity (EU)



565 de la Montagne Street
Valcourt (Québec) J0E 2L0
Canada

www.brp.com

EU Declaration of Conformity

Authorized Representative: BRP-Rotax GmbH Co. KG, Rotaxstrasse 1, Guns kirchen, A-4623, Austria

This declaration of conformity is issued under the sole responsibility of the manufacturer.

The undersigned, representing the manufacturer, hereby declares that model year **2025 Snowmobiles** marked with the **CE** mark and a 17-character vehicle identification number (VIN) structured as **4UF9S4ExxSTxxxxxx** under commercial names **Ski-Doo (000YWSC00)** & **Lynx (000LYSA00)** comply with all the relevant provisions of the following Directives and Regulations:

Machinery Directive 2006/42/EC as amended up to and including Reg. 2019/1243/EU ISO 12100:2010

Non-Road Mobile Machinery (NRMM) Regulation (EU) 2016/1628 on gaseous pollutants

Electromagnetic Compatibility (EMC) Directive 2014/30/EU as amended up to and including Reg. (EU) 2018/1139 CISPR 12:2007/A1:2009 & IEC 61000-6-1:2005 or UN R10.04 or later version

Battery Directive 2006/66/EC as amended up to and including Dir. (EU) 2018/849

Radio Equipment (RED) Directive 2014/53/EU as amended up to and including Reg. 2018/1139 (If fitted with radio frequency (RF) D.E.S.S. key)

Dominic Tessier

Dominic Tessier (Nov 13, 2023 17:02 EST)

Dominic Tessier, Eng.
Director, Vehicle Engineering, Ski-Doo
Bombardier Recreational Products Inc.

Valcourt, QC, Canada

Nov 13, 2023

ski-doo LYNX SEVADOO EVINRUDE ROTAX CAN-AM

Declaration of Conformity (UK)



BRP Finland Oy
PL 8040 (Isoaavantie 7)
FI-96101 Rovaniemi, Finland
T 358 40 800 7700
F 358 16 318 114
www.brp.com

UK Declaration of Conformity

Authorized Representative: BRP UK Ltd., (BWM Accountants Limited), Suite 5.1, 12
Tithebarn Street, Liverpool, L2 2DT

This declaration of conformity is issued under the sole responsibility of the manufacturer.

The undersigned, representing the manufacturer, hereby declares that model year **2025** Snowmobile marked with the ^{UK}CA mark and a 17-character vehicle identification number (VIN) structured as **4UF9S4ExxSTxxxxxx** under commercial names **Ski-Doo (000YWSC00) & Lynx (000LYSA00)** comply with all the relevant provisions of the following UK Statutory instrument and Regulations:

The Supply of Machinery (Safety) Regulations 2008, ISO 12100:2010
UK Statutory Instrument 2008/1597 as amended up
to and including SI 2020/1112

Non-Road Mobile Machinery (Type-Approval and
Emission of Gaseous and Particulate Pollutants)
Regulation 2018, UK SI 2018/764 as amended up to
and including SI 2020/1393

Electromagnetic Compatibility Regulations 2016, UK CISPR 12:2007/A1:2009 &
SI 2016/1091 as amended up to and including SI IEC 61000-6-1:2005 or
2020/1112 UN R10.04 or later version

Batteries and Accumulators (Placing on the Market)
Regulations 2008, UK SI 2008/2164 as amended up
to and including UK SI 2020/904

Radio Equipment Regulations 2017, UK SI
2017/1206 as amended up to and including SI
2020/1112

Dominic Tessier

Dominic Tessier (Nov 13, 2023 17:01 EST)

Dominic Tessier, Eng.
Director, Vehicle Engineering, Ski-Doo
Bombardier Recreational Products Inc.

Valcourt, QC, Canada

Nov 13, 2023

ski-doo LYNX SEVADO EVIRUDE ROTAX CAN-AM

Emissions Regulation 2016/1628 (EU models)

Equipment complies with Emissions Regulation 2016/1628 as shown by a Non-Road Mobile Machinery (NRMM) identification decal on the engine cylinder head cover.

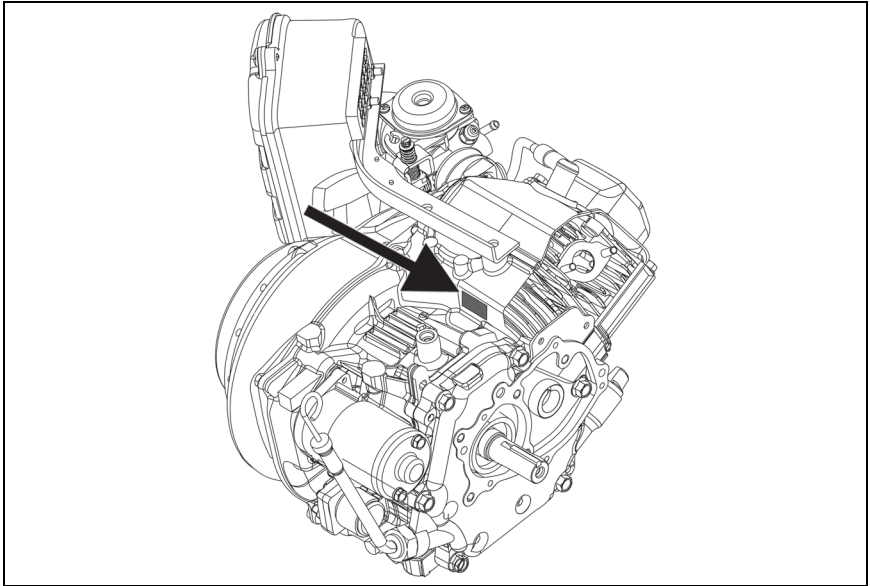

ONS-311

Reporting Safety Defects

In Canada, if you believe that your vehicle has a defect which could cause a crash or could cause injury or death, you should immediately inform Transport Canada in addition to notifying Bombardier Recreational Products Inc.

If Transport Canada receives similar complaints, it may open an investigation, and if it finds that a safety defect exists in a group of vehicles, it may order a recall and remedy campaign. However, Transport Canada cannot become involved in any individual problems between you, your dealer or Bombardier Recreational Products Inc.

To contact Transport Canada

PHONE

- 819-994-3328 (Gatineau-Ottawa area or internationally)

MAIL

- Transport Canada - ASFAD
330 Sparks Street
Ottawa, ON
K1A 0N5

INTERNET

- <http://www.tc.gc.ca/recalls>

Preparing to Safely Operate the MXZ 120

■ **NOTE:** This section and Operating the MXZ 120 section must be read and explained to the child/operator by the owner/parent/guardian. Refer to Control Locations or the snowmobile while explaining this section.

Like most boys and girls, you are anxiously waiting to drive the snowmobile. Remember that the snowmobile is not a toy. It must be driven carefully at all times!

First, you must understand the controls, know where the controls are, and know how to use them correctly.

- A. **BRAKE LEVER** — To slow down or stop the snowmobile, the brake lever should be pulled (squeezed) toward the handlebar grip.

■ **NOTE:** When the brake is being used, the throttle lever must be in the idle (released) position.

- B. **THROTTLE LEVER** — Controls the speed of the snowmobile. The closer the throttle control lever is to the handlebar grip (the more it is squeezed), the faster the snowmobile will go.
- C. **IGNITION SWITCH** — When the key is in the OFF position, the engine will neither start nor run. If the key is in the RUN position, the engine will start and run.
- D. **EMERGENCY STOP SWITCH** — If something happens that you do not understand or if there is an emergency, move the emergency stop switch to the OFF (down) position to immediately stop the engine.
- E. **TETHER SWITCH** — The engine will neither start nor run unless the tether switch cap is connected to the tether switch located on the top right-hand side of the console. The tether cord **MUST BE** attached to the operator before attempting to start the engine.

Second, you must check several things every time before the engine is started.

- A. Make sure the brake lever works properly (moves freely) by pulling (squeezing) the brake lever and releasing it several times.
- B. Make sure the throttle lever works properly (moves freely) and that it snaps back to the idle position quickly when it is released. The idle position is when the throttle lever is farthest away from the handlebar grip. If the throttle lever does not snap back quickly, the engine must not be started and the throttle system must be repaired.
- C. Make sure that you have enough clothes on to keep yourself warm but **NEVER** wear clothes such as long or loose scarves or long shoe laces that could get caught in a moving part of the snowmobile.

Third, make sure that you can answer yes to all of the following questions before each ride.

- A. Do you have permission from the owner or parent or guardian to operate the snowmobile?
- B. Are you wearing an approved safety helmet?
- C. Are you wearing something to protect your eyes (such as goggles or a visor)?
- D. Are you dressed warmly enough?
- E. Has your parent or guardian checked to make sure you have enough gasoline?
- F. Do the throttle lever and brake lever move freely?
- G. Are all shields and covers in the right place and is the hood securely latched?
- H. Do you have a safe area to ride in? Is the area free of rocks, wires, trees, traffic, etc.?

Operating the MXZ 120

You must be a responsible, careful, and considerate snowmobile operator at all times. Your safety is our concern and must always be yours.

- A. When you are learning how to operate the snowmobile, have a parent or guardian take you to an open area to practice figure eights, starting, and stopping. This practice is important and will give you a good “feel” of the snowmobile. You will also be able to learn how the snowmobile handles under different conditions (deep snow, hard-packed snow, etc.).
- B. Always sit on the seat and keep both feet on the running boards when operating the snowmobile. Do not get off the snowmobile until it has come to a complete stop.
- C. Never drive the snowmobile faster than a safe speed. Do not drive too close to roads, buildings, trees, other snowmobiles, or people. Never show off!
- D. Never operate the snowmobile unless the headlight and taillight are in working order.
- E. The snowmobile is designed for your enjoyment. DO NOT give rides to your friends. It is made to carry only one person.
- F. Do not pull sleds, sleighs, etc., behind the snowmobile.
- G. If you get stuck, shut the engine off and get help.

General Information

Control Locations

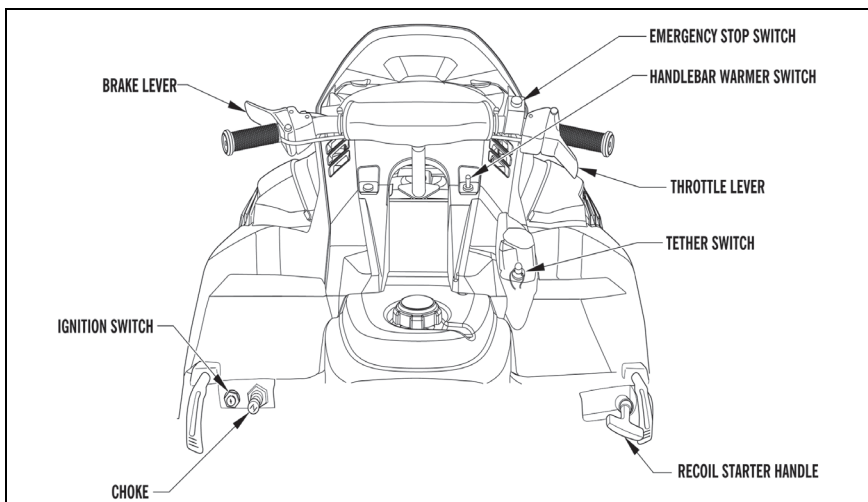

0753-830

Snowmobile Identification

This snowmobile has two identification numbers: The Vehicle Identification Number (VIN) is stamped into the right side of the tunnel and the Engine Serial Number (ESN) is on the front side of the recoil cover.

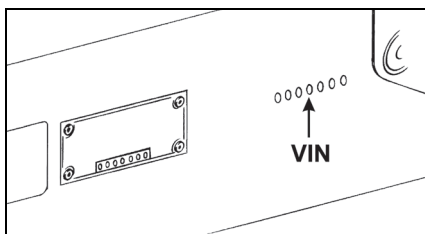

0726-200

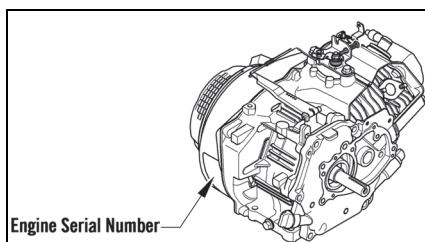

0744-926

These numbers are required by the dealer to complete warranty claims properly. No warranty will be allowed by BRP if either the ESN or VIN is removed or mutilated in any way.

Always provide the snowmobile model name, VIN, and engine serial number when contacting an authorized BRP Snowmobile dealer for parts, service, accessories, or warranty.

Gasoline — Oil

This snowmobile has a four-cycle engine; therefore, it is unnecessary to premix gasoline and oil.

Fuel Requirements

CAUTION

Always use fresh gasoline. Gasoline will oxidize; the result is loss of octane, volatile compounds, and the production of gum and varnish deposits which can damage the fuel system.

Alcohol fuel blending varies by country and region. Your vehicle has been designed to operate using the recommended fuels, however, be aware of the following:

Use of fuel containing alcohol above the percentage specified by government regulations is not recommended and can result in the following problems in the fuel system components:

- Starting and operating difficulties.
- Deterioration of rubber or plastic parts.
- Corrosion of metal parts.
- Damage to internal engine parts.
- Inspect frequently for the presence of fuel leaks or other fuel system abnormalities if you suspect the presence of alcohol in gasoline exceeds the current government regulations.
- Alcohol blended fuels attract and hold moisture which may lead to fuel phase separation and can result in engine performance problems or engine damage.

Recommended Fuel

Use unleaded gasoline containing MAXIMUM 10% ethanol. The gasoline must have the following minimum octane requirements.

Fuel Type	Engine	Minimum Octane Rating
Fuel with NO ethanol	120	87 Pump Posted AKI (RON+MON)/2 92 RON
Fuel which may contain up to 10% MAX ethanol	120	91 AKI (RON+MON)/2 95 RON

CAUTION

Never experiment with other fuels. Engine or fuel system damages may occur with the use of an inadequate fuel.

CAUTION

Do NOT use fuel from fuel pumps labeled E85.

Use of fuel labeled E15 is prohibited by U.S. EPA Regulations.

Recommended Oil

■ **NOTE:** This snowmobile comes from the factory with SAE 0W-40 synthetic oil installed.

The recommended oil to use in the engine is XPS 0W-40 Synthetic oil. See the viscosity chart for details.

CAUTION

Any oil used in place of the recommended oil may cause serious engine damage.

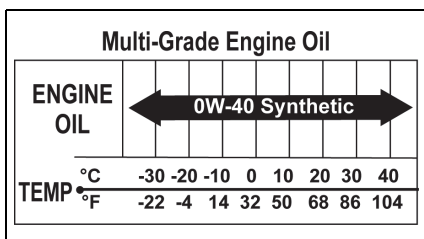

OILCHART.J

Engine Break-In

The engine requires a short break-in period (approximately 10 operating hours) before being subjected to heavy load conditions or full-throttle operation. Strict adherence to the break-in procedure will contribute to optimum performance and longevity of the engine.

During break-in, a maximum of 1/2 throttle is recommended; however, brief full-throttle accelerations and variations in driving speeds contribute to good engine break-in. After the 10-hour break-in period, the snowmobile may be taken to an authorized BRP Snowmobile dealer for a checkup and oil change. This service is at the discretion and expense of the snowmobile owner.

Muffler

The muffler is designed to reduce engine noise and improve the total performance of the engine. If the muffler is removed from the engine, severe engine damage will result.

Operating Instructions

Starting and Stopping Engine

WARNING

Never allow anyone to stand in front of the snowmobile at any time, especially when starting the engine.

It is imperative that all safety checks found in the accompanying Snowmobile Safety Handbook be performed before attempting to start the engine.

This snowmobile is equipped with a recoil starter. The recoil starter handle is located on the lower right-hand side of the console.

NOTE: If the recoil starter rope should break or if the recoil starter should malfunction, take the snowmobile to an authorized BRP Snowmobile dealer for service.

To start the engine, use the following procedure:

1. Test the throttle lever by completely compressing and releasing it several times. The lever **MUST** return to the idle position quickly and completely.
2. Open the gas tank shut-off valve located under the gas tank by rotating the valve counterclockwise. Open the valve completely; otherwise, it may close during operation of the snowmobile due to engine vibration.

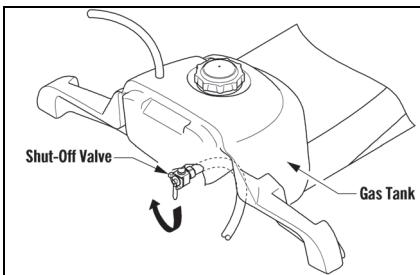

0744-944

3. Insert the key into the ignition switch; then rotate the key to the RUN position.

NOTE: Make sure the emergency stop switch is in the ON (up) position and the tether cap is connected to the tether switch.

4. For a cold engine, pull the choke out completely. If the engine is warm, choking is not normally necessary.
5. Pull the recoil starter handle slowly until resistance is felt; then give a short quick pull. The engine should start; however, if the engine does not start, repeat this step.

CAUTION

To avoid damaging the recoil starter, DO NOT pull the recoil starter rope to its limit or release the recoil starter handle from an extended position. Allow recoil rope to rewind slowly.

6. When the engine starts, push the choke approximately half way in. Allow a cold engine to “warm up” for approximately 2-3 minutes. The choke should be pushed in completely after the “warm up.”
7. Flooding — If the engine does not start when the choke is being used but seems ready to start, push the choke in completely.

NOTE: Continued choking will only cause the engine to flood more.

NOTE: If the engine fails to start during the attempt with the throttle lever compressed, remove the spark plug and clean and dry it thoroughly or install a new, properly gapped, recommended spark plug.

8. To shut the engine off, turn the ignition key to the OFF position, move the emergency stop switch to the OFF (down) position, or pull the tether cap from the tether switch.

NOTE: Unless the engine will be started within a short period of time, close the gas tank shut-off valve (located under the gas tank) by rotating the valve clockwise.

CAUTION

If the snowmobile is not to be used for an extended period of time, be sure to close the gas tank shut-off valve.

Periodic Maintenance/Tune-Up Chart

	Daily	1st 10 Hours (2 Weeks)	Every 20 Hours (1 Month)	Every 50 Hours (3 Months)	Every 100 Hours (6 Months)	Every 300 Hours (12 Months)
Valve Clearance						IA
Engine Compression						I
Spark Plug					I	
Fuel Supply Hose	I-R					Replace every 3 years
Gas Tank Shut-Off Valve	I				IC*	
Carburetor Float Chamber	I				C*	
Engine Oil	I	R*			R*	
Nuts/Screws/Bolts	I			T		
Rear Suspension			IC			
Recoil Starter	I					I-IC-IL-*
Air Filter			I*	C*		
Carburetor						IC
Pilot Air Screw						IA
In-Line Fuel Filter			I			

C = Clean
 I = Inspect
 R = Replace
 T = Tighten

IA = Inspect and adjust (if necessary)
 IC = Inspect and clean (replace if necessary)
 IL = Inspect and lubricate (replace if necessary)
 * = Service more frequently if used in adverse conditions

Maintenance

Engine Oil

■ **NOTE:** After the engine break-in period, the engine oil should be changed every 100 operating hours (6 months) and before prolonged storage.

Checking

The engine oil level should be checked each day before operating the snowmobile. To check the engine oil level, use the following procedure:

■ **NOTE:** The front of the snowmobile must be elevated until the bottom of the front bumper is approximately 47 cm (18.5 in.) off the floor when checking the oil level. Also, ensure the engine is “cooled down” to room temperature to allow the oil to drain into the sump.



BRP-003A

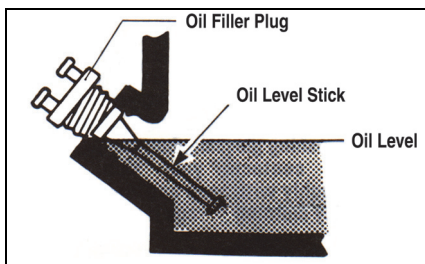

1. Release the two hold-down straps and open the hood.
2. Rotate the oil level stick counter-clockwise; then remove the stick from the crankcase and wipe it clean.

CAUTION

Clean the area around the fill hole to keep dirt, debris, etc., out of the engine.

3. Insert the stick into the crankcase and remove and check oil level on the stick.

CAUTION

Seeing oil in the crankcase does not mean the level is in the safe operating range. Always use the oil level stick to check engine oil. Never operate the engine with the oil level below the point of overflowing the fill hole.

■ **NOTE:** If the oil level is below the oil level mark, add recommended oil until it reaches the oil level mark.

4. Insert the oil level stick into the crankcase; then rotate the stick clockwise until snug.
5. Close the hood and secure with the straps.

Changing

To change the engine oil, use the following procedure:

■ **NOTE:** The front of the snowmobile must be elevated until the engine is in a level position when changing the oil.

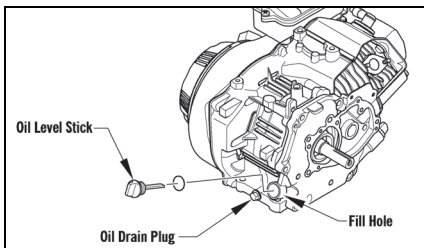

1. Remove the access plug; then place a drain pan beneath the engine.
2. Release the two hold-down straps and open the hood.
3. Loosen the oil level stick; then remove the oil drain plug from the crankcase and allow the oil to drain.
4. Install the drain plug.
5. Remove the oil level stick; then pour 600 mL (20.3 fl oz) of recommended oil into the fill hole.

6. Install the oil level stick; then tighten until snug. Install the access plug.
7. Close the hood and secure with the straps.

Carburetor

The carburetor has been calibrated for average riding conditions; however, altitude, temperature, and general wear may necessitate certain carburetor adjustments. Since carburetor adjustments critically affect engine performance, BRP recommends that any changes in internal carburetor calibration be made by an authorized BRP Snowmobile dealer; however, three external adjustments can be made on the carburetor. These are the throttle stop screw, idle fuel adjuster screw, and throttle cable.

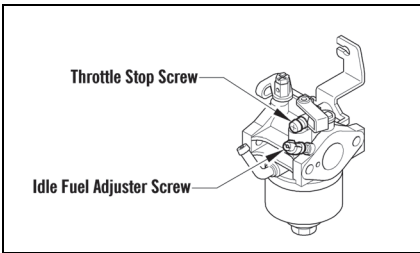

0744-921

Throttle Stop Screw

This screw controls the seating position of the throttle valve which in turn determines the proper idle speed. Rotate the screw clockwise to increase engine idle speed and counterclockwise to decrease engine idle speed.

Idle Fuel Adjuster Screw

This adjuster screw determines the fuel/air mixture for idling. To adjust, use the following procedure:

1. Start the engine and allow to run at half throttle 5-10 minutes to warm up.
2. Place the throttle in the idle position; then rotate the idle fuel adjuster screw/cap in or out within the adjustment range to obtain smooth low speed performance.

Throttle Cable

The correct throttle cable adjustment is when (with the engine OFF) the carburetor throttle is completely open (against its limit) while the throttle lever lightly contacts the handlebar grip. The throttle arm on the carburetor should also contact the speed control screw when the throttle lever is released.

To adjust the throttle cable, use the following procedure:

⚠ WARNING

Do not attempt to adjust the throttle cable with the engine running. Personal injury could result.

1. Loosen the throttle cable jam nuts.

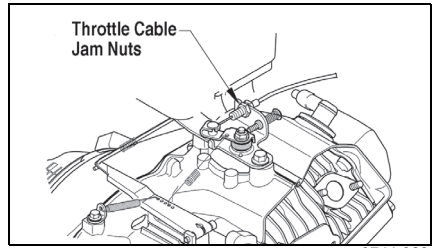

0744-922

2. Pull all slack from the throttle cable wire and exert slight tension on the wire.
3. Tighten the throttle cable jam nuts.

⚠ WARNING

DO NOT operate the snowmobile when any component in the throttle system is damaged, frayed, kinked, worn, or improperly adjusted. If the snowmobile is operated when the throttle system is not functioning properly, personal injury could result.

Speed Control Screw

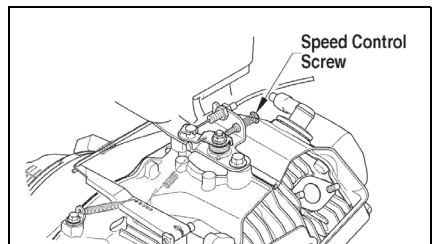

0744-949

The maximum speed of the snowmobile can be reduced by adjusting the speed control screw.

To reduce the maximum speed, rotate the speed control screw clockwise. **DO NOT EVER INCREASE THE MAXIMUM SPEED BEYOND THE ORIGINAL 8 MPH (12.8 KM/H) MAXIMUM!**

In-Line Fuel Filter

WARNING

Whenever any maintenance or inspection is made on a fuel system when there may be fuel leakage, there should be no welding, smoking, open flames, etc., in the area.

BRP recommends that the in-line fuel filter be checked once a month. The filter is located in the fuel hose between the gas tank and carburetor. The only cleaning possible is to back-flush the filter using clean gasoline. To check, clean, or replace the filter, use the following procedure:

1. Turn the gas tank shut-off valve to the CLOSED position.
2. Remove and discard the clamps; then pry the fuel hoses off the in-line fuel filter and remove the filter.
3. Install the in-line fuel filter in the fuel hose so the arrow on the filter points toward the carburetor. Make sure the fuel hoses fit tightly on the filter. If a fuel hose does not fit tightly, cut 6 mm (1/4 in.) from the end of the fuel hose; then install on the filter. Install new clamps.

CAUTION

The fuel hoses must fit tightly on the fuel filter. If the fuel hose length doesn't permit this procedure, replace the fuel hose. Also, after installing the fuel hoses on the filter, check to be sure that the fuel hoses do not contact any hot or rotating components.

4. Turn the gas tank shut-off valve to the OPEN position.

Air Cleaner/Filter

The air filter inside the air cleaner housing must be kept clean to provide good engine power and gas mileage. If the snowmobile is used under normal conditions, service the filter at the intervals specified. If operated in adverse conditions, inspect and service the filter more frequently. Use the following procedure to remove the filter and to inspect and/or clean it.

CAUTION

Failure to inspect the air filter frequently if the snowmobile is used in adverse conditions can damage the engine.

1. Remove the two screws securing the air cleaner cover; then remove the cover.
2. Remove the foam filter from the housing.
3. Clean the foam filter in a non-flammable cleaning solvent; then allow the filter to dry.
4. Put the dry filter in a plastic bag; then pour in recommended air filter oil and work the oil into the filter.

CAUTION

A torn air filter can cause damage to the engine. Contaminants may get inside the engine if the filter is torn. Carefully examine the filter for tears before and after cleaning it. Replace the filter with a new one if it is torn.

5. Clean any debris from inside the air cleaner. Be sure no debris enters the carburetor.
6. Place the filter into the housing.
7. Place the air cleaner cover onto the housing; then secure with the two screws.

Spark Plug

This snowmobile comes equipped with a specified spark plug. See the Specifications chart on page 36 for the correct spark plug type. To help prevent cold weather fouling, make sure to thoroughly warm up the engine before operating.

To maintain a hot, strong spark, keep the plug free of carbon.

Before removing the spark plug, be sure to clean the area around the spark plug. If you do not, dirt could enter engine when removing or installing the spark plug.

Adjust the gap to specified amount (see Specifications chart on page 36) for proper ignition. Use a feeler gauge to check the gap.

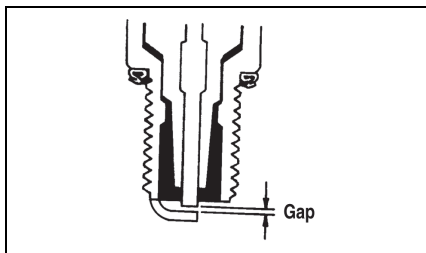

ATV0052B

When installing the spark plug, be sure to tighten it securely. A new spark plug should be tightened 1/2 turn once the washer contacts the cylinder head. A used spark plug should be tightened 1/8-1/4 turn once the washer contacts the cylinder head.

Brake

WARNING

DO NOT operate the snowmobile when any component in the brake system is damaged, worn, or adjusted improperly.

BRP recommends that the complete brake system be checked daily for wear or damage and for smooth operation. Periodically, the brake band should be inspected for cracks and to ensure the liner is intact and not worn excessively. Replace the brake band if cracked or worn excessively.

Checking Brake Lever Travel

1. Compress the brake lever fully.
2. Check the distance between the brake lever and the lever stop. The distance must be within the specified range of 6-13 mm (1/4-1/2 in.).

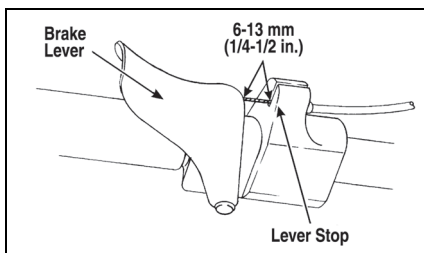

ONS-412

3. If travel distance is not as specified, adjust the brake.

Adjusting Brake Lever Travel

To adjust the brake lever travel, use the following procedure:

1. Remove the drive chain shield.
2. Loosen the rearward brake cable jam nut; then tighten the forward jam nut to set up the brake.

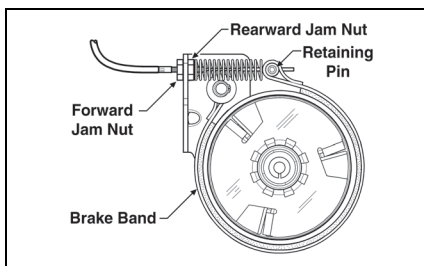

0735-457

3. Check the brake lever travel distance periodically while tightening the forward jam nut. When the distance is within the specified range of 6-13 mm (1/4-1/2 in.), tighten the rearward jam nut to secure the adjustment.

Drive Chain

The drive chain should be lubricated every 10 operating hours with Synthetic Chain Lube or with a suitable dry, graphite-based chain lubricant. By using the recommended chain lube or a dry, graphite-based chain lubricant, dirt buildup on the drive chain will be minimized. Before each lubrication, inspect the drive chain for dirt accumulation.

To lubricate the drive chain, shut the engine off and wait for all moving parts to stop, remove the drive chain shield, and lubricate the drive chain. After lubricating the drive chain, install the drive chain shield.

■ **NOTE:** If the recommended chain lube or a dry, graphite-based chain lubricant is not available, lubricate the drive chain with several drops of petroleum-based oil. If the snowmobile is operated in the summer with the optional wheel kit, the drive chain should be lubricated more frequently.

Drive Chain Tensioner

The drive chain tensioner is automatic; therefore, no adjustment is required by the snowmobile owner. The tensioner and chain should be checked annually for proper operation and excessive wear and replaced when necessary. Check the tensioner by pushing down on it and releasing it. It should immediately spring back and put tension on the drive chain.

Track Tension

■ **NOTE:** Track tension and track alignment are interrelated; therefore, always check both, even if only one adjustment seems necessary.

Track tension is directly related to the overall performance of the snowmobile. If the track is too loose, it may slap against the tunnel causing wear, or it may ratchet on the track drive sprockets. BRP recommends that the track tension be checked once a month and adjusted accordingly.

WARNING

Track tension must be properly maintained. Personal injury could result if a track is allowed to become excessively loose.

Checking

WARNING

DO NOT attempt to check or adjust track tension with engine running. Turn ignition key to the OFF position. Personal injury could result from contact with a rotating track.

1. Remove excess ice and snow buildup from the track, track drive sprockets, and the inside of the skid frame.
2. Place the rear of the snowmobile up on a safety stand high enough so the track is free of the floor.
3. Without exerting any pressure on the track, measure the distance between the bottom of the wear strip and the inside surface of the track. The measurement must be within specifications of 6.4-9.5 mm (1/4-3/8 in.). If the measurement is not within specifications, an adjustment is necessary.

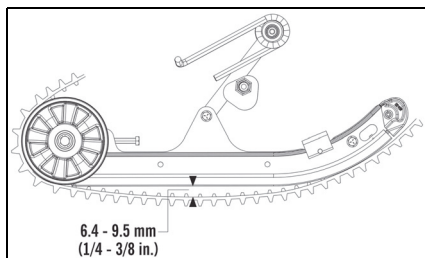

0755-095

Adjusting

1. Loosen the idler wheel bolts.
2. If the deflection (distance between the bottom of the wear strip and the inside of the track) exceeds specifications, tighten the adjusting bolts to take up excessive slack in the track.
3. If the distance between the bottom of the wear strip and the inside surface of the track is less than specified, loosen the adjusting bolts to increase the slack in the track.

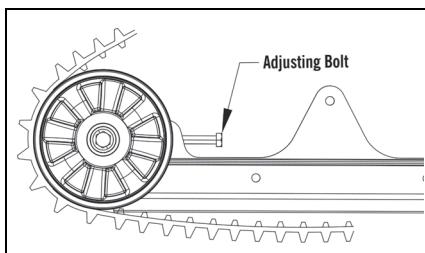

0755-096

■ **NOTE:** To ensure proper track tension adjustment, perform all adjustments on both sides of the snowmobile.

4. Check track alignment (see Track Alignment section).
5. When proper track tension is obtained, tighten idler wheel bolts securely.

■ **NOTE:** Since track tension and track alignment are interrelated, always check both even if only one adjustment seems necessary.

⚠ WARNING

Always make sure the adjusting bolts are snug against the axle and the idler wheel bolts are tightened to specifications. Failure to do so could cause the track to become extremely loose and, under some operating conditions, allow the idler wheels to climb over the track lugs forcing the track against the tunnel causing the track to "lock." If a track "locks" during operation, severe personal injury could result.

Track Alignment

Proper track alignment is obtained when the idler wheels are equal distance from the edge of the track. Excessive wear to the idler wheels, drive lugs, and track will occur if the track is improperly aligned. BRP recommends that the track alignment be checked once a week or whenever the track tension is adjusted.

Checking

⚠ WARNING

Make sure the ignition key is in the OFF position and the track is not rotating before checking or adjusting track alignment. Personal injury could result if contact is made with a rotating track.

1. Remove excess ice and snow buildup from the track, track drive sprockets, and the inside of the skid frame.
2. Position the tips of the skis against a wall; then using a shielded safety stand, raise the rear of the snowmobile off the floor making sure the track is free to rotate.

⚠ WARNING

The tips of the skis must be positioned against a wall or similar object for safety.

3. Start the engine and accelerate slightly. Use only enough throttle to turn the track several revolutions. SHUT ENGINE OFF.

■ **NOTE:** Allow the track to coast to a stop. DO NOT apply the brake because it could produce an inaccurate alignment condition.

4. When the track stops rotating, check the relationship of the idler wheels and the outside edge of the track. If the distance from the idler wheels to the outside edge of the track is the same on both sides, no adjustment is necessary.

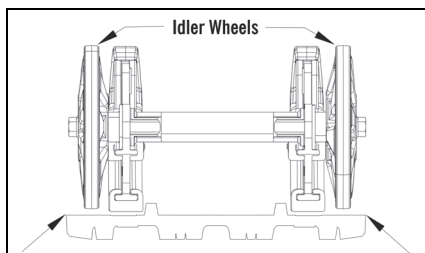

0755-097

5. If the distance from the idler wheels to the inner track drive lugs is not the same on both sides, an adjustment is necessary.

Adjusting

1. On the side of the track which has the inner track drive lugs closer to the idler wheel, loosen the idler wheel bolt and the adjusting bolt jam nut; then rotate the adjusting bolt clockwise 1 to 1-1/2 turns.

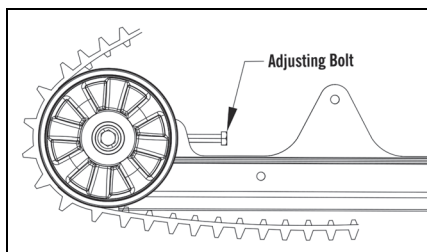

0755-096

2. Check track alignment and continue adjustment until proper alignment is obtained.

■ **NOTE:** Make sure correct track tension is maintained after adjusting track alignment (see Track Tension section).

3. After proper track alignment is obtained, tighten the idler wheel bolt securely.

WARNING

Always make sure the adjusting bolts are snug against the axle and the idler wheel bolts are tightened to specifications. Failure to do so could cause the track to become extremely loose and, under some operating conditions, allow the idler wheels to climb over the track lugs forcing the track against the tunnel causing the track to "lock." If a track "locks" during operation, severe personal injury could result.

4. Field test the track under actual conditions.
5. After the field test, check the alignment of the track. If additional adjustment is necessary, repeat Adjusting Track Alignment procedure.

Adjusting Front Ski Shock Springs

The front ski shock springs are individually adjustable for the driving style of the operator.

■ **NOTE:** Equal adjustments should be maintained on both sides of the snowmobile.

The front shock absorbers have a preload adjustment sleeve with five preload adjustment positions to increase or decrease coil spring tension.

To adjust the spring tension, rotate the preload adjustment sleeve with a suitable spanner wrench until the desired spring tension is achieved.

Position	Spring Tension	Setting	Load
1	↓ ↓ ↓ ↓ ↓	Soft	Light
2		↑	↑
3		↕	↕
4		↓	↓
5		Stronger	Stiff

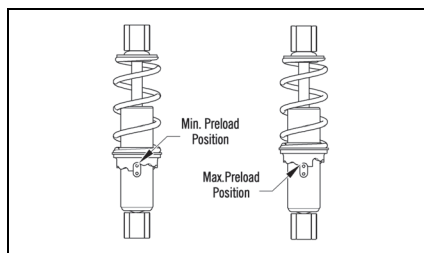

0753-279

Adjusting Rear Spring Tension

Rear spring tension adjustment is accomplished by rotating the adjusting cams. Position 3 provides the stiffest ride, and position 1 is for the light driver or slow-speed trail riding. Position 2 is for the average operator under normal conditions. Always rotate the cam from the lighter position to the heavier position.

CAUTION

Never force the adjustment cams from the low position to the high position. Cam damage may occur.

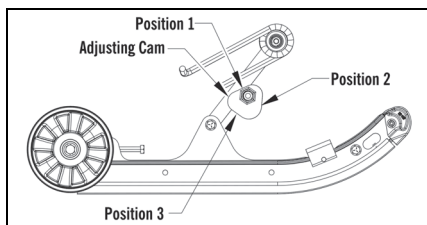

Using a 13/16-in. wrench, rotate the cam until it is in the desired position. To stiffen the ride, rotate the cam so as to raise the spring end. Make the adjustment on the other cam and be sure both cams are adjusted equally.

Ski Alignment

The skis have been aligned during setup of the snowmobile. Ski alignment usually will not change unless a rock or similar hard object is hit while the snowmobile is being operated. BRP recommends that the ski alignment be checked once a week.

Checking

1. Turn the handlebar to the straight-ahead position.
2. Measure the distances to the inside edges of the skis. Make sure the measurements are taken behind the front mount bracket and ahead of the rear mount bracket.

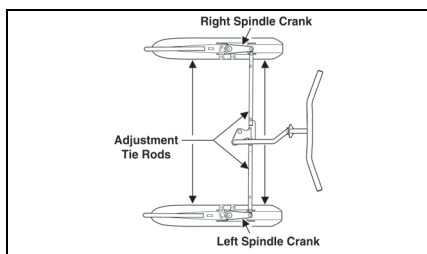

■ **NOTE:** Ski alignment is correct when the skis are parallel to each other (equal measurements front and rear) or when the skis have up to a maximum of 6 mm (1/4 in.) “toe out” (front measurement 6 mm (1/4 in.) more than rear measurement).

3. If ski alignment is not as specified, the snowmobile will have a tendency to wander and may be difficult to control; therefore, an adjustment is necessary.

Adjusting

1. Make sure the ignition key is in the OFF position.
2. Visually examine the skis to determine which ski is out of alignment with respect to the handlebar.
3. Open the hood and loosen the jam nut on each end of the adjustment tie rod.
4. While holding the ski in position, rotate the adjustment tie rod until the measurement between the skis is within specifications.
5. When the ski alignment is correct, apply blue Loctite 243 to the jam nut threaded areas and tighten each jam nut securely against its adjustment tie rod.

⚠ WARNING

Neglecting to lock the tie rod by tightening the jam nuts against the adjustment tie rod may cause loss of snowmobile control and possible personal injury.

Ski Wear Bar

The ski wear bar is a replaceable bar attached to the underside of the ski. The purpose of the wear bar is to assist in turning the snowmobile, to minimize ski wear, and to maintain good steering control. If the snowmobile is operated primarily in deep snow, ski wear bar wear will be minimal; however, if the snowmobile is operated on terrain where the snow cover is minimal, the ski wear bar will wear faster.

To maintain positive steering characteristics, BRP recommends that the ski wear bars be checked once a week and replaced if worn to 1/2 of original diameter. Ski wear bars are available from an authorized BRP Snowmobile dealer.

WARNING

Operating the snowmobile with excessively worn ski wear bars may result in a loss of steering control.

Removing

1. Raise the front of the snowmobile.
2. Remove the lock nuts securing the wear bar to the ski.

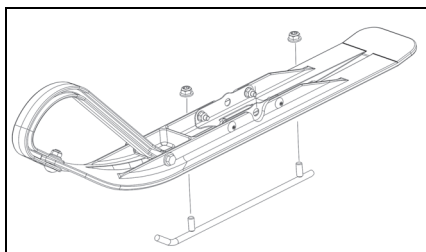

SNO-945

3. Remove the wear bar.

Installing

1. Insert the wear bar studs into the holes in the ski.
2. Center the wear bar studs in the holes and install the lock nuts.
3. Tighten lock nuts securely.

Recoil Starter Air Vents

It is important for proper engine cooling that the air vents located on the recoil starter are kept clean. These air vents should be checked periodically and cleaned if necessary.

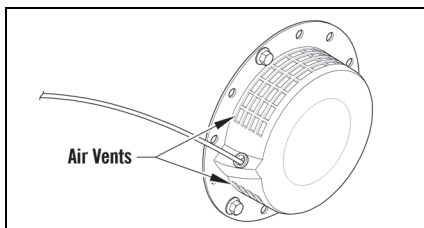

0744-923

CAUTION

Serious overheating of the engine and engine damage will result if the air vents are not kept clean.

Lights

To change the headlight bulb, use the following procedure:

1. Open the hood; then disconnect the harness connector from the headlight bulb.
2. Remove the bulb from the housing by rotating it counterclockwise until loose.

CAUTION

Do not touch the glass portion of the bulb. If the glass portion is touched, it must be cleaned with a dry cloth before installing.

3. Install the new bulb into the housing; then rotate the bulb clockwise to lock it into place.

The headlight aim can be adjusted to provide maximum illumination for the operator. To adjust headlight aim, adjust the screw until maximum illumination for the operator is apparent.

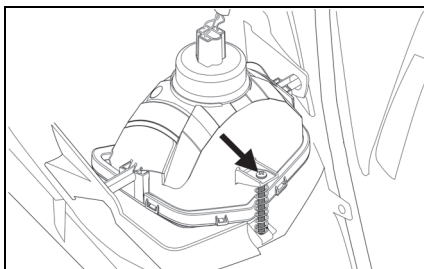

0752-957

Maintenance Records

Send photocopy of maintenance record to BRP if needed.

Pre-Delivery	
Serial Number:	Signature/Print:
Mileage/km:	
Hours:	
Date:	
Dealer no:	
Notes:	
Refer to vehicle Pre-Delivery Bulletin for detailed installation procedures	

First Inspection	
Mileage/km:	Signature/Print:
Hours:	
Date:	
Dealer no:	
Notes:	
For maintenance schedule refer to Maintenance Information section of this operator's guide.	

Service

Mileage/km:	Signature/Print:
Hours:	
Date:	
Dealer no:	
Notes:	

For maintenance schedule refer to Maintenance Information section of this operator's guide.

Service

Mileage/km:	Signature/Print:
Hours:	
Date:	
Dealer no:	
Notes:	

For maintenance schedule refer to Maintenance Information section of this operator's guide.

Service

Mileage/km:	Signature/Print:
Hours:	
Date:	
Dealer no:	
Notes:	

For maintenance schedule refer to Maintenance Information section of this operator's guide.

Service

Mileage/km:	Signature/Print:
Hours:	
Date:	
Dealer no:	
Notes:	

For maintenance schedule refer to Maintenance Information section of this operator's guide.

Service

Mileage/km:	Signature/Print:
Hours:	
Date:	
Dealer no:	
Notes:	

For maintenance schedule refer to Maintenance Information section of this operator's guide.

Service

Mileage/km:	Signature/Print:
Hours:	
Date:	
Dealer no:	
Notes:	

For maintenance schedule refer to Maintenance Information section of this operator's guide.

Service

Mileage/km:	Signature/Print:
Hours:	
Date:	
Dealer no:	
Notes:	

For maintenance schedule refer to Maintenance Information section of this operator's guide.

Service

Mileage/km:	Signature/Print:
Hours:	
Date:	
Dealer no:	
Notes:	

For maintenance schedule refer to Maintenance Information section of this operator's guide.

Service

Mileage/km:	Signature/Print:
Hours:	
Date:	
Dealer no:	
Notes:	

For maintenance schedule refer to Maintenance Information section of this operator's guide.

Service

Mileage/km:

Signature/Print:

Hours:

Date:

Dealer no:

Notes:

For maintenance schedule refer to Maintenance Information section of this operator's guide.

Service

Mileage/km:

Signature/Print:

Hours:

Date:

Dealer no:

Notes:

For maintenance schedule refer to Maintenance Information section of this operator's guide.

Service

Mileage/km:

Signature/Print:

Hours:

Date:

Dealer no:

Notes:

For maintenance schedule refer to Maintenance Information section of this operator's guide.

Preparation for Storage

Prior to storing the snowmobile, it is extremely important that it be properly serviced to prevent corrosion and component deterioration. BRP recommends the following procedure to prepare the snowmobile for storage:

1. Clean the seat cushion with Vinyl Protectant and a damp cloth.
2. Clean the snowmobile thoroughly by hosing dirt, oil, grass, and other foreign matter from the undercarriage, tunnel, hood, and belly pan. Allow the snowmobile to dry thoroughly. DO NOT get water into any part of the engine.
3. Drain all gas from the gas tank. Close the gas tank shut-off valve by rotating it clockwise; then drain the gasoline from the carburetor by loosening the drain screw on the carburetor float chamber.
4. Plug the muffler outlet with a clean cloth.
5. With the ignition key in the OFF position:
 - A. Disconnect the high tension wire from the spark plug; then remove the spark plug.
 - B. Pour 10 mL (approximately two teaspoons) of petroleum-based oil into the spark plug hole; then pull the recoil starter handle slowly about five times.
- C. Install the spark plug and connect the high tension wire.
6. Remove the drive chain and clean thoroughly in a solvent. Install drive chain and lubricate with a dry, graphite-based chain lubricant.
7. Change the oil; then clean the air filter.
8. Tighten all screws, nuts, and bolts securely.
9. Make sure all rivets holding components together are tight. Replace all loose rivets.
10. Clean and polish the hood, console, and chassis with XPS Spray Cleaner and Polish. DO NOT USE SOLVENTS. THE PROPELLANT WILL DAMAGE THE FINISH.
11. If possible, store the snowmobile indoors. Raise the rear of the snowmobile off the floor and block up the rear end. Cover the snowmobile with a snowmobile cover to protect it from dirt and dust.
12. If the snowmobile must be stored outdoors, block the entire snowmobile off the ground and cover it with a snowmobile cover to protect it from dirt, dust, and rain.

CAUTION

Never crank the engine over without grounding the spark plug. Damage to the transistorized ignition may result.

CAUTION

Avoid using a plastic cover as moisture will collect on the snowmobile causing corrosion.

Preparation after Storage

Taking the snowmobile out of storage and correctly preparing it for operation will ensure many miles and hours of trouble-free snowmobiling. BRP recommends the following procedure to prepare the snowmobile:

1. Clean the snowmobile thoroughly. Polish the exterior of the snowmobile using the cleaner.
2. Clean the engine cooling fins and the recoil starter vents. Remove the cloth from the muffler.
3. Check all control wires and cables for signs of wear or fraying. Replace if necessary. Use cable ties or tape to route wires and cables away from hot or rotating parts.
4. Inspect the drive chain and drive chain tightener. Replace if necessary.
5. Lubricate the drive chain with recommended lube or with a dry, graphite-based chain lubricant.
6. Check brake-lever travel distance, all controls, ski alignment, track tension, track alignment, brake band, and ski wear bars; adjust or replace as necessary.
7. Examine the in-line fuel filter and clean or replace if necessary.
8. Fill the gas tank.
9. Clean the seat cushion with the vinyl protectant.
10. Check the spark plug (clean, gap, and/or replace as necessary); then start the engine and ensure proper carburetor adjustments.

Specifications

ENGINE AND DRIVE	
Type	Forced Air Cooled/4-Cycle
Bore x Stroke	56 x 50 mm (2.2 x 1.97 in.)
Valve Arrangement	Overhead
Displacement	123 cc (7.5 cu in.)
Lighting Coil Output	12V/55W
Compression Ratio	8.3:1
Lubrication	Forced Splash
Cooling System	Forced Air
Drive Clutch	Centrifugal
Drive Chain Tensioner	Automatic
Brake Type	Band
Ignition Type	Transistorized
Track Width	25.4 cm (10 in.)
Track Length	170.1 cm (67 in.)
Track Tension (Range)	6.4-9.5 mm (1/4-3/8 in.)
Track Style	Cobra
Spark Plug Type	NGK BPR4ES
Spark Plug Gap	0.7-0.8 mm (0.028-0.031 in.)
Ignition Timing (Fixed)	24° BTDC @ 3600 RPM
CARBURETOR	
Type	Mikuni BV18-11-84Z1
CHASSIS	
Overall Length	185.4 cm (73 in.)
Overall Height	86.3 cm (34 in.)
Overall Width	91.4 cm (36 in.)
Ski Center-to-Center Distance (Stance)	77.4 cm (30.5 in.)
MISCELLANEOUS	
Gasoline (Recommended)	87 Minimum Octane Regular Unleaded
Gas Tank Capacity (Rated)	1.7 L (0.45 U.S. gal.)
Engine Oil (Recommended)	Synthetic 0W-40
Crankcase Oil Capacity	600 mL (20.3 fl oz)
Air Cleaner	Semi-Dry Polyurethane Foam Element
Taillight (p/n)	0609-934
Headlight Bulb (p/n)	0609-991
Starting System	Manual Recoil
Dry Weight	75.0 kg (167 lb)
Vibration — Hand/Arm	< 2.5 m/s ²
Vibration — Seat	< 0.5 m/s ²

Specifications subject to change without notice.

Warranty

BRP LIMITED WARRANTY USA AND CANADA: 2025 SKI-DOO® SNOWMOBILES

SCOPE OF THE LIMITED WARRANTY

Bombardier Recreational Products Inc. (“BRP”) warrants its 2025 Ski-Doo snowmobiles sold by authorized BRP dealers (as defined below) in the United States of America (“USA”) and in Canada from defects in material or workmanship for the period and under the conditions described below. This limited warranty will become null and void if: (1) the snowmobile was used for racing or any other competitive activity, at any point, even by a previous owner; or (2) the snowmobile has been altered or modified in such a way so as to adversely affect its operation, performance or durability, or has been altered or modified to change its intended use.

Non-factory installed parts and accessories are not covered under this limited warranty. Please refer to the applicable parts and accessories limited warranty text.

LIMITATIONS OF LIABILITY

THIS WARRANTY IS EXPRESSLY GIVEN AND ACCEPTED IN LIEU OF ANY AND ALL OTHER WARRANTIES, EXPRESSED OR IMPLIED, INCLUDING WITHOUT LIMITATION ANY WARRANTY OF MERCHANTABILITY OR FITNESS FOR A PARTICULAR PURPOSE. TO THE EXTENT THAT THEY CANNOT BE DISCLAIMED, THE IMPLIED WARRANTIES ARE LIMITED IN DURATION TO THE LIFE OF THE EXPRESS WARRANTY. INCIDENTAL AND CONSEQUENTIAL DAMAGES ARE EXCLUDED FROM COVERAGE UNDER THIS WARRANTY. SOME STATES/PROVINCES DO NOT ALLOW FOR THE DISCLAIMERS, LIMITATIONS AND EXCLUSIONS IDENTIFIED ABOVE, AS A RESULT, THEY MAY NOT APPLY TO YOU. THIS WARRANTY GIVES YOU SPECIFIC RIGHTS, AND YOU MAY ALSO HAVE OTHER LEGAL RIGHTS WHICH MAY VARY FROM STATE TO STATE, OR PROVINCE TO PROVINCE.

Neither the distributor, any BRP dealer nor any other person has been authorized to make any affirmation, representation or warranty regarding the product, other than those contained in this limited warranty, and if made, shall not be enforceable against BRP. BRP reserves the right to modify this limited warranty at any time, being understood that such modification will not alter the warranty conditions applicable to the products sold while this warranty is in effect.

EXCLUSIONS - ARE NOT WARRANTED

The following are not warranted under any circumstances:

- Normal wear and tear;
- Routine maintenance items, tune ups, adjustments;
- Damage caused by failure to provide proper maintenance and/or storage, as described in the Operator's Guide;
- Damage resulting from removal of parts, improper repairs, service, maintenance, modifications or use of parts or accessories not manufactured or approved by BRP or resulting from repairs done by a person that is not an authorized servicing BRP dealer;
- Damage caused by abuse, abnormal use, neglect, use of the product on surfaces other than snow, or operation of the product in a manner inconsistent with the recommended operation described in the Operator's Guide;
- Damage resulting from accident, submersion, fire, theft, vandalism or any act of God;
- Operation with fuels, oils or lubricants which are not suitable for use with the product (see the Operator's Guide);

- Snow or water ingestion;
- Incidental or consequential damages, or damages of any kind including without limitation towing, storage, telephone, rental, taxi, inconvenience, insurance coverage, loan payments, loss of time, loss of income; and
- Damage resulting from studs installed on tracks if the installation does not conform to BRP's instructions.

WARRANTY COVERAGE PERIOD

This limited warranty will be in effect from the date of delivery to the first retail consumer or the date the product is first put into use, whichever occurs first and for the following period:

TWELVE (12) CONSECUTIVE MONTHS, for private or commercial use owners. However, the warranty coverage period on a snowmobile delivered between June 1st and December 1st of a given year will expire November 30th of the following year.

For emission-related components; please also refer to the US EPA EMISSION-RELATED WARRANTY US EPA EMISSION-RELATED WARRANTY contained herein.

The repair or replacement of parts or the performance of service under this warranty does not extend the life of this warranty beyond its original expiration date.

CONDITIONS REQUIRED FOR WARRANTY COVERAGE

This warranty coverage is available only if each of the following conditions has been fulfilled:

- The 2025 Ski-Doo snowmobile must be purchased as new and unused by its first owner from a BRP dealer authorized to distribute Ski-Doo snowmobiles in the country in which the sale occurred ("BRP dealer");
- The BRP specified pre-delivery inspection process must be completed and documented and signed by the purchaser;
- The 2025 Ski-Doo snowmobile must have undergone proper registration by an authorized BRP dealer;
- The 2025 Ski-Doo snowmobile must be purchased in the country in which the purchaser resides; and
- Routine maintenance outlined in the Operator's Guide must be timely performed in order to maintain warranty coverage. BRP reserves the right to make warranty coverage contingent upon proof of proper maintenance.

BRP will not honor this limited warranty to any private use owner or commercial use owner if one of the preceding conditions has not been met. Such limitations are necessary in order to allow BRP to preserve both the safety of its products, and also that of its consumers and the general public.

WHAT TO DO TO OBTAIN WARRANTY COVERAGE

The customer must cease using the snowmobile upon the appearance of an anomaly. The customer must notify a servicing BRP dealer within three (3) days of the appearance of a defect, and provide it with reasonable access to the product and reasonable opportunity to repair it. The customer must also present to the authorized BRP dealer, proof of purchase of the product and must sign the repair/work order prior to starting the repair in order to validate the warranty repair. All parts replaced under this limited warranty become the property of BRP.

WHAT BRP WILL DO

BRP's obligations under this warranty are limited to, at its sole discretion, repairing parts found defective under normal use, maintenance and service, or replacing such parts without charge for parts and labor, at any authorized BRP dealer during the warranty coverage period under the conditions described herein. No claim of breach of warranty shall be cause for cancellation or rescission of the sale of the snowmobile to the owner.

In the event that service is required outside of the country of original sale, the owner will bear responsibility for any additional charges due to local practices and conditions, such as, but not limited to, freight, insurance, taxes, license fees, import duties, and any and all other financial charges, including those levied by governments, states, territories and their respective agencies.

BRP reserves the right to improve or modify products from time to time without assuming any obligation to modify products previously manufactured.

TRANSFER

If the ownership of a product is transferred during the warranty coverage period, this limited warranty, subject to its terms and conditions, shall also be transferred and be valid for the remaining coverage period provided BRP or an authorized Ski-Doo Distributor/Dealer receives a proof that the former owner agreed to the transfer of ownership, in addition to the co-ordinates of the new owner.

CONSUMER ASSISTANCE

In the event of a controversy or a dispute in connection with this limited warranty, BRP suggests that you try to resolve the issue at the dealership level. We recommend discussing the issue with the authorized dealer's service manager or owner.

If the matter still remains unresolved, contact BRP by filling out the customer contact form at www.brp.com or contact BRP by mail at one of the addresses listed under the CONTACT US section of this guide.

US EPA EMISSION-RELATED WARRANTY

Bombardier Recreational Products Inc. ("BRP") warrants to the ultimate purchaser and each subsequent purchaser that this new engine, including all parts of its exhaust emission-control system and its evaporative emission-control system, meets two conditions:

1. It is designed, built, and equipped so it conforms at the time of sale to the ultimate purchaser with the requirements of 40 CFR 1051 and 40 CFR 1060.
2. It is free from defects in materials and workmanship that may keep it from meeting the requirements of 40 CFR 1051 and 40 CFR 1060.

Where a warrantable condition exists, BRP will repair or replace, as it elects, any part or component with a defect in materials or workmanship that would increase the engine's emissions of any regulated pollutant within the stated warranty period at no cost to the owner, including expenses related to diagnosing and repairing or replacing emission-related parts. All defective parts replaced under this warranty become the property of BRP.

For all emission-related warranty claims, BRP is limiting the diagnosis and repair of emission-related parts to the authorized Ski-Doo dealers, unless for emergency repairs as required by item 2 of the following list.

As a certifying manufacturer, BRP will not deny emission-related warranty claims based on any of the following:

1. Maintenance or other service BRP or BRP's authorized facilities performed.

2. Engine/equipment repair work that an operator performed to correct an unsafe, emergency condition attributable to BRP as long as the operator tries to restore the engine/equipment to its proper configuration as soon as possible.
3. Any action or inaction by the operator unrelated to the warranty claim.
4. Maintenance that was performed more frequently than BRP specify.
5. Anything that is BRP fault or responsibility.
6. The use of any fuel that is commonly available where the equipment operates unless BRP written maintenance instructions state that this fuel would harm the equipment's emission control system and operators can readily find the proper fuel. See maintenance information section and fuel requirements of fueling section.

Emission-Related Warranty Period

The emission-related warranty is valid for the following period whichever comes first:

	Hours	Months	Kilometers
Exhaust emission-related components	200	30	400
Evaporative emission-related components	N/A	24	N/A

Components Covered

The emission-related warranty covers all components whose failure would increase an engine's emissions of any regulated pollutant, including the following listed components:

1. For exhaust emissions, emission-related components include any engine parts related to the following systems:
 - Air-induction system
 - Fuel system
 - Ignition system
 - Exhaust gas recirculation systems
2. The following parts are also considered emission-related components for exhaust emissions:
 - After treatment devices
 - Crankcase ventilation valves
 - Sensors
 - Electronic control units
3. The following parts are considered emission-related components for evaporative emissions:
 - Fuel tank
 - Fuel cap
 - Fuel line
 - Fuel line fittings
 - Clamps*
 - Pressure relief valves*
 - Control valves*
 - Control solenoids*
 - Electronic controls*
 - Vacuum control diaphragms*
 - Control cables*

- Control linkages*
- Purge valves
- Vapor hoses
- Liquid/vapor separator
- Carbon canister
- Canister mounting brackets
- Carburetor purge port connector

NOTE: *As related to the evaporative emission control system

4. Emission-related components also include any other part whose only purpose is to reduce emissions or whose failure will increase emissions without significantly degrading engine/equipment performance.

Limited Applicability

As a certifying manufacturer, BRP may deny emission-related warranty claims for failures that have been caused by the owner's or operator's improper maintenance or use, by accidents for which the manufacturer has no responsibility, or by acts of God. For example, an emission-related warranty claim need not be honored for failures that have been directly caused by the operator's abuse of the engine/ equipment or the operator's use of the engine/equipment in a manner for which it was not designed and are not attributable to the manufacturer in anyway.

If you have any question regarding your warranty rights and responsibility or for the name and location of the nearest authorized BRP dealer, you should contact BRP by filling out the customer contact form at www.brp.com or contact BRP by mail at one of the addresses listed under the CONTACT US section of this guide, or call at 1-888-272-9222.

BRP INTERNATIONAL LIMITED WARRANTY: 2025 SKI-DOO® SNOWMOBILES

SCOPE OF THE LIMITED WARRANTY

Bombardier Recreational Products Inc. (“BRP”) warrants its 2025 Ski-Doo snowmobiles sold by distributors or dealers authorized by BRP to distribute Ski-Doo snowmobiles (“Ski-Doo Distributor/Dealer”) outside of the fifty United States, Canada, members of the European Economic Area (which is comprised of the member states of the European Union plus the United Kingdom, Norway, Iceland and Liechtenstein) (“EEA”), members states of the Commonwealth of the Independent States (including Ukraine and Turkmenistan) (“CIS”) and Turkey, from defects in material or workmanship for the period and under the conditions described below.

Non-factory installed parts and accessories are not covered under this limited warranty. Please refer to the applicable parts and accessories limited warranty text.

This limited warranty will become null and void if: (1) the snowmobile was used for racing or any other competitive activity, at any point, even by a previous owner; or (2) the snowmobile has been altered or modified in such a way so as to adversely affect its operation, performance or durability, or has been altered or modified to change its intended use.

LIMITATIONS OF LIABILITY

TO THE EXTENT PERMITTED BY LAW, THIS WARRANTY IS EXPRESSLY GIVEN AND ACCEPTED IN LIEU OF ANY AND ALL OTHER WARRANTIES, EXPRESSED OR IMPLIED, INCLUDING WITHOUT LIMITATION ANY WARRANTY OF MERCHANTABILITY OR FITNESS FOR A PARTICULAR PURPOSE. TO THE EXTENT THAT THEY CANNOT BE DISCLAIMED, THE IMPLIED WARRANTIES ARE LIMITED IN DURATION TO THE LIFE OF THE EXPRESS WARRANTY. INCIDENTAL AND CONSEQUENTIAL DAMAGES ARE EXCLUDED FROM COVERAGE UNDER THIS WARRANTY. SOME JURISDICTIONS DO NOT ALLOW FOR THE DISCLAIMERS, LIMITATIONS AND EXCLUSIONS IDENTIFIED ABOVE, AS A RESULT, THEY MAY NOT APPLY TO YOU. THIS WARRANTY GIVES YOU SPECIFIC RIGHTS, AND YOU MAY ALSO HAVE OTHER LEGAL RIGHTS WHICH MAY VARY FROM COUNTRY TO COUNTRY. (FOR PRODUCTS PURCHASED IN AUSTRALIA REFER TO “FOR PRODUCTS SOLD IN AUSTRALIA ONLY”). BRP SHALL NOT BE HELD LIABLE IF PRODUCTS OR WARRANTY PARTS ARE NOT AVAILABLE IN CERTAIN COUNTRIES FOR REASONS OUTSIDE OF BRP’S CONTROL.

Neither the Ski-Doo Distributor/Dealer nor any other person has been authorized to make any affirmation, representation or warranty regarding the product, other than those contained in this limited warranty, and if made, shall not be enforceable against BRP.

BRP reserves the right to modify this warranty at any time, being understood that such modification will not alter the warranty conditions applicable to the products sold while this warranty is in effect.

EXCLUSIONS - ARE NOT WARRANTED

The following are not warranted under this limited warranty under any circumstances:

- Normal wear and tear;
- Routine maintenance items, tune ups, adjustments;
- Damage caused by negligence or failure to provide proper maintenance and/or storage, as described in the operator’s guide;

- Damage resulting from removal of parts, improper repairs, service, maintenance, modifications or use of parts or accessories not manufactured or approved by BRP which in its reasonable judgment are either incompatible with the product or adversely affect its operation, performance and durability, or resulting from repairs done by a person that is not an authorized servicing BRP snowmobile distributor/ dealer;
- Damage caused by abuse, abnormal use, neglect, racing or operation of the product on surfaces other than snow, or operation of the product in a manner inconsistent with the recommended operation described in the Operator's Guide;
- Damage resulting from accident, submersion, fire, snow or water ingestion, theft, vandalism or any act of God;
- Operation with fuels, oils or lubricants which are not suitable for use with the product (see the Operator's Guide);
- Damage resulting from rust, corrosion or exposure to the elements;
- Incidental or consequential damages, or damages of any kind including without limitation towing, storage, transportation expenses, telephone, rental, taxi, inconvenience, insurance coverage, loan payments, loss of time, loss of income; or time missed for downtime experience due to service work.
- And damage resulting from studs installed on tracks if the installation does not conform to BRP's instructions.

WARRANTY COVERAGE PERIOD

This warranty will be in effect from (1) the date of delivery to the first retail consumer or (2) the date the product is first put into use, whichever occurs first and for a period of:

TWELVE (12) CONSECUTIVE MONTHS, for private or commercial use owners. However, the warranty coverage period on a snowmobile delivered between June 1st and December 1st of a given year will expire November 30th of the following year.

The repair or replacement of parts or the performance of service under this warranty does not extend the life of this warranty beyond its original expiration date.

Note that the duration and any other modalities of the warranty coverage are subject to the applicable national or local legislation in the customer's country.

FOR PRODUCTS SOLD IN AUSTRALIA ONLY

Nothing in these Warranty terms and conditions should be taken to exclude, restrict or modify the application of any condition, warranty, guarantee, right or remedy conferred or implied under the Competition and Consumer Act 2010 (Cth), including the Australian Consumer Law or any other law, where to do so would contravene that law, or cause any part of these terms and conditions to be void. The benefits given to you under this limited warranty are in addition to other rights and remedies that you have under Australian law.

Our goods come with guarantees that cannot be excluded under the Australian Consumer Law. You are entitled to a replacement or refund for a major failure and for compensation for any other reasonably foreseeable loss or damage. You are also entitled to have the goods repaired or replaced if the goods fail to be of acceptable quality and the failure does not amount to a major failure.

CONDITIONS TO HAVE WARRANTY COVERAGE

This warranty coverage is available only if each of the following conditions has been fulfilled:

- The 2025 Ski-Doo snowmobile must be purchased as new and unused by its first owner from a Ski-Doo Distributor/Dealer authorized to distribute Ski-Doo snowmobiles in the country in which the sale occurred;
- The BRP specified pre-delivery inspection process must be completed and documented;
- The product must have undergone proper registration by an authorized Ski-Doo Distributor/Dealer;
- The 2025 Ski-Doo snowmobile must be purchased in the country or union of countries in which the purchaser resides.
- Routine maintenance outlined in the Operator's Guide must be timely performed in order to maintain warranty coverage. BRP reserves the right to make warranty coverage contingent upon proof of proper maintenance.

BRP will not honor this limited warranty to any private use owner or commercial use owner if one of the preceding conditions has not been met. Such limitations are necessary in order to allow BRP to preserve both the safety of its products, and also that of its consumers and the general public.

WHAT TO DO TO OBTAIN WARRANTY COVERAGE

The customer must cease using the snowmobile upon the appearance of an anomaly. The customer must notify a servicing BRP snowmobile distributor/dealer within two (2) months of the appearance of a defect, and provide it with reasonable access to the product and reasonable opportunity to repair it. The customer must also present to the authorized BRP snowmobile distributor/ dealer, proof of purchase of the product and must sign the repair/work order prior to starting the repair in order to validate the warranty repair. All parts replaced under this limited warranty become the property of BRP.

Note that the notification period is subject to the applicable national or local legislation in customer's country.

WHAT BRP WILL DO

To the extent permitted by law, BRP's obligations under this warranty are limited to, at its sole discretion, repairing parts found defective under normal use, maintenance and service, or replacing such parts without charge for parts and labor, at any authorized Ski-Doo Distributor/Dealer during the warranty coverage period under the conditions described herein. BRP's responsibility is limited to making the required repairs or replacements of parts. No claim of breach of warranty shall be cause for cancellation or rescission of the sale of the snowmobile to the owner. You may have other legal rights which may vary from country to country.

In the event that service is required outside of the country of original sale, the owner will bear responsibility for any additional charges due to local practices and conditions, such as, but not limited to, freight, insurance, taxes, license fees, import duties, and any and all other financial charges, including those levied by governments, states, territories and their respective agencies.

BRP reserves the right to improve or modify products from time to time without assuming any obligation to modify products previously manufactured.

TRANSFER

If the ownership of a product is transferred during the warranty coverage period, this limited warranty, subject to its terms and conditions, shall also be transferred and be valid for the remaining coverage period provided BRP or an authorized Ski-Doo Distributor/Dealer receives a proof that the former owner agreed to the transfer of ownership, in addition to the co-ordinates of the new owner.

CONSUMER ASSISTANCE

In the event of a controversy or a dispute in connection with this limited warranty, BRP suggests that you try to resolve the issue at the Ski-Doo Distributor/Dealer level. We recommend discussing the issue with the authorized Ski-Doo Distributor/Dealer's service manager or owner. If the matter still remains unresolved, contact BRP by filling out the customer contact form at www.brp.com or contact BRP by mail at one of the addresses listed under the CONTACT US section of this guide.

BRP LIMITED WARRANTY FOR THE EUROPEAN ECONOMIC AND THE COMMONWEALTH OF THE INDEPENDENT STATES (CIS) AREAS AND TURKEY: 2025 SKI-DOO® SNOWMOBILES

SCOPE OF THE LIMITED WARRANTY

Bombardier Recreational Products Inc. ("BRP") warrants its 2025 Ski-Doo snowmobiles sold by distributors or dealers authorized by BRP to distribute Ski-Doo snowmobiles ("Ski-Doo Distributor/Dealer") in member states of the European Economic Area (which is comprised of the member states of the European Union plus the United Kingdom, Norway, Iceland and Liechtenstein) ("EEA"), in member states of the Commonwealth of the Independent States (including Ukraine and Turkmenistan) ("CIS") and Turkey from defects in material or workmanship for the period and under the conditions described below.

Non-factory installed parts and accessories are not covered under this limited warranty. Please refer to the applicable parts and accessories limited warranty text.

This limited warranty will become null and void if: (1) the snowmobile was used for racing or any other competitive activity, at any point, even by a previous owner; or (2) the snowmobile has been altered or modified in such a way so as to adversely affect its operation, performance or durability, or has been altered or modified to change its intended use.

LIMITATIONS OF LIABILITY

TO THE EXTENT PERMITTED BY LAW, THIS WARRANTY IS EXPRESSLY GIVEN AND ACCEPTED IN LIEU OF ANY AND ALL OTHER WARRANTIES, EXPRESSED OR IMPLIED, INCLUDING WITHOUT LIMITATION ANY WARRANTY OF MERCHANTABILITY OR FITNESS FOR A PARTICULAR PURPOSE. TO THE EXTENT THAT THEY CANNOT BE DISCLAIMED, THE IMPLIED WARRANTIES ARE LIMITED IN DURATION TO THE LIFE OF THE EXPRESS WARRANTIES. INCIDENTAL AND CONSEQUENTIAL DAMAGES ARE EXCLUDED FROM COVERAGE UNDER THIS WARRANTY. SOME JURISDICTIONS DO NOT ALLOW FOR THE DISCLAIMERS, LIMITATIONS AND EXCLUSIONS IDENTIFIED ABOVE, AS A RESULT, THEY MAY NOT APPLY TO YOU. THIS WARRANTY GIVES YOU SPECIFIC RIGHTS, AND YOU MAY ALSO HAVE OTHER LEGAL RIGHTS WHICH MAY VARY FROM COUNTRY TO COUNTRY. BRP SHALL NOT BE HELD LIABLE IF PRODUCTS OR WARRANTY PARTS ARE NOT AVAILABLE IN CERTAIN COUNTRIES FOR REASONS OUTSIDE OF BRP'S CONTROL.

Neither the Ski-Doo Distributor/Dealer nor any other person has been authorized to make any affirmation, representation or warranty regarding the product, other than those contained in this limited warranty, and if made, shall not be enforceable against BRP.

BRP reserves the right to modify this warranty at any time, being understood that such modification will not alter the warranty conditions applicable to the products sold while this warranty is in effect.

EXCLUSIONS - ARE NOT WARRANTED

The following are not warranted under this limited warranty under any circumstances:

- Normal wear and tear;
- Routine maintenance items, tune ups, adjustments;
- Damage caused by negligence or failure to provide proper maintenance and/or storage, as described in the operator's guide;
- Damage resulting from removal of parts, improper repairs, service, maintenance, modifications or use of parts or accessories not manufactured or approved by BRP which in its reasonable judgment are either incompatible with the product or adversely affect its operation, performance and durability, or resulting from repairs done by a person that is not an authorized servicing BRP snowmobile distributor/ dealer;
- Damage caused by abuse, abnormal use, neglect, racing or operation of the product on surfaces other than snow, or operation of the product in a manner inconsistent with the recommended operation described in the Operator's Guide;
- Damage resulting from accident, submersion, fire, snow or water ingestion, theft, vandalism or any act of God;
- Operation with fuels, oils or lubricants which are not suitable for use with the product (see the Operator's Guide);
- Damage resulting from rust, corrosion or exposure to the elements;
- Incidental or consequential damages, or damages of any kind including without limitation towing, storage, transportation expenses, telephone, rental, taxi, inconvenience, insurance coverage, loan payments, loss of time, loss of income; or time missed for downtime experience due to service work.
- And damage resulting from studs installed on tracks if the installation does not conform to BRP's instructions.

WARRANTY COVERAGE PERIOD

This warranty will be in effect from (1) the date of delivery to the first retail consumer or (2) the date the product is first put into use, whichever occurs first and for a period of:

TWENTY-FOUR (24) CONSECUTIVE MONTHS, for private use owners and TWELVE (12) CONSECUTIVE MONTHS for commercial use owners. However, the warranty coverage period on a snowmobile delivered between June 1st and December 1st of a given year will expire November 30th of the applicable year. A snowmobile is used commercially when it is used in connection with generating income or any work or employment during any part of the warranty period. A snowmobile is also used commercially when, at any point during the warranty period, it has commercial tags or is licensed for commercial use.

The repair or replacement of parts or the performance of service under this warranty does not extend the life of this warranty beyond its original expiration date.

Note that the duration and any other modalities of the warranty coverage are subject to the applicable national or local legislation in the customer's country.

CONDITIONS TO HAVE WARRANTY COVERAGE

This warranty coverage is available only if each of the following conditions has been fulfilled:

- The Product must be purchased as new and unused by its first owner from a Distributor/Dealer authorized to distribute Products in the country (or in the case of the EEA, union of countries) in which the sale occurred (“Distributor/Dealer”);
- The BRP specified pre-delivery inspection process must be completed, documented and signed by the purchaser;
- The Product must have undergone proper registration by an authorized Distributor/Dealer;
- The Product must be purchased in the country (or in the case of the EEA, union of countries) in which the purchaser resides;
- Routine maintenance outlined in the Operator’s Guide must be timely performed in order to maintain warranty coverage. BRP reserves the right to make warranty coverage contingent upon proof of proper maintenance.

BRP will not honor this limited warranty to any private use owner or commercial use owner if one of the preceding conditions has not been met. Such limitations are necessary in order to allow BRP to preserve both the safety of its products, and also that of its consumers and the general public.

WHAT TO DO TO OBTAIN WARRANTY COVERAGE

The customer must cease using the snowmobile upon the appearance of an anomaly. The customer must notify a servicing BRP snowmobile distributor/ dealer within two (2) months of the appearance of a defect, and provide it with reasonable access to the product and reasonable opportunity to repair it. The customer must also present to the authorized BRP snowmobile distributor/ dealer, proof of purchase of the product and must sign the repair/work order prior to starting the repair in order to validate the warranty repair. All parts replaced under this limited warranty become the property of BRP.

Note that the notification period is subject to the applicable national or local legislation in customer's country.

WHAT BRP WILL DO

To the extent permitted by law, BRP’s obligations under this warranty are limited to, at its sole discretion, repairing parts found defective under normal use, maintenance and service, or replacing such parts without charge for parts and labor, at any authorized Ski-Doo Distributor/Dealer during the warranty coverage period under the conditions described herein. BRP’s responsibility is limited to making the required repairs or replacements of parts. No claim of breach of warranty shall be cause for cancellation or rescission of the sale of the snowmobile to the owner. You may have other legal rights which may vary from country to country.

In the event that service is required outside of the country of original sale, or for EEA residents, if service is required outside of the EEA, the owner will bear responsibility for any additional charges due to local practices and conditions, such as, but not limited to, freight, insurance, taxes, license fees, import duties, and any and all other financial charges, including those levied by governments, states, territories and their respective agencies.

BRP reserves the right to improve or modify products from time to time without assuming any obligation to modify products previously manufactured.

TRANSFER

If the ownership of a product is transferred during the warranty coverage period, this limited warranty, subject to its terms and conditions, shall also be transferred and be valid for the remaining coverage period provided BRP or an authorized Ski-Doo Distributor/Dealer receives a proof that the former owner agreed to the transfer of ownership, in addition to the co-ordinates of the new owner.

CONSUMER ASSISTANCE

In the event of a controversy or a dispute in connection with this limited warranty, BRP suggests that you try to resolve the issue at the Ski-Doo Distributor/Dealer level. We recommend discussing the issue with the authorized Ski-Doo Distributor/Dealer's service manager or owner.

If the matter still remains unresolved, contact BRP by filling out the customer contact form at www.brp.com or contact BRP by mail at one of the addresses listed under the CONTACT US section of this guide.

ADDITIONAL TERMS AND CONDITIONS FOR FRANCE ONLY

The following terms and conditions are applicable to products sold in France only:

The seller shall deliver goods that are complying with the contract and shall be responsible for defects existing upon delivery. The seller shall also be responsible for defects resulting from packaging, assembling instructions or the installation when it is its responsibility per the contract or if accomplished under its responsibility. To be compliant with the contract, the good shall:

1. Be fit for normal use for goods similar thereto and, if applicable:
 - Correspond to the description provided by the seller and have the qualities presented to the buyer through sample or model;
 - Have the qualities that a buyer may legitimately expect considering the public declarations of the seller, the manufacturer of its representative, including in advertising or labeling; or
2. Have the characteristics mutually agreed upon as between the parties or be fit for the specific use intended by the buyer and brought to the attention of the seller and which accepted.

The action for failure to comply is prescribed after two years after delivery of the goods. The seller is responsible for the warranty for hidden defects of the good sold if such hidden defects are rendering the good unfit for the intended use, or if they diminish its use in such a way that the buyer would not have acquired the good or would have given a lesser price, had he known. The action for such hidden defects shall be taken by the buyer within 2 years of the discovery of the defect.

Customer Information

Data Privacy Information

Bombardier Recreational Products inc., its affiliates and subsidiaries (“BRP”) is committed to protecting your privacy and support a general policy of openness about how we collect, use and disclose your personal information in the course of managing our relationship with you. **More details can be found by visiting BRP’s Privacy Policy at: <https://brp.com/en/privacy-policy.html> or by scanning the QR Code below.**

Please be assured that we have appropriate security measures in place to ensure that your personal information is protected against loss and unauthorized access.

Your personal information that may be collected by BRP, directly from you or from authorized dealers or authorized third parties, includes:

- **Contact, Demographic & Registration Information** (e.g., name, full address, phone number, email, gender, ownership history, language of communication)
- **Vehicle Information** (e.g., serial number, purchase and delivery date, unit usage, vehicle location and movements)
- **Third Party Information** (e.g., information received from BRP partners, joint-marketing activities information, social media)
- **Technological Information** (e.g., IP address, type of device, operating system, browser type, webpages you view, cookies and similar technologies when you use BRP or dealers’ websites or mobile application)
- **Interaction with BRP Information** (e.g., information collected when you call BRP’s in-house sales representatives, buy items on a BRP web Site, sign up for BRP emails, participate in BRP-sponsored contests and sweepstakes or attend BRP-sponsored events)
- **Transactional Information** (e.g., information necessary to handle returns, payment information when you purchase our products or services through our websites or mobile applications and other issues related to your purchase of BRP products)

This information may be used and processed for the following purposes:

- Safety & Security
- Customer Support for Sales & After Sales (e.g., complete or follow up with you about your purchase or maintenance)
- Registration & Warranty
- Communication (e.g., sending you a BRP satisfaction survey)
- Online Behavioural Advertising, Profiling and Location-Based Services (e.g., offer customized experience)
- Compliance & Dispute Resolution
- Marketing & Advertising
- Assistance (e.g., help with any delivery issues, handle returns, and other issues related to your purchase of BRP products).

We also may use personal information to generate aggregated or statistical data that no longer identifies you personally.

Your personal information may be disclosed to the following: BRP, BRP’s authorized dealerships, distributors, service providers, advertising & market research partners and other authorized third parties.

We may receive information about you from diverse sources, including third parties, such as BRP’s authorized dealerships and partners, with whom we offer services or engage in joint-marketing activities. We may also receive information about you from social media platforms such as Facebook and Twitter, when you interact with us on those platforms.

Depending on the circumstances, your personal information may be communicated outside the region where you reside. Your personal information is retained only for as long as necessary for the purpose for which we obtained it and according to our retention policies.

To exercise your data privacy rights (e.g. right of access, right of rectification), to withdraw your consent in order to be removed from the address list for marketing purposes or for the satisfaction survey or for general data privacy questions, please contact BRP’s Data Protection Officer at or by mail at privacyofficer@brp.com or by mail at: BRP Legal Service, 726 St-Joseph, Valcourt, Quebec, Canada, J0E 2L0.

When BRP processes your personal information, they do so in compliance with its Privacy Policy available at: <https://www.brp.com/en/privacy-policy.html> or by using the following QR Code.



Contact Us

www.brp.com

Europe

Finland

Isoaavantie 7
PL 8040
96101 Rovaniemi

Norway

Ingvald Ystgaardsvei 15
N-7484 Trondheim
Salg, marketing, ettermarked

Sweden

Spinnvägen 15
903 61 Umeå
Sweden 90821

North America

Canada

3200A, rue King Ouest,
Suite 300
Sherbrooke, Québec J1L 1C9

United States of America

10101 Science Drive
Sturtevant, Wisconsin 53177

Change of Address/Ownership

If your address has changed or if you are the new owner of the snowmobile, be sure to notify BRP by either:

- Notifying an authorized BRP snowmobile dealer or distributor.
- **North America Only:** calling at 1-888-272-9222.
- Mailing one of the change of address cards on the following pages at one of the BRP addresses indicated in the Contact Us section of this guide.

In case of change of ownership, please join a proof that the former owner agreed to the transfer.

Notifying BRP, even after the expiration of the limited warranty, is very important as it enables BRP to reach the snowmobile owner if necessary, like when safety recalls are initiated. It is the owner's responsibility to notify BRP.

STOLEN UNITS: If your personal snowmobile is stolen, you should notify BRP or an authorized BRP snowmobile dealer. We will ask you to provide your name, address, phone number, the vehicle identification number and the date it was stolen.

This page is
intentionally blank



CHANGE OF ADDRESS CHANGE OF OWNERSHIP

VEHICLE IDENTIFICATION NUMBER

--	--	--	--	--	--	--	--	--	--	--	--	--	--	--	--	--	--	--	--	--

Model Number

Vehicle Identification Number (V.I.N.)

OLD ADDRESS
OR PREVIOUS OWNER:

NAME

NO.

STREET

APT

CITY

STATE/PROVINCE

ZIP/POSTAL CODE

COUNTRY

TELEPHONE

NEW ADDRESS
OR NEW OWNER:

NAME

NO.

STREET

APT

CITY

STATE/PROVINCE

ZIP/POSTAL CODE

COUNTRY

TELEPHONE

E-MAIL ADDRESS

This page is
intentionally blank

Model No. _____

VEHICLE

IDENTIFICATION NUMBER (V.I.N.) _____

ENGINE

IDENTIFICATION NUMBER (E.I.N.) _____

Owner: _____
NAME

No. STREET APT

CITY STATE/PROVINCE ZIP/POSTAL CODE

Purchase Date _____
YEAR MONTH DAY

Warranty Expiry Date _____
YEAR MONTH DAY

To be completed by the dealer at the time of the sale.

DEALER IMPRINT AREA

⚠ WARNING

Disregarding any of the safety precautions and instructions contained in the operator's guide, safety handbook, safety video and on product safety labels could cause injury including the possibility of death.



®TM AND THE BRP LOGO ARE TRADEMARKS OF BOMBARDIER RECREATIONAL PRODUCTS INC. OR ITS AFFILIATES.
©2024 BOMBARDIER RECREATIONAL PRODUCTS INC.
ALL RIGHTS RESERVED.

www.brp.com

SKI-DOO®

LYNX®

SEA-DOO®

CAN-AM®

ROTAX®

ALUMACRAFT®

MANITOU®

QUINTREX®