

# can-am



## SPYDER RT SERIES

# OPERATOR'S GUIDE

Includes Safety, Use and Maintenance Information

# FOR NEW

### **▲ WARNING**

Learn how the vehicle is different.

Read this operator's guide and watch the safety video on:

<https://can-am.brp.com/spyder/owners/safety/safety-information.html>

Complete a training course (if available), practice and become proficient with the controls.

Consult local laws - license requirements vary by location.

Keep this guide in the front storage compartment.

219002365

Original Instructions

**⚠ WARNING**

Disregarding any of the safety precautions and instructions contained in the Operator's Guide, Safety Video and on product safety labels could cause injury including the possibility of death.

## CALIFORNIA PROPOSITION 65 WARNING

**⚠ WARNING**

Operating, servicing and maintaining a passenger vehicle can expose you to chemicals including engine exhaust, carbon monoxide, phthalates, and lead, which are known to the State of California to cause cancer and birth defects or other reproductive harm. To minimize exposure, avoid breathing exhaust, do not idle the engine except as necessary, service your vehicle in a well-ventilated area and wear gloves or wash your hands frequently when servicing your vehicle. For more information go to [www.p65warnings.ca.gov/products/passenger-vehicle](http://www.p65warnings.ca.gov/products/passenger-vehicle).

™® Trademarks of BRP or its affiliates.

This is a non-exhaustive list of trademarks that are the property of Bombardier Recreational Products Inc. or its affiliates.

Trademarks may not be registered in every jurisdictions.

ACETM

Can-Am®

D.E.S.S.™

ROTAX®

Spyder®

XPS®

All rights reserved. No parts of this Manual may be reproduced in any form without the prior written permission of Bombardier Recreational Products Inc.

©Bombardier Recreational Products Inc. (BRP) 2023

Bombardier Recreational Products (BRP)

Deutsch	Dieses Handbuch ist möglicherweise in Ihrer Landessprache verfügbar. Bitte wenden Sie sich an Ihren Händler oder besuchen Sie: <a href="http://www.operatorsguides.brp.com">www.operatorsguides.brp.com</a>
English	This guide may be available in your language. Check with your dealer or go to: <a href="http://www.operatorsguides.brp.com">www.operatorsguides.brp.com</a>
Español	Es posible que este manual esté disponible en su idioma. Consulte a su distribuidor o visite: <a href="http://www.operatorsguides.brp.com">www.operatorsguides.brp.com</a>
Français	Ce guide peut être disponible dans votre langue. Vérifier avec votre concessionnaire ou aller à: <a href="http://www.operatorsguides.brp.com">www.operatorsguides.brp.com</a>
Italiano	Questa guida potrebbe essere disponibile nella propria lingua. Contattare il concessionario o consultare: <a href="http://www.operatorsguides.brp.com">www.operatorsguides.brp.com</a>
中文	本手册可能有您的语种的翻译版本。请向经销商询问，或者登录 <a href="http://www.operatorsguides.brp.com">www.operatorsguides.brp.com</a> 查询。
日本語	このガイドは、言語によって翻訳版が用意されています。ディーラーに問い合わせるか、次のアドレスでご確認ください： <a href="http://www.operatorsguides.brp.com">www.operatorsguides.brp.com</a>
Nederlands	Deze handleiding kan beschikbaar zijn in uw taal. Vraag het aan uw dealer of ga naar: <a href="http://www.operatorsguides.brp.com">www.operatorsguides.brp.com</a>
Norsk	Denne boken kan finnes tilgjengelig på ditt eget språk. Kontakt din forhandler eller gå til: <a href="http://www.operatorsguides.brp.com">www.operatorsguides.brp.com</a>
Português	Este manual pode estar disponível em seu idioma. Fale com sua concessionária ou visite o site: <a href="http://www.operatorsguides.brp.com">www.operatorsguides.brp.com</a>
Русский	Воспользуйтесь руководством на вашем языке. Узнайте о его наличии у дилера или на странице по адресу <a href="http://www.operatorsguides.brp.com">www.operatorsguides.brp.com</a>
Suomi	Käyttöohjekirja voi olla saatavissa omalla kielelläsi. Tarkista jälleenmyyjältä tai käy osoitteessa: <a href="http://www.operatorsguides.brp.com">www.operatorsguides.brp.com</a>
Svenska	Denna bok kan finnas tillgänglig på ditt språk. Kontakta din återförsäljare eller gå till: <a href="http://www.operatorsguides.brp.com">www.operatorsguides.brp.com</a>

Covered Models
Spyder RT STD
Spyder RT Limited
Spyder RT Sea-to-Sky Edition

In Canada, products are distributed and serviced by Bombardier Recreational Products Inc. (BRP).

In the USA, products are distributed and serviced by BRP US Inc.

In the European Economic Area (which is comprised of the member states of the European Union plus the United Kingdom, Norway, Iceland and Liechtenstein), the Commonwealth of the Independent States (including Ukraine and Turkmenistan) and Turkey, products are distributed and serviced by BRP European Distribution S.A. and other affiliates or subsidiaries of BRP.

For all other countries, products are distributed and serviced by Bombardier Recreational Products Inc. (BRP) or its affiliates.

# TABLE OF CONTENTS

## GENERAL INFORMATION

<b>GENERAL INFORMATION</b> .....	<b>10</b>
Know Before you Go .....	10
Safety Messages .....	10
About this Operator's Guide .....	10
Refer to Other Sources of Information .....	11
Acknowledgment .....	11

## GENERAL PRECAUTIONS

<b>AVOID CARBON MONOXIDE POISONING</b> .....	<b>14</b>
<b>AVOID GASOLINE FIRES AND OTHER HAZARDS</b> .....	<b>15</b>
<b>AVOID BURNS FROM HOT PARTS</b> .....	<b>16</b>
<b>ACCESSORIES AND MODIFICATIONS</b> .....	<b>17</b>

## VEHICLE INFORMATION

<b>PRIMARY CONTROLS</b> .....	<b>20</b>
HANDLEBAR .....	21
THROTTLE .....	21
GEARSHIFT SELECTOR .....	21
BRAKE PEDAL .....	22
PARKING BRAKE BUTTON .....	22
<b>SECONDARY CONTROLS</b> .....	<b>24</b>
IGNITION SWITCH .....	25
SWITCH CLUSTER .....	25
RIGHT MULTIFUNCTION SWITCH .....	27
LEFT MULTIFUNCTION SWITCH .....	29
<b>PASSENGER'S CONTROLS</b> .....	<b>33</b>
Heated Grips Switch .....	33
Heated Seat Switch .....	33
<b>EQUIPMENT</b> .....	<b>34</b>
MIRRORS .....	34
GLOVE BOX .....	34
USB PORTS .....	34
FRONT STORAGE COMPARTMENT .....	35
OPERATOR'S SEAT .....	35
DRIVER'S BACKREST .....	35
PASSENGER'S SEAT .....	36
STORAGE COMPARTMENTS .....	37
HELMET HOOK .....	38
TOOL KIT .....	39
OPERATOR'S GUIDE .....	39
SERVICE COVER .....	39
<b>10.25" COLOR TOUCHSCREEN DISPLAY</b> .....	<b>42</b>
First Safety Display .....	42
Default Display .....	42

Navigating the Digital Display .....	42
Central Display .....	43
Views Display .....	44
Applet Menu .....	46
Icons and Indicators - Multifunction Display .....	51
Messages in Touchscreen Display .....	52
Pairing Your Smartphone Through Bluetooth .....	52
<b>OPERATING MODES .....</b>	<b>54</b>
ECO Mode .....	54
Standard Mode .....	54
Mode Display .....	54
<b>BASIC PROCEDURES .....</b>	<b>55</b>
ADJUSTING THE PASSENGER FOOTREST .....	55
STARTING AND STOPPING THE ENGINE .....	55
OPERATING IN REVERSE .....	57
OPERATION DURING BREAK-IN .....	57
FUELING .....	58
Adjusting the Rear Suspension .....	59
 <b>SAFE OPERATING INSTRUCTIONS</b> 	
<b>WHAT'S DIFFERENT FROM OTHER VEHICLES .....</b>	<b>62</b>
Stability .....	62
Response to Road Conditions .....	62
Brake Pedal .....	62
Parking Brake .....	62
Steering .....	62
Width .....	63
Reverse .....	63
Driver's License and Local Laws .....	63
<b>DRIVING AID TECHNOLOGIES .....</b>	<b>64</b>
Vehicle Stability System (VSS) .....	64
Dynamic Power Steering (DPS) .....	65
<b>UNDERSTANDING RISK ON THE ROAD .....</b>	<b>66</b>
Type of Vehicle .....	66
Operator Skills and Judgment .....	66
Rider Condition .....	67
Vehicle Condition .....	67
Road and Weather Conditions .....	67
<b>RIDING GEAR .....</b>	<b>68</b>
Helmets .....	68
Other Riding Gear .....	68
<b>REQUIRED RIDING SKILLS AND PRACTICE EXERCISES .....</b>	<b>71</b>
Choosing a Practice Area .....	71
Preparing to Ride .....	72
Riding Posture .....	72
Practice Exercises .....	72
Developing Advanced Riding Skills .....	79
<b>STREET STRATEGIES .....</b>	<b>81</b>
Plan your Trip .....	81
Defensive Riding .....	81
Being Visible .....	82

Lane Position .....	83
Common Riding Situations .....	84
Road Conditions and Hazards .....	85
On-Road Emergencies.....	87
Tire Failure.....	87
<b>CARRYING A PASSENGER, CARGO OR TOWING A TRAILER.....</b>	<b>88</b>
Weight Limits .....	88
Operating with Extra Weight .....	88
Carrying a Passenger .....	88
Where to Store Cargo .....	89
Towing a Trailer.....	90
<b>KNOWLEDGE SELF-TEST .....</b>	<b>93</b>
Questionnaire.....	93
Answers.....	96
<b>SAFETY INFORMATION ON THE VEHICLE .....</b>	<b>98</b>
Important Pre-Ride Safety Message.....	99
Safety Hang Tag.....	100
Safety Labels .....	101
<b>REPORTING SAFETY DEFECTS .....</b>	<b>111</b>

### *PRE-RIDE INSPECTION*

<b>PRE-RIDE CHECKLIST .....</b>	<b>114</b>
Before Starting the Vehicle, Inspect the Following: .....	114
Turn Ignition Key to the ON Position:.....	115

### *MAINTENANCE*

<b>MAINTENANCE SCHEDULE .....</b>	<b>118</b>
EPA Regulation - Canadian and USA Vehicles .....	118
Severe Dusty or Wet Conditions – Air Filter Maintenance Guideline.....	118
Break-In Inspection.....	119
Maintenance Schedule.....	119
Maintenance Records .....	124
<b>MAINTENANCE PROCEDURES .....</b>	<b>130</b>
Engine Oil .....	130
Air Filter.....	134
Engine Coolant.....	135
Radiator Fans.....	136
Battery.....	136
Drive Belt .....	137
Wheels and Tires.....	139
Brakes .....	140
Headlights.....	141
<b>VEHICLE CARE .....</b>	<b>144</b>
Cleaning the Vehicle .....	144
Vehicle Protection.....	144
<b>STORAGE AND PRESEASON PREPARATION .....</b>	<b>145</b>
Storage.....	145
Preseason Preparation .....	145

**ROAD SIDE REPAIRS**

**DIAGNOSTIC GUIDELINES ..... 148**  
 Will not Shift into Neutral ..... 148  
 Will not Shift ..... 148  
 Engine Does Not Start ..... 148  
**MESSAGES IN MULTIFUNCTION GAUGE ..... 150**  
**WHAT TO DO IN THE FOLLOWING CIRCUMSTANCES ..... 153**  
 Lost Keys ..... 153  
 Cannot Open the Side Storage Compartment ..... 153  
 Flat Tire ..... 153  
 Dead Battery ..... 153  
**HOW CHANGING A BULB ..... 155**  
 Lights ..... 155  
**HOW REPLACING FUSES ..... 157**  
 Fuses ..... 157  
**HOW TRANSPORTING THE VEHICLE ..... 161**

**TECHNICAL INFORMATION**

**VEHICLE IDENTIFICATION ..... 164**  
 Vehicle Identification Number ..... 164  
 Engine Identification Number ..... 164  
**VEHICLE COMPLIANCE LABELS ..... 165**  
 Safety Compliance Hang Tag ..... 165  
 EPA Compliance Label ..... 165  
 European Compliance Label ..... 165  
 Deployment of Alternative Fuel Infrastructure Compliance Label ..... 165  
**NOISE EMISSION CONTROL SYSTEM REGULATION ..... 167**  
**RADIO FREQUENCY DIGITALLY ENCODED SECURITY SYSTEM (RF D.  
 E.S.S. KEY) ..... 168**  
**MULTIFUNCTION GAUGE REGULATORY INFORMATION ..... 169**

**TECHNICAL SPECIFICATIONS**

**TECHNICAL SPECIFICATIONS ..... 174**

**WARRANTY**

**BRP LIMITED WARRANTY – CANADA AND USA: 2024 CAN-AM®  
 SPYDER® VEHICLE SERIES ..... 182**  
 1) Scope of the Limited Warranty ..... 182  
 2) Limitations of Liability ..... 182  
 3) EXCLUSIONS–Are Not Warranted ..... 182  
 4) Warranty Coverage Period ..... 183  
 5) Conditions to Have Warranty Coverage ..... 184  
 6) What to Do to Obtain Warranty Coverage ..... 184  
 7) What BRP Will Do ..... 184  
 8) Transfer ..... 185  
 9) Consumer Assistance ..... 185



**US EPA EMISSIONS PERFORMANCE WARRANTY ..... 186**  
**US EPA FEDERAL NOISE EMISSION WARRANTY ..... 189**  
**CALIFORNIA EMISSION CONTROL SYSTEM WARRANTY ..... 190**  
 California Emission Control System Warranty Statement ..... 190  
 California Emission Control System Defects Warranty ..... 190  
**BRP INTERNATIONAL LIMITED WARRANTY : 2024 CAN-AM® SPYDER®**  
**SERIES ..... 194**  
 1) Scope of the Limited Warranty ..... 194  
 2) Limitation of Liability ..... 194  
 3) EXCLUSIONS – Are Not Warranted ..... 195  
 4) Warranty Coverage Period ..... 195  
 5) Conditions to Have Warranty Coverage ..... 196  
 6) What to Do to Obtain Warranty Coverage ..... 196  
 7) What BRP Will Do ..... 197  
 8) Transfer ..... 197  
 9) Consumer Assistance ..... 197  
**BRP LIMITED WARRANTY FOR THE EUROPEAN ECONOMIC AREA,**  
**THE COMMONWEALTH OF THE INDEPENDENT STATES AND TURKEY:**  
**2024 CAN-AM® SPYDER® SERIES ..... 198**  
 1) Scope of the Limited Warranty ..... 198  
 2) Limitations of Liability ..... 198  
 3) EXCLUSIONS – Are Not Warranted ..... 199  
 4) Warranty Coverage Period ..... 199  
 5) For Products Sold In France Only ..... 200  
 6) Conditions to Have Warranty Coverage ..... 200  
 7) What to Do to Obtain Warranty Coverage ..... 201  
 8) What BRP Will Do ..... 201  
 9) Transfer ..... 201  
 10) Consumer Assistance ..... 202

**CUSTOMER INFORMATION**

**DATA PRIVACY INFORMATION ..... 204**

This page is intentionally blank

# GENERAL INFORMATION

---

## GENERAL INFORMATION

Congratulations on your purchase of a new Can-Am® 3-wheel vehicle. It is backed by the Bombardier Recreational Products Inc. (BRP) warranty and a large network of authorized dealers ready to provide the parts, service or accessories you may require.

Your dealer is committed to your satisfaction. He has taken training to prepare, inspect and performed the final adjustment of your new vehicle before you took possession of it.

If you need more information concerning the servicing of your vehicle, please ask your dealer.

At delivery, you were informed about the warranty coverage and also, you signed the *PRE-DELIVERY CHECK LIST* to ensure your new vehicle was prepared to your entire satisfaction.

### Know Before you Go

For your safety and the safety of passengers and bystanders, read the following sections before you operate this vehicle:

- *General Precautions*
- *Vehicle Information*
- *Safe Operating Instructions*
- *Pre-ride Inspection.*

Experienced motorcyclists should pay special attention to *What's Different From Other Vehicles.*

### Safety Messages

The types of safety messages, what they look like and how they are used in this guide are explained as follows:

The safety alert symbol  indicates a potential injury hazard.

#### **WARNING**

**Indicates a potential hazard which, if not avoided, could result in serious injury or death.**

#### **CAUTION**

**Indicates a hazardous situation which, if not avoided, could result in minor or moderate injury.**

#### **NOTICE**

**Indicates an instruction which, if not followed, could result in severely damaged vehicle components or other property.**

### About this Operator's Guide

This Operator's Guide was written in North America in a right-lane driving environment. Please adapt your application of these maneuvers to your jurisdiction and rules of the road.

In this Operator's Guide, the word motorcycle typically refers to a two-wheeled motorcycle.

Keep this Operator's Guide in the vehicle at all time so that you can refer to it for things such as maintenance, road side repairs and instructing others.

If you want to view and/or print an extra copy of your Operator's Guide, simply visit the following web site:

**[www.operatorsguides.brp.com](http://www.operatorsguides.brp.com)**

The informations contained in this document are correct at the time of publication. BRP, however, maintains a policy of continuous improvement of its products without imposing upon itself any obligation to install them on products previously manufactured.

Due to late changes, some differences between the manufactured product and the descriptions and/or specifications in this guide may occur. BRP reserves the right at any time to discontinue or change specifications, designs, features, models or equipment without incurring any obligation upon itself.

This Operator's Guide should remain with the vehicle when it is sold.

## Refer to Other Sources of Information

In addition to reading this Operator's Guide, you should read the Safety Messages on the display, all on-product safety labels and watch the *safety video* located at:

<https://can-am.brp.com/spyder/owners/safety/safety-information.html>

Or, use the following QR code.



If possible, take a training course that is specifically designed for a 3-wheel vehicle.

For more information about upcoming training course availability, visit our web site at:

[www.can-am.brp.com](http://www.can-am.brp.com)

If a training course specifically designed for a 3-wheel vehicle is not available in your area, it could be a good idea to take a training course for motorcycles.

Many of the skills required are similar and also, the received information about managing the risk on the road are suitable for a 3-wheel vehicle.

## Acknowledgment

BRP wishes to thank the Motorcycle Safety Foundation (MSF) for giving permission to BRP to use their material related to street motorcycle safety found in this Operator's Guide.

The MSF is an internationally recognized not for profit foundation and is supported by motorcycle manufacturers. It provides training, tools and partnerships to the motorcycle safety community. Visit its website at:

[www.msf-usa.org](http://www.msf-usa.org)

This page is intentionally blank

# GENERAL PRECAUTIONS

---

## **AVOID CARBON MONOXIDE POISONING**

All engine exhaust contains carbon monoxide, a deadly gas. Breathing carbon monoxide can cause headaches, dizziness, drowsiness, nausea, confusion and eventually death.

Carbon monoxide is a colorless, odorless, tasteless gas that may be present even if you do not see or smell any engine exhaust. Deadly levels of carbon monoxide can collect rapidly, and you can quickly be overcome and unable to save yourself. Also, deadly levels of carbon monoxide can linger for hours or days in enclosed or poorly ventilated areas. If you experience any symptoms of carbon monoxide poisoning, leave the area immediately, get fresh air and seek medical treatment.

To prevent serious injury or death from carbon monoxide:

- Never run the vehicle in poorly ventilated or partially enclosed areas such as garages, carports or barns. Even if you try to ventilate engine exhaust with fans or open windows and doors, carbon monoxide can rapidly reach dangerous levels.
- Never run the vehicle outdoors where engine exhaust can be drawn into a building through openings such as windows and doors.



---

## **AVOID GASOLINE FIRES AND OTHER HAZARDS**

Gasoline is extremely flammable and highly explosive. Fuel vapors can spread and be ignited by a spark or flame many feet away from the engine. To reduce the risk of fire or explosion, follow these instructions:

- Refuel outdoors in a well ventilated area away from flames, sparks, lit cigarettes and other sources of ignition.
- Never add fuel with engine running.
- Never top off the fuel tank. Leave some room for the fuel to expand with temperature changes.
- Wipe up any spilled fuel.
- Never start or operate the engine with the fuel filler door opened.
- Use only an approved red gasoline container to store fuel.
- Do not carry gasoline containers on the vehicle.

Gasoline is poisonous and can cause injury or death.

- Never siphon gasoline by mouth.
- If you swallow gasoline, get any in your eye or inhale gasoline vapor, see your doctor immediately.

If gasoline spills on you, wash with soap and water and change your clothes.

---

## **AVOID BURNS FROM HOT PARTS**

The exhaust, oil, and cooling systems as well the engine become hot during operation. Other vehicle parts, such as multifunction gauge glass, can also be hot if exposed to sunlight. Temperature higher than 60 °C (140 °F) can be reached. Avoid contact during and shortly after operation to avoid burns.

---

## ACCESSORIES AND MODIFICATIONS

Do not make unauthorized modifications, or use attachments or accessories that are not approved by BRP. Since these changes have not been tested by BRP, they may increase the risk of crashes on the road or injuries, and they can make the vehicle illegal for use on the road.

Unlike most motorcycles, this vehicle is equipped with a Vehicle Stability System (VSS), which is calibrated for the vehicle normal configuration. VSS may not function properly if the vehicle is modified, such as changing weight distribution, wheelbase, tires, suspension, brakes or steering.

See your authorized Can-Am On-Road dealer for available BRP accessories for your vehicle.

For safety reasons, some BRP accessories must be installed by a BRP dealer but if you decide to install the accessory by yourself, when not required to be done by the dealer, it is important to follow all the instructions carefully and, if applicable, understand all the information on how to use the product or for servicing.

If the accessory has been installed on your vehicle by another person than you, BRP strongly recommends you to read the corresponding instruction sheet as there may be more for information on how to use it safely or for the servicing.

The instruction sheets can be found at this address:

– [HTTPS://INSTRUCTIONS.BRP.COM](https://instructions.brp.com)

This page is intentionally blank

# VEHICLE INFORMATION

---

# PRIMARY CONTROLS

It is important to know the location and operation of all controls, and to

develop and practice smooth and coordinated use of them.

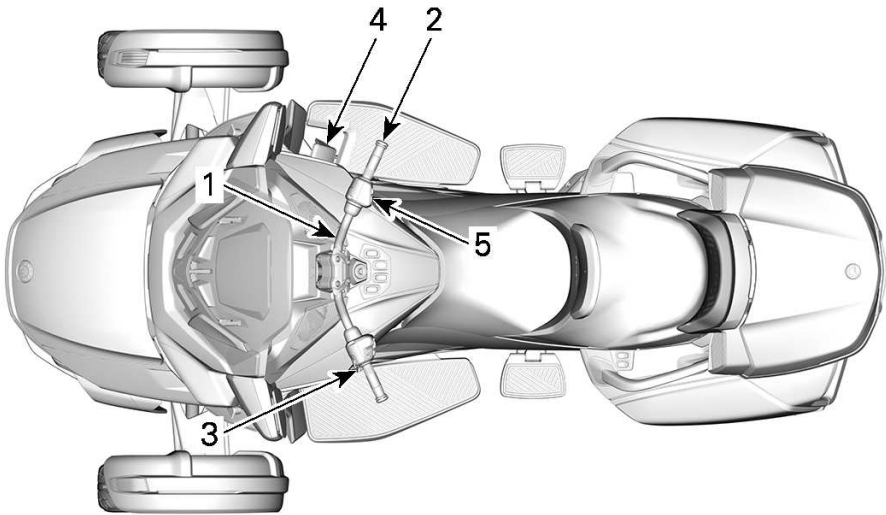

## **TYPICAL**

1. *Handlebar*
2. *Throttle*
3. *Gearshift Selector*
4. *Brake Pedal*
5. *Parking Brake Button*

## HANDLEBAR

Grip the handlebar with both hands. Steer the handlebar in the direction you want to go.

## THROTTLE

Twist the right handle grip to operate the throttle. This controls the vehicle's speed by controlling the flow of fuel to the engine.

To speed up, twist the throttle toward you (lower your wrist).

To slow down, twist it away from you (raise your wrist).



**TO INCREASE SPEED**



**TO DECREASE SPEED**

The throttle is spring loaded and should return to idle when you release your grip.

This vehicle is equipped with an Electronic Throttle Control (ETC). The throttle plates in the throttle body are controlled electronically and can be opened or closed irrespective of the throttle twist grip position when necessary.

It may happen that when you accelerate, the Vehicle Stability System (VSS) prevents engine acceleration in order to maintain vehicle stability. Then, when the vehicle is stabilized, the engine RPM would increase as requested if the throttle was maintained.

This would be felt as a "delayed" acceleration.

The VSS can never accelerate the vehicle. All it can do is to open the throttle slightly to decrease the amount of engine braking on slippery surfaces. This prevents the rear tire from slipping because of engine braking.

## GEARSHIFT SELECTOR

The gearshift selector is underneath the left handle grip.

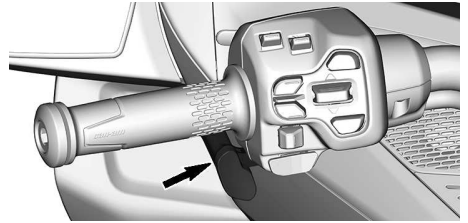

The gear pattern is Reverse-Neutral-1-2-3-4-5-6.

Press selector forward to upshift. Pull selector toward you to downshift.

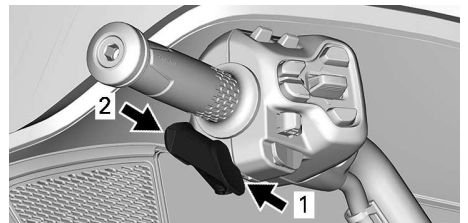

1. Upshift
2. Downshift

This shifts sequentially from one gear to the next. Release the selector after shifting.

- To shift through multiple gears, use the selector multiple times.
- To shift into neutral from 1<sup>st</sup> gear, press the brake pedal and shift down.
- To shift from neutral to 1<sup>st</sup> gear, press the brake pedal and shift up.
- To shift into or out of reverse, refer to *OPERATING IN REVERSE*.

When the gearshift selector is released, the mechanism resets for the next shift up or down.

If operator does not downshift when slowing down and engine RPM drops below a threshold value, the gearbox will automatically downshift to the next available gear.

If the engine is started with the gearbox in gear, it will automatically shift to neutral position.

## BRAKE PEDAL

The brake pedal is located on the right floorboard. Press it down to operate. This pedal brakes all three wheels.

### NOTICE

**When riding, make sure not to lean your foot on brake pedal. Otherwise, the engine management will activate the limp home mode to protect the braking system.**

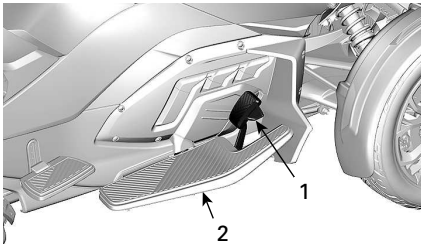

1. Brake pedal
2. Floorboard

## PARKING BRAKE BUTTON

The parking brake button is located on the RH side handlebar. It allows to engage or release the electric parking brake.

There will be a 20 second beep sound when stopping the engine while the parking brake is not engaged.

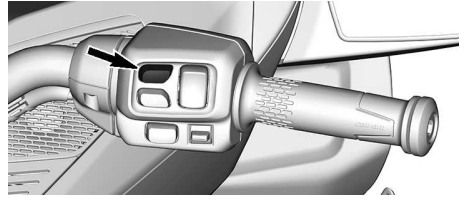

### Applying Parking Brake

With the vehicle stopped and ignition key turned ON, press the button  to apply the parking brake. The brake indicator lamp will turn on.

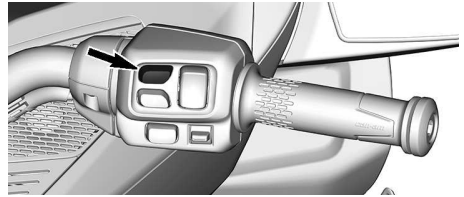

### NOTE:

A minimum of 11 V is required to activate the parking brake. If the battery voltage is below 11 V, the parking brake indicator lamp will flashing and a message will appear in the cluster display.

### CAUTION

**To avoid personal injury or vehicle damages, the parking brake cannot be activated when the vehicle is running above 10 km/h (6 mi/h).**

Check that the parking brake is fully engaged. Rock the vehicle back and forth.

### Releasing Parking Brake

To release parking brake, press the button  and make sure brake indicator lamp will turn OFF.



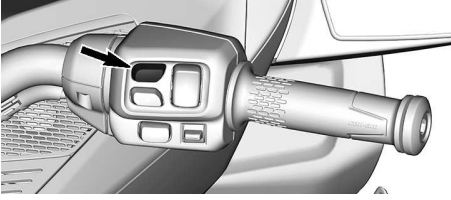

# SECONDARY CONTROLS

Some features may not apply to your model or could be optional.

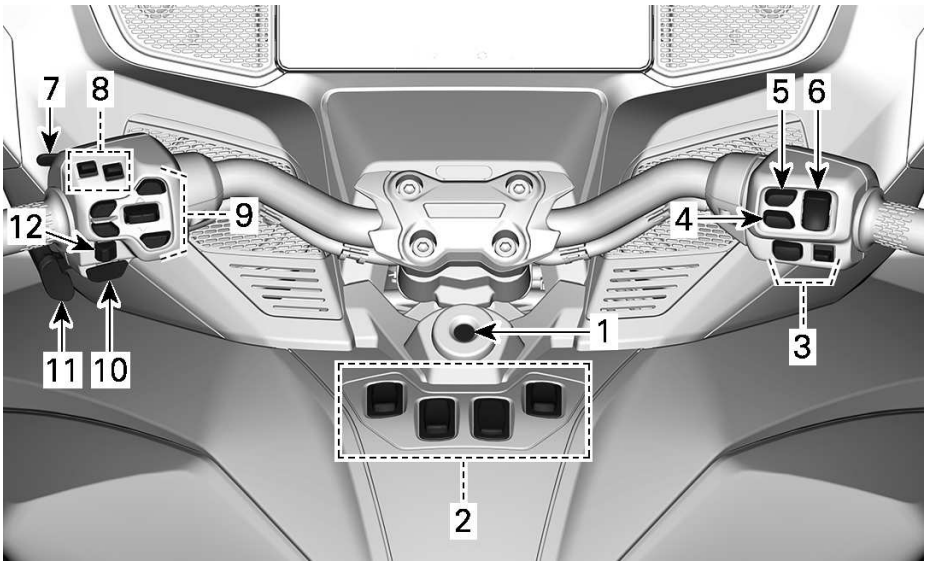

## TYPICAL

1. Ignition switch
2. Switch cluster
3. Cruise control switch
4. Hazard warning switch
5. Parking brake button
6. Engine start/stop switch
7. Headlight switch
8. Audio controls
9. Multimedia controls
10. Horn button
11. Gear selector
12. Turn signal button

## IGNITION SWITCH

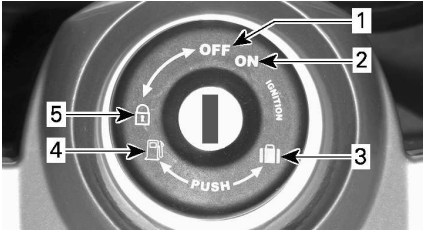

### IGNITION SWITCH

1. OFF
2. ON
3. Front storage compartment opening
4. Seat opening
5. Handlebar and glove box locking position

The ignition switch is located just below the center of the handlebar.

### NOTICE

**If the key does not turn easily, do not force it. Pull it out and reinsert.**

### ⚠ WARNING

**If you turn the ignition switch to OFF, it shuts off the engine and all the electrical systems including the VSS and DPS. If you do this while the vehicle is moving, you could lose control and crash.**

Two keys are provided with your vehicle. Each key contains a transponder chip specifically pre-programmed that is read via radio frequency by the immobilizer system to allow starting the engine. The keys do not contain batteries. Do not take the key apart. If the immobilizer system cannot read the key, the engine will not start. For the conditions that can lead to the immobilizer system failing to read the key, refer to the *Diagnostic Guidelines*. Store the spare key in a safe place because you **must** have your spare key to have another one made by an authorized Can-Am On-Road dealer.

## Ignition Function

### OFF

The key can be inserted or removed in this position.

In the OFF position, the electrical system of the vehicle is disabled.

The engine is shut down by turning the ignition switch to the OFF position.

### ON

When the key is turned to this position, the electrical system of the vehicle is activated.

The gauge should wake-up.

The vehicle lights are turned on.

The engine can be started.

### Locking the Handlebar/Glove Box

To lock the steering mechanism and the glove box:

1. Insert key in ignition switch.
2. Rotate the handlebar all the way to the right or to the left.
3. Turn the key 1/4 turn counterclockwise to the steering lock position then remove key.



**KEY POSITION TO LOCK HANDLEBAR**

## SWITCH CLUSTER

The switch cluster is located on the central console.

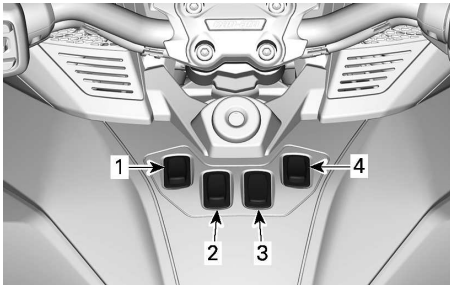

1. Windshield
2. Driver's heated grip
3. Location for accessories switch
4. Driver's heated seat (Limited models only)

It includes many switches that control of numerous electrical accessories.

**NOTE:**

The battery voltage must be at 11 V minimum to activate these accessory switches.

**Windshield Switch**

To change the windshield position, press the top of the switch to raise it or press the bottom of the switch to lower it.

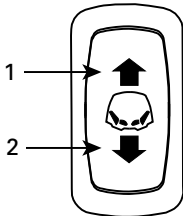

1. Press here to raise the windshield
2. Press here to lower the windshield

**Driver's Heated Grip Switch**

The heated grip switch allows to control the heating intensity of the heated grips.

To increase the intensity, press the top of the switch.

To decrease the intensity, press the bottom of the switch.

There are 5 levels of heating and the OFF option that can be selected.

To select the OFF option, press the bottom of the switch until the heated grips are turned OFF.

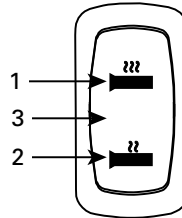

1. Increase intensity
2. Decrease intensity
3. Resting position

**NOTE:** The switch will automatically return to the middle position after pressing either the top or the bottom of the switch.

**Driver's Heated Seat Switch**  
*Limited models only*

The heated seat switch allows to turn on and off the heated seat and to control the heating intensity.

To activate the heating seat, press the top (HI) or the bottom (LOW) of the switch.

To turn OFF the heating seat, toggle the switch to the middle position.

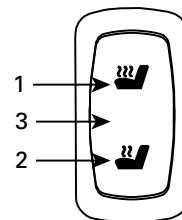

1. HI intensity
2. LOW intensity
3. OFF (middle position)

## RIGHT MULTIFUNCTION SWITCH



1. Engine Start/Stop switch
2. Cruise control switches
3. Hazard warning button
4. Parking brake button (refer to Primary Controls)

### ENGINE START/STOP SWITCH

The engine start switch is located at the top right of the right handlebar housing.

This toggle switch has multiple position.



1. Engine stop position
2. Run position
3. Engine start. position

### Engine Stop Position

The engine stop position is activated when the top of the toggle switch is pressed.

This position can also use to stop the engine anytime without removing your hand from the handlebar.

### RUN Position

The RUN position is activated when the toggle switch is placed to the center.

The toggle switch must be set to the run position before starting the engine.

### Engine Start Position

The engine start position is activated when the bottom of the toggle switch is pressed.

Press and hold the bottom of the toggle switch until the engine is started.

### Cruise Control Switches

The cruise control switches are located at the bottom of the right handlebar housing.



The button  is used to activate the cruise control function

**NOTE:** The cruise control function can only be canceled, it cannot be completely deactivated when the engine is running.

The toggle switch is multifunctional. It allows to set, resume, increase or decrease the speed.

Also, the following icon  appears

inside the digital display when the cruise control is activated.

<b>⚠ WARNING</b>
<b>It is not recommended to use the cruise control when towing a trailer.</b>

When set, the cruise control allows to maintain a steady speed while riding the vehicle. It will increase or reduce engine speed as necessary.

**NOTE:**

The vehicle torque may vary slightly depending on the road conditions such as the wind, going downhill or uphill.

The cruise control is designed to be used for prolonged drives on low traffic highways. Never ride the vehicle with the cruise control activated in city streets, winding roads, in adverse weather or in any circumstances when you need the throttle control.

**Cruise Control Limitations**

The cruise control is not an automatic pilot, it will not drive the vehicle.

The cruise control is not aware of what is going on the road and it does not steer or apply the brakes for you.

<b>⚠ WARNING</b>
<b>Improper use of the cruise control can lead the vehicle to a loss of control.</b>

**Activating the Cruise Control**

To activate the cruise control function, press the button .

**Cancelling the Cruise Control**

Any of the following event will cancel the cruise control but do not deactivate it (complete stop of the feature).

- Pressing the brake pedal.

- Gear change.
- Any vehicle stability system intervention.
- Twisting the throttle grip forward.
- Pressing the button .

**Setting the Cruise Control**

To use the cruise control, the vehicle speed must be above approximately 40 km/h (25 MPH).

First, active the cruise control function.

**NOTE:**

The cruise control status will light in **gray** in the digital display.

Bring the vehicle at the speed you want to maintain then press the toggle button downward to SET the speed.



**NOTE:**

The cruise control status will light in **green** in the digital display.

You can now release the throttle.

<b>⚠ WARNING</b>
<b>Always keep both hands on the handlebar while riding. Otherwise, this could cause a vehicle loss of control.</b>

**NOTE:**

You can increase engine speed using the throttle grip if you need to go faster than the set speed. Releasing the throttle will allow the cruise control to recover the set speed.

Once the cruise control has been set, the speed setting may be increased or reduced by pushing the toggle button UP or DOWN. Each press of the button will change the speed setting by increments of 1.6 km/h (1 MPH). Holding the button will change the speed setting until released or the operating limit has been reached.

**Resuming the Cruise Control**

If the cruise control was cancelled and the cruise control feature is still activated, the cruise control operation can be resumed by pushing the toggle button upwards. The cruise control will then recover the previous set speed.

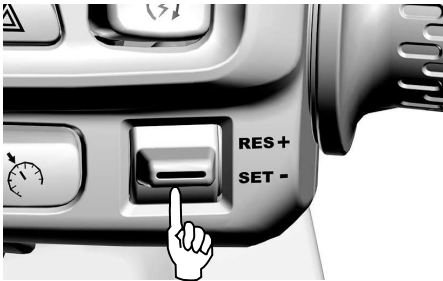
**NOTE:**

The cruise control status will show CRUISE SET in the digital display.

**Hazard Warning Button**

The hazard warning button is located in the center of the right multifunction switch, beside of the engine start/stop switch.

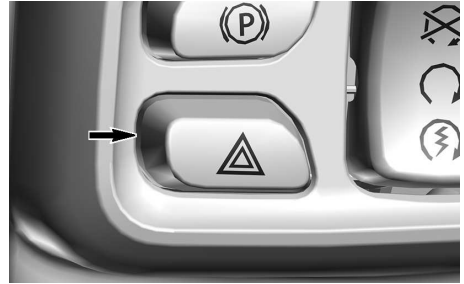

Push the button to turn ON the hazard warning lights.

Press again to stop the hazard warning lights.

**LEFT MULTIFUNCTION SWITCH****Headlight Switch**

The headlight switch is located on the back of the left multifunction switch.

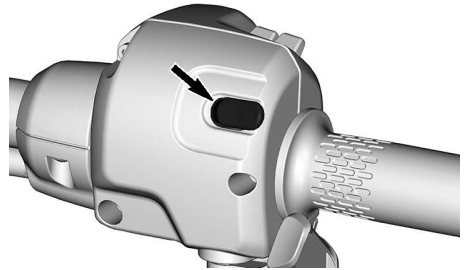

One of the following icon (☰☷☷) appears inside the digital display when the headlight are turn on.

The switch is used to select high or low beam for the headlight. The headlights automatically turn on when the engine reaches 800 RPM and turn off after approximately 20 seconds when engine has been stopped.

To select high beams, push the switch to the front position. To select low beams, push the switch to the back position.

To flash the high beams, press the switch fully in, then release it. The high beams will stay on as long as you hold down the switch.

### Turn Signal Button

The turn signal button is located on the lower left portion of the multifunction switch.

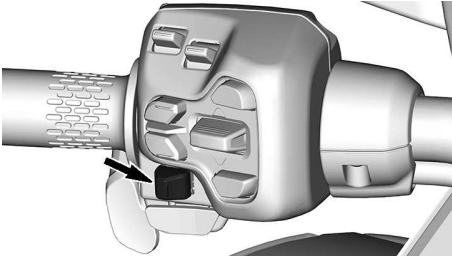

One of the following icon (◀▶) appears inside the digital display when the turn signal is activated.

The turn signal button turns off automatically after a normal turn, but you may have to turn it off manually after a shallow turn or lane change.

To turn the signal off, press the button in.

Turn signals will automatically turn off after 30 seconds while the vehicle is moving.

### Horn Button

The horn button is located at the bottom of the left multifunction switch.

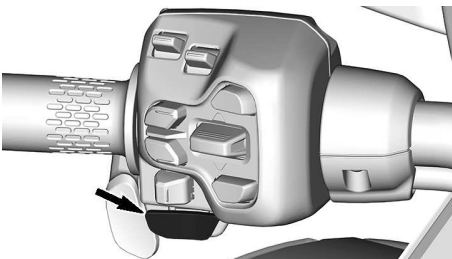

Press the button to activate the horn.

### Audio Controls

The audio controls buttons are located on the top left portion of the multifunction switch.

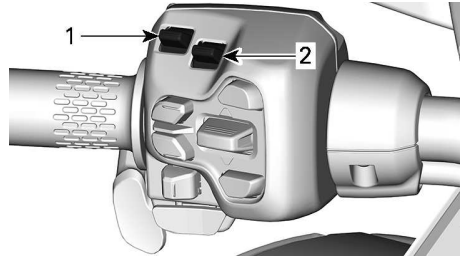

1. Volume Up / Down
2. Audio Prev / Next

### Volume Up / Down

Use to adjust the volume of the vehicle audio system.



### Audio Prev / Next

Use to go to the next or previous song or channel.





## Multimedia Controls

The multimedia controls buttons are located in the center of the multifunction switch.

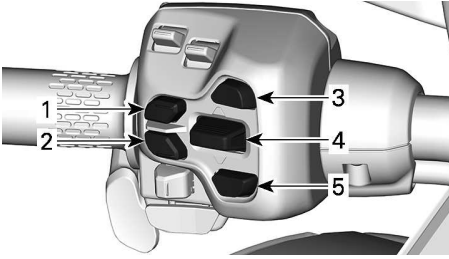

1. Back Button
2. Applet Switcher Button
3. PushToTalk (PTT) Button
4. OK / Select Button
5. Ride Settings Button

### Back Button



Used to return to the previous page/ menu.

### Applet Switcher Button

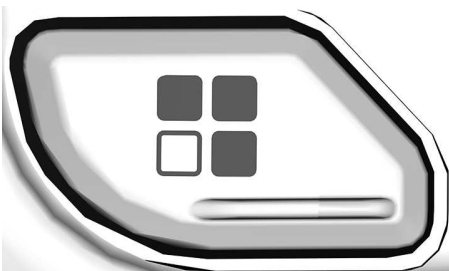

Used to change applets configured in the Applet Switcher manager menu.

- Phone (if CarPlay connected)
- Media
- Statistics

- Full gauge
- Radio (if equipped)
- Maps (if CarPlay connected)

### PushToTalk (PTT) Button



Used to trigger the voice assistant of the Phone. The operator must have a phone and a headset connected via Bluetooth to use this function.

### OK / Select Button



Move the button up or down to navigate through the touchscreen options.

Press in the button to accept a choice or a command.

### Ride Settings Button



Quick access to change settings included in the Ride Settings manager. May include:

- Audio output selection
- Driving mode
- Heated grips

# PASSENGER'S CONTROLS

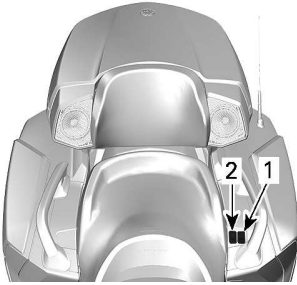

- 1. Heated grips switch
- 2. Heated seat switch

## Heated Grips Switch

The heated grips switch is located between the seat and the left passenger grip.



The heated grips switch allows to turn on and off the heated grips and to control the heating intensity.

To activate the heating grip, press the top (HI) or the bottom (LOW) of the switch.

To turn OFF the heating grip, toggle the switch to the middle position.

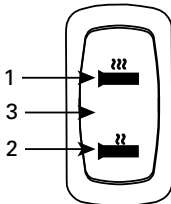

- 1. HI intensity
- 2. LOW intensity
- 3. OFF (middle position)

### NOTE:

The heated grips will shut off when engine is under 800 RPM and will not resume automatically.

## Heated Seat Switch

The heated seat switch is located between the seat and the left passenger grip.



The heated seat switch allows to turn on and off the heated seat and to control the heating intensity.

To activate the heating seat, press the top (HI) or the bottom (LOW) of the switch.

To turn OFF the heating seat, toggle the switch to the middle position.

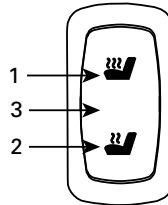

- 1. HI intensity
- 2. LOW intensity
- 3. OFF (middle position)

### NOTE:

The heated seat will shut off when engine is under 800 RPM and will not resume automatically.

# EQUIPMENT

## MIRRORS

With your fingers, press the mirror at the points shown below to adjust its position in the four directions.

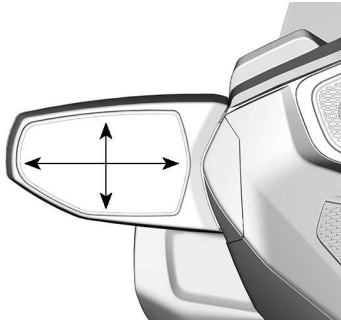

*MIRROR ADJUSTMENT POINTS*

## GLOVE BOX



### *Opening the Glove Box*

1. First ensure handlebar is not locked to allow glove box opening.
2. Push on the bottom of the cover to release it.



1. *Push here to release*

3. Open cover.
4. When done, close cover then push on the lower end of glove box to latch it.

### **NOTE:**

Always latch the glove box after usage.

## USB PORTS

A USB port is located in the glove box and a second in the rear storage compartment.

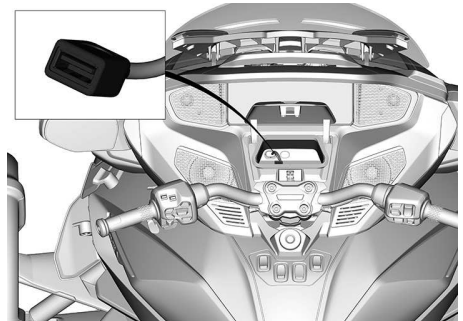

*GLOVE BOX*

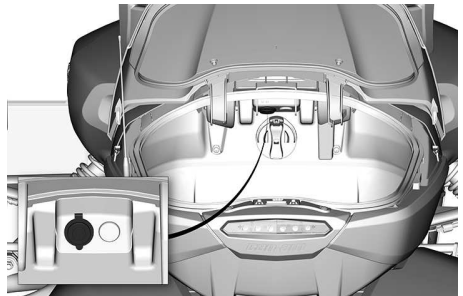

*TOP STORAGE COMPARTMENT*

The front USB port must be used to run Apple CarPlay.

The rear USB ports located inside the top storage compartment are only used to charge a smartphone. No data is transferred through these USB ports.

## FRONT STORAGE COMPARTMENT

### Opening the Front Storage Compartment

1. Insert key in ignition switch.
2. **Push** and turn the key 1/4 turn counterclockwise to the front storage compartment position and hold while lifting cover.



KEY POSITION TO OPEN FRONT STORAGE COMPARTMENT

## OPERATOR'S SEAT

The operator seat includes a location to install a backrest (available in accessory and on Sea-to-Sky models).

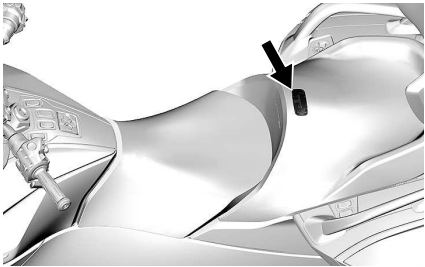

### Opening the Seat

1. Insert key in ignition switch.
2. Push and turn the key 1/4 turn clockwise to the seat opening position and hold while lifting seat.



KEY POSITION TO OPEN SEAT

1. Push key
2. Turn key 1/4 turn

### NOTICE

Do not force the seat past the maximum opening angle or it may break.

## DRIVER'S BACKREST

### Removing the Driver's Backrest

1. Open the operator's seat.
2. Pull the latch rod to unlock the backrest.

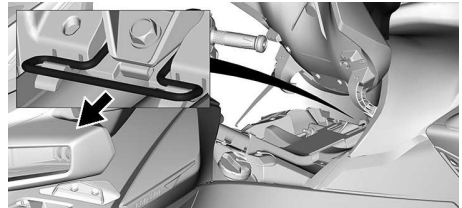

3. Remove the backrest and push back the latch rod.

### Adjusting the Driver's Backrest

1. Slightly pull the backrest forward to unlock it and lift to adjust.

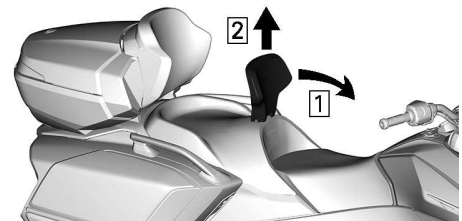

- Step 1. Pull forward  
Step 2. Lift

2. Tilt forward the backrest and slightly pull up the cover. Turn the adjustment screw to adjust the backrest angle in the desired position.
  - By turning it clockwise it will slightly incline the backrest towards the back.
  - By turning it counterclockwise it will slightly incline the backrest towards the front.

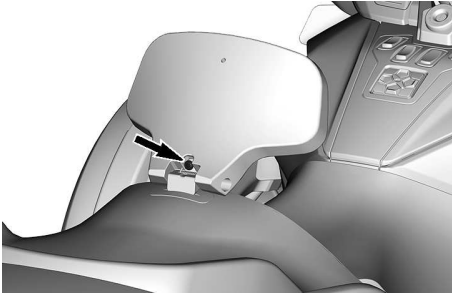

### Installing the Driver's Backrest

1. Pull on the latch rod.

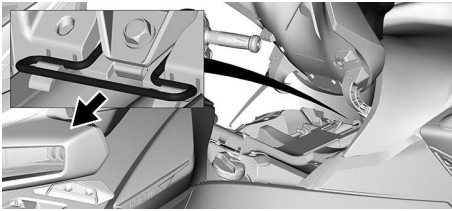

2. Lower the backrest in place.

### **⚠ CAUTION**

The backrest has two height positions. Make sure the backrest is properly positioned in one of the two positions.

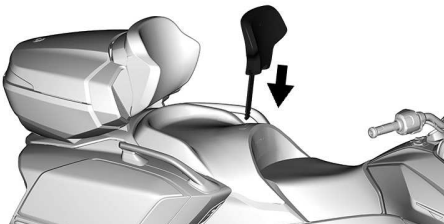

3. Push back the latch rod.

## PASSENGER'S SEAT

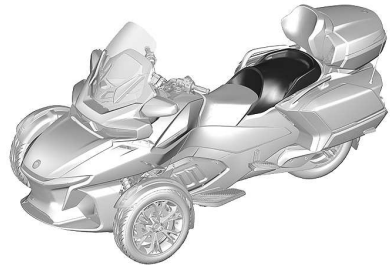

### Removing the Seat

1. Open the operator's seat.
2. Unlatch seat. One latch on each side.

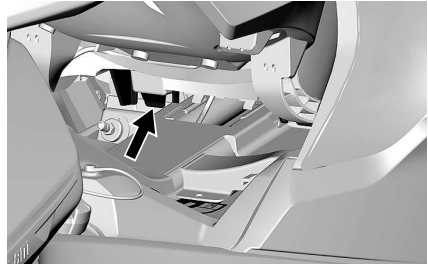

### RIGHT PASSENGER' SEAT LATCH SHOWN

3. Pull seat forwards to release the rear tabs.
4. Lift the seat slightly and unplug the heat seat connector.

### Installing the Seat

1. Plug the heat seat connector.
2. Insert the rear tabs into the support openings.
3. Push on the front of the seat to latch it.
4. Close the operator's seat.

## STORAGE COMPARTMENTS

### Opening the Side Storage Compartments

The latches are located on the front portion of the side storage compartments.

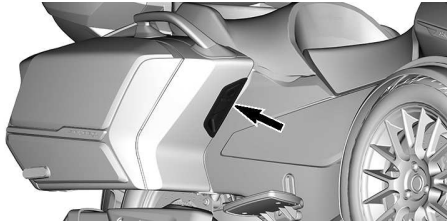

*RH SIDE*

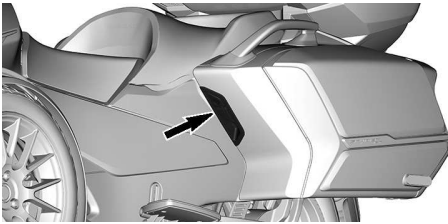

*LH SIDE*

Pull up the latch to open the side storage compartment cover. If locked, use the ignition key to unlock it.



#### NOTE:

Open the cover slowly, the objects inside the compartment may have moved during the ride.

### Closing the Side Storage Compartments

#### ⚠ WARNING

Always close and latch the covers after usage. Never ride the vehicle with an opened cover or improperly latched. The content of the compartment could fall out-side and causing a road hazard.

Slowly close to let air flow out.

Put your hand in the upper center of the cover and push to lock.

### Opening the Top Storage Compartment

The top storage compartment latch is located at the rear of vehicle.

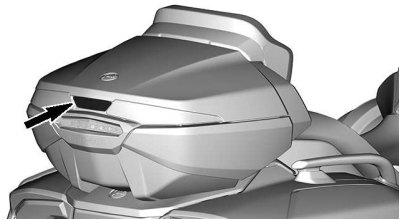

Pull up the latch to open the cover. If locked, use the ignition key to unlock it.

#### NOTE:

If the cover refuses to open, gently move it back and fore and side to side while pressing the latch. See your authorized Can-Am dealer to perform the latch adjustment.

### Closing the Top Storage Compartment

#### NOTICE

The cover mechanism must be **UNLOCKED** to close the top storage compartment. If the cover cannot be closed, **DO NOT FORCE**. Check if something block the cover and if the latch moves.

Bring the cover at closing position.

Put your hand just above the latch in the center of the cover then push to lock.

### Removing the Top Storage Compartment

#### **⚠ WARNING**

**Always have the top storage compartment installed and properly locked when riding. Do not use the vehicle if the top storage compartment is missing.**

1. Open the top storage compartment cover.
2. Unlock the center LinQ knob by turning it 1/4 turn counterclockwise.



3. Using the rear handle, unlatch the top storage compartment from the vehicle.

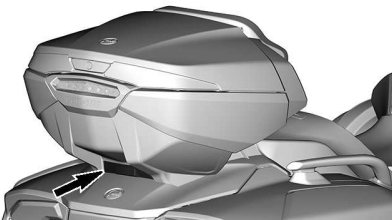

4. Lift the storage compartment slightly and slide your hand underneath to disconnect the connector located near the passenger seat.
5. Pull the storage compartment rearwards to remove it from the vehicle.

### Installing the Top Storage Compartment

#### **⚠ WARNING**

**Always have the top storage compartment installed and properly locked when riding. Do not use the vehicle if the top storage compartment is missing.**

1. Align both arms of the storage compartment with the support located on each side of the passenger's seat.
2. Hold the storage compartment in the raise position and connect the connector near the passenger's seat.
3. Lower the storage compartment and push down to lock it.
4. Open the top storage compartment cover.
5. Secure the storage compartment by turning the center LinQ knob 1/4 turn clockwise.



6. Grab the storage compartment firmly and check if it is properly installed and locked on the vehicle.
7. Close the top storage compartment cover.

### HELMET HOOK

Two helmet hooks are provided under the seat to secure a helmet.

1. Open the driver's seat.
2. Secure the helmet strap buckle on the hook.



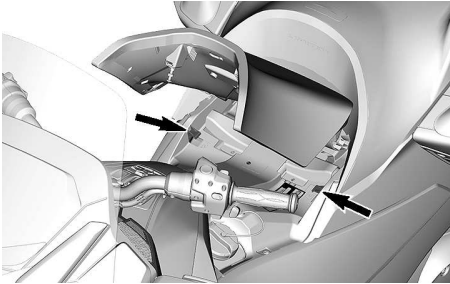

3. Gently put down helmet on the vehicle side panel.
4. Carefully close the seat and latch.

## TOOL KIT

The tool kit is located in the top storage compartment.

The tool kit contains the tools for the basic maintenance described in this Operator's Guide.

## OPERATOR'S GUIDE

The operator's guide is located inside the front storage compartment.

## SERVICE COVER

### Front Service Cover

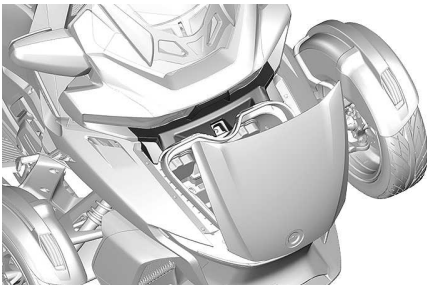

The front service cover must be removed to reach the following items:

- Coolant reservoir
- Diagnostic connector

### Removing the Front Service Cover

1. Open the front storage compartment cover.

2. Pull the top middle of the service cover to unlatch it.



3. Remove the service cover from the vehicle.

### Installing the Front Service Cover

1. Insert both ends of the service cover under the console covers.
2. Push the top middle of the service cover to clip it.

### Right Service Cover

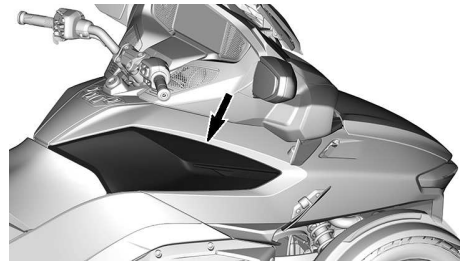

The right service cover must be removed to reach the following items:

- Brake fluid reservoir
- Engine oil filter

### Removing the Right Service Cover

1. Open the operator seat.
2. Pull the rear lower end of the service cover to unlatch it.

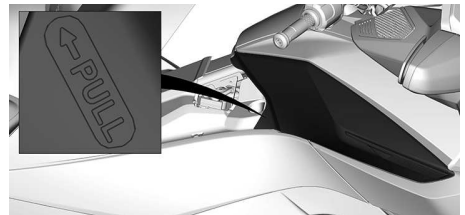

3. Pull the service cover to remove it from the vehicle.

**NOTE:**

Six retaining tabs hold the service cover in place.

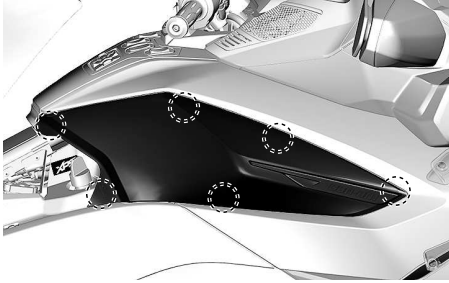

**RETAINING TAB LOCATIONS**

**Installing the Right Service Cover**

1. Insert the front retaining tab first.
2. Align the other retaining tabs with their slots.
3. Push near the retaining tab locations to fix the service cover.

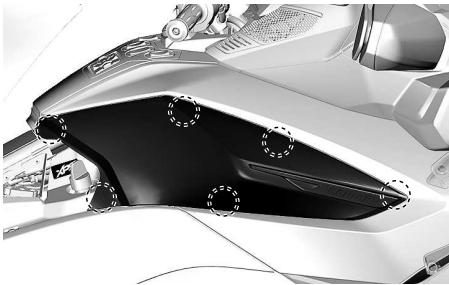

**Left Service Cover**

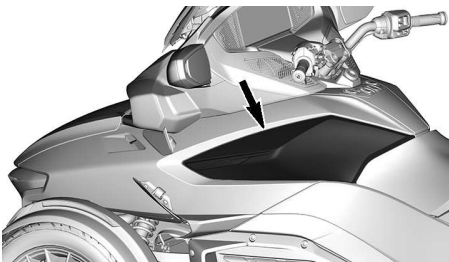

The left service cover must be removed to reach the engine air filter.

**Removing the Left Service Cover**

1. Open the operator seat.
2. Pull the rear lower end of the service cover to unlatch it.

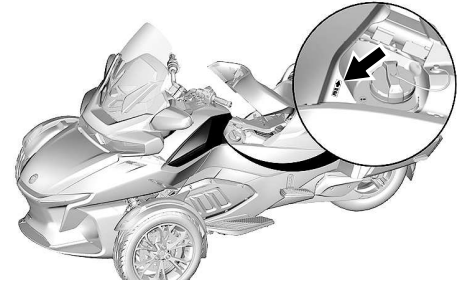
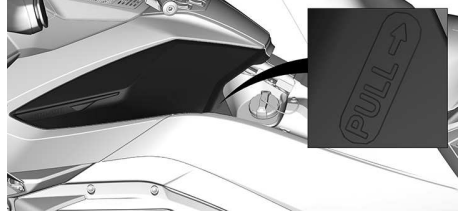

3. Pull the service cover to remove it from the vehicle.

**NOTE:**

Six retaining tabs hold the service cover in place.

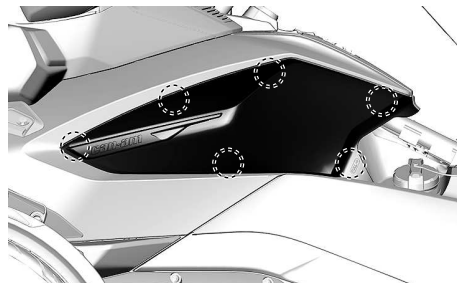

**RETAINING TAB LOCATIONS**

**Installing the Left Service Cover**

1. Insert the front retaining tab first.
2. Align the other retaining tabs with their slots.
3. Push near the retaining tab locations to fix the service cover.

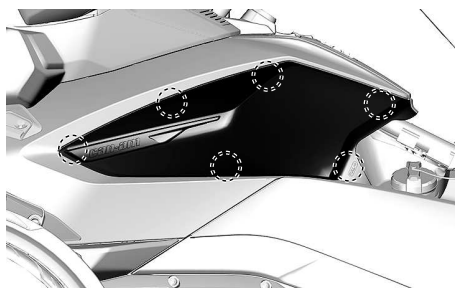

# 10.25" COLOR TOUCHSCREEN DISPLAY

## First Safety Display

This first safety message is displayed each time the ignition key is turned ON.

Press the white portion of the message directly in the touchscreen display or press the OK button on the left multifunction switch to see the Important Pre-Ride Safety Message.

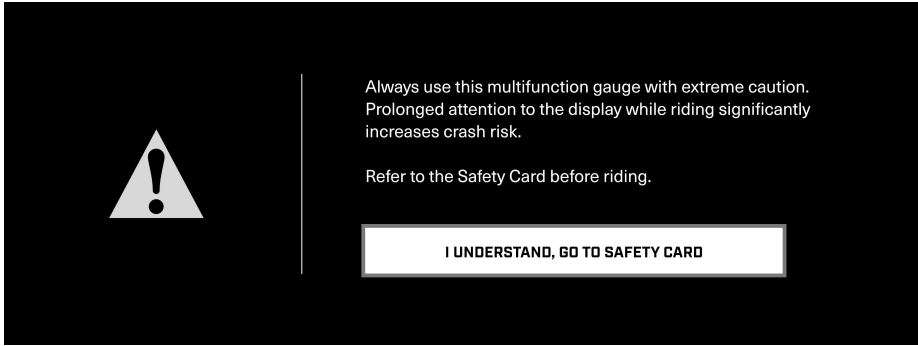

## Default Display

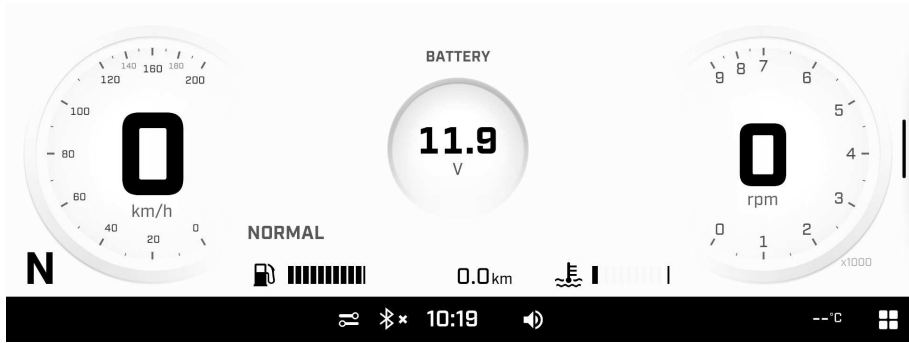

A dark mode is also available when riding in the evening or at night.

## Navigating the Digital Display

### **⚠ WARNING**

Reading or tampering with the digital displays can distract you from the operation of the vehicle, particularly from constantly scanning the environment.

Always pay attention to road conditions, ensure your environment is clear and free from obstacles.

Furthermore, when riding, only glance at the digital displays briefly to maintain awareness of road conditions.

We recommend that you practice selecting some functions on the infotainment center before starting your ride. You will get used to them, and they will be easier to use during the ride.

The display is touchscreen, you can navigate the different menus and functions while the vehicle is at rest.

The touchscreen is deactivated as soon as the vehicle is moving.

When the vehicle is moving, only the left handlebar multifunction switch can be used to navigate through the menus and functions of the display.

Pressing the **Applet Switcher** button on the left handlebar multifunction switch will allow you to cycle through the applet in the right lateral display, in the order that can be defined in the preferences.

## Central Display

In full-gauge view, long tap in the upper-center area of the screen to show one of the following extra gauges. Use additional long taps to cycle through the extra gauges:

- Battery voltage
- Distance to empty (range)
- Blank view

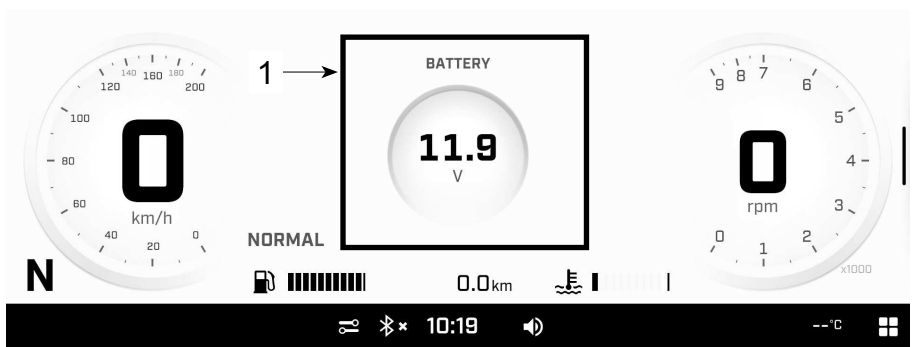

1. Long tap in this area to view extra gauges

In full-gauge view, long tap in the lower-center area of the screen to show the following information. Use additional long taps to cycle through the items:

- Trip A distance
- Trip A hours
- Trip B distance
- Trip B hours
- Total distance (odometer)
- Total hour(s)

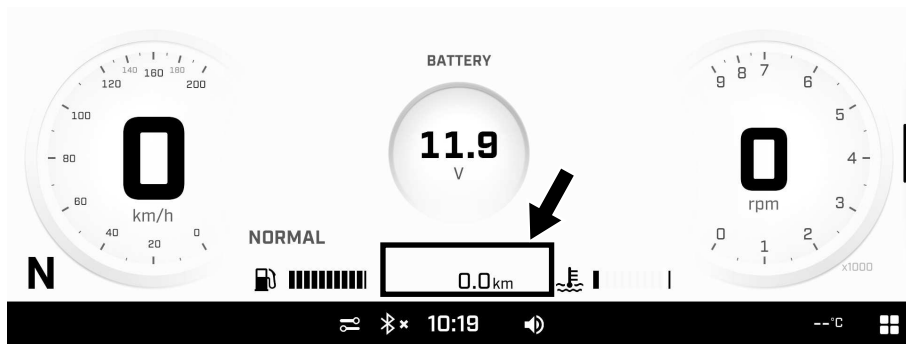

## Views Display

To change from full-gauge view to split screen view, press the applet switcher or drag the divider from the right side of the display.

To change back to full-gauge view, long press on the applet switcher or drag the divider to its original position.

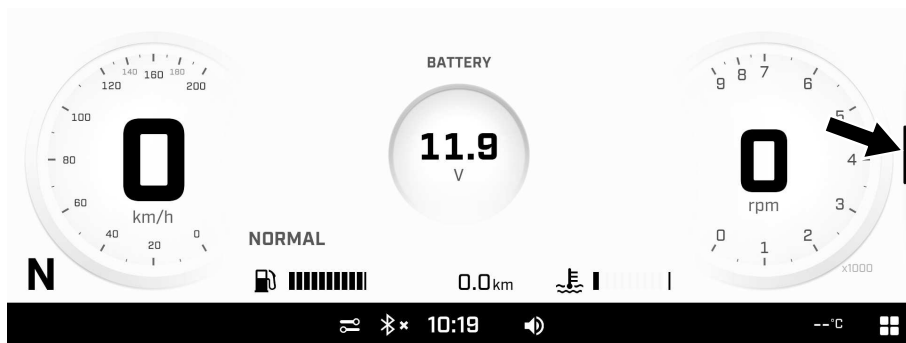

The sizes of the left and right lateral displays cannot be adjusted.

## Left Lateral Display

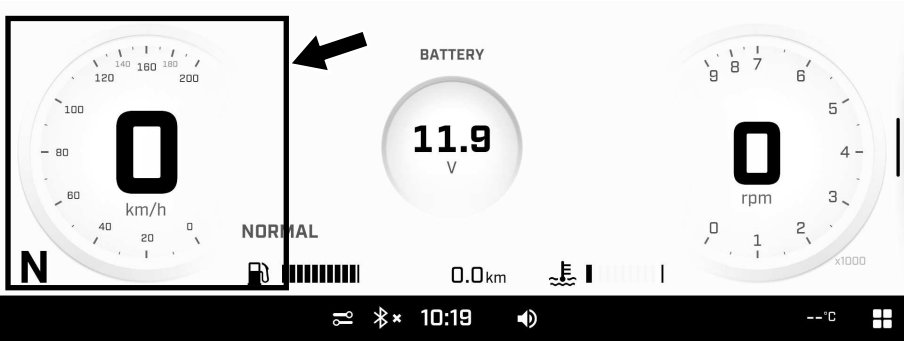

In split screen view, the left lateral display includes:

- Gauge
  - Speedometer
  - Vehicle odometer
  - Trip meter
- Tachometer

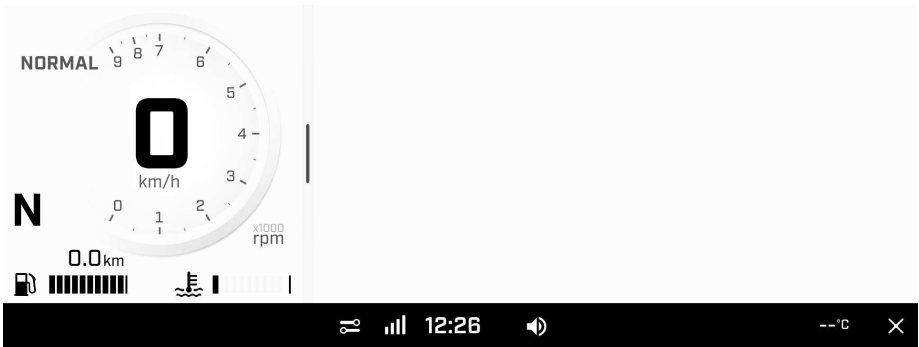

In split screen view, long tap the trip meter to show one of the following. Use additional long taps to cycle through the items.

- Trip A distance
- Trip A hours
- Trip B distance
- Trip B hours
- Total distance (odometer)
- Total hour(s)

### Right Lateral Display

In split screen view, the right lateral display includes various applets. Refer to *Right Applet Menu* for more information.

## Applet Menu

To access the app menu, tap the **Applet Menu** icon in the bottom-right corner.

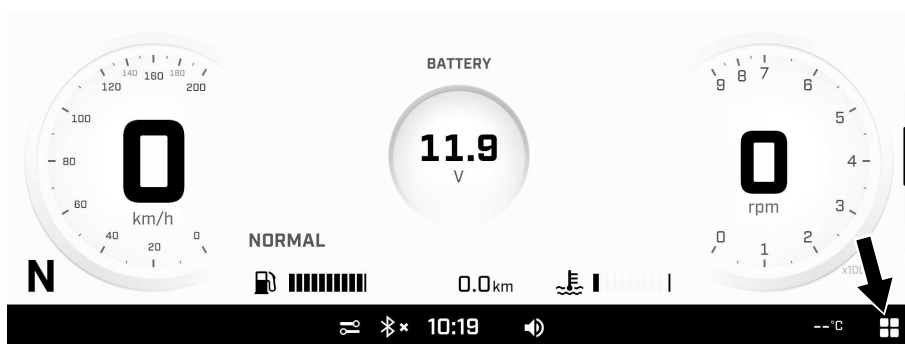

Select through the illustrated icons to open the corresponding applet.

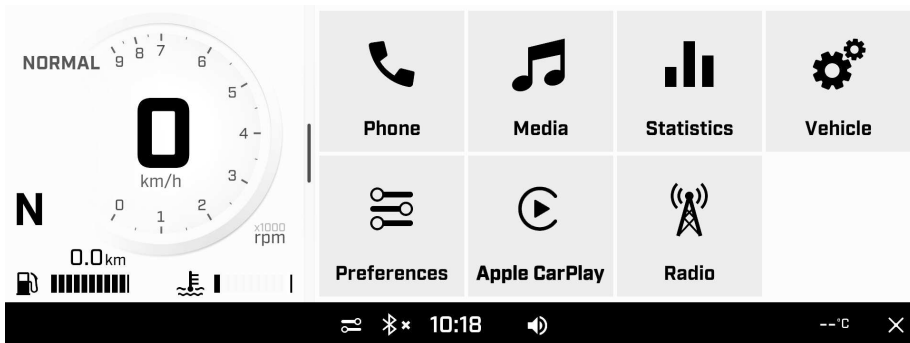

## Phone

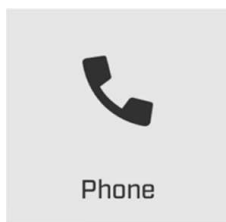

To have access to the *Phone* menu, a phone **and** a helmet audio system must be paired. Refer to *Pair Your Smartphone Through Bluetooth*.



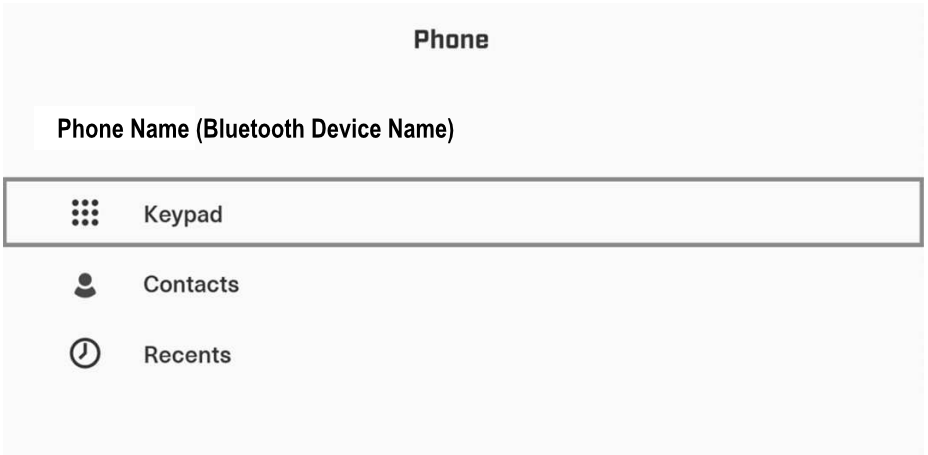

The *Phone* applet is used to access the following:

- The keypad
- The phone contact list
- The phone history

## Media

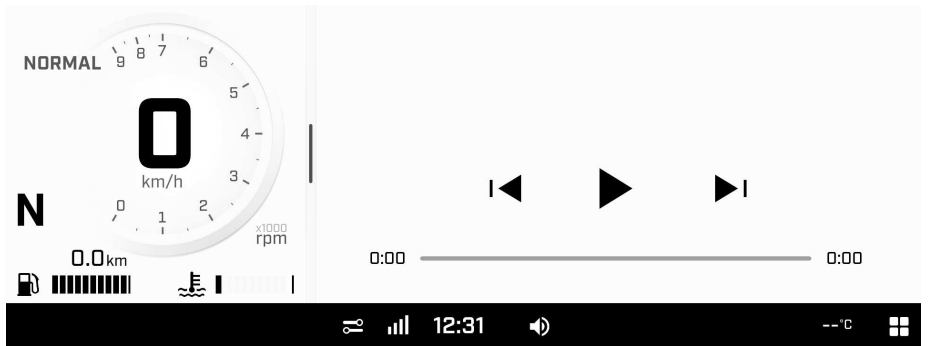
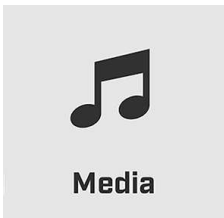

## MEDIA

The *Media* applet is used to:

- Control song choice and volume in the helmet audio system
- View song information (when available)

## Statistics



### STATISTICS

#### Statistics

■ ■ ■ Current Ride

**A** Trip A

**B** Trip B

The *Statistics* applet is used to access the following:

- Trip distance information
- Trip elapsed time information
- Average speed
- Average fuel consumption.

Three sets of statistics are stored in memory.

- Trip A can be reset independently.
- Trip B can be reset independently.
- Current ride statistics will be reset when the vehicle restart.

## Vehicle Settings

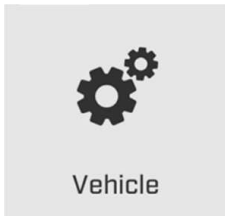

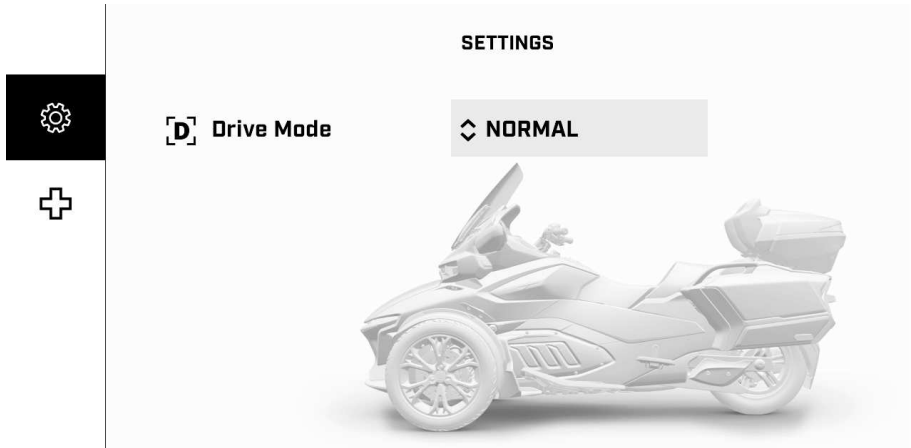

The *Vehicle Settings* menu is used for the following:

- Adjusting the drive mode settings
- Viewing vehicle health:
  - Vehicle information
  - Faults (codes and descriptions)
  - Safety card

## Preferences



The *Preferences* applet is used for the following:

- Adjusting the display brightness and appearance (LIGHT/DARK/AUTO)
- Pairing Bluetooth devices:
  - Phone
  - Driver headset
  - Passenger headset
- Connecting the vehicle to a Wi-Fi network
- Accessing to the *Audio* menu
  - Configure the audio output (headset or speaker (if equipped))
  - Access to Fade/Balance configuration
  - Auto volume control
- Accessing *General* settings:
  - Adjusting the units (Imperial/Metric)
  - Setting the language
  - Setting the date and time

- Updating the software via WiFi
  - Getting information about the manufacturer information and device regulatory compliance
  - Resetting the display to factory settings
- Defining the applets to be used with the Applet Switcher button while riding
  - Defining the settings to be used with the Ride Settings button while riding

It is recommended that you check regularly for software updates.

## Quick Preferences

To access the *Quick Preferences* menu, tap the following icon.

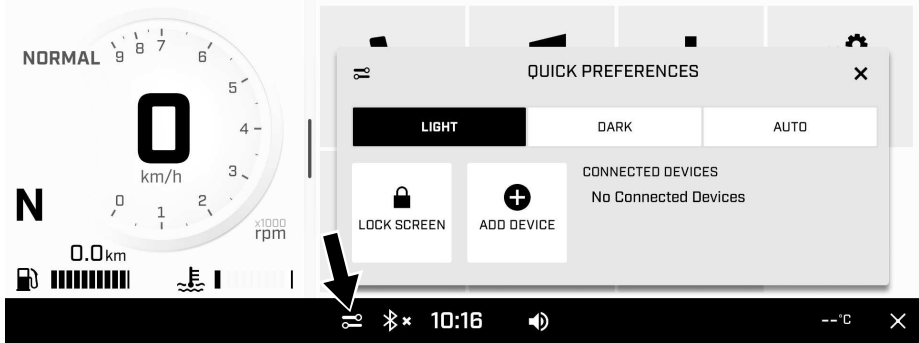

The *Quick Preferences* menu is used for the following:

- Adjusting the display appearance (LIGHT/DARK/AUTO)
- Locking the screen (press and hold anywhere on the screen to unlock)
- Adding a Bluetooth device
- Viewing connected Bluetooth devices

## Apple CarPlay



To use the Apple CarPlay, you must

1. Connect a compatible smartphone to the display via USB cable.
2. Pair a helmet audio system to the display via Bluetooth.

### NOTE:

If one of the two devices is not properly connected, Apple CarPlay can not be used.

Apple CarPlay is used to play music, place or receive calls, and view Apple Maps.

Apple CarPlay can also runs many other supported applications.

For details on the service or the operation, check the Apple CarPlay site (<https://www.apple.com/ios/carplay/>).

**NOTE:**

An undamaged genuine USB cable is greatly recommended.

The USB port is located in the glove box.

## Radio



### RADIO

The Radio applet is used to:

- Control the radio selection and volume in the helmet or vehicle audio system
- View radio information (when available)

## Icons and Indicators - Multifunction Display

Icon	Description
	App menu
	Audio volume
	Bluetooth
	Clock
	Quick preferences
	Smartphone network connection
	Temperature

## Messages in Touchscreen Display

Infotainment notifications include messages regarding connected devices

Notifications will always appear at the top right corner of the screen.

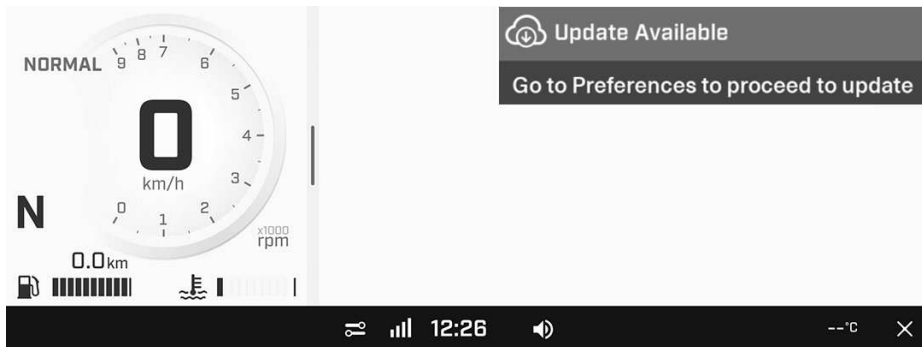

## Pairing Your Smartphone Through Bluetooth On the Vehicle

1. Open the *Applet* menu.
2. From the *Preferences* menu, choose **Bluetooth**.

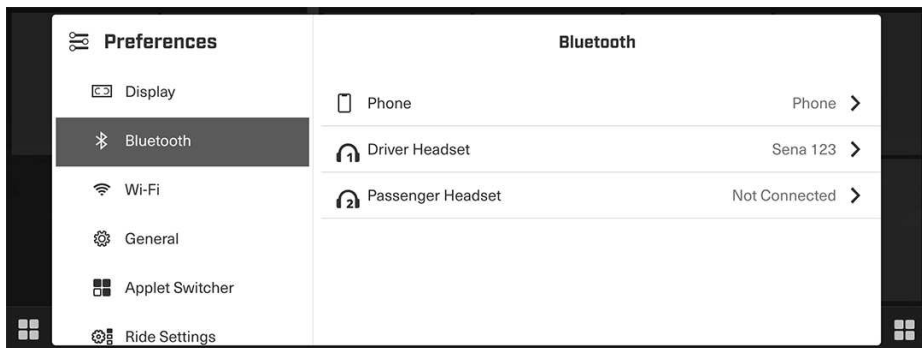

3. Expand **Phone**.
4. Select **Add Device**.

### NOTE:

Up to two smartphones can be paired with the vehicle. However, only one will connect at any given time.

## On the Phone

1. Activate your phone's Bluetooth™ function. Once the vehicle display finds your phone, its name (i.e, **BRP\_[last 4 digits of the vehicle's VIN]**) will appear on the phone.

**NOTE:**

Refer to your phone manufacturer's user guide for the detailed procedure.

2. On the vehicle display, select your phone's name.
3. A confirmation number will appear on your phone *and* on the vehicle display. Make sure that these numbers match.
4. On your phone, tap **Pair**.
5. Allow **Contacts and Favorites Sync** on your phone to use **Recent** and **Contacts** in the phone app. A notification will confirm the pairing.

**Pairing a Helmet**

Put your headset audio system in pairing mode. The process will vary depending on the headset model, so consult your headset's user guide if need be.

To pair a helmet, refer to *Pairing your Smartphone Through Bluetooth*. Then select **Driver Headset** or **Passenger Headset**.

---

# OPERATING MODES

## ECO Mode

When the fuel economy mode (ECO) is selected, the vehicle torque and speed are limited whereby an optimal cruising speed is maintained in order to reduce fuel consumption.

Once activated, the ECO mode will remain active until it is deactivated by the operator.

## Standard Mode

In standard mode, acceleration is reduced when accelerating from a complete stop and when operating in the low vehicle speed range under certain conditions.

## Mode Display

When a mode is selected, a message is displayed in the lower display.

At the same time one or more icons will turn on to confirm your choice.

<b>Driving mode</b>	<b>Display</b>
ECO	ECO
STD	NORMAL



# BASIC PROCEDURES

## ADJUSTING THE PASSENGER FOOTREST

For the passenger's comfort, its footrest height can be adjusted.

1. Flip the footrest upward.
2. Remove the footrest retaining screw and its washer.

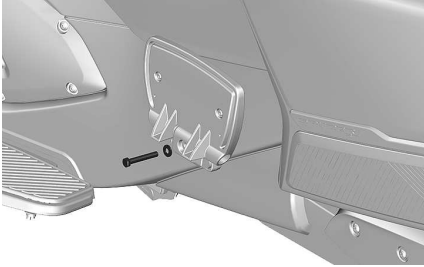

### NOTE:

A wrench is available in the tool kit to do this.

3. Reinstall the footrest at the desired height and tighten retaining screw to the specified torque.

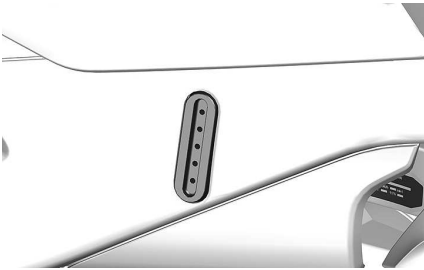

### Tightening Torque

Passenger footrest screw	24.5 ± 3.5 Nm (18 ± 3 lbf-ft)
--------------------------	----------------------------------

## STARTING AND STOPPING THE ENGINE

### Starting the Engine

#### **⚠ WARNING**

Exhaust gas contains poisonous carbon monoxide that can rapidly accumulate in an enclosed or poorly ventilated area. If inhaled, it can cause serious injury or death.

Only run the engine in an unenclosed, well ventilated area. See the *General Precautions* section.

1. Push down and hold the brake pedal.

The vehicle can be started in any gear with the brake pedal pressed. The transmission automatically shifts to neutral when the engine has been started.

2. Turn the ignition key to ON.

#### **NOTICE**

Do not apply throttle while electrical system is initializing.

3. Twist gently the throttle handle away from you (raise your wrist) to activate the starting system.

- Once this motion is done, release the throttle handle.
- The engine can be started in the next 30 seconds without doing this motion again.
- Each time the engine is stopped, this motion must be performed to start the engine.

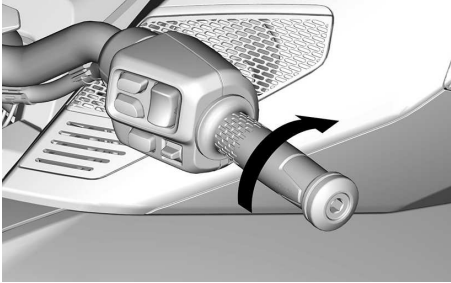

4. Press down the engine start switch until the engine starts. Do not hold the start button for more than 15 seconds. If it does not start, release the button and wait 30 seconds to let the starter cool down before trying again.

**NOTICE**

**Do not apply throttle while starting the engine.**



1. Engine start. position

5. Check the touchscreen display for problems and to ensure that the oil light turns off.
6. Release the parking brake. Make sure the brake indicator lamp in the touchscreen display is off.

**Stopping the Engine**

1. Shift into neutral.
2. Set the engine stop switch to OFF.
3. Engage the parking brake. The brake indicator lamp will turn on.
4. Turn the key to OFF.

**NOTE:**

If the parking brake is not engaged while the key is OFF, the parking brake indicator lamp will flash and a beeper will sound.

5. Before dismounting, check that the parking brake is fully engaged. Rock the vehicle back and forth.

**⚠ WARNING**

**Always engage the parking brake. The vehicle can roll if the parking brake is not engaged, regardless of what gear it is in. The clutch is always disengaged when the vehicle is stopped, so the transmission will not hold the vehicle in place.**

**Pushing the Vehicle**

Before pushing the vehicle, ensure the ignition key is in the ON position.

**⚠ CAUTION**

**Avoid pushing the vehicle on a slope. If you must push the vehicle on a slope, take extra care to stay within reach of the brake pedal in case the vehicle starts to roll.**

To move the vehicle a short distance without starting the engine:

1. While seated on the vehicle, push down and hold the brake pedal.
2. Disengage the parking brake.
3. Dismount on the right side of the vehicle, keeping your foot on the brake pedal.
4. Push the vehicle, using the brake as needed.

**⚠ CAUTION**

Only push from the right side, so you can reach the brake pedal. Stay clear of the hot exhaust pipe. When pulling the vehicle backward, be careful that the front wheel does not roll over your feet.

- Remount the vehicle and park as specified above.

**OPERATING IN REVERSE**

For safe operation in reverse, refer to *Safe Operating Instructions* section.

**Shifting Into Reverse**

- With engine running, the vehicle stopped, and the brake depressed, shift into neutral.
- Twist gently the throttle handle forwards (raise your wrist) and keep this position.

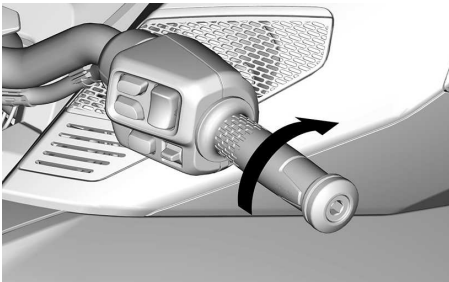

- Push or pull the gearshift selector again toward you to downshift in reverse.

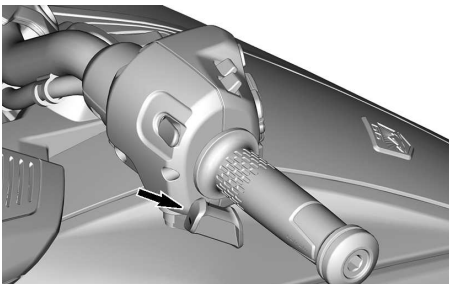

The icon **(R)** will appear in the display to confirm the activation of the reverse.

- When confirmed, apply throttle slightly to go backwards carefully.

**Driving in Reverse**

Check that the area behind you is clear and continue to look backwards while you operate in reverse. Keep your speed low and do not back up for long distances.

**Shifting Out of Reverse**

To shift out of reverse, stop vehicle and push on upshift selector quickly to shift into neutral and more longer to shift in first gear.

**NOTE:**

To shift out of reverse into 1st gear, press the brake pedal and shift up.

**OPERATION DURING BREAK-IN**

A break-in period of 1 000 km (600 mi) is required for the vehicle.

During the first 300 km (200 mi), avoid hard braking.

**⚠ WARNING**

**New brakes and tires do not operate at their maximum efficiency until their break-in is completed. Braking, steering and VSS performance may be reduced, so use extra caution. Brakes and tires take about 300 km (200 mi) of riding with frequent braking and steering to break-in. For riding with infrequent braking and steering, allow extra time to break-in the brakes and tires.**

During the first 1 000 km (600 mi):

- Avoid full throttle acceleration.
- Avoid prolonged riding maintaining constant RPM.

- If the cooling fans operate continuously during stop and go traffic, pull over and shut off the engine to let it cool off or speed up to let air cool off the engine.

After the break-in period, your vehicle should be inspected as per the *Maintenance Schedule*.

## FUELING

### Fuel Requirements

#### NOTICE

**Always use fresh gasoline. Gasoline will oxidize; the result is loss of octane, volatile compounds, and the production of gum and varnish deposits which can damage the fuel system.**

Alcohol fuel blending varies by country and region. Your vehicle has been designed to operate using the recommended fuels, however, be aware of the following:

- Use of fuel containing alcohol above the percentage specified by government regulations is not recommended and can result in the following problems in the fuel system components:
  - Starting and operating difficulties.
  - Deterioration of rubber or plastic parts.
  - Corrosion of metal parts.
  - Damage to internal engine parts.
- Inspect frequently for the presence of fuel leaks or other fuel system abnormalities if you suspect the presence of alcohol in gasoline exceeds the current government regulations.
- Alcohol blended fuels attract and hold moisture which may lead to fuel phase separation and can

result in engine performance problems or engine damage.

### Recommended Fuel

Use premium unleaded gasoline with an AKI (RON+MON)/2 octane rating of 91, or an RON octane rating of 95.

#### NOTICE

**Never experiment with other fuels. Engine or fuel system damages may occur with the use of an inadequate fuel.**

#### NOTICE

**Do NOT use fuel from fuel pumps labeled E85.**

Use of fuel labeled E15 is prohibited by U.S. EPA Regulations.

### Refueling Procedure

#### ⚠ WARNING

**Gasoline is extremely flammable and highly explosive. Follow the refueling procedure to reduce the risk of fire or explosion. See the *General Precautions* section.**

1. Park outdoors in a well ventilated area away from flames, sparks, anyone smoking and other sources of ignition.
2. Stop the engine.
3. Unlatch and lift the seat (see *Equipment*). The fuel cap is located on the left side.

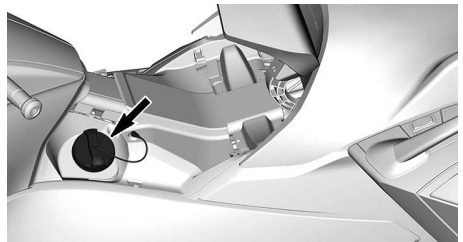

4. Slowly rotate the cap counterclockwise and remove it.

- Fill the tank until the fuel level reaches the higher point of the filler tube.

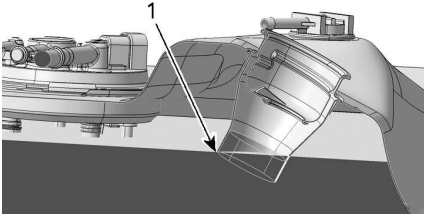

**TYPICAL**

- Higher point of the filler tube

**NOTE:**

Do not try to top off the fuel tank. Leave some room for the fuel to expand with temperature changes.

- Wipe up any spilled fuel. If fuel spills on you, wash with soap and water and change your clothes.
- Put the cap on and fully tighten clockwise until you hear three clicks. Pull on the cap to make sure it is correctly tightened. Never start or operate the engine with the fuel cap removed.
- Close the seat.

## Adjusting the Rear Suspension

### Base Models

The rear air suspension is pressurized for general operation. If the vehicle load changes (adding a passenger, riding with more cargo etc.) or if a softer or a harder setting is desired, the pressure of the rear suspension can be changed to your preferences.

The suspension pressure is adjustable by deflating or inflating the air spring. Use an air compressor (from a gas station) and a pressure gauge.

To soften suspension, reduce the air pressure and to harden suspension, increase air pressure.

Always refer to the *Rear Suspension Pressure* label located underneath the operator's seat to determine the proper pressure required with vehicle load.

**NOTE:** The pressures indicate on the label are a guideline only. You may adjust the pressure to your riding preference as long as you do not exceed the maximum allowed pressure.

### NOTICE

**Do not exceed the maximum allowed pressure. This might damage the air suspension.**

**NOTE:**

When adjusting the pressure, do not put your weight on the vehicle and do not load cargo in the storage compartment.

The air spring is connected directly to an air hose with a schrader valve located under the seat.

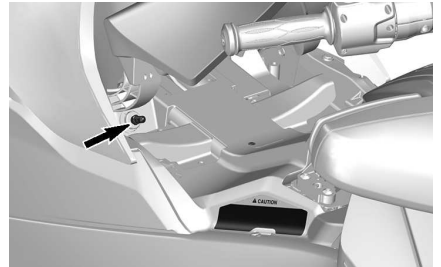

To change the air pressure, proceed the same way as for setting the pressure in a tire.

When finished, ensure to reinstall cap on the valve.

### Limited Models

The rear suspension is calibrated for a general riding and will adjust

automatically, using an integrated compressor, while riding to maintain this preset when the road conditions change or if the vehicle load changes (adding a passenger, riding with more cargo etc.).

**NOTE:**

It is normal to hear pressure release or the air compressor operating while engine is running. It indicates the suspension is self-adjusting.

# **SAFE OPERATING INSTRUCTIONS**

---

# WHAT'S DIFFERENT FROM OTHER VEHICLES

This section will help you understand some of the vehicle distinctive features and operating characteristics.

## Stability

The “Y” configuration of this 3-wheel vehicle provides greater low-speed stability than a motorcycle.

However, it is not as stable as a four-wheeled vehicle such as an automobile. Driving aid technologies, like the electronic Vehicle Stability System (VSS), help maintain stability during maneuvers, but you can still lose control, tip or roll the vehicle due to extreme maneuvers (such as hard turns), overloading the vehicle or striking uneven surfaces or objects. In addition, the operator or passenger can fall off due to hard turns, acceleration, braking or impacts.

## Response to Road Conditions

The road behavior of this vehicle may be different from other vehicles on the road. Follow these recommendations.

- Do not ride off-road or on ice or snow.
- Avoid puddles and running water. The vehicle hydroplanes more easily than a car. If you must go through water, slow down.
- Slow down on gravel, dirt or sand covered roads.
- Driving at temperature lower than 5 °C (41 °F) will result in reduced adherence.

Refer to *Street Strategies* for detailed instructions.

## Brake Pedal

One pedal applies brakes on all three wheels. There is no hand-operated brake, and there is no way to brake front and rear wheels separately.

This vehicle is able to brake and steer at the same time, much better than a

motorcycle and can stop very quickly. Be aware of vehicles behind you, they may not be able to stop or react as quickly.

## Anti-lock Braking System (ABS)

The vehicle is equipped with an Anti-lock Braking System (ABS) as part of the Vehicle Stability System (VSS).

This system helps to maintain the steering control during an emergency braking situation by keeping the brakes from locking.

## Parking Brake

The parking brake mechanically brakes the rear wheel only, and it locks in place when engaged. It is not controlled by driving aid technologies (e.g., Anti-lock Braking System (ABS), Electronic Brake Distribution (EBD)).

## Steering

### Direct Steering

To take a turn, always steer the handlebar in the direction of the turn.

Motorcyclists - Do not countersteer as you do with a motorcycle. Unlike a motorcycle, this 3-wheel vehicle cannot lean while turning. You must re-learn how to turn. Practice the turns at different speeds until you are proficient.

### Sideways Forces in Turns

Unlike a motorcycle, this vehicle cannot lean while turning. You will feel sideways forces pushing you to the outside of the turn.

To maintain balance, the operator and passenger must hold back with their both hands and keep their feet firmly planted on the footpegs.

In tight turns, it may help to lean your upper body forward and toward the inside of the turn.



## Width

Because this vehicle is wider than a typical motorcycle:

- Always keep the front wheels in your lane. Be particular aware of the front wheels location when entering in a curve or during an overtaking.
- Do not share lanes or split lanes (ride between two lanes of traffic). Group riding should proceed in a single file, even with motorcycles.
- Be prepared to swerve farther to avoid obstacles.

### NOTE:

Clearing an obstacle with the front wheels does not guarantee clearing the obstacle with the rear wheel.

## Reverse

The reverse icon  appears into the selected gear display when the reverse position is selected.

This vehicle may back in reverse like a car. However, there are some important differences:

- If necessary, have the passenger dismount if your visibility is limited.
- Remember that the front is wider than the rear. Do not back up too close to objects or you may hit them with the front tires.
- Keep your speed low and do not back up for long distances.
- When possible, park so that you do not have to back out of the parking space.

### CAUTION

**Always keep both feet on the footpegs while operating in reverse. Never put your feet on the ground while backing-up.**

## Driver's License and Local Laws

Driver's license requirements for operating this vehicle vary by location. Depending on local laws, you may need an automobile driver's license, a motorcycle's license, or a specific endorsement for a 3-wheel vehicle.

Check with local authorities to make sure you have the proper license before operating the vehicle on public roads.

---

# DRIVING AID TECHNOLOGIES

## Vehicle Stability System (VSS)

This vehicle is equipped with a Vehicle Stability System (VSS).

This system helps to keeping the control of the direction and reduce the risk of tipping or rolling over in some situations.

The VSS is composed of:

- An **Antilock Braking System (ABS)** that helps maintain steering control during an emergency braking situation by keeping the brakes from locking.
- An **Electronic Brake Distribution (EBD)** system that automatically adjusts the brake balance between all three wheels. With the ABS, EBD helps maintain directional control and maximize the braking force depending on the traction available.
- A **Traction Control System (TCS)** that helps prevent the rear wheel from slipping under throttle demand. The TCS will limit rear wheel spin only if you turn the handlebar (steer out of straight line) or if vehicle speed exceeds 50 km/h (31 MPH). When off-throttle (deceleration), the TCS will prevent the rear wheel from blocking.
- A **Stability Control System (SCS)** is designed to limit the power driving the rear tire and to brake individual wheels, which reduces the risk of losing control of the vehicle or rolling over.

### NOTE:

The VSS light in the gauge will turn on when VSS intervenes and will remain on for 2 seconds after VSS intervention.

### Limitations

VSS cannot help you maintain control in all situations.

## Surfaces with Poor Traction

The grip of tires on the road surface limits the maximum braking. Even with ABS and EBD, your stopping distance will be longer on surfaces with poor traction' if you do not maintain the recommended tire pressure or if tire tread condition is degraded.

If your tires lose traction with the road surface you may lose control of the vehicle, even with VSS.

If the paved road surface is covered or partially covered with ice, snow or slush, there is not enough traction available to maintain control of the vehicle, even with VSS. Do not operate on snow, ice or slush.

### NOTE:

The grip of the vehicle tires starts to decrease below 6 °C (43 °F).

Like other on-road vehicles, this vehicle can hydroplane on water (lose traction on a layer of water). If you ride too fast into a layer of water, such as a large puddle or flowing water on the road, the vehicle can lose traction and spin out, and the VSS cannot keep you in control. Avoid large water puddles or water streams, and slow down or pull off the road during heavy rains. If you must pass through water, slow down as much as possible before you reach it.

Reduce speed on surfaces with poor traction, like mud, sand, gravel or wet pavement. This vehicle is not for off-road operation. Always operate the vehicle on maintained roadways. Do not use the vehicle on any other terrain.

### Tires

The VSS on the vehicle has been calibrated to perform best with a tire of a specific size, material and tread pattern. Replacing your tires with ones not approved by BRP can cause the VSS to be less effective.

Use only BRP recommended tires, which can be ordered only from an authorized Can-Am On-Road dealer.

Proper tire inflation pressure and tread condition are important for maintaining traction, especially on loose or wet surfaces. Tire pressure that is too low may result in hydroplaning and excessive tire heat build up, while a tire pressure that is too high can reduce VSS effectiveness.

### Hard Turns

The VSS does not control or limit steering input — it cannot keep you from turning too sharply. Large and rapid steering handlebar movements can cause the vehicle to go out of control, spin, tip or roll over.

### Excess Speed

The VSS does not control the vehicle speed, except when SCS intervenes during a turn. The VSS does not prevent the vehicle from entering a turn too fast. If you drive too fast for conditions, you can lose control, even with VSS.

### Excess Weight

Never load vehicle above specified values.

<b>Total Vehicle Load Allowed</b>
252 kg (556 lb)

## Dynamic Power Steering (DPS)

The DPS (Dynamic Power Steering) provides a computer controlled, variable power assist, achieved by an electric motor to optimize the amount of steering effort required by the rider.

The steering assist level is dependent of the handlebar effort, the steering angle and the vehicle speed.

When vehicle is in the reverse gear, power steering assist will decrease as vehicle speed increases.

---

# UNDERSTANDING RISK ON THE ROAD

Before operating this 3-wheel vehicle, watch the safety video, read the safety card and all on-product safety labels.

Consider your risk of being hurt or killed in a crash, think how you can reduce this risk and whether, you are willing to take this risk.

There are many factors that contribute to the risk that you face. You can control some of these factors, but others, like the behavior of other drivers, are beyond your control.

Here are some of the factors that affect your risk:

## Type of Vehicle

Different types of vehicles vary in terms of size, visibility and maneuverability and provide different degrees of protection.

This vehicle is small and maneuverable. Maneuverability can help avoid crashes. However, smaller vehicles are harder to see, which increases the chance that other motorists will cause a crash. In some situations, this vehicle is less likely to be in a crash than a motorcycle. For example, you are less likely to tip over at low speeds while operating the vehicle. However, in other situations, the vehicle is more likely to be in a crash. For example, because the vehicle is wider, it will not fit through as small an opening as many motorcycles.

In cars and trucks, the structure of the vehicle provides protection in crashes and from other road hazards. In addition, passengers can protect themselves by wearing seat belts. You should expect that the riding of this vehicle is riskier than riding in a car and that the risk of injury is more like riding a motorcycle.

As when riding a motorcycle, you can reduce the risk of injuries by wearing a helmet and riding gear.

## Operator Skills and Judgment

Every driver has some control over their own risk on the road.

Drivers who develop good skills will have better control of their vehicle.

Do not rely on your experience with motorcycles, automobiles, ATVs, snowmobiles or any other kind of vehicle to prepare you to operate the vehicle.

Learn how this vehicle is different. Read this Operator's Guide, watch the safety video located at:

<https://can-am.brp.com/spyder/owners/safety/safety-information.html>

Or, use the following QR code:



If available, take a training course. Become proficient with the controls and be able to do the practice exercises accurately and with confidence before going on the road.

When you begin riding on the road, start with less challenging situations (e.g., light traffic, lower speeds, good weather, no passenger) and gradually move on to more challenging riding situations as you develop your skills. Plan ahead to avoid situations that are too difficult for your skill level, or that present more risk than you want to take on.

Even skilled drivers cause crashes. For example, if you use your skills to do extreme maneuvers or stunts, you increase your risk. The smart driver uses good judgment along with skills to increase the margin of safety and minimize risk. Learn the defensive

driving techniques in *Street Strategies*.

## Rider Condition

A driver needs to be alert, sober, and physically ready to ride. Never use this vehicle with drugs or alcohol. Riding when intoxicated, tired or otherwise impaired increases the risk of a crash.

Alcohol, drugs, medications, fatigue, drowsiness and emotions can all inhibit your ability to ride safely. Like riding a motorcycle, riding this vehicle is a challenging activity — being in good physical and mental condition is even more important than for a car. The safest policy is to never operate the vehicle unless you are alert and completely sober. Even if your blood alcohol level is not over the legal limit, your judgment and skills are impaired by any alcohol consumption.

You must be physically able to operate all controls, turn the handlebar through the full range of steering, mount and dismount, and monitor your surroundings to operate the vehicle.

Passengers also need to be alert, sober and physically able to maintain their posture, hold on and react appropriately to curves, bumps, acceleration and stops.

## Vehicle Condition

Keep your vehicle in good condition.

Do pre-operation checks and perform regular maintenance. Watch for any messages on the multifunction gauge cluster when you start the vehicle, and address any problems before you ride.

Always use the multifunction gauge with extreme caution. Prolonged attention to the display while riding significantly increases the risk of a crash.

## Road and Weather Conditions

Roads with heavy traffic, poor visibility or poor traction surfaces increase your risk. Choose routes that are appropriate for your skill level and the level of risk you are willing to accept.

# RIDING GEAR

Riding this vehicle requires the same protective gear as motorcycling. Even though the vehicle is more stable at low speeds than a motorcycle, you can still be thrown off.

This section is based on guidance for motorcyclists given by the Motorcycle Safety Foundation (MSF).

In the event of a crash, protective gear may prevent or reduce injuries. Protective gear also helps you stay comfortable and can help provide protection against the elements.

Recommended basic protective gear for riders and passenger includes sturdy over-the-ankle footwear with non-slip soles, long pants, a jacket, full-fingered gloves and, above all, an approved helmet with proper eye protection.

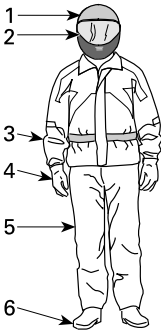

## RIDING GEAR

1. Approved helmet
2. Eye and face protection
3. Jacket with long sleeves
4. Gloves
5. Long pants
6. Over-the-ankle footwear

Proper apparel can reduce the severity of injuries in case of a crash, either for the operator or the passenger.

## Helmets

Helmets protect the head and brain from injury. A helmet can also protect the passenger's face from impact with the back of the operator's helmet.

Even the best helmet is no guarantee against injury, but statistics indicate that helmet use significantly reduces the risk of brain injury. So, be safe and always wear a helmet while riding.

## Choosing a Helmet

Helmets should be manufactured to meet the appropriate standard in your state, province or country.

A full-face helmet gives the most protection against impacts since it covers all of the head and face. It can also protect against debris, stones, insects, etc.

A three-quarter or open-face helmet can also offer protection. It is constructed with the same basic components but does not offer the face and chin protection of full-face helmets. If you wear an open-face helmet, you should use a snap-on face shield or a pair of goggles.

## NOTE:

Ordinary glasses or sunglasses are not sufficient eye protection for a motorcyclist. They can shatter or fly off, and they allow wind and airborne objects to reach the eyes.

Use tinted face shields, goggles or glasses in the daytime only; do not use them at night or in poor illumination. Do not use them if they impair your ability to discern color.

## Other Riding Gear

### Footwear

Always wear closed toe footwear. Sturdy over-the-ankle boots protect against a variety of riding hazards, such as stones that get thrown up from the roadway and burns from the hot exhaust pipe.

Avoid long shoelaces that can be tangled in the gearshift lever, brake pedal or other parts. Rubber soles

and low heels are a good idea to help keep feet on the footrests.

### **Gloves**

Full-fingered gloves protect hands from the wind, sun, heat, cold and flying objects. Gloves that fit snugly will improve grip on the handlebar and help reduce hand fatigue. Sturdy, reinforced motorcycle gloves help protect hands in the event of a fall. Gloves made specifically for motorcyclists have seams on the outside to prevent irritation, and are curved to provide a natural grip when curled around the handgrips. If gloves are too bulky, it may be difficult to operate the controls. Gauntlets keep cold air from going up sleeves and protect the wrists.

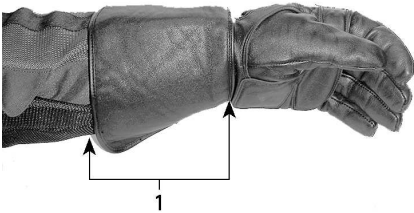

1. Glove gauntlet

### **Jackets, Pants and Riding Suits**

Wear a jacket and long pants, or a full riding suit. Quality motorcycle-type protective gear will provide comfort, and it can help you avoid being distracted by adverse environmental elements. In case of a crash, good quality protective gear made of sturdy material may prevent or reduce injury. Some gear includes padding or hard armor that may further reduce the risk of injury in a crash. Pants also help protect against burns from hot parts.

Protective gear sold for motorcycling will often provide the best combination of fit and protection. These garments are designed to fit while sitting in a riding position. They are cut longer in the sleeves and legs and are fuller across

the shoulders. Riding suits are available in both one-piece and two-piece sets.

Leather is a good choice because it is durable and wind-resistant and provides protection against injury. Other abrasive-resistant protective gear made of synthetic fabrics are good choices, too. Do not wear loose or long clothing or scarves that can become tangled in the moving parts.

Flaps and fasteners seal out the wind. A jacket with a zippered front will be more wind resistant than a jacket with buttons or snaps. A flap of material over the zipper of a jacket gives additional protection against the wind. Jackets with snug cuffs and waist are recommended to keep wind from blowing in. A large, loose collar can flap when riding and may irritate skin or be a distraction.

In cool-weather riding, protect yourself against hypothermia. Hypothermia, a condition of low body temperature, can cause loss of concentration, slowed reactions and loss of smooth, precise muscle movement. In cool conditions, proper protective gear like a windproof jacket and insulated layers of clothing are essential. Even at moderate temperatures, you can feel very cold due to the wind while riding.

Protective gear that is appropriate for cold-weather riding may be too hot when stopped. Dress in layers so that clothing can be removed as desired. Topping the protective gear with a windproof outer layer can prevent cold air from reaching the skin.

Riding gear can also help a rider be more visible. Wearing bright colors is a wise choice. If a dark jacket is worn, an inexpensive reflective vest can be worn over it. It is a good idea to put extra reflective tape on garments worn regularly while riding.

### ***Rain Gear***

If you must ride in wet weather, a rain suit or a waterproof riding suit is recommended. On long rides, it is a good idea to carry rain gear. A dry rider will be much more comfortable and alert than a rider who is wet and cold.

One or two-piece styles are available, and those designed specifically for motorcycling are best. High-visibility orange or yellow colors are good choices. A feature to look for is elastic in the waist, pant legs and sleeves. The jacket should have a high collar and zip up with wide flaps across the opening. When purchasing a rain suit, consider adding waterproof gloves and footwear.

Remember, if the weather is wet, it is best to avoid riding. If you do ride in wet weather, you may need to stop if water starts to accumulate on the road.

### ***Hearing Protection***

Long-term exposure to wind and motor noise when riding can cause permanent hearing loss. Properly worn hearing protective devices such as earplugs can help prevent hearing loss. Check local laws before using any hearing protective devices.



# REQUIRED RIDING SKILLS AND PRACTICE EXERCISES

Before you take this vehicle on the road, you need to develop riding skills and strategies for managing risk on the road.

If you have experience with motorcycles or other motor vehicles, pay particular attention to how the operation and performance of this vehicle are different from vehicles you are used to.

The following exercises will familiarize you with the basic operation of the vehicle. Practice each exercise until you can perform it proficiently before moving on to the next.

This section includes the following exercises:

1. Revving the engine and using the engine stop switch
2. Starting, stopping, and basic handling
3. Engine stop while in motion
4. Basic turns
5. Quick stops
6. Weaves
7. Shifting
8. Swerve
9. Operating in reverse.

## Choosing a Practice Area

Perform these exercises in a paved area at least 30 by 76 m (100 by 250 ft) that is not open to traffic. A closed, well marked parking lot without obstacles (light poles, curbs, etc.) makes a good practice area. Be aware of oil left by parked cars. Look for parking lots that are empty during off hours, such as schools, churches, community centers or shopping centers. Do not trespass on private property.

Once you have selected a suitable location, get permission to use it from the owner. If there are obstructions, such as light poles or islands, be sure that they do not interfere with the

required open paths shown in the diagram below.

Keep this basic parking lot diagram in mind when setting up the exercises. 3 m (10 ft) wide parking lot spaces are indicated in the diagrams for convenience, but the size of the spaces in the lot you use may be different. If the parking lot you choose does not have lines or if the parking spaces are sized much larger or smaller than the ones in the diagrams, use the dimensions shown below. Mark them using a tape measure and chalk or markers such as cones or milk containers weighted with water or sand.

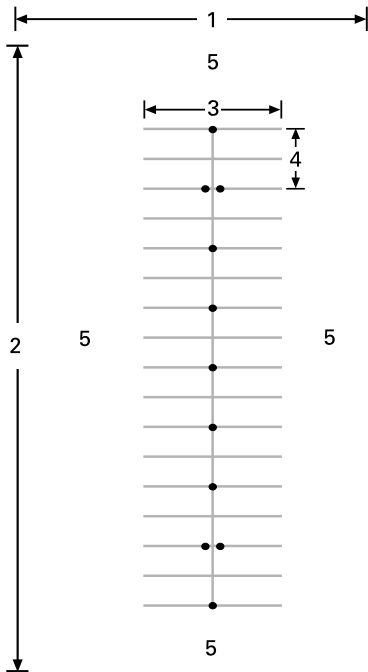

### TYPICAL PARKING LOT

1. At least 30 m (100 ft)
2. At least 76 m (250 ft)
3. 12 m (40 ft)
4. 6 m (20 ft)
5. Open area

Even in a closed lot, be aware of potential traffic. Check to the front, sides

and rear before doing an exercise. Also, watch out for children and animals.

## Preparing to Ride

Know the location and operation of all the vehicle controls. Refer to *Vehicle Information* section.

Adjust handlebar, footpegs and brake pedal to meet driver needs. Refer to *Control Components Adjustment* in *Equipment* section.

Perform the pre-ride inspection. Refer to *Pre-Ride Inspection* section.

Always start and stop the engine according to the instructions in *Starting and Stopping the Engine* in *Basic Procedures*.

## Riding Posture

Good posture helps you maneuver the vehicle more easily. Always keep both hands and both feet in position so that you can operate the controls easily. The wrist should typically be aligned straight with the arm (this position helps you apply the amount of throttle you want). Arms should be relaxed and bent. Keep your back straight and your head and eyes up. Keep both feet on the pegs near the controls.

Never operate the vehicle, even for a short distance, unless you are in the proper riding posture.



TYPICAL RIDING POSTURE

## Practice Exercises

### 1) Revving the Engine and Using the Engine Stop Switch

#### Purpose

- Become familiar with the operation of the twist throttle.
- Become familiar with the sound of the engine at different RPMs. This will help you to know when to up-shift and downshift based on the engine sound.
- Become familiar with using the engine stop switch.

#### Directions

- Start with the vehicle in NEUTRAL, the parking brake engaged, and your right foot on the brake pedal. Check the multifunction gauge cluster to be sure you are in NEUTRAL — if you are in first gear, the vehicle will try to start moving when you apply the throttle.
- Watch the tachometer and apply throttle (twist by lowering your wrist) a few times to raise the RPM to no more than 4000. Practice applying the throttle gently and smoothly, holding it steady at about 3000 RPM, and releasing it. As long as the transmission is in neutral the power will not transfer to the rear wheel.
- Use the engine stop switch to cut all power to the vehicle. Press the switch with your right thumb while keeping your hand on the handgrip.

#### Tips for Additional Practice

- Practice pressing the engine stop switch without looking at it.

### 2) Starting, Stopping and Basic Handling

#### Purpose

- Learn throttle control and how to get the vehicle moving.

- Become familiar with low speed deceleration and braking.

### Directions

If you feel like you are losing control while doing these exercises, release the throttle to stop accelerating and apply the brake as needed to slow down. You can also use the engine stop switch to cut power entirely.

### 2a) Apply and Immediately Release Throttle

#### Directions

At first, you will only use the throttle for a moment at a time, then release it and coast.

- Start the engine and release the park position lever.
- With the brake pedal pressed, push on the shift lever to ensure the forward position is selected.
- Release the brake.
- Slowly apply throttle until the vehicle starts to creep forward. As soon as you start moving release the throttle and coast, then press the brake to stop. Repeat to the end of the straightaway.
- To turn around at the end of the straightaway, stop, turn the handlebar all the way to the right, then briefly apply and release the throttle, and coast through the turn. You may need to briefly apply the throttle more than once to complete the turn. Stop when you are in line with the straightaway in the opposite direction.
- Continue with this part of the exercise until you are comfortable with applying and releasing the throttle.

### 2b) Hold Throttle, Release and Stop Every 12 m (40 ft)

Next, you will be holding the throttle a little longer, then stopping every 12 m (40 ft) (every other marker/every fourth line).

- Again, slowly apply throttle until the vehicle starts to creep forward. This time, hold the throttle at this point.
- As you approach the stopping point, release the throttle and press the brake to stop.
- Turn around at the end of the straightaway as before, except now you do not need to release the throttle during the turn. Pay attention to maintaining a steady throttle position as you turn. Stop when you are in line with the straightaway in the opposite direction.

### 2c) Hold Throttle, Release and Stop at Ends

Next, use the entire straightaway, stopping only at the ends. Keep the throttle moderate.

### 3) Engine Stop while in Motion

#### Purpose

- Become familiar with using the engine stop switch when in motion so you know how the vehicle will react if you need to use it later.

#### Directions

- Partway down the straightaway, while operating at 8 km/h (5 MPH), toggle the engine stop switch to OFF position and coast to a stop.
- Restart the engine and repeat the exercise. Try increasing your speed (to a maximum of 20 km/h (12 MPH) before using the engine stop switch.

#### NOTE:

Vehicle will not start in gear without brake pedal depressed.

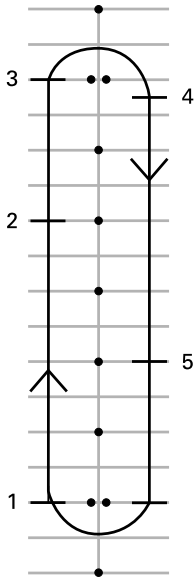

1. Start
2. Press engine stop switch
3. Proceed to end of straightaway, stop and turn as before
4. Stop
5. Press engine stop switch

Restart the engine and proceed to the next exercise.

#### 4) Basic Turns

##### Purpose

- Get comfortable turning in a controlled manner.

##### Directions

This exercise is similar to what you did before, except that now instead of stopping for each turn, you will make the turn at low speed.

- Roll in a straight line. Ride a little farther from the cones so you can make a wide arcing turn at the end of the straightaway.
- As you approach the curve, slow down to no more than 8 km/h (5 MPH) by releasing the throttle and apply brake if needed.

- Hold the throttle to maintain your low speed.
- Look in the direction of the curve.
- Turn the handlebar in the direction of the curve, pulling on the inside handgrip and pushing on the outside, being careful not to apply throttle.
- Leaning forward and into the curve may help you turn the handlebar more easily.
- Straighten your handlebar after the turn and proceed down the straightaway.



**TYPICAL - RIDING POSTURE WHEN TURNING**

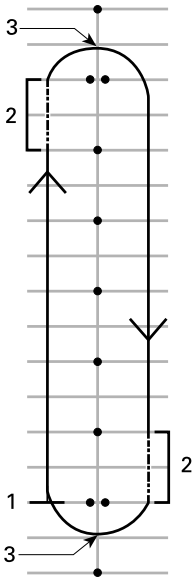

1. Start
2. Friction zone
3. Apex

#### NOTE:

Motorcyclists - Riding through turns and curves with this vehicle is different than on a motorcycle. The vehicle does not lean during a turn, so you may need to shift your body weight towards the inside of the turn to keep a comfortable posture on the vehicle. You will need to exert more force to turn the handlebar of your vehicle than is needed to turn a motorcycle. However, it is easier to stop while turning than with a motorcycle.

#### Tips for Additional Practice

- After you are comfortable turning in one direction, try going around the course the other way. Be careful not to apply more throttle than you intend when turning left.
- Stop at the apex of the turn to see what it is like to use your brakes in a curve or turn.

### 5) Quick Stops

#### Purpose

- Become familiar with the vehicle braking ability.
- Learn to apply brakes with maximum force.

#### Directions

This exercise is similar to what you did before, except you'll be applying the brake more firmly, working up to braking as hard as possible. The Anti-lock Braking System (ABS) will prevent the wheels from locking and help you maintain steering control while applying maximum braking force. Always release the throttle completely for quick stops. If you apply throttle and brake at the same time, your stopping distance will be longer.

- Start at one end of the straightaway and accelerate to 8 km/h (5 MPH). Partway down the straightaway, release the throttle completely and brake quickly. Never pump the brake as the ABS will prevent wheel lock.
- Keep head and eyes up, keep handlebar straight, and do not release the brake until fully stopped.
- Repeat, increasing your speed and braking harder.

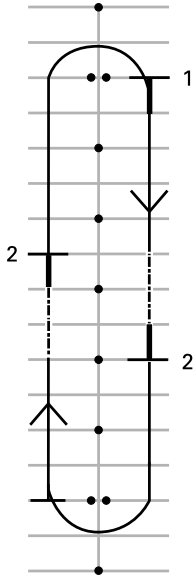

1. Start
2. Stop

### Tips for Additional Practice

- Practice checking your mirrors before braking hard.

## 6) Weaves

### Purpose

- Get more experience with the vehicle handling and rider position.

### Directions

#### 6 m (20 ft) Weave

1. Weave between every marker/intersection of every other parking spot. Keep your speed low initially as you get used to making the changes of direction.
2. Lean into each turn and turn the handlebar in the direction you want to go by pulling and pushing the grips.

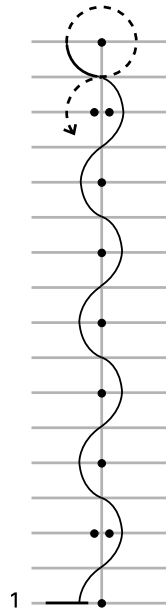

1. Start

#### 12 m (40 ft) Weave

Once you're comfortable, try doing 12 m (40 ft) weaves between every other cone/every fourth parking space.

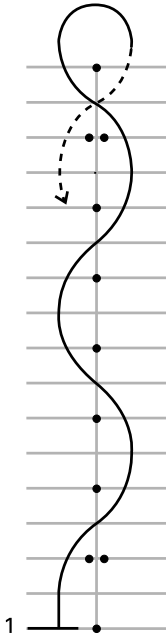

1. Start

### Tips for Additional Practice

- You can gradually increase speed as you get comfortable to 16 - 19 km/h (10 - 12 MPH) for the weaves, but slow down for the U-turns at the ends.

### 7) Shifting

When riding, you must change gears to match the engine speed with road speed. Lower gears are used for lower speeds and higher gears are used for higher speeds, just like on a manual transmission car or truck.

The transmission will automatically downshift if the engine speed drops under 1800 RPMs.

### Purpose

- Learn to upshift and downshift.

### Directions

This exercise is similar to what you did before, except now you will be

upshifting on the straightaways, then coming to a stop at the end of each straightaway. You may want to use the parking lot aisles for this exercise rather than riding in the spaces.

### 7a) Practice Using the Gear Selector at a Stop

First, while stopped, practice to single shift between reverse, neutral and first gear. Then practice to:

- Double shift from reverse to first gear
- Double shift from first to reverse gear
- Repeat until you are comfortable.

### 7b) Upshifting from First into Second Gear

- In the straightaway, accelerate until the engine speed reaches 3000 RPM.
- Press the gear selector forward to shift into second gear. You do not have to release the throttle while shifting.
- Once you are comfortable, if space allows, you can adjust the throttle to increase speed in second gear.

As you approach the end of the straightaway, come to a stop:

- Release the throttle
- Apply brake
- The transmission will downshift automatically as the speed slows. You can also manually downshift by pulling the gear selector towards you.

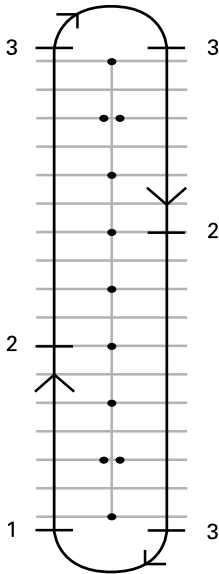

1. Start
2. Shift into second at 25 km/h (16 MPH)
3. Stop

### 7c) If Space Allows, Practice Downshifting into First While Moving

In the straightaway:

- Pull the gear selector toward you without releasing throttle.
- You will feel more engine braking when you downshift without throttle.

### 7d) Other Gears

If space allows, you can try shifting into and out of higher gears as well. Follow the same process and shift up or down one gear at a time.

### NOTE:

Applying slightly more throttle while downshifting can help the engine rev up to match vehicle speed more quickly and make the downshift smoother. When you do not apply throttle while downshifting, engine braking will slow the vehicle. This can help you decrease speed, but remember that VSS does not control engine braking. If you shift into too low a gear when you are at high speed, the rear tire can skid and you can lose control, spin out, tip or roll over, particularly in a curve.

### 8) Swerve

#### Purpose

- Become familiar with the vehicle's handling for quick maneuvers.
- Try different variations of braking and swerving.

#### Directions

At this point you will need to change your course. Set up your markers as shown in the diagram below. Do not use any fixed or hard, heavy objects as markers for this exercise.

- Enter between the double cones at about 8 km/h (5 MPH) and maintain that speed throughout.
- Steer around the line of cones.
- Exit through the second set of double cones.
- Repeat the exercise multiple times, swerving in both directions.



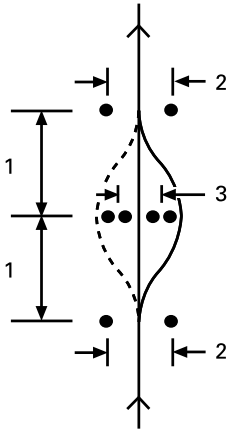

1. 6 m (20 ft)
2. 3 m (10 ft)
3. 2.5 m (8 ft)

### Tips for Additional Practice

- You can gradually increase your entry speed (to no more than 13 to 19 km/h (8 to 12 MPH) and try some variations. For example, approach faster and slow before entering the exercise, apply brakes during the swerve, etc.
- A helper can add an element of surprise to the exercise by deciding which direction you should swerve, or if you should come to a stop instead. Have your helper stand at a safe distance (e.g., beyond the end of your practice area). As you reach the first set of cones, the helper can use hand signals to indicate which direction to swerve or for you to stop.
- Practice checking your mirrors and blind spot before you swerve.

## 9) Operating in Reverse

### Purpose

- Become familiar with the vehicle handling and turning radius in reverse.

### Directions

- Shift into reverse. See *Operating in Reverse* in *Basic Procedures*.
- Check that the area behind you is clear. Continue to look backwards. Be careful not to strike anything with your front wheels as you back up. Slow and stop by releasing throttle and using brake, just like when operating normally.
- Back for a few feet at time, stopping in between.
- Keep your speed low and do not back up for long distances.
- After you are comfortable with reverse, back into a parking space as shown in the diagram below.

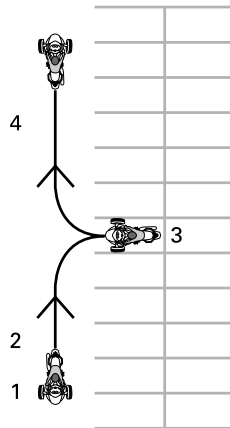

1. Start
2. Reverse
3. Stop
4. Forward

## Developing Advanced Riding Skills

Once you have mastered basic riding skills, you can begin developing more advanced skills. First, learn the *Street Strategies* covered in the next section. Then you can take the vehicle on the road in relatively low-risk situations.

Start by riding in less challenging situations:

- Short distances

- Good weather
- Low traffic
- Daytime
- Lower speeds
- No passenger.

You can gradually move on to more challenging riding situations as you develop your skills.

---

# STREET STRATEGIES

This section provides some strategies to reduce your risk on the road. Many of these strategies are similar to those used for motorcycles.

This section is based on guidance for motorcyclists given by the Motorcycle Safety Foundation (MSF). However, even experienced motorcyclists should read this section, as some strategies are different for a 3-wheel vehicle.

## Plan your Trip

Always check weather conditions before riding the vehicle. Take appropriate gear for any weather you might encounter.

Plan a route and ride in conditions that are appropriate for your skill level.

The vehicle has a 20 l (5.3 gal (liq., US)) fuel tank. When the low fuel indicator light flashes, fill fuel tank as soon as possible. Plan your refueling stops, particularly in unpopulated areas.

## Defensive Riding

As with a motorcycle, defensive riding can help you avoid crashes. You need to stay alert at all times. Never stop watching your surroundings, including the area behind you. Always scan for potential hazards, plan ahead, and leave space and time to avoid trouble. Do not assume other motorists will see you or follow the rules of the road.

### *Following Distance*

Always leave at least a two-second following distance between you and the vehicle in front of you when operating under ideal riding conditions. This means that you should pass any fixed point on the road at least two full seconds after the vehicle in front of you.

When conditions make braking distance longer, or visibility is limited, use a longer following distance for a

greater margin of safety. For example, braking distance is longer on slippery road surfaces, down hills, or when carrying more weight, and visibility may be limited in fog, in curves or at night.

### *Scanning Ahead*

In addition to leaving adequate following distance to the next vehicle, scan ahead and plan your path even farther in advance.

Plan your immediate path at least four seconds ahead. Watch this path for hazards, such as anything in the road or anything entering the road.

Scan ahead 12 seconds along your anticipated path to identify potential hazardous situations before they happen. For example, look for intersections where other vehicles may appear or places where pedestrians might enter the road. Be prepared to respond if a hazardous situation develops.

### *Watch Behind and to the Sides*

Vehicles and other hazards can approach from all directions. Constantly be aware of your surroundings. Check your mirrors frequently to see directly behind you. Also do frequent head checks (turn your head to look) to monitor your blind spot.

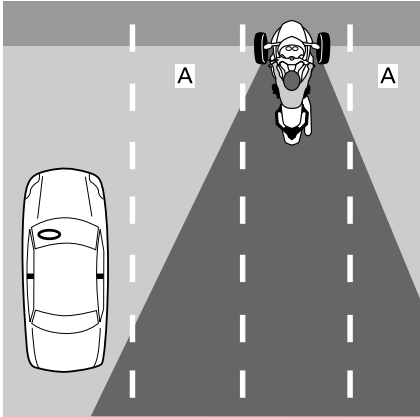

1. Operator's blind spots

When braking, be particularly aware of vehicles behind you that may not be able to stop as quickly than you.

### **Keep your Eyes Moving**

To stay aware of your surroundings, do not fixate on any one thing. Move your eyes constantly to monitor the road, traffic control markings and devices and other vehicles. Look near and far, in all directions.

### **Anticipate Trouble**

Whenever you notice a potential hazard, plan a way to avoid it. This might mean adjusting your speed or lane position, or changing lanes. You should be ready for evasive maneuvers such as swerving and/or braking if something enters your path. Always leave time and space to react to trouble.

### **Being Visible**

Motorists tend not to see smaller vehicles like motorcycles. Therefore you should use strategies to become more visible.

## **To Be More Visible to Other Motorists**

### **Lighting and Reflectors**

Make sure that the headlights, running lights and taillights on your vehicle work properly. Your vehicle is equipped with reflectors on the fenders, sides, and back. Make sure that all reflectors are clean and not broken or missing.

Use your high beams whenever possible, both day and night. Use low beams to avoid blinding other motorists at night or when too much light reflects back, such as in fog.

### **Signals**

Use your turn signals to inform others of your intentions. The vehicle has automatic canceling turn signals, but they may not cancel after shallow turns. Make sure turn signals are off after you have completed your maneuver; leaving them on may confuse other motorists.

When possible, flash your brake lights before slowing and when waiting at intersections, to alert motorists behind you.

You can also use your horn to attempt to alert other motorists of your presence.

Do not assume that other motorists will notice your lights, signals or horn.

Use your hazard warning lights to make yourself visible when needed.

### **Blind Spots**

Avoid riding in the blind spots of other vehicles. Position yourself so that drivers ahead can see you in their mirrors. In some cases, such as when you are following a truck or a bus, you must be farther behind the vehicle in front of you.

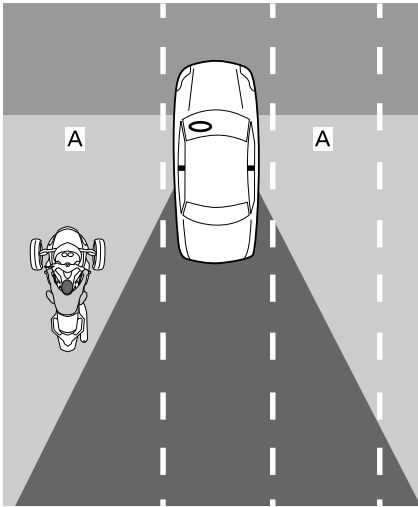

A. Blind spots of other vehicles

### Time of Day and Weather

In dim light, such as at night, at dawn or dusk, or in poor weather such as rain or fog, you may be harder to see. Glare at dawn and dusk or very bright sunlight can also make it harder for other motorists to see you.

### Clothing

Bright colors or reflective clothing can increase your visibility.

### Be Careful Even When Motorists See You

Even when motorists seem to notice you, they may still drive in a way that puts you at risk of a crash. Drive defensively, and do not rely on other motorists to operate their vehicles safely.

### Lane Position

Normally, position the vehicle in the center of the lane. This position keeps the front tires in the lane. It also provides distance from vehicles in other lanes, reducing wind from large vehicles and reducing the risk of being struck by vehicles that leave their lane. This position also keeps your

front wheels out of the slippery area in the middle of the lane, helping maintain braking and steering ability. If you are used to driving a car, remember that you are sitting in the center of the vehicle, your perspective is different.

You can move to the left or right part of the lane, to avoid hazards, keep distance from other vehicles, or handle curves. You can also move to the left or right part of the lane to get a better view or to be seen by other vehicles. Because of the central seat position and the width of the vehicle, it may be harder to see around traffic, even when you are near the edge of the lane. You may need a greater following distance behind wide or tall vehicles. Avoid putting your wheel outside of the lane to see around traffic. In order for drivers ahead to see you, you must be able to see their mirrors. When you are being followed by a large vehicle, passing vehicles may not be able to see you easily if you are not in the left part of the lane.

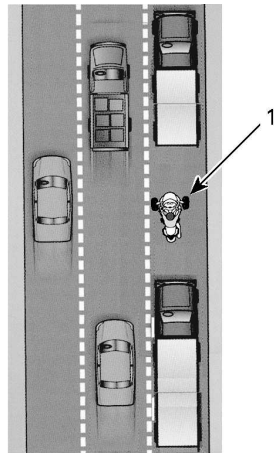

1. Vehicle in left portion of lane

Because the vehicle is wider than a motorcycle, the range of lane positions is smaller. When riding in the left or right part of the lane be sure that the front wheels stay in the lane.

On multilane roads, choose a lane that is appropriate for your speed in the flow of traffic, and also consider your ability to see and be seen, and possible paths for evasive maneuvers (such as swerving into other lanes or onto the shoulder).

## Common Riding Situations

### *Intersections*

Intersections, including small intersections with alleys and driveways, present an additional risk due to the cross traffic. Always watch for traffic in all directions: behind, in front and to the left and right.

When stopping at an intersection, stop in the middle of the lane, even if you are preparing to turn. This can make you more visible and discourage other motorists from trying to drive around you. Watch for vehicles approaching from behind. Flash your brake lights as they approach. Be prepared to move if necessary to avoid a collision.

### *Lane Changes and Passing*

Remember that the vehicle is wider than a motorcycle and needs more lateral space to pass another vehicle. Also remember that the vehicle is less visible than a car, so it is particularly important to signal your lane change well in advance and check your mirrors and blind spots. Be sure to turn off your turn signal after changing lanes; a lane change will not turn the handlebar far enough to automatically cancel the signal.

Never drive on the line between two lanes of traffic (split lanes). The vehicle is too wide.

Never drive on the shoulder to pass vehicles. If you put one wheel off the road, you can lose control.

## *Turns*

Remember to slow, look, and steer through turns.

- **Slow:** Reduce speed as needed before entering a turn by rolling off the throttle and/or using the brakes. Enter the turn at a speed that you can maintain throughout the turn.

Although the vehicle is better able to brake while turning than a motorcycle, it is still important to slow down before you enter a turn or curve rather than braking in the turn. Braking and turning both require traction. The more traction you use for braking, the less there is available for turning at the same time.

When you take a turn or curve too fast, you may notice the inside front wheel lifting off the pavement and feel and hear VSS cutting back engine power. While VSS can help you maintain control, it is still possible to spin or roll over if you turn too hard and fast.

- **Look:** Search through the entire turn and keep your eyes moving. Evaluate the entire turn as soon as possible — surface characteristics, sharpness of the turn, and overall traffic conditions — so you have time to make decisions about speed and position. Sometimes turning your head in the direction of the turn helps to keep a good visual picture.
- **Steer:** Turn the handlebar to steer the vehicle in the direction of the turn. This vehicle is not like a motorcycle, so it does not counter-steer, and the vehicle does not lean. Remember, you will experience the lateral force generated by turning, so you may need to shift your body weight to the inside of the turn to keep a comfortable posture on the vehicle. You will need to exert more force to turn the

handlebar of your vehicle than is needed to turn a motorcycle.

### Curves

Because the vehicle is narrower than a car, you can move from side to side in the lane in curves to straighten your path of travel. But the vehicle is wider than a motorcycle, so less lateral movement is possible, and it is important to make sure that your front tires do not leave the lane.

For typical curves, an outside, inside, outside path is best.

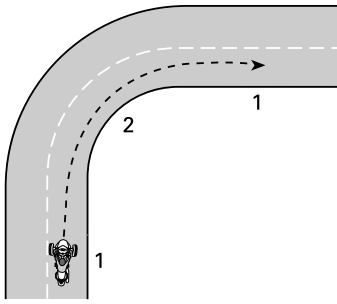

#### PATH FOR TYPICAL CURVES

1. Outside
2. Inside (at the apex)

### Hills

When stopped, the vehicle can roll regardless of what gear it is in. The clutch is always disengaged when the vehicle is stopped, so the transmission will not hold the vehicle in place. Hold the brake pedal when stopped on an incline. To start while on an incline, hold the brake pedal as you increase throttle. Release the brake pedal as you feel the clutch engage.

### Night Riding

In addition to using your lights and signals to be seen by other motorists, consider your own ability to see at night. Use high beams when appropriate. Avoid overriding your headlight (riding so fast that you cannot see as far as your stopping distance). You

can also use other vehicles headlights to see the road ahead.

Do not use tinted or colored visors or lenses at night, and be particularly careful that your visor does not have scratches or smudges.

### Group Riding

Ride single file only. Never share lanes, even with a motorcycle.

When riding with motorcycles, maintain proper following distance from the motorcycle in front of you, even if they are riding to one side of the lane. In curves, do not try to follow the path of motorcycles. Motorcycles can move farther to the edges of the lane in curves — if you follow them exactly, your front wheel can leave the lane. Motorcycles may be able to take curves faster than this vehicle. Do not try to match their speed.

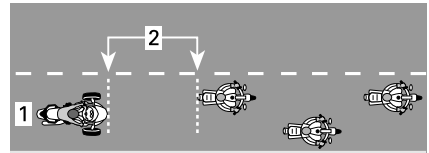

#### GROUP RIDING POSITION

1. Center of lane
2. Distance of 2 seconds

Particularly on curvy roads, the riders might become tired sooner than motorcyclists. Do not push yourself to keep up with motorcycles; stop if you are tired.

## Road Conditions and Hazards

### Ice, Snow and Slush

Do not ride on ice, snow or slush. Even with VSS, there will not be enough traction to maintain control on these slippery surfaces. This vehicle is more likely than a car to spin out of control in slippery surfaces.

### **Gravel, Dirt and Sand**

On gravel, dirt, or sand-covered roads, use extra caution and reduce your speed, particularly for curves. These surfaces do not provide as much traction as paved surfaces and you can lose control, even with VSS.

### **Wet Pavement and Puddles**

There is normally enough traction to maintain control on pavement that is moist or wet, as long as there is not a layer of water on top of the pavement (like a puddle or flowing water on the road). As with other vehicles, the vehicle can hydroplane if you drive too fast over water that has accumulated on the road, but hydroplaning occurs at lower speeds than with most cars or motorcycles. You are more likely to hydroplane in deeper water. Watch for splashing or spraying when other vehicles go through water as an indicator of depth.

When hydroplaning occurs, one or more wheels rise up on a layer of water, losing contact with the road. If this happens to the rear wheel, you may feel it slide sideways. Hydroplaning wheels do not have the traction necessary to control the vehicle. You can lose control and spin out, and the VSS cannot keep you in control.

Avoid large water puddles or water streams, and slow down or pull off the road during heavy rains. If you must pass through water, slow down as much as possible before you reach it.

After passing through water, test your brakes. Apply them several times if necessary to let friction dry the brake pads.

Properly maintained tires reduce the risk of hydroplaning. Always maintain recommended tire pressure:

Refer to *Tire Pressure in Maintenance Procedures* section

### **NOTE:**

The pressure difference between the left and right side tire should not exceed 3.4 kPa (.5 lbf/in<sup>2</sup>).

Immediately replace any tire that shows the maximum tread wear indicator to minimize risk of hydroplaning.

The middle of a lane can be particularly slick in the first few minutes of rain, as oil and dirt combine with the water. After more rain, water can accumulate in ruts in worn pavement. Avoid both of these low traction areas. When possible, keep your front tires in areas with the best traction.

### **Off-Road Use**

Do not use your vehicle off road. The vehicle cannot handle the rough, low-traction, uneven surfaces that you may encounter in off-road riding. You could easily get stuck, lose control or roll over. Also, it may be illegal for off-road use in certain areas.

### **Obstacles, Holes and Bumps**

Whenever possible, avoid riding over obstacles, holes and bumps. If you must ride over them, slow down as much as possible before you get there, then release the brake as you go over.

For wide obstacles or bumps, approach straight on if possible, so that both front tires go over at the same time. When going over an obstacle, bump or hole with both front wheels, riders should stand up slightly on the pegs and use legs to absorb the shock. Be prepared for the rear wheel to strike the obstacle.

For narrower obstacles, bumps or holes, it is better to ride over it with the rear tire. If you ride over them with a front tire, maintain a firm grip on the handlebar, take care not to accidentally applying the throttle and be



prepared to correct your trajectory if necessary.

If you strike a large enough obstacle, bump or hole, the impact can make the vehicle jump and strike you, eject riders, make you lose control, spin or roll over.

If you can't come to a complete stop in time to avoid an obstacle, you can swerve to avoid it. You can swerve and brake at the same time if necessary.

If you encounter a large animal in the road, like a deer, it is best to stop before reaching it and wait until the animal leaves, or go past slowly.

If a dog chases you, a good strategy is to slow down and downshift as the dog approaches, then accelerate away as you get closer to where the dog would intercept you.

## On-Road Emergencies

A vehicle malfunction or an unexpected situation can occur any time during a ride. A well-maintained vehicle can help reduce the risk of malfunction, but you should still be prepared for an emergency.

- Always have the Operator's Guide in the vehicle.
- When stopping on the road, follow these precautions:
  - If the road has paved shoulders, signal your intention to pull off the highway, pull off at near traffic speed, then slow down to a complete stop.
  - If the shoulder is unpaved, signal your intention to pull off the roadway, slow down to a safe speed before pulling off the paved roadway and stop the vehicle.
  - Let the turn signal activated to increase your visibility.

- On models equipped with hazard warning lights, activate them to increase your visibility.
- If you have cellular phone or other communication device, fully charge it before long rides.
- If you are involved in an accident, BRP strongly recommends that you have your vehicle transported (see *Transporting the Vehicle*) to the nearest Can-Am On-Road dealer to have it thoroughly inspected for safety before riding again.

## Tire Failure

If a tire failure or a blowout suddenly occurs, firmly grip the handlebar, gradually slow down and carefully steer to a safe place to stop. Avoid hard braking, downshifting, or sharp steering. If a front tire fails, the vehicle may tend to pull in the direction of the failed tire, so you will need to maintain a firm grip on the handlebar to control your direction. Refer to *Road Side Repairs* section for instructions on tire repair.

# CARRYING A PASSENGER, CARGO OR TOWING A TRAILER

## Weight Limits

Do not exceed the weight limits for riders and cargo.

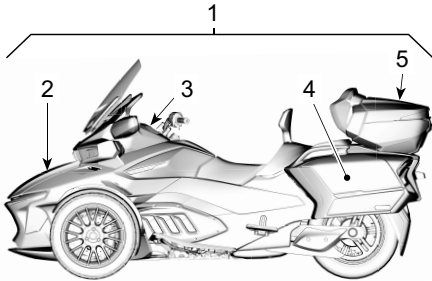

1. Vehicle load limit
2. Front storage compartment
3. Glove box
4. Side storage compartments
5. Top storage compartment

Excess weight will:

- Reduce your ability to accelerate, brake and turn.
- Reduce the effectiveness of the VSS.
- Increase the risk of rolling over if the weight is high or toward the rear.
- Reduce ground clearance, increasing the risk of striking low obstacles or uneven road surfaces.
- Increase the risk of tire failure.

Weight Limits	
Vehicle load limit (including operator, passenger, cargo and added accessories)	252 kg (556 lb)
Front storage compartment	16 kg (35 lb)
Glove box	2 kg (4 lb)
Side storage compartment (each)	6.8 kg (15 lb)

Weight Limits	
Top storage compartment	6.8 kg (15 lb) (with top rack installed)
	9 kg (20 lb) (without top rack)

## Operating with Extra Weight

Carrying a passenger or heavy cargo affects the way the vehicle handles because of the greater weight, and because the weight distribution will be different.

1. You will not be able to accelerate as quickly. Allow more time and space for passing.
2. You will not be able to stop as quickly. Use a longer following distance from the vehicle in front of you, at least three seconds. Use an even longer distance if riding conditions are not ideal (e.g., low visibility, poor road surface).
3. You will not be able to turn as sharply or at as high a speed. Slow down more than usual before turning and avoid sharp turns.
4. The vehicle may be less stable. There is a greater risk of tipping or rolling during extreme maneuvers with weight that is higher or farther to the rear (like a passenger).

### NOTE:

VSS effectiveness is decreased when operating above maximum allowed load.

## Carrying a Passenger

This vehicle is designed for only one passenger, seated behind the operator. Never carry multiple passengers.

Do not carry a passenger until you have experience riding alone in a variety of conditions and can proficiently handle the vehicle.

The passenger must be sober, alert, able to reach the passenger footrests and handholds, maintain balance and hold on in sudden maneuvers, and not distract the operator.

The passenger should use its audio control in respect to the rider's directives.

Be sure the passenger is wearing appropriate protective gear. The passenger should wear all of the protective gear recommended for the operator, particularly a helmet. A full-face helmet is recommended; in a sudden stop, the passenger's face can strike the back of the operator's helmet.

Keep the brakes applied and the transmission in neutral until the passenger is in riding position.

Instruct the passenger on how to ride before starting out. Have the passenger follow these rules:

Avoid abrupt acceleration, braking and turns, especially with inexperienced passengers. Sudden, unexpected maneuvers can make the passenger fall off.

1. Maintain proper riding position. Hold the passenger handholds and keep feet on the passenger footrests at all times. The passenger footrest height is adjustable. Refer to *Adjusting the Passenger Footrest*.
2. The passenger should not hold on to the operator as the operator may not be able to withstand the lateral force generated by both.
3. Different gripping positions on the handholds may be more comfortable for different maneuvers. (e.g., one hand at the front corner of and one hand at the opposite back

corner for turns, both hands further forward or back for other situations).



A. Gripping positions on the handholds

4. Stay clear of the exhaust pipe, the rear wheel and the drive belt.
5. Avoid turning around or leaning except to keep balance in a turn. In an unexpected maneuver, a passenger who is not in the normal riding position is more likely to fall off.
6. Watch the road and respond to upcoming road conditions. Lean into curves as needed to resist any sideways force. When crossing an obstacle, hole or bump, rise slightly off the seat without locking your elbows.

## Where to Store Cargo

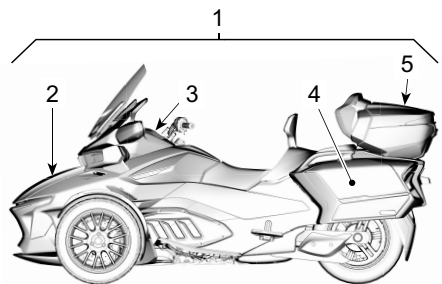

1. Vehicle load limit
2. Front storage compartment
3. Glove box
4. Side storage compartments
5. Top storage compartment

You can carry cargo in the following compartments. Do not carry cargo in any other location unless the vehicle is equipped with approved BRP accessories.

Never store flammable items, such as fuel, in any of these compartments.

Always respect the load limit of each compartment. Refer to *Weight Limits* in this section.

### **Glove Box**

The glove box provides room to store small personal articles.

It is very convenient to store items that could be needed quickly during a ride (such as money for pay toll).

### **Front Storage Compartment**

The front storage compartment is the most spacious and has room to store two helmets or other items. The front storage compartment includes a designated space for this Operator's Guide.

Make sure the compartment cover is securely latched before riding.

### **Side Storage Compartments**

The side storage compartments have room to store a helmet or other light objects.

Make sure the storage compartment cover is securely latched before riding.

### **Top Storage Compartment**

The top storage compartment has room to store a helmet or other light items.

Make sure the storage compartment cover is securely latched before riding.

## **Towing a Trailer**

The RT series has been designed to be able to tow a BRP optional trailer (with the optional BRP hitch).

The Vehicle Stability System (VSS) on this vehicle incorporates a program that allows to tow a BRP trailer while maintaining appropriate vehicle stability control.

Use only a BRP trailer designed specifically for this vehicle or a BRP approved equivalent. This is important to ensure the trailer and the vehicle remain stable during normal operation and it does not interfere with the vehicle stability system.

### **NOTICE**

**The use of a non-recommended wiring harness may lead to vehicle electrical system failure.**

### **⚠ WARNING**

**The use of any other trailer could damage the vehicle or interfere with the proper operation of the vehicle stability system. It is not recommended to use the cruise control when towing a trailer. Towing a trailer affects the way the vehicle handles due to the greater weight and the different weight distribution.**

- **Allow more time and space for passing.**
- **Allow a greater distance for braking.**
- **Use a longer following distance from the vehicle in front of you.**
- **Reduce your speed and slow down more than usual before turning and avoid sharp turns.**
- **There is a greater risk of tipping or rolling during extreme maneuvers.**

Crosswinds and air turbulence caused when crossing or being passed by others can disrupt the steering and make the trailer to sway. To minimize the effect, keep a constant speed and do not make quick steering or braking corrections.

Reduce your speed before entering in a curve.

When cornering, achieve the turn on a larger radius. It takes more space to turn with a trailer.

Try to anticipate the riding ahead to avoid having to backup with a trailer.

Always move slowly when backing up. Ask someone to guide you when possible. Practice in an open area at the first opportunity. Refer to *Required Riding Skills and Practice Exercises*.

When possible, avoid swerving, twist and turns, sharp and abrupt turns as well as sudden braking. This could cause the trailer to jackknife or to turn over. It is easier to unstabilize an empty trailer. When accelerating, it is normal to shift at a higher RPM to avoid loading excessively the engine.

### NOTICE

**Avoid spinning the rear wheel. Rocks or pebbles could be projected on the trailer and damage it.**

### Load Limits

#### **⚠ WARNING**

**Never add cargo on the trailer cover as it will increase the risk of tipping over. All cargo must be stored and secured inside the trailer.**

Load limits must be observed with the appropriate towing equipment.

### Towing Specifications

Maximum weight on trailer tongue	18 kg (40 lb)
Maximum towed weight (trailer and cargo)	182 kg (400 lb)

#### NOTE:

For information about the maximum cargo that can be loaded in trailer, refer to the *Can-am Freedom Trailer Operator's Guide*.

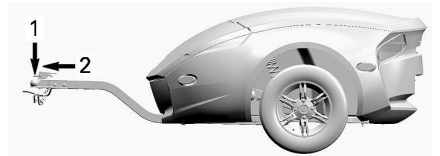

1. 18 kg (40 lb)
2. 182 kg (400 lb)

The weight at the tongue applies when the trailer is loaded. A scale can be used to measure the weight at the tongue when it is not latched to the vehicle. If the trailer is not fully loaded, place cargo in the front part of the trailer then, if the weight at the tongue is reached, place the remaining cargo at the rear in the trailer. The weight distribution in the trailer affects the weight at the tongue. Redistribute the weight in the trailer to meet the weight at the tongue specification. Too much weight at the tongue reduces steering control. Too little weight at the tongue can render the trailer unstable and make it sway.

**⚠ WARNING**

Exceeding the maximum towed weight can seriously affect handling and performance of the vehicle. The vehicle handling, stability, acceleration and braking distance are affected when towing a trailer. Correct loading and weight distribution are important. Never overload, tow or carry cargo improperly. Always ensure the cargo is safely secured and properly distributed in the trailer before operating the vehicle. Always secure cargo as low as possible in the trailer to reduce the effect of a higher center of gravity. Failure to follow the recommendations here could cause affect the vehicle handling which could lead to the vehicle loss of control.

**NOTICE**

Exceeding the maximum towed weight can damage vehicle or trailer. Avoid transporting heavy parts with sharp edges that could damage the trailer. Place the cargo so that it does not shift while the trailer is being towed.

**Hitch**

Use only a BRP hitch or a BRP approved equivalent. The BRP hitch properly fits the vehicle swing arm and is securely bolted to the wheel axle.

**NOTICE**

The use of a non-approved hitch may lead to rear swing arm failure.

**⚠ WARNING**

If the hitch is removed from vehicle, always install a new cotter pin to lock the wheel axle nut.

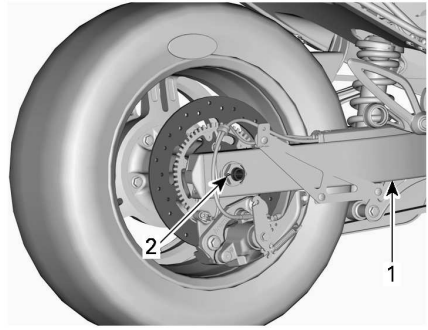

**TYPICAL - WHEEL AXLE CAP AND MUFFLER REMOVED FOR CLARITY PURPOSE**

1. Swing arm
2. New cotter pin here

**Safety Cables**

Always use safety cables when towing a trailer. Ensure they are secured to the trailer and to the hitch, and that they cross under the tongue. Leave enough slack in cables to allow the trailer to turn corners. When trailer is in straight line with the vehicle, ensure chains will not drag on the ground.

---

# KNOWLEDGE SELF-TEST

The following provides a sample of information that you should have learned by reading this guide. It does not include all of the important information, but should give you an idea of whether you have a general understanding of the vehicle and its operation.

See the *Answers* on the page following the questionnaire.

## Questionnaire

1. If you need to stop quickly, apply the brakes and the parking brake.

True

False

2. A pre-ride inspection should be performed once a week.

True

False

3. VSS allows you to use the vehicle in any kind of weather.

True

False

4. You should only replace the tires with those approved by BRP obtained from an authorized Can-Am On-Road dealer.

True

False

5. It is important for the passenger to be alert and sober.

True

False

6. Name six items of protective gear that can reduce your risk of injury.

1) \_\_\_\_\_

2) \_\_\_\_\_

3) \_\_\_\_\_

4) \_\_\_\_\_

5) \_\_\_\_\_

6) \_\_\_\_\_

7. Protective gear is important for preventing and reducing injuries, keeping you comfortable, and providing protection against the elements.

True

False

8. Which of the following is not one of the vehicle driving controls?
- a. Handlebar
  - b. Twist throttle
  - c. Front brake lever
9. You should leave your low beam lights on during the day for added visibility.
- True False
10. You should normally position the vehicle in the center of the lane.
- True False
11. Unlike a typical motorcycle, you should make it common practice to brake and turn at the same time.
- True False
12. Under normal conditions, the following distance should be at least \_\_\_\_\_.
- a. 1 second
  - b. 2 seconds
  - c. 3 seconds
13. You should never carry flammable liquids such as gasoline on the vehicle or in a storage compartment, even if they are in approved containers.
- True False
14. List 5 ways of being more noticeable to other drivers.
- 1) \_\_\_\_\_
  - 2) \_\_\_\_\_
  - 3) \_\_\_\_\_
  - 4) \_\_\_\_\_
  - 5) \_\_\_\_\_
15. When braking on surfaces with less than ideal traction, you should pump the brakes to help maintain control of the vehicle.
- True False



- 
16. The vehicle's maximum load includes: the operator, the passenger, the cargo and all accessories
- True False
17. The vehicle can safely tow a trailer.
- True False
18. When the vehicle configuration allows it, the passenger should hold the operator firmly.
- True False
19. Riding a 3-wheel vehicle is as safe as riding in a car.
- True False
20. ABS allows you to press the brake pedal hard without locking the wheels.
- True False

## Answers

1. **False**

To stop quickly, press the brake pedal only. Never use the parking brake while the vehicle is moving.

2. **False**

You should do a pre-ride inspection every time you ride.

3. **False**

The VSS can not help you maintain control if there is ice, snow, slush or enough water to cause hydroplaning. The VSS performance may also be reduced when tires adherence decreases due to cold temperatures or when riding on unpaved road..

4. **True**

5. **True**

6. 1) Helmet

2) Eye and face protection

3) Jacket with long sleeves

4) Gloves

5) Long pants

6) Closed-toe footwear, preferably over the ankle.

7. **True**

8. **c. Front brake lever**

The vehicle does not have a front brake lever.

9. **False**

You should use your high beams during the day.

10. **True**

11. **False**

You can brake and turn at the same time if you need to, but generally it is better to brake before the turn.

12. **b. 2 seconds**

Under normal conditions, following distance should be at least two seconds.

13. **True**

- 
14. 1) Make sure your lights and reflectors are clean.  
2) Use your high beams whenever possible.  
3) Use your turn signals.  
4) Flash your brake lights before slowing.  
5) Use your emergency flashers as needed.  
6) Use your horn to alert others of your presence.  
7) Avoid riding in blind spots.  
8) Wear bright colors and reflective clothing.
15. **False**  
You should press and hold the brake pedal, not pump. The vehicle is equipped with ABS, which keeps the wheels from locking.
16. **True**
17. **False**
18. **False**  
The passenger should always hold on to the handholds.
19. **False**  
In cars and trucks, the structure of the vehicle provides protection. In addition, passengers can protect themselves by wearing seat belts. You should expect that riding a 3-wheel vehicle is much riskier than riding in a car. The risk of injury is more like the one for a motorcycle.
20. **True**

---

## SAFETY INFORMATION ON THE VEHICLE

This vehicle comes with a hang tag and labels containing important safety information.

Any person who rides this vehicle should read and understand this information on the vehicle before riding.

**NOTE:**

In the event of any discrepancy between this guide and the vehicle, the safety labels on the vehicle have precedence over the labels in this guide.

## Important Pre-Ride Safety Message

An important safety message is displayed in the touchscreen display, each time the vehicle is ready to start.

Read and understand it carefully.

To see the entire message, scroll it on the screen using your finger.

Pressing the X in the right upper corner will close the message but return to the legal message.

### WARNING

**This Can-Am On-Road product is a different type of vehicle. It requires special skills and knowledge.**

**Learn how this product is different. Read the operator's guide and watch the safety video using the QR code link or visit Can-Am On-Road web site. Complete a training course (if available), practice, become proficient with the controls, and get a proper license.**

- The Vehicle Stability System (VSS) cannot stop you from losing control, flipping over, or falling off if you exceed this vehicle's limits.
- Do not ride on ice, snow, or off road. Avoid puddles and running water.
- This type of vehicle can hydroplane on water and slip on gravel, dirt and sand covered roads. If you must go through these road conditions, slow down.

**Wear a helmet and riding gear.**

- With this type of vehicle, riders are exposed to more road risks than in a car.
- Even skilled operators can be struck by other vehicles or lose control.
- This vehicle will not protect you in a crash.

**Instruct the passenger:**

- Always hold handholds and keep feet on pegs.
- Watch the road. Lean into curves. Brace for bumps.

**Always keep in mind:**

- Brake with the foot pedal.
- Steer in the direction of a turn; do not countersteer.
- Keep all wheels in your lane, always ride in a single file, and do not split lanes.
- Perform Pre-ride Inspection.

**Twist the throttle handle backward (away from you) to enable the starter button.**

## Safety Hang Tag

### WARNING

**This Can-Am On-Road is a different type of vehicle - It requires special skills and knowledge. Learn how this product is different.**

**Read** the operator's guide and watch the safety video using the QR code link or visit Can-Am On-Road web site.

**Complete** a training course (if available), **practice**, become proficient with the controls, and get a proper licence.

**Refer** to the Safety Card before riding.



#### **Always wear a helmet and riding gear.**

With this type of vehicle, riders are exposed to more road risks than in a car. Even skilled operators can be struck by other vehicles or lose control. This vehicle will not protect you in a crash.

#### **Handling limits and road conditions**

The Vehicle Stability System (VSS) cannot stop you from losing control, flipping over, or falling off if you exceed this vehicle's limits. Know the limits for different road conditions. Do not ride on ice, snow, or off road. Avoid puddles and running water. This type of vehicle can hydroplane on water and slip on gravel, dirt and sand covered roads. If you must go through these road conditions, slow down.

This hangtag may only be removed by the customer.

704907713



### AVERTISSEMENT

**Ce produit routier est différent. Il nécessite des habiletés et des connaissances spéciales. Sachez ce qui distingue ce produit Can-Am des autres véhicules.**

**Lisez** le guide du conducteur et visionnez la vidéo de sécurité via le lien QR code ou en visitant le site internet Can-Am On-Road.

**Suivez** une formation (si disponible), **exercez-vous**, apprenez à maîtriser les commandes et obtenez le permis approprié.

**Consultez** la carte de sécurité avant de conduire le véhicule.



#### **Portez toujours un casque et des vêtements appropriés.**

Sur ce type de véhicule, les utilisateurs sont exposés à davantage de risques routiers qu'en automobile. Même un conducteur habile peut être frappé par un autre véhicule ou perdre le contrôle. Ce véhicule ne vous protégera pas en cas de collision.

#### **Limites de manoeuvrabilité et conditions routières**

Le système de stabilité du véhicule (VSS) ne peut pas vous empêcher de perdre le contrôle, de faire des tonneaux ou de tomber si vous dépassez les limites du véhicule. Apprenez à connaître ces limites dans différentes conditions routières. Ne conduisez pas sur la glace, sur la neige ou hors route. Évitez les flaques et les ruissellements d'eau. Ce type de véhicule peut faire de l'aquaplanage sur les chaussées détrempées et dériver sur les routes recouvertes de gravier, de terre ou de sable. Si vous devez conduire dans ces conditions, ralentissez. Seul le client doit enlever cette étiquette.

704907713

## Safety Labels

These labels are affixed to the vehicle for the safety of the operator, passenger or bystanders.

The following labels are on your vehicle, and they should be considered permanent parts of the vehicle. If missing or damaged, they can be replaced free of charge. See an authorized Can-Am On-Road dealer.

## Tire Pressure and Maximum Load

Located under the operator's seat



### TIRE AND LOADING INFORMATION / RENSEIGNEMENTS SUR LES PNEUS ET LE CHARGEMENT



SEATING CAPACITY / NOMBRE DE PLACES	TOTAL	2	FRONT AVANT	1	REAR ARRIÈRE	1
--	-------	---	----------------	---	-----------------	---

The combined weight of occupants and cargo should never exceed 252 kg or 556 lb  
Le poids total des occupants et du chargement ne doit jamais dépasser 252 kg ou 556 lb

RT 9917

TIRE / PNEU	SIZE/ DIMENSION	COLD TIRE PRESSURE/ PRESSION PNEUS À FROID	RIM SIZE/ DIMENSION JANTE
FRONT/AVANT	165/55R15 M/C 55H	138 kPa / 20 psi	15 x 5 in
REAR/ARRIÈRE	225/50R15 M/C 76H	193 kPa / 28 psi	15 x 7 in
SPARE / SECOURS	NONE / AUCUN	NONE / AUCUN	NONE/AUCUN

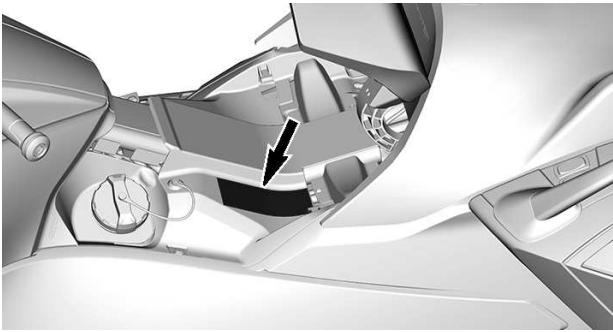

## Checking Engine Oil Level

Located under the operator's seat

### **⚠ CAUTION**

**ENGINE OIL AND CERTAIN COMPONENTS IN THE ENGINE COMPARTMENT  
MAY BE HOT. DIRECT CONTACT MAY RESULT IN SKIN BURNS.**

**Checking Engine Oil Level:**

- Make sure engine is at operating temperature.
- For procedure refer to the operator's guide.
- Ride at least 15 km (9 miles).
- Vehicle must be on a level surface.
- Let engine idle for 10 minutes.
- Stop engine.
- Take measurement within 2 minutes after the engine stop.
- Dipstick must be screwed in completely before checking oil level.
- Use XPS 4-stroke 5W40 synthetic blend oil or equivalent motorcycle oil.

8194





## Brake Fluid - Clean and Refill

Located behind the RH front service cover

### **⚠ WARNING**

Clean filler cap before removing.  
Use only DOT 4 brake fluid from a sealed container.

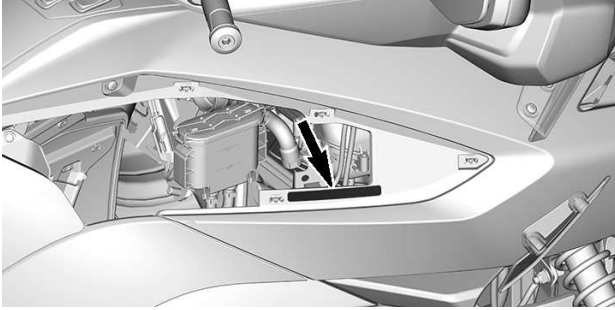

## Rear Suspension Pressure

Located underneath the operator's seat

# WARNING

**MINIMUM PRESSURE 70 kPa / 10 Psi / 0.7 bar**  
**DO NOT EXCEED RECOMMENDED PRESSURE BY 70 kPa / 10 Psi / 0.70 bar**

LOAD		(PASSENGER + CARGO) Kg / Lb <small>704905155</small>				
		0	45/100	70/150	90/200	115/250
DRIVER	Kg/Lb	kPa/Psi/bar	kPa/Psi/bar	kPa/Psi/bar	kPa/Psi/bar	kPa/Psi/bar
	70/150	310/45/3.10	380/55/3.80	450/65/4.50	480/70/4.80	515/75/5.15
	90/200	345/50/3.45	415/60/4.15	480/70/4.80	515/75/5.15	550/80/5.50
	115/250	380/55/3.80	450/65/4.50	515/75/5.15	550/80/5.50	585/85/5.85

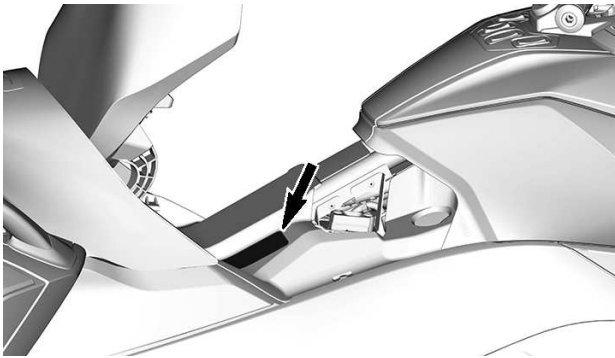

## Side Storage Compartment Load

Located inside the back of the side storage compartment covers

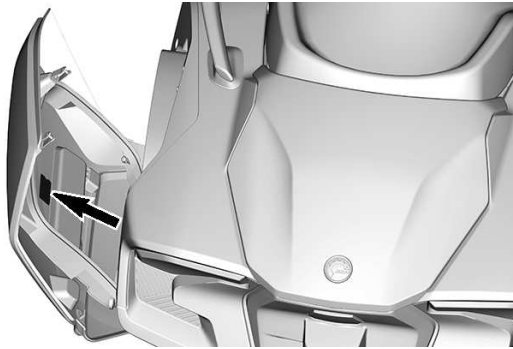

LH SIDE

## Front Storage Compartment Load

Located inside the front storage compartment

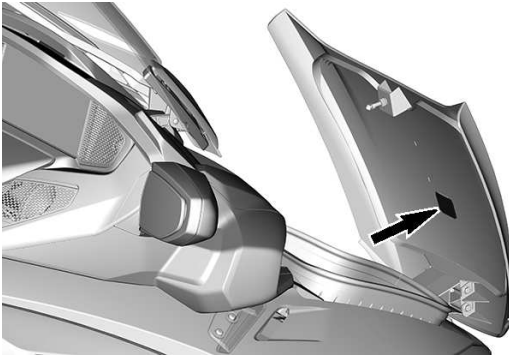

## Top Storage Compartment Load

Located inside the back of the top storage compartment cover

<b>⚠ WARNING</b>	
<b>DO NOT OVERLOAD:</b>	
<b>Without top rack</b>	
<i>Maximum case load.....</i>	<b>9 kg (20 lb)</b>
<b>With top rack installed</b>	
<i>Maximum case + top rack load.....</i>	<b>6.8 kg (15 lb)</b>

5964

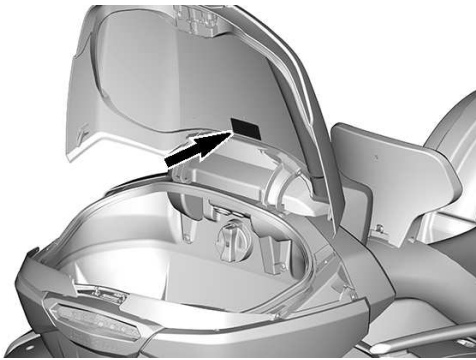

## Coolant Hot - Do Not Open

Located underneath the front service cover

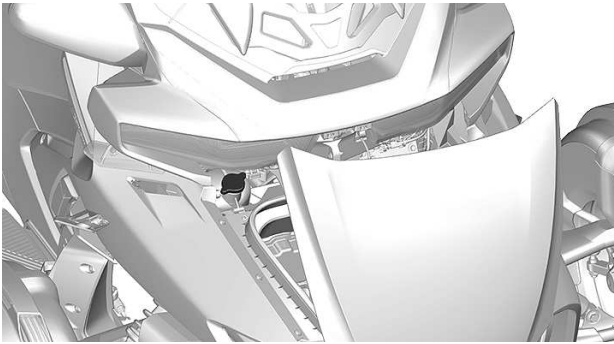

## Vehicle Cleaning

Located inside the back of the front service compartment cover

### NOTICE

-Matt finish paint needs special care to maintain its appearance.

See operator's guide

-PVD chrome wheel should be washed with water and a mild soap. Do not polish, use acid based or abrasive chrome cleaner on the PVD chrome wheel.

-Do not clean windshield with alkaline or acid cleaner, gasoline or solvent to avoid windshield damage.

See operator's guide.

Patents :

[www.brp.com/en/about-brp/patents.html](http://www.brp.com/en/about-brp/patents.html)

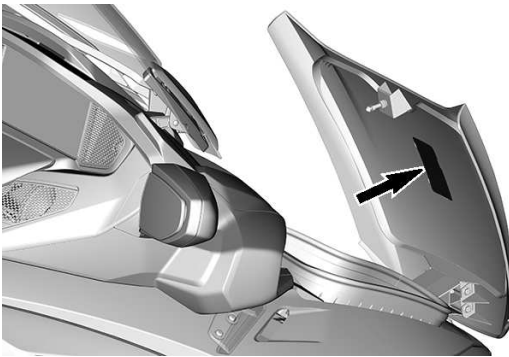

## Shifting Pattern (Japanese Model)

This label is installed by the dealer

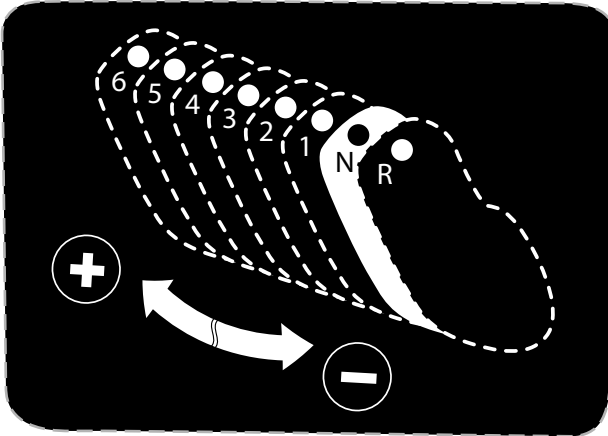



---

## REPORTING SAFETY DEFECTS

Your safety is very important to Bombardier Recreational Products Inc. (BRP). If you have any concerns you should immediately contact BRP customer service.

If you believe that your vehicle has a defect which could cause a crash or could cause injury or death, you should immediately inform the following authorities in addition to notifying Bombardier Recreational Products Inc.:

- In the USA, the National Highway Traffic Safety Administration (NHTSA)
- In Canada, Transport Canada
- In other countries, the competent authorities.

If any of these authorities receives similar complaints, it may open an investigation, and if it finds that a safety defect exists in a group of vehicles, it may order a recall and remedy campaign.

However, these authorities cannot become involved in any individual problems between you, your dealer or Bombardier Recreational Products Inc.

### To contact NHTSA:



888-327-4236



1 800-424-9153



National Highway Traffic Safety Administration  
1200 New Jersey Avenue, SE  
Washington, DC 20590



[www.safercar.gov](http://www.safercar.gov)

### To contact Transport Canada:



819-994-3328 (Gatineau-Ottawa area or internationally)  
Toll free : 1 800-333-0510 (in Canada)



Transport Canada - ASFAD  
330 Sparks Street  
Ottawa, ON  
K1A 0N5



<https://www.tc.gc.ca/recalls>

This page is intentionally blank

# **PRE-RIDE INSPECTION**

# PRE-RIDE CHECKLIST

We encourage you to have an Annual Safety Inspection of your vehicle. Please contact an authorized Can-Am On-Road dealer for further details. Though not required, it is recommended that an authorized Can-Am On-Road dealer performs the preseason preparation of your vehicle. Each visit is a great opportunity for your dealer to verify if your vehicle is included in any warranty campaign. We also urge you to visit your authorized Can-Am On-Road dealer in a timely manner if you become aware of any safety related campaigns.

## WARNING

**Perform a pre-ride inspection before each ride to detect potential problems during operation. The pre-ride inspection can help you monitor wear and deterioration before they become a problem. Correct any problems that you discover to reduce the risk of a breakdown or crash. See an authorized Can-Am On-Road dealer as necessary.**

## Before Starting the Vehicle, Inspect the Following:

Item	Procedure	
Tires	Look for damage. Inspect inflation and tread wear. Refer to <i>Maintenance Procedures</i> .	
Wheels and lug nuts	Look for damage. Twist each front wheel lug nut by hand to be sure it is not loose. Be sure the rear wheel axle nut is in place.	
Drive belt	Look for fraying, cuts, punctures and missing teeth. Visually verify the belt alignment. For additional information, refer to <i>Maintenance Procedures</i> .	
Leaks	Look under the vehicle for any leaks.	
Storage compartment covers and glove box	Pull to check that they are all properly latched.	
ACS rear suspension (Base Models)	Verify inflation. Refer to <i>Basic Procedures</i> .	
Seats	Ensure the seats are properly locked in position by pulling (the front and the rear), back and up several time. Even if a distinctive snap is heard during the installation, always pull it back and up to confirm proper installation.	
Mirrors	Clean and adjust them. Refer to <i>Mirrors in Equipment</i> .	

Item	Procedure	✓
Brake pedal	Press and make sure you feel firm resistance. Pedal must fully return when released.	
Throttle handle	Twist several times. Be sure it operates freely and returns to idle position when released.	
Gearshift selector	Be sure gearshift selector operates normally in both directions and returns to center when released.	
Weight	Ensure that total load on the vehicle (including operator, passenger, cargo and added accessories) does not exceed recommended load as indicate on the <i>Tire Pressure and Maximum Load</i> label.	
Trailer	If a trailer is towed, be sure: <ul style="list-style-type: none"> <li>– The cargo is properly loaded and secured,</li> <li>– The covers are latched,</li> <li>– The trailer and safety cables are properly latched to vehicle hitch,</li> <li>– All the trailer lights work and reflectors are clean,</li> <li>– Tires are in good condition and properly inflated.</li> </ul>	
Radiator fan grilles	Remove any debris from the grilles. Do not clean with a pressure washer because it can damage the radiator fins. Clean only with compressed air.	

### Turn Ignition Key to the ON Position:

Item	Procedure	✓
Multifunction display	Check the gauges, indicators, messages and the fuel level	
Lights	Check operation of headlights, taillight, brake light, turn signals and hazard warning lights.	
Horn	Check operation.	
Steering	Start engine and verify that steering operates freely.	
Engine stop switch	Check that the engine stop switch is working properly.	
Parking brake	Start engine, release parking brake and ensure brake indicator lamp is off on the multifunction gauge.	
Brake	Drive a short distance forward slowly then apply brake to test.	

This page is intentionally blank

# MAINTENANCE

---

# MAINTENANCE SCHEDULE

Maintenance is very important for keeping your vehicle in safe operating condition.

The vehicle should be serviced as per the maintenance schedule.

Proper maintenance is the owner's responsibility. A warranty claim may be denied if, among other things, the owner or operator caused the problem through improper maintenance or use.

Perform periodic checks and follow the maintenance schedule. **The maintenance schedule does not exempt the pre-ride inspection.**

## WARNING

**Failure to properly maintain the vehicle according to the maintenance schedule and procedures can make it unsafe to operate.**

## EPA Regulation - Canadian and USA Vehicles

**A repair shop or person of the owner's choosing may maintain, replace, or repair** emission control devices and systems. These instructions do not require components or service by BRP or authorized Can-Am On-Road dealers.

Although an authorized Can-Am On-Road dealer has an in-depth technical knowledge and tools to service your vehicle, the emission-related warranty is not conditioned on the use of an authorized Can-Am On-Road dealer or any other establishment with which BRP has a commercial relationship.

Proper maintenance is the owner's responsibility. A warranty claim may be denied if, among other things, the owner or operator caused the problem through improper maintenance or use.

For emission-related warranty claims, BRP is limiting the diagnosis and repair of emission-related parts to the authorized Can-Am On-Road dealers. For more information, please refer to the *US EPA Emissions Performance Warranty* contained in the *Warranty* section.

You must follow the instructions for fuel requirements in the fueling section of this manual. Even if gasoline containing greater than ten volume percent ethanol is readily available, the US EPA issued a prohibition against the use of gasoline containing greater than 10 vol% ethanol that applies to this vehicle. The use of gasoline containing greater than 10 vol% ethanol with this engine may harm the emission control system.

## Severe Dusty or Wet Conditions – Air Filter Maintenance Guideline

Engine air filter and CVT air filter maintenance should be adjusted according to riding conditions.

Air filter maintenance must be increased in frequency when riding on dry sand, dirt, gravel or similar conditions which have high dust or particle dispersion. Also frequently driving in rain and high traffic increases the air particles being trapped by the air filter(s).



Riding in a group in these conditions would increase even more the filters maintenance.

## Break-In Inspection

We recommend that after the first 5 000 km (3,000 mi) of operation, your vehicle be inspected by an authorized Can-Am On-Road dealer, repair shop, or person of your own choosing. This maintenance is very important and must not be neglected.

**NOTE:** This inspection is at the expense of the vehicle owner.

We recommend that this inspection be signed by the authorized Can-Am On-Road dealer, repair shop, or person of your own choosing having performed the first inspection.

---

Date of inspection

---

Signature of the Authorized Can-Am On-Road dealer, repair shop, or person

---

Name of the Authorized Can-Am On-Road dealer, repair shop, or person

## Maintenance Schedule

Make sure to perform proper maintenance at recommended intervals as indicated in the tables.

The maintenance chart indicates the items needing to be addressed based on 2 criteria, whichever happens first:

- Calendar time
- Odometer reading.

Your driving habits will determine which criteria you should adhere too. For example:

- Someone who uses their vehicle daily or for frequent long weekend rides would follow the **odometer reading** to determine the frequency of his maintenance.
- Someone using their vehicle seldomly over the year or only on a few

occasions (vacation, short rides every few weekends) would follow the **calendar time** to determine the frequency of his maintenance.

**IMPORTANT:** The following table shows the appropriate maintenance application for the first 2 years. For subsequent years, repeat the same pattern alternatively.

<b>Maintenance Overview</b>		
Calendar Years	Odometer	Regular Duty
—	5 000 km (3,000 mi)	Break-In
1	15 000 km (9,300 mi)	<b>A</b>
—	Beyond 15 000 km (9,300 mi)	<b>A and B</b>

Regular Maintenance	Break-In	A	B
<b>A = Adjust</b> <b>C = Clean</b> <b>I = Inspect</b> <b>L = Lubricate</b> <b>R = Replace</b> <b>T = Torque</b>	5 000 km (3,000 mi)	1 year or 15 000 km (9,300 mi)	After the 1 <sup>st</sup> year or 30 000 or 45 000 km (19,000 or 28,000 mi)
<b>Air Delivery</b>			
Engine air filter		R	
		<b>Dusty or wet conditions:</b> R Every 15 000 km (9,300 mi), regardless of calendar time	
Engine air filter housing		C	
		<b>Dusty or wet conditions:</b> C Every 15 000 km (9,300 mi), regardless of calendar time	
<b>Engine</b>			
Engine oil level	I Every 1 500 km (1,000 mi), regardless of calendar time		
Engine oil and oil filter	R	R	
Engine seals and gaskets		I	
Hydraulic Control Module (HCM) oil filter		R Every 45 000 km (28,000 mi), regardless of calendar time	
Spark plugs		R Every 5 years or 45 000 km (28,000 mi)	
<b>Emissions</b>			
Canister vent pre-filter (CARB and EVAP models)		R Every 45 000 km (28,000 mi), regardless of calendar time	
<b>Cooling</b>			
Engine cooling components (coolant concentration, coolant level, hose condition, clamps, leaks)	I, A	I, A	
Radiator		C	
Coolant		R	

Regular Maintenance	Break-In	A	B
<b>A = Adjust</b> <b>C = Clean</b> <b>I = Inspect</b> <b>L = Lubricate</b> <b>R = Replace</b> <b>T = Torque</b>	5 000 km (3,000 mi)	1 year or 15 000 km (9,300 mi)	After the 1 <sup>st</sup> year or 30 000 or 45 000 km (19,000 or 28,000 mi)
		Every 5 years or 50 000 km (30,000 mi)	
<b>Exhaust</b>			
Exhaust clamp rings		I, T	
Exhaust components (gaskets, pipes, muffler condition, leaks)		I	
<b>Fuel Delivery</b>			
Fuel components and function (Fuel hoses, clamps, fuel evaporation lines and canister, leaks)		I	
In-line fuel filter		R Every 5 years or 45 000 km (28,000 mi)	
<b>Brake</b>			
Brake components and function	I	I	
Brake fluid		R Every 2 years, regardless the odometer	
<b>Drive</b>			
Check the drive belt alignment (Performed by an authorized Can-Am On-Road dealer)		I, A	
Check the drive belt condition and tension (Performed by an authorized Can-Am On-Road dealer)	I, A	I, A	
Drive components and function	I	I	
Tires		I, A	
Wheel lug nuts	T	T	
Rear wheel axle nut (Performed by an authorized Can-Am On-Road dealer)	T	T	
<b>Electrical</b>			
Battery connections and condition		I	

Regular Maintenance	Break-In	A	B
<b>A = Adjust</b> <b>C = Clean</b> <b>I = Inspect</b> <b>L = Lubricate</b> <b>R = Replace</b> <b>T = Torque</b>	5 000 km (3,000 mi)	1 year or 15 000 km (9,300 mi)	After the 1 <sup>st</sup> year or 30 000 or 45 000 km (19,000 or 28,000 mi)
Modules and applicable software updates		I	
Operation of control switches and lighting	I	I	
<b>Steering</b>			
Steering components and function		I	
<b>Controls</b>			
Throttle operation		I	
<b>Body and Frame</b>			
Body panels and hardware	I, T	I, T	
Pivots, latches, hinges and key barrels	L	L	
<b>Suspension</b>			
Suspension components and function		I Every 5 years or 45 000 km (28,000 mi)	

## Maintenance Records

Send photocopy of maintenance record to BRP if needed.

Pre-delivery	
Serial number: _____ Mileage / km: _____ Hours: _____ Date: _____ Dealer no: _____ Notes: _____ _____	Signature/Print: _____
Refer to vehicle Pre-Delivery Bulletin for detailed installation procedures	

FIRST inspection	
Mileage / km: _____ Hours: _____ Date: _____ Dealer no: _____ Notes: _____ _____	Signature/Print: _____
For maintenance schedule refer to Maintenance Information section of this operator's guide	

<b>Service</b>	
Mileage / km: _____ Hours: _____ Date: _____ Dealer no: _____ Notes: _____ _____	Signature/Print:
For maintenance schedule refer to Maintenance Information section of this operator's guide	

<b>Service</b>	
Mileage / km: _____ Hours: _____ Date: _____ Dealer no: _____ Notes: _____ _____	Signature/Print:
For maintenance schedule refer to Maintenance Information section of this operator's guide	

<b>Service</b>	
Mileage / km: _____ Hours: _____ Date: _____ Dealer no: _____ Notes: _____ _____	Signature/Print:
For maintenance schedule refer to Maintenance Information section of this operator's guide	

**Service**

Mileage / km:

\_\_\_\_\_

Hours:

\_\_\_\_\_

Date:

\_\_\_\_\_

Dealer no:

\_\_\_\_\_

Notes:

\_\_\_\_\_

\_\_\_\_\_

Signature/Print:

For maintenance schedule refer to Maintenance Information section of this operator's guide



<b>Service</b>	
Mileage / km: _____ Hours: _____ Date: _____ Dealer no: _____ Notes: _____ _____	Signature/Print:
For maintenance schedule refer to Maintenance Information section of this operator's guide	

<b>Service</b>	
Mileage / km: _____ Hours: _____ Date: _____ Dealer no: _____ Notes: _____ _____	Signature/Print:
For maintenance schedule refer to Maintenance Information section of this operator's guide	

<b>Service</b>	
Mileage / km: _____ Hours: _____ Date: _____ Dealer no: _____ Notes: _____ _____	Signature/Print:
For maintenance schedule refer to Maintenance Information section of this operator's guide	

**Service**

Mileage / km:

\_\_\_\_\_

Hours:

\_\_\_\_\_

Date:

\_\_\_\_\_

Dealer no:

\_\_\_\_\_

Notes:

\_\_\_\_\_

\_\_\_\_\_

Signature/Print:

For maintenance schedule refer to Maintenance Information section of this operator's guide

**Service**

Mileage / km:

\_\_\_\_\_

Hours:

\_\_\_\_\_

Date:

\_\_\_\_\_

Dealer no:

\_\_\_\_\_

Notes:

\_\_\_\_\_

\_\_\_\_\_

Signature/Print:

For maintenance schedule refer to Maintenance Information section of this operator's guide

**Service**

Mileage / km:

\_\_\_\_\_

Hours:

\_\_\_\_\_

Date:

\_\_\_\_\_

Dealer no:

\_\_\_\_\_

Notes:

\_\_\_\_\_

\_\_\_\_\_

Signature/Print:

For maintenance schedule refer to Maintenance Information section of this operator's guide

<b>Service</b>	
Mileage / km: _____ Hours: _____ Date: _____ Dealer no: _____ Notes: _____ _____	Signature/Print:
For maintenance schedule refer to Maintenance Information section of this operator's guide	

<b>Service</b>	
Mileage / km: _____ Hours: _____ Date: _____ Dealer no: _____ Notes: _____ _____	Signature/Print:
For maintenance schedule refer to Maintenance Information section of this operator's guide	

<b>Service</b>	
Mileage / km: _____ Hours: _____ Date: _____ Dealer no: _____ Notes: _____ _____	Signature/Print:
For maintenance schedule refer to Maintenance Information section of this operator's guide	

# MAINTENANCE PROCEDURES

This section includes instructions for basic maintenance procedures.

Due to the complexity of some maintenance procedures, good mechanical skills are required.

Several procedures must be done by an authorized Can-Am On-road dealer, repair shop, or person of your own choosing.

If you are not comfortable with the mechanics, do not hesitate to contact an authorized Can-Am On-road dealer, repair shop, or person of your own choosing.

## WARNING

**Turn off the engine and follow these maintenance procedures when performing maintenance. If you do not follow proper maintenance procedures you can be injured by hot parts, moving parts, electricity, chemicals or other hazards.**

## Engine Oil

### *Recommended Engine Oil*

Rotax® engines were developed and validated using the XPS® oil.

BRP recommends the use of its XPS engine oil or an equivalent at all time.

Damage caused by the use of an oil not suitable for the engine may not be covered by the BRP Limited Warranty.

XPS Recommended Engine Oil

5W40 synthetic blend oil

If the recommended XPS engine oil is not available:

- Use a 4-stroke SAE engine synthetic or synthetic blend oil meeting or exceeding the following lubricant industry specifications.

- Always check the API service label certification on the oil container, it must contain at least one of the indicated standards.
  - API service classification SN, or
  - JASO MA2

### *Verifying the Engine Oil Level*

#### NOTICE

**Operating the engine with an improper engine oil level may cause severe engine damages. Follow this procedure to obtain a precise reading of the engine oil level.**

In order to perform the engine oil level verification, the engine must be at normal operating temperature.

#### NOTICE

**Adjusting the oil level on a cold engine will result in overfilling.**

1. Take a ride of at least 15 km (9 mi).
2. Park the vehicle on a level surface and apply the parking brake.
3. Let the engine idle for 10 minutes.

## WARNING

**Exhaust gas contains poisonous carbon monoxide that can rapidly accumulate in an enclosed or poorly ventilated area. If inhaled, it can cause serious injury or death. Only run the engine in an unenclosed, well ventilated area.**

#### NOTICE

**Adjusting the oil level on a cold engine will result in overfilling.**

4. Stop engine.

**NOTE:**

Engine oil level verification must be performed within 2 minutes after engine stop.

5. Open the seat. Refer to *Opening the Seat in Equipment*.
6. Unscrew and remove the oil dipstick.

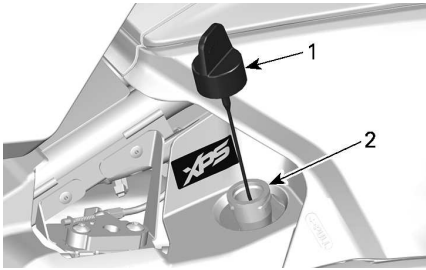

1. Oil dipstick  
2. Oil filler tube

7. Wipe off the dipstick.
8. Reinsert and **completely screw in** the dipstick.
9. Unscrew and remove the dipstick again.
10. Check the engine oil level on the dipstick. It should be near or equal to the upper mark.

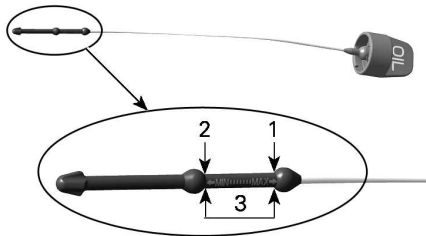

1. MAX  
2. MIN  
3. Operating range, 500 ml (17 fl oz(US))

**Oil Level between Lower (MIN) and Upper (MAX) Marks:**

1. Do not add oil.
2. Properly insert and tighten dipstick.
3. Close the seat.

**Oil Level under MIN Mark**

**Adjustment:**

1. Add approximately 500 ml (17 fl oz (US)) of recommended oil.

**NOTE:**

The oil quantity between MIN and MAX marks is 500 ml (17 fl oz (US)).

2. Restart the engine and let it idle for 10 minutes.

<b>⚠ WARNING</b>
<p><b>Exhaust gas contains poisonous carbon monoxide that can rapidly accumulate in an enclosed or poorly ventilated area. If inhaled, it can cause serious injury or death. Only run the engine in an unenclosed, well ventilated area.</b></p>

<b>NOTICE</b>
<p><b>Adjusting the oil level on a cold engine will result in overfilling.</b></p>

3. Stop the engine.
4. Recheck oil level.

**NOTE:**

Engine oil level verification must be performed within 2 minutes after engine stop.

5. Repeat the above steps until oil level reaches the dipstick between the lower and upper marks. **Do not overfill.**
6. Properly insert and tighten dipstick.
7. Close seat.

**Changing the Engine Oil and Oil Filter**

1. Prior to changing the oil, ensure vehicle is on a level surface.

**NOTICE**

The engine oil and the engine oil filter must be replaced at the same time. The oil change should be carried out with a warm engine.

**CAUTION**

Engine oil can be very hot.

2. Clean area around drain plug under oil sump cover.
3. Place an appropriate drain pan under oil sump cover.
4. Remove the drain plug and discard the sealing washer and O-rings.

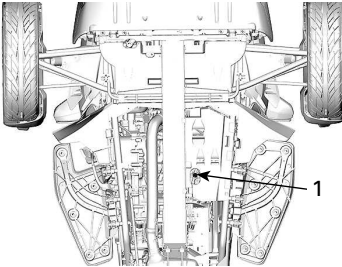

**TYPICAL**

1. Engine oil drain plug

5. Remove the dipstick.
6. Allow sufficient time for oil to completely drain.
7. Clean area around magnetic drain plug in the clutch cover.
8. Place an appropriate drain pan under the clutch cover.
9. Remove the magnetic oil drain plug and discard the sealing ring.

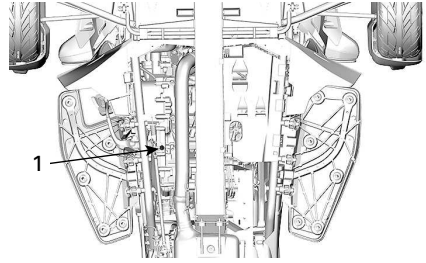

**TYPICAL**

1. Clutch cover magnetic drain plug

10. Remove the left service cover. Refer to *Service Cover* in *Equipment*.
11. Unplug the brake level switches connector.

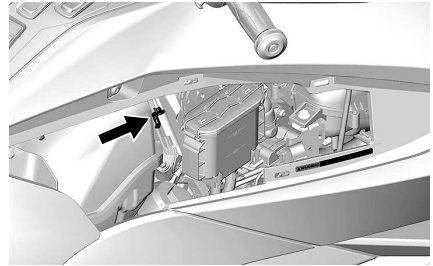

12. Detach both brake level switches from the bottom of the reservoir.

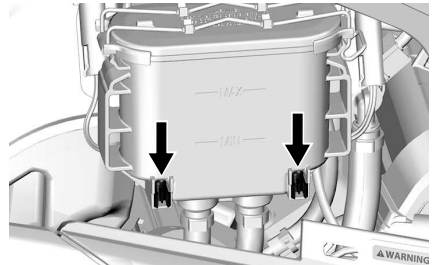

13. Move spring pin and remove reservoir from its support.

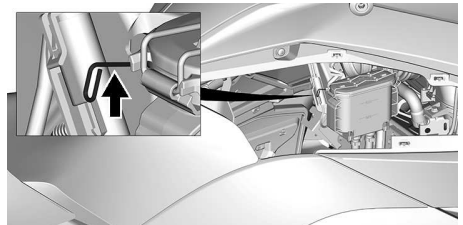

14. Move the reservoir rearwards and secure it with a bungee cord to the handlebar.

**NOTICE**

**Do not let the reservoir hang from the end of the hoses.**

15. Remove oil filter cover and discard its O-rings.
16. Remove and discard oil filter.

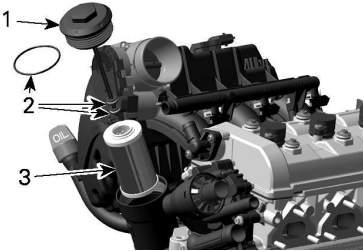

1. Oil filter cover
2. O-rings
3. Oil filter

17. Allow sufficient time for oil to completely drain from clutch cover.
18. Check and clean oil filter cavity for dirt and contamination.
19. Clean the magnet on the magnetic drain plug.
20. Using **NEW** sealing washers and O-rings and install both drain plugs.

**NOTICE**

**Never reuse the drain plug sealing washers and O-rings. Always replace it with a new one.**

21. Tighten drain plugs as specified.

**Tightening Torque**

Drain plug (oil sump cover)	28 ± 2 Nm (21 ± 1 lbf-ft)
Magnetic drain plug (clutch cover)	20 ± 1 Nm (15 ± 1 lbf-ft)

22. Insert **NEW** engine oil filter.
23. Install **NEW** O-rings on oil filter cover.
24. Install oil filter cover and tighten to specification.

**Tightening Torque**

Oil filter cover	25 ± 3 Nm (18 ± 2 lbf-ft)
------------------	------------------------------

25. Pour following amount of the recommended oil into the oil tank.

When doing...	Quantity
Engine oil and engine oil filter replacement	4.7 l (5 qt (liq.,US))
Engine oil, engine oil filter and HCM surface filter replacement	4.9 l (5.2 qt (liq.,US))

26. Reposition the brake fluid reservoir.

1. Install both brake level switches.
2. Reinstall the retaining pin at the back of the reservoir.
3. Connect the brake switches connector.

27. Reinsert and completely screw in the dipstick.
28. Check engine oil level. Refer to *Engine Oil Level Verification* in this section.

**NOTICE**

Ensure oil pressure warning lamp goes out within 5 seconds from engine start. If oil pressure warning lamp stays ON for more than 5 seconds, STOP ENGINE and re-check oil level.

29. Ensure engine oil filter cover, magnetic drain plug (clutch cover) and drain plug (oil sump cover) are not leaking.
30. Stop engine.
31. Reinstall the left service cover.
32. Dispose of used oil as per your local environmental regulations.

**Air Filter**

**Removing the Air Filter**

1. Remove the right service cover. Refer to *Service Cover in Equipment*.

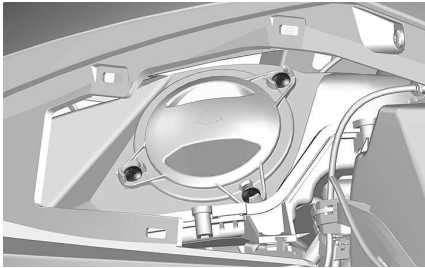

2. Remove the air filter cover and the filter.

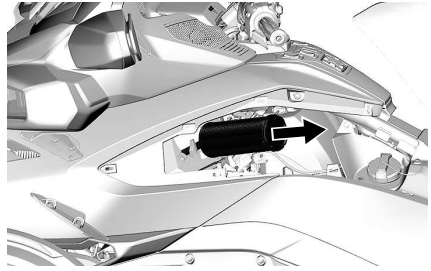

**Inspecting the Air Filter**

Inspect air filter for cleanliness and damage.

**NOTICE**

It is not recommended to blow compressed air on the paper filter. This could damage the paper fibers and reduce its filtration ability when used in dusty environments.

**NOTICE**

Do not wash the paper filter with any cleaning solution.

**NOTICE**

Inspect air intake silencer and remove any dust or debris taking care not to blow or move anything inside the clean side of the engine air inlet (passed air filter).

**NOTICE**

Remove any dust or debris that may have moved or shifted inside the clean side of the air intake silencer (passed air filter). Clean by pulling on the dust and not pushing it inside.

Replace air filter as necessary according to recommended maintenance schedule and particular use (especially in dusty environments).



### Installing the Air Filter

Carefully install air filter into position.

**NOTE:**

The air filter should sit itself correctly. Please make sure the seat/receptacle of the intake hose is not deformed before inserting the air filter.

Properly position air filter cover then secure with all screws.

Tightening Torque	
Air filter cover screws	3 ± 0.5 Nm (27 ± 4 lbf-in)

Reinstall the right service cover.

### Engine Coolant

#### Recommended Engine Coolant

NOTICE
<b>Always use ethylene-glycol anti-freeze containing corrosion inhibitors specifically for internal combustion aluminum engines.</b>

To prevent antifreeze deterioration, always use the same brand and grade. Never mix different brands or grades unless cooling system is completely flushed and refilled.

XPS Recommended Coolant
Extended life pre-mixed coolant
If the Recommended XPS Product is not Available
Use a low silicate, extended life ethylene-glycol premixed coolant (50%-50%) specifically formulated for internal combustion aluminum engines.

### Verifying the Engine Coolant Level

⚠ WARNING
<b>When opening the reservoir, the coolant can be very hot and spray out if the engine is hot. In order to avoid getting burned, check the coolant level when the engine is cold.</b>

With the engine cold, check the coolant level as follows:

1. Park the vehicle on a firm, level surface.
2. Open the front storage compartment cover.
3. Remove the front service cover. Refer to *Service Cover* in *Equipment*.
4. Check the coolant level on the right hand side of the reservoir. Coolant must be visible slightly above the COLD level mark.

**NOTE:**

If engine is hot, coolant must be visible without exceeding the HOT level mark.

5. If required, add coolant until it is visible in the reservoir slightly above the COLD level mark. Use a funnel to avoid spillage. **Do not overfill.**
6. Stop adding coolant once coolant starts to appear in the tube.

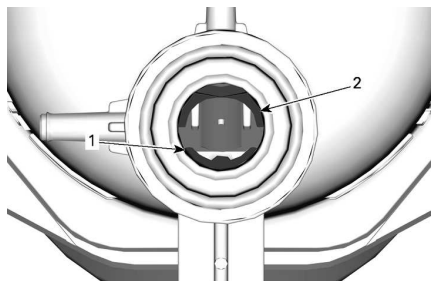

1. COLD coolant level reference line
2. HOT coolant level reference line

7. Reinstall the service cover.

**NOTE:**

A coolant system that frequently requires coolant indicates leaks or engine problems. See an authorized Can-Am On-Road dealer.

## Radiator Fans

### *Cleaning the Radiator Fans*

Remove any debris from the grills.

**NOTE:**

Do not clean with a pressure washer because it can damage the radiator fins. Clean only with compressed air from behind (blow the air from the back towards the front).

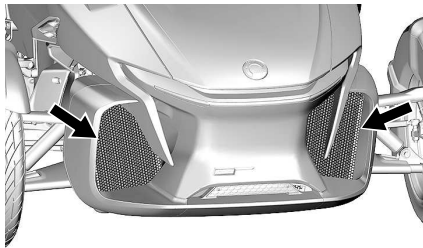

**NOTE:**

When the engine is running and the vehicle is stopped or travelling at low speed, the radiator fans push air towards the front of the vehicle. When the vehicle is travelling at higher speed the fans push the air towards the back of the vehicle.

## Battery

### *Battery Location*

The battery is located in the front storage compartment.

To access the battery, open the front storage compartment.

On **LIMITED MODELS**, open the zipper of the inner liner.

Remove the battery access panel.

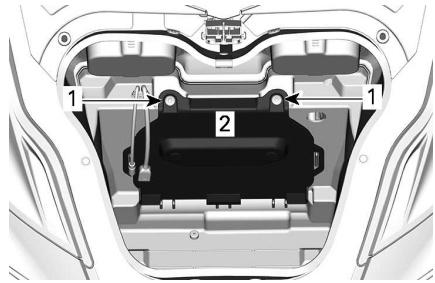

1. Screw
2. Battery access panel

### *Charging the Battery*

The vehicle is equipped with a maintenance-free type battery and is completely sealed; there is no need to add water to adjust the electrolyte level. The battery may need to be charged if the vehicle has not been ridden for at least one month.

Always have the battery replaced by an authorized Can-Am On-Road dealer.

**⚠ WARNING**

**Do not use conventional lead-acid type batteries. Acid may leak out through the battery vent of a conventional lead-acid type battery. Acid may also leak if the battery case is cracked or damaged, which can cause severe burns.**

The battery can be charged while it is installed on the vehicle.

A standard battery charger can be used. If the battery is dead, it can be jump started with a car battery (see *Roadside Repairs* section).

For home charging, a “trickle” charger can be used to slow charge the battery. This type of charger can be left connected for a long period of time without damaging the battery. Always follow the charging time as recommended in the charger instructions.

**NOTICE**

Follow the instructions provided with your battery charger. Improper charging may damage the battery.

To charge the battery, proceed as follows:

1. Open the front storage compartment.
2. On **LIMITED MODELS**, open the zipper of the inner liner.
3. Remove the battery access panel.
4. First connect the RED (+) cable to the corresponding terminal.

**NOTICE**

Always connect the RED (+) cable first to avoid damaging the electrical system of the vehicle.

5. Connect the BLACK (-) cable to the corresponding terminal.

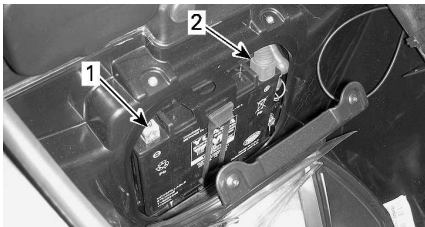

1. BLACK (-) terminal
2. RED (+) terminal

6. Start the battery charger. Charging time will depend on the charging rate.

When the battery is charged:

7. First disconnect the BLACK (-) cable.

**NOTICE**

Always disconnect the BLACK (-) cable first to avoid damaging the electrical system of the vehicle.

8. Disconnect the RED (+) cable.
9. Close the battery access panel and the front storage compartment.

**Drive Belt**

Visually inspect belt alignment and condition before each ride.

Belt alignment and deflection adjustment should always be performed by an authorized Can-Am On-Road dealer according to the *Maintenance Schedule*.

**Drive Belt Alignment**

If belt goes beyond the outside edge of sprocket, have the belt properly aligned by an authorized Can-Am On-Road dealer as soon as possible.

**NOTE:**

Belt must **NOT** be in contact with flange from **FRONT SPROCKET**.

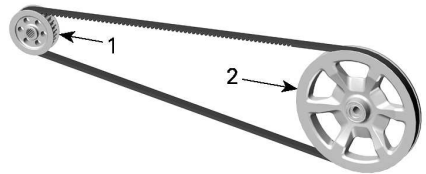

**TYPICAL**

1. Front sprocket
2. Rear sprocket

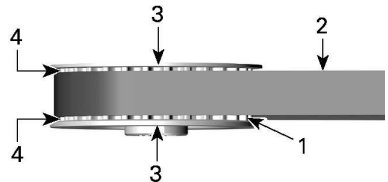

**TYPICAL - FRONT SPROCKET**

1. Front sprocket teeth
2. Belt
3. Sprocket flange
4. Gap between flange and belt

### Drive Belt Wear



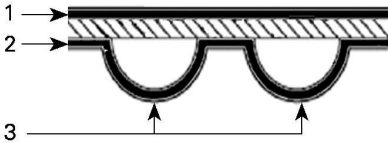



Inspect the drive belt with the vehicle in neutral, engine off, on a level surface with plenty of room — you will have to roll the vehicle forward or backward to see the full length of the belt.





#### DRIVE BELT SURFACES

1. Outer surface
2. Teeth side surface
3. Tooth

Inspect for the following conditions:

Wear Condition	Required Action
Good condition 	None
Hairline cracks 	Monitor condition
Minor chipping 	Monitor condition
Opened cracks 	Replace belt
Hook wear 	Replace belt
Missing teeth 	Replace belt

Wear Condition	Required Action
Belt fabric worn, exposing internal components 	Replace belt
Stone damage 	Replace belt

#### NOTE:

Hairline cracks do not require the replacement of the belt, but must be monitored closely — they may lead to opened cracks or missing teeth, requiring belt replacement. Damage to the center of the belt will eventually require belt replacement, but when cracks extend to the edge of the belt, belt failure is imminent.

When a drive belt is replaced, also replace the sprockets to increase the longevity of the new drive belt.

#### Drive Belt Tension

While riding, if you feel vibrations or noise in the belt or if the belt is skipping sprocket teeth, have the belt tension adjusted as soon as possible by an authorized Can-Am On-Road dealer. Pay particular attention during break-in period (first 1 000 km (600 mi)).

## Wheels and Tires

### WARNING

**Tires that are not the recommended type, damaged, worn down below the minimum tread wear limit indicator or not properly inflated can cause loss of control. New tires will not operate at their maximum efficiency until their break-in is completed. Braking, steering and VSS performance may be reduced, so use extra caution. Tires take about 300 km (200 mi) of riding with frequent braking to break-in. For riding with infrequent braking, allow extra time to break-in the tires.**

The tires have been specifically designed for this vehicle. Use only the BRP recommended radial tires, which can be ordered only from an authorized Can-Am On-Road dealer.

When the rear tire is removed or replaced, perform the following:

- Check and clean the rear sprocket bearing. Replace if damaged or broken.
- Check and clean the rear axle bearings. Replace if damaged or broken.
- Replace and lubricate the bearing seal of the rear axle.
- Replace and lubricate rear axle O-ring.
- Check and clean the rear axle wear sleeves. Replace if damaged or broken.

When the rear wheel is removed or replaced, perform the following:

- Replace rear wheel nut.
- Replace and lubricate the bearing seal of the rear axle.
- Replace and lubricate rear axle O-ring.
- Check rubber damper condition. Replace if damaged or broken.

## Tire Pressure

Use the recommended cold inflation pressure for optimum tire performance and wear. Under-inflation or over-inflation may cause uneven tread wear patterns.

Recommended tire inflation pressure is found on the Tire Label located inside the right side service cover.

When weather temperature changes occur, tire inflation pressures also change. A drop of 6 °C (10 °F) can cause a corresponding drop of 7 kPa (1 lbf/in<sup>2</sup>) in inflation pressure. Check your tire pressures frequently and adjust them to the proper pressure

### NOTE:

The pressure difference between the left and right side tire should not exceed 3.4 kPa (.5 lbf/in<sup>2</sup>).

## Tire Damage

Check all tires for:

- Cuts, slits and cracks in the tires.
- Bumps or bulges in the side of the tire or the tread.
- Nails or other foreign objects in the side of the tire or tread.
- Air leaks (hissing sound) caused by an ill-fitting rim or a faulty tire valve.

If any of the above occurs, have the tire repaired or replaced as soon as possible by an authorized Can-Am On-Road dealer.

## Tire Tread Wear

Check minimum tread depth by using the tread-wear indicators (hard rubber bars molded at the base of the tread; 1 in figure below). Check in three locations across the tire tread:

- Outer edge
- Center
- Inside edge.

The tread-wear indicators will appear across the treads that have been worn

down to the minimum tread depth. When at least one tread-wear indicator appears across the tread, have the tire replaced as soon as possible by an authorized Can-Am On-Road dealer.

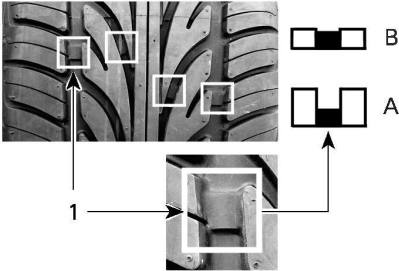

**TIRE TREAD WEAR**

1. Tread-wear limit indicator

- A. Appropriate tread depth
- B. Minimum tread depth, replace tire

It is normal to see uneven wear on tires depending on how the vehicle is driven and road conditions. The front tires external or internal edges and the rear tire center tread will wear unevenly depending on if the vehicle is driven smoothly or aggressively.

**Tire Rotation**

Rotate front tires when tread depth reaches 4 mm (5/32 in). This will maximize tire life.

<p><b>⚠ WARNING</b></p>
<p>The tires are designed to rotate only in one direction. Do not switch the left and right front wheels. The tires must be dismounted from the wheels for tire rotation. If a tire is mounted on the incorrect side, you will have less traction and could lose control.</p>

<p><b>⚠ CAUTION</b></p>
<p>Do not hold the front wheel spoke while attempting to spin the front wheel as your fingers may be caught between the wheel and the brake caliper.</p>

**Tire Registration Form**

In the event of a tire recall, we can only contact you if we have your name and address. As a vehicle manufacturer, BRP keeps a record of the Tire Identification Number (TIN) associated with the Vehicle Identification Number (VIN) (see *Vehicle Identification*) and its current owner information.

If you replace any tire on your vehicle, a "Tire Registration Form" must be completed and sent to the tire manufacturer consumer service group. The "Tire Registration Form" is available at an authorized Can-Am On-Road dealer.

**Brakes**

<p><b>⚠ WARNING</b></p>
<p>New brakes will not operate at their maximum efficiency until their break-in is completed. Braking performance may be reduced, so use extra caution. Brakes take about 300 km (200 mi) of riding with frequent braking to break-in. For riding with infrequent braking, allow extra time to break-in the brakes.</p>

**Verifying the Brake Fluid Level**

Use only DOT 4 brake fluid from a sealed container.

Check the brake fluid level as follows:

1. Park the vehicle on a firm, level surface.

- Remove the right service cover. Refer to *Service Cover in Equipment*.
- Check the brake fluid level in reservoir. It should be above the MIN. line.

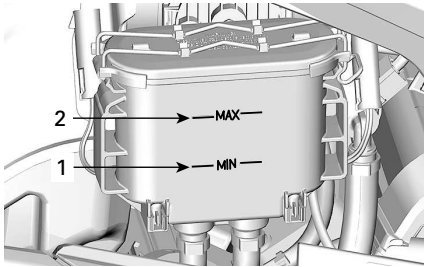

- Brake fluid MAX. level mark
- Brake fluid MIN. level mark

- Add fluid as required. Refer to *Adding Brake Fluid*.

**⚠ CAUTION**

**Low brake fluid may indicate leaks or worn brake pads. See an authorized Can-Am On-Road dealer.**

### Adding Brake Fluid

- Clean the filler cap.

**⚠ WARNING**

**Clean filler cap before removing. Use only DOT 4 brake fluid from a sealed container.**

- Remove the filler cap.

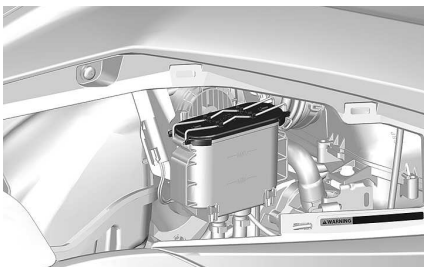

- Add fluid to MAX level.

### NOTE:

Replacing brake pads will increase brake fluid level. If replaced when at MAX level, brake fluid spills may occur.

**NOTICE**

**Brake fluid can damage painted surfaces or plastic parts. Wipe up any spills.**

- Reinstall filler cap and lock in place.
- Reinstall the service cover.

### Verifying the Brake System

The front and rear brakes are hydraulic disc types. These brakes are self-adjusting and do not require adjustment.

The brake pedal also requires no adjustment.

To keep brakes in good condition, check the following as per the *Maintenance Schedule*:

- Entire brake system for fluid leaks
- Brake pedal for spongy feel
- Brake discs for excessive wear and surface condition
- Brake pads for wear, damage or looseness.

See an authorized Can-Am On-Road dealer if there are any problems with the brake system.

### Headlights

#### Verifying the Headlights Aiming

- Verify tires are correctly inflated. Refer to the *Tires Pressure Label* located under the operator's seat.
- On base models, set the rear suspension air pressure to the correct loading condition (refer to the *Rear Suspension Pressure* label located also under the operator's seat).

**NOTE:**

For Limited models, the compressor levels the vehicle automatically.

3. Position vehicle in front of a test surface as shown. Make sure vehicle is on leveled ground.

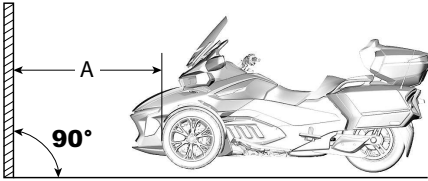

1. 10 m (33 ft)

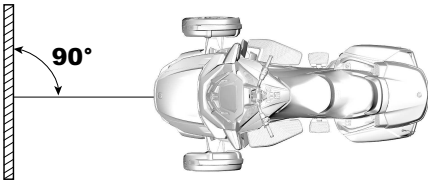

Trace 2 lines parallel to the ground on the test surface as follows:

Lines on the Test Surface	
Line A	770 mm (30-5/16 in) above ground
Line B	718 mm (28-9/32 in) above ground

4. Select **low** beam.

**NOTICE**

**Make sure the loading conditions are representatives of the riding conditions when adjusting the headlights.**

5. Beam aiming is correct when the top line of the headlight reflection is between lines A and B.

**Headlights Vertical Aiming Adjustment**

When adjusting the headlight, low and high beam are adjusted simultaneously.

1. Remove the mirror trim.

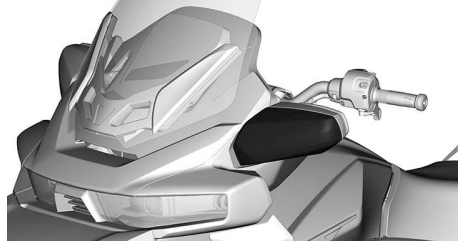

2. On Australian models:

1. Unplug the flasher connector.



2. Remove the screw on the end of the mirror housing.

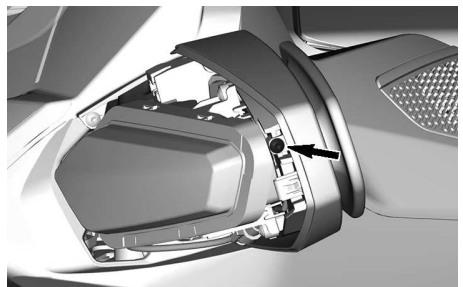

3. Slightly, pull the mirror to make more room.

3. Using the Phillips screwdriver provides in the tool kit, turn the headlight adjuster to adjust the headlights vertically.



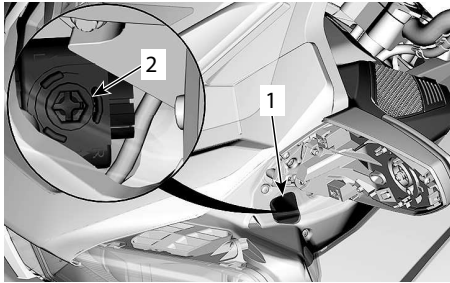

1. Access hole
2. Headlight adjuster

Headlight Beam Adjustment	
Raise beam	Turn adjuster screw clockwise
Lower beam	Turn adjuster screw counterclockwise

4. Reinstall the mirror trim.

### Headlights Horizontal Aiming Adjustment

1. Lift up the glove box and move it aside to make room.

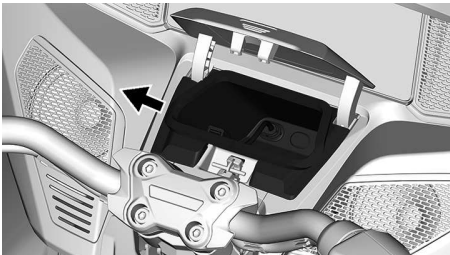

2. Insert your hand in the opening and push to the foam part under the display to access the inner of the console. It may be necessary to displace the electric harness aside to work easily.
3. With your fingers, locate the adjuster on the headlight housing.
4. Using the short bent side of the Allen key provides in the tool kit, turn

the headlight adjuster to adjust the headlights horizontally.

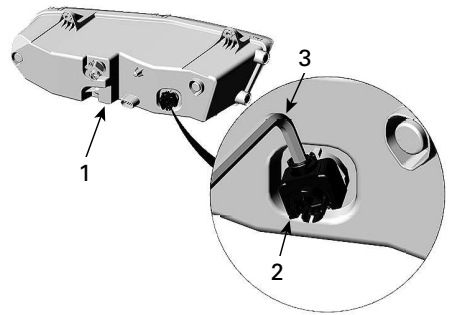

### LH HEADLIGHT ADJUSTER SHOWN

1. LH headlight housing
2. Headlight adjuster - horizontal adjustment
3. 6mm Allen key
5. Adjust the headlight so that the center of the focus point (brightest spot on the wall) is located at approximately 160 mm (6.3 in) each side of the center of the vehicle.

# VEHICLE CARE

## Cleaning the Vehicle

Do not use high-pressure washers (like the ones found in car washes) as they may damage certain parts of the vehicle.

### NOTICE

Do not clean the windshield with alkaline or acid cleaner, gasoline or solvent to avoid windshield damage.

### NOTICE

For matte finishes, do not use wax, detail spray, or other products used on regular paint. Do not wash with abrasive materials. Do not use mechanical cleaners or polishers, and do not rub the surfaces vigorously.

To clean the vehicle:

1. Rinse the vehicle thoroughly with water to remove loose dirt.
2. Using a soft, clean cloth, wash the vehicle with water mixed with a mild detergent, such as soap specially formulated for motorcycles or automobiles.

### NOTE:

Using warm water works well to remove bugs in the windshield and front panels.

3. While washing the vehicle, check for grease or oil. You can use service product or a mild automotive degreaser. Thoroughly follow the manufacturer's instructions.

### XPS Roadster wash

4. Dry the vehicle with a chamois or a soft towel.

## Vehicles with Matte Finishes

### NOTICE

Do not use wax, detail spray, or other products used on regular paint. Do not wash with abrasive materials. Do not use mechanical cleaners or polishers, and do not rub the surfaces vigorously.

Hand-wash with a soft wash mitt and a mild cleaning product safe for matte paint. To remove foreign substances such as insects, use a soft applicator and a mild solvent. Saturate and soak area before cleaning. Rub lightly.

This paint finish may require more frequent cleaning.

## Vehicle Protection

Apply non-abrasive wax to plastic parts.

### NOTICE

Do not wax or polish matte surfaces (including matte paint finishes).

Surface	Recommendation
Glossy paint finishes	Apply only non-abrasive wax, safe for clear coat paints
Matte finishes	Do not apply wax

### NOTICE

Do not polish windshield with any plastic cleaner/polisher.

### ⚠ WARNING

Do not apply a vinyl or plastic protector on the seats as the surface will become slippery and the operator or the passenger may slip off the vehicle.

---

# STORAGE AND PRESEASON PREPARATION

## Storage

If the vehicle will not be ridden for at least four months, such as during the winter, proper storage is necessary to keep the vehicle in good condition.

BRP recommends you have your authorized Can-Am On-Road dealer, repair shop, or person of your own choosing fully prepare your vehicle for storage. Or, at your convenience, you can follow the basic procedures below.

### *To Prepare the Vehicle for Storage*

1. Inspect vehicle and have your authorized Can-Am On-Road dealer, repair shop, or person of your own choosing for maintenance, repair, or replacement if necessary.

#### **NOTE:**

For US and Canadian citizens, please refer to the *US EPA Emission Performance Warranty* contained in the *Warranty* section for information about warranty claims.

2. Change the engine oil and filter. Seek service from an authorized Can-Am On-Road dealer, repair shop, or person of your own choosing for maintenance, repair, or replacement.
3. Check engine coolant, brake fluid and clutch fluid levels.
4. Fill the fuel tank, add fuel stabilizer and run the engine to prevent the tank from rusting and the fuel from deteriorating. Strictly follow instructions on fuel stabilizer container.
5. Inflate all tires to their recommended pressure.
6. Clean the vehicle.
7. Lubricate all control cables, latches, key barrels, and pivoting points of all levers.
8. Close and latch all storage compartments.
9. Store the vehicle in a dry area, away from sunlight, with a small amount of daily temperature variation.
10. In some locations, it will be a good idea to block the engine air intake entering and the muffler opening with clean rag to avoid intrusion of field mice, mice, squirrels or other small unwanted visitors. Don't push the rag to far. Leave a small portion of the rag overshoot as a reminder.
11. Cover the vehicle with a permeable materials (e. g., tarpaulin). Avoid using plastic or similar non-breathing, coated materials that restrict air flow and allow heat and moisture to accumulate.
12. Slow charge the battery once a month at the recommended charging rate indicate on the battery. It is not necessary to remove the battery.

## Preseason Preparation

After a storage period, the vehicle must be prepared and inspected before riding. Perform the following:

1. Uncover the vehicle.
2. Remove rags from the engine air intake entering and the muffler opening.
3. Clean the vehicle.
4. Charge the battery if needed.
5. Perform a pre-ride inspection, then test-ride the vehicle at low speed.

This page is intentionally blank

# ROAD SIDE REPAIRS

# DIAGNOSTIC GUIDELINES

## NOTICE

If the vehicle must be transported, do not have it towed – towing can seriously damage the vehicle. Refer to *Transporting the Vehicle* in this section for detailed instructions.

## Will not Shift into Neutral

If the gearbox cannot shift into neutral when vehicle is not moving:

1. The engine speed will be automatically increased to approximately 1300 RPM then it will be brought back to idle speed.
2. Up to 3 attempts will be done.
3. If it does not work, retry pressing upshift or downshift.

## Will not Shift

Have your vehicle transported to the nearest Can-Am On-Road dealer.

## Engine Does Not Start

### Troubleshooting

### 1. ENGINE DOES NOT TURN OVER

Scrolling safety message on the multi-function gauge not acknowledged.

- Twist the throttle away from you (lift your wrist) to acknowledge the safety message.

Engine stop switch in the OFF position.

- Make sure that the engine stop switch is in the ON position.

Ignition switch in the OFF position.

- Turn the ignition key to the ON position.

Battery dead or poor battery connections.

- Check the battery charge. Recharge if necessary (see *Maintenance Procedures*).

- Check the battery connections in the front storage compartment (see *Maintenance Procedures*).

Blown fuse.

- Check fuse condition (see the *How to Replace Fuses and Lights*).

Transmission is in gear.

- Depress brake pedal if transmission is in gear.

The key is not read. If the immobilizer system cannot read the key, the engine will not start. The following conditions can lead to the immobilizer system failing to read the key:

- Damaged computer chip
- Large metallic object near the key
- Electronic device near the key
- Second electronic coded key near the main key
- Other strong electromagnetic field in the key area

- If the engine does not start and a key error message is displayed in the cluster, make sure that none of the above conditions are present. If the problem is still present without these conditions, see an authorized Can-Am On-Road dealer.

### 2. ENGINE TURNS OVER, BUT DOES NOT START

Low fuel.

- Fill the fuel tank. Refer to *Basic Procedures*.

Weak battery.

- Check battery charge. Recharge if necessary (see *Maintenance Procedures*).
- Check the battery connections in the front storage compartment (see *Maintenance Procedures*).











---

Engine management problem.











- *Check to see whether the engine malfunction indicator lamp is ON while starting. Seek service from an authorized Can-Am On-Road dealer, repair shop, or person of your own choosing for maintenance, repair, or replacement. Please refer to the US EPA Emissions Performance Warranty contained herein for information about warranty claims.*





# MESSAGES IN MULTIFUNCTION GAUGE

Important information about vehicle condition is displayed on the multifunction gauge. When starting the engine, always look at the gauge for any indicator lamps or special messages.

Indicator Lamps (Malfunctions)		
Indicator	Message/ Warning	Description
	CHECK ENGINE	<ul style="list-style-type: none"> <li>– All active or previously activated faults that require attention.</li> <li>– No engine limitations engaged.</li> <li>– Contact an authorized Can-Am On-Road dealer as soon as possible.</li> </ul>
	LIMP HOME MODE	<ul style="list-style-type: none"> <li>– Critical faults requiring diagnostic as soon as possible.</li> <li>– An engine limitation is engaged and/or the engine behavior is modified.</li> <li>– * Have the vehicle transported to the nearest authorized Can-Am On-Road dealer.</li> </ul>
	VSS FAULT	<ul style="list-style-type: none"> <li>– Vehicle Stability System malfunction.</li> </ul>
	BRAKE FAILURE Low brake fluid	<ul style="list-style-type: none"> <li>– Check for brake fluid leaks.</li> <li>– Check brake fluid level and adjust (refer <i>Maintenance Procedures</i>).</li> </ul>
	BRAKE FAILURE Parking Brake Failure	<ul style="list-style-type: none"> <li>– Have the vehicle transported to the nearest authorized Can-Am On-Road dealer.</li> </ul>
	PARKING BRAKE APPLIED	<ul style="list-style-type: none"> <li>– Release Parking Brake.</li> </ul>
	LOW OIL PRESSURE	<ul style="list-style-type: none"> <li>– Stop engine.</li> <li>– Check for oil leaks.</li> <li>– Check oil level and adjust (see <i>Maintenance Procedures</i>).</li> </ul>
	NO OIL	<ul style="list-style-type: none"> <li>– Stop engine.</li> <li>– Check for oil leaks.</li> <li>– Check oil level and adjust (see <i>Maintenance Procedures</i>).</li> </ul>
	ENGINE OVERHEAT	<ul style="list-style-type: none"> <li>– Engine temperature too high.</li> </ul>
	HIGH ENGINE TEMPERATURE	<ul style="list-style-type: none"> <li>– Stop and wait for engine to cool down.</li> <li>– Check for leaks.</li> <li>– Check coolant level and adjust (refer to <i>Maintenance Procedures</i>).</li> </ul>



Indicator Lamps (Malfunctions)		
Indicator	Message/Warning	Description
		<ul style="list-style-type: none"> <li>– If coolant level is correct and overheating persists, contact an authorized Can-Am On-Road dealer. Do not run the engine if condition persists.</li> </ul>
	WARM UP	<ul style="list-style-type: none"> <li>– Power is reduced.</li> </ul>
	WRONG KEY	<ul style="list-style-type: none"> <li>– Unable to read key (bad connection).</li> <li>– Make sure the key is clean and correctly snapped on post.</li> <li>– Use the right key for the vehicle or contact an authorized Can-Am On-Road dealer.</li> </ul>
	CHECK DPS	<ul style="list-style-type: none"> <li>– Check engine pilot light on ().</li> <li>– Indicates that the DPS (Dynamic Power Steering) does not work properly.</li> <li>– Contact an authorized Can-Am On-Road dealer as soon as possible.</li> </ul>
	SUSPENSION FAULT	<ul style="list-style-type: none"> <li>– Check pressure in the air spring.</li> <li>– Check rear suspension position sensor.</li> <li>– Have the vehicle transported to the nearest authorized Can-Am On-Road Dealer to verify the Air Controlled Suspension Min/Max values calibration.</li> </ul>
	TRANSMISSION FAULT	<ul style="list-style-type: none"> <li>– Remove key, wait 20 seconds, and reinsert key.</li> <li>– Have the vehicle repaired by an authorized Can-Am On-Road dealer.</li> </ul>
	DROWN MODE ACTIVE	<ul style="list-style-type: none"> <li>– Release throttle to deactivate Drown Mode.</li> </ul>
	THROTTLE IS OPEN	<ul style="list-style-type: none"> <li>– Release throttle to deactivate limitation.</li> </ul>
	KNOCK	<ul style="list-style-type: none"> <li>– Engine detonation (RPM is limited when this condition occurs).</li> <li>– Ensure recommended fuel is used.</li> <li>– Check fuel quality, replace if necessary.</li> <li>– If fault still occurs, contact an authorized Can-Am On-Road dealer, repair shop, or person of your own choosing.</li> </ul>
	ENGINE WILL SHUTDOWN	<ul style="list-style-type: none"> <li>– Shutdown procedure in force due to engine overheating or fuel pump problem.</li> </ul>

Indicator Lamps (Malfunctions)		
Indicator	Message/Warning	Description
	FUEL LEVEL SENSOR FAULT	– Fuel sender resistor value is out of range.
	LOW FUEL	– Fuel level is low or fuel tank is near empty.
	HIGH BATTERY VOLTAGE	– Indicate a high battery voltage condition. Contact an authorized Can-Am On-Road dealer as soon as possible.
	12V BATTERY	– System overload - Park in a safe place.

\*BRP recommends having the vehicle transported when in LIMP HOME. If you operate the vehicle in LIMP HOME, avoid abrupt maneuvers and immediately go to the nearest authorized Can-Am On-Road dealer to have your vehicle serviced before riding again. In LIMP HOME, the engine RPM is limited and therefore the vehicle speed.

Important information messages can also be displayed temporarily to assist indicator lamps.

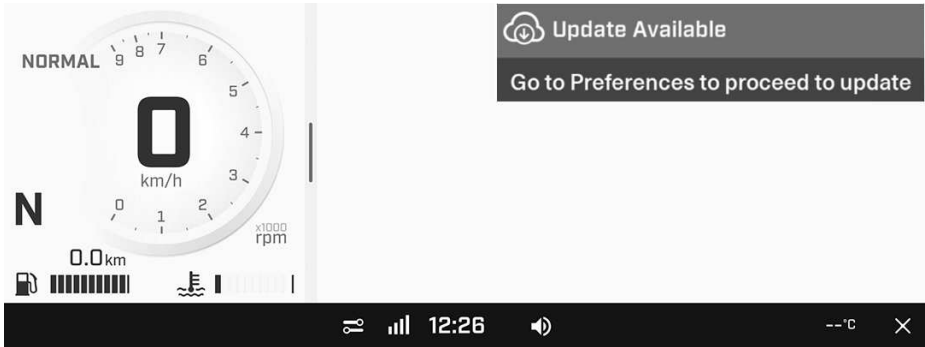

# WHAT TO DO IN THE FOLLOWING CIRCUMSTANCES

## Lost Keys

Use your spare key to have another one made by an authorized Can-Am On-Road dealer as soon as possible. **If both keys are lost**, the ignition switch, the key barrel of the rear storage compartment and the trailer key barrel (if using a BRP trailer) will need to be replaced at the expense of the vehicle owner.

## Cannot Open the Side Storage Compartment

Remove the passenger's seat.

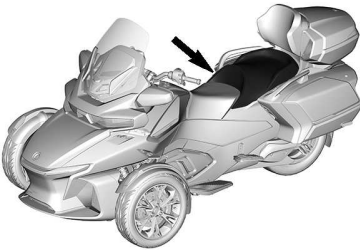

Remove both retaining screws from the access panel.

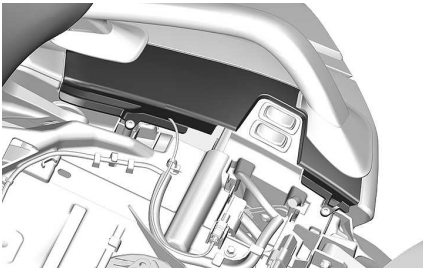

Pull out access panel.

Move the mechanism to release the latch.

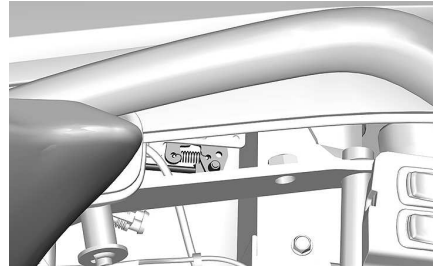

## Flat Tire

If a tire has a **major** puncture or cut in the tread and is completely deflated, have the vehicle transported to the nearest Can-Am On-Road dealer. Refer to *Transporting the Vehicle* for transporting instructions.

If a tire has a **minor** nail or stone puncture and is not completely deflated, the tire can be temporarily repaired. To temporarily repair a tire, a self-inflating tire sealer or tire plug repair kit can be used. Follow the manufacturer's instructions that come with the tire sealer or repair kit and have the tire repaired or replaced by an authorized Can-Am On-Road dealer **as soon as possible**.

When a tire is temporarily repaired, ride slowly and carefully, and frequently check tire pressure until it is replaced or permanently repaired.

## Dead Battery

If the battery is dead or too low to crank the engine, it can be jump started.

### **WARNING**

**Connect the jumper cables as specified in the jump start procedure. Batteries can emit explosive gas that can ignite if jumper cables are not properly connected.**

**NOTICE**

**Do not disconnect the discharged battery.**

1. Park the booster vehicle closed to the front of your vehicle.
2. Shift the vehicle into NEUTRAL (N).
3. Open the front storage compartment cover.
4. Remove the battery access panel.
5. Remove the positive terminal cover and clean corrosion from battery posts before connecting the jumper cables.

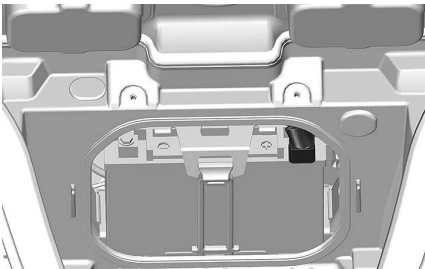

6. Beginning by connecting one end of the RED jump lead to the positive (+) post of the discharged battery.
7. Connect the other end of the RED jump lead to the positive (+) post of the booster vehicle battery.
8. Connect one end of the BLACK jump lead to the negative (-) post of the discharged battery.
9. Connect the other end of the BLACK jump lead to the negative (-) post of the booster vehicle battery.
10. Start the booster vehicle and let run to idle.
11. Start your vehicle in the usual way; if the engine does not start, wait a few minutes before repeating the attempt in order to protect the starter motor and the booster battery.

**NOTE:**

If it still does not start, there might be a problem with the starting system. Have the vehicle transported (see *Transporting the Vehicle*) in this section) and repaired by an authorized Cam-Am On-Road dealer.

12. Once the vehicle has been started, let run both vehicles to idle for a few minutes before disconnecting the jumper cables.
13. Remove the jumper cables in the reverse order that they were connected.

**NOTE:**

If the engine dies shortly after it has been started or when the jumper cables are disconnected, there might be a problem with the charging system. Have the vehicle transported (see *Transporting the Vehicle*) in this section) and repaired by an authorized Cam-Am On-Road dealer.

14. Have the battery fully recharged with a battery charger (see *Maintenance Procedures*) or by a qualified service station as soon as possible.

After recharging battery, have the vehicle inspected by an authorized Can-Am On-Road dealer.

# HOW CHANGING A BULB

## Lights

This vehicle is equipped with LEDs (light emitting diode) and this technology proved to be reliable. Only the back-up light and the rear flashers use bulbs.

The LED technology proved to be reliable and in the unlikely event they do not work, have them checked by an authorized Can-Am On-Road dealer.

Due to the complexity of the procedure, refer to an authorized Can-Am On-Road dealer to replace bulbs of rear flashers and back-up light.

### Australian Models



**FRONT OF VEHICLE**

1. Headlights — low beam
2. Position lights
3. Headlights — high beam
4. Turn signals

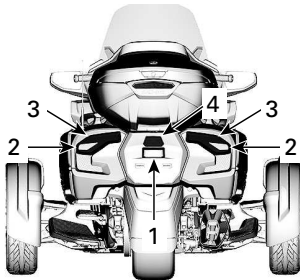

**REAR OF VEHICLE**

1. License plate light
2. Taillights and brake lights
3. Turn signal lights
4. Backup light

### Japanese Models

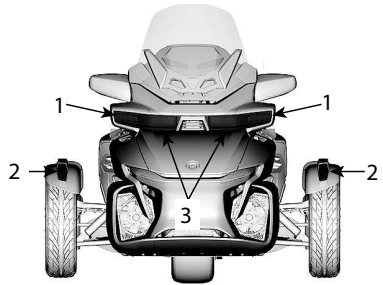

**FRONT OF VEHICLE**

1. Headlights — low beam
2. Position lights/Turn signals
3. Headlights — high beam

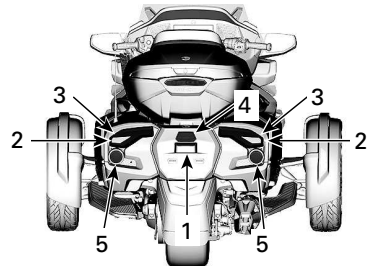

**REAR OF VEHICLE**

1. License plate light
2. Taillights
3. Turn signal lights
4. Backup light
5. Brake lights

### All Other Models

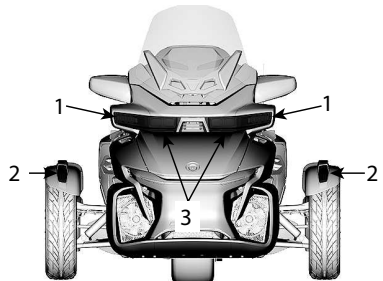

**FRONT OF VEHICLE**

1. Headlights — low beam
2. Position lights/Turn signals
3. Headlights — high beam

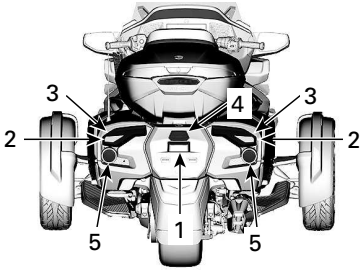

**REAR OF VEHICLE**

1. License plate light
2. Taillights and brake lights
3. Turn signal lights
4. Signature light (Limited only - Canada and USA)
5. Backup light

# HOW REPLACING FUSES

## Fuses

If any electrical accessories stop working on the vehicle, check for blown fuses and replace if necessary.

If an electrical failure still occurs, have the vehicle serviced by an authorized Can-Am On-Road dealer.

### Fuse Locations

Fuses are located in the front storage compartment.

To access the fuses, open the front storage compartment.

On **LIMITED MODELS**, open the zipper of the inner liner.

Push down on the fuse service covers and pull the covers off.

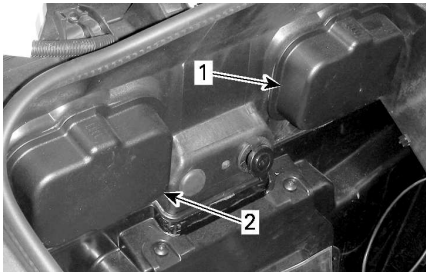

**INSIDE FRONT STORAGE COMPARTMENT**

1. Left fuse service cover
2. Right fuse service cover

Push down on the tabs and carefully remove the fuse box covers.

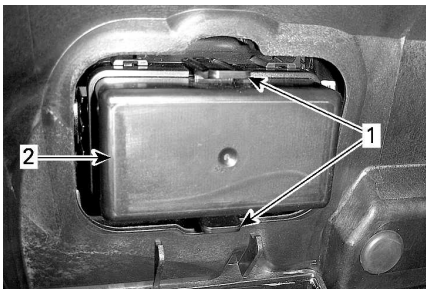

1. Tabs
2. Fuse box cover

## Fuse Description

Refer to decal located between both fuse boxes for correct identification.

### Left Fuse Box

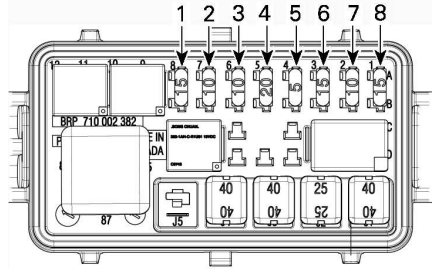

Fuse No.	Description	Rating
1	Cluster / Hazard / DLC	15 A
2	YRS / VCM / ECM / DESS / PRS / MSR	10 A
3	Alternator	10 A
4	Parking brake / Windshield	20 A
5	ECM	5 A
6	Injectors / Ignition Coils	15 A
7	MLS / DLC / TCM / DPS / Cluster / Reverse actuator	10 A
8	Fuel pump / EVAP / Starter relay / HO2S heaters	15 A

**Right Fuse Box**

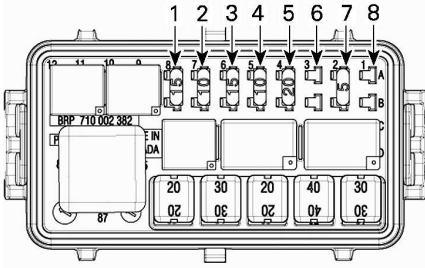

Fuse No.	Description	Rating
1	Parking lights / Plate lights	15 A
2	Brake lights / Hazard	10 A
3	Amplifier	15 A
4	Trailer module	10 A
5	Headlamps	7.5 A
6	GPS_Acc	5 A
7	Not use	—
8	Horn	15 A

**Left JCase Fuse Box**

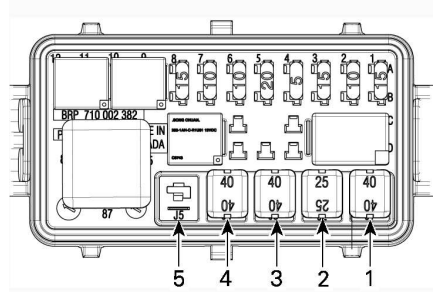

Fuse No.	Description	Rating
1	VSS pump	40 A
2	VSS valves	25 A
3	DPS	40 A
4	Main control	40 A
5	Not used	

**Right JCase Fuse Box**

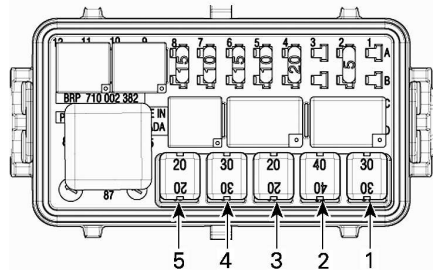

Fuse No.	Description	Rating
1	Cooling fan	30 A
2	Amplifier / Trailer module	40 A
3	TCM solenoids	20 A



Fuse No.	Description	Rating
4	Headlamps lighting / Horn	40 A
5	Accessory	25 A

### Alternator Circuit Fuse

The fuse holder is located to the LH of the battery.

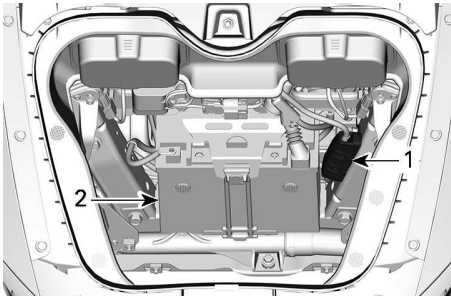

- 1. Fuse holder
- 2. Battery

To check if the fuse is burnt, remove the fuse holder cover, if the metal section between the two terminals is melted or broken, the fuse is burned.

Alternator	80 A (must be replaced only by an authorized On-road dealer)
------------	--

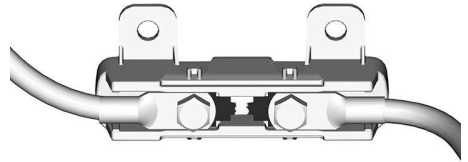

### NOTICE

**Do not replace a burnt fuse, have the vehicle transported to the nearest authorized Can-Am On-Road dealer, repair shop or person of your choosing.**

### Replacing a Fuse

1. Set the ignition switch to OFF.
2. Pull the fuse out.
3. Check whether the filament is melted.

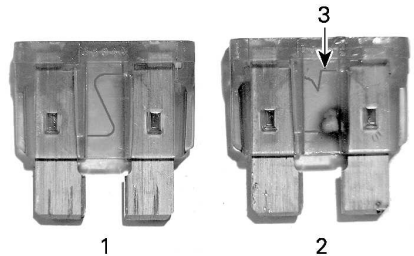

### FUSE

1. Good fuse
  2. Blown fuse
  3. Melted filament
4. Replace the fuse with one with the same rating. Spare fuses are located in the fuse box cover.

### NOTICE

**Using a higher-rated fuse can cause severe damage and may cause fires.**

5. To close the fuse box covers, position covers over fuses and carefully push down until they click.
6. To close the fuse service covers, position covers over fuse boxes and push down carefully until the fuse service covers engage.
7. Install basket and close the front storage compartment.

# HOW TRANSPORTING THE VEHICLE

If your vehicle needs to be transported, it should be carried on a flatbed trailer of the proper size and capacity.

## **CAUTION**

If you need to push the vehicle, do it from the right-hand side to be able to reach the brake pedal. When pulling the vehicle backwards, be careful that the front wheel does not roll over your feet.

## **NOTICE**

Do not tow this vehicle — towing can seriously damage the vehicle drive system.

When contacting a towing or transporting service, be sure to ask if they have a flatbed trailer, loading ramp or power ramp to safely lift the vehicle and tie-down straps. Ensure the vehicle is properly transported as specified in this section.

## **NOTICE**

Avoid using chains to tie the vehicle — they may damage the surface finish or plastic components.

To load the vehicle for transport, proceed as follows:

1. Shift the vehicle into NEUTRAL (N).
2. Remove the key from the ignition switch.
3. Put a strap around the lower arm of each front suspension.

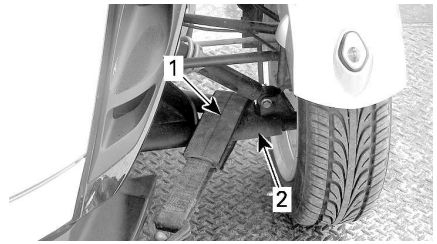

**TYPICAL**

1. Strap
2. Lower suspension arm

4. Attach the straps to the winch cable. If possible, use chains or additional straps to attach the straps to the winch cable as indicated below to avoid damaging the bumper cover.

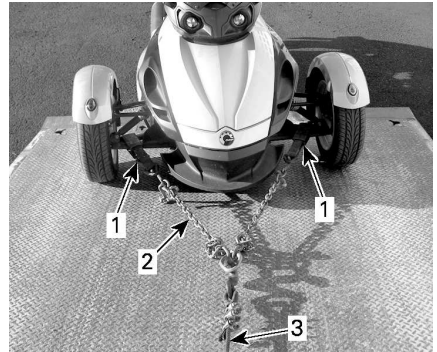

**TYPICAL**

1. Strap around front suspension lower arms
2. Chains to avoid damaging the bumper cover
3. Winch cable
5. Ensure that the parking brake is released.
6. Pull the vehicle on the flatbed trailer with the winch.
7. Engage the parking brake.
8. Ensure that the vehicle is in NEUTRAL (N).
9. Strap the front tires by using one the following methods indicated below.

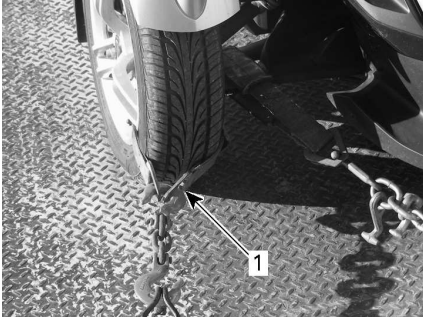

**FRONT WHEELS ATTACHMENT — TYPICAL METHOD 1**

1. Strap around the rim of each front wheel and attached to the front of trailer

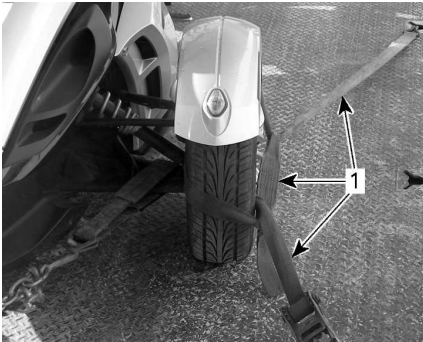

**FRONT WHEELS ATTACHMENT — TYPICAL METHOD 2**

1. Strap around each wheel and fixed to the front and rear of trailer

10. Pass a tie-down strap inside the rear wheel rim only. Do not pass the tie-down strap inside the rear sprocket.

**NOTICE**

Passing the tie-down strap inside the rear sprocket may seriously damage the drive system.

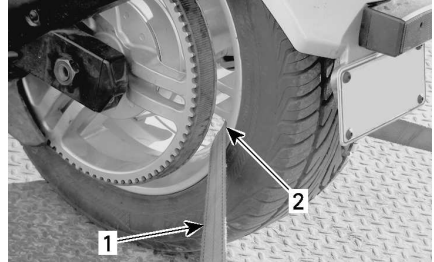

**REAR WHEEL ATTACHMENT - TYPICAL**

1. Tie-down strap
2. Inside rear wheel rim ONLY

11. Firmly attach the rear wheel tie-down strap to the rear of the trailer with a ratchet.
12. Ensure that both the front and rear wheels are firmly attached to the trailer.



**TYPICAL - VEHICLE FACING TOWARDS FRONT OF TOWING**

1. Front and rear wheel firmly attached to trailer

# TECHNICAL INFORMATION

# VEHICLE IDENTIFICATION

The main components of your vehicle (engine and frame) are identified by different serial numbers. It may sometimes become necessary to locate these numbers for warranty purposes or to trace your vehicle in the event of loss. These numbers are required by the authorized Can-Am On-Road dealer to complete warranty claims properly. We strongly recommend that you take note of all the serial numbers on your vehicle and supply them to your insurance company.

## Vehicle Identification Number

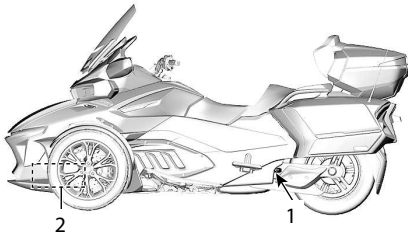

### LOCATION OF VIN

1. Swing arm (VIN label)
2. Lower frame (VIN stamped on the right side)

## Australia

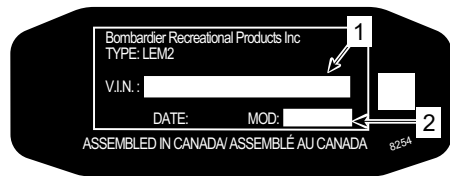

1. VIN (Vehicle Identification Number)
2. Model number

## Canada and USA



1. VIN (Vehicle Identification Number)
2. Model number

## Japan

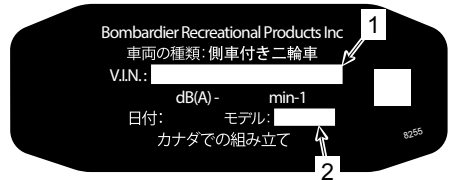

1. VIN (Vehicle Identification Number)
2. Model number

## All Other Countries

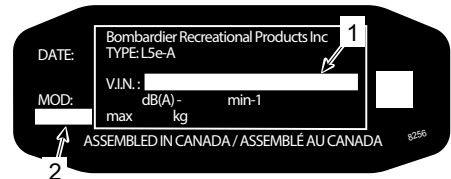

1. VIN (Vehicle Identification Number)
2. Model number

## Engine Identification Number

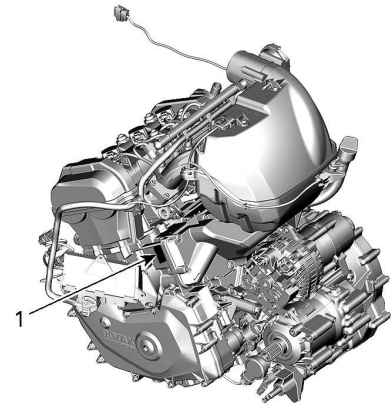

### TYPICAL

1. EIN (Engine Identification Number) location

# VEHICLE COMPLIANCE LABELS

## Safety Compliance Hang Tag California Proposition 65 Warning

**⚠ WARNING.** Operating, servicing and maintaining a passenger Vehicle can expose you to chemicals including engine exhaust, carbon monoxide, phthalates, and lead, which are known to the State of California to cause cancer and birth defects or other reproductive harm.

To minimize exposure, avoid breathing exhaust, do not idle the engine except as necessary, service your vehicle in a well-ventilated area and wear gloves or wash your hands frequently when servicing your vehicle.

For more information go to [www.P65Warnings.ca.gov/products/passenger-vehicle](http://www.P65Warnings.ca.gov/products/passenger-vehicle)



704906973

## EPA Compliance Label North American Models

This label is located on the central frame member, under the driver's seat.

**VEHICLE EMISSION CONTROL INFORMATION**

BOMBARDIER RECREATIONAL PRODUCTS INC.  
THIS VEHICLE CONFORMS TO U.S. EPA AND CALIFORNIA REGULATIONS APPLICABLE TO MODEL YEAR NEW MOTORCYCLES AND IS CERTIFIED TO AN HC+NOx EMISSION STANDARD OF GRAM/KILOMETER. See operator's guide for maintenance specifications.

**RENSEIGNEMENT SUR LE DISPOSITIF ANTIPOLLUTION**

BOMBARDIER PRODUITS RÉCRÉATIFS INC.  
CE VÉHICULE EST CONFORME AUX RÈGLEMENTS DE L'EPA DES É.U. ET DE LA CALIFORNIE APPLICABLES AUX MOTOCYCLETTES NEUVES DE L'ANNÉE MODELE ET EST CERTIFIÉ À LA NORME D'ÉMISSIONS HC+NOx de GRAMME/KILOMÈTRE. Voir guide du conducteur pour les spécifications de maintenance.

Engine Displacement		Cylindrée
Engine Family		Famille de moteur
Permeation Family		Famille de perméation
Evaporation Family		Famille d'évaporation
Exhaust Emission Control System		Système de contrôle des émissions
Idle Speed		Ralenti moteur
Fuel		Essence

704907628

**VACUUM HOSE ROUTING**

ENGINE FAMILY:	EVAPORATION FAMILY:

**MOTORCYCLE NOISE EMISSION CONTROL INFORMATION**

THIS \_\_\_\_\_ MOTORCYCLE, \_\_\_\_\_, MEETS U.S. EPA NOISE EMISSION REQUIREMENTS OF \_\_\_\_\_ dBA AT \_\_\_\_\_ RPM BY THE FEDERAL TEST PROCEDURE. MODIFICATIONS WHICH CAUSE THIS MOTORCYCLE TO EXCEED FEDERAL NOISE STANDARDS ARE PROHIBITED BY FEDERAL LAW. SEE OPERATOR'S GUIDE.

**TYPICAL - NORTH AMERICAN MODELS - LOCATED UNDER THE SEAT**

**European Compliance Label**  
This label is located under the driver's seat.

**E13**



9561

## Deployment of Alternative Fuel Infrastructure Compliance Label Models Outside North America



**LOCATED NEAR GAS CAP**



---

# **NOISE EMISSION CONTROL SYSTEM REGULATION**

## **Tampering with Noise Control System Is Prohibited!**

U.S. Federal law and Canadian provincial laws may prohibit the following acts or the causing there of:

1. The removal or rendering inoperative by any person other than for purposes of maintenance, repair or replacement of any device or element of design incorporated into any new vehicle for the purpose of noise control prior to its sale or delivery to the ultimate purchaser or while it is in use or
2. The use of the vehicle after such device or element of design has been removed or rendered inoperative by any person.

## **Among those Acts Presumed to Constitute Tampering Are the Acts Listed Below:**

1. Removal or alteration or the puncturing of the muffler or any engine component which conducts removal of engine exhaust gases.
2. Removal or alteration or the puncturing of any part of the intake system.
3. Replacing any moving parts of the vehicle or parts of the exhaust or intake system, with non-compliant part.
4. Lack of proper maintenance.

---

# **RADIO FREQUENCY DIGITALLY ENCODED SECURITY SYSTEM (RF D.E.S.S. KEY)**

This device complies with FCC Part 15 and Industry Canada license exempt RSS standard(s). Operation is subject to the following two conditions: (1) this device may not cause interference, and (2) this device must accept any interference, including interference that may cause undesired operation of the device.

Le présent appareil est conforme aux CNR d'Industrie Canada applicables aux appareils radio exempts de licence. L'exploitation est autorisée aux deux conditions suivantes: (1) l'appareil ne doit pas produire de brouillage, et (2) l'utilisateur de l'appareil doit accepter tout brouillage radioélectrique subi, même si le brouillage est susceptible d'en compromettre le fonctionnement.

Changes or modifications not expressly approved by the party responsible for compliance could void the user's authority to operate the equipment.

IC: 11538A-246416

FCC ID: 2ABBF-246416

---

# MULTIFUNCTION GAUGE REGULATORY INFORMATION

## Technical Information

Digital Audio Broadcasting:

- Operating frequency range: 174 – 240 MHz

Transmitter:

- BT operating frequency range: 2402 – 2480 MHz
- BT version: 5.0
- BT max transmit power: +8 dBm

Receiver:

- FM operating range: 88 - 108 MHz

## Manufacturer and Address

Manufacturer:

- Enovation Controls LLC

Address:

- 5311 S 122nd E. Ave. Tulsa, OK 74146, USA

To display the regulatory information on the vehicle digital display, go to **Preferences, General** then **About**.

## USA and Canada

This device complies with FCC Part 15 and Industry Canada license exempt RSS standard(s). Operation is subject to the following two conditions:

1. this device may not cause interference, and
2. this device must accept any interference, including interference that may cause undesired operation of the device.

L'émetteur/récepteur exempt de licence contenu dans le présent appareil est conforme aux CNR d'Innovation, Sciences et Développement économique Canada applicables aux appareils radio exempts de licence.

1. l'appareil ne doit pas produire de brouillage, et

2. l'appareil doit accepter tout brouillage radioélectrique subi, même si le brouillage est susceptible d'en compromettre le fonctionnement.

Changes or modifications not expressly approved by the party responsible for compliance could void the user's authority to operate the equipment.

IC: 28102-ECB01

FCC ID: 2A3FV-ECB01

RF exposure:

1. The equipment complies with FCC RF exposure limits set forth for an uncontrolled environment.
2. This equipment must be installed and operated with a separation distance of at least 20 cm from all persons.
3. The antenna(s) used for this transmitter must not be co-located or operating in conjunction with any other antenna or transmitter.

## Mexico

IFETEL

Marca: Enovation Controls LLC

Número: RCPENOD22-2195

Modelo: OD1025-01

NOM-208-SCFI-2016 (Disposición Técnica IFT-008-2015)

La operación de este equipo está sujeta a las siguientes dos condiciones:

1. es posible que este equipo o dispositivo no cause interferencia perjudicial y
2. este equipo o dispositivo debe aceptar cualquier interferencia, incluyendo la que pueda causar su operación no deseada.

## Brazil



Este equipamento não tem direito à proteção contra interferência prejudicial e não pode causar interferência em sistemas devidamente autorizados. Para maiores informações, consulte o site da ANATEL.

### ***Japan***

This device is granted pursuant to the Japanese Radio Law (電波法) and the

Japanese Telecommunications Business Law (電気通信事業法). This device should not be modified (otherwise the granted designation number will become invalid).

### ***Europe***

#### **Declaration of Conformity**

Simplified EU Declaration of Conformity according Radio Equipment Directive 2014/53/EU



DE

Hiermit erklärt Enovation Controls LLC, dass der Funkanlagentyp OD1025-01 der Richtlinie 2014/53/EU entspricht. Der vollständige Text der EU-Konformitätserklärung ist unter der folgenden Internetadresse verfügbar: <https://www.brp.com/en/sustainability/product-responsibility.html>

FR

Le soussigné, Enovation Controls LLC, déclare que l'équipement radioélectrique du type OD1025-01 est conforme à la directive 2014/53/UE. Le texte complet de la déclaration UE de conformité est disponible à l'adresse internet suivante: <https://www.brp.com/en/sustainability/product-responsibility.html>

BG

С настоящото Enovation Controls LLC декларира, че този тип радиосъоръжение OD1025-01 е в съответствие с Директива 2014/53/ЕС.

Цялостният текст на ЕС декларацията за съответствие може да се намери на следния интернет адрес: <https://www.brp.com/en/sustainability/product-responsibility.html>

EL

Με την παρούσα ο/η Enovation Controls LLC, δηλώνει ότι ο ραδιοεξοπλισμός OD1025-01 πληροί την οδηγία 2014/53/ΕΕ. Το πλήρες κείμενο της δήλωσης συμμόρφωσης ΕΕ διατίθεται στην ακόλουθη ιστοσελίδα στο διαδίκτυο:

<https://www.brp.com/en/sustainability/product-responsibility.html>

CS

Tímto Enovation Controls LLC prohlašuje, že typ rádiového zařízení OD1025-01 je v souladu se směrnicí 2014/53/EU. Úplné znění EU prohlášení o shodě je k dispozici na této internetové adrese:

<https://www.brp.com/en/sustainability/product-responsibility.html>

DA

Hermed erklærer Enovation Controls LLC, at radioudstyrstypen OD1025-01 er i overensstemmelse med direktiv 2014/53/EU.

EU-overensstemmelseserklæringens fulde tekst kan findes på følgende internetadresse:

<https://www.brp.com/en/sustainability/product-responsibility.html>

ET

Käesolevaga deklareerib Enovation Controls LLC, et käesolev raadioseadme tüüp OD1025-01 vastab direktiivi 2014/53/EL nõuetele.

ELi vastavusdeklaratsiooni täielik tekst on kättesaadav järgmisel internetiaadressil:

<https://www.brp.com/en/sustainability/product-responsibility.html>

ES

Por la presente, Enovation Controls LLC declara que el tipo de equipo radioeléctrico OD1025-01 es conforme con la Directiva 2014/53/UE.

El texto completo de la declaración UE de conformidad está disponible en la dirección Internet siguiente:

<https://www.brp.com/en/sustainability/product-responsibility.html>

FI

Enovation Controls LLC vakuuttaa, että radiolaitetyypin OD1025-01 on direktiivin 2014/53/EU mukainen.

EU-vaatimustenmukaisuusvakuutuksen täysimittainen teksti on saatavilla seuraavassa internetosoitteessa:

<https://www.brp.com/en/sustainability/product-responsibility.html>

EN

Hereby, Enovation Controls LLC declares that the radio equipment type OD1025-01 is in compliance with Directive 2014/53/EU. The full text of the EU declaration of conformity is available at the following internet address:

<https://www.brp.com/en/sustainability/product-responsibility.html>

HR

Enovation Controls LLC ovime izjavljuje da je radijska oprema tipa OD1025-01 u skladu s Direktivom 2014/53/EU.

Cjeloviti tekst EU izjave o sukladnosti dostupan je na sljedećoj internetskoj adresi:

<https://www.brp.com/en/sustainability/product-responsibility.html>

HU

Enovation Controls LLC igazolja, hogy a OD1025-01 típusú rádióberendezés megfelel a 2014/53/EU irányelvnek.

Az EU-megfelelőségi nyilatkozat teljes szövege elérhető a következő internetes címen:

<https://www.brp.com/en/sustainability/product-responsibility.html>

IT

Il fabbricante, Enovation Controls LLC, dichiara che il tipo di apparecchiatura radio OD1025-01 è conforme alla direttiva 2014/53/UE.

Il testo completo della dichiarazione di conformità UE è disponibile al seguente indirizzo Internet:

<https://www.brp.com/en/sustainability/product-responsibility.html>

LT

Aš, Enovation Controls LLC, patvirtinu, kad radijo įrenginių tipas OD1025-01 atitinka Direktyvą 2014/53/ES.

Visas ES atitikties deklaracijos tekstas prieinamas šiuo interneto adresu:

<https://www.brp.com/en/sustainability/product-responsibility.html>

LV

Ar šo Enovation Controls LLC deklarē, ka radioiekārta OD1025-01 atbilst Direktīvai 2014/53/ES.

Pilns ES atbilstības deklarācijas teksts ir pieejams šādā interneta vietnē:

<https://www.brp.com/en/sustainability/product-responsibility.html>

MT

B'dan, Enovation Controls LLC, niddikjara li dan it-tip ta' taghmir tar-radju OD1025-01 huwa konformi mad-Direttiva

2014/53/UE. It-test kollu tad-dikjarazzjoni ta' konformità ta-UE huwa disponibbli f'dan l-indirizz ta-Internet li ġej:

<https://www.brp.com/en/sustainability/product-responsibility.html>

NL

Hierbij verklaar ik, Enovation Controls LLC, dat het type radioapparatuur OD1025-01 conform is met Richtlijn 2014/53/EU.

De volledige tekst van de EU-conformiteitsverklaring kan worden geraadpleegd op het volgende internetadres:

<https://www.brp.com/en/sustainability/product-responsibility.html>

PL

Enovation Controls LLC niniejszym oświadcza, że typ urządzenia radiowego OD1025-01 jest zgodny z dyrektywą

2014/53/UE. Pełny tekst deklaracji zgodności UE jest dostępny pod następującym adresem internetowym:

<https://www.brp.com/en/sustainability/product-responsibility.html>

PT

O(a) abaixo assinado(a) Enovation Controls LLC declara que o presente tipo de equipamento de rádio OD1025-01 está em conformidade com a Diretiva 2014/53/UE.

O texto integral da declaração de conformidade está disponível no seguinte endereço de Internet:

<https://www.brp.com/en/sustainability/product-responsibility.html>

RO

Prin prezenta, Enovation Controls LLC declară că tipul de echipamente radio OD1025-01 este în conformitate cu

Directiva 2014/53/UE. Textul integral al declarației UE de conformitate este disponibil la următoarea adresă internet:

<https://www.brp.com/en/sustainability/product-responsibility.html>

SV

Härmed försäkrar Enovation Controls LLC att denna typ av radioutrustning OD1025-01 överensstämmer med direktiv

2014/53/EU. Den fullständiga texten till EU-försäkran om överensstämmelse finns på följande webbadress:

<https://www.brp.com/en/sustainability/product-responsibility.html>

SL

Enovation Controls LLC potrjuje, da je tip radijske opreme OD1025-01 skladen z Direktivo 2014/53/EU.

Celotno besedilo izjave EU o skladnosti je na voljo na naslednjem spletnem naslovu:

<https://www.brp.com/en/sustainability/product-responsibility.html>

SK

Enovation Controls LLC týmto vyhlasuje, že rádiové zariadenie typu OD1025-01 je v súlade so smernicou 2014/53/EÚ.

Úplné EÚ vyhlásenie o zhode je k dispozícii na tejto internetovej adrese:

<https://www.brp.com/en/sustainability/product-responsibility.html>

IS

Enovation Controls LLC lýsir því hér með yfir að þráðlausir fjarskiptabúnaðurinn OD1025-01 er í samræmi við tilskipun

2014/53/ESB. Östyttan texta ESB-samræmisyfirlýsingarinnar er að finna á veffanginu:

<https://www.brp.com/en/sustainability/product-responsibility.html>

Liechtenstein

Hiermit erklärt Enovation Controls LLC, dass der Funkanlagentyp OD1025-01 der Richtlinie 2014/53/EU entspricht.

Der vollständige Text der EU-Konformitätserklärung ist unter der folgenden Internetadresse verfügbar:

<https://www.brp.com/en/sustainability/product-responsibility.html>

NO

Hermed erklærer Enovation Controls LLC at radioustyrstypen OD1025-01 er i samsvar med direktiv 2014/53/EU.

Hele teksten i EU-samsvarserklæringen finnes på følgende internetadresse:

<https://www.brp.com/en/sustainability/product-responsibility.html>

RU

Компания Enovation Controls LLC настоящим заявляет, что радиотехническое оборудование

категории OD1025-01 отвечает требованиям Директивы 2014/53/ЕУ.

Полный текст декларации соответствия ЕС доступен на сайте

<https://www.brp.com/en/sustainability/product-responsibility.html>

# **TECHNICAL SPECIFICATIONS**

# TECHNICAL SPECIFICATIONS

Because of our ongoing commitment to product quality and innovation, BRP reserves the right, at any time, to make changes in design and specifications and/or to make additions to, or improvements in its products without imposing any obligation upon itself to install them on its previously manufactured products.

ENGINE			
Engine type		ROTAX® 1330 ACE, 4-stroke, Dual Over Head Camshaft (DOHC), liquid cooled	
Number of cylinders		3	
Number of valves		12	
Bore		84 mm (3.31 in)	
Stroke		80 mm (3.14 in)	
Displacement		1 330 cm <sup>3</sup> (81.16 in <sup>3</sup> )	
Compression ratio		12:1	
Lubrication	Type		Dry sump with separate oil tank and oil cooler
	Engine oil filter		BRP Rotax microglass fibre type, replaceable
	Transmission/HCM oil filter		BRP Rotax multi-layer surface filter, replaceable
	Engine oil capacity	Oil change with new engine filter	4.7 l (5 qt (liq.,US))
		Oil change with new engine and HCM filters	4.9 l (5.2 qt (liq.,US))
Recommended engine oil		See <i>Recommended Engine Oil</i> in the <i>Maintenance Procedures</i> section of this guide	
Clutch	Type		Hydraulic clutch + wet multi-plate clutch automatically controlled by TCM
	Engagement		1100 RPM
Exhaust system		3 into 1 manifold, primary muffler with catalytic converter, with secondary muffler	
Air filter		Paper element	



<b>GEARBOX</b>	
Type	Sequential Electronic 6-speed (SE6) with remote electronic reverse interlock

<b>COOLING SYSTEM</b>		
Type	Liquid cooled, double radiator with cooling fans	
Coolant	Type	See <i>Recommended Engine Coolant</i> in the <i>Maintenance Procedures</i> section of this guide
	Capacity	4.2 l (1.1 gal (liq.,US))

<b>ELECTRICAL SYSTEM</b>		
Ignition system type	Electronic ignition with dual output coil	
Ignition timing	Not adjustable	
Spark plug	Quantity	3
	Make and type	NGK MR7BI-8 (iridium) or equivalent
	Gap	0.7 - 0.8 mm (.028 - .031 in)
Engine RPM limiter setting	Forward	8100 RPM with engaged drivetrain
		7500 RPM with open clutch or on neutral
Battery	Type	Maintenance free
	Voltage	12 volts
	Nominal rating	21 A•h
	Recommended charging rate	2 A
Headlight Hi/Low		LED
Taillight/brake light		LED
Turn signal lights		LED
Position lights		LED
License plate light		5 W

<b>ELECTRICAL SYSTEM</b>	
Backup light	2 x 21 W
Fuses	Refer to <i>Fuses</i> in <i>How to Replace Fuses and Lights</i>

<b>FUEL SYSTEM</b>		
Fuel delivery	Type	Multi-point Electronic Fuel Injection (EFI) with ETC (Electronic Throttle Control) Single throttle body (54 mm) with an actuator
Fuel pump	Type	Electrical module in fuel tank
Idle speed		900 RPM Electronically controlled, not adjustable
Fuel	Type	Premium unleaded gasoline
	Minimum octane	87 Pump Posted AKI (RON+MON)/2
		92 RON
	Recommended octane	91 Pump Posted AKI (RON+MON)/2
95 RON		
Fuel tank capacity		26.5 l (7 gal (liq.,US))

<b>DRIVE SYSTEM</b>	
Final drive type	Carbon reinforced drive belt
Final drive ratio	79/28

<b>STEERING</b>	
Type	Dynamic Power Steering (DPS)

<b>FRONT SUSPENSION</b>		
Suspension type		Double suspension arms with stabilizer bar
Suspension travel		174 mm (6.9 in)
Shock absorber	Qty	2

FRONT SUSPENSION		
	Type	Oil damper
Spring preload adjustment		Not adjustable

REAR SUSPENSION		
Suspension type	Base models	Swing arm with mono shock with a manually adjustable pneumatic preload
	Limited models	Swing arm with mono shock. Air Controlled Suspension (ACS). Compressor-controlled
Suspension travel		152 mm (6 in)
Shock absorber	Qty	1
	Type	Oil damper
Preload adjustment (base models)		Adjustable air pressure: 135 to 625 kPa (20 to 91 lbf/in <sup>2</sup> )
Preload adjustment (ACS with automatic adjustment)		Air controlled suspension with automatic self leveling adjustment Swing arm with monoshock

BRAKES		
Type		Foot actuated, fully integrated hydraulic 3 wheel braking system with ABS and EBD
Front brake		Dual discs of 270 mm (11 in), radially mounted Brembo monobloc with 4 piston calipers, 2-pad
Rear brake		Single disc of 270 mm (11 in) with 1 piston floating caliper with integrated parking brake
Brake fluid	Capacity	480 ml (16.2 fl oz (US))
	Type	DOT 4
Parking brake		Mechanical, electrically actuated to the rear caliper

BRAKES	
Minimum brake pad thickness	1 mm (.04 in)
Minimum brake disc thickness	6.4 mm (.252 in)
Maximum brake disc warpage	0.100 mm (.004 in)

TIRES		
Type (use only radial tires recommended by BRP)	Front	Kenda KR31 165/55R15 M/C 55H
	Rear	Kenda KR21A 225/50R15 M/C 76H
Pressure	Always refer to the <i>Tire Pressure and Maximum Load</i> label. <b>NOTE:</b> The pressure difference between the front tires should not exceed 3.4 kPa (.5 lbf/in <sup>2</sup> )	
Minimum tire tread depth	Front	2.5 mm (3/32 in)
	Rear	4.0 mm (5/32 in)

WHEELS		
Size (diameter X width)	Front	381 x 127 mm (15 x 5 in)
	Rear	381 x 178 mm (15 x 7 in)
Front wheel nuts torque	109 ± 4 Nm (80 ± 3 lbf-ft)	
Rear drive axle nut torque	225 ± 15 Nm (166 ± 11 lbf-ft)	

DIMENSIONS		
Overall length	Base	2 777 mm (109.3 in)
	Limited	2 833 mm (111.5 in)
Overall width	1 554 mm (61.2 in)	
Overall height	1 464 mm (57.6 in)	
Seat height (top)	755 mm (29.7 in)	
Wheel base	1 714 mm (67.5 in)	

<b>DIMENSIONS</b>	
Front wheel track	1 384 mm (54.5 in)
Ground clearance, front and under engine	115 mm (4.5 in)

<b>WEIGHT AND LOADING CAPACITY</b>		
Dry weight	Base	449 kg (987 lb)
	Limited	464 kg (1 021 lb)
Maximum load	Front storage compartment	16 kg (35 lb)
	Glove box	2 kg (4 lb)
	Saddlebags	6.8 kg (15 lb)
	Top storage compartment	9 kg (20 lb)
Total vehicle load allowed (including operator, all other loads and added accessories)		224 kg (494 lb)
Gross vehicle weight rating (GVWR)		750 kg (1,653 lb)
Maximum weight on trailer tongue		18 kg (40 lb)
Maximum towed weight (trailer and cargo)		182 kg (400 lb)

This page is intentionally blank

# WARRANTY

---

# **BRP LIMITED WARRANTY – CANADA AND USA: 2024 CAN-AM® SPYDER® VEHICLE SERIES**

## **1) Scope of the Limited Warranty**

Bombardier Recreational Products Inc. ("BRP") warrants its 2024 Can-am Spyder ("Product(s)") sold by authorized BRP Dealers (as hereinafter defined) in the United States of America ("USA") and in Canada from defects in material or workmanship for the period and under the conditions described below.

This limited warranty will become null and void if:

1. the Product was used for racing or any other competitive activity, at any point, even by a previous owner; or
2. the Product has been altered or modified in such a way so as to adversely affect its operation, performance or durability, or has been altered or modified to change its intended use; or
3. the odometer was removed or has been tampered with; or
4. the Product was used off-road.

Non-factory installed parts and accessories are not covered under this limited warranty. Please refer to the applicable parts and accessories limited warranty text.

## **2) Limitations of Liability**

**TO THE EXTEND PERMITTED BY LAW, THIS WARRANTY IS EXPRESSLY GIVEN AND ACCEPTED IN LIEU OF ANY AND ALL OTHER WARRANTIES, EXPRESSED OR IMPLIED, INCLUDING WITHOUT LIMITATION ANY WARRANTY OF MERCHANTABILITY OR FITNESS FOR A PARTICULAR PURPOSE. TO THE EXTENT THAT THEY CANNOT BE DISCLAIMED, THE IMPLIED WARRANTIES ARE LIMITED IN DURATION TO THE LIFE OF THE EXPRESS WARRANTY. INCIDENTAL AND CONSEQUENTIAL DAMAGES ARE EXCLUDED FROM COVERAGE UNDER THIS WARRANTY. SOME STATES/PROVINCES DO NOT ALLOW FOR THE DISCLAIMERS, LIMITATIONS AND EXCLUSIONS IDENTIFIED ABOVE. AS A RESULT, THEY MAY NOT APPLY TO YOU. THIS WARRANTY GIVES YOU SPECIFIC RIGHTS, AND YOU MAY ALSO HAVE OTHER LEGAL RIGHTS WHICH MAY VARY FROM STATE TO STATE, OR PROVINCE TO PROVINCE.**

Neither the distributor, any BRP dealer nor any other person has been authorized to make any affirmation, representation or warranty regarding the product, other than those contained in this limited warranty, and if made, shall not be enforceable against BRP.

BRP reserves the right to modify this limited warranty at any time, being understood that such modification will not alter the warranty conditions applicable to the Products sold while this warranty is in effect.

## **3) EXCLUSIONS—Are Not Warranted**

The following are not warranted under any circumstances:

- Normal wear and tear;
- Routine maintenance items, tune ups, adjustments;
- Damage caused by negligence or failure to provide proper maintenance and/or storage, as described in the Operator's Guide;



- Damage resulting from removal of parts, improper repairs, service, maintenance, modifications or use of parts not manufactured or approved by BRP or resulting from repairs done by a person that is not an authorized servicing BRP dealer;
- Damage caused by abuse, abnormal use, neglect or operation of the product in a manner inconsistent with the recommended operation described in the Product's Operator's Guide;
- Damage resulting from accident, submersion, fire, theft, vandalism or any act of God;
- Operation with fuels, oils or lubricants which are not suitable for use with the Product (see the Operator's Guide);
- Damages from rust, corrosion or exposure to the elements;
- Damage resulting from water or snow ingestion;
- Incidental or consequential damages, or damages of any kind including without limitation transportation expenses, towing, storage, telephone, rental, taxi, inconvenience, insurance coverage, loan payments, loss of time, loss of income or time missed for downtime experience due to service work.
- Damage resulting from corrosion from road salts, battery acid, environmental influences or treatment contrary to the Operator's Guide
- Damages related to the appearance of the Product, including without limitation scratches, dents, fading, flaking, peeling and damages to seat cover material.
- Damage resulting from the installation of parts with specifications that differ from the original Product parts, such as, without limitation, different tires, exhaust system, wheels or brakes

#### 4) Warranty Coverage Period

This limited warranty will be in effect from (1) the date of delivery to the first retail consumer, or (2) the date the product is first put into use, whichever occurs first and for the applicable period below:

1. **TWENTY-FOUR (24) consecutive months**, for private use owners, except for the items covered in points (3) to (6) below.
2. **TWELVE (12) consecutive months**, for commercial use owners, except for the items covered in points (3) to (6) below.  
A Product is used commercially when it is used in connection with any work or employment that generates income during any part of the warranty period. A Product is also used commercially when, at any point during the warranty period, it is licensed for commercial use.
3. For the battery, **SIX (6) CONSECUTIVE MONTHS**.
4. For the tires, **SIX (6) CONSECUTIVE MONTHS** or until tires are worn to the last three thirty-seconds of an inch (3/32 ") (2.38 millimeters) for the front tires and the last five thirty-seconds of an inch (5/32 ") (3.97 millimeters) for the rear tire, which-ever occurs first
5. **For emission-related components**; please also refer to the *US EPA Emission-Performance Warranty* contained herein.
6. For Products produced for sale in the state of California, that are originally sold to residents or subsequently warranty registered to residents in the state of California, please also refer to the applicable *California Emissions Control Warranty Statement*.

The repair or replacement of parts or the performance of service under this warranty does not extend the life of this limited warranty beyond its original expiration date.

## 5) Conditions to Have Warranty Coverage

This warranty coverage is available **only** if **each** of the following conditions has been fulfilled:

1. The Product must be purchased as new and unused by its first owner from a Dealer authorized to sell the Products in the country in which the sale occurred (“Dealer”);
2. The BRP specified pre-delivery inspection process must be completed, documented and signed by the purchaser;
3. The Product must have undergone proper registration by an authorized Dealer;
4. The Product must be purchased in the country in which the purchaser resides;
5. Routine maintenance outlined in the Operator’s Guide must be timely performed in order to maintain warranty coverage. BRP reserves the right to make warranty coverage contingent upon proof of proper maintenance.

BRP will not honor this limited warranty to any private use owner or commercial use owner if one of the preceding conditions has not been met. Such limitations are necessary in order to allow BRP to preserve both the safety of its products, and also that of its consumers and the general public.

## 6) What to Do to Obtain Warranty Coverage

The customer must cease using the Product upon the appearance of an anomaly, notify a servicing BRP dealer within three (3) days of the appearance of the anomaly and provide the Dealer with reasonable access to the Product and reasonable opportunity to repair it.

The customer must also present to the Dealer, proof of purchase of the Product and must sign the repair/work order prior to starting the repair in order to validate the warranty repair.

All parts replaced under this limited warranty become the property of BRP.

## 7) What BRP Will Do

BRP’s obligations under this warranty are limited to, at its sole discretion, repairing or replacing parts found defective under normal use, maintenance and service without charge for parts and labor, at any authorized BRP dealer during the warranty coverage period under the conditions described herein. No claim of breach of warranty shall be cause for cancellation or rescission of the sale of the Product to the owner.

In the event that service is required outside of the country of original sale, the owner will bear responsibility for any additional charges due to local practices and conditions, such as, but not limited to, freight, insurance, taxes, license fees, import duties, and any and all other financial charges, including those levied by governments, states, territories and their respective agencies.

BRP reserves the right to improve or modify products from time to time without assuming any obligation to modify products previously manufactured.

## 8) Transfer

If the ownership of a Product is transferred during the warranty coverage period, this limited warranty, subject to its terms and conditions, shall also be transferred and be valid for the remaining coverage period provided BRP or an authorized Product Distributor/Dealer receives a proof that the former owner agreed to the transfer of ownership, in addition to the coordinates of the new owner.

## 9) Consumer Assistance

In the event of a controversy or a dispute in connection with this limited warranty, BRP suggests that you try to resolve the issue at the dealership level. We recommend discussing the issue with the authorized dealer's service manager or owner.

If the matter still remains unresolved, contact BRP by filling out the customer contact form at [www.brp.com](http://www.brp.com) or contact BRP by mail at one of the addresses listed under the *Contact Us* section of this guide.

---

# US EPA EMISSIONS PERFORMANCE WARRANTY

Bombardier Recreational Products Inc. (“BRP”) warrants that if:

1. The Product is maintained and operated in accordance with the written instructions for proper maintenance and use, and
2. The Product fails to conform at any time during its useful life to the applicable emission standards or family emission limits as determined by an EPA-approved emission test, and
3. Such nonconformity results or will result in the Product owner having to bear any penalty or other sanction (including the denial of the right to use the Product) under local, State or Federal law, then BRP shall remedy the nonconformity at no cost to the owner; except that, if the Product has been in operation for more than 5 years or 30,000 kilometers (18,641 miles). BRP shall be required to remedy only those non-conformities resulting from the failure of components which have been installed in or on the Product for the sole or primary purpose of reducing Product emissions and that were not in general use prior to model year 1968.

The warranty period begins on the date the Product is delivered to its ultimate purchase, or if the Product is first placed in service as a “demonstrator” or “company” motorcycle prior to delivery, on the date it is first placed in service.

Items which are covered by the Emissions Performance Warranty for the full useful life of the Product:

## **Fuel System and Air Admission Systems**

- Fuel Injectors, Fuel Pump Module, Fuel Filter Ass’y, Throttle Body (Including Throttle Position Sensor), Air Intake Manifold

## **Ignition Components and Sensors**

- Engine Control Module (ECM), Engine Wiring Harness, Ignition Coils, Spark Plugs (covered only up to the first maintenance replacement), Noise Sensor (Knock Sensor), Camshaft Position Sensor, Crankshaft Position Sensor, Temperature Sensor (Coolant), Pressure And Temperature Sensor, Oxygen Sensors

## **Exhaust System**

- Primary Muffler (Containing Catalytic Converter), Exhaust Manifolds
- Clamps, Gaskets and Seals (from Engine up to Primary Muffler)

## **Crankcase Ventilation System**

- Crankcase Vent Breather, Crankcase Vent Hose, Oil Filler Cap

## **Evaporative Emission Control System**

- Fuel Tank, Fuel Cap, Fuel Hose, Vapor Canister, Vapor Canister Mounting Bracket, Bleed Valve (Purge Valve), Check Valve, Filters, Evaporative Components Mounting Brackets
- Clamp, Seal, Gasket and Fitting (associated with fuel system assembly)

See maintenance information section in this operator’s guide for proper maintenance.

This operator’s guide contains information for proper use of the Product.

Under the Emissions Performance Warranty, BRP shall be liable for the total cost of the remedy for any Product validly presented for repair to any authorized Can-Am On-Road dealer, unless for emergency repairs as required by item 2 of the following list. State or local limitations as to the extent of the penalty or sanction imposed upon an owner of a failed Product shall have no bearing on this liability.

In no case may BRP deny an emission performance warranty claim on the basis of:

1. Warranty work or pre-delivery service performed by any facility authorized by BRP to perform such work or service; or
2. Work performed in an emergency situation to rectify an unsafe condition, including an unsafe driveability condition, attributable to BRP, provided the Product owner has taken steps to put the Product back in a conforming condition in a timely manner; or
3. The use of any uncertified part or non-compliance with any written instruction for proper maintenance and use which is not relevant to the reason that the Product failed to comply with applicable emission standards; or
4. Any cause attributable to BRP; or
5. The use of any fuel which is commonly available in the geographical area in which the Product is located, unless the written instructions for proper maintenance and use specify that the use of that fuel would adversely affect the emission control devices and systems of the Product, and there is commonly available information for the owner to identify the proper fuel to be used. See maintenance information section and fuel requirements of fueling section.

Except as stated in the previous items; BRP may deny an emission performance warranty claim on the basis of an uncertified aftermarket part used in the maintenance or repair of a Product if the use of the uncertified part caused the Product's failure to meet emission standards. The use of parts not equivalent to the original parts or uncertified aftermarket parts may have a negative impact on the effectiveness of the emission control system and results in the Product's failure to meet emission standards. The use of certified parts does not affect the emission performance warranty. **Maintenance, replacement, or repair of the emission control devices and systems may be performed by any motorcycle repair establishment or individual using any certified part.**

As soon as you become aware of a defect; you are responsible for presenting your Product to an authorized Can-Am On-Road dealer. Authorized Can-Am On-Road dealer will proceed with the warranty claim.

In the case an authorized Can-Am On-Road dealer is unable (for reasons not attributable to the Product owner or events beyond the control of BRP or an authorized Can-Am On-Road dealer) to repair a Product within 30 days after the initial presentation of the Product to an authorized Can-Am On-Road dealer, then the owner shall be entitled to have the warranty remedy performed, at the expense of BRP, by any repair facility of the owner's choosing.

All defective parts replaced under this warranty become the property of BRP.

Contact the Director, Field Operations and Support Division (6406J), Environmental Protection Agency, 401 "M" Street, SW., Washington, DC 20460 (Attention: Warranty Claim) for further information concerning the Emissions

Performance Warranty or to report a violations of the terms of the Emissions Performance Warranty.

Bombardier Recreational Products Inc. (“BRP”) \* also warrants to the ultimate purchaser and each subsequent purchaser that this new Product, including all parts of its exhaust emission-control system and its evaporative emission-control system, meets two conditions:

- It is designed, built, and equipped so it conforms at the time of sale to the ultimate purchaser with the requirements of 40 CFR 86 and with the evaporative emission standards of 40 CFR 1051, as applicable to onroad motorcycles.
- It is free from defects in materials and workmanship that may keep it from meeting the requirements of 40 CFR 86 and with the evaporative emission standards of 40 CFR 1051, as applicable to onroad motorcycles.

Where a warrantable condition exists, BRP will repair or replace, as it elects, any part or component with a defect in materials or workmanship that would increase the engine’s emissions of any regulated pollutant within the stated warranty period at no cost to the owner, including expenses related to diagnosing and repairing or replacing emission-related parts.

The emission-related warranty is valid for the following period whichever comes first:

	Kilometers/Mile	Years
Exhaust and Evaporative emission-related components	30 000 / 18,641	5

---

# US EPA FEDERAL NOISE EMISSION WARRANTY

Bombardier Recreational Products Inc. ("BRP") warrants to the ultimate purchaser and each subsequent purchaser that this new Product, at time of sale, was designed, built and equipped to meet all applicable US EPA Federal noise control standards and is free from defects in materials and workmanship that may keep it, when properly maintained and used, from meeting the requirements of all applicable US EPA Federal noise standards for the following period whichever comes first:

<b>Kilometers/ Miles</b>	<b>Years</b>
6,000/3,730	1

---

# CALIFORNIA EMISSION CONTROL SYSTEM WARRANTY

## California Emission Control System Warranty Statement Your Warranty Rights and Obligations

The California Air Resources Board and BRP US Inc. ("BRP") are pleased to explain the emission control system warranty on your 2024 Can-Am Spyder. In California, new motor vehicles must be designated, built, and equipped to meet the State's stringent anti-smog standards. BRP must warrant the emission control system on your vehicle for the periods of time listed below provided there has been no abuse, neglect or improper maintenance of your vehicle.

Your emission control system may include parts such as the fuel-injection system, ignition system, catalytic converter, and engine computer. Also included may be hoses, connectors, and other emission-related assemblies. Where a warrantable condition exists, BRP will repair your vehicle at no cost to you including diagnosis, parts, and labor.

### Manufacturer's Warranty Coverage

5 years or 30 000 km (18,641 mi), whichever first occurs.

### Owner's Warranty Responsibilities

- As the vehicle owner, you are responsible for the performance of the required maintenance listed in your owner's manual. BRP recommends that you retain all receipts covering maintenance on your vehicle, but BRP cannot deny warranty solely for the lack of receipts or for your failure to ensure the performance of all scheduled maintenance.
- You are responsible for presenting your vehicle to a BRP dealer as soon as a problem exists. The warranty repairs should be completed in a reasonable amount of time, not to exceed 30 days.
- As the vehicle owner, you should also be aware that BRP may deny you warranty coverage if your vehicle or a part has failed due to abuse, neglect, improper maintenance, or unapproved modifications.

If you have any questions regarding your warranty rights and responsibilities, you should contact:

- BRP's customer assistance center at 1-888-272-9222 or,
- The California Air Resources Board at 4001 Iowa Avenue, Riverside, CA 92507.

## California Emission Control System Defects Warranty General Emissions Defects Warranty Coverage

BRP warrants to the owner that the vehicle:

- is designed, built, and equipped so as to conform, at the time of sale, with all applicable regulations adopted by the Air Resources Board pursuant to its authority in chapters 1 and 2, part 5, division 26 of the Health and Safety Code; and
- is free from defects in materials and workmanship which cause the failure of a warranted part to be identical in all material respects to that part as described in the vehicle manufacturer's application for certification.



This warranty begins on the date the vehicle is delivered to the first purchaser other than an authorized dealer, or the date it is first used as a demonstrator, lease, or company vehicle, whichever comes first and continues for the time or mileage listed below.

The Emissions Control System Defects Warranty is in addition to BRP Limited Warranty.

The warranty on emissions-related parts shall function as follows:

1. Any warranted part which is not scheduled for replacement as required maintenance in the written instructions shall be warranted for the warranty period defined below. If any such part fails during the warranty period, it shall be repaired or replaced by BRP. Any such part repaired or replaced under warranty shall be warranted for the remaining warranty period.
2. Any warranted part which is scheduled only for regular inspection in the written instructions shall be warranted for the warranty period defined below. A statement in such written instructions to the effect of "repair or replace as necessary" shall not reduce the period of warranty coverage. Any such part repaired or replaced under warranty shall be warranted for the remaining warranty period.
3. Any warranted part which is scheduled for replacement as required maintenance in the written instructions shall be warranted for the period of time or mileage, whichever first occurs, prior to the first scheduled replacement point for that part. If the part fails before the first scheduled replacement point, the part shall be repaired or replaced by BRP. Any such part repaired or replaced under warranty shall be warranted for the remainder of the period prior to the first scheduled replacement point for the part.
4. Repair or replacement of any warranted part shall be performed at no charge to the vehicle owner, at a warranty station, except in the case of an emergency when a warranted part or a warranty station is not reasonably available to the vehicle owner. In an emergency, repairs may be performed at any available service establishment, or by the owner, using any replacement part. BRP shall reimburse the owner for his or her expenses including diagnostic charges for such emergency repair or replacement, not to exceed the manufacturer's suggested retail price for all warranted parts replaced and labor charges based on the manufacturer's recommended time allowance for the warranty repair and the geographically appropriate hourly labor rate. A vehicle owner may reasonably be required to keep receipts and failed parts in order to receive compensation for warranted repairs reimbursable due to an emergency, provided the manufacturer's written instructions advise the owner of his obligation.
5. Warranty services or repairs shall be provided at all BRP's dealership which are franchised to service the subject vehicles.
6. The vehicle owner shall not be charged for diagnostic labor which leads to the determination that a warranted part is in fact defective, provided that such diagnostic work is performed at a warranty station.
7. BRP shall be liable for damages to other vehicle components proximately caused by a failure under warranty any warranted part.
8. The lack of availability of such parts or the incompleteness of repairs within a reasonable time period, not to exceed 30 days from the time the vehicle is initially presented to the warranty station for repair, shall constitute an emergency.

9. Any replacement part may be used in the performance of any maintenance or repairs. Any replacement part designated by a manufacturer may be used in warranty repairs provided without charge to the vehicle owner. Such use shall not reduce the warranty obligations of the vehicle or engine manufacturer, except that BRP shall not be liable for repair or replacement of any replacement part which is not a warranted part (except as provided under subsection (7)).
10. Any add-on or modified part exempted by the Air Resources Board from the prohibitions of section 27156 of the California Vehicle Code may be used on a vehicle. Such use, in and of itself, shall not be grounds for disallowing a warranty claim made in accordance with this article. BRP shall not be liable under this article to warrant failures of warranted parts caused by the use of an add-on or modified part.

## **Warranty Period**

5 years or 30 000 km (18 641 mi), whichever first occurs.

## **Exclusions**

The repair or replacement of any warranted part otherwise eligible for warranty coverage, shall be excluded for such warranty coverage if BRP demonstrates that the vehicle has been abused, neglected, or improperly maintained, and that such abuse, neglect, or improper maintenance was the direct cause of the need for the repair or replacement.

Except as provided above, any adjustment of a component which as a factory installed, and properly operating, adjustment limiting device is eligible for warranty coverage.

## **Manufacturer's Warranty Coverage**

5 years or 30 000 km (18,641 mi), whichever first occurs.

## **Parts Covered**

### **Fuel System and Air Admission Systems**

- Fuel Injectors, Fuel Pump Module, Fuel Filter Assembly, Throttle Body (including Throttle Position Sensor), Air Intake Manifold.

### **Ignition Components and Sensors**

- Engine Control Module (ECM), Engine Wiring Harness, Ignition Coils, Spark Plugs (covered only up to the first maintenance replacement), Noise Sensor (Knock Sensor) Camshaft Position Sensor, Temperature Sensor (Coolant) Pressure and Temperature Sensor, Oxygen Sensors.

### **Exhaust System**

- Primary Muffler (Containing Catalytic Converter) Exhaust Manifolds.
- Clamps, Gaskets and Seals (From Engine up to Primary Muffler).

### **Crankcase Ventilation System**

- Crankcase Vent Breather, Crankcase Vent Hose, Oil Filler Cap.

### **Evaporative Emission Control System**

- Fuel Tank, Fuel Cap, Fuel Hose, Vapor Canister, Vapor Canister Mounting Bracket, Bleed Valve (Purge Valve), Check Valve, Filters, Evaporative Components Mounting Brackets.
- Clamp, Seal, Gasket, and Fitting (associated with fuel system assembly).

See maintenance information section in this operator's guide for proper maintenance, This Operator's guide contains information for proper use of the vehicle.

---

# **BRP INTERNATIONAL LIMITED WARRANTY : 2024 CAN-AM® SPYDER® SERIES**

## **1) Scope of the Limited Warranty**

Bombardier Recreational Products Inc. ("BRP") warrants its 2024 Can-am Spyder ("Product(s)") sold by distributors or dealers authorized by BRP to distribute the Products outside of the United States of America ("USA"), Canada, member states of the European Economic Area (which is comprised of the states of the European Union plus the United Kingdom, Norway, Iceland and Liechtenstein) ("EEA"), Turkey, member states of the Commonwealth of the Independent States (including Ukraine and Turkmenistan) ("CIS") from defects in material or workmanship for the period and under the conditions described below.

This limited warranty will become null and void if:

1. the Product was used for racing or any other competitive activity, at any point, even by a previous owner; or
2. the Product has been altered or modified in such a way so as to adversely affect its operation, performance or durability, or has been altered or modified to change its intended use.
3. the odometer was removed or has been tampered with; or
4. the Product was used off-road.

Non-factory installed parts and accessories are not covered under this limited warranty. Please refer to the applicable parts and accessories limited warranty text.

## **2) Limitation of Liability**

**TO THE EXTEND PERMITTED BY LAW, THIS WARRANTY IS EXPRESSLY GIVEN AND ACCEPTED IN LIEU OF ANY AND ALL OTHER WARRANTIES, EXPRESSED OR IMPLIED, INCLUDING WITHOUT LIMITATION ANY WARRANTY OF MERCHANTABILITY OR FITNESS FOR A PARTICULAR PURPOSE. TO THE EXTENT THAT THEY CANNOT BE DISCLAIMED, THE IMPLIED WARRANTIES ARE LIMITED IN DURATION TO THE LIFE OF THE EXPRESS WARRANTY. INCIDENTAL AND CONSEQUENTIAL DAMAGES ARE EXCLUDED FROM COVERAGE UNDER THIS WARRANTY. SOME STATES/PROVINCES DO NOT ALLOW FOR THE DISCLAIMERS, LIMITATIONS AND EXCLUSIONS IDENTIFIED ABOVE. AS A RESULT, THEY MAY NOT APPLY TO YOU. THIS WARRANTY GIVES YOU SPECIFIC RIGHTS, AND YOU MAY ALSO HAVE OTHER LEGAL RIGHTS WHICH MAY VARY FROM COUNTRY TO COUNTRY. BRP SHALL NOT BE HELD LIABLE IF PRODUCTS OR WARRANTY PARTS ARE NOT AVAILABLE IN CERTAIN COUNTRIES FOR REASONS OUTSIDE OF BRP'S CONTROL.**

For Products purchased in Australia, refer to the Australia-specific section below.

Neither the distributor, any BRP Distributor/Dealer nor any other person has been authorized to make any affirmation, representation or warranty regarding the product, other than those contained in this limited warranty, and if made, shall not be enforceable against BRP.

BRP reserves the right to modify this limited warranty at any time, being understood that such modification will not alter the warranty conditions applicable to the Products sold while this warranty is in effect.

### 3) EXCLUSIONS – Are Not Warranted

The following are not warranted under any circumstances:

- Normal wear and tear;
- Routine maintenance items, tune ups, adjustments;
- Damage caused by negligence or failure to provide proper maintenance and/or storage, as described in the Operator's Guide;
- Damage resulting from removal of parts, improper repairs, service, maintenance, modifications or use of parts not manufactured or approved by BRP or resulting from repairs done by a person that is not an authorized servicing BRP Distributor/Dealer;
- Damage caused by abuse, abnormal use, neglect or operation of the product in a manner inconsistent with the recommended operation described in the Product's Operator's Guide;
- Damage resulting from accident, submersion, fire, theft, vandalism or any act of God;
- Operation with fuels, oils or lubricants which are not suitable for use with the Product (see the Operator's Guide);
- Damages from rust, corrosion or exposure to the elements;
- Damage resulting from water or snow ingestion;
- Incidental or consequential damages, or damages of any kind including without limitation transportation expenses, towing, storage, telephone, rental, taxi, inconvenience, insurance coverage, loan payments, loss of time, loss of income or time missed for downtime experience due to service work.
- Damage resulting from corrosion from road salts, battery acid, environmental influences or treatment contrary to the Operator's Guide
- Damages related to the appearance of the Product, including without limitation scratches, dents, fading, flaking, peeling and damages to seat cover material.
- Damage resulting from the installation of parts with specifications that differ from the original Product parts, such as, without limitation, different tires, exhaust system, wheels or brakes

### 4) Warranty Coverage Period

This limited warranty will be in effect from (1) the date of delivery to the first retail consumer, or (2) the date the product is first put into use, whichever occurs first and for the applicable period below:

1. **TWENTY-FOUR (24) consecutive months**, for private use owners, except for the items covered in points (3) and (4) below.
2. **TWELVE (12) consecutive months**, for commercial use owners, except for the items covered in points (3) and (4) below.
3. A Product is used commercially when it is used in connection with any work or employment that generates income during any part of the warranty period. A Product is also used commercially when, at any point during the warranty period, it is licensed for commercial use.
4. For the battery, **SIX (6) consecutive months**
5. For the tires, **SIX (6) consecutive months** or until tires are worn to the last three thirty-second of an inch (3/32") (2.38 millimeters) for the front tires and the last five thirty-second of an inch (5/32") (3.97 millimeters) for the rear tire, whichever occurs first.

The repair or replacement of parts or the performance of service under this warranty does not extend the life of this warranty beyond its original expiration date.

The warranty coverage period identified above are a minimal limited warranty period which can be extended by any applicable warranty promotional program, as the case may be.

Note that the duration and any other modalities of the warranty coverage are subject to the applicable national or local legislation in the customer's country.

## **FOR PRODUCTS SOLD IN AUSTRALIA ONLY**

Our goods come with guarantees that cannot be excluded under the Australian Consumer Law.

You are entitled to a replacement or refund for a major failure and for compensation for any other reasonably foreseeable loss or damage.

You are also entitled to have the goods repaired or replaced if the goods fail to be of acceptable quality and the failure does not amount to a major failure.

Nothing in these Warranty terms and conditions should be taken to exclude, restrict or modify the application of any condition, warranty, guarantee, right or remedy conferred or implied under the Competition and Consumer Act 2010 (Cth), including the Australian Consumer Law or any other law, where to do so would contravene that law, or cause any part of these terms and conditions to be void. The benefits given to you under this limited warranty are in addition to other rights and remedies that you have under Australian law.

## **5) Conditions to Have Warranty Coverage**

This warranty coverage is available **only if each** of the following conditions has been fulfilled:

- The Product must be purchased as new and unused by its first owner from a Distributor/Dealer authorized to distribute Products in the country in which the sale occurred (“Distributor/Dealer”);
- The BRP specified pre-delivery inspection process must be completed, documented and signed by the purchaser;
- The Product must have undergone proper registration by an authorized Distributor/Dealer;
- The Product must be purchased in the country in which the purchaser resides;
- Routine maintenance outlined in the Operator’s Guide must be timely performed in order to maintain warranty coverage. BRP reserves the right to make warranty coverage contingent upon proof of proper maintenance.

BRP will not honor this limited warranty to any private use owner or commercial use owner if one of the preceding conditions has not been met. Such limitations are necessary in order to allow BRP to preserve both the safety of its products, and also that of its consumers and the general public.

## **6) What to Do to Obtain Warranty Coverage**

The customer must cease using the Product upon the appearance of an anomaly, notify a servicing BRP Distributor/Dealer within two (2) months of the

appearance of the anomaly and provide the Distributor/Dealer with reasonable access to the Product and reasonable opportunity to repair it.

The notification period is subject to the applicable national or local legislation in customer's country.

The customer must also present to the Distributor/Dealer, proof of purchase of the Product and must sign the repair/work order prior to starting the repair in order to validate the warranty repair.

All parts replaced under this limited warranty become the property of BRP.

## **7) What BRP Will Do**

To the extent permitted by law, BRP's obligations under this warranty are limited to, at its sole discretion, repairing or replacing parts found defective under normal use, maintenance and service without charge for parts and labor, at any authorized BRP Distributor/Dealer during the warranty coverage period under the conditions described herein. No claim of breach of warranty shall be cause for cancellation or rescission of the sale of the Product to the owner. You may have other legal rights which may vary from country to country.

In the event that service is required outside of the country of original sale, the owner will bear responsibility for any additional charges due to local practices and conditions, such as, but not limited to, freight, insurance, taxes, license fees, import duties, and any and all other financial charges, including those levied by governments, states, territories and their respective agencies.

BRP reserves the right to improve or modify products from time to time without assuming any obligation to modify products previously manufactured.

## **8) Transfer**

If the ownership of a Product is transferred during the warranty coverage period, this limited warranty, subject to its terms and conditions, shall also be transferred and be valid for the remaining coverage period provided BRP or an authorized Product Distributor/Dealer receives a proof that the former owner agreed to the transfer of ownership, in addition to the coordinates of the new owner.

## **9) Consumer Assistance**

In the event of a controversy or a dispute in connection with this limited warranty, BRP suggests that you try to resolve the issue at the dealership level. We recommend discussing the issue with the authorized Distributor/Dealer's service manager or owner.

If the matter still remains unresolved, contact BRP by filling out the customer contact form at **www.brp.com** or contact BRP by mail at one of the addresses listed under the *Contact Us* section of this guide.

---

# **BRP LIMITED WARRANTY FOR THE EUROPEAN ECONOMIC AREA, THE COMMONWEALTH OF THE INDEPENDENT STATES AND TURKEY: 2024 CAN-AM® SPYDER® SERIES**

## **1) Scope of the Limited Warranty**

Bombardier Recreational Products Inc. ("BRP") warrants its 2024 Can-am Spyder ("Product(s)") sold by distributors or dealers authorized by BRP to distribute the Products in member states of the European Economic Area (which is comprised of the states of the European Union plus the United Kingdom, Norway, Iceland and Liechtenstein) ("EEA"), Turkey, member states of the Commonwealth of the Independent States (including Ukraine and Turkmenistan) ("CIS") ("Distributor/Dealer") from defects in material or workmanship for the period and under the conditions described below.

This limited warranty will become null and void if:

1. the Product was used for racing or any other competitive activity, at any point, even by a previous owner; or
2. the Product has been altered or modified in such a way so as to adversely affect its operation, performance or durability, or has been altered or modified to change its intended use.
3. the odometer was removed or has been tampered with; or
4. the Product was used off-road.

Non-factory installed parts and accessories are not covered under this limited warranty. Please refer to the applicable parts and accessories limited warranty text.

## **2) Limitations of Liability**

**TO THE EXTENT PERMITTED BY LAW, THIS WARRANTY IS EXPRESSLY GIVEN AND ACCEPTED IN LIEU OF ANY AND ALL OTHER WARRANTIES, EXPRESSED OR IMPLIED, INCLUDING WITHOUT LIMITATION ANY WARRANTY OF MERCHANTABILITY OR FITNESS FOR A PARTICULAR PURPOSE. TO THE EXTENT THAT THEY CANNOT BE DISCLAIMED, THE IMPLIED WARRANTIES ARE LIMITED IN DURATION TO THE LIFE OF THE EXPRESS WARRANTY. INCIDENTAL AND CONSEQUENTIAL DAMAGES ARE EXCLUDED FROM COVERAGE UNDER THIS WARRANTY. SOME STATES/PROVINCES DO NOT ALLOW FOR THE DISCLAIMERS, LIMITATIONS AND EXCLUSIONS IDENTIFIED ABOVE. AS A RESULT, THEY MAY NOT APPLY TO YOU. THIS WARRANTY GIVES YOU SPECIFIC RIGHTS, AND YOU MAY ALSO HAVE OTHER LEGAL RIGHTS WHICH MAY VARY FROM STATE TO STATE, OR PROVINCE TO PROVINCE. BRP SHALL NOT BE HELD LIABLE IF PRODUCTS OR WARRANTY PARTS ARE NOT AVAILABLE IN CERTAIN COUNTRIES FOR REASONS OUTSIDE OF BRP'S CONTROL.**

For Products purchased in France, refer to the France-specific section below.

Neither the distributor, any BRP Distributor/Dealer nor any other person has been authorized to make any affirmation, representation or warranty regarding the product, other than those contained in this limited warranty, and if made, shall not be enforceable against BRP.



BRP reserves the right to modify this limited warranty at any time, being understood that such modification will not alter the warranty conditions applicable to the Products sold while this warranty is in effect.

### 3) EXCLUSIONS – Are Not Warranted

The following are not warranted under any circumstances:

- Normal wear and tear;
- Routine maintenance items, tune ups, adjustments;
- Damage caused by negligence or failure to provide proper maintenance and/or storage, as described in the Operator's Guide;
- Damage resulting from removal of parts, improper repairs, service, maintenance, modifications or use of parts not manufactured or approved by BRP or resulting from repairs done by a person that is not an authorized servicing BRP Distributor/Dealer;
- Damage caused by abuse, abnormal use, neglect or operation of the product in a manner inconsistent with the recommended operation described in the Product's Operator's Guide;
- Damage resulting from accident, submersion, fire, theft, vandalism or any act of God;
- Operation with fuels, oils or lubricants which are not suitable for use with the Product (see the Operator's Guide);
- Damages from rust, corrosion or exposure to the elements;
- Damage resulting from water or snow ingestion;
- Incidental or consequential damages, or damages of any kind including without limitation transportation expenses, towing, storage, telephone, rental, taxi, inconvenience, insurance coverage, loan payments, loss of time, loss of income or time missed for downtime experience due to service work.
- Damage resulting from corrosion from road salts, battery acid, environmental influences or treatment contrary to the Operator's Guide
- Damages related to the appearance of the Product, including without limitation scratches, dents, fading, flaking, peeling and damages to seat cover material.
- Damage resulting from the installation of parts with specifications that differ from the original Product parts, such as, without limitation, different tires, exhaust system, wheels or brakes.

### 4) Warranty Coverage Period

This limited warranty will be in effect from (1) the date of delivery to the first retail consumer, or (2) the date the product is first put into use, whichever occurs first and for the applicable period below:

1. **TWENTY-FOUR (24) consecutive months**, for private use owners, except for the items covered in points (3) and (4) below.
2. **TWELVE (12) consecutive months**, for commercial use owners, except for the items covered in points (3) and (4) below.  
A Product is used commercially when it is used in connection with any work or employment that generates income during any part of the warranty period. A Product is also used commercially when, at any point during the warranty period, it is licensed for commercial use.
3. For the battery, **SIX (6) consecutive months**

4. For the tires, **SIX (6) consecutive months** or until tires are worn to the last three thirty-second of an inch (3/32") (2.38 millimeters) for the front tires and the last five thirty-second of an inch (5/32") (3.97 millimeters) for the rear tire, whichever occurs first

The repair or replacement of parts or the performance of service under this warranty does not extend the life of this warranty beyond its original expiration date.

The warranty coverage period identified above are a minimal limited warranty period which can be extended by any applicable warranty promotional program, as the case may be.

Note that the duration and any other modalities of the warranty coverage are subject to the applicable national or local legislation in the customer's country.

## 5) For Products Sold In France Only

The seller shall deliver goods that are complying with the contract and shall be responsible for defects existing upon delivery. The seller shall also be responsible for defects resulting from packaging, assembling instructions or the installation when it is its responsibility per the contract or if accomplished under its responsibility. To be compliant with the contract, the good shall:

1. Be fit for normal use for goods similar thereto and, if applicable:
  - Correspond to the description provided by the seller and have the qualities presented to the buyer though sample or model;
  - Have the qualities that a buyer may legitimately expect considering the public declarations of the seller, the manufacturer of its representative, including in advertising or labeling; or
2. Have the characteristics mutually agreed upon as between the parties or be fit for the specific use intended by the buyer and brought to the attention of the seller and which accepted.

The action for failure to comply is prescribed after two years after delivery of the goods. The seller is responsible for the warranty for hidden defects of the good sold if such hidden defects are rendering the good unfit for the intended use, or if they diminish its use in such a way that the buyer would not have acquired the good or would have given a lesser price, had he known. The action for such hidden defects shall be taken by the buyer within 2 years of the discovery of the defect.

## 6) Conditions to Have Warranty Coverage

This warranty coverage is available **only** if **each** of the following conditions has been fulfilled:

1. The Product must be purchased as new and unused by its first owner from a Distributor/Dealer authorized to distribute Products in the country (or in the case of the EEA, union of countries) in which the sale occurred ("Distributor/Dealer");
2. The BRP specified pre-delivery inspection process must be completed, documented and signed by the purchaser;
3. The Product must have undergone proper registration by an authorized Distributor/Dealer;

4. The Product must be purchased in the country (or in the case of the EEA, union of countries) in which the purchaser resides;
5. Routine maintenance outlined in the Operator's Guide must be timely performed in order to maintain warranty coverage. BRP reserves the right to make warranty coverage contingent upon proof of proper maintenance.

BRP will not honor this limited warranty to any private use owner or commercial use owner if one of the preceding conditions has not been met. Such limitations are necessary in order to allow BRP to preserve both the safety of its products, and also that of its consumers and the general public.

## **7) What to Do to Obtain Warranty Coverage**

The customer must cease using the Product upon the appearance of an anomaly, notify a servicing BRP Distributor/Dealer within two (2) months of the appearance of the anomaly and provide the Distributor/Dealer with reasonable access to the Product and reasonable opportunity to repair it.

The notification period is subject to the applicable national or local legislation in customer's country.

The customer must also present to the Distributor/Dealer, proof of purchase of the Product and must sign the repair/work order prior to starting the repair in order to validate the warranty repair.

All parts replaced under this limited warranty become the property of BRP.

## **8) What BRP Will Do**

To the extent permitted by law, BRP's obligations under this warranty are limited to, at its sole discretion, repairing or replacing parts found defective under normal use, maintenance and service without charge for parts and labor, at any authorized BRP Distributor/Dealer during the warranty coverage period under the conditions described herein. No claim of breach of warranty shall be cause for cancellation or rescission of the sale of the Product to the owner. You may have other legal rights which may vary from country to country.

In the event that service is required outside of the country of original sale, or for EEA residents, if service is required outside of the EEA, the owner will bear responsibility for any additional charges due to local practices and conditions, such as, but not limited to, freight, insurance, taxes, license fees, import duties, and any and all other financial charges, including those levied by governments, states, territories and their respective agencies.

BRP reserves the right to improve or modify products from time to time without assuming any obligation to modify products previously manufactured.

## **9) Transfer**

If the ownership of a Product is transferred during the warranty coverage period, this limited warranty, subject to its terms and conditions, shall also be transferred and be valid for the remaining coverage period provided BRP or an authorized Product Distributor/Dealer receives a proof that the former owner agreed to the transfer of ownership, in addition to the coordinates of the new owner.

## 10) Consumer Assistance

In the event of a controversy or a dispute in connection with this limited warranty, BRP suggests that you try to resolve the issue at the dealership level. We recommend discussing the issue with the authorized Distributor/Dealer's service manager or owner.

If the matter still remains unresolved, contact BRP by filling out the customer contact form at [www.brp.com](http://www.brp.com) or contact BRP by mail at one of the addresses listed under the *Contact Us* section of this guide.

# **CUSTOMER INFORMATION**

---

# DATA PRIVACY INFORMATION

Bombardier Recreational Products inc., its affiliates and subsidiaries (“BRP”) is committed to protecting your privacy and support a general policy of openness about how we collect, use and disclose your personal information in the course of managing our relationship with you. **More details can be found by visiting BRP’s Privacy Policy at: <https://brp.com/en/privacy-policy.html> or by scanning the QR Code below.**

Please be assured that we have appropriate security measures in place to ensure that your personal information is protected against loss and unauthorized access.

Your personal information that may be collected by BRP, directly from you or from authorized dealers or authorized third parties, includes:

- **Contact, Demographic & Registration Information** (e.g., name, full address, phone number, email, gender, ownership history, language of communication)
- **Vehicle Information** (e.g., serial number, purchase and delivery date, unit usage, vehicle location and movements)
- **Third Party Information** (e.g., information received from BRP partners, joint-marketing activities information, social media)
- **Technological Information** (e.g., IP address, type of device, operating system, browser type, webpages you view, cookies and similar technologies when you use BRP or dealers’ websites or mobile application)
- **Interaction with BRP Information** (e.g., information collected when you call BRP’s in-house sales representatives, buy items on a BRP web Site, sign up for BRP emails, participate in BRP-sponsored contests and sweepstakes or attend BRP-sponsored events)
- **Transactional Information** (e.g., information necessary to handle returns, payment information when you purchase our products or services through our websites or mobile applications and other issues related to your purchase of BRP products)

This information may be used and processed for the following purposes:

- Safety & Security
- Customer Support for Sales & After Sales (e.g., complete or follow up with you about your purchase or maintenance)
- Registration & Warranty
- Communication (e.g., sending you a BRP satisfaction survey)
- Online Behavioural Advertising, Profiling and Location-Based Services (e.g., offer customized experience)
- Compliance & Dispute Resolution
- Marketing & Advertising
- Assistance (e.g., help with any delivery issues, handle returns, and other issues related to your purchase of BRP products).

We also may use personal information to generate aggregated or statistical data that no longer identifies you personally.

**Your personal information may be disclosed to the following: BRP, BRP’s authorized dealerships, distributors, service providers, advertising & market research partners and other authorized third parties.**

We may receive information about you from diverse sources, including third parties, such as BRP’s authorized dealerships and partners, with whom we offer

services or engage in joint-marketing activities. We may also receive information about you from social media platforms such as Facebook and Twitter, when you interact with us on those platforms.

Depending on the circumstances, your personal information may be communicated outside the region where you reside. Your personal information is retained only for as long as necessary for the purpose for which we obtained it and according to our retention policies.

To exercise your data privacy rights (e.g. right of access, right of rectification), to withdraw your consent in order to be removed from the address list for marketing purposes or for the satisfaction survey or for general data privacy questions, please contact BRP's Data Protection Officer at or by mail at **privacyofficer@brp.com** or by mail at:

BRP Legal Service, 726 St-Joseph, Valcourt, Quebec, Canada, J0E 2L0.

**When BRP processes your personal information, they do so in compliance with its Privacy Policy available at: <https://www.brp.com/en/privacy-policy.html> or by using the following**

**QR Code.**



[www.brp.com](http://www.brp.com)

## **Asia Pacific**

### **Australia**

Level 26  
477 Pitt Street  
Sydney, NSW 2020

### **China**

上海市徐汇区衡山路10号6号楼301  
Rm 301, Building 6,  
No.10 Heng Shan Rd,  
Shanghai, China

### **Japan**

21F Shinagawa East One Tower  
2-16-1 Konan, Minato-ku-ku,  
Tokyo 108-0075

### **New Zealand**

Suite 1.6, 2-8 Osborne Street,  
Newmarket, Auckland 2013

## **Europe, Middle East and Africa**

### **Belgium**

Oktrooiplein 1  
9000 Gent

### **Czech Republic**

Stefanikova 43a  
Prague 5  
150 00

### **Germany**

Itterpark 11  
40724 Hilden

### **Finland**

Isoaavantie 7  
PL 8040  
96101 Rovaniemi

### **France**

Arteparc Bâtiment B  
Route de la côte d'Azur,  
13 590 Meyreuil

### **Norway**

Ingvald Ystgaardsvei 15  
N-7484 Trondheim  
Salg, marketing, ettermarked



**Sweden**

Spinnvägen 15  
903 61 Umeå  
Sweden 90821

**Switzerland**

Avenue d'Ouchy 4-6  
1006 Lausanne

**Latin America**

**Brazil**

Av. James Clerck Maxwell, 230  
Campinas, Sao Paulo  
CEP 13069-380

**Mexico**

Av. Ferrocarril 202  
Parque Industrial Querétaro  
Santo Rosa Jauregui, Querétaro  
C.P. 76220

**North America**

**Canada**

3200A, rue King Ouest,  
Suite 300  
Sherbrooke (Québec) J1L 1C9

**United States of America**

10101 Science Drive  
Sturtevant, Wisconsin  
53177

If your address has changed or if you are the new owner of the vehicle, be sure to notify BRP by either:

- Notifying an authorized Can-Am dealer.
- **North America Only:** calling at 1 888 272-9222.
- Mailing one of the change of address cards on the following pages at one of the BRP addresses indicated in the *Contact Us* section of this guide.

In case of change of ownership, please join a proof that the former owner agreed to the transfer.

Notifying BRP, even after the expiration of the limited warranty, is very important as it enables BRP to reach the vehicle owner if necessary, like when safety recalls are initiated. It is the owner's responsibility to notify BRP.

**STOLEN UNITS:** If your personal vehicle is stolen, you should notify BRP or an authorized Can-Am dealer. We will ask you to provide your name, address, phone number, the vehicle identification number and the date it was stolen.



This page is  
intentionally blank



This page is  
intentionally blank











Model No. \_\_\_\_\_

**VEHICLE**

IDENTIFICATION NUMBER (V.I.N.) \_\_\_\_\_

**ENGINE**

IDENTIFICATION NUMBER (E.I.N.) \_\_\_\_\_

**Owner:** \_\_\_\_\_

NAME

No.

STREET

APT

CITY

STATE/PROVINCE

ZIP/POSTAL CODE

**Purchase Date** \_\_\_\_\_

YEAR

MONTH

DAY

**Warranty Expiry Date** \_\_\_\_\_

YEAR

MONTH

DAY

To be completed by the dealer at the time of the sale.

DEALER IMPRINT AREA

## WARNING

This Can-Am On-road product is a different type of vehicle. It requires special skills and knowledge. Learn how this product is different.

• BEFORE YOU OPERATE THIS VEHICLE, READ THIS OPERATOR'S GUIDE, ALL ON PRODUCT SAFETY LABELS AND WATCH THE SAFETY VIDEO.



- COMPLETE a training course (if available), practice, become proficient with the controls, and get a proper license.
- REFER to the Safety Card before riding.

• ALWAYS WEAR A HELMET AND RIDING GEAR. With this type of vehicle, riders are exposed to more road risks than in a car. Even skilled operators can be struck by other vehicles or lose control. This vehicle will not protect you in a crash.

• HANDLING LIMITS AND ROAD CONDITIONS. The Vehicle Stability System (VSS) cannot stop you from losing control, flipping over, or falling off if you exceed this vehicle's limits. Know the limits for different road conditions. Do not ride on ice, snow, or off road. Avoid puddles and running water.

This type of vehicle can hydroplane on water and slip on gravel, dirt and sand covered roads. If you must go through these road conditions, slow down.

®TM and the BRP logo are trademarks of BOMBARDIER RECREATIONAL PRODUCTS INC. or its affiliates.

©2023 BOMBARDIER RECREATIONAL PRODUCTS INC. ALL RIGHTS RESERVED.

[www.brp.com](http://www.brp.com)

**ALUMACRAFT®**

**MANITOU®**

**SEA-DOO®**

**CAN-AM®**

**QUINTREX®**

**SKI-DOO®**

**LYNX®**

**ROTAX®**

219002365