

can-amTM



2013

**Operator's
Guide**

**Includes
Safety, Vehicle
and Maintenance Information**

OUTLANDERTM 650 X mp

⚠ WARNING

Read this guide thoroughly. It contains important safety information. Minimum recommended operator's age: 16 years old. Experienced operator only. Keep this Operator's Guide in the vehicle.

2 1 9 0 0 1 1 2 8

WARNING

YOUR VEHICLE CAN BE HAZARDOUS TO OPERATE. A collision or rollover can occur quickly, if you fail to take proper precautions, even during routine maneuvers such as turning and driving on hills or over obstacles. For your safety, understand and follow all the warnings contained in this Operator's Guide and on the labels on your vehicle. **Failure to follow these warnings can result in SEVERE INJURY OR DEATH!** Keep this Operator's Guide with the vehicle at all times.

WARNING

Disregarding any of the safety precautions and instructions contained in this Operator's Guide, *SAFETY DVD* video and on-product safety labels could result in an injury including the possibility of death!

WARNING

This vehicle may exceed the performance of other vehicles you may have ridden in the past. Take time to familiarize yourself with your new vehicle.

CALIFORNIA PROPOSITION 65 WARNING

WARNING

This product contains or emits chemicals known to the state of California to cause cancer and birth defects or other reproductive harm.

In Canada, products are distributed by Bombardier Recreational Products Inc. (BRP).

In USA, products are distributed by BRP US Inc.

The following trademarks are the property of Bombardier Recreational Products Inc.:

Can-Am™

D.E.S.S.™

DPS™

Rotax®

TTI™

XPS™

This document contains the trademark of the following company:

– Visco-lok is a trademark of GKN Viscodrive GmbH.

FOREWORD

Deutsch	Dieses Handbuch ist möglicherweise in Ihrer Landessprache verfügbar. Bitte wenden Sie sich an Ihren Händler oder besuchen Sie: www.operatorsguide.brp.com .
English	This guide may be available in your language. Check with your dealer or go to: www.operatorsguide.brp.com .
Español	Es posible que este manual esté disponible en su idioma. Consulte a su distribuidor o visite: www.operatorsguide.brp.com .
Français	Ce guide peut être disponible dans votre langue. Vérifier avec votre concessionnaire ou aller à: www.operatorsguide.brp.com .
Nederlands	Deze handleiding kan beschikbaar zijn in uw taal. Vraag het aan uw dealer of ga naar: www.operatorsguide.brp.com .
Norsk	Denne boken kan finnes tilgjengelig på ditt eget språk. Kontakt din forhandler eller gå til: www.operatorsguide.brp.com .
Português	Este manual pode estar disponível em seu idioma. Fale com sua concessionária ou visite o site: www.operatorsguide.brp.com .
Suomi	Käyttöohjekirja voi olla saatavissa omalla kielelläsi. Tarkista jälleenmyyjältä tai käy osoitteessa: www.operatorsguide.brp.com
Svenska	Denna bok kan finnas tillgänglig på ditt språk. Kontakta din återförsäljare eller gå till: www.operatorsguide.brp.com .

Congratulations on your purchase of a new Can-Am™ ATV. It's backed by the BRP limited warranty and a network of authorized Can-Am dealers ready to provide the parts, accessories or service you may require.

At delivery, you were informed of the warranty coverage and signed the *PREDELIVERY CHECK LIST* to ensure your new vehicle was prepared to your entire satisfaction.

Your dealer is committed to your satisfaction. If you need more information, please ask your dealer.

Know Before you Go

To learn how to reduce the risk for you or bystanders being injured or killed, read this Operator's Guide before you operate the vehicle.

Also, read all safety labels on your ATV and watch attentively your *SAFETY DVD* video.

This vehicle is a category S, always follow this age recommendation: A person under 16 years old should never operate this vehicle.

This vehicle is for recreational use by experienced operators only.

We highly recommend that you take a safety riding course. Refer to *SPECIAL SAFETY MESSAGES* subsection for details.

Failure to follow the warnings contained in this Operator's Guide can result in **SERIOUS INJURY** or **DEATH**.

Safety Messages

The types of safety messages, what they look like and how they are used in this guide are explained as follows:

The safety alert symbol  indicates a potential injury hazard.

 **WARNING**

Indicates a potential hazard, if not avoided, could result in serious injury or death.

 **CAUTION** Indicates a hazard situation which, if not avoided, could result in minor or moderate injury.

NOTICE Indicates an instruction which, if not followed, could severely damage vehicle components or other property.

About This Operator's Guide

This Operator's Guide has been prepared to acquaint the owner/operator of a new vehicle with the various vehicle controls, maintenance and safe operating instructions. It is indispensable for the proper use of the product.

Keep this Operator's Guide in the vehicle as you can refer to it for things such as maintenance, troubleshooting and instructing others.

Note that this guide is available in several languages. In the event of any discrepancy, the english version shall prevail.

If you want to view and/or print an extra copy of your Operator's Guide, simply visit the following website www.operatorsguide.brp.com.

The informations contained in this document are correct at the time of publication. However, BRP maintains a policy of continuous improvement of its products without imposing upon itself any obligation to install them on products previously manufactured. Due

to late changes, some differences between the manufactured product and the descriptions and/or specifications in this guide may occur. BRP reserves the right at any time to discontinue or change specifications, designs, features, models or equipment without incurring any obligation upon itself.

This Operator's Guide and the *SAFETY DVD* video should remain with the vehicle when it is sold.

While reading this Operator's Guide, remember that:

 **WARNING**

Indicates a potential hazard that, if not avoided, could result in serious injury or death.

TABLE OF CONTENTS

FOREWORD	1
Know Before you Go	1
Safety Messages.....	1
About This Operator's Guide	2

SAFETY INFORMATION

GENERAL PRECAUTIONS	8
Avoid Carbon Monoxide Poisoning	8
Avoid Gasoline Fires and Other Hazards	8
Avoid Burns from Hot Parts	8
Accessories and Modifications	8
SPECIAL SAFETY MESSAGES	9
Training Course	10
OPERATION WARNINGS	11
RIDING THE VEHICLE	37
Pre-Ride Inspection	38
Riding Gear	40
Carrying a Passenger is Prohibited	40
Carrying Loads	41
Hauling a Trailer.....	41
Working with your Vehicle.....	41
Recreational Riding	41
Mud Riding	42
Environment.....	42
Design Limitation	43
Off-Road Operation	43
General Operating and Safety Precautions	43
Riding Techniques.....	45
IMPORTANT ON-PRODUCT LABELS	51
Hang Tag	51
Vehicle Safety Labels	52
Compliance Labels	56
Technical Information Label	56

VEHICLE INFORMATION

CONTROLS/INSTRUMENTS/EQUIPMENT	58
1) Throttle Lever.....	59
2) 2WD/4WD Selector	59
3) LH Brake Lever	60
4) Brake Lock	60
5) Shift Lever	61
6) Multifunction Switch.....	62
7) 12-Volt Power Outlet.....	64

CONTROLS/INSTRUMENTS/EQUIPMENT (cont'd)	
8) Ignition Switch and Keys.....	64
9) Brake Pedal	66
10) Footpegs.....	66
11) Seat	66
12) Rear Storage Compartment.....	67
13) Cargo Rack	67
14) Trailer Hitch	68
15) Tool kit	68
16) Winch - Outside North America Only.....	68
17) Winch Control Switch - Outside North America Only	68
18) Roller Fairlead - Outside North America Only.....	69
19) Winch Remote Control - Outside North America Only.....	69
20) Winch Remote Control Connection - Outside North America Only	69
MULTIFUNCTION GAUGE (LCD)	70
Multifunction Gauge Description	70
Multifunction Gauge Features	72
Multifunction Gauge Set-Up	72
FUEL	74
Recommended Fuel	74
Fueling Procedure.....	74
BREAK-IN PERIOD	75
Operation During Break-In.....	75
BASIC PROCEDURES	76
Starting the Engine.....	76
Changing Gear Selection	76
Stopping the Engine	76
SPECIAL PROCEDURES	77
What to Do if Water is in the CVT	77
What to Do if Water is in the Air Filter Housing	77
What to Do if Vehicle is Turned Over	78
What to Do if Vehicle is Immersed in Water	78
TUNE YOUR RIDE	80
Suspension Adjustment	80
Spring Preload Adjustment.....	80
Steering Assist Adjustment (DPS).....	80
VEHICLE TRANSPORTATION	82
MAINTENANCE	
BREAK-IN INSPECTION	84
MAINTENANCE SCHEDULE	86
MAINTENANCE PROCEDURES	90
Air Filter	90
Engine Oil.....	92

MAINTENANCE PROCEDURES (cont'd)	
Oil Filter	94
Radiator	94
Engine Coolant	95
Muffler Spark Arrester	97
CVT Air Filter	98
Gearbox Oil	100
Throttle Cable	101
Spark Plugs	103
Battery	104
Fuses	104
Lights	106
Drive Shaft Boot and Protector	107
Wheels and Tires	108
Suspension	109
Steering	110
Brakes	110
VEHICLE CARE	112
Post-Operation Care	112
Vehicle Cleaning and Protection	112
STORAGE AND PRESEASON PREPARATION	113
<i>TECHNICAL INFORMATION</i>	
VEHICLE IDENTIFICATION	116
Vehicle Identification Number	116
Engine Identification Number	116
NOISE EMISSION CONTROL SYSTEM REGULATION	117
EC-DECLARATION OF CONFORMITY	118
SPECIFICATIONS	119
<i>TROUBLESHOOTING</i>	
TROUBLESHOOTING GUIDELINES	126
MULTIFUNCTION GAUGE MESSAGES	130
<i>WARRANTY</i>	
BRP LIMITED WARRANTY USA AND CANADA: 2013 CAN-AM™ ATV ..	132
BRP INTERNATIONAL LIMITED WARRANTY: 2013 CAN-AM™ ATV	136

**BRP LIMITED WARRANTY FOR THE EUROPEAN AND THE RUSSIAN
ECONOMIC AREAS AND TURKEY ECONOMIC AREA: 2013 CAN-AM™
ATV 140**

CUSTOMER INFORMATION

PRIVACY INFORMATION 146
CHANGE OF ADDRESS/OWNERSHIP 147

SAFETY INFORMATION

GENERAL PRECAUTIONS

Avoid Carbon Monoxide Poisoning

All engine exhaust contains carbon monoxide, a deadly gas. Breathing carbon monoxide can cause headaches, dizziness, drowsiness, nausea, confusion and eventually death.

Carbon monoxide is a colorless, odorless, tasteless gas that may be present even if you do not see or smell any engine exhaust. Deadly levels of carbon monoxide can collect rapidly, and you can quickly be overcome and unable to save yourself. Also, deadly levels of carbon monoxide can linger for hours or days in enclosed or poorly ventilated areas. If you experience any symptoms of carbon monoxide poisoning, leave the area immediately, get fresh air and seek medical treatment.

To prevent serious injury or death from carbon monoxide:

- Never run the vehicle in poorly ventilated or partially enclosed areas such as garages, carports or barns. Even if you try to ventilate engine exhaust with fans or open windows and doors, carbon monoxide can rapidly reach dangerous levels.
- Never run the vehicle outdoors where engine exhaust can be drawn into a building through openings such as windows and doors.

Avoid Gasoline Fires and Other Hazards

Gasoline is extremely flammable and highly explosive. Fuel vapors can spread and be ignited by a spark or flame many feet away from the engine. To reduce the risk of fire or explosion, follow these instructions:

- Use only an approved gasoline container to store fuel.
- Strictly adhere to instructions in *FUEL* subsection.
- Never start or operate the engine if the fuel cap is not properly installed.

Gasoline is poisonous and can cause injury or death.

- Never siphon gasoline by mouth.
- If you swallow gasoline, get any in your eye(s), or inhale gasoline vapor, see your doctor immediately.

If gasoline spills on you, wash with soap and water and change your clothes.

Avoid Burns from Hot Parts

Certain components become hot during operation. Avoid contact with those parts during and shortly after operation to avoid burns.

Accessories and Modifications

Do not make unauthorized modifications, or use attachments or accessories that are not approved by BRP. Since these changes have not been tested by BRP, they may increase the risk of crashes or injury, and can render the vehicle illegal.

See your authorized Can-Am dealer for available accessories for your vehicle.

SPECIAL SAFETY MESSAGES

THIS VEHICLE IS NOT A TOY AND CAN BE HAZARDOUS TO OPERATE.

- This vehicle handles differently from other vehicles. A collision or rollover can occur quickly, if you fail to take proper precautions, even during routine maneuvers such as turning and driving on hills or over obstacles.

SEVERE INJURY OR DEATH can result if you do not comply with the following instructions:

- Read this Operator's Guide and all on-product safety labels carefully and follow the operating procedures described. Watch and pay attention to the *SAFETY DVD* video before operating the vehicle.
- Always follow this age recommendation: A person under 16 years old should never operate this vehicle.
- Never carry a passenger on this vehicle.
- Never operate this vehicle on any paved surfaces, including sidewalks, driveways, parking lots and streets.
- Never operate this vehicle on any public street, road or highway, even a dirt or gravel one.
- Never take place on this vehicle without wearing an approved helmet that fits properly. You should also wear eye protection (goggles or face shield), gloves, boots, long sleeved shirt or jacket, and long pants.
- Never use this vehicle if you are tired, ill or with drugs or alcohol. Your reaction time and judgement is greatly affected under these conditions.
- Never operate at excessive speeds. Always go at a speed that is proper for the terrain, visibility, and operating conditions, and your experience.
- Never attempt wheelies, jumps, or other stunts.
- Always inspect and confirm the safe operating condition of your vehicle prior to ride. Always follow the inspection and maintenance procedures and schedules described in this Operator's Guide.
- Always keep both hands on the handlebars and both feet on the footrests of the vehicle during operation.
- Always go slowly and be extra careful when operating on unfamiliar terrain. Always be alert to changing terrain conditions when operating this vehicle.
- Never operate on excessively rough, slippery or loose terrain until you have learned and practiced the skills necessary to control this vehicle on such terrain. Always be especially cautious on these kinds of terrain.
- Always follow proper procedures for turning as described further in this Operator's Guide. Practice turning at low speeds before attempting to turn at faster speeds. Do not turn at excessive speed.
- Never operate this vehicle on hills too steep for the vehicle or for your abilities. Practice on smaller hills before attempting larger hills.
- Always follow proper procedures for climbing hills as described further in this Operator's Guide. Check the terrain carefully before you start up any hill. Never climb hills with excessively slippery or loose surfaces. Shift your weight forward. Never open the throttle suddenly or make sudden gear changes. Never go over the top of any hill at high speed.
- Always follow proper procedures for going down hills and for braking on hills as described further in this Operator's Guide. Check the terrain carefully before you start down any hill. Shift your weight backward.

- Always follow proper procedures for crossing the side of a hill as described further in this Operator's Guide. Avoid hills with excessively slippery or loose surfaces. Shift your weight to the uphill side of the vehicle.
- Always use proper procedures if you stall or roll backwards when climbing a hill. To avoid stalling, use proper range and maintain a steady speed when climbing a hill. If you stall or roll backwards, follow the special procedure for braking described in this Operator's Guide. Dismount on the uphill side or to a side if pointed straight uphill. Turn the vehicle around and remount, following the procedure described further in this Operator's Guide.
- Always check for obstacles before operating in a new area. Never attempt to operate over large obstacles, such as large rocks or fallen trees. Always follow proper procedures when operating over obstacles as described further in this Operator's Guide.
- Always be careful when skidding or sliding. Learn to safely control skidding or sliding by practicing at low speeds and on level smooth terrain. On extremely slippery surfaces, such as ice, go slowly and be very cautious in order to reduce the chance of skidding out of control.
- Never operate this vehicle in fast flowing water or in water deeper than that specified in this Operator's Guide. Remember that wet brakes may have reduced stopping ability. Test your brakes after leaving water, mud or snow. If necessary, apply them several times to let friction dry out the pads.
- Always keep in mind that braking distance is readily affected by but not limited to; weather and terrain conditions, braking system and tire conditions, vehicle speed and attitude, and vehicle load including towing. Remember to adjust your driving accordingly.
- Always be sure there are no obstacles or people behind the vehicle when you operate in reverse. When it is safe to proceed in reverse, go slowly.
- BRP recommends sitting on your ATV when operating in reverse. Avoid standing up. Your weight could shift forward against throttle lever, causing an unexpected acceleration and loss of control.
- Always use the size and type tires specified further in this Operator's Guide. Always maintain proper tire pressure as described further in this Operator's Guide.
- Never modify this vehicle through improper installation or use of accessories. Only use BRP's approved accessories. NEVER install passenger seat or use the cargo area to carry a passenger.
- Never exceed the stated load limits for this vehicle including operator, all other loads and added accessories. Cargo should be properly distributed and securely attached. Reduce speed and follow instructions in this manual for carrying cargo or pulling a trailer. Allow greater distance for braking.
- Never operate the vehicle if the controls do not function normally.

Training Course

Never operate this vehicle without proper instruction. **Take a training course.** All operators should receive training from a certified instructor.

FOR MORE INFORMATION ABOUT ATV SAFETY, contact an authorized Can-Am dealer to find out about available training courses nearest you.

USA and Canada only: call the Specialty Vehicle Institute of America (SVIA) at 1 800 887-2887 or in Canada, the Canada Safety Council (CSC) at 1 613 739-1535.

OPERATION WARNINGS

The following warning and their format have been requested by the United States Consumer Product Safety Commission and are required to be in the Operator's Guide for all ATVs.

NOTE: The following illustrations are general representations only. Your model may differ.

WARNING



POTENTIAL HAZARD

Operating this vehicle without proper instruction.

WHAT CAN HAPPEN

The risk of an accident is greatly increased if the operator does not know how to operate this vehicle properly in different situations and on different types of terrain.

HOW TO AVOID THE HAZARD

Beginners and inexperienced operators should complete a training course. They should then regularly practice the skills learned during the course as well as the operating techniques described in this Operator's Guide.

For more information about the training course, contact an authorized Can-Am dealer.

⚠ WARNING



V00A01Q

POTENTIAL HAZARD

Failure to follow the age recommendations for this vehicle.

WHAT CAN HAPPEN

A lack of respect for this age recommendation can lead to severe injury or death of the child.

Even though a child may be within the age group for which this vehicle is recommended, he may not have the skills, abilities, or judgment needed to operate this vehicle safely and may be involved in a serious accident.

HOW TO AVOID THE HAZARD

No one under 16 should operate this vehicle.

⚠ WARNING

V00A02Q

POTENTIAL HAZARD

Carrying a passenger on this vehicle.

WHAT CAN HAPPEN

Greatly reduces your ability to balance and control this vehicle.

Could cause an accident, resulting in harm to you and/or your passenger.

HOW TO AVOID THE HAZARD

Never carry passenger. Even with a long seat that provides unrestricted operator movement, it is not designed nor intended to carry passenger(s).

⚠ WARNING



POTENTIAL HAZARD

Operating this vehicle on paved surfaces.

WHAT CAN HAPPEN

The tires are designed for off-road use only, not for use on pavement. Paved surfaces may seriously affect handling and control of this vehicle, and may cause the vehicle to go out of control.

HOW TO AVOID THE HAZARD

Never operate this vehicle on any paved surfaces, including sidewalks, driveways, parking lots and streets.

⚠ WARNING**POTENTIAL HAZARD**

Operating this vehicle on public streets, roads or highways.

WHAT CAN HAPPEN

You can collide with another vehicle.

HOW TO AVOID THE HAZARD

Never operate this vehicle on any public street, road or highway, even a dirt or gravel one. In many states or provinces it is illegal to operate this vehicle on public streets, roads or highways.

⚠ WARNING



POTENTIAL HAZARD

Riding this vehicle without wearing an approved helmet, eye protection and protective clothing.

WHAT CAN HAPPEN

The following items concern all ATV's operator:

- Riding without an approved helmet increases the chances of a severe head injury or death in the event of an accident.
- Riding without eye protection can result in an accident and increases the chances of a severe injury in the event of an accident.
- Riding without protective clothing increases the chances of severe injury in the event of an accident.

HOW TO AVOID THE HAZARD

Always wear an approved helmet that fits properly. You should also wear:

- Eye protection (goggles or face shield)
- Gloves and boots
- Long sleeved shirt or jacket
- Long pants.

! WARNING

V00A07Q

POTENTIAL HAZARD

Using this vehicle under influence of drugs or alcohol.

WHAT CAN HAPPEN

- Using this vehicle with drugs or alcohol.
- Could seriously affect your judgment.
- Could cause you to react more slowly.
- Could affect your balance and perception.
- Could result in an accident or death.

HOW TO AVOID THE HAZARD

Never use this vehicle with drugs or alcohol.

⚠ WARNING

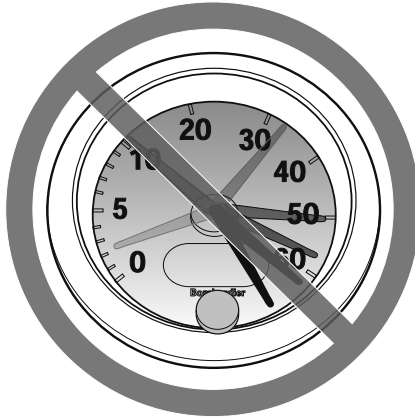

V00A08Q

POTENTIAL HAZARD

Operating this vehicle at excessive speeds.

WHAT CAN HAPPEN

Increases your chances of losing control of the vehicle, which can result in an accident.

HOW TO AVOID THE HAZARD

Always travel at a speed which is appropriate for the terrain, visibility and operating conditions, and your experience.

⚠ WARNING**POTENTIAL HAZARD**

Attempting wheelies, jumps and other stunts.

WHAT CAN HAPPEN

Increases the chance of an accident, including an overturn.

HOW TO AVOID THE HAZARD

Never attempt stunts, such as wheelies or jumps. Do not try to show off.

⚠ WARNING**POTENTIAL HAZARD**

Failure to inspect the vehicle before operating.

Failure to properly maintain the vehicle.

WHAT CAN HAPPEN

Increases the possibility of an accident or equipment damage.

HOW TO AVOID THE HAZARD

Always inspect your vehicle prior to every time you use it to make sure the vehicle is in safe operating condition.

Always follow the inspection and maintenance procedures and schedules described further in this Operator's Guide.

⚠ WARNING

POTENTIAL HAZARD

Riding on frozen waterways.

WHAT CAN HAPPEN

Breaking through the ice can lead to severe injury or death.

HOW TO AVOID THE HAZARD

Never ride this vehicle on a frozen surface before you are sure the ice is thick enough and sound enough to support the vehicle and its load, as well as the force that is created by a moving vehicle.

⚠ WARNING



POTENTIAL HAZARD

Removing hands from handlebar or feet from the footrests during operation.

WHAT CAN HAPPEN

Removing even one hand or foot can reduce your ability to control the vehicle or could cause you to lose your balance and fall off the vehicle. If you remove a foot from the footrests, your foot or leg may come into contact with the rear wheels, which could injure you or cause an accident.

HOW TO AVOID THE HAZARD

Always keep both hands on the handlebar and both feet on the footrests during vehicle operation.

⚠ WARNING**POTENTIAL HAZARD**

Failure to use extra care when operating this vehicle on unfamiliar terrain.

WHAT CAN HAPPEN

You can come upon hidden rocks, bumps, or holes, without enough time to react.

Could result in the vehicle overturning or loss of control.

HOW TO AVOID THE HAZARD

Go slowly and be extra careful when operating on unfamiliar terrain.

Always be alert to changing terrain conditions when operating the vehicle.

⚠ WARNING



POTENTIAL HAZARD

Failure to use extra care when operating on excessively rough, slippery or loose terrain.

WHAT CAN HAPPEN

Could cause loss of traction or vehicle control, which could result in an accident, including an overturn.

HOW TO AVOID THE HAZARD

Do not operate on excessively rough, slippery or loose terrain until you have learned and practiced the skills necessary to control this vehicle on such terrain.

Always be especially cautious on these kinds of terrain.

⚠ WARNING**POTENTIAL HAZARD**

Turning improperly.

WHAT CAN HAPPEN

Vehicle could go out of control, causing a collision or overturn.

HOW TO AVOID THE HAZARD

Always follow proper procedures for turning as described further in this Operator's Guide. Practice turning at low speeds before attempting to turn at faster speeds.

Do not turn at excessive speed.

⚠ WARNING



POTENTIAL HAZARD

Operating on excessively steep hills.

WHAT CAN HAPPEN

The vehicle can overturn more easily on extremely steep hills than on level surfaces or small hills.

HOW TO AVOID THE HAZARD

Never operate this vehicle on hills too steep for the vehicle or for your abilities.

Practice on smaller hills before attempting larger hills.

⚠ WARNING**POTENTIAL HAZARD**

Climbing hills improperly.

WHAT CAN HAPPEN

Could cause loss of control or cause vehicle to overturn.

HOW TO AVOID THE HAZARD

Always follow proper procedures for climbing hills as described further in this Operator's Guide.

Always check the terrain carefully before you start up any hill.

Never climb hills with excessively slippery or loose surfaces.

Shift your weight forward.

Never open the throttle suddenly or make sudden gear changes. The vehicle could flip over backwards.

Never go over the top of any hill at high speed. An obstacle, a sharp drop, or another vehicle or person could be on the other side of the hill.

⚠ WARNING



POTENTIAL HAZARD

Going down a hill improperly.

WHAT CAN HAPPEN

Could cause loss of control or cause vehicle to overturn.

HOW TO AVOID THE HAZARD

Always follow proper procedures for going down hills as described further in this Operator's Guide.

NOTE: A special technique is required when braking as you go down a hill.

Always check the terrain carefully before you start down any hill.

Shift your weight backward.

Never go down a hill at high speed.

Avoid going down a hill at an angle which would cause the vehicle to lean sharply to one side. Go straight down the hill where possible.

⚠ WARNING**POTENTIAL HAZARD**

Improperly crossing hills or turning on hills.

WHAT CAN HAPPEN

Could cause loss of control or cause vehicle to overturn.

HOW TO AVOID THE HAZARD

Never attempt to turn the vehicle around on any hill until you have mastered the turning technique as described further in this Operator's Guide on level ground. Be very careful when turning on any hill.

Avoid crossing the side of a steep hill if possible.

When crossing the side of a hill:

Always follow proper procedures as described further in this Operator's Guide.

Avoid hills with excessively slippery or loose surfaces.

Shift your weight to the uphill side of the vehicle.

! WARNING

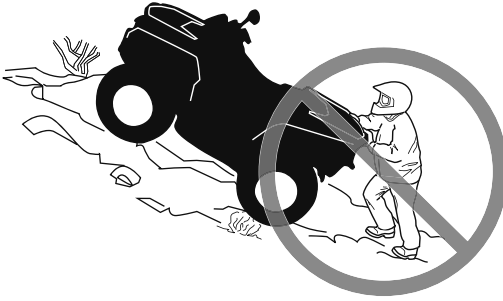

POTENTIAL HAZARD

Stalling, rolling backwards or improperly dismounting while climbing a hill.

WHAT CAN HAPPEN

Could result in vehicle overturning.

HOW TO AVOID THE HAZARD

Use proper range and maintain steady speed when climbing a hill.

If you lose all forward speed:

Keep your weight uphill. Never open the throttle suddenly or make sudden gear changes. The vehicle could flip over backwards.

Apply the brakes.

Lock brake lock after you have stopped.

Dismount on uphill side, or to a side if pointed straight uphill.

If you begin rolling backwards:

Keep your weight uphill. Never open the throttle suddenly or make sudden gear changes. The vehicle could flip over backwards.

Never apply the rear brake while rolling backwards.

Apply the front brake gradually.

When fully stopped, apply rear brake as well and lock brake lock.

Dismount on uphill side, or to a side if pointed straight uphill.

Turn the vehicle around and remount, following the procedure described further in this Operator's Guide.

⚠ WARNING**POTENTIAL HAZARD**

Improperly operating over obstacles.

WHAT CAN HAPPEN

Could cause loss of control or a collision.

Could cause the vehicle to overturn.

HOW TO AVOID THE HAZARD

Before operating in a new area, check for obstacles.

Never attempt to ride over large obstacles, such as large rocks or fallen trees.

When you go over obstacles, always follow proper procedures as described further in this Operator's Guide.

⚠ WARNING



POTENTIAL HAZARD

Skidding or sliding improperly.

WHAT CAN HAPPEN

You may lose control of this vehicle.

You may also regain traction unexpectedly, which may cause the vehicle to overturn.

HOW TO AVOID THE HAZARD

Learn to safely control skidding or sliding by practicing at low speeds and on level smooth terrain.

On extremely slippery surfaces, such as ice, go slowly and be very cautious in order to reduce the chance of skidding or sliding out of control.

⚠ WARNING**POTENTIAL HAZARD**

Operating this vehicle through deep or fast flowing water.

WHAT CAN HAPPEN

Tires may float, causing loss of traction and loss of control, which could lead to an accident.

HOW TO AVOID THE HAZARD

Never operate this vehicle in fast flowing water or in water deeper than that specified further in this Operator's Guide.

Check water depth and current before you attempt to cross any water. Water should not go above tires.

Remember that wet brakes may have reduced stopping ability. Test your brakes after leaving water. If necessary, apply them several times to let friction dry out the pads.

⚠ WARNING



POTENTIAL HAZARD

Improperly operating in reverse.

WHAT CAN HAPPEN

You could hit an obstacle or person behind the vehicle, resulting in serious injury.

HOW TO AVOID THE HAZARD

When you select reverse gear, make sure there are no obstacles or people behind the vehicle. When it is safe to proceed, go slowly.

⚠ WARNING**POTENTIAL HAZARD**

Operating this vehicle with improper tires, or with improper or uneven tire pressure.

WHAT CAN HAPPEN

Use of improper tires on this vehicle, or operation of this vehicle with improper or uneven tire pressure, may cause loss of control, tire blow outs, tire to move around on its rim and increases the risk of an accident.

HOW TO AVOID THE HAZARD

Always use the size and type of tires specified further in this Operator's Guide for this vehicle.

Always maintain proper tire pressure as described further in this Operator's Guide.

Always replace wheels or tires that are damaged.

⚠ WARNING



POTENTIAL HAZARD

Operating this vehicle with improper modifications.

WHAT CAN HAPPEN

Improper installation of accessories or modification of this vehicle may cause changes in handling which in some situations could lead to an accident.

HOW TO AVOID THE HAZARD

Never modify this vehicle through improper installation or use of accessories. All parts and accessories added to this vehicle should be approved by BRP and should be installed and used according to instructions. If you have questions, consult an authorized Can-Am dealer.

NEVER install passenger seat or use the cargo area to carry a passenger.

Modification of the vehicle to increase speed and performance may violate the terms and conditions of your vehicle's limited warranty. In addition, certain modifications including the removal of engine or exhaust components are illegal under most laws.

⚠ WARNING**POTENTIAL HAZARD**

Overloading this vehicle, carrying or towing cargo improperly.

WHAT CAN HAPPEN

Could cause changes in vehicle handling which could lead to an accident.

HOW TO AVOID THE HAZARD

Never exceed the stated load capacity for this vehicle including operator, as well as other loads and added accessories.

Cargo should be properly distributed and securely attached.

Reduce speed when carrying cargo or pulling a trailer. Allow greater distance for braking.

Always follow the instructions in this Operator's Guide for carrying cargo or pulling a trailer.

⚠ WARNING



V03M01Q

POTENTIAL HAZARD

Transporting flammable or dangerous material can lead to explosions.

WHAT CAN HAPPEN

This can cause serious injury or death.

HOW TO AVOID THE HAZARD

Never transport flammable or dangerous material.

RIDING THE VEHICLE

To fully appreciate the pleasures and excitement of riding this vehicle, there are some basic rules and tips that you **MUST** follow. Some may be new to you while others may be common sense or obvious.

Please take the time to study this Operator's Guide and all on-product safety labels as well as the *SAFETY DVD* video that came with this vehicle. They more completely describe what you should know about this vehicle before riding it.

Whether you are a new user or an experienced rider, it is important for your personal safety that you know the controls and features of this vehicle. Equally important is knowing how to properly ride.

This is a high performance ATV for off-road use only. Inexperienced riders may overlook risks and be surprised by the specific behavior of this ATV in any terrain condition.

We recommend following the age recommendation indicated on the safety label affixed on the unit. Even though a person may be within the age group for which this vehicle is recommended, he may not have the skills, abilities, or judgment needed to operate this vehicle safely and may be involved in a serious accident.

Individuals with cognitive or physical impairments or who are high risk takers have an increased exposure to overturns or collisions which may result in injury including death.

Not all vehicles are the same. Each has its own unique performance characteristics, controls and features. Each will ride and handle differently.

Become completely familiar with the operational controls and the general operation of the vehicle before venturing into off road conditions. Practice driving in a suitable area free of hazards and feel the response of each control. Drive at low speeds. Higher speeds require greater experience, knowledge and suitable riding conditions.

Riding conditions vary from place to place. Each is subject to weather conditions which may radically change from time to time and from season to season.

Riding on sand is different than riding on snow or through forests or marshes. Each location may require a greater degree of awareness and skill. Show good judgement. Always proceed with caution. Please do not take any unnecessary risks that could leave you stranded or possibly injured.

Never assume that the vehicle will go everywhere safely. Sudden changes in terrain caused by holes, depressions, banks, softer or harder "ground" or other irregularities may cause the vehicle to topple or become unstable. To avoid this, slow down and always observe the terrain ahead. If the vehicle does begin to topple or tip over, the best advice is to immediately get off **AWAY** from the direction of the tip over!

Pre-Ride Inspection

WARNING

Perform a pre-ride inspection before each ride to detect any potential problem that could occur during operation. The pre-ride inspection can help you monitor component wear and deterioration before they become a problem. Correct any problem that you discover to reduce the risk of a breakdown or crash. See an authorized Can-Am dealer as necessary.

Before using this vehicle, the operator should always perform the following pre-ride inspection check list.

Correct any problem found before riding the vehicle. See an authorized Can-Am dealer if necessary.

Pre-Ride Inspection Check List

What to Do Before Starting the Engine (Key OFF)

ITEMS TO BE INSPECTED	INSPECTION TO PERFORM	✓
Fluids	Check fuel, engine oil and coolant levels.	
Leaks	Check for any leaks under vehicle.	
Throttle lever	Activate throttle lever several times to ensure it operates freely. It must return to idle position when released.	
Brake lock	Apply brake lock and check if it operates properly.	
Tires	Check tire pressure and condition.	
Wheels	Check wheels for damage and for abnormal play.	
Radiator	Check cleanliness of the radiator.	
Drive shaft boots	Check drive shaft boots and protectors condition.	
Seat	Check if operator seat is in place and properly latched.	
Cargo	If you transport a cargo, respect the load capacity. Ensure cargo is properly secured to the rear cargo area.	
	If you are pulling a trailer or an other equipment: <ul style="list-style-type: none"> – Check hitch and trailer ball condition. – Respect the tongue capacity and towing capacity. – Ensure trailer is properly secured to hitch. 	
Storage compartments	Check if rear storage compartments are properly latched.	
Chassis and suspension	Check underneath vehicle for any debris on chassis or suspension and clean them properly.	

What to Do Before Starting the Engine (Key ON)

ITEMS TO BE INSPECTED	INSPECTION TO PERFORM	✓
Multifunction gauge	Check operation of indicator lamps in multifunction gauge (during first few seconds of key ON).	
	Check for messages on multifunction gauge.	
Lights	Check operation and cleanliness of headlights and taillight.	
	Check operation of high and low beam.	
	Check operation of brake light.	

What to Do After the Engine Is Started

ITEMS TO BE INSPECTED	INSPECTION TO PERFORM	✓
Steering	Check if steering operates freely by completely turning it from side to side.	
Shift lever	Check operation of shift lever (P, R, N, H and L).	
2WD/4WD selector	Check operation of 2WD/4WD selector.	
Brakes	Drive forward slowly a few feet and apply brakes individually to test them. The brakes must fully apply. Lever and pedal must fully return when released.	
Emergency engine stop switch	Check that the emergency engine stop switch is working properly.	
Ignition switch	Check if ignition switch is working properly by restarting and stopping the engine.	

Riding Gear

Actual weather conditions should help you decide how to dress. Dress for the coldest weather expected. Thermal underwear next to the skin also provides a good insulation. It is important that the operator always wears the appropriate protective clothing and apparel, including an approved helmet, eye protection, boots, gloves, a long sleeved shirt and pants. This type of clothing will provide you protection from some of the minor hazards you may encounter en route. The operator must never wear loose clothing such as a scarf that may get entangled in the vehicle or on tree branches and shrubs. Depending on conditions, anti-fogging goggles or sunglasses may be required. Different colored lenses available for goggles or sunglasses help you distinguish terrain variations. Sunglasses should only be worn during the daytime.

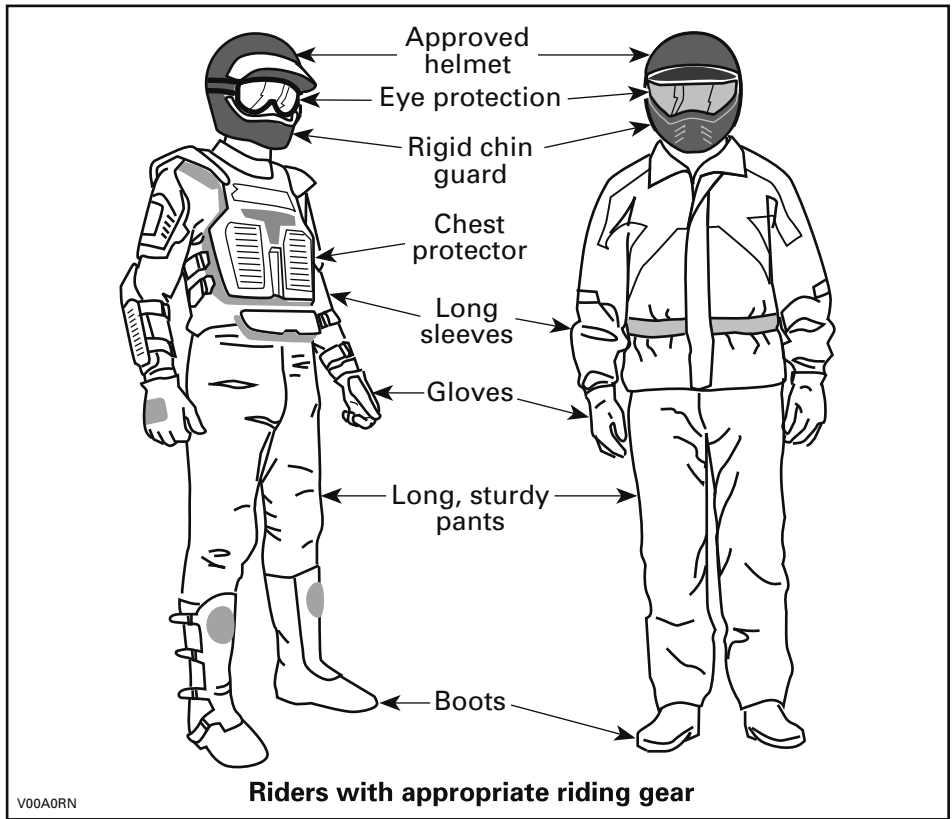

Carrying a Passenger is Prohibited

This vehicle is designed specifically to carry an operator only. Even with a long seat, this vehicle is not designed nor intended to carry passenger(s). NEVER install passenger seat or use the cargo area to carry passenger(s). Carrying passenger(s) may affect the stability and your control of the vehicle.

Carrying Loads

Any load carried on the vehicle will affect the handling, stability and braking distance of the vehicle. For this reason, do not exceed the load limits of the vehicle's manufacturer. Refer to *MAXIMUM LOADS* table below. Always make sure the load is secured, properly distributed and cannot interfere with your proper control. Always be aware that the "load" may slide or fall off and create an accident. Avoid loads that may protrude sideways and get snagged or caught in brush or other obstacles. Avoid covering and obstructing the headlights or brake light with the cargo.

Safely reduce speed according to terrain conditions when carrying cargo or pulling a trailer. Allow greater distance for braking. Always secure cargo as low as possible on the rack to reduce the effect of a higher center of gravity.

MAXIMUM LOADS		
TOTAL LOAD ALLOWED	189 kg (417 lb)	Includes driver, all other loads, tongue weight and added accessories.
REAR CARGO AREA	90 kg (200 lb)	Evenly distributed. Includes rear rack, rear storage box, rear storage compartment and tongue load.

Hauling a Trailer

Riding this vehicle with a trailer substantially increases the risk of toppling, especially on inclined slopes. If a trailer is used, make sure that its hitch is compatible with the one on the vehicle. Make sure the trailer is horizontal with the vehicle (in some instances a special extension may have to be installed on the vehicle hitch). Use security chains to secure the trailer with the vehicle. This vehicle may require additional stopping distance if hauling heavy loads, especially on inclined surfaces. Always use low range. Keep vehicle speed at a slow pace, especially for turning. Be careful not to skid or slide. When stopped or parked, block the vehicle and trailer wheels from possible movement. Always make sure load is evenly distributed on the trailer. Use caution when disconnecting a loaded trailer; it or its load may topple on you or others.

Working with your Vehicle

Your vehicle can help you perform a number of different LIGHT tasks ranging from snow removal to pulling wood or carrying cargo. A variety of accessories are available from your authorized Can-Am dealer. However, always respect the load and capacities of the vehicle. Overloading of the vehicle can overstress the components and cause failure. To prevent possible injury, it is equally important to follow the instructions and warnings that accompany the accessory. Avoid any physical exertion through lifting or pulling of heavy loads or man powering the vehicle. (Continue to read *RECREATIONAL RIDING* below).

Recreational Riding

Respect the rights and limitations of others. Stay away from areas designated for other types of off road use. This includes snowmobile trails, equestrian trails, cross country ski trails, mountain bike trails, etc. Never assume there are no other

users on the trail. Always stay to the complete right of the trail and do not zig zag to one side of the trail then the other. Be prepared to stop or pull off to the side if another trail user appears in front of you.

Join a local ATV club. It will provide you with a map and advice or inform you where you can ride. If a club does not exist in your area, help to start one. Group riding and club activities provide a pleasurable, social experience.

Always keep a safe distance from other riders. Your judgment of speed, terrain conditions, weather, mechanical condition of your vehicle and the "trust in judgment" you have in others around you will help you make a better choice of appropriate safe distance. This vehicle, like any other motorized vehicle, cannot stop "on a dime".

Before you ride, tell someone where you are planning to travel and your expected time of return.

Depending on the length of your ride, carry additional tools, drinking water, food and emergency equipment. Find out where you can get additional gasoline and oil. Be prepared for the possible conditions you may encounter.

First aid kit	Adjustable wrench
Mobile phone	Knife
Friction tape	Flashlight
A rope	Colored lens goggles
Spare light bulbs	Trail map
Provided tool kit	Snack

Mud Riding

This vehicle is designed specifically for mud riding and unless ridden in ATV trails, it should be run in low range.

Although this vehicle is built for rough terrain, extreme conditions and improper use may lead to premature wear or even failure of certain vehicle components. Avoid jerking steering and/or full steering stroke in very thick mud under high throttle demand.

Inspection and maintenance schedule need to be followed rigorously.

Environment

One of the benefits of this vehicle is that it can take you off the beaten path away from most communities. However, you should always respect nature and the rights of others to enjoy it. Do not ride in environmentally sensitive areas. Do not drive over forest crops or shrubs, nor cut down trees or take down fencing, nor spin your wheels and destroy the terrain. "Tread Lightly".

Chasing wildlife is in many areas illegal. Wildlife can die of exhaustion after being chased by a motorized vehicle. If you encounter animals on the trail, stop and observe quietly and with caution. It will be one of the better memories of your life.

Observe the rule: “what you take in, carry out”. Do not litter. Do not start campfires unless you have permission to do so, and then only away from dry areas. The hazards you may create on the trail may cause injury to others or yourself, even at a later date.

Respect farm lands. Always obtain the permission of the landowner before riding on private land. Respect crops, farm animals and property lines. If you come to a closed a gate, close it again behind you.

Finally, do not pollute streams, lakes or rivers and do not modify the engine or exhaust system, or remove any of its components.

Design Limitation

Although the vehicle is exceptionally rugged for its class, it is still a light vehicle by definition and its operation must be restricted to its proper purpose.

The addition of weight to any part of the vehicle changes its gravitational stability and modifies its performance.

Off-Road Operation

The very nature of off-road operation is dangerous. Any terrain, which has not been specially prepared to carry vehicles, presents an inherent danger where terrain substance and exact steepness are unpredictable. The terrain itself presents a continual element of danger, which must be knowingly accepted by anyone venturing over it.

An operator who takes a vehicle off-road should always exercise the utmost care in selecting the safest path and keeping close watch on the terrain ahead of him. On no account should the vehicle be operated by anyone who is not completely familiar with the driving instructions applicable to the vehicle, nor should it be operated on steep or treacherous terrain.

General Operating and Safety Precautions

Care, caution, experience and driving skill are the best precautions against the hazards of vehicle operation.

Whenever there is the slightest doubt that the vehicle can safely negotiate an obstacle or a particular piece of terrain, always choose an alternate route.

In off-road operation, power and traction, not speed, are important. Never drive faster than visibility and your own ability to select a safe route permit.

Constantly watch the terrain ahead for sudden changes in slopes or obstacles, such as rocks or stumps, that may cause loss of stability, resulting in tip over or rollover.

When operating in reverse, check that the path behind the vehicle is free of people or obstacles. Proceed slowly and avoid sharp turns.

It is also wise to know the terrain condition on the other side of a hill or bank. All too often there exists a sharp drop-off that is impossible to negotiate or descend.

Whenever there is the slightest doubt that the vehicle can safely negotiate an obstacle or a particular piece of terrain, always choose an alternate route.

Reverse Operation

When operating in reverse, check that the path behind the vehicle is free of people or obstacles. Proceed slowly and avoid sharp turns.

We recommend sitting on your ATV when operating in reverse. Avoid standing up. Your weight could shift forward against throttle lever, causing an unexpected acceleration.

Uphill Driving

Due to configuration, this vehicle has excellent climbing ability, so much so that it is possible to tip over before traction is lost. For example, it is common to encounter terrain situations where the top of the hill has eroded to a point that the hill peak rises very sharply. The vehicle can readily negotiate such a condition, however, in doing so, when the front of the vehicle is driven to a point that the vehicle's balance moves rearward, a tip over can occur.

The same situation may apply if an embedded object causes the front of the vehicle to climb more than desired. If such a situation occurs take an alternate route. Be aware of side hilling dangers when doing so.

It is also wise to know the terrain condition on the other side of the hill or bank. All too often there exists a sharp drop-off that is impossible to negotiate or descend.

Downhill Driving

This vehicle can climb slopes that are steeper than it can safely descend. Therefore, it is essential to assure that a safe route exists to descend a slope before you climb it.

Decelerating while negotiating a slippery downhill slope could "toboggan" the vehicle. Maintain steady speed and/or accelerate slightly to regain control.

Side Hilling

Whenever possible, such operation should be avoided. If necessary, do so with extreme caution. Side hilling on steep inclines could result in rollover. In addition, slippery or loose surfaces could result in uncontrollable side sliding. Do not attempt to turn the vehicle downhill with the slide. Avoid all objects or depressions that will intensify the raising of one side of the vehicle higher than the other, thus causing rollover.

Drop-Offs

This vehicle will "bottom-out" and usually stop if either the front or rear wheels are driven over a drop-off. If the drop is sharp or deep, the vehicle will nose dive and tip over.

WARNING

Avoid negotiating drop-offs. Reverse and select an alternate route.

Riding on Snow Covered Surfaces

When performing the pre-ride inspection, pay special attention to locations on the vehicle where snow and/or ice accumulations may obstruct visibility of the taillight and reflectors, clog ventilation openings, block the radiator and fan, and interfere

with the movement of control levers, switches and brake pedal. Before starting with your ATV check the steering, throttle and brake lever and pedal controls for interference free operation.

Whenever an ATV is ridden on a snow covered drive path the tire grip is generally reduced causing the vehicle to react differently to control inputs from the operator. On low grip surfaces, the steering responses are not as crisp and precise, stopping distances are lengthened and acceleration becomes sluggish. Slow down and do not "gun" the throttle. This will only result in spinning of the tires and possibly in an over steering slide of the vehicle. Avoid hard braking. This will possibly result in a straight line slide of the vehicle. Again, the best advice is to safely reduce speed in anticipation of a maneuver so to give yourself time and distance to regain total vehicle control before it spins out of your control.

As you drive your ATV over a loose snow covered surface, snow dust will be picked up in the wake turbulence of the moving vehicle and transported to contact and accumulate or melt on some exposed components including rotating parts like brake discs. Water, snow or ice may affect the response time of the brake system of your ATV. Even when not required to reduce vehicle speed apply brakes frequently to prevent ice or snow accumulation and to dry brake pads and discs. While doing so in low risk driving situations you will test for grip level and keep yourself alerted to how the vehicle reacts to your control inputs. Always keep brake pedal, footrests, floor boards, brake and throttle levers free of snow and ice. Frequently wipe snow off seat, hand grips, headlights, taillights and reflectors.

The depth of the snow cover may hide rocks, tree stumps or other objects and if it is wet may totally impede the drivability as the vehicle becomes bogged down or completely loses traction in slushy snow. Look far ahead and always be watchful of any visible clues that might indicate the presence of such obstacles. In doubt steer clear. Avoid driving on any frozen body of water before checking that the ice will safely support the ATV, its riders and its load of cargo. Remember that a given thickness of ice may be sufficient to support a snowmobile but not an ATV of an identical weight because of the smaller load bearing surface of the four tire contact patches as compared to that of a snowmobile track and skis.

To maximize comfort and avoid frostbite, always wear clothing and ATV protective equipment appropriate for the weather conditions you will be exposed to during your ride.

At the end of each ride it is a good practice to clean the vehicle body and all moving components (brakes, steering components, drivelines, controls, radiator fan etc.) from any snow or ice accumulations. Wet snow will turn to ice during the shut down period and become more difficult to remove at the next pre-ride inspection.

Riding Techniques

Riding your vehicle too fast for the conditions may result in injury. Apply only enough throttle to proceed safely. Statistics show that high speed turns usually result in mishaps and injury. Always remember that this vehicle is heavy! Its pure weight alone may entrap you should it fall and pin you down.

This vehicle is not designed for jumping, nor can it fully absorb the high impact energy generated during manoeuvres such as jumping which, can be passed on to you, the operator. Performing wheelies can cause the vehicle to flip over onto you. Both practices have a high risk for you and should be avoided at all times.

To maintain proper control it is strongly advised that you keep your hands on the handlebar and within easy reach of all controls. The same holds true for your feet. To minimize the possibility of a leg or foot injury, keep your feet on the footrests at all times. Do not direct your toes outwards nor extend your feet out to assist in turning as they can be hit or be snagged on passing obstacles, or may come into contact with the wheels.

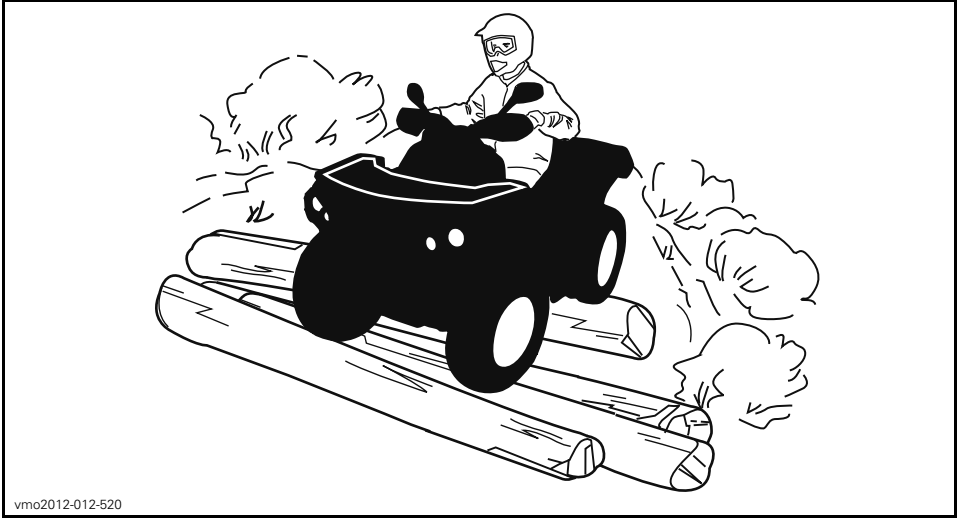

Even though there is an adequate suspension system on this vehicle there are “washboard” or rough terrain conditions that will make you feel uncomfortable and can even cause a back injury. “Posting” or riding in a crouched position will often be required. Slow down and allow your flexed legs to absorb part of the impact energy.

This vehicle is not designed for riding on roads or highways. (In most places it is an illegal practice). Riding your vehicle on roads or highways could cause a collision to occur with another vehicle.

The tires of this vehicle are not suited for paved road use. Also this vehicle is not equipped with a rear differential (rear wheels are always turning at the same speed). For these reasons, pavement may seriously affect the handling and control of the vehicle.

Riding on roads or soft shoulders may confuse other road users, especially if your lights are on.

If you have to cross a road, the lead driver should get off his vehicle, then observe and give directions to the other riders. The last person after crossing then assists the lead driver to cross. Do not travel on sidewalks. They are designated for pedestrian use.

Water can be a unique hazard. If it is too deep the vehicle may “float” and topple. Check the water depth and current before you attempt to cross any water. Water should not go above the tires. Be wary of slippery surfaces such as rocks, grass,

logs, etc., both in the water and on its banks. A loss of traction may occur. Do not attempt to enter the water at high speed. The water will act as a brake and could throw you off the vehicle, on the ground.

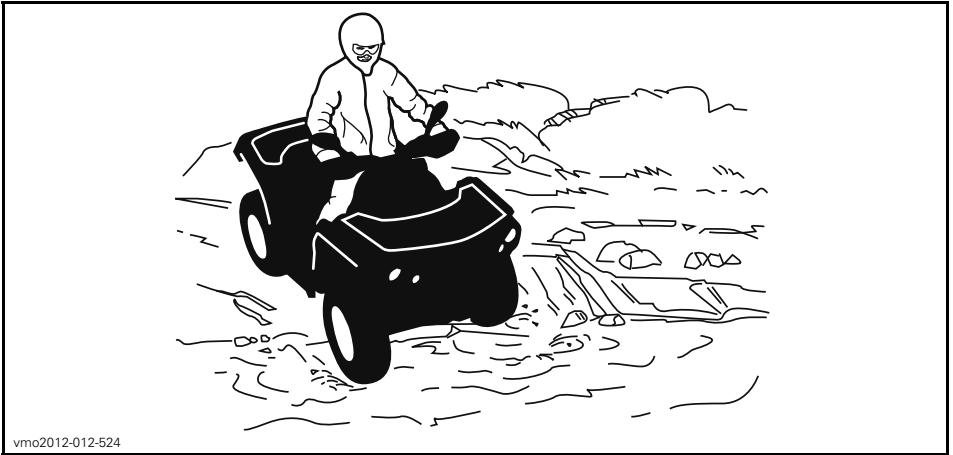

Water will affect the braking ability of your vehicle. Make sure you dry the brakes by applying them several times after the vehicle leaves the water.

Mud or marsh lands may be encountered near water. Be prepared for sudden "holes" or changes in depth. Similarly so, be watchful of hazards such as rocks, logs, etc., partially covered by vegetation.

If your route crosses frozen waterways, make sure the ice is thick enough and sound enough to support the total weight of yourself, the vehicle and its load. Be ever watchful of open water, it is a sure indication that the ice thickness will vary. If in doubt, do not attempt to cross.

Ice will also affect the control of the vehicle. Slow down and do not "gun" the throttle. This will only result in spinning of the tires and possible tip over of the vehicle. Avoid rapid braking. This again will possibly result in an uncontrolled slide and tip over of the vehicle. Slush should be avoided at all times since it could block the operation or controls of the vehicle.

Riding in snow may reduce the brakes stopping capability. Safely reduce speed and allow greater distance for braking. Snow projection may cause ice build up or snow accumulation on brake components and controls. Apply brakes frequently to prevent ice or snow accumulation. Refer to *GENERAL OPERATING AND SAFETY PRECAUTIONS* in this subsection for more detailed information regarding riding on snow covered surfaces.

Riding on sand, sand dunes or on snow is another unique experience, but there are some basic precautions that should be observed. Wet, deep or fine sand/snow may create a loss of traction and cause the vehicle to slide, drop off or become "bogged" down. If this occurs look for a firmer base. Again, the best advice is to slow down and be watchful of the conditions.

When riding in sand dunes it is advisable to equip the vehicle with an antenna type safety flag. This will help make your location more visible to others over the next sand dune. Proceed carefully should you see another safety flag ahead. Since the antenna type safety flag can snag and rebound on your body if caught, do not use it in areas where there are low hanging branches or obstacles.

Riding on loose stones or gravel is very similar to riding on ice. They will affect the steering of vehicle, possibly causing it to slide and tip over especially at high speeds. In addition, braking distance may be affected. Remember that "gunning" the throttle or sliding may cause loose stones to be ejected rearwards into the path of another rider. Never do it deliberately.

If you do get into a slide or skid, it may help to turn the handlebar in the direction of the skid until you regain control. Never jam the brakes and lock the wheels.

Respect and follow all posted trail signs. They are there to help you and others.

Obstacles in the "trail" should be traversed with caution. This includes loose rocks, fallen trees, slippery surfaces, fences, posts, and embankments and depressions. You should avoid them whenever possible. Remember that some obstacles are too large or dangerous to cross and should be avoided. Small rocks or fallen trees may be safely crossed, approach at a 90° angle. Stand on the footrests while keeping your knees flexed. Adjust speed without losing momentum and do not "gun" the throttle. Hold handlebar firmly. Place your body weight rearwards and proceed. Do not try to lift the vehicle front wheels off the ground. Be aware that the object may be slippery or may move while crossing.

When driving on hills or slopes two things are highly important. Be prepared for slippery surfaces or terrain variations and obstacles and use proper body positioning.

When stopped or parked always apply the parking device. This is especially important when parking on a slope. On very steep inclines or if the ATV is carrying cargo, the wheels should be blocked using rocks or bricks.

Uphill

Keep your body weight forward towards the top of the hill. Keep your feet on the footrests and shift into low range then accelerate. Do not over-speed since this may cause the front of the vehicle to lift from the ground and fall back on you. If the hill is too steep and you cannot proceed or the vehicle begins to roll backwards, apply the front brake, being careful not to slide. Dismount, then use the "U" turn or "K" turn (while walking back, next to the vehicle on the up hill side and with a hand on the brake lever, slowly back the rear of the vehicle toward the top of the hill then drive downhill). Always walk or dismount on the upside of the slope while keeping clear of the vehicle and its rotating wheels. Do not try to hold on to the vehicle if it begins to topple. Stay clear. Do not ride over the crest of the hill at high speed. Obstacles, including sharp drop-offs, may exist.



vmo2012-012-526

Downhill

Keep your body weight rearwards. Apply the brake gradually to prevent skidding. Do not "coast" down the slope using solely engine compression or in neutral gear.

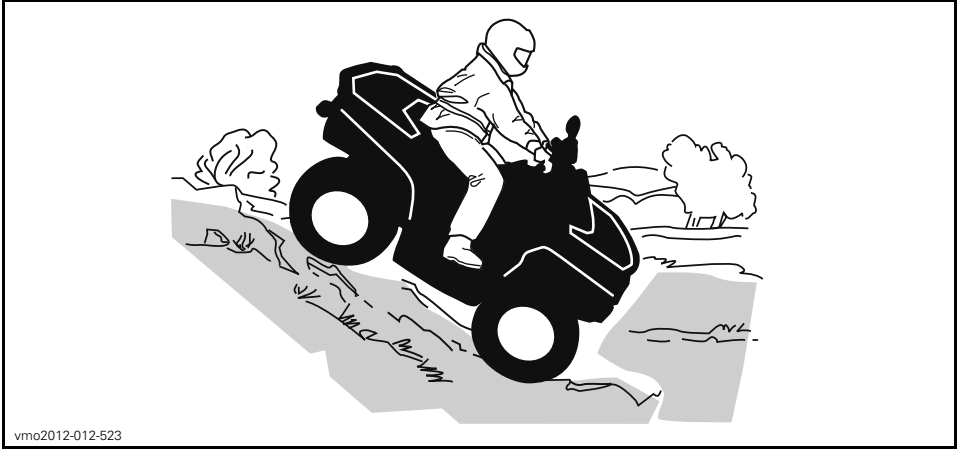

Side Hilling

This is one of the **most risky** types of riding since it may drastically change the balance of the vehicle. It should be avoided wherever possible. However, if it is necessary to do so, it is important that you **ALWAYS** keep your body weight on the up-side of the slope and be prepared to dismount on that side should the vehicle begin to topple. **Do not try to stop or save the vehicle from damage.**



IMPORTANT ON-PRODUCT LABELS

This vehicle comes with hang tags and labels containing important safety information.

Any person who rides this vehicle should read and understand this information before riding.

Hang Tag

S SPORT MODEL

THIS ATV IS FOR
RECREATIONAL USE
BY EXPERIENCED OPERATORS ONLY.

OPERATOR ONLY-NO PASSENGERS

NO OPERATOR UNDER AGE 16

THIS CATEGORY S (SPORT) ATV IS A HIGH PERFORMANCE ATV FOR OFF ROAD USE ONLY. IT IS FOR SPORT TYPE RECREATIONAL AND COMPETITIVE USE BY OPERATORS WITH ADVANCED SKILLS AND SUBSTANTIAL EXPERIENCE.

TRAINING COURSES TO TEACH ATV RIDING SKILLS ARE AVAILABLE. FOR INFORMATION CONTACT YOUR DEALER.

CHECK WITH YOUR DEALER TO FIND OUT ABOUT STATE OR LOCAL LAWS REGARDING ATV OPERATION.

THIS HANGTAG IS NOT TO BE REMOVED BEFORE SALE.

704903318

704903318

⚠ WARNING

Improper ATV use can result in SEVERE INJURY or DEATH.



ALWAYS USE AN APPROVED HELMET AND PROTECTIVE GEAR.



NEVER USE ON PUBLIC ROADS.



NEVER CARRY PASSENGERS.



NEVER USE WITH DRUGS OR ALCOHOL.

NEVER operate:

- without proper training or instructions.
- at speeds too fast for your skills or the conditions.
- on public roads - a collision can occur with another vehicle.
- with a passenger - passengers affect balance and steering and increase risk of losing control.

ALWAYS:

- use proper riding techniques to avoid vehicle overturns on hills and rough terrain and in turns.
- avoid paved surfaces - pavement may seriously affect handling and control.

LOCATE AND READ OPERATOR'S GUIDE.
FOLLOW ALL INSTRUCTIONS & WARNINGS.

VEHICLE ENGINE DESCRIPTION:

650 H.O. 4 STROKE

EPA CERTIFIED

NER (NORMALIZED EMISSION RATE) = **6.3**
ON A 0 TO 10 SCALE, 0 BEING THE CLEANEST

*NOT TO BE REMOVED PRIOR TO SALE

704901764



704901764

DESCRIPTION DU MOTEUR DU VEHICULE:

650 H.O. 4 TEMPS

EPA CERTIFIÉ

TEN (TAUX D'EMISSION NORMALISÉ) = **6.3**
SUR UNE ÉCHELLE DE 0 À 10,
0 ÉTANT LE PLUS PROPRE.

*NE PAS ENLEVER AVANT LA VENTE.

704901764



TYPICAL

Vehicle Safety Labels

Read and understand all the safety labels on your vehicle.

The safety labels on your vehicle should be considered permanent parts of the vehicle. If missing or damaged, they can be replaced free of charge. See an authorized Can-Am dealer.

NOTE: The following illustrations used in this Operator's Guide are a general representation only. Your model may differ.

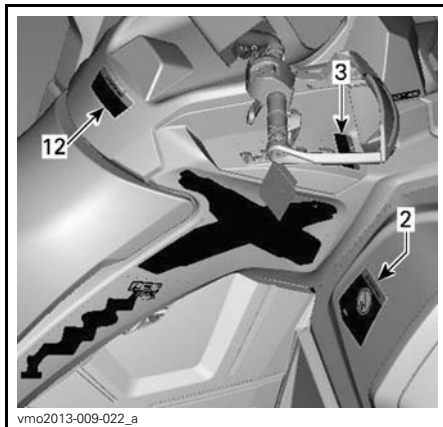
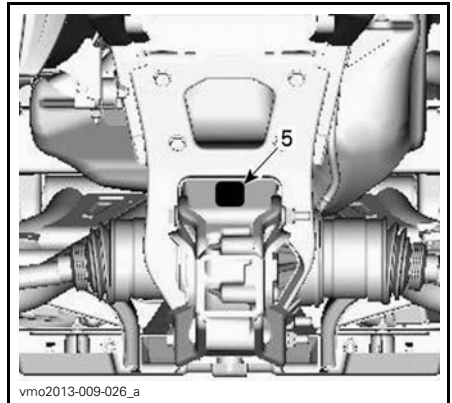
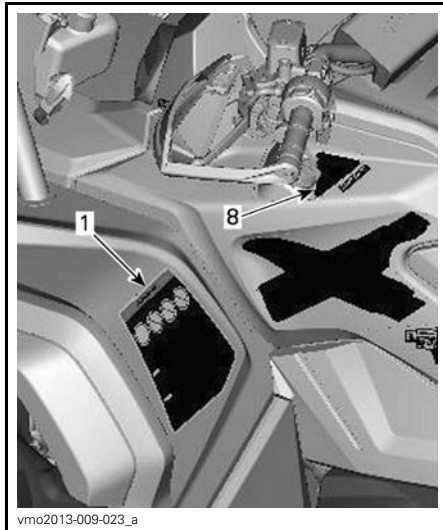

TYPICAL

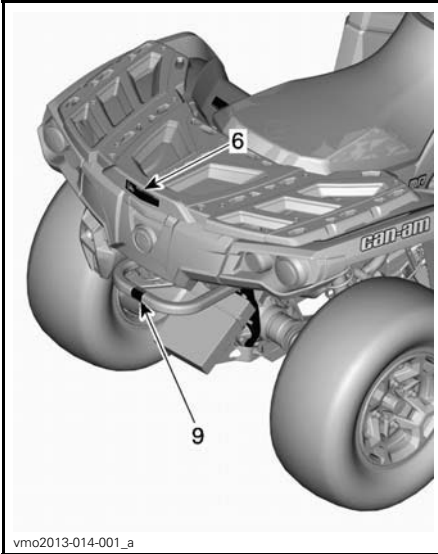

WARNING

Improper ATV use can result in SEVERE INJURY or DEATH

ALWAYS USE AN APPROVED HELMET AND PROTECTIVE GEAR

NEVER USE ON PUBLIC ROADS

NEVER CARRY PASSENGERS

NEVER USE WITH DRUGS OR ALCOHOL

NEVER operate:

- without the proper ATV training or instructions.
- at speeds too fast for your skills or conditions.
- on public roads - a collision can occur with another vehicle.
- with a passenger - passengers affect balance and steering and increase risk of losing control.

ALWAYS

- use proper riding techniques to avoid vehicle overturns on hills and rough terrain and in turns.
- avoid paved surfaces - pavement may seriously affect handling and control.

LOCATE AND READ OPERATOR'S GUIDE
FOLLOW ALL INSTRUCTIONS & WARNINGS.

704902787

LABEL 1

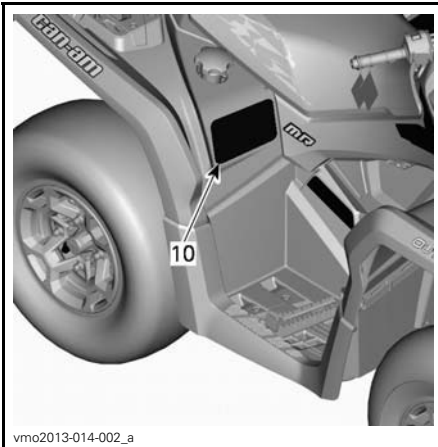

WARNING

UNDER 16

Operating this ATV if you are under the age 16 increases the chance of SEVERE INJURY or DEATH.

NEVER operate this ATV if you are under the age 16.

704902775A

LABEL 2

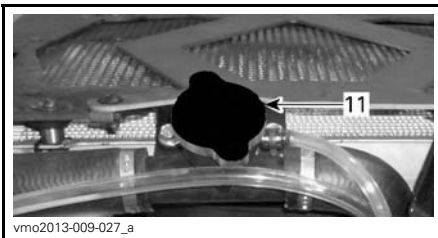

NOTICE

- ATV MUST be stopped before shifting lever.
- ALWAYS apply foot brake to shift from Park (P) and Neutral (N).

704902793

LABEL 3



LABEL 4



LABEL 5: REFER TO SPECIFICATIONS FOR VALUES

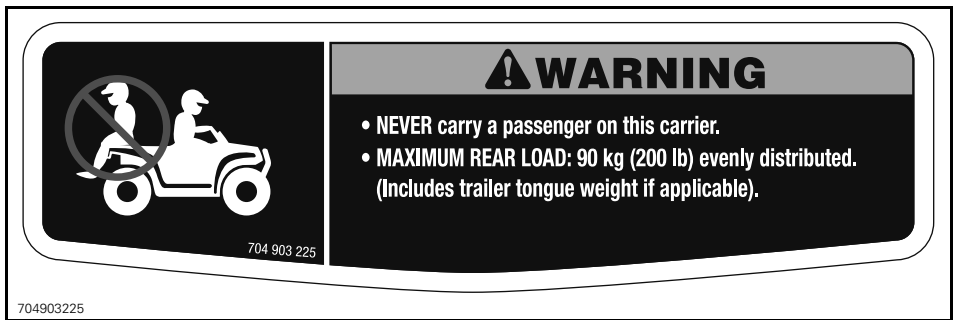

LABEL 6: FRONT AND REAR FENDER (REFER TO SPECIFICATIONS FOR VALUES)

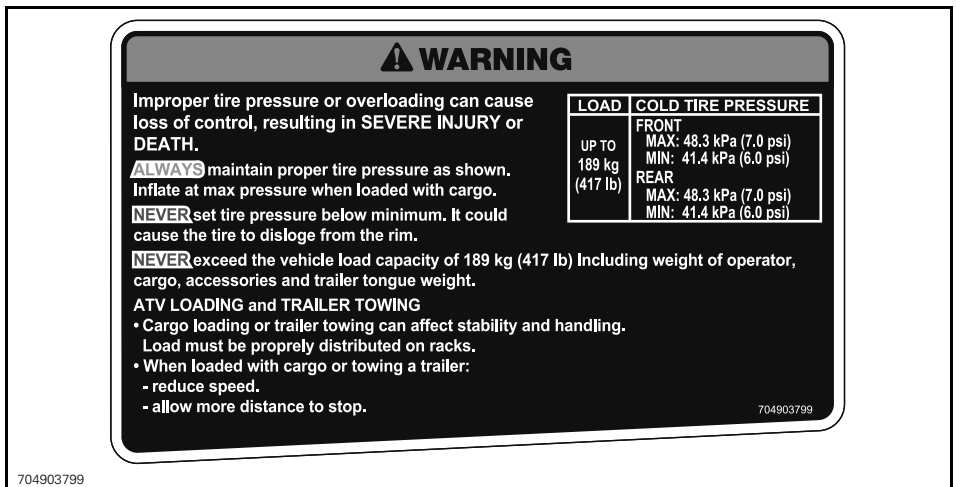

LABEL 7: (REFER TO SPECIFICATIONS FOR VALUES)

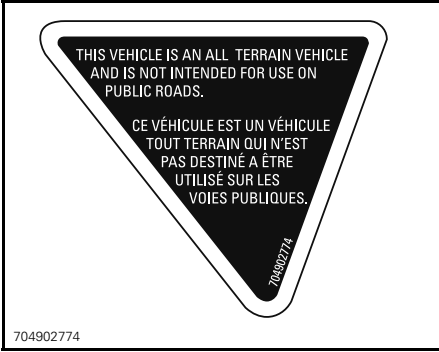

704902774
LABEL 8



704902777A
LABEL 9



704902779A
LABEL 10: FOR VEHICLES OUTSIDE CANADA - US



vmo2010-010-100_a
LABEL 11 - LOCATED ON RADIATOR CAP

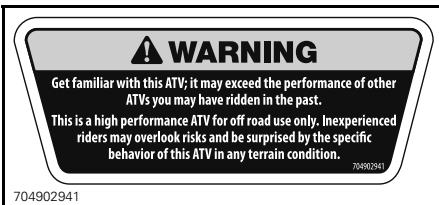

704902941
LABEL 12

Compliance Labels

These labels indicate vehicle's compliance.



LOCATION: UNDER SEAT, ON THE UPPER BAR OF FRAME



LOCATION: UNDER SEAT, ON THE UPPER BAR OF FRAME



LOCATION: REAR FENDER

Technical Information Label

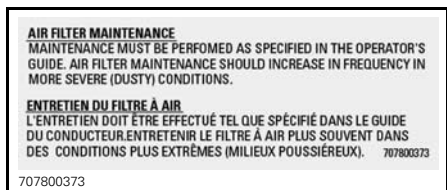

LOCATION: UNDER SEAT, ON THE UPPER BAR OF FRAME

VEHICLE INFORMATION

CONTROLS/INSTRUMENTS/EQUIPMENT

NOTE: Some controls/instruments/equipment are optional.

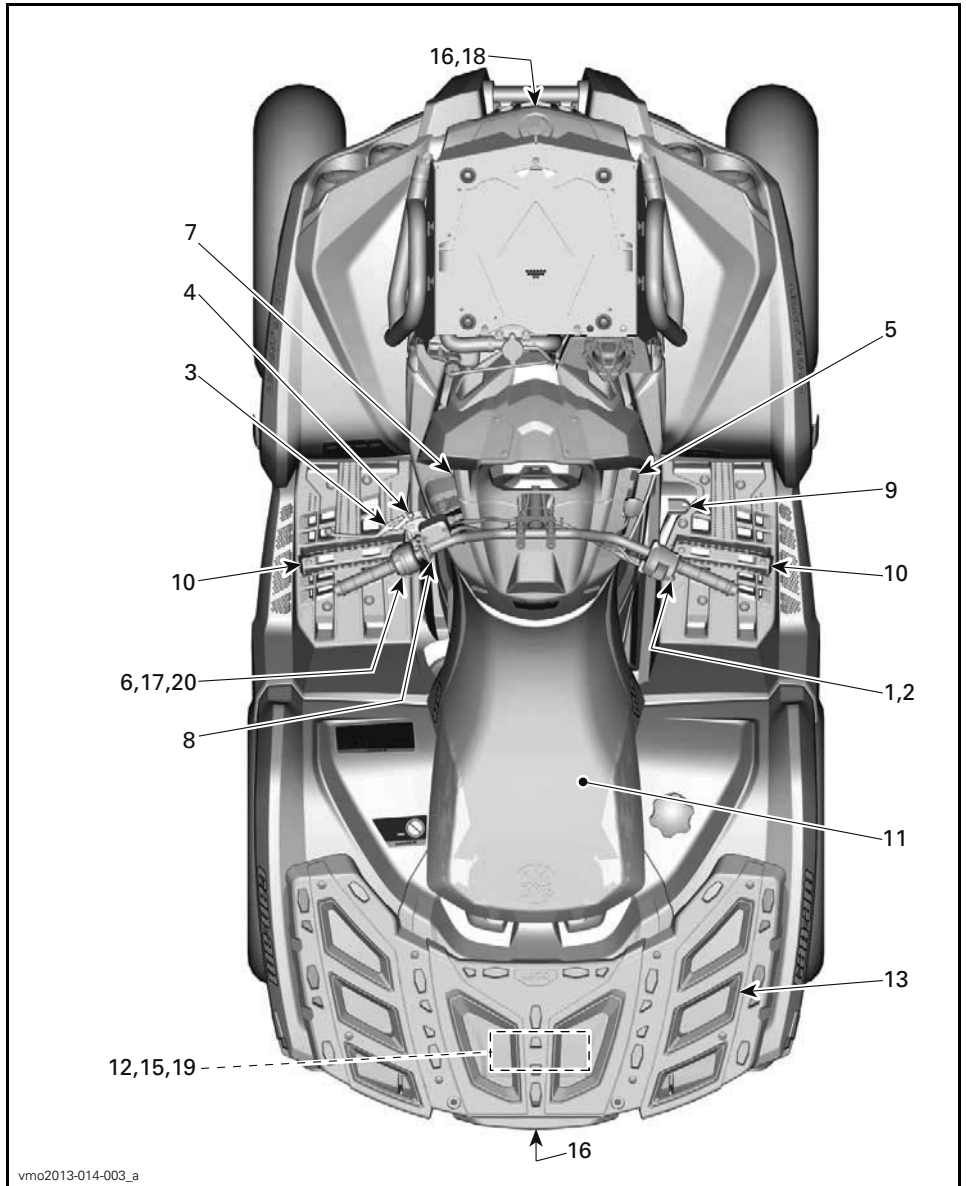

TYPICAL

1) Throttle Lever

The throttle lever is located on the RH side of the handlebar.

When pushed forward, it increases the engine speed and allows engagement of the transmission on the selected range.

When released, the engine speed should automatically return to idle and the vehicle will gradually slow down.

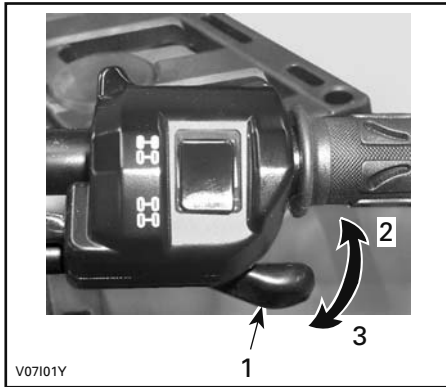

TYPICAL

1. Throttle lever
2. To accelerate
3. To decelerate

2) 2WD/4WD Selector

The 2WD/4WD selector is located on the RH side of the handlebar.

This selector allows to choose between 2WD and 4WD when the vehicle is stopped.

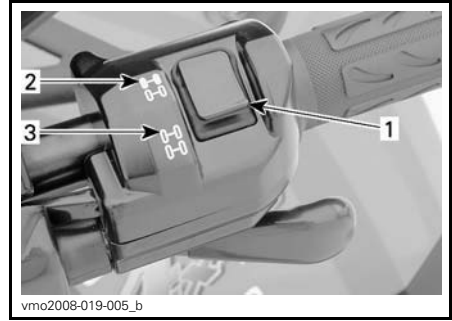

TYPICAL

1. Selector
2. 2WD position
3. 4WD position

NOTICE The vehicle must be stopped to engage or disengage 2WD/4WD selector. Mechanical damage may occur if selector is engaged or disengaged while driving.

NOTICE If the rear wheels are spinning, release the throttle and wait engine return to the idle before selecting the 4WD mode.

The 4WD mode is engaged when the selector is pushed downwards.

While reading this Operator's Guide, remember that:

WARNING

Indicates a potential hazard that, if not avoided, could result in serious injury or death.



V0710DY

4WD MODE

To deselect the 4WD mode, press the selector on 2WD.



V0710EY

2WD MODE

When the selector is located on the 2WD, the vehicle is in 2 wheel drive at all time.

3) LH Brake Lever

When the LH brake lever is pressed the front and rear brakes are applied.

When released the brake lever should automatically return to its original position.

Braking effect is proportional to the force applied on the lever.

NOTE: As on other wheeled vehicles, the vehicle weight is transferred to the front wheels when braking. To obtain greater stopping efficiency, the brake system distributes more braking force to the front wheels. This will affect vehicle handling and steering control when braking vigorously. Take it into account when braking.

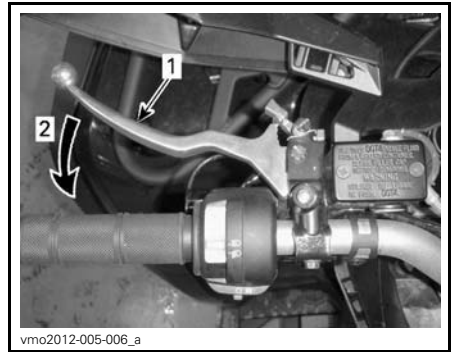

vmo2012-005-006_a

- TYPICAL**
1. Brake lever
 2. To apply brakes

4) Brake Lock

The brake lock is located on the LH side of the handlebar.

The brake lock function is to apply brake to all wheels to prevent vehicle from moving when parked.

⚠ WARNING

Always use the brake lock **and** engage the **PARK** position on the shift lever when the vehicle is not in operation.

To engage brake lock: Squeeze brake lever and maintain while moving lever lock. Brake lever is now compressed and applying all brakes.

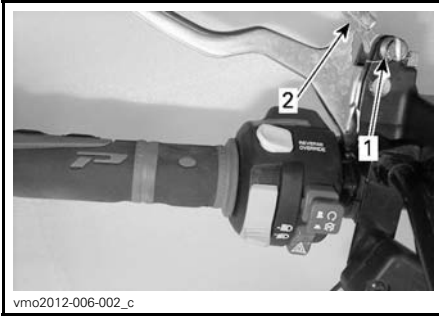
**TYPICAL**

1. Brake lever lock
2. Press to apply brake locks

NOTE: Locking lever can be adjusted in several positions.

NOTICE Ensure when the brake lock is applied that the vehicle stays securely in place.

To release brake lock: Squeeze brake lever. Lever lock should automatically return to its original position. Brake lever should return to rest position.

⚠ WARNING

Make sure brake lock is released before operating the vehicle. If brake lock is left ON while riding, it may cause damage to the brake system and cause loss of braking capacity and/or fire.

5) Shift Lever

The shift lever is located on the RH side of the vehicle near steering column.

**SHIFT LEVER LOCATION**

The shift lever is used to change the gearbox position.

The shift lever has 5 positions:

SHIFT LEVER POSITIONS	
POSITION	GEAR
P	Park
R	Reverse
N	Neutral
H	High range (forward)
L	Low range (forward)

**SHIFT PATTERN**

The vehicle must be stopped and brakes applied prior to selecting any gear.

NOTICE This gearbox is not designed to shift while vehicle is moving.

P: Park

The park position locks the gearbox to help prevent vehicle movement.

⚠ WARNING

Always use the PARK (P) position when the vehicle is not in operation. The vehicle can roll if the shift lever is not set to P (PARK).

R: Reverse

The reverse position allows the vehicle to go backwards.

NOTE: In reverse operation, the engine's RPM is limited, thus limiting the vehicle reverse speed.

⚠ WARNING

When driving downhill in reverse, gravity can increase the vehicle speed above the set limited reverse speed.

Neutral

The neutral position disengages the gearbox.

⚠ WARNING

Always use the PARK (P) position when the vehicle is not in operation. The vehicle can roll if the shift lever is set to N (NEUTRAL).

High Range (Forward)

This position selects the high speed range of the gearbox. It is the normal driving speed range. It allows the vehicle to reach its maximum speed.

Low Range (Forward)

This position selects the low speed range of the gearbox. It allows the vehicle to move slowly with maximum torque at the wheels.

NOTICE Use the low speed range to pull a trailer, carry heavy cargo, go over obstacles or drive uphill and downhill.

6) Multifunction Switch

The multifunction switch is located on the LH side of the handlebar.

The controls located on this multifunction switch are:

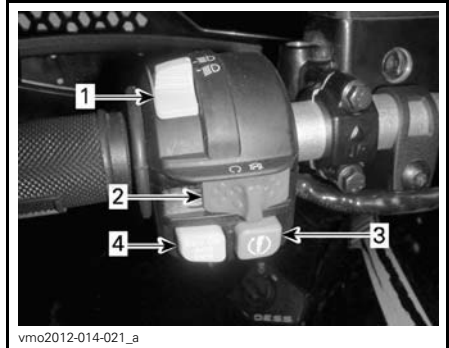

TYPICAL — MULTIFUNCTION SWITCH

1. Headlight switch
2. Emergency engine stop switch
3. Engine start button
4. Override/DPS button

Headlight Switch

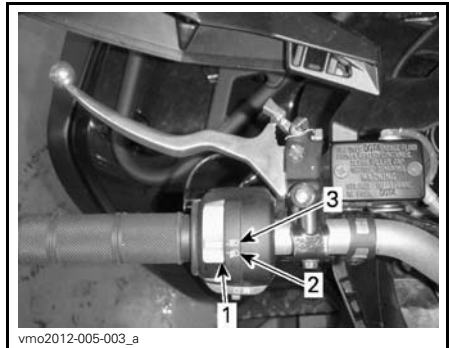

HEADLIGHT SWITCH FUNCTIONS

1. Headlight switch
2. Low beam and taillight
3. High beam and taillight

NOTE: Place ignition switch to ON "without light" position to close the headlight.



IGNITION SWITCH POSITIONS

1. OFF
2. ON "with light"
3. ON "without light"

Emergency Engine Stop Switch

This switch can be used to stop the engine and as an emergency control.

To stop engine, fully release throttle lever then set the emergency engine stop switch to the STOP position.

NOTE: While the engine can be stopped by turning the ignition key to OFF position, we recommend the engine be stopped by setting the emergency engine stop switch to the STOP position.



TYPICAL

1. Emergency engine stop switch

Engine Start Button

To start engine, place the emergency engine stop switch to RUN.

Press and hold the engine start button. Release immediately after engine is started.

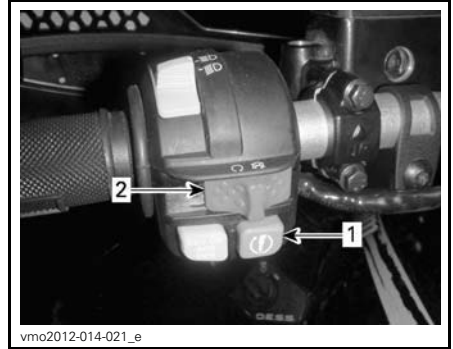

TYPICAL

1. Engine start button
2. Emergency engine stop switch

NOTE: The engine will not turn over if the emergency engine stop switch and/or the ignition switch are turned to the OFF position.

Override/DPS Button

Depending on the vehicle model, this button has up to 2 functions.



1. Override/DPS button

Override Function

The override switch main function is to bypass the engine speed limiter in reverse operation by allowing maximum engine torque.

⚠ WARNING

Only use the override to help get the vehicle unstuck from mud or other soft terrain. Do not use the override for normal operation in reverse. This would allow driving in reverse at excessive speeds and can increase the risk of losing control.

To engage the override function, proceed as follows:

While the shift lever is set to REVERSE position.

1. Ensure that the vehicle is stopped.

While reading this Operator's Guide, remember that:

⚠ WARNING

Indicates a potential hazard that, if not avoided, could result in serious injury or death.

2. Press and hold the override switch then press the throttle lever gradually.

NOTE: When using the override function, the gauge will scroll an **OVER-RIDE** message to confirm that the function is activated.

3. To disengage the override function, simply release the override switch.

DPS Function

This button is also used to change the DPS mode.

To change DPS mode, refer to *TUNE YOUR RIDE* subsection.

7) 12-Volt Power Outlet

Convenient for handheld spotlight or other portable equipment.

Remove protective cap to use. Always reinstall it after use to protect against weather.

Do not exceed the rating capacity. Refer to *SPECIFICATIONS* subsection.

8) Ignition Switch and Keys

The ignition switch is located on the LH side of the central panel below the handlebar.

**IGNITION SWITCH POSITIONS**

1. OFF
2. ON "with light"
3. ON "without light"

OFF

The key can be inserted or removed in this position only.

In OFF position, the electrical system of the vehicle is disabled.

The engine is shut down by turning the ignition switch to OFF position.

NOTE: While the engine can be stopped by turning the ignition key to OFF position, we recommend the engine be stopped by setting the emergency engine stop switch to the STOP position.

NOTE: When turning the key to OFF position, the vehicle electrical system will take a few seconds to shut down.

ON with Lights

When the key is turned in this position, the electrical system of the vehicle is activated.

The gauge should wake-up.

The vehicle lights are turned on.

The engine can be started.

ON

This position offers the same functions as ON with lights position, except the vehicle lights are turned off.

Digitally Encoded Security System (D.E.S.S.)

The ignition keys contain an electronic circuit that gives it a unique electronic serial number.

The D.E.S.S. system reads the key code and allows engine starting for keys it recognizes.

Types of Keys

This vehicle can be operated using 2 different types of ignition keys:

- Normal key (grey)
- Performance key (black).

The key type is differentiated by its color.

⚠ WARNING

Rollovers, tipovers, collisions and loss of control resulting in serious injury or death are possible with the performance or normal keys. Using the normal key is not a substitute for the operator being prepared, qualified, and operating with care.

Normal Key

The vehicle is delivered with a normal key.

The normal key limits the vehicle rate of acceleration and the vehicle speed to 70 km/h (43 MPH).

⚠ WARNING

On steep downhills, the engine speed limiter may not prevent the vehicle from accelerating beyond this speed.

This key may be useful for riders who prefer more gradual acceleration, or for riding in environments where full speed and high acceleration are not desirable. For example, in narrow, winding trails, operators may prefer the normal key.

Performance Key

The vehicle is delivered with a performance key, which allows the user to access the full torque of the engine as well as the top speed of the vehicle.

This may be useful for riders who prefer crisper throttle response, and for environments where higher speeds and greater acceleration are appropriate. For example, in wide-open, straight trails, operators may prefer the performance key.

9) Brake Pedal

The brake pedal is located on the RH side of the vehicle near engine.

When the brake pedal is pressed down, the rear brake is applied.

When released, the brake pedal should return to its original position.

Braking effect is proportional to the force applied on the pedal.

NOTE: The brake will have also an effect on front wheels through the drive train when 4WD is engaged.

The brake pedal applies the rear brake only. Should the brake lever system fail, the rear brake can be activated by depressing the brake pedal.

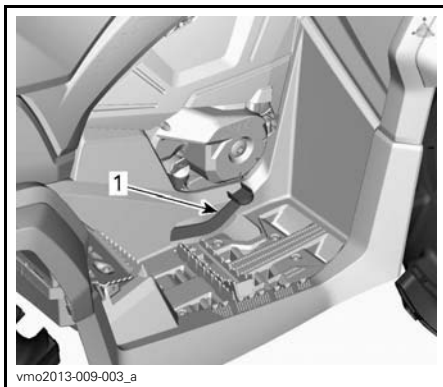

1. Brake pedal

10) Footpegs

The footpegs are located on the RH and LH side of the vehicle near engine.

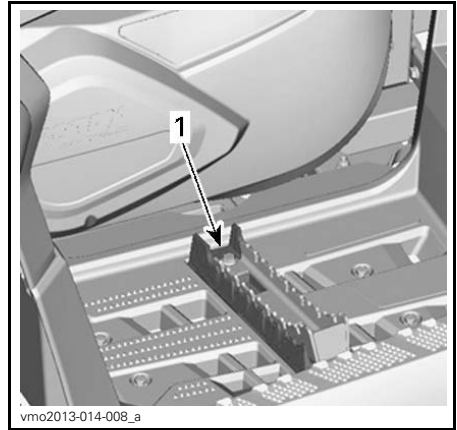

TYPICAL

1. Operator's footpeg for normal riding

11) Seat

Seat Removal

To remove the operator's seat, push its latch forward. This latch is located underneath the rear of seat.



TYPICAL

1. Seat latch

Pull seat rearward. Continue lifting movement until you can release the front retaining device then completely remove seat.

Seat Installation

Insert front tabs of seat into console openings. When seat rests in its position, firmly push seat down to latch.

NOTE: A distinctive snap will be felt. Double check that the seat is secure by giving it a tug to confirm proper latching.

⚠ WARNING

It is of the utmost importance for the operator's safety that you confirm that the operator's seat is properly locked in position by pulling back and up several times.

12) Rear Storage Compartment

Convenient location to carry personal articles.

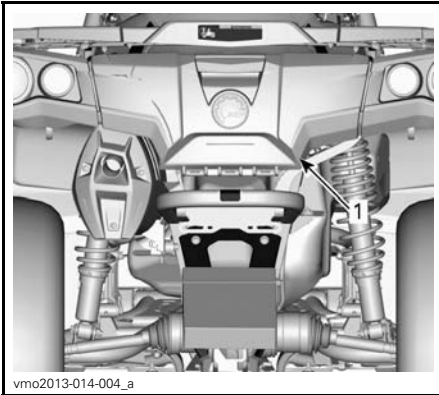

vmo2013-014-004_a

TYPICAL

1. Rear storage compartment cover

⚠ WARNING

When engine is running, always engage the PARK position on the shift lever before opening cover. Never leave any heavy or loose breakable objects in the storage area. Always latch cover before riding.

To Open Rear Storage Compartment

Unlatch cover and gently lower cover.

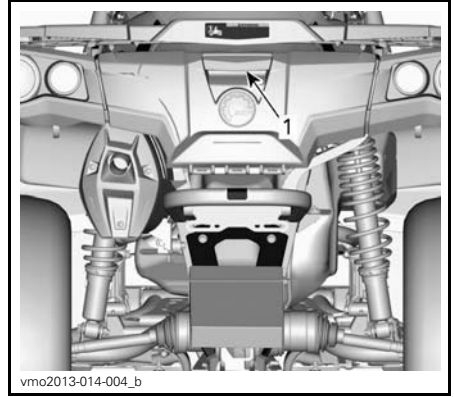

vmo2013-014-004_b

1. Rear storage compartment latch

To Close Rear Storage Compartment

Gently lift and push cover until the latch clicks two times to ensure the seal is compressed.

13) Cargo Rack

Cargo rack is convenient for carrying equipment and various other cargo. It must never be used to carry a passenger.

⚠ WARNING

- Never carry a passenger on a cargo rack.
- Cargo must never interfere with the drivers line of sight or affect his ability to properly steer the vehicle.
- Do not overload the vehicle.
- Always ensure all cargo is properly secured and does not extend out pass the rack.

Refer to *SPECIFICATIONS* subsection for cargo weight recommendations.

14) Trailer Hitch

Convenient hitch to install a ball to tow a trailer or other equipment. Install the proper ball size as per trailer manufacturer recommendations. Refer to *SPECIFICATIONS* subsection for carrying loads and towing recommendations.

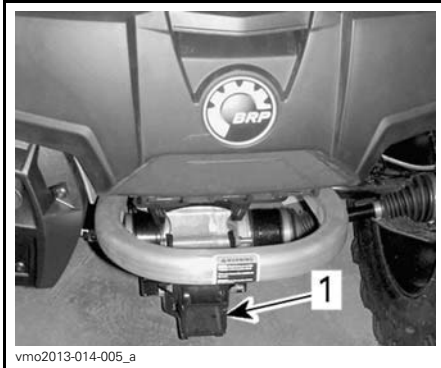

TYPICAL

1. Trailer hitch

⚠ WARNING

Ensure to install the proper ball size that matches the equipment you will tow.

NOTE: Follow manufacturer's instructions for proper attachment.

15) Tool kit

The tool kit is located under the seat. It contains tools for basic maintenance.

16) Winch - Outside North America Only

The winch can be actuated using the winch control switch or with the remote control.

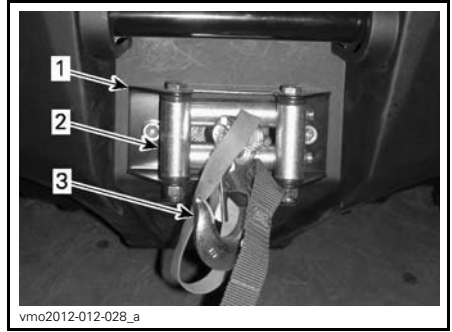

1. Winch

2. Roller fairlead

3. Winch hook

NOTE: Using the winch intensively over a long period of time may discharge the battery.

Refer to *BASIC GUIDE TO WINCHING TECHNIQUES* for more information about the winch.

17) Winch Control Switch - Outside North America Only

Use this switch to roll in or out wire from winch.

To let out the cable, press the left side of switch.

To reel in the cable, press the right side of switch.

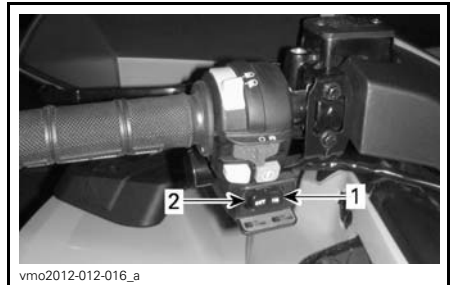

TYPICAL

1. In

2. Out

NOTE: A winch remote control is also provided with the vehicle to ease winch operation if necessary, refer to *WINCH REMOTE CONTROL* further in this subsection.

18) Roller Fairlead - Outside North America Only

The roller fairlead is used to prevent damage to the vehicle and guide the wire rope into the winch.

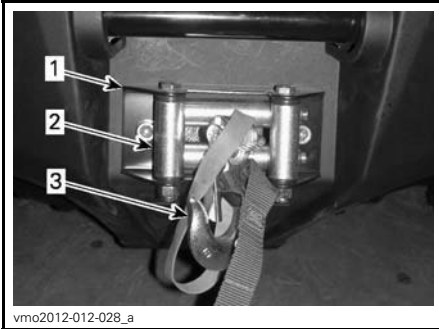

vmo2012-012-028_a

1. Winch
2. Roller fairlead
3. Winch hook

19) Winch Remote Control - Outside North America Only

A winch remote control is provided with the vehicle to ease winch operation if necessary.

The winch remote control is located in the access panel of the rear compartment.



vmo2012-012-025_a

1. Winch remote control

20) Winch Remote Control Connection - Outside North America Only

To use the winch remote control instead of the handlebar control switch, connect the remote control into the winch remote control connection located under the LH handlebar controls.



vmo2012-012-053_a

- TYPICAL**
1. Winch remote control connector

NOTICE Always disconnect and store the remote control when not in use.

MULTIFUNCTION GAUGE (LCD)

⚠ WARNING

Reading the multifunction gauge display can distract from the operation of the vehicle, particularly from constantly scanning the environment.

Multifunction Gauge Description

The multifunction gauge is located in the middle of the handlebar.

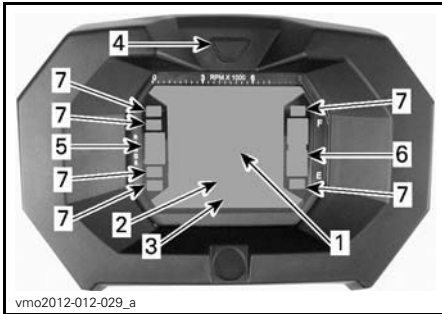

1. Display 1
2. Display 2
3. Display 3
4. Display selector button
5. Transmission position display
6. Fuel level display
7. Indicator lamps

Tachometer

Measures engine revolutions per minute (RPM). Multiply by 1000 to obtain the actual revolutions.

NOTE: RPM can also be displayed via Display 2 (mode) display. Refer to *DISPLAY 2 (MODE)* in this subsection.

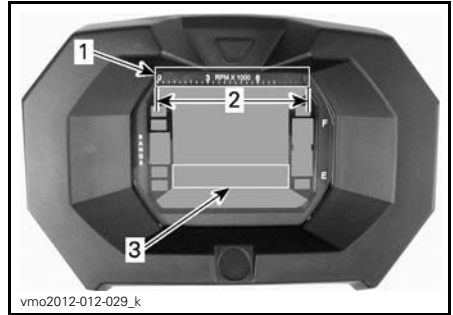

1. Tachometer
2. Operating range
3. Tachometer via display 2 (mode)

Transmission Position Display

This display will show transmission position.

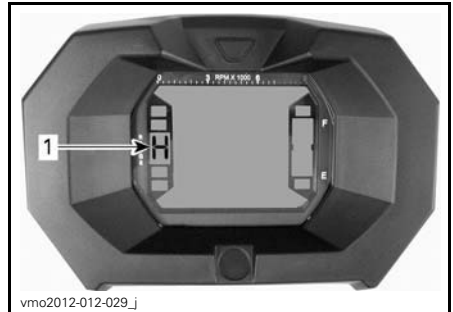

1. Transmission position

Speedometer

This display will show vehicle speed.



1. Vehicle speed (Display 1)

DISPLAY	FUNCTION
P	Park
R	Reverse
N	Neutral
H	High gear
L	Low gear

NOTE: If the letter “E” is displayed in the transmission position display, it means that there is a electrical communication error. Contact an authorized Can-Am dealer.

Fuel Level Display

Bar gauge continuously indicates the fuel level in the fuel tank.

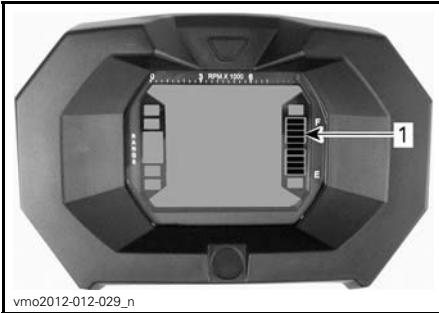

vmo2012-012-029_n

1. Fuel level display

Low fuel level Indicator Lamp



When this indicator turns ON, it indicates that there is approximately 5 L (1.3 U.S. gal.) of fuel left in fuel tank.

4WD Indicator Lamp



When this indicator is ON, it indicates the 4WD system is activated.

Brake Lock Indicator Lamp



When this indicator is ON, it indicates the brake is activated for more than 15 seconds (while riding).

High Beam Indicator Lamp



When this indicator is ON, it indicates that **high beam** is selected.

Check Engine Indicator Lamp



When this indicator is ON, it indicates an engine fault code, look for a message at the LCD display.

Refer to *TROUBLESHOOTING* section for more details.

Multifunction Gauge Features

! WARNING

Never adjust or set functions on the multifunction gauge while riding the vehicle.

The modes can be displayed by pressing the selector button.

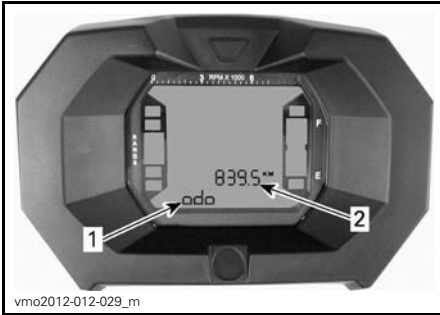

vmo2012-012-029_m

1. Display 2 (mode)
2. Display 3 (mode/message)

Odometer

Records the total distance travelled.

Clock

Shows current time.

Trip Meter

Records the distance travelled since it has been reset.

Press and HOLD display selection button to reset.

Hour Meter (Trip Time)

Records the vehicle running time when the electrical system is activated since it has been reset.

Press and HOLD display selection button to reset.

Engine Hour Meter

Records engine running time.

Engine RPM

Measures engine revolutions per minute (RPM).

Multifunction Gauge Set-Up

! WARNING

Never adjust or set functions on the multifunction gauge while riding the vehicle.

Unit Selection (MPH vs KM/H)

This multifunction gauge is factory preset in Imperial units but it is possible to change it to Metric units, contact an authorized Can-Am dealer for unit settings.

NOTE: All features will have their units changed all together.

Language Selection

The gauge display language can be changed. Refer to an authorized Can-Am dealer for language availability and setup the gauge to your preference.

Clock Setting

To set current time, proceed as follows:

1. Select the clock display.

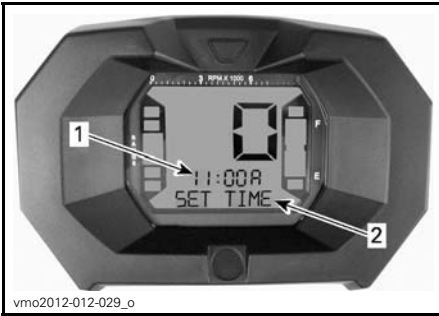

1. Time (Display 2)
2. Message (Display 3)

2. Press and HOLD button (SET TIME will appear on display 3).
3. Choose the 12-hour (12H) or 24-hour (24H) format by pressing button.
4. If the 12-hour format was selected, choose Am ("A") or Pm ("P") by pressing button.
5. Press and HOLD button.
6. Choose hour first digit by pressing button.
7. Press and HOLD button.
8. Choose hour second digit by pressing button.
9. Press and HOLD button.
10. Choose minutes first digit by pressing button.
11. Press and HOLD button.
12. Choose minutes second digit by pressing button.
13. Press button to enter settings (CLOCK will appear on display 3).

FUEL

Recommended Fuel

Use regular unleaded gasoline containing MAXIMUM 10% ethanol. The gasoline must have the following minimum octane requirements.

MINIMUM OCTANE RATING	
Inside North America	87 (R + M)/2
Outside North America	92 RON

NOTICE Never experiment with other fuels. Engine or fuel system damages may occur with the use of an inadequate fuel

Fueling Procedure

⚠ WARNING

- Fuel is flammable and explosive under certain conditions.
- Never use an open flame to check fuel level.
- Never smoke or allow a flame or spark in the vicinity.
- Always work in a well-ventilated area.

NOTICE Always clean the surrounding of the fuel cap of any debris, dust, sand to avoid contaminating fuel.

1. Stop engine.

⚠ WARNING

Always stop engine before refueling.

2. Do not allow anyone to remain seated on the vehicle while fuelling.
3. Slowly unscrew fuel tank cap counterclockwise to remove it.

⚠ WARNING

If a differential pressure condition is noticed (whistling sound heard when loosening fuel tank cap) have vehicle inspected and/or repaired before further operation.

4. Insert the spout in the filler neck.
5. Pour fuel slowly to allow time for the air in the tank to escape and prevent fuel flow back. Be careful not to spill fuel.
6. Stop fuelling when the fuel reaches the bottom of filler neck. Do not overflow.

⚠ WARNING

Always wipe off any fuel spillage from the vehicle.

7. Fully tighten fuel tank cap clockwise.

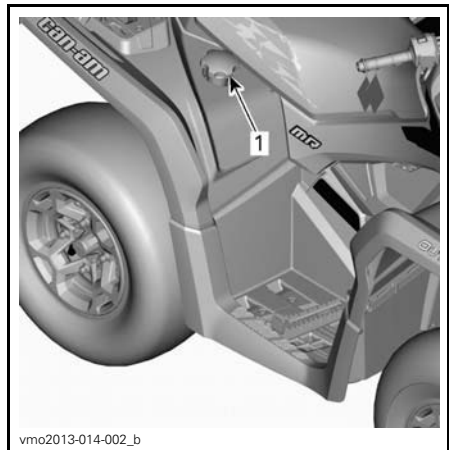

1. Fuel tank cap

⚠ WARNING

Never top up the fuel tank before placing the vehicle in a warm area. As temperature increases, fuel expands and may overflow.

BREAK-IN PERIOD

Operation During Break-In

A break-in period of 10 operating hours or 300 km (200 mi) is required for the vehicle.

After the break-in period, the vehicle should be inspected by an authorized Can-Am dealer. Refer to *MAINTENANCE* section.

Engine

During the break-in period:

- Avoid full throttle operation.
- Maximum throttle should not exceed 3/4.
- Avoid sustained accelerations.
- Avoid prolonged cruising speeds.
- Avoid engine overheating.

However, brief accelerations and speed variations contribute to a good break-in.

Brakes

**WARNING**

New brakes will not operate at their maximum efficiency until their break-in is completed. Use extra caution.

Belt

A new belt requires a break in period of 50 km (30 mi).

During the break-in period:

- Avoid strong acceleration and deceleration (throttle should not exceed 3/4).
- Avoid pulling a load.
- Avoid high speed cruising.

BASIC PROCEDURES

Starting the Engine

The shift lever must be set to PARK or NEUTRAL.

NOTE: For your convenience, an over-ride mode allows the engine to be started with the shift lever in any position. Press and hold the brake lever(s) or the brake pedal while pressing the engine start button.

Insert key in ignition switch and turn to ON position.

Set the emergency engine stop switch to RUN.

Press the engine start button and hold until the engine starts.

NOTICE If engine does not start after a few seconds, do not hold the engine start button more than 10 seconds. Refer to *TROUBLESHOOTING* section.

Release the engine start button immediately when the engine has started.

NOTE: If the battery is dead, engine cannot be started. Have the battery recharged or replaced.

Changing Gear Selection

Apply brakes and select the desired shift lever position.

Release brakes.

NOTICE When changing gear selection, always completely stop the vehicle and apply the brakes prior to moving the shift lever. Otherwise damage to the transmission may occur.

Stopping the Engine

WARNING

Avoid parking on slope as the vehicle may roll away.

WARNING

Always put the vehicle in PARK when stopped or parked to prevent rolling.

WARNING

Avoid parking in places where hot parts can start a fire.

Release throttle and completely stop the vehicle.

Set shift lever in PARK position.

Apply the brake lock.

Push the emergency engine stop switch to OFF position.

Turn key in ignition switch to OFF position.

Remove key from ignition switch.

SPECIAL PROCEDURES

What to Do if Water is in the CVT

The CVT drain plug is located on the rear portion of the CVT cover. It is accessible from the rear LH fender.

Inspect the CVT drain plug to validate if water is present.

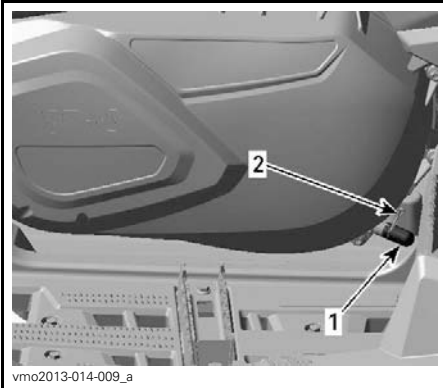

NEAR LH FOOTREST

1. Drain plug
2. Spring clamp

NOTICE If water entered your CVT while in a muddy environment, limit vehicle usage and bring your vehicle to your nearest authorized Can-Am dealer for a proper CVT cleaning procedure.

If water is present, remove CVT drain plug to expel water.

Reinstall the drain plug and secure it using the spring clamp.

NOTE: Make sure hose is properly inserted on CVT cover nipple.

NOTICE See an authorized Can-Am dealer to have the CVT inspected and cleaned.

What to Do if Water is in the Air Filter Housing

Inspect the drain reservoirs in the back of the front left wheel to validate if water is present.

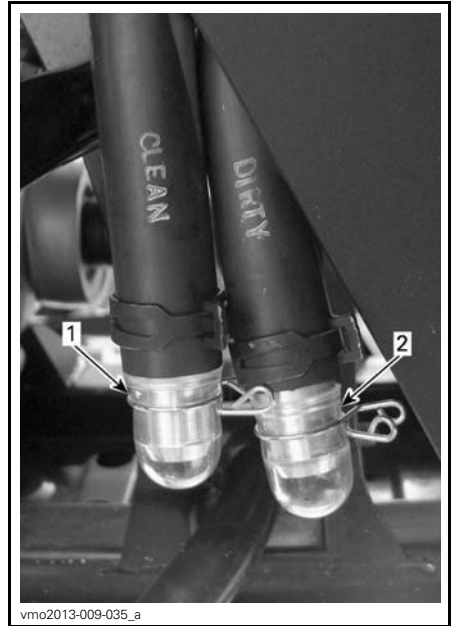

TYPICAL

1. Clean air filter housing drain reservoir
2. Dirty air filter housing drain reservoir

If water is present, press clamps and remove reservoirs to drain water from air filter housing.

If one of the following conditions is met, bring the vehicle to your nearest authorized Can-Am dealer to have the vehicle serviced:

- If more than 50 ml (2 U.S. oz) of water (approximately 5 drain reservoirs) is found in the clean chamber air hose.
- If any deposits are present in the clean chamber drain reservoir.
- If either hose is obstructed.

In such a case, the vehicle must be serviced for:

- Air filter housing cleaning
- Vents (radiator cooling fan, water pump, coolant reservoir, fuel tank, gearbox, front differential and rear final drive)
- CVT air filter cleaning
- CVT cleaning

- Fuel tank breather replacement
- Lubricant inspection and replacement as required (engine, gearbox and rear final drive).

NOTICE Failure to have vehicle serviced may lead to permanent damage to the following components but not limited to:

- Engine and gearbox
- Fuel pump
- CVT
- Cooling fan
- Front differential
- Rear final drive.

What to Do if Vehicle is Turned Over

When vehicle is turned over or stays tilted on the side, put the vehicle back on its wheels. Inspect vehicle for damages.

⚠ WARNING

Never operate the vehicle if damaged. Refer to an authorized Can-Am dealer.

If vehicle has no damage, refer to *MAINTENANCE* section and inspect the following.

- Inspect air filter housing for oil accumulation, if any oil is found, clean air filter and air filter housing.
- Check engine oil level and refill if necessary.
- Check engine coolant level and refill if necessary.
- Check gearbox oil level and refill if necessary.
- Check rear final drive oil level and refill if necessary.
- Check front differential level and refill if necessary.
- Start engine. If the oil pressure light stays on, stop engine immediately. See an authorized Can-Am dealer.

Whenever the vehicle is turned over, it should be inspected by an authorized Can-Am dealer.

NOTICE When reinstalling dashboard over air filter housing, ensure that all vent hoses are routed properly close to the air duct.

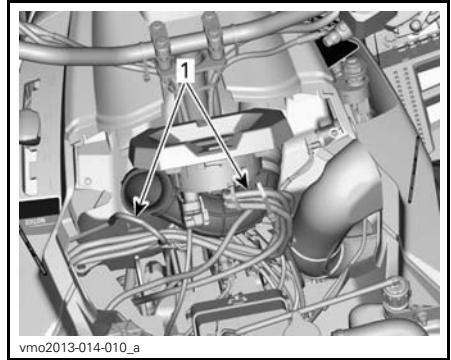

SUPPORT CONSOLE REMOVED FOR CLARITY

1. Route vent hoses close to air duct

What to Do if Vehicle is Immersed in Water

Should the vehicle become immersed, immediately stop the engine. Do not use:

- Any electrical equipments
- Winch (Outside North America Only).

It will be necessary to take the vehicle to an authorized Can-Am dealer as soon as possible. **NEVER ATTEMPT TO START THE ENGINE!**

NOTICE Immersion of the vehicle can cause serious damage if the correct restart procedure is not followed.

As soon as vehicle is pulled out of water, carry out the following:

- Drain air filter housing. See procedure in this subsection.
- Drain CVT. See procedure in this subsection.

NOTICE The vehicle should be serviced as soon as possible by an authorized Can-Am dealer.

TUNE YOUR RIDE

⚠ WARNING

Suspension adjustment could affect vehicle handling. Always take time to familiarize yourself with the vehicle's behavior after any suspension adjustment have been made.

Suspension Adjustment

Suspension adjustment and loading can have an effect on your vehicle handling and comfort.

Choice of suspension adjustments vary with driver's weight, personal preference, riding speed and field condition.

Spring Preload Adjustment

⚠ WARNING

The left and right shock adjustment on front or rear suspension must always be set to the same position. Never adjust one only. Uneven adjustment can cause poor handling and loss of stability, which could lead to an accident.

Shorten the springs for a firmer ride and rough conditions.

Lengthen the springs for a softer ride and smooth conditions.

Adjust spring preload by turning adjustment cam. Use tool from vehicle tool kit.

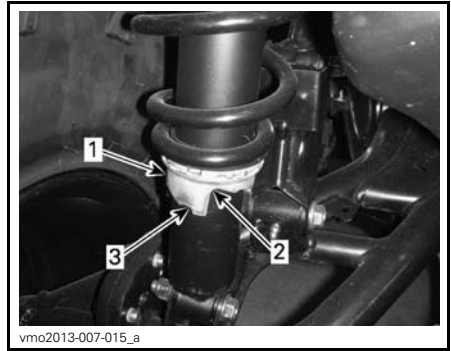

1. Adjustment cam
2. Softer adjustment
3. Firmer adjustment

Steering Assist Adjustment (DPS)

The applicable models are equipped with a Dynamic Power Steering (DPS) system. The DPS reduces the effort to turn the handlebars.

The following DPS modes are preset in the vehicle.

DPS MODE	
DPS MAX.	Maximum steering assist
DPS MED.	Medium steering assist
DPS MIN.	Minimum steering assist

To show the active DPS mode, proceed as follows:

1. Press and release **DPS** button.

**TYPICAL**

1. *DPS* button
2. Check the multifunction gauge to confirm the active *DPS* mode.

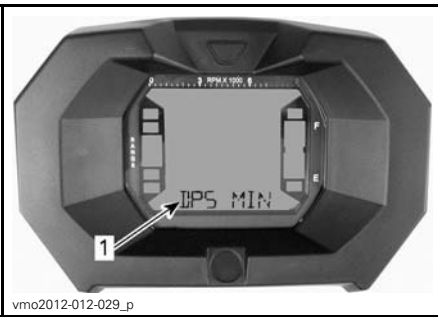
**LCD GAUGE**

1. *DPS* mode (Display 3)

To change the *DPS* mode, proceed as follows:

1. Press and hold **DPS** button for 2 seconds to go to the next setting.
2. Release **DPS** button.
3. Repeat until desired setting is selected.

NOTE: The *DPS* adjustment will not be possible if the vehicle transmission is set to **REVERSE**.

VEHICLE TRANSPORTATION

When transporting this vehicle, secure it to a trailer or in pickup box with suitable tie-downs. Use of ordinary ropes is not recommended.

⚠ WARNING

Do not tow this vehicle behind a car or other vehicle. Use a trailer. Never tip this vehicle on end for transporting. The vehicle must be in its normal operating position (on all four wheels).

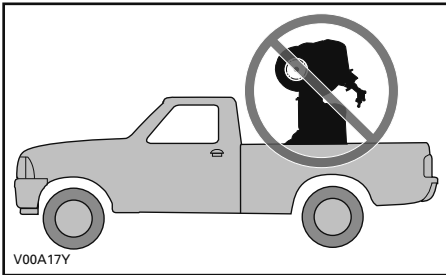

Remember to:

- Unload vehicle racks before transportation.
- Set shift lever to PARK position.
- Set the brake lock.
- Secure the vehicle by the front and rear tie-down points.

NOTICE Always tow this vehicle facing the same direction as the towing vehicle.

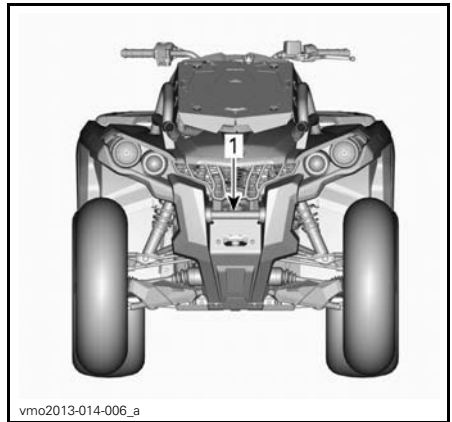

1. Front tie-down point location

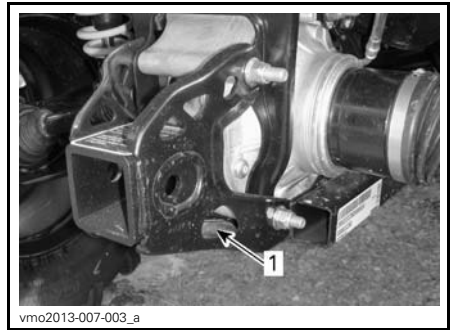

1. Rear tie-down point location

NOTICE Securing vehicle at other locations may damage the vehicle.

MAINTENANCE

BREAK-IN INSPECTION

BRP suggests that after the first 10 hours or 300 km (200 mi) of operation, whichever comes first, your vehicle be inspected by an authorized Can-Am dealer. The break-in inspection is very important and must not be neglected.

NOTE: The break-in inspection is at the expense of the vehicle owner.

We recommend that this inspection be signed by an authorized Can-Am dealer.

Date of inspection

Authorized dealer signature

Dealer name

BREAK-IN INSPECTION
Replace engine oil and filter
Check engine mounting fasteners
Check valve clearance and adjust as required
Check coolant
Clean radiator and carry out a cooling system leak test
Inspect engine seals and gaskets for leaks
Inspect fuel lines, fuel rails, connections, check valves and carry out a fuel system leak test
Inspect throttle cable and adjust as required
Inspect exhaust system and check for leaks
Replace engine air filter
Inspect/clean CVT inlet/outlet
Inspect/clean CVT air filter
Inspect battery connections
Replace gearbox oil
Clean vehicle speed sensor
Check operation of 4 x 4 coupling unit
Inspect front differential and rear final drive (oil level, seals and vents)
Inspect rear propeller shaft joints
Check brake fluid level
Inspect steering system for abnormal play or damage
Check front wheel alignment
Inspect wheel nuts/studs and tighten as required

MAINTENANCE SCHEDULE

Maintenance is very important for keeping your vehicle in safe operating condition. Proper maintenance is the owner's responsibility. The vehicle should be serviced as per the maintenance schedule.

The maintenance schedule does not exempt the pre-ride inspection or post operation inspection.

WARNING

Failure to properly maintain the vehicle according to the maintenance schedule and procedures can make it unsafe to operate.

Follow the appropriate maintenance intervals according to the environment where the vehicle is used: normal environment or extreme environment (mud, water, dust).

POST OPERATION CARE AFTER EACH USE IN AN EXTREME ENVIRONMENT
Rinse the vehicle and its components with fresh water
Clean the CVT air filter (refer to <i>MAINTENANCE PROCEDURES</i> subsection)
Drain the CVT compartment (and clean if any water or mud is found)
Inspect and clean engine air filter. Clean if any water or mud is found (refer to <i>MAINTENANCE PROCEDURES</i> subsection)
Inspect and drain the air filter housing (and clean if any water or mud is found) (refer to <i>MAINTENANCE PROCEDURES</i> subsection)
Clean radiator (refer to <i>MAINTENANCE PROCEDURES</i> subsection)
Visually inspect for any water accumulation in the vent hoses (fuel tank, gearbox, front differential and rear final drive). If there is water, bring the vehicle to your nearest authorized Can-Am dealer for inspection and servicing of main components related to the vents
Carefully clean front and rear shock absorbers to prevent seal damage from dust or dirt

**EVERY 750 KM (500 MI) OR 25 HOURS OF OPERATION
IN A NORMAL ENVIRONMENT (whichever comes first)
EVERY 375 KM (250 MI) OR 12.5 HOURS OF OPERATION IN AN EXTREME
ENVIRONMENT (whichever comes first)**

Inspect and clean (or replace if necessary) engine air filter. For dusty conditions, we recommend oiling the foam filter

Inspect and clean CVT air filter and air filter drain reservoirs

Grease rear propeller shaft joints

Inspect tie rod ends and ball joints

Inspect and lubricate front suspension arms

Inspect and lubricate rear anti-sway bar bushings

Inspect and clean muffler spark arrester

Check brake fluid level

Inspect brake pads

Tighten wheel lug nuts

Inspect the drive shaft boots and protectors

**EVERY 1 500 KM (1,000 MI) OR 50 HOURS OF OPERATION
IN A NORMAL ENVIRONMENT (whichever comes first)
EVERY 750 KM (500 MI) OR 25 HOURS OF OPERATION IN AN EXTREME
ENVIRONMENT (whichever comes first)**

Inspect, adjust and lubricate throttle cable

Replace engine air filter

Check battery condition and boots

Inspect front differential/rear final drive oil level and watch for oil contamination

Inspect drive shaft joint condition

Inspect front/rear propeller shaft joint condition

Inspect shock absorbers

Inspect wheel nuts and studs

Inspect steering system (check for abnormal play)

EVERY 3 000 KM (2,000 MI) OR 100 HOURS OF OPERATION IN A NORMAL ENVIRONMENT OR 1 YEAR (whichever comes first) EVERY 1 500 KM (1,000 MI) OR 50 HOURS OF OPERATION IN AN EXTREME ENVIRONMENT OR 6 MONTHS (whichever comes first)
Replace engine oil and filter
Inspect and adjust valve clearance
Inspect engine mounting fasteners
Inspect exhaust system
Inspect engine coolant
Check engine coolant strength
Inspect and clean throttle body
Carry out a fuel pump pressure test
Replace fuel vent breather filter
Inspect CVT drive belt
Inspect, clean and lubricate CVT drive and driven pulleys (including one-way bearing)
Check gearbox oil level and condition
Inspect 4 x 4 coupling unit
Inspect wheel bearings
Inspect handlebar fasteners
Inspect front wheel alignment and adjust as required
Inspect rear trailing arms and bearings
Clean and lubricate lower and upper steering column half bushings
Inspect and clean brake system
Inspect hitch condition
Inspect seat latch operation
Replace rear final drive oil

<p>EVERY 6 000 KM (4,000 MI) OR 200 HOURS OF OPERATION IN A NORMAL ENVIRONMENT OR 2 YEARS (whichever comes first) EVERY 3 000 KM (2,000 MI) OR 100 HOURS OF OPERATION IN AN EXTREME ENVIRONMENT OR 1 YEAR (whichever comes first)</p>
Replace the engine coolant
Check cooling system and perform a pressure test on pressure cap and cooling system
Check fuel system condition and perform a fuel system leak test
Inspect the fuel pump pre-filter
Replace spark plugs
Replace front differential oil
Replace gearbox oil
Clean vehicle speed sensor
Replace the brake fluid
Inspect or replace gearbox and differential seals

MAINTENANCE PROCEDURES

This section includes instructions for basic maintenance procedures. If you have the necessary mechanical skills and the required tools, you can perform these procedures. If not, see your authorized Can-Am dealer.

Other important items in the maintenance schedule that are more difficult and require in-depth technical knowledge or special tools are best performed by your authorized Can-Am dealer.

⚠ WARNING

Turn off the engine and follow these maintenance procedures when performing maintenance. If you do not follow proper maintenance procedures you can be injured by hot parts, moving parts, electricity, chemicals or other hazards.

⚠ WARNING

Should removal of a locking device be required (e.g. lock tab, self-locking fastener, etc.), always replace it with a new one.

Air Filter

Air Filter Maintenance Guideline

As with any ATV, air filter maintenance is critical to ensure proper engine performance and life span.

Air filter maintenance should be adjusted according to riding conditions.

Air filter maintenance must be increased in frequency and oil must be added to the foam filter element for the following dusty conditions:

- Riding on dry sand
- Riding on dry dirt covered surfaces
- Riding on dry gravel roads or similar conditions.

NOTE: Riding in a group in these conditions would increase even more the air filter maintenance. Refer to *AIR FILTER CLEANING AND OILING* in this subsection for maintenance procedure.

NOTE: An accessory pre-filter for "dusty conditions" may be used. Contact an authorized Can-Am dealer for details.

Air Filter Removal

NOTICE Never remove or modify any component in the air filter housing. Otherwise, engine performance degradation or damage can occur. The engine is calibrated to operate specifically with these components.

Remove seat.

Remove console.

Lift rear portion of console upwards.



LIFT REAR PORTION

Pull console rearwards.

Rotate air filter cover counterclockwise to remove.



1. Air filter cover

Remove air filter.



AIR FILTER REMOVAL

Air Filter Cleaning and Oiling

⚠ CAUTION Always wear appropriate skin and eye protection. Chemicals can cause a skin rash and eye injury.

Paper Filter Cleaning

1. Ensure that the foam filter element is removed from paper filter.
2. Tap out heavy dust from the paper element.

This will allow dirt and dust to get out of the paper filter.

NOTE: Paper filter have a limited life span; replace filter if too dirty or clogged.

NOTICE It is not recommended to blow compressed air on the paper filter; this could damage the paper fibers and reduce its filtration ability when used in dusty environments.

NOTICE Do not wash the paper filter with any cleaning solution.

Foam Filter Element Cleaning

1. Spray the foam filter element inside and out with AIR FILTER CLEANER (P/N 219 700 341).



AIR FILTER CLEANER (P/N 219 700 341)



TYPICAL - SPRAY THE FOAM ELEMENT

2. Let stand for 3 minutes.
3. As stated on air filter cleaner (UNI) container, rinse with plain water.
4. Dry the foam element completely.



vbs2009-012-005

TYPICAL - DRY

NOTE: A second application may be necessary for heavily soiled elements.

Foam Filter Element Lubrication

1. Make sure filter is clean. Refer to *FOAM FILTER CLEANING*.
2. Spray AIR FILTER OIL (P/N 219 700 340) on the foam filter element previously dried.



219700340

AIR FILTER OIL (P/N 219 700 340)



vbs2009-012-014

TYPICAL - OIL THE FOAM FILTER ELEMENT

3. Let stand for 3 to 5 minutes.

4. Remove any excess of oil that could transfer to the paper filter by wrapping the foam filter element into an absorbent cloth and squeezing gently. This will also ensure a full oil coverage on foam filter.
5. Reinstall the foam filter element over the paper filter.

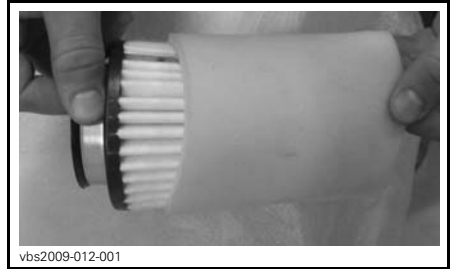

vbs2009-012-001

TYPICAL

Air Filter Installation

Properly reinstall removed parts in the reverse order of their removal.

Engine Oil

Engine Oil Level

NOTICE Check level frequently and refill if necessary. **Do not over-fill.** Operating the engine/gearbox with an improper level may severely damage engine/gearbox. Wipe off any spillage.

NOTE: While checking the oil level, visually inspect engine area for leaks.



vmo2006-007-013_a

RH SIDE OF ENGINE

1. Dipstick

With vehicle on a level surface and engine cold, not running, check the oil level as follows:

1. Unscrew dipstick then remove it and wipe clean.
2. Reinstall dipstick, screw in it completely.
3. Remove and check oil level. It should be near or equal to the upper mark.

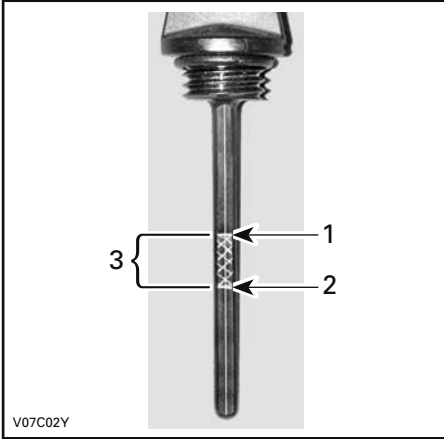

TYPICAL

1. Full
2. Add
3. Operating range

To add oil, remove dipstick. Place a funnel into the dipstick tube to avoid spillage.

Add a small amount of recommended oil and recheck oil level.

Repeat the above procedures until oil level reaches the dipstick's upper mark. **Do not overfill.**

Properly tighten dipstick.

Recommended Engine Oil

For the summer season, use XPS 4-STROKE SYNTH. BLEND OIL (SUMMER) (P/N 293 600 121).

For the all season, use XPS 4-STROKE SYNTHETIC OIL (ALL CLIMATE) (P/N 293 600 112).

NOTE: The XPS oil is specially formulated and tested for the severe requirements of this engine.

If not available, use 4-stroke SAE 5W40 engine oil that meets or exceeds the requirements for API service classification SM, SL or SJ. Always check the API service label certification on the oil container it must contain at least one of the above standards. Refer to the viscosity chart for details.

Engine Oil Change

Oil and filter are to be replaced at the same time.

Oil change should be done with a warm engine.

! CAUTION The engine oil can be very hot. In order to avoid potential burns, do not remove the engine drain plug or the filter cover if the engine is hot. Wait until engine oil is warm.

Ensure vehicle is on a level surface.

Remove dipstick.

Clean the oil drain plug area.

Place a drain pan under the oil drain plug area.

Unscrew oil drain plug.

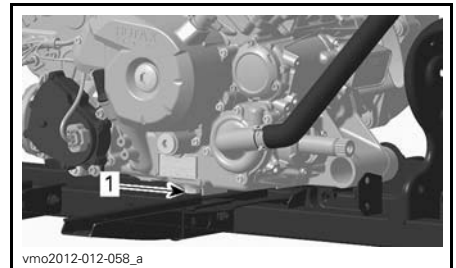

TYPICAL

1. Oil drain plug

Allow enough time for oil to flow out of oil filter.

Replace the oil filter. Refer to *OIL FILTER* in this subsection.

Change gasket on oil drain plug.
 Clean gasket area on engine and oil drain plug then reinstall plug.
 Refill engine at the proper level with the recommended oil.
 Refer to *SPECIFICATIONS* subsection for oil capacity.
 Start engine and let idle for a few minutes.
 Ensure oil filter area and oil drain plug areas are not leaking.
 Stop engine.
 Wait a while to allow oil to flow down to crankcase then check oil level.
 Refill as necessary.
 Dispose of oil as per your local environmental regulations.

Oil Filter

Oil Filter Replacement

Remove the right engine cover.
 Unscrew the oil filter cover.



1. Oil filter cover

Remove the oil filter and replace with a new filter.
 Check the cover O-ring and change it if necessary.
 Screw oil filter cover in place.
 Wipe out any oil spillage on engine.

Radiator

Radiator Inspection and Cleaning

Periodically check the radiator area for cleanliness.

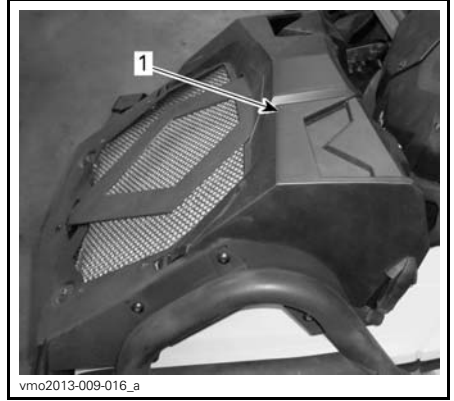

TYPICAL
 1. Radiator

Inspect radiator and hoses for leaks or any damage.

To access the hoses and the engine coolant reservoir, remove the radiator cover.

Release the latch on each side of the cover, push on the two tabs and remove the cover.

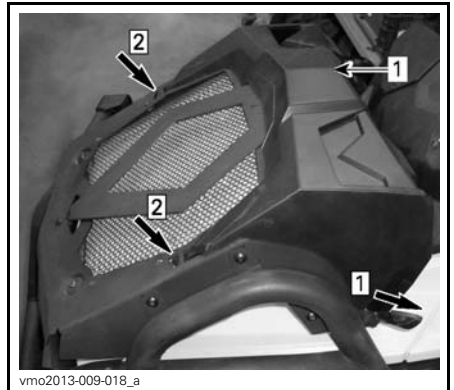

Step 1: Release the latches
 Step 2: Push on the tabs

1. Radiator cover

Inspect radiating fins. They must be clean, free of mud, dirt, leaves and any other deposit that would prevent the radiator to cool properly.

To access the radiating fins, remove the three screws and pull off the diamond-shaped plate.

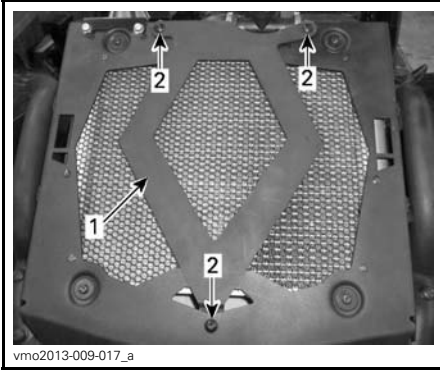

1. Diamond-shaped plate
2. Screws

Remove as much deposits as you can with your hands. If water is available in proximity, try rinsing the radiating fins.

If available, use a garden hose to rinse the radiating fins.

CAUTION Never clean radiator with your hands when it is hot. Let the radiator cool down before cleaning.

NOTICE Be careful not to damage the radiating fins when cleaning. Do not use any object/tool that could damage the fins. The fins are purposely thin parts to allow efficient cooling. **WHEN HOSING, USE LOW PRESSURE ONLY, NEVER USE A HIGH PRESSURE WASHER.**

See an authorized Can-Am dealer to check the performance of the cooling system.

Engine Coolant

Engine Coolant Level

⚠ WARNING
Check coolant level with engine cold. Never add coolant in cooling system when engine is hot.

1. To access the engine coolant reservoir, remove the radiator cover.

Release the latch on each side of the cover, push on the two tabs and remove the cover.

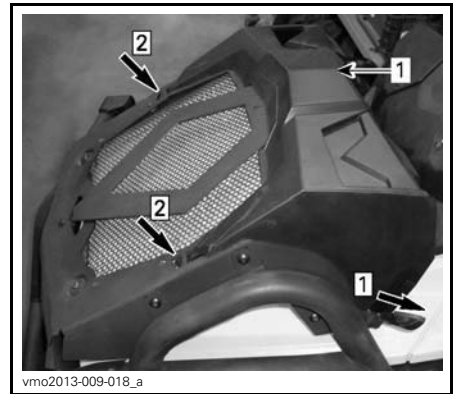

Step 1: Release the latches
Step 2: Push on the tabs

1. Radiator cover
2. With vehicle on a level surface, liquid should be between MIN. and MAX. level marks of coolant reservoir.

NOTE: When checking level at temperature lower than 20°C (68°F), it may be slightly lower than MIN. mark.

NOTE: Ensure coolant reservoir hose is properly routed as per the above illustration to avoid any interference, when closing cover.

If coolant is added in the coolant reservoir, check also the level in the radiator.

⚠ WARNING

In order to avoid potential burning, do not remove the radiator cap if the engine is hot.

NOTE: A cooling system that frequently requires coolant is the indication of leaks or engine problems. See an authorized Can-Am dealer.

Adding Coolant

1. Remove the coolant reservoir cap.



1. Coolant reservoir cap

- NOTE:** Take note of the vent routing.
2. Add coolant up to Max mark. Do not overfill.

- NOTE:** Use a funnel to avoid spillage.
3. Properly reinstall and tighten coolant reservoir cap.

NOTICE Do not store any objects in the front service compartment.

4. Reinstall the radiator cover.

Recommended Engine Coolant

Always use ethylene-glycol antifreeze containing corrosion inhibitors specifically for internal combustion aluminum engines.

Cooling system must be filled with BRP PREMIXED COOLANT (P/N 219 700 362) or with distilled water and antifreeze solution (50% distilled water, 50% antifreeze).

Engine Coolant Replacement

⚠ WARNING

In order to avoid potential burns, do not remove the radiator cap or loosen the coolant drain plug if the engine is hot.

NOTICE Do not store any objects in the front service compartment.

Remove the radiator cap by applying pressure and turning it counterclockwise.

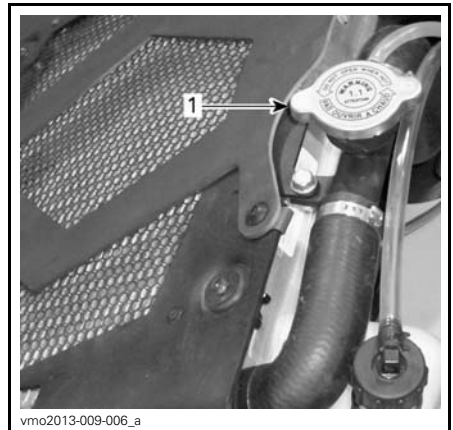

TYPICAL
1. Radiator cap

Unscrew the coolant drain plug on the water pump and drain the coolant into a suitable container.

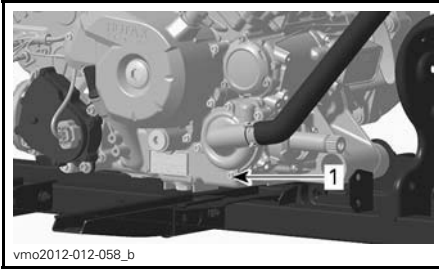

1. Coolant drain plug

NOTE: Do not unscrew the coolant drain plug completely.

Remove the RH side panel.

Unscrew the bleeding screw on the top of thermostat housing.

NOTE: To gain access to the bleeding screw, remove the CVT filter outlet.



1. Bleeding screw

Drain the system completely.

Reinstall the coolant drain plug.

Fill the radiator until the coolant comes out by the thermostat housing hole.

Install the bleeding screw.

Complete the radiator filling.

Check the level in the coolant reservoir and refill if necessary.

Run engine at idle with the radiator cap off. Slowly add coolant if necessary.

At this point, wait until engine reaches normal operating temperature.

Depress the throttle lever two or three times; then add coolant if required.

Install radiator cap as the reverse of removal.

Inspect all connections for leaks and check coolant level in the reservoir.

Muffler Spark Arrester

Muffler Spark Arrester Cleaning and Inspection

CAUTION Let exhaust system cool down before proceeding with cleaning and inspection.

Remove the muffler cover. Discard retaining screws.

NOTICE Do not use impact tool for any screw removal.

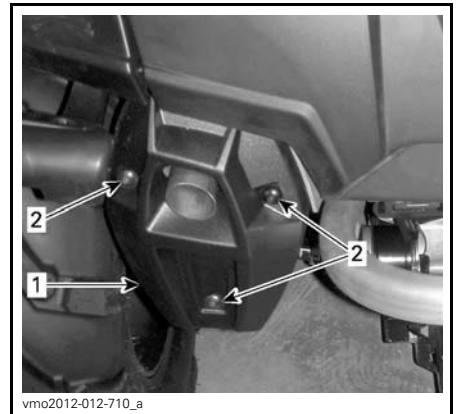

1. Muffler cover
2. Retaining screw

Remove and discard the tail pipe retaining screws.



vmo2012-012-709
TYPICAL - REMOVE TAIL PIPE

Remove exhaust tail pipe, gasket (discard) and spark arrester.



tmo2011-001-043_a
1. Clean spark arrester

Inspect mesh of spark arrester for any damage. Replace as required.

NOTE: Spark arrester screen replacement is required only when damaged. Inspect spark arrester chamber in muffler. Clean any debris as required.

Install new gasket, tail pipe and new retaining screws.

Reinstall muffler cover with new retaining screws. Tighten to specification.

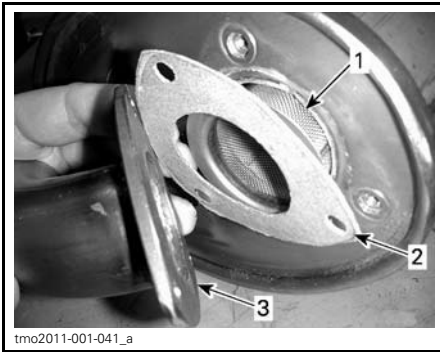

tmo2011-001-041_a
TYPICAL
1. Spark arrester
2. Gasket
3. Exhaust tail pipe

Remove carbon deposits from the spark arrester using a brush.

NOTICE Use a soft brush and be careful to avoid damaging spark arrester mesh.

CAUTION Wear eye protection and gloves.

TORQUE	
Tail pipe retaining screws and cover retaining screws	11 N•m ± 1 N•m (97 lbf•in ± 9 lbf•in)

CVT Air Filter

CVT Air Filter Removal

1. To access the CVT air filter, remove the radiator cover.
2. Release the latch on each side of the cover, push on the two tabs and remove the cover.

While reading this Operator's Guide, remember that:

WARNING

Indicates a potential hazard that, if not avoided, could result in serious injury or death.

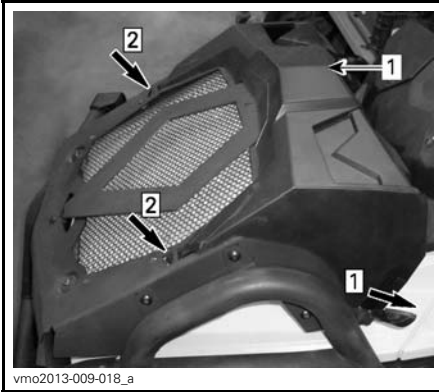

vmo2013-009-018_a

Step 1: Release the latches
Step 2: Push on the tabs

1. Radiator cover
3. Remove the CVT air filter by removing the three screws and pressing on the tabs.



219700341

AIR FILTER CLEANER (P/N 219 700 341)

2. Let stand for 3 minutes.
3. As stated on air filter cleaner (UNI) container, rinse filter with plain water.
4. Dry filter completely.

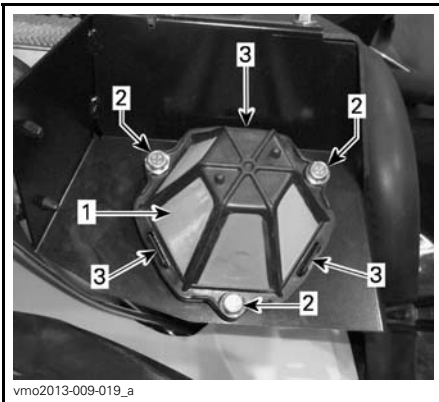

vmo2013-009-019_a

1. CVT air filter
2. Screws
3. Tabs



vmo2013-007-019_a

1. CVT air filter

CVT Air Filter Installation

1. Carefully push the CVT air filter until the three tabs click and tighten the three screws. Tighten to specification.

CVT Air Filter Cleaning

1. Spray filter inside and out with AIR FILTER CLEANER (P/N 219 700 341).

TORQUE	
CVT air filter screws	2.5 N•m ± 0.5 N•m (22 lbf•in ± 4 lbf•in)

2. Reinstall the radiator cover. Slide the tabs into the slots until they click and latch the sides.

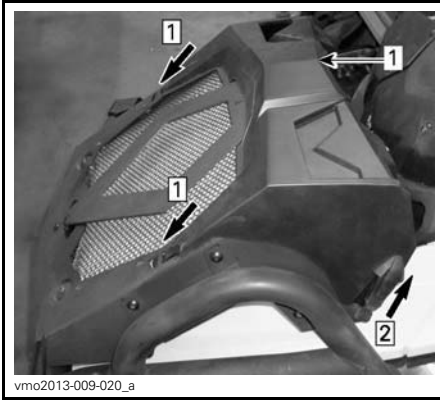

Step 1: Slide the radiator cover tabs
Step 2: Latch the sides

1. Radiator cover

Gearbox Oil

Gearbox Oil Level

NOTICE Check level and refill if necessary. **Do not overfill.** Operating the gearbox with an improper level may severely damage gearbox. Wipe off any spillage.

Place the vehicle on a level surface.

Select NEUTRAL position.

Apply brake lock.

Check the gearbox oil level when engine cold, not running, by removing the gearbox oil level plug.

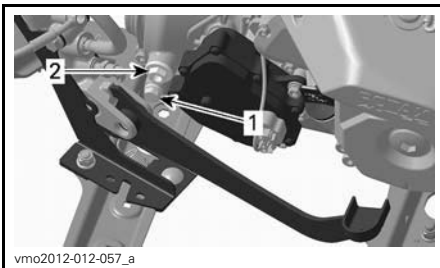

1. Drain plug
2. Oil level plug

The oil should be level with the bottom of the oil level hole.

Refill as required until gearbox oil level flows through oil level hole.

Recommended Gearbox Oil

Use XPS SYNTHETIC GEAR OIL (75W 140) (P/N 293 600 140).

If the recommended oil is not available, use a 75W140 gearbox oil that meets the API GL-5 specification.

NOTICE Do not use another types of oil when servicing. Do not mix with other types of oil.

Gearbox Oil Change

Place the vehicle on a level surface.

Clean drain plug area and oil level plug.

Remove the gearbox drain plug.

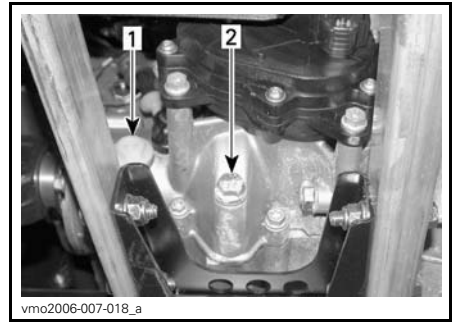

1. Oil level plug
2. Oil drain plug

NOTE: To completely drain the gearbox, place a jack under the left footrest and tilt the vehicle toward the right side. When the gearbox is empty, install the drain plug and replace the vehicle on the ground.

Refill gearbox, using XPS SYNTHETIC GEAR OIL (75W 140) (P/N 293 600 140) or an equivalent.

NOTICE Do not use another types of oil when servicing. Do not mix with other types of oil.

The oil should be level with the bottom of the oil level hole.

Refill as required until gearbox oil level flows through oil level hole.

Reinstall oil level plug.

Throttle Cable

Throttle Cable Lubrication

The throttle cable must be lubricated with CABLE LUBRICANT (P/N 293 600 041) or an equivalent.

⚠ WARNING

Always use a silicone-based lubricant. Using another lubricant (like a water-based lubricant) could cause the throttle lever/cable to become sticky and stiff.

Open the throttle lever housing.

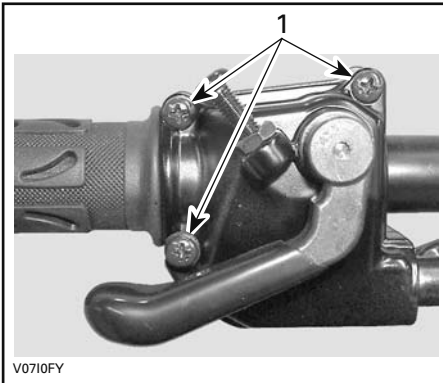

1. Remove these screws

Separate the housing.

Slide rubber protector back to expose throttle cable adjuster.

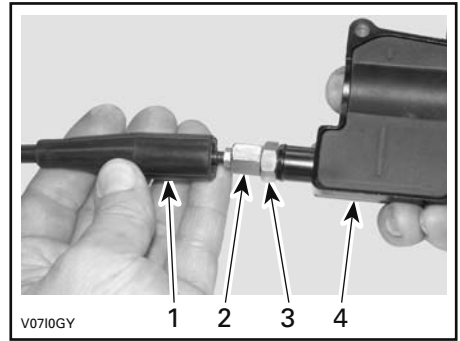

1. Cable protector
2. Throttle cable adjuster
3. Lock nut
4. Throttle lever housing

Screw in the throttle cable adjuster.
Remove inner housing protector.

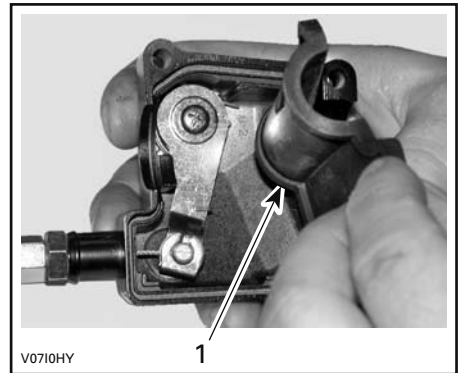

1. Inner housing protector

Remove the cable from the throttle lever housing.

NOTE: Slide cable in clip slot and remove the end of cable from clip.

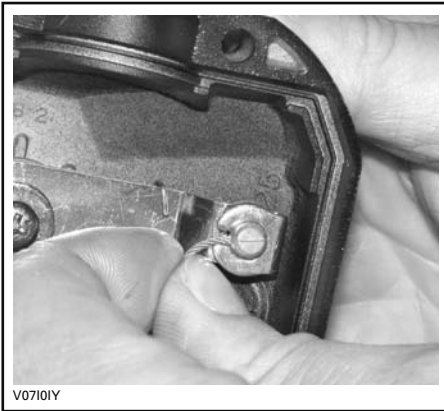

V07101Y

Remove the throttle body side cover.

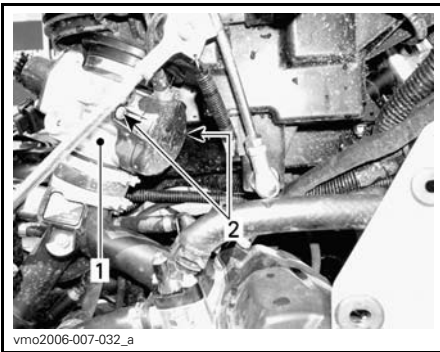

vmo2006-007-032_a

1. Throttle body
2. Side cover screws

Insert the needle of the lubricant can in the end of throttle cable adjuster.

⚠ CAUTION Always wear appropriate skin and eye protection. Chemicals can cause a skin rash and eye injury.



V0710JY

TYPICAL

NOTE: Place a rag around the throttle cable adjuster to prevent the lubricant from splashing.

Add lubricant until it runs out at throttle body end of the throttle cable.

Reinstall and adjust the cable.

Throttle Cable Adjustment

Slide rubber protector back to expose throttle cable adjuster.

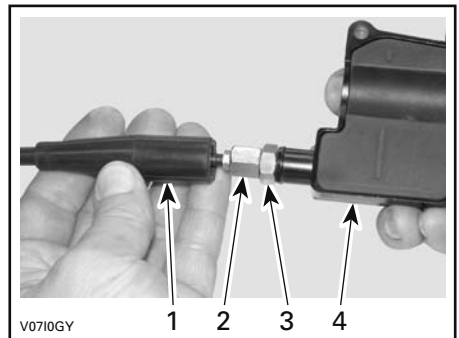

V0710GY

1. Cable protector
2. Throttle cable adjuster
3. Lock nut
4. Throttle lever housing

Loosen lock nut then turn the adjuster to obtain correct throttle lever free play.

NOTE: Measure throttle free play at the tip of throttle lever.

Tighten lock nut and reinstall protector.

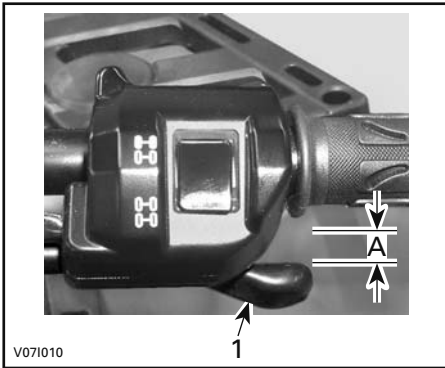

V071010

1. Throttle lever
- A. 2 mm (.079 in)

With the shift lever on PARK position, start the engine.

Check if the throttle cable is adjusted correctly by turning handlebar fully to the right then fully to the left. If the engine revolutions per minute (RPM) increases, readjust the throttle lever free play.

Spark Plugs

Spark Plug Access

- Remove side panels.
- Unplug spark plug cables.

Spark Plug Removal

⚠ CAUTION Always wear safety goggles when using pressurized air.

- Unscrew spark plugs one turn.
- Clean spark plugs and cylinder heads with pressurized air if possible.
- Unscrew spark plugs completely then remove them.

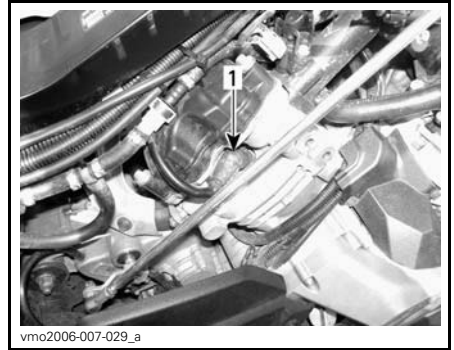

vmo2006-007-029_a

RH SIDE — REAR CYLINDER
1. Spark plug

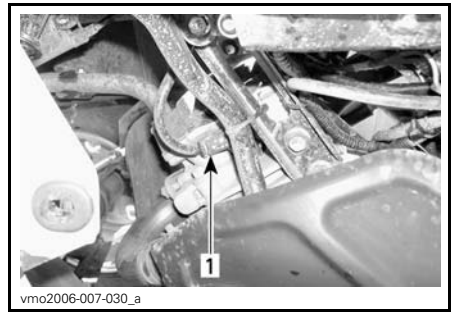

vmo2006-007-030_a

LH SIDE — FRONT CYLINDER
1. Spark plug

Spark Plug Installation

Prior to installation, make sure that contact surfaces of cylinder heads and spark plugs are free of grime.

Using a feeler gauge, set the spark plug gap between 0.6 mm to 0.7 mm (.024 in to .028 in).

Apply a copper-based anti-seize lubricant over spark plug threads.

Screw spark plugs into cylinder heads by hand and tighten with a torque wrench and a proper socket.

SPARK PLUG TIGHTENING TORQUE

20 N•m ± 2.4 N•m (15 lbf•ft ± 2 lbf•ft)

Battery

⚠ WARNING

Unless otherwise indicated, always turn ignition switch to the OFF position before performing any maintenance or repair on electrical system.

⚠ CAUTION Never charge a battery while installed in vehicle.

These vehicles are equipped with a VRLA battery (Valve Regulated Lead Acid). It is a maintenance-free type battery, there is no need to add water to adjust electrolyte level.

NOTICE Never remove the battery sealing cap.

Battery Removal

NOTICE Always disconnect BLACK (-) battery cable first.

Disconnect BLACK (-) cable first then RED (+) cable.

Remove the retaining screws and the battery holder, then pull the battery out of frame.

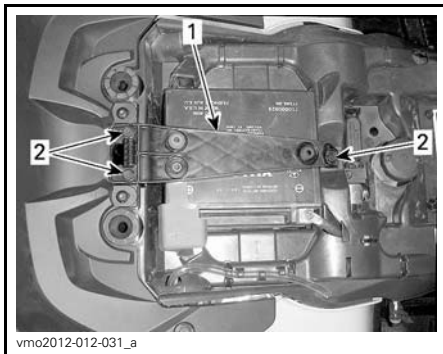

1. Battery holder
2. Retaining screws

Battery Cleaning

Clean battery, battery casing and battery posts using a solution of baking soda and water.

Remove corrosion from battery cable terminals and battery posts using a firm wire brush.

Battery Installation

Reinstall battery in vehicle.

NOTICE Always connect RED (+) battery cable first.

Fuses

⚠ CAUTION Always turn the ignition switch to OFF position before replacing a defective fuse.

Fuse Inspection

Check if filament is melted.

If filament is melted, replace damaged fuse, refer to *FUSE LOCATION* tables for proper rating.

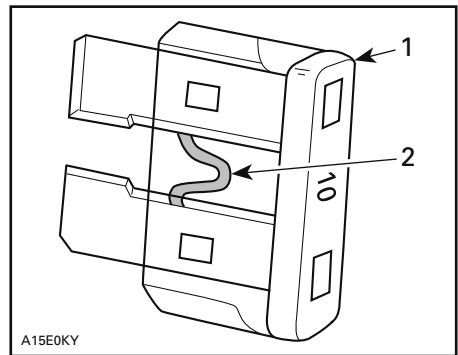

TYPICAL

1. Fuse
2. Check if melted

NOTICE Do not use a higher rated fuse as this can cause severe damage.

Front Fuse Location

To gain access to the fuse box, located between the radiator and the front console, carefully release and remove the gauge support from its location.

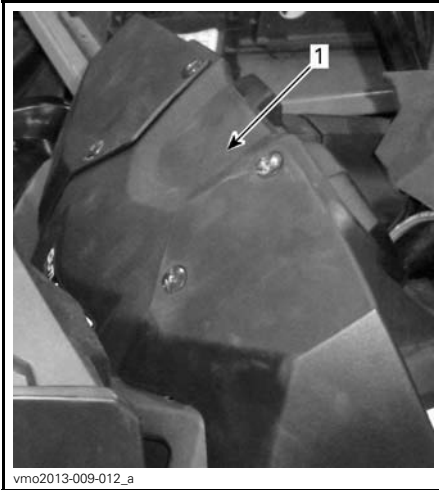

vmo2013-009-012_a

1. Gauge support

Remove the cover from the front fuse box.

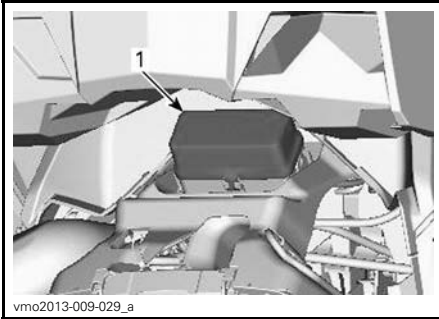

vmo2013-009-029_a

TYPICAL

1. Front fuse box

FRONT FUSE BOX		
NO.	DESCRIPTION	RATING
R1	Fan Relay	-
R2	Main Relay	-
R3	Accessories relay	-
R4	Fuel pumps relay	-
R5	Lights relay	-
R8	Brake relay	-
F4	Lights / clock	10 A
F5	Injectors / ignition	5 A
F6	Engine control module (ECM)	5 A
F7	Winch 2WD/4WD (Outside North America Only)	5 A
F8	Key switch / starter solenoid	5 A
F9	Resetable cooling fan	25 A
F10	Euro control / clock	5 A
F11	Lights	30 A
F12	DC outlet	15 A
F15	Fuel pump	5 A

NOTE: Check inside fuse box cover to know fuses location.

NOTICE Do not store any objects in the front service compartment.

Rear Fuse Location

The rear fuse holder is located at the rear of vehicle near battery.



TYPICAL
1. Rear fuse holder

REAR FUSE HOLDER		
NO.	DESCRIPTION	RATING
F1	Main	30 A
F2	Fan/Accessories	40 A
F3	Dynamic power steering (DPS)	40 A



Lights

CAUTION Always turn the ignition switch to OFF position before replacing a defective bulb.

Always check light operation after replacement.

Headlight Bulb Replacement

NOTICE Never touch glass portion of a halogen bulb with bare fingers, it shortens its operating life. If glass is touched, clean it with isopropyl alcohol which will not leave a film on the bulb.

Unplug connector from bulb.

Rotate light bulb counterclockwise to release it from light housing.

Pull out bulb.

Properly reinstall removed parts in the reverse order of their removal.

Validate headlights operation.

Taillight/Brake Light Bulb Replacement

Rotate taillight counterclockwise to remove it from taillight housing.



ROTATE TAILLIGHT CCW TO REMOVE

Pull tail light out of its location.
 Unplug connector from bulb.
 Rotate light bulb counterclockwise to remove it from taillight.



vmo2012-012-062_a
ROTATE BULB COUNTERCLOCKWISE

Remove bulb socket from taillight.
 Installation is the reverse of the removal procedure.

Headlight Beam Aiming

Turn adjustment knobs to adjust beam height to your convenience.

NOTE: Adjust headlights evenly.

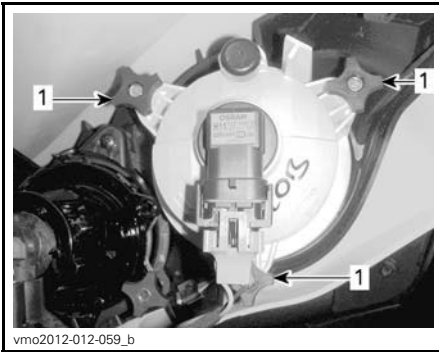

vmo2012-012-059_b
LOW BEAM ADJUSTMENT
 1. Adjustment knobs

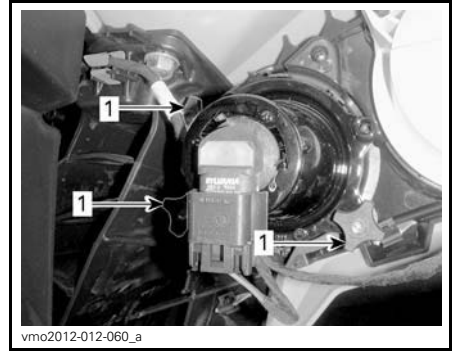

vmo2012-012-060_a
HIGH BEAM ADJUSTMENT
 1. Adjustment knobs

Drive Shaft Boot and Protector

Drive Shaft Boot and Protector Inspection

Visually inspect drive shaft protectors and boots conditions.

Check protectors for damage or rubbing against shafts.

Check boots for cracks, tears, leaking grease etc.

Repair or replace damaged parts as necessary.



vmo2012-015-003_a
TYPICAL — FRONT OF VEHICLE
 1. Drive shaft boots
 2. Drive shaft protector

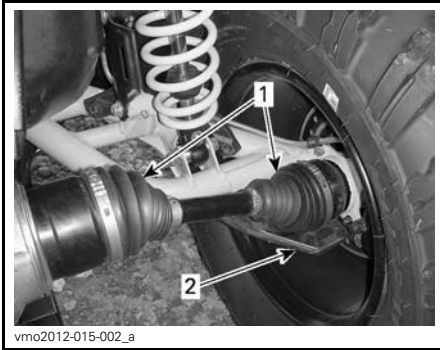

TYPICAL — REAR OF VEHICLE

1. Drive shaft boots
2. Drive shaft protector

Wheels and Tires

Tire Pressure

⚠ WARNING

Tire pressure greatly affects vehicle handling and stability. Underpressure may cause tire to deflate and rotate on wheel. Overpressure may burst the tire. Always follow recommended pressure. Since tires are low-pressure types, a manual pump should be used.

Check pressure when tires are cold before using the vehicle. Tire pressure changes with temperature and altitude. Recheck pressure if one of these conditions has changed.

For your convenience, a pressure gauge is supplied in tool kit.

TIRE PRESSURE		
FRONT/REAR		
Xmr	MAX.	48.3 kPa (7 PSI)
	MIN.	41.4 kPa (6 PSI)

Although the tires are specifically designed for off-road use, a flat may still occur. Therefore, it is recommended to carry a tire pump and a repair kit.

Tire Inspection

Check tire for damage and wear. Replace if necessary.

The tires are directional and their rotation must be kept in a specific direction for proper operation.

Tire Replacement

Tires replacement should be performed by an authorized Can-Am dealer.

⚠ WARNING

- When the tires are replaced, never install a bias tire with a radial tire. Such a combination could create handling and/or stability problems.
- Do not mix tires of different size and/or design on the same axle.
- Front and rear tire pairs must have an identical model and manufacturer.
- For unidirectional tread pattern, ensure that the tires are installed in the correct direction of rotation.
- The radial tires must be installed as a complete set.

While reading this Operator's Guide, remember that:

⚠ WARNING

Indicates a potential hazard that, if not avoided, could result in serious injury or death.

Wheel Bearing Inspection

- Place vehicle on a level surface.
- Apply brake lock.
- Lift vehicle.
- Secure vehicle on jack stands.
- Push and pull the wheels from the upper edge to feel the play.
- See an authorized Can-Am dealer if there is any play.



TYPICAL

Wheel Removal and Installation

- Place vehicle on a level surface.
- Apply brake lock.
- Loosen lug nuts then lift vehicle.
- Secure vehicle on jack stands.
- Remove nuts then remove wheel.
- At installation, it is recommended to apply anti-seize lubricant on threads.
- Carefully tighten nuts in a criss-cross sequence then apply final torque.

WHEEL NUT TORQUE
100 N•m ± 10 N•m (74 lbf•ft ± 7 lbf•ft)

NOTE: Occasionally, wheel nuts should be removed to apply anti-seize lubricant on studs to ease future removal. This is particularly important when vehicle is used in salt-water environment or in mud. Remove one nut at a time, lubricate then retorque.

NOTICE Always use the recommended wheel nuts according to the type of wheel. Using a different nut could cause damage to the rim.

Suspension

Suspension Lubrication

Lubricate front A-arms.

SUSPENSION GREASE	
BRP recommended product	SUSPENSION GREASE (P/N 293 550 033)

There is two grease fittings on each A-arm.

Suspension Inspection

Shock Absorbers

- Inspect shock absorber for oil leaks or other damage.
- Check tightness of fasteners.
- See an authorized Can-Am dealer as necessary.

Ball Joints

Inspect ball joint boots for cracks.

WARNING
The ball joint must be replaced if the boot is cracked.

Front A-Arms

- Check A-arms for cracks, bending or other damage.
- See an authorized Can-Am dealer as necessary.

Rear Trailing Arms

- Check trailing arms for distortion, cracks or bending.
- See an authorized Can-Am dealer if any problem is detected.

Steering

Steering Inspection

Tie Rods

Inspect tie rod boots for cracks.

⚠ WARNING

The tie rod must be replaced if the boot is cracked.

Brakes

⚠ WARNING

New brakes will not operate at their maximum efficiency until their break-in is completed. Braking performance may be reduced, so use extra caution.

Brake Fluid Reservoir Level

NOTICE Use only DOT 4 brake fluid from a sealed container. Do not use brake fluid taken from old or already opened containers.

With vehicle on a level surface, check brake fluid in reservoirs for proper level. They should be above MIN. mark.

Add fluid as required. **Do not overfill.**

Clean filler cap before removing.

NOTE: A low level may indicate leaks or worn brake pads. See an authorized Can-Am dealer.

Brake Lever Fluid Reservoir(s)

Turn steering in the straight-ahead position to ensure reservoir is level.

Check the brake fluid level, the reservoir is full when the fluid reaches of the top of window.

Visually inspect lever boot condition.

Check for cracks, tears, etc. Replace if damaged.



TYPICAL

Brake Pedal Fluid Reservoir

With vehicle on a level surface, liquid should be between MIN. and MAX. level marks of brake pedal fluid reservoir.

NOTICE Do not store any objects in the front service compartment.

Recommended Brake Fluid

Always use brake fluid meeting the specification DOT 4 only.

NOTICE To avoid serious damage to the braking system, do not use fluids other than the recommended one, nor mix different fluids for topping up.

Brake Inspection

Check the following to keep the brakes in a good operating condition:

- Brake fluid level
- Brake system for fluid leaks
- Brake for spongy feel
- Brake cleanliness
- Brake discs for excessive wear and surface condition
- Brake pads for wear, damage or looseness.

SERVICE LIMITS	
Brake pads thickness	1.0 mm (.039 in)
Front discs thickness	4 mm (.157 in)
Rear disc thickness	4 mm (.157 in)
Maximum discs warpage	0.2 mm (.008 in)

See your authorized Can-Am dealer if a problem is detected concerning the brake system.

 **WARNING**

The brake fluid replacement or brake system maintenance and repairs should be performed by an authorized Can-Am dealer.

VEHICLE CARE

Post-Operation Care

To preserve the vehicle and its components, clean the vehicle with fresh water as per the *VEHICLE CLEANING AND PROTECTION* recommendations whenever the vehicle is used in the following conditions:

- Muddy conditions
- Salt-water environment.

NOTE: In salt-water environment, it is also recommended to protect metallic parts with XPS LUBE (P/N 293 600 016) or an equivalent.

NOTICE When reinstalling dashboard over air filter housing, ensure that all vent hoses are routed properly close to the air duct.

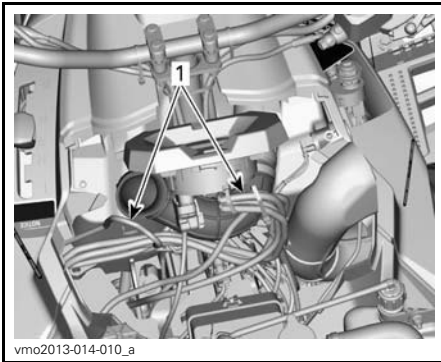

SUPPORT CONSOLE REMOVED FOR CLARITY

1. Route vent hoses close to air duct

Vehicle Cleaning and Protection

Never use a high pressure washer to clean the vehicle. **USE LOW PRESSURE ONLY (like a garden hose).** High pressure can cause electrical or mechanical damage.

Painted parts which are damaged should be properly repainted to prevent rust.

When required, wash the body with warm water and soap (only use mild detergent). Apply non-abrasive wax.

NOTICE Never clean plastic parts with strong detergent, degreasing agent, paint thinner, acetone, etc.

STORAGE AND PRESEASON PREPARATION

WARNING

Have an authorized Can-Am dealer inspect fuel system integrity as specified in *MAINTENANCE SCHEDULE* subsection.

When a vehicle is not in use for a period of four (4) months, proper storage is a necessity.

See an authorized Can-Am dealer for proper procedures.

When using your vehicle after storage, a post storage preparation is required. See an authorized Can-Am dealer for proper procedures.

***This page is
intentionally blank***

TECHNICAL INFORMATION

VEHICLE IDENTIFICATION

The main components of your vehicle (engine and frame) are identified using different serial numbers. It may sometimes become necessary to locate these numbers for warranty purposes or to trace your vehicle in the event of loss. These numbers are also required by the authorized Can-Am dealer to complete warranty claims properly. No warranty will be allowed by BRP Inc. if the engine identification number (E.I.N.) or vehicle identification number (V.I.N.) is removed, mutilated or altered in any way. We strongly recommend that you take note of all the serial numbers on your vehicle and supply them to your insurance company.

Vehicle Identification Number

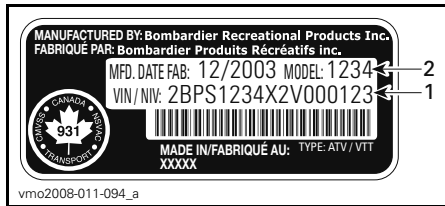

TYPICAL — VEHICLE SERIAL NUMBER LABEL

1. V.I.N. (Vehicle Identification Number) (label under RH side of the seat)
2. V.I.N. (Vehicle Identification Number) (stamped on the frame behind the RH front wheel)

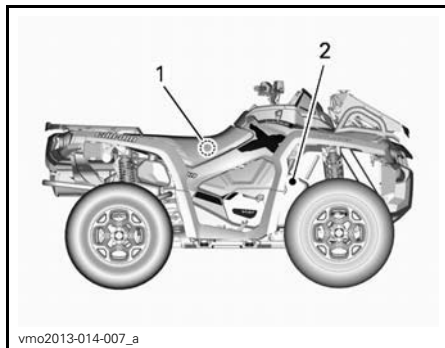

SIDEVIEW OF XMR

1. V.I.N. label under RH side of seat
2. V.I.N. stamped onto frame behind RH front wheel

Engine Identification Number

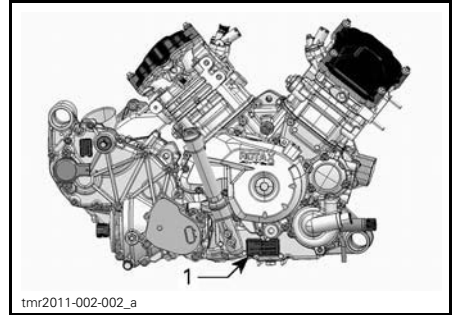

TYPICAL — RH SIDE OF ENGINE SERIAL
1. E.I.N. (Engine Identification Number)

NOISE EMISSION CONTROL SYSTEM REGULATION

USA and Canada Only

Tampering with Noise Control System is Prohibited!

U.S. Federal law and Canadian provincial laws may prohibit the following acts or the causing there of:

1. The removal or rendering inoperative by any person other than for purposes of maintenance, repair or replacement of any device or element of design incorporated into any new vehicle for the purpose of noise control prior to its sale or delivery to the ultimate purchaser or while it is in use or
2. The use of the vehicle after such device or element of design has been removed or rendered inoperative by any person.

Among those Acts Presumed to Constitute Tampering Are the Acts Listed Below:

1. Removal or alteration or the puncturing of the muffler or any engine component which conducts removal of engine exhaust gases.
2. Removal or alteration or the puncturing of any part of the intake system.
3. Replacing any moving parts of the vehicle or parts of the exhaust or intake system, with parts other than those specified by the manufacturer.
4. Lack of proper maintenance.

The EC-Declaration of Conformity does not appear in this version of the Operator's Guide.

Please refer to the printed version that was delivered with your vehicle.

SPECIFICATIONS

MODEL		OUTLANDER 650 X mr	
ENGINE			
Engine type		ROTAX® 660 4-stroke, liquid cooled, SOHC	
Number of cylinders		2	
Number of valves		4 valves/cylinder (mechanical adjustment)	
Bore		82 mm (3.23 in)	
Stroke		61.5 mm (2.42 in)	
Displacement		649.6 cm ³ (39.64 in ³)	
Compression ratio		10.3+/-0.3	
Maximum Horsepower RPM		8000 RPM	
Lubrication	Type	Wet sump with replaceable filter	
	Oil filter	BRP Rotax® cartridge, replaceable	
	Engine oil	Capacity (oil change with filter)	2 L (.53 U.S. gal.)
		Recommended	For the summer season, use XPS 4-STROKE SYNTH. BLEND OIL (SUMMER) (P/N 293 600 121). For the winter season, use XPS 4-STROKE SYNTHETIC OIL (ALL CLIMATE) (P/N 293 600 112). See <i>OIL VISCOSITY CHART</i>
Exhaust system		Bosal stainless steel 409	
Air filter		Synthetic paper filter with foam	
COOLING SYSTEM			
Radiator		Aluminium single row	
Coolant	Type	Ethyl glycol/water mix (50% coolant, 50% water). Use premixed coolant sold by BRP (P/N 219 700 362) or coolant specifically designed for aluminum engines	
	Capacity	3.5 L (.9 U.S. gal.)	

SPECIFICATIONS

MODEL		OUTLANDER 650 X mr	
ELECTRICAL SYSTEM			
Magneto generator output		625 W @ 6000 RPM	
Ignition system type		DC IDI (Inductive Discharge Ignition)	
Ignition timing		Variable	
Spark plug	Quantity	2	
	Make and type	NGK DCPR8E	
	Gap	0.6 mm (.024 in)	
Engine revolutions per minute (RPM) limiter setting	Forward	8000 RPM	
Battery	Type	Yuasa Maintenance Free	
	Voltage	12 volts	
	Nominal rating	18 A•h	
	Power starter output	0.7 KW	
Headlight		2 x 60 W, 2 x 55 W	
Taillight		2 x 8/27 W	
Indicator lamps		LEDS, 0.7 V approximately (each)	
Fuses	Front fuse box	Injectors	5 A
		Fan	25 A
		4WD actuator	5 A
		Speedometer/speed sensor/taillight	10 A
		Fuel pump	5 A
		Engine control module (ECM)	5 A
		Accessories	15 A
		Key switch	5 A
		Winch (Option)	5 A
		Starter solenoid	10 A
	Rear fuse holder	Main	30 A
		Fan/Accessories	30 A
		Dynamic power steering (DPS)	40 A

MODEL		OUTLANDER 650 X mr	
FUEL SYSTEM			
Fuel delivery	Type	Electronic Fuel Injection (EFI), Dell'Orto 46 mm throttle body, 1 injector per cylinder	
Fuel pump	Model	Pressure	
Idle speed		1250 ± 50 RPM	
Fuel	Type	Regular unleaded gasoline (10% MAX ethanol)	
	Minimum octane	Inside North America	87 (R+M)/2 or higher
		Outside North America	92 RON or higher
Fuel tank capacity		20.5 L (5.4 U.S. gal.)	
Remaining fuel in fuel tank when display light turns ON		± 2 L (.5 U.S. gal.)	
CVT TRANSMISSION			
Type		CVT (Continuously Variable Transmission)	
Engagement RPM		1800 ± 100 RPM	
GEARBOX			
Type		Dual range (HI-LO) with park, neutral and reverse	
Gearbox oil	Capacity	350 ml (12 U.S. oz)	
	Recommended	XPS chaincase oil (P/N 413 801 900)	
DRIVE SYSTEM			
Front differential oil/rear final drive oil	Capacity	Front	500 ml (17 U.S. oz)
		Rear	300 ml (10.1 U.S. oz)
	Recommended	Front	XPS synthetic gear oil (P/N 293 600 043) or a 75W 90 API GL-5 synthetic gear oil
		Rear	XPS Synthetic gear oil (P/N 293 600 140) or a 75W 140 API GL-5 synthetic gear oil
Front drive		Bevel straight gears with Visco-Lok	
Front drive ratio		3.6:1	
Rear drive		Straight bevel gears	
Rear drive ratio		3.6:1	
CV joint grease		CV joint grease (P/N 293 550 019)	
Propeller shaft grease		XPS synthetic grease (P/N 293 550 010)	

SPECIFICATIONS

MODEL		OUTLANDER 650 X mr
STEERING		
Turning radius		3 315 mm (130.5 in)
Total toe (vehicle on ground)		2 mm ± 2 mm (.079 in ± .079 in)
Camber angle		0°
SUSPENSION		
<i>FRONT</i>		
Suspension type		Double A-Arm
Suspension travel		226 mm (8.9 in)
Shock absorber	Qty	2
<i>REAR</i>		
Suspension type		Torsional Trailing arm Independant (TTI)
Suspension travel		236 mm (9.3 in)
Shock absorber	Qty	2
BRAKES		
Front brake	Type	BBI hydraulic twin-pistons / 2 (right and left wheels)
Rear brake	Type	BBI hydraulic twin-pistons / 1 (right wheel)
Brake fluid	Capacity	260 ml (8.8 U.S. oz)
	Type	DOT 4
Parking brake		Transmission (Park position)
Caliper		Floating twin-pistons (26 mm x 2)
Brake pad material	Front	Organic
	Rear	Organic
Minimum brake pad thickness		1 mm (.039 in)
Minimum brake disc thickness		4.0 mm (.157 in)
Maximum brake disc warpage		0.2 mm (.008 in)

MODEL		OUTLANDER 650 X mr
TIRES AND WHEELS		
<i>TIRES</i>		
Pressure	Front	Recommended: 48.3 kPa (7 PSI) Minimum: 41.4 kPa (6 PSI)
	Rear	Recommended: 48.3 kPa (7 PSI) Minimum: 41.4 kPa (6 PSI)
Minimum tire tread depth		20 mm (.787 in)
Size	Front	AT 711 mm (28 in) X 203 mm (8 in) X 305 mm (12 in)
	Rear	AT 711 mm (28 in) X 254 mm (10 in) X 305 mm (12 in)
<i>WHEELS</i>		
Size	Front	30.5 cm (12 in) X 15.2 cm (6 in)
	Rear	30.5 cm (12 in) X 19.05 cm (7.5 in)
Wheel nuts torque		100 N•m ± 10 N•m (74 lbf•ft ± 7 lbf•ft)
Power Steering		Dual-mode dynamic power steering (DPS)
DIMENSIONS		
Overall length		2 240 mm (88 in)
Overall width		1 180 mm (46.5 in)
Handlebar overall width		800 mm (31.5 in)
Overall height		1 137 mm (44.75 in)
Wheelbase		1 295 mm (51 in)
Wheel track	Front	945 mm (37 in)
	Rear	925 mm (36 in)
Ground clearance		298 mm (11.75 in)

SPECIFICATIONS

MODEL		OUTLANDER 650 X mr
LOADING CAPACITY AND WEIGHT		
Weight distribution	Front/rear	52/48
Rear storage box		21.4 L (5.65 U.S. gal.)
Rack	Rear	90 kg (200 lb)
Total vehicle load allowed (including driver, all other loads and added accessories)		189 kg (417 lb)
Gross vehicle weight rating	Inside North America	611 kg (1,347 lb)
	Outside North America	620 kg (1,367 lb)
Maximum towing weight		590 kg (1,300 lb)
Maximum tongue weight		23 kg (50 lb)

TROUBLESHOOTING

TROUBLESHOOTING GUIDELINES

ENGINE DOES NOT TURN

1. Ignition switch is in the OFF position.
 - Place switch to the ON position.
2. Emergency engine stop switch.
 - Make sure that emergency engine stop switch is in ON position.
3. Transmission is not set on PARK or NEUTRAL.
 - Set transmission either in PARK or in NEUTRAL or press the brake lever(s).
4. Burnt fuse.
 - Check main fuse condition.
5. Weak battery or loose connections.
 - Check charging system fuse.
 - Check connections and terminals condition.
 - Have the battery checked.
 - Contact an authorized Can-Am dealer.

ENGINE TURNS OVER BUT FAILS TO START

1. Flooded engine (spark plug wet when removed).
 - If the engine does not start and it fuel-flooded, the drowned mode can be activated to prevent fuel injection and to cut ignition while cranking. Proceed as follows:
 - Insert key in ignition switch and turn to ON position.
 - Press completely and HOLD throttle lever.
 - Press the engine START button.

The engine should be cranked for 20 seconds. Release engine START button.

Release throttle lever and start/crank engine again to allow starting.

If it does not work:

 - Clean the spark plug caps area then remove them.
 - Remove the spark plugs (tools are supplied in tool kit).
 - Crank engine several times.
 - Install new spark plugs if possible or clean and dry spark plugs.
 - Start engine as explained above.

If engine continues to flood, see an authorized Can-Am dealer.

NOTE: Make sure to verify that there is no fuel in engine oil, if so, replace engine oil.
2. No fuel to the engine (spark plug dry when removed).
 - Check fuel tank level.
 - A failure of the fuel pump may have occurred.
 - Contact an authorized Can-Am dealer.

ENGINE TURNS OVER BUT FAILS TO START (cont'd)

3. Spark plug/ignition (no spark).

- *Check main fuse condition.*
- *Remove spark plug then reconnect to ignition coil.*
- *Check that ignition switch and/or emergency engine stop switch is/are at the ON position.*
- *Start engine with spark plug grounded to the engine away from spark plug hole. If no spark appears, replace spark plug.*
- *If trouble persists, contact an authorized Can-Am dealer.*

4. Multifunction gauge CHECK ENGINE indicator lamp is on and display shows CHECK ENGINE.

- *Contact an authorized Can-Am dealer.*

5. Engine is under a protection mode.

- *Multifunction gauge CHECK ENGINE indicator lamp is on and display shows CHECK ENGINE, contact an authorized Can-Am dealer.*

ENGINE LACKS ACCELERATION OR POWER

1. Fouled or damaged spark plug.

- *Check item ENGINE TURNS OVER BUT FAILS TO START.*

2. Lack of fuel to engine.

- *Check item ENGINE TURNS OVER BUT FAILS TO START.*

3. Engine is overheating.

- *Check ENGINE OVERHEATS.*

4. Air filter/housing plugged or dirty.

- *Check air filter and clean if necessary.*
- *Check deposits in air filter housing drain.*
- *Check the position of the air intake tube.*

5. CVT dirty or worn-out.

- *Contact an authorized Can-Am dealer.*

6. Engine is under a protection mode.

- *Check multifunction gauge display for messages.*
- *Multifunction gauge CHECK ENGINE indicator lamp is on and display shows CHECK ENGINE, contact an authorized Can-Am dealer.*

ENGINE OVERHEATS

1. Low coolant in cooling system.

- *Check engine coolant, refer to MAINTENANCE PROCEDURES subsection.*

2. Dirty radiator fins.

- *Clean radiator fins, refer to RADIATOR in MAINTENANCE PROCEDURES subsection.*

3. Cooling fan inoperative.

- *Check cooling fan fuse, refer to MAINTENANCE PROCEDURES subsection. If the fuse is good, contact an authorized Can-Am dealer.*

ENGINE BACKFIRE

- 1. Exhaust system leakage.**
 - *Contact an authorized Can-Am dealer.*
- 2. Engine is running too hot.**
 - *See ENGINE LACKS ACCELERATION OR POWER.*
- 3. Ignition timing is incorrect or there is an ignition system failure.**
 - *Contact an authorized Can-Am dealer.*

ENGINE MISFIRE

- 1. Fouled/damaged/worn spark plug.**
 - *Clean/verify spark plug and heat range. Replace as required.*
- 2. Water in fuel.**
 - *Drain fuel system and refill with fresh fuel.*

VEHICLE CANNOT REACH FULL SPEED

- 1. Engine.**
 - *See ENGINE LACKS ACCELERATION OR POWER.*
- 2. Brake lock.**
 - *Ensure brake lock is completely removed.*
- 3. Air filter/housing plugged or dirty.**
 - *Check air filter and clean if necessary.*
 - *Check deposits in air filter housing drain.*
 - *Check the position of the air intake tube.*
- 4. CVT dirty or worn-out.**
 - *Contact an authorized Can-Am dealer.*
- 5. Engine is under a protection mode.**
 - *Check multifunction gauge display for messages.*
 - *Multifunction gauge CHECK ENGINE indicator lamp is on and display shows CHECK ENGINE , contact an authorized Can-Am dealer.*

SHIFT LEVER IS HARD TO MOVE

- 1. Transmission gears are in a position that prevents the shift lever to work.**
 - *Rock the vehicle back and forth to move the gears in the transmission and allow the shift lever to be set.*
- 2. CVT dirty or worn-out.**
 - *Contact an authorized Can-Am dealer.*

THE RPM INCREASES BUT THE VEHICLE DOES NOT MOVE

- 1. The transmission is on PARK or NEUTRAL position.**
 - *Select the R, HI or LO position.*
- 2. CVT dirty or worn-out.**
 - *Contact an authorized Can-Am dealer.*

THE RPM INCREASES BUT THE VEHICLE DOES NOT MOVE (cont'd)

3. Water in the CVT.

- See *SPECIAL PROCEDURES*.

MULTIFUNCTION GAUGE MESSAGES

MESSAGE	PILOT LAMP(S) ON	DESCRIPTION
DESS KEY NOT RECOGNIZED	Check engine	Indicates that you have used the wrong ignition key, use the proper key for this vehicle. It is also possible that the ignition key has a bad contact, remove and clean key.
PARK BRAKE	Brake lock	Displayed when brake is applied for more than 15 seconds (while riding).
LO BATT VOLT	Check engine	Low battery voltage, check battery voltage and charging system.
HIGH BATT VOLT	Check engine	High battery voltage, check battery voltage and charging system.
LOW OIL ⁽¹⁾	Check engine	Engine low oil pressure, stop engine immediately.
HI TEMP	Check engine	Engine is overheating, refer to <i>ENGINE OVERHEATS</i> in <i>TROUBLESHOOTING</i> section.
LIMP HOME	Check engine	Serious fault on the engine that can change the normal operation of the engine, CHECK ENGINE indicator lamp will also blink, refer to <i>TROUBLESHOOTING</i> section.
CHECK ENGINE	Check engine	Engine fault, CHECK ENGINE indicator lamp will also be ON, refer to <i>TROUBLESHOOTING</i> section.
MAINTENANCE REQUIRED ⁽²⁾	Check engine	Periodic maintenance required. See an authorized Can-Am dealer.
ECM NOT RECOGNIZED	Check engine	Communication error between speedometer and engine control module (ECM), contact an authorized Can-Am dealer.
CHECK DPS	Check engine	Indicates that the DPS (Dynamic Power Steering) does not work properly. See an authorized Can-Am dealer.
TPS FAULT PRESS OVERRIDE BUTTON TO LIMP HOME	Check engine	Throttle position sensor does not work properly. See an authorized Can-Am dealer.
NOTICE ⁽¹⁾ If the message and the check engine light stay on after engine starting, stop engine. Check engine oil level. Refill if necessary. If the oil level is good, see an authorized Can-Am dealer. Do not use the vehicle until repaired.		
⁽²⁾ Message must be erased by an authorized Can-Am dealer.		

WARRANTY

BRP LIMITED WARRANTY USA AND CANADA: 2013 CAN-AM™ ATV

1) SCOPE OF THE LIMITED WARRANTY

Bombardier Recreational Products Inc. ("BRP")* warrants its 2013 Can-Am ATV sold by authorized Can-Am ATV dealers (as hereinafter defined) in the fifty United States and Canada from defects in material or workmanship for the period and under the conditions described below. This limited warranty will become null and void if: (1) the ATV was used for racing or any other competitive activity, at any point, even by a previous owner; or (2) the ATV has been altered or modified in such a way so as to adversely affect its operation, performance or durability, or has been altered or modified to change its intended use.

Except if otherwise specified, all genuine Can-Am ATV parts and accessories installed by an authorized BRP dealer at the time of delivery of the 2013 Can-Am ATV, carry the same warranty as that of the Can-Am ATV. Without limiting the generality of the foregoing, the Apache™ and Apache 360™ track kits do not carry the same warranty as that of the Can-Am ATV.

2) LIMITATIONS OF LIABILITY

THIS WARRANTY IS EXPRESSLY GIVEN AND ACCEPTED IN LIEU OF ANY AND ALL OTHER WARRANTIES, EXPRESSED OR IMPLIED, INCLUDING WITHOUT LIMITATION ANY WARRANTY OF MERCHANTABILITY OR FITNESS FOR A PARTICULAR PURPOSE TO THE EXTENT THAT THEY CANNOT BE DISCLAIMED, THE IMPLIED WARRANTIES ARE LIMITED IN DURATION TO THE LIFE OF THE EXPRESS WARRANTY INCIDENTAL AND CONSEQUENTIAL DAMAGES ARE EXCLUDED FROM COVERAGE UNDER THIS WARRANTY SOME STATES/PROVINCES DO NOT ALLOW FOR THE DISCLAIMERS, LIMITATIONS AND EXCLUSIONS IDENTIFIED ABOVE, AS A RESULT, THEY MAY NOT APPLY TO YOU. THIS WARRANTY GIVES YOU SPECIFIC RIGHTS, AND YOU MAY ALSO HAVE OTHER LEGAL RIGHTS WHICH MAY VARY FROM STATE TO STATE, OR PROVINCE TO PROVINCE.

Neither the distributor, any BRP dealer nor any other person has been authorized to make any affirmation, representation or warranty regarding the product, other than those contained in this limited warranty, and if made, shall not be enforceable against BRP. BRP reserves the right to modify this warranty at any time, being understood that such modification will not alter the warranty conditions applicable to the products sold while this warranty is in effect.

3) EXCLUSIONS – ARE NOT WARRANTED

The following are not warranted under any circumstances:

- Normal wear and tear;
- Routine maintenance items, tune ups, adjustments;
- Damage caused by failure to provide proper maintenance and/or storage, as described in the Operator's Guide;
- Damage resulting from removal of parts, improper repairs, service, maintenance, modifications or use of parts not manufactured or approved by BRP or resulting from repairs done by a person that is not an authorized servicing Can-Am ATV dealer;

- Damage caused by abuse, abnormal use, neglect or operation of the product in a manner inconsistent with the recommended operation described in the Can-Am ATV Operator’s Guide;
- Damage resulting from accident, submersion, fire, theft, vandalism or any act of God;
- Operation with fuels, oils or lubricants which are not suitable for use with the product (see the Operator’s Guide);
- Damages from rust, corrosion or exposure to the elements;
- Damage resulting from water or snow ingestion;
- Incidental or consequential damages, or damages of any kind including without limitation towing, storage, telephone, rental, taxi, inconvenience, insurance coverage, loan payments, loss of time, loss of income.

4) WARRANTY COVERAGE PERIOD

This warranty will be in effect from (1) the date of delivery to the first retail consumer or (2) the date the product is first put into use, whichever occurs first and for the following period:

SIX (6) CONSECUTIVE MONTHS, for private use or commercial use owners, except that emission-related components installed on EPA certified ATVs registered in the USA are covered for 5000 km or thirty (30) consecutive months whichever comes first; and evaporative emission related components are warranted for twenty-four (24) consecutive months. To obtain a list of the current warranted emission-related components, please see an authorized Can-Am ATV dealer.

The repair or replacement of parts or the performance of service under this warranty does not extend the life of this warranty beyond its original expiration date.

5) CONDITIONS TO HAVE WARRANTY COVERAGE

This warranty coverage is available **only** if **each** of the following conditions has been fulfilled:

- The 2013 Can-Am ATV must be purchased as new and unused by its first owner from a Can-Am ATV dealer authorized to distribute Can-Am ATVs in the country in which the sale occurred (“Can-Am ATV dealer”);
- The BRP specified pre-delivery inspection process must be completed and documented and signed by the purchaser;
- The 2013 Can-Am ATV must have undergone proper registration by an authorized Can-Am ATV dealer;
- The 2013 Can-Am ATV must be purchased in the country in which the purchaser resides;
- Routine maintenance outlined in the Operator’s Guide must be timely performed in order to maintain warranty coverage. BRP reserves the right to make warranty coverage contingent upon proof of proper maintenance.

BRP will not honor this limited warranty to any private use owner or commercial use owner if one of the preceding conditions has not been met. Such limitations are necessary in order to allow BRP to preserve both the safety of its products, and also that of its consumers and the general public.

6) WHAT TO DO TO OBTAIN WARRANTY COVERAGE

The customer must cease using the ATV upon the appearance of an anomaly. The customer must notify a servicing BRP dealer within three (3) days of the appearance of a defect, and provide it with reasonable access to the product and reasonable opportunity to repair it. The customer must also present to the authorized BRP dealer, proof of purchase of the product and must sign the repair/work order prior to starting the repair in order to validate the warranty repair. All parts replaced under this limited warranty become the property of BRP.

7) WHAT BRP WILL DO

BRP's obligations under this warranty are limited to, at its sole discretion, repairing parts found defective under normal use, maintenance and service, or replacing such parts with new genuine Can-Am ATV parts without charge for parts and labor, at any authorized BRP dealer during the warranty coverage period under the conditions described herein. No claim of breach of warranty shall be cause for cancellation or rescission of the sale of the ATV to the owner.

In the event that service is required outside of the country of original sale, the owner will bear responsibility for any additional charges due to local practices and conditions, such as, but not limited to, freight, insurance, taxes, license fees, import duties, and any and all other financial charges, including those levied by governments, states, territories and their respective agencies.

BRP reserves the right to improve or modify products from time to time without assuming any obligation to modify products previously manufactured.

8) SUPPLIER WARRANTIES

A GPS receiver may be supplied by BRP as standard equipment on certain 2013 Can-Am ATV's. The GPS receiver is covered by the limited warranty issued by the GPS receiver's manufacturer and is not covered by this limited warranty. Please contact the following distributors if in Canada or the manufacturer if in the USA:

In the USA:

Garmin International Inc.

U.S.: 913 397-8200

U.S. Toll Free: 1 800 800-1020

Website: www.garmin.com

In Canada (one or the other):

Raytech Électronique

Tel.: 450 975-1015

Fax: 800 975-0025 / 450 975-0817

Contact: raytech@raytech.qc.ca

Web Site: www.raytech.qc.ca

Coord. GPS: N45o35.25' - W73o42.95'

Naviclub Ltd

Tel.: 418 835-9279

Fax: 418 835-6681

Contact: naviclub@naviclub.com

Web Site: www.naviclub.com

9) TRANSFER

If the ownership of a product is transferred during the warranty coverage period, this warranty shall also be transferred and be valid for the remaining coverage period provided that BRP is notified of such transfer of ownership in the following way:

1. The former owner contacts BRP (at the phone number provided below) or an authorized BRP dealer and gives the coordinates of the new owner; or
2. BRP or an authorized BRP dealer receives a proof that the former owner agreed to the transfer of ownership, in addition to the coordinates of the new owner.

10) CONSUMER ASSISTANCE

In the event of a controversy or a dispute in connection with this limited warranty, BRP suggests that you try to resolve the issue at the dealership level. We recommend discussing the issue with the authorized dealer's service manager or owner.

If the issue has not yet been resolved, please submit your complaint in writing or call the appropriate number below:

In Canada

BOMBARDIER RECREATIONAL PRODUCTS INC.

CAN-AM ATV
CUSTOMER ASSISTANCE CENTER
75 J.-A. Bombardier Street
Sherbrooke QC J1L 1W3
Tel.: 819 566-3366

In USA

BRP US INC.
CAN-AM ATV
CUSTOMER ASSISTANCE CENTER
7575 Bombardier Court
Wausau WI 54401
Tel.: 715 848-4957

* In the USA, products are distributed and serviced by BRP US Inc.

© 2011 Bombardier Recreational Products Inc. All rights reserved.

™ trademark of Bombardier Recreational Products Inc. or its affiliates.

† Carlisle and ITP are trademarks owned by or licensed to Carlisle Tire & Wheel Company.

BRP INTERNATIONAL LIMITED WARRANTY: 2013 CAN-AM™ ATV

1) SCOPE OF THE LIMITED WARRANTY

Bombardier Recreational Products Inc. ("BRP")* warrants its 2013 Can-Am ATV sold by Can-Am ATV distributors or dealers authorized by BRP to distribute Can-Am ATVs ("Can-Am ATV Distributor/Dealer") outside of the fifty United States, Canada and states that are members of the European Economic Area ("EEA") (which is comprised of the states members of the European Union plus Norway, Iceland and Liechtenstein), Turkey, and states members of the Commonwealth of the Independent States ("CIS") (which is comprised of the Russian Federation and ex-members states of the USSR), from defects in material or workmanship for the period and under the conditions described below.

All genuine Can-Am ATV parts and accessories, installed by an authorized Can-Am ATV Distributor/Dealer at the time of delivery of the 2013 Can-Am ATV, carry the same warranty as that of the Can-Am ATV.

This limited warranty will become null and void if: (1) The ATV was used for racing or any other competitive activity, at any point, even by a previous owner; or (2) the ATV has been altered or modified in such a way so as to adversely affect its operation, performance or durability, or has been altered or modified to change its intended use.

2) LIMITATIONS OF LIABILITY

TO THE EXTENT PERMITTED BY LAW, THIS WARRANTY IS EXPRESSLY GIVEN AND ACCEPTED IN LIEU OF ANY AND ALL OTHER WARRANTIES, EXPRESSED OR IMPLIED, INCLUDING WITHOUT LIMITATION ANY WARRANTY OF MERCHANTABILITY OR FITNESS FOR A PARTICULAR PURPOSE. TO THE EXTENT THAT THEY CANNOT BE DISCLAIMED, THE IMPLIED WARRANTIES ARE LIMITED IN DURATION TO THE LIFE OF THE EXPRESS WARRANTY. INCIDENTAL AND CONSEQUENTIAL DAMAGES ARE EXCLUDED FROM COVERAGE UNDER THIS WARRANTY. SOME JURISDICTIONS DO NOT ALLOW FOR THE DISCLAIMERS, LIMITATIONS AND EXCLUSIONS IDENTIFIED ABOVE, AS A RESULT, THEY MAY NOT APPLY TO YOU. THIS WARRANTY GIVES YOU SPECIFIC RIGHTS, AND YOU MAY ALSO HAVE OTHER LEGAL RIGHTS WHICH MAY VARY FROM COUNTRY TO COUNTRY. (FOR PRODUCTS PURCHASED IN AUSTRALIA SEE CLAUSE 4 BELOW).

Neither the Can-Am ATV Distributor/Dealer nor any other person has been authorized to make any affirmation, representation or warranty regarding the product, other than those contained in this limited warranty, and if made, shall not be enforceable against BRP.

BRP reserves the right to modify this warranty at any time, being understood that such modification will not alter the warranty conditions applicable to the products sold while this warranty is in effect.

3) EXCLUSIONS – ARE NOT WARRANTED

The following are not warranted under this limited warranty under any circumstances:

- Normal wear and tear;
- Routine maintenance items, tune ups, adjustments;

- Damage caused by negligence or failure to provide proper maintenance and/or storage, as described in the Operator's Guide;
- Damage resulting from removal of parts, improper repairs, service, maintenance, modifications or use of parts or accessories not manufactured or approved by BRP which in its reasonable judgement are either incompatible with the product or adversely affect its operation, performance and durability, or resulting from repairs done by a person that is not an authorized servicing Can-Am ATV Distributor/Dealer;
- Damage caused by abuse, abnormal use, neglect, racing or operation of the product in a manner inconsistent with the recommended operation described in the Operator's Guide;
- Damage resulting from accident, submersion, fire, snow or water ingestion, theft, vandalism or any act of God;
- Operation with fuels, oils or lubricants which are not suitable for use with the product (see the Operator's Guide);
- Damage resulting from rust, corrosion or exposure to the elements;
- Incidental or consequential damages, or damages of any kind including without limitation towing, storage, transportation expenses, telephone, rental, taxi, inconvenience, insurance coverage, loan payments, loss of time, loss of income; or time missed for downtime experience due to service work.

4) WARRANTY COVERAGE PERIOD

This warranty will be in effect from (1) the date of delivery to the first retail consumer or (2) the date the product is first put into use, whichever occurs first and for a period of:

SIX (6) CONSECUTIVE MONTHS for private use or commercial use.

The repair or replacement of parts or the performance of service under this warranty does not extend the life of this warranty beyond its original expiration date.

Note that the duration and any other modalities of the warranty coverage are subject to the applicable national or local legislation in the customer's country.

FOR PRODUCTS SOLD IN AUSTRALIA ONLY

Nothing in these Warranty terms and conditions should be taken to exclude, restrict or modify the application of any condition, warranty, guarantee, right or remedy conferred or implied under the Competition and Consumer Act 2010 (Cth), including the Australian Consumer Law or any other law, where to do so would contravene that law, or cause any part of these terms and conditions to be void. The benefits given to you under this limited warranty are in addition to other rights and remedies that you have under Australian law.

Our goods come with guarantees that cannot be excluded under the Australian Consumer Law. You are entitled to a replacement or refund for a major failure and for compensation for any other reasonably foreseeable loss or damage. You are also entitled to have the goods repaired or replaced if the goods fail to be of acceptable quality and the failure does not amount to a major failure.

5) CONDITIONS TO HAVE WARRANTY COVERAGE

This warranty coverage is available **only** if each of the following conditions has been fulfilled:

- The 2013 Can-Am ATV must be purchased as new and unused by its first owner from a Can-Am ATV Distributor/Dealer authorized to distribute Can-Am ATVs in the country in which the sale occurred;
- The BRP specified pre-delivery inspection process must be completed and documented;
- The product must have undergone proper registration by an authorized Can-Am ATV Distributor/Dealer;
- The 2013 Can-Am ATV must be purchased in the country or union of countries in which the purchaser resides; and
- Routine maintenance outlined in the Operator's Guide must be timely performed in order to maintain warranty coverage. BRP reserves the right to make warranty coverage contingent upon proof of proper maintenance.

BRP will not honour this limited warranty to any private use owner or commercial use owner if one of the preceding conditions has not been met. Such limitations are necessary in order to allow BRP to preserve both the safety of its products, and also that of its consumers and the general public.

6) WHAT TO DO TO OBTAIN WARRANTY COVERAGE UNDER THIS WARRANTY

The customer must cease using the ATV upon the appearance of an anomaly. The customer must notify a servicing Can-Am ATV Distributor/Dealer within two (2) days of the appearance of a defect, and provide it with reasonable access to the product and reasonable opportunity to repair it. The customer must also present to the authorized Can-Am ATV Distributor/Dealer proof of purchase of the product and must sign the repair/work order prior to starting the repair in order to validate the warranty repair. All parts replaced under this limited warranty become the property of BRP.

Note that the notification period is subject to the applicable national or local legislation in customer's country.

7) WHAT BRP WILL DO

To the extent permitted by law, BRP's obligations under this warranty are limited to, at its sole discretion, repairing parts found defective under normal use, maintenance and service, or replacing such parts with new genuine Can-Am ATV parts without charge for parts and labour, at any authorized Can-Am ATV Distributor/Dealer during the warranty coverage period under the conditions described herein. BRP's responsibility is limited to making the required repairs or replacements of parts. No claim of breach of warranty shall be cause for cancellation or rescission of the sale of the Can-Am ATV to the owner. You may have other legal rights which may vary from country to country.

In the event that service is required outside of the country of original sale, the owner will bear responsibility for any additional charges due to local practices and conditions, such as, but not limited to, freight, insurance, taxes, license fees, import duties, and any and all other financial charges, including those levied by governments, states, territories and their respective agencies.

BRP reserves the right to improve or modify products from time to time without assuming any obligation to modify products previously manufactured.

8) TRANSFER

If the ownership of a product is transferred during the warranty coverage period, this warranty shall also be transferred and be valid for the remaining coverage period provided BRP or an authorized Can-Am ATV Distributor/Dealer receives a proof that the former owner agreed to the transfer of ownership, in addition to the co-ordinates of the new owner.

9) CONSUMER ASSISTANCE

1. In the event of a controversy or a dispute in connection with this limited warranty, BRP suggests that you try to resolve the issue at the Can-Am ATV Dealer level. We recommend discussing the issue with the authorized Can-Am ATV Distributor/Dealer's service manager or owner.
2. If further assistance is required, the Can-Am ATV Distributor/Dealer service department should be contacted in order to resolve the matter.
3. If the matter still remains unresolved then contact BRP by writing at the address listed below.

For countries within Middle East and Africa please contact our European office:

BRP EUROPE N.V.

Customer Assistance Center
Skaldenstraat 125
9042 Gent
Belgium
Tel.: + 32 9 218 26 00

For all other countries, please contact your local Can-Am ATV Distributor/Dealer (visit our website at www.brp.com for contact information), or contact our North American office at:

BOMBARDIER RECREATIONAL PRODUCTS INC.

Customer Assistance Center
75 J.-A. Bombardier Street
Sherbrooke QC J1L 1W3
Tel.:+ 1 819 566-3366

* For the territory covered by this limited warranty, products are distributed and serviced by Bombardier Recreational Products Inc. or its affiliates.

© 2012 Bombardier Recreational Products Inc. All rights reserved.

™ Trademark of Bombardier Recreational Products Inc. or its affiliates.

BRP LIMITED WARRANTY FOR THE EUROPEAN AND THE RUSSIAN ECONOMIC AREAS AND TURKEY ECONOMIC AREA: 2013 CAN-AM™ ATV

1) SCOPE OF THE LIMITED WARRANTY

Bombardier Recreational Products Inc. ("BRP")* warrants its 2013 Can-Am ATVs sold by distributors or dealers authorized by BRP to distribute Can-Am ATVs ("Can-Am ATV Distributor/Dealer") in states members of the European Economic Area, ("EEA") (which is comprised of the states member of the European Union plus Norway, Iceland and Liechtenstein) in member states of the Commonwealth of the Independent States ("CIS") (which is comprised of the Russian Federation and ex-members states of the USSR) and Turkey from defects in material or workmanship for the period and under the conditions described below.

All genuine Can-Am ATV parts and accessories, installed by an authorized Can-Am ATV Distributor/Dealer at the time of delivery of the 2013 Can-Am ATV, carry the same warranty as that of the ATV.

This limited warranty will become null and void if: (1) The ATV was used for racing or any other competitive activity, at any point, even by a previous owner; or (2) the ATV has been altered or modified in such a way so as to adversely affect its operation, performance or durability, or has been altered or modified to change its intended use.

2) LIMITATIONS OF LIABILITY

TO THE EXTENT PERMITTED BY LAW, THIS WARRANTY IS EXPRESSLY GIVEN AND ACCEPTED IN LIEU OF ANY AND ALL OTHER WARRANTIES, EXPRESSED OR IMPLIED, INCLUDING WITHOUT LIMITATION ANY WARRANTY OF MERCHANTABILITY OR FITNESS FOR A PARTICULAR PURPOSE. TO THE EXTENT THAT THEY CANNOT BE DISCLAIMED, THE IMPLIED WARRANTIES ARE LIMITED IN DURATION TO THE LIFE OF THE EXPRESS WARRANTY. INCIDENTAL AND CONSEQUENTIAL DAMAGES ARE EXCLUDED FROM COVERAGE UNDER THIS WARRANTY. SOME JURISDICTIONS DO NOT ALLOW FOR THE DISCLAIMERS, LIMITATIONS AND EXCLUSIONS IDENTIFIED ABOVE, AS A RESULT, THEY MAY NOT APPLY TO YOU. THIS WARRANTY GIVES YOU SPECIFIC RIGHTS, AND YOU MAY ALSO HAVE OTHER LEGAL RIGHTS WHICH MAY VARY FROM COUNTRY TO COUNTRY.

Neither the Can-Am ATV Distributor/Dealer nor any other person has been authorized to make any affirmation, representation or warranty regarding the product, other than those contained in this limited warranty, and if made, shall not be enforceable against BRP.

BRP reserves the right to modify this warranty at any time, being understood that such modification will not alter the warranty conditions applicable to the products sold while this warranty is in effect.

3) EXCLUSIONS – ARE NOT WARRANTED

The following are not warranted under any circumstances:

- Normal wear and tear;
- Routine maintenance items, tune ups, adjustments;
- Damage caused by negligence or failure to provide proper maintenance and/or storage, as described in the Operator's Guide;

- Damage resulting from removal of parts, improper repairs, service, maintenance, modifications or use of parts or accessories not manufactured or approved by BRP which in its reasonable judgement are either incompatible with the product or adversely affect its operation, performance and durability, or resulting from repairs done by a person that is not an authorized servicing Can-Am ATV Distributor/Dealer;
- Damage caused by abuse, abnormal use, neglect, racing or operation of the product in a manner inconsistent with the recommended operation described in the Operator's Guide;
- Damage resulting from accident, submersion, fire, snow or water ingestion, theft, vandalism or any act of God;
- Operation with fuels, oils or lubricants which are not suitable for use with the product (see the Operator's Guide);
- Damage resulting from rust, corrosion or exposure to the elements;
- Incidental or consequential damages, or damages of any kind including without limitation towing, transportation expenses, storage, telephone, rental, taxi, inconvenience, insurance coverage, loan payments, loss of time, loss of income or time missed for downtime experience due to service work.

4) WARRANTY COVERAGE PERIOD

This warranty will be in effect from (1) the date of delivery to the first retail consumer or (2) the date the product is first put into use, whichever occurs first and for a period of:

TWENTY-FOUR (24) CONSECUTIVE MONTHS for private use.

SIX (6) CONSECUTIVE MONTHS for commercial use or rental use.

The product is used commercially when it is used in connection with any work or employment that generates income during any part of the warranty period. The product is also used commercially when, at any point during the warranty period, it is licensed for commercial use.

The repair or replacement of parts or the performance of service under this warranty does not extend the life of this warranty beyond its original expiration date.

Note that the duration and any other modalities of the warranty coverage are subject to the applicable national or local legislation in the customer's country.

5) CONDITIONS TO HAVE WARRANTY COVERAGE

This warranty coverage is available **only** if **each** of the following conditions has been fulfilled:

- The 2013 Can-Am ATV must be purchased as new and unused by its first owner from a Can-Am ATV Distributor/Dealer authorized to distribute Can-Am ATVs in the country in which the sale occurred;
- The BRP specified pre-delivery inspection process must be completed and documented;
- The product must have undergone proper registration by an authorized Can-Am ATV Distributor/Dealer;

- The 2013 Can-Am ATV must be purchased within the EEA by an EEA resident, in the CIS for residents of the countries comprised in such area and in Turkey for residents of Turkey; and
- Routine maintenance outlined in the Operator's Guide must be timely performed in order to maintain warranty coverage. BRP reserves the right to make warranty coverage contingent upon proof of proper maintenance.

BRP will not honour this limited warranty to any private use owner or commercial use owner if one of the preceding conditions has not been met. Such limitations are necessary in order to allow BRP to preserve both the safety of its products, and also that of its consumers and the general public.

6) WHAT TO DO TO OBTAIN WARRANTY COVERAGE UNDER THIS WARRANTY

The customer must cease using the ATV upon the appearance of an anomaly. The customer must notify a servicing Can-Am ATV Distributor/Dealer within two (2) months of the appearance of a defect and provide it with reasonable access to the product and reasonable opportunity to repair it. The customer must also present to the authorized Can-Am ATV Distributor/Dealer, proof of purchase of the product and must sign the repair/work order prior to starting the repair in order to validate the warranty repair. All parts replaced under this limited warranty become the property of BRP.

Note that the notification period is subject to the applicable national or local legislation in customer's country.

7) WHAT BRP WILL DO

To the extent permitted by law, BRP's obligations under this warranty are limited to, at its sole discretion, repairing parts found defective under normal use, maintenance and service, or replacing such parts with new genuine Can-Am ATV parts without charge for parts and labour, at any authorized Can-Am ATV Distributor/Dealer during the warranty coverage period under the conditions described herein. BRP's responsibility is limited to making the required repairs or replacements of parts. No claim of breach of warranty shall be cause for cancellation or rescission of the sale of the Can-Am ATV to the owner. You may have other legal rights which may vary from country to country.

In the event that service is required outside of the EEA, CIS or Turkey, the owner will bear responsibility for any additional charges due to local practices and conditions, such as, but not limited to, freight, insurance, taxes, license fees, import duties, and any and all other financial charges, including those levied by governments, states, territories and their respective agencies.

BRP reserves the right to improve or modify products from time to time without assuming any obligation to modify products previously manufactured.

8) TRANSFER

If the ownership of a product is transferred during the warranty coverage period, this warranty shall also be transferred and be valid for the remaining coverage period provided BRP or an authorized Can-Am ATV Distributor/Dealer receives a proof that the former owner agreed to the transfer of ownership, in addition to the co-ordinates of the new owner.

9) CONSUMER ASSISTANCE

1. In the event of a controversy or a dispute in connection with this limited warranty, BRP suggests that you try to resolve the issue at the Can-Am ATV Distributor/Dealer level. We recommend discussing the issue with the authorized Can-Am ATV Distributor/Dealer's service manager or owner.
2. If further assistance is required, the Can-Am ATV Distributor/Dealer service department should be contacted in order to resolve the matter.
3. If the matter still remains unresolved then contact BRP at the address listed below:

For countries within Europe, Turkey, the CIS and Russia please contact our European office:

BRP EUROPE N.V.

Customer Assistance Center
Skaldenstraat 125
9042 Gent
Belgium
Tel.: + 32 9 218 26 00

For Scandinavian countries, please contact our Finland office:

BRP FINLAND OY

Service Department
Isoaavantie 7
FIN-96320 Rovaniemi
Finland
Tel.: + 358 16 3208 111

You can find your Can-Am Distributor/Dealer's coordinates on www.brp.com.

* In the EEA, products are distributed and serviced by BRP European Distribution S.A. and other affiliates or subsidiaries of BRP.

© 2012 Bombardier Recreational Products Inc. All rights reserved.

™ Trademark of Bombardier Recreational Products Inc. or its affiliates.

ADDITIONAL TERMS AND CONDITIONS FOR FRANCE ONLY

The following terms and conditions are applicable to products sold in France only:

The seller shall deliver goods that are complying with the contract and shall be responsible for defects existing upon delivery. The seller shall also be responsible for defects resulting from packaging, assembling instructions or the installation when it is its responsibility per the contract or if accomplished under its responsibility. To be compliant with the contract, the good shall:

1. Be fit for normal use for goods similar thereto and, if applicable:
 - Correspond to the description provided by the seller and have the qualities presented to the buyer through sample or model;
 - Have the qualities that a buyer may legitimately expect considering the public declarations of the seller, the manufacturer of its representative, including in advertising or labeling; or
2. Have the characteristics mutually agreed upon as between the parties or be fit for the specific use intended by the buyer and brought to the attention of the seller and which accepted.

The action for failure to comply is prescribed after two years after delivery of the goods. The seller is responsible for the warranty for hidden defects of the good sold if such hidden defects are rendering the good unfit for the intended use, or if they diminish its use in such a way that the buyer would not have acquired the good or would have given a lesser price, had he known. The action for such hidden defects shall be taken by the buyer within 2 years of the discovery of the defect.

CUSTOMER INFORMATION

PRIVACY INFORMATION

BRP wishes to inform you that your coordinates will be used for safety and warranty related purposes. Furthermore, BRP and its affiliates may use its customer list to distribute marketing and promotional information about BRP and related products.

To exercise your right to consult or correct your data, or to be removed from the addressee-list for direct marketing, please contact BRP.

By E-mail: privacyofficer@brp.com

By mail: BRP
Senior Legal Counsel-Privacy Officer
726 St-Joseph
Valcourt QC
Canada
J0E 2L0

CHANGE OF ADDRESS/OWNERSHIP

If your address has changed or if you are the new owner of the ATV, be sure to notify BRP by either:

- Mailing one of the change of address cards on the following pages.
- North America only: Calling at 715 848-4957 (USA) or 819 566-3366 (Canada).
- Notifying an authorized Can-Am dealer.

In case of change of ownership, please join a proof that the former owner agreed to the transfer.

Notifying BRP, even after the expiration of the limited warranty, is very important as it enables BRP to reach the ATV owner if necessary, like when safety recalls are initiated. It is the owner's responsibility to notify BRP.

STOLEN UNITS: If your personal ATV is stolen, you should notify BRP or an authorized Can-Am dealer. We will ask you to provide your name, address, phone number, the vehicle identification number and the date it was stolen.

North America

BOMBARDIER RECREATIONAL PRODUCTS INC.

Warranty Department
75 J.-A. Bombardier Street
Sherbrooke QC J1L 1W3
Canada

Scandinavian countries

BRP FINLAND OY

Service Department
Isoaavantie 7
FIN-96320 Rovaniemi

Other countries in the world

BRP EUROPEAN DISTRIBUTION

Warranty Department
Chemin de Messidor 5-7
1006 Lausanne
Switzerland

***This page is
intentionally blank***

CHANGE OF ADDRESS

CHANGE OF OWNERSHIP



VEHICLE IDENTIFICATION NUMBER

Model Number

Vehicle Identification Number (V.I.N.)

OLD ADDRESS
OR PREVIOUS OWNER:

NAME

NO. STREET APT

CITY STATE/PROVINCE ZIP/POSTAL CODE

COUNTRY TELEPHONE

NEW ADDRESS
OR NEW OWNER:

NAME

NO. STREET APT

CITY STATE/PROVINCE ZIP/POSTAL CODE

COUNTRY TELEPHONE

E-MAIL ADDRESS

V00A2F

CHANGE OF ADDRESS

CHANGE OF OWNERSHIP



VEHICLE IDENTIFICATION NUMBER

Model Number

Vehicle Identification Number (V.I.N.)

OLD ADDRESS
OR PREVIOUS OWNER:

NAME

NO. STREET APT

CITY STATE/PROVINCE ZIP/POSTAL CODE

COUNTRY TELEPHONE

NEW ADDRESS
OR NEW OWNER:

NAME

NO. STREET APT

CITY STATE/PROVINCE ZIP/POSTAL CODE

COUNTRY TELEPHONE

E-MAIL ADDRESS

V00A2F

CHANGE OF ADDRESS

CHANGE OF OWNERSHIP



VEHICLE IDENTIFICATION NUMBER

Model Number

Vehicle Identification Number (V.I.N.)

OLD ADDRESS
OR PREVIOUS OWNER:

NAME

NO. STREET APT

CITY STATE/PROVINCE ZIP/POSTAL CODE

COUNTRY TELEPHONE

NEW ADDRESS
OR NEW OWNER:

NAME

NO. STREET APT

CITY STATE/PROVINCE ZIP/POSTAL CODE

COUNTRY TELEPHONE

E-MAIL ADDRESS

V00A2F

CHANGE OF ADDRESS

CHANGE OF OWNERSHIP



VEHICLE IDENTIFICATION NUMBER

Model Number

Vehicle Identification Number (V.I.N.)

OLD ADDRESS
OR PREVIOUS OWNER:

NAME

NO. STREET APT

CITY STATE/PROVINCE ZIP/POSTAL CODE

COUNTRY TELEPHONE

NEW ADDRESS
OR NEW OWNER:

NAME

NO. STREET APT

CITY STATE/PROVINCE ZIP/POSTAL CODE

COUNTRY TELEPHONE

E-MAIL ADDRESS

V00A2F

ATV MODEL No. _____

VEHICLE
IDENTIFICATION NUMBER (V.I.N.) _____

ENGINE
IDENTIFICATION NUMBER (E.I.N.) _____

Owner: _____
NAME

No. STREET APT

CITY STATE/PROVINCE ZIP/POSTAL CODE

Purchase Date _____
YEAR MONTH DAY

Warranty Expiry Date _____
YEAR MONTH DAY

To be completed by the dealer at the time of the sale.

DEALER IMPRINT AREA

V00A2IL

Please verify with your dealer to ensure your vehicle has been registered with BRP.

While reading this Operator's Guide, remember that:

 **WARNING**

Indicates a potential hazard that, if not avoided, could result in serious injury or death.



WARNING

THIS VEHICLE CAN BE HAZARDOUS TO OPERATE.

A collision or rollover can occur quickly, even during routine maneuvers such as turning and driving on hills or over obstacles, if you fail to take proper precautions.

SEVERE INJURY OR DEATH can result if you do not follow these instructions:

- **BEFORE YOU OPERATE THIS VEHICLE, READ THIS OPERATOR'S GUIDE AND ALL ON-PRODUCT SAFETY LABELS.**
- **NEVER OPERATE THIS VEHICLE WITHOUT PROPER INSTRUCTIONS.** Complete a certified training course.
- **NEVER CARRY A PASSENGER.** You increase your risk of losing control if you carry a passenger.
- **NEVER OPERATE THIS VEHICLE ON A PAVED SURFACE.** You increase your risk of losing control if you operate this vehicle on pavement.
- **NEVER OPERATE THIS VEHICLE ON PUBLIC ROADS.** You can collide with another vehicle if you operate this vehicle on a public road.
- **ALWAYS WEAR AN APPROVED HELMET,** eye protection, and protective clothing.
- **NEVER USE WITH DRUGS OR ALCOHOL.** They slow reaction time and impair judgment.
- **NEVER OPERATE THIS VEHICLE AT EXCESSIVE SPEEDS.** You increase your risk of losing control if you operate this vehicle at speeds too fast for the terrain, visibility conditions, or your experience.
- **NEVER ATTEMPT WHEELIES, JUMPS, OR OTHER STUNTS.**

219 001 128

CA

OPERATOR'S GUIDE, OUTLANDER 650 X mr / ENGLISH
GUIDE DU CONDUCTEUR, OUTLANDER 650 X mr / ANGLAIS

FAIT AU / MADE IN CANADA

U/M:P.C.