

can-am



RENEGADE X MR SERIES

OPERATOR'S GUIDE

Includes Safety, Use and Maintenance Information

RENEGADE

⚠ WARNING

Read this operator's guide thoroughly. It contains important safety information.

Minimum recommended operator age: 16 or older.

Keep this operator's guide with the vehicle at all times.

The removal or modification of evaporative emission-related parts on this OHRV is illegal.

Violators may be subject to civil and/or criminal penalties under California and federal law.

219002270

Original Instructions

⚠ WARNING

YOUR VEHICLE CAN BE HAZARDOUS TO OPERATE. A collision or rollover can occur quickly, if you fail to take proper precautions, even during routine maneuvers such as turning and driving on hills or over obstacles.

For your safety, understand and follow all the warnings contained in this operator's guide and on the labels on your vehicle. Failure to follow these warnings can result in **SEVERE INJURY OR DEATH.** Keep this operator's guide with the vehicle at all times.

⚠ WARNING

Disregarding any of the safety precautions and instructions contained in the Operators's Guide, SAFETY VIDEO and on product safety labels could cause injury including the possibility of death.

⚠ WARNING

This vehicle may exceed the performance of other vehicles you may have ridden in the past. Take time to familiarize yourself with your new vehicle.

CALIFORNIA PROPOSITION 65 WARNING

⚠ WARNING

Operating, servicing and maintaining an off-road vehicle can expose you to chemicals including engine exhaust, carbon monoxide, phthalates, and lead, which are known to the State of California to cause cancer and birth defects or other reproductive harm. To minimize exposure, avoid breathing exhaust, do not idle the engine except as necessary, service your vehicle in a well-ventilated area and wear gloves or wash your hands frequently when servicing your vehicle. For more information go to www.p65warnings.ca.gov/products/passenger-vehicle.

All rights reserved. No parts of this Manual may be reproduced in any form without the prior written permission of Bombardier Recreational Products Inc.

©Bombardier Recreational Products Inc. (BRP) 2022

Deutsch	Dieses Handbuch ist möglicherweise in Ihrer Landessprache verfügbar. Bitte wenden Sie sich an Ihren Händler oder besuchen Sie: www.operatorsguides.brp.com
English	This guide may be available in your language. Check with your dealer or go to: www.operatorsguides.brp.com
Español	Es posible que este manual esté disponible en su idioma. Consulte a su distribuidor o visite: www.operatorsguides.brp.com
Français	Ce guide peut être disponible dans votre langue. Vérifier avec votre concessionnaire ou aller à: www.operatorsguides.brp.com
Italiano	Questa guida potrebbe essere disponibile nella propria lingua. Contattare il concessionario o consultare: www.operatorsguides.brp.com
中文	本手册可能有您的语种的翻译版本。请向经销商询问，或者登录 www.operatorsguides.brp.com 查询。
日本語	このガイドは、言語によって翻訳版が用意されています。ディーラーに問い合わせるか、次のアドレスでご確認ください： www.operatorsguides.brp.com
Nederlands	Deze handleiding kan beschikbaar zijn in uw taal. Vraag het aan uw dealer of ga naar: www.operatorsguides.brp.com
Norsk	Denne boken kan finnes tilgjengelig på ditt eget språk. Kontakt din forhandler eller gå til: www.operatorsguides.brp.com
Português	Este manual pode estar disponível em seu idioma. Fale com sua concessionária ou visite o site: www.operatorsguides.brp.com
Русский	Воспользуйтесь руководством на вашем языке. Узнайте о его наличии у дилера или на странице по адресу www.operatorsguides.brp.com
Suomi	Käyttöohjekirja voi olla saatavissa omalla kielelläsi. Tarkista jälleenmyyjältä tai käy osoitteessa: www.operatorsguides.brp.com
Svenska	Denna bok kan finnas tillgänglig på ditt språk. Kontakta din återförsäljare eller gå till: www.operatorsguides.brp.com

Covered Models
Renegade X mr 650
Renegade X mr 1000R

In Canada, products are distributed and serviced by Bombardier Recreational Products Inc. (BRP).

In the USA, products are distributed and serviced by BRP US Inc.

In the European Economic Area (which is comprised of the member states of the European Union plus the United Kingdom, Norway, Iceland and Liechtenstein), the Commonwealth of the Independent States (including Ukraine and Turkmenistan) and Turkey, products are distributed and serviced by BRP European Distribution S.A. and other affiliates or subsidiaries of BRP.

For all other countries, products are distributed and serviced by Bombardier Recreational Products Inc. (BRP) or its affiliates.

While reading this Operator's Guide, remember that:

 WARNING
Indicates a potential hazard which, if not avoided, could result in serious injury or death.

TABLE OF CONTENTS

GENERAL INFORMATION

GENERAL INFORMATION	8
Know Before you Go	8
Safety Messages	9
About this Operator's Guide.....	9

SAFETY INFORMATION

GENERAL PRECAUTIONS	12
Avoid Carbon Monoxide Poisoning.....	12
Avoid Gasoline Fires and Other Hazards	12
Avoid Burns from Hot Parts	12
Accessories and Modifications.....	12
SPECIAL SAFETY MESSAGES	14
OPERATION WARNINGS	17
Carrying a Passenger	19
Riding Without Protective Gear	21
Drugs or Alcohol	22
Excessive Speeds	23
Proper Position on the Vehicle	25
Unfamiliar Terrain	26
Operating on Excessively Rough, Slippery or Loose Terrain	27
Turning Improperly.....	28
Excessively Steep Hills	29
Climbing Hills	30
Down a Hill.....	31
Crossing or Turning on Hills.....	32
Stalling, Rolling Backwards or Dismounting While Climbing a Hill	33
Operating Over Obstacles	34
Skidding or Sliding	35
Improper Modifications.....	39
Loading, Carrying or Towing Cargo	40
PRE-RIDE INSPECTION	42
Pre-Ride Inspection Check List.....	42
RIDING THE VEHICLE	45
Riding Gear.....	46
Carrying a Passenger is Prohibited	47
Recreational Riding	47
Mud Riding.....	47
Environment.....	48
Design Limitation	48
Off-Road Operation	48
Riding Techniques.....	49
MOVING LOADS AND DOING WORK	56
Working with Your Vehicle.....	56
Carrying Loads.....	56
IMPORTANT ON-PRODUCT LABELS(CANADA/UNITED STATES)	60
Safety Hang Tag.....	60
Safety Labels	61
Compliance Hang Tags.....	70

IMPORTANT ON-PRODUCT LABELS (COUNTRIES OUTSIDE CANADA AND UNITED STATES)	71
Safety Labels	72
REPORTING SAFETY DEFECTS	82

VEHICLE INFORMATION

PRIMARY CONTROLS	84
Handlebar	85
Throttle Lever	85
Brake Lever	85
Brake Lock Lever	85
Brake Pedal	86
Engine Stop Switch	86
RF D.E.S.S. Key and Post	87
SECONDARY CONTROLS	88
Throttle Lever Control Housing	89
Shift Lever	92
Multifunction Switch	93
Horn Button	94
EQUIPMENT	95
Operator's Seat	95
Footpegs	95
12-Volt Power Outlet	96
Rear Cargo Area	96
Tool Kit	96
Console	96
Snorkel Cover	97
Winch (If Equipped)	97
4.5" DIGITAL DISPLAY	99
Multifunction Display	99
Indicator Lamps	100
Settings	101
FUEL	104
Fuel Requirements	104
Vehicle Fueling Procedure	105
BREAK-IN PERIOD	106
Operation During Break-In	106
BASIC PROCEDURES	107
Waking Up the Electrical System	107
Starting the Engine	107
Stopping the Engine	107
Applying the Parking Brake	108
Changing Gear Selection	108
SPECIAL PROCEDURES	109
Fuel Flooded Engine	109
Water into the CVT	109
Water Into the Air Filter Housing	109
Vehicle is Turned Over	110
Vehicle is Immersed in Water	111
TUNE YOUR RIDE	112
Suspension Adjustments	112

Dynamic Power Steering (DPS) Assist Level Adjustment (Models with DPS) 113

TRANSPORTING THE VEHICLE 115

Using Vehicle Power to Climb Onto Trailering Equipment 116

Using a Winch to Pull Vehicle Onto Trailering Equipment..... 116

Securing Vehicle for Transport..... 117

Getting Vehicle Out of Trailer..... 118

MAINTENANCE

MAINTENANCE SCHEDULE 120

EPA Regulation - Canadian and USA Vehicles 120

Post Operation Care After Each Use in an Extreme Environment 120

Severe Dusty Conditions 121

Maintenance Schedule..... 121

Maintenance Records 132

MAINTENANCE PROCEDURES 137

Resetting the Message: Maintenance Required 137

Engine Air Filter 137

CVT Air Filter..... 140

Engine Oil 141

Engine Oil Filter 143

Fuel Vent Breather Filter 144

Radiator..... 144

Engine Coolant..... 145

Muffler and Spark Arrester..... 147

Gearbox..... 149

Throttle Body..... 150

Spark Plugs..... 151

CVT Cover..... 152

Drive Belt 153

Drive and Driven Pulleys 154

Battery..... 154

Fuses 155

Lights..... 156

Drive Shaft Bellow and Protector..... 158

Wheel Bearing..... 158

Wheels and Tires..... 158

Steering..... 162

Suspension 162

Brakes..... 163

VEHICLE CARE 165

Vehicle Cleaning and Protection 165

STORAGE AND PRESEASON PREPARATION 167

TECHNICAL INFORMATION

VEHICLE IDENTIFICATION..... 170

Vehicle Identification Number 170

Engine Identification Number (EIN) 170

Compliance Hang Tags..... 171

Compliance Label.....	172
Technical Information Labels	175
RADIO FREQUENCY DIGITALLY ENCODED SECURITY SYSTEM (RF D. E. S. S. KEY).....	176
NOISE EMISSION CONTROL SYSTEM REGULATION (CANADA/UNITED STATES).....	177
NOISE EMISSION AND VIBRATION VALUES (ALL COUNTRIES EXCEPT CANADA/UNITED STATES).....	178
EC-DECLARATION OF CONFORMITY.....	179
UK-DECLARATION OF CONFORMITY.....	180
EAC DECLARATION OF CONFORMITY.....	181

TECHNICAL SPECIFICATIONS

TECHNICAL SPECIFICATIONS	184
---------------------------------------	------------

TROUBLESHOOTING

TROUBLESHOOTING GUIDELINES.....	192
Engine Does Not Turn.....	192
Engine Turns Over But Fails To Start	192
Engine Lacks Acceleration or Power	193
Engine Overheats.....	194
Engine Backfire	194
Engine Misfire	195
Vehicle Cannot Reach Full Speed.....	195
Shift Lever Is Hard To Move	195
The RPM Increases But The Vehicle Does Not Move	196
Reduced Power Steering Assist.....	196
DIGITAL DISPLAY MESSAGES.....	197

WARRANTY

BRP LIMITED WARRANTY USA AND CANADA: 2023 CAN-AM® ATV..	200
US EPA EMISSION - RELATED WARRANTY.....	203
CALIFORNIA EVAPORATIVE EMISSIONS CONTROL WARRANTY STATEMENT.....	206
BRP INTERNATIONAL LIMITED WARRANTY: 2023 CAN-AM® ATV	209
BRP LIMITED WARRANTY FOR THE EUROPEAN ECONOMIC AREAS, THE COMMONWEALTH OF THE INDEPENDENT STATES AND TURKEY: 2023 CAN-AM® ATV.....	213

CUSTOMER INFORMATION

DATA PRIVACY INFORMATION	218
CONTACT US	220
Asia Pacific	220
Europe, Middle East and Africa.....	220
Latin America	220
North America	220
CHANGE OF ADDRESS AND OWNERSHIP	221

GENERAL INFORMATION

GENERAL INFORMATION

Congratulations on your purchase of a new Can-Am® ATV vehicle. It's backed by the BRP limited warranty and a network of authorized Can-Am Off-road dealers ready to provide the parts, accessories or service you may require.

At delivery, you were informed of the warranty coverage and signed the Pre-delivery Check List to ensure your new vehicle was prepared to your entire satisfaction.

Your dealer is committed to your satisfaction. If you need more information, please ask your dealer.

Know Before you Go

To learn how to reduce the risk of accident for you or bystanders, read this Operator's Guide before you operate the vehicle.

Also, read all safety labels on your vehicle and watch the *Safety Video* located at:

<https://can-am.brp.com/off-road/safety>

Or use the following QR code.



This vehicle is for off-road use only. It is mainly for general recreational use but it may also be used for utility purposes.

Failure to follow the warnings contained in this Operator's Guide can result in **SERIOUS INJURY** or **DEATH**.

Age Recommendation

This vehicle is a category S, always follow this age recommendation:

- A person under 16 years old should never operate this vehicle.

Training Course

Never operate this vehicle without proper instruction. **Take a training course.** All operators should receive training from a certified instructor.

For more information about ATV safety, contact an authorized Can-Am Off-road dealer to find out about available training courses nearest you.

In the United States, call the Specialty Vehicle Institute of America (SVIA) at 1 800 887-2887 or in Canada, the Canada Safety Council (CSC) at 1 613 739-1535.

Safety Messages

The types of safety messages, what they look like and how they are used in this guide are explained as follows:

The safety alert symbol  indicates a potential injury hazard.

WARNING

Indicates a potential hazard which, if not avoided, could result in serious injury or death.

CAUTION

Indicates a hazardous situation which, if not avoided, could result in minor or moderate injury.

NOTICE

Indicates an instruction which, if not followed, could result in severely damaged vehicle components or other property.

About this Operator's Guide

This Operator's Guide has been prepared to acquaint the owner/operator of a new vehicle with the various vehicle controls, maintenance and safe operating instructions. It is indispensable for the proper use of the product.

Keep this Operator's Guide in the vehicle as you can refer to it for things such as maintenance, troubleshooting and instructing others.

Note that this guide is available in several languages. In the event of any discrepancy, the English version shall prevail.

If you want to view and/or print an extra copy of your Operator's Guide, simply visit the following website:

www.operatorsguides.brp.com

The information contained in this document is correct at the time of publication. BRP, however, maintains a policy of continuous improvement of its products without imposing upon itself any obligation to install them on products previously manufactured. Due to late changes, some differences between the manufactured product and the descriptions and/or specifications in this guide may occur. BRP reserves the right at any time to discontinue or change specifications, designs, features, models or equipment without incurring any obligation upon itself.

This Operator's Guide should remain with the vehicle when it is sold.

While reading this Operator's Guide, remember that:



WARNING

Indicates a potential hazard which, if not avoided, could result in serious injury or death.

SAFETY INFORMATION

GENERAL PRECAUTIONS

Avoid Carbon Monoxide Poisoning

All engine exhaust contains carbon monoxide, a deadly gas. Breathing carbon monoxide can cause headaches, dizziness, drowsiness, nausea, confusion and eventually death.

Carbon monoxide is a colorless, odorless, tasteless gas that may be present even if you do not see or smell any engine exhaust. Deadly levels of carbon monoxide can collect rapidly, and you can quickly be overcome and unable to save yourself. Also, deadly levels of carbon monoxide can linger for hours or days in enclosed or poorly ventilated areas. If you experience any symptoms of carbon monoxide poisoning, leave the area immediately, get fresh air and seek medical treatment.

To prevent serious injury or death from carbon monoxide:

- Never run the vehicle in poorly ventilated or partially enclosed areas such as garages, carports or barns. Even if you try to ventilate engine exhaust with fans or open windows and doors, carbon monoxide can rapidly reach dangerous levels.
- Never run the vehicle outdoors where engine exhaust can be drawn into a building through openings such as windows and doors.

Avoid Gasoline Fires and Other Hazards

Gasoline is extremely flammable and highly explosive. Fuel vapors can spread and be ignited by a spark or flame many feet away from the engine. To reduce the risk of fire or explosion, follow these instructions:

- Use only an approved red gasoline container to store fuel.
- The container must be firmly secured to the vehicle and placed so that it does not touch the ground in the event of an overturning. BRP LinQ containers are highly recommended.
- Never fill a gasoline container on the vehicle. An electrical static discharge may ignite the fuel.
- For refueling, strictly adhere to instructions in *Fuel*.
- Never start or operate the engine if the fuel cap is not properly installed.

Gasoline is poisonous and can cause injury or death.

- Never siphon gasoline by mouth.
- If you swallow gasoline, get any in your eye(s), or inhale gasoline vapor, see your doctor immediately.

If gasoline spills on you, wash with soap and water and change your clothes.

Avoid Burns from Hot Parts

Certain components like brake rotors and exhaust components become hot during operation. Avoid contact with those parts during and shortly after operation to avoid burn wounds.

Accessories and Modifications

Any modifications or addition of accessories approved by BRP may affect the handling of your vehicle. It is important to take the time to get familiar with the

vehicle once modifications are made to understand how to adapt your driving behavior accordingly.

Avoid installing equipment not specifically approved by BRP for the vehicle and avoid unauthorized modifications. These modifications and equipment have not been tested by BRP and may create hazards. For example, they could:

- Create a loss of control and increase risk of crash
- Cause overheating or short circuits increasing the risk of fire or burn injuries
- Affect the protection features provided by the vehicle.
- Affect the behavior of the trailer when the vehicle is transported
- Cause a risk of losing objects on the road when transported.

Your vehicle may also become illegal to ride.

Ask your authorized BRP dealer for suitable available accessories for your vehicle.

SPECIAL SAFETY MESSAGES

THIS VEHICLE IS NOT A TOY AND CAN BE HAZARDOUS TO OPERATE.

- This vehicle handles differently from other vehicles including motorcycles and cars. A collision or rollover can occur quickly, if you fail to take proper precautions, even during routine maneuvers such as turning and driving on hills or over obstacles.

SEVERE INJURY OR DEATH can result if you do not comply with the following instructions:

- Read this Operator's Guide and all on-product safety labels carefully and follow the operating procedures described. Watch and pay attention to the safety video before operating the vehicle.
- Always follow this age recommendation: A person under 16 years old should never operate this vehicle.
- Never take place on this vehicle without wearing an approved helmet of the proper size and other required riding gears. Refer to *RIDING GEAR* in *RIDING THE VEHICLE* for detailed information.
- Always inspect and confirm the safe operating condition of your vehicle prior to ride. Refer to *PRE-RIDE INSPECTION*. Always follow the maintenance schedules as described in this Operator's Guide. Refer to *MAINTENANCE*.
- On 1-UP models, do not make any modifications to accommodate a passenger or use racks to carry a passenger.
- Never carry a passenger on this vehicle. Passenger(s) affect balance and steering and increase risk of losing control.
- The tires of this vehicle are not suited for paved road use.
- Never operate this vehicle on any paved surfaces, including sidewalks, driveways, parking lots and streets.
- This vehicle is not designed to ride on paved surfaces; if you must shortly use the vehicle on such surfaces, avoid abrupt inputs to steering, accelerator and brakes. Reduce your speed.
- This vehicle is not designed for riding on roads or highways (in most places it is an illegal practice). Riding your vehicle on roads or highways could cause a collision with another vehicle.
- Never operate this ATV after using drugs or alcohol, when tired or ill. This must be applied also to the passenger (if applicable). Your reaction time and judgement is greatly affected under these conditions. Always operate your ATV prudently.
- Never attempt wheelies, jumps, or other stunts.
- Never operate at excessive speeds. Always go at a speed that is proper for the terrain, visibility, and operating conditions, and your experience.
- Always go slowly and be extra careful when operating on unfamiliar terrain. Always be alert to changing terrain conditions when operating this vehicle.
- Never operate on excessively rough, slippery or loose terrain until you have learned and practiced the skills necessary to control this vehicle on such terrain. Always be especially cautious on these kinds of terrain.
- Always follow proper procedures for turning as described in *RIDING TECHNIQUES*.
- Never operate this vehicle on hills too steep for the vehicle or for your abilities.
- Always follow proper procedures for climbing hills as described in *RIDING TECHNIQUES*. Check the terrain carefully before you start up any hill. Never climb hills with excessively slippery or loose surfaces.

- Always follow proper procedures for going down hills and for braking on hills as described in *RIDING TECHNIQUES*. Check the terrain carefully before you start down any hill.
- Always follow proper procedures for crossing the side of a hill as described in *RIDING TECHNIQUES*. Avoid hills with excessively slippery or loose surfaces.
- Always use proper procedures if you stall or roll backwards when climbing a hill. To avoid stalling, use low gear and maintain a steady speed when climbing a hill. If you stall or roll backwards, follow the driving technique procedures as described in *RIDING TECHNIQUES*.
- Always check for obstacles before operating in a new area. Never attempt to operate over large obstacles, such as large rocks or fallen trees. Always follow proper procedures when operating over obstacles as described in *RIDING TECHNIQUES*.
- Always be careful when skidding or sliding. Learn to safely control skidding or sliding by practicing at low speeds and on level smooth terrain. On extremely slippery surfaces, such as ice, go slowly and be very cautious in order to reduce the chance of skidding out of control.
- Always be sure there are no obstacles or people behind the vehicle when you operate in reverse. When it is safe to proceed in reverse, go slowly.
- Never exceed the stated load limits for this vehicle including operator, all other loads and added accessories. Cargo should be properly distributed and securely attached. Reduce speed and follow instructions in this guide for carrying cargo or pulling a trailer. Allow greater distance for braking.
- This vehicle is not designed for jumping, nor can it fully absorb the high impact energy generated during manoeuvres such as jumping which, can be passed on to you, the operator. Performing wheelies can cause the vehicle to flip over onto you. Both practices have a high risk for you and should be avoided at all times.
- Never operate this vehicle through deep or fast flowing water. Water should never exceed footrests. Remember that wet brakes may have reduced stopping ability. Test your brakes after leaving water, mud or snow. If necessary, apply them several times to let friction dry out the pads.
- Always keep in mind that braking distance is readily affected by but not limited to; weather and terrain conditions, braking system and tire conditions, vehicle speed and attitude, and vehicle load including towing. Remember to adjust your driving accordingly.
- BRP recommends sitting on your ATV when operating in reverse. Avoid standing up. Your weight could shift forward against throttle lever, causing an unexpected acceleration and may lead to a loss of control.
- Never operate the vehicle if the controls do not function normally.
- Always maintain proper tire pressure. When replacing tires, use only the recommended tire size and type. For tire information, refer to *TECHNICAL SPECIFICATIONS* in this guide.
- Riding your vehicle too fast for your skills or the conditions may result in injury. Apply only enough throttle to proceed safely. Statistics show that mishaps and injury usually result from high speed turns. Always remember that this vehicle is heavy! Its pure weight alone may entrap you should it fall resulting in injury.
- Never modify this vehicle through improper installation or use of accessories. Only use BRP's approved accessories.

- Never exceed the stated load limits for this vehicle including operator, all other loads and added accessories. Cargo should be properly distributed and securely attached. Reduce speed and follow instructions in this manual for carrying cargo or pulling a trailer. Allow greater distance for braking.

OPERATION WARNINGS

The following warning and their format have been requested by the United States Consumer Product Safety Commission and are required to be in the Operator's Guide for all ATVs.

The following illustrations are general representations only. Your model may differ.

Operating Vehicle Without Proper Instruction

WARNING



POTENTIAL HAZARD

Operating this vehicle without proper instruction.

WHAT CAN HAPPEN

The risk of an accident is greatly increased if the operator does not know how to operate this vehicle properly in different situations and on different types of terrain.

HOW TO AVOID THE HAZARD

Beginners and inexperienced operators should complete a training course. They should then regularly practice the skills learned during the course as well as the operating techniques described in this Operator's Guide.

For more information about a training course, contact an authorized Can-Am dealer.

Age Recommendations

⚠ WARNING



V00A1AQ

POTENTIAL HAZARD

Failure to follow the age recommendations for this vehicle.

WHAT CAN HAPPEN

A lack of respect for this age recommendation can lead to severe injury or death of the child.

Even though a child may be within the age group for which this vehicle is recommended, he may not have the skills, abilities, or judgment needed to operate this vehicle safely and may be involved in a serious accident.

HOW TO AVOID THE HAZARD

No one under 16 should operate this vehicle.

Carrying a Passenger

WARNING



V00A02Q

POTENTIAL HAZARD

Carrying a passenger on this vehicle.

WHAT CAN HAPPEN

Greatly reduces your ability to balance and control this vehicle.

Could cause an accident, resulting in harm to you and/or your passenger.

HOW TO AVOID THE HAZARD

Never carry passenger. Even with a long seat that provides unrestricted operator movement, it is not designed nor intended to carry passenger(s).

Vehicle on Public Streets, Roads or Highways

⚠ WARNING



POTENTIAL HAZARD

Operating this vehicle on public streets, roads or highways.

WHAT CAN HAPPEN

You can collide with another vehicle.

HOW TO AVOID THE HAZARD

Never operate this vehicle on any public street, road or highway, even a dirt or gravel one. In many states it is illegal to operate this vehicle on public streets, roads and highways.

Riding Without Protective Gear

WARNING



POTENTIAL HAZARD

Riding this vehicle without wearing an approved helmet, eye protection and protective gear.

WHAT CAN HAPPEN

- Riding without an approved helmet increases the chances of a severe head injury or death in the event of an accident.
- Riding without eye protection can result in an accident and increases the chances of a severe injury in the event of an accident.
- Riding without protective gear increases the chances of severe injury in the event of an accident.

HOW TO AVOID THE HAZARD

Always wear an approved helmet that fits properly. You should also wear:

- Eye protection (goggles or face shield)
- Rigid chin guard
- Gloves and boots
- Long sleeved shirt or jacket
- Long pants.

Drugs or Alcohol

⚠ WARNING



V00A07Q

POTENTIAL HAZARD

Using this vehicle with drugs or alcohol.

WHAT CAN HAPPEN

Could seriously affect your judgment.

Could cause you to react more slowly.

Could affect your balance and perception.

Could result in an accident or death.

HOW TO AVOID THE HAZARD

Never use this vehicle with drugs or alcohol.

Excessive Speeds

WARNING

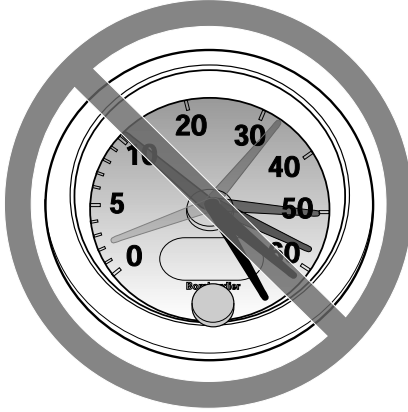

V00A08Q

POTENTIAL HAZARD

Operating this vehicle at excessive speeds.

WHAT CAN HAPPEN

Increases your chances of losing control of the vehicle, which can result in an accident.

HOW TO AVOID THE HAZARD

Always travel at a speed which is appropriate for the terrain, visibility and operating conditions, and your experience.

Wheelies, Jumps and Other Stunts

WARNING



POTENTIAL HAZARD

Attempting wheelies, jumps and other stunts.

WHAT CAN HAPPEN

Increases the chance of an accident, including an overturn.

HOW TO AVOID THE HAZARD

Never attempt stunts, such as wheelies or jumps. Do not try to show off.

Vehicle Inspection

WARNING

POTENTIAL HAZARD

Failure to inspect the vehicle before operating.

Failure to properly maintain the vehicle.

WHAT CAN HAPPEN

Increases the possibility of an accident or equipment damage.

HOW TO AVOID THE HAZARD

Always inspect your vehicle prior to ride to make sure the vehicle is in safe operating condition.

Always follow the maintenance schedule described in this Operator's Guide.

Frozen Waterways

⚠ WARNING

POTENTIAL HAZARD

Riding on frozen waterways.

WHAT CAN HAPPEN

Breaking through the ice can lead to severe injury or death.

HOW TO AVOID THE HAZARD

Never ride this vehicle on a frozen surface before you are sure the ice is thick enough and sound enough to support the vehicle and its load, as well as the force that is created by a moving vehicle.

Proper Position on the Vehicle

⚠ WARNING



POTENTIAL HAZARD

Removing hands from handlebars or feet from the footrests during operation.

WHAT CAN HAPPEN

Removing even one hand or foot can reduce your ability to control the vehicle or could cause you to lose your balance and fall off the vehicle. If you remove a foot from the footrests, your foot or leg may come into contact with the rear wheels, which could injure you or cause an accident.

HOW TO AVOID THE HAZARD

Operator must always keep both hands on the handlebars and both feet on the footrests during vehicle operation.

Unfamiliar Terrain

WARNING



POTENTIAL HAZARD

Failure to use extra care when operating this vehicle on unfamiliar terrain.

WHAT CAN HAPPEN

You can come upon hidden rocks, bumps, or holes, without enough time to react.

Could result in the vehicle overturning or loss of control.

HOW TO AVOID THE HAZARD

Go slowly and be extra careful when operating on unfamiliar terrain.

Always be alert to changing terrain conditions when operating the vehicle.

Operating on Excessively Rough, Slippery or Loose Terrain

⚠ WARNING



POTENTIAL HAZARD

Failure to use extra care when operating on excessively rough, slippery or loose terrain.

WHAT CAN HAPPEN

Could cause loss of traction or vehicle control, which could result in an accident, including an overturn.

HOW TO AVOID THE HAZARD

Do not operate on excessively rough, slippery or loose terrain until you have learned and practiced the skills necessary to control this vehicle on such terrain.

Always be especially cautious on these kinds of terrain.

Turning Improperly

⚠ WARNING



POTENTIAL HAZARD

Turning improperly.

WHAT CAN HAPPEN

Vehicle could go out of control, causing a collision or an overturn.

HOW TO AVOID THE HAZARD

Always follow proper procedures for turning as described in this Operator's Guide. Practice turning at low speeds before attempting to turn at faster speeds.

Do not turn at excessive speed.

Excessively Steep Hills

WARNING



POTENTIAL HAZARD

Operating on excessively steep hills.

WHAT CAN HAPPEN

The vehicle can overturn more easily on extremely steep hills than on level surfaces or small hills.

HOW TO AVOID THE HAZARD

Never operate this vehicle on hills too steep for the vehicle or for your abilities.

Practice on smaller hills before attempting larger hills.

Climbing Hills

⚠ WARNING



POTENTIAL HAZARD

Climbing hills improperly.

WHAT CAN HAPPEN

Could cause loss of control or cause vehicle to overturn.

HOW TO AVOID THE HAZARD

Always follow proper procedures for climbing hills as described in this Operator's Guide.

Always check the terrain carefully before you start up any hill.

Never climb hills with excessively slippery or loose surfaces.

Shift your weight forward.

Never open the throttle suddenly or make sudden gear changes. The vehicle could flip over backwards.

Never go over the top of any hill at high speed. An obstacle, a sharp drop, or another vehicle or person could be on the other side of the hill.

Down a Hill

WARNING



POTENTIAL HAZARD

Going down a hill improperly.

WHAT CAN HAPPEN

Could cause loss of control or cause vehicle to overturn.

HOW TO AVOID THE HAZARD

Always follow proper procedures for going down hills as described in this Operator's Guide.

NOTE:

A special technique is required when braking as you go down a hill.

Always check the terrain carefully before you start down any hill.

Shift your weight backward.

Never go down a hill at high speed.

Avoid going down a hill at an angle which would cause the vehicle to lean sharply to one side. Go straight down the hill where possible.

Crossing or Turning on Hills

⚠ WARNING



POTENTIAL HAZARD

Improperly crossing hills or turning on hills.

WHAT CAN HAPPEN

Could cause loss of control or cause vehicle to overturn.

HOW TO AVOID THE HAZARD

Never attempt to turn the vehicle around on any hill until you have mastered the turning technique as described in this Operator's Guide on level ground. Be very careful when turning on any hill.

Avoid crossing the side of a steep hill if possible.

When crossing the side of a hill:

Always follow proper procedures as described further in this Operator's Guide.

Avoid hills with excessively slippery or loose surfaces.

Operator must shift weight to the uphill side of the vehicle.

Stalling, Rolling Backwards or Dismounting While Climbing a Hill

⚠ WARNING

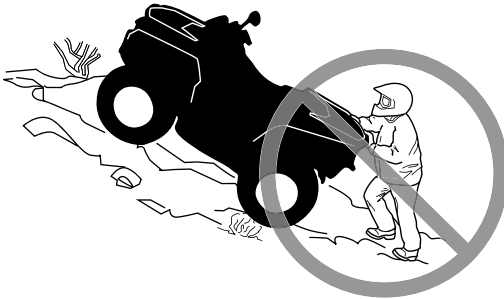

POTENTIAL HAZARD

Stalling, rolling backwards or improperly dismounting while climbing a hill.

WHAT CAN HAPPEN

Could result in vehicle overturning.

HOW TO AVOID THE HAZARD

Use low gear and maintain steady speed when climbing a hill.

If you lose all forward speed:

Operator must keep their weight uphill. Never open the throttle suddenly or make sudden gear changes. The vehicle could flip over backwards.

Apply the brakes.

Lock parking brake after you have stopped.

Disembark on uphill side, or to a side if pointed straight uphill.

If you begin rolling backwards:

Operator must keep their weight uphill. Never open the throttle suddenly or make sudden gear changes. The vehicle could flip over backwards.

Never apply the rear brake while rolling backwards.

Apply the front brake gradually.

When fully stopped, apply rear brake as well and lock parking brake.

Disembark on uphill side, or to a side if pointed straight uphill.

Turn the vehicle around and remount, following the procedure described further in this Operator's Guide.

Operating Over Obstacles

⚠ WARNING



POTENTIAL HAZARD

Improperly operating over obstacles.

WHAT CAN HAPPEN

Could cause loss of control or a collision.

Could cause the vehicle to overturn.

HOW TO AVOID THE HAZARD

Before operating in a new area, check for obstacles.

Never attempt to ride over large obstacles, such as large rocks or fallen trees.

When you go over obstacles, always follow proper procedures as described in this Operator's Guide.

Skidding or Sliding

WARNING



POTENTIAL HAZARD

Skidding or sliding improperly.

WHAT CAN HAPPEN

You may lose control of this vehicle.

You may also regain traction unexpectedly, which may cause the vehicle to overturn.

HOW TO AVOID THE HAZARD

Learn to safely control skidding or sliding by practicing at low speeds and on level smooth terrain.

On extremely slippery surfaces, such as ice, go slowly and be very cautious in order to reduce the chance of skidding or sliding out of control.

Deep or Fast Flowing Water

⚠ WARNING



POTENTIAL HAZARD

Operating this vehicle through deep or fast flowing water.

WHAT CAN HAPPEN

Tires may float, causing loss of traction and loss of control, which could lead to an accident.

HOW TO AVOID THE HAZARD

Never operate this vehicle in fast flowing water or in deep water.

Check water depth and current before you attempt to cross any water.

Water should not go above the top of the wheels.

Remember that wet brakes may have reduced stopping ability. Test your brakes after leaving water. If necessary, apply them several times to let friction dry out the pads.

Operating in Reverse

WARNING



POTENTIAL HAZARD

Improperly operating in reverse.

WHAT CAN HAPPEN

You could hit an obstacle or person behind the vehicle, resulting in serious injury.

HOW TO AVOID THE HAZARD

When you select reverse gear, make sure there are no obstacles or people behind the vehicle. When it is safe to proceed, go slowly.

Tire Pressure

⚠ WARNING



POTENTIAL HAZARD

Operating this vehicle with improper tires, or with improper or uneven tire pressure.

WHAT CAN HAPPEN

Use of improper tires on this vehicle, or operation of this vehicle with improper or uneven tire pressure, may cause loss of control, tire blow outs, tire to move around on its rim, and increases the risk of an accident.

HOW TO AVOID THE HAZARD

Always use the size and type of tires specified in this Operator's Guide for this vehicle.

Always maintain proper tire pressure as described in this Operator's Guide.

Always replace wheels or tires that are damaged.

Improper Modifications

WARNING



POTENTIAL HAZARD

Operating this vehicle with improper modifications.

WHAT CAN HAPPEN

Improper installation of accessories or modification of this vehicle may cause changes in handling which in some situations could lead to an accident.

HOW TO AVOID THE HAZARD

Never modify this vehicle through improper installation or use of accessories. All parts and accessories added to this vehicle should be approved by BRP and should be installed and used according to instructions. If you have questions, consult an authorized Can-Am Off-road dealer.

NEVER install a passenger seat or use the racks to carry a passenger. Modification of the vehicle to increase speed and performance may violate the terms and conditions of your vehicle limited warranty. In addition, certain modifications including the removal of engine or exhaust components are illegal under most laws.

Loading, Carrying or Towing Cargo

⚠ WARNING



POTENTIAL HAZARD

Overloading this vehicle, carrying or towing cargo improperly.

WHAT CAN HAPPEN

Could cause changes in vehicle handling which could lead to an accident.

HOW TO AVOID THE HAZARD

Never exceed the stated load capacity for this vehicle including operator as well as other loads and added accessories.

Cargo should be properly distributed and securely attached.

Reduce speed when carrying cargo or pulling a trailer. Allow greater distance for braking.

Always follow the instructions in this Operator's Guide for carrying cargo or pulling a trailer.

Transporting Flammable or Dangerous Material

 **WARNING**



V03M01Q

POTENTIAL HAZARD

Transporting flammable or dangerous material can lead to explosions.

WHAT CAN HAPPEN

This can cause serious injury or death.

HOW TO AVOID THE HAZARD

Never transport flammable or dangerous material.

PRE-RIDE INSPECTION

WARNING

Perform a pre-ride inspection before each ride to detect any potential problem that could occur during operation. The pre-ride inspection can help you monitor component wear and deterioration before they become a problem. Correct any problem that you discover to reduce the risk of a breakdown or crash.

Before using this vehicle, the operator should always perform the following pre-ride inspection check list.

Pre-Ride Inspection Check List

What to Do Before Starting the Engine (Key OFF)

Items to be Inspected	Inspection to Perform	✓
Engine oil	Check engine oil level.	
Coolant	Check coolant level.	
Brake fluid	Check brake fluid level	
Leaks	Check for any leaks under vehicle	
Throttle lever	Activate throttle lever several times to ensure it operates freely. It must return to idle position when released	
Brake lock lever	Engage the brake lock lever and check if it operates properly	
Engine air filter	Inspect and clean engine air filter	
CVT air filter	Inspect and clean CVT air filter	
Exhaust system	If not already done, clean the area surrounding the exhaust system, especially if during the last ride, the vehicle was used in a swamp, bog, hay or dead leaves.	
Radiator	Check cleanliness of the radiator	
Seat	Ensure operator's seat is properly locked in position by pulling back and up several time. Even if a distinctive snap is heard during the installation, always pull it back and up to confirm proper latching.	
Drive shaft bellows	Check drive shaft bellows and protectors condition	
Tires	Check tire pressure and condition. Refer to the <i>Tire Pressure and Maximum Load</i> label and adjust according to load.	

Items to be Inspected	Inspection to Perform	✓
Wheels	Check wheels for damage and for abnormal play, and check lug nuts are tightened. Tighten wheel beadlock bolts (if equipped). Refer to <i>Wheels and Tires</i> in <i>Maintenance Procedures</i> for torque specification.	
Cargo	If you transport a cargo, respect the load capacity. Refer to <i>Loading the Cargo Racks</i> . Ensure cargo is properly secured to the racks	
	If you are pulling a trailer or another equipment: <ul style="list-style-type: none"> – Check hitch and trailer ball condition – Respect the tongue capacity and towing capacity as indicated on the label affixed to the hitch or refer to <i>Technical Specifications</i>. – Ensure trailer is properly secured to hitch. 	
Storage compartment	Check if rear storage compartment is properly latched	
Chassis and suspension	Check underneath vehicle for any debris on chassis or suspension components and clean them properly	

What to Do Before Starting the Engine (Key ON)

Items to be Inspected	Inspection to Perform	✓
Digital display	Check operation of indicator lamps in digital display(during first few seconds of key ON).	
	Check for messages on digital display.	
Lights	Check operation and cleanliness of: <ul style="list-style-type: none"> – Headlights (High and Low) – Taillights – Brake lights. 	
Fuel level	Check the fuel level.	
Horn	Check operation of the horn (If equipped).	

What to Do After the Engine is Started

Items to be inspected	Inspection to perform	✓
Steering	Check if steering operates freely by completely turning it from side to side	
Shift lever	Check operation of shift lever (P, R, N, H and L)	
2WD/4WD selector	Check operation of 2WD/4WD selector	
Brakes	Drive forward slowly a few feet and apply brake lever and brake pedal individually. The brakes must fully apply. Lever and pedal must fully return when released	
Engine stop switch	Check that the engine stop switch is working properly	
RF D.E.S.S. Post	Check if D.E.S.S. post is working properly by pulling the D.E.S.S. key from the D.E.S.S. post and stopping the engine	

RIDING THE VEHICLE

To fully appreciate the pleasures and excitement of riding this vehicle, there are some basic rules and tips that you **MUST** follow. Some may be new to you while others may be common sense or obvious.

Please take the time to study this Operator's Guide and all on-product safety labels as well as the safety video located at <https://can-am.brp.com/off-road/safety>. They more completely describe what you should know about this vehicle before riding it.

Whether you are a new user or an experienced rider, it is important for your personal safety that you know the controls and features of this vehicle. Equally important is knowing how to properly ride.

This is a high performance ATV for off-road use only. Inexperienced riders may overlook risks and be surprised by the specific behavior of this ATV in any terrain condition.

Information in this Operator's Guide is limited. It is strongly recommended that you obtain further information and training from your local authorities, ATV clubs, a recognized ATV training organization or contact an authorized Can-Am Off-road dealer.

We recommend following the age recommendation indicated on the safety label affixed on the unit. Even though a person may be within the age group for which this vehicle is recommended, he may not have the skills, abilities, or judgment needed to operate this vehicle safely and may be involved in a serious accident.

Individuals with cognitive or physical impairments or who are high risk takers have an increased exposure to overturns or collisions which may result in injury including death.

Not all vehicles are the same. Each has its own unique performance characteristics, controls and features. Each will ride and handle differently.

Become completely familiar with the operational controls and the general operation of the vehicle before venturing into off road conditions. Practice driving in a suitable area free of hazards and feel the response of each control. Drive at low speeds. Higher speeds require greater experience, knowledge and suitable riding conditions.

Riding conditions vary from place to place. Each is subject to weather conditions which may radically change from time to time and from season to season.

Riding on sand is different than riding on snow or through forests or marshes. Each location may require a greater degree of awareness and skill. Show good judgement. Always proceed with caution. Please do not take any unnecessary risks that could leave you stranded or possibly injured.

Never assume that the vehicle will go everywhere safely. Sudden changes in terrain caused by holes, depressions, banks, softer or harder "ground" or other irregularities may cause the vehicle to topple or become unstable. To avoid this, slow down and always observe the terrain ahead. If the vehicle does begin to topple or tip over, the best advice is to immediately get off **AWAY** from the direction of the tip over!

We encourage you to have an Annual Safety Inspection of your vehicle. Please contact an authorized Can-Am Off-road dealer for further details. Though not required, it is recommended that an authorized Can-Am Off-road dealer performs the preseason preparation of your vehicle. Each visit to your authorized Can-Am Off-road dealer is a great opportunity for your dealer to verify if your vehicle is included in any safety campaign. We also urge you to visit your authorized Can-Am Off-road dealer in a timely manner if you become aware of any safety related campaigns.

See an authorized Can-Am Off-road dealer for available accessories you may require.

Riding Gear

Actual weather conditions should help you decide how to dress. Dress for the coldest weather expected. Thermal underwear next to the skin also provides a good insulation. It is important that the operator always wears the appropriate protective riding gear and apparel, including an approved helmet, eye protection, boots, gloves, a long sleeved shirt and pants. This type of clothing will provide you protection from some of the minor hazards you may encounter en route. The operator must never wear loose clothing such as a scarf that may get entangled in the vehicle or on tree branches and shrubs. Depending on conditions, anti-fogging goggles or sunglasses may be required. Different colored lenses available for goggles or sunglasses help you distinguish terrain variations. Sunglasses should only be worn during the daytime.



Riders with appropriate riding gear

Carrying a Passenger is Prohibited

This vehicle is designed specifically to carry an operator only. Even with a long seat, this vehicle is not designed nor intended to carry passenger(s). NEVER install passenger seat or use the cargo area to carry passenger(s). Carrying passenger(s) may affect the stability and your control of the vehicle.

Recreational Riding

Respect the rights and limitations of others. Stay away from areas designated for other types of off road use. This includes snowmobile trails, equestrian trails, cross country ski trails, mountain bike trails, etc. Never assume there are no other users on the trail. Always stay to the complete right of the trail and do not zig-zag to one side of the trail then the other. Be prepared to stop or pull off to the side if another trail user appears in front of you.

Join a local ATV club. It will provide you with a map and advice or inform you where you can ride. If a club does not exist in your area, help to start one. Group riding and club activities provide a pleasurable, social experience.

Always keep a safe distance from other riders. Your judgment of speed, terrain conditions, weather, mechanical condition of your vehicle and the "trust in judgment" you have in others around you will help you make a better choice of appropriate safe distance. This vehicle, like any other motorized vehicle, cannot stop "on a dime".

Before you ride, tell someone where you are planning to travel and your expected time of return.

Depending on the length of your ride, carry additional tools, drinking water, food and emergency equipment. Find out where you can get additional gasoline and oil. Be prepared for the possible conditions you may encounter.

First aid kit	Adjustable wrench
Mobile phone	Knife
Friction tape	Flashlight
A rope	Colored lens goggles
Spare light bulbs	Trail map
Provided tool kit	Snack

Mud Riding

This vehicle is designed specifically for riding in mud. Unless if ridden in ATV trails, the low range should be used.

Although this vehicle is built for rough terrain and extreme conditions, an improper use may lead to premature wear or even failure of certain components.

Avoid jerking steering and/or full steering stroke in very thick mud under high throttle demand.

Inspection and maintenance schedule need to be followed rigorously.

Environment

One of the benefits of this vehicle is that it can take you off the beaten path away from most communities. However, you should always respect nature and the rights of others to enjoy it. Do not ride in environmentally sensitive areas. Do not drive over forest crops or shrubs, nor cut down trees or take down fencing, nor spin your wheels and destroy the terrain. "Tread Lightly".

This vehicle can cause OHV wildfires if debris builds up near the exhaust or other engine hot spots and ignites then falls off into dry grass. Avoid riding in wet areas, through muskeg or tall grass, where debris can build up. Should you ride in those areas, inspect and remove all debris from your engine and hot spots. Refer to *Vehicle Care* for details.

Chasing wildlife is in many areas illegal. Wildlife can die of exhaustion after being chased by a motorized vehicle. If you encounter animals on the trail, stop and observe quietly and with caution. It will be one of the better memories of your life.

Observe the rule "what you take in, carry out". Do not litter. Do not start campfires unless you have permission to do so, and then only away from dry areas. The hazards you may create on the trail may cause injury to others or yourself, even at a later date.

Respect farm lands. Always obtain the permission of the landowner before riding on private land. Respect crops, farm animals and property lines.

Finally, do not pollute streams, lakes or rivers and do not modify the engine or exhaust system, or remove any of its components as it will alter the vehicle emissions.

Design Limitation

Although the vehicle is exceptionally rugged for its class, it is still a light vehicle by definition and its operation must be restricted to its proper purpose.

The addition of weight to any part of the vehicle changes its gravitational stability and modifies its performance.

Off-Road Operation

The very nature of off-road operation is dangerous. Any terrain, which has not been specially prepared to carry vehicles, presents an inherent danger where terrain substance, shape and steepness are unpredictable. The terrain itself presents a continual element of danger, which must be knowingly accepted by anyone venturing over it.

An operator who takes a vehicle off-road should always exercise the utmost care in selecting the safest path and keeping close watch on the terrain ahead of him. The vehicle should never be operated by anyone who is not completely familiar with the driving instructions applicable to the vehicle, nor should it be operated on steep or treacherous terrain.

Riding Techniques

Information in this guide is limited. Increase your knowledge and improve your skills by following a certified training course.

Care, caution, experience and driving skill are the best precautions against the hazards of vehicle operation.

Respect and follow all posted trail signs. They are there to help you and others.

When driving on hills or slopes two things are highly important be prepared for slippery surfaces or terrain variations and obstacles and use proper body positioning.

Whenever there is the slightest doubt that the vehicle can safely negotiate an obstacle or a particular piece of terrain, always choose an alternate route.

In off-road operation, power and traction, not speed, are important. Never drive faster than visibility and your own ability to select a safe route permits.

Constantly watch the terrain ahead for sudden changes in slopes or obstacles, such as rocks or stumps, that may cause loss of stability, resulting in tip over or rollover.

Never operate the vehicle if the controls do not function normally.

When stopped or parked, always set the shift lever to PARK position apply the parking brake. This is especially important when parking on a slope. On very steep inclines or if the vehicle is carrying cargo, the wheels should be blocked using rocks or bricks.

Always use proper riding techniques to avoid vehicle overturns on hills and rough terrain and in turns.

Body Position

To maintain proper control, it is strongly advised that you keep your hands on the handlebar and within easy reach of all controls. The same holds true for your feet on the foot pegs. To minimize the possibility of a leg or foot injury, keep your feet on the foot pegs at all times. Do not direct your toes outwards nor extend your feet out to assist in turning as they can be hit or be snagged on passing obstacles, or may come into contact with the wheels.

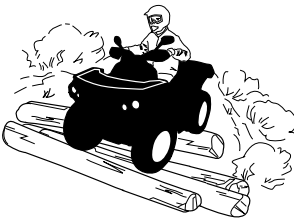

Even though there is a suspension on this vehicle, there are “washboard” or rough terrain conditions that will make you feel uncomfortable and can even cause a back injury. “Posting” or riding in a crouched position will often be

required. Slow down and allow your flexed legs to absorb part of the impact energy.

Crossing Roads

If you have to cross a road, the lead driver should get off his vehicle, then observe and give directions to the other riders. The last person after crossing then assists the lead driver to cross. Do not travel on sidewalks. They are designated for pedestrian use.

Turning

Practice turning at low speeds before attempting to turn at faster speeds.

Keep both hands on handlebars and feet on foot pegs.

Maintain a constant speed or a slight acceleration during turn.

To reduce the risk of rollovers:

- Use care when turning.
 - Do not turn the handlebar too far or too fast for your speed and environment. Adjust steering inputs accordingly.
 - Slow down before entering a turn. Avoid hard braking during a turn.
 - Avoid sudden or hard acceleration when turning, even from a stop or low speed.
- Never attempt donuts, skids, slides, fishtails, jumps, or other stunts. If vehicle starts to skid or slide, steer in the direction of the skid or slide. Never slam the brakes and lock the wheels.
- Avoid paved surfaces. This vehicle is not designed to operate on paved surfaces and is more likely to roll over. If you must drive on pavement, turn gradually, go slowly, and avoid abrupt acceleration and braking.

Avoid sudden inputs to steering, throttle or brakes while turning.

⚠ WARNING

Do not attempt turns at excessive speed.

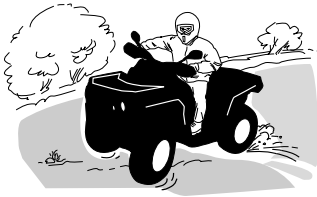

If you do get into a slide or skid, it may help to turn the handlebar in the direction of the skid until you regain control. Never jam the brakes and lock the wheels.

⚠ WARNING

The tires of this vehicle are not suited for paved road use. Also this vehicle is not equipped with a rear differential (rear wheels are always turning at the same speed). For these reasons, pavement may seriously affect the handling and control of the vehicle.

Braking

Always keep both hands on handlebars and feet on foot pegs when braking.

Practice braking to get familiar with the brake response.

- Do it at low speed first, then increase the speed.
- Practice braking in straight line at different speeds and different braking force.
- Practice emergency braking; optimal braking is obtained in straight line, with high force applied, without locking the wheels.

Remember, braking distance depends on vehicle speed, load and the type of surface. Also, the tires and brakes conditions play a major role.

NOTE:

If going forward the vehicle weight is transferred to the front wheels when braking. To obtain greater stopping efficiency, the brake system distributes more braking force to the front wheels. This will affect vehicle handling and steering control when braking vigorously. Take it into account when braking.

Reverse Operation

When operating in reverse, check that the path behind the vehicle is free of people or obstacles. Proceed slowly and avoid sharp turns.

We recommend sitting on your ATV when operating in reverse. Avoid standing up. Your weight could shift forward against throttle lever, causing an unexpected acceleration.

⚠ WARNING

Unexpected acceleration when the ATV is operated in reverse can cause a loss of control.

Obstacles

Obstacles in the “trail” should be traversed with caution. This includes loose rocks, fallen trees, slippery surfaces, fences, posts, and embankments and depressions. You should avoid them whenever possible. Remember that some obstacles are too large or dangerous to cross and should be avoided. Small rocks or fallen trees may be safely crossed approach at a 90° angle. Stand on the footrests while keeping your knees flexed. Adjust speed without losing momentum and do not “gun” the throttle. Hold handlebar firmly. Place operator body weight rearwards and proceed. Do not try to lift the vehicle front wheels off the ground. Be aware that the object may be slippery or may move while crossing.

Uphill Driving

Due to configuration, this vehicle has excellent climbing ability, so much so that it is possible to tip over before traction is lost. For example, it is common to encounter terrain situations where the top of the hill has eroded to a point that the hill peak rises very sharply. The vehicle can readily negotiate such a condition, however, in doing so, when the front of the vehicle is driven to a point that the vehicle's balance moves rearward, a tip over can occur.

The same situation may apply if an embedded object causes the front of the vehicle to climb more than desired. If such a situation occurs take an alternate route. Be aware of side hilling dangers when doing so.

It is also wise to know the terrain condition on the other side of the hill or bank. All too often there exists a sharp drop-off that is impossible to negotiate or descend.

Before trying to climb a hill, keep these things in mind. Hill climbing should only be attempted by experienced operators. Start on shallow slopes. Always drive straight uphill and keep your body weight forward towards the top of the hill. Keep your feet on the footrests, shift your ATV into a lower gear and accelerate before you start to climb. Try to keep a steady speed and go easy on the throttle to avoid acceleration. Abrupt slope or terrain variation or rolling one wheel over an obstacle could have a big impact on the stability as it will lift the front of the vehicle increasing the risk of tipping over. Some hills are too steep to safely stop or recover from after an unsuccessful climbing attempt. Try to avoid steep inclines. If you're not careful, you could tip over when going up hills. If the hill is too steep and you cannot proceed or the vehicle begins to roll backwards, apply the brake, being careful not to slide, put the parking brake. Dismount on the left side then use the "K" turn (while walking back, next to the vehicle on the up hill side and with a hand on the brake lever, slowly back the rear of the vehicle toward the top of the hill then drive downhill). Always walk or dismount on the upside of the slope while keeping clear of the vehicle and its rotating wheels. Do not try to hold on to the vehicle if it begins to topple. Stay clear. Do not ride over the crest of the hill at high speed. Obstacles, including sharp drop-offs, may exist.



Downhill Driving

This vehicle can climb slopes that are steeper than it can safely descend. Therefore, it is essential to ensure that a safe route exists to descend a slope before you climb it.

Decelerating while negotiating a slippery downhill slope could "toboggan" the vehicle. Maintain steady speed and/or accelerate slightly to regain control.

Keep your body weight rearwards. Apply the brake gradually to prevent skidding. Do not "coast" down the slope using solely engine compression or in neutral

gear. Try to avoid steep inclines. If you're not careful, you could tip over when going down hills.

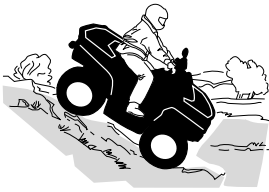

Side Hilling

This is one of the **most risky** types of riding since it may drastically change the balance of the vehicle. It should be avoided whenever possible. However, if it is necessary to do so, it is important that you **ALWAYS** keep your body weight on the upside of the slope and be prepared to dismount on that side should the vehicle begin to topple. **Do not try to stop or save the vehicle from damage.**

Avoid all objects or depressions that will intensify the raising of one side of the vehicle higher than the other, thus causing rollover.

⚠ WARNING

Be careful when loading and transporting liquid reservoirs. They can affect vehicle stability when side hilling by pulling downhill and increasing the risk of a roll over.

Drop-Offs

This vehicle will “bottom-out” and usually stop if either the front or rear wheels are driven over a drop-off. If the drop is sharp or deep, the vehicle will nose dive and tip over.

⚠ WARNING

Avoid negotiating drop-offs. Reverse and select an alternate route.

Crossing Water

Water can be a unique hazard. If it is too deep the vehicle may “float” and topple. Check the water depth and current before you attempt to cross any water. Water should not go above the footrest. Be wary of slippery surfaces such as rocks, grass, logs, etc., both in the water and on its banks. A loss of traction may occur. Do not attempt to enter the water at high speed. The water will act as a brake and could throw you off the vehicle, on the ground.



Wet brakes will affect the braking ability of your vehicle. Make sure you dry the brakes by applying them several times after the vehicle leaves the water, mud or snow. Allow greater distance for braking.

Mud or marsh lands may be encountered near water. Be prepared for sudden "holes" or changes in depth. Similarly so, be watchful of hazards such as rocks, logs, etc., partially covered by vegetation.

Riding on Ice

If your route crosses frozen waterways, make sure the ice is thick enough and sound enough to support the total weight of yourself, the vehicle and its load. Be ever watchful of open water it is a sure indication that the ice thickness will vary.

Ice will also affect the control of the vehicle. Slow down and do not "gun" the throttle. This will only result in spinning of the tires and possible tip over of the vehicle. Avoid rapid braking. This again will possibly result in an uncontrolled slide and tip over of the vehicle. Slush should be avoided at all times since it could block the operation or controls of the vehicle.

Riding on Snow Covered Surfaces

When performing the pre-ride inspection, pay special attention to locations on the vehicle where snow and/or ice accumulations may obstruct visibility of the taillight and reflectors, clog ventilation openings, block the radiator and fan, and interfere with the movement of control levers, switches and brake pedal. Before starting with your ATV check the steering, throttle and brake lever and pedal controls for interference free operation.

Whenever an ATV is ridden on a snow covered drive path the tire grip is generally reduced causing the vehicle to react differently to control inputs from the operator. On low grip surfaces, the steering responses are not as crisp and precise, stopping distances are lengthened and acceleration becomes sluggish. Slow down and do not "gun" the throttle. This will only result in spinning of the tires and possibly in an over steering slide of the vehicle. Avoid hard braking. This will possibly result in a straight line slide of the vehicle. Again, the best advice is to safely reduce speed in anticipation of a maneuver so to give yourself time and distance to regain total vehicle control before it spins out of your control.

As you drive your ATV over a loose snow covered surface, snow dust will be picked up in the wake turbulence of the moving vehicle and transported to contact and accumulate or melt on some exposed components including rotating parts like brake discs. Water, snow or ice may affect the response time of the brake system of your ATV. Even when not required to reduce vehicle speed apply brakes frequently to prevent ice or snow accumulation and to dry brake pads and discs. While doing so in low risk driving situations you will test for grip level and keep yourself alerted to how the vehicle reacts to your control inputs. Always keep brake pedal, footrests, floor boards, brake and throttle levers free of snow and ice. Frequently wipe snow off seat, hand grips, headlights, taillights and reflectors.

The depth of the snow cover may hide rocks, tree stumps or other objects and if it is wet may totally impede the driveability as the vehicle becomes bogged down or completely loses traction in slushy snow. Look far ahead and always be watchful of any visible clues that might indicate the presence of such obstacles.

In doubt steer clear. Avoid driving on any frozen body of water before checking that the ice will safely support the ATV, its riders and its load of cargo. Remember that a given thickness of ice may be sufficient to support a snowmobile but not an ATV of an identical weight because of the smaller load bearing surface of the four tire contact patches as compared to that of a snowmobile track and skis.

To maximize comfort and avoid frostbite, always wear clothing and ATV protective equipment appropriate for the weather conditions you will be exposed to during your ride.

At the end of each ride it is a good practice to clean the vehicle body and all moving components (brakes, steering components, drivelines, controls, radiator fan etc.) from any snow or ice accumulations. Wet snow will turn to ice during the shut down period and become more difficult to remove at the next pre-ride inspection.

Riding in snow may reduce the brakes stopping capability. Safely reduce speed and allow greater distance for braking. Snow projection may cause ice build up or snow accumulation on brake components and controls. Apply brakes frequently to prevent ice or snow accumulation.

Riding on Sand

Riding on sand, sand dunes or on snow is another unique experience, but there are some basic precautions that should be observed. Wet, deep or fine sand/snow may create a loss of traction and cause the vehicle to slide, drop off or become “bogged” down. If this occurs look for a firmer base. Again, the best advice is to slow down and be watchful of the conditions.

When riding in sand dunes it is advisable to equip the vehicle with an antenna type safety flag. This will help make your location more visible to others over the next sand dune. Proceed carefully should you see another safety flag ahead. Since the antenna type safety flag can snag and rebound on your body if caught, do not use it in areas where there are low hanging branches or obstacles.

Riding on Loose Stones

Riding on loose stones or gravel is very similar to riding on ice. They will affect the steering of vehicle possibly causing it to slide or tip over especially at high speeds. In addition, braking distance may be affected. Remember that “gunning” the throttle or sliding may cause loose stones to be ejected rearwards into the path of another rider. Never do it deliberately.

MOVING LOADS AND DOING WORK

Working with Your Vehicle

Your vehicle can help you perform a number of different LIGHT tasks ranging from snow removal to pulling wood or carrying cargo. A variety of accessories are available from your authorized Can-Am Off-road dealer. To prevent possible injury, follow the instructions and warnings that accompany the accessory. Always respect the load limits of the vehicle. Overloading the vehicle can overstress the components and cause failure. Avoid overexerting yourself if you lift or pull heavy loads or manually push the vehicle.

WARNING

Mounted machinery must be lowered on the ground before leaving the vehicle.

Carrying Loads

Any load carried on the vehicle will affect the handling, stability and braking distance of the vehicle. Do not exceed the total load allowed for this vehicle, including the weight of operator and passenger cargo, accessories and trailer tongue weight. Refer to *Technical Specifications*. Always make sure the cargo is secured, properly distributed and cannot interfere with your controls or lights. Always be aware that the cargo may slide or fall off and cause an accident. Avoid loads that may protrude sideways and get snagged or caught in brush or other obstacles.

WARNING

Never overload, tow or carry cargo improperly. Safely reduce speed according to terrain conditions when carrying cargo or pulling a trailer, and avoid hills and rough terrain. Allow greater distance for braking. Always secure cargo as low as possible to reduce the effect of a higher center of gravity. Failure to follow the recommendations here could cause changes in vehicle handling which could lead to an accident.

Maximum Load Table

Total load allowed	141 kg (310 lb)	Includes weight of operator, cargo, accessories and tongue weight.
Rear cargo area maximum load	23 kg (50 lb)	Includes rear cargo area and tongue weight (if applicable).

The following is an example of suitable load distribution:

Example of Load Distribution				
Total Vehicle Load	Operator	Cargo Load	Accessories	Tongue Weight
141 kg (310 lb)	108 kg (238 lb)	9 kg (20 lb)	10 kg (22 lb)	13 kg (30 lb)

Loading the Rear Cargo Area

Load cargo as low as possible – a higher load can raise the vehicle's center of gravity, which can reduce stability. Position cargo on the rack as evenly distributed as possible.

Secure the load on the rear cargo area. Do not secure cargo to other parts of the vehicle. If it is not properly secured, a load may slide or fall off, possibly striking occupants or bystanders; or it may shift during riding, affecting the handling of the vehicle.

Objects that are high may affect visibility for the driver and may act as projectiles in case of an accident. Loads that protrude sideways can get snagged or caught in bush, branches or other obstacles. Avoid covering and obstructing the brake lights with the cargo. Ensure no cargo protrudes outside the cargo area and that cargo will not interfere with your visibility or control of the vehicle.

NOTICE

Do not exceed the cargo racks capacity. Refer to *Technical Specifications*.

Never carry gasoline container(s) or any dangerous liquids on the rear cargo area.

⚠ WARNING

Never overload, tow or carry cargo improperly. Safely reduce speed according to terrain conditions when carrying cargo or pulling a trailer, and avoid hills and rough terrain. Allow greater distance for braking. Always secure cargo as low as possible to reduce the effect of a higher center of gravity. Failure to follow the recommendations here could cause changes in vehicle handling which could lead to an accident.

Hauling a Load (if Equipped with Hitch)

Never pull a load by attaching it to the bumper, rear cargo area or any other parts or accessories; this can cause the vehicle to tip over. Use only the trailer hitch (if installed) or winch to pull a load.

In an emergency situation, use the recovery hook to recover a stuck vehicle. Refer to *Recovery Hook* in *Equipment*.

When pulling loads with a chain or cable, ensure that there is no slack before starting and maintain tension while pulling.

When pulling loads with a chain or cable, be sure to brake progressively. The inertia of the load could lead to an impact.

When hauling a load, respect the maximum . See *Pulling a Trailer* in this section.

⚠ WARNING

A slack in the chain or cable can cause it to break and snap back.

When pulling another vehicle, be sure that someone is controlling the pulled vehicle. They must brake and steer to prevent the vehicle from going out of control.

Before pulling loads with a winch, refer to the winch manufacturer's instructions.

Reduce your speed when hauling a load and turn gradually. Avoid hills and rough terrain. Never attempt steep hills. Allow more distance for braking, especially on inclined surfaces. Be careful not to skid or slide.

Pulling a Trailer (If Equipped with a Hitch)

NOTICE

A BRP approved rear hitch must be properly installed on the vehicle for hauling trailers.

Riding this vehicle with a trailer substantially increases the risk of toppling, especially on inclined slopes. If a trailer is used behind the vehicle make sure that its hitch is compatible with the one installed on the vehicle as an accessory. Make sure the trailer is horizontal with the vehicle. (In some instances a special extension may have to be installed on the vehicle hitch). Use security chains or cables to secure the trailer with the vehicle.

Reduce your speed when pulling a trailer and turn gradually. Avoid hills and rough terrain. Never attempt steep hills. Allow more distance for braking, especially on inclined surfaces. Be careful not to skid or slide.

Improperly loading a trailer may cause a loss of control.

Do not exceed the towing capacity or tongue capacity. Refer to *Specifications*.

Make sure there is at least some weight on the tongue.

Always make sure load is evenly distributed and safely secured on the trailer; an evenly balanced trailer is easier to control.

Always put the shift lever to L (low range) for hauling a trailer – in addition to providing more torque, operating in low range helps account for the increased load on the rear tires.

When stopped or parked, block the vehicle and trailer wheels from possible movement.

Use caution when disconnecting a loaded trailer; it or its load may topple on you or others.

When hauling a trailer, respect the following maximum hauling capacity.

IMPORTANT ON-PRODUCT LABELS (CANADA/UNITED STATES)

Safety Hang Tag

This vehicle comes with a hang tag and labels containing important safety information.

Any person who rides this vehicle should read and understand this information before riding.

S SPORT MODEL

THIS ATV IS FOR
RECREATIONAL USE
BY EXPERIENCED OPERATORS ONLY.

OPERATOR ONLY-NO PASSENGERS

NO OPERATOR UNDER AGE 16

THIS CATEGORY S (SPORT) ATV IS A HIGH PERFORMANCE ATV FOR OFF ROAD USE ONLY. IT IS FOR SPORT TYPE RECREATIONAL AND COMPETITIVE USE BY OPERATORS WITH ADVANCED SKILLS AND SUBSTANTIAL EXPERIENCE.

TRAINING COURSES TO TEACH ATV RIDING SKILLS ARE AVAILABLE. FOR INFORMATION CONTACT YOUR DEALER.





CHECK WITH YOUR DEALER TO FIND OUT ABOUT STATE OR LOCAL LAWS REGARDING ATV OPERATION.

THIS HANGTAG IS NOT TO BE REMOVED BEFORE SALE.

704903318

⚠ WARNING

Improper ATV use can result in SEVERE INJURY or DEATH.

			
ALWAYS USE AN APPROVED HELMET AND PROTECTIVE GEAR.	NEVER USE ON PUBLIC ROADS.	NEVER CARRY PASSENGERS.	NEVER USE WITH DRUGS OR ALCOHOL.

NEVER operate:

- without proper training or instructions.
- at speeds too fast for your skills or the conditions.
- on public roads - a collision can occur with another vehicle.
- with a passenger - passengers affect balance and steering and increase risk of losing control.

ALWAYS:

- use proper riding techniques to avoid vehicle overturns on hills and rough terrain and in turns.
- avoid paved surfaces - pavement may seriously affect handling and control.

LOCATE AND READ OPERATOR'S GUIDE.
FOLLOW ALL INSTRUCTIONS & WARNINGS.

Safety Labels

Read and understand all the safety labels on your vehicle.

These labels are affixed to the vehicle for the safety of the operator or bystanders.

The safety labels on your vehicle should be considered permanent parts of the vehicle.

If missing or damaged, they can be replaced free of charge. See an authorized Can-Am Off-road dealer.





NOTE:

In the event of any discrepancy between this guide and the vehicle, the safety labels on the vehicle have precedence over the labels in this guide.

General Warning Label

⚠ WARNING

Improper ATV use can result in SEVERE INJURY or DEATH.

			
ALWAYS USE AN APPROVED HELMET AND PROTECTIVE GEAR	NEVER USE ON PUBLIC ROADS	NEVER CARRY PASSENGERS	NEVER USE WITH DRUGS OR ALCOHOL

NEVER operate:

- without the proper ATV training or instructions.
- at speed too fast for your skills or conditions.
- on public roads - a collision can occur with another vehicle.
- with a passenger - passengers affect balance and steering and increase risk of losing control.

ALWAYS:

- use proper riding techniques to avoid vehicle overturns on hills and rough terrain and in turns.
- avoid paved surfaces - pavement may seriously affect handling and control.

Read and understand all safety labels, locate and read operator's guide and watch the safety video using the QR code link or visit Can-am web site before operation.

**LOCATE AND READ OPERATOR'S GUIDE
FOLLOW ALL INSTRUCTIONS & WARNINGS.**



8016

Patent : www.brp.com/en/about-brp/patents.html

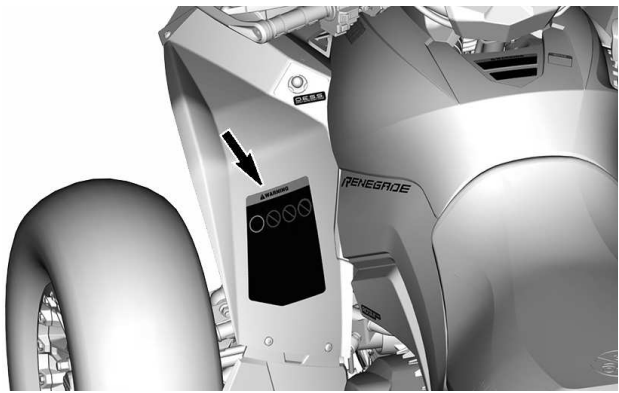

Recommended Age – Warning Label

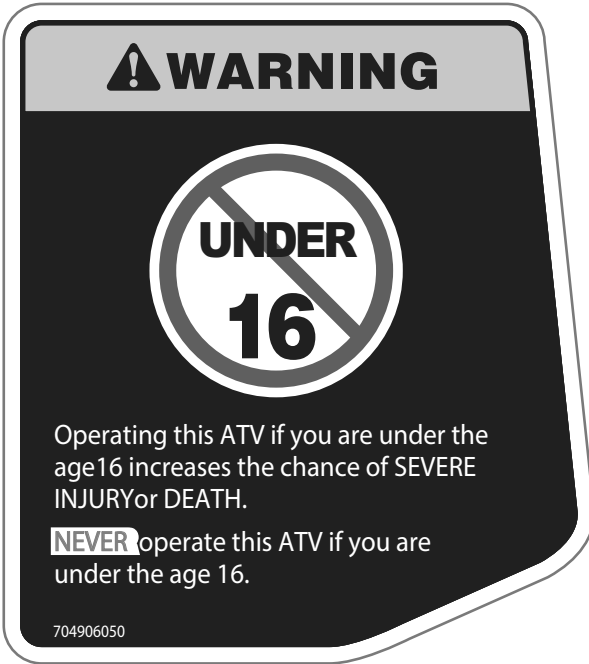

Tire Pressure and Maximum Load - Warning Label

WARNING

Improper tire pressure or overloading can cause loss of control, resulting in SEVERE INJURY or DEATH.

ALWAYS maintain proper tire pressure according to the load on the vehicle. Refer to table.

NEVER underinflate tire as it could cause the tire to dislodge from the rim.

NEVER exceed the vehicle load capacity of 141 kg (310 lb) including weight of operator, cargo and accessories.

NEVER exceed 110 km/h if total load is more than 114 kg (250 lb),

COLD TIRE PRESSURE

FRONT 48.3 kPa (7 psi)

REAR 48.3 kPa (7 psi)



7620

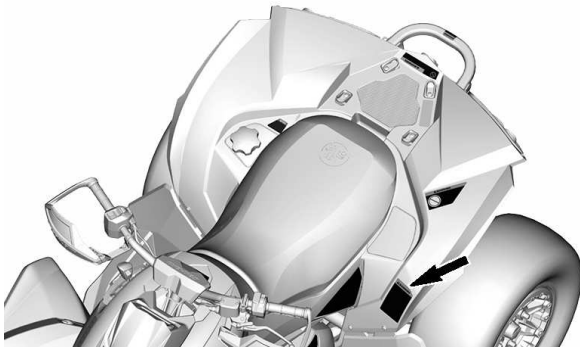

Vehicle Performance - Warning Label

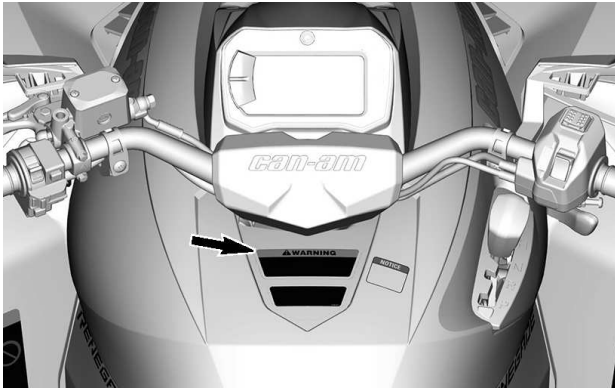

Maximum Rear Cargo Loading - Warning Label

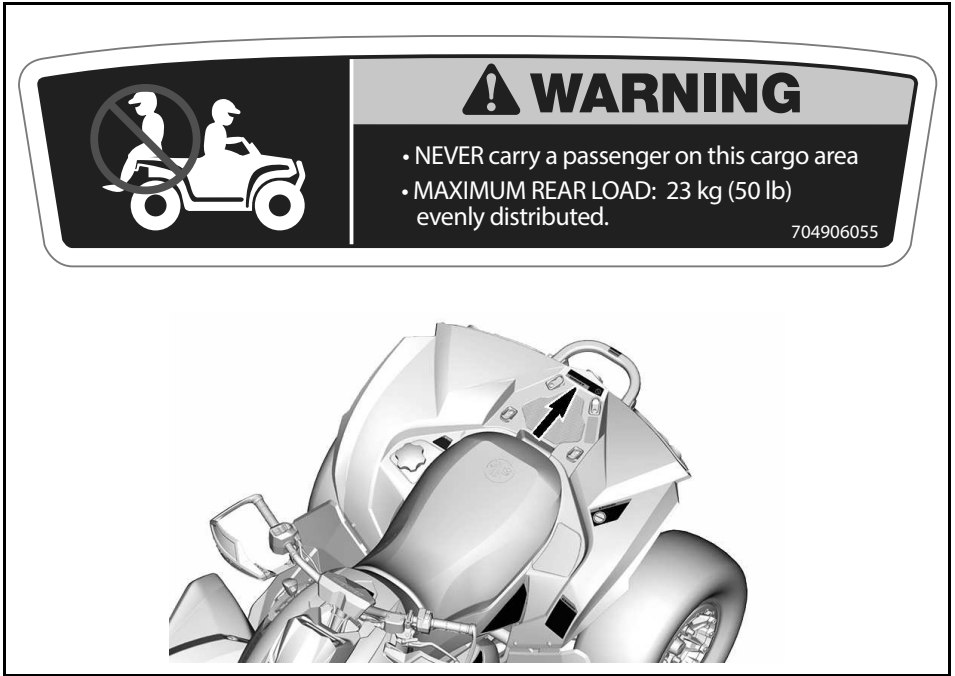

The image shows a warning label for a vehicle's maximum rear cargo loading. The label is rectangular with rounded corners and a black background. On the left side, there is a white icon of a person riding a vehicle with a passenger in the rear cargo area, crossed out with a large 'X' inside a circle. To the right of the icon, the word "WARNING" is written in large, bold, white capital letters. Below "WARNING", there are two bullet points in white text: "• NEVER carry a passenger on this cargo area" and "• MAXIMUM REAR LOAD: 23 kg (50 lb) evenly distributed." In the bottom right corner of the label, the number "704906055" is printed in white. Below the label, there is a grayscale photograph of the rear of a vehicle, showing the seat and cargo area. An arrow points to the top of the cargo area, indicating where the load should be placed.

WARNING

- NEVER carry a passenger on this cargo area
- MAXIMUM REAR LOAD: 23 kg (50 lb) evenly distributed.

704906055

No On-Road Use - Warning Label

⚠ WARNING

This vehicle is an all terrain vehicle and is not intended for use on public roads. 704905680

⚠ AVERTISSEMENT

Ce véhicule est un véhicule tout terrain qui n'est pas destiné à être utilisé sur les voies publiques.

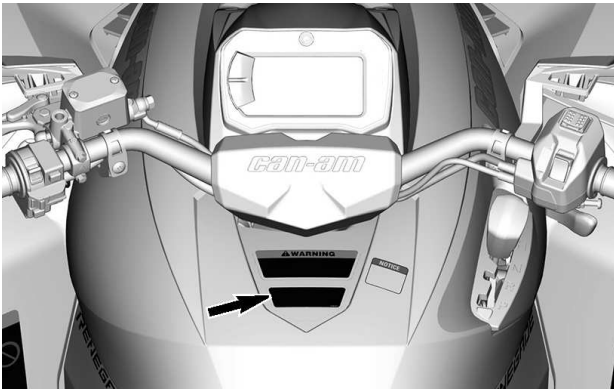

Passenger Warning Label

⚠ WARNING

NEVER ride as a passenger. Passengers can cause a loss of control, resulting in SEVERE INJURY or DEATH.



704906860



Shifting Procedure – Notice Label

NOTICE

- ATV MUST be stopped before shifting lever.
- ALWAYS apply foot brake to shift from Park (P) and Neutral (N).

704906054

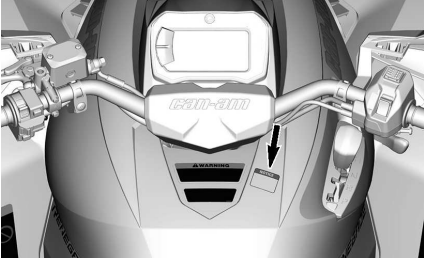

Pulling a Load Using the Racks — Warning Label

⚠ WARNING

NEVER attach here or on the luggage rack to pull a load. This can cause the vehicle to tip over.

ALWAYS use the trailer hitch or the recovery hook to pull a load.

704905698

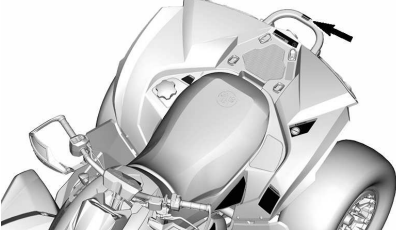

Coolant Hot - Warning Label

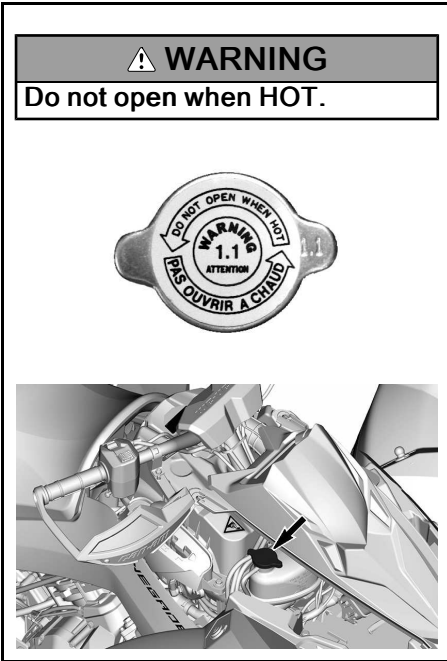

Possible Burn - Warning Pictogram



Compliance Hang Tags

California Proposition 65 Warning

 **WARNING.** Operating, servicing and maintaining an off-road vehicle can expose you to chemicals including engine exhaust, carbon monoxide, phthalates, and lead, which are known to the State of California to cause cancer and birth defects or other reproductive harm.

To minimize exposure, avoid breathing exhaust, do not idle the engine except as necessary, service your vehicle in a well-ventilated area and wear gloves or wash your hands frequently when servicing your vehicle.

For more information go to
[www.P65Warnings.ca.gov/products/
passenger-vehicle](http://www.P65Warnings.ca.gov/products/passenger-vehicle)



704906872

IMPORTANT ON-PRODUCT LABELS (COUNTRIES OUTSIDE CANADA AND UNITED STATES)

Read and understand all the safety labels on your vehicle.

These labels are affixed to the vehicle for the safety of the operator, passengers or bystanders.

The following labels are on your vehicle, and they should be considered permanent parts of the vehicle. They need to be clean and visible at all times. If missing or damaged, they need to be replaced. Safety labels are free of charge. See an authorized Can-Am Off-road dealer.

Upon replacement of parts that have warnings on them, make sure to order (free of charge) the applicable safety warnings if not already installed on the replacement part.

NOTE:

In the event of any discrepancy between this guide and the vehicle, the safety labels on the vehicle have precedence over the labels in this guide.

Safety Labels

Read and understand all the safety labels on your vehicle.

These labels are affixed to the vehicle for the safety of the operator or bystanders.

The safety labels on your vehicle should be considered permanent parts of the vehicle. If missing or damaged, they can be replaced free of charge. See an authorized Can-Am Off-road dealer.

NOTE:

In the event of any discrepancy between this guide and the vehicle, the safety labels on the vehicle have precedence over the labels in this guide.

General Warning Pictogram

⚠ WARNING

- Improper ATV use can result in **SEVERE INJURY** or **DEATH**. Follow all instructions and warnings.
- Always use an approved helmet and protective gear.
- Always wear ear protection.
- Locate and read operator's guide and watch the safety video.
- Never use on public roads.
- Never carry a passenger.
- Never use with drugs or alcohol.



Passenger Warning Pictogram

⚠ WARNING

- Read the entire operator's guide and watch the safety video.
- NEVER carry a passenger.

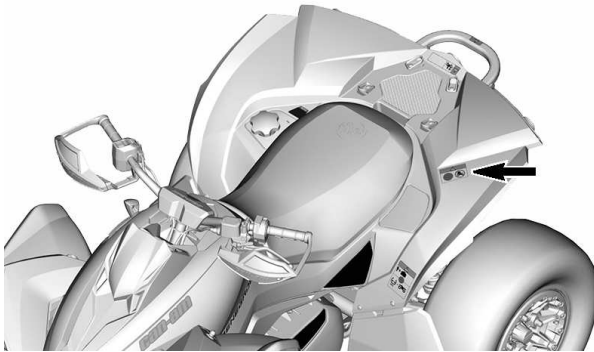
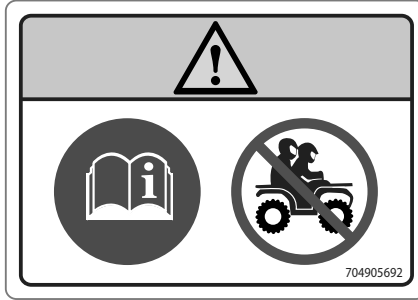

Tire Pressure and Maximum Load - Warning Pictogram

⚠ WARNING

- NEVER exceed the load capacity of 141 kg (310 lb) including weight of operator, cargo, and accessories (and including trailer tongue weight if applicable).
- NEVER exceed 110 km/h (68 MPH) when the total load of (114 kg (250 lb)) is reached.
- Locate and read operator's guide and watch the safety video.
- ALWAYS maintain proper tire pressure as shown. Improper tire pressure and overloading can cause loss of control, resulting in SEVERE INJURY or DEATH.

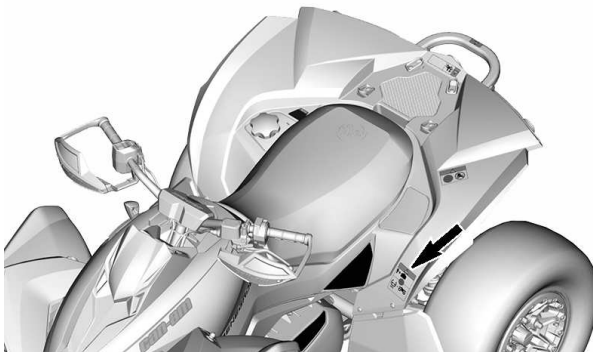
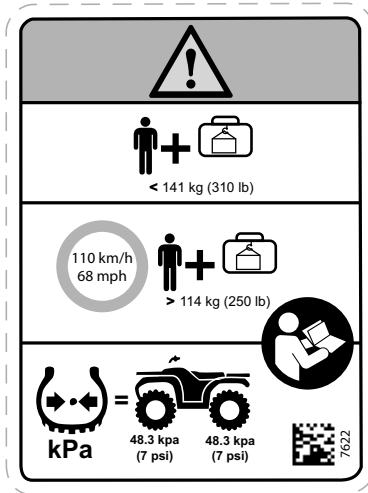

Maximum Racks Loading — Warning Pictogram

⚠ WARNING

- NEVER carry a passenger on this carrier.
- MAXIMUM REAR LOAD: 23 kg (50 lb) evenly distributed (including trailer tongue weight if applicable).

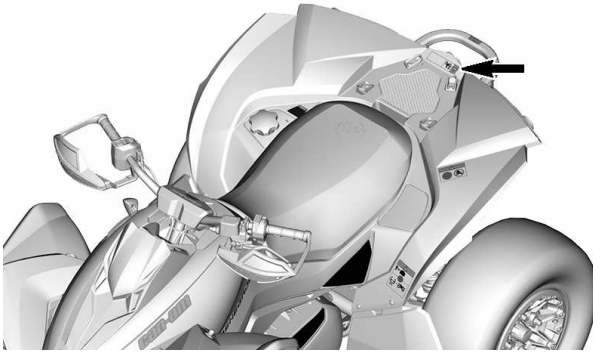
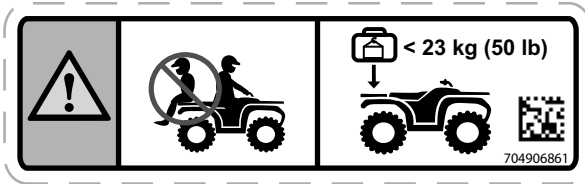

Recommended Age - Warning Pictogram

WARNING

Operating this ATV if you are under the age of 16 increases the chance of SEVERE INJURY or DEATH to the operator.
NEVER operate this ATV if you are under age 16.

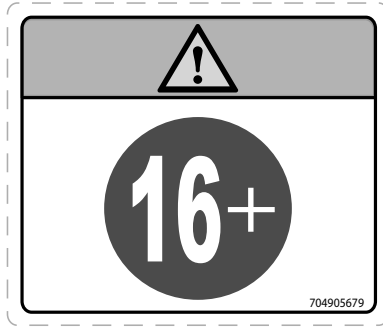

Shifting Procedures - Notice Pictogram

NOTICE

This vehicle must be stopped before shifting lever. **ALWAYS** apply foot brake to shift from Park (P) and Neutral (N).

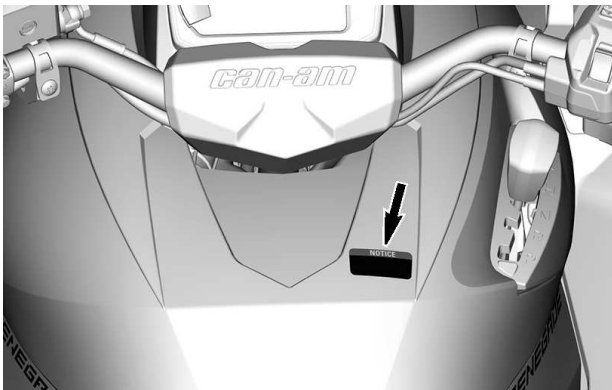
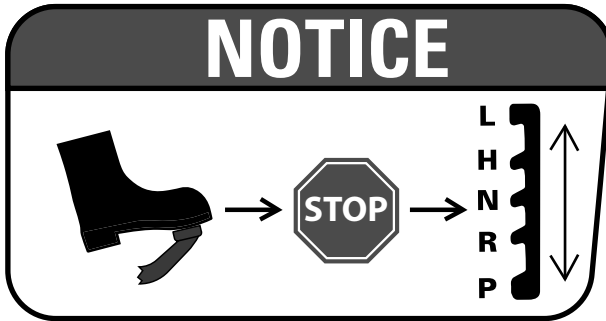

Pulling a Load Using the Racks or Bumpers- Warning Pictogram

⚠ WARNING

NEVER attach to the bumper or on the luggage rack to pull a load This can cause the vehicle to tip over.
ALWAYS use the trailer hitch or the recovery hook to pull a load.

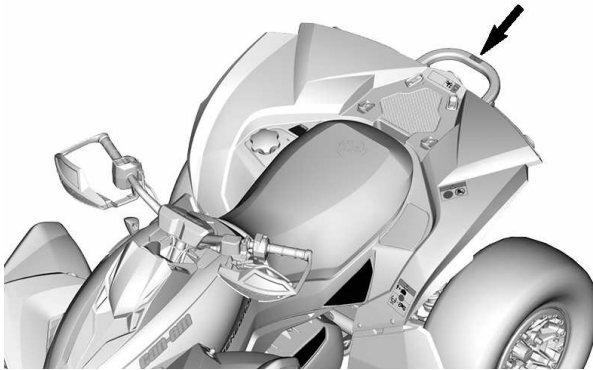

Coolant Hot - Warning Label

⚠ WARNING

Do not open when HOT.

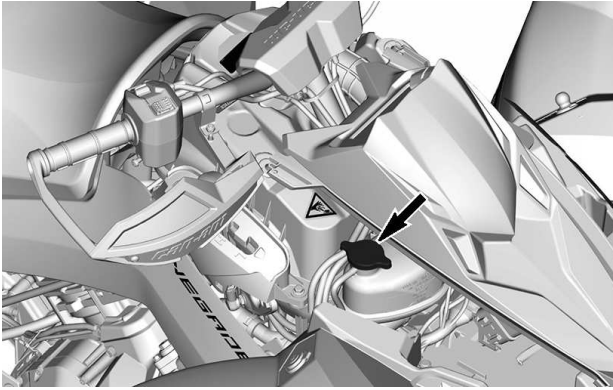

Possible Burn - Warning Pictogram

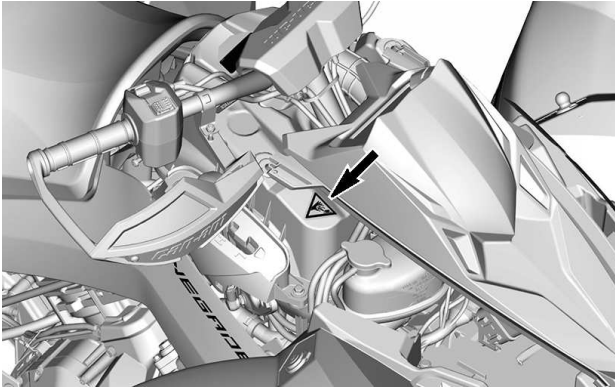

REPORTING SAFETY DEFECTS

In Canada, if you believe that your vehicle has a defect which could cause a crash or could cause injury or death, you should immediately inform Transport Canada in addition to notifying Bombardier Recreational Products Inc.

If Transport Canada receives similar complaints, it may open an investigation, and if it finds that a safety defect exists in a group of vehicles, it may order a recall and remedy campaign. However, Transport Canada cannot become involved in any individual problems between you, your dealer or Bombardier Recreational Products Inc.

To contact Transport Canada:



819-994-3328 (Gatineau-Ottawa area or internationally)
Toll free : 1 800-333-0510 (in Canada)



Transport Canada - ASFAD
330 Sparks Street
Ottawa, ON
K1A 0N5



<https://www.tc.gc.ca/recalls>

VEHICLE INFORMATION

PRIMARY CONTROLS

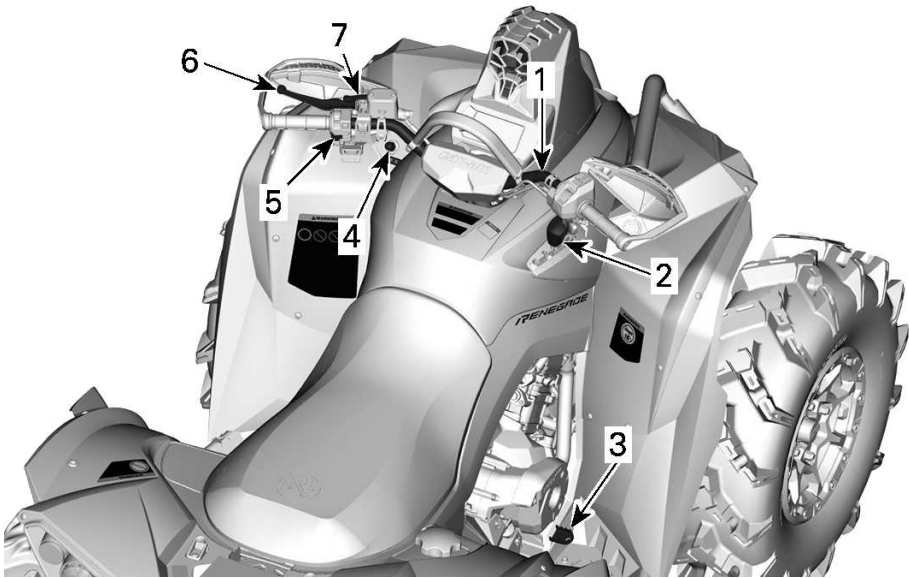

1. Handlebar
2. Throttle lever
3. Brake pedal
4. RF D.E.S.S. post
5. Engine stop switch
6. Brake lever
7. Brake lock lever

While reading this Operator's Guide, remember that:

 **WARNING**

Indicates a potential hazard which, if not avoided, could result in serious injury or death.

Handlebar

The handlebar controls the steering of the vehicle.

As the handlebar is rotated to right or left, the front wheels are turned in this direction to steer the vehicle.

⚠ WARNING

Fast reverse while turning, could result in loss of stability and control.

Throttle Lever

The throttle lever is located on the RH side of the handlebar.

The throttle lever controls the engine speed.

To increase or maintain vehicle speed, press the throttle lever with your right thumb.

To decrease vehicle speed, release the throttle lever.

Brake Lever

The brake lever is located on the LH side of the handlebar.

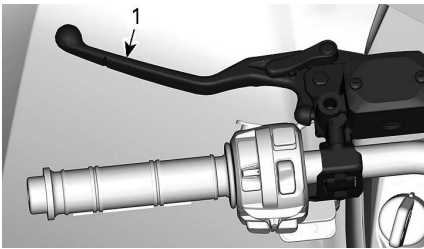

1. Brake lever

The brake lever function is to slow down or stop the vehicle.

When the brake lever is compressed, the front and rear brakes are applied.

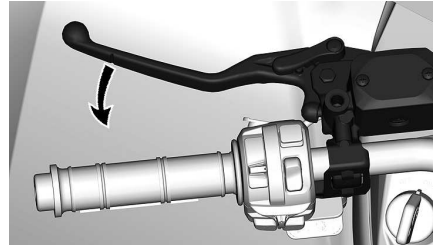

Braking effect is proportional to the force applied on the lever.

Brake Lock Lever

The brake lock lever is located on the LH side of the handlebar.

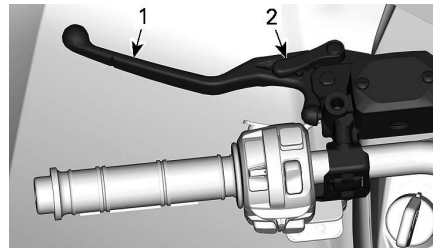

1. Brake lever
2. Brake lock lever

Engage the brake lock whenever the vehicle is parked.

⚠ WARNING

Always apply the parking brake when the vehicle is not in operation by engaging the brake lock lever and moving the shifter on the PARK position.

To engage the brake lock lever proceed as shown:

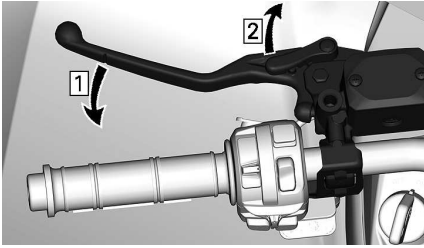

1. Apply brakes
2. Lock brakes

NOTE:
The brake lock lever can be set to several positions.

NOTICE

When the brake lock lever is applied, make sure the vehicle stays securely in place.

To unlock the brake lock lever, simply squeeze the brake lever. It should return to the rest position.

⚠ WARNING

Make sure brake lock lever is released before operating the vehicle. If brake lock lever is left engaged while riding, it may cause damage to the brake system and cause loss of braking capacity and/or fire.

Brake Pedal

The brake pedal is located on the RH side footrest.



1. Brake pedal

When the brake pedal is pressed down, the rear brake is applied.

When released, the brake pedal should return to its original position.

Braking effect is proportional to the force applied on the pedal.

NOTE:

The brake will have also an effect on front wheels through the drive train when 4WD is engaged.

Should the brake lever system fail, the rear brake can be used by depressing the brake pedal.

Engine Stop Switch

This switch can be used to stop the engine and as an emergency control.

To stop engine, fully release throttle lever then set the engine stop switch to the STOP position.

Even if the engine can be stopped either by either turning the ignition key to OFF position or by removing the D. E.S.S. key, we recommend the engine be stopped by setting the engine stop switch to the STOP position.

The engine stop switch is located at the middle of the multifunction switch.

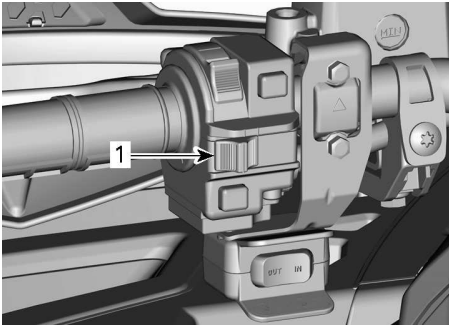

1. Engine stop switch

RF D.E.S.S. Key and Post

D.E.S.S. Key

These keys contain an electronic circuit that gives it a unique electronic serial number.

The D.E.S.S. system reads the key code and allows engine starting for keys it recognizes.

This vehicle can be operated using 2 different types of key programming:

- Normal
- Performance

Refer to your authorized Can-Am Off-road dealer for complete information.

The vehicle is delivered with 1 performance key.

NOTE:

Additional keys are available from your dealer as an accessory.

⚠ WARNING

Rollovers, tipovers, collisions and loss of control resulting in serious injury or death are possible with the performance or normal key. Using the normal key is not a substitute for the operator being prepared, qualified, and operating with care.

Performance Key

The performance key allows the user to access the full torque of the engine as well as the top speed of the vehicle.

This may be useful for riders who prefer crisper throttle response, and for environments where higher speeds and greater acceleration are appropriate.

For example, in wide-open straight trails, operators may prefer the performance key.

Normal Key

The normal key limits the vehicle rate of acceleration and/or the vehicle speed to 70 km/h (43 MPH).

⚠ WARNING

On steep downhills, the engine speed limiter may not prevent the vehicle from accelerating beyond this speed.

This key may be useful for riders who prefer more gradual acceleration, or for riding in environments where full speed and high acceleration are not desirable.

For example, in narrow, winding trails, operators may prefer a normal key.

D.E.S.S. Flexibility

The D.E.S.S. of your vehicle can be programmed by your authorized Can-Am Off-road dealer to accept up to 8 different keys.

If you have more than one D.E.S.S. equipped Can-Am vehicle, each can be programmed by your authorized Can-Am Off-road dealer to accept the other vehicle D.E.S.S. keys.

SECONDARY CONTROLS

Some features may not apply to your model or could be optional.

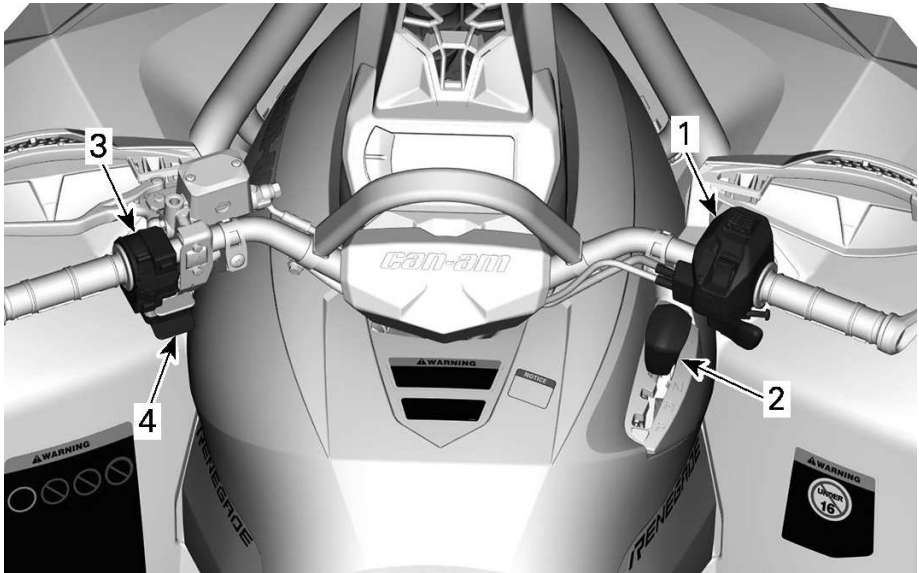

1. Throttle lever control housing
2. Shifter lever
3. Multifunction switch
4. Winch switch

While reading this Operator's Guide, remember that:

WARNING

Indicates a potential hazard which, if not avoided, could result in serious injury or death.

Throttle Lever Control Housing

Electronic Throttle Control (ETC)

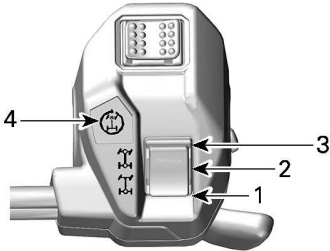

1. 2WD position
2. 4WD position
3. 4WDLock position
4. 4WDLock telltale

Changing Traction Mode

Before passing in 2WD or in 4WD modes:

1. Stop the vehicle completely.
2. Let the engine idling.
3. Select desired mode.

NOTICE

Front differential damage may occur if the 2WD/4WD selector is used while vehicle is moving.

Models with 4WDLock Mode

To engage or disengage the 4WDLock mode:

1. Make sure 4WD mode is selected.
2. Reduce your speed under 30 km/h (20 MPH).
3. Release the throttle.
4. Momentary fully press the selector up.
5. To disengage the 4WDLock mode, press the selector up again.

When the 4WDLock is activated, the telltale on the throttle lever control housing and the icon in the digital

display will turn on and a beep sound will be heard.

NOTE:

If the telltale flashes then stays off, the request is not acknowledged. Reduce your speed under 30 km/h (20 MPH), release the throttle and try again.

2WD Mode

In this mode, the engine power is transferred through the rear wheels only.

To engage the 2WD mode, press the selector **DOWN**.



4WD Mode

The engine power is distributed by both the front and the rear wheels.

The transfer between the front wheels is made depending on traction using the Visco-Lok system

To engage the 4WD mode, move the selector **in center**.



4WDLock Mode

⚠ WARNING

Changing the direction abruptly can cause loss of control or injury. Never apply the 4WDLock mode before entering a turn or during the turn. The vehicle behavior is modified when the 4WDLock mode is activated. The turning radius is also increased.

This mode is designed to lock the front differential allowing more traction to free the vehicle from a situation (ex: vehicle caught in mud or other soft terrains).

The engine power is then distributed equally at all 4 wheels.

In 4WDLock mode, a speed limiter restricts the vehicle speed to 40 km/h (25 MPH). Refer to *Multifunction Switch* to have more information about how overriding this limitation.

Driving Modes Selector

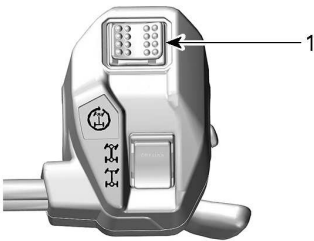

1. Driving modes selector

The driving modes selector is located on the top of the throttle lever control housing.

2 specific modes can be selected:

- ECO or WORK
- SPORT

The selected mode will be indicated in the Mode Display of the gauge.

Also, when the SPORT mode is activated a beep sound will be heard.

ECO or WORK Mode

The ECO or WORK mode provides a smoother throttle response and is limited to a maximum speed of 70 km/h (43 MPH).

To activate the ECO or WORK mode, toggle the selector towards the LEFT.

Toggle to the RIGHT to deactivate.

SPORT Mode

The SPORT mode provides a crisper throttle response.

This mode can be activated with all key types and provides the maximum power with the used key.

To activate the SPORT mode, toggle the selector towards the RIGHT.

Toggle to the LEFT to deactivate.

NOTE: On 850, 1000 and 1000R models, the SPORT mode is automatically disabled after the complete shutdown of the digital display.

Driving Modes Selector

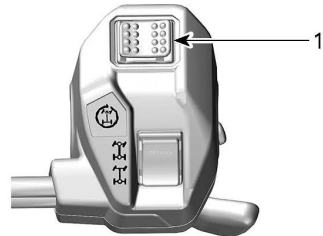

1. Driving modes selector

The driving modes selector is located on the top of the throttle lever control housing.

2 specific modes can be selected:

- ECO or WORK
- SPORT

The selected mode will be indicated in the Mode Display of the gauge.

Also, when the SPORT mode is activated a beep sound will be heard.

ECO or WORK Mode

The ECO or WORK mode provides a smoother throttle response and is limited to a maximum speed of 70 km/h (43 MPH).

To activate the ECO or WORK mode, toggle the selector towards the LEFT.

Toggle to the RIGHT to deactivate.

SPORT Mode

The SPORT mode provides a crisper throttle response.

This mode can be activated with all key types and provides the maximum power with the used key.

To activate the SPORT mode, toggle the selector towards the RIGHT.

Toggle to the LEFT to deactivate.

NOTE: On 850, 1000 and 1000R models, the SPORT mode is automatically disabled after the complete shutdown of the digital display.

Intelligent Engine Braking (iEB) Mode Selector (if equipped)

The Intelligent Engine Braking (iEB)

allows to user to adjust the level of the engine braking before or while riding.

⚠ WARNING

The level of engine braking will have an effect on the deceleration rate when the throttle lever is released.
It's not recommended to change the iEB setting while performing some actions.
These actions include but not limited to the following: braking, turning or when descending.
Be ready to use the brake to reduce the speed when needed.

The iEB selector is located on the back of the throttle lever housing.

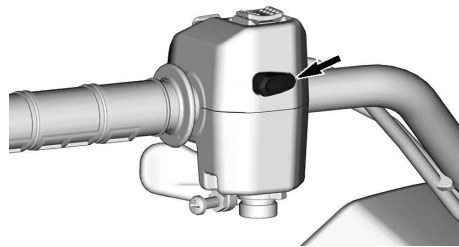

Three (3) specific levels are available and the selected mode is indicated in the Mode Display of the gauge.

Mode	Description	Display message
Mode 1	Maximum engine braking	IEB MAX
Mode 2	Medium engine braking	IEB MED
Mode 3	Very low engine braking	IEB MIN

Use the selector to change the iEB level or showing the selected level in the gauge.

- **Short press (less than 0.5 second):** Display the current iEB level in the gauge.
- **Long press (more than 1 second):** Change to the next level.

The level change is sequenced from MAX to MIN at each long press, and returns to MAX after MIN.

After a level change, the message into the gauge shows the new selected level.

When the MAX level is selected and the throttle lever is released, the engine braking alone is slowing down the vehicle significantly, allowing less usage of the brake lever.

With the MIN level, more brake lever input is required to slow down or stop the vehicle.

The last selected level is automatically activated when the vehicle is restarted after a complete shut down.

Shift Lever

The shift lever is located on the RH side of the vehicle near steering column.



SHIFT LEVER LOCATION

The shift lever is used to change the gearbox position.

The shift lever has 5 positions:

Shift Lever Positions	
Position	Gear
P	Park
R	Reverse
N	Neutral
H	High range (forward)
L	Low range (forward)



SHIFT PATTERN

The vehicle must be stopped and brakes applied prior to selecting any gear.

NOTICE

This gearbox is not designed to shift while vehicle is moving.

Park

The park position locks the gearbox to help prevent vehicle movement.

⚠ WARNING

Always use the PARK (P) position when the vehicle is not in operation. The vehicle can roll if the shift lever is not set to P (PARK).

Reverse

The reverse position allows the vehicle to go backwards.

NOTE:

In reverse operation, the engine's RPM is limited, thus limiting the vehicle reverse speed.

⚠ WARNING

When driving downhill in reverse, gravity can increase the vehicle speed above the set limited reverse speed.

Neutral

The neutral position disengages the gearbox.

⚠ WARNING

Always use the PARK (P) position when the vehicle is not in operation. The vehicle can roll if the shift lever is set to N (NEUTRAL).

High Range (Forward)

This position selects the high speed range of the gearbox. It is the normal driving speed range. It allows the vehicle to reach its maximum speed.

Low Range (Forward)

This position selects the low speed range of the gearbox. It allows the vehicle to move slowly with maximum torque at the wheels.

NOTICE

Use the low speed range to pull a trailer, carry heavy cargo, go over obstacles, riding in mud or drive uphill and downhill.

Multifunction Switch

The multifunction switch is located on the LH side of the handlebar.

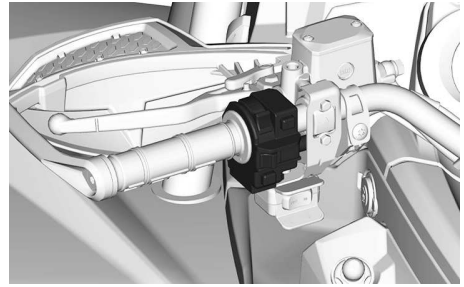
**Headlight Switch**

1. Light OFF
2. Low beam and taillight
3. High beam and taillight

Engine Start Button

The engine start button is located at the top of the multifunction switch.

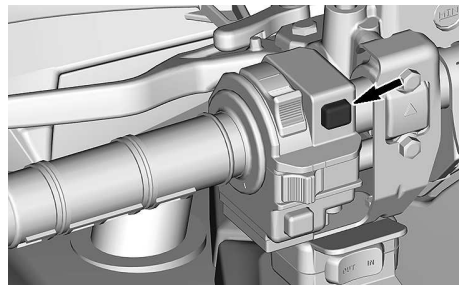

When depressed and held, it starts the engine.

Refer to *Starting the Engine* in the *Basic Procedures* section for complete starting procedure.

Override/DPS Button

This button is located at the bottom of the multifunction switch.

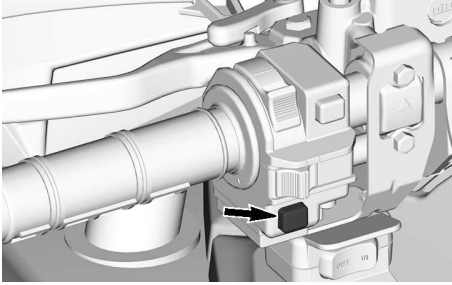

It has 2 functions.

- Activate the override function
- Change DPS modes.

Override Function

This function allows to bypass the engine speed limiter when the vehicle is used in reverse.

⚠ WARNING

Make sure the area around the vehicle is clear before using the override mode.

The override mode must be used only at low speed and when the vehicle is caught in mud or other soft terrain.

Do not use the override mode when driving normally in reverse, this would result in excessive speed,

To engage the override function, proceed as follows:

1. Ensure that the vehicle is completely stopped.
2. Press and hold the override/DPS button then press the throttle lever gradually.

NOTE:

When using the override function, the gauge will scroll an **OVERRIDE** message to confirm that the function is activated.

3. To disengage the override function, simply release the override/DPS button.

DPS Function

This button is also used to change the Dynamic Power Steering (DPS) mode.

For complete information on DPS modes, refer to *Tune Your Ride*.

Horn Button

Vehicle Sold in Finland Only

The horn button is located under the left multifunction switch.

Press on the horn button to activate the horn.

EQUIPMENT

Some equipment may not be available to your models or could be optional.

Operator's Seat

The seat is designed for an operator only.

WARNING

Never allow anyone to seat as a passenger on this vehicle.

Removing the Seat

1. Push its latch forward. This latch is located underneath the rear of seat.

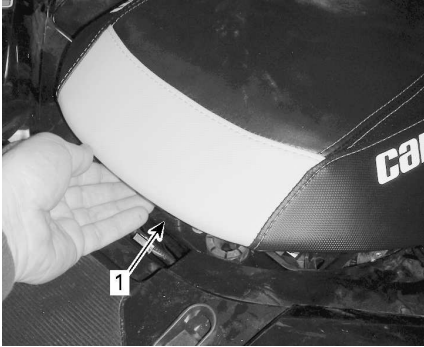

1. Seat latch

2. Pull seat rearward. Continue lifting movement until you can release the front retaining device under the seat from the retaining bar, then completely remove seat.

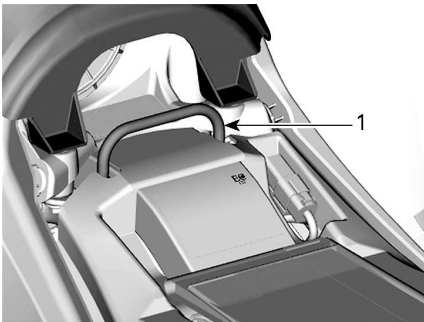

1. Retaining bar

Installing the Seat

1. Position front end of seat so that the front retaining device under the seat engages with the retaining bar.

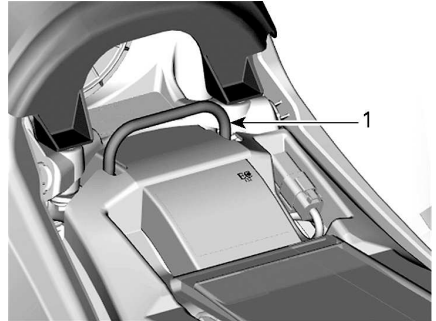

1. Retaining bar

2. When seat rests in its position, firmly push seat down to latch. A distinctive snap will be felt.
3. Double check that the seat is secure by giving it a tug to confirm proper latching.

WARNING

Ensure operator's seat is properly locked in position by pulling back and up several time. Even if a distinctive snap is heard during the installation, always pull it back and up to confirm proper latching.

Footpegs

The footpegs are located on the RH and LH footrests.



TYPICAL

1. RH footpeg

⚠ WARNING

Operator must have both feet on footpegs at all times during vehicle operation.

12-Volt Power Outlet

Convenient for handheld spotlight or other portable equipment.

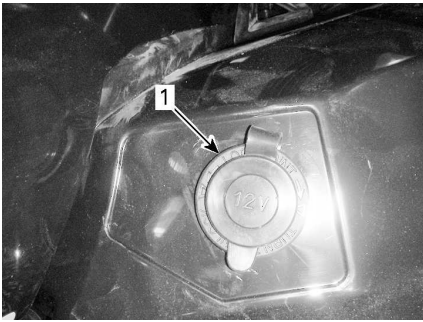

1. 12V power outlet

Remove protective cap to use. Always reinstall it after use to protect against weather.

Rear Cargo Area

Rear cargo area is convenient for carrying small articles.

Secure cargo using the eyelets.

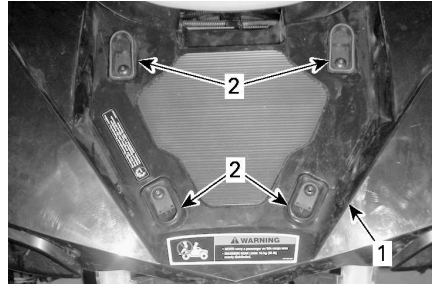

1. Cargo area
2. Plastic eyelets

⚠ WARNING

MAXIMUM load for cargo area is 16 kg (35 lb).

⚠ WARNING

- Never carry a passenger on the rear cargo area.
- Cargo must never interfere with the driver's line of sight or reduce his ability to steer the vehicle.
- Cargo must be secured and should not protrude the cargo area.

Tool Kit

The tool kit is located under seat. It contains tools for basic maintenance.

Console

Removing the Console

1. See procedures in this section and remove the seat.
2. Pull up the front of the console to release both front lugs.
3. Continue the lifting to release the both hooks.

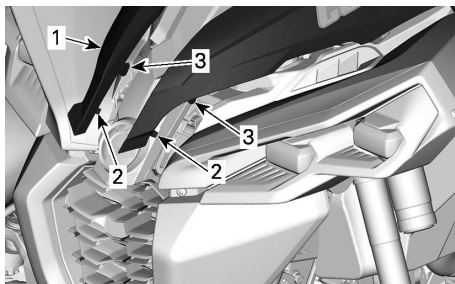

1. Console
2. Lugs
3. Hooks

4. Pull the rear of console up to release the lugs from the grommets.

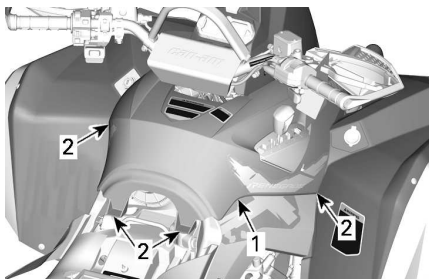

1. Rear of console
2. Lugs

5. Remove console by pulling it rearwards.

Installing the Console

Reverse the removal procedure.

Snorkel Cover

Removing the Snorkel Cover

1. Remove the seat.
2. Remove the console.
3. At front, remove the plastic rivets.

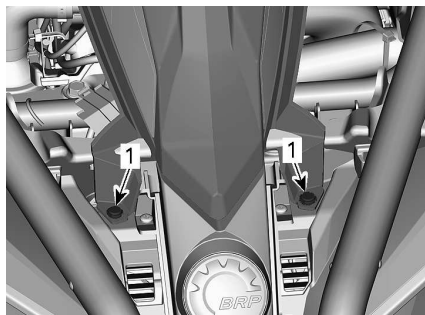

1. Plastic rivets

4. Pull the rear of snorkel cover up to release the lugs from the grommets.

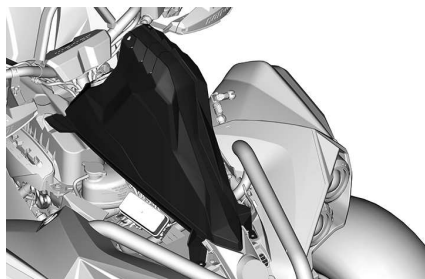

5. Disconnect the gauge connector.

Installing the Snorkel Cover

Reverse the removal procedure

Winch (If Equipped)

⚠ WARNING

To avoid severe injury or death or important components damages.

- Never use the winch cable/rope to retain a vehicle during trailering.
- Never ride with the winch cable/rope attached to a load or another vehicle.
- Only use the winch to help a stuck vehicle (snow, mud, etc.).
- Always refer to the winch manufacturer's instruction before pulling loads.

The winch can be actuated using the winch control switch or with the remote control (sold separately).

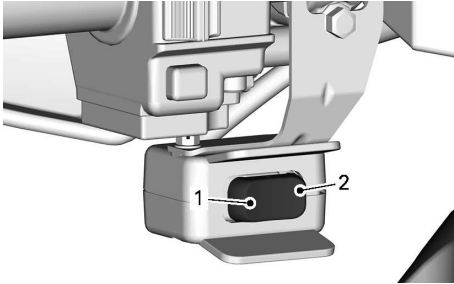

- 1. OUT
- 2. IN

A roller fairlead is used to prevent damages to the vehicle and guide the wire rope into the winch.

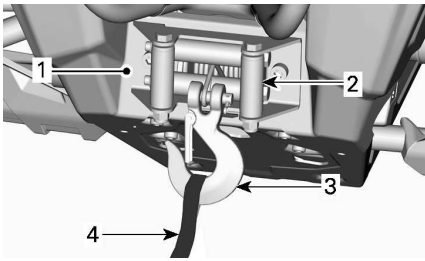

- 1. Winch
- 2. Roller fairlead
- 3. Winch hook
- 4. Hook strap

NOTE:

Using the winch intensively over a long period of time may discharge the battery.

The following tips will help to reduce the risk of discharging the battery:

Unwind manually: Unlock the cable using the handle then pull on the hook strap to unreel.

It is recommended to let the engine run while winching or rewinding. Do not stop the engine immediately after winching to let battery recharge.

Also, when winching for more than 30 seconds, it is recommended to increase engine RPM in the range of 3000 RPM to increase charging power to the battery.

NOTICE

Make sure vehicle is in NEUTRAL (N) before increasing engine RPM.

Refer to the winch manufacturer's instruction, supplied with the vehicle, for more information about the winch.

4.5" DIGITAL DISPLAY

Multifunction Display

Lower Display



May display the following:

- RPM
- Speed
- Engine Temperature
- Battery Voltage
- Settings
- Messages

Use LOWER (MENU) button to change the displayed information.

The SPEED display shows the Maximum and the averaged speed.

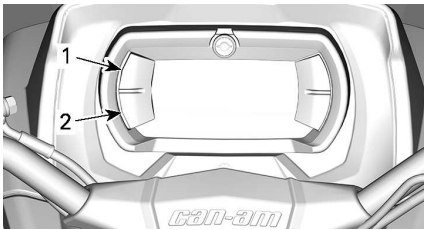

1. Upper button
2. Lower button

Left Lateral Display

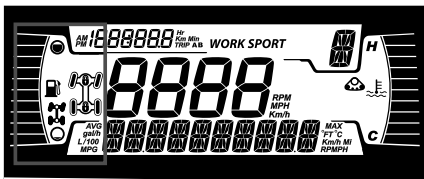

The left lateral display includes:

- Fuel level indicator
- 2X4 / 4X4 telltale

- Front differential lock - Visco-4Lok icon

Icon	Description
	2x4 icon
	4X4 icon
	Front differential lock - Visco-4Lok icon

Right Lateral Display

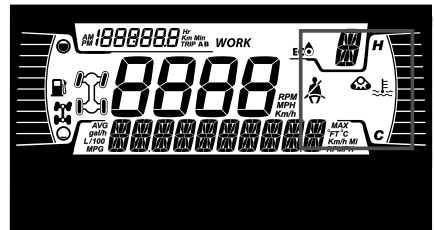

The right lateral display includes:

- Engine Temperature
- Track Kit active

When a track kit is installed, a message will scroll in the lower display.

Central Display

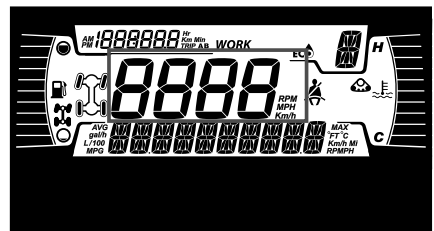

Display the vehicle speed in km/h or MPH.

Transmission Position Display

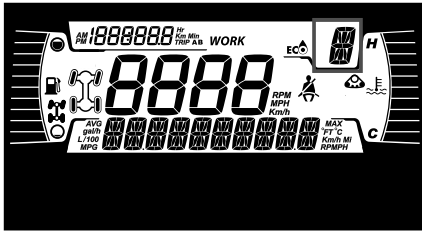

This display shows gear position of gearbox:

- P (Park)
- R (Reverse)
- N (Neutral)
- H (High Range)
- L (Low Range)
- - (Invalid Range)

MODE Display

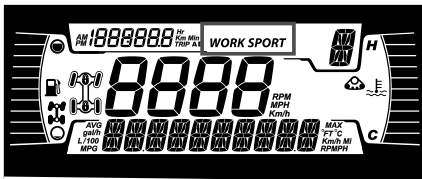

The MODE display indicates the selected mode of operation:

- SPORT
- ECO or WORK

Trip Display

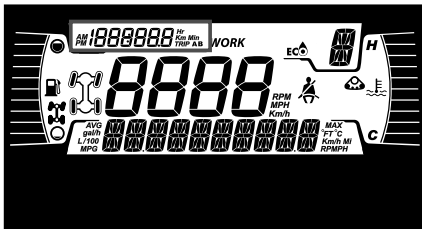

This display shows trip informations:

- Cumulative distance odometer
- Trip A
- Trip B

- Vehicle hour meter
- Clock

Use UPPER button to change the displayed information.



Hold UPPER button to reset Trip A/B meters.

Indicator Lamps



Warning and Telltale Lights



WARNING and Telltale Lights	
	ORANGE - Vehicle Malfunction
	BLUE - High Beam
	RED - The engine temperature is too high.
	GREEN - Neutral
	RED - Brake lock lever is engaged or malfunction of the brake system
	RED - The battery voltage too low or problem with the electrical system
	RED - Low oil pressure Normally ON when engine is OFF

WARNING and Telltale Lights	
	ORANGE - Low fuel level
	<p>ORANGE Turn on: Malfunction of the vehicle emissions control system Blink: Engine problems, the limp home mode is activated. Have the vehicle serviced immediately.</p>

Icons and Indicators - Multifunction Display

Icons and Indicators	
<i>SPORT</i>	– Denotes SPORT mode is selected.
<i>WORK</i>	– Denotes WORK mode is selected.
	<ul style="list-style-type: none"> – When lit, indicates that a maintenance is required. – See your authorized Can-Am Off-road dealer or person of your own choosing for the maintenance.
	– Track kit active (when installed).
	– Denote front differential lock - Visco-4Lok is activated. When this option is available.

Settings

The buttons to navigate through menus are located on the left side of the LCD display.

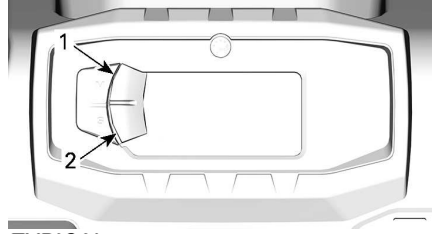

TYPICAL

1. Upper button
2. Lower button

Setup

Using LOWER button, select **SETTINGS** and hold to enter setting menu.

Speed Limiter Mode

If available

Speed limiter mode allows the operator to set the desired maximum speed.

This is useful when operating in limited speed zones.

The operator must keep the throttle depressed to maintain forward speed.

Once the maximum speed is set, the operator can vary the from stopped to the set speed using the throttle.

The set speed will be exceeded when the throttle is fully depressed, at that time, the speed limiter will be temporarily deactivated (the icon will be blinking) until vehicle speed is under or equal the speed limiter's set point.

As you proceed under a constant speed setting, keep your attention level up to maintain good situational awareness.

Slowing down is a matter of releasing the throttle.

Activating Speed Limiter Mode

1. Press the gauge switch to go to the SETTINGS menu.
2. Select SPEED LIM, then you will have a choice of:

Unit selection	Information displayed
Metric (km/h)	- -- (Unlimited) - From 30 km/h to 100 km/h by step of 10 km/h.
Imperial (MPH)	- -- (Unlimited) - From 20 MPH to 65 MPH by step of 5 MPH.

The speed limiter indicator  will turn on.

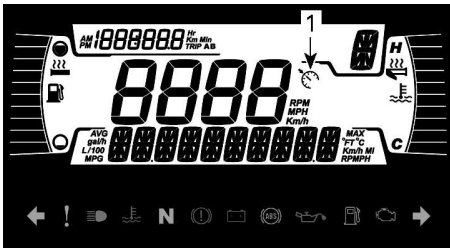

1. Speed limiter indicator
3. Hold menu button to confirm selected speed limit.

Activating speed limiter mode of operation only limits the maximum speed available when depressing the throttle.

The throttle must be held in to maintain forward speed.

Speed can be varied from idle up to the set speed using the throttle

once the speed limiter function is activated.

Deactivating Speed Limiter Mode

1. To deactivate speed limiter mode, in SETTINGS, select SPEED LIM and then select the - (unlimited) limit.

Maintenance Reset

To reset the maintenance message, refer to *Resetting the Message: Maintenance Required* in the *Maintenance Procedures* section.

NOTE: Available only when the maintenance is due (after every 100 engine hours).

Fault Codes

Available only when at least one code is activated.

Using LOWER button, select **CODES** and hold to see actives fault codes.

Fault codes will be scrolled on the Lower Display.

Reset Stats

Using LOWER button, select **RESET STAT** and hold to reset.

Unit Selection

This multifunction gauge is factory preset in Imperial units but it is possible to change it to Metric units.

Using LOWER button, select **UNITS** and hold button to change units.

Setting Clock

All of the following action must be performed using the LOWER button.

1. Select **CLOCK** and hold to adjust clock.
2. Press the button to select clock display.
3. Push and hold the button for 1 second.

4. Press the button to select 12:00 AM PM or 24:00 time base.
5. Push and hold the button to acknowledge selection.
6. Press the button to change hours (hours flash).
7. Push and hold the button to acknowledge hour selection.
8. Press the button to switch to minutes (minutes flash).
9. Push and hold the button to acknowledge minutes selection.

Setting Language

The gauge display language can be changed.

Refer to an authorized Can-Am Off-road dealer for language availability and to setup the gauge to your preference.

Setting Brightness

The brightness of the LCD display can be adjusted.

Using LOWER button, select **BRIGHTNESS** and hold button to change brightness.

Using LOWER button, adjust brightness then push and hold the button to acknowledge selection.

FUEL

While reading this Operator's Guide, remember that:

WARNING

Indicates a potential hazard which, if not avoided, could result in serious injury or death.

Fuel Requirements

NOTICE

Always use fresh gasoline. Gasoline will oxidize; the result is loss of octane, volatile compounds, and the production of gum and varnish deposits which can damage the fuel system.

Alcohol fuel blending varies by country and region. Your vehicle has been designed to operate using the recommended fuels, however, be aware of the following:

- Use of fuel containing alcohol above the percentage specified by government regulations is not recommended and can result in the following problems in the fuel system components:
 - Starting and operating difficulties.
 - Deterioration of rubber or plastic parts.
 - Corrosion of metal parts.
 - Damage to internal engine parts.
- Inspect frequently for the presence of fuel leaks or other fuel system abnormalities if you suspect the presence of alcohol in gasoline exceeds the current government regulations.
- Alcohol blended fuels attract and hold moisture which may lead to fuel phase separation and can result in engine performance problems or engine damage.

Recommended Fuel

The gasoline must have the following minimum octane requirements:

1000R Engines	Premium unleaded gasoline with an AKI (R+M)/2 octane rating of 91, or a RON octane rating of 95
All Other Engines	Common unleaded gasoline with an AKI (R+M)/2 octane rating of 87, or a RON octane rating of 91

Use unleaded gasoline containing **MAXIMUM 10%** ethanol.

E10

NOTICE

Never experiment with other fuels. Engine or fuel system damages may occur with the use of an inadequate fuel.

NOTICE

Do NOT use fuel from fuel pumps labeled E85.

Use of fuel labeled E15 is prohibited by U.S. EPA Regulations.

Vehicle Fueling Procedure

⚠ WARNING

- Fuel is flammable and explosive under certain conditions.
- Never use an open flame to check fuel level.
- Never smoke or allow flame or spark in vicinity.
- Always work in a well-ventilated area.
- Vehicle must be on a level surface to perform fueling.

1. Stop engine.

⚠ WARNING

Always stop engine before refueling.

2. Have operator get off vehicle.

⚠ WARNING

Do not allow anyone to remain in the vehicle while fueling. If there is a fire or explosion during fueling, a vehicle occupant could be unable to quickly leave the area.

3. Unscrew slowly the fuel reservoir cap counterclockwise to remove it.



1. Fuel reservoir cap

⚠ WARNING

If a differential pressure condition is noticed (whistling sound heard when loosening fuel reservoir cap) have vehicle inspected and/or repaired before further operation.

4. Insert the spout into the filler neck.
5. Pour fuel slowly so that air can escape from the tank and prevent fuel flow back. Be careful not to spill fuel.
6. Stop filling when the fuel reaches the bottom of filler neck. **Do not overfill.**

⚠ WARNING

Never top up the fuel tank before placing the vehicle in a warm area. As temperature increases, fuel expands and may overflow.

7. Fully tighten fuel reservoir cap clockwise.

⚠ WARNING

Always wipe off any fuel spillage from the vehicle.

BREAK-IN PERIOD

While reading this Operator's Guide, remember that:



WARNING

Indicates a potential hazard which, if not avoided, could result in serious injury or death.

Operation During Break-In

A break-in period of 10 operating hours or 300 km (200 mi) is required for the vehicle.

Engine

During the break-in period:

- Avoid full throttle operation.
- Avoid pressing the throttle lever more than 3/4 of the stroke.
- Avoid sustained accelerations.
- Avoid prolonged cruising speeds.
- Avoid engine overheating.

However, brief accelerations and speed variations contribute to a good break-in.

Brakes



WARNING

New brakes will not operate at their maximum efficiency until their break-in is completed. Braking performance may be reduced, so use extra caution.

Belt

A new belt requires a break in period of 50 km (30 mi).

During the break-in period:

- Avoid strong acceleration and deceleration.
- Avoid pulling a load.
- Avoid high speed cruising.

BASIC PROCEDURES

While reading this Operator's Guide, remember that:



WARNING

Indicates a potential hazard which, if not avoided, could result in serious injury or death.

Waking Up the Electrical System

Press and release the START button for less than half a second and the electrical system will turn ON:

- For 30 seconds, **without** powering any equipment:
 - With the D.E.S.S. key not installed or ignition key in the OFF position, **OR**
 - With the Engine Stop switch sets to the STOP position
- For 10 minutes, powering equipment:
 - With the D.E.S.S. key installed or the ignition key in the ON position, **AND**
 - With the Engine Stop switch sets to the RUN position.

The electrical system will be shut-down after 30 seconds if either the D.E.S.S. key or the ignition key is removed **OR** the Engine Stop switch is set to the STOP position.

NOTICE

Waking up the electrical system repeatedly or using electrical equipment will discharge the battery and you may not be able to start the engine.

Starting the Engine

The shift lever must be set to PARK or NEUTRAL.

NOTE:

For your convenience, an override mode allows the engine to be started with the shift lever in any position. Press and hold the brake lever or the brake pedal while pressing the engine start button.

Ensure D.E.S.S. key is installed on D. E.S.S. post.

Set the engine stop switch to RUN.

Press the engine start button and hold until the engine starts.

Release the engine start button immediately when the engine has started.

NOTICE

If engine does not start after a few seconds, do not hold the start position more than 10 seconds. Refer to *Troubleshooting*.

Stopping the Engine



WARNING

Avoid stopping the vehicle:

- On steep slope as the vehicle may roll away.
- In an area where hot parts of the vehicle can start a fire.



WARNING

Always apply the parking brake when stopping the vehicle.

1. Select the flattest terrain available.
2. Stop the vehicle completely.
3. Apply the parking brake.

4. Use the vehicle engine stop switch to stop the vehicle.
5. Depending your vehicle:
 - Remove the D.E.S.S. key from the D.E.S.S. post, or
 - Place ignition key to the OFF position then remove it from the ignition switch..
6. When parking on a steep incline or if the vehicle is carrying cargo, block the wheels using wheel chocks. If not available use rocks or bricks.

At the opposite, when the throttle lever is released, the engine speed decreases.

Applying the Parking Brake

Application of the parking brake is the combination of the 2 following actions.

1. After stopping completely the vehicle, move the shifter lever to the PARK position, AND...
2. Engage the brake lock lever, refer to *Brake Lock Lever* in *Primary Controls*.

NOTE:

When parking on a steep incline or if the vehicle is carrying cargo, block the wheels using wheel chocks. If not available use rocks or bricks.

Changing Gear Selection

Apply brakes and immobilize vehicle, then select the desired shift lever position.

Release brakes.

NOTICE

When changing gear selection, always completely stop the vehicle and apply the brakes prior to shifting. Damage to the gearbox may occur.

Gradually press the throttle lever to increase engine speed and thus engaging the continuously variable transmission (CVT).

SPECIAL PROCEDURES

Fuel Flooded Engine

If the engine does not start and it is fuel-flooded, this special mode can be activated to prevent fuel injection and to cut ignition while cranking. Proceed as follows:

1. Move shift lever in park position.
2. Install key on D.E.S.S. post or turn the ignition key in ON position.
3. Press completely and HOLD throttle lever.
4. Press the engine START button for 20 seconds.
5. Release throttle lever.
6. Press the START button again to allow starting.

If the engine does not start:

1. Unplug injector electrical connector
2. Clean the spark plug caps area then remove them.
3. Remove the spark plugs.
4. Crank engine several times.
5. Install new spark plugs if possible or clean and dry spark plugs.
6. Start engine as explained above.

If engine continues to flood, see an authorized Can-Am Off-road dealer.

NOTICE

Verify that there is no fuel in engine oil. If so, replace engine oil.

Water into the CVT

The CVT drain plug is located on the rear portion of the CVT cover. It is accessible from the rear LH fender.

Inspect the CVT drain plug to validate if water is present.

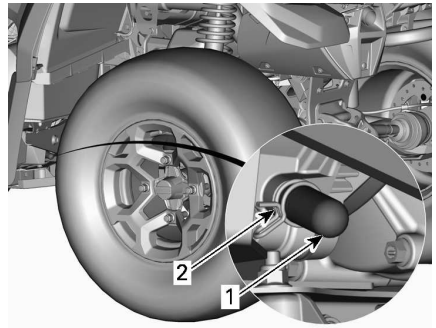

1. drain plug
2. Spring clamp

NOTICE

If water is present in the CVT, it could result in belt slippage. The engine will accelerate but the vehicle will remain still.

If water is present, remove CVT drain plug to expel water.

Reinstall the drain plug and secure it using the spring plug.

NOTE:

Make sure hose is properly inserted on CVT cover nipple.

NOTICE

See an authorized Can-Am Off-road dealer to have the CVT inspected and cleaned.

Water Into the Air Filter Housing

Remove the LH side panel.

Inspect the drain reservoir underneath the air filter housing to validate if water is present.

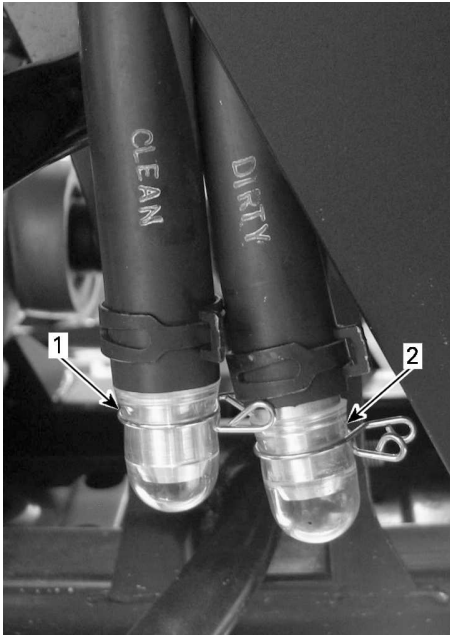

1. Clean air filter housing drain reservoir
2. Dirty air filter housing drain reservoir

If water is present, press clamp and remove reservoir to drain water from air filter housing.

If one of the following conditions is met, bring the vehicle to your nearest authorized Can-Am Off-road dealer to have the vehicle serviced:

- If more than 50 ml (2 fl oz (US)) of water (approximately 5 drain reservoirs) is found in the air filter housing.
- If any deposits are present in the drain reservoir.

In such a case, the vehicle must be serviced for:

- Vents
- CVT air filter cleaning
- CVT cleaning
- Fuel tank breather replacement
- Lubricant inspection and replacement as required (engine, gearbox and rear final drive).

NOTICE

Failure to have vehicle serviced may lead to permanent damage to the following components but not limited to:

- Engine and gearbox
- Fuel pump
- CVT
- Front differential
- Rear final drive.

Vehicle is Turned Over

When vehicle is turned over or stays tilted on the side, put the vehicle back on its wheel.

Inspect vehicle for damages.

⚠ WARNING

Never operate the vehicle if damaged.
Refer to an authorized Can-Am Off-road dealer.

If vehicle has no damage, refer to *Maintenance Procedures* and inspect the following.

- Inspect air filter housing for oil accumulation, if any oil is found, clean air filter and air filter housing.
- Check engine oil level and refill if necessary.
- Check engine coolant level and refill if necessary.
- Check gearbox oil level and refill if necessary.
- Check rear final drive oil level and refill if necessary.
- Start engine. If the oil pressure light stays on, stop engine immediately. See an authorized Can-Am Off-road dealer.

Whenever the vehicle is turned over, it should be inspected by an authorized Can-Am Off-road dealer.

Vehicle is Immersed in Water

Should the vehicle become immersed, immediately stop the engine. Do not use:

- Any electrical equipments
- Winch (if equipped)

It will be necessary to take the vehicle to an authorized Can-Am Off-road dealer as soon as possible. **NEVER ATTEMPT TO START THE ENGINE!**

NOTICE

Immersion of the vehicle can cause serious damage if the correct restart procedure is not followed.

As soon as vehicle is pulled out of water, carry out the following:

- Drain air filter housing, refer to *Water Into the Air Filter Housing*.
- Drain CVT, refer to *Water Into the CVT*.

NOTICE

The vehicle should be serviced as soon as possible by an authorized Can-Am Off-road dealer.

TUNE YOUR RIDE

While reading this Operator's Guide, remember that:

WARNING

Indicates a potential hazard which, if not avoided, could result in serious injury or death.

WARNING

Suspension adjustment could affect vehicle handling. Always take time to familiarize yourself with the vehicle's behavior after any suspension adjustment has been made.

Following are guidelines to fine-tune suspension.

Use suspension adjustment tool provided in the tool kit.

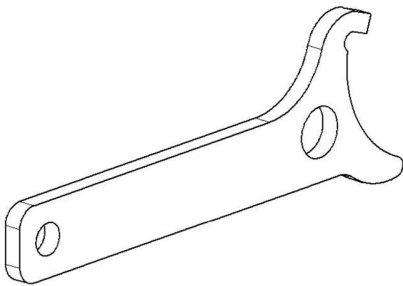

Suspension Adjustments

Suspension adjustment and loading can have an effect on your vehicle handling and comfort.

Choice of suspension adjustments vary with driver's weight, personal preference, riding speed and field condition.

Perform adjustments one position (click) at a time. Test run the vehicle under the same conditions; trail, speed, driver riding position, etc. Proceed methodically until you are satisfied.

Factory settings are suitable for almost all conditions. Take into consideration that an increase in ground clearance can affect the handling of the vehicle.

Front Suspension Factory Preload Settings

Model	Factory Setting
650	49 mm (1.9 in)
1000R	63 mm (2.5 in)

Rear Suspension Factory Preload Settings

Model	Factory setting
650	107 mm (4.2 in)
1000R	85 mm (3.34 in)

Spring Preload Adjustment

WARNING

The left and right shock adjustment on front or rear suspension must always be set to the same position. Never adjust one shock only. Uneven adjustment can cause poor handling and loss of stability, which could lead to an accident.

Shorten the springs for a firmer ride and rough conditions.

Lengthen the springs for a softer ride and smooth conditions.

Adjust spring preload by turning the adjuster ring.

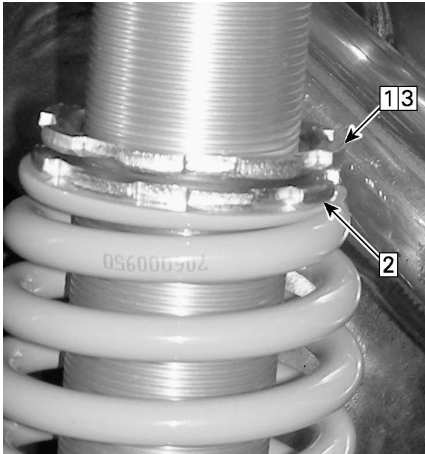

TYPICAL – SHOCK WITH THREADED ADJUSTMENT

1. Loosen top locking ring
2. Turn adjusting ring accordingly
3. Tighten top locking ring

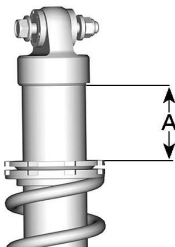

A = SPRING PRELOAD DISTANCE

**Shock Damping Adjustments
1000R Models only**

Compression damping controls how the shock absorber reacts when riding.

Turn adjuster clockwise to **increase** shock damping action (stiffer).

Turn adjuster counterclockwise to **decrease** shock damping action (softer).

⚠ WARNING

Make sure compression damping setting is the same on both sides.

Position	Setting	Result on big bumps
1	Soft	Softer compression damping
2	Medium (Factory)	Medium compression damping
3	Hard	Firmer compression damping

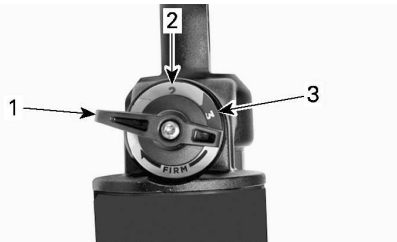

1. Position 1
2. Position 2
3. Position 3

Dynamic Power Steering (DPS) Assist Level Adjustment (Models with DPS)

The DPS mode cannot be changed if the transmission lever is set to REVERSE.

The tri-mode Dynamic Power Steering (DPS) offers easy steering assistance to the rider. The level of assistance will automatically adapt according to the vehicle's speed and rider's demand, in order to provide maximum steering power at lower speed where

the demand is normally higher. As speed increases, the assistance is progressively reduced to keep maximum steering feel and precision to the rider.

It is possible to choose between three modes of assistance: Minimum, Medium and Maximum. Each mode will continue to automatically adapt to the vehicle's speed and rider's demand, so it does not require to be changed when riding. These modes are used to set the level of assistance to match each rider's preferences.

The following DPS modes are preset in the vehicle.

DPS MODE	
DPS MAX.	Maximum steering assist
DPS MED.	Medium steering assist
DPS MIN.	Minimum steering assist

Models Equipped with a Visco-4Lock Front Differential

When the 4WDLock mode is selected, a special setting is automatically selected to give an optimal assist.

It is not possible to change the DPS setting while the 4WDLock mode is selected.

To change the DPS mode using the multifunction switch, the engine must be running. Wake up the electrical system is not enough to do this procedure.

To see which DPS mode is activated.

- Do a short press (1 second) on the DPS button.

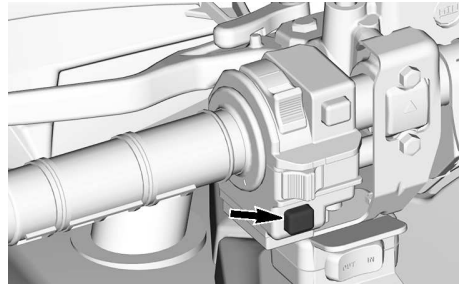

- Repress on the same button to return to previous screen.

To change the DPS mode.

- Do a short press (1 second) on the DPS button to see which DPS mode is activated.
- Do a long press (2 seconds) on the DPS button to select another mode. Repeat until the desired mode is activated.

NOTE: It is also possible to change the DPS mode by doing a long press on either the LOWER button of the cluster or on the TRIP/MENU switch (depending your model). To do this, the engine does not need to be running, but the electrical system must be awake.

TRANSPORTING THE VEHICLE

When contacting a towing or transporting service, be sure to ask if they have a flatbed trailer, loading ramp or power ramp to safely lift the vehicle and tie-down straps. Ensure the vehicle is properly transported as specified in this section.

NOTICE

Do not tow this vehicle — towing can seriously damage the vehicle's drive system.

NOTICE

Avoid using chains to tie the vehicle — they may damage the surface finish or plastic components.

WARNING

To avoid severe injury or death or important components damages.

- **Never use the winch cable/rope to retain a vehicle during trailering.**
- **Never ride with the winch cable/rope attached to a load or another vehicle.**
- **Only use the winch to help a stuck vehicle (snow, mud, etc.).**
- **Always refer to the winch manufacturer's instruction before pulling loads.**

WARNING

Make sure all seats, accessories, cargo and loose objects inside the vehicle are properly secured, or remove it to prevent from failing on the road and creating a hazard for following vehicles.

WARNING

Always transport the vehicle facing forward to avoid damaging the windshield or other components. Parts may detach during transport.

WARNING

Before attempting to mount vehicle onto a platform or a trailer, make sure to respect the following safety precautions.

SAFETY PRECAUTIONS

Carrying equipment	The carrying item (platform or trailer or flat bed) must be of appropriate dimensions and capacity to safely support and transport the vehicle.
Hauling vehicle	Do not exceed vehicle hauling capacity and specifications. Ensure the trailer or platform is properly secured to the hauling vehicle hitch.
Visibility	Ensure you have a good visibility during the entire maneuver.

SAFETY PRECAUTIONS

Terrain	The hauling vehicle and trailer must be on a leveled surface. Use wheel chocks on trailer and hauling vehicle to avoid any movement.
Ramps	Use ramps with proper rating and secure ramps to the trailer or platform. Avoid steep ramps.
Bystanders	Always make sure bystanders are not close to the vehicle or the trailering equipment while climbing up.
Seat and Accessories	Make sure all seats, accessories and cargo are properly secured, or remove it to prevent from falling on the road and creating a hazard for following vehicles.

Using Vehicle Power to Climb Onto Trailering Equipment

When vehicle can climb on its own power, proceed as follows;

1. Wear protective gear.
2. Use low gear only (if equipped).
3. When driving remain seated at all times.
4. Ensure proper alignment on rails or platform.
5. Start from a sufficient distance from the trailer to align the vehicle in a straight line with the ramps. Never attempt to turn while getting closer to the ramp. Rear wheels might not be aligned once you get to the ramp and vehicle may fall off.
6. Slowly climb the front wheels onto the ramp to verify alignment.
7. Back off the vehicle, verify ramps are still secure, then proceed at proper speed.
8. Carefully drive vehicle onto platform or trailer. Use sufficient speed to climb without spinning or abruptly accelerating. Avoid acceleration while on ramps to prevent ramps movement.
9. If trailer is inclined towards front, simply let vehicle roll in without acceleration.

10. Once vehicle is climbed, put shift lever to Park. Apply brake locking mechanism (if equipped).

When vehicle cannot move on its own power, or in case overshooting is a risk or if any dangerous condition prevents for embarking on its own power, proceed using a winch;

Using a Winch to Pull Vehicle Onto Trailering Equipment

When vehicle cannot climb on its own power, proceed as follows;

 WARNING

Have the help of an assistant. One person should be in vehicle to have access to vehicle steering, brakes and winch switch, while the other person controls the environment and safety of the maneuver.

 WARNING

Ensure the winch hook can be safely attached to a proper anchoring point. Use proper rigging.

NOTE:

If vehicle can be started safely, let engine idle during winching to avoid draining the battery.

1. Place shift lever to NEUTRAL (N).
2. If the vehicle is equipped with a winch, use the winch to roll the vehicle on the platform.
3. If the vehicle is not equipped with a winch, proceed as follows:
 1. Attach strap to lower front bumper anchor.
 2. Attach the strap to the winch cable of the towing vehicle.
 3. Pull the vehicle on the flatbed trailer with the winch.
4. Put shift lever to Park. Apply brake locking mechanism (if equipped).

Securing Vehicle for Transport

When transporting this vehicle, secure it to a trailer or in pickup box with suitable tie-downs. Use of ordinary ropes is not recommended.

⚠ WARNING

To avoid severe injury or death or important components damages.

- Never use the winch cable/rope to retain a vehicle during trailering.
- Never ride with the winch cable/rope attached to a load or another vehicle.
- Only use the winch to help a stuck vehicle (snow, mud, etc.).
- Always refer to the winch manufacturer's instruction before pulling loads.

⚠ WARNING

Do not tow this vehicle behind a car or other vehicle. Use a trailer. Never tip this vehicle on end for transporting. The vehicle must be in its normal operating position (on all wheels).

Remember to:

- Unload vehicle racks before transportation.
- Set shift lever to PARK position.
- Set the parking brake.
- Secure the vehicle by the front and rear tie-down points.

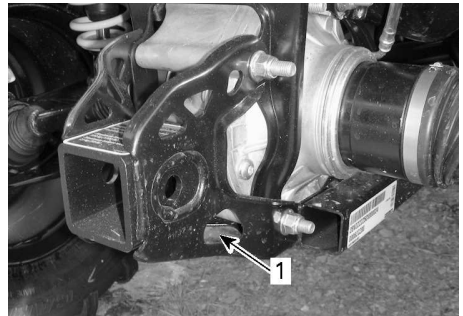
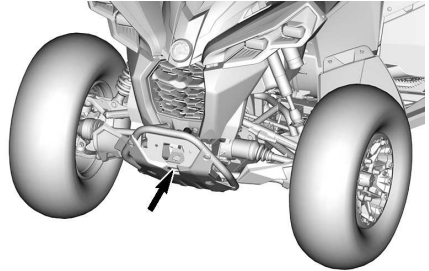

1. Rear tie-down point location

NOTICE

Securing vehicle at other locations may damage the vehicle.

Getting Vehicle Out of Trailer

 **WARNING**

Vehicle may have moved during transport. Ensure vehicle is properly aligned with ramps before proceeding.

 **WARNING**

Visibility will be greatly reduced when backing off from the trailer. Have the help of an assistant to ensure proper alignment and safe environment.

MAINTENANCE

MAINTENANCE SCHEDULE

Maintenance is very important for keeping your vehicle in safe operating condition. The vehicle should be serviced as per the maintenance schedule.

Proper maintenance is the owner's responsibility. A warranty claim may be denied if, among other things, the owner or operator caused the problem through improper maintenance or use.

Perform periodic checks and follow the maintenance schedule. **The maintenance schedule does not exempt the pre-ride inspection.**

Verifying fault codes, as first maintenance step, is a good practice and is highly recommended.

WARNING

Failure to properly maintain the vehicle according to the maintenance schedule and procedures can make it unsafe to operate.

EPA Regulation - Canadian and USA Vehicles

A repair shop or person of the owner's choosing may maintain, replace, or repair emission control devices and systems. These instructions do not require components or service by BRP or authorized Can-Am Off-road dealers.

Although an authorized Can-Am Off-road dealer has an in-depth technical knowledge and tools to service your vehicle, the emission-related warranty is not conditioned on the use of an authorized Can-Am Offroad dealer or any other establishment with which BRP has a commercial relationship.

Proper maintenance is the owner's responsibility. A warranty claim may be denied if, among other things, the owner or operator caused the problem through improper maintenance or use.

For emission-related warranty claims, BRP is limiting the diagnosis and repair of emission-related parts to the authorized Can-Am Offroad dealers. For more information, please refer to the *US EPA Emission-Related Warranty* contained in the *Warranty* section.

You must follow the instructions for fuel requirements in the fueling section of this manual. Even if gasoline containing greater than ten volume percent ethanol is readily available, the US EPA issued a prohibition against the use of gasoline containing greater than 10 vol% ethanol that applies to this vehicle. The use of gasoline containing greater than 10 vol% ethanol with this engine may harm the emission control system.

Post Operation Care After Each Use in an Extreme Environment

- Rinse the entire vehicle with fresh water.
- Clean the CVT air filter(s).
- Drain the CVT cover. Remove the cover and clean if water or mud is found.
- Inspect the engine air filter. Clean the engine air filter housing if water or mud is found.

- Visually check if any water is present into the vent hose of the gearbox, the front differential and the rear final drive. Bring the vehicle to your authorized Can-Am Off-road dealer for inspection and servicing if water is found.
- Clean shock absorber to prevent damage from dust or dirt.
- Clean the drive shaft bellows.

Severe Dusty Conditions

Air Filter Maintenance Guideline

Air filter maintenance should be adjusted according to riding conditions.

Air filter maintenance must be increased in frequency in the following dusty conditions:

- Riding on dry sand
- Riding on dry dirt covered surfaces
- Riding on snow covered surfaces
- Riding on dry gravel roads or similar conditions.

Riding in a group under these conditions increases the frequency of the air filter maintenance.

NOTE:

An accessory pre-filter should be used to avoid snow accumulation when the vehicle is used in such conditions. Contact an authorized Can-Am dealer for details.

Maintenance Schedule

Make sure to perform proper maintenance at recommended intervals as indicated in the tables.

The maintenance chart intervals are based on 3 factors:

- Calendar time
- Vehicle hours
- Odometer reading.

Take in account whichever comes first to determine the maintenance threshold.

Your driving habits determines the factors you shall adhere too. For example:

- Someone who uses their vehicle every other weekend trail riding with friends would most likely follow the **odometer reading** to determine the maintenance interval.
- Someone who uses their vehicle seldomly over the year or only on a few occasions (hunting, camping) would most likely follow the **calendar time** to determine the maintenance interval.
- Someone who uses their vehicle daily / weekly for long periods of time such as agricultural / work would most likely follow the **vehicle hours** to determine the maintenance interval.

IMPORTANT: The following tables show the appropriate maintenance application for the first 3 years. For subsequent years, repeat the same pattern alternatively.

Regular Maintenance Overview

Calendar Years	Vehicle Hours	Odometer	Regular Duty
1	100	3000 km (2000 mi)	A
2	200	6000 km (4000 mi)	A and B
3	300	9000 km (5500 mi)	A

Severe Duty and Mud/Water Maintenance Overview

Calendar Years	Vehicle Hours	Odometer	Severe Duty and Deep Mud / Water
0.5	50	1500 km (1000 mi)	A+
1	100	3000 km (2000 mi)	A+ and A
1.5	150	4500 km (3000 mi)	A+
2	200	6000 km (4000 mi)	A+ and A and B
2.5	250	7500 km (5700 mi)	A+
3	300	9000 km (5500 mi)	A+ and A

REGULAR DUTY	A	B
A = Adjust C = Clean I = Inspect L = Lubricate R = Replace T = Torque	Every year or 100 hours or 3000 km (2000 mi)	Every 2 years or 200 hours or 6000 km (4000 mi)
Air and Fuel Delivery		
Engine air filter	C, L or R	
Air delivery components and function (filters, throttle body, ducts, clamps)*	I, C	
Fuel components and function*	I	
Fuel pump pressure		I
Engine and Cooling		
Engine oil and filter	R	
Engine seals and gaskets	I	
Spark plugs		R Every 200 hours or 6000 km (4000 mi)
Valve clearance	I, A Every 100 hours or 3000 km (2000 mi)	
Engine cooling components (coolant concentration, coolant level, hose condition, clamps, leaks)*	I, A	
Coolant	R Every 5 years or 12 000 km (8000 mi)	
Radiator	C	
Exhaust and Emissions		
Fuel tank vent breather filter (Non-EVAP models)	R	
Canister vent pre-filter (CARB and EVAP models)		R
Debris around exhaust pipe and muffler area	C	
Muffler spark arrester	C	
Brake		
Brake components and function*	I, L	
Brake fluid		R Every 2 years

REGULAR DUTY	A	B
A = Adjust C = Clean I = Inspect L = Lubricate R = Replace T = Torque	Every year or 100 hours or 3000 km (2000 mi)	Every 2 years or 200 hours or 6000 km (4000 mi)
Drive		
Drive components and function*	I, L	
Gearbox oil	R Replace at first 3000 km (2000 mi) and at 6000 km (4000 mi), then follow the regular schedule	R
Gearbox oil level	I	
Front differential oil	I	R
Rear final drive oil	I	R
Tires	I, A	
Wheel beadlock bolts	T	
Wheel lug nuts	T	
Continuously Variable Transmission (CVT)		
CVT components and function*	I, C, L	
Electrical		
Battery connections and condition	I	
Electrical harness routing	I	
Modules and applicable software updates	I	
Operation of control switches and lighting	I	
Vehicle speed sensor	C Clean at first 3000 km (2000 mi) and at 6000 km (4000 mi), then follow the regular schedule	C
Steering		
Steering components and function*	I	
Steering column half bushings		C, L
Controls		
Gearbox position lever operation	I, A	

REGULAR DUTY	A	B
A = Adjust C = Clean I = Inspect L = Lubricate R = Replace T = Torque	Every year or 100 hours or 3000 km (2000 mi)	Every 2 years or 200 hours or 6000 km (4000 mi)
Throttle cable (If equipped)	I, A, L	
Throttle operation	I	
Suspension		
Suspension components and function*	I, L	

*For an extensive list of maintenance actions to be performed, refer to your local dealership.

SEVERE DUTY	A+	A	B
A = Adjust C = Clean I = Inspect L = Lubricate R = Replace T = Torque	Every 6 months or 50 hours or 1500 km (1000 mi)	Every year or 100 hours or 3000 km (2000 mi)	Every 2 years or 200 hours or 6000 km (4000 mi)
Air and Fuel Delivery			
Engine air filter	C, L or R		
Air delivery components and function (filters, throttle body, ducts, clamps)*	I, C		
Fuel components and function*		I	
Fuel pump pressure			I
Engine and Cooling			
Engine oil and filter	R		
Engine seals and gaskets		I	
Spark plugs			R Every 200 hours or 6000 km (4000 mi)
Valve clearance		I, A Every 100 hours or 3000 km (2000 mi)	
Engine cooling components (coolant concentration, coolant level, hose condition, clamps, leaks)*		I, A	
Coolant	R Every 5 years or 12 000 km (8000 mi)		
Radiator		C	
Exhaust and Emissions			
Fuel tank vent breather filter (Non-EVAP models)		R	
Canister vent pre-filter (CARB and EVAP models)			R
Debris around exhaust pipe and muffler area	C		
Muffler spark arrester	C		
Brake			
Brake components and function*	I	I, L	

SEVERE DUTY	A+	A	B
A = Adjust C = Clean I = Inspect L = Lubricate R = Replace T = Torque	Every 6 months or 50 hours or 1500 km (1000 mi)	Every year or 100 hours or 3000 km (2000 mi)	Every 2 years or 200 hours or 6000 km (4000 mi)
Brake fluid			R Every 2 years
Drive			
Drive components and function*	I, L		
Gearbox oil	R Replace at first 1500 km (1000 mi) and at 3000 km (2000 mi), then follow the regular schedule	R	
Gearbox oil level	I		
Front differential oil	I	R	
Rear final drive oil	I	R	
Tires	I, A	I, A	
Wheel beadlock bolts		T	
Wheel lug nuts	T		
Continuously Variable Transmission (CVT)			
CVT components and function*		I, C, L	
Electrical			
Battery connections and condition		I	
Electrical harness routing		I	
Modules and applicable software updates		I	
Operation of control switches and lighting		I	
Vehicle speed sensor		C Clean at first 3000 km (2000 mi) and at 6000 km (4000 mi), then follow the regular schedule	C

SEVERE DUTY	A+	A	B
A = Adjust C = Clean I = Inspect L = Lubricate R = Replace T = Torque	Every 6 months or 50 hours or 1500 km (1000 mi)	Every year or 100 hours or 3000 km (2000 mi)	Every 2 years or 200 hours or 6000 km (4000 mi)
Steering			
Steering column half bushings			C, L
Steering components and function*		I	
Controls			
Gearbox position lever operation		I, A	
Throttle cable (If equipped)		I, A, L	
Throttle operation		I	
Suspension			
Suspension components and function*	I, L		

*For an extensive list of maintenance actions to be performed, refer to your local dealership.

DEEP MUD / WATER	A+	A	B
A = Adjust C = Clean I = Inspect L = Lubricate R = Replace T = Torque	Every 6 months or 50 hours or 1500 km (1000 mi)	Every year or 100 hours or 3000 km (2000 mi)	Every 2 years or 200 hours or 6000 km (4000 mi)
Air and Fuel Delivery			
Engine air filter	C, L or R		
Air delivery components and function (filters, throttle body, ducts, clamps)*	I, C		
Fuel components and function*		I	
Fuel pump pressure			I
Engine and Cooling			
Engine oil and filter		R	
Engine oil level	I		
Engine seals and gaskets		I	
Spark plugs			R Every 200 hours or 6000 km (4000 mi)
Valve clearance		I, A Every 100 hours or 3000 km (2000 mi)	
Engine cooling components (coolant concentration, coolant level, hose condition, clamps, leaks)*		I, A	I
Coolant	R Every 5 years or 12 000 km (8000 mi)		
Radiator	C		
Exhaust and Emissions			
Fuel tank vent breather filter (Non-EVAP models)		R	
Canister vent pre-filter (CARB and EVAP models)			R
Debris around exhaust pipe and muffler area	C		
Muffler spark arrester	C		
Brake			

DEEP MUD / WATER	A+	A	B
A = Adjust C = Clean I = Inspect L = Lubricate R = Replace T = Torque	Every 6 months or 50 hours or 1500 km (1000 mi)	Every year or 100 hours or 3000 km (2000 mi)	Every 2 years or 200 hours or 6000 km (4000 mi)
Brake components and function*	I	I, L	
Brake fluid			R Every 2 years
Drive			
Drive components and function*	I, L		
Gearbox oil		R Replace at first 3000 km (2000 mi) and at 6000 km (4000 mi), then follow the regular schedule	R
Gearbox oil level	I		
Front differential oil	I		R
Rear final drive oil	I		R
Tires	I, A		
Wheel beadlock bolts		T	
Wheel lug nuts	T		
Continuously Variable Transmission (CVT)			
CVT components and function*		I, C, L	
Electrical			
Battery connections and condition		I	
Electrical harness routing		I	
Modules and applicable software updates		I	
Operation of control switches and lighting		I	
Vehicle speed sensor		C Clean at first 3000 km (2000 mi) and at 6000 km (4000 mi), then follow	C

DEEP MUD / WATER	A+	A	B
A = Adjust C = Clean I = Inspect L = Lubricate R = Replace T = Torque	Every 6 months or 50 hours or 1500 km (1000 mi)	Every year or 100 hours or 3000 km (2000 mi)	Every 2 years or 200 hours or 6000 km (4000 mi)
		the regular schedule	
Steering			
Steering column half bushings			C, L
Steering components and function*	I		
Controls			
Gearbox position lever operation		I, A	
Throttle cable (If equipped)		I, A, L	
Throttle operation	I		
Suspension			
Suspension components and function*	I, L		

*For an extensive list of maintenance actions to be performed, refer to your local dealership.

Maintenance Records

Send photocopy of maintenance record to BRP if needed.

Pre-delivery	
Serial number: _____ Mileage / km: _____ Hours: _____ Date: _____ Dealer no: _____ Notes: _____ _____	Signature/Print:
Refer to vehicle Pre-Delivery Bulletin for detailed installation procedures	

FIRST inspection	
Mileage / km: _____ Hours: _____ Date: _____ Dealer no: _____ Notes: _____ _____	Signature/Print:
For maintenance schedule refer to Maintenance Information section of this operator's guide	

Service	
Mileage / km: _____ Hours: _____ Date: _____ Dealer no: _____ Notes: _____ _____	Signature/Print:
For maintenance schedule refer to Maintenance Information section of this operator's guide	

Service	
Mileage / km: _____ Hours: _____ Date: _____ Dealer no: _____ Notes: _____ _____	Signature/Print: _____
For maintenance schedule refer to Maintenance Information section of this operator's guide	

Service	
Mileage / km: _____ Hours: _____ Date: _____ Dealer no: _____ Notes: _____ _____	Signature/Print: _____
For maintenance schedule refer to Maintenance Information section of this operator's guide	

Service	
Mileage / km: _____ Hours: _____ Date: _____ Dealer no: _____ Notes: _____ _____	Signature/Print: _____
For maintenance schedule refer to Maintenance Information section of this operator's guide	

Service

Mileage / km:

Hours:

Date:

Dealer no:

Notes:

Signature/Print:

For maintenance schedule refer to Maintenance Information section of this operator's guide

Service

Mileage / km:

Hours:

Date:

Dealer no:

Notes:

Signature/Print:

For maintenance schedule refer to Maintenance Information section of this operator's guide

Service

Mileage / km:

Hours:

Date:

Dealer no:

Notes:

Signature/Print:

For maintenance schedule refer to Maintenance Information section of this operator's guide

Service	
Mileage / km: _____ Hours: _____ Date: _____ Dealer no: _____ Notes: _____ _____	Signature/Print: _____ _____
For maintenance schedule refer to Maintenance Information section of this operator's guide	

Service	
Mileage / km: _____ Hours: _____ Date: _____ Dealer no: _____ Notes: _____ _____	Signature/Print: _____ _____
For maintenance schedule refer to Maintenance Information section of this operator's guide	

Service	
Mileage / km: _____ Hours: _____ Date: _____ Dealer no: _____ Notes: _____ _____	Signature/Print: _____ _____
For maintenance schedule refer to Maintenance Information section of this operator's guide	

Service

Mileage / km:

Hours:

Date:

Dealer no:

Notes:

Signature/Print:

For maintenance schedule refer to Maintenance Information section of this operator's guide

Service

Mileage / km:

Hours:

Date:

Dealer no:

Notes:

Signature/Print:

For maintenance schedule refer to Maintenance Information section of this operator's guide

Service

Mileage / km:

Hours:

Date:

Dealer no:

Notes:

Signature/Print:

For maintenance schedule refer to Maintenance Information section of this operator's guide

MAINTENANCE PROCEDURES

This section includes instructions for basic maintenance procedures.

Due to the complexity of some of the maintenance procedures, good mechanical skills are required.

If you are not comfortable with these procedures, do not hesitate to contact an authorized Can-Am off-road dealer, repair shop or person of your own choosing.

⚠ WARNING

Unless otherwise indicated, the engine must be stopped and the key always removed before performing any maintenance

⚠ WARNING

Should removal of a locking device be required (e.g. lock tab, self-locking fastener, etc.) , always replace it with a new one.

Resetting the Message: Maintenance Required

This option is available only when the maintenance is due.

1. Using the LOWER button (4.5" digital display) or the MENU button (7.6" digital display), select **RES MAIN** in **SETTINGS**.
2. Hold the button to reset the maintenance message.

Engine Air Filter

Removing the Engine Air Filter

NOTICE

Never remove or modify any component in the air filter housing. Otherwise, engine performance degradation or damage can occur. The engine is calibrated to operate specifically with these components.

1. Remove seat.
2. Lift the front part of the central panel.

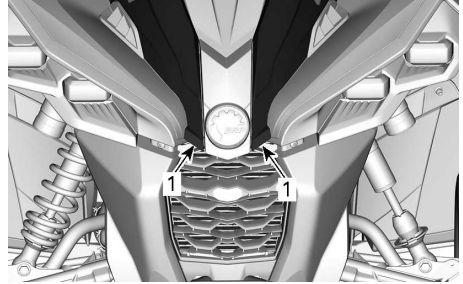

1. Lift here

3. Remove the console, refer to *Equipment*.
4. Rotate air filter cover counterclockwise to remove it.

NOTE:

A socket wrench may be used to ease removal.



1. Air filter cover

5. Remove air filter.



AIR FILTER REMOVAL

Inspecting and Draining the Engine Air Filter Housing

1. Remove LH side panel.
2. Drain air filter housing inlet drain tube.

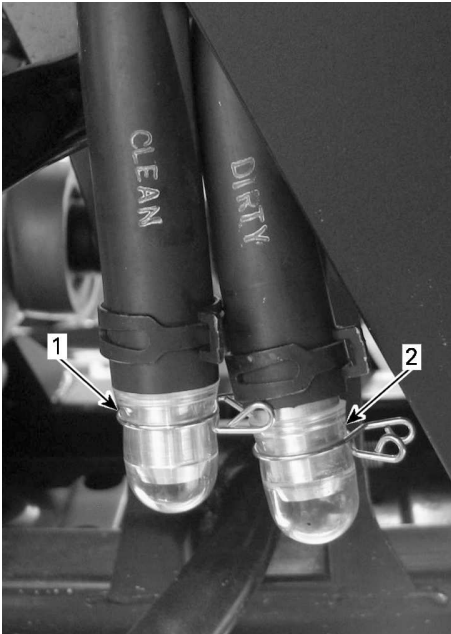

1. Clean air filter housing drain reservoir
2. Dirty air filter housing drain reservoir
3. Check air filter dirty chamber for cleanliness.
 - If any debris or water are

found, clean air filter chamber using a vacuum cleaner.

NOTICE

Do not blow compressed air into air filter chamber.

4. Check air filter drain tube (clean chamber).
 - If any debris or water are found, refer to *Special Procedures*.
 - Investigate for contamination source.

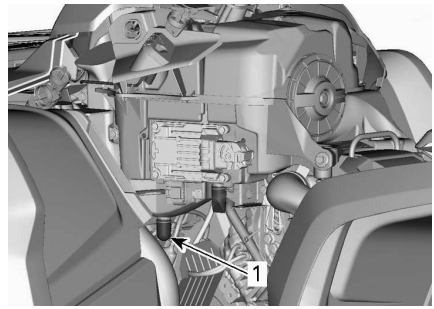

1. Air filter drain tube

Cleaning and Oiling the Engine Air Filter

Cleaning the Paper Filter

1. Ensure that the foam filter is removed from paper filter.
2. Tap out heavy dust from the paper filter.

This will allow dirt and dust to get out of the paper filter.

NOTE:

Paper filter have a limited life span; replace filter if too dirty or clogged.

NOTICE

It is not recommended to blow compressed air on the paper element; this could damage the paper fibers and reduce its filtration ability when used in dusty environments. If engine air filter is too dirty and cannot be cleaned following the recommended procedure, it should be replaced.

NOTICE

Do not wash the paper filter with any cleaning solution.

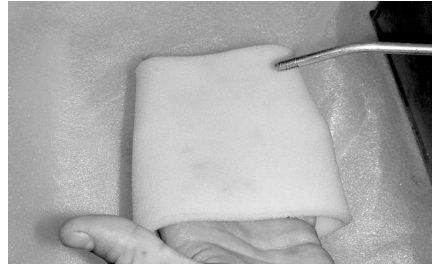

TYPICAL

NOTE:

A second application may be necessary for heavily soiled elements.

Oiling the Foam Filter

1. Make sure filter is clean. Refer to *Cleaning the Foam Filter*.
2. Spray an air filter oil on the foam filter previously dried.



TYPICAL

Cleaning the Foam Filter

1. Spray the foam filter inside and out with a good air filter cleaner and follow manufacturer's instructions.



TYPICAL

2. Dry the foam filter completely.

3. Let stand for 3 to 5 minutes.
4. Remove any excess of oil that could transfer to the paper filter by wrapping the foam filter into an absorbent cloth and squeezing gently. This will also ensure a full oil coverage on foam filter.
5. Reinstall the foam filter over the paper filter.

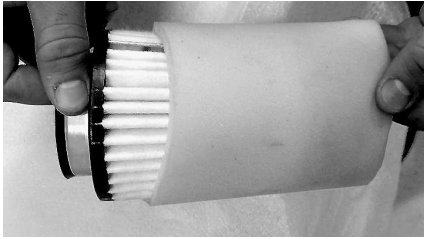

TYPICAL

6. Slightly grease plastic body of filter for ease of installation and future removal.

Installing the Air Filter

1. Reinstall oiled foam filter on paper air filter.
2. Slightly grease O-ring seal and plastic body of air filter.
3. Install air filter as the reverse of removal.
4. Ensure air filter cover is properly locked onto the air filter housing. See indications on filter cover and housing.

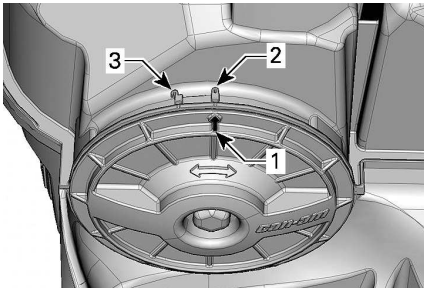

1. Cover position arrow
2. Locked
3. Unlocked

5. Reinstall all removed parts.

CVT Air Filter

Removing the CVT Air Filter

1. Remove air filter from the snorkel cover as shown.

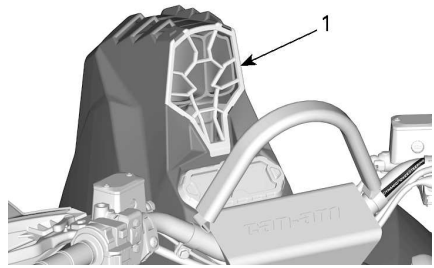

1. CVT air filter

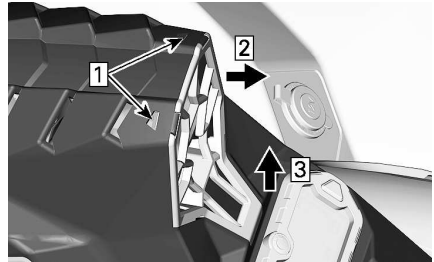

1. Push down on tabs
2. Gently pull top of grille out
3. Pull bottom of grille up

Cleaning the CVT Air Filter

1. Inspect filter and replace if damaged.
2. Gently clean filter using a solution of soft soap and tap water, then rinse thoroughly.
3. Dry filter completely.
4. Clean inside the CVT air inlet duct.

Installing the CVT Air Filter

1. Securely reinstall the air filter on the snorkel cover.

Engine Oil

Verifying the Engine Oil Level

NOTICE

Operating the engine/gearbox with an improper level may severely damage engine/gearbox.

NOTICE

Check the oil level when the engine is cold.

1. Place vehicle on a level surface.
2. Clean dipstick area to avoid foreign particles falling down in the engine.

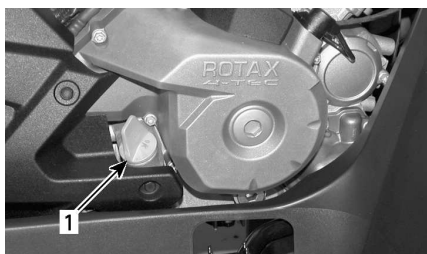

TYPICAL - RH SIDE OF ENGINE

1. Dipstick

3. Unscrew dipstick then remove it and wipe clean.
4. Reinstall dipstick, screw in it completely.
5. Remove and check oil level. It should be near or equal to the upper mark.

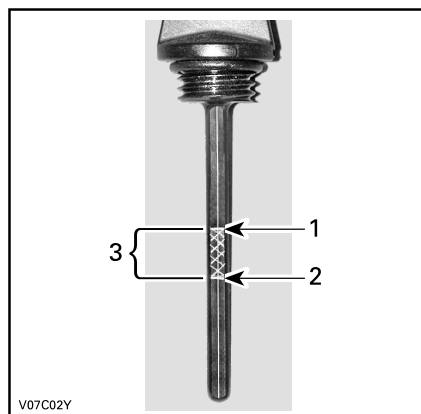

TYPICAL

1. Full
2. Add
3. Operating range

If the level is between marks, reinstall the dipstick.

If the level is below the lower mark, add oil as follow:

- Place a funnel into the dipstick hole.
- Add a small amount of recommended oil and recheck oil level.
- Continue to add oil until the level reaches the upper mark.

NOTICE

Do not overfill. Wipe off any spillage.

6. Properly tighten dipstick.

Recommended Engine Oil

Rotax® engines were developed and validated using the XPS® oil.

BRP recommends the use of its XPS engine oil or an equivalent at all time.

Damages caused by the use of an oil not suitable for the engine may not be covered by the BRP Limited Warranty.

XPS Recommended Engine Oil	
General purpose	5W40 Synthetic blend oil
Cold temperature	0W40 Synthetic oil
Warm temperature	10W50 Synthetic oil
If the recommended XPS Engine Oil Is Not Available	
Use a 4-stroke SAE engine oil meeting or exceeding the following lubricant industry specifications.	
Always check the API service label certification on the oil container, it must contain at least one of the indicated standards.	
<ul style="list-style-type: none"> – API service classification SN, or – JASO MA2. 	

Changing the Engine Oil

⚠ CAUTION
The engine oil can be very hot. Wait until engine oil is warm.

NOTICE
Engine oil and oil filter must be replaced at the same time.

1. Ensure vehicle is on a level surface.
2. Bring engine to its normal operating temperature and stop it.
3. Remove dipstick.
4. Clean the oil drain plug area.
5. Place a drain pan under the oil drain plug area.
6. Unscrew magnetic drain plug and discard the gasket ring.

⚠ CAUTION
The engine oil can be very hot.

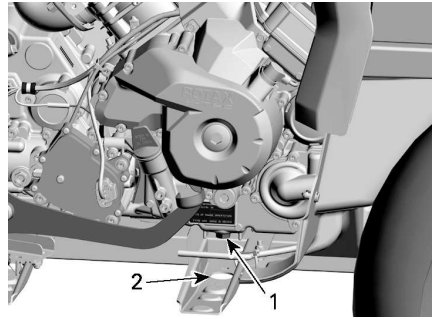

1. Magnetic drain plug
2. Access through the frame

7. Allow enough time for oil to flow out of engine and oil filter.
8. Replace the oil filter, refer to *Engine Oil Filter*.
9. Clean the magnetic drain plug from metal shavings and residue.

NOTICE
Presence of debris gives an indication of internal engine damages.

10. Install a NEW gasket ring on the magnetic drain plug.

NOTICE
Never use the gasket ring a second time. Always replace by a new one.

11. Install and tighten magnetic drain plug.

Tightening Torque	
M12 drain plug	20 ± 2 Nm (15 ± 1 lbf-ft)
M18 drain plug	30 ± 2 Nm (22 ± 1 lbf-ft)

12. Refill engine at the proper level with the recommended oil.

Refer to *Technical Specifications* for oil capacity.

13. Start engine and let idle for a few minutes.
14. Ensure oil filter area and oil drain plug areas are not leaking.
15. Stop engine.
16. Wait a while to allow oil to flow down to crankcase then check oil level.
17. Refill as necessary.
18. Dispose of oil as per your local environmental regulations.

Engine Oil Filter

Removing the Oil Filter

Clean oil filter area.

Remove oil filter cover.

Remove oil filter.

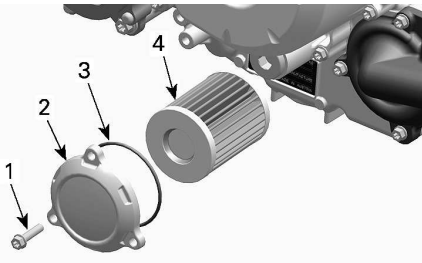

TYPICAL

1. Oil filter screw
2. Oil filter cover
3. O-ring
4. Oil filter

Installing the Oil Filter

1. Check and clean the oil filter inlet and outlet area for dirt and other contaminations.

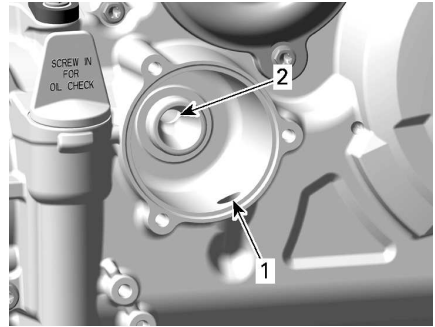

1. Inlet bore from the oil pump to the oil filter
2. Outlet bore to the engine oil providing system

2. Install a NEW O-ring on oil filter cover.
3. Install the new filter into the cover.
4. Apply engine oil on O-ring and grease on the end of filter.

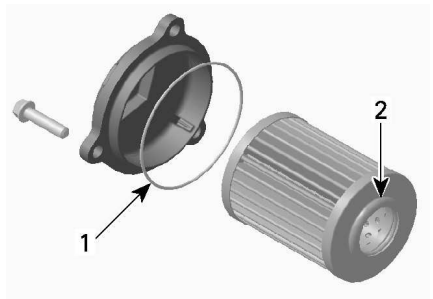

1. Slightly oil
2. Slightly oil

NOTICE

Pay attention to avoid pinching the O-ring during filter and cover installation.

5. Install the cover on the engine.
6. Tighten oil filter cover screws to recommended specification.

Tightening Torque

Oil filter cover screws

10 ± 1 Nm
(89 ± 9 lbf-in)

7. Wipe off any oil spillage on engine.

Fuel Vent Breather Filter

Replacing the Fuel Vent Breather Filter

The fuel vent breather filter is located under the rear fender between the fuel tank neck and the seat.

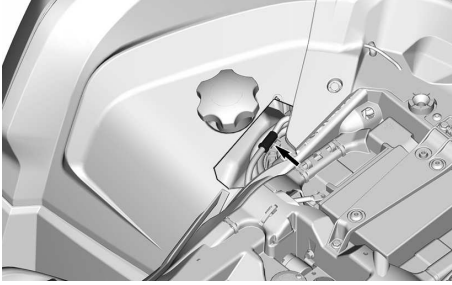

1. By the rear right-hand wheel arch, unplug hoses from the filter.

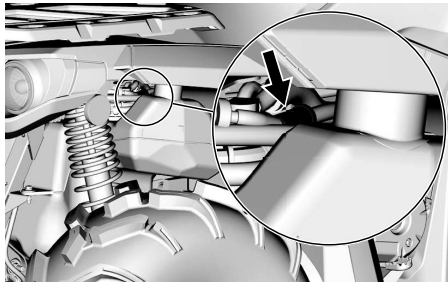

2. Remove and discard the filter.
3. Install the new filter with the arrow pointing towards the rear of the vehicle.

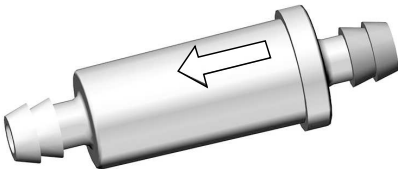

4. Make sure hoses are well plugged.

Radiator

Inspecting the Radiator

1. Periodically check the radiator area for cleanliness.

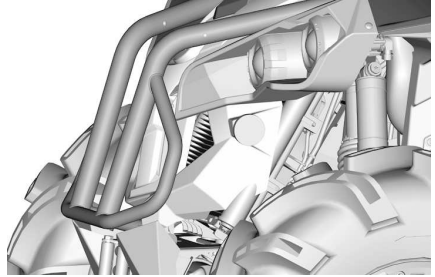

TYPICAL

2. Inspect radiator and hoses for leaks or any damage.
3. Inspect radiating fins. They must be clean, free of mud, dirt, leaves and any other deposit that would prevent the radiator to cool properly.
4. Remove as much deposits as you can with your hands. If a garden hose is available in proximity, try rinsing the radiating fins.

CAUTION

Never clean radiator with your hands when it is hot. Let the radiator cool down before cleaning.

NOTICE

Be careful not to damage the radiating fins when cleaning. Do not use any object/tool that could damage the fins. When hosing, use low pressure only. Never use a HIGH PRESSURE washer.

5. See an authorized Can-Am Off-road dealer, repair shop or person of your own choosing to check the performance of the cooling system.

Engine Coolant

Verifying the Engine Coolant Level

⚠ WARNING

Check coolant level with engine cold. Never add coolant in cooling system when engine is hot.

1. Place vehicle on a level surface.
2. Remove console, refer to *Equipment*.
3. Remove coolant reservoir cap.
4. With vehicle on a level surface, liquid should be between MIN. and MAX. level marks of coolant reservoir.

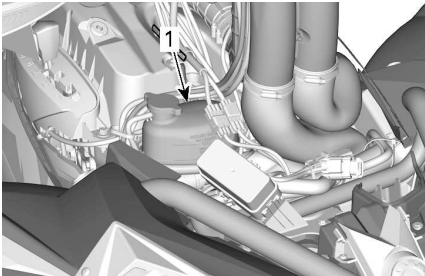

1. Engine coolant reservoir

NOTE:

When checking level at temperature lower than 20 °C (68 °F), it may be slightly lower than MIN. mark.

5. Add coolant if required.

⚠ WARNING

Do not remove the coolant reservoir cap if engine is hot.

6. Use a funnel to avoid spillage. Do not overfill.
7. Properly reinstall and tighten reservoir cap.

⚠ WARNING

In order to avoid potential burns, do not remove the radiator cap if the engine is hot.

NOTE:

A cooling system that frequently requires coolant is the indication of leaks or engine problems. See an authorized Can-Am Off-road dealer.

8. Reinstall all removed parts.

Recommended Engine Coolant

XPS Recommended Engine Coolant

XPS Extended life pre-mixed coolant

If the Recommended XPS Engine Coolant Is Not Available

Distilled water and antifreeze solution (50% distilled water, 50% antifreeze)

NOTICE

Always use ethylene-glycol anti-freeze containing corrosion inhibitors specifically for internal combustion aluminum engines.

Engine Coolant Replacement

Draining the Cooling System

1. Remove the console, refer to *Equipment*.
2. Remove the coolant reservoir cap.

⚠ WARNING

In order to avoid potential burns, do not remove the pressure cap or loosen the coolant drain plug if the engine is hot.

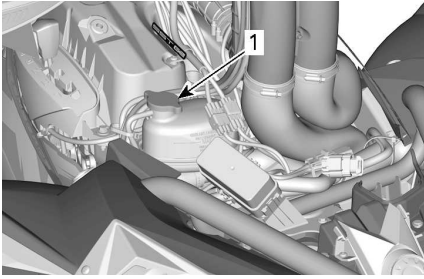

1. Engine coolant reservoir cap

3. Unscrew the coolant drain plug and drain the coolant into a suitable container.

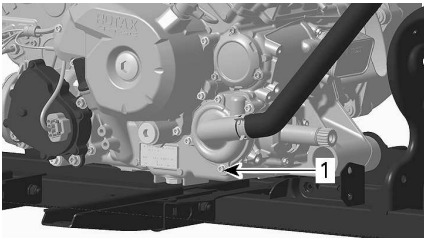

1. Coolant drain plug

NOTE:

Do not unscrew the coolant drain plug completely.

650 Engines

4. Disconnect the lower radiator hose and drain the remaining coolant into a suitable container.

NOTE:

Take note of the position of the hose clamp on the lower radiator hose at the radiator.

5. Reinstall lower radiator hose.
6. Position the radiator hose clamp as noted during removal.

All Engines

7. Install cooling system drain plug with a new sealing ring and tighten to specification.

Tightening Torque	
Cooling system drain plug	10 ± 1 Nm (89 ± 9lbf-in)

8. Bleed cooling system, refer to *Bleeding the Cooling System*.

Bleeding the Cooling System

1. Unscrew bleed screws on both front and rear cylinders.

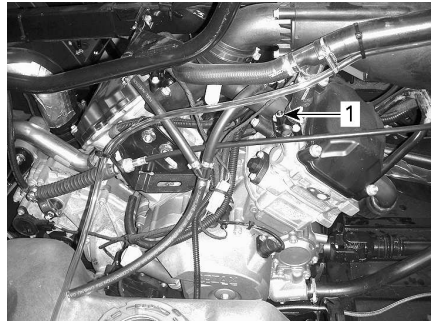

TYPICAL

1. Front cylinder bleed screw

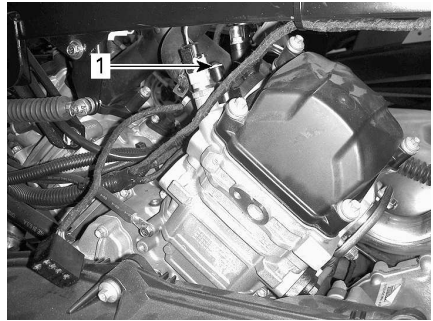

TYPICAL

1. Rear cylinder bleed screw

2. Remove the pressure cap.
3. Fill the cooling system until coolant comes out of the bleed screw(s).
4. Install the bleed screws using **NEW** gasket rings and tighten to specification.

Tightening Torque	
Bleed screw	5 ± 0.6Nm (44 ± 5 lbf-in)

5. Add coolant until system is full up to the pressure cap seat.
6. Start engine.

NOTE:

Do not install pressure cap.

7. Run engine at idle until coolant fan turns ON.

NOTE:

Monitor coolant level during engine warm-up and add coolant as required.

8. Depress the throttle lever two or three times; check coolant level.
9. Stop the engine and let it cool down.
10. Inspect cooling system for leaks.
11. Check coolant level in the reservoir. Add coolant as required.
12. Install pressure cap.
13. Reinstall all removed parts.

Muffler and Spark Arrester

Cleaning the Area Surrounding the Exhaust System

 WARNING
<p>Debris accumulation could lead to a vehicle fire when the exhaust system is hot and the debris are dried.</p> <p>In some cases, that could result in serious properly damages, injuries or even death.</p> <p>Clean often and regularly the area surrounding the exhaust system when riding in swamp, bog, hay or dead leaves.</p> <p>In other situations, clean as per maintenance schedule requirement.</p>

 CAUTION
<p>Never perform this operation immediately after the engine has been running because exhaust system is very hot.</p>

1. From the rear of the vehicle, clean the areas around the muffler.
2. Remove the seat.
3. Remove the LH side panel with the middle panel.
4. Remove the left front inner fender.
5. Clean the areas around the front exhaust pipe and all along the rear exhaust pipe.

 WARNING
Clean also under the heat shields.

6. Reinstall all removed parts.

Cleaning and Inspecting the Muffler Spark Arrester

NOTE:

Spark arrester screen replacement is required only when damaged.

⚠ CAUTION

Let exhaust system cool down before proceeding with cleaning and inspection.

1. Remove and discard the tail pipe retaining screws.

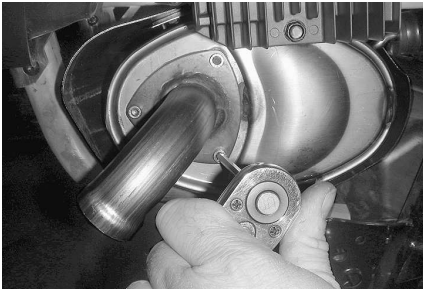

TYPICAL - REMOVE TAIL PIPE

2. Remove exhaust tail pipe, gasket (discard) and spark arrester.

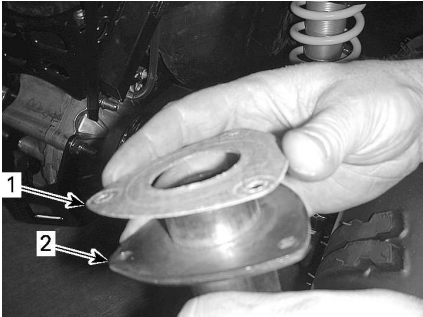

TYPICAL

1. Gasket
2. Exhaust tail pipe

3. Remove carbon deposits from the spark arrester using a brush.

NOTICE

Use a metallic soft brush and be careful to avoid damaging spark arrester mesh.

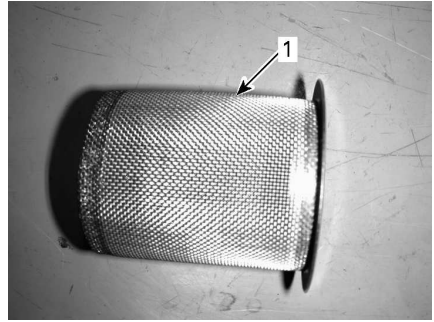

1. Clean spark arrester

4. Inspect mesh of spark arrester for any damage. Replace as required.
5. Inspect spark arrester chamber in muffler. Clean any debris as required.
6. Install new gasket, tail pipe and new retaining screws.
7. Reinstall muffler cover with new retaining screws. Tighten to specification.

Tightening Torque

Tail pipe retaining screws	11 ± 1 Nm (97 ± 9 lbf-in)
Cover retaining screws	

Gearbox

Verifying The Gearbox Oil Level

NOTICE

Check level and refill if necessary. Do not overfill. Operating the gearbox with an improper level may severely damage gearbox. Wipe off any spillage.

1. Place the vehicle on a level surface.
2. Select NEUTRAL position.
3. Apply the parking brake.

NOTE:

Check the gearbox oil level when engine is cold and not running.

4. Remove the gearbox oil level plug.

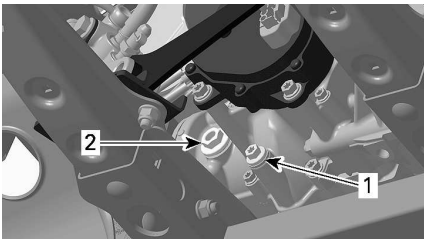

TYPICAL

1. Drain plug
2. Oil level plug

5. Check the level. The oil should be level with the bottom of the oil level hole.
6. Refill as required until gearbox oil level flows through oil level hole.

Recommended Gearbox Oil

The XPS oil is specially formulated to meet the lubrication requirements of this gearbox. BRP strongly recommends the use of its XPS oil.

XPS Recommended Gearbox oil

XPS 75W140 Synthetic gear oil

If the Recommended XPS Gearbox Oil Is Not Available

Use a gearbox oil meeting or exceeding the following lubricant industry specifications.

- 75W 140 API GL-5 synthetic gear oil

NOTICE

Do not use another type of oil when servicing.

Changing the Gearbox Oil

Draining the Gearbox Oil

1. Ensure vehicle is on a level surface.
2. Bring engine to its normal operating temperature and stop it.

NOTE: Running the engine at idle is not sufficient, vehicle gearbox must be operated.

3. Clean the areas around the drain and level plugs.

CAUTION

The gearbox and the gearbox oil can be very hot.

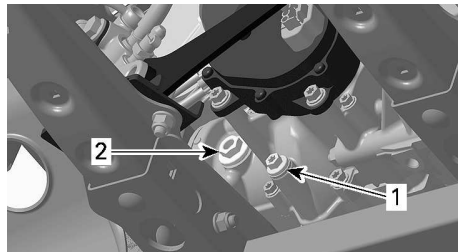

1. Drain plug
2. Oil level plug

4. Place a drain pan underneath the drain and level plugs.
5. Remove the magnetic drain plug.
6. Discard the sealing ring.
7. Remove the oil level plug and its O-ring.
8. To completely drain the gearbox, place a jack under the left footrest and tilt the vehicle toward the right side.
9. Wait a while to allow oil to flow out of the gearbox.
10. When the gearbox is empty, install the drain plug and replace the vehicle on the ground.
11. Clean the magnetic drain plug from metal shavings and residue.

NOTICE
Presence of debris gives an indication of internal gearbox damages.

12. Install a NEW sealing washer on the magnetic drain plug.

NOTICE
Never use the sealing washer a second time. Always replace by a new one.

13. Install and tighten magnetic drain plug.

Tightening Torque	
Magnetic drain plug	20 ± 2 Nm (15 ± 1 lbf-ft)

14. Dispose of oil as per your local environmental regulations.

Filling the Gearbox Oil

1. With the oil level plug, add recommended gearbox oil through the oil level hole until the level reach the bottom of the hole.
2. Install the oil level plug with its O-ring.

Tightening Torque	
Oil level plug	5 ± 0.6 Nm (44 ± 5 lbf-in)

Throttle Body

Inspecting the Throttle Body

1. Remove the air filter housing.
2. Remove the adapter hose between air filter housing and throttle body.
3. Visually inspect throttle plate and throttle body venturi for cleanliness.
4. Clean inside throttle body using a common throttle body cleaner if necessary.

Lubricating the Throttle Body

No lubrication is required.

Cleaning the Throttle Body

1. Remove air inlet hose from throttle body.
2. Check throttle body cleanliness using a flashlight. Fully open throttle plate and verify:
 - Throttle body bore
 - Throttle plate edge.

Look for:

- Dirt
 - Oily surfaces
 - Carbon and salt deposits on throttle plate and the surrounding bore.
3. Clean as necessary.
 4. Use a throttle body cleaner such as GUNK INTAKE MEDIC or an equivalent.

NOTICE

Only use an appropriate throttle body cleaner that will not damage O-rings and EFI sensors.

CAUTION

Use the product in a well ventilated area. Refer to product manufacturer's warnings.

- To avoid getting dirt into engine, spray cleaner on a clean rag then rub rag against throttle plate and bore. A toothbrush may also be used.

CAUTION

Ensure key is removed so that nobody can activate the electrical system, otherwise the ECM would turn on. This could cause serious finger injury as the throttle plate moves quickly.

- Gently open throttle plate and hold fully open to reach all surfaces.
- To remove residual dirt, spray cleaner on throttle plate and on bore.
- Reinstall removed parts.

Spark Plugs

Removing the Spark Plug

- Remove the side panels to reach the spark plug areas.
- Unplug the spark plug cable.
- Unscrew spark plugs one turn.
- Clean spark plugs and cylinder heads with pressurized air if possible.
- Unscrew spark plugs completely using a spark plug socket, then remove them.

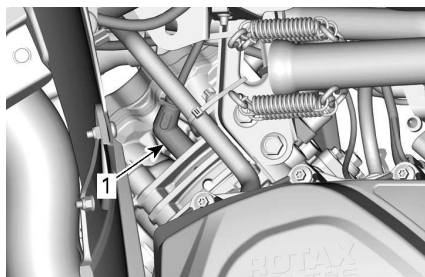

RH SIDE — REAR CYLINDER

- Spark plug

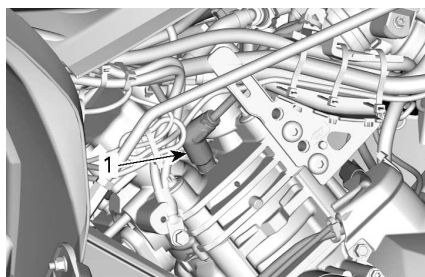

LH SIDE — FRONT CYLINDER

- Spark plug

Installing the Spark Plug

- Prior to installation, make sure that contact surfaces of cylinder heads and spark plugs are free of grime.
- Using a feeler gauge, set the electrode gap as specified in *Technical Specifications*.
- Apply a small of lubricant over spark plug threads to prevent a possible seizure.

Copper based anti-seize lubricant

- Screw spark plugs into cylinder heads by hand and tighten with a torque wrench and a proper socket.

NOTICE

Do not overtighten spark plugs, engine damage can occur.

Tightening Torque	
650	20 ± 2 Nm (15 ± 2 lbf-ft)
1000R	11 ± 1 Nm (97 ± 9 lbf-in)

CVT Cover

For a better understanding, some illustrations are taken with engine out of vehicle. To perform the following instructions, it is not necessary to remove engine.

⚠ WARNING
Never touch CVT while engine is running. Never drive vehicle when CVT cover is removed.

⚠ CAUTION
Engine must be cool before cover is removed.

NOTICE
This CVT is lubrication free. Never lubricate any components except drive pulley bearing.

Accessing the CVT Cover

The CVT cover is located on the LH side of the vehicle.

1. Remove the side panels.
2. Remove the footboard panel.

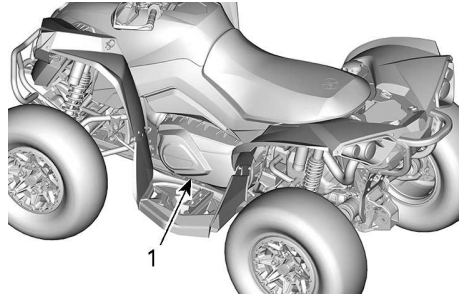

1. CVT cover

Removing the CVT Cover

1. Disconnect the inlet and outlet air cooling ducts from the CVT cover.
2. Remove all CVT cover retaining screws.
3. Remove the center top screw last to support the cover during removal.

NOTICE
Do not use an impact tool to remove CVT cover screws.

4. Remove the CVT cover and its gasket.

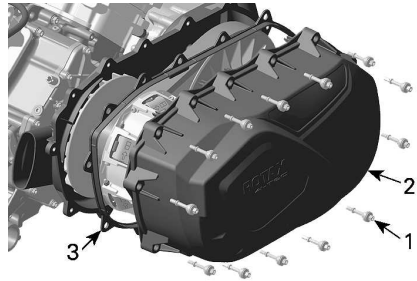

1. CVT cover screw
2. CVT cover
3. Gasket

Installing the CVT Cover

1. Position the cover against the engine.
2. Install the center top screw of first.

NOTICE

Do not use an impact tool to install CVT cover screws.

3. Tighten the CVT cover screws as per following sequence.

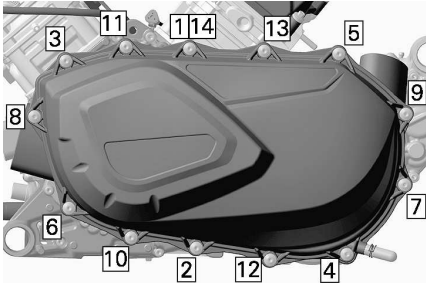

Tightening torque

CVT cover screws	$7 \pm 0.8 \text{ Nm}$ ($62 \pm 7 \text{ lbf-in}$)
------------------	---

4. Install the inlet and outlet air cooling ducts.

Drive Belt

Inspecting the Drive Belt

1. Inspect drive belt for cracks, fraying or abnormal wear. Replace if necessary.
2. Check drive belt width at cord level. Replace if the belt is out of the specification.

Drive Belt Width

Service limit	30 mm (1.181 in)
---------------	---------------------

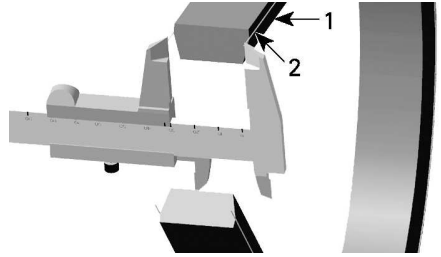

1. Drive belt
2. Cord in drive belt

Removing the Drive Belt

NOTICE

In case of a drive belt failure, the CVT cover, drain reservoir and air outlet must be cleaned and inspected for obstruction.

1. Remove the CVT Cover.
2. Open the driven pulley.

Puller/locking tool

(529036098)



3. Screw tool in the threaded hole of driven pulley and tighten to open the pulley.

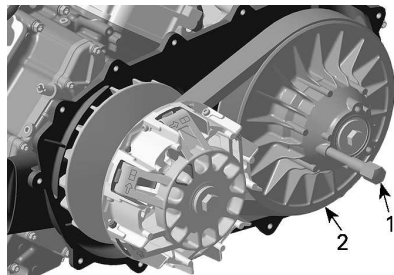

1. Puller/locking tool
2. Fixed sheave of driven pulley

4. Slide the belt over the top edge of fixed sheave to remove it.

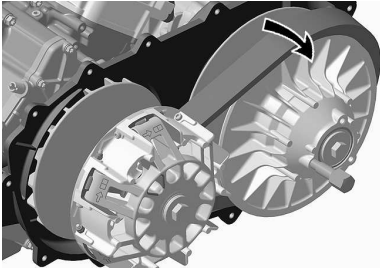

Installing the Drive Belt

For installation, reverse the removal procedure. Pay attention to the following details.

The maximum drive belt life span is obtained when the drive belt has the proper rotation direction.

1. Install drive belt so that the arrow printed on belt is pointing towards front of the vehicle, viewed from top.

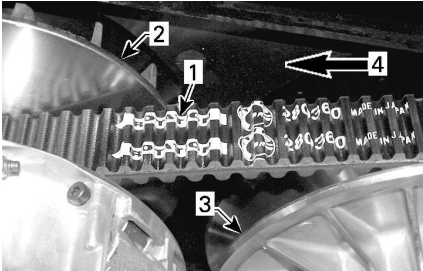

1. Arrow printed on belt
 2. Drive pulley (front)
 3. Driven pulley (rear)
 4. Rotation direction
2. Turn the driven pulley until the lowest portion of the cogs on the external surface of drive belt is even with the driven pulley edge.



1. Lowest portion of cogs even with external surface of drive belt

Drive and Driven Pulleys

Inspecting the Drive and Driven Pulleys

This inspection must be performed by an authorized Can-Am Off-road dealer, repair shop, or person of your own choosing for maintenance, repair, or replacement.

Drive Pulley

Inspect the bushings and rollers of the sliding sheave of the drive pulley, replace worn parts.

Driven Pulley

Inspect the bushings of the cam and of the sliding sheave of the driven pulley, replace worn parts.

Battery

CAUTION

Never charge a battery while installed in vehicle.

These vehicles are equipped with a VRLA battery (Valve Regulated Lead Acid). It is a maintenance-free type battery, there is no need to add water to adjust electrolyte level.

NOTICE

Never remove the battery sealing cap.

Removing the Battery

1. Disconnect BLACK (-) cable first then RED (+) cable.

NOTICE

Always disconnect BLACK (-) battery cable first.

2. Remove retaining screws, battery holding strap then pull the battery out of frame.

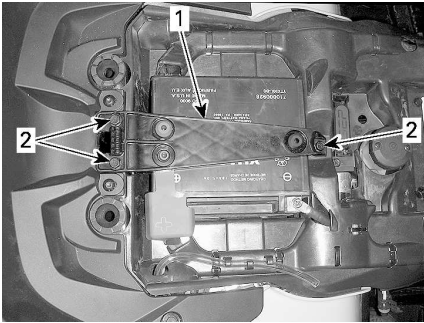

1. Battery holding strap
2. Retaining screws

Cleaning the Battery

1. Clean battery, battery casing and battery posts using a solution of baking soda and water.
2. Remove corrosion from battery cable terminals and battery posts using a firm wire brush.

Installing the Battery

The installation is the reverse of the removal procedure.

NOTICE

Always connect RED (+) battery cable first.

Main Fuse Box Description

Models Equipped with an Electronic Throttle Control (ETC)

Fuses

Fuses Location

The main fuse box is located under the gauge support.

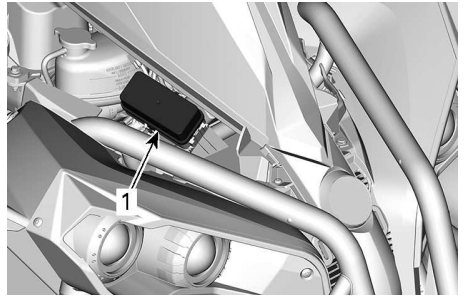

1. Main fuse holder

NOTE:

Check inside fuse box cover to know fuses location.

The holder of the following fuse are located behind the rear of the right side panel.

Battery/voltage regulator fuse	40 A
DPS fuse	40 A

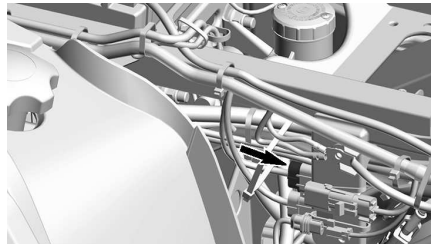

No.	Description	Rating
RY1	Cooling fan relay	—
RY2	Main relay	—
RY3	Lights relay	—
RY5	Accessory relay	—
RY6	Brake relay	—
F1	Start switch/Cluster	10A
F2	Lights	30A
F3	ACC 1	20A
F4	ACC2	20A
F5	Fuel Pump/Injectors/ Ignition coils/EVAP	10A
F6	Cluster/Relays/DPS/ Speed limiter	10A
F7	Brake lights/Tail lights	10A
F8	D.E.S.S./ECM	10A
F9	2WD/4WD	10A
F12	Cooling fan (resettable)	25A

Lights

⚠ CAUTION

Always remove the D.E.S.S. key from the D.E.S.S. post or turn the ignition switch to OFF position before replacing a defective bulb.

Always check light operation after replacement.

Headlight Bulb Replacement

No headlight bulb replacement is required for this vehicle. It is equipped with LEDs (Light Emitting Diode) headlights. This technology has proven itself to be very reliable.

In the unlikely event they do not work, have them checked by an authorized Can-Am Off-road dealer, repair shop or person of your own choosing.

Headlight Beam Aiming

1. Load the vehicle as per normal use.
2. Position vehicle on a level surface 5 m (16 ft) in front of a test surface (wall or screen) as in first illustration.
3. Measure the distance from the center of each headlight to the ground (high beam and low beam).
4. Trace a line on the test surface parallel to the ground at each

measured height (one for high beam and one for low beam).

Low beam aiming is correct when the crest of the low beam is 40 mm (1.57 in) **below** the applicable horizontal center line traced on the test surface as per specification.

High beam aiming is correct when the center of the high beam (focus point) is 50 mm (2 in) **below** the applicable horizontal center line traced on the test surface as per specification.

NOTE: The headlights can only be adjusted vertically.

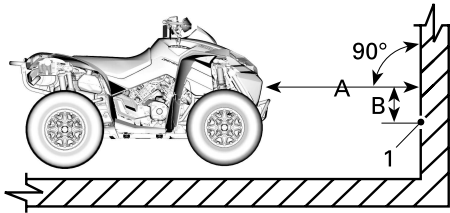

1. Light beam center

A. 5 m (16 ft)

B. Beam aiming specification

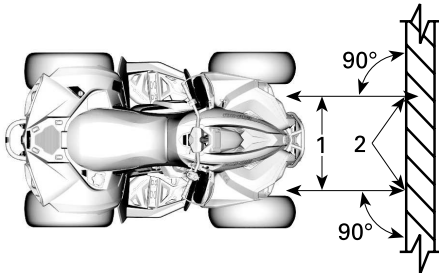

1. Headlight center lines

2. Light beam center

5. To adjust, turn the adjustment screw.

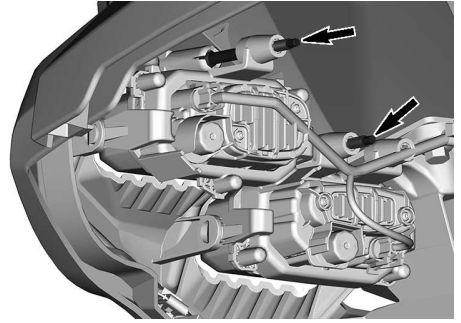

Taillight/Brake Light Bulb Replacement

1. Rotate taillight counterclockwise to remove it from taillight housing.



2. Disconnect the light bulb connector.

3. Rotate light bulb counterclockwise to remove it from taillight.



4. Installation is the reverse of the removal procedure.

Drive Shaft Bellow and Protector

Inspecting the Drive Shaft Bellow and Protector

1. Visually inspect drive shaft protectors and bellows conditions.
2. Check protectors for damage or rubbing against shafts.
3. Check bellows for cracks, tears, leaking grease etc.
4. Repair or replace damaged parts as necessary.

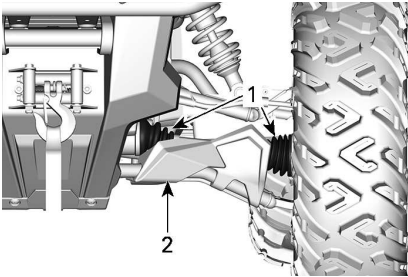

TYPICAL — FRONT OF VEHICLE

1. Drive shaft bellows
2. Protector

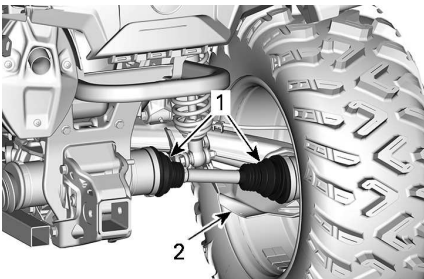

TYPICAL — REAR OF VEHICLE

1. Drive shaft bellows
2. Protector

Wheel Bearing

Inspecting the Wheel Bearing

1. Place vehicle on a level surface.
2. Apply the parking brake.
3. Lift and support vehicle.
4. Secure vehicle on jack stands.

5. Push and pull the wheels from the upper edge to feel the play.
6. See an authorized Can-Am Off-road dealer if there is an abnormal play.



TYPICAL

Wheels and Tires

Tire Pressure

⚠ WARNING

Tire pressure greatly affects vehicle handling and stability. Insufficient pressure may cause tire to deflate and rotate on wheel. Overpressure may burst the tire. Always follow recommended pressure. NEVER set tire pressure below minimum. It could cause the tire to dislodge from the rim.

Check pressure when tires are cold before using the vehicle. Tire pressure changes with temperature and altitude. Recheck pressure if one of these conditions has changed.

Refer to the *Tire Pressure and Maximum Load* decal for proper tire pressure.

NOTE:

Although the tires are specifically designed for off-road use, a flat may still occur. Therefore, it is recommended to carry a tire gauge, tire pump and a repair kit.

Tire Inspection

Check tire for damage and wear. Replace if necessary.

⚠ WARNING

Do not rotate tires. The front and rear tires have a different size. The left and right tires have different unidirectional tread patterns.

Tire Replacement

Tire replacement should be performed by an authorized Can-Am Off-road dealer, a repair shop or a person of your choosing.

⚠ WARNING

Replace tires only with the same type and size as original tires. For unidirectional tread pattern, ensure that the tires are installed in the correct direction of rotation. Tires should be replaced, by an experienced person, in accordance with tire industry standards and tools.

Removing the Wheel

1. Place vehicle on a level surface.
2. Apply the parking brake.
3. Loosen lug nuts then lift vehicle.
4. Secure vehicle on jack stands.
5. Remove lug nuts, then remove wheel.

Installing the Wheel

Occasionally, the wheel lug nuts should be removed to apply anti-seize lubricant to the studs to ease future removal. This is particularly important when the vehicle is used in a salt water environment or in mud. Remove

one nut at a time, lubricate and then re-torque.

1. Anti-seize lubricant on threads.

Loctite 767 (antiseize lubricant)

2. If tires are unidirectional, make sure to install wheel according to tire rotation.
3. Carefully tighten lug nuts in a criss-cross sequence then tighten to specification.

NOTICE

Always use the recommended wheel lug nuts for the type of wheel. Using a different wheel lug nuts could cause damages to the rim or studs.

Tightening Torque

Wheel lug nut	80 ± 5 Nm (59 ± 4 lbf-ft)
---------------	------------------------------

Inspecting Wheel Beadlock

Wheel Beadlock Retorque

NOTICE

Do not use an impact wrench for installing beadlock screws. The risk of screw breaking or screw stripping is high when using an impact wrench.

1. Retorque all screws to specification and according to the following tightening sequence.

Tightening torque

Beadlock screws	11 ± 1 Nm (97 ± 9 lbf-in)
-----------------	------------------------------

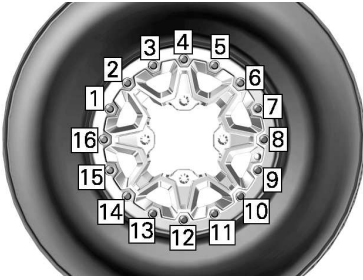

TYPICAL - FINAL TIGHTENING SEQUENCE

2. Tighten screws a few turns at a time to ensure even pressure on the beadlock clamp ring.

NOTE:

It is normal that the beadlock clamp ring flexes slightly to match the tire bead.

Verifying the Wheel Beadlock Gap

1. Verify the gap between tire and beadlock clamp ring, it should be practically equal all around the ring.

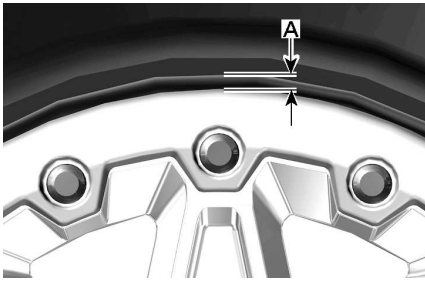

TYPICAL

1. Gap between tire and ring

If the gap is not acceptable, refer to *Tire Mounting on Beadlock Wheels*.

Tire Mounting on Beadlock Wheel

1. On the opposite side of beadlock, apply tire mounting lube on inner bead of tire and wheel to ensure proper seat when inflating.
2. Mount the inner bead over the wheel like normal.

3. Seat tire outer bead in the shoulder of the beadlock inner ring and center the tire.
4. Install manually all beadlock screws to avoid cross threading.

NOTICE

Do not use an impact wrench for installing beadlock screws. The risk of screw breaking or screw stripping is high when using an impact wrench.

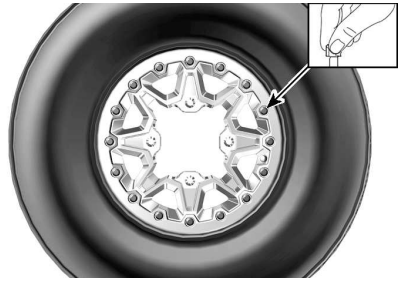

TYPICAL

5. Tighten beadlock screws as per following specification and sequence.

NOTE:

To ensure even pressure on the beadlock clamp ring, tighten screws a few turns at a time.

Tightening torque	
Beadlock screws (FIRST Sequence)	3 ± 1 Nm (27 ± 9 lbf-in)

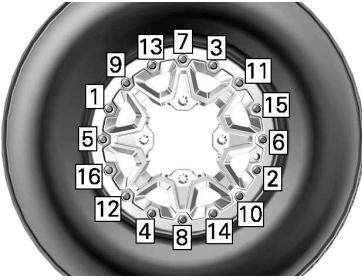

TYPICAL - TIGHTENING SEQUENCE

6. At this time check if the tire is still centered on wheel. Reposition it if necessary.
7. Tighten beadlock screws as per the **second** torque using the same sequence.

Tightening torque	
Beadlock screws (SECOND Sequence)	$8 \pm 1 \text{ Nm}$ ($71 \pm 9 \text{ lbf-in}$)

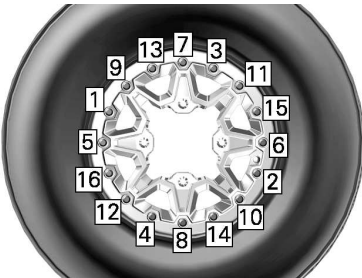

TYPICAL - TIGHTENING SEQUENCE

NOTE:

The beadlock clamp ring can flex slightly to match the tire bead. IT IS NORMAL.

8. Verify the gap between tire and beadlock clamp ring, it should be practically equal all around the ring.

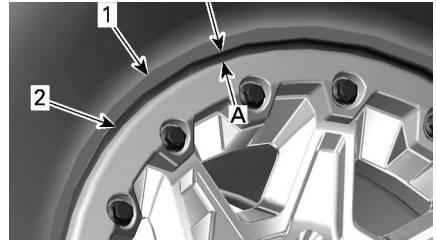

1. Tire
2. Beadlock clamp ring edge

1. Gap equal all around beadlock clamp ring

If the gap is not acceptable,

- Loosen all screws.
- Check tire position on wheel and reposition it if necessary.
- Restart the torquing sequence as detailed.

9. Torque beadlock screws a **final** time following the indicated sequence.

Tightening torque	
Beadlock screws (FINAL Sequence)	$11 \pm 1 \text{ Nm}$ ($97 \pm 9 \text{ lbf-in}$)

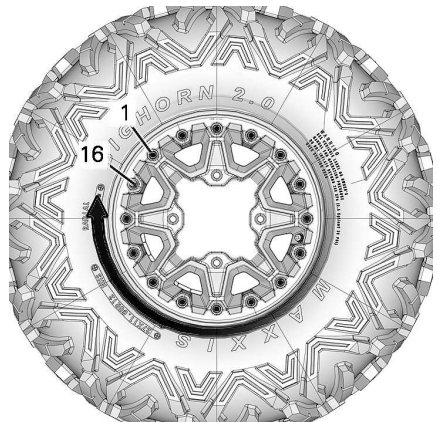

TYPICAL - FINAL TIGHTENING SEQUENCE

- Inflate tire to seat the inner bead on wheel. Always use safe practices, such as a tire safety cage.

⚠ WARNING

Never exceed tire's recommended maximum pressure for seating beads.

Steering

Inspecting Tie-Rod Ends

- Place vehicle on a level surface.
- Apply the parking brake.
- Lift vehicle.
- Secure vehicle on jack stands.
- Inspect tie-rod bellows for cracks.
- Push and pull the wheels from the front or rear edge to feel the play.
- See an authorized Can-Am Off-road dealer if there is an abnormal play or the bellow is cracked.

⚠ WARNING

The tie-rod end must be replaced if the bellow is cracked or shows an abnormal play.

Suspension

Lubricating the Front Suspension

- Lubricate front stabilizer bar bushing and suspension arms at grease fittings.

XPS Synthetic suspension grease

Lubricating the Rear Suspension

- Lubricate rear stabilizer bar links and pivot bushing at grease fittings.

XPS Synthetic suspension grease

Inspecting the Suspension

See an authorized Can-Am Off-road dealer, a repair shop or person of your choosing if any problem is detected.

Shock Absorbers

- Inspect shock absorber for oil leaks or other damage.
- Check tightness of fasteners.
- See an authorized Can-Am Off-road dealer as necessary.

Ball Joints

- Place vehicle on a level surface.
- Apply the parking brake.
- Lift vehicle.
- Secure vehicle on jack stands.
- Inspect ball joint bellow for cracks.
- Push and pull the wheels from the upper and lower edge to feel the play.
- See an authorized Can-Am Off-road dealer if there is an abnormal play or the bellow is cracked.



TYPICAL

⚠ WARNING

The ball joint must be replaced if the bellow is cracked or it shows an abnormal play.

Front Suspension Arms

- Check suspension arms for cracks, bending or other damage.
- See an authorized Can-Am Off-road dealer as necessary.

Rear Trailing Arms

1. Check trailing arms for distortion, cracks or bending.
2. See an authorized Can-Am Off-road dealer if any problem is detected.

Brakes

Verifying the Front Brake Reservoir Level

1. Turn steering in the straight-ahead position to ensure reservoir is level.
2. Check the brake fluid level, the reservoir is full when the fluid reaches of the top of window.
3. Visually inspect lever boot condition.
4. Check for cracks, tears, etc. Replace if damaged.



Verifying the Rear Reservoir Level

1. Remove the seat.
2. With vehicle on a level surface, liquid should be between MIN. and MAX. level marks of brake pedal fluid reservoir.



1. Rear brake fluid reservoir

Adding Brake Fluid

1. Clean filler cap.

⚠ WARNING
Clean filler cap before removing to avoid brake system contamination.

2. Remove reservoir cap.
3. Add fluid as required using a clean funnel. **Do not overfill.**

NOTICE
Brake fluid can damage plastic and painted surface. Wipe off and clean any spillage.

4. Reinstall reservoir cap.

NOTE:

Ensure filler cap diaphragm is pushed inside the cap before closing the brake fluid reservoir.

5. On front reservoir, tighten screws to specification.

Tightening Torque	
Brake fluid reservoir screws	1.3 ± 0.1 Nm (12 ± 1 lbf-in)

Recommended Brake Fluid

Always use brake fluid meeting the specification DOT 4 only.

NOTICE

To avoid serious damage to the braking system, do not use fluids other than the recommended one, nor mix different fluids for topping up.
Do not use brake fluid taken from old or already opened containers.

Inspecting the Brake System

⚠ WARNING

The brake fluid replacement or brake system maintenance and repairs should be performed by an authorized Can-Am Off-road dealer.

⚠ CAUTION

The brakes can be very hot after prolonged use of the vehicle and can cause burns. Wait for the brakes to cool down.

The brake inspection, maintenance and repair should be performed by an authorized Can-Am Off-road dealer.

1. However, verify the following between visits to your dealer:
 - Brake fluid level
 - Brake system for fluid leaks
 - Brake cleanliness.

VEHICLE CARE

Vehicle Cleaning and Protection

NOTICE

Never use a high pressure washer to clean the vehicle. USE LOW PRESSURE ONLY (like a garden hose). High pressure can cause damage to electrical or mechanical components.

Pay attention to certain areas where salt-water, mud or debris can accumulate and potentially cause:

- Fire
- Wear
- Interference
- Corrosion.

This list includes but is not limited to:

- Around exhaust system and between muffler and muffler cover
- Under and around the fuel tank
- Radiator
- Shock absorbers
- Around front and rear differentials
- Around and underneath engine and gearbox
- Inside wheels
- On top of skid plates.

WARNING

Debris accumulation could lead to a vehicle fire when the exhaust system is hot and the debris are dried.

In some cases, that could result in serious properly damages, injuries or even death.

Clean often and regularly the area surrounding the exhaust system when riding in swamp, bog, hay or dead leaves.

In other situations, clean as per maintenance schedule requirement.

fresh water is necessary to preserve vehicle and its components after each operating day.

Metallic parts lubrication is highly recommended.

Use anti-corrosive lubricant or an equivalent.

XPS Lubricant and anti-corrosive

Painted parts which are damaged should be properly repainted to prevent rust.

When required, wash the body with warm water and soap (only use mild detergent). Apply non-abrasive wax.

NOTICE

Never clean plastic parts with strong detergent, degreasing agent, paint thinner, acetone, etc.

Protect the vehicle with a cover to prevent dust accumulation during storage.

NOTICE

The vehicle has to be stored in a cool and dry place and covered with an opaque tarpaulin. This will prevent sun rays and grime from affecting plastic components and vehicle finish.

When vehicle is used in salt-water environment rinsing the vehicle with

Non Compatible Cleaning Products

Material Type	Non-compatible Cleaning Products
Polypropylene	<ul style="list-style-type: none">- Any petroleum base cleaning products- XPS ATV finishing spray- XPS ATV cleaning kit (it contains the above XPS ATV Finishing Spray)

Compatible Cleaning Products

Material Type	Compatible Cleaning Product
Polypropylene	<ul style="list-style-type: none">- XPS ATV wash- Soapy water

STORAGE AND PRESEASON PREPARATION

When a vehicle is not in use for more than 4 months, proper storage is a necessity.

If the vehicle is to be remain inactive for more than 21 days, disconnect the BLACK (-) cable of the battery.

The use of a low amperage trickle charger is recommended to keep battery fully charged.

Before using your vehicle after storage, a preparation is required.

See an authorized Can-Am Off-road dealer, a repair shop, or a person of your own choosing to have your vehicle prepared properly.

While reading this Operator's Guide, remember that:



WARNING

Indicates a potential hazard which, if not avoided, could result in serious injury or death.

This page is intentionally blank

TECHNICAL INFORMATION

VEHICLE IDENTIFICATION

The main components of your vehicle (engine and frame) are identified by different serial numbers. It may sometimes become necessary to locate these numbers for warranty purposes or to trace your vehicle in the event of loss. These numbers are required by the authorized Can-Am Off-road dealer to complete warranty claims properly. We strongly recommend that you take note of all the serial numbers on your vehicle and supply them to your insurance company.

Engine Identification Number (EIN)

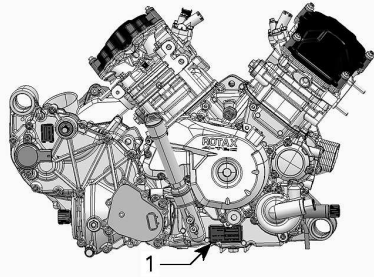

TYPICAL - RH SIDE OF ENGINE

1. Engine Identification Number (EIN)

Vehicle Identification Number



VIN LABEL - EUROPEAN COUNTRIES



VIN LABEL - OTHER COUNTRIES

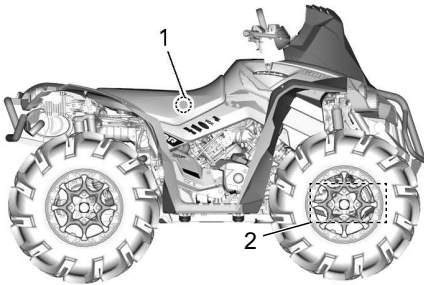

1. VIN Label - On the frame under the seat
2. Stamped VIN - On right side below the front differential

Compliance Hang Tags

EPA Certification

VEHICLE MODEL NAME:	
ENGINE DESCRIPTION:	
EPA CERTIFIED	
NER (NORMALIZED EMISSION RATE) =	<input type="text"/>
ON 0 TO 10 SCALE, 0 BEING THE CLEANEST.	
BOMBARDIER RECREATIONAL PRODUCTS INC	
*NOT TO BE REMOVED PRIOR SALE.	



Compliance Label

Regulation (EU) 2016/1628 applicable for Non-Road Mobile Machineries

Vehicles who comply to Regulation (EU) 2016/1628 (NRMM) are identified on the engine valve cover as well as on the frame under the seat.

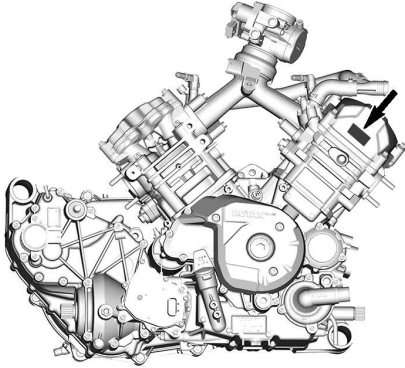

TYPICAL

8639 	Rotax NRSC G1 CO2 g/kWh:	XXXX
	#	MXXXXXXXX
	Production date:	MM-YYYY
	Family type:	XXXXXX
e13		AT1/P V-####

TYPICAL - NRMM IDENTIFICATION LABEL

NOTE:

Tampering with the engine or its components voids the EU type-approval of that particular engine.

Emission Control Information (Typical)

CARB and EPA Models

VEHICLE EMISSIONS CONTROL INFORMATION  **121**

BOMBARDIER RECREATIONAL PRODUCTS INC.
 THIS VEHICLE IS CERTIFIED TO OPERATE ON UNLEADED GASOLINE AND CONFORMS TO U.S. EPA & CALIFORNIA EMISSIONS REGULATIONS FOR ALL TERRAIN VEHICLE.
 RENSEIGNEMENT SUR LE DISPOSITIF ANTIPOLLUTION CE VEHICULE EST CERTIFIE POUR FONCTIONNER A L'ESSENCE SANS PLOMB ET EST CONFORME AUX NORMES DE L'EPA POUR LES VTT

ENGINE FAMILY / FAMILLE DE MOTEUR	PERMEATION FAMILY / FAMILLE DE PERMEATION
CERTIFICATION STANDARDS (FEL) NORMES DE CERTIFICATION (SEF)	
DISPLACEMENT / CYLINDRÉE	
EMISSION CONTROL SYSTEM SYSTÈME DE CONTRÔLE DES ÉMISSIONS	

THIS VEHICLE CONFORMS TO CALIFORNIA EVAPORATIVE EMISSIONS REGULATIONS APPLICABLE TO NEW ALL TERRAIN VEHICLE AND IS CERTIFIED TO 1.0 TOG GRAM PER DAY EVAPORATIVE EVAP FAMILY MODEL

EVAP EMISSION CONTROL SYSTEM UPT, UPT, PURGE CANISTER.
 SEE OPERATOR'S GUIDE FOR MAINTENANCE SCHEDULE AND FUEL, OIL AND SPARK PLUG SPECIFICATIONS. VOIR LE CALENDRIER D'ENTRETIEN ET LES SPÉCIFICATIONS D'ESSENCE, D'HUILE ET DE BOUGIE D'ALLUMAGE DANS LE GUIDE DE L'OPÉRATEUR.

104880171

EPA only Models

EMISSION CONTROL INFORMATION  **121**

THIS VEHICLE IS CERTIFIED TO OPERATE ON UNLEADED GASOLINE AND CONFORMS TO U.S. EPA EMISSION /EVAP REGULATIONS FOR VTC. CERTIFIED FOR SALE IN ALL U.S. STATES EXCEPT CALIFORNIA.

ENGINE FAMILY	FAMILLE DE MOTEUR
PERMEATION FAMILY	FAMILLE DE PERMEATION
CERTIFICATION STANDARD (FEL)	LIMITE DES ÉMISSIONS DE LA FAMILLE
ENGINE DISPLACEMENT	CYLINDRÉE
EXHAUST EMISSION CONTROL SYSTEM	SYSTÈME DE CONTRÔLE DES ÉMISSIONS

RENSEIGNEMENTS SUR LE DISPOSITIF ANTIPOLLUTION
 CE VEHICULE EST CERTIFIE POUR FONCTIONNER A L'ESSENCE SANS PLOMB ET IL EST CONFORME AUX NORMES DE L'EPA AU NIVEAU DES REGLEMENTATIONS DE L'ÉCHAPPEMENT ET DE L'ÉVAPORATION POUR LES VTT.

SEE OPERATOR'S GUIDE FOR MAINTENANCE SCHEDULE
 VOIR LE PROGRAMME D'ENTRETIEN DANS LE GUIDE DU CONDUCTEUR

BOMBARDIER RECREATIONAL PRODUCTS INC. 104880171

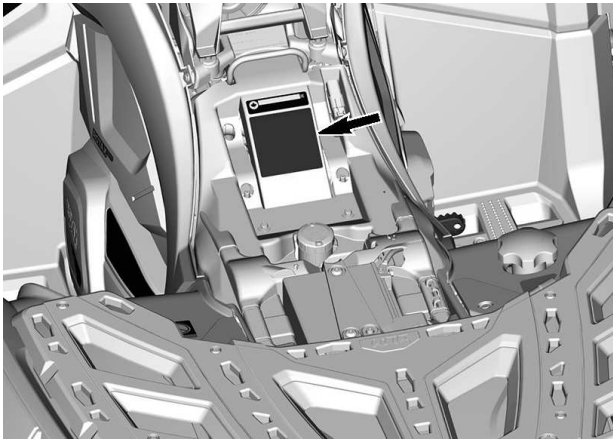

ANSI/SVIA Compliance

Bombardier Recreational Products Inc. certifies that this ATV complies with ANSI / SVIA-1-2017 standard and is subject to an approved ATV Action Plan submitted by BRP and on file with the U.S. Consumer Product Safety Commission.



Fuel Octane

This label is located near the gas cap.



Technical Information Labels

Air Filter Maintenance

AIR FILTER MAINTENANCE

MAINTENANCE MUST BE PERFORMED AS SPECIFIED IN THE OPERATOR'S GUIDE. AIR FILTER MAINTENANCE SHOULD INCREASE IN FREQUENCY IN MORE SEVERE (DUSTY) CONDITIONS.

ENTRETIEN DU FILTRE À AIR

L'ENTRETIEN DOIT ÊTRE EFFECTUÉ TEL QUE SPÉCIFIÉ DANS LE GUIDE DU CONDUCTEUR. ENTRETIENIR LE FILTRE À AIR PLUS SOUVENT DANS DES CONDITIONS PLUS EXTRÊMES (MILIEUX POUSSIÉREUX). 707800373

LOCATED UNDER SEAT

Recommended Fuel

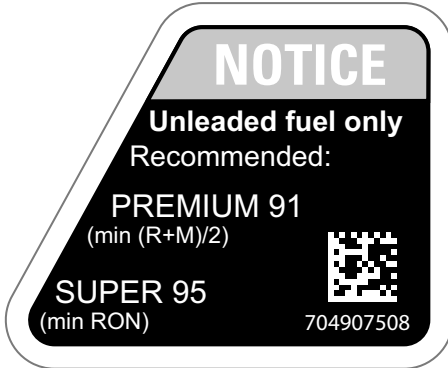

1000R ENGINES - NEAR THE FUEL TANK CAP

RADIO FREQUENCY DIGITALLY ENCODED SECURITY SYSTEM (RF D.E.S.S. KEY)

This device complies with FCC Part 15 and Industry Canada license exempt RSS standard(s). Operation is subject to the following two conditions: (1) this device may not cause interference, and (2) this device must accept any interference, including interference that may cause undesired operation of the device.

Changes or modifications not expressly approved by the party responsible for compliance could void the user's authority to operate the equipment.

IC Registration Number: 12006A-M01456

FCC ID: 2ACERM01456

We, the party responsible for compliance, declare under our sole responsibility that the device is in conformity with the provisions of the following Council Directive: 2014/53/EU. To which this declaration relates is in conformity with the essential requirements and other relevant requirements. The product is in conformity with the following directives, harmonized standards and regulations: Radio Equipment Directive (RED) 2014/53/EU and Harmonized Standards: EN 300 330-2, EN 60950-1.

NOISE EMISSION CONTROL SYSTEM REGULATION (CANADA/UNITED STATES)

Tampering with Noise Control System Is Prohibited!

U.S. Federal law and Canadian provincial laws may prohibit the following acts or the causing there of:

1. The removal or rendering inoperative by any person other than for purposes of maintenance, repair or replacement of any device or element of design incorporated into any new vehicle for the purpose of noise control prior to its sale or delivery to the ultimate purchaser or while it is in use or
2. The use of the vehicle after such device or element of design has been removed or rendered inoperative by any person.

Among those Acts Presumed to Constitute Tampering Are the Acts Listed Below:

1. Removal or alteration or the puncturing of the muffler or any engine component which conducts removal of engine exhaust gases.
2. Removal or alteration or the puncturing of any part of the intake system.
3. Replacing any moving parts of the vehicle or parts of the exhaust or intake system, with parts other than those specified by the manufacturer.
4. Lack of proper maintenance.

NOISE EMISSION AND VIBRATION VALUES (ALL COUNTRIES EXCEPT CANADA/UNITED STATES)

NOISE EMISSION AND VIBRATION VALUES ¹		
Model		X mr 1000R
Noise	Sound pressure (L_{pA})	80 dB @ 4000 RPM (Uncertainty (K_{pA}) 3 dB)
Vibration	Hand-arm system	<2.5 m/s ² @ 4000 RPM
	Whole body at seat	<0.5 m/s ² @ 4000 RPM
1: Noise emission and Vibration values are measured in accordance with Standard EN 15997:2011 on a paved surface, at Neutral.		

EC-DECLARATION OF CONFORMITY



555 de la Montagne Street
Valcourt (Québec) J0E 2L0
Canada
www.brp.com

EU Declaration of Conformity

Authorised Representative: BRP Europe N.V., Skaldenstraat 125, Gent, Belgium, 9042

This declaration of conformity is issued under the sole responsibility of the manufacturer.

The undersigned, representing the manufacturer, hereby declares that model year **2023 All Terrain Vehicles** marked with the **CE** mark and a 17-character vehicle identification number structured as **3JBxxxxxPxxxxxx** under commercial names **Can-Am Outlander** and **Can-Am Renegade** comply with all the relevant provisions of the following Directives and Regulations:

Machinery (MD) Directive 2006/42/EC as amended up to and including Regulation (EU) 2019/1243	ISO 12100:2010 & EN 15997:2011
Non-Road Mobile Machinery (NRMM) Regulation (EU) 2016/1628 on gaseous pollutants as amended up to and including Regulation (EU) 2020/1040	Category ATS, Stage V emissions limits
Electromagnetic Compatibility (EMC) Directive 2014/30/EU as amended up to and including Regulation (EU) 2018/1139	CISPR 12:2007/A1:2009 & IEC 61000-6-1:2016 or UN R10.04 or later version
Battery Directive 2006/66/EC as amended up to and including Directive (EU) 2018/849 and, Regulation (EU) 1103/2010 on battery capacity labelling	EN 50342-7:2015
Radio Equipment (RED) Directive 2014/53/EU as amended up to and including Regulation (EU) 2018/1139 (If fitted with radio frequency (RF) D.E.S.S. key)	Art. 3.1a: IEC 62368-1:2014 Art. 3.1b: CISPR 25:2016 & ISO 11452-2:2004 Art. 3.2: ETSI EN 300 330 V2.1.1:2017

Renald Plante, Eng.
Director, Product Development, Can-Am ATV & Spyder
Bombardier Recreational Products Inc.

Valcourt, QC, Canada

May 9th, 2022

ski-doo LYNX SEVADO EVTRADE ROTAX CAN-AM

UK-DECLARATION OF CONFORMITY



565 de la Montagne Street
Valcourt (Québec) J0E 2L0
Canada
www.brp.com

UK Declaration of Conformity

Authorized Representative: BRP Recreational Products UK Ltd.,
Castle Chambers, 43 Castle Street, Liverpool, L2 9SH

This declaration of conformity is issued under the sole responsibility of the manufacturer.

The undersigned, representing the manufacturer, hereby declares that model year **2023 All Terrain Vehicles** marked with the ^{UK}CA mark and a 17-character vehicle identification number structured as **3JBxxxxxxPxxxxxxx** under commercial names **Can-Am Outlander** and **Can-Am Renegade** comply with all the relevant provisions of the following Statutory Instruments:

Supply of Machinery (Safety) Regulations 2008, UK SI 2008/1597 as amended up to and including SI 2020/1112	ISO 12100:2010 & EN 15997:2011
Non-Road Mobile Machinery (Type-Approval and Emission of Gaseous and Particulate Pollutants) Regulations 2018, UK SI 2018/764 as amended up to and including SI 2020/1393	Category ATS, Stage V emissions limits
Electromagnetic Compatibility Regulations 2016, UK SI 2016/1091 as amended up to and including SI 2020/1112	CISPR 12:2007/A1:2009 & IEC 61000-6-1:2016 or UN R10.04 or later version
Batteries and Accumulators (Placing on the Market) Regulations 2008, UK SI 2008/2164 as amended up to and including UK SI 2020/904	EN 50342-7:2015
Radio Equipment Regulations 2017, UK SI 2017/1206 as amended up to and including SI 2020/1112 (If fitted with radio frequency (RF) D.E.S.S. key)	Art. 3.1a: IEC 62368-1:2014 Art. 3.1b: CISPR 25:2016 & ISO 11452-2:2004 Art. 3.2: ETSI EN 300 330 V2.1.1:2017

Renald Plante, Eng.
Director, Product Development, Can-Am ATV & Spyder
Bombardier Recreational Products Inc.

Valcourt, QC, Canada

May 9th, 2022

skf-doo LYNX SENADOO EVRIDE ROTAX CAN-AM

EAC DECLARATION OF CONFORMITY

**Left blank for Eurasian Conformity
mark where applicable**

This page is intentionally blank

TECHNICAL SPECIFICATIONS

TECHNICAL SPECIFICATIONS

ENGINE			
Engine type		ROTAX®, 4-stroke, 2 cylinders (V-twin), liquid cooled	
Valve train		4 valves/cylinder (mechanical adjustment), single overhead camshaft (SOHC) with timing chain	
Valve clearance		Intake	0.06 to 0.14 mm (.0024 to .0055 in)
		Exhaust	0.11 to 0.19 mm (.0043 to .0075 in)
Bore		650	82 mm (3.23 in)
		1000R	91 mm (3.58 in)
Stroke		650	61.5 mm (2.42 in)
		1000R	75 mm (2.95 in)
Displacement		650	650 cm ³ (39.7 in ³)
		1000R	976 cm ³ (59.6 in ³)
Exhaust system		NRMM models	Catalyst
		All other	Spark arrestor approved by USDA Forest Service
Air filter		Synthetic paper filter with foam	

LUBRICATION SYSTEM				
Type		Wet sump. Replaceable cartridge oil filter		
Oil filter		BRP Rotax paper type, replaceable		
Engine oil		Capacity (oil change with filter)	2.0 l (2.1 qt (liq.,US))	
		Recommended XPS oil	General purpose	5W40 Synthetic blend oil
			Cold temperature	0W40 Synthetic oil
		Warm temperature	10W50 Synthetic oil	

LUBRICATION SYSTEM		
	Alternate oil if XPS products are not available	5W40 or 10W50 motor oil that meets the requirements for API service classification SN or JASO MA2

COOLING SYSTEM			
Coolant	Recommended XPS coolant		XPS extended life pre-mixed coolant
	Alternate if XPS product is not available		Ethyl glycol / water mix (50%/50%), or coolant specifically designed for aluminum engines
	Capacity	650	3.4 l (.9 gal (liq.,US))
1000R		3.5 l (.92 gal (liq.,US))	

TRANSMISSION	
Type	CVT (Continuously Variable Transmission), sub-transmission with L/H/N/R/P, standard engine braking
Engagement RPM	1800 RPM

GEARBOX		
Type	Dual range (HI-LO) with park, neutral and reverse	
Gearbox oil	Capacity	450 ml (15.22 fl oz (US))
	Recommended XPS oil	XPS 75W140 Synthetic gear oil
	Alternate if XPS product is not available	75W140 API GL-5 synthetic gear oil

ELECTRICAL SYSTEM	
Magneto generator output	650 W @ 6000 RPM
Ignition system type	IDI (Inductive Discharge Ignition)
Ignition timing	Not adjustable

ELECTRICAL SYSTEM			
Spark plug	Quantity	650	2
	Make and type		NGK DCPR8E or equivalent
	Gap		0.8 to 0.9 mm (.031 to .035 in)
	Quantity	1000R	2
	Make and type		NGK LMAR8D-J or equivalent
	Gap		0.7 to 0.9 mm (.028 to .035 in)
Engine RPM limiter setting	Forward	8000 RPM	
	Reverse	15 km/h (9 MPH) (without override)	
Battery	Type	Maintenance free	
	Voltage	12 volts	
	Nominal rating	18 A•h	
	Power starter output	0.7 KW	
Headlights	High	LEDs	
	Low	LEDs	
Taillights			2 x 5/21 W
Fuses	Refer to <i>Fuses</i> in <i>Maintenance</i>		

FUEL SYSTEM			
Fuel delivery	650		Electronic Fuel Injection (EFI), 46 mm throttle body, 1 injector per cylinder
	1000R		Electronic Fuel Injection (EFI), 54 mm throttle body, 1 injector per cylinder
Fuel pump	Type	Electrical (in fuel tank)	
Idle speed			1250 ± 100 RPM
Fuel	Type	650	Regular unleaded gasoline Refer to <i>Fuel Requirement</i>

FUEL SYSTEM			
	Minimum octane rating		87 Pump Posted AKI (91 RON or 95 E10 RON)
	Type	1000R	Premium unleaded gasoline Refer to <i>Fuel Requirement</i>
	Recommended octane rating		91 Pump Posted AKI (95 E10 RON)
	Minimum octane rating		87 Pump Posted AKI (91 RON or 95 E10 RON)
Fuel tank capacity			20.5 l (5.4 gal (liq.,US))
Fuel remaining when low fuel light turns ON			± 5 l (1.3 gal (liq.,US))

DRIVE SYSTEM		
Drive system type		Selectable 2WD, 4WD and 4WDLock
Front drive		Visco-4Lok auto-locking and full lock front differential
Front drive ratio		3.6:1
Rear drive		Straight bevel gear / Shaft driven final drive
Rear drive ratio		3.6:1
Front differential oil	Capacity	400 ml (14 fl oz (US))
	Recommended XPS oil	XPS 75W90 Synthetic gear oil
	Alternate if XPS product is not available	75W90 API GL-5 synthetic gear oil
Rear final drive oil	Capacity	250 ml (8.45 fl oz (US))
	Recommended XPS oil	75W140 Synthetic gear oil
	Alternate if XPS product is not available	75W140 API GL-5 synthetic gear oil
CV joint grease		CV joint grease or an equivalent
Propeller shaft grease		Propeller shaft grease or an equivalent

FRONT SUSPENSION			
Suspension type			Double suspension-arm with dive-control geometry and external stabilizer bar
Shock absorber	Qty		2
	Type	650	HPG
		1000R	Fox QS3† shocks with piggyback reservoir, quick switch 3 positions
Preload adjustment type			Threaded

REAR SUSPENSION			
Suspension type			Torsional Trailing arm Independent (TTI) with external stabilizer bar
Shock absorber	Qty		2
	Type	650	HPG
		1000R	Fox QS3† shocks with piggyback reservoir, quick switch 3 positions
Preload adjustment type			Threaded

BRAKES			
Front brake	Qty		2
	Type		214 mm cross drilled disc brakes with hydraulic twin-piston calipers
Rear brake	Qty		1
	Type		214 mm cross drilled disc brake with hydraulic twin-piston caliper
Brake fluid	Capacity		260 ml (8.8 fl oz (US))
	Type		DOT 4
Caliper			Floating twin pistons (2 x 26 mm)
Brake pad material			Metallic
Minimum brake pad thickness			1 mm (.04 in)

BRAKES	
Minimum brake disc thickness	4.0 mm (.157 in)
Maximum brake disc warpage	0.2 mm (.01 in)

TIRES			
Pressure		Recommended tire inflation pressure is found on the Tire Label. Refer to appropriate <i>Important On-Product Labels</i> section for its location.	
Minimum tire thread depth		3 mm (.118 in)	
Size	Front	650	28 x 9-12
		1000R	30 x 9-14
	Rear	650	28 x 11-12
		1000R	30 x 9-14

WHEELS			
Type		Cast aluminum with beadlocks	
Rim size	Front	650	30,5 x 15,2 cm (12 x 6 in)
		1000R	35,5 x 16,5 cm (14 x 6.5 in)
	Rear	650	30,5 x 19,1 cm (12 x 7.5 in)
		1000R	35,5 x 16,5 cm (14 x 6.5 in)
Wheel offset	Front	650	41.2 mm (1.62 in)
		1000R	32 mm (1.3 in)
	Rear	650	51 mm (2.01 in)
		1000R	32 mm (1.3 in)
Wheel lug nut torque		80 ± 5 Nm (59 ± 4 lbf-ft)	

DIMENSIONS		
Overall length		224 cm (83 in)
Overall width		127 cm (50 in)
Overall height		131 cm (56 in)
Wheelbase		129.5 cm (51 in)
Wheel track	Front	103.5 cm (40.75 in)
	Rear	100.6 cm (39.61 in)
Ground clearance	650	30.5 cm (12 in)
	1000R	31.8 cm (12.5 in)

WEIGHT AND LOADING CAPACITY		
Dry weight	650	395 kg (870 lb)
	1000R	440 kg (971 lb)
Rear cargo area capacity		16 kg (35 lb)
Total vehicle load allowed (including driver, passenger, all other loads and added accessories)		141 kg (310 lb)
Towing capacity		590 kg (1,300 lb)
Rear load (including rear cargo area and tongue load if applicable)		23 kg (50 lb)

TROUBLESHOOTING

TROUBLESHOOTING GUIDELINES

Engine Does Not Turn

- 1. Engine stop switch.**
 - *Make sure that engine stop switch is in ON position.*
- 2. Ignition switch (if equipped).**
 - *Turn ignition key in ON (Start) position.*
- 3. D. E. S. S. key is not installed on D. E. S. S. post (if equipped).**
 - *Securely install D.E.S.S. key to D.E.S.S. post.*
- 4. The digital display shows BAD KEY (D. E. S. S. equipped models).**
 - *Wrong D.E.S.S. key, use the proper key for this vehicle.*
- 5. Transmission is not set on PARK or NEUTRAL.**
 - *Set transmission either in PARK or in NEUTRAL or press the brake lever.*
 - *Press the brake lever*
- 6. Burnt fuse.**
 - *Check main fuse condition.*
- 7. Weak battery or loose connections.**
 - *Check charging system.*
 - *Check connections and terminals condition.*
 - *Have the battery checked.*
 - *Contact an authorized Can-Am Off-road dealer.*
- 8. Weak starter or loose connections.**
 - *Check starter connections.*
 - *Check starter relay.*

Engine Turns Over But Fails To Start

- 1. Flooded engine (spark plug wet when removed).**
 - *Refer to Flooded Engine in Special Procedures.*
- 2. No fuel to the engine (spark plug dry when removed).**
 - *Check fuel tank level.*
 - *Check fuel pump fuse and relay.*
 - *A failure of the fuel pump may have occurred.*
 - *If engine does not start, seek service from an authorized Can-Am Off-road dealer, repair shop, or person of your own choosing for maintenance, repair, or replacement.*

Please refer to the US EPA Emission-related Warranty contained herein for information about warranty claims.

3. Spark plug/ignition (no spark).

- Check injectors/ignition fuse condition.
- Remove spark plug then reconnect to ignition coil.
- Start engine with spark plug grounded to the engine away from spark plug hole. If no spark appears, replace spark plug.
- If trouble persists, seek service from an authorized Can-Am Off-road dealer, repair shop or person of your own choosing for maintenance, repair or replacement

Please refer to the US EPA Emission-related Warranty contained herein for information about warranty claims.

4. CHECK ENGINE indicator lamp is on and the digital display shows CHECK ENGINE.

- Seek service from an authorized Can-Am Off-road dealer, repair shop or person of your own choosing for maintenance, repair or replacement.

Please refer to the US EPA Emission-related Warranty contained herein for information about warranty claims.

5. Engine is under a protection mode (limp home).

- The CHECK ENGINE indicator lamp is on and the digital display shows CHECK ENGINE, seek service from an authorized Can-Am Off-road dealer, repair shop or person of your own choosing for maintenance, repair or replacement.

Please refer to the US EPA Emission-related Warranty contained herein for information about warranty claims.

Engine Lacks Acceleration or Power

1. Fouled or defective spark plug.

- Refer to Engine Turns Over But Fails To Start.

2. Lack of fuel to engine.

- Refer to Engine Turns Over But Fails To Start.

3. Engine is overheating. (CHECK ENGINE indicator light will turn on and HI TEMP will appear in the digital display.)

- Refer to Engine Overheats.

4. Air filter/housing clogged or dirty.

- Check air filter and clean if necessary.
- Check deposits in air filter housing drain.
- Check the position of the air intake tube.

5. CVT dirty or worn-out.

- *Contact an authorized Can-Am Off-road dealer.*

6. Engine is under a protection (limp home) mode.

- *Check digital display for messages.*
- *The CHECK ENGINE indicator lamp is on and the digital display shows CHECK ENGINE or LIMP HOME, seek service from an authorized Can-Am Off-road dealer, repair shop or person of your own choosing for maintenance, repair or replacement.*

Please refer to the US EPA Emission-related Warranty contained herein for information about warranty claims.

Engine Overheats

1. Low coolant in cooling system.

- *Check engine coolant, refer to Verifying the Engine Coolant in Maintenance Procedures.*

2. Dirty radiator fins.

- *Clean radiator fins, refer to Inspecting the Radiator in Maintenance Procedures.*

3. Cooling fan inoperative.

- *Check cooling fan fuse or relay, refer to Fuses in Maintenance Procedures. If the fuse is good, seek service from an authorized Can-Am Off-road dealer, repair shop or person of your own choosing for maintenance, repair or replacement.*

Please refer to the US EPA Emission-related Warranty contained herein for information about warranty claims.

Engine Backfire

1. Exhaust system leakage.

- *Seek service from an authorized Can-Am Off-road dealer, repair shop or person of your own choosing for maintenance, repair or replacement.*

Please refer to the US EPA Emission-related Warranty contained herein for information about warranty claims.

2. Engine is running too hot.

- *Refer to Engine Lacks Acceleration Or Power.*

3. Ignition timing is incorrect or there is an ignition system failure.

- *Seek service from an authorized Can-Am Off-road dealer, repair shop or person of your own choosing for maintenance, repair or replacement.*

Please refer to the US EPA Emission-related Warranty contained herein for information about warranty claims.

Engine Misfire

1. Fouled/defective/worn spark plug.

- Clean/verify spark plug and heat range. Replace as required.

2. Water in fuel.

- Drain fuel system and refill with fresh fuel.

Vehicle Cannot Reach Full Speed

1. Engine problems.

- Refer to Engine Lacks Acceleration Or Power.

2. Brake lock lever engaged.

- Ensure the brake lock lever is completely disengaged.

3. Air filter/housing plugged or dirty.

- Check air filter and clean if necessary.
- Check deposits in air filter housing drain.
- Check the position of the air intake tube.

4. CVT dirty or worn-out.

- Contact an authorized Can-Am Off-road dealer.

5. Engine is under a protection mode (limp home).

- Check digital display for messages.
- The CHECK ENGINE indicator lamp is on and the digital display shows CHECK ENGINE or LIMP HOME, seek service from an authorized Can-Am Off-road dealer, repair shop or person of your own choosing for maintenance, repair or replacement.

Please refer to the US EPA Emission-related Warranty contained herein for information about warranty claims.

Shift Lever Is Hard To Move

1. Transmission gears are in a position that prevents the shift lever to work.

- Rock the vehicle back and forth to move the gears in the transmission and allow the shift lever to be set.

2. CVT dirty or worn-out.

- Contact an authorized Can-Am Off-road dealer.













The RPM Increases But The Vehicle Does Not Move



- 1. The transmission is on PARK or NEUTRAL position.**
 - *Select the R, HI or LO position.*
- 2. CVT dirty or worn-out.**
 - *Contact an authorized Can-Am Off-road dealer.*
- 3. Water in the CVT housing.**
 - *Contact an authorized Can-Am Off-road dealer.*

Reduced Power Steering Assist

- 1. When DPS is subjected to sustained severe steering conditions, the assistance provided by the DPS motor may be reduced to protect the system.**
 - *Once the load is reduced, the normal steering assistance will return.*
- 2. The CHECK ENGINE indicator lamp is ON and the digital display shows CHECK DPS**
 - *Seek service from an authorized Can-Am Off-road dealer, repair shop or person of your own choosing for maintenance, repair or replacement.*

DIGITAL DISPLAY MESSAGES

Message	Pilot lamp(s) ON	Beeper	Description
BAD KEY		None	Indicates that you have used the wrong ignition key or D.E.S.S. key, use the proper key for this vehicle. It is also possible that the key has a bad contact, remove and clean key.
DESS KEY NOT RECOGNIZED		None	Indicates that there possibly is a bad contact, remove and clean key.
PARK BRAKE		None	Is displayed when the brake lock lever is engaged for more than 15 seconds (while riding).
LO BATT		None	Low battery voltage, check battery voltage and charging system.
HI BATT		None	High battery voltage, check battery voltage and charging system.
LOW OIL (1)		Single - long	Engine low oil pressure, stop engine immediately.
No oil		Buzzer 2 seconds ON and 15 minutes OFF	No engine oil, stop engine immediately.
HI TEMP		Single - long	Engine is overheating, refer to <i>ENGINE OVERHEATS</i> in <i>Troubleshooting</i>
LIMP HOME		Single - long	Serious fault on the engine that can change the normal operation of the engine, CHECK ENGINE indicator lamp will also blink, refer to <i>Troubleshooting</i> .
CHECK ENGINE		None	Engine fault, CHECK ENGINE indicator lamp will also be ON, refer to <i>Troubleshooting</i> .
NO ECM COMMUNICATION		None	Communication error between speedometer and engine control module (ECM)
CHECK DPS		None	Indicates that the Dynamic Power Steering (DPS) does not work properly. See an authorized Off-road Can-Am dealer.

MAINTENANCE REQUIRED		None	Displayed in gauge when vehicle is due for a maintenance
TPS FAULT PRESS OVERRIDE BUTTON TO LIMP HOME		None	Throttle position sensor does not work properly. Seek service from an authorized OFF-road Can-Am dealer, repair shop or person of your own choosing for maintenance, repair or replacement.
FRONT DIFFERENTIAL LOCK -LOCK ACTIVATION		Single - short	The front differential lock is activated.
FRONT DIFFERENTIAL LOCK -UNLOCK	None	Double - short	The front differential lock is unlocked.
SPORT MODE ACTIVE	<i>SPORT</i>	Single - short	The SPORT mode is now selected.

NOTICE

(1) If the message and the check engine light stays on after engine starting, stop engine. Check engine oil level. Refill if necessary. If the oil level is good, seek service from an authorized Can-Am off-road dealer, repair shop or person of your own choosing for maintenance, repair or replacement. Please refer to the US EPA Emissions-related warranty contained herein for information about warranty claims. Do not use the vehicle until repaired.

WARRANTY

BRP LIMITED WARRANTY USA AND CANADA: 2023 CAN-AM® ATV

SCOPE OF THE LIMITED WARRANTY

Bombardier Recreational Products Inc. ("BRP") warrants its 2023 Can-Am ATV sold by authorized Can-Am ATV dealers (as hereinafter defined) in the United States of America ("USA") and in Canada from defects in material or workmanship for the period and under the conditions described below. This limited warranty will become null and void if: (1) the ATV was used for racing or any other competitive activity, at any point, even by a previous owner; or (2) the ATV has been altered or modified in such a way so as to adversely affect its operation, performance or durability, or has been altered or modified to change its intended use.

Non-factory installed parts and accessories are not covered under this limited warranty.

Please refer to the applicable parts and accessories limited warranty text.

LIMITATIONS OF LIABILITY

THIS WARRANTY IS EXPRESSLY GIVEN AND ACCEPTED IN LIEU OF ANY AND ALL OTHER WARRANTIES, EXPRESSED OR IMPLIED, INCLUDING WITHOUT LIMITATION ANY WARRANTY OF MERCHANTABILITY OR FITNESS FOR A PARTICULAR PURPOSE TO THE EXTENT THAT THEY CANNOT BE DISCLAIMED, THE IMPLIED WARRANTIES ARE LIMITED IN DURATION TO THE LIFE OF THE EXPRESS WARRANTY. INCIDENTAL AND CONSEQUENTIAL DAMAGES ARE EXCLUDED FROM COVERAGE UNDER THIS WARRANTY SOME STATES/PROVINCES DO NOT ALLOW FOR THE DISCLAIMERS, LIMITATIONS AND EXCLUSIONS IDENTIFIED ABOVE, AS A RESULT, THEY MAY NOT APPLY TO YOU. THIS WARRANTY GIVES YOU SPECIFIC RIGHTS, AND YOU MAY ALSO HAVE OTHER LEGAL RIGHTS WHICH MAY VARY FROM STATE TO STATE, OR PROVINCE TO PROVINCE.

Neither the distributor, any BRP dealer nor any other person has been authorized to make any affirmation, representation or warranty regarding the product, other than those contained in this limited warranty, and if made, shall not be enforceable against BRP.

BRP reserves the right to modify this limited warranty at any time, being understood that such modification will not alter the warranty conditions applicable to the products sold while this warranty is in effect.

EXCLUSIONS—ARE NOT WARRANTED

The following are not warranted under any circumstances:

- Normal wear and tear;
- Routine maintenance items, tune ups, adjustments;
- Damage caused by failure to provide proper maintenance and/or storage, as described in the Operator's Guide;
- Damage resulting from removal of parts, improper repairs, service, maintenance, modifications or use of parts not manufactured or approved by BRP or resulting from repairs done by a person that is not an authorized servicing Can-Am ATV dealer;

- Damage caused by abuse, abnormal use, neglect or operation of the product in a manner inconsistent with the recommended operation described in the Can-Am ATV Operator's Guide;
- Damage resulting from accident, submersion, fire, theft, vandalism or any act of God;
- Operation with fuels, oils or lubricants which are not suitable for use with the product (see the Operator's Guide);
- Damages from rust, corrosion or exposure to the elements;
- Damage resulting from water or snow ingestion;
- Incidental or consequential damages, or damages of any kind including without limitation towing, storage, telephone, rental, taxi, inconvenience, insurance coverage, loan payments, loss of time, loss of income.

WARRANTY COVERAGE PERIOD

This limited warranty will be in effect from (1) the date of delivery to the first retail consumer or (2) the date the product is first put into use, whichever occurs first and for the applicable period below:

- SIX (6) CONSECUTIVE MONTHS, for private use or commercial use owners.
- For emission-related components; please also refer to the *US EPA Emission-Related Warranty* contained herein.
- For evaporative emission-related components of California models equipped with evaporative emission control system produced by BRP for sale in the State of California that are originally sold to a resident or subsequently warranty registered to a resident in the State of California, please also refer to the *California Evaporative Emissions Control Warranty Statement* contained herein.

The repair or replacement of parts or the performance of service under this warranty does not extend the life of this warranty beyond its original expiration date.

CONDITIONS TO HAVE WARRANTY COVERAGE

This warranty coverage is available only if each of the following conditions has been fulfilled:

- The 2023 Can-Am ATV must be purchased as new and unused by its first owner from a Can-Am ATV dealer authorized to distribute Can-Am ATVs in the country in which the sale occurred ("Can-Am ATV dealer");
- The BRP specified pre-delivery inspection process must be completed and documented and signed by the purchaser;
- The 2023 Can-Am ATV must have undergone proper registration by an authorized Can-Am ATV dealer;
- The 2023 Can-Am ATV must be purchased in the country in which the purchaser resides;
- Routine maintenance outlined in the Operator's Guide must be timely performed in order to maintain warranty coverage. BRP reserves the right to make warranty coverage contingent upon proof of proper maintenance.

BRP will not honor this limited warranty to any private use owner or commercial use owner if one of the preceding conditions has not been met. Such limitations

are necessary in order to allow BRP to preserve both the safety of its products, and also that of its consumers and the general public.

WHAT TO DO TO OBTAIN WARRANTY COVERAGE

The customer must cease using the Can-Am ATV upon the appearance of an anomaly.

The customer must notify a servicing BRP dealer within three (3) days of the appearance of a defect, and provide it with reasonable access to the product and reasonable opportunity to repair it.

The customer must also present to the authorized BRP dealer, proof of purchase of the product and must sign the repair/work order prior to starting the repair in order to validate the warranty repair.

All parts replaced under this limited warranty become the property of BRP.

WHAT BRP WILL DO

BRP's obligations under this warranty are limited to, at its sole discretion, repairing parts found defective under normal use, maintenance and service, or replacing such parts with new genuine Can-Am ATV parts without charge for parts and labor, at any authorized BRP dealer during the warranty coverage period under the conditions described herein. No claim of breach of warranty shall be cause for cancellation or rescission of the sale of the Can-Am ATV to the owner.

In the event that service is required outside of the country of original sale, the owner will bear responsibility for any additional charges due to local practices and conditions, such as, but not limited to, freight, insurance, taxes, license fees, import duties, and any and all other financial charges, including those levied by governments, states, territories and their respective agencies.

BRP reserves the right to improve or modify products from time to time without assuming any obligation to modify products previously manufactured.

TRANSFER

If the ownership of a product is transferred during the warranty coverage period, this limited warranty, subject to its terms and conditions, shall also be transferred and be valid for the remaining coverage period provided BRP or an authorized Can-Am ATV Distributor/Dealer receives a proof that the former owner agreed to the transfer of ownership, in addition to the coordinates of the new owner.

CONSUMER ASSISTANCE

In the event of a controversy or a dispute in connection with this limited warranty, BRP suggests that you try to resolve the issue at the dealership level. We recommend discussing the issue with the authorized dealer's service manager or owner.

If the matter still remains unresolved, contact BRP by filling out the customer contact form at www.brp.com or contact BRP by mail at one of the addresses listed under the *Contact Us* section of this guide.

US EPA EMISSION - RELATED WARRANTY

Bombardier Recreational Products Inc. ("BRP") warrants to the ultimate purchaser and each subsequent purchaser that this new vehicle, including all parts of its exhaust emission control system and its evaporative emission control system, meets two conditions:

1. It is designed, built, and equipped so it conforms at the time of sale to the ultimate purchaser with the requirements of 40 CFR 1051 and 40 CFR 1060.
2. It is free from defects in materials and workmanship that may keep it from meeting the requirements of 40 CFR 1051 and 40 CFR 1060.

Where a warrantable condition exists, BRP will repair or replace, as it elects, any part or component with a defect in materials or workmanship that would increase the engine's emissions of any regulated pollutant within the stated warranty period at no cost to the owner, including expenses related to diagnosing and repairing or replacing emission-related parts. All defective parts replaced under this warranty become the property of BRP.

For all emission-related warranty claims, BRP is limiting the diagnosis and repair of emission-related parts to the authorized Can-Am dealers, unless for emergency repairs as required by item 2 of the following list.

As a certifying manufacturer, BRP will not deny emission-related warranty claims based on any of the following:

1. Maintenance or other service BRP or BRP's authorized facilities performed.
2. Engine/equipment repair work that an operator performed to correct an unsafe, emergency condition attributable to BRP as long as the operator tries to restore the engine/equipment to its proper configuration as soon as possible.
3. Any action or inaction by the operator unrelated to the warranty claim.
4. Maintenance that was performed more frequently than BRP specify.
5. Anything that is BRP fault or responsibility.
6. The use of any fuel that is commonly available where the equipment operates unless BRP written maintenance instructions state that this fuel would harm the equipment's emission control system and operators can readily find the proper fuel. See maintenance information section and fuel requirements of fueling section.

Emission-Related Warranty Period

The emission-related warranty is valid for the following period whichever comes first.

	HOURS	MONTHS	KILOMETERS
Exhaust emission-related components	500	30	5000
Evaporative emission-related components	N/A	24	N/A

Components Covered

The emission-related warranty covers all components whose failure would increase an engine's emissions of any regulated pollutant, including the following listed components:

1. For exhaust emissions, emission-related components include any engine parts related to the following systems:
 - Air-induction system
 - Fuel system
 - Ignition system
 - Exhaust gas recirculation systems.
2. The following parts are also considered emission-related components for exhaust emissions:
 - After treatment devices
 - Crankcase ventilation valves
 - Sensors
 - Electronic control units.
3. The following parts are considered emission-related components for evaporative emissions:
 - Fuel tank
 - Fuel cap
 - Fuel line
 - Fuel line fittings
 - Clamps*
 - Pressure relief valves*
 - Control valves*
 - Control solenoids*
 - Electronic controls*
 - Vacuum control diaphragms*
 - Control cables*
 - Control linkages*
 - Purge valves
 - Vapor hoses
 - Liquid/vapor separator
 - Carbon canister
 - Canister mounting brackets
 - Carburetor purge port connector.

NOTE: *As related to the evaporative emission control system.

4. Emission-related components also include any other part whose only purpose is to reduce emissions or whose failure will increase emissions without significantly degrading engine/equipment performance.

Limited Applicability

As a certifying manufacturer, BRP may deny emission-related warranty claims for failures that have been caused by the owner's or operator's improper maintenance or use, by accidents for which the manufacturer has no responsibility, or by acts of God. For example, an emission-related warranty claim need not be honored for failures that have been directly caused by the operator's abuse of the engine/equipment or the operator's use of the engine/equipment in a manner for which it was not designed and are not attributable to the manufacturer in anyway.

If you have any question regarding your warranty rights and responsibility or for the name and location of the nearest authorized BRP dealer, you should contact BRP by filling out the customer contact form at www.brp.com or contact BRP by mail at one of the addresses listed under the CONTACT US section of this guide, or call at 1-888-272-9222.

CALIFORNIA EVAPORATIVE EMISSIONS CONTROL WARRANTY STATEMENT

The warranty periods begin on the date the new Off-Highway Recreational Vehicle ("OHRV") is delivered to an ultimate purchaser.

Bombardier Recreational Products Inc. ("BRP") warrants to the ultimate purchaser and each subsequent purchaser that the OHRV is:

1. Designed, built, and equipped so as to conform, at the time of sale, with all applicable laws, rules and regulations; and
2. Free from defects in materials and workmanship that may cause the failure of a warranted part. All replacement parts must be identical in all material respects to that part as described in BRP's Executive Order of Certification application.

The warranty on emissions-related parts function as follows:

1. Repair or replacement of any warranted part must be performed at no charge to the OHRV owner, at a warranty station, except in the case of a temporary repair when a warranted part or a warranty station is not reasonably available to the OHRV owner. In the event a temporary repair is permitted, repairs may be performed at any available service establishment, or by the owner, using any replacement part. BRP must reimburse the owner for his or her expenses including diagnostic charges for such temporary repair or replacement, not to exceed BRP's suggested retail price for all warranted parts replaced and labor charges based on BRP's recommended time allowance for the warranty repair and the geographically appropriate hourly labor rate.
2. The lack of availability of warranted parts or the incompleteness of repairs within a reasonable time period, not to exceed 30 days from the time the OHRV is initially presented to the warranty station for repair, will qualify the need for a temporary repair.
3. Any warranted part which is not scheduled for replacement as part of maintenance in the written instructions must be warranted for the warranty period defined below. If any such part fails during the warranty period, it must be repaired or replaced by BRP. Any such part repaired or replaced under warranty must be fully warranted.
4. Any warranted part which is scheduled only for regular inspection in the written instructions must be warranted for the warranty period defined below. A statement in such written instructions to the effect of "repair or replace as necessary" does not reduce the period of warranty coverage. Any such part repaired or replaced under warranty is warranted for the remaining warranty period.
5. Any warranted part which is scheduled for replacement as part of maintenance in the written instructions is warranted for the period of time prior to the first scheduled replacement point for that part. If the part fails before the first scheduled replacement point, the part will be repaired or replaced by BRP. Any such part repaired or replaced under warranty is warranted for the remainder of the period prior to the first scheduled replacement point for the part.
6. Warranty services or repairs are provided at all manufacturer dealerships that are owned by the manufacturer or franchised to service the subject OHRVs.
7. The OHRV owner will not be charged for diagnostic labor which leads to the determination that a warranted part is, in fact, defective, provided that such diagnostic work is performed at a warranty station.

8. BRP is liable for damages to other vehicle components proximately caused by a failure, under warranty, of any warranted part.
9. Any replacement part designated by BRP may be used in warranty repairs provided without charge to the OHRV owner. Such use will not reduce the warranty obligations of BRP, except that BRP will not be liable for repair or replacement of any replacement part which is not a warranted part.
10. Any add-on or modified part exempted by the Air Resources Board from the prohibitions of section 27156 of the California Vehicle Code may be used on an OHRV. Such use, in and of itself, will not be grounds for disallowing a warranty claim. BRP is not liable to warrant failures of warranted parts caused by the use of an add-on or modified part (s) unless such part (s) are also warranted.

Conditions and exclusions:

- BRP may deny you warranty coverage if your OHRV or a part has failed directly due to abuse, neglect, improper maintenance or unapproved modifications.

Your Warranty Rights And Obligations

The California Air Resources Board is pleased to explain the evaporative emissions control system warranty on your 2023 All-Terrain Vehicle. In California, new off-highway recreational vehicles must be designed, built, and equipped to meet the State's stringent anti-smog standards. BRP must warrant the evaporative emissions control system on your All-Terrain Vehicle for the periods of time listed below provided there has been no abuse, neglect, improper maintenance, or unapproved modification of your All-Terrain Vehicle.

Your evaporative emissions control system may include parts such as the carburetor or fuel-injection system, fuel tank, fuel hoses, carbon canister, and engine computer. Also included may be hoses, belts, connectors and other evaporative emissions-related assemblies. Where a warrantable condition exists, Bombardier Recreational Products Inc. will repair your All-Terrain Vehicle at no cost to you including diagnosis, parts and labor.

OHRV Manufacturer's Warranty Coverage

The warranty period for this OHRV is 60 months, or 5000 miles, or 500 hours, whichever comes first.

Parts covered:

1. Canister Mounting Bracket(s)
2. Carbon Canister
3. Purge Port Connector
4. Clamp(s)*
5. Electronic Control*
6. Fuel Cap
7. Filler Neck
8. Filler Neck Hose
9. Fuel Line(s)
10. Fuel Line Fitting(s)
11. Fuel Tank
12. Pressure Relief Valve(s)*

13. Purge Valve(s)
14. Check Valve(s)*
15. Vapor Hose(s)
16. Flow Reducer
17. Filter(s)*
18. All other parts not listed that may affect the evaporative emissions control system

NOTE: *As related to the evaporative emission control system.

If any evaporative emissions-related part on your All-Terrain Vehicle is defective the part will be repaired or replaced by Bombardier Recreational Products Inc.

Owner's Warranty Responsibilities

As the All-Terrain Vehicle owner, you are responsible for the performance of the required maintenance listed in your owner's manual. Bombardier Recreational Products Inc. recommends that you retain all receipts covering maintenance on your All-Terrain Vehicle, but Bombardier Recreational Products Inc. cannot deny warranty solely for the lack of receipts or for failure to ensure the performance of a scheduled maintenance.

As an owner you are responsible for presenting your All-Terrain Vehicle to a Bombardier Recreational Products Inc. dealer as soon as a problem exists. The warranty repairs should be completed in a reasonable time, not to exceed 30 days.

As an All-Terrain Vehicle owner, you should also be aware that Bombardier Recreational Products Inc. may deny you warranty coverage if your All-Terrain Vehicle or a part has failed due to abuse, neglect, improper maintenance or unapproved modifications.

If you have any questions regarding your warranty rights and responsibilities, you should contact:

- Bombardier Recreational Products Inc. at 1-888-272-9222 or,
- The California Air Resources Board at 9528 Telstar Avenue, El Monte, CA 91731.

BRP INTERNATIONAL LIMITED WARRANTY: 2023 CAN-AM® ATV

SCOPE OF THE LIMITED WARRANTY

Bombardier Recreational Products Inc. ("BRP") warrants its 2023 Can-Am ATV sold by Can-Am ATV distributors or dealers authorized by BRP to distribute Can-Am ATVs ("Can-Am ATV Distributor/Dealer") outside of the United States of America ("USA"), Canada, member states of the European Economic Area (which is comprised of the member states of the European Union plus the United Kingdom, Norway, Iceland and Liechtenstein) ("EEA"), Turkey, member states of the Commonwealth of the Independent States (including Ukraine and Turkmenistan) ("CIS") and Turkey, from defects in material or workmanship for the period and under the conditions described below.

Non-factory installed parts and accessories are not covered under this limited warranty.

Please refer to the applicable parts and accessories limited warranty text.

This limited warranty will become null and void if: (1) The ATV was used for racing or any other competitive activity, at any point, even by a previous owner; or (2) the ATV has been altered or modified in such a way so as to adversely affect its operation, performance or durability, or has been altered or modified to change its intended use.

LIMITATIONS OF LIABILITY

TO THE EXTENT PERMITTED BY LAW, THIS WARRANTY IS EXPRESSLY GIVEN AND ACCEPTED IN LIEU OF ANY AND ALL OTHER WARRANTIES, EXPRESSED OR IMPLIED, INCLUDING WITHOUT LIMITATION ANY WARRANTY OF MERCHANTABILITY OR FITNESS FOR A PARTICULAR PURPOSE. TO THE EXTENT THAT THEY CANNOT BE DISCLAIMED, THE IMPLIED WARRANTIES ARE LIMITED IN DURATION TO THE LIFE OF THE EXPRESS WARRANTY. INCIDENTAL AND CONSEQUENTIAL DAMAGES ARE EXCLUDED FROM COVERAGE UNDER THIS WARRANTY. SOME JURISDICTIONS DO NOT ALLOW FOR THE DISCLAIMERS, LIMITATIONS AND EXCLUSIONS IDENTIFIED ABOVE, AS A RESULT, THEY MAY NOT APPLY TO YOU. THIS WARRANTY GIVES YOU SPECIFIC RIGHTS AND YOU MAY ALSO HAVE OTHER LEGAL RIGHTS WHICH MAY VARY FROM COUNTRY TO COUNTRY. (FOR PRODUCTS PURCHASED IN AUSTRALIA SEE WARRANTY COVERAGE PERIOD BELOW).

Neither the Can-Am ATV Distributor/Dealer nor any other person has been authorized to make any affirmation, representation or warranty regarding the product, other than those contained in this limited warranty, and if made, shall not be enforceable against BRP.

BRP reserves the right to modify this warranty at any time, being understood that such modification will not alter the warranty conditions applicable to the products sold while this warranty is in effect.

EXCLUSIONS – ARE NOT WARRANTED

The following are not warranted under this limited warranty under any circumstances:

- Normal wear and tear;
- Routine maintenance items, tune ups, adjustments;
- Damage caused by negligence or failure to provide proper maintenance and/or storage, as described in the Operator's Guide;
- Damage resulting from removal of parts, improper repairs, service, maintenance, modifications or use of parts or accessories not manufactured or approved by BRP which in its reasonable judgement are either incompatible with the product or adversely affect its operation, performance and durability, or resulting from repairs done by a person that is not an authorized servicing Can-Am ATV Distributor/Dealer;
- Damage caused by abuse, abnormal use, neglect, racing or operation of the product in a manner inconsistent with the recommended operation described in the Operator's Guide;
- Damage resulting from accident, submersion, fire, snow or water ingestion, theft, vandalism or any act of God;
- Operation with fuels, oils or lubricants which are not suitable for use with the product (see the Operator's Guide);
- Damage resulting from rust, corrosion or exposure to the elements;
- Incidental or consequential damages, or damages of any kind including without limitation towing, storage, transportation expenses, telephone, rental, taxi, inconvenience, insurance coverage, loan payments, loss of time, loss of income; or time missed for downtime experience due to service work.

WARRANTY COVERAGE PERIOD

This warranty will be in effect from (1) the date of delivery to the first retail consumer or (2) the date the product is first put into use, whichever occurs first and for a period of:

- SIX (6) CONSECUTIVE MONTHS for private use or commercial use.

In AUSTRALIA and NEW-ZEALAND only, this warranty will be in effect from (1) the date of delivery to the first retail consumer or (2) the date the product is first put into use, whichever occurs first, and for a period of (1) TWENTY-FOUR (24) CONSECUTIVE MONTHS or (2) a total use of FIFTEEN THOUSAND (15 000) kilometers, whichever occurs first, for private use or commercial use.

The repair or replacement of parts or the performance of service under this warranty does not extend the life of this warranty beyond its original expiration date.

Note that the duration and any other modalities of the warranty coverage are subject to the applicable national or local legislation in the customer's country.

FOR PRODUCTS SOLD IN AUSTRALIA ONLY

Nothing in these Warranty terms and conditions should be taken to exclude, restrict or modify the application of any condition, warranty, guarantee, right or remedy conferred or implied under the Competition and Consumer Act 2010 (Cth), including the Australian Consumer Law or any other law, where to do so would contravene that law, or cause any part of these terms and conditions to be void. The benefits given to you under this limited warranty are in addition to other rights and remedies that you have under Australian law.

Our goods come with guarantees that cannot be excluded under the Australian Consumer Law. You are entitled to a replacement or refund for a major failure

and for compensation for any other reasonably foreseeable loss or damage. You are also entitled to have the goods repaired or replaced if the goods fail to be of acceptable quality and the failure does not amount to a major failure.

CONDITIONS TO HAVE WARRANTY COVERAGE

This warranty coverage is available only if each of the following conditions has been fulfilled:

- The 2023 Can-Am ATV must be purchased as new and unused by its first owner from a Can-Am ATV Distributor/Dealer authorized to distribute Can-Am ATVs in the country in which the sale occurred;
- The BRP specified pre-delivery inspection process must be completed and documented;
- The product must have undergone proper registration by an authorized Can-Am ATV Distributor/Dealer;
- The 2023 Can-Am ATV must be purchased in the country or union of countries in which the purchaser resides; and
- Routine maintenance outlined in the Operator's Guide must be timely performed in order to maintain warranty coverage. BRP reserves the right to make warranty coverage contingent upon proof of proper maintenance.

BRP will not honour this limited warranty to any private use owner or commercial use owner if one of the preceding conditions has not been met. Such limitations are necessary in order to allow BRP to preserve both the safety of its products, and also that of its consumers and the general public.

WHAT TO DO TO OBTAIN WARRANTY COVERAGE

The customer must cease using the ATV upon the appearance of an anomaly. The customer must notify a servicing Can-Am ATV Distributor/Dealer within two (2) days of the appearance of a defect, and provide it with reasonable access to the product and reasonable opportunity to repair it. The customer must also present to the authorized Can-Am ATV Distributor/Dealer proof of purchase of the product and must sign the repair/work order prior to starting the repair in order to validate the warranty repair. All parts replaced under this limited warranty become the property of BRP.

Note that the notification period is subject to the applicable national or local legislation in customer's country.

WHAT BRP WILL DO

To the extent permitted by law, BRP's obligations under this warranty are limited to, at its sole discretion, repairing parts found defective under normal use, maintenance and service, or replacing such parts with new genuine Can-Am ATV parts without charge for parts and labour, at any authorized Can-Am ATV Distributor/Dealer during the warranty coverage period under the conditions described herein. BRP's responsibility is limited to making the required repairs or replacements of parts. No claim of breach of warranty shall be cause for cancellation or rescission of the sale of the Can-Am ATV to the owner. You may have other legal rights which may vary from country to country.

In the event that service is required outside of the country of original sale, the owner will bear responsibility for any additional charges due to local practices and conditions, such as, but not limited to, freight, insurance, taxes, license fees, import duties, and any and all other financial charges, including those levied by governments, states, territories and their respective agencies.

BRP reserves the right to improve or modify products from time to time without assuming any obligation to modify products previously manufactured.

TRANSFER

If the ownership of a product is transferred during the warranty coverage period, this warranty shall also be transferred and be valid for the remaining coverage period provided BRP or an authorized Can-Am ATV Distributor/Dealer receives a proof that the former owner agreed to the transfer of ownership, in addition to the coordinates of the new owner.

CONSUMER ASSISTANCE

In the event of a controversy or a dispute in connection with this limited warranty, BRP suggests that you try to resolve the issue at the Can-Am ATV Distributor/Dealer level. We recommend discussing the issue with the authorized Can-Am ATV Distributor/Dealer's service manager or owner.

If the matter still remains unresolved, contact BRP by filling out the customer contact form at **www.brp.com** or contact BRP by mail at one of the addresses listed under the *Contact Us* section of this guide.

BRP LIMITED WARRANTY FOR THE EUROPEAN ECONOMIC AREAS, THE COMMONWEALTH OF THE INDEPENDENT STATES AND TURKEY: 2023 CAN-AM® ATV

SCOPE OF THE LIMITED WARRANTY

Bombardier Recreational Products Inc. ("BRP") warrants its 2023 Can-Am ATVs sold by distributors or dealers authorized by BRP to distribute Can-Am ATVs ("Can-Am ATV Distributor/Dealer") in member states of the European Economic Area (which is comprised of the member states of the European Union plus the United Kingdom, Norway, Iceland and Liechtenstein) ("EEA"), in member states of the Commonwealth of the Independent States (including Ukraine and Turkmenistan) ("CIS") and Turkey from defects in material or workmanship for the period and under the conditions described below.

Non-factory installed parts and accessories are not covered under this limited warranty.

Please refer to the applicable parts and accessories limited warranty text.

This limited warranty will become null and void if: (1) The ATV was used for racing or any other competitive activity, at any point, even by a previous owner; or (2) the ATV has been altered or modified in such a way so as to adversely affect its operation, performance or durability, or has been altered or modified to change its intended use.

LIMITATIONS OF LIABILITY

TO THE EXTENT PERMITTED BY LAW, THIS WARRANTY IS EXPRESSLY GIVEN AND ACCEPTED IN LIEU OF ANY AND ALL OTHER WARRANTIES, EXPRESSED OR IMPLIED, INCLUDING WITHOUT LIMITATION ANY WARRANTY OF MERCHANTABILITY OR FITNESS FOR A PARTICULAR PURPOSE. TO THE EXTENT THAT THEY CANNOT BE DISCLAIMED, THE IMPLIED WARRANTIES ARE LIMITED IN DURATION TO THE LIFE OF THE EXPRESS WARRANTY. INCIDENTAL AND CONSEQUENTIAL DAMAGES ARE EXCLUDED FROM COVERAGE UNDER THIS WARRANTY. SOME JURISDICTIONS DO NOT ALLOW FOR THE DISCLAIMERS, LIMITATIONS AND EXCLUSIONS IDENTIFIED ABOVE, AS A RESULT, THEY MAY NOT APPLY TO YOU. THIS WARRANTY GIVES YOU SPECIFIC RIGHTS AND YOU MAY ALSO HAVE OTHER LEGAL RIGHTS WHICH MAY VARY FROM COUNTRY TO COUNTRY.

Neither the Can-Am ATV Distributor/Dealer nor any other person has been authorized to make any affirmation, representation or warranty regarding the product, other than those contained in this limited warranty, and if made, shall not be enforceable against BRP.

BRP reserves the right to modify this warranty at any time, being understood that such modification will not alter the warranty conditions applicable to the products sold while this warranty is in effect.

EXCLUSIONS – ARE NOT WARRANTED

The following are not warranted under this limited warranty under any circumstances:

- Normal wear and tear;
- Routine maintenance items, tune ups, adjustments;
- Damage caused by negligence or failure to provide proper maintenance and/or storage, as described in the Operator's Guide;
- Damage resulting from removal of parts, improper repairs, service, maintenance, modifications or use of parts or accessories not manufactured or approved by BRP which in its reasonable judgement are either incompatible with the product or adversely affect its operation, performance and durability, or resulting from repairs done by a person that is not an authorized servicing Can-Am ATV Distributor/Dealer;
- Damage caused by abuse, abnormal use, neglect, racing or operation of the product in a manner inconsistent with the recommended operation described in the Operator's Guide;
- Damage resulting from accident, submersion, fire, snow or water ingestion, theft, vandalism or any act of God;
- Operation with fuels, oils or lubricants which are not suitable for use with the product (see the Operator's Guide);
- Damage resulting from rust, corrosion or exposure to the elements;
- Incidental or consequential damages, or damages of any kind including without limitation towing, transportation expenses, storage, telephone, rental, taxi, inconvenience, insurance coverage, loan payments, loss of time, loss of income or time missed for downtime experience due to service work.

WARRANTY COVERAGE PERIOD

This warranty will be in effect from (1) the date of delivery to the first retail consumer or (2) the date the product is first put into use, whichever occurs first and for a period of:

1. TWENTY-FOUR (24) CONSECUTIVE MONTHS for private use.
2. SIX (6) CONSECUTIVE MONTHS for commercial use or rental use.

The product is used commercially when it is used in connection with any work or employment that generates income during any part of the warranty period. The product is also used commercially when, at any point during the warranty period, it is licensed for commercial use.

The repair or replacement of parts or the performance of service under this warranty does not extend the life of this warranty beyond its original expiration date.

Note that the duration and any other modalities of the warranty coverage are subject to the applicable national or local legislation in the customer's country.

CONDITIONS TO HAVE WARRANTY COVERAGE

This warranty coverage is available only if each of the following conditions has been fulfilled:

- The 2023 Can-Am ATV must be purchased as new and unused by its first owner from a Can-Am ATV Distributor/Dealer authorized to distribute Can-Am ATVs in the country in which the sale occurred;
- The BRP specified pre-delivery inspection process must be completed and documented;
- The product must have undergone proper registration by an authorized Can-Am ATV Distributor/Dealer;

- The 2023 Can-Am ATV must be purchased within the EEA by an EEA resident, in the CIS for residents of the countries comprised in such area and in Turkey for residents of Turkey; and
- Routine maintenance outlined in the Operator's Guide must be timely performed in order to maintain warranty coverage. BRP reserves the right to make warranty coverage contingent upon proof of proper maintenance.

BRP will not honour this limited warranty to any private use owner or commercial use owner if one of the preceding conditions has not been met. Such limitations are necessary in order to allow BRP to preserve both the safety of its products, and also that of its consumers and the general public.

WHAT TO DO TO OBTAIN WARRANTY COVERAGE

The customer must cease using the ATV upon the appearance of an anomaly. The customer must notify a servicing Can-Am ATV Distributor/Dealer within two (2) months of the appearance of a defect and provide it with reasonable access to the product and reasonable opportunity to repair it. The customer must also present to the authorized Can-Am ATV Distributor/Dealer, proof of purchase of the product and must sign the repair/work order prior to starting the repair in order to validate the warranty repair. All parts replaced under this limited warranty become the property of BRP.

Note that the notification period is subject to the applicable national or local legislation in customer's country.

WHAT BRP WILL DO

To the extent permitted by law, BRP's obligations under this warranty are limited to, at its sole discretion, repairing parts found defective under normal use, maintenance and service, or replacing such parts with new genuine Can-Am ATV parts without charge for parts and labour, at any authorized Can-Am ATV Distributor/Dealer during the warranty coverage period under the conditions described herein. BRP's responsibility is limited to making the required repairs or replacements of parts. No claim of breach of warranty shall be cause for cancellation or rescission of the sale of the Can-Am ATV to the owner. You may have other legal rights which may vary from country to country.

In the event that service is required outside of the EEA, CIS or Turkey, the owner will bear responsibility for any additional charges due to local practices and conditions, such as, but not limited to, freight, insurance, taxes, license fees, import duties, and any and all other financial charges, including those levied by governments, states, territories and their respective agencies.

BRP reserves the right to improve or modify products from time to time without assuming any obligation to modify products previously manufactured.

TRANSFER

If the ownership of a product is transferred during the warranty coverage period, this warranty shall also be transferred and be valid for the remaining coverage period provided BRP or an authorized Can-Am ATV Distributor/Dealer receives a proof that the former owner agreed to the transfer of ownership, in addition to the coordinates of the new owner.

CONSUMER ASSISTANCE

In the event of a controversy or a dispute in connection with this limited warranty, BRP suggests that you try to resolve the issue at the Can-Am ATV Distributor/Dealer level. We recommend discussing the issue with the authorized Can-Am ATV Distributor/Dealer's service manager or owner.

If the matter still remains unresolved, contact BRP by filling out the customer contact form at www.brp.com or contact BRP by mail at one of the addresses listed under the *Contact Us* section of this guide.

ADDITIONAL TERMS AND CONDITIONS FOR FRANCE

The following terms and conditions are applicable to products sold in France only.

The seller shall deliver goods that are complying with the contract and shall be responsible for defects existing upon delivery. The seller shall also be responsible for defects resulting from packaging, assembling instructions or the installation when it is its responsibility per the contract or if accomplished under its responsibility. To be compliant with the contract, the good shall:

1. Be fit for normal use for goods similar thereto and, if applicable:
 - Correspond to the description provided by the seller and have the qualities presented to the buyer through sample or model;
 - Have the qualities that a buyer may legitimately expect considering the public declarations of the seller, the manufacturer of its representative, including in advertising or labeling; or
2. Have the characteristics mutually agreed upon as between the parties or be fit for the specific use intended by the buyer and brought to the attention of the seller and which accepted by the seller.

The action for failure to comply is prescribed after two years after delivery of the goods. The seller is responsible for the warranty for hidden defects of the good sold if such hidden defects are rendering the good unfit for the intended use, or if they diminish its use in such a way that the buyer would not have acquired the good or would have given a lesser price, had he known. The action for such hidden defects shall be taken by the buyer within 2 years of the discovery of the defect.

CUSTOMER INFORMATION

DATA PRIVACY INFORMATION

Bombardier Recreational Products inc., its affiliates and subsidiaries (“BRP”) is committed to protecting your privacy and support a general policy of openness about how we collect, use and disclose your personal information in the course of managing our relationship with you. **More details can be found by visiting BRP’s Privacy Policy at: <https://brp.com/en/privacy-policy.html> or by scanning the QR Code below.**

Please be assured that we have appropriate security measures in place to ensure that your personal information is protected against loss and unauthorized access.

Your personal information that may be collected by BRP, directly from you or from authorized dealers or authorized third parties, includes:

- **Contact, Demographic & Registration Information** (e.g., name, full address, phone number, email, gender, ownership history, language of communication)
- **Vehicle Information** (e.g., serial number, purchase and delivery date, unit usage, vehicle location and movements)
- **Third Party Information** (e.g., information received from BRP partners, joint-marketing activities information, social media)
- **Technological Information** (e.g., IP address, type of device, operating system, browser type, webpages you view, cookies and similar technologies when you use BRP or dealers’ websites or mobile application)
- **Interaction with BRP Information** (e.g., information collected when you call BRP’s in-house sales representatives, buy items on a BRP web Site, sign up for BRP emails, participate in BRP-sponsored contests and sweepstakes or attend BRP-sponsored events)
- **Transactional Information** (e.g., information necessary to handle returns, payment information when you purchase our products or services through our websites or mobile applications and other issues related to your purchase of BRP products)

This information may be used and processed for the following purposes:

- Safety & Security
- Customer Support for Sales & After Sales (e.g., complete or follow up with you about your purchase or maintenance)
- Registration & Warranty
- Communication (e.g., sending you a BRP satisfaction survey)
- Online Behavioural Advertising, Profiling and Location-Based Services (e.g., offer customized experience)
- Compliance & Dispute Resolution
- Marketing & Advertising
- Assistance (e.g., help with any delivery issues, handle returns, and other issues related to your purchase of BRP products).

We also may use personal information to generate aggregated or statistical data that no longer identifies you personally.

Your personal information may be disclosed to the following: BRP, BRP’s authorized dealerships, distributors, service providers, advertising & market research partners and other authorized third parties.

We may receive information about you from diverse sources, including third parties, such as BRP’s authorized dealerships and partners, with whom we offer

services or engage in joint-marketing activities. We may also receive information about you from social media platforms such as Facebook and Twitter, when you interact with us on those platforms.

Depending on the circumstances, your personal information may be communicated outside the region where you reside. Your personal information is retained only for as long as necessary for the purpose for which we obtained it and according to our retention policies.

To exercise your data privacy rights (e.g. right of access, right of rectification), to withdraw your consent in order to be removed from the address list for marketing purposes or for the satisfaction survey or for general data privacy questions, please contact BRP's Data Protection Officer at or by mail at **privacyofficer@brp.com** or by mail at:

BRP Legal Service, 726 St-Joseph, Valcourt, Quebec, Canada, J0E 2L0.

When BRP processes your personal information, they do so in compliance with its Privacy Policy available at: <https://www.brp.com/en/privacy-policy.html> or by using the following

QR Code.



CONTACT US

www.brp.com

Asia Pacific

Australia

6 Lord Street
Lakes Business Park
Botany, NSW 2019

China

Room 3703, Tower 2,
Grand Gateway
3 Hong Qiao Road,
Xuhui District,
Shanghai 200030

Japan

21F Shinagawa East One Tower
2-16-1 Konan, Minato-ku-ku,
Tokyo 108-0075

New Zealand

Suite 1.6, 2-8 Osborne Street,
Newmarket, Auckland 2013

Europe, Middle East and Africa

Belgium

Oktrooiplein 1
9000 Gent

Czech Republic

Stefanikova 43a
Prague 5
150 00

Germany

Itterpark 11
40724 Hilden

Finland

Isoaavantie 7
PL 8040
96101 Rovaniemi

France

Arteparc Bâtiment B
Route de la côte d'Azur,
13 590 Meyreuil

Norway

Ingvald Ystgaardsvei 15
N-7484 Trondheim
Salg, marketing, ettermarked

Sweden

Spinnvägen 15
903 61 Umeå
Sweden 90821

Switzerland

Avenue d'Ouchy 4-6
1006 Lausanne

Latin America

Brazil

Av. James Clerck Maxwell, 230
Campinas, Sao Paulo
CEP 13069-380

Mexico

Av. Ferrocarril 202
Parque Industrial Querétaro
Santo Rosa Jauregui, Querétaro
C.P. 76220

North America

Canada

3200A, rue King Ouest,
Suite 300
Sherbrooke (Québec) J1L 1C9

United States of America

10101 Science Drive
Sturtevant, Wisconsin
53177

CHANGE OF ADDRESS AND OWNERSHIP

If your address has changed or if you are the new owner of the vehicle, be sure to notify BRP by either:

- Notifying an authorized Can-Am dealer.
- **North America Only:** calling at 1 888 272-9222.
- Mailing one of the change of address cards on the following pages at one of the BRP addresses indicated in the *Contact Us* section of this guide.

In case of change of ownership, please join a proof that the former owner agreed to the transfer.

Notifying BRP, even after the expiration of the limited warranty, is very important as it enables BRP to reach the vehicle owner if necessary, like when safety recalls are initiated. It is the owner's responsibility to notify BRP.

STOLEN UNITS: If your personal vehicle is stolen, you should notify BRP or an authorized Can-Am dealer. We will ask you to provide your name, address, phone number, the vehicle identification number and the date it was stolen.

This page is
intentionally blank

This page is
intentionally blank

NOTE: _____

NOTE: _____

NOTE: _____

Model No. _____

VEHICLE

IDENTIFICATION NUMBER (V.I.N.) _____

ENGINE

IDENTIFICATION NUMBER (E.I.N.) _____

Owner: _____

NAME

No.

STREET

APT

CITY

STATE/PROVINCE

ZIP/POSTAL CODE

Purchase Date _____

YEAR

MONTH

DAY

Warranty Expiry Date _____

YEAR

MONTH

DAY

To be completed by the dealer at the time of the sale.

DEALER IMPRINT AREA

WARNING

THIS VEHICLE CAN BE HAZARDOUS TO OPERATE. A collision or rollover can occur quickly, even during routine maneuvers such as turning and driving on hills or over obstacles, if you fail to take proper precautions.

SEVERE INJURY OR DEATH can result if you do not follow these instructions:

• BEFORE YOU OPERATE THIS VEHICLE, READ THIS OPERATOR'S GUIDE, ALL ON PRODUCT SAFETY LABELS AND WATCH THE SAFETY VIDEO.



- NEVER OPERATE THIS VEHICLE WITHOUT PROPER INSTRUCTIONS. Complete a certified training course.
- DO NOT EXCEED VEHICLE SEATING CAPACITY
- FOR 1 UP MODELS, NEVER CARRY A PASSENGER. You increase your risk of losing control if you carry a passenger.

- NEVER OPERATE THIS VEHICLE ON A PAVED SURFACE. You increase your risk of losing control if you operate this vehicle on pavement.
- NEVER OPERATE THIS VEHICLE ON PUBLIC ROADS. You can collide with another vehicle if you operate this vehicle on a public road.
- OPERATOR AND PASSENGER (MAX models) SHOULD ALWAYS WEAR AN APPROVED HELMET, eye protection, and protective clothing.
- NEVER USE WITH DRUGS OR ALCOHOL. They slow reaction time and impair judgment.
- NEVER OPERATE THIS VEHICLE AT EXCESSIVE SPEEDS. You increase your risk of losing control if you operate this vehicle at speeds too fast for the terrain, visibility conditions, or your experience.
- NEVER ATTEMPT WHEELIES, JUMPS, OR OTHER STUNTS.

®TM and the BRP logo are trademarks of BOMBARDIER RECREATIONAL PRODUCTS INC. or its affiliates.

©2022 BOMBARDIER RECREATIONAL PRODUCTS INC. ALL RIGHTS RESERVED.

www.brp.com

SKI-DOO®
LYNX®

SEA-DOO®
EVINRUDE®

CAN-AM®
ROTAX®