

LYNX[®]



RAVE 120/ 200 SERIES

SAFETY HANDBOOK

Includes Safety,
and Use Information



2023

⚠ WARNING

Minimum recommended operators age under adult supervision:

- 120: 6 years old
- 200: 13 years old

Read this operator's manual thoroughly. It contains important safety information. Adult supervision is required for the proper understanding of the risks involved with the usage of these vehicles.

Review and explain the content of this operator's guide with the young operator and make sure that the young operator understands the proper safe operation of the vehicle.

Keep this operator's guide handy for reference at all times.

520003032

**Original
Instructions**

In Canada, products are distributed and serviced by Bombardier Recreational Products Inc. (BRP).

In the USA, products are distributed and serviced by BRP US Inc. In the European Economic Area (which is comprised of the member states of the European Union plus the United Kingdom, Norway, Iceland and Liechtenstein), the Commonwealth of the Independent States (including Ukraine and Turkmenistan) and Turkey, products are distributed and serviced by BRP European Distribution S.A. and other affiliates or subsidiaries of BRP.

For all other countries, products are distributed and serviced by Bombardier Recreational Products Inc. (BRP) or its affiliates.

TM® Trademarks of BRP or its affiliates.

This is a non-exhaustive list of trademarks that are the property of Bombardier Recreational Products Inc. or its affiliates:

LYNX®

RAVE®

XPS®

All rights reserved. No parts of this Operator's Guide may be reproduced in any form without the prior written permission of Bombardier Recreational Products Inc.

©Bombardier Recreational Products Inc. (BRP) 2022

Foreword

Snowmobiling is an exhilarating experience and a highly enjoyable sport. However, it also carries with it many responsibilities. The freedom snowmobilers experience will only continue as long as snowmobilers continue to act responsibly. Essentially, that means caring for your personal safety and the safety and rights of others, and protecting our environment.

Reading and following the information in the Operator's Guide and this Snowmobile Safety Handbook is the first step in maintaining the sport of snowmobiling and the safety of all. Common sense, proper judgment, and experience all play a very important role in the safe operation of a snowmobile. You, the operator, are the most important aspect of safety. Safety must be your concern before, during, and after snowmobiling.

Proper snowmobile maintenance, observation of all laws, operator education, and practice all contribute to a safe, enjoyable experience. Please exercise patience since many of the special skills and knowledge required for safe snowmobiling must be learned over a period of time.

Taking a snowmobile safety course and a first-aid class, and joining a snowmobile club will greatly enhance your snowmobiling experience and will ensure many years of safe snowmobiling.

Every BRP snowmobile bears the SSCC label and meets or exceeds the standards of the Snowmobile Safety and Certification Committee. BRP endorses and encourages the safe use of all snowmobiles. Always wear an approved helmet and eye protection. Drive with caution, observe all state and local laws, and respect the rights of others. International Snowmobile Manufacturers Association (ISMA) members like BRP do their part to improve trails, sponsor events, and generally support the sport of snowmobiling. As a member of the American Council of Snowmobile Associations (ACSA), BRP promotes snowmobiling through education, charity, and research programs.

This Snowmobile Safety Handbook should be considered a permanent part of the snowmobile and must remain with the snowmobile at the time of resale.

Table of Contents

Before Operation	1-6
Snowmobile Controls	1
Towing with a Snowmobile	3
Safety Labels.....	3
Safety Equipment	4
Trailing a Snowmobile	6
Operator Preparation	7-11
Word to All Snowmobile Operators	7
Trail Signs	7
Proper Dress	8
Wind Chill Chart	8
Physical and Mental Fitness.....	9
Environmental	10
Responsibilities	10
Registration and Permits	11
Code of Ethics	11
Operating a Snowmobile	12-14
Safe Operating Instructions	12
Preparing a Snowmobile.....	15-16
Maintenance.....	15
Pre-Ride/Start Inspection	15
Proper Fueling.....	16
Riding a Snowmobile	17-22
The First Ride.....	17
Mastering Basic Snowmobile Control.....	17
Riding Positions.....	17
If a Snowmobile Gets Stuck in Snow	18
Group (Safari) Riding	18
Terrain and Riding Variations.....	19
Hazards	20
Emergencies.....	23-25
Cold Weather Injuries	23
Emergency Situation	24
Suggested Extra Equipment.....	24
Survival.....	25
Rescue Signals	25
Closing.....	26

Before Operation

SNOWMOBILE CONTROLS

■ NOTE: The illustrations and descriptions below explain typical snowmobile controls. Read the Operator's Guide for information on the controls of your specific snowmobile model.

120

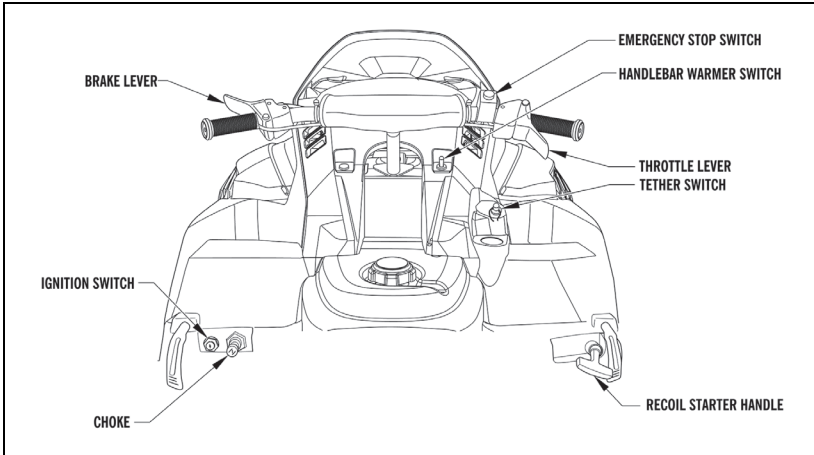

0753-830

200

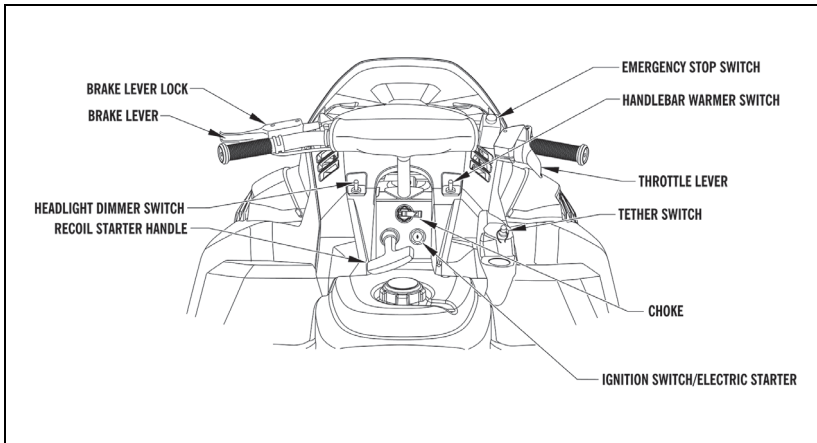

0753-827

BRAKE LEVER — Located on the left handlebar, the BRAKE LEVER can be compressed to slow down or stop the forward movement of the snowmobile.

BRAKE LEVER LOCK (200) — Located next to or on the BRAKE LEVER, the BRAKE LEVER LOCK holds the BRAKE LEVER in the compressed position. To activate the lock actuator, compress the BRAKE LEVER fully; then using an index finger, engage the actuator and release the BRAKE LEVER. To release the lock actuator, compress the BRAKE LEVER and allow the actuator to release.

 **WARNING**

The brake lever lock is not a parking brake and should not be applied for periods exceeding 5 minutes. The brake lever lock maintains the brake lever in the compressed position and maintains pressure against the brake disc; however, after a period of time, the pressure applied to the brake disc may relax below the amount required to hold the snowmobile stationary.

CHOKE — To start a cold engine, activate the choke button or choke lever. Read the Operator's Guide for detailed instructions. A warm engine requires little or no use of the choke.

EMERGENCY STOP SWITCH — Located on the right handlebar, the EMERGENCY STOP SWITCH can be activated to immediately stop the engine. In the up position, the EMERGENCY STOP SWITCH allows the engine to run. Pushing down on the EMERGENCY STOP SWITCH interrupts engine ignition and stops the engine to allow the snowmobile to coast to a stop.

HEADLIGHT DIMMER SWITCH (200) — Located on the hood, the HEADLIGHT DIMMER SWITCH can be pressed to select either high or low beam.

IGNITION SWITCH — Operated with a key, the IGNITION SWITCH allows the engine to be started (RUN or START position) or stopped (OFF position). If the snowmobile is equipped with a start switch and/or recoil starter, the IGNITION SWITCH must be in the RUN or START position to activate the starter motor. To reduce the chances of unauthorized usage, always remove the key from the IGNITION SWITCH after each use.

CAUTION

Severe damage to the starter and/or engine ring gear will occur if the starter is engaged while the engine is running or if the IGNITION SWITCH is held in the START position after the engine has started.

THROTTLE LEVER — Located on the right handlebar, the THROTTLE LEVER is used to operate the snowmobile at various speeds. The actual speed of the snowmobile is dependent on terrain conditions and is directly proportionate to the throttle lever movement. When the THROTTLE LEVER is released, it **must** automatically return to the idle position.

 **WARNING**

If the throttle lever does not return quickly and completely to the idle position, the throttle system must be repaired or damaged components replaced before the snowmobile is operated.

WARMER SWITCHES — Located on the hood, engage the switches to activate warming elements for the handlebars, thumb (THROTTLE LEVER).

TOWING WITH A SNOWMOBILE

Pulling a tow-sled or another snowmobile demands special attention. Tow-sleds towed behind a snowmobile must always be loaded with the lowest possible center of gravity. A rigid tow bar **must** be used when pulling a tow-sled. When pulling passengers in a tow-sled, use a slow speed and avoid rough terrain for safety. Also, have all passengers get out of the tow-sled and walk when crossing a road. Every tow-sled must have reflective material on each side and on the rear. Never use a rope to tow a toboggan, sled, etc., with passengers. Towing a tow-sled with a rope is extremely dangerous and **is strictly forbidden!**

If a snowmobile must be towed by another snowmobile, the first step is to remove the drive belt of the towed snowmobile. Then, using a tow rope, secure (with a knot) the center portion of a rope to the center of the towing snowmobile's rear bumper, making sure the rope ends are equal in length; then wrap each end of the rope two times around a spindle of the towed snowmobile and secure.

CAUTION

When towing a snowmobile, use a slow speed and avoid rough terrain. Also, when braking, remember that the towed snowmobile will not brake when the lead snowmobile brakes but instead coast to a stop. Do not tow by the ski loops.

SAFETY LABELS

BRP snowmobiles display three types of labels relating to maintenance and snowmobile operation in the Operator's Guide, Snowmobile Safety Handbook, and on the snowmobile.

⚠ WARNING identifies personal safety-related information. Be sure to follow the directive because it deals with the possibility of severe personal injury or even death.

⚠ CAUTION identifies a hazard situation which, if not avoided, could result in minor or moderate injury.

CAUTION identifies unsafe practices which may result in snowmobile-related damage. Follow the directive because it deals with the possibility of damaging part or parts of the snowmobile.

■ NOTE: identifies supplementary information worthy of particular attention.

You, the owner/operator, must ensure that all labeling is retained on the snowmobile and that the related information is being followed.

Minimum safety standards for snowmobiles have been adopted by the Snowmobile Safety Certification Committee. All BRP snowmobiles carry a certification label affixed to the tunnel. This label signifies that an independent testing laboratory has verified compliance with the safety standards set by the SSCC.

<p>CE MODÈLE A ÉTÉ ÉVALUÉ PAR UN LABORATOIRE D'ESSAIS INDÉPENDANT ET SATISFAIT TOUTES LES NORMES DE SÉCURITÉ DU SSCC EN VIGUEUR À LA DATE DE FABRICATION.</p> <p>PARRAINÉ PAR LE COMITÉ DE SÉCURITÉ ET DE CERTIFICATION DE LA MOTONEIGE, INC.</p>	<p>CERTIFIED</p>  <p>CERTIFIÉ</p> <p>PRINTED IN U.S.A.</p>  <p>D 5 4 4 8 7 5 4</p>	<p>THIS MODEL HAS BEEN EVALUATED BY AN INDEPENDENT TESTING LABORATORY AND IT MEETS ALL SSCC SAFETY STANDARDS IN EFFECT ON THE DATE OF ITS MANUFACTURE.</p> <p>SPONSORED BY THE SNOWMOBILE SAFETY AND CERTIFICATION COMMITTEE, INC.</p>
---	--	--

0155-567A

SAFETY EQUIPMENT

BRP snowmobiles have safety equipment designed to protect the operator and the passenger, if the snowmobile is designed to carry a passenger:

- A. **RUNNING BOARD WITH ANTI-SKID SURFACE** — Serves as a footrest while the operator is riding the snowmobile. It also protects the operator/passenger feet from hitting foreign objects on the trail. The operator/passenger **must** keep feet on the RUNNING BOARD at all times. **Never** place feet beyond the outside edge of the snowmobile when attempting to turn or while the snowmobile is in motion. If the surface of the RUNNING BOARD becomes packed with snow or ice, clean the surface immediately. The RUNNING BOARD should be cleaned before each use. An ANTI-SKID SURFACE is located on the RUNNING BOARD to help prevent accidental slippage by the operator/passenger during operation and mounting or dismounting when free of snow and ice.
- B. **SNOWFLAP** — Extends from the rear of the snowmobile and deflects snow, ice and other objects hurled by the track.



SNO-WL12

- C. **FRONT BUMPER** — Provides protection from damage in minor collisions.
- D. **REAR BUMPER** — Provides protection from damage in minor collisions. The REAR BUMPER may be used as a handle for lifting the rear of the snowmobile.
- E. **EMERGENCY STOP SWITCH** — Works independently of the ignition switch and must be in the ON (raised) position before the engine will start. If an emergency occurs requiring the engine to be immediately shut off, the EMERGENCY STOP SWITCH is pushed down to the OFF position to stop the engine; then the brake is applied to stop the forward movement of the snowmobile.

- F. **WINDSHIELD** — Provides the operator with comfort as well as protection by deflecting wind and snow.
- G. **TAILLIGHT, BRAKE LIGHT, HEADLIGHT AND REFLECTORS** — The LIGHTS provide the operator with the proper operating and night visibility. Also, for the snowmobiler's safety, the snowmobile has REFLECTORS to increase the visibility of the snowmobile. Never drive a snowmobile unless all LIGHTS are working properly and REFLECTORS are in place.
- H. **BRAKE LEVER LOCK (200)** — Provides a locking device for the BRAKE LEVER. The actuator should be engaged whenever the snowmobile is parked, idling or unattended. Never operate the snowmobile with the actuator engaged.

 **WARNING**

The brake lever lock is not a parking brake and should not be applied for periods exceeding 5 minutes. The brake lever lock maintains the brake lever in the compressed position and maintains pressure against the brake disc; however, after a period of time, the pressure applied to the brake disc may relax below the amount required to hold the snowmobile stationary.

- I. **THROTTLE CONTROL SWITCH** — Protects against a runaway snowmobile caused by a throttle slide that will not return to the idle position. If ice forms in the throttle system or if there is some other malfunction, the switch will stop the engine when the THROTTLE LEVER is released. If a situation occurs in which the throttle system does not operate properly, immediately activate the EMERGENCY STOP SWITCH. If the THROTTLE CONTROL SWITCH stops the engine or the above situations occur, correct the problem before re-starting the engine.
- J. **TETHER SWITCH** — When the TETHER SWITCH cord is connected to the rider, the TETHER SWITCH interrupts the ignition circuit when the cap is removed from the base if the operator falls off the snowmobile. Attach the TETHER SWITCH cord to the operator in some manner before starting the engine. Use of a TETHER SWITCH is mandatory for all racing applications.

CAUTION

When using a TETHER SWITCH, be careful to ensure the cord does not become entangled with the handlebars or come into contact with tree branches or other objects. This could cause the cap to be inadvertently removed, resulting in an unexpected loss of power, which could cause loss of control of the snowmobile and serious injury.

BELT GUARD (not shown) — Protects the operator should the clutch or drive belt break. **Never** operate the snowmobile or run the engine without the BELT GUARD secured and the hood/access panels fastened securely.

WARMERS FOR HANDLEBAR/THUMB (not shown) — Provide the operator with comfort and are controlled with a switch.

 **WARNING**

People who are unable to feel pain to the skin because of advanced age, chronic illness, diabetes, spinal cord injury, medication, alcohol use, exhaustion or other physical conditions, must exercise care when using the seat heater. The seat heater may cause burns even at low temperatures, especially if used for long periods of time. Do not place anything on the seat that insulates against heat, such as a blanket or cushion, because this may cause the seat heater to overheat. Do not puncture the seat with pins, needles or other pointed objects because this may damage the heating element which may cause the seat heater to overheat. An overheated seat may cause serious personal injury.

HANDGRIPS (not shown) — If the snowmobile is equipped with a passenger seat, HANDGRIPS provide the passenger with secure handholds. Before riding, the operator must advise the passenger to use the HANDGRIPS at all times. **Never carry a passenger on a snowmobile designed for only one person.**

TRAILERING A SNOWMOBILE

It is best to use a trailer that is specifically designed for hauling snowmobiles, such as tilt-bed trailers, flatbed open trailers, and enclosed trailers. A tilt-bed trailer may be equipped with a winch system to assist with loading your snowmobile. Open flatbed trailers are equipped with folding or self-storing ramps that allow snowmobiles to be loaded onto the trailer from the rear and unloaded off the trailer in the front. Enclosed trailers typically have doors in the front and rear that fold down to serve as loading and unloading ramps.

Be sure you have all the proper equipment to attach the trailer to your vehicle, including safety chains, the proper size hitch ball and the proper electrical connections to power the trailer lights. Before you trailer a snowmobile, check the maximum load capacity limit and required tire pressure of your trailer and the gross vehicle weight rating and towing capacity of your towing vehicle.

CAUTION

BEFORE loading the snowmobile on the trailer, always double-check to ensure that the trailer tongue is properly secured to your towing vehicle's hitch ball. This will prevent the trailer from popping off the hitch when a snowmobile is driven onto the trailer bed, particularly with 2-place trailers.

When securing your snowmobile on the trailer, avoid using rope or rubber straps since they can easily fray, stretch or break. After securing the snowmobile, check to be certain the trailer's brakes (if the trailer is equipped with brakes), taillights/brake lights/turn signals and side marker lights all function properly. After the re-check, always cover your snowmobile if on an open trailer to protect it while towing.

 **WARNING**

Make sure all seats, accessories and cargo are properly secured, or remove it to prevent from falling on the road and creating a hazard for following vehicles.

Operator Preparation

















WORD TO ALL SNOWMOBILE OPERATORS

Regardless of previous experience in operating an automobile, motorcycle or motorboat, everyone is a beginner the first time one sits behind the controls of a snowmobile. Every sport requires skill and judgment on the part of the participant to keep risks well within acceptable boundaries. Variable conditions of snow, ice, light, terrain, weather, and temperature, and their effects on snowmobile operation and the operator, **must** be learned. How to balance the snowmobile under varying terrain conditions and speeds **must** be learned by the operator. How to compensate for other vehicles or activities when snowmobiling **must also** be learned. It is highly recommended for a novice operator to participate in a certified Snowmobile Safety Course before operating a snowmobile.

Every snowmobile operator should familiarize themselves with:

1. snowmobile controls
2. safety equipment
3. trail signs
4. proper dress
5. responsibilities
6. safe operating instructions
7. general maintenance

TRAIL SIGNS

	Dead End/Private Trail		Right or Left Turn
	Stop		Steep Hill
	Snowmobiles Permitted		Snowmobile Crossing
	No Snowmobiling		Two-Way Traffic
	One-Way — Do Not Enter		Stop Ahead
	Informational		Trail Marker
	Danger		Directional Marker
	Caution		Trail Intersection

0000-066

Trail signs are used to control, direct or regulate the use of snowmobiles on trails and to inform the operator of trail conditions. A snowmobile operator **MUST** become familiar with and be able to recognize all signs in any area.

Regulatory, warning, trail marking and informational are the four types of signs used on trails. The trail signs in the above illustration are recognized by most agencies having jurisdiction over snowmobile use areas. Other trail signs may be used in certain areas, so be sure to become familiar with them before trail riding.

PROPER DRESS

Snowmobiling and related winter sports require wearing warm clothing. In an effort to keep warm, however, a person may overdress, perspire and end up getting chilled. A basic theory in keeping warm is if dressed properly, the clothing will keep out cold air and will allow moisture to evaporate from the body.

Wind chill, the temperature your body feels as a result of the temperature and combined wind/snowmobile speed, provides the biggest exposure problem when snowmobiling. Notice in the wind chill chart below that as the wind/snowmobile speed is increased, the danger of freezing is also increased. When dressing for snowmobiling, it is important to dress according to the coldest anticipated wind chill factor, the length of your exposure, and the anticipated weather conditions. It is often not enough to dress according to the current temperature and conditions.

Wind Chill Chart

WIND CHILL CHART																							
U.S. STANDARD							METRIC																
Combined Speed of Wind and Snowmobile	Actual Thermometer Reading (°F)										Combined Speed of Wind and Snowmobile	Actual Thermometer Reading (°C)											
	50	40	30	20	10	0	-10	-20	-30	-40		-50	-60	5	0	-5	-10	-15	-20	-25	-30	-35	-40
	Equivalent Temperature (°F)											Equivalent Temperature (°C)											
0	50	40	30	20	10	0	-10	-20	-30	-40	-50	-60	0	5	0	-5	-10	-15	-20	-25	-30	-35	-40
5	48	37	27	16	6	-5	-15	-26	-36	-47	-57	-68	10	1	-4	-11	-16	-22	-27	-33	-38	-45	-50
10	40	28	16	4	-9	-21	-33	-46	-58	-70	-83	-95	20	-4	-9	-17	-23	-29	-36	-42	-48	-54	-61
15	36	22	9	-5	-18	-36	-45	-58	-72	-85	-99	-112	30	-7	-13	-21	-28	-35	-42	-48	-55	-63	-69
20	32	18	4	-10	-25	-39	-53	-67	-82	-96	-110	-124	40	-9	-16	-24	-32	-39	-47	-53	-61	-69	-76
25	30	16	0	-15	-29	-44	-59	-74	-88	-104	-118	-133	50	-11	-18	-26	-34	-41	-49	-57	-64	-73	-80
30	28	13	-2	-18	-33	-48	-63	-79	-94	-109	-125	-140	60	-12	-19	-27	-35	-43	-51	-59	-66	-75	-82
35	27	11	-4	-20	-35	-49	-67	-82	-98	-113	-129	-145	70	-13	-20	-28	-36	-44	-52	-60	-68	-76	-84
40	26	10	-6	-21	-37	-53	-69	-85	-100	-116	-132	-148											
(Wind speeds greater than 40 mph have little additional effect)	LITTLE DANGER* (for properly clothed person)	INCREASING DANGER*			GREAT DANGER*			(Wind speeds greater than 70 km/h have little additional effect)	LITTLE DANGER* (for properly clothed person)	INCREASING DANGER*			GREAT DANGER*										
	*DANGER FROM FREEZING OF EXPOSED FLESH												*DANGER FROM FREEZING OF EXPOSED FLESH										

WINDCHILL

Good quality one or two-piece snowmobile suits with water-resistant fabric and lightweight, high insulating linings should be worn by all snowmobilers. The type and amount of clothing worn underneath the snowmobile suit depends on the weather conditions of the day. Thermal, breathable underwear next to the skin provides an important layer of air space necessary for proper insulation.

Approved helmets, which provide warmth and protection, should always be worn with the chin strap buckled at all times. Helmets should be full-coverage with a plastic protective shield and a durable chin strap. If the helmet is not equipped with the protective plastic shield, protective eye goggles must be worn. Goggles or a face shield are important attire for eye protection and increased visibility in varying light conditions. Suggested lens colors per operator preference are gray or dark green in bright sunlight and amber or yellow will improve visibility in overcast conditions or late afternoons. Colored lenses must be removed at night. Clear lenses (which are suitable for all light conditions) must be used at night.

In extremely cold weather, a face mask is recommended in addition to the helmet and goggles/face shield to reduce the possibility of frostbite.

Hands must be protected by a pair of well-insulated snowmobile gloves or mittens that will permit unhampered use of the thumbs and fingers for operation of the controls.

Rubber-soled boots with a waterproof nylon or leather upper and a synthetic, felt or wool liner, are best suited for snowmobiling as they provide the necessary warmth, dryness, and traction. A pair of wool or thermal socks, in addition to snowmobile boots, gives the feet the required protection from the cold. Several points concerning snowmobile clothing need to be stressed:

1. Clothing that ventilates as well as insulates is a necessity.
2. Dress in layers which do not limit mobility. Layers of clothing function better than a single heavy layer: an inner layer with a ventilating weave (thermal underwear), a second layer of a durable, utility nature (wool shirt and sturdy pants), and a third insulating layer (snowmobile suit).
3. Remember when purchasing snowmobile clothing that COMFORTABLE and PROPERLY FITTED clothing is essential for warmth.
4. Keep insulating clothing dry, as it loses its insulating effectiveness when wet. Keep snow out of clothing. To cool off, open clothing at the collar. Allow clothing to dry after use.
5. Hand and foot warmth is dependent on movement. Do not wear socks or gloves that are too heavy. One pair of wool or thermal socks and one pair of snowmobile gloves with glove liners are adequate for most winter conditions.
6. Cover all exposed skin to prevent frostbite.
7. NEVER wear long scarves or loose clothing that could get drawn into or caught by moving parts of the snowmobile.
8. Dress appropriately; never overdress or underdress.

PHYSICAL AND MENTAL FITNESS

Snowmobiling requires physical exertion. In order to enjoy snowmobiling to its fullest, good physical preconditioning is required to handle the snowmobile with the required muscle and reduce the “morning after” stiff muscles and aching arms. Also, in difficult situations such as becoming stuck in deep snow, the snowmobiler in good physical condition will have the advantage.

Extended riding and snowmobile safaris (group riding) require physical stamina above and beyond the stamina required for short rides. Getting plenty of sleep and eating healthy meals is a good practice to provide the necessary stamina. Frequent rest stops when fatigued are a must.

High altitude riding presents another complication. Lower oxygen levels in high altitude areas cause premature exhaustion and fatigue following limited exertion. The best preparation for high altitude riding is short “adapting” rides with extended rest stops.

Mental preparation for snowmobiling is extremely important. Mental fatigue is hazardous as it can lead to poor judgment and unsafe operating performance. Prompt reactions and expert judgment are required at all times by snowmobile operators. If an operator is not prepared to properly react to a possible emergency, there has not been enough preparation to operate a snowmobile.

Never operate a snowmobile (or any motorized vehicle) under the influence of drugs, alcohol or medication which may impair your judgment or reactions.

ENVIRONMENTAL

Environmental stewardship is the responsibility of every snowmobiler. Damaging or destroying snowmobiling areas is strictly forbidden and can lead to more restrictive laws concerning snowmobile use. Common sense and courtesy should guide the snowmobiler. The policy of all snowmobilers should be, “What you carry in, you carry out; take only pictures and leave only tracks.” Several guidelines should be followed:

1. Operate a snowmobile only when there is sufficient snow cover to protect the ground vegetation.
2. Leave trees and shrubs alone; do not drive over them.
3. When encountering wildlife on trails, allow them to move off leisurely. Do not chase or harass wildlife.
4. Do not litter or pollute.
5. Ride only in designated areas and on designated trails. Observe all rules and regulations. Obtain permits as required.
6. Snowmobile noise may disrupt specified “quiet zones” such as hospitals, rest homes and residential areas, so use common sense and courtesy when near these zones.

RESPONSIBILITIES

Federal, state, provincial and local governments have enacted laws and regulations pertaining to the use and operation of snowmobiles. It is the responsibility of the snowmobile owner and operator to learn and obey these laws and regulations. Also, the owner and operator must be aware of the liability, property damage and insurance laws relating to snowmobile operation.

Respect other people’s privacy and property at all times. Always obtain the property owner’s consent before snowmobiling on the property. Check with the proper officials before riding on public lands and drive slowly in residential areas.

A parent must be the judge of a child's capability to safely understand, operate and control a snowmobile. It is the parent's responsibility to determine how involved the child should be in the sport of snowmobiling. Never under any circumstances let children ride a snowmobile unsupervised; warn them against speed, carelessness and overconfidence. To reduce the chance of unauthorized usage, always remove the key from the ignition switch after each use.

REGISTRATION AND PERMITS

Most countries, states, and provinces require by law that new and used snowmobiles be registered with the governing body having jurisdiction over snowmobile use. Snowmobile registration has several purposes: It allows the state or province to maintain records of existing snowmobiles, and those records provide the owner/operator with a means to identify their snowmobile if recovered after theft. Registration fees also generate a revenue stream for governmental agencies to establish and maintain trails.

Be sure to obtain all necessary permits. Snowmobiles can be operated by people of any age. However, if a juvenile is to operate a snowmobile across public property or private property not owned by a parent or guardian, an operator's permit is required by most states and provinces. Consult a local law enforcement official or conservation officer for specific laws concerning juvenile snowmobile operator permits.

CODE OF ETHICS

1. I will be a good snowmobiler. I recognize that people judge all snowmobilers by my actions. I will use my influence with other snowmobilers to promote proper conduct.
2. I will not litter any trails or camping areas, nor will I pollute streams or lakes. I will carry out what I carry in.
3. I will not damage trees, shrubs or other natural features.
4. I will respect other people's property and rights.
5. I will lend a helping hand when I see someone in distress.
6. I will make myself and my snowmobile available to assist in search and rescue operations.
7. I will not interfere with the activities of other winter sports enthusiasts. I will respect their right to enjoy their recreational activities and facilities.
8. I will know and obey all federal, state, provincial and local laws and regulations related to the speed and operation of snowmobiles in areas where I snowmobile.
9. I will not harass wildlife.
10. I will not snowmobile where prohibited.
11. I will not operate a snowmobile under the influence of drugs, alcohol or medication.

Operating a Snowmobile

SAFE OPERATING INSTRUCTIONS

Before the snowmobile engine is started:

1. Check weather forecasts for possible dangerous weather conditions.
2. Dress properly. A helmet, eye protection and proper clothing, based on current and forecasted weather conditions, are a must. Never wear long or loose scarves, shoelaces, etc., which could get caught in a moving part of the snowmobile.
3. Inform someone as to where you are going and when you plan to return.
4. Arrange to ride with friends using the “buddy system.” Avoid riding alone.
5. Equip the snowmobile with a survival kit and all necessary supplies. A flashlight, critical spare parts and the tool kit should be carried with the snowmobile at all times. It is also a good idea to carry personal identification, money, wireless phone, matches, knife, compass, paper and a writing instrument.
6. Complete the Pre-Ride/Start Inspection of the snowmobile (see page 15 for details).
7. Forbid a new or inexperienced rider to operate the snowmobile without proper instruction. Carefully supervise and control these individuals over flat, predetermined courses. Observe federal, state, provincial and local requirements regarding minimum-age licensing and operation. Read the Operator’s Guide and Snowmobile Safety Handbook thoroughly; understand and follow all recommendations.
8. Obtain permission before crossing private property.
9. Never operate the snowmobile while under the influence of alcohol, drugs or medication which may impair your judgment or reactions.
10. Make sure the track is free to rotate by rocking the snowmobile from side to side, because in certain weather, the track may freeze to the ground or other contact surface. This procedure will prevent unnecessary drive belt wear.
11. BE MENTALLY PREPARED TO OPERATE THE SNOWMOBILE. Emergency situations require automatic reactions.

Once the snowmobile engine is running:

1. Check the headlight (high and low beam), taillight and brake light to ensure they are properly working and correctly adjusted. Make sure all lights are clean to provide maximum illumination. The headlight and taillight must be illuminated whenever the engine is running.
2. Activate the emergency stop switch to ensure it properly operates. If the emergency stop switch properly shuts off the engine, restart the engine.



WARNING

Do not operate the snowmobile if the emergency stop switch does not function.

3. Keep feet, hands and clothing away from moving parts of the engine and drivetrain. Always shut off the engine to make adjustments or repairs.

4. When the snowmobile is operated in extremely cold weather, the drive system must be “run in.” Raise the back of the snowmobile with a shielded safety stand or lay the snowmobile on its side and open the throttle slightly allowing the track to turn several revolutions. This rotation allows the drive belt, bearings and track to “warm up” properly. Never run the engine at high RPM when “warming up” the track.



WARNING

Do not allow anyone else to stand near the snowmobile during “warm-up” of the track. Severe personal injury may result from flying debris or contact with the track.

5. Check the tether switch to ensure it operates by removing the cap. Attach the tether switch cord to the operator in some manner (suit, vest, etc.) before applying the throttle.

Once the ride has started:

1. Keep feet on the running board at all times and away from the revolving track. NEVER extend feet or legs over the edge of the running board under any circumstances while the snowmobile is moving.
2. Obey restrictions on the number of riders. If the snowmobile is designed for one operator, never carry passengers. If the snowmobile is designed to carry a passenger (equipped with handgrips), carry the passenger only after providing the passenger with safety instructions.
3. Never operate the snowmobile faster than allowed by the designated speed limit, terrain and conditions. Use common sense. Avoid obstructions and suspicious-looking areas; snow and glare can conceal a steep drop-off or ravine.
4. Never operate the snowmobile between railroad tracks or on the railroad right-of-way. The sound of an approaching train may be drowned out by the snowmobile engine.
5. Stay away from ice skaters and skiers; never use ski slopes or ski trails for snowmobiling.
6. Do not cut across another snowmobiler’s line of travel; a collision can cause serious bodily injury or death.
7. Operate the snowmobile well away from a roadway. Come to a complete stop before crossing roads or highways, and yield to all vehicular traffic. Driving close to a highway or toward oncoming automobile traffic at night may cause confusion and contribute to a serious accident.
8. Never over-drive the headlight of the snowmobile. Visibility is the key to snowmobiling safety. Always operate the snowmobile at a speed that will allow ample time to recognize and avoid a hazard.

9. Always use the appropriate hand/arm signals, especially when group (safari) riding. The recognized signals are:
- A. LEFT TURN: Extend the left arm straight out to the left of the body.
 - B. RIGHT TURN: Extend the left arm horizontally, bending it at the elbow to vertically raise the hand.
 - C. SLOW DOWN OR STOP: Raise either arm vertically above the head.

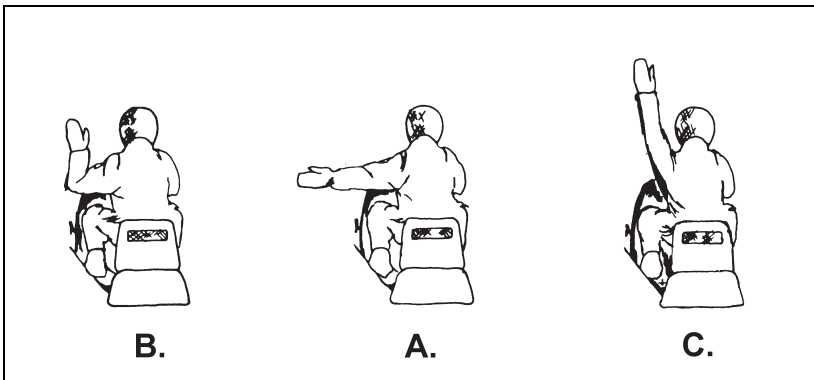

0000-051

10. When operating a snowmobile in reverse, always use caution and minimal speed. Be sure the reverse switch is in the desired position before applying throttle.

Preparing a Snowmobile

MAINTENANCE

To ensure snowmobiling safety and enjoyment, snowmobiles require proper maintenance and care at regular intervals. Since snowmobiles are often operated in the harshest weather and terrain conditions, care must be taken in performing certain mechanical procedures. It is imperative that all snowmobile maintenance be done correctly and professionally if needed. Use only genuine BRP snowmobile replacement parts and accessories as they have been tested to ensure the safety and reliability of your snowmobile. Always follow the maintenance schedules and procedures specified in the Operator's Guide. Ensure your safety by completing the Pre-Ride/Start Inspection BEFORE you ride.

In addition to the proper maintenance and Pre-Ride/Start Inspection, proper snowmobile preparation is important for variations in terrain, altitude and temperature. Carbide ski wear bar kits, track stud kits, high altitude kits and wheel kits are available to improve handling and performance of the snowmobile under prescribed conditions. Consult an authorized BRP snowmobile dealer regarding the specific kits to be used in your specific operating terrain.

PRE-RIDE/START INSPECTION

Never start the engine or ride a snowmobile without first completing the following inspection and making the appropriate corrections or adjustments:

1. Make sure the **carburetor** and **exhaust systems** are securely fastened.
2. Make sure the **belt guard** and **hood/access panels** are in place and securely fastened.
3. Make sure the **windshield** is not broken or jagged.
4. Check for **loose bolts** or **rivets**. Tighten all loose bolts securely or to specified torque values. Replace any loose rivets.
5. Check the operation of the **brake**. Make necessary adjustments as required.
6. Check for proper operation of the **steering system** by manually (do not force) moving the skis completely to the right and left. If difficulty is encountered, check and repair/replace any component causing the difficulty or remove any ice and snow buildup that may be obstructing the steering components. There should be no excessive free-play in the steering linkage, ball joints or connections to the skis.
7. Check the operation of the **throttle**. Completely compress the throttle lever several times to make sure it operates smoothly and returns quickly and completely to the idle position.



WARNING

If the throttle lever does not return quickly and completely to the idle position, the throttle system must be repaired or damaged components replaced before the snowmobile is operated.

8. Check the **drive belt** and the **track** for wear and alignment. Replace or adjust if necessary.
9. Check the **gasoline** and **oil supply** of the snowmobile. Never take extended trips without the gas tank being full and always have a reserve for possible emergencies. A good habit is filling the gas tank and checking all fluid levels before each day of snowmobiling.

10. Make sure an **Operator's Guide** and all necessary **emergency equipment** are included with the snowmobile.
11. Make sure the snowmobile is **facing an open area** and no one is in front of or behind the snowmobile before starting.

PROPER FUELING

Proper fueling is an extremely important aspect of snowmobile operation. Most snowmobiles manufactured today do not require gasoline and oil to be pre-mixed except in certain circumstances. Read the Operator's Guide for specific instructions, including gasoline octane and type requirements and oil recommendations.

Common sense must be used when handling gasoline as it is highly explosive. Always fill the gas tank in a well-ventilated area. Do not ingest or come into contact with gasoline. If gasoline is ingested or comes into contact with the eyes, seek medical attention immediately. Skin contacted with gasoline must be washed with soap and water immediately. Gasoline-soaked clothing must be changed immediately.

When filling the gas tank from a gas can, a funnel with a fine-mesh screen should be used to prevent spillage of gasoline and foreign particles from entering the gas tank. Since gasoline expands as its temperature rises, fill the gas tank to the rated capacity only.

When adding fuel to the snowmobile:

1. NEVER smoke or light any matches.
2. NEVER add fuel while the snowmobile engine is running.
3. NEVER over-fill the gas tank.
4. NEVER spill fuel during fueling.

Riding a Snowmobile

THE FIRST RIDE

Never operate a snowmobile without proper instruction. It is recommended that all snowmobile operators attend a certified Snowmobile Safety Course. The most important objective when first operating a snowmobile is getting the feel of starting, stopping and turning. Once the novice snowmobiler has read and understands the information in the Operator's Guide and Snowmobile Safety Handbook, and been advised by an experienced snowmobiler of the proper starting, stopping and turning procedures, operating the snowmobile should be practiced on an open, flat, obstruction-free area. The main caution for the novice is that overconfidence must never take over from practice and experience. Operating a snowmobile requires special skills and knowledge that must be learned over a period of time.

MASTERING BASIC SNOWMOBILE CONTROL

When starting, compress the throttle lightly and move ahead slowly. Gradually increase speed, release the throttle and try braking. Turning a snowmobile is similar to turning a motorcycle. When turning, the operator should lean toward the direction of the turn. Turning does not merely happen; it depends on four basic factors: 1) snowmobile speed; 2) the type of turn; 3) snow conditions; and 4) weight on the skis. When turning the snowmobile in soft or lightly packed snow, in sweeping turns, or in medium-speed turns, the operator should assume the kneeling position and lean into the direction of the turn. For faster turns, the operator should use the sitting position and lean far into the turn. Turning at a high rate of speed on hard-packed snow or ice can be dangerous and is not recommended. Inexperienced operators should maintain a slower rate of speed when practicing turns on hard-packed snow or ice. Only experience will teach how much to lean into turns at different speeds.

RIDING POSITIONS

Standing, kneeling, posting and sitting are the four basic positions normally used while operating a snowmobile. Each position has its advantages and disadvantages under different terrain and snow conditions. Only experience will determine which position is best for each operator under each situation.

SITTING — Position both feet on the running boards, body midway back on the seat, and hips and knees in a flexible position. The sitting position is ideal for snowmobile operation over smooth and familiar terrain. The position is generally accepted as the most relaxing and safest, allowing the operator to maintain the best control in an emergency situation.

KNEELING — Position one foot firmly on the running board and the opposite knee on the seat. The kneeling position allows the operator at slower speeds to shift weight quickly and put more "body English" into turns, especially in deep snow. One disadvantage of this position is that the windshield does not protect the operator from the onrush of cold air and snow. The kneeling position also does not allow the operator to gain quick control of the snowmobile in an emergency situation. Quick stops must be avoided in this position.

STANDING — Position both feet on the running boards with knees flexed. The standing position allows the operator to see better, obtain maximum traction, and shift weight as conditions dictate. When traveling up a steep incline, the operator should lean forward in the standing position. As with the kneeling position, the standing position does not allow the operator to gain quick control of the snowmobile in an emergency situation. Quick stops must be avoided in this position.

POSTING — Position the body off the seat in a squatting posture. The posting position allows the legs to work as shock absorbers when traveling over rough terrain.

IF A SNOWMOBILE GETS STUCK IN SNOW

It is always better to prevent a snowmobile from becoming stuck in snow than to exert oneself in attempting to free a stuck snowmobile. Two techniques will greatly reduce the possibility of becoming stuck in snow. First, in deep, fresh snow, stop the snowmobile in snow that has already been packed down. This can be accomplished by driving the snowmobile in complete circle and then stopping on the packed circumference of the circle. Second, always stop the snowmobile facing downhill, never uphill.

If a snowmobile becomes stuck in snow, do not attempt to lift it out — that is physically hard on a person's back and heart.

In deep snow conditions, there are two methods to free a snowmobile. The first method is to stand on the rear of the running board, compress the throttle gently (without spinning the track or breaking traction), and bounce up and down. This will apply more pressure to the track of the snowmobile and remove some weight from the skis. If this method does not work, do not compress the throttle wide open as this will merely bury the snowmobile deeper.

The second method is to turn off the snowmobile engine and tamp down a short trail approximately three to five feet (one to two meters) in front of the snowmobile at a lower level than the snowmobile. Then lift (from the knees) the rear of the snowmobile onto new snow, start the engine, compress the throttle gently (without spinning the track or breaking traction) and drive forward. Never place foreign material beneath the track for support or attempt to push the snowmobile by the handlebar while accelerating. Models with a reverse switch can, under certain conditions, free themselves from a stuck situation by simply backing up.

GROUP (SAFARI) RIDING

The enjoyment and safety of group (safari) riding should be a concern of all snowmobilers. Before starting out on a group ride, the person who is most familiar with the trail should be designated as the leader. All members of the group should be knowledgeable of the proposed route and destination. A "shadow," the rider who follows up the group, should also be designated. The following group riding rules should be followed:

1. Never overtake the leader or any other snowmobile.
2. Use appropriate hand signals at all times.
3. Maintain safe distances between all snowmobiles at all times.
4. Use moderate speeds and keep a steady pace. Obey all speed limits. Never drive faster than conditions and common sense dictate.
5. Stop periodically for rests.
6. Cross all roadways and railroad tracks in single file at a 90° angle.
7. Assist others when necessary.
8. Carry sufficient gasoline and all necessary and emergency tools and equipment.

TERRAIN AND RIDING VARIATIONS

Not all snowmobiles can ride on trails. Check with local authorities to make sure that your snowmobile can be used on trails.

The snowmobile, unlike a car or motorcycle which generally travels on familiar roads or trails, can get into areas where other vehicles cannot travel. Because the snowmobile is a versatile vehicle, operators are often tempted to put the snowmobile into places and situations which may be hazardous. It is important, at all times, to understand the limitations of the snowmobile and to drive cautiously no matter what the terrain conditions. Learn to read the trail as you ride. Know what's coming; be prepared to react long before you get there. The following sections are a briefing on the variety of conditions a snowmobiler is likely to encounter and a general overview of how the snowmobile should be operated under each condition. Snowmobiles are not designed for use on roads, streets or highways.

Groomed Trail

The sitting position is the preferred riding position on a groomed trail. Always observe all trail signs, keep to the right side of the trail, and be prepared for the unexpected. Never race or zigzag from one side of the trail to the other. Never stop unexpectedly, directly on the trail or in a location where you cannot be clearly seen by other snowmobilers on the trail.

Ungroomed Trail

The sitting, kneeling and posting positions are preferred riding positions on an ungroomed trail. You can expect snowdrift and washboard conditions unless there has been a recent snowfall. Because of these conditions, it is important to use moderate speed and to keep a watchful eye out for hidden rocks, tree stumps, etc.

Deep Snow

The kneeling and standing positions are the preferred riding positions in deep snow conditions. You can expect the snowmobile to perform differently in deep powder snow than snow six inches (15 centimeters) deep. Turns are harder, the risk of becoming stuck is greater, and the snowmobile can begin to bog down. A higher rate of speed will be required to negotiate a turn and turns should be wide and sweeping. Be sure to always stop on a previously traveled track with the snowmobile facing an open area or downhill.

Ice or Hard-Packed Snow

Since the skis and track do not have much traction on ice or hard-packed snow, the snowmobiler is advised to slow down and avoid rapid acceleration, turning and braking. Traction aids are recommended for this type of riding. Turning should be done only at a slow speed. Always use extreme caution as braking capability is reduced on ice or hard-packed snow. If brakes are firmly applied and the track locks, the snowmobile may swerve, risking the chance of the operator losing control. The sitting position will give the operator the best control. If swerving results from attempting to turn or brake, turn the skis into the direction of the slide and gently apply throttle.

If at all possible, avoid waterways; traveling on frozen lakes and rivers can be fatal. Consult local authorities concerning the ice conditions if there is any question or doubt as to the thickness or strength of the ice or if you are unfamiliar with the area. Also, be familiar with or ask about inlets, outlets, springs, fast-moving currents, or any other hazard that may create thin ice. NEVER ride on ice you THINK is thick enough.

Uphill

Depending on the angle of the incline, climbing a hill can be accomplished by two methods. The SLALOM METHOD (sidehilling) can be used if there are few obstacles on the hill. The operator assumes a kneeling position while keeping their body weight on the uphill side at all times. While maintaining a steady, safe speed, the operator crosses the hill at an angle as far as possible in one direction, and then turns back at the same angle in the opposite direction, switching the riding position to keep weight on the uphill side of the snowmobile. The DIRECT CLIMB method should be approached with caution. The operator should assume the standing position, accelerate before the start of the climb and then reduce throttle pressure to prevent track slippage.

In either type of climb, the snowmobile speed should be only as fast as the incline dictates. Always slow down as the crest of the hill is approached. If the snowmobile stalls, shut off the engine, free the skis by pulling them out and downhill, place the rear of the snowmobile uphill, position yourself on the snowmobile to avoid tipping, start the engine, and ease it out with slow, even throttle pressure.

Downhill

The sitting position is best for downhill riding in order to have full control of the snowmobile. Keep a low center of gravity and maintain slight throttle pressure, allowing the snowmobile to run downhill with the engine operating. Speed should be held to a minimum, but if a higher than safe speed is reached, apply frequent light pressure to the brakes. Never lock the track by jamming on the brake.

Sidehill

The preferred position for sidehill riding is the kneeling position with the downhill leg on the seat of the snowmobile. This position will allow the necessary shifting of weight as quickly as needed. All riders are advised to lean into the hill. The harder the lean inside, the more pressure placed on the inside of the track allowing for better control. "Sidehilling" is fairly easy in fresh deep snow but is extremely difficult on ice or hard-packed snow. Only experienced "sidehillers" should be allowed to break trail on an icy hill.

HAZARDS

Snowmobiling is not without hazards. Trail systems and heavy use areas are generally free of most obstacles, but low-hanging branches, guy wires, posts, ditches, roadways, fences and open water are hazards that should be watched for carefully.

Fences and Posts

Fences and posts may be partially or completely covered by snow. Care should be taken to locate fences before riding. Proceed with caution in unfamiliar terrain. Newly found fences should be marked with a flag or reflective device. Do not drive over small snow mounds that may be a fence or a rock pile.

Wires

Always be on the lookout for hidden wires. Fence wires, guy wires, and chains or wires used as road closures are all hazards that should be avoided. Trails should be routed a safe distance from guy wires. Trails should not be cut between a pole and a guy wire. Reflective devices should be attached to guy wires and fences for easy recognition at night. Do not operate in unfamiliar territory at night as wires are extremely difficult to detect.

Ditches, Excavations and Culverts

Ditches and excavations may become partially or completely covered with snow obscuring any possible danger. Open water, deep trenches, culverts or rough excavations are particular hazards along snowmobile trails that pass near roads or residential areas. Snowmobilers must not attempt to ride in ditches unless absolutely sure of the ditch base.

Culverts possess the potential of hooking a ski, causing the snowmobile to flip. Use caution when approaching a crossing with a culvert or when you suspect a culvert may be present.

Roadway Crossing

Improper crossing of roadways is dangerous and, in some places, illegal. When approaching a roadway, approach with caution and choose a place to cross without difficulty. Assume the standing position for increased visibility. Come to a complete stop, look both ways, wait for the traffic to clear and proceed across the road at a 90° angle. NEVER drive diagonally across a road and remember that steering on dry or icy pavement is nearly impossible. Also, never stop a snowmobile on a paved road because it is very difficult to get started again.

Railroad Crossing

Snowmobile trails may cross railroad tracks. When crossing tracks, come to a complete stop, look both ways, and proceed directly across the tracks at a 90° angle. Proceeding diagonally across the tracks may result in the skis becoming wedged in the tracks. NEVER use railroad tracks as a snowmobile trail as it is illegal and very dangerous. Because of the sound level of the snowmobile engine, the snowmobile operator may not hear a train approaching from the rear.

Unfamiliar Territory

Always operate the snowmobile with extreme caution in an unfamiliar area even when following existing snowmobile tracks or trail. Proceed slowly enough to recognize potential hazards and obstacles which could shorten your ride and enjoyment. Even hitting a small rock or stump could throw the snowmobile out of control and cause severe injury to the operator or passenger. Be safety conscious, slow down and enjoy the scenery of unfamiliar territory.

In fog or heavy snow, even a very familiar trail becomes unfamiliar and hazardous. If you must proceed into the fog or heavy snow, do so slowly and watch intently for hazards. DO NOT PROCEED if not sure of what is ahead.

Night Riding

Riding a snowmobile at night is very popular; however, riding at night can be very hazardous. Obstacles and other hazards (that are easily identified during daytime) are much more difficult to see and avoid. When night riding, make sure the snowmobile's lights are properly adjusted and in good working order. Reduce speed; do not over-drive the headlight. Never travel in an unfamiliar area or blaze a new trail at night. Always carry a flashlight or flare for signaling an emergency.

Avalanche Areas

In some cases, snowmobilers may be driving in mountainous areas. Since even a footstep is enough to start an avalanche, a snowmobile is certainly capable of starting one.

The best way to avoid an avalanche is to stay out of the area where the potential for avalanche exists. The safest snowmobile routes are on ridgetops, slightly on

the windward side, away from cornices. Windward slopes are usually safer than leeward slopes. If you cannot travel on the ridgetop, the next safest route is out in the valley far from the bottom of slopes. Avoid disturbing the cornices from either below or above. Drive to the top of the ridge by detouring around cornice areas.

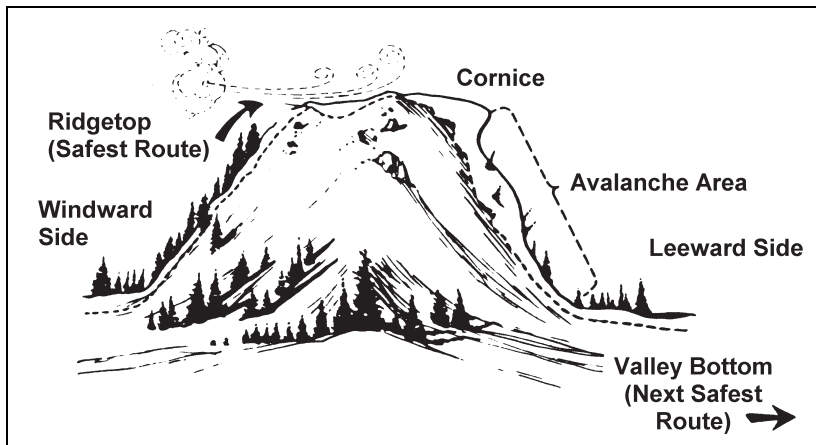

0000-063

Snowmobiles should not cross the lower part of slopes. Do not drive a snowmobile across especially long open slopes or known avalanche paths. Many potential hazard areas will be posted and closed to travel. In cornice areas, trail an avalanche cord behind your snowmobile. If you are buried, this brightly colored, lightweight rope will float to the snow's surface to aid in a quick recovery.

If caught in an avalanche, discard all equipment and get away from the snowmobile. Make swimming motions, trying to stay on top and trying to get to the side of the avalanche. Before coming to a stop, get your hands in front of your face and try to make an air space in the snow as you are coming to a stop.

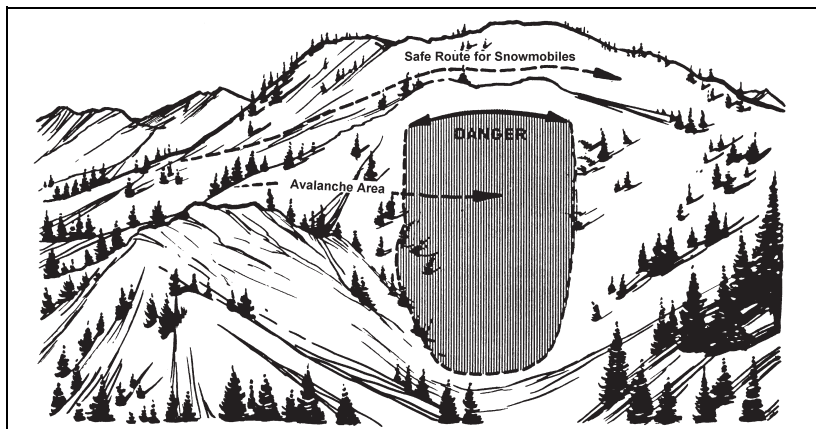

0000-064

Illustrations reprinted with permission from Outdoor Empire Publishing, Inc., Seattle, Washington. Copyright 1983. All rights reserved.

Emergencies

COLD WEATHER INJURIES

Frostbite, hypothermia and snowblindness are the most common snowmobiling injuries. Recognizing the early symptoms of these injuries and knowing how to treat them can prevent permanent injury and possibly death. For your own and others' protection, enroll in a certified first-aid course.

Frostbite

Frostbite, the crystallization of the fluids and underlying soft tissues of the skin, is the most common cold weather injury. The nose, cheeks, ears, fingers and toes are the areas most commonly affected by frostbite. Often the victim is not aware of the frostbite until told by someone else. As frostbite develops, the symptoms follow this order:

1. The affected skin may be slightly flushed.
2. The skin changes to white or grayish-yellow in appearance.
3. Pain is sometimes felt early but subsides later (often there is no pain).
4. Blisters may appear.
5. The affected part feels intensely cold and numb.
6. Mental confusion and impairment of judgment set in.
7. The victim staggers.
8. Eyesight fails.
9. The victim falls and may become unconscious.
10. Shock is evident.
11. Breathing may cease.

Minor frostbite may be treated by slowly warming the affected area. Do not rub the frostbitten area. Severe frostbite must be treated by a physician.

Hypothermia

Hypothermia, the state at which the body is losing heat faster than it can produce it, drains valuable energy from the body. As hypothermia develops, the symptoms follow this order:

1. Uncontrolled shivering and fumbling hands.
2. Numbness and memory lapses.
3. A dangerously low body temperature.
4. Stupor, frequent stumbling and a lurching walk.
5. Vague slow speech, drowsiness and apparent exhaustion.
6. The victim collapses.

Hypothermia should be treated by a physician as soon as possible. In the meantime, the victim should be covered with warm, dry clothing and/or blankets. The best way to prevent hypothermia is to dress adequately and to stay dry.

Snowblindness

Snowblindness is a condition snowmobilers may experience during medium-bright to intense sunshine days. The symptoms are the following:

1. Severe headache.
2. Dizziness.
3. Sensitivity to light and seeing stars.

The recommended treatment is immediate removal to a totally dark area. Snowblindness can be prevented by wearing goggles or a face shield with the proper colored lens.

EMERGENCY SITUATION

All snowmobilers are advised to be prepared for an emergency situation at all times. Informing someone of your intended journey and time of expected return is good insurance for your safety. If, while riding a snowmobile on a trail, an accident is encountered or if the snowmobile breaks down and cannot be fixed, **YOU** are involved in an emergency situation! If confronted with an emergency situation, remember to stay calm, dry and warm. Panic and exhaustion can lead to needless actions that can result in injury or death. Do not attempt to walk through extremely deep snow as it could take two or three days to cover the area traveled by a snowmobile in 10 or 20 minutes.

Extended snowmobile trips require the following suggested additional equipment for safety and protection:

SUGGESTED EXTRA EQUIPMENT

space blanket	rope
candy bars	pocketknife
Operator's Guide	friction tape
waterproof matches	extra starter rope
flashlight	tool kit
extra spark plugs	gasoline de-icer
first-aid kit	shovel
snow shoes	ax
extra mittens, socks, and boot liners	flares
extra drive belt	metal cup or kettle
compass	tarp or plastic sheet
area map	wireless phone

■ **NOTE: A single snowmobile could not possibly carry all of this equipment by itself unless equipped with a cargo rack or pulling a sled. That is one reason why it is necessary to take extended trips with other snowmobilers and divide the load.**

SURVIVAL

There are several steps which will make a survival situation easier. It is imperative to remember that the best tool of survival is your brain; use it in a survival situation. The following steps will help save a life, POSSIBLY YOURS:

1. Do not panic.
2. Plan a course of action.
3. Stay together.
4. Conserve energy and warmth.
5. Make an adequate shelter.
6. Build a fire.
7. Melt clean snow for water.
8. Signal for help.

■ **NOTE: Consult a library or enroll in a first-aid course for further information on survival techniques. The above list is only a summary of the steps to follow.**

RESCUE SIGNALS

Ground-to-air rescue signals should be tamped approximately 100 feet (30 meters) long with one side of the signal “walled up” or with boughs placed in the signal to increase its visibility. Make your emergency situation clear by using the appropriate signal in the following illustration:

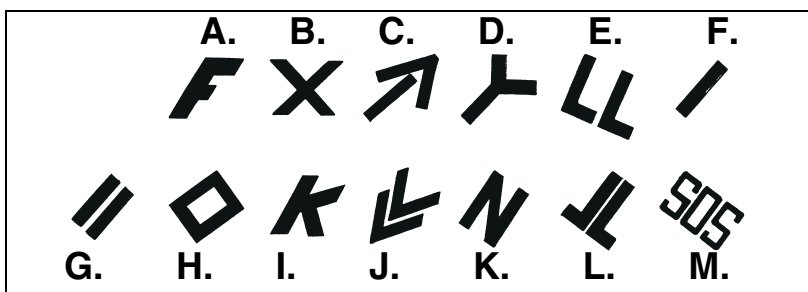

0726-101

- | | |
|--------------------------|----------------------------|
| A. Need Food | H. Need Compass and Map |
| B. Can't Proceed | I. Tell Me Direction to Go |
| C. Am Going This Way | J. Need a Gun |
| D. Yes | K. No |
| E. All Well | L. Don't Understand |
| F. Need a Doctor | M. Universal Help |
| G. Need Medical Supplies | |

Closing

Join a snowmobile club or help start one. Read, understand and follow the information in the Operator's Guide and on all decals found on the snowmobile. Enroll in a certified snowmobile safety course and first-aid class. Be a responsible snowmobiler. Enjoy snowmobiling and remember, SAFETY FIRST!

NOTES

 **WARNING**

Disregarding any of the safety precautions and instructions contained in the operator's guide, safety handbook, safety video and on product safety labels could cause injury including the possibility of death.



®TM AND THE BRP LOGO ARE TRADEMARKS OF BOMBARDIER RECREATIONAL PRODUCTS INC. OR ITS AFFILIATES.
©2022 BOMBARDIER RECREATIONAL PRODUCTS INC. ALL RIGHTS RESERVED.

www.brp.com

SKI-DOO®

LYNX®

SEA-DOO®

CAN-AM®

ROTAX®

ALUMACRAFT®

MANITOU®

QUINTREX®