

# *ski-doo*



## MXZ 200

# OPERATOR'S GUIDE

Includes Safety,  
Maintenance and  
Use Information



# 2023

## **⚠ WARNING**

Minimum recommended operators age under adult supervision:  
– 13 years old

Read this operator's guide thoroughly. It contains important safety information. Adult supervision is required for the proper understanding of the risks involved with the usage of these vehicles.

Review and explain the content of this operator's guide with the young operator and make sure that the young operator understands the proper safe operation of the vehicle.

Keep this operator's guide handy for reference at all times.

520003029

**Original  
Instructions**

# CALIFORNIA PROPOSITION 65 WARNING

## **WARNING**

Operating, servicing and maintaining an off-road vehicle can expose you to chemicals including engine exhaust, carbon monoxide, phthalates, and lead, which are known to the State of California to cause cancer and birth defects or other reproductive harm. To minimize exposure, avoid breathing exhaust, do not idle the engine except as necessary, service your vehicle in a well-ventilated area and wear gloves or wash your hands frequently when servicing your vehicle. For more information go to [www.p65warnings.ca.gov/products/passenger-vehicle](http://www.p65warnings.ca.gov/products/passenger-vehicle).

In Canada, products are distributed and serviced by Bombardier Recreational Products Inc. (BRP).

In the USA, products are distributed and serviced by BRP US Inc.

In the European Economic Area (which is comprised of the member states of the European Union plus the United Kingdom, Norway, Iceland and Liechtenstein), the Commonwealth of the Independent States (including Ukraine and Turkmenistan) and Turkey, products are distributed and serviced by BRP European Distribution S.A. and other affiliates or subsidiaries of BRP.

For all other countries, products are distributed and serviced by Bombardier Recreational Products Inc. (BRP) or its affiliates.

TM® Trademarks of BRP or its affiliates.

This is a non-exhaustive list of trademarks that are the property of Bombardier Recreational Products Inc. or its affiliates:

SKI-DOO®

MXZ®

XPS®

All rights reserved. No parts of this Operator's Guide may be reproduced in any form without the prior written permission of Bombardier Recreational Products Inc.

©Bombardier Recreational Products Inc. (BRP) 2022

## This vehicle can be hazardous to operate.

Never accelerate rapidly or drive at high speed beyond the limits of visibility or without being totally familiar with the terrain and what lies in front of you. Obey speed limits and never operate at speeds that do not allow adequate maneuvering and stopping distances. Read and study the entire Operator's Guide and Snowmobile Safety Handbook.

Failure to follow this warning could result in personal injury to yourself or others. For your safety, understand and follow all the warnings contained in this Operator's Guide and on the labels on this vehicle.

Keep this Operator's Guide with this vehicle at all times. If you lose your guide, an electronic printable version is available on [www.operatorsguides.brp.com](http://www.operatorsguides.brp.com) or visit your authorized dealer for a hard copy replacement. The safety labels should be considered permanent parts of the vehicle. If a safety label comes off or becomes hard to read, contact your authorized dealer for a free replacement.

**FAILURE TO FOLLOW THE WARNINGS CONTAINED IN THIS GUIDE CAN RESULT IN SERIOUS INJURY OR DEATH.**

The Operator's Guide, Snowmobile Safety Handbook, and Snowmobile Decals display important information:



The Safety Alert Symbol means **ATTENTION! BE ALERT! YOUR SAFETY IS INVOLVED.**



**WARNING**

**WARNING** identifies personal safety-related information. Follow the directive because it deals with the possibility of serious personal injury or even death.



**CAUTION**

**CAUTION** indicates a hazard situation which, if not avoided, could result in minor or moderate injury.

**CAUTION**

**CAUTION**, without the safety alert symbol, identifies unsafe practices. Follow the directive because it deals with the possibility of damaging part or parts of the snowmobile.

■ **NOTE:**

A **NOTE** identifies supplementary information worthy of particular attention.

### Personal Injury

- To avoid injury to yourself and others, **NEVER** operate the snowmobile without first reading and understanding this guide and the Snowmobile Safety Handbook; then follow the instructions and heed the warnings given.
- **USE COMMON SENSE.**
- **DON'T DRINK and DRIVE.**
- **STAY IN CONTROL at ALL TIMES.**
- **TELL YOUR FRIENDS.** If you see a friend operating a snowmobile recklessly, at excessive speeds, while intoxicated, or in other unsafe ways, don't wait until it is too late to warn of the consequences of snowmobile misuse. Such conduct endangers everyone. **TAKE AN ACTIVE ROLE IN THE SAFETY OF YOURSELF AND OTHERS.**

# Table of Contents

Foreword.....	3	<b>Maintenance .....</b>	<b>22-32</b>
Snowmobile Safety Rules .....	4	Engine Oil.....	22
Hangtags.....	5-7	Battery (Electric Start).....	23
Warning Labels & Information .....	8-9	Carburetor.....	24
Declaration of Conformity (EU) .....	10	Checking/Adjusting Throttle Lever (Tension) .....	25
Declaration of Conformity (UK) .....	11	In-Line Fuel Filter .....	25
Emissions Regulation 2016/1628 (EU) ...	12	Spark Plug.....	26
Reporting Safety Defects .....	13	Braking.....	26
Getting Ready to Safely Operate the MXZ 200.....	14	Track Tension .....	27
Operating the MXZ 200 .....	15	Track Alignment .....	28
<b>General Information .....</b>	<b>16-19</b>	Adjusting Shock Springs .....	29
Control Locations .....	16	Adjusting Rear Spring Tension.....	30
Snowmobile Identification .....	16	Ski Alignment .....	30
Gasoline — Oil .....	16	Ski Wear Bar .....	31
Carburetor.....	17	Recoil Starter Air Vents .....	31
Engine Break-In .....	17	Lights.....	31
Muffler .....	18	<b>Preparation for Storage.....</b>	<b>33</b>
Suspension .....	18	<b>Preparation after Storage .....</b>	<b>34</b>
Battery.....	18	<b>Specifications .....</b>	<b>35</b>
<b>Operating Instructions .....</b>	<b>20</b>	<b>Warranty .....</b>	<b>36</b>
Starting and Stopping Engine .....	20	<b>Customer Information.....</b>	<b>48</b>
<b>Periodic Maintenance/Tune-Up Chart ....</b>	<b>21</b>	<b>Contact Us .....</b>	<b>50</b>
		<b>Change of Address/Ownership .....</b>	<b>51</b>

# Foreword

The MXZ 200 Snowmobile is intended to be a learning/recreational snowmobile for a responsible operator at least 13 years of age and under adult supervision. This snowmobile is intended to be ridden by the operator only; there shall be no passenger. Use of this snowmobile on public streets, roads, and highways can be hazardous and is prohibited by law in most cases. This vehicle is not factory equipped to ride on public trails. Additional equipment may be necessary to meet local regulations. Refer to your authorized BRP dealer for more information. However, make sure to comply with the local regulations in regards to other requirements like the minimum age for the operator and license. As a parent or guardian, one must accept the responsibility of training the operator in the safe operation of the snowmobile. Teach all operators the basic principles of operation, snowmobile rules and regulations, and especially how to stop the snowmobile in case of an emergency. Impress upon the operator a sense of snowmobile courtesy and responsibility.

This snowmobile is a quality Ski-Doo product designed, engineered, and assembled to give dependable service. Be sure, as the owner, to become thoroughly familiar with its basic operation, maintenance, and storage procedures. Read this guide and the accompanying Snowmobile Safety Handbook to ensure safe and proper use of the snowmobile.

This guide is divided into sections. The sections “Getting Ready to Operate the MXZ 200 Safely” and “Operating the MXZ 200” must be read and explained to the operator. The other sections are for the owner/parent/guardian and contain information on snowmobile identification, safe operating instructions, lubrication, maintenance, storage, and after-storage preparation. If repair or service is ever required, contact an authorized BRP Snowmobile dealer for professional service.

At the time of publication, all information and illustrations were technically correct. No retroactive obligation is incurred.









This Ski-Doo Operator’s Guide should be considered a permanent part of the snowmobile and must remain with the snowmobile at time of resale.

Every BRP snowmobile meets or exceeds the standards of the Snowmobile Safety and Certification Committee and displays the SSCC decal. BRP endorses and encourages the safe use of all snowmobiles. Always wear a helmet and eye protection. Drive with caution, observe all state and local laws, and respect the rights of others. International Snowmobile Manufacturers Association (ISMA) members like BRP do their part to improve trails, sponsor events, and generally support the sport of snowmobiling. As a member of the National Snowmobile Foundation, BRP promotes snowmobiling through education, charity, and research programs.

© **Bombardier Recreational Products Inc. (BRP) 2022**

Printed in U.S.A.

# Snowmobile Safety Rules

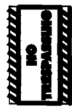
<p><b>4</b></p> <p><b>SHI-DOO</b> endorses and encourages the safe use of all snowmobiles. Always wear your seat belt and please don't drink and drive.</p> <p>Receive proper training and operate within your capabilities. See operator's manual for complete safety instructions.</p> <p><b>RÈGLEMENTS DE SÉCURITÉ EN MOTONEIGE</b></p> <p>SHI-DOO endorse et encourage l'utilisation sécuritaire de toutes motoneiges. Respectez toujours ces règlements qui vous permettront de pratiquer ce sport avec plaisir. Les motoneiges sont un moyen de transport et non un jouet. Veuillez vous référer à la notice d'utilisation pour plus d'informations complètes de sécurité.</p> <p><b>SAKERHETSREGLER VID SNØSKOTERKØRNING</b></p> <p>SHI-DOO støtter og oppfordrer til sikker bruk av snøscootere. Følg alltid disse reglene når du er ute og kjører.</p> <p><b>MOOTTORIKELKAN TURVASÄÄNNÖT</b></p> <p>SHI-DOO korostaa ja kannustaa moottorikelkkojen turvallista käyttöä. Niihin sääntöihin kannattaa noudattaa saat koki hauskaa ja turvaa hiihtämisen iloa ja hyödyn.</p> <p><b>SIKKEHETSREGLER FOR BRUK AV SNØSKOOTER</b></p> <p>SHI-DOO oppfordrer alle til å behandle snøscooterne med respekt og sikkerhet.</p> <p><b>NORME DI SICUREZZA PER LE MOTOSLITTE</b></p> <p>SHI-DOO sostiene ed incoraggia la sicurezza delle motoslitte. Per un divertimento continuo di questo sport sempre la sicurezza norme.</p> <p><b>スノーモービルの安全運転ルール</b></p> <p>SHI-DOO は、スノーモービルの安全運転を奨励し、安全運転を促すことを目的として、本安全運転ルールを制定しました。</p>	<p><b>1</b></p> <p>Don't drink and ride. No booze pas foreque vous conduisez. No alcohol while driving. Jos olet, älä ajokalla! Kjer aldri under påverking av alkohol. Non bevete mentre ti guida.</p> <p><b>飲酒運転はしないこと。</b></p> <p></p>	<p><b>2</b></p> <p>Always wear a helmet. Portez toujours un casque. Always wear your seat belt. Käytä aina suojakypärää. Brak alltid hjelm. Imossaa sempre il casco. 常時、ヘルメットを着用すること。</p> <p></p>	<p><b>3</b></p> <p>Watch out for thin ice/open water. Be aware of the depth of the snow. Si urgei fet tunni suloppak vettä. Vero hääloja jäätä ja avantoja. Always wear your seat belt. Atorri allu sponsostruttura del ghiaccio. 氷水や雪が凍っていない箇所は避けること。</p> <p></p>	<p><b>5</b></p> <p>Don't ride after midnight. Ne conduisez pas après minuit. Don't drink and drive. Alli sika alkoholilla. Non guidate dopo le mezzanotte. Ungtill å kjøre etter midnatt. Realmente a noite não é hora de dirigir. 夜中以後は乗らないこと。</p> <p></p>	<p><b>6</b></p> <p>Beware of trees and other hazards. So you should not ride in a forest. Vero metsi ja muuta vaarata. Atorri allu alberi e altri ostacoli. 木や障害物に用心すること。</p> <p></p>	<p><b>7</b></p> <p>Always use a solid tie for towing. Assurez-vous d'avoir une attache solide pour remorquer. Käytä aina vahvoja vetolinkkejä. Ungtill å koppla till koppling vid bogstapning. Usate un gancio fisso per il traino. 車引にはしっかりと 車ロープを使うこと。</p> <p></p>	<p><b>8</b></p> <p>Observe proper rider capacity. Respectez le nombre recommandé de passagers. A. Fugittorri. B. Maximum deux passagers sur les sièges. Bogtörna antal åkare. C. Ductorsignificati pasageri. Ola hienonon kuormittamista. B. Korottoman laadun hengen kulkua. Vero opetormokom på passagerkapabiliteten. B. Maks. To perättör på förtörers scotörora. Osaverte lo copolone del velovelo. Z-potör. Maksimalno 2 passageri. 一人乗りには一人乗り。 乗客定員を必ず守ること。</p> <p></p>	<p><b>9</b></p> <p>Obey all local laws and regulations. Respecter alle lokale lover og forskrifter. Respecter alle regler og forskrifter. Dovete sempre rispettare le leggi. 運轉 地の法令に 従って下さいこと。</p> <p></p>	<p><b>10</b></p> <p>Be of legal age. Käyttör on oltava laillisen iän. Respecter allegränser. Dovete sempre rispettare le leggi. Dovete sempre rispettare le leggi. 運轉 地の法令に 従って下さいこと。</p>	<p><b>11</b></p> <p>Read and understand your Operator's Manual. Lisez et comprenez votre Manuel de l'opérateur. Lue ja ymmärrä mieltä Käyttörmanuaalin sanot. Loppo attentamente il Manuale di Guida. オーナーマニュアルをよく読んで、守ること。</p> <p></p>	<p><b>12</b></p> <p>Obey all local laws and regulations and use of seat belts. Dovete sempre rispettare le leggi. Dovete sempre rispettare le leggi. 運轉 地の法令に 従って下さいこと。</p> <p></p>
--	---	--	---	--	--	---	---	--	---	--	--



## Hangtags

This snowmobile comes with hangtags containing important safety information. Anyone who rides the snowmobile should read and understand this information before riding.

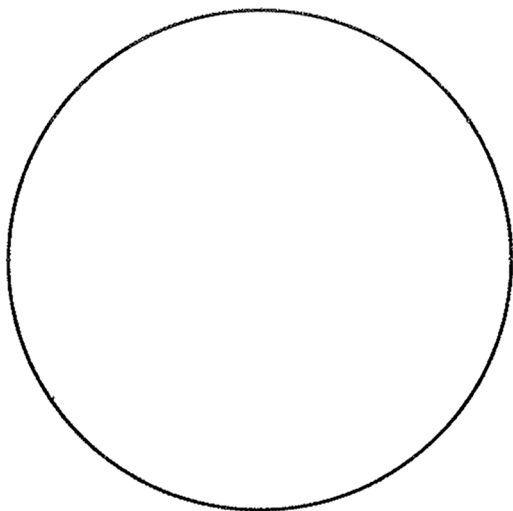

• **CAUTION** •

**4 CYCLE ENGINE  
DO NOT USE  
MIXED GAS!**

1655-318



# Hangtags

This snowmobile comes with hangtags containing important safety information. Anyone who rides the snowmobile should read and understand this information before riding.

	
<b>SNOWMOBILE SAFETY AND CERTIFICATION COMMITTEE</b>	
<b>SOUND RATING</b>	<b>73/78</b>
<p>THE SOUND EMISSION OF THIS MODEL SNOWMOBILE HAS BEEN MEASURED IN ACCORDANCE WITH SOCIETY OF AUTOMOTIVE ENGINEERS SOUND EMISSION TEST PROCEDURES J1161 AND J192 AT FIFTY FEET (15.2m) AND DOES NOT EXCEED 73 dB (A) TRAVELING AT 15 MILES PER HOUR (24 km/h). NOR 78 dB (A) AT WIDE OPEN THROTTLE. A 2dB (A) TOLERANCE IS PROVIDED IN THE TEST PROCEDURES FOR VARIATIONS IN TESTING CONDITIONS.</p>	
<p>THIS LABEL IS NOT TO BE REMOVED PRIOR TO PURCHASE</p>	<p>THIS LABEL MAY ONLY BE AFFIXED TO A SNOWMOBILE WHICH ALSO BEARS AN SSCC SAFETY CERTIFICATION LABEL.</p>
<p>1655-766</p>	

# Warning Labels & Information

This snowmobile comes with labels containing important safety information. Anyone who rides the snowmobile should read and understand this information before riding. The labels should be considered as permanent parts of the snowmobile. If a label comes off or becomes hard to read, contact your authorized dealer for a replacement.

## ⚠ WARNING

SEVERE INJURY OR EVEN DEATH MAY RESULT IF ANY OF THE FOLLOWING ARE IGNORED.

- Before operation this snowmobile, all operators must read, understand, and follow the information contained in the Operator's Manual, Safety Handbook and all Warning Decals.
- Wear an approved helmet, eye protection, and appropriate snowmobile clothing.
- Before starting engine, check throttle, brake and steering for proper operation.
- To stop engine in an emergency, push the emergency stop switch down.
- Stay clear of the rotating track. Entanglement may result.
- Do not operate this vehicle on public roads.
- Avoid contact with hot or moving parts. Turn engine off before opening the hood. Leave all shields in place.
- After refueling, secure fuel tank cap before sitting on or operating this vehicle. Do not store this vehicle in an enclosed area with a full fuel tank.
- Check brake fluid level and pad wear before each use or brake loss can occur. Loss of brakes can result in severe injury or even death.
- Excessive repetitive use of the hydraulic brake for high speed stops will cause overheating of the brake fluid and premature brake pad wear which will result in an unexpected loss of brakes.
- The brake lever lock is not a parking brake and should not be applied for periods exceeding 5 minutes. Longer time period can cause loss of brake lock.
- Refer to Operator's Manual for more information and instructions. A free Operator's Guide for this model is available upon written request.

## ⚠ CAUTION

The engine must be properly warmed up before high speed operation or severe engine damage may occur. Do not operate the engine at more than half throttle until the engine has reached normal operating temperatures. If this vehicle is equipped with a battery, it should be removed before turning vehicle onto its side to prevent battery acid spillage.

## ⚠ WARNING / AVERTISSEMENT

This vehicle is designed for one (1) operator only, no passengers.  
Ce véhicule est conçu pour un (1) conducteur seulement, aucun passagers.

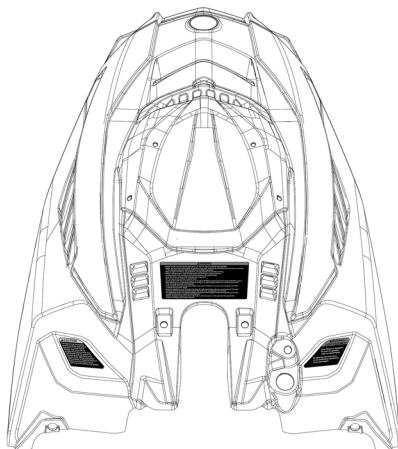

# Warning Labels & Information

This snowmobile comes with labels containing important safety information. Anyone who rides the snowmobile should read and understand this information before riding. The labels should be considered as permanent parts of the snowmobile. If a label comes off or becomes hard to read, contact your authorized dealer for a replacement.

CE MODÈLE A ÉTÉ ÉVALUÉ PAR UN LABORATOIRE D'ESSAIS INDÉPENDANT ET SATISFAIT TOUTES LES NORMES DE SÉCURITÉ DU SSCC EN VIGUEUR À LA DATE DE FABRICATION.

PARRAINÉ PAR LE COMITÉ DE SÉCURITÉ ET DE CERTIFICATION DE LA MOTONEIGE, INC.

**CERTIFIED**



**CERTIFIÉ**



THIS MODEL HAS BEEN EVALUATED BY AN INDEPENDENT TESTING LABORATORY AND IT MEETS ALL SSCC SAFETY STANDARDS IN EFFECT ON THE DATE OF ITS MANUFACTURE.

SPONSORED BY THE SNOWMOBILE SAFETY AND CERTIFICATION COMMITTEE, INC.

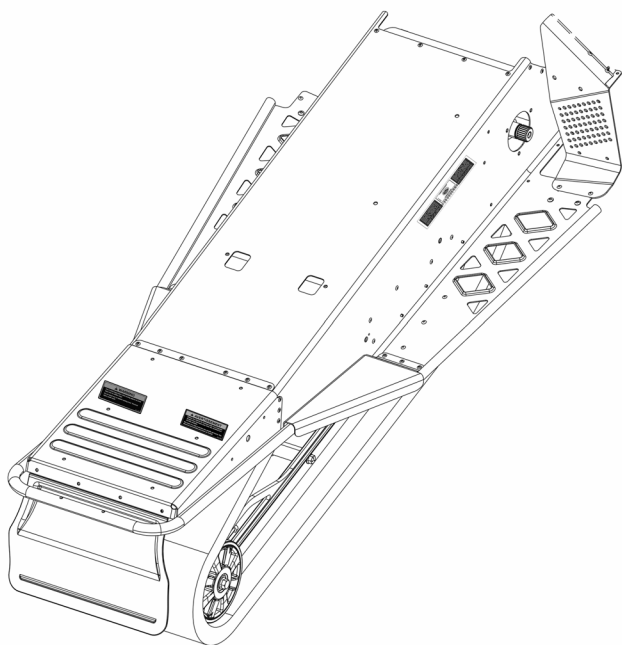

## **⚠ WARNING**

Use a solid tongue hitch when towing objects to avoid injury due to sudden stops.

Do not stand near or behind rotating track. Personal injury could result.

5611-953

## **⚠ AVERTISSEMENT**

Utilisez une attache de remorque soide avec languette lorsque vous remorquez pour éviter des accidents lors d'arrêts soudains.

Ne restez ni à côté ni derrière une chenille qui tourne. Des blessures personnelles pourraient en résulter.

5611-852

# Declaration of Conformity (EU)



ADVENTURE BY DESIGN

565 de la Montagne Street  
Valcourt (Québec) J0E 2L0  
Canada

[www.brp.com](http://www.brp.com)

## EU Declaration of Conformity

**Authorized Representative:** BRP Europe N.V., Skaldenstraat 125, Gent, Belgium, 9042

This declaration of conformity is issued under the sole responsibility of the manufacturer.

The undersigned, representing the manufacturer, hereby declares that model year **2023 Snowmobiles** marked with the **CE** mark and a 17-character vehicle identification number (VIN) structured as **4UF9S4MxxPVxxxxxx** under commercial names **Ski-Doo & Lynx** comply with all the relevant provisions of the following Directives and Regulations:

Machinery Directive 2006/42/EC as amended up to and including Reg. 2019/1243/EU	ISO 12100:2010
Non-Road Mobile Machinery (NRMM) Regulation (EU) 2016/1628 on gaseous pollutants	Category SMB, Stage V emissions limits
Electromagnetic Compatibility (EMC) Directive 2014/30/EU as amended up to and including Reg. (EU) 2018/1139	CISPR 12:2007/A1:2009 & IEC 61000-6-1:2005 or UN R10.04 or later version
Battery Directive 2006/66/EC as amended up to and including Dir. (EU) 2018/849	
Radio Equipment (RED) Directive 2014/53/EU as amended up to and including Reg. 2018/1139 (If fitted with radio frequency (RF) D.E.S.S. key)	

*Dominic Tessier*

Dominic Tessier, Eng.  
Director, Vehicle Engineering, Ski-Doo  
Bombardier Recreational Products Inc.

Valcourt, QC, Canada

June 13<sup>th</sup>, 2022

*ski-doo LYNX SEAWOO EVERSE ROTAX CAN-AM*

# Declaration of Conformity (UK)



BRP Finland Oy  
PL 8040 (Isoaavantie 7)  
FI-96101 Rovaniemi, Finland  
T 358 40 800 7700  
F 358 16 318 114  
[www.brp.com](http://www.brp.com)

## UK Declaration of Conformity

**Authorized Representative:** BRP Recreational Products UK Ltd., Castle Chambers, 43 Castle Street, Liverpool, L2 9SH

This declaration of conformity is issued under the sole responsibility of the manufacturer.

The undersigned, representing the manufacturer, hereby declares that model year **2023 Snowmobile** marked with the <sup>UK</sup>CA mark and a 17-character vehicle identification number (VIN) structured as **4UF9S4MxxPVxxxxxx** under commercial name **Ski-Doo & Lynx** comply with all the relevant provisions of the following UK Statutory instrument and Regulations:

The Supply of Machinery (Safety) Regulations 2008, ISO 12100:2010  
UK Statutory Instrument 2008/1597 as amended up  
to and including SI 2020/1112

Non-Road Mobile Machinery (Type-Approval and  
Emission of Gaseous and Particulate Pollutants)  
Regulation 2018, UK SI 2018/764 as amended up to  
and including SI 2020/1393

Category SMB, Stage V  
emissions limits

Electromagnetic Compatibility Regulations 2016, UK  
SI 2016/1091 as amended up to and including SI  
2020/1112

CISPR 12:2007/A1:2009 &  
IEC 61000-6-1:2005 or  
UN R10.04 or later version

Batteries and Accumulators (Placing on the Market)  
Regulations 2008, UK SI 2008/2164 as amended up  
to and including UK SI 2020/904

Radio Equipment Regulations 2017, UK SI  
2017/1206 as amended up to and including SI  
2020/1112

*Dominic Tessier*

Dominic Tessier, Eng.  
Director, Vehicle Engineering, Ski-Doo  
Bombardier Recreational Products Inc.

Valcourt, QC, Canada

June 13<sup>th</sup>, 2022

*ski-doo LYNX SEVADOO EVRNUDE ROTAX CAN-AM*

# Emissions Regulation 2016/1628 (EU)

Equipment complies with Emissions Regulation 2016/1628 as shown by a Non-Road Mobile Machinery (NRMM) identification decal on the engine cylinder head cover.

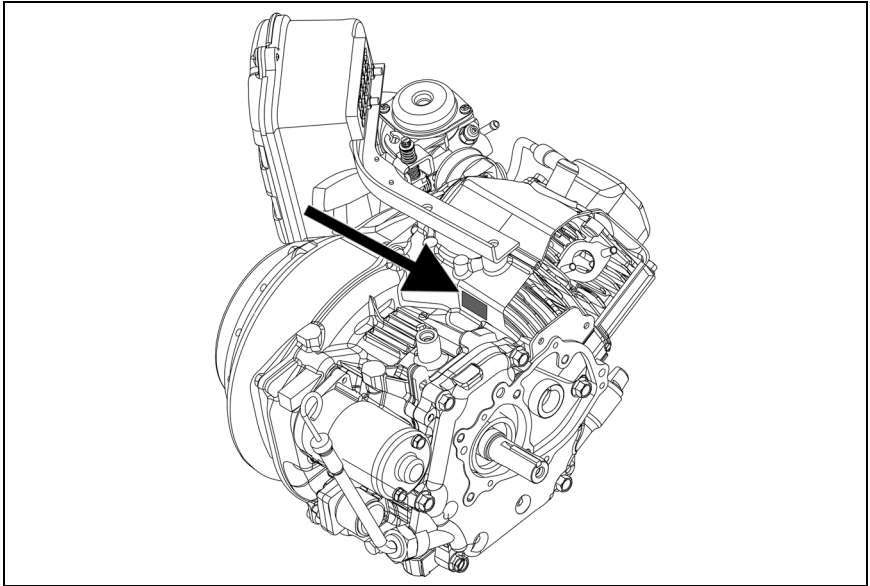

ONS-311

# Reporting Safety Defects

In Canada, if you believe that your vehicle has a defect which could cause a crash or could cause injury or death, you should immediately inform Transport Canada in addition to notifying Bombardier Recreational Products Inc.

If Transport Canada receives similar complaints, it may open an investigation, and if it finds that a safety defect exists in a group of vehicles, it may order a recall and remedy campaign. However, Transport Canada cannot become involved in any individual problems between you, your dealer or Bombardier Recreational Products Inc.

## To contact Transport Canada

### PHONE

- 819-994-3328 (Gatineau-Ottawa area or internationally)
- 1-800-333-0510

### MAIL

- Transport Canada – ASFAD  
330 Sparks Street  
Ottawa, ON K1A 0N5

### INTERNET

- <http://www.tc.gc.ca/recalls>

# Getting Ready to Safely Operate the MXZ 200

■ **NOTE:** This section and Operating the MXZ 200 section must be read and explained to the operator by the owner/parent/guardian. Refer to Control Locations or the snowmobile while explaining this section.

Like most riders, you are anxiously waiting to drive the snowmobile. Remember that the snowmobile is not a toy. It must be driven carefully at all times!

First, you must understand the controls, know where the controls are, and know how to use them correctly.

- A. **BRAKE LEVER** — To slow down or stop the snowmobile, the brake lever should be pulled (squeezed) toward the handlebar grip.

■ **NOTE:** When the brake is being used, the throttle lever must be in the idle (released) position.

- B. **THROTTLE LEVER** — Controls the speed of the snowmobile. The closer the throttle control lever is to the handlebar grip (the more it is squeezed), the faster the snowmobile will go.

- C. **IGNITION SWITCH** — When the key is in the OFF position, the engine will neither start nor run. If the key is in the RUN position, the engine will start and run.

- D. **EMERGENCY STOP SWITCH**  
If something happens that you do not understand or if there is an emergency, move the emergency stop switch to the OFF (down) position to immediately stop the engine.

- E. **TETHER SWITCH** — The engine will neither start nor run unless the tether switch cap is connected to the tether switch located on the top right-hand side of the console. The tether cord **MUST BE** attached to the operator before attempting to start the engine.

Second, you must check several things every time before the engine is started.

- A. Make sure the brake lever works properly (moves freely) by pulling (squeezing) the brake lever and releasing it several times.
- B. Make sure the throttle lever works properly (moves freely) and that it snaps back to the idle position quickly when it is released. The idle position is when the throttle lever is farthest away from the handlebar grip. If the throttle lever does not snap back quickly, the engine must not be started and the throttle system must be repaired.
- C. Make sure that you have enough clothes on to keep yourself warm but **NEVER** wear clothes such as long or loose scarves or long shoe laces that could get caught in a moving part of the snowmobile.

Third, make sure that you can answer yes to all of the following questions before each ride.

- A. Do you have permission from the owner or parent or guardian to operate the snowmobile?
- B. Are you wearing an approved safety helmet?
- C. Are you wearing something to protect your eyes (such as goggles or a visor)?
- D. Are you dressed warmly enough?
- E. Has your parent or guardian checked to make sure you have enough gasoline?
- F. Do the throttle lever and brake lever move freely?
- G. Are all shields and covers in the right place and is the hood securely latched?
- H. Do you have a safe area to ride in? Is the area free of rocks, wires, trees, traffic, etc.?



## Operating the MXZ 200

You must be a responsible, careful, and considerate snowmobile operator at all times. Your safety is our concern and must always be yours.

- A. When you are learning how to operate the snowmobile, have a parent or guardian take you to an open area to practice figure eights, starting, and stopping. This practice is important and will give you a good “feel” of the snowmobile. You will also be able to learn how the snowmobile handles under different conditions (deep snow, hard-packed snow, etc.).
- B. Always sit on the seat and keep both feet on the running boards when operating the snowmobile. Do not get off the snowmobile until it has come to a complete stop.
- C. Never drive the snowmobile faster than a safe speed. Do not drive too close to roads, buildings, trees, other snowmobiles, or people. Never show off!
- D. Never operate the snowmobile unless the headlight and taillight are in working order.
- E. The snowmobile is designed for your enjoyment. DO NOT give rides to your friends. It is made to carry only one person.
- F. Do not pull sleds, sleighs, etc., behind the snowmobile.
- G. If you get stuck, shut the engine off and get help.

# General Information

## Control Locations

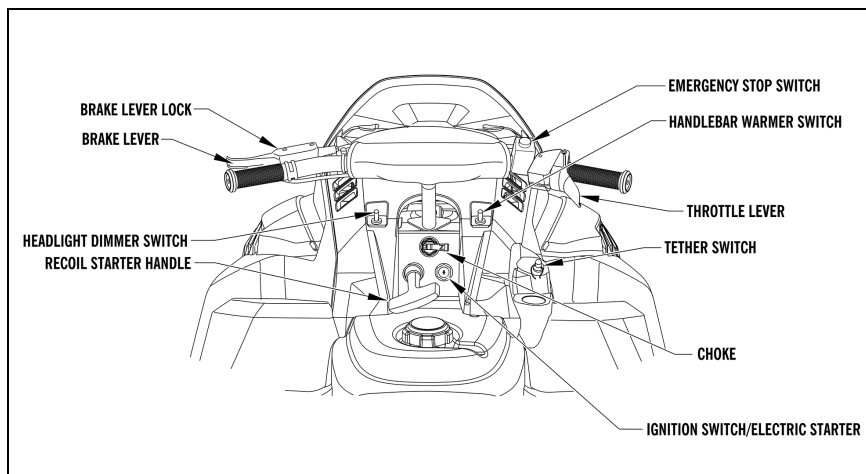

0753-827

## Snowmobile Identification

This snowmobile has two identification numbers: The Vehicle Identification Number (VIN) is stamped into the right side of the tunnel and the Engine Serial Number (ESN) is stamped into the front side of the crankcase.

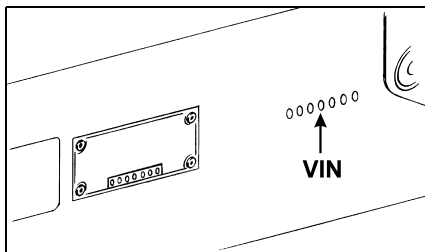

0726-200

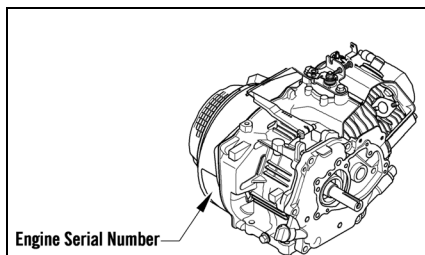

0744-926

These numbers are required by the dealer to complete warranty claims properly. No warranty will be allowed by BRP if either the ESN or VIN is removed or mutilated in any way.

Always provide the snowmobile model name, VIN, and engine serial number when contacting an authorized BRP Snowmobile dealer for parts, service, accessories, or warranty. If the complete engine must be replaced, ask the dealer to notify BRP for correct registration information.

## Gasoline — Oil

This snowmobile has a four-cycle engine; therefore, it is unnecessary to premix gasoline and oil.

## Fuel Requirements

### CAUTION

**Always use fresh gasoline. Gasoline will oxidize; the result is loss of octane, volatile compounds, and the production of gum and varnish deposits which can damage the fuel system.**

Alcohol fuel blending varies by country and region. Your vehicle has been designed to operate using the recommended fuels, however, be aware of the following:

Use of fuel containing alcohol above the percentage specified by government regulations is not recommended and can result in the following problems in the fuel system components:

- Starting and operating difficulties.
- Deterioration of rubber or plastic parts.
- Corrosion of metal parts.
- Damage to internal engine parts.
- Inspect frequently for the presence of fuel leaks or other fuel system abnormalities if you suspect the presence of alcohol in gasoline exceeds the current government regulations.
- Alcohol blended fuels attract and hold moisture which may lead to fuel phase separation and can result in engine performance problems or engine damage.

## Recommended Fuel

Use unleaded gasoline containing MAX-IMUM 10% ethanol. The gasoline must have the following minimum octane requirements.

Fuel Type	Engine	Minimum Octane Rating
Fuel with NO ethanol	200	87 Pump Posted AKI (RON+MON)/2 92 RON
Fuel which may contain up to 10% MAX ethanol	200	91 AKI (RON+MON)/2 95 RON

## CAUTION

Never experiment with other fuels. Engine or fuel system damages may occur with the use of an inadequate fuel.

## CAUTION

Do NOT use fuel from fuel pumps labeled E85.

Use of fuel labeled E15 is prohibited by U.S. EPA Regulations.

## Recommended Oil

■ **NOTE:** This snowmobile comes from the factory with SAE 0W-40 Synthetic oil installed.

The recommended oil to use in the engine is 0W-40 Synthetic oil. See the viscosity chart for details.

## CAUTION

Any oil used in place of the recommended oil may cause serious engine damage.

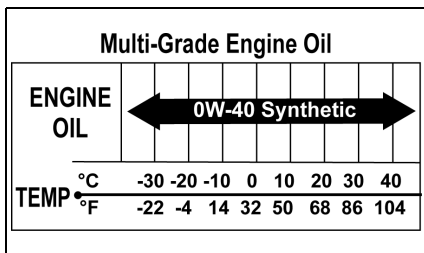

## Carburetor

Main Jet	Pilot Jet	Pilot Screw (Turns Out)	Float Height
107.5	17.5	2	8 mm (0.31")

**Carburetor Jet Chart for: 200**

Altitude Feet (Meters)	Main Jet (MJ) Pilot Jet (PJ) Jet Needle (JN) Pilot Screw (PS)			
	6000+ (1829+)	MJ P2 JN PS	105 17.5 4E0J.R 3.0	102.5 15 4E0J.R 3.0
4000 (1219)	MJ P2 JN PS	107.5 17.5 4E0J.R 3.0	105 17.5 4E0J.R 3.0	102.5 17.5 4E0J.9 3.0
0 (0)	MJ P2 JN PS	115 17.5 4E0J.R 3.0	107.5 17.5 4E0J.R 3.0	105 17.5 4E0J.8 3.0
100 (30)				102.5 17.5 4E0J.8 3.0
2000 (610)				100 17.5 4E0J.8 3.0
Temperature F		-40 to -5	-10 to 20	15 to 45
Temperature C		(-40 to -20)	(-25 to -7)	(10 to 7)

5621-854  
ONS-257

## Engine Break-In

The engine requires a short break-in period (approximately 10 operating hours) before being subjected to heavy load conditions or full-throttle operation. Strict adherence to the break-in procedure will contribute to optimum performance and longevity of the engine.

During break-in, a maximum of 1/2 throttle is recommended; however, brief full-throttle accelerations and variations in driving speeds contribute to good engine break-in. After the 10 hour break-in period, the snowmobile may be taken to an authorized BRP Snowmobile dealer for a checkup and oil change. This service is at the discretion and expense of the snowmobile owner.

## Muffler

The muffler is designed to reduce engine noise and improve the total performance of the engine. If the engine is run without the muffler installed, severe engine damage will result.

## Suspension

An optional Heavy Duty Spring Kit is available from any BRP snowmobile dealer. This kit includes stiffer ski shock springs as well as stiffer rear torsion springs.

## Battery

It is extremely important that the battery be maintained at full charge at all times and that the battery connections be clean and tight. If charging the battery becomes necessary, refer to Battery sub-section in the Maintenance section.

### Jump-Starting

■ **NOTE:** BRP does not recommend jump-starting a snowmobile with a dead battery but rather to remove the battery, service it, and correctly charge it; however, in an emergency, it may be necessary to jump-start a snowmobile. If so, use the following procedure to carefully and safely complete this procedure.

### CAUTION

Jump-starting the vehicle without a battery is not advisable as it may cause damage. Additionally, running the unit without a battery in place or the use of a "Jumper Pack" could cause damage to the electrical system.

### ⚠ WARNING

Improper handling or connecting of a battery may result in severe injury including acid burns, electrical burns, or blindness as a result of an explosion. Always remove rings and watches.

1. On the snowmobile to be jump-started, slide any terminal boots away.

### ⚠ WARNING

Any time service is performed on a battery, the following must be observed: keep sparks, open flame, cigarettes, or any other flame away. Always wear safety glasses. Protect skin and clothing when handling a battery. When servicing a battery in an enclosed space, keep the area well-ventilated.

2. Inspect the battery for any signs of electrolyte leaks, loose terminals, or bulging sides. Leaking or bulging battery cases may indicate a frozen or shorted battery.

### ⚠ WARNING

If any of these conditions exist, DO NOT attempt to jump-start, boost, or charge the battery. An explosion could occur causing serious injury.

3. Inspect the vehicle to be used for jump-starting to determine if voltage and ground polarity are compatible. The vehicle must have a 12-volt DC, negative ground electrical system.

### CAUTION

Always make sure the electrical systems are of the same voltage and ground polarity prior to connecting jumper cables. If not, severe electrical damage may occur.

4. Move the vehicle to be used for the jump-start close enough to ensure the jumper cables easily reach; then set and lock the brakes, shut off all electrical accessories, and turn the ignition switch OFF.

■ **NOTE:** Make sure all switches on the snowmobile to be jump-started are turned OFF.

5. Attach one clamp of the positive (red) cable to the positive (+) terminal (1) of the dead battery (C) being careful not to touch any metal with the other clamp; then attach the other clamp of the positive (red) cable to the positive (+) terminal (2) of the good battery (B).

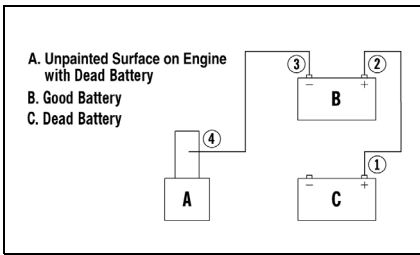

0744-527

■ **NOTE: Some jumper cables may be the same color but the clamps or ends will be color-coded red and black.**

- Attach one clamp of the negative jumper cable (black) to the negative (-) terminal (3) of good battery (B); then attach the other clamp of the negative (black) jumper cable (4) to an unpainted metal surface (A) on the engine well away from the dead battery and fuel system components.

■ **NOTE: Have the battery and electrical system checked prior to operating the snowmobile again.**

- Stand well away from the dead battery and start the vehicle with the good battery. Allow the vehicle to run for several minutes applying some charge to the dead battery.
- Start the snowmobile with the dead battery and allow it to run for several minutes before disconnecting the jumper cables.
- Remove the jumper cables in opposite order of hook-up (4, 3, 2, 1). Be careful not to short cables against bare metal.

**⚠ WARNING**

**Never make the final connection to a battery as a spark could ignite hydrogen gases causing an explosion of the battery resulting in acid burns or blindness.**

# Operating Instructions

## Starting and Stopping Engine

### **WARNING**

**Never allow anyone to stand in front of the snowmobile at any time, especially when starting the engine.**

It is imperative that all safety checks found in the accompanying Snowmobile Safety Handbook be performed before attempting to start the engine.

This snowmobile is equipped with a recoil starter as well as an electric starter. The recoil starter handle and the key switch are located below the steering post.

To start the engine, use the following procedure:

1. Test the throttle lever by completely compressing and releasing it several times. The lever **MUST** return to the idle position quickly and completely.
2. Move the emergency stop switch to the UP or RUN position.

**NOTE: Make sure the tether cap is connected to the tether switch and tether is attached to the rider.**

3. Insert key into ignition switch; then rotate key to the RUN position.
4. For a cold engine, move the choke lever to the full-choke position. If the engine is warm, choking is normally not necessary.

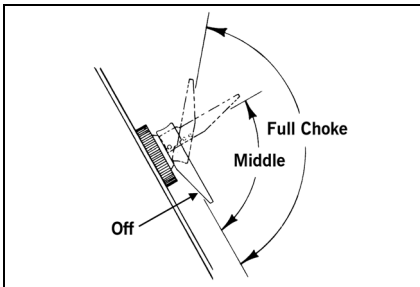

0725-001

5. Using the recoil starter to manually start the snowmobile, pull the recoil starter handle slowly until resistance is felt; then give a short, quick pull. The engine should start; however, if the engine does not start, repeat this step while applying 1/8 throttle until the engine is running.

### **CAUTION**

**To avoid damaging the recoil starter, DO NOT pull the recoil rope to its limit or release the recoil handle from an extended position. Allow the rope to rewind slowly.**

6. Using the electric start feature, rotate the key to the START position; then when the engine starts, release the key.

### **CAUTION**

**Do not continuously run the starter for more than 5 seconds at a time.**

7. When the engine starts, allow it to warm up for approximately 30 seconds with the choke lever in the full-choke position. After 30 seconds, move the choke lever to the middle position. The choke lever should be moved to the OFF position when engine is warm. Slight throttle control lever compression may be necessary after the engine starts and during warm-up. Idle the engine several minutes until the engine has reached normal operating temperature.
8. Flooding — If the engine does not start when the choke is being used but seems ready to start, move the choke lever to the OFF position.

**NOTE: Continued choking will only cause the engine to flood more.**

**NOTE: If the engine fails to start during the attempt with the throttle lever compressed, remove the spark plug and clean and dry it thoroughly or install a new, properly gapped, recommended spark plug.**

9. To shut the engine off, turn the ignition key to the OFF position, move the emergency stop switch to the OFF (down) position, or pull the tether cap from the tether switch.

# Periodic Maintenance/Tune-Up Chart

	Daily	1st 10 Hours (2 Weeks)	Every 20 Hours (1 Month)	Every 50 Hours (3 Months)	Every 100 Hours (6 Months)	Every 300 Hours (12 Months)
Valve Clearance						IA
Engine Compression						I
Spark Plug					I	
Fuel Supply Hose	I**					Replace every 3 years
Carburetor Float Chamber					C*	
Engine Oil	I	R*			R*	
Nuts/Screws/ Bolts	I			T		
Rear Suspension			I			
Recoil Starter	I					I-IC-IL*
Carburetor						IC
Pilot Air Screw						IA
Brake System	I					
In-Line Fuel Filter			I			
Battery	I					

C = Clean

I = Inspect

R = Replace

T = Tighten

IA = Inspect and adjust (if necessary)

IC = Inspect and clean (replace if necessary)

IL = Inspect and lubricate (replace if necessary)

\* = Service more frequently if used in adverse conditions

\*\* = Inspect daily and replace if required or as recommended

# Maintenance

## Engine Oil

■ **NOTE:** After the engine break-in period, the engine oil should be changed every 100 operating hours (6 months) and before prolonged storage.

### Checking

The engine oil level should be checked each day before operating the snowmobile.

The snowmobile must be on a level surface for this procedure.

■ **NOTE:** Ensure the engine is “cooled down” to room temperature to allow the oil to drain into the sump.

1. Release the two hold-down straps and open the hood.
2. Remove the oil level stick and wipe it with a clean cloth.

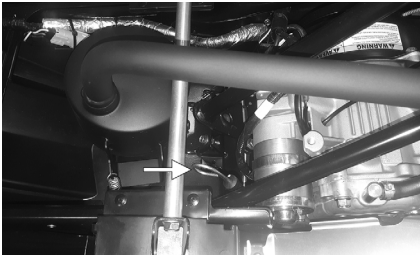

ZR-303

3. Install the oil level stick and remove the oil level stick; the engine oil level should be within the operating range but not above the MAX/FULL mark.

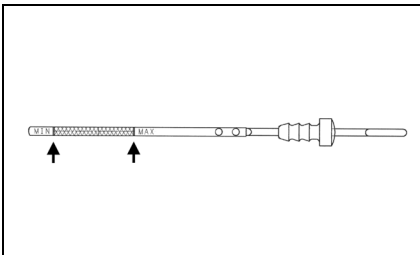

ONS-071

4. If step 1-3 was followed and the oil level is not within the operating range, add the recommended engine oil through the oil stick tube. Install the oil level stick and close and latch the hood.

### Changing

1. Remove the access plug; then place a drain pan beneath the engine.
2. Release the two hold-down straps and open the hood.
3. Remove the oil drain plug from the crankcase and allow the oil to drain.

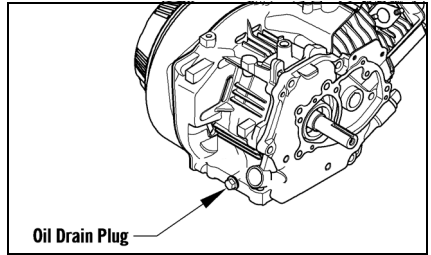

ONS-072

4. Install the drain plug and the access plug.
5. Remove the oil level stick; then pour 600 mL (20.3 fl oz) of recommended oil into the oil level stick tube.
6. Check the oil level using the oil level stick making sure the oil is within the operating range.
7. Close the hood and secure with the two straps.



## Battery (Electric Start)

These sealed batteries, after being in service, require regular cleaning and recharging in order to deliver peak performance and maximum service life. The following procedures are recommended for cleaning and maintaining sealed batteries. Always read and follow instructions provided with battery chargers and battery products.

■ **NOTE:** Battery maintenance may be done by the snowmobile owner if qualified to do so. If the owner does not feel qualified, take the snowmobile to an authorized BRP Snowmobile dealer for this service. This service is at the discretion and expense of the snowmobile owner.

### CAUTION

Jump-starting the vehicle without a battery is not advisable as it may cause damage. Additionally, running the unit without a battery in place or the use of a "Jumper Pack" could cause damage to the electrical system.

To remove and charge the battery, use the following procedure:

### ⚠ WARNING

Improper handling or connecting of a battery may result in severe injury including acid burns, electrical burns, or blindness as a result of an explosion. Always remove rings and watches. Any time service is performed on a battery, the following must be observed: keep sparks, open flame, cigarettes, or any other flame away. Always wear safety glasses. Protect skin and clothing when handling a battery. When servicing a battery in an enclosed space, keep the area well-ventilated.

### ⚠ WARNING

Battery posts, terminals, and related accessories contain lead and lead compounds, chemicals known to the state of California to cause cancer and reproductive harm. Wash hands after handling.

1. Open the hood; then remove the negative battery cable and ground wire; then remove the positive cable.
2. Remove the rubber strap securing the battery. Remove the battery.



### ⚠ WARNING

Avoid spillage and contact with skin, eyes, and clothing.

### CAUTION

Do not charge the battery while it is in the snowmobile with the battery terminals connected.

3. Thoroughly wash the battery with soap and water; then using a wire brush, clean the battery posts and cable ends removing all corrosive buildup.

■ **NOTE:** If battery posts or cable ends have a build-up of white/green powder residue, apply water and baking soda to neutralize acid; then flush off with warm soapy water.

### CAUTION

Do not remove the seal strip on a sealed battery.

### ⚠ WARNING

Battery acid is harmful if it contacts eyes, skin, or clothing. Care must be taken whenever handling a battery.

4. Using a multimeter, test the battery voltage. The meter must read no less than 12.8 DC Volts for a fully charged battery.

■ **NOTE:** At this point if the meter reads as specified, the battery may be returned to service.

5. If the meter reads less than specified voltage, charge the battery using the following guidelines.
  - A. When using an automatic battery charger, always follow the charger manufacturer's instructions.
  - B. When using a constant-current battery charger, use the following Battery Charging Chart.

**CAUTION**

Never exceed the standard charging rate.

**⚠ WARNING**

An overheated battery could explode causing severe injury or death. Always monitor charging times and charge rates carefully. Stop charging if the battery becomes very warm to the touch. Allow it to cool before resuming charging.

Battery Charging Chart (Constant-Current Charger)		
Battery Voltage (DC)	Charge State	Charge Time Required (at 1.5-2.0 Amps)
12.8 -13.0	100%	None
12.5-12.8	75%-100%	3-6 hours
12.0-12.5	50%-75%	5-11 hours
11.5-12.0	25%-50%	13 hours (minimum)
11.5 or less	0-25%	20 hours (minimum)

■ **NOTE:** If the battery voltage is 11.5 DC Volts or less, some chargers may “cut off” and fail to charge. If this occurs, connect a fully charged booster battery in parallel (positive to positive and negative to negative) for a short period of time with the charger connected. After 10-15 minutes, disconnect the booster battery leaving the charger connected and the charger should continue to charge. If the charger “cuts off,” replace the battery.

6. After charging the battery for the specified time, remove the battery charger and allow the battery to sit for 1-2 hours.

7. Connect the multimeter and test the battery voltage. The meter should read no less than 12.8 DC Volts. If the voltage is as specified, the battery is ready for service.

■ **NOTE:** If voltage in step 7 is below specifications, charge the battery an additional 1-5 hours; then retest. The battery is ready for service.

8. Place the battery into position in the snowmobile; then coat the battery posts and cable ends with a light coat of multi-purpose grease.

**CAUTION**

Before installing the battery, make sure the ignition switch is in the OFF position.

9. Secure the red positive cable to the positive terminal on the battery using a bolt. Tighten securely.
10. Secure the main black negative cable and the small black negative cable to the battery using a bolt. Tighten securely.

**CAUTION**

Connecting cables in reverse (positive to negative and negative to positive) can cause serious damage to the electrical system.

11. Secure the battery to the bracket using the rubber strap.

## Carburetor

The carburetor has been calibrated for average riding conditions; however, altitude, temperature, and general wear may necessitate certain carburetor adjustments. Since carburetor adjustments critically affect engine performance and emissions, BRP recommends that any changes in internal carburetor calibration be made by an authorized BRP Snowmobile dealer; however, three external adjustments can be made on the carburetor. These are the throttle stop screw, pilot screw, and throttle cable.

■ **NOTE:** When using non-ethanol gasoline, the pilot screw on the carburetor should be turned fully clockwise to the stop. When using gasoline containing ethanol, the pilot screw should be turned fully counterclockwise to the stop.

### Throttle Stop Screw

This screw controls the seating position of the throttle valve which in turn determines the proper idle speed. Rotate the screw clockwise to increase engine idle speed and counterclockwise to decrease engine idle speed.

### Checking/Adjusting Throttle Lever (Tension)

■ **NOTE:** Ensure that the throttle cable is properly seated in the throttle control housing.

1. Verify when releasing the throttle lever that the round switch in the control housing is compressed. If the switch is not compressed the engine will shut down when the throttle lever is released.



ZR-089A



ZR-090

2. If the throttle cable needs to be adjusted, locate the throttle cable in-line adjuster next to the steering post.

3. Tighten nut against the in-line adjuster and cover the adjuster with rubber boot.

### In-Line Fuel Filter

#### **WARNING**

Whenever any maintenance or inspection is made on a fuel system when there may be fuel leakage, there should be no welding, smoking, open flames, etc., in the area.

BRP recommends that the in-line fuel filter be checked once a month. The filter is located in the fuel hose between the gas tank and fuel pump. The only cleaning possible is to back-flush the filter using clean gasoline. To check, clean, or replace the filter, use the following procedure:

1. Using a suitable hose clamping pliers, pinch off the fuel hose between the gas tank and the filter.
2. Remove and discard the clamps; then slowly remove the fuel hoses from the fuel filter. Dispose of the excess fuel from the filter properly.
3. Install the in-line fuel filter in the fuel hose so the arrow on the filter points toward the fuel pump. Make sure the fuel hoses fit tightly on the filter. If a fuel hose does not fit tightly, cut 6 mm (1/4 in.) from the end of the fuel hose; then install on the filter. Install new clamps and remove the clamping pliers.

#### **CAUTION**

The fuel hoses must fit tightly on the fuel filter. If the fuel hose length doesn't permit this procedure, replace the fuel hose. Also, after installing the fuel hoses on the filter, check to be sure that the fuel hoses do not contact any hot or rotating components.

## Spark Plug

This snowmobile comes equipped with a specified spark plug. See the specifications chart for the correct spark plug. To help prevent cold weather fouling, make sure to thoroughly warm up the engine before operating.

To maintain a hot, strong spark, keep the plug free of carbon.

Before removing the spark plug, be sure to clean the area around the spark plug. If you do not, dirt could enter engine when removing or installing the spark plug.

Adjust the gap to specified amount (see Specifications chart on page 35) for proper ignition. Use a feeler gauge to check the gap.

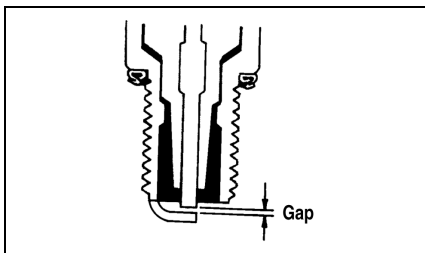

ATV0052B

When installing the spark plug, be sure to tighten it securely. A new spark plug should be tightened 1/2 turn once the washer contacts the cylinder head. A used spark plug should be tightened 1/8-1/4 turn once the washer contacts the cylinder head.

## Braking

The following items are items that the operator must be familiar with when operating this snowmobile and its hydraulic brake system.

1. Use the brakes wisely. Each time the brakes are applied in all hydraulic brake systems, heat is transferred to the brake fluid.

2. Be sure to maintain the brake fluid at the proper level and take care not to get any moisture in the system as moisture in the brake fluid lowers the boiling point. If the brake fluid is ever boiled (by high speed stops or repetitive use) or if moisture is allowed to enter the system, it must be changed. Never substitute or mix different types or grades of brake fluid.

### **WARNING**

**Use only BRP approved DOT 4 brake fluid. Never substitute or mix different types or grades of brake fluid. Brake loss can result. Check brake fluid level and pad wear before each use. Brake loss can result in severe injury or even death.**

3. Never ride the brake. Even maintaining minimal pressure on the brake lever will cause the brake pads to drag on the disc and may overheat the brake fluid.
4. The brake lever lock is not a parking brake and should not be applied for periods exceeding 5 minutes. **NEVER OPERATE THE SNOWMOBILE WITH THE BRAKE LEVER LOCK ENGAGED.**

### **WARNING**

**The brake lever lock is not a parking brake and should not be applied for periods exceeding 5 minutes. The brake lever lock maintains the brake lever in the compressed position and maintains pressure against the brake disc; however, after a period of time, the pressure applied to the brake disc may relax below the amount required to hold the snowmobile stationary.**

5. Pumping the brake lever is permissible; however, if pumping the brake lever more than twice is necessary to obtain the necessary stopping power, immediately take the snowmobile to an authorized BRP Snowmobile dealer for service. If not under warranty, this service is at the discretion and expense of the snowmobile owner.
6. When new brake pads are installed, a "burnishing" process is required.

## Checking Brake Lever Travel

1. Test the operation of the hydraulic brake system by compressing the brake lever.
2. The brake lever must feel firm when compressed.
3. To verify lever travel, compress and hold the brake lever to its maximum resistance.

■ **NOTE:** Do not pump the brake lever as it will produce an inaccurate reading.

4. Make sure there is clearance between brake lever and the handlebar. The lever should not meet the handlebar.

### **WARNING**

Do not operate the snowmobile if the brake lever touches the handlebar. Brake loss may occur. Brake loss can result in severe personal injury.

## Burnishing Brake Pads

Disc brakes require a special burnish period to achieve maximum braking power. The burnish period lasts for about hard 30-50 stops. During this period some noise may occur.

To properly burnish the brakes, use following procedure:

1. Choose an area sufficiently large to safely accelerate and to brake to a stop.

■ **NOTE:** This procedure can also be accomplished using a shielded jack stand.

2. Accelerate; then compress brake lever to decelerate to a stop.

■ **NOTE:** Lightly apply the brake lever to come to an easy stop; do not over-apply brakes or "lock up" the track.

3. Repeat procedure 10-15 times allowing some cooling between stops.

### **WARNING**

Do not attempt sudden stops or put yourself into a situation where a sudden stop will be required until the brake pads are properly burnished.

## Track Tension

■ **NOTE:** Track tension and track alignment are interrelated; therefore, always check both, even if only one adjustment seems necessary.

Track tension is directly related to the overall performance of the snowmobile. If the track is too loose, it may slap against the tunnel causing wear, or it may ratchet on the track drive sprockets. BRP recommends that the track tension be checked once a month and adjusted accordingly.

### **WARNING**

Track tension must be properly maintained. Personal injury could result if a track is allowed to become excessively loose.

## Checking

### **WARNING**

DO NOT attempt to check or adjust track tension with engine running. Turn ignition key to the OFF position. Personal injury could result from contact with a rotating track.

1. Remove excess ice and snow buildup from the track, track drive sprockets, and the inside of the skid frame.
2. Place the rear of the snowmobile up on a safety stand high enough so the track is free of the floor.
3. At the lower mounting position of the rear shock, hook a spring scale around a track clip; then pull down on the scale to 9 kg (20 lb). Measure the deflection (distance) between the bottom of the wear strip and the inside surface of the track clip. Measurement should be 50 mm (2.0 in.).

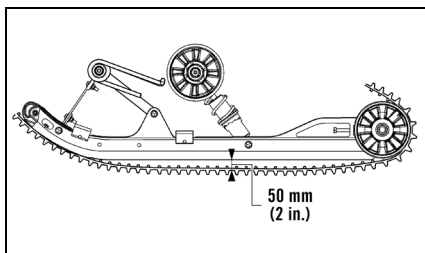

0753-328

## Adjusting

1. Loosen the idler wheel bolts.

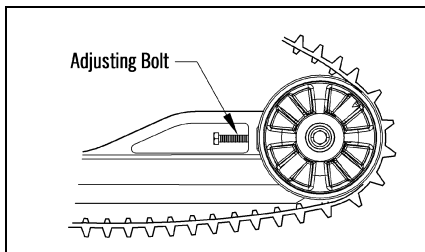

0753-329

■ **NOTE:** To ensure proper track tension adjustment, perform all adjustments on both sides of the snowmobile.

2. If the deflection (distance between the bottom of the wear strip and the inside of the track) exceeds specifications, tighten the adjusting bolts to take up excessive slack in the track.
3. If the distance between the bottom of the wear strip and the inside surface of the track is less than specified, loosen the adjusting bolts to increase the slack in the track.
4. Check track alignment (see Track Alignment section).
5. When proper track tension is obtained, tighten idler wheel bolts securely.

■ **NOTE:** Since track tension and track alignment are interrelated, always check both even if only one adjustment seems necessary.

## **⚠ WARNING**

Always make sure the adjusting bolts are snug against the axle and the idler wheel bolts are tightened to specifications. Failure to do so could cause the track to become extremely loose and, under some operating conditions, allow the idler wheels to climb over the track lugs forcing the track against the tunnel causing the track to "lock." If a track "locks" during operation, severe personal injury could result.

## Track Alignment

Proper track alignment is obtained when the outside of the rear idler wheels are equal distance from the edge of the track. Excessive wear to the idler wheels, drive lugs, and track will occur if the track is improperly aligned. BRP recommends that the track alignment be checked once a week or whenever the track tension is adjusted.

## Checking

### **⚠ WARNING**

Make sure the ignition key is in the OFF position and the track is not rotating before checking or adjusting track alignment. Personal injury could result if contact is made with a rotating track.

1. Position the tips of the skis against a wall; then using a shielded safety stand, raise the rear of the snowmobile off the floor making sure the track is free to rotate.

### **⚠ WARNING**

The tips of the skis must be positioned against a wall or similar object for safety.

2. Start the engine and accelerate slightly. Use only enough throttle to turn the track several revolutions. SHUT ENGINE OFF.

**NOTE:** Allow the track to coast to a stop. **DO NOT** apply the brake because it could produce an inaccurate alignment condition.

- When the track stops rotating, check the relationship of the idler wheels and the edge of the track. If the distance from the rear idler wheels to the edge of the track is the same on both sides, no adjustment is necessary.
- If the distances from the idler wheels to the edge of the track are not the same on both sides, an adjustment is necessary.

**Adjusting**

- On the side of the track which has the edge of the track furthest to the outside of the rear idler wheel, loosen the idler wheel bolt; then rotate the adjusting bolt clockwise 1 to 1 1/2 turns.

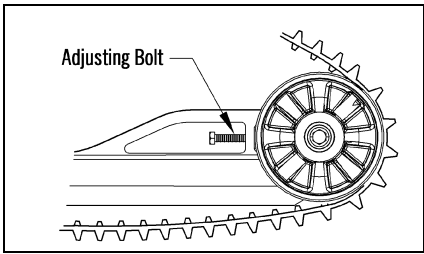

- Check track alignment and continue adjustment until proper alignment is obtained.

**NOTE:** Make sure correct track tension is maintained after adjusting track alignment (see Track Tension section).

- After proper track alignment is obtained, tighten the idler wheel bolt securely.

**WARNING**

Always make sure the adjusting bolts are snug against the axle and the idler wheel bolts are tightened to specifications. Failure to do so could cause the track to become extremely loose and, under some operating conditions, allow the idler wheels to climb over the track lugs forcing the track against the tunnel causing the track to "lock." If a track "locks" during operation, severe personal injury could result.

- Field test the track under actual conditions.
- After the field test, check the alignment of the track. If additional adjustment is necessary, repeat Adjusting Track Alignment procedure.

**Adjusting Shock Springs**

The shock springs are individually adjustable for the driving style of the operator.

**NOTE:** Equal adjustments should be maintained on both ski shock springs.

The front shock absorbers have a preload adjustment sleeve with five preload adjustment positions to increase or decrease coil spring tension.

To adjust the spring tension, rotate the preload adjustment sleeve with a suitable spanner wrench until the desired spring tension is achieved.

Position	Spring Tension	Setting	Load
1	↓  Stronger	Soft	Light
2		↑	↑
3		↑↓	↑↓
4		↓	↓
5		Stiff	Heavy

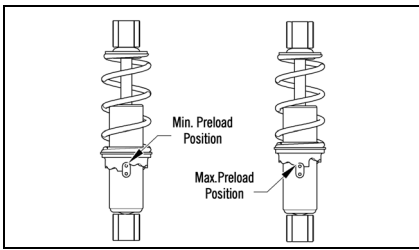

## Adjusting Rear Spring Tension

Rear spring tension adjustment is accomplished by rotating the adjusting cams. Position 3 provides the stiffest ride, and position 1 is for the light driver or slow-speed trail riding. Position 2 is for the average operator under normal conditions. Always rotate the cam from the lighter position to the heavier position.

**CAUTION**

**Never force the adjustment cams from the low position to the high position. Cam damage may occur.**

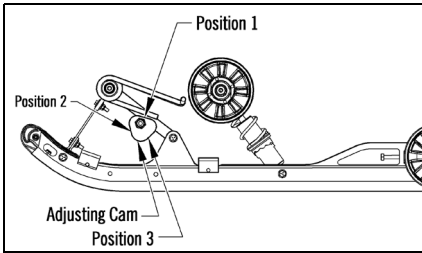

Using a 13/16 in. wrench, rotate the cam until it is in the desired position. To stiffen the ride, rotate the cam so as to raise the spring end. Make the adjustment on the other cam and be sure both cams are adjusted equally.

## Ski Alignment

The skis have been aligned during setup of the snowmobile. Ski alignment usually will not change unless a rock or similar hard object is hit while the snowmobile is being operated. BRP recommends that the ski alignment be checked once a week.

### Checking

1. Turn the handlebar to the straight-ahead position.

2. Measure the distances to the inside edges of the skis. Measure 5 inches in front of the ski mounting bolt and 5 inches behind the ski mounting bolt.

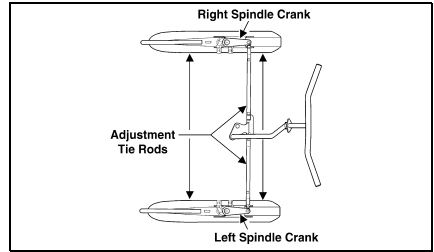

**NOTE: Ski alignment is correct when the skis are parallel to each other (equal measurements front and rear) or when the skis have up to a maximum of 1.58-6.35 mm (1/16-1/4 in.) "toe out" (front measurement 1.58-6.35 mm [1/16-1/4 in.] more than rear measurement).**

3. If ski alignment is not as specified, the snowmobile will have a tendency to wander and may be difficult to control; therefore, an adjustment is necessary.

## Adjusting

1. Make sure the ignition key is in the OFF position.
2. Visually examine the skis to determine which ski is out of alignment with respect to the handlebar.
3. Open the hood and loosen the jam nut on each end of the adjustment tie rod.
4. While holding the ski in position, rotate the adjustment tie rod until the measurement between the skis is within specifications.
5. When the ski alignment is correct, apply blue Loctite 243 to the jam nut threaded areas and tighten each jam nut securely against its adjustment tie rod.

**⚠ WARNING**

**Neglecting to lock the tie rod by tightening the jam nuts against the adjustment tie rod may cause loss of snowmobile control and possible personal injury.**



## Ski Wear Bar

The ski wear bar is a replaceable bar attached to the underside of the ski. The purpose of the wear bar is to assist in turning the snowmobile, to minimize ski wear, and to maintain good steering control. If the snowmobile is operated primarily in deep snow, ski wear bar wear will be minimal; however, if the snowmobile is operated on terrain where the snow cover is minimal, the ski wear bar will wear faster.

To maintain positive steering characteristics, BRP recommends that the ski wear bars be checked once a week and replaced if worn to 1/2 of original diameter. Ski wear bars are available from an authorized BRP Snowmobile dealer.

### **WARNING**

**Operating the snowmobile with excessively worn ski wear bars may result in a loss of steering control.**

## Removing

1. Raise the front of the snowmobile.
2. Remove the lock nuts securing the wear bar to the ski.

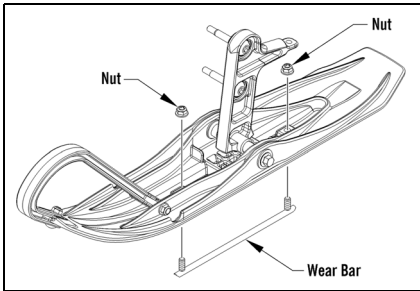

0750-990

3. Remove the wear bar.

## Installing

1. Insert the wear bar studs into the holes in the ski.
2. Center the wear bar studs in the holes and install the lock nuts.
3. Tighten lock nuts securely.

## Recoil Starter Air Vents

It is important for proper engine cooling that the air vents located on the recoil starter are kept clean. These air vents should be checked periodically and cleaned if necessary.

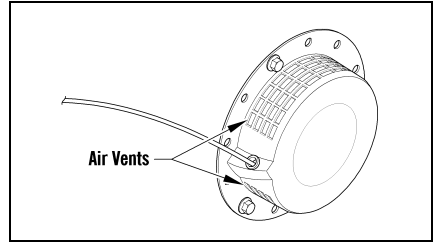

0744-923

### **CAUTION**

**Serious overheating of the engine and engine damage will result if the air vents are not kept clean.**

## Lights

To change the headlight bulb, use the following procedure:

1. Open the hood; then disconnect the harness connector from the headlight bulb.
2. Remove the bulb from the housing by rotating it counterclockwise until loose.

### **CAUTION**

**Do not touch the glass portion of the bulb. If the glass portion is touched, it must be cleaned with a dry cloth before installing.**

3. Install the new bulb into the housing; then rotate the bulb clockwise to lock it into place.

## Adjusting Headlight Aim

The headlight can be adjusted for vertical aim of the HIGH/LOW beam. The geometric center of HIGH beam zone is to be used for vertical aiming.

1. Position the snowmobile on a level floor so the headlight is approximately 8 m (25 ft) from an aiming surface (wall or similar surface).

■ **NOTE:** There should be an “average” operating load on the snowmobile when adjusting headlight aim.

2. Measure the distance from the floor to midpoint of the headlight.
3. Using the measurement obtained in step 2, make a horizontal mark on the aiming surface.
4. Make a vertical mark which intersects the horizontal mark on the aiming surface directly in front of the headlight.
5. Engage the brake lever lock and start the engine. Move the headlight dimmer switch to the LOW beam position. DO NOT USE HIGH BEAM.
6. Observe the LOW beam aim. Proper aim is when the LOW beam is centered on the vertical mark 5 cm (2 in.) below the horizontal mark on the aiming surface.

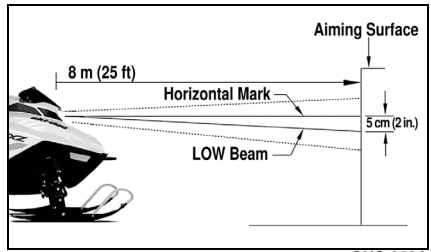

ONS-052A

7. Adjust the headlight using the screw on the backside of the headlight until correct aim is obtained. Shut the engine off; then disengage the brake lever lock.

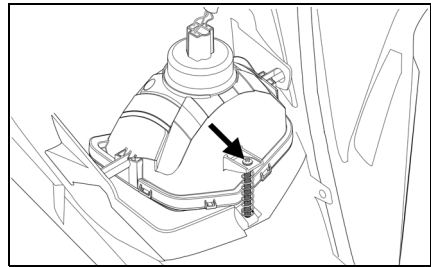

# Preparation for Storage

Prior to storing the snowmobile, it is extremely important that it be properly serviced to prevent corrosion and component deterioration. BRP recommends the following procedure to prepare the snowmobile for storage:

1. Clean the seat cushion with Vinyl Protectant and a damp cloth.
2. Clean the snowmobile thoroughly by hosing dirt, oil, grass, and other foreign matter from the undercarriage, tunnel, hood, and belly pan. Allow the snowmobile to dry thoroughly. DO NOT get water into any part of the engine.
3. Drain all gas from the gas tank; then drain the gasoline from the carburetor by loosening the drain screw on the carburetor float chamber.
4. Plug the muffler outlet with a clean cloth.
5. With the ignition key in the OFF position:
  - A. Disconnect the high tension wire from the spark plug; then remove the spark plug.
  - B. Pour 10 mL (approximately two teaspoons) of petroleum-based oil into the spark plug hole; then pull the recoil starter handle slowly about five times.

C. Install the spark plug and connect the high tension wire.

6. Change the oil.
7. Tighten all screws, nuts, and bolts securely.
8. Make sure all rivets holding components together are tight. Replace all loose rivets.
9. Clean and polish the hood, console, and chassis with XPS Spray Cleaner and Polish. DO NOT USE SOLVENTS. THE PROPELLANT WILL DAMAGE THE FINISH.

■ **NOTE: Disconnect the battery cables making sure to disconnect the negative cable first; then clean the battery posts and cables. Charge the battery.**

10. If possible, store the snowmobile indoors. Raise the rear of the snowmobile off the floor and block up the rear end. Cover the snowmobile with a snowmobile cover to protect it from dirt and dust.
11. If the snowmobile must be stored outdoors, block the entire snowmobile off the ground and cover it with a snowmobile cover to protect it from dirt, dust, and rain.

## CAUTION

Never crank the engine over without grounding the spark plug. Damage to the transistorized ignition may result.

## CAUTION

Avoid using a plastic cover as moisture will collect on the snowmobile causing corrosion.

## Preparation after Storage

Taking the snowmobile out of storage and correctly preparing it for operation will ensure many miles and hours of trouble-free snowmobiling. BRP recommends the following procedure to prepare the snowmobile:

1. Clean the snowmobile thoroughly. Polish the exterior of the snowmobile using the cleaner.
2. Clean the engine cooling fins and the recoil starter vents. Remove the cloth from the muffler.
3. Check all control wires and cables for signs of wear or fraying. Replace if necessary. Use cable ties or tape to route wires and cables away from hot or rotating parts.
4. Check brake-lever travel distance, throttle lever tension, all controls, ski alignment, track tension, track alignment, brake pads, and ski wear bars; adjust or replace as necessary.
5. Examine the in-line fuel filter and clean or replace if necessary.
6. Fill the gas tank.
7. Clean the seat cushion with the vinyl protectant.
8. Check the spark plug (clean, gap, and/or replace as necessary); then start the engine and ensure proper carburetor adjustments.
9. Fully charge the battery; then connect the battery cables making sure to connect the positive cable first. Test the electric start system.

# Specifications

ENGINE AND DRIVE	
Type	Forced Air Cooled/4-Cycle
Bore x Stroke	70 x 50 mm (2.76 x 1.97 in.)
Valve Arrangement	Overhead
Displacement	192 cc (11.7 cu in.)
Lighting Coil Output	96W @ 3000 RPM
Lubrication	Forced Splash
Cooling System	Forced Air
Drive Clutch	RPM sensing
Brake Type	Hydraulic Brake
Ignition Type	CDI
Track Width	25.4 cm (10 in.)
Track Length	236.2 cm (93 in.)
Track Tension	50 mm (2 in.) @ 20 lb
Track Style	Cobra
Spark Plug Type	NGK BPR4ES
Spark Plug Gap	0.7-0.8 mm (0.028-0.031 in.)
Ignition Timing (Fixed)	28° BTDC @ 3600 RPM
CARBURETOR	
Type	Mikuni BS25-157
CHASSIS	
Overall Length	213.3 cm (84 in.)
Overall Height	91.4 cm (36 in.)
Overall Width	91.4 cm (36 in.)
Ski Center-to-Center Distance	77.5 cm (30.5 in.)
MISCELLANEOUS	
Gasoline (Recommended)	87 Minimum Octane Regular Unleaded
Gas Tank Capacity	8.3 L (2.2 U.S. gal.)
Engine Oil (Recommended)	Synthetic 0W-40
Crankcase Oil Capacity	600 mL (20.3 fl oz)
Taillight (p/n)	0609-963
Headlight Bulb (p/n)	0609-956
Starting System	Electric Start/Manual Recoil
Dry Weight	93.9 kg (207 lb)
Battery	100 Amps (cold)
Vibration — Hand/Arm	< 3.8 m/s <sup>2</sup>
Vibration — Seat	< 0.5 m/s <sup>2</sup>

Specifications subject to change without notice.

# Warranty

## **BRP LIMITED WARRANTY USA AND CANADA: 2023 SKI-DOO® SNOWMOBILES**

### **SCOPE OF THE LIMITED WARRANTY**

Bombardier Recreational Products Inc. (“BRP”) warrants its 2023 Ski-Doo snowmobiles sold by authorized BRP dealers (as defined below) in the United States of America (“USA”) and in Canada from defects in material or workmanship for the period and under the conditions described below. This limited warranty will become null and void if: (1) the snowmobile was used for racing or any other competitive activity, at any point, even by a previous owner; or (2) the snowmobile has been altered or modified in such a way so as to adversely affect its operation, performance or durability, or has been altered or modified to change its intended use.

Non-factory installed parts and accessories are not covered under this limited warranty. Please refer to the applicable parts and accessories limited warranty text.

### **LIMITATIONS OF LIABILITY**

THIS WARRANTY IS EXPRESSLY GIVEN AND ACCEPTED IN LIEU OF ANY AND ALL OTHER WARRANTIES, EXPRESSED OR IMPLIED, INCLUDING WITHOUT LIMITATION ANY WARRANTY OF MERCHANTABILITY OR FITNESS FOR A PARTICULAR PURPOSE. TO THE EXTENT THAT THEY CANNOT BE DISCLAIMED, THE IMPLIED WARRANTIES ARE LIMITED IN DURATION TO THE LIFE OF THE EXPRESS WARRANTY. INCIDENTAL AND CONSEQUENTIAL DAMAGES ARE EXCLUDED FROM COVERAGE UNDER THIS WARRANTY. SOME STATES/PROVINCES DO NOT ALLOW FOR THE DISCLAIMERS, LIMITATIONS AND EXCLUSIONS IDENTIFIED ABOVE, AS A RESULT, THEY MAY NOT APPLY TO YOU. THIS WARRANTY GIVES YOU SPECIFIC RIGHTS, AND YOU MAY ALSO HAVE OTHER LEGAL RIGHTS WHICH MAY VARY FROM STATE TO STATE, OR PROVINCE TO PROVINCE.

Neither the distributor, any BRP dealer nor any other person has been authorized to make any affirmation, representation or warranty regarding the product, other than those contained in this limited warranty, and if made, shall not be enforceable against BRP. BRP reserves the right to modify this limited warranty at any time, being understood that such modification will not alter the warranty conditions applicable to the products sold while this warranty is in effect.

### **EXCLUSIONS - ARE NOT WARRANTED**

The following are not warranted under any circumstances:

- Normal wear and tear;
- Routine maintenance items, tune ups, adjustments;
- Damage caused by failure to provide proper maintenance and/or storage, as described in the Operator's Guide;
- Damage resulting from removal of parts, improper repairs, service, maintenance, modifications or use of parts or accessories not manufactured or approved by BRP or resulting from repairs done by a person that is not an authorized servicing BRP dealer;
- Damage caused by abuse, abnormal use, neglect, use of the product on surfaces other than snow, or operation of the product in a manner inconsistent with the recommended operation described in the Operator's Guide;
- Damage resulting from accident, submersion, fire, theft, vandalism or any act of God;
- Operation with fuels, oils or lubricants which are not suitable for use with the product (see the Operator's Guide);

- Snow or water ingestion;
- Incidental or consequential damages, or damages of any kind including without limitation towing, storage, telephone, rental, taxi, inconvenience, insurance coverage, loan payments, loss of time, loss of income; and
- Damage resulting from studs installed on tracks if the installation does not conform to BRP's instructions.

## **WARRANTY COVERAGE PERIOD**

This limited warranty will be in effect from the date of delivery to the first retail consumer or the date the product is first put into use, whichever occurs first and for the following period:

TWELVE (12) CONSECUTIVE MONTHS, for private or commercial use owners. However, the warranty coverage period on a snowmobile delivered between June 1st and December 1st of a given year will expire November 30th of the following year.

For emission-related components; please also refer to the US EPA EMISSION-RELATED WARRANTY US EPA EMISSION- RELATED WARRANTY contained herein.

The repair or replacement of parts or the performance of service under this warranty does not extend the life of this warranty beyond its original expiration date.

## **CONDITIONS REQUIRED FOR WARRANTY COVERAGE**

This warranty coverage is available only if each of the following conditions has been fulfilled:

- The 2023 Ski-Doo snowmobile must be purchased as new and unused by its first owner from a BRP dealer authorized to distribute Ski-Doo snowmobiles in the country in which the sale occurred ("BRP dealer");
- The BRP specified pre-delivery inspection process must be completed and documented and signed by the purchaser;
- The 2023 Ski-Doo snowmobile must have undergone proper registration by an authorized BRP dealer;
- The 2023 Ski-Doo snowmobile must be purchased in the country in which the purchaser resides; and
- Routine maintenance outlined in the Operator's Guide must be timely performed in order to maintain warranty coverage. BRP reserves the right to make warranty coverage contingent upon proof of proper maintenance.

BRP will not honor this limited warranty to any private use owner or commercial use owner if one of the preceding conditions has not been met. Such limitations are necessary in order to allow BRP to preserve both the safety of its products, and also that of its consumers and the general public.

## **WHAT TO DO TO OBTAIN WARRANTY COVERAGE**

The customer must cease using the snowmobile upon the appearance of an anomaly. The customer must notify a servicing BRP dealer within three (3) days of the appearance of a defect, and provide it with reasonable access to the product and reasonable opportunity to repair it. The customer must also present to the authorized BRP dealer, proof of purchase of the product and must sign the repair/work order prior to starting the repair in order to validate the warranty repair. All parts replaced under this limited warranty become the property of BRP.

## **WHAT BRP WILL DO**

BRP's obligations under this warranty are limited to, at its sole discretion, repairing parts found defective under normal use, maintenance and service, or replacing such parts with new genuine Ski-Doo parts without charge for parts and labor, at any authorized BRP dealer during the warranty coverage period under the conditions described herein. No claim of breach of warranty shall be cause for cancellation or rescission of the sale of the snowmobile to the owner.

In the event that service is required outside of the country of original sale, the owner will bear responsibility for any additional charges due to local practices and conditions, such as, but not limited to, freight, insurance, taxes, license fees, import duties, and any and all other financial charges, including those levied by governments, states, territories and their respective agencies.

BRP reserves the right to improve or modify products from time to time without assuming any obligation to modify products previously manufactured.

## **TRANSFER**

If the ownership of a product is transferred during the warranty coverage period, this limited warranty, subject to its terms and conditions, shall also be transferred and be valid for the remaining coverage period provided BRP or an authorized Ski-Doo Distributor/Dealer receives a proof that the former owner agreed to the transfer of ownership, in addition to the co-ordinates of the new owner.

## **CONSUMER ASSISTANCE**

In the event of a controversy or a dispute in connection with this limited warranty, BRP suggests that you try to resolve the issue at the dealership level. We recommend discussing the issue with the authorized dealer's service manager or owner.

If the matter still remains unresolved, contact BRP by filling out the customer contact form at [www.brp.com](http://www.brp.com) or contact BRP by mail at one of the addresses listed under the CONTACT US section of this guide.

## **US EPA EMISSION-RELATED WARRANTY**

Bombardier Recreational Products Inc. ("BRP") warrants to the ultimate purchaser and each subsequent purchaser that this new engine, including all parts of its exhaust emission-control system and its evaporative emission-control system, meets two conditions:

1. It is designed, built, and equipped so it conforms at the time of sale to the ultimate purchaser with the requirements of 40 CFR 1051 and 40 CFR 1060.
2. It is free from defects in materials and workmanship that may keep it from meeting the requirements of 40 CFR 1051 and 40 CFR 1060.

Where a warrantable condition exists, BRP will repair or replace, as it elects, any part or component with a defect in materials or workmanship that would increase the engine's emissions of any regulated pollutant within the stated warranty period at no cost to the owner, including expenses related to diagnosing and repairing or replacing emission-related parts. All defective parts replaced under this warranty become the property of BRP.

For all emission-related warranty claims, BRP is limiting the diagnosis and repair of emission-related parts to the authorized Ski-Doo dealers, unless for emergency repairs as required by item 2 of the following list.

As a certifying manufacturer, BRP will not deny emission-related warranty claims based on any of the following:

1. Maintenance or other service BRP or BRP's authorized facilities performed.



2. Engine/equipment repair work that an operator performed to correct an unsafe, emergency condition attributable to BRP as long as the operator tries to restore the engine/equipment to its proper configuration as soon as possible.
3. Any action or inaction by the operator unrelated to the warranty claim.
4. Maintenance that was performed more frequently than BRP specify.
5. Anything that is BRP fault or responsibility.
6. The use of any fuel that is commonly available where the equipment operates unless BRP written maintenance instructions state that this fuel would harm the equipment's emission control system and operators can readily find the proper fuel. See maintenance information section and fuel requirements of fueling section.

## **Emission-Related Warranty Period**

The emission-related warranty is valid for the following period whichever comes first:

	<b>Hours</b>	<b>Months</b>	<b>Kilometers</b>
Exhaust emission-related components	200	30	400
Evaporative emission-related components	N/A	24	N/A

## **Components Covered**

The emission-related warranty covers all components whose failure would increase an engine's emissions of any regulated pollutant, including the following listed components:

1. For exhaust emissions, emission-related components include any engine parts related to the following systems:
  - Air-induction system
  - Fuel system
  - Ignition system
  - Exhaust gas recirculation systems
2. The following parts are also considered emission-related components for exhaust emissions:
  - After treatment devices
  - Crankcase ventilation valves
  - Sensors
  - Electronic control units
3. The following parts are considered emission-related components for evaporative emissions:
  - Fuel tank
  - Fuel cap
  - Fuel line
  - Fuel line fittings
  - Clamps\*
  - Pressure relief valves\*
  - Control valves\*
  - Control solenoids\*
  - Electronic controls\*
  - Vacuum control diaphragms\*
  - Control cables\*

- Control linkages\*
- Purge valves
- Vapor hoses
- Liquid/vapor separator
- Carbon canister
- Canister mounting brackets
- Carburetor purge port connector

NOTE: \*As related to the evaporative emission control system

4. Emission-related components also include any other part whose only purpose is to reduce emissions or whose failure will increase emissions without significantly degrading engine/equipment performance.

### **Limited Applicability**

As a certifying manufacturer, BRP may deny emission-related warranty claims for failures that have been caused by the owner's or operator's improper maintenance or use, by accidents for which the manufacturer has no responsibility, or by acts of God. For example, an emission-related warranty claim need not be honored for failures that have been directly caused by the operator's abuse of the engine/ equipment or the operator's use of the engine/equipment in a manner for which it was not designed and are not attributable to the manufacturer in anyway.

If you have any question regarding your warranty rights and responsibility or for the name and location of the nearest authorized BRP dealer, you should contact BRP by filling out the customer contact form at [www.brp.com](http://www.brp.com) or contact BRP by mail at one of the addresses listed under the CONTACT US section of this guide, or call at 1-888-272-9222.

# **BRP INTERNATIONAL LIMITED WARRANTY: 2023 SKI-DOO® SNOWMOBILES**

## **SCOPE OF THE LIMITED WARRANTY**

Bombardier Recreational Products Inc. (“BRP”) warrants its 2023 Ski-Doo snowmobiles sold by distributors or dealers authorized by BRP to distribute Ski-Doo snowmobiles (“Ski-Doo Distributor/Dealer”) outside of the fifty United States, Canada, members of the European Economic Area (which is comprised of the member states of the European Union plus the United Kingdom, Norway, Iceland and Liechtenstein) (“EEA”), members states of the Commonwealth of the Independent States (including Ukraine and Turkmenistan) (“CIS”) and Turkey, from defects in material or workmanship for the period and under the conditions described below.

Non-factory installed parts and accessories are not covered under this limited warranty. Please refer to the applicable parts and accessories limited warranty text.

This limited warranty will become null and void if: (1) the snowmobile was used for racing or any other competitive activity, at any point, even by a previous owner; or (2) the snowmobile has been altered or modified in such a way so as to adversely affect its operation, performance or durability, or has been altered or modified to change its intended use.

## **LIMITATIONS OF LIABILITY**

TO THE EXTENT PERMITTED BY LAW, THIS WARRANTY IS EXPRESSLY GIVEN AND ACCEPTED IN LIEU OF ANY AND ALL OTHER WARRANTIES, EXPRESSED OR IMPLIED, INCLUDING WITHOUT LIMITATION ANY WARRANTY OF MERCHANTABILITY OR FITNESS FOR A PARTICULAR PURPOSE. TO THE EXTENT THAT THEY CANNOT BE DISCLAIMED, THE IMPLIED WARRANTIES ARE LIMITED IN DURATION TO THE LIFE OF THE EXPRESS WARRANTY. INCIDENTAL AND CONSEQUENTIAL DAMAGES ARE EXCLUDED FROM COVERAGE UNDER THIS WARRANTY. SOME JURISDICTIONS DO NOT ALLOW FOR THE DISCLAIMERS, LIMITATIONS AND EXCLUSIONS IDENTIFIED ABOVE, AS A RESULT, THEY MAY NOT APPLY TO YOU. THIS WARRANTY GIVES YOU SPECIFIC RIGHTS, AND YOU MAY ALSO HAVE OTHER LEGAL RIGHTS WHICH MAY VARY FROM COUNTRY TO COUNTRY. (FOR PRODUCTS PURCHASED IN AUSTRALIA REFER TO “FOR PRODUCTS SOLD IN AUSTRALIA ONLY”, BELOW).

Neither the Ski-Doo Distributor/Dealer nor any other person has been authorized to make any affirmation, representation or warranty regarding the product, other than those contained in this limited warranty, and if made, shall not be enforceable against BRP.

BRP reserves the right to modify this warranty at any time, being understood that such modification will not alter the warranty conditions applicable to the products sold while this warranty is in effect.

## **EXCLUSIONS - ARE NOT WARRANTED**

The following are not warranted under this limited warranty under any circumstances:

- Normal wear and tear;
- Routine maintenance items, tune ups, adjustments;
- Damage caused by negligence or failure to provide proper maintenance and/or storage, as described in the Operator's Guide;
- Damage resulting from removal of parts, improper repairs, service, maintenance, modifications or use of parts or accessories not manufactured or approved by BRP which in its reasonable judgment are either incompatible with the product or

adversely affect its operation, performance and durability, or resulting from repairs done by a person that is not an authorized servicing BRP snowmobile distributor/ dealer;

- Damage caused by abuse, abnormal use, neglect, racing or operation of the product on surfaces other than snow, or operation of the product in a manner inconsistent with the recommended operation described in the Operator's Guide;
- Damage resulting from accident, submersion, fire, snow or water ingestion, theft, vandalism or any act of God;
- Operation with fuels, oils or lubricants which are not suitable for use with the product (see the Operator's Guide);
- Damage resulting from rust, corrosion or exposure to the elements;
- Incidental or consequential damages, or damages of any kind including without limitation towing, storage, transportation expenses, telephone, rental, taxi, inconvenience, insurance coverage, loan payments, loss of time, loss of income; or time missed for downtime experience due to service work.
- And damage resulting from studs installed on tracks if the installation does not conform to BRP's instructions.

## **WARRANTY COVERAGE PERIOD**

This warranty will be in effect from (1) the date of delivery to the first retail consumer or (2) the date the product is first put into use, whichever occurs first and for a period of:

TWELVE (12) CONSECUTIVE MONTHS, for private or commercial use owners. However, the warranty coverage period on a snowmobile delivered between June 1st and December 1st of a given year will expire November 30th of the following year.

The repair or replacement of parts or the performance of service under this warranty does not extend the life of this warranty beyond its original expiration date.

Note that the duration and any other modalities of the warranty coverage are subject to the applicable national or local legislation in the customer's country.

## **FOR PRODUCTS SOLD IN AUSTRALIA ONLY**

Nothing in these Warranty terms and conditions should be taken to exclude, restrict or modify the application of any condition, warranty, guarantee, right or remedy conferred or implied under the Competition and Consumer Act 2010 (Cth), including the Australian Consumer Law or any other law, where to do so would contravene that law, or cause any part of these terms and conditions to be void. The benefits given to you under this limited warranty are in addition to other rights and remedies that you have under Australian law.

Our goods come with guarantees that cannot be excluded under the Australian Consumer Law. You are entitled to a replacement or refund for a major failure and for compensation for any other reasonably foreseeable loss or damage. You are also entitled to have the goods repaired or replaced if the goods fail to be of acceptable quality and the failure does not amount to a major failure.

## **CONDITIONS TO HAVE WARRANTY COVERAGE**

This warranty coverage is available only if each of the following conditions has been fulfilled:

- The 2023 Ski-Doo snowmobile must be purchased as new and unused by its first owner from a Ski-Doo Distributor/Dealer authorized to distribute Ski-Doo snowmobiles in the country in which the sale occurred;
- The BRP specified pre-delivery inspection process must be completed and documented;

- The 2023 Ski-Doo snowmobile must be purchased in the country or union of countries in which the purchaser resides.
- Routine maintenance outlined in the Operator's Guide must be timely performed in order to maintain warranty coverage. BRP reserves the right to make warranty coverage contingent upon proof of proper maintenance.

BRP will not honor this limited warranty to any private use owner or commercial use owner if one of the preceding conditions has not been met. Such limitations are necessary in order to allow BRP to preserve both the safety of its products, and also that of its consumers and the general public.

## **WHAT TO DO TO OBTAIN WARRANTY COVERAGE**

The customer must cease using the snowmobile upon the appearance of an anomaly. The customer must notify a servicing BRP snowmobile distributor/ dealer within two (2) months of the appearance of a defect, and provide it with reasonable access to the product and reasonable opportunity to repair it. The customer must also present to the authorized BRP snowmobile distributor/ dealer, proof of purchase of the product and must sign the repair/work order prior to starting the repair in order to validate the warranty repair. All parts replaced under this limited warranty become the property of BRP.

Note that the notification period is subject to the applicable national or local legislation in customer's country.

## **WHAT BRP WILL DO**

To the extent permitted by law, BRP's obligations under this warranty are limited to, at its sole discretion, repairing parts found defective under normal use, maintenance and service, or replacing such parts with new genuine Ski-Doo parts without charge for parts and labour, at any authorized Ski-Doo Distributor/Dealer during the warranty coverage period under the conditions described herein. BRP's responsibility is limited to making the required repairs or replacements of parts. No claim of breach of warranty shall be cause for cancellation or rescission of the sale of the snowmobile to the owner. You may have other legal rights which may vary from country to country.

In the event that service is required outside of the country of original sale, the owner will bear responsibility for any additional charges due to local practices and conditions, such as, but not limited to, freight, insurance, taxes, license fees, import duties, and any and all other financial charges, including those levied by governments, states, territories and their respective agencies.

BRP reserves the right to improve or modify products from time to time without assuming any obligation to modify products previously manufactured.

## **TRANSFER**

If the ownership of a product is transferred during the warranty coverage period, this limited warranty, subject to its terms and conditions, shall also be transferred and be valid for the remaining coverage period provided BRP or an authorized Ski-Doo Distributor/Dealer receives a proof that the former owner agreed to the transfer of ownership, in addition to the co-ordinates of the new owner.

## **CONSUMER ASSISTANCE**

In the event of a controversy or a dispute in connection with this limited warranty, BRP suggests that you try to resolve the issue at the Ski-Doo Distributor/Dealer level. We recommend discussing the issue with the authorized Ski-Doo Distributor/Dealer's service manager or owner. If the matter still remains unresolved, contact BRP by filling out the customer contact form at [www.brp.com](http://www.brp.com) or contact BRP by mail at one of the addresses listed under the CONTACT US section of this guide.

# **BRP LIMITED WARRANTY FOR THE EUROPEAN ECONOMIC AND THE COMMONWEALTH OF THE INDEPENDENT STATES (CIS) AREAS AND TURKEY: 2023 SKI-DOO® SNOWMOBILES**

## **SCOPE OF THE LIMITED WARRANTY**

Bombardier Recreational Products Inc. (“BRP”) warrants its 2023 Ski-Doo snowmobiles sold by distributors or dealers authorized by BRP to distribute Ski-Doo snowmobiles (“Ski-Doo Distributor/Dealer”) in member states of the European Economic Area (which is comprised of the member states of the European Union plus the United Kingdom, Norway, Iceland and Liechtenstein) (“EEA”), in member states of the Commonwealth of the Independent States (including Ukraine and Turkmenistan) (“CIS”) and Turkey from defects in material or workmanship for the period and under the conditions described below.

Non-factory installed parts and accessories are not covered under this limited warranty. Please refer to the applicable parts and accessories limited warranty text.

This limited warranty will become null and void if: (1) the snowmobile was used for racing or any other competitive activity, at any point, even by a previous owner; or (2) the snowmobile has been altered or modified in such a way so as to adversely affect its operation, performance or durability, or has been altered or modified to change its intended use.

## **LIMITATIONS OF LIABILITY**

TO THE EXTENT PERMITTED BY LAW, THIS WARRANTY IS EXPRESSLY GIVEN AND ACCEPTED IN LIEU OF ANY AND ALL OTHER WARRANTIES, EXPRESSED OR IMPLIED, INCLUDING WITHOUT LIMITATION ANY WARRANTY OF MERCHANTABILITY OR FITNESS FOR A PARTICULAR PURPOSE. TO THE EXTENT THAT THEY CANNOT BE DISCLAIMED, THE IMPLIED WARRANTIES ARE LIMITED IN DURATION TO THE LIFE OF THE EXPRESS WARRANTIES. INCIDENTAL AND CONSEQUENTIAL DAMAGES ARE EXCLUDED FROM COVERAGE UNDER THIS WARRANTY. SOME JURISDICTIONS DO NOT ALLOW FOR THE DISCLAIMERS, LIMITATIONS AND EXCLUSIONS IDENTIFIED ABOVE, AS A RESULT, THEY MAY NOT APPLY TO YOU. THIS WARRANTY GIVES YOU SPECIFIC RIGHTS, AND YOU MAY ALSO HAVE OTHER LEGAL RIGHTS WHICH MAY VARY FROM COUNTRY TO COUNTRY.

Neither the Ski-Doo Distributor/Dealer nor any other person has been authorized to make any affirmation, representation or warranty regarding the product, other than those contained in this limited warranty, and if made, shall not be enforceable against BRP.

BRP reserves the right to modify this warranty at any time, being understood that such modification will not alter the warranty conditions applicable to the products sold while this warranty is in effect.

## **EXCLUSIONS - ARE NOT WARRANTED**

The following are not warranted under this limited warranty under any circumstances:

- Normal wear and tear;
- Routine maintenance items, tune ups, adjustments;
- Damage caused by negligence or failure to provide proper maintenance and/or storage, as described in the Operator's Guide;

- Damage resulting from removal of parts, improper repairs, service, maintenance, modifications or use of parts or accessories not manufactured or approved by BRP which in its reasonable judgment are either incompatible with the product or adversely affect its operation, performance and durability, or resulting from repairs done by a person that is not an authorized servicing BRP snowmobile distributor/ dealer;
- Damage caused by abuse, abnormal use, neglect, racing or operation of the product on surfaces other than snow, or operation of the product in a manner inconsistent with the recommended operation described in the Operator's Guide;
- Damage resulting from accident, submersion, fire, snow or water ingestion, theft, vandalism or any act of God;
- Operation with fuels, oils or lubricants which are not suitable for use with the product (see the Operator's Guide);
- Damage resulting from rust, corrosion or exposure to the elements;
- Incidental or consequential damages, or damages of any kind including without limitation towing, storage, transportation expenses, telephone, rental, taxi, inconvenience, insurance coverage, loan payments, loss of time, loss of income; or time missed for downtime experience due to service work.
- And damage resulting from studs installed on tracks if the installation does not conform to BRP's instructions.

## **WARRANTY COVERAGE PERIOD**

This warranty will be in effect from (1) the date of delivery to the first retail consumer or (2) the date the product is first put into use, whichever occurs first and for a period of:

TWENTY-FOUR (24) CONSECUTIVE MONTHS, for private use owners and TWELVE (12) CONSECUTIVE MONTHS for commercial use owners. However, the warranty coverage period on a snowmobile delivered between June 1st and December 1st of a given year will expire November 30th of the applicable year. A snowmobile is used commercially when it is used in connection with generating income or any work or employment during any part of the warranty period. A snowmobile is also used commercially when, at any point during the warranty period, it has commercial tags or is licensed for commercial use.

The repair or replacement of parts or the performance of service under this warranty does not extend the life of this warranty beyond its original expiration date.

Note that the duration and any other modalities of the warranty coverage are subject to the applicable national or local legislation in the customer's country.

## **CONDITIONS TO HAVE WARRANTY COVERAGE**

This warranty coverage is available only if each of the following conditions has been fulfilled:

- The 2023 Ski-Doo snowmobile must be purchased as new and unused by its first owner from a Ski-Doo Distributor/Dealer authorized to distribute Ski-Doo products in the country in which the sale occurred;
- The BRP specified pre-delivery inspection process must be completed and documented;
- The product must have undergone proper registration by an authorized Ski-Doo Distributor/Dealer;
- The 2023 Ski-Doo snowmobile must be purchased within the EEA by an EEA resident, in the CIS for residents of the countries comprised in such area and in Turkey for residents of Turkey;

- Routine maintenance outlined in the Operator's Guide must be timely performed in order to maintain warranty coverage. BRP reserves the right to make warranty coverage contingent upon proof of proper maintenance.

BRP will not honor this limited warranty to any private use owner or commercial use owner if one of the preceding conditions has not been met. Such limitations are necessary in order to allow BRP to preserve both the safety of its products, and also that of its consumers and the general public.

## **WHAT TO DO TO OBTAIN WARRANTY COVERAGE**

The customer must cease using the snowmobile upon the appearance of an anomaly. The customer must notify a servicing BRP snowmobile distributor/ dealer within two (2) months of the appearance of a defect, and provide it with reasonable access to the product and reasonable opportunity to repair it. The customer must also present to the authorized BRP snowmobile distributor/ dealer, proof of purchase of the product and must sign the repair/work order prior to starting the repair in order to validate the warranty repair. All parts replaced under this limited warranty become the property of BRP.

Note that the notification period is subject to the applicable national or local legislation in customer's country.

## **WHAT BRP WILL DO**

To the extent permitted by law, BRP's obligations under this warranty are limited to, at its sole discretion, repairing parts found defective under normal use, maintenance and service, or replacing such parts with new genuine Ski-Doo parts without charge for parts and labor, at any authorized Ski-Doo Distributor/Dealer during the warranty coverage period under the conditions described herein. BRP's responsibility is limited to making the required repairs or replacements of parts. No claim of breach of warranty shall be cause for cancellation or rescission of the sale of the snowmobile to the owner. You may have other legal rights which may vary from country to country.

In the event that service is required outside of the EEA, CIS or Turkey, the owner will bear responsibility for any additional charges due to local practices and conditions, such as, but not limited to, freight, insurance, taxes, license fees, import duties, and any and all other financial charges, including those levied by governments, states, territories and their respective agencies.

BRP reserves the right to improve or modify products from time to time without assuming any obligation to modify products previously manufactured.

## **TRANSFER**

If the ownership of a product is transferred during the warranty coverage period, this limited warranty, subject to its terms and conditions, shall also be transferred and be valid for the remaining coverage period provided BRP or an authorized Ski-Doo Distributor/Dealer receives a proof that the former owner agreed to the transfer of ownership, in addition to the co-ordinates of the new owner.

## **CONSUMER ASSISTANCE**

In the event of a controversy or a dispute in connection with this limited warranty, BRP suggests that you try to resolve the issue at the Ski-Doo Distributor/Dealer level. We recommend discussing the issue with the authorized Ski-Doo Distributor/Dealer's service manager or owner.

If the matter still remains unresolved, contact BRP by filling out the customer contact form at [www.brp.com](http://www.brp.com) or contact BRP by mail at one of the addresses listed under the CONTACT US section of this guide.



## **ADDITIONAL TERMS AND CONDITIONS FOR FRANCE ONLY**

The following terms and conditions are applicable to products sold in France only:

The seller shall deliver goods that are complying with the contract and shall be responsible for defects existing upon delivery. The seller shall also be responsible for defects resulting from packaging, assembling instructions or the installation when it is its responsibility per the contract or if accomplished under its responsibility. To be compliant with the contract, the good shall:

1. Be fit for normal use for goods similar thereto and, if applicable:
  - Correspond to the description provided by the seller and have the qualities presented to the buyer through sample or model;
  - Have the qualities that a buyer may legitimately expect considering the public declarations of the seller, the manufacturer of its representative, including in advertising or labeling; or
2. Have the characteristics mutually agreed upon as between the parties or be fit for the specific use intended by the buyer and brought to the attention of the seller and which accepted.

The action for failure to comply is prescribed after two years after delivery of the goods. The seller is responsible for the warranty for hidden defects of the good sold if such hidden defects are rendering the good unfit for the intended use, or if they diminish its use in such a way that the buyer would not have acquired the good or would have given a lesser price, had he known. The action for such hidden defects shall be taken by the buyer within 2 years of the discovery of the defect.

# Customer Information

## Data Privacy Information

Bombardier Recreational Products inc., its affiliates and subsidiaries (“BRP”) is committed to protecting your privacy and support a general policy of openness about how we collect, use and disclose your personal information in the course of managing our relationship with you. **More details can be found by visiting BRP’s Privacy Policy at: <https://brp.com/en/privacy-policy.html> or by scanning the QR Code below.**

Please be assured that we have appropriate security measures in place to ensure that your personal information is protected against loss and unauthorized access.

Your personal information that may be collected by BRP, directly from you or from authorized dealers or authorized third parties, includes:

- **Contact, Demographic & Registration Information** (e.g., name, full address, phone number, email, gender, ownership history, language of communication)
- **Vehicle Information** (e.g., serial number, purchase and delivery date, unit usage, vehicle location and movements)
- **Third Party Information** (e.g., information received from BRP partners, joint-marketing activities information, social media)
- **Technological Information** (e.g., IP address, type of device, operating system, browser type, webpages you view, cookies and similar technologies when you use BRP or dealers’ websites or mobile application)
- **Interaction with BRP Information** (e.g., information collected when you call BRP’s in-house sales representatives, buy items on a BRP web Site, sign up for BRP emails, participate in BRP-sponsored contests and sweepstakes or attend BRP-sponsored events)
- **Transactional Information** (e.g., information necessary to handle returns, payment information when you purchase our products or services through our websites or mobile applications and other issues related to your purchase of BRP products)

This information may be used and processed for the following purposes:

- Safety & Security
- Customer Support for Sales & After Sales (e.g., complete or follow up with you about your purchase or maintenance)
- Registration & Warranty
- Communication (e.g., sending you a BRP satisfaction survey)
- Online Behavioral Advertising, Profiling and Location-Based Services (e.g., offer customized experience)
- Compliance & Dispute Resolution
- Marketing & Advertising
- Assistance (e.g., help with any delivery issues, handle returns, and other issues related to your purchase of BRP products).

We also may use personal information to generate aggregated or statistical data that no longer identifies you personally.

Your personal information may be disclosed to the following: BRP, BRP’s authorized dealerships, distributors, service providers, advertising & market research partners and other authorized third parties.

We may receive information about you from diverse sources, including third parties, such as BRP's authorized dealerships and partners, with whom we offer services or engage in joint-marketing activities. We may also receive information about you from social media platforms such as Facebook and Twitter, when you interact with us on those platforms.

Depending on the circumstances, your personal information may be communicated outside the region where you reside. Your personal information is retained only for as long as necessary for the purpose for which we obtained it and according to our retention policies.

To exercise your data privacy rights (e.g. right of access, right of rectification), to withdraw your consent in order to be removed from the address list for marketing purposes or for the satisfaction survey or for general data privacy questions, please contact BRP's Data Protection Officer at or by mail at [privacyofficer@brp.com](mailto:privacyofficer@brp.com) or by mail at: BRP Legal Service, 726 St-Joseph, Valcourt, Quebec, Canada, J0E 2L0.

When BRP processes your personal information, they do so in compliance with its Privacy Policy available at: <https://www.brp.com/en/privacy-policy.html> or by using the following QR Code.



# Contact Us

www.brp.com

## Europe

### Finland

Isoaavantie 7  
PL 8040  
96101 Rovaniemi

### Norway

Ingvald Ystgaardsvei 15  
N-7484 Trondheim  
Salg, marketing, ettermarked

### Sweden

Spinnvägen 15  
903 61 Umeå  
Sweden 90821

## North America

### Canada

3200A, rue King Ouest,  
Suite 300  
Sherbrooke, Québec J1L 1C9

### United States of America

10101 Science Drive  
Sturtevant, Wisconsin 53177

## Change of Address/Ownership

If your address has changed or if you are the new owner of the snowmobile, be sure to notify BRP by either:

- Notifying an authorized BRP snowmobile dealer or distributor.
- **North America Only:** calling at 1-888-272-9222.
- Mailing one of the change of address cards on the following pages at one of the BRP addresses indicated in the Contact Us section of this guide.

In case of change of ownership, please join a proof that the former owner agreed to the transfer.

Notifying BRP, even after the expiration of the limited warranty, is very important as it enables BRP to reach the snowmobile owner if necessary, like when safety recalls are initiated. It is the owner's responsibility to notify BRP.

**STOLEN UNITS:** If your personal snowmobile is stolen, you should notify BRP or an authorized BRP snowmobile dealer. We will ask you to provide your name, address, phone number, the vehicle identification number and the date it was stolen.

This page is  
intentionally blank



CHANGE OF ADDRESS

CHANGE OF OWNERSHIP

VEHICLE IDENTIFICATION NUMBER

12 individual boxes for the Vehicle Identification Number

Model Number

Vehicle Identification Number (V.I.N.)

OLD ADDRESS  
OR PREVIOUS OWNER:

NAME

NO.

STREET

APT

CITY

STATE/PROVINCE

ZIP/POSTAL CODE

COUNTRY

TELEPHONE

NEW ADDRESS  
OR NEW OWNER:

NAME

NO.

STREET

APT

CITY

STATE/PROVINCE

ZIP/POSTAL CODE

COUNTRY

TELEPHONE

E-MAIL ADDRESS

This page is  
intentionally blank



# NOTES

# NOTES

Model No. \_\_\_\_\_

**VEHICLE**

IDENTIFICATION NUMBER (V.I.N.) \_\_\_\_\_

**ENGINE**

IDENTIFICATION NUMBER (E.I.N.) \_\_\_\_\_

**Owner:** \_\_\_\_\_  
NAME

\_\_\_\_\_  
No. STREET APT

\_\_\_\_\_  
CITY STATE/PROVINCE ZIP/POSTAL CODE

**Purchase Date** \_\_\_\_\_  
YEAR MONTH DAY

**Warranty Expiry Date** \_\_\_\_\_  
YEAR MONTH DAY

To be completed by the dealer at the time of the sale.

DEALER IMPRINT AREA

**⚠ WARNING**

Disregarding any of the safety precautions and instructions contained in the operator's guide, safety handbook, safety video and on product safety labels could cause injury including the possibility of death.



®TM AND THE BRP LOGO ARE TRADEMARKS OF BOMBARDIER RECREATIONAL PRODUCTS INC. OR ITS AFFILIATES.  
©2022 BOMBARDIER RECREATIONAL PRODUCTS INC. ALL RIGHTS RESERVED.

[www.brp.com](http://www.brp.com)

SKI-DOO®

LYNX®

SEA-DOO®

CAN-AM®

ROTAX®

ALUMACRAFT®

MANITOU®

QUINTREX®