

can-am™



2011

**Operator's
Guide**

**Includes
Safety, Vehicle
and Maintenance Information**

**OUTLANDER™
OUTLANDER™ MAX**

500/650/800R EFI

⚠ WARNING

Read this guide thoroughly. It contains important safety information.
Minimum recommended age: Operator: 16 years. Passenger for **MAX models only**: 12 years.
Experienced operator only (Outlander 800R X xc). Keep this Operator's Guide in the vehicle.

2 1 9 0 0 0 6 8 9

⚠ WARNING

YOUR VEHICLE CAN BE HAZARDOUS TO OPERATE. A collision or rollover can occur quickly, if you fail to take proper precautions, even during routine maneuvers such as turning and driving on hills or over obstacles. For your safety, understand and follow all the warnings contained in this Operator's Guide and on the labels on your vehicle. **Failure to follow these warnings can result in SEVERE INJURY OR DEATH!** Keep this Operator's Guide with the vehicle at all times.

⚠ WARNING

Disregarding any of the safety precautions and instructions contained in this Operator's Guide, *SAFETY DVD* and on-product labels could result in an injury including the possibility of death!

⚠ WARNING

This vehicle may exceed the performance of other vehicles you may have ridden in the past. Take time to familiarize yourself with your new vehicle.

CALIFORNIA PROPOSITION 65 WARNING

⚠ WARNING

This product contains or emits chemicals known to the state of California to cause cancer and birth defects or other reproductive harm.

The following trademarks are the property of Bombardier Recreational Products Inc.:

In Canada, products are distributed by Bombardier Recreational Products Inc. (BRP). In USA, products are distributed by BRP US Inc.

Can-Am™ D.E.S.S.™ Outlander™ Rotax® TTi™ XPS™
DPS™

This document contains the trademark of the following company:

- Garmin®, Garmin logo, City Navigator®, MapSource™ and nüvi® are trademarks of Garmin Ltd or its subsidiaries.
- MicroSD™ and SD™ are trademarks of SanDisk or its subsidiaries.

FOREWORD

Congratulations on your purchase of a new Can-Am™ ATV. It is backed by the BRP warranty and a network of authorized Can-Am dealers ready to provide the parts, service or accessories you may require.

Your dealer is committed to your satisfaction. He has taken training to perform the initial setup and inspection of your vehicle as well as completed the final adjustment before you took possession. If you need more complete servicing information, please ask your dealer.

At delivery, you were also informed of the warranty coverage and signed the *PREDELIVERY CHECK LIST* to ensure your new vehicle was prepared to your entire satisfaction.

Know Before you Go

To learn how to reduce the risk for you or bystanders being injured or killed, read this Operator's Guide before you operate the vehicle.

Also, read all safety labels on your ATV and watch attentively your *SAFETY DVD*.

This vehicle is for off road use only. It is mainly for general recreational use but it may also be used for utility purposes.

The following table provides the vehicle category according to models.

MODELS	CATEGORY
All models except Outlander 800R X xc	Category G
Outlander 800R X xc	Category S

Always follow this age recommendation as per **G** and **S** categories:

- A person under 16 years old should never operate this vehicle.
- Passenger on 2-UP models should be 12 years old or more and must be capable of keeping his feet on the footrests and his hands on grab handles at all times when seated on this vehicle.

Also, a category **S** model is for experienced operator only.

We highly recommend that you take a safety riding course. Please check with your dealer or local authorities for availability in your area.

Failure to follow the warnings contained in this Operator's Guide can result in **SERIOUS INJURY** or **DEATH**.

Safety Messages

The types of safety messages, what they look like and how they are used in this guide are explained as follows:

WARNING

Indicates a potential hazard, if not avoided, could result in serious injury or death.

 **CAUTION** Indicates a hazard situation which, if not avoided, could result in minor or moderate injury.

 **NOTICE** Indicates an instruction which, if not followed, could severely damage vehicle components or other property.

About this Operator's Guide

This Operator's Guide has been prepared to acquaint the owner/operator of a new vehicle with the various vehicle controls, maintenance and safe operating instructions. It is indispensable for the proper use of the product.

WARNING

Throughout this Operator's Guide, the term "1-UP" refers to vehicles designed to carry the operator only while the term "2-UP" refers to vehicles designed to carry also a passenger.

Make sure to identify and follow the warnings and instructions that are applicable to your specific model.

Note that this guide is available in several languages. In the event of any discrepancy, the English version shall prevail.

Keep this Operator's Guide in the vehicle as you can refer to it for things such as maintenance, troubleshooting and instructing others.

If you want to view and/or print an extra copy of your Operator's Guide, simply visit the following website www.operatorsguide.brp.com.

The information contained in this document are correct at the time of publication. However, BRP maintains a policy of continuous improvement of its products without imposing upon itself

any obligation to install them on products previously manufactured. Due to late changes, some differences between the manufactured product and the descriptions and/or specifications in this guide may occur. BRP reserves the right at any time to discontinue or change specifications, designs, features, models or equipment without incurring any obligation upon itself.

This Operator's Guide and the *SAFETY DVD* should remain with the vehicle when it is sold.

While reading this Operator's Guide, remember that:

WARNING

Indicates a potential hazard that, if not avoided, could result in serious injury or death.

TABLE OF CONTENTS

FOREWORD	1
Know Before you Go	1
Safety Messages	1
About this Operator's Guide	2

SAFETY INFORMATION

GENERAL PRECAUTIONS	8
Avoid Carbon Monoxide Poisoning	8
Avoid Gasoline Fires and Other Hazards	8
Avoid Burns from Hot Parts	8
Accessories and Modifications	8

SPECIAL SAFETY MESSAGES	9
--------------------------------------	----------

OPERATION WARNINGS	13
---------------------------------	-----------

RIDING THE VEHICLE	43
---------------------------------	-----------

Pre-Ride Inspection	44
Clothing	46
Carrying a Passenger	47
Carrying Loads	48
Hauling a Trailer	48
Working with your Vehicle	49
Recreational Riding	49
Environment	50
Design Limitation	50
Off-Road Operation	50
General Operating and Safety Precautions	51
Riding Techniques	53

IMPORTANT ON-PRODUCT LABELS	62
--	-----------

Hang Tag	62
Vehicle Safety Labels	65
Compliance Labels	70
Technical Information Labels	70

VEHICLE INFORMATION

CONTROLS/INSTRUMENTS/EQUIPMENT	72
---	-----------

1) Throttle Lever	74
2) 2WD/4WD Selector	74
3) Brake Lever(s)	75
4) Parking Brake	76
5) Transmission Lever	77

CONTROLS/INSTRUMENTS/EQUIPMENT (cont'd)

6) Multifunction Switch	78
7) Multifunction Gauge	81
8) 12-Volt Power Outlet	86
9) Ignition Switch	86
10) Brake Pedal	87
11) Footpeg	87
12) Grab Handles	87
13) Passenger's Seat/Storage Box	88
14) Operator's Seat	90
15) Rear Storage Compartment	91
16) Cargo Racks	91
17) Trailer Hitch	92
18) Tool Kit	92
19) Winch	92
20) Winch Control Switch	92
21) Roller Fairlead	93
22) Winch Remote Control	93
23) Winch Remote Control Connection	94
24) GPS Receiver (Global Positioning System)	94
25) ACS Compressor	96
FUEL	97
Recommended Fuel	97
Fueling Procedure	97
BREAK-IN PERIOD	99
Operation During Break-In	99
OPERATING INSTRUCTIONS	100
Starting the Engine	100
Shifting the Transmission	100
Stopping the Engine	100
What to Do if Vehicle Is Turned Over	101
What to Do if Vehicle Is Immersed in Water	101
TUNE YOUR RIDE	102
Suspension Adjustment	102
Steering Assist Adjustment (DPS)	105
VEHICLE TRANSPORTATION	107

MAINTENANCE

BREAK-IN INSPECTION	110
MAINTENANCE SCHEDULE	113

MAINTENANCE PROCEDURES	117
Air Filter	117
Engine Oil	120
Oil Filter	122
Radiator	122
Engine Coolant	123
Muffler Spark Arrester	126
CVT Air Filter	127
CVT Cover	128
Gearbox Oil	128
Throttle Cable	129
Spark Plugs	131
Battery	132
Fuses	133
Lights	134
Drive Shaft Boot and Protector	137
Wheels and Tires	137
Suspension	140
ACS Compressor	140
ACS Hoses and Fittings	142
Brakes	142
Fuel Tank Breather Filter	144
VEHICLE CARE	145
Post-Operation Care	145
Vehicle Cleaning and Protection	145
STORAGE AND PRESEASON PREPARATION	146

TECHNICAL INFORMATION

VEHICLE IDENTIFICATION	148
Engine and Vehicle Identification Number Location	148
NOISE EMISSION CONTROL SYSTEM REGULATION	149
EC-DECLARATION OF CONFORMITY	150
SPECIFICATIONS	151

TROUBLESHOOTING

TROUBLESHOOTING GUIDELINES	164
MULTIFUNCTION GAUGE MESSAGES	168

WARRANTY

BRP LIMITED WARRANTY USA AND CANADA: 2011 CAN-AM™ ATV .. 170
BRP INTERNATIONAL LIMITED WARRANTY: 2011 CAN-AM™ ATV 175
BRP LIMITED WARRANTY FOR THE EUROPEAN ECONOMIC AREA: 2011
CAN-AM™ ATV 179
ADDITIONAL TERMS AND CONDITIONS FOR FRANCE ONLY 184

CUSTOMER INFORMATION

PRIVACY INFORMATION 186
CHANGE OF ADDRESS/OWNERSHIP..... 187

SAFETY INFORMATION

GENERAL PRECAUTIONS

Avoid Carbon Monoxide Poisoning

All engine exhaust contains carbon monoxide, a deadly gas. Breathing carbon monoxide can cause headaches, dizziness, drowsiness, nausea, confusion and eventually death.

Carbon monoxide is a colorless, odorless, tasteless gas that may be present even if you do not see or smell any engine exhaust. Deadly levels of carbon monoxide can collect rapidly, and you can quickly be overcome and unable to save yourself. Also, deadly levels of carbon monoxide can linger for hours or days in enclosed or poorly ventilated areas. If you experience any symptoms of carbon monoxide poisoning, leave the area immediately, get fresh air and seek medical treatment.

To prevent serious injury or death from carbon monoxide:

- Never run the vehicle in poorly ventilated or partially enclosed areas such as garages, carports or barns. Even if you try to ventilate engine exhaust with fans or open windows and doors, carbon monoxide can rapidly reach dangerous levels.
- Never run the vehicle outdoors where engine exhaust can be drawn into a building through openings such as windows and doors.

Avoid Gasoline Fires and Other Hazards

Gasoline is extremely flammable and highly explosive. Fuel vapors can spread and be ignited by a spark or flame many feet away from the engine. To reduce the risk of fire or explosion, follow these instructions:

- Use only an approved red gasoline container to store fuel.

- Strictly adhere to instructions in *FUEL* subsection.
- Never start or operate the engine if the fuel cap is not properly installed.

Gasoline is poisonous and can cause injury or death.

- Never siphon gasoline by mouth.
- If you swallow gasoline, get any in your eye(s), or inhale gasoline vapor, see your doctor immediately.

If gasoline spills on you, wash with soap and water and change your clothes.

Avoid Burns from Hot Parts

The exhaust system and engine become hot during operation. Avoid contact during and shortly after operation to avoid burns.

Accessories and Modifications

Do not make unauthorized modifications, or use attachments or accessories that are not approved by BRP. Since these changes have not been tested by BRP, they may increase the risk of crashes or injury, and can render the vehicle illegal.

See your authorized Can-Am dealer for available accessories for your vehicle.

SPECIAL SAFETY MESSAGES

THIS VEHICLE IS NOT A TOY AND CAN BE HAZARDOUS TO OPERATE.

- This vehicle handles differently from other vehicles including motorcycles and cars. A collision or rollover can occur quickly, if you fail to take proper precautions, even during routine maneuvers such as turning and driving on hills or over obstacles.

SEVERE INJURY OR DEATH can result if you do not follow these instructions:

- Read this Operator's Guide and all on-product safety labels carefully and follow the operating procedures described. Watch and pay attention to the *SAFETY DVD* before operating the vehicle.
- Always follow this age recommendation: A person under 16 years old should never operate this vehicle.
- Passenger on 2-UP models should be 12 years old or more and must be capable of keeping his feet on the footrests and his hands on grab handles at all times when seated on this vehicle.
- Outlander 800R X xc model (category **S**) is for experienced operator only.
- Passenger must be seated on the designated passenger's seat and hold on to the grab handles at all times. Do not allow passenger to sit anywhere else. Never hold on to the operator.
- Never carry a passenger on this vehicle unless you are operating a 2-UP model.
- Never carry more than one (1) passenger on a 2-UP model.
- Never operate this vehicle on any paved surfaces, including sidewalks, driveways, parking lots and streets.
- Never operate this vehicle on any public street, road or highway, even a dirt or gravel one.
- Never take place on this vehicle without wearing an approved helmet that fits properly. The operator and the passenger (2-UP models) should also wear eye protection (goggles or face shield), gloves, boots, long sleeved shirt or jacket, and long pants. The passenger on 2-UP models should have an approved helmet including a rigid chin guard.
- Never ride this vehicle if you are tired, ill or under influence of alcohol or drugs. Your reaction time and judgement is greatly affected under these conditions.
- Never attempt wheelies, jumps, or other stunts.
- Never operate at excessive speeds. Always go at a speed that is proper for the terrain, visibility, and operating conditions, and your experience.
- Always go slowly and be extra careful when operating on unfamiliar terrain. Always be alert to changing terrain conditions when operating this vehicle. If you are operating a 2-UP model, always keep in mind that you are carrying a passenger.
- Never operate on excessively rough, slippery or loose terrain until you have learned and practiced the skills necessary to control this vehicle on such terrain. Always be especially cautious on these kinds of terrain. If you are operating a 2-UP model, always keep in mind that you are carrying a passenger.

- Always follow proper procedures for turning as described further in this Operator's Guide. Practice turning at low speeds before attempting to turn at faster speeds. Do not turn at excessive speed. Carrying a passenger with 2-UP models may affect the stability and the handling of the vehicle.
- Never operate this vehicle on hills too steep for the vehicle or for your abilities. Do not forget, with 2-UP models, the operator is responsible for the safety of the passenger. In doubt, disembark him before climbing hill. Always remember that the vehicle handling, stability and braking distance may be affected when riding with a passenger.
- Always follow proper procedures for climbing hills as described further in this Operator's Guide. Check the terrain carefully before you start up any hill. Never climb hills with excessively slippery or loose surfaces. Shift operator and passenger (2-UP models) weight forward. Never open the throttle suddenly or make sudden gear changes. Never go over the top of any hill at high speed. If you are operating a 2-UP model, always keep in mind that you are carrying a passenger.
- Always follow proper procedures for going down hills and for braking on hills as described further in this Operator's Guide. Check the terrain carefully before you start down any hill. Shift operator and passenger (2-UP models) weight backward. Never go down a hill at high speed. Avoid going down a hill at an angle that would cause the vehicle to lean sharply to one side. Go straight down the hill where possible. If you are operating a 2-UP model, always keep in mind that you are carrying a passenger.
- Always follow proper procedures for crossing the side of a hill as described further in this Operator's Guide. Avoid hills with excessively slippery or loose surfaces. Shift operator and passenger weight (2-UP models) to the uphill side of the vehicle. Never attempt to turn the vehicle around on any hill until you have mastered the turning technique described in this Operator's Guide on level ground. Avoid crossing the side of a steep hill if possible. If you are operating a 2-UP model, always keep in mind that you are carrying a passenger.
- Always use proper procedures if you stall or roll backwards when climbing a hill. To avoid stalling, use proper gear and maintain a steady speed when climbing a hill. If you stall or roll backwards, follow the special procedure for braking described in this Operator's Guide. First, disembark the passenger (2-UP models) then the operator. Dismount on the uphill side or to a side if pointed straight uphill. Turn the vehicle around and remount, following the procedure described further in this Operator's Guide.
- Always check for obstacles before operating in a new area. Never attempt to operate over large obstacles, such as large rocks or fallen trees. Always follow proper procedures when operating over obstacles as described further in this Operator's Guide. Do not forget, with 2-UP models, the operator is responsible for the safety of the passenger. In doubt, disembark him to get through the obstacles.

- Always be careful when skidding or sliding. If you are operating a 2-UP model and have a passenger onboard, never attempt skidding or sliding; overturn or passenger ejection may occur. Learn to safely control skidding or sliding by practicing at low speeds and on level smooth terrain. On extremely slippery surfaces, such as ice, go slowly and be very cautious in order to reduce the chance of skidding out of control.
- Never operate this vehicle in fast flowing water or in water deeper than that specified in this Operator's Guide. Remember that wet brakes may have reduced stopping ability. Test your brakes after leaving water. If necessary, apply them several times to let friction dry out the pads. With 2-UP models, the vehicle braking distance may be affected when riding with a passenger. Safely reduce speed when riding with a passenger. Allow greater distance for braking.
- Always keep in mind that braking distance is readily affected by but not limited to; weather and terrain conditions, braking system and tire conditions, vehicle speed and attitude, and vehicle load including towing. Remember to adjust your driving accordingly.
- Always be sure there are no obstacles or people behind the vehicle when you operate in reverse. When it is safe to proceed in reverse, go slowly. Take into account that on a 2-UP model the passenger can obstruct your view.
- BRP recommends sitting on your ATV when operating in reverse. Avoid standing up. Your weight could shift forward against throttle lever, causing an unexpected acceleration and may lead to a loss of control.
- Never exceed the stated load limits for this vehicle including operator and passenger (2-UP models), all other loads and added accessories. Cargo should be properly distributed and securely attached. Reduce speed and follow instructions in this guide for carrying cargo or pulling a trailer. Allow greater distance for braking.
- Always inspect and confirm the safe operating condition of your vehicle prior to ride. Always follow the inspection and maintenance procedures and schedules described in this Operator's Guide.
- Always use the tire size and type specified further in this Operator's Guide. Always maintain proper tire pressure as described further in this Operator's Guide.
- Never modify this vehicle through improper installation or use of accessories. Only use BRP's approved accessories. NEVER install a passenger seats on a 1-UP model or use the racks to carry a passenger.
- Never operate this vehicle without proper instruction. **Take a training course.** All operators should receive training from a certified instructor.

FOR MORE INFORMATION ABOUT ATV SAFETY, contact an authorized Can-Am dealer to find out about available training courses nearest you.

USA and Canada only: call the Specialty Vehicle Institute of America (SVIA) at 1 800 887-2887 or in Canada, the Canada Safety Council (CSC) at 1 613 739-1535.

2-UP Models Only

Driver must:

- Inform the passenger concerning the basic rules for a safe ride.
- Not forget, the operator is responsible for the safety of the passenger. If in doubt, disembark him before executing any maneuver. Always practice the maneuvers described in this Operator's Guide without and with passenger. Always remember that the vehicle handling, stability and braking distance may be affected when riding with a passenger. Safely reduce speed when riding with a passenger. Allow greater distance for braking. In some situations, this vehicle can be used easily with the operator alone but not necessarily with a passenger. Use your common sense.
- Never carry passenger on a 2-UP model if the storage box is installed (in place of rear seat).
- Always keep both hands on the handlebars and both feet on the footrests of the vehicle during operation.
- Never operate a 2-UP model without the passenger's seat or the storage box properly installed.

Passenger must:

- Never take place on this vehicle without wearing an approved helmet (including a chin guard) that fits properly. You should also wear eye protection (goggles or face shield), gloves, boots, long sleeved shirt or jacket, and long pants.
- Be seated on the designated passenger's seat and hold on to the grab handles at all times. Never hold on to the operator.
- Always keep hands and feet in the proper place during operation.
- Never get up during vehicle operation. An excessive movement could cause loss of control.
- Pay attention to vehicle and operator movements.
- Not wait and tell the driver to slow down or stop if you feel uncomfortable or insecure for any reason.

OPERATION WARNINGS

The following warning and their format have been requested by the United States Consumer Product Safety Commission and are required to be in the Operator's Guide for all ATVs.

NOTE: The following illustrations are general representations only. Your model may differ.

WARNING



V00A0AQ

POTENTIAL HAZARD

Operating this vehicle without proper instruction.

WHAT CAN HAPPEN

The risk of an accident is greatly increased if the operator does not know how to operate this vehicle properly in different situations and on different types of terrain with or without passenger (2-UP models).

HOW TO AVOID THE HAZARD

Beginners and inexperienced operators should complete a training course. They should then regularly practice the skills learned during the course as well as the operating techniques described in this Operator's Guide.

For more information about a training course, contact an authorized Can-Am dealer.

⚠ WARNING



V00A1AQ

POTENTIAL HAZARD

Failure to follow the age recommendations for this vehicle.

WHAT CAN HAPPEN

A lack of respect for this age recommendation can lead to severe injury or death of the child.

Even though a child may be within the age group for which this vehicle is recommended, he may not have the skills, abilities, or judgment needed to operate this vehicle safely and may be involved in a serious accident.

HOW TO AVOID THE HAZARD

No one under 16 should operate this vehicle.

*2-UP Models Only***⚠ WARNING**

V00A1BQ

POTENTIAL HAZARD

Failure to follow the age recommendations on 2-UP models for the passenger.

WHAT CAN HAPPEN

A child, under 12, may not have the ability needed to ride safely and may be involved in a serious accident.

HOW TO AVOID THE HAZARD

No one under 12 should be riding on this vehicle.

⚠ WARNING**POTENTIAL HAZARD**

Failure to respect the physical limitations of the passenger on 2-UP models.

WHAT CAN HAPPEN

A passenger that cannot completely lean his feet on footrests can be ejected when riding on uneven terrain.

HOW TO AVOID THE HAZARD

The passenger must be capable of keeping his feet on the footrests and his hands on grab handles at all times when he is seated on the vehicle.

1-UP Models Only

⚠ WARNING



V00A02Q

POTENTIAL HAZARD

Carrying a passenger on this vehicle.

WHAT CAN HAPPEN

Greatly reduces your ability to balance and control this vehicle.

Could cause an accident, resulting in harm to you and/or your passenger.

HOW TO AVOID THE HAZARD

Never carry passenger. Even with a long seat that provides unrestricted operator movement, it is not designed nor intended to carry passenger(s).

*2-UP Models Only***⚠ WARNING**

V00A1CQ

POTENTIAL HAZARD

Carrying more than one (1) passenger on this vehicle.

WHAT CAN HAPPEN

Carrying more than one (1) passenger reduces your ability to balance and control this vehicle.

Could cause an accident, resulting in harm to you and/or your passengers.

HOW TO AVOID THE HAZARD

Never carry more than one (1) passenger. Even with a long seat that provides unrestricted operator movement, the vehicle is not designed nor intended to carry more than one (1) operator and one (1) passenger. The passenger must be used the designated passenger's seat when he is seated on the vehicle.

When the storage box is installed (in place of rear seat), the vehicle becomes a ONE-RIDER vehicle (1-UP model) and NO PASSENGER must be allowed on it.

2-UP Models Only

⚠ WARNING



V00A2DQ

POTENTIAL HAZARD

Allowing passenger to sit in a location other than the designated passenger's seat.

WHAT CAN HAPPEN

Passenger seated in a location other than the designated passenger's seat could:

- Impair vehicle stability which could lead to a loss of control
- Suffer injury from impact on hard surfaces.

Could cause an accident, resulting in harm to you and/or your passenger.

HOW TO AVOID THE HAZARD

Passenger must always remain seated on designated passenger's seat with feet firmly planted on footrests and always hold on to the grab handles.

⚠ WARNING

V00A1DQ

POTENTIAL HAZARD

Operating this vehicle on paved surfaces.

WHAT CAN HAPPEN

The tires are designed for off-road use only, not for use on pavement. Paved surfaces may seriously affect handling and control of the vehicle, and may cause the vehicle to go out of control.

HOW TO AVOID THE HAZARD

Never operate this vehicle on any paved surfaces, including sidewalks, driveways, parking lots and streets.

⚠ WARNING



V00A04Q

POTENTIAL HAZARD

Operating this vehicle on public streets, roads or highways.

WHAT CAN HAPPEN

You can collide with another vehicle.

HOW TO AVOID THE HAZARD

Never operate this vehicle on any public street, road or highway, even a dirt or gravel one. In many states it is illegal to operate this vehicle on public streets, roads and highways.

⚠ WARNING

V00A06Q

POTENTIAL HAZARD

Riding this vehicle without wearing an approved helmet, eye protection and protective clothing. On 2-UP models, passenger should also have an approved helmet with a rigid chin guard.

WHAT CAN HAPPEN

The following items concern the operator and the passenger (2-UP models):

- Riding without an approved helmet increases the chances of a severe head injury or death in the event of an accident.
- Riding without eye protection can result in an accident and increases the chances of a severe injury in the event of an accident.
- Riding without protective clothing increases the chances of severe injury in the event of an accident.

HOW TO AVOID THE HAZARD

Always wear an approved helmet that fits properly. You should also wear:

- Eye protection (goggles or face shield)
- Rigid chin guard (recommended for the passenger)
- Gloves and boots
- Long sleeved shirt or jacket
- Long pants.

⚠ WARNING



V00A07Q

POTENTIAL HAZARD

Riding this vehicle under influence of alcohol or drugs.

WHAT CAN HAPPEN

Could cause the passenger to fall off (2-UP models).

Could seriously affect your judgment.

Could cause you to react more slowly.

Could affect your balance and perception.

Could result in an accident or death of passenger (2-UP models) and/or operator.

HOW TO AVOID THE HAZARD

The operator and the passenger (2-UP models) should never ride this vehicle under influence of alcohol or drugs.

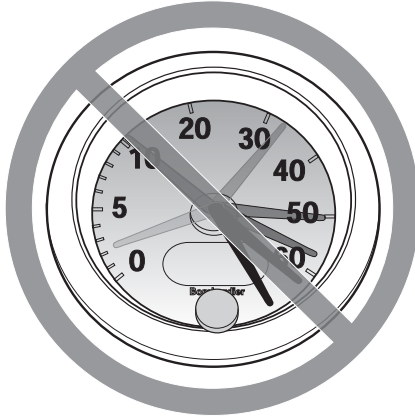
⚠ WARNING

V00A08Q

POTENTIAL HAZARD

Operating this vehicle at excessive speeds.

WHAT CAN HAPPEN

Increases your chances of losing control of the vehicle, which can result in an accident.

HOW TO AVOID THE HAZARD

Always travel at a speed which is appropriate for the terrain, visibility and operating conditions, and your experience.

On 2-UP models, the vehicle handling, stability and braking distance may be affected when riding with a passenger. Safely reduce speed when riding with a passenger. Allow greater distance for braking.

⚠ WARNING



V00A09Q

POTENTIAL HAZARD

Attempting wheelies, jumps and other stunts.

WHAT CAN HAPPEN

Increases the chance of an accident, for the operator and the passenger (2-UP models), including an overturn.

HOW TO AVOID THE HAZARD

Never attempt stunts, such as wheelies or jumps. Do not try to show off.

⚠ WARNING

POTENTIAL HAZARD

Failure to inspect the vehicle before operating.

Failure to properly maintain the vehicle.

WHAT CAN HAPPEN

Increases the possibility of an accident or equipment damage.

HOW TO AVOID THE HAZARD

Always inspect your vehicle prior to every time you use it to make sure the vehicle is in safe operating condition.

Always follow the inspection and maintenance procedures and schedules described further in this Operator's Guide.

⚠ WARNING**POTENTIAL HAZARD**

Riding on frozen waterways.

WHAT CAN HAPPEN

Breaking through the ice can lead to severe injury or death.

HOW TO AVOID THE HAZARD

Never ride this vehicle on a frozen surface before you are sure the ice is thick enough and sound enough to support the vehicle and its load, as well as the force that is created by a moving vehicle.

⚠ WARNING

V00A0BQ

POTENTIAL HAZARD

Removing hands from handlebars for the operator and from grab handles for the passenger (2-UP models), or feet from the footrests during operation.

WHAT CAN HAPPEN

Removing even one hand or foot can reduce your ability to control the vehicle or could cause you to lose your balance and fall off the vehicle. If you remove a foot from the footrests, your foot or leg may come into contact with the rear wheels, which could injure you or cause an accident.

HOW TO AVOID THE HAZARD

Operator and passenger (2-UP models) must always keep both hands on the handlebars or on grab handles and both feet on the footrests during vehicle operation.

⚠ WARNING

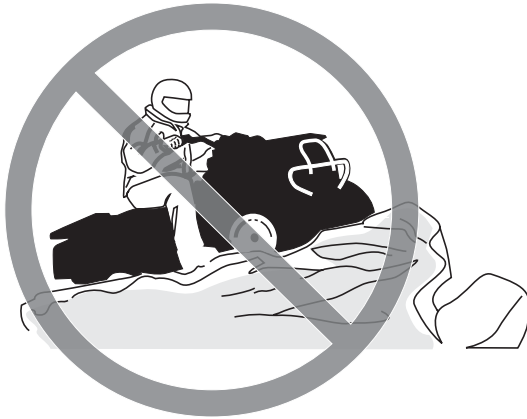

V00A0CQ

POTENTIAL HAZARD

Failure to use extra care when operating this vehicle on unfamiliar terrain.

WHAT CAN HAPPEN

You can come upon hidden rocks, bumps, or holes, without enough time to react.

Could result in the vehicle overturning, passenger ejection (2-UP models) or loss of control.

HOW TO AVOID THE HAZARD

Go slowly and be extra careful when operating on unfamiliar terrain.

Always be alert to changing terrain conditions when operating the vehicle.

Do not forget, on 2-UP models, the operator is responsible for the safety of his passenger. Safely reduce speed when riding with a passenger.

⚠ WARNING

V00A0DQ

POTENTIAL HAZARD

Failure to use extra care when operating on excessively rough, slippery or loose terrain.

WHAT CAN HAPPEN

Could cause loss of traction or vehicle control, which could result in an accident, including an overturn or passenger ejection (2-UP models).

HOW TO AVOID THE HAZARD

Do not operate on excessively rough, slippery or loose terrain until you have learned and practiced the skills necessary to control this vehicle on such terrain.

Always be especially cautious on these kinds of terrain.

Do not forget, on 2-UP models, the operator is responsible for the safety of the passenger. In doubt, disembark him before operating on these terrains.

⚠ WARNING



V00A0EQ

POTENTIAL HAZARD

Turning improperly.

WHAT CAN HAPPEN

Vehicle could go out of control, causing a collision, an overturn or a passenger ejection (2-UP models).

HOW TO AVOID THE HAZARD

Always follow proper procedures for turning as described further in this Operator's Guide. Practice turning at low speeds before attempting to turn at faster speeds.

Do not forget, on 2-UP models, the operator is responsible for the safety of the passenger. Never perform this maneuver with a passenger. Always remember that the vehicle handling, stability and braking distance may be affected when riding with a passenger.

Do not turn at excessive speed.

⚠ WARNING

V00AQQ

POTENTIAL HAZARD

Operating on excessively steep hills.

WHAT CAN HAPPEN

The vehicle can overturn more easily on extremely steep hills than on level surfaces or small hills.

HOW TO AVOID THE HAZARD

Never operate this vehicle on hills too steep for the vehicle or for your abilities.

Practice, without and with passenger (2-UP models), on smaller hills before attempting larger hills.

Always remember that, on 2-UP models, even if this vehicle can climb some steep hills, it is not recommended to climb such hills with a passenger; always disembark him before attempting this maneuver. Show good judgment.

⚠ WARNING



V00A0FQ

POTENTIAL HAZARD

Climbing hills improperly.

WHAT CAN HAPPEN

Could cause loss of control, passenger ejection (2-UP models) or cause vehicle to overturn.

HOW TO AVOID THE HAZARD

Always follow proper procedures for climbing hills as described further in this Operator's Guide.

Always check the terrain carefully before you start up any hill. Do not forget, on 2-UP models, the operator is responsible for the safety of the passenger. In doubt, disembark him before climbing hill. Always remember that the vehicle handling, stability and braking distance may be affected when riding with a passenger.

Never climb hills with excessively slippery or loose surfaces.

Shift operator and passenger (2-UP models) weight forward.

Never open the throttle suddenly or make sudden gear changes. The vehicle could flip over backwards.

Never go over the top of any hill at high speed. An obstacle, a sharp drop, or another vehicle or person could be on the other side of the hill.

⚠ WARNING

V00A0GQ

POTENTIAL HAZARD

Going down a hill improperly.

WHAT CAN HAPPEN

Could cause loss of control, passenger ejection (2-UP models) or cause vehicle to overturn.

HOW TO AVOID THE HAZARD

Always follow proper procedures for going down hills as described further in this Operator's Guide.

NOTE: A special technique is required when braking as you go down a hill.

Always check the terrain carefully before you start down any hill. Do not forget, on 2-UP models, the operator is responsible for the safety of the passenger. In doubt, disembark him before going down hill. Always remember that the vehicle handling, stability and braking distance may be affected when riding with a passenger.

Shift operator and passenger (2-UP models) weight backward. On 2-UP models, passenger must hold the grab handles firmly.

Never go down a hill at high speed.

Avoid going down a hill at an angle which would cause the vehicle to lean sharply to one side. Go straight down the hill where possible.

⚠ WARNING



V00A0HQ

POTENTIAL HAZARD

Improperly crossing hills or turning on hills.

WHAT CAN HAPPEN

Could cause loss of control, passenger ejection (2-UP models) or cause vehicle to overturn.

HOW TO AVOID THE HAZARD

Never attempt this maneuver on 2-UP models when the passenger is on board. Always disembark him before executing.

Never attempt to turn the vehicle around on any hill until you have mastered the turning technique as described further in this Operator's Guide on level ground. Be very careful when turning on any hill.

Avoid crossing the side of a steep hill if possible.

When crossing the side of a hill:

Always follow proper procedures as described further in this Operator's Guide.

Avoid hills with excessively slippery or loose surfaces.

Operator and passenger (2-UP models) must shift their weight to the uphill side of the vehicle.

*1-UP Models Only***! WARNING**

V00A01Q

POTENTIAL HAZARD

Stalling, rolling backwards or improperly dismounting while climbing a hill.

WHAT CAN HAPPEN

Could result in vehicle overturning.

HOW TO AVOID THE HAZARD

Use proper gear and maintain steady speed when climbing a hill.

If you lose all forward speed:

Keep your weight uphill. Never open the throttle suddenly or make sudden gear changes. The vehicle could flip over backwards.

Apply the brakes.

Lock parking brake after you have stopped.

Dismount on uphill side, or to a side if pointed straight uphill.

If you begin rolling backwards:

Keep your weight uphill. Never open the throttle suddenly or make sudden gear changes. The vehicle could flip over backwards.

Never apply the rear brake while rolling backwards.

Apply the front brake gradually.

When fully stopped, apply rear brake as well and lock parking brake.

Dismount on uphill side, or to a side if pointed straight uphill.

Turn the vehicle around and remount, following the procedure described further in this Operator's Guide.

2-UP Models Only

⚠ WARNING



V00A1PQ

POTENTIAL HAZARD

Stalling, rolling backwards or improperly dismounting while climbing a hill.

WHAT CAN HAPPEN

Could result in vehicle overturning.

HOW TO AVOID THE HAZARD

Use proper gear and maintain steady speed when climbing a hill.

If you lose all forward speed:

Operator and passenger must keep their weight uphill. Never open the throttle suddenly or make sudden gear changes. The vehicle could flip over backwards.

Apply the brakes.

Lock parking brake after you have stopped.

First, disembark the passenger, then dismount on uphill side, or to a side if pointed straight uphill.

If you begin rolling backwards:

Operator and passenger must keep their weight uphill. Never open the throttle suddenly or make sudden gear changes. The vehicle could flip over backwards.

Never apply the rear brake while rolling backwards.

Apply the front brake gradually.

When fully stopped, apply rear brake as well and lock parking brake.

First, disembark the passenger, then dismount on uphill side, or to a side if pointed straight uphill.

Turn the vehicle around and remount, following the procedure described further in this Operator's Guide.

⚠ WARNING

V00A0JQ

POTENTIAL HAZARD

Improperly operating over obstacles.

WHAT CAN HAPPEN

Could cause loss of control, passenger ejection (2-UP models) or a collision.

Could cause the vehicle to overturn.

HOW TO AVOID THE HAZARD

On 2-UP models, the operator is responsible for the safety of his passenger. In doubt, disembark him before riding over obstacles. Always remember that the vehicle handling and stability may be affected when riding with a passenger.

Before operating in a new area, check for obstacles.

Never attempt to ride over large obstacles, such as large rocks or fallen trees.

When you go over obstacles, always follow proper procedures as described further in this Operator's Guide.

⚠ WARNING



V00A0KQ

POTENTIAL HAZARD

Skidding or sliding improperly.

WHAT CAN HAPPEN

You may lose control of this vehicle.

You may also regain traction unexpectedly, which may cause the vehicle to overturn or passenger ejection (2-UP models).

HOW TO AVOID THE HAZARD

On 2-UP models, never slide or skid with passenger. Always remember that the vehicle handling and stability may be affected when riding with a passenger.

Learn to safely control skidding or sliding by practicing at low speeds and on level smooth terrain.

On extremely slippery surfaces, such as ice, go slowly and be very cautious in order to reduce the chance of skidding or sliding out of control.

⚠ WARNING

V00A0LQ

POTENTIAL HAZARD

Operating this vehicle through deep or fast flowing water.

WHAT CAN HAPPEN

Tires may float, causing loss of traction and loss of control, which could lead to an accident.

HOW TO AVOID THE HAZARD

Never operate this vehicle in fast flowing water or in water deeper than that specified further in this Operator's Guide.

Check water depth and current before you attempt to cross any water. Water should not go above footrests.

Remember that wet brakes may have reduced stopping ability. Test your brakes after leaving water. If necessary, apply them several times to let friction dry out the pads. Do not forget, on 2-UP models, allow greater distance for braking when you ride with a passenger.

⚠ WARNING



V00A0MQ

POTENTIAL HAZARD

Improperly operating in reverse.

WHAT CAN HAPPEN

You could hit an obstacle or person behind the vehicle, resulting in serious injury.

HOW TO AVOID THE HAZARD

When you select reverse gear, make sure there are no obstacles or people behind the vehicle. When it is safe to proceed, go slowly. On 2-UP models, take account that the passenger can obstruct your view.

⚠ WARNING

V00A00Q

POTENTIAL HAZARD

Operating this vehicle with improper tires, or with improper or uneven tire pressure.

WHAT CAN HAPPEN

Use of improper tires on this vehicle, or operation of this vehicle with improper or uneven tire pressure, may cause loss of control, tire blow outs, tire to move around on its rim, and increases the risk of an accident.

HOW TO AVOID THE HAZARD

Always use the size and type of tires specified further in this Operator's Guide for this vehicle.

Always maintain proper tire pressure as described further in this Operator's Guide.

Always replace wheels or tires that are damaged.

⚠ WARNING



V00A26Q

POTENTIAL HAZARD

Operating this vehicle with improper modifications.

WHAT CAN HAPPEN

Improper installation of accessories or modification of this vehicle may cause changes in handling which in some situations could lead to an accident.

HOW TO AVOID THE HAZARD

Never modify this vehicle through improper installation or use of accessories. All parts and accessories added to this vehicle should be approved by BRP and should be installed and used according to instructions. If you have questions, consult an authorized Can-Am dealer.

NEVER install passenger seat (1-UP models) or use the racks to carry a passenger.

Modification of the vehicle to increase speed and performance may violate the terms and conditions of your vehicle limited warranty. In addition, certain modifications including the removal of engine or exhaust components are illegal under most laws.

⚠ WARNING

V00A0PQ

POTENTIAL HAZARD

Overloading this vehicle, carrying or towing cargo improperly.

WHAT CAN HAPPEN

Could cause changes in vehicle handling which could lead to an accident.

HOW TO AVOID THE HAZARD

Never exceed the stated load capacity for this vehicle including operator and passenger (2-UP models), as well as other loads and added accessories.

Cargo should be properly distributed and securely attached.

Reduce speed when carrying cargo or pulling a trailer. Allow greater distance for braking.

Always follow the instructions in this Operator's Guide for carrying cargo or pulling a trailer.

⚠ WARNING



V03M01Q

POTENTIAL HAZARD

Transporting flammable or dangerous material can lead to explosions.

WHAT CAN HAPPEN

This can cause serious injury or death.

HOW TO AVOID THE HAZARD

Never transport flammable or dangerous material.

RIDING THE VEHICLE

While reading this Operator's Guide, remember that:

WARNING

Indicates a potential hazard that, if not avoided, could result in serious injury or death.

To fully appreciate the pleasures and excitement of riding this vehicle, there are some basic rules and tips that you **MUST** follow. Some may be new to you while others may be common sense or obvious.

Please take the time to study this Operator's Guide and all on-product safety labels as well as the *SAFETY DVD* that came with this vehicle. They more completely describe what you should know about this vehicle before riding it.

Whether you are a new user or an experienced rider, it is important for your personal safety as well as passenger safety that you know the controls and features of this vehicle. Equally important is knowing how to properly ride.

Information in this Operator's Guide is limited. It is strongly recommended that you obtain further information and training from your local authorities, ATV clubs, a recognized ATV training organization or contact an authorized Can-Am dealer.

USA and Canada only: to find out about available training course nearest you, call the Specialty Vehicle Institute of America (SVIA) at 1 800 887-2887 or in Canada, the Canada safety Council (CSC) at 1 613 739-1535.

The U.S. Consumer Product Safety Commission and all ATV manufacturers recommend that no one under the age of 16 drives an ATV having an engine higher than 90 cc. Even though a child may be within the age group for which this vehicle is recommended, he may not have the skills, abilities, or judgment needed to operate this vehicle safely and may be involved in a serious accident.

Persons with cognitive or physical impairments or who are high risk takers have an increased exposure to overturns or collisions which may result in injury including death.

Not all vehicles are the same. Each has its own unique performance characteristics, controls and features. Each will ride and handle differently.

Become completely familiar with the operational controls and the general operation of the vehicle before venturing into off road conditions. Practice driving in a suitable area free of hazards and feel the response of each control. Drive at low speeds. Higher speeds require greater experience, knowledge and suitable riding conditions.

Riding conditions vary from place to place. Each is subject to weather conditions which may radically change from time to time and from season to season.

The vehicle handling, stability and braking distance will be affected when riding with a passenger. Safely reduce speed when riding with a passenger. Allow greater distance for braking. Remember, the operator is responsible for the safety of the passenger.

Riding on sand is different than riding on snow or through forests or marshes. Each location may require a greater degree of awareness and skill may not be suitable with a passenger. Show good judgement. Always proceed with caution. Please do not take any unnecessary risks that could leave you or your passenger stranded or possibly injured.

Never assume that the vehicle will go everywhere safely. Sudden changes in terrain caused by holes, depressions, banks, softer or harder "ground" or other irregularities may cause the vehicle to topple or become unstable. To avoid this, slow down and always observe the terrain ahead. If the vehicle does begin to topple or tip over, the best advice is to immediately get off... AWAY from the direction of the tip over!

Pre-Ride Inspection

WARNING

Perform a pre-ride inspection before each ride to detect any potential problem that could occur during operation. The pre-ride inspection can help you monitor component wear and deterioration before they become a problem. Correct any problem that you discover to reduce the risk of a breakdown or crash. See an authorized Can-Am dealer as necessary.

Before using this vehicle, the operator should always perform the following pre-ride inspection check list.

Correct any problem found before riding the vehicle. See an authorized Can-Am dealer if necessary.

Pre-Ride Inspection Check List

What to Do Before Starting the Engine (Key OFF)

ITEMS TO BE INSPECTED	INSPECTION TO PERFORM	✓
Fluids	Check fuel, engine oil and coolant levels	
Leaks	Check for any leaks under vehicle	
Throttle lever	Activate throttle lever several times to ensure it operates freely. It must return to idle position when released.	
Parking brake	Apply parking brake and check if it operates properly	
Tires	Check tire pressure and condition	
Wheels	Check wheels for damage	
Radiator	Check cleanliness of the radiator	
Drive shaft boots	Check drive shaft boots and protectors condition	
Seat(s)	Check if operator seat is in place and properly latched	
	Check if passenger seat or the storage box are in place and properly latched (2-UP Models)	
	Check the passenger backrest and grab handles condition (2-UP Models)	
Cargo	If you transport a cargo, respect the load capacity. Ensure cargo is properly secured to the racks	
	If you are pulling a trailer or an other equipment: <ul style="list-style-type: none"> – Check hitch and trailer ball condition – Respect the tongue capacity and towing capacity – Ensure trailer is properly secured to hitch. 	
Service and storage compartments	Check if front service compartment and rear storage compartment are properly latched	
Chassis and suspension	Check underneath vehicle for any debris on chassis or suspension and clean them properly	

What to Do Before Starting the Engine (Key ON)

ITEMS TO BE INSPECTED	INSPECTION TO PERFORM	✓
Multifunction gauge	Check operation of indicator lamps in multifunction gauge (during first few seconds of key ON)	
	Check for messages on multifunction gauge	
Lights	Check operation and cleanliness of headlights and taillight	
	Check operation of high and low beam	
	Check operation of brake light	

What to Do After the Engine is Started

ITEMS TO BE INSPECTED	INSPECTION TO PERFORM	✓
Steering	Check if steering operates freely by completely turning it from side to side	
Transmission lever	Check operation of transmission lever (P, R, N, H and L)	
2WD/4WD selector	Check operation of 2WD/4WD selector	
Brakes	Drive forward slowly a few feet and apply all brakes individually to test them. The brakes must fully apply. Lever and pedal must fully return when released.	
Emergency engine stop switch	Check that the emergency engine stop switch is working properly	
Ignition switch	Check if ignition switch is working properly by restarting and stopping the engine	

Clothing

Actual weather conditions should help you decide how to dress. Dress for the coldest weather expected. Thermal underwear next to the skin also provides a good insulation. It is important that the operator and the passenger always wears the appropriate protective clothing and apparel, including an approved helmet, eye protection, boots, gloves, a long sleeved shirt and pants. The passenger should have an approved helmet including a rigid chin guard. This type of clothing will provide you protection from some of the minor hazards you may encounter en route. The operator and passenger must never wear loose clothing such as a scarf that may get entangled in the vehicle or on tree branches and shrubs. Depending on conditions, anti-fogging goggles or sunglasses may be required. Different colored lenses available for goggles or sunglasses help you distinguish terrain variations. Sunglasses should only be worn during the daytime.

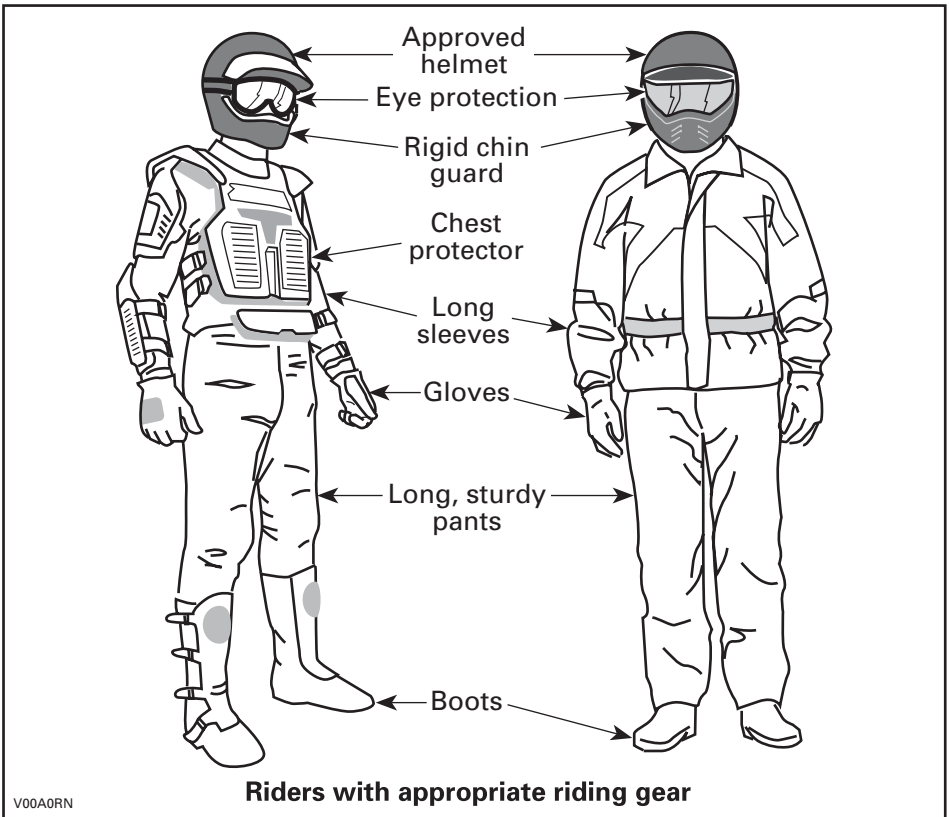

Carrying a Passenger

1-UP Models

This vehicle is designed to carry ONE (1) operator only. Do not install passenger seats or use the racks to carry a passenger.

2-UP Models

This vehicle is designed specifically to carry an operator and ONE (1) passenger only. The passenger must be seated on the designated passenger's seat and hold on to the grab handles at all times. NEVER install other passenger's seat other than the one recommended by BRP. Do not use the racks or their location to carry passenger(s). Carrying more than one (1) passenger may affect the stability and your control of the vehicle. When the storage box is installed (in place of rear seat), the vehicle becomes a ONE-RIDER vehicle (1-UP model) and NO PASSENGER must be allowed on it.

Carrying Loads

Any load carried on the vehicle and/or the carrying rack(s) will affect the stability and braking distance of the vehicle. For this reason, do not exceed the load limits of the vehicle manufacturer, refer to *MAXIMUM LOAD TABLE* below. Always make sure the load is secured, properly distributed and cannot interfere with your proper control. Always be aware that the “load” may slide or fall off and create an accident. Avoid loads that may protrude sideways and get snagged or caught in brush or other obstacles. Avoid covering and obstructing the headlights or taillight with the cargo.

Safely reduce speed according to terrain conditions when carrying cargo or pulling a trailer. Allow greater distance for braking. Always secure cargo as low as possible on the rack(s) to reduce the effect of a higher center of gravity.

WARNING

The vehicle handling, stability and braking distance are affected when loading racks and using the vehicle. Correct loading and weight distribution are therefore important. Never overload, tow or carry cargo improperly. Always ensure the cargo is safely secured and properly distributed on the rack(s) before operating the vehicle. Safely reduce speed according to terrain conditions when carrying cargo or pulling a trailer. Allow greater distance for braking. Always secure cargo as low as possible on the rack(s) to reduce the effect of a higher center of gravity. Failure to follow the recommendations here could cause changes in vehicle handling which could lead to an accident.

When transporting cargo on the vehicle, respect these maximum loads.

MAXIMUM LOAD TABLE			
Total load allowed	1-UP models	235 kg (518 lb)	Includes weight of operator, passenger, cargo, accessories and trailer tongue weight.
	2-UP models	272 kg (600 lb)	
Front load		45 kg (100 lb)	Evenly distributed.
Rear load		90 kg (200 lb)	Evenly distributed. Includes rear rack, rear storage box and tongue load.

Hauling a Trailer

Riding this vehicle with a trailer substantially increases the risk of toppling, especially on inclined slopes. If a trailer is used make sure that its hitch is compatible with the one on the vehicle. Make sure the trailer is horizontal with the vehicle. (In some instances a special extension may have to be installed on the vehicle hitch). Use security chains to secure the trailer with the vehicle. This vehicle may

require additional stopping distance if hauling heavy loads, especially on inclined surfaces and when a passenger (2-UP models) is on board. Be careful not to skid or slide. When stopped or parked, block the vehicle and trailer wheels from possible movement. Always make sure load is evenly distributed on the trailer. Use caution when disconnecting a loaded trailer; it or its load may topple on you or others. Do not turn at high speeds. Always use low gear range and slow down a lot.

Working with your Vehicle

Your vehicle can help you perform a number of different LIGHT tasks ranging from snow removal to pulling wood or carrying cargo. A variety of accessories are available from your authorized Can-Am dealer. However, always respect the load and capacities of the vehicle. Overloading of the vehicle can overstress the components and cause failure. To prevent possible injury, it is equally important to follow the instructions and warnings that accompany the accessory. Avoid any physical exertion through lifting or pulling of heavy loads or manpowering the vehicle. (Continue to read *RECREATIONAL RIDING* below.)

Recreational Riding

Respect the rights and limitations of others. Stay away from areas designated for other types of off road use. This includes snowmobile trails, equestrian trails, cross country ski trails, mountain bike trails, etc. Never assume there are no other users on the trail. Always stay to the complete right of the trail and do not zigzag to one side of the trail then the other. Be prepared to stop or pull off to the side if another trail user appears in front of you.

Join a local ATV club. It will provide you with a map and advice or inform you where you can ride. If a club does not exist in your area, help to start one. Group riding and club activities provide a pleasurable, social experience.

Always keep a safe distance from other riders. Your judgment of speed, terrain conditions, weather, mechanical condition of your vehicle and the "trust in judgment" you have in others around you will help you make a better choice of appropriate safe distance. This vehicle, like any other motorized vehicle, cannot stop "on a dime". On 2-UP models, the vehicle handling, stability and braking distance may be affected when riding with a passenger. Safely reduce speed when riding with a passenger. Allow greater distance for braking.

Before you ride, tell someone where you are planning to travel and your expected time of return.

Depending on the length of your ride, carry additional tools, drinking water, food and emergency equipment. Find out where you can get additional gasoline and oil. Be prepared for the possible conditions you may encounter.

- First aid kit
- Mobile phone
- Friction tape
- Rope

- Spare light bulbs
- Provided tool kit
- Adjustable wrench
- Knife
- Flashlight
- Colored lens goggles
- Trail map
- Snack.

Environment

One of the benefits of this vehicle is that it can take you off the beaten path away from most communities. However, you should always respect nature and the rights of others to enjoy it. Do not ride in environmentally sensitive areas. Do not drive over forest crops or shrubs... nor cut down trees or take down fencing... nor spin your wheels and destroy the terrain. "Tread Lightly".

Chasing wildlife is in many areas illegal. Wildlife can die of exhaustion after being chased by a motorized vehicle. If you encounter animals on the trail, stop and observe quietly and with caution. It will be one of the better memories of your life.

Observe the rule... "what you take in, carry out". Do not litter. Do not start campfires unless you have permission to do so... and then only... away from dry areas. The hazards you may create on the trail may cause injury to others or yourself, even at a later date.

Respect farm lands. Always obtain the permission of the landowner before riding on private land. Respect crops, farm animals and property lines. If you come to a closed a gate, close it again behind you.

Finally, do not pollute streams, lakes or rivers and do not modify the engine or exhaust system, or remove any of its components.

Design Limitation

Although the vehicle is exceptionally rugged for its class, it is still a light vehicle by definition and its operation must be restricted to its proper purpose.

The addition of weight to any part of the vehicle changes its gravitational stability and modifies its performance.

Off-Road Operation

The very nature of off-road operation is dangerous. Any terrain, which has not been specially prepared to carry vehicles, presents an inherent danger where angularity, terrain substance and exact steepness are unpredictable. The terrain itself presents a continual element of danger, which must be knowingly accepted by anyone venturing over it.

An operator who takes a vehicle off-road should always exercise the utmost care in selecting the safest path and keeping close watch on the terrain ahead of him. On no account should the vehicle be operated by anyone who is not completely familiar with the driving instructions applicable to the vehicle, nor should it be operated on steep or treacherous terrain.

General Operating and Safety Precautions

Care, caution, experience and driving skill are the best precautions against the hazards of vehicle operation.

Whenever there is the slightest doubt that the vehicle can safely negotiate an obstacle or a particular piece of terrain, always choose an alternate route.

In off-road operation, power and traction, not speed, are important. Never drive faster than visibility and your own ability to select a safe route permit.

Constantly watch the terrain ahead for sudden changes in slopes or obstacles, such as rocks or stumps, that may cause loss of stability, resulting in tip over or rollover.

On 2-UP models, the vehicle handling, stability and braking distance may be affected when riding with a passenger. Safely reduce speed when riding with a passenger. Allow greater distance for braking.

Never operate the vehicle if the controls do not function normally.

When stopped or parked, always apply the parking brake. This is especially important when parking on a slope. On very steep inclines or if the vehicle is carrying cargo, the wheels should be blocked using rocks or bricks. Remember to turn the fuel valve to the closed position.

Reverse Operation

When operating in reverse, check that the path behind the vehicle is free of people or obstacles. Proceed slowly and avoid sharp turns. When riding on a 2-UP models, take into account that the passenger can obstruct your view. Disembark him if necessary.

We recommend sitting on your ATV when operating in reverse. Avoid standing up. Your weight could shift forward against throttle lever, causing an unexpected acceleration.

Uphill Driving

Due to configuration, this vehicle has excellent climbing ability, so much so that it is possible to tip over before traction is lost. For example, it is common to encounter terrain situations where the top of the hill has eroded to a point that the hill peak rises very sharply. The vehicle can readily negotiate such a condition, however, in doing so, when the front of the vehicle is driven to a point that the vehicle's balance moves rearward, a tip over can occur.

The same situation may apply if an embedded object causes the front of the vehicle to climb more than desired. If such a situation occurs take an alternate route. Be aware of side hilling dangers when doing so.

It is also wise to know the terrain condition on the other side of the hill or bank. All too often there exists a sharp drop-off that is impossible to negotiate or descend.

Downhill Driving

This vehicle can climb slopes that are steeper than it can safely descend. Therefore, it is essential to assure that a safe route exists to descend a slope before you climb it.

Decelerating while negotiating a slippery downhill slope could "toboggan" the vehicle. Maintain steady speed and/or accelerate slightly to regain control.

Side Hilling

Whenever possible, such operation should be avoided. If necessary, do so with extreme caution. Always disembark the passenger before performing this operation. Side hilling on steep inclines could result in rollover. In addition, slippery or loose surfaces could result in uncontrollable side sliding. Do not attempt to turn the vehicle downhill with the slide. Avoid all objects or depressions that will intensify the raising of one side of the vehicle higher than the other, thus causing rollover.

Drop-Offs

This vehicle will "bottom-out" and usually stop if either the front or rear wheels are driven over a drop-off. If the drop is sharp or deep, the vehicle will nose dive and tip over.

WARNING

Avoid negotiating drop-offs. Reverse and select an alternate route.

Riding on Snow Covered Surfaces

When performing the pre-ride inspection, pay special attention to locations on the vehicle where snow and/or ice accumulations may obstruct visibility of the taillight and reflectors, clog ventilation openings, block the radiator and fan, and interfere with the movement of control levers, switches and brake pedal. Before starting with your ATV check the steering, throttle and brake lever and pedal controls for interference free operation.

Whenever an ATV is ridden on a snow covered drive path the tire grip is generally reduced causing the vehicle to react differently to control inputs from the operator. On low grip surfaces, the steering responses are not as crisp and precise, stopping distances are lengthened and acceleration becomes sluggish. Slow down and do not "gun" the throttle. This will only result in spinning of the tires and possibly in an over steering slide of the vehicle. Avoid hard braking. This will possibly result in a

straight line slide of the vehicle. Again, the best advice is to safely reduce speed in anticipation of a maneuver so to give yourself time and distance to regain total vehicle control before it spins out of your control.

As you drive your ATV over a loose snow covered surface, snow dust will be picked up in the wake turbulence of the moving vehicle and transported to contact and accumulate or melt on some exposed components including rotating parts like brake discs. Water, snow or ice may affect the response time of the brake system of your ATV. Even when not required to reduce vehicle speed apply brakes frequently to prevent ice or snow accumulation and to dry brake pads and discs. While doing so in low risk driving situations you will test for grip level and keep yourself alerted to how the vehicle reacts to your control inputs. Always keep brake pedal, footrests, floor boards, brake and throttle levers free of snow and ice. Frequently wipe snow off seat, hand grips, headlights, taillights and reflectors.

The depth of the snow cover may hide rocks, tree stumps or other objects and if it is wet may totally impede the drivability as the vehicle becomes bogged down or completely loses traction in slushy snow. Look far ahead and always be watchful of any visible clues that might indicate the presence of such obstacles. In doubt steer clear. Avoid driving on any frozen body of water before checking that the ice will safely support the ATV, its riders and its load of cargo. Remember that a given thickness of ice may be sufficient to support a snowmobile but not an ATV of an identical weight because of the smaller load bearing surface of the four tire contact patches as compared to that of a snowmobile track and skis.

Always remember that the vehicle handling and stability is affected when riding with a passenger. So never attempt maneuvers with a passenger that may cause the vehicle to enter into a slide that if halted abruptly will result in the ejection of the passenger and/or a vehicle roll or tip over.

To maximize comfort and avoid frostbite, always wear clothing and ATV protective equipment appropriate for the weather conditions you will be exposed to during your ride.

At the end of each ride it is a good practice to clean the vehicle body and all moving components (brakes, steering components, drivelines, controls, radiator fan etc.) from any snow or ice accumulations. Wet snow will turn to ice during the shut down period and become more difficult to remove at the next pre-ride inspection.

Riding Techniques

Riding your vehicle too fast for the conditions may result in injury. Apply only enough throttle to proceed safely. Statistics show that high speed turns usually result in mishaps and injury. Always remember that this vehicle is heavy! Its pure weight alone may entrap you should it fall and pin you down.

This vehicle is not designed for jumping, nor can it fully absorb the high impact energy generated during manoeuvres such as jumping which, can be passed on to you, the operator. Performing wheelies can cause the vehicle to flip over onto you. Both practices have a high risk for you and should be avoided at all times.

To maintain proper control, it is strongly advised that you keep your hands on the handlebar and within easy reach of all controls. The same holds true for your feet. To minimize the possibility of a leg or foot injury, keep your feet on the footrests at all times. Do not direct your toes outwards nor extend your feet out to assist in turning as they can be hit or be snagged on passing obstacles, or may come into contact with the wheels. When riding on a 2-UP models, your passenger must keep his hands on grab handles and his feet on footrests at all times.

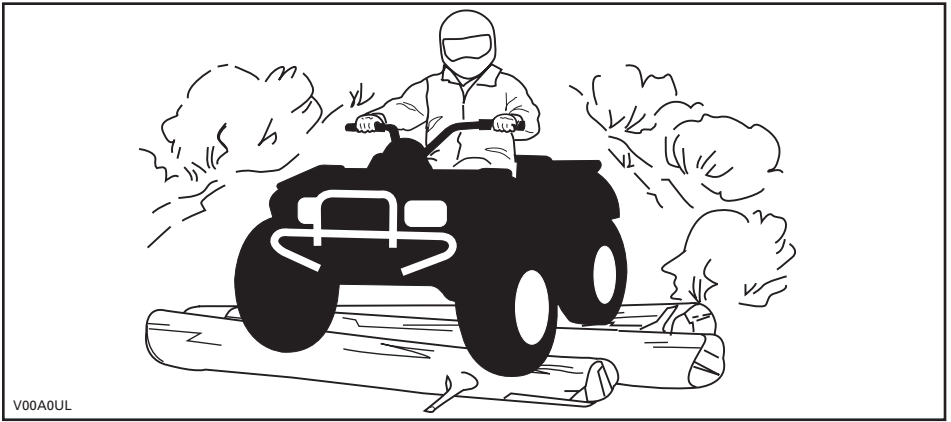

Even though there is an adequate suspension system on this vehicle, there are “washboard” or rough terrain conditions that will make you feel uncomfortable and can even cause a back injury. “Posting” or riding in a crouched position will often be required. Slow down and allow your flexed legs to absorb part of the impact energy.

This vehicle is not designed for riding on roads or highways. (In most places it is an illegal practice). Riding your vehicle on roads or highways could cause a collision to occur with another vehicle.

The tires of this vehicle are not suited for paved road use. Also this vehicle is not equipped with a rear differential (rear wheels are always turning at the same speed). For these reasons, pavement may seriously affect the handling and control of the vehicle.

Riding on roads or soft shoulders may confuse other road users, especially if your lights are on.

If you have to cross a road, the lead driver should get off his vehicle, then observe and give directions to the other riders. The last person after crossing then assists the lead driver to cross. Do not travel on sidewalks. They are designated for pedestrian use.

Water can be a unique hazard. If it is too deep the vehicle may “float” and topple. Check the water depth and current before you attempt to cross any water. Water should not go above the footrest. Be wary of slippery surfaces such as rocks,

grass, logs, etc., both in the water and on its banks. A loss of traction may occur. Do not attempt to enter the water at high speed. The water will act as a brake and could throw you off the vehicle, on the ground.

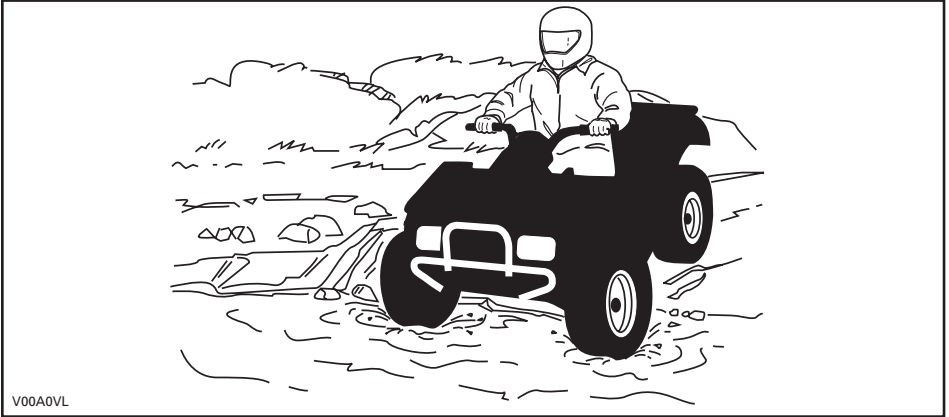

Water will affect the braking ability of your vehicle. Make sure you dry the brakes by applying them several times after the vehicle leaves the water. On 2-UP models, the vehicle braking distance may be affected when riding with a passenger. Safely reduce speed when riding with a passenger. Allow greater distance for braking.

Mud or marsh lands may be encountered near water. Be prepared for sudden "holes" or changes in depth. Similarly so, be watchful of hazards such as rocks, logs, etc., partially covered by vegetation.

If your route crosses frozen waterways, make sure the ice is thick enough and sound enough to support the total weight of yourself, your passenger (2-UP models), the vehicle and its load. Be ever watchful of open water... it is a sure indication that the ice thickness will vary. On 2-UP models, the operator is responsible for the safety of the passenger. If in doubt, do not attempt to cross.

Ice will also affect the control of the vehicle. Slow down and do not "gun" the throttle. This will only result in spinning of the tires and possible tip over of the vehicle. Avoid rapid braking. This again will possibly result in an uncontrolled slide and tip over of the vehicle or passenger ejection (2-UP models). Slush should be avoided at all times since it could block the operation or controls of the vehicle. When riding on a 2-UP models, never attempt this maneuver with a passenger. Always remember that the vehicle handling and stability may be affected when riding with a passenger.

Riding in snow may reduce the brakes stopping capability. Safely reduce speed and allow greater distance for braking. Snow projection may cause ice build up or snow accumulation on brake components and controls. Apply brakes fre-

quently to prevent ice or snow accumulation. Refer to *GENERAL OPERATING AND SAFETY PRECAUTIONS* in this subsection for more detailed information regarding riding on snow covered surfaces.

Riding on sand, sand dunes or on snow is another unique experience, but there are some basic precautions that should be observed. Wet, deep or fine sand/snow may create a loss of traction and cause the vehicle to slide, drop off or become "bogged" down. If this occurs look for a firmer base. Again, the best advice is to slow down and be watchful of the conditions. When you ride with a passenger (2-UP models), drive slowly.

When riding in sand dunes it is advisable to equip the vehicle with an antenna type safety flag. This will help make your location more visible to others over the next sand dune. Proceed carefully should you see another safety flag ahead. Since the antenna type safety flag can snag and rebound on your body if caught, do not use it in areas where there are low hanging branches or obstacles. Always remember when riding on a 2-UP model that the vehicle handling and stability may be affected when riding with a passenger.

Riding on loose stones or gravel is very similar to riding on ice. They will affect the steering of vehicle... possibly causing it to slide or cause passenger ejection (2-UP models) and tip over especially at high speeds. In addition, braking distance may be affected. Remember that "gunning" the throttle or sliding may cause loose stones to be ejected rearwards into the path of another rider. Never do it deliberately. Always remember on a 2-UP models that vehicle handling, stability and braking distance may be affected when riding with a passenger.

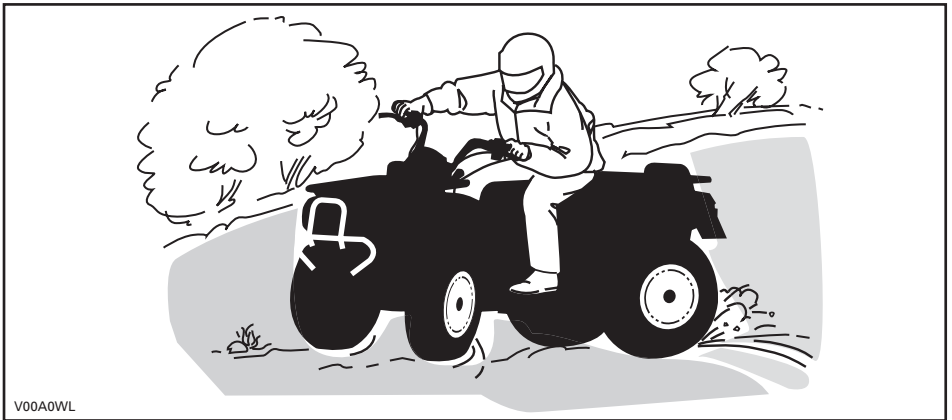

If you do get into a slide or skid, it may help to turn the handlebar in the direction of the skid until you regain control. Never jam the brakes and lock the wheels.

Respect and follow all posted trail signs. They are there to help you and others.

Obstacles in the “trail” should be traversed with caution. This includes loose rocks, fallen trees, slippery surfaces, fences, posts, and embankments and depressions. You should avoid them whenever possible. Remember that some obstacles are too large or dangerous to cross and should be avoided. When riding on 2-UP models, the operator is responsible for the safety of the passenger and in doubt, disembark him before getting through the obstacles. Small rocks or fallen trees may be safely crossed... approach at a 90° angle. Stand on the footrests while keeping your knees flexed. Adjust speed without losing momentum and do not “gun” the throttle. Hold handlebar or grab handles firmly. Place operator and passenger (2-UP models) body weight rearwards and proceed. Do not try to lift the vehicle front wheels off the ground. Be aware that the object may be slippery or may move while crossing.

When driving on hills or slopes two things are highly important... be prepared for slippery surfaces or terrain variations and obstacles and... use proper body positioning. When riding on 2-UP models, the operator is responsible for the safety of the passenger and in doubt, disembark him before getting through the obstacles.

When stopped or parked always apply the parking device. This is especially important when parking on a slope. On very steep inclines or if the ATV is carrying cargo, the wheels should be blocked using rocks or bricks.

Uphill

1-UP Models

Keep your body weight forward towards the top of the hill. Keep your feet on the footpegs and shift into low gear then accelerate and when necessary, change gear quickly as you climb. Do not over-speed since this may cause the front of the vehicle to lift from the ground and fall back on you. If the hill is too steep and you cannot proceed or the vehicle begins to roll backwards, apply the front brake, being careful not to slide. Dismount, then use the “U” turn or “K” turn (while walking back, next to the vehicle on the up hill side and with a hand on the brake lever, slowly back the rear of the vehicle toward the top of the hill then drive downhill). Always walk or dismount on the upside of the slope while keeping clear of the vehicle and its rotating wheels. Do not try to hold on to the vehicle if it begins to topple. Stay clear. Do not ride over the crest of the hill at high speed. Obstacles, including sharp drop-offs, may exist.

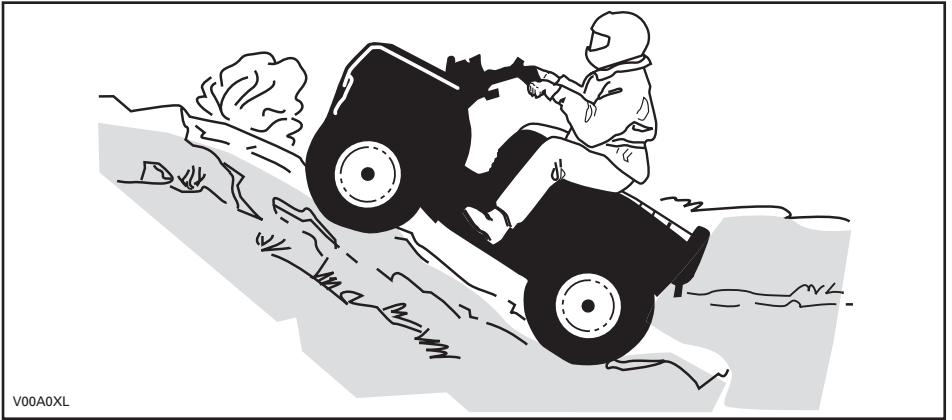

2-UP Models

Do not forget, the operator is responsible for the safety of the passenger. In doubt, disembark him before climbing hill. Always remember that the vehicle handling, stability and braking distance may be affected when riding with a passenger.

If you decide to keep your passenger, he must synchronize his movements with yours.

Operator and passenger must keep their body weight forward, towards the top of the hill. Keep feet on the footrests and shift into low gear then accelerate and when necessary, change gear quickly as you climb. Do not over-speed since this may cause the front of the vehicle to lift from the ground and fall back on you. If the hill is too steep and you cannot proceed or the vehicle begins to roll backwards, apply the brake, being careful not to slide. Dismount, passenger first, then use the "U" turn or "K" turn (while walking back, next to the vehicle on the up hill side and with a hand on the brake lever, slowly back the rear of the vehicle toward the top of the hill then drive downhill). Always walk or dismount on the upside of the slope while keeping clear of the vehicle and its rotating wheels. Do not try to hold on to the vehicle if it begins to topple. Stay clear. Do not ride over the crest of the hill at high speed. Obstacles, including sharp drop-offs, may exist. The passenger should get on the vehicle only when the vehicle has returned to a safe location.

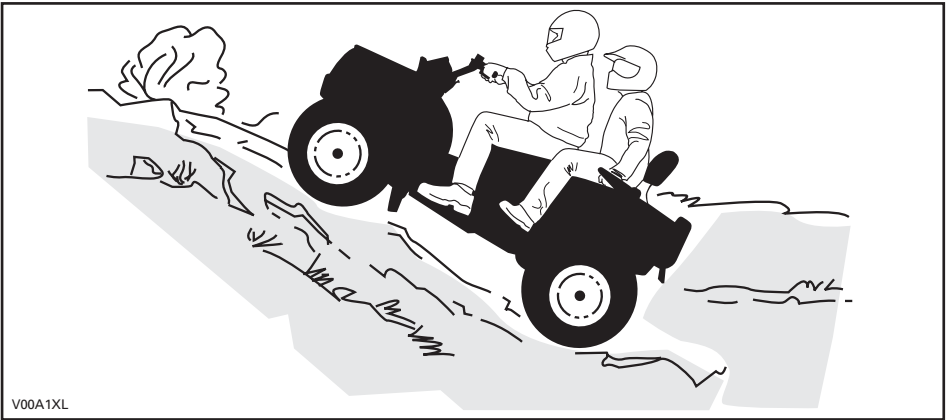

V00A1XL

Downhill

1-UP Models

Keep your body weight rearwards. Apply the brake gradually to prevent skidding. Do not "coast" down the slope using solely engine compression or in neutral gear.

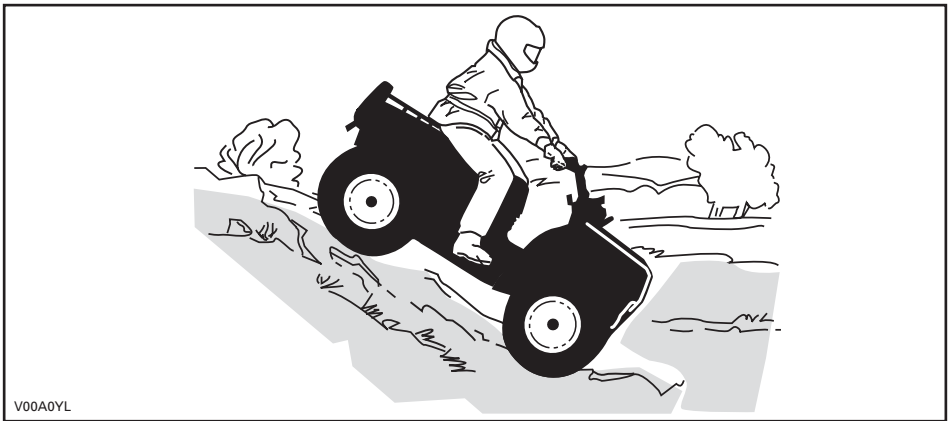

V00A0YL

2-UP Models

Do not forget, the operator is responsible for the safety of the passenger. In doubt, disembark him before going down the hill. Always remember that the vehicle handling, stability and braking distance may be affected when riding with a passenger.

If you decide to keep your passenger, he must synchronize his movements with yours.

Operator and passenger must keep their body weight rearwards. Apply the brake gradually to prevent skidding. Do not "coast" down the slope using solely engine compression or in neutral gear.

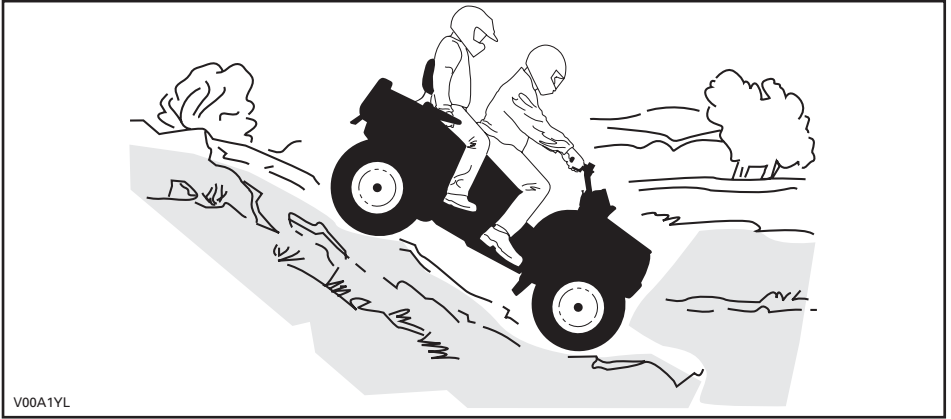

Side Hilling

1-UP Models

This is one of the **most risky** types of riding since it may drastically change the balance of the vehicle. It should be avoided wherever possible. However, if it is necessary to do so, it is important that you **ALWAYS** keep your body weight on the up-side of the slope... and be prepared to dismount on that side should the vehicle begin to topple. **Do not try to stop or save the vehicle from damage.**

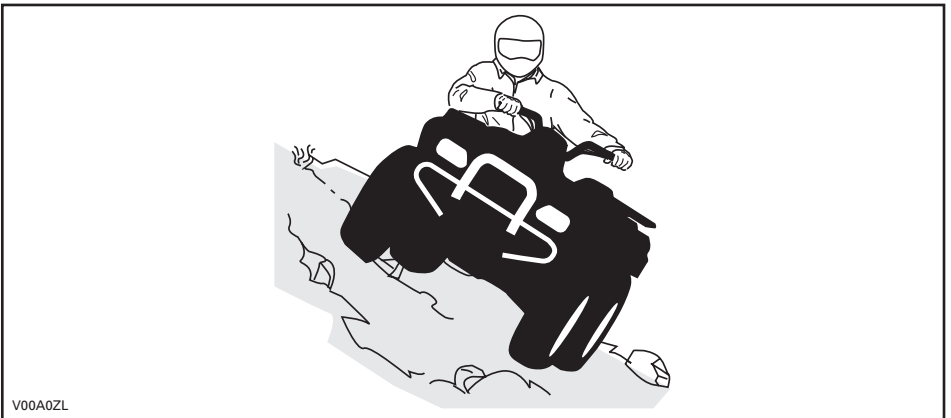

2-UP Models

Do not forget, the operator is responsible for the safety of the passenger. In doubt, disembark him before proceeding. Always remember that the vehicle handling, stability and braking distance may be affected when riding with a passenger.

If you decide to keep your passenger, he must synchronize his movements with yours.

This is one of the **most risky** types of riding since it may drastically change the balance of the vehicle. It should be avoided wherever possible. If it is necessary to do so however, it is important that you **ALWAYS** keep your body weight on the upside of the slope... and be prepared to dismount on that side should the vehicle begin to topple. **Do not try to stop or save the vehicle from damage.**

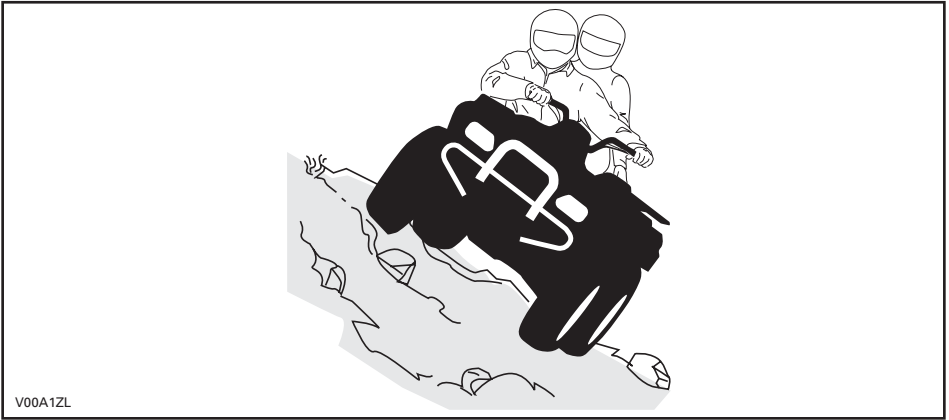













IMPORTANT ON-PRODUCT LABELS

Hang Tag

This vehicle comes with a hang tag and labels containing important safety information.

Any person who rides this vehicle should read and understand this information before riding.

All Models except 800R X xc (1-UP)

<p style="text-align: center;">G GENERAL USE MODEL</p> <p style="text-align: center;">THIS ATV IS FOR RECREATIONAL USE OR UTILITY USE</p> <p style="text-align: center;">OPERATOR ONLY-NO PASSENGERS</p> <p style="text-align: center;">NO OPERATOR UNDER AGE 16</p> <hr/> <p style="text-align: center;">TRAINING COURSES TO TEACH ATV RIDING SKILLS ARE AVAILABLE. FOR INFORMATION CONTACT YOUR DEALER.</p> <hr/> <p style="text-align: center;">CHECK WITH YOUR DEALER TO FIND OUT ABOUT STATE OR LOCAL LAWS REGARDING ATV OPERATION.</p> <p style="text-align: center;">THIS HANGTAG IS NOT TO BE REMOVED BEFORE SALE.</p>	<p style="text-align: center;">⚠ WARNING</p> <p>Improper ATV use can result in SEVERE INJURY or DEATH.</p> <table border="0" style="width: 100%; text-align: center;"><tr><td></td><td></td><td></td><td></td></tr><tr><td>ALWAYS USE AN APPROVED HELMET AND PROTECTIVE GEAR.</td><td>NEVER USE ON PUBLIC ROADS.</td><td>NEVER CARRY PASSENGERS.</td><td>NEVER USE UNDER THE INFLUENCE OF DRUGS OR ALCOHOL.</td></tr></table> <p>NEVER operate:</p> <ul style="list-style-type: none">• without proper training or instructions.• at speeds too fast for your skills or the conditions.• on public roads - a collision can occur with another vehicle.• with a passenger - passengers affect balance and steering and increase risk of losing control. <p>ALWAYS:</p> <ul style="list-style-type: none">• use proper riding techniques to avoid vehicle overturns on hills and rough terrain and in turns.• avoid paved surfaces - pavement may seriously affect handling and control. <p style="text-align: center;">LOCATE AND READ OPERATOR'S GUIDE. FOLLOW ALL INSTRUCTIONS & WARNINGS.</p>					ALWAYS USE AN APPROVED HELMET AND PROTECTIVE GEAR.	NEVER USE ON PUBLIC ROADS.	NEVER CARRY PASSENGERS.	NEVER USE UNDER THE INFLUENCE OF DRUGS OR ALCOHOL.
									
ALWAYS USE AN APPROVED HELMET AND PROTECTIVE GEAR.	NEVER USE ON PUBLIC ROADS.	NEVER CARRY PASSENGERS.	NEVER USE UNDER THE INFLUENCE OF DRUGS OR ALCOHOL.						

vmo2009-002-004_en

All Models except 800R X xc (2-UP)

G
GENERAL USE MODEL

THIS ATV IS FOR
RECREATIONAL USE OR UTILITY USE.

NO OPERATOR UNDER AGE 16

TRAINING COURSES TO TEACH
ATV RIDING SKILLS ARE AVAILABLE.
FOR INFORMATION CONTACT
YOUR DEALER.
MAKE SURE TO WATCH SAFETY VIDEO.

CHECK WITH YOUR DEALER TO
FIND OUT ABOUT STATE OR LOCAL
LAWS REGARDING ATV
OPERATION.

This hangtag is not to be removed before sale.

⚠ WARNING

Improper use can result in SEVERE INJURY or DEATH



ALWAYS USE
AN APPROVED
HELMET AND
PROTECTIVE
GEAR FOR DRIVER
AND PASSENGER.



NEVER USE
ON PUBLIC
ROADS.



NEVER CARRY
MORE THAN
1 PASSENGER.



NEVER USE UNDER
THE INFLUENCE OF
DRUGS OR ALCOHOL.

NEVER operate:

- without proper ATV training or instructions,
- at speeds too fast for your skills or the conditions,
- on public roads - a collision can occur with another vehicle,
- with a passenger unless passenger seat is securely in place.

THE OPERATOR MUST ALWAYS:













- use proper riding techniques to avoid overturns on hills and rough terrain and in turns.
- avoid paved surfaces - pavement may seriously affect handling and control.
- reduce speed and use extra caution at all times when carrying a passenger - dismount passenger when conditions require,
- make sure passenger reads and understands this label and passenger safety label.

**LOCATE AND READ OPERATOR'S GUIDE.
FOLLOW ALL INSTRUCTIONS & WARNINGS.**

This hangtag is not to be removed before sale.

vmo2009-008-012_en

800R X xc Models

<p>S SPORT MODEL</p> <p>THIS ATV IS FOR RECREATIONAL USE BY EXPERIENCED OPERATORS ONLY.</p> <p>OPERATOR ONLY-NO PASSENGERS</p> <p>NO OPERATOR UNDER AGE 16</p> <hr/> <p>THIS CATEGORY S (SPORT) ATV IS A HIGH PERFORMANCE ATV FOR OFF ROAD USE ONLY. IT IS FOR SPORT TYPE RECREATIONAL AND COMPETITIVE USE BY OPERATORS WITH ADVANCED SKILLS AND SUBSTANTIAL EXPERIENCE.</p> <hr/> <p>TRAINING COURSES TO TEACH ATV RIDING SKILLS ARE AVAILABLE. FOR INFORMATION CONTACT YOUR DEALER.</p> <hr/> <p>CHECK WITH YOUR DEALER TO FIND OUT ABOUT STATE OR LOCAL LAWS REGARDING ATV OPERATION.</p> <p>THIS HANGTAG IS NOT TO BE REMOVED BEFORE SALE.</p>	<p>! WARNING</p> <p>Improper ATV use can result in SEVERE INJURY or DEATH.</p> <table border="0"><tr><td></td><td></td><td></td><td></td></tr><tr><td>ALWAYS USE AN APPROVED HELMET AND PROTECTIVE GEAR.</td><td>NEVER USE ON PUBLIC ROADS.</td><td>NEVER CARRY PASSENGERS.</td><td>NEVER USE UNDER THE INFLUENCE OF DRUGS OR ALCOHOL.</td></tr></table> <p>NEVER operate:</p> <ul style="list-style-type: none">• without proper training or instructions.• at speeds too fast for your skills or the conditions.• on public roads - a collision can occur with another vehicle.• with a passenger - passengers affect balance and steering and increase risk of losing control. <p>ALWAYS:</p> <ul style="list-style-type: none">• use proper riding techniques to avoid vehicle overturns on hills and rough terrain and in turns.• avoid paved surfaces - pavement may seriously affect handling and control. <p>LOCATE AND READ OPERATOR'S GUIDE. FOLLOW ALL INSTRUCTIONS & WARNINGS.</p>					ALWAYS USE AN APPROVED HELMET AND PROTECTIVE GEAR.	NEVER USE ON PUBLIC ROADS.	NEVER CARRY PASSENGERS.	NEVER USE UNDER THE INFLUENCE OF DRUGS OR ALCOHOL.
									
ALWAYS USE AN APPROVED HELMET AND PROTECTIVE GEAR.	NEVER USE ON PUBLIC ROADS.	NEVER CARRY PASSENGERS.	NEVER USE UNDER THE INFLUENCE OF DRUGS OR ALCOHOL.						

vmo2009-005-003_en

All Models

VEHICLE ENGINE DESCRIPTION:

XXXXX

EPA CERTIFIED

NER (NORMALIZED EMISSION RATE) = X

ON A 0 TO 10 SCALE, 0 BEING THE CLEANEST

***NOT TO BE REMOVED PRIOR TO SALE**



704901107

vmo2006-005-009_en

LTD Models

ⓘ
WARNING

Always inflate tire to the recommended air pressure. Refer to the warning label or your operator's guide.

Note: The output pressure will vary according to the ACS suspension setting (level 1 to 6).

The "ACS 1" will provide less pressure than the "ACS 6" adjustment.

704902076

ⓘ
AVERTISSEMENT

Toujours gonfler les pneus à la pression recommandée. Vous référez à l'étiquette d'avertissement ou au guide du conducteur.

Note: la pression fournie variera en fonction de l'ajustement de la suspension ACS (niveau 1 à 6).

Le niveau "ACS 1" fournira moins de pression que le niveau "ACS 6".

704902076

704902076

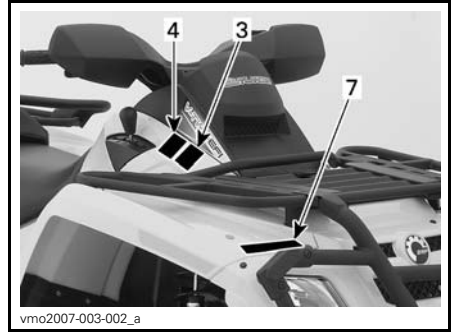

ALL MODELS EXCEPT 800R X XC

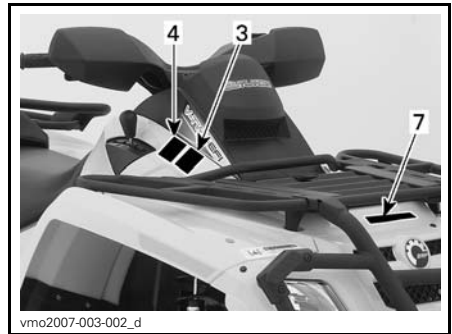

800R X XC MODELS

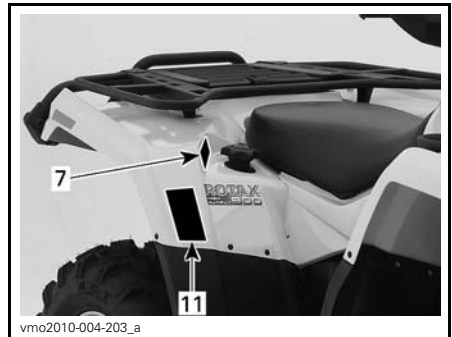

Vehicle Safety Labels

Read and understand all the safety labels on your vehicle.

The safety labels on your vehicle should be considered permanent parts of the vehicle. If missing or damaged, they can be replaced free of charge. See an authorized Can-Am dealer.

NOTE: The following illustrations used in this Operator's Guide are a general representation only. Your model may differ.

IMPORTANT ON-PRODUCT LABELS

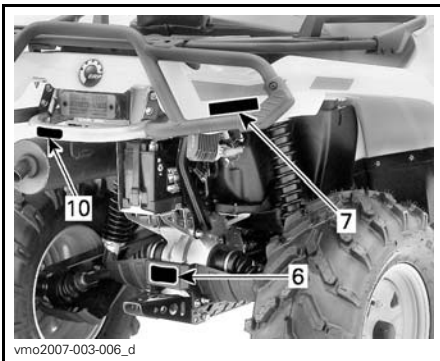
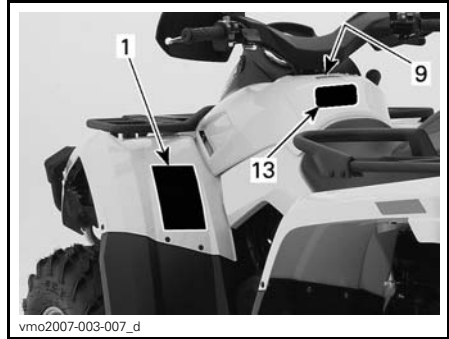
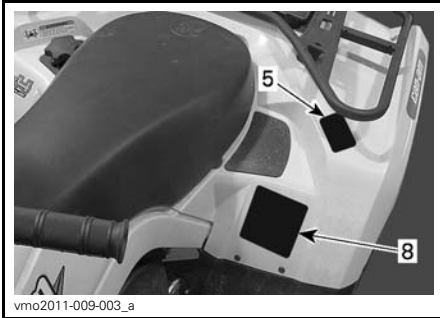

⚠ WARNING

Improper ATV use can result in SEVERE INJURY or DEATH.

ALWAYS USE AN APPROVED HELMET AND PROTECTIVE GEAR.

NEVER USE ON PUBLIC ROADS.

NEVER CARRY PASSENGERS.

NEVER USE UNDER THE INFLUENCE OF DRUGS OR ALCOHOL.

NEVER operate:

- without proper training or instructions.
- at speeds too fast for your skills or the conditions.
- on public roads - a collision can occur with another vehicle.
- with a passenger - passengers affect balance and steering and increase risk of losing control.

ALWAYS:

- use proper riding techniques to avoid vehicle overturns on hills and rough terrain and in turns.
- avoid paved surfaces - pavement may seriously affect handling and control.

LOCATE AND READ OPERATOR'S GUIDE.
FOLLOW ALL INSTRUCTIONS & WARNINGS.

vmo2009-003-004_en

LABEL 1: 1-UP MODELS

⚠ WARNING

Improper use can result in SEVERE INJURY or DEATH

ALWAYS USE AN APPROVED HELMET AND PROTECTIVE GEAR FOR DRIVER AND PASSENGER.

NEVER USE ON PUBLIC ROADS.

NEVER CARRY MORE THAN 1 PASSENGER.

NEVER USE UNDER THE INFLUENCE OF DRUGS OR ALCOHOL.

NEVER operate:

- without proper ATV training or instructions.
- at speeds too fast for your skills or the conditions.
- on public roads - a collision can occur with another vehicle.
- With a passenger unless passenger seat is securely in place.

THE OPERATOR MUST ALWAYS:

- use proper riding techniques to avoid overturns on hills and rough terrain and in turns.
- avoid paved surfaces - pavement may seriously affect handling and control.
- reduce speed and use extra caution at all times when carrying a passenger - dismount passenger when conditions require.
- make sure passenger reads and understands this label and passenger safety label.

LOCATE AND READ OPERATOR'S GUIDE.
FOLLOW ALL INSTRUCTIONS & WARNINGS.

vmo2009-008-011_en

LABEL 1: 2-UP MODELS

⚠ WARNING

Operating this ATV if you are under the age of 16 increases your chance of SEVERE INJURY or DEATH.

NEVER operate this ATV if you are under age 16.

V01M02Z 704 900 011

LABEL 2: 1-UP MODELS

⚠ WARNING

Operating this vehicle if you are under age 16 increases the chance of SEVERE INJURY or DEATH to both rider and passenger.

NEVER operate this vehicle if you are under age 16.

NEVER carry more than one passenger.

V01M0RY 704 900 515

LABEL 2: 2 UP MODELS

CAUTION

- ATV **MUST** be stopped before shifting lever.
- Always apply foot brake to shift from Park(P) and Neutral(N).

V07M06Y 704 900 470

LABEL 3

CAUTION

ATV MUST be stopped to engage or disengage 4WD switch. mechanical damage may occur if switch is engaged or disengaged while driving.

704 900 471

V07M07Y

LABEL 4

WARNING



NEVER ride as a passenger. Passengers can cause a loss of control, resulting in **SEVERE INJURY or DEATH.**

704 900 005

V01M07Z

LABEL 5: 1-UP MODELS

WARNING

PASSENGER SAFETY to reduce the risk of **SEVERE INJURY OR DEATH**



NEVER CARRY MORE THAN 1 PASSENGER.



NEVER USE UNDER THE INFLUENCE OF DRUGS OR ALCOHOL.

NEVER carry a passenger too small to firmly plant feet on footrests and securely grasp hand holds.

THE PASSENGER MUST ALWAYS:

- use an approved helmet and protective gear.
- securely grasp hand holds and plant feet firmly on footrests while seated in the passenger seat
- tell operator to slow down or stop if uncomfortable - get off and walk if conditions require.

vmo2009-008-010_en

LABEL 5: 2-UP MODELS

WARNING

Improper loading of a trailer may cause loss of vehicle control, resulting in severe injury or death.

- Maximum towing weight: XXX lb (XXXkg).
- Maximum tongue weight: XX lb (XXkg).

704900766

vmo2006-016-008_en

LABEL 6: ALL MODELS EXCEPT 800R X XC (REFER TO SPECIFICATIONS FOR VALUES)



WARNING

- NEVER carry a passenger on this carrier.
- MAXIMUM FRONT LOAD: X lb (X kg) evenly distributed.
- MAXIMUM REAR LOAD: X lb (X kg) evenly distributed. (Includes trailer tongue weight if applicable).

704 901 000

vmo2006-005-010_en

LABEL 7: FRONT AND REAR FENDER (REFER TO SPECIFICATIONS FOR VALUES)

WARNING

Improper tire pressure or overloading can cause loss of control, resulting in **SEVERE INJURY or DEATH.**

LOAD	COLD TIRE PRESSURE
UP TO XXX kg (XXX lb)	FRONT MAX: XX.X kPa (X.X psi) MIN: XX.X kPa (X.X psi)
	REAR MAX: XX.X kPa (X.X psi) MIN: XX.X kPa (X.X psi)

ALWAYS maintain proper tire pressure as shown. Inflate at max pressure when loaded with cargo.

NEVER set the pressure below minimum. It could cause the tire to dislodge from the rim.

NEVER exceed the vehicle load capacity of XXX kg (XXX lb) including weight of operator, passenger, cargo, accessories and trailer tongue weight.

ATV LOADING and TRAILER TOWING

- Cargo/passenger loading or trailer towing can affect stability and handling. Load must be properly distributed on racks.
- When loaded with cargo or a passenger or towing a trailer:
 - reduce speed.
 - allow more distance to stop.
 - avoid hills and rough terrain.

704901120

vmo2006-008-004_aen

LABEL 8: (REFER TO SPECIFICATIONS FOR VALUES)



LABEL 9



LABEL 10

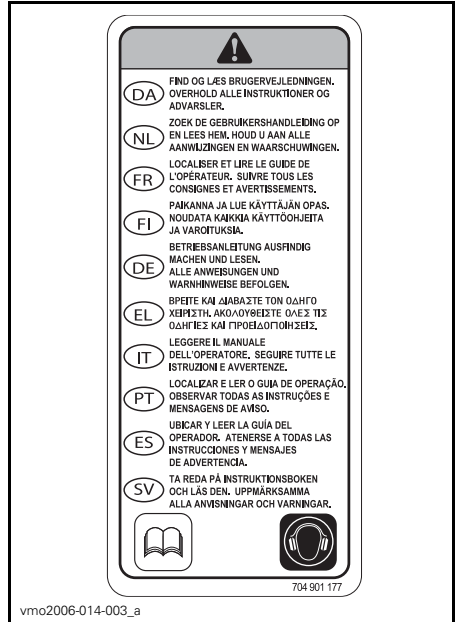

LABEL 11



LABEL 12

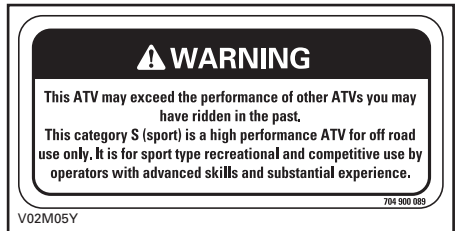

LABEL 13: 800R X XC MODELS

Compliance Labels

These labels indicate vehicle's compliance.



LOCATION: UNDER SEAT, ON THE UPPER BAR OF FRAME

Technical Information Labels

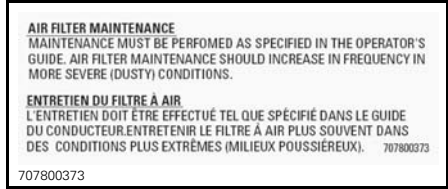

LOCATION: UNDER SEAT, ON THE UPPER BAR OF FRAME

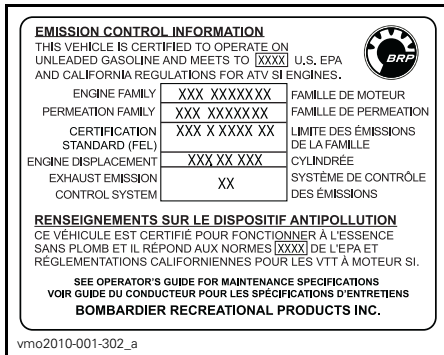

LOCATION: UNDER SEAT, ON THE UPPER BAR OF FRAME

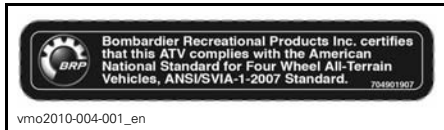

LOCATION: REAR FENDER

VEHICLE INFORMATION

CONTROLS/INSTRUMENTS/EQUIPMENT

NOTE: Some controls/instruments/equipment are optional.

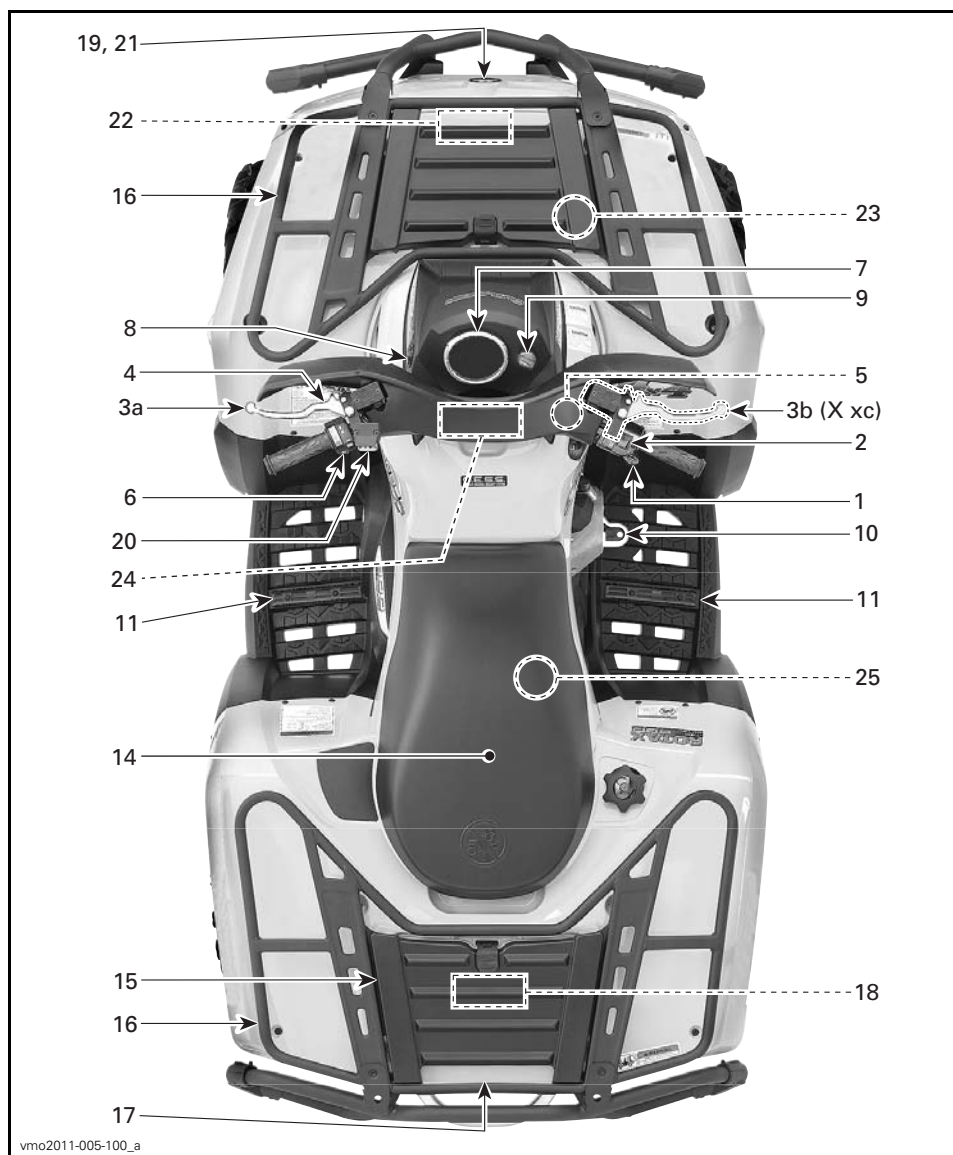

TYPICAL : 1-UP MODELS

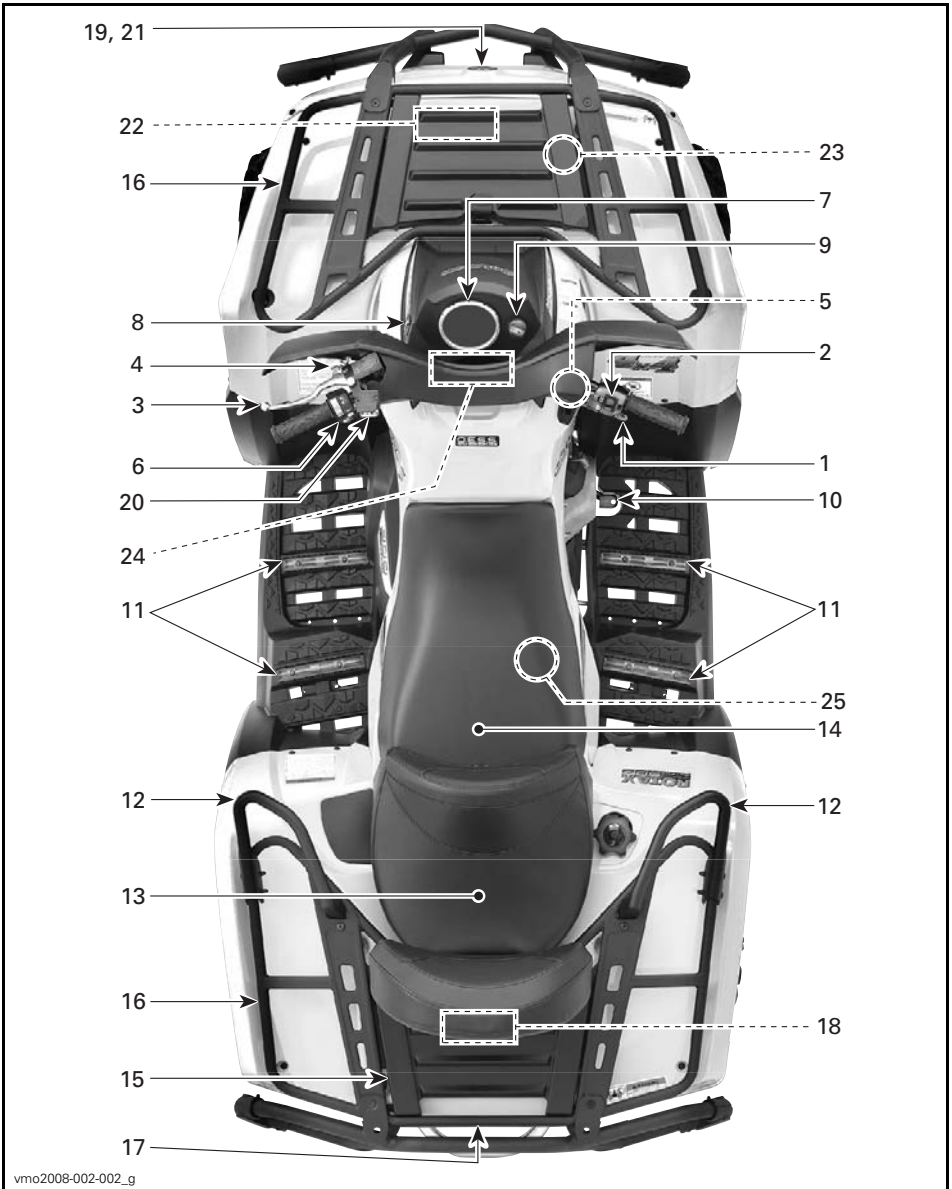

vmo2008-002-002_g

TYPICAL : 2-UP MODELS

1) Throttle Lever

The throttle lever is located on the RH side of the handlebar.

When pushed forward, it increases the engine speed and allows engagement of the transmission on the selected gear.

When released, the engine speed should automatically return to idle and the vehicle will gradually slow down.

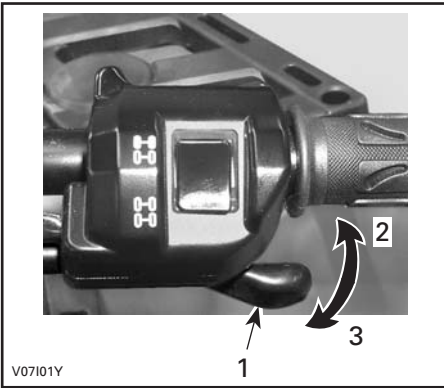

TYPICAL

1. Throttle lever
2. To accelerate
3. To decelerate

2) 2WD/4WD Selector

The 2WD/4WD selector is located on the RH side of the handlebar.

This selector allows to choose between 2WD and 4WD when the vehicle is stopped.

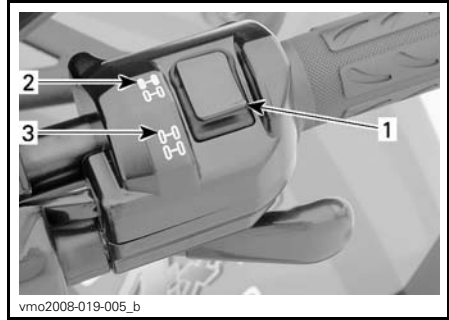

TYPICAL

1. Selector
2. 2WD position
3. 4WD position

NOTICE The vehicle must be stopped to engage or disengage 2WD/4WD selector. Mechanical damage may occur if selector is engaged or disengaged while driving.

NOTICE If the rear wheels are spinning, release the throttle and wait engine return to the idle before selecting the 4WD mode.

The 4WD mode is engaged when the selector is pushed downwards.



V0710DY

4WD MODE

To deselect the 4WD mode, press the selector on 2WD.



V0710EY

2WD MODE

When the selector is located on the 2WD, the vehicle is in 2 wheel drive at all time.

3) Brake Lever(s)**3a) LH Brake Lever**

The LH brake lever is located on the LH side of the handlebar.

All Models except 800R X xc

When the brake lever is compressed, the front and rear brakes are applied.

While reading this Operator's Guide, remember that:

⚠ WARNING

Indicates a potential hazard that, if not avoided, could result in serious injury or death.

NOTE: As on other wheeled vehicles, the vehicle weight is transferred to the front wheels when braking. To obtain greater stopping efficiency, the brake system distributes more braking force to the front wheels. This will affect vehicle handling and steering control when braking vigorously. Take it into account when braking.

800R X xc

When the brake lever is pressed, the rear brake is applied.

All Models

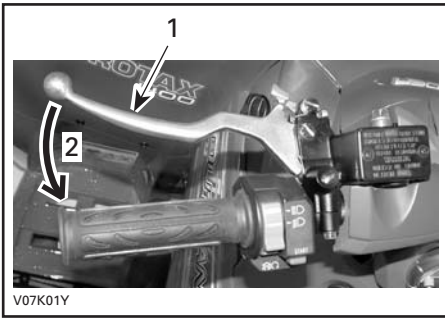

TYPICAL

1. Brake lever
2. To apply brakes

When released, the brake lever should automatically return to its original position

Braking effect is proportional to the force applied on the lever.

3b) RH Brake Lever (800R X xc)

The RH brake lever is located on the RH side of the handlebar.

When the brake lever is pressed, the front brakes are applied.

When released, the brake lever should automatically return to its original position.

Braking effect is proportional to the force applied on the lever.

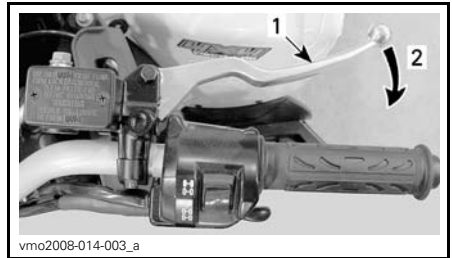

TYPICAL

1. Brake lever
2. To apply brakes

4) Parking Brake

The parking brake is located on the LH side of the handlebar.

When applied, it prevents the vehicle from moving. Useful when the brake needs to be locked for example when doing a K-turn, during transportation or when the vehicle is not in operation.

⚠ WARNING

Always use the parking brake **and** engage the **PARK** position on the transmission lever when the vehicle is not in operation.

To engage mechanism: Squeeze brake lever and maintain while moving lever lock. Brake lever is now compressed and applying all brakes.

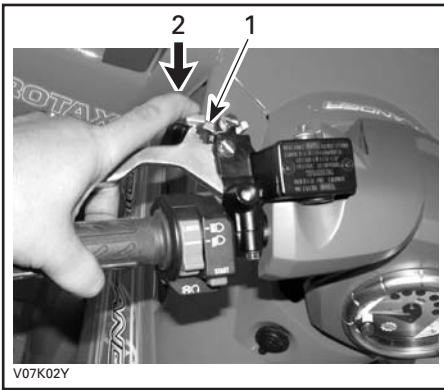
**TYPICAL**

1. Brake lever lock
2. Press to apply parking brakes

NOTE: Locking lever can be adjusted in several positions.

NOTICE Parking brake position can vary depending on brake pads wear. Ensure when the parking brake is applied that the vehicle stays securely in place.

To release mechanism: Squeeze brake lever. Lever lock should automatically return to its original position. Brake lever should return to rest position. Always release parking brake before riding.

WARNING

Make sure parking brake is fully disengaged before operating the vehicle. When you ride the vehicle, brakes that are caused to drag by a continuous pressure on the lever may cause damage to the brake system and cause loss of braking capacity and/or fire.

5) Transmission Lever

The transmission lever is located on the RH side of the vehicle near steering column.

A 5-position lever: P, R, N, H and L.

To change the transmission position, completely stop vehicle then move lever to the desired position. Do not force lever. If unable to shift, rock the vehicle back and forth to move the gears in the transmission and try again.

**SHIFT PATTERN**

NOTICE Always completely stop the vehicle and apply the brake prior to moving the transmission lever.

P: Park

This position locks the transmission to help prevent vehicle movement. Always use when the vehicle is not in operation. In some circumstances, it may be necessary to rock the vehicle back and forth to move the gears in the transmission to allow the park to be engaged.

R: Reverse

This allows the vehicle to go backwards. The vehicle speed is limited.

⚠ WARNING

Before moving vehicle in reverse, ensure the path behind is clear of obstacles or bystanders. We recommend sitting on your ATV when operating in reverse. Avoid standing up. Your weight could shift forward against throttle lever, causing an unexpected acceleration.

N: Neutral

This position disengages the transmission to allow manual vehicle movement.

H: High gear

This selects the high speed range of the transmission in the gear box. It is the normal driving speed range. It allows the vehicle to reach its maximum speed.

L: Low gear

This selects the low speed range of the transmission in the gear box. It is the working position. It allows the vehicle to move slowly with the maximum traction and power.

NOTE: Use the low speed range to pull any load or to climb a steep incline.

6) Multifunction Switch

The multifunction switch is located on the LH side of the handlebar.

The controls located on this multifunction switch are:

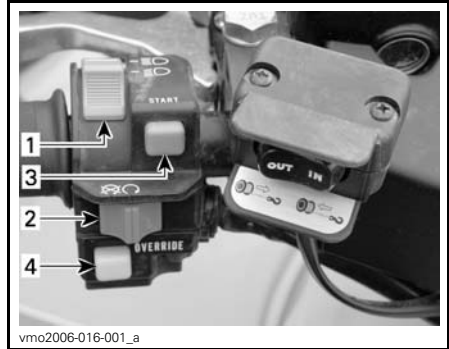

TYPICAL — MULTIFUNCTION SWITCH

1. Headlight switch
2. Emergency engine stop switch
3. Engine start button
4. Override/DPS/ACS button (if applicable)

Headlight Switch

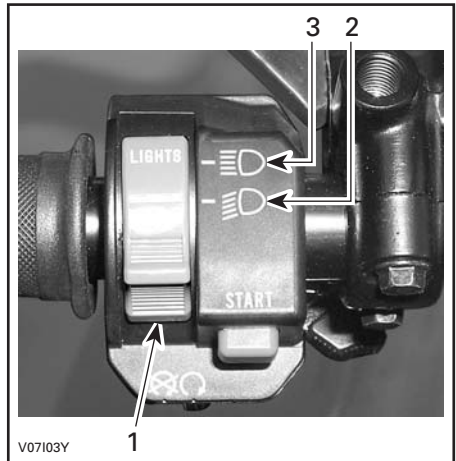

HEADLIGHT SWITCH FUNCTIONS

1. Headlight switch
2. Low beam and taillight
3. High beam and taillight

NOTE: Place ignition switch to ON “without light” position to close the headlight.

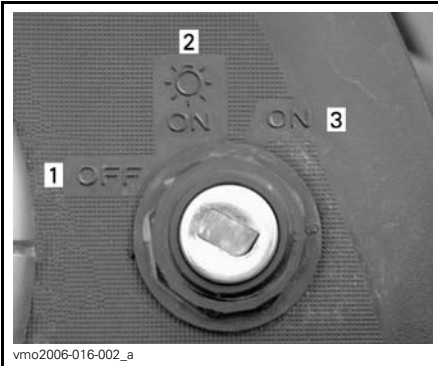

vmo2006-016-002_a

IGNITION SWITCH POSITIONS

1. OFF
2. ON "with light"
3. ON "without light"



V07105Y

TYPICAL

1. Emergency engine stop switch

Emergency Engine Stop Switch

This switch can be used to stop the engine and as an emergency control.

To stop engine, fully release throttle lever then set the emergency engine stop switch to the STOP position.

NOTE: While the engine can be stopped by turning the ignition key to OFF position, we recommend the engine be stopped by setting the emergency engine stop switch to the STOP position.

Engine Start Button

To start engine, place the emergency engine stop switch to RUN.

Press and hold the engine start button. Release immediately after engine is started.

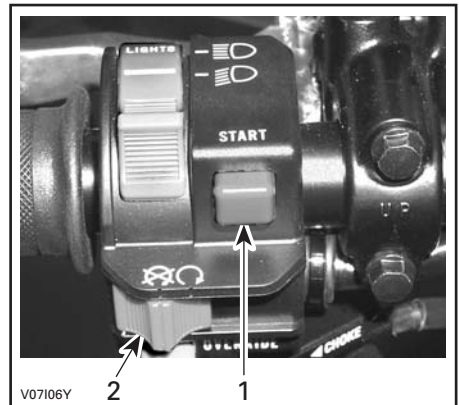

V07106Y

TYPICAL

1. Engine start button
2. Emergency engine stop switch

NOTE: The engine will not turn over if the emergency engine stop switch and/or the ignition switch are turned to the OFF position.

Override/DPS/ACS Button

Depending on the vehicle model, this button has up to 3 functions.

Override Function

All Models

This button is used to override the reverse speed limiter system while power backing up.

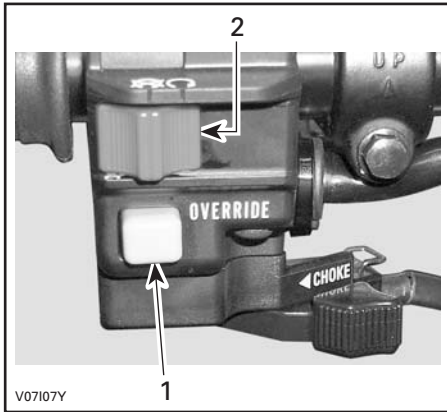

TYPICAL

1. Override button
2. Emergency engine stop switch

To use the override function, proceed as follows:

While the transmission lever is set to REVERSE position.

1. Ensure that the vehicle is stopped.
2. Press and hold the override button, then depress throttle lever gradually.

NOTE: When using the override function, the multifunction gauge will scroll an **OVERRIDE** message to confirm that the function is properly activated.

⚠ WARNING

Never activate the override button if throttle lever is already depressed as a loss of control may result.

⚠ WARNING

If driving downhill in reverse, gravity can increase the vehicle speed above the set limited reverse speed.

DPS Function

XT, XT-P, Xxc and LTD Models

This button is also used to change the DPS (Dynamic Power Steering) mode.

While reading this Operator's Guide, remember that:

⚠ WARNING

Indicates a potential hazard that, if not avoided, could result in serious injury or death.



1. DPS button

To change the DPS mode, refer to *TUNE YOUR RIDE* subsection.

ACS Function

LTD Models

This button is also used to change the ACS suspension setting.



1. ACS button

To change the ACS suspension setting, refer to *TUNE YOUR RIDE* subsection.

7) Multifunction Gauge

The multifunction gauge is located in the middle of the handlebar.

⚠ WARNING

Selecting various numerical displays, system modes of operation or changing settings should only be carried out with the vehicle stopped. Selecting these various functions while operating the vehicle at speed is not recommended as it deters your attention from situational awareness.

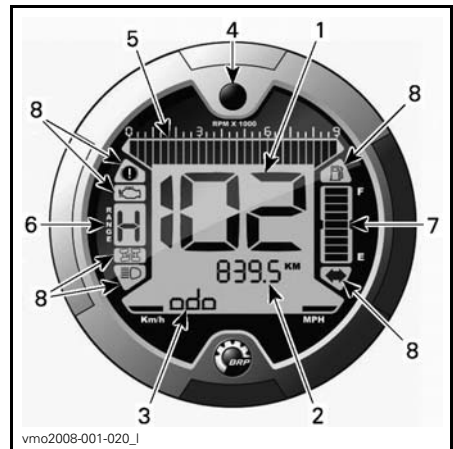

1. Display 1 (speedometer)
2. Display 2 (mode)
3. Display 3 (mode/message)
4. Display selector button
5. Tachometer
6. Transmission position display
7. Fuel level display
8. Indicator lamps

Unit Selection (MPH vs km/h)

This multifunction gauge is factory preset in Imperial units but it is possible to change it to Metric units, contact an authorized Can-Am dealer for unit settings.

NOTE: All features will have their units changed all together.



1. Unit selection

Language Selection

The gauge can be set in different languages.

To have the gauge setup to your preferred available language, contact an authorized Can-Am dealer.

Display 1 (Speedometer)

This display will show vehicle speed.



1. Vehicle speed
2. Unit selection

Display 2 (Mode)

Depending on the vehicle model, the following modes can be displayed by pressing the selector button:

- Odometer (ODO)
- Trip meter (TRIP)
- Hour meter (TRIP TIME)
- Vehicle hour meter (ENGINE HOURS)
- Engine revolutions per minute (RPM)
- ACS suspension (AIR_SUSP)
- Clock (CLOCK).

NOTE: An abbreviation of the mode selected will also be displayed in display 3 (see abbreviations in parenthesis).

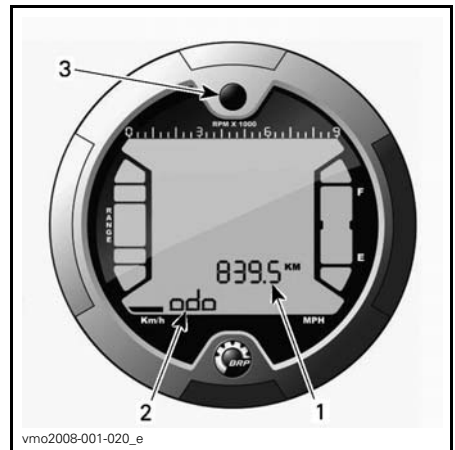

1. Display 2 (mode)
2. Display 3 (mode/message)
3. Selector button

Odometer

Records the total distance travelled.

Trip Meter

Records the distance travelled since it has been reset.

Press and HOLD display selection button to reset.

Hour Meter

Records the vehicle running time when the electrical system is activated since it has been reset.

Press and HOLD display selection button to reset.

Engine Hour Meter

Records engine running time.

Engine RPM

Measures engine revolutions per minute (RPM).

ACS Suspension

It shows the setting of the ACS suspension.

Clock

Shows current time.

To set current time, proceed as follows:

1. Select the clock display.



1. *Display selector button*
2. *Time (Display 2)*
3. *Am/Pm (12-hour format)*
4. *Message (Display 3)*

2. Press and HOLD button (SET TIME will appear on display 3).
3. Choose the 12-hour (12H) or 24-hour (24H) format by pressing button.
4. If the 12-hour format was selected, choose Am ("A") or Pm ("P") by pressing button.
5. Press and HOLD button.
6. Choose hour first digit by pressing button.
7. Press and HOLD button.
8. Choose hour second digit by pressing button.
9. Press and HOLD button.
10. Choose minutes first digit by pressing button.
11. Press and HOLD button.
12. Choose minutes second digit by pressing button.
13. Press button to enter settings (CLOCK will appear on display 3).

Display 3 (Mode/Message)

This display will show an abbreviation of the mode selected in display 2.

It will also communicate important messages to the operator if an anomaly occurs.

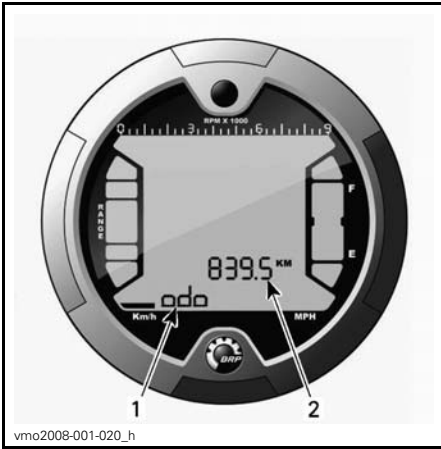

1. Display 3 (mode/message)
2. Display 2 (mode)

Mode Abbreviation

Depending on the vehicle model, the following abbreviations can be displayed:

- ODO (odometer)
- TRIP (trip meter)
- TRIP TIME (hour meter)
- ENGINE HOURS (vehicle hour meter)
- RPM (engine revolutions per minute)
- AIR_SUSP (ACS suspension)
- DPS (Dynamic Power Steering)
- CLOCK (Clock).

Display Selector Button

Button used to navigate between modes or to reset data depending on the feature selected.

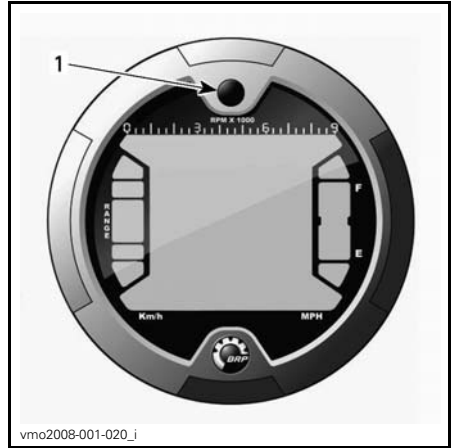

1. Selector button

Tachometer

Measures engine revolutions per minute (RPM). Multiply by 1000 to obtain the actual revolutions.

NOTE: RPM can also be displayed via Display 2 (mode) display. Refer to *DISPLAY 2 (MODE)* in this subsection.

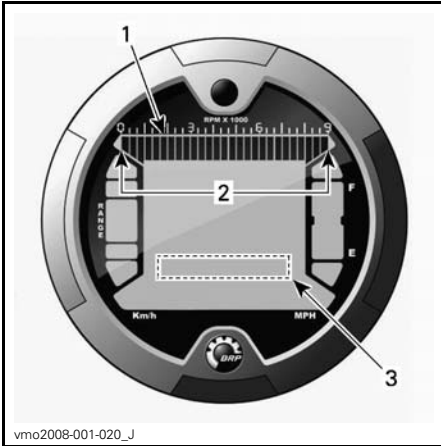

1. Tachometer
2. Operating range
3. Tachometer via display 2 (mode)

Transmission Position Display

This display will show transmission position.

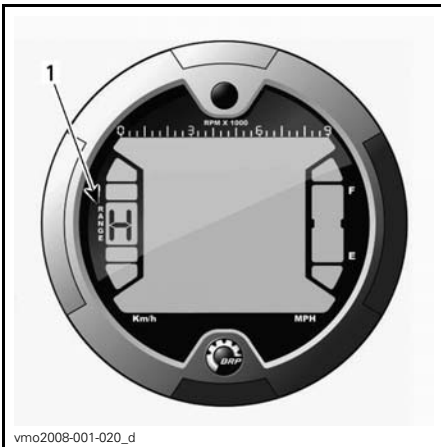

1. Transmission position

DISPLAY	FUNCTION
P	Park
R	Reverse
N	Neutral
H	High gear
L	Low gear

NOTE: If the letter “E” is displayed in the transmission position display, it means that there is a electrical communication error. Contact an authorized Can-Am dealer.

Fuel Level Display

Bar gauge that continuously indicates the amount of fuel left in the fuel tank.

Also, an indicator lamp will indicate a low-fuel condition as only one bar is displayed.

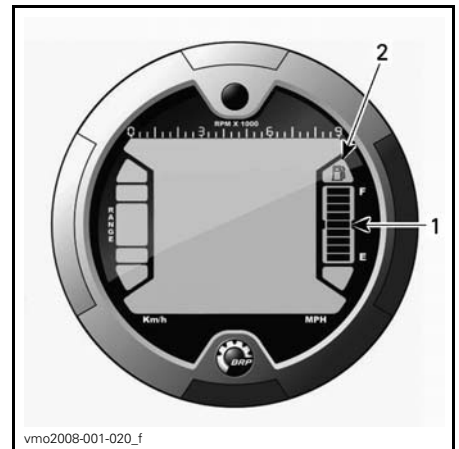



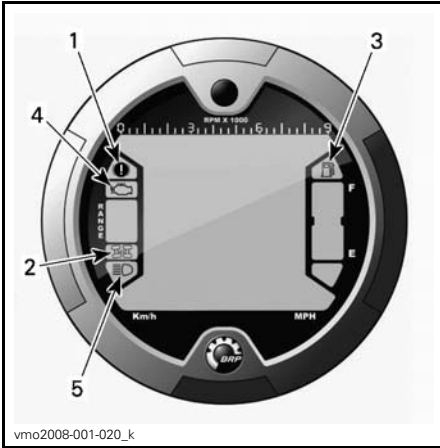

1. Fuel level display
2. Low fuel indicator lamp

Indicator Lamps



1. Parking brake indicator lamp
2. 4WD indicator lamp
3. Low fuel level indicator lamp
4. Check engine indicator lamp
5. High beam indicator lamp

Description:

-  Parking brake is activated.
-  4WD system is activated.
-  Low fuel level. There is approximately 2.0 L (.5 U.S. gal.) of fuel left in the fuel tank.
-  Check engine and D.E.S.S. system operation.
-  High headlight beam position selected.

8) 12-Volt Power Outlet

Convenient for handheld spotlight or other portable equipment.

Remove protective cap to use. Always reinstall it after use to protect against weather.

Do not exceed the rating capacity. Refer to *SPECIFICATIONS* subsection.

An auxiliary supply is available to connect additional accessories. Two wires are hidden in the wiring harness at the front of vehicle underneath dash board. See an authorized Can-Am dealer for more details.

9) Ignition Switch

The ignition switch is located on the central panel near steering column.

Key-operated 3-position switch.

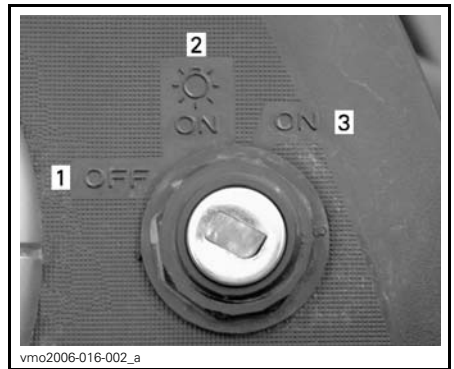

IGNITION SWITCH POSITIONS

1. OFF
2. ON "with light"
3. ON "without light"

Insert key in switch and turn to the desired position. To remove key, turn key to OFF position then pull it out.

NOTE: When turning the key to OFF position and removing the key, the vehicle electrical system will take a few seconds to shut down.

The ON with lights position turns on all lights with either the engine running or not. Remember that having the lights on without the engine running discharges the battery. Always turn ignition key to the OFF position after engine has been stopped.

NOTE: While engine can be stopped by turning ignition key to OFF position, we recommend the engine be stopped by the emergency engine stop switch.

Digitally Encoded Security System (D.E.S.S.)

The ignition key specifically contains an electronic circuit that gives it a unique electronic serial number.

This ignition key cannot be used on another vehicle and conversely, the one from another vehicle cannot be used on your vehicle except if it was programmed this way.

However, the D.E.S.S. brings a great flexibility. You can buy additional ignition keys and have them programmed for your vehicle.

To have additional ignition keys, refer to an authorized Can-Am dealer.

10) Brake Pedal

The brake pedal is located on the RH side of the vehicle near engine.

When the brake pedal is pressed down, the rear brake is applied.

When released, the brake pedal should return to its original position.

Braking effect is proportional to the force applied on the pedal.

NOTE: The brake will have also an effect on front wheels through the drive train when 4WD is engaged.

The brake pedal applies the rear brake only. Should the brake lever system fail, the rear brake can be activated by depressing the brake pedal.

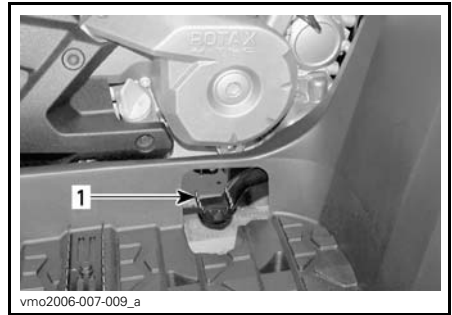

1. Brake pedal

11) Footpeg

The footpegs are located on the RH and LH side of the vehicle near engine.

Use this area to keep your feet and the passenger's (2-UP models) feet stable.

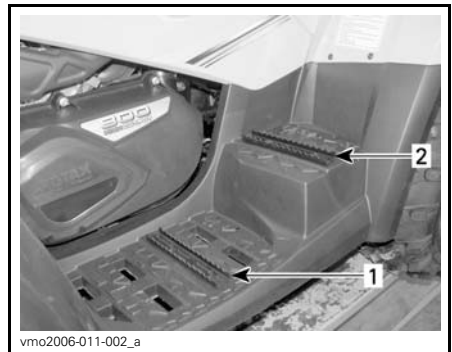

TYPICAL — 2-UP MODELS

1. Operator's footpeg
2. Passenger's footpeg

12) Grab Handles

2-UP Models

The grab handles are located on the RH and LH side of the passenger's seat.

The grab handles must be used by the passenger to hold on firmly during vehicle operation.

⚠ WARNING

The passenger must always hold on to the passenger grab handles, not the operator. He must also have both feet resting firmly against the footrests.

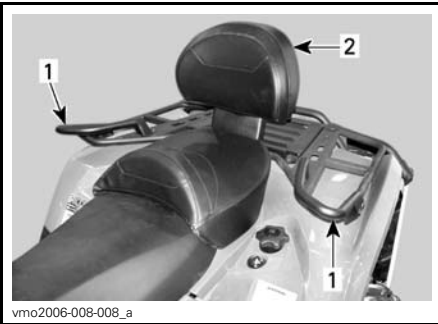

TYPICAL

1. Grab handles
2. Passenger's seat

**13) Passenger's Seat/
Storage Box**

2-UP Models

⚠ WARNING

Never operate the vehicle without passenger's seat or storage box properly installed.

The passenger's seat is designed specially to allow a secure and pleasant ride at ONE (1) passenger. The integrated backrest supports his back during the ride.

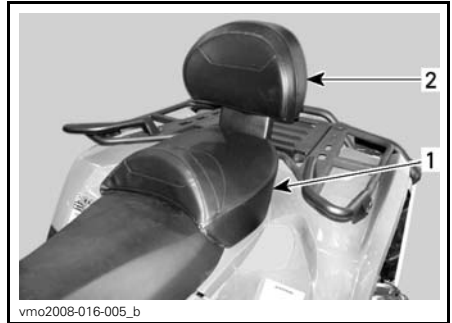

1. Passenger's seat
2. Integrated backrest

The storage box is used to convert a two-rider vehicle (2-UP model) to a one-rider vehicle (1-UP model) with extra cargo capacity.

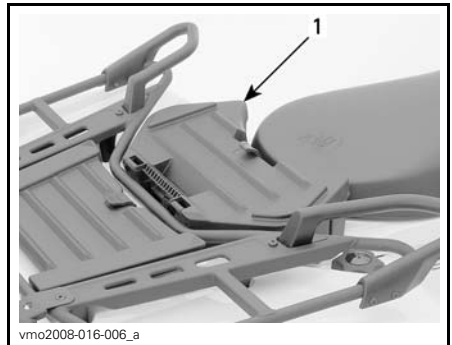

1. Storage box

While reading this Operator's Guide, remember that:

⚠ WARNING

Indicates a potential hazard that, if not avoided, could result in serious injury or death.

The conversion of the vehicle is easy, remove the passenger's seat then install the storage box or vice versa. Use the procedure describes below to remove and install the features correctly.

⚠ WARNING

Without its passenger's seat, the vehicle becomes a **ONE RIDER** vehicle (1-UP model) and **NO PASSENGER** must be allowed on vehicle. **NEVER** carry passenger on storage box.

Passenger's Seat Removal

1. Pull one of the passenger's seat handles. Those handles are located underneath the RH and LH rear end of seat.



TYPICAL — LH SIDE

1. *Seat latch*
2. Gently lift the rear of seat.
3. Pull seat rearwards.
4. Continue lifting movement until you can release the front retaining device then completely remove passenger's seat.

Passenger's Seat Installation

1. Insert passenger's seat positioning tubes into rear fender provided holes.

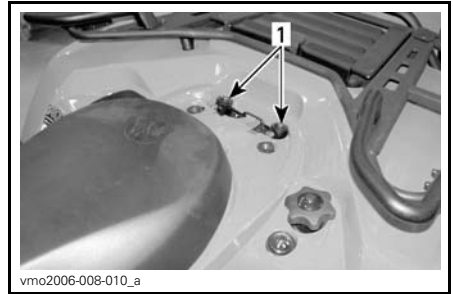

TYPICAL

1. *Holes for passenger's seat positioning tubes*
2. When seat rests in its position, firmly push seat down to latch.

NOTE: A distinctive snap will be felt. Double check that the seat is secure by giving it a tug to confirm proper latching.

⚠ WARNING

It is of the utmost importance for the passenger's safety that you confirm that the passenger's seat is properly locked in position by pulling back and up several times.

Storage Box Installation

1. Remove passenger's seat. Refer to *PASSENGER'S SEAT REMOVAL* in this subsection.
2. Position storage box onto rear fender.
3. When storage box rests in its position, firmly push down to latch.
4. To open storage box, unhook the rubber latch.

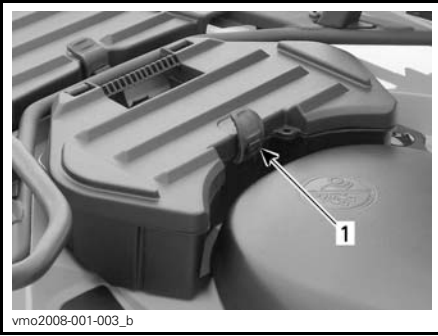

1. Rubber latch

Storage Box Removal

1. Pull storage box strap to release from vehicle.
2. Remove storage box.
3. Reinstall passenger's seat. Refer to *PASSENGER'S SEAT INSTALLATION* in this subsection.



1. Strap

14) Operator's Seat

NOTE: On applicable models, to remove the operator's seat, the passenger's seat removal is necessary. Refer to *PASSENGER'S SEAT REMOVAL* in this subsection.

Seat Removal

To remove the operator's seat, push its latch forward. This latch is located underneath the rear of seat.



1. Seat latch

Pull seat rearward. Continue lifting movement until you can release the front retaining device then completely remove seat.

Seat Installation

Insert front tabs of seat into frame hooks. When seat rests in its position, firmly push seat down to latch.

NOTE: A distinctive snap will be felt. Double check that the seat is secure by giving it a tug to confirm proper latching.

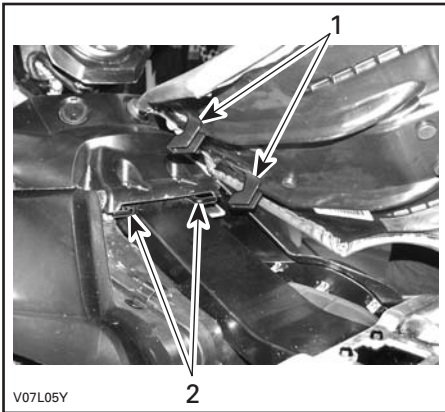

V07L05Y

2

1. Insert these tabs in hooks
2. Hooks

⚠ WARNING

It is of the utmost importance for the operator's safety that you confirm that the operator's seat is properly locked in position by pulling back and up several times.

15) Rear Storage Compartment

Convenient location to carry personal articles such as a spare spark plugs, first aid kit, etc. Unlatch cover, gently lift then remove cover.

The compartment is equipped with a drain plug. Remove plug to allow draining when necessary. Reinstall plug when finished.

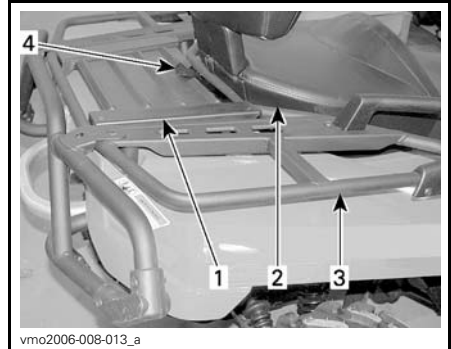

vmo2006-008-013_a

TYPICAL

1. Rear storage compartment cover
2. Seat
3. Rear racks
4. Latch

⚠ WARNING

When engine is running, always engage the PARK position on the transmission lever before opening cover. Never leave any heavy or loose breakable objects in the storage basket. Always latch cover before riding. If storage cover is removed to provide greater carrying area, ensure that cargo is secured and will not "fly out" when riding at speed on rough terrain. **Slow down.**

16) Cargo Racks

Cargo racks are convenient for carrying equipment and various other cargo. They must never be used to carry a passenger.

⚠ WARNING

- Never carry a passenger on a cargo rack.
- Cargo must never interfere with the driver's line of sight or affect his ability to properly steer the vehicle.
- Do not overload the vehicle.
- Always ensure all cargo is properly secured and does not extend out past the racks.

Refer to *SPECIFICATIONS* subsection for cargo weight recommendations.

17) Trailer Hitch

All Models except 800R X xc

Convenient hitch to install a ball to tow a trailer or other equipment. Install the proper ball size as per trailer manufacturer recommendations. Refer to *SPECIFICATIONS* subsection for carrying loads and towing recommendations.

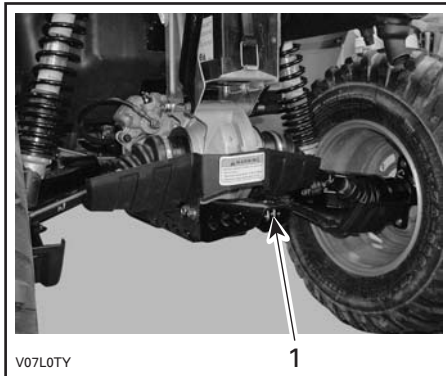

TYPICAL

1. Trailer hitch

⚠ WARNING

Ensure to install the proper ball size that matches the equipment you will tow.

NOTE: Follow manufacturer's instructions for proper attachment.

18) Tool Kit

The tool kit is located in the rear storage compartment. It contains tools for basic maintenance.

19) Winch

XT, XT-P and LTD Models

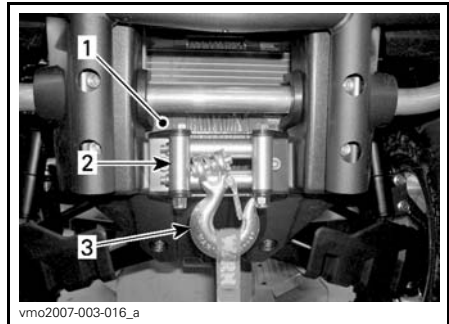

1. Winch
2. Roller fairlead
3. Winch hook

20) Winch Control Switch

XT, XT-P and LTD Models

Use this switch to roll in or out wire from winch.

To let out the cable, press the left side of switch.

To reel in the cable, press the right side of switch.

Refer to *BASIC GUIDE TO WINCHING TECHNIQUES* for proper operating instructions.

NOTE: A winch remote control is also provided with the vehicle to ease winch operation if necessary, refer to *WINCH REMOTE CONTROL* further in this subsection.

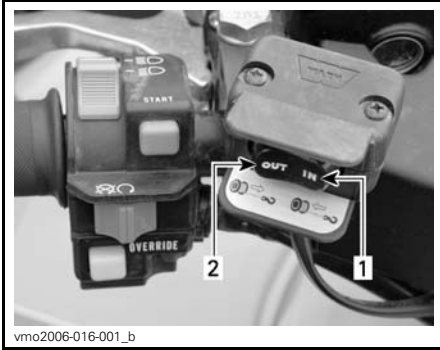

vmo2006-016-001_b

TYPICAL

1. In
2. Out

21) Roller Fairlead*XT, XT-P and LTD Models*

The roller fairlead is used to prevent damages to the vehicle and guide the wire rope into the winch.

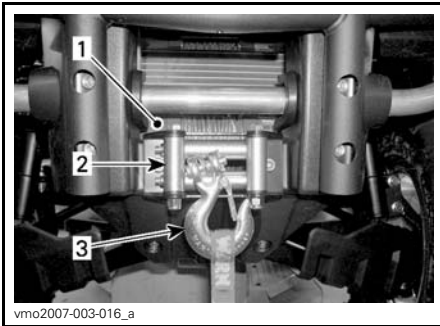

vmo2007-003-016_a

1. Winch
2. Roller fairlead
3. Winch hook

22) Winch Remote Control*XT, XT-P and LTD Models*

A winch remote control is provided with the vehicle to ease winch operation if necessary.

The winch remote control is located in the access panel of the front service compartment.



vmo2008-001-001_a

TYPICAL — FRONT ACCESS PANEL

1. Winch remote control

To use the winch remote control switch instead of the handlebar control switch, connect the remote control into the provided connection of the front service compartment. Refer to *WINCH REMOTE CONTROL CONNECTION* further in this subsection.

Refer to *BASIC GUIDE TO WINCHING TECHNIQUES* for more informations about the winch.

NOTICE Always disconnect and store the remote control when not in use.

NOTE: Ensure coolant reservoir hose is properly routed as per the following illustration to avoid any interference, when closing cover, with the winch remote control.

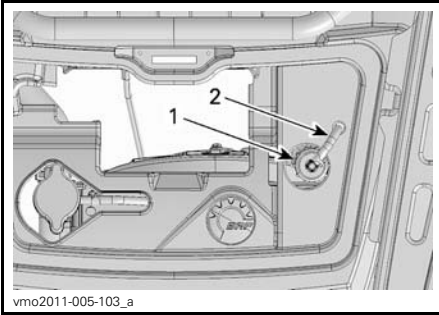

TYPICAL

1. Filler cap
2. Coolant reservoir hose

NOTICE Do not store any objects in the front service compartment.

23) Winch Remote Control Connection

XT, XT-P and LTD Models

Connection used to plug-in winch remote control to ease winch operation if necessary.



TYPICAL - FRONT SERVICE COMPARTMENT

1. Remote control connection

24) GPS Receiver (Global Positioning System)

LTD Models

The GPS receiver is located on the handlebar and provides the vehicle position on earth.

CAUTION Always install the GPS on its support whenever using the vehicle.



TYPICAL

1. GPS receiver

It is powered via the vehicle electrical system when installed on its support (with ignition switch to ON position), or via batteries when removed from its support.

GPS receiver can be activated using the ON/OFF button on the receiver or with the vehicle ignition switch when turned to ON or OFF position (when installed on the vehicle).

The GPS comes from factory with all the necessary accessories to be specifically used on this vehicle. It includes:

- nüvi 500 with rechargeable battery
- 800 meg of internal memory; approx. 300 meg are being used for internal software

- Standard map: WW Autoroute DEM Basemap NR 3.00 with general basic road information
- CE models come with the standard map and City Navigator Europe NT map on a pre-programmed microSD data card
- Quick Start Manual and Warranty information.



vbs2010-009-001

nüvi 500 KIT

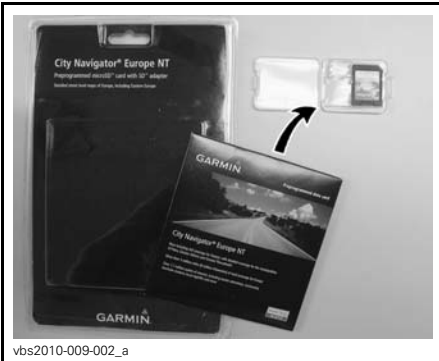

vbs2010-009-002_a

CE MAPS ON MICROSD CARD

NOTE: Always refer to manufacturer's documentation supplied with the GPS receiver for proper use.

NOTE: For more details about the GPS receiver, available maps or accessories, contact an authorized Can-Am dealer or visit **Garmin** website at www.garmin.com.

⚠ WARNING

- Reading the GPS receiver can distract from the operation of the vehicle, particularly from constantly scanning the environment. This could lead to a collision.
- Before reading the GPS receiver, ensure your environment is clear and free from obstacle, and bring the vehicle to a low speed.
- Additionally, make sure to often double-check for obstacles.

⚠ WARNING

Remember, the data provided by the GPS receiver is for reference only. For your safety, **NEVER** rely solely on this information.

GPS Receiver Installation

Remove GPS power cord from GPS support.

Connect GPS power cord into the GPS receiver.

Insert GPS receiver onto the lower tab of support.

Lock GPS receiver onto its support by pushing it towards locking tab.

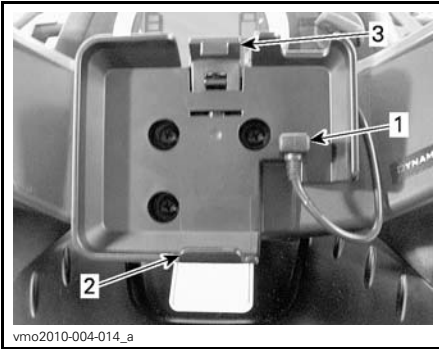

1. GPS power cord
2. Lower tab
3. Locking tab

NOTICE To prevent weather damage or theft to your GPS receiver, always remove it from its support when leaving the vehicle.

GPS Receiver Removal

The removal is the reverse of installation procedure.

25) ACS Compressor

LTD Models Only

The air compressor is specially designed to inflate tires.

NOTE: The air compressor output pressure will vary according to the ACS suspension setting. The **ACS 1** adjustment will provide less pressure than the **ACS 6** adjustment.

To inflate tires, proceed as follows:

1. Ensure that the transmission lever is set in **PARK** position.
2. Apply parking brake.
3. Start engine and let it run at idle.
4. Remove seat(s).
5. Connect supplied hose into the compressor fitting.



1. Compressor fitting

6. Inflate tire at the recommended air pressure.

NOTE: Usually, to properly inflate an ATV tire, the proper ACS suspension setting should be **ACS 1**.



vmo2010-004-008

NOTE: For your convenience, a pressure gauge is supplied in tool kit.

NOTICE Always inflate tires at the recommended air pressure. Refer to **MAINTENANCE PROCEDURES** sub-section.

FUEL

Recommended Fuel

Use regular unleaded gasoline, available from most service stations, or oxygenated fuel containing a maximum of 10% of ethanol or methanol. The gasoline used must have the following recommended minimum octane rating.

MINIMUM OCTANE RATING	
Inside North America	87 ((R + M)/2)
Outside North America	92 RON

NOTICE Never experiment with other fuels. The use of non recommended fuel can result in vehicle performance deterioration and damage to critical parts in the fuel system and engine.

Fueling Procedure

WARNING

- Always stop engine before refueling. Open cap slowly.
- If a differential pressure condition is noticed (whistling sound heard when loosening fuel tank cap) have vehicle inspected and/or repaired before further operation.
- Fuel is flammable and explosive under certain conditions.
- Never use an open flame to check fuel level.
- Never smoke or allow a flame or spark in the vicinity.
- Always work in a well-ventilated area.
- Never top up the fuel tank before placing the vehicle in a warm area. As temperature increases, fuel expands and may overflow.
- Always wipe off any fuel spillage from the vehicle.

NOTICE Never place anything over fuel tank cap because the vent hole on the top of fuel tank cap can be blocked and the engine could misfire.

1. Stop engine.
2. Do not allow anyone to remain seated on the vehicle while fuelling.
3. Unscrew fuel tank cap counter-clockwise to remove it.
4. Insert the spout in the filler neck.

5. Pour fuel slowly to allow time for the air in the tank to escape and prevent fuel flow back. Be careful not to spill fuel.
6. Stop fuelling when the fuel reaches the bottom of filler neck. **Do not overfill.**
7. Fully tighten fuel tank cap clockwise.

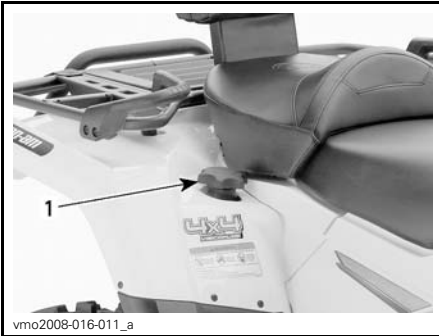

1. Fuel tank cap

While reading this Operator's Guide, remember that:

⚠ WARNING

Indicates a potential hazard that, if not avoided, could result in serious injury or death.

BREAK-IN PERIOD

Operation During Break-In

A break-in period of 10 operating hours or 300 km (200 mi) is required for the vehicle.

After the break-in period, the vehicle should be inspected by an authorized Can-Am dealer. Refer to *MAINTENANCE* section.

Engine

During the break-in period:

- Avoid full throttle operation.
- Maximum throttle should not exceed 3/4.
- Avoid sustained accelerations.
- Avoid prolonged cruising speeds.
- Avoid engine overheating.

However, brief accelerations and speed variations contribute to a good break-in.

Brakes

**WARNING**

New brakes will not operate at their maximum efficiency until their break-in is completed. Braking performance may be reduced, so use extra caution.

Belt

A new belt requires a break in period of 50 km (30 mi).

During the break-in period:

- Avoid strong acceleration and deceleration.
- Avoid pulling a load.
- Avoid high speed cruising.

OPERATING INSTRUCTIONS

Starting the Engine

The transmission lever must be set to PARK or NEUTRAL.

NOTE: For your convenience, an over-ride mode allows the engine to be started with the transmission lever in any position. Press and hold the brake lever or the brake pedal while pressing the engine start button.

Insert key in ignition switch and turn to ON position.

Set the emergency engine stop switch to RUN.

Press the engine start button and hold until the engine starts.

NOTICE Do not hold the engine start button more than 30 seconds. A rest period should be observed between the cranking cycles to let the starter cool down. Pay attention not to discharge the battery.

Release the engine start button immediately when the engine has started.

NOTE: If the battery is dead, engine cannot be started. Have the battery recharged or replaced.

Shifting the Transmission

Let engine idle to warm up.

Apply brakes and select the desired gear range: H or L.

NOTE: The brake must be applied when the transmission lever is engaged in the park position.

Release brakes.

NOTICE Make sure parking brake is fully disengaged before operating the vehicle.

Gradually press the throttle lever to increase engine speed and thus engaging the continuously variable transmission (CVT).

At the opposite, when the throttle lever is released, the engine speed decreases.

Using Reverse Override

When the transmission lever is in the **REVERSE** position, engine RPM is limited thus limiting the reverse speed that can normally be commanded using the throttle lever.

WARNING

If driving downhill in reverse, gravity can increase the vehicle speed above the set limited reverse speed.

To engage the override function, press and hold the override button, then gradually press the throttle lever to increase engine power.

To disengage the override function, release the throttle lever then the override button.

WARNING

Never activate the override button if the throttle lever is not fully released as a loss of control may result.

Stopping the Engine

WARNING

Avoid parking on slope.

Release throttle and completely stop the vehicle.

Apply the parking brake.

Set transmission lever in PARK position.

Push the emergency engine stop switch in OFF position.

Turn key in ignition switch to OFF position.

Remove key from ignition switch.

What to Do if Vehicle Is Turned Over

When vehicle is turned over or stays tilted on the side, put the vehicle back on its wheels, then wait 3 to 5 minutes before starting the engine. Refer to *MAINTENANCE* section and inspect the following.

- Inspect air filter housing drain tube for oil accumulation, if any oil is found, clean air filter and air filter housing.
- Check engine oil level and refill if necessary.
- Check engine coolant level and refill if necessary.
- Start engine. If the oil pressure light stays on, stop engine immediately. See an authorized Can-Am dealer.

What to Do if Vehicle Is Immersed in Water

Should the vehicle become immersed, it will be necessary to take it to an authorized Can-Am dealer as soon as possible. **NEVER START THE ENGINE!**

NOTICE Immersion of the vehicle can cause serious damage if the correct restart procedure is not followed.

TUNE YOUR RIDE

⚠ WARNING

Suspension adjustment could affect vehicle handling. Always take time to familiarize yourself with the vehicle's behavior after any suspension adjustment have been made.

Suspension Adjustment

Suspension adjustment and loading can have an effect on your vehicle handling and comfort.

Choice of suspension adjustments vary with driver's weight, personal preference, riding speed and field condition.

Spring Preload Adjustment

NOTE: Front shocks are not adjustable on **Outlander 500** models.

NOTE: Rear shocks are adjustable electronically on **Outlander LTD** models.

⚠ WARNING

The left and right shock adjustment on front or rear suspension must always be set to the same position. Never adjust one only. Uneven adjustment can cause poor handling and loss of stability, which could lead to an accident.

Shorten the springs for a firmer ride and rough conditions.

Lengthen the springs for a softer ride and smooth conditions.

Adjust by turning adjustment cam or ring accordingly. Use tool from vehicle tool kit.

All Models except 800R X xc

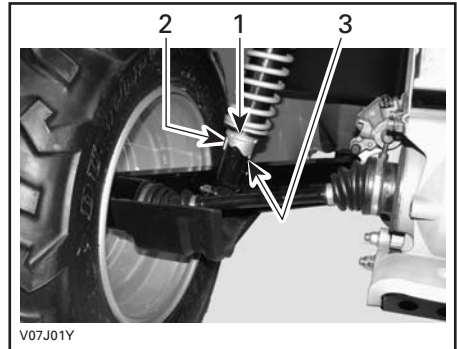

TYPICAL — REAR SHOCKS

1. Adjusting cams
2. Smooth adjustment
3. Hard adjustment

800R X xc

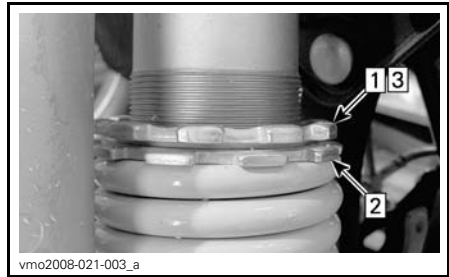

TYPICAL

- Step 1: Loosen top locking ring
- Step 2: Turn adjusting ring accordingly
- Step 3: Tighten top locking ring

Shock Damping Adjustments

800R X xc

Perform adjustments **one** position (click) at a time. Test run the vehicle under the same conditions; trail, speed, driver riding position, etc. Proceed methodically until you are satisfied.

Low Speed Compression Damping

Use a flat screwdriver to adjust it.



TYPICAL
1. Compression adjuster (flat screwdriver)

Turning it clockwise (H) **increases** shock damping action (stiffer).
Turning it counterclockwise (S) **decreases** shock damping action (softer).

High Speed Compression Damping
Use a 17 mm wrench to adjust it.



TYPICAL
1. High speed compression adjuster

Turning it clockwise (H) **increases** shock damping action (stiffer).
Turning it counterclockwise (S) **decreases** shock damping action (softer).

Rebound Damping
Use a flat screwdriver to adjust it.

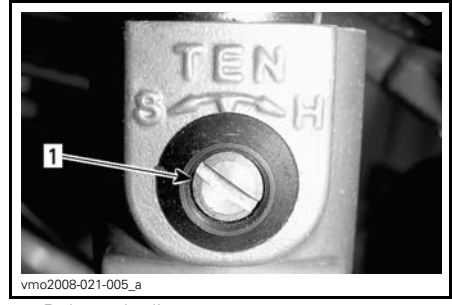

1. Rebound adjuster

Turning it clockwise (H) **increases** shock damping action (stiffer).
Turning it counterclockwise (S) **decreases** shock damping action (softer).

Air Controlled Suspension (ACS) Adjustment

LTD Models

This system allows the operator to adjust the rear suspension by simply pressing a button. By changing the ACS setting, air pressure in the rear shocks absorber will change to provide a different suspension adjustment.

The following suspension settings are preset in the vehicle.

ACS SUSPENSION SETTINGS		
SETTING	RIDING COMFORT	RECOMMENDED LOAD
ACS 1	Softest	Operator only
ACS 2	Soft	
ACS 3	Semi-soft	Transporting a passenger OR a cargo
ACS 4	Semi-firm	
ACS 5	Firm	Transporting a passenger AND a cargo
ACS 6	Firmest	

⚠ WARNING

Always adjust the ACS suspension setting according to load. Adhere to the above recommendations regarding the transportation of a load (passenger and cargo) on your vehicle.

To show the actual setting, proceed as follows:

1. Press selector button several times until **AIR_SUSP** is displayed.
2. Check the multifunction gauge to confirm the actual setting.

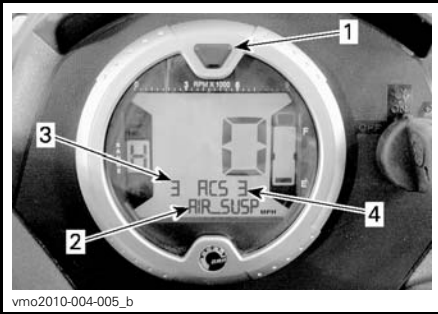

1. Selector button
2. **AIR_SUSP** displayed
3. Actual setting (pressure transducer reading)
4. Requested setting (set point)

To change the actual setting, proceed as follows:

1. Press selector button several times until **AIR_SUSP** is displayed.

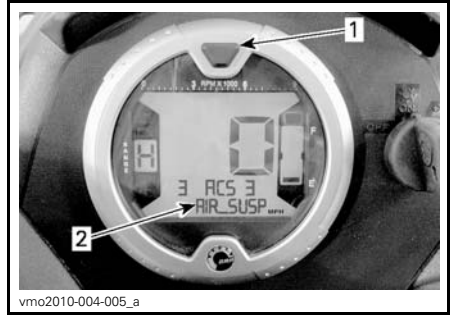

1. Selector button
2. **AIR_SUSP** displayed

2. Press and release **ACS** button until the requested setting is displayed.



TYPICAL

1. ACS button

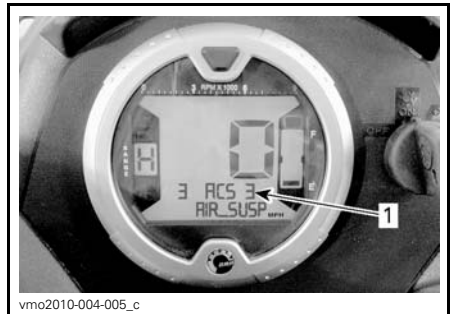

1. Requested setting

ACS Suspension Setting Acknowledgement

If ACS suspension was set to **ACS 5** or **ACS 6** before shutting down the vehicle for a short period of time, the multifunction gauge will scroll an acknowledgement message at startup. Make sure that the suspension is adjusted according to the load carried.

To acknowledge the ACS suspension setting, press and release **ACS** button while message appears.



TYPICAL

1. ACS button

NOTE: If the message is not acknowledged, the suspension will automatically return to setting **ACS 3**.

NOTE: If the selector button is pressed while the acknowledgement message appears, the suspension will directly return to setting **ACS 3**.

NOTE: If the vehicle transmission is set to **REVERSE** position at startup, the override message will be displayed instead of acknowledgement message.

Steering Assist Adjustment (DPS)

XT, XT-P, Xxc and LTD Models

The applicable models are equipped with a Dynamic Power Steering (DPS) system. The DPS reduces the effort to turn the handlebars.

The following DPS modes are preset in the vehicle.

DPS MODE	
DPS MAX.	Provides more steering assist (The handlebar will be easier to turn)
DPS MIN.	Provides less steering assist (The handlebar will be harder to turn)

To show the current DPS mode, proceed as follows:

1. Press and release **DPS** button.



1. DPS button

2. Check the multifunction gauge to confirm the current DPS mode.

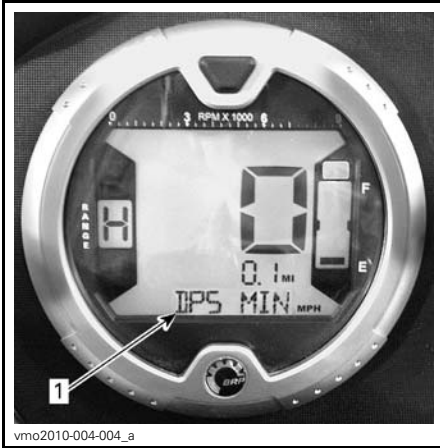

1. DPS mode display

To change the DPS mode, proceed as follows:

1. Press and hold **DPS** button for 4 seconds.

NOTE: The DPS adjustment will not be possible if the vehicle transmission is set to **REVERSE** or if the ACS mode is displayed in the multifunction gauge.

VEHICLE TRANSPORTATION

When transporting this vehicle, secure it to a trailer or in pickup box with suitable tie-downs. Use of ordinary ropes is not recommended.

⚠ WARNING

Do not tow this vehicle behind a car or other vehicle. Use a trailer. Never tip this vehicle on end for transporting. The vehicle must be in its normal operating position (on all four wheels).



Remember to:

- Unload vehicle racks before transportation.
- Set transmission lever to PARK position.
- Set the parking brake.
- Secure the vehicle by the front bumper and rear bumper.

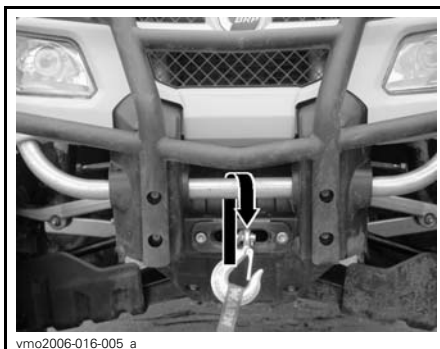

TYPICAL - ALL MODELS EXCEPT 800R X XC - FRONT TIE-DOWN POINT LOCATION



TYPICAL - 800R X XC MODELS - FRONT TIE-DOWN POINT LOCATION

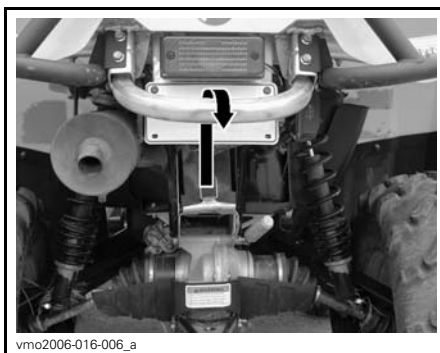

TYPICAL - REAR TIE-DOWN POINT LOCATION

NOTICE Securing vehicle at other locations may damage the vehicle.

***This page is
intentionally blank***

MAINTENANCE

BREAK-IN INSPECTION

BRP suggests that after the first 10 hours or 200 km (125 mi) of operation, whichever comes first, your vehicle be inspected by an authorized Can-Am dealer. The break-in inspection is very important and must not be neglected.

NOTE: The break-in inspection is at the expense of the vehicle owner.

We recommend that this inspection be signed by an authorized Can-Am dealer.

Date of inspection

Authorized dealer signature

Dealer name

BREAK-IN INSPECTION CHART	REPLACE					
	ADJUST					
	TIGHTEN					
	LUBRICATE					
	CLEAN					
	INSPECT					
ENGINE						
Engine oil and filter						X
Valve clearance	X				X	
Engine seals	X					
Engine mounting fasteners	X					
Exhaust system	X					
COOLING SYSTEM						
Radiator cap/cooling system pressure test	X					
Radiator		X				
ENGINE MANAGEMENT SYSTEM						
EMS sensors	X					
EMS fault codes	X					
FUEL SYSTEM						
Throttle body	X					
Throttle cable	X				X	
Fuel lines, fuel rails, connections, check valves and fuel tank leak test	X					
ELECTRICAL SYSTEM						
Spark plugs	X					
Battery connections	X					
Electrical connections and fastening (ignition system, starting system, fuel injectors etc.)	X					
CVT TRANSMISSION						
CVT air inlet (500/650)	X					
CVT air filter (800R)	X					

BREAK-IN INSPECTION CHART	REPLACE					
	ADJUST					
	TIGHTEN					
	LUBRICATE					
	CLEAN					
	INSPECT					
GEARBOX						
Gearbox oil						X
Speed sensor		X				
4 x 4 coupling unit	X					
DRIVE SYSTEM						
Front/rear differentials (oil level, seals and vents)	X					
Rear propeller shaft joint	X					
WHEELS						
Wheel nuts/studs	X					
Wheel beadlocks (800R X xc)				X		
STEERING SYSTEM						
Steering system (column, bearing, etc.)	X					
Front wheel alignment	X					
BRAKES						
Brake fluid	X					

MAINTENANCE SCHEDULE

Maintenance is very important for keeping your vehicle in safe operating condition. Proper maintenance is the owner's responsibility. The vehicle should be serviced as per the maintenance schedule.

The maintenance schedule does not exempt the pre-ride inspection.

WARNING

Failure to properly maintain the vehicle according to the maintenance schedule and procedures can make it unsafe to operate.

MAINTENANCE SCHEDULE						
PART/TASK	25 h or 750 km (500 mi)					
	50 h or 1 500 km (1,000 mi)					
PART/TASK	100 h or 1 year or 3 000 km (2,000 mi)					
	200 h or 2 years or 6 000 km (4,000 mi)					
To be performed by						LEGEND
ENGINE						
Engine oil and filter			R		Customer	(1) More often under dusty conditions. See <i>AIR FILTER</i> in <i>MAINTENANCE PROCEDURES</i> . (2) Oil must be added to the foam filter element of the air filter.
Valve clearance			I, A		Dealer	
Air filter	I, C ⁽¹⁾ , L ⁽²⁾	R ⁽¹⁾			Customer	
Engine seals			I		Dealer	
Engine mounting fasteners			I		Dealer	
Exhaust system			I		Dealer	
Muffler spark arrester			C		Customer	
COOLING SYSTEM						
Engine coolant			I ⁽³⁾	R	Customer	(3) Every 100 hours, check coolant strength.
Radiator cap/cooling system pressure test				I	Dealer	
ENGINE MANAGEMENT SYSTEM						
EMS sensors			I		Dealer	—
EMS fault codes			I		Dealer	

MAINTENANCE SCHEDULE

A: Adjust C: Clean I: Inspect L: Lubricate R: Replace	25 h or 750 km (500 mi)					To be performed by	LEGEND
	50 h or 1 500 km (1,000 mi)						
	100 h or 1 year or 3 000 km (2,000 mi)						
	200 h or 2 years or 6 000 km (4,000 mi)						
	PART/TASK						
FUEL SYSTEM							
Throttle body			I, L		Dealer	(4) More often under severe use such as dusty area, sand, snow, wet or muddy conditions.	
Throttle cable		I, A, L			Dealer/ Customer		
Fuel lines, fuel rails, connections, check valves and fuel tank leak test				I	Dealer		
Fuel pump pre-filter				I (4)	Dealer		
Fuel pump pressure test				I (4)	Dealer		
Fuel tank breather filter			R (4)		Customer		
ELECTRICAL SYSTEM							
Spark plugs				R (5)	Customer	(5) Make sure the spark plug is correctly gapped.	
Battery connections		I			Customer		
ECM connectors (visual inspection without disconnecting)			I		Dealer		
Electrical connections and fastening (ignition system, starting system, fuel injectors etc.)			I		Dealer		
CVT TRANSMISSION							
Drive belt			I		Dealer	(4) More often under severe use such as dusty area, sand, snow, wet or muddy conditions.	
Drive and driven pulleys (including one-way bearing)			I, C, L		Dealer		
CVT air inlet (500/650)		I, C			Dealer		
CVT air filter (800R)	I, C (4)				Customer		
GEARBOX							
Gearbox oil			I	R (4)	Dealer	(4) More often under severe use such as dusty area, sand, snow, wet or muddy conditions.	
Speed sensor				C	Dealer		
4 x 4 coupling unit			I		Dealer		

MAINTENANCE SCHEDULE						
A: Adjust C: Clean I: Inspect L: Lubricate R: Replace	25 h or 750 km (500 mi)					
	50 h or 1 500 km (1,000 mi)					
	100 h or 1 year or 3 000 km (2,000 mi)					
	200 h or 2 years or 6 000 km (4,000 mi)					
	To be performed by					
PART/TASK						LEGEND
DRIVE SYSTEM						
Front/rear differentials (oil level, seals and vents)		I		R	Dealer	(4) More often under severe use such as dusty area, sand, snow, wet or muddy conditions.
Drive shaft joints		I			Dealer	
Rear propeller shaft joint		I, L (4)			Dealer	
WHEEL/TIRES						
Wheel nuts/studs		I			Customer	(6) Retorque screws, Refer to <i>MAINTENANCE PROCEDURES</i> subsection.
Wheel bearings			I		Customer	
Wheel Beadlocks (800R X xc)	I (6)				Customer	
STEERING SYSTEM						
Handlebar fasteners			I		Dealer	(4) More often under severe use such as dusty area, sand, snow, wet or muddy conditions.
Steering system (column, bearing, etc.)			I (4)		Dealer	
Tie rod ends		I			Dealer	
Front wheel alignment			I, A		Dealer	
SUSPENSION						
Rear trailing arms			I		Dealer	(4) More often under severe use such as dusty area, sand, snow, wet or muddy conditions.
Rear trailing arm bearings				I	Dealer	
Shock absorbers		I			Dealer	
Front A-arms		I, L			Customer	
Ball joints	I				Dealer	
ACS compressor air filter	I, C (4)	R (4)			Customer	
ACS rear shock absorbers hoses and fittings			I		Customer	

MAINTENANCE SCHEDULE						
A: Adjust C: Clean I: Inspect L: Lubricate R: Replace	25 h or 750 km (500 mi)					
	50 h or 1 500 km (1,000 mi)					
	100 h or 1 year or 3 000 km (2,000 mi)					
	200 h or 2 years or 6 000 km (4,000 mi)					
	To be performed by					
PART/TASK						LEGEND
BRAKES						
Brake fluid	I			R (7)	Dealer/ Customer	(4) More often under severe use such as dusty area, sand, snow, wet or muddy conditions. (7) Brake fluid replacement or any brake system repairs must be performed by an authorized Can-Am dealer.
Brake pads	I (4) (7)				Dealer	
Brake system (discs, hoses, etc.)			I (4)		Customer	
BODY/CHASSIS						
Body and frame fasteners		I			Customer	—
Frame			I		Dealer	

MAINTENANCE PROCEDURES

This section includes instructions for basic maintenance procedures. If you have the necessary mechanical skills and the required tools, you can perform these procedures. If not, see your authorized Can-Am dealer.

Other important items in the maintenance schedule that are more difficult and require special tools are best performed by your authorized Can-Am dealer.

⚠ WARNING

Turn off the engine and follow these maintenance procedures when performing maintenance. If you do not follow proper maintenance procedures you can be injured by hot parts, moving parts, electricity, chemicals or other hazards.

⚠ WARNING

Should removal of a locking device be required (e.g. lock tab, self-locking fastener, etc.), always replace it with a new one.

Air Filter

Air Filter Maintenance Guideline

As with any ATV, air filter maintenance is critical to ensure proper engine performance and life span.

Air filter maintenance should be adjusted according to riding conditions.

Air filter maintenance must be increased in frequency and oil must be added to the foam filter element for the following dusty conditions:

- Riding on dry sand

- Riding on dry dirt covered surfaces
- Riding on dry gravel roads or similar conditions.

NOTE: Riding in a group in these conditions would increase even more the air filter maintenance. Refer to *AIR FILTER CLEANING AND LUBRICATION* in this subsection for maintenance procedure.

NOTE: An accessory pre-filter for "dusty conditions" may be used. Contact an authorized Can-Am dealer for details.

Air Filter Removal

NOTICE Never remove or modify any component in the air filter housing. Otherwise, engine performance degradation or damage can occur. The engine is calibrated to operate specifically with these components.

Remove seat.

Release central panel tabs from frame.

Remove central panel by pulling it towards the rear.



1. Central panel
2. Tabs

Release clamps and remove air filter box cover.

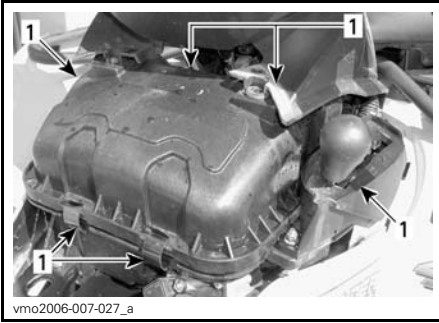

1. Release clamps

500 Models

Loosen clamp and remove air filter.

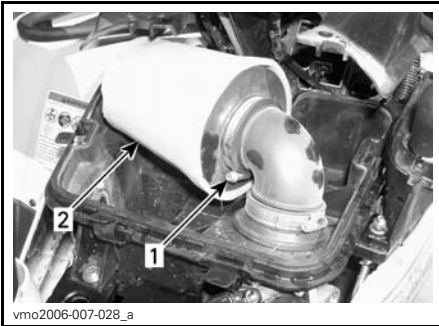

500 AIR FILTER SHOWN

1. Clamp
2. Air filter

Remove foam filter element by carefully pulling it outwards.

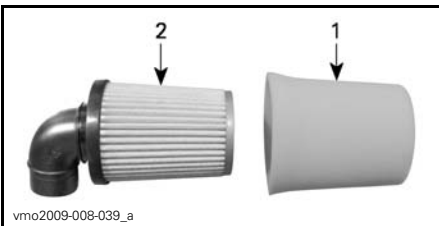

1. Foam filter element
2. Paper filter

650 and 800R Models

Loosen clamp and remove air filter.



650 AND 800R AIR FILTER SHOWN

1. Clamp
2. Air filter

Remove foam filter element by carefully pushing the extremities toward the inside.

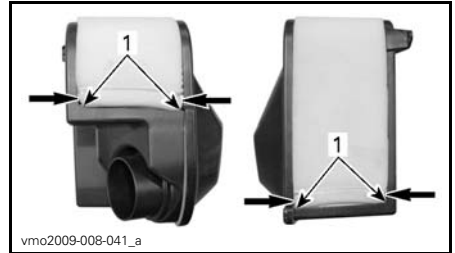

1. Foam filter element extremities



1. Foam filter element
2. Paper filter

Air Filter Cleaning and Lubrication

⚠ CAUTION Always wear appropriate skin and eye protection. Chemicals can cause a skin rash and eye injury.

Paper Filter Cleaning

1. Ensure that the foam filter element is removed from paper filter.
2. Tap out heavy dust from the paper element.

This will allow dirt and dust to get out of the paper filter.

NOTE: Paper filter have a limited life span; replace filter if too dirty or clogged.

NOTICE It is not recommended to blow compressed air on the paper filter; this could damage the paper fibers and reduce its filtration ability when used in dusty environments.

NOTICE Do not wash the paper filter with any cleaning solution.

Foam Filter Element Cleaning

1. Spray the foam filter element inside and out with AIR FILTER CLEANER (P/N 219 700 341).



219700341

AIR FILTER CLEANER (P/N 219 700 341)



vbs2009-012-015_a

TYPICAL - SPRAY THE FOAM ELEMENT

2. Let stand for 3 minutes.
3. As stated on air filter cleaner (UNI) container, rinse with plain water.
4. Dry the foam element completely.

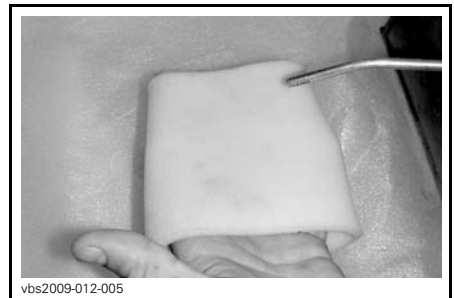

vbs2009-012-005

TYPICAL - DRY

NOTE: A second application may be necessary for heavily soiled elements.

Foam Filter Element Lubrication

1. Spray AIR FILTER OIL (P/N 219 700 340) on the foam filter element previously dried.



219700340

AIR FILTER OIL (P/N 219 700 340)



vbs2009-012-014

TYPICAL - OIL THE FOAM FILTER ELEMENT

2. Let stand for 3 to 5 minutes.
3. Remove any excess of oil that could transfer to the paper filter by wrapping the foam filter element into an absorbent cloth and squeezing gently. This will also ensure a full oil coverage on foam filter.
4. Reinstall the foam filter element over the paper filter.

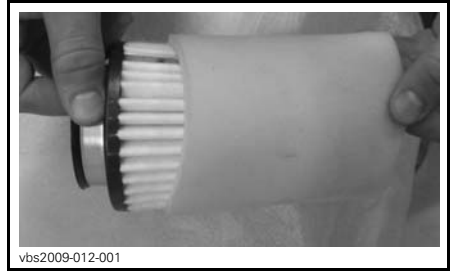

vbs2009-012-001

TYPICAL

Air Filter Installation

Properly reinstall removed parts in the reverse order of their removal.

Engine Oil

Engine Oil Level

NOTICE Check level frequently and refill if necessary. **Do not overfill.** Operating the engine/gearbox with an improper level may severely damage engine/gearbox. Wipe off any spillage.

NOTE: While checking the oil level, visually inspect engine area for leaks.

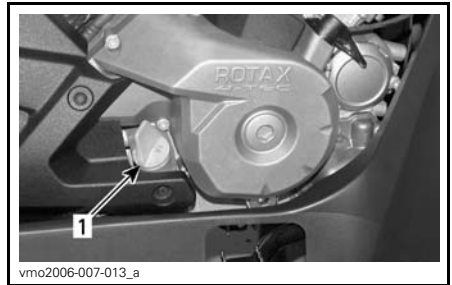

vmo2006-007-013_a

RH SIDE OF ENGINE

1. Dipstick

With vehicle on a level surface and engine cold, not running, check the oil level as follows:

1. Unscrew dipstick then remove it and wipe clean.

2. Reinstall dipstick, screw in it completely.
3. Remove and check oil level. It should be near or equal to the upper mark.

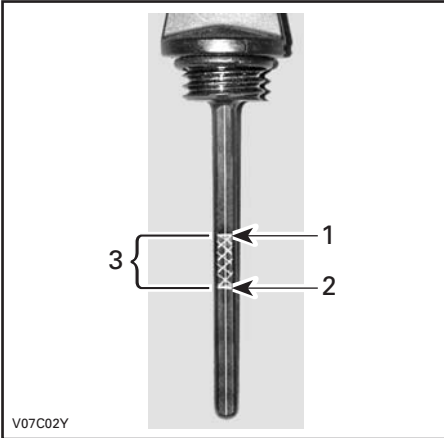

TYPICAL

1. Full
2. Add
3. Operating range

To add oil, remove dipstick. Place a funnel into the dipstick tube to avoid spillage.

Add a small amount of recommended oil and recheck oil level.

Repeat the above procedures until oil level reaches the dipstick's upper mark. **Do not overfill.**

Properly tighten dipstick.

NOTE: The XPS oil is specially formulated and tested for the severe requirements of this engine.

If not available, use 4-stroke SAE 5W30 engine oil that meets or exceeds the requirements for API service classification SM, SL or SJ. Always check the API service label certification on the oil container it must contain at least one of the above standards. Refer to the viscosity chart for details.

Engine Oil Viscosity Chart

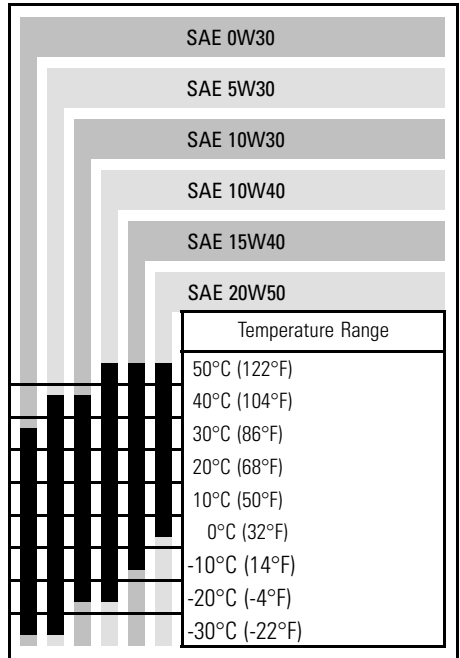

Recommended Engine Oil

For the summer season, use XPS SYNTHETIC BLEND OIL (SUMMER GRADE) (P/N 293 600 121).

For the winter season, use XPS SYNTHETIC OIL (WINTER GRADE) (P/N 293 600 112).

Engine Oil Change

Oil and filter are to be replaced at the same time.

Oil change should be done with a warm engine.

⚠ CAUTION The engine oil can be very hot. In order to avoid potential burns, do not remove the engine drain plug or the filter cover if the engine is hot. Wait until engine oil is warm.

Ensure vehicle is on a level surface.

Remove dipstick.

Clean the oil drain plug area.

Place a drain pan under the oil drain plug area.

Unscrew oil drain plug.

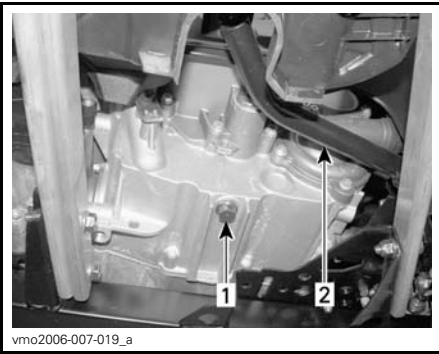

TYPICAL
1. Oil drain plug
2. Brake pedal

Allow enough time for oil to flow out of oil filter.

Replace the oil filter. Refer to *OIL FILTER* in this subsection.

Change gasket on oil drain plug.

Clean gasket area on engine and oil drain plug then reinstall plug.

Refill engine at the proper level with the recommended oil.

Refer to *SPECIFICATIONS* subsection for oil capacity.

Start engine and let idle for a few minutes.

Ensure oil filter area and oil drain plug areas are not leaking.

Stop engine.

Wait a while to allow oil to flow down to crankcase then check oil level.

Refill as necessary.

Dispose of oil as per your local environmental regulations.

Oil Filter

Oil Filter Replacement

Remove the right engine cover.

Unscrew the oil filter cover.



1. Oil filter cover

Remove the oil filter and replace with a new filter.

Check the cover O-ring and change it if necessary.

Screw oil filter cover in place.

Wipe out any oil spillage on engine.

Radiator

Radiator Inspection

Periodically check the radiator area for cleanliness.

Engine Coolant

Engine Coolant Level

WARNING

Check coolant level with engine cold. Never add coolant in cooling system when engine is hot.

NOTE: While checking the coolant level, visually inspect engine area for leaks.

Remove the front service compartment panel.

– To remove front service compartment panel, unlatch and lift it.



TYPICAL
1. Radiator

Inspect radiator and hoses for leaks or any damage.

Inspect radiating fins. They must be clean, free of mud, dirt, leaves and any other deposit that would prevent the radiator to cool properly.

Remove as much deposits as you can with your hands. If water is available in proximity, try rinsing the radiating fins.

If available, use a garden hose to rinse the radiating fins.

CAUTION  Never clean radiator with your hands when it is hot. Let the radiator cool down before cleaning.

NOTICE Be careful not to damage the radiating fins when cleaning. Do not use any object/tool that could damage the fins. The fins are purposely thin parts to allow efficient cooling. **WHEN HOSING, USE LOW PRESSURE ONLY, NEVER USE A HIGH PRESSURE WASHER.**

See an authorized Can-Am dealer to check the performance of the cooling system.

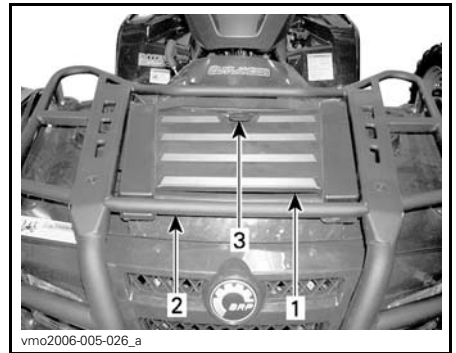

1. Front service compartment panel
2. Front rack
3. Latch

With vehicle on a level surface, liquid should be between MIN. and MAX. level marks of coolant reservoir.

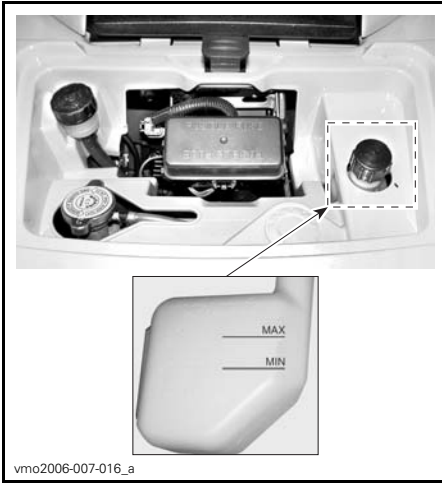

TYPICAL - COOLANT RESERVOIR

NOTE: When checking level at temperature lower than 20°C (68°F), it may be slightly lower than MIN. mark.

Add coolant up to MAX. mark if required.

Use a funnel to avoid spillage. Do not overfill.

Properly reinstall and tighten filler cap.

Route coolant reservoir hose as per the following illustration.

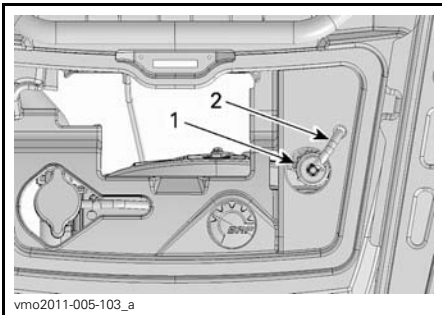

TYPICAL

1. Filler cap
2. Coolant reservoir hose

NOTE: Ensure coolant reservoir hose is properly routed as per the above illustration to avoid any interference, when closing cover, with the winch remote control.

Reinstall front service compartment panel.

If the coolant is added in the coolant reservoir, check the level in the radiator too.

Add coolant if necessary.

⚠ WARNING

In order to avoid potential burning, do not remove the radiator cap if the engine is hot.

NOTE: A cooling system that frequently requires coolant is the indication of leaks or engine problems. See an authorized Can-Am dealer.

NOTICE Do not store any objects in the front service compartment.

Recommended Engine Coolant

Always use ethylene-glycol antifreeze containing corrosion inhibitors specifically for internal combustion aluminum engines.

Cooling system must be filled with BRP PREMIXED COOLANT (P/N 219 700 362) or with distilled water and antifreeze solution (50% distilled water, 50% antifreeze).

Engine Coolant Replacement

⚠ WARNING

In order to avoid potential burns, do not remove the radiator cap or loosen the coolant drain plug if the engine is hot.

NOTICE Do not store any objects in the front service compartment.

Remove the front service compartment panel. Refer to *ENGINE COOLANT LEVEL* in this subsection.

Remove the radiator cap.

To remove the radiator cap, press and turn it counterclockwise.



1. Radiator cap

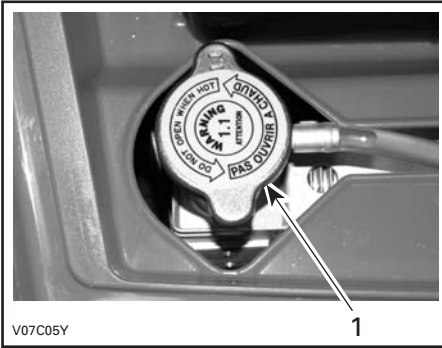

1. Radiator cap

Unscrew the coolant drain plug and drain the coolant into a suitable container.

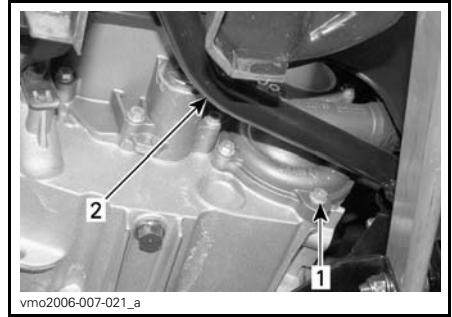

1. Coolant drain plug
2. Brake pedal

NOTE: Do not unscrew the coolant drain plug completely.

Remove the RH side panel.

Unscrew the bleeding screw on the top of thermostat housing.



1. Bleeding screw

Drain the system completely.

Reinstall the coolant drain plug.

Pinch hose between radiator and thermostat housing with a LARGE HOSE PINCHER (P/N 529 032 500) or an equivalent.

NOTICE Do not use vise-grip pliers to pinch hose.



1. Hose pincher

Fill the radiator until the coolant comes out by the thermostat housing hole.

Install the bleeding screw then remove the hose pincher.

Complete the radiator filling.

Check the level in the coolant reservoir and refill if necessary.

Run engine at idle with the radiator cap off. Slowly add coolant if necessary.

At this point, wait until engine reaches normal operating temperature.

Depress the throttle lever two or three times; then add coolant if required.

Install radiator cap as the reverse of removal.

Inspect all connections for leaks and check coolant level in the reservoir.

Muffler Spark Arrester

Spark Arrester Cleaning

The muffler must be periodically purged of accumulated carbon.

⚠ WARNING

Never run engine in an enclosed area. Never perform this operation immediately after the engine has been run because exhaust system is very hot. Make sure that there are no combustible materials in the area. Wear eye protection and gloves. Never stand behind the vehicle while purging exhaust system. Respect all applicable laws and regulations.

Select a well-ventilated area and make sure the muffler is cool.

Place transmission on PARK position.

Remove the clean out plug of the muffler.



TYPICAL
1. Clean out plug
2. Muffler

Block the end of the muffler with a shop rag and start engine.

Momentarily increase engine RPM several times to purge accumulated carbon out of the muffler.

Stop engine and allow muffler to cool.

Reinstall the clean out plug.

CVT Air Filter

800R Only

CVT Air Filter Removal

1. Remove seat from vehicle.
2. Release central panel tabs from frame.
3. Remove central panel by pulling it towards the rear of vehicle.



1. Central panel
2. Tabs

4. Lift dashboard upwards.

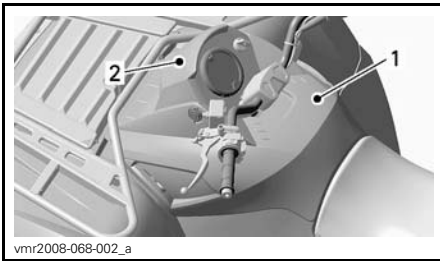

TYPICAL

1. Central panel
2. Dashboard

5. Remove air filter from CVT air inlet by stretching its sides.

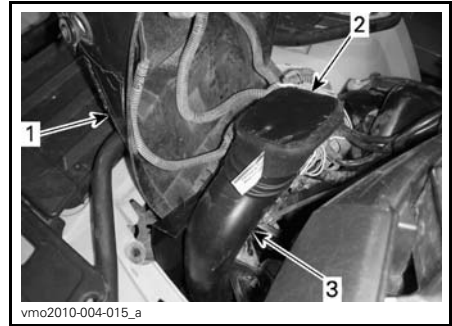

1. Dashboard
2. CVT air filter
3. CVT air inlet

CVT Air Filter Cleaning

1. Spray filter inside and out with AIR FILTER CLEANER (P/N 219 700 341).



AIR FILTER CLEANER (P/N 219 700 341)

2. Let stand for 3 minutes.

While reading this Operator's Guide, remember that:

⚠️ WARNING

Indicates a potential hazard that, if not avoided, could result in serious injury or death.

3. As stated on air filter cleaner (UNI) container, rinse filter with plain water.
4. Dry filter completely.

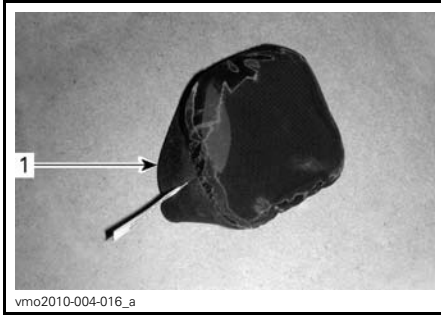

1. CVT air filter

5. Clean inside the CVT air inlet end

CVT Air Filter Installation

1. Install air filter on CVT inlet by stretching its sides.
2. Move dashboard downwards and properly clip tabs.
3. Install central panel.
4. Install seat.

CVT Cover

CVT Cover Draining

Any time you suspect that water has entered the CVT cover, drain the CVT housing by removing the drain screw.



BEHIND LH FOOTREST

1. Drain screw

Gearbox Oil

Gearbox Oil Level

NOTICE Check level and refill if necessary. **Do not overfill.** Operating the gearbox with an improper level may severely damage gearbox. Wipe off any spillage.

Place the vehicle on a level surface.

Select NEUTRAL position.

Apply parking brake.

Check the gearbox oil level by removing the gearbox oil level plug.

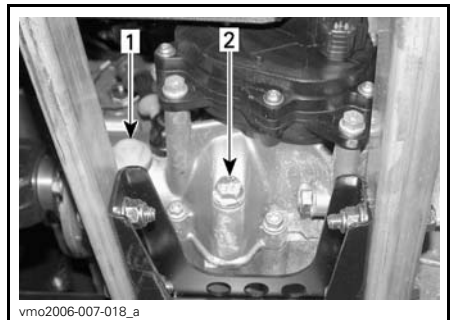

1. Oil level plug
2. Oil drain plug

The oil should be level with the bottom of the oil level hole.

Refill as required until gearbox oil level flows through oil level hole.

Recommended Gearbox Oil

Use XPS CHAINCASE OIL (P/N 415 129 500) or an equivalent.

NOTICE Do not use another types of oil when servicing. Do not mix with other types of oil.

Gearbox Oil Change

Place the vehicle on a level surface.

Clean drain plug area and oil level plug.

Remove the gearbox drain plug.

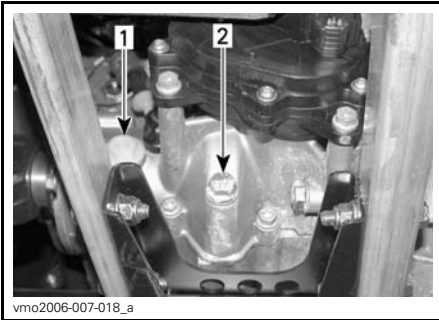

1. Oil level plug
2. Oil drain plug

NOTE: To completely drain the gearbox, place a jack under the left footrest and tilt the vehicle toward the right side. When the gearbox is empty, install the drain plug and replace the vehicle on the ground.

Refill gearbox, using XPS CHAINCASE OIL (P/N 415 129 500) or an equivalent.

NOTICE Do not use another types of oil when servicing. Do not mix with other types of oil.

The oil should be level with the bottom of the oil level hole.

Refill as required until gearbox oil level flows through oil level hole.

Reinstall oil level plug.

Throttle Cable

Throttle Cable Lubrication

The throttle cable must be lubricated with CABLE LUBRICANT (P/N 293 600 041) or an equivalent.

⚠ WARNING

Always use a silicone-based lubricant. Using another lubricant (like a water-based lubricant) could cause the throttle lever/cable to become sticky and stiff.

Open the throttle lever housing.

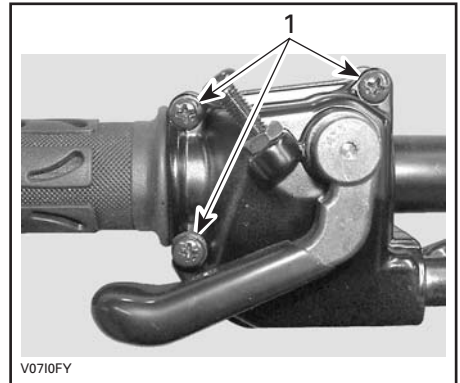

1. Remove these screws

Separate the housing.

Slide rubber protector back to expose throttle cable adjuster.

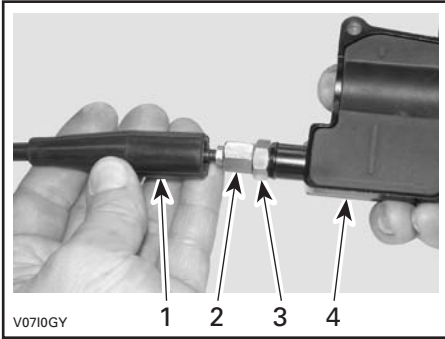

1. Cable protector
2. Throttle cable adjuster
3. Lock nut
4. Throttle lever housing

Screw in the throttle cable adjuster.
Remove inner housing protector.

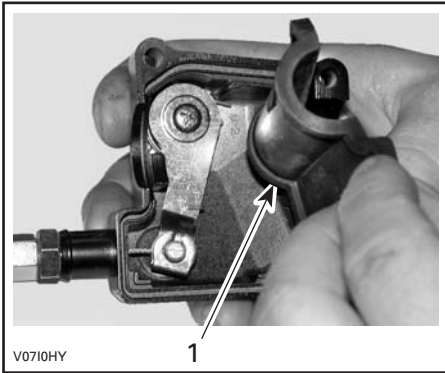

1. Inner housing protector

Remove the cable from the throttle lever housing.

NOTE: Slide cable in clip slot and remove the end of cable from clip.

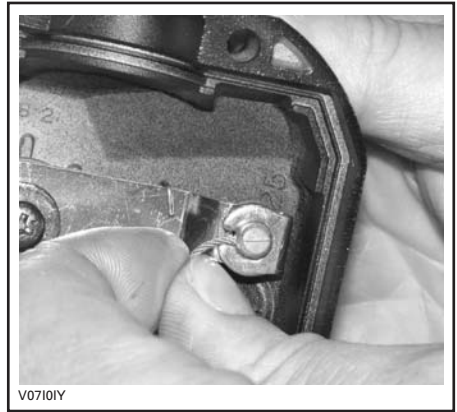

Remove the throttle body side cover.

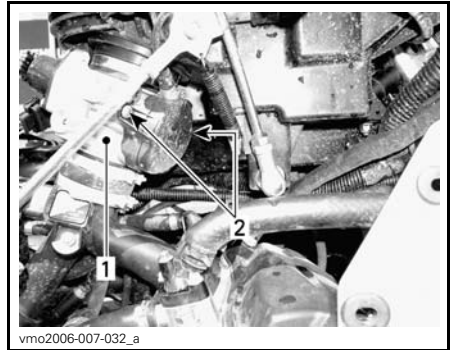

1. Throttle body
2. Side cover screws

Insert the needle of the lubricant can in the end of throttle cable adjuster.

⚠ CAUTION Always wear appropriate skin and eye protection. Chemicals can cause a skin rash and eye injury.

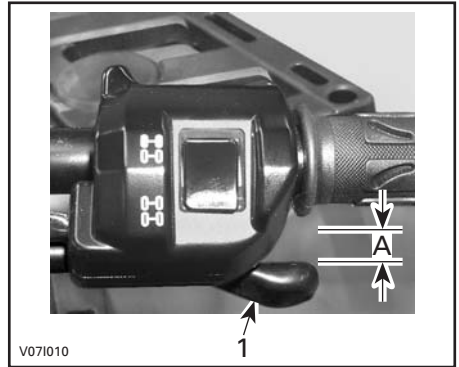

- 1. Throttle lever
- A. 3 mm to 6 mm (1/8 in to 1/4 in)

With the transmission lever on PARK position, start the engine.

Check if the throttle cable is adjusted correctly by turning handlebar fully to the right then fully to the left. If the engine RPM increases, readjust the throttle lever free play.

Spark Plugs

⚠ WARNING

Unless otherwise indicated, always turn ignition switch to the OFF position before performing any maintenance or repair on electrical system.

Spark Plug Removal

⚠ CAUTION Always wear safety goggles when using pressurized air.

- Remove side panels.
- Unplug spark plug cables.
- Unscrew spark plugs one turn.
- Clean spark plugs and cylinder heads with pressurized air if possible.

TYPICAL

NOTE: Place a rag around the throttle cable adjuster to prevent the lubricant from splashing.

Add lubricant until it runs out at throttle body end of the throttle cable.

Reinstall and adjust the cable.

Throttle Cable Adjustment

Slide rubber protector back to expose throttle cable adjuster.

Loosen lock nut then turn the adjuster to obtain correct throttle lever free play.

NOTE: Measure throttle free play at the tip of throttle lever.

Tighten lock nut and reinstall protector.

Unscrew spark plugs completely then remove them.

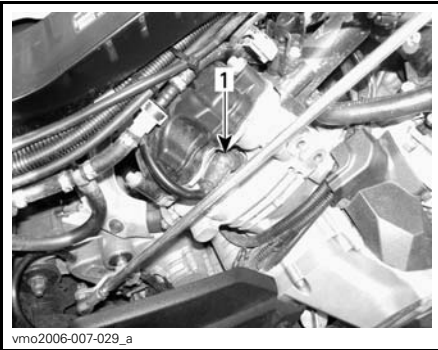

RH SIDE — REAR CYLINDER
1. Spark plug



LH SIDE — FRONT CYLINDER
1. Spark plug

Spark Plug Installation

Prior to installation, make sure that contact surfaces of cylinder heads and spark plugs are free of grime.

Using a feeler gauge, set the spark plug gap between 0.6 mm to 0.7 mm (.024 in to .028 in).

Apply anti-seize lubricant over spark plug threads to prevent a possible seizure.

Screw spark plugs into cylinder heads by hand and tighten with a torque wrench and a proper socket.

Torque spark plugs to $20 \text{ N}\cdot\text{m} \pm 2.4 \text{ N}\cdot\text{m}$ ($15 \text{ lbf}\cdot\text{ft} \pm 2 \text{ lbf}\cdot\text{ft}$).

Battery

⚠ WARNING

Unless otherwise indicated, always turn ignition switch to the OFF position before performing any maintenance or repair on electrical system.

⚠ CAUTION Never charge a battery while installed in vehicle.

These vehicles are equipped with a VRLA battery (Valve Regulated Lead Acid). It is a maintenance-free type battery, there is no need to add water to adjust electrolyte level.

NOTICE Never remove the battery sealing cap.

Battery Removal

NOTICE Always disconnect BLACK (-) battery cable first.

Disconnect BLACK (-) cable first then RED (+) cable.

Remove the holding strap then pull the battery out of frame.



vmo2006-007-025_a

1. Battery
2. Holding strap

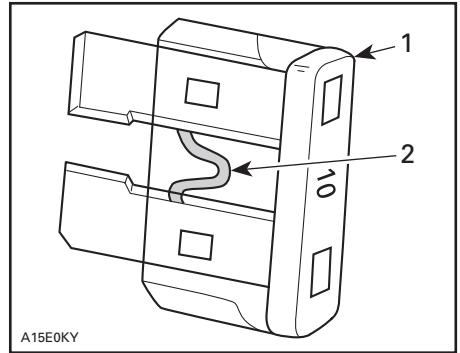

A15E0KY

TYPICAL

1. Fuse
2. Check if melted

NOTICE Do not use a higher rated fuse as this can cause severe damage.

Front Fuse Location

Remove the front service compartment panel.

- To remove front service compartment panel, unlatch and lift it.

Battery Cleaning

Clean battery, battery casing and battery posts using a solution of baking soda and water.

Remove corrosion from battery cable terminals and battery posts using a firm wire brush.

Battery casing should be cleaned by soft brush and baking soda solution.

Battery Installation

Reinstall battery in vehicle.

NOTICE Always connect RED (+) battery cable first.

Fuses

CAUTION Always turn the ignition switch to OFF position before replacing a defective fuse.

Fuse Inspection

Check if filament is melted.

If filament is melted, replace damaged fuse, refer to *FUSE LOCATION* tables for proper rating.

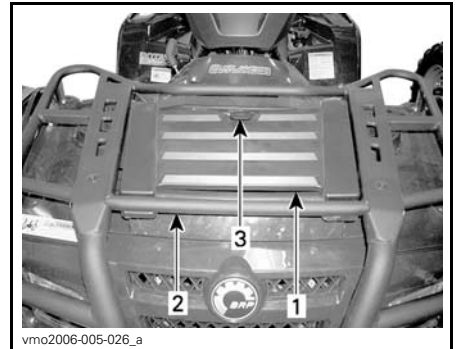

vmo2006-005-026_a

1. Front service compartment panel
2. Front rack
3. Latch



TYPICAL - FRONT SERVICE COMPARTMENT
1. Front fuse box



TYPICAL - OUTLANDER 800R LTD SHOWN
1. Rear fuse holder

FRONT FUSE BOX		
NO	DESCRIPTION	RATING
F1	Ignition coils	5 A
F2	Fan	20 A
F3	Fuel injectors	5 A
F4	Speedometer, speed sensor, taillight	7.5 A
F5	Fuel pump	7.5 A
F6	Engine control module (ECM)	5 A
F7	Accessories	20 A
F14	Air controlled suspension (ACS) (If applicable)	20 A

NOTE: Check inside fuse box cover to know fuses location.

NOTICE Do not store any objects in the front service compartment.

Rear Fuse Location

The rear fuse holder is located at the rear of vehicle near battery.

All Models except LTD

REAR FUSE HOLDER		
NO	DESCRIPTION	RATING
F1	Main	30 A
F2	Fan/Accessories	30 A
F3	Dynamic power steering (DPS) (If applicable)	40 A

LTD Models

REAR FUSE HOLDER		
No	DESCRIPTION	RATING
F1	Main	30 A
F2	Fan/Accessories	40 A
F3	Dynamic power steering (DPS)	40 A

Lights

CAUTION Always turn the ignition switch to OFF position before replacing a defective bulb.

Always check light operation after replacement.

Headlight Bulb Replacement

NOTICE Never touch glass portion of a halogen bulb with bare fingers, it shortens its operating life. If glass is touched, clean it with isopropyl alcohol which will not leave a film on the bulb.

NOTE: On the following illustration, the headlight has been removed for a better comprehension.

Turn the ignition switch to **OFF** position.

Remove cover screws.

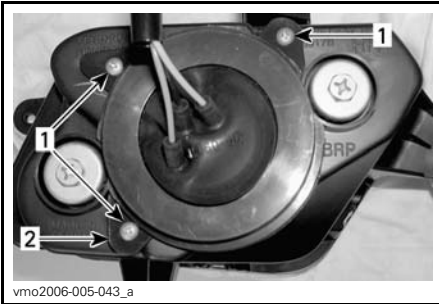

1. Screws
2. Holder

Remove rubber protector from headlight housing.

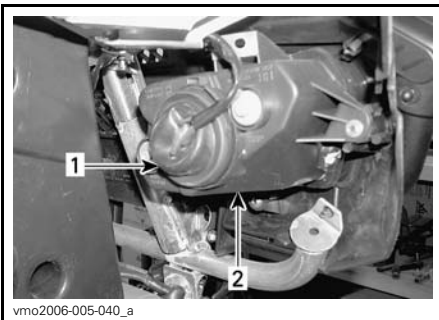

1. Rubber protector
2. Headlight housing

Unplug connector from headlight.

NOTE: Press small locking tab to unlock connector then pull on connector.

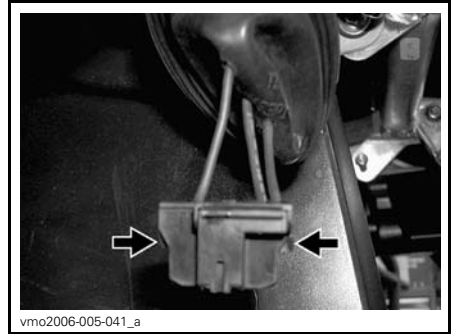

PUSH ON LOCKING TAB TO UNLOCK CONNECTOR

NOTE: Concerning the following illustrations, the front fascia has been removed from the vehicle for a better comprehension.

Press the spindle then push it on the side to unlock headlight bulb.

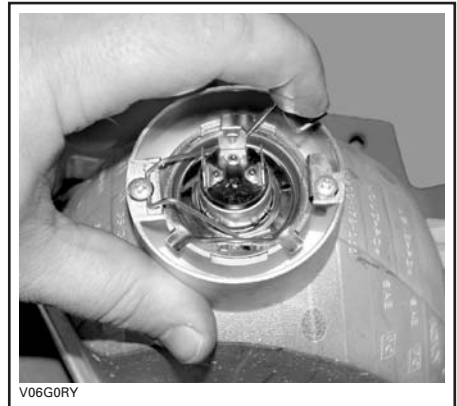

TYPICAL

Lift and hold the spindle then remove the bulb.



TYPICAL

Properly reinstall removed parts in the reverse order of their removal.

Taillight/Brake Light Bulb Replacement

Turn the ignition switch to **OFF** position.

To have access to bulb, pull on taillight to release it from its rubber grommets.

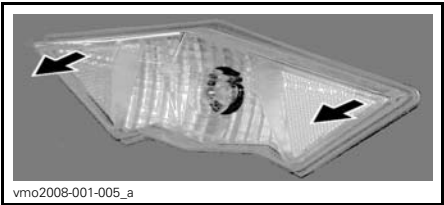

Turn and pull light socket to expose bulb.



Push the bulb in and hold while turning counterclockwise to release.

Install the new bulb by pushing in while turning clockwise.

Reinstall all removed parts.

Headlight Beam Aiming

Adjust beam aiming as follows:

Turn knobs to adjust beam height and side orientation to your convenience.

Adjust both headlights evenly.

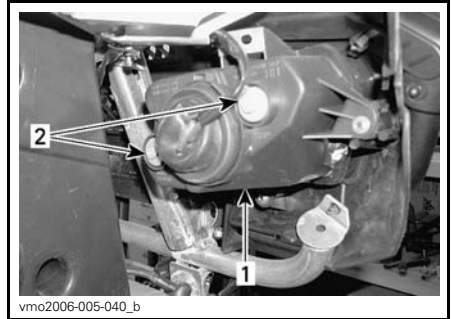

TYPICAL

1. Headlight cover
2. Adjustment screws

Drive Shaft Boot and Protector

Drive Shaft Boot and Protector Inspection

Visually inspect drive shaft protectors and boots conditions.

Check protectors for damage or rubbing against shafts.

Check boots for cracks, tears, leaking grease etc.

Repair or replace damaged parts as necessary.

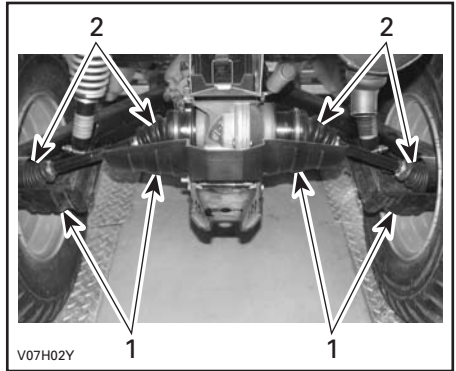

TYPICAL — REAR OF VEHICLE

1. Drive shaft protectors
2. Drive shaft boots

Wheels and Tires

Tire Pressure

⚠ WARNING

Tire pressure greatly affects vehicle handling and stability. Under-pressure may cause tire to deflate and rotate on wheel. Overpressure may burst the tire. Always follow recommended pressure. Since tires are low-pressure types, a manual pump should be used.

Check pressure when tires are cold before using the vehicle. Tire pressure changes with temperature and altitude. Recheck pressure if one of these conditions has changed.

For your convenience, a pressure gauge is supplied in tool kit.

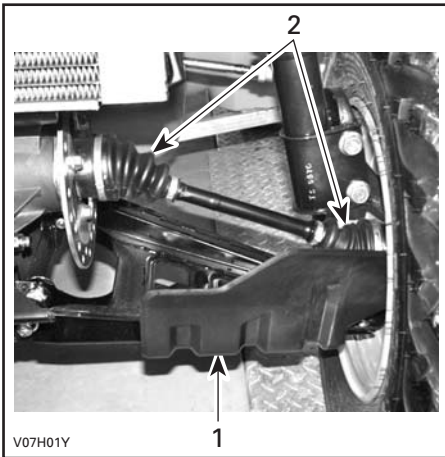

TYPICAL — FRONT OF VEHICLE

1. Drive shaft protector
2. Drive shaft boots

While reading this Operator's Guide, remember that:

⚠ WARNING

Indicates a potential hazard that, if not avoided, could result in serious injury or death.

TIRE PRESSURE			
All Models	MAX.	FRONT	REAR
		48.3 kPa (7 PSI)	48.3 kPa (7 PSI)
	MIN.	34.5 kPa (5 PSI)	34.5 kPa (5 PSI)

Although the tires are specifically designed for off-road use, a flat may still occur. Therefore, it is recommended to carry a tire pump and a repair kit.

Tire Inspection

Check tire for damage and wear. Replace if necessary.

Do not rotate tires. The front and rear tires have a different size. The tires are directional and their rotation must be kept in a specific direction for proper operation.

Tire Replacement

Tires replacement should be performed by an authorized Can-Am dealer.

⚠ WARNING

- When the tires are replaced, never install a bias tire with a radial tire. Such a combination could create handling and/or stability problems.
- Do not mix tires of different size and/or design on the same axle.
- Front and rear tire pairs must have an identical model and manufacturer.
- For unidirectional tread pattern, ensure that the tires are installed in the correct direction of rotation.
- The radial tires must be installed as a complete set.

Wheel Bearing Inspection

Place vehicle on a level surface.

Apply parking brake.

Lift vehicle.

Secure vehicle on jack stands.

Push and pull the wheels from the upper edge to feel the play.

See an authorized Can-Am dealer if there is any play.

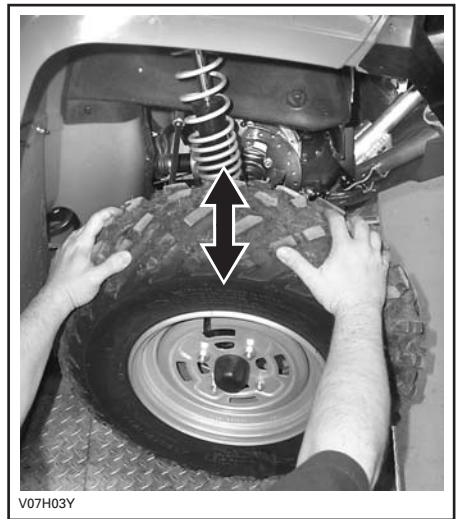

V07H03Y

TYPICAL

Wheel Beadlock Inspection

Wheel Beadlock Retorque

800R X xc Models

NOTICE Do not use an impact wrench for tightening beadlock screws in order to avoid to damage them.

1. Retorque all screws to 6N•m (53 lbf•in) in a criss-cross sequence.

2. Tighten screws a few turns at a time to ensure even pressure on the beadlock clamp ring.



NOTE: It is normal that the beadlock clamp ring flexes slightly to match the tire bead.

Wheel Beadlock Gap Verification

800R Xxc Models

1. Verify the gap between tire and beadlock clamp ring, it should be practically equal all around the ring.

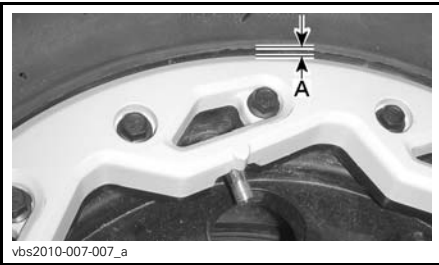

A. Gap equal all around bead lock clamp ring

If the gap is not acceptable, see an authorized Can-Am dealer.

Wheel Removal and Installation

- Place vehicle on a level surface.
- Apply parking brake.
- Loosen lug nuts then lift vehicle.

Secure vehicle on jack stands.

Remove nuts then remove wheel.

At installation, it is recommended to apply anti-seize lubricant on threads.

Carefully tighten nuts in a criss-cross sequence then apply final torque.

WHEEL NUT TORQUE	
Steel Wheel	70 N•m ± 7 N•m (52 lbf•ft ± 5 lbf•ft)
Aluminum Wheel	100 N•m ± 10 N•m (74 lbf•ft ± 7 lbf•ft)

NOTE: Occasionally, wheel nuts should be removed to apply anti-seize lubricant on studs to ease future removal. This is particularly important when vehicle is used in salt-water environment or in mud. Remove one nut at a time, lubricate then retorque.

NOTICE Always use the recommended wheel nuts according to the type of wheel. Using a different nut could cause damages to the rim.

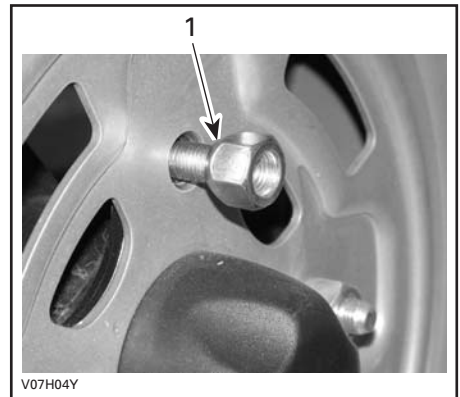

TYPICAL — STEEL WHEEL

1. Taper side of nut (opened end type)

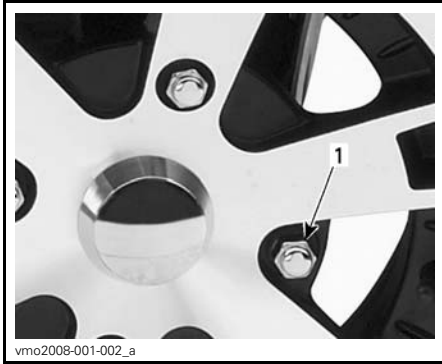

TYPICAL — ALUMINUM WHEEL
1. Wheel nut (closed end type)

Suspension

Suspension Lubrication

Lubricate front A-arms.

Use SUSPENSION GREASE (P/N 293 550 033) or an equivalent.

There is two grease fittings on each A-arm.

Suspension Inspection

Shock Absorbers

Inspect the McPherson struts or shock absorber for oil leaks or other damages.

Check tightness of fasteners.

See an authorized Can-Am dealer as necessary.

Front A-Arms

Check A-arms for cracks, bending or other damages.

See an authorized Can-Am dealer as necessary.

Rear Trailing Arms

Check trailing arms for distortion, cracks or bending.

See an authorized Can-Am dealer if any problem is detected.

ACS Compressor

Air Filter Cleaning (ACS Compressor)

Remove seat.

Release central panel tabs from frame.

Remove central panel by pulling it towards the rear.



1. Central panel
2. Tabs

Release clamps and remove air filter box cover.

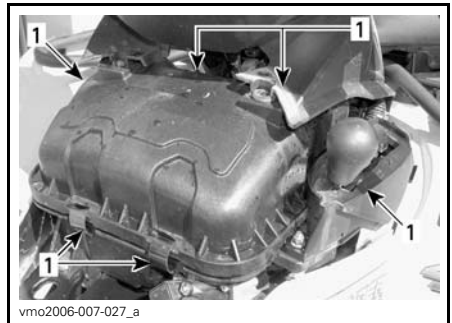

1. Release clamps

Locate ACS compressor air filter.



vmo2010-004-009_a

1. ACS compressor air filter

Push tabs then open cover.

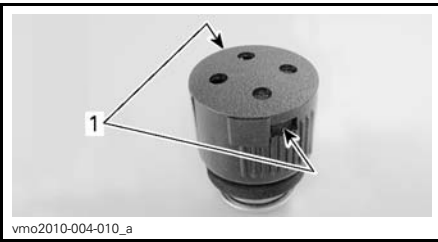

vmo2010-004-010_a

ACS COMPRESSOR AIR FILTER REMOVED FOR CLARITY PURPOSE

1. tabs

Remove prefilter (foam) and filter (disc).

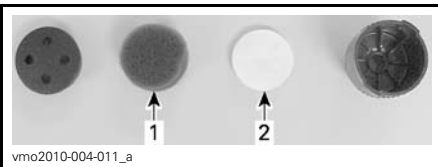

vmo2010-004-011_a

ACS COMPRESSOR AIR FILTER REMOVED FOR CLARITY PURPOSE

1. Prefilter (foam)
2. Filter (disc)

Clean prefilter (foam) as follows:

1. Spray the prefilter inside and out with AIR FILTER CLEANER (P/N 219 700 341).
2. Let stand for 3 minutes.

3. As stated on air filter cleaner (UNI) container, rinse prefilter with plain water.

4. Dry the prefilter completely.

Clean filter (disc) as follows:

1. Blow low pressure compressed air on filter to clean it.

NOTICE Do not wash the filter (disc) with any cleaning solution.

Clean ACS air filter housing as follows:

1. Disconnect the compressor inlet hose from air box fitting as follows:
 - 1.1 Push fitting ring toward fitting.
 - 1.2 Hold ring in place.
 - 1.3 Pull inlet hose.

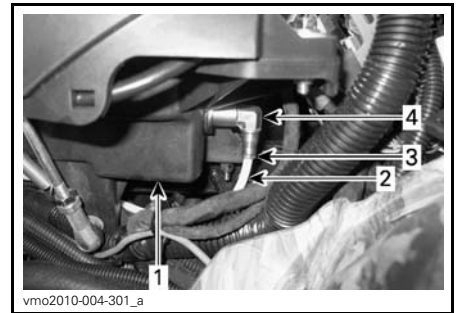

vmo2010-004-301_a

1. Air box
2. Compressor inlet hose
3. Fitting ring
4. Fitting

2. Clean inside the ACS air filter housing.
3. Connect compressor inlet hose on air box fitting.
4. Push hose until the mark is completely inserted into fitting.

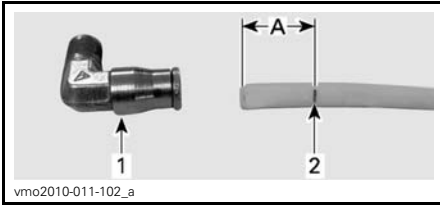

1. Fitting
2. Mark

A. Must be inserted into fitting



HOSE PROPERLY INSERTED INTO FITTING

NOTE: Always disconnect compressor inlet hose from air box fitting before cleaning the filter housing in order to avoid pushing dirt into the hose.

NOTICE Ensure that inlet hose is completely pushed into fitting in order to avoid disconnecting.

Reinstall air filter on vehicle as the reverse of removal procedure.

ACS Hoses and Fittings

ACS Hoses and Fittings Inspection

- Check rear shock hoses for damages.
- Check rear shock fittings for damages.
- Check hoses and fittings for air leaks.

Brakes

⚠ WARNING

New brakes will not operate at their maximum efficiency until their break-in is completed. Braking performance may be reduced, so use extra caution.

Brake Fluid Reservoir Level

NOTICE Use only DOT 4 brake fluid from a sealed container. Do not use brake fluid taken from old or already opened containers.

With vehicle on a level surface, check brake fluid in reservoirs for proper level. They should be above MIN. mark.

Add fluid as required. **Do not overfill.**

Clean filler cap before removing.

NOTE: A low level may indicate leaks or worn brake pads. See an authorized Can-Am dealer.

Brake Lever Fluid Reservoir(s)

Turn steering in the straight-ahead position to ensure reservoir is level.

Check the brake fluid level, the reservoir is full when the fluid reaches of the top of window.

Visually inspect lever boot condition.

Check for cracks, tears, etc. Replace if damaged.

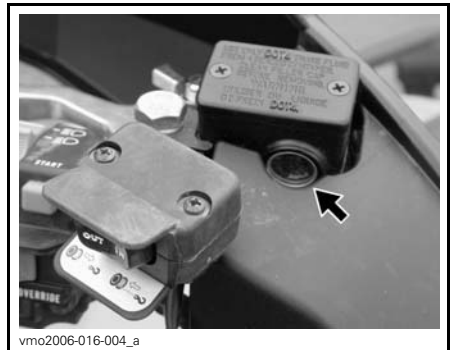

TYPICAL

Brake Pedal Fluid Reservoir

Remove the front service compartment panel as follows:

- Unlatch and lift it.

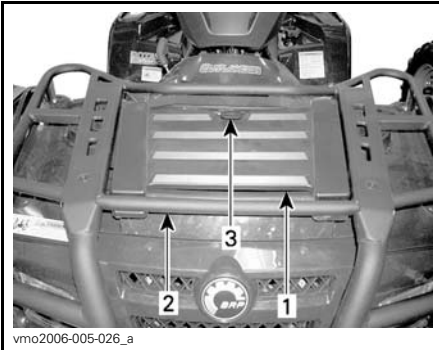

1. Front service compartment panel
2. Front rack
3. Latch

With vehicle on a level surface, liquid should be between MIN. and MAX. level marks of brake pedal fluid reservoir.



TYPICAL - BRAKE PEDAL FLUID RESERVOIR

NOTICE Do not store any objects in the front service compartment.

Recommended Brake Fluid

Always use brake fluid meeting the specification DOT 4 only.

NOTICE To avoid serious damage to the braking system, do not use fluids other than the recommended one, nor mix different fluids for topping up.

Brake Inspection

Check the following to keep the brakes in a good operating condition:

- Brake fluid level
- Brake system for fluid leaks
- Brake for spongy feel
- Brake cleanliness
- Brake discs for excessive wear and surface condition
- Brake pads for wear, damage or looseness.

SERVICE LIMITS	
Brake pads thickness	1.0 mm (.039 in)
Front discs thickness	3.5 mm (.138 in)
Rear disc thickness	4.3 mm (.169 in)
Maximum discs warp	0.2 mm (.008 in)

See your authorized Can-Am dealer if a problem is detected concerning the brake system.

⚠ WARNING
The brake fluid replacement or brake system maintenance and repairs should be performed by an authorized Can-Am dealer.

Fuel Tank Breather Filter

Fuel Tank Breather Filter Replacement

1. Remove seat.
2. Locate fuel tank breather filter.

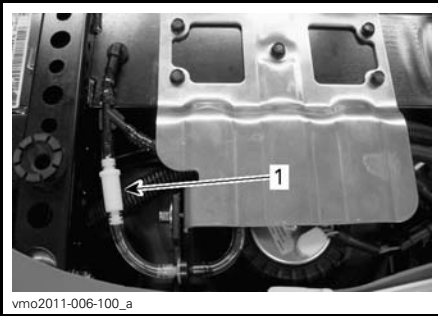

1. Fuel tank breather filter

3. Remove filter by carefully cutting hoses at both ends.

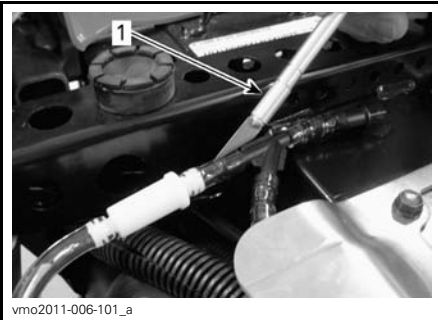

TYPICAL - CAREFULLY CUT HOSE

1. Cutting tool

4. Replace both hoses on fuel tank breather line.
5. Install a **new** filter with the arrow pointing towards the outside of vehicle.

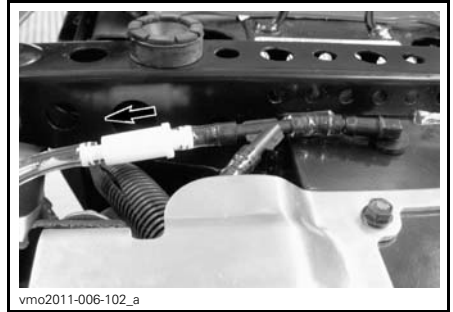

ARROW POINTING TOWARDS OUTSIDE

NOTICE Ensure that all hoses are properly pushed into fittings in order to avoid disconnecting.

6. Reinstall seat.

VEHICLE CARE

Post-Operation Care

When vehicle is used in salt-water environment (beach area, launching and loading boats etc.), rinsing the vehicle with fresh water is necessary to preserve vehicle and its components. Metallic parts lubrication is highly recommended. Use XPS LUBE (P/N 293 600 016) or an equivalent. This must be performed at the end of each operating day.

When vehicle is operated in muddy conditions, rinsing the vehicle is recommended to preserve vehicle and its components and to keep lights clean.

NOTE: Never use a high pressure washer to clean the vehicle. **USE LOW PRESSURE ONLY (like a garden hose).** High pressure can cause electrical or mechanical damages.

Vehicle Cleaning and Protection

Never use a high pressure washer to clean the vehicle. **USE LOW PRESSURE ONLY (like a garden hose).** High pressure can cause electrical or mechanical damages.

Painted parts which are damaged should be properly repainted to prevent rust.

When required, wash the body with warm water and soap (only use mild detergent). Apply non-abrasive wax.

NOTICE Never clean plastic parts with strong detergent, degreasing agent, paint thinner, acetone, etc.

STORAGE AND PRESEASON PREPARATION



WARNING

Have an authorized Can-Am dealer inspect fuel system integrity as specified in *MAINTENANCE SCHEDULE* subsection.

When a vehicle is not in use for a period of four (4) months, proper storage is a necessity.

See an authorized Can-Am dealer for proper procedures.

When using your vehicle after storage, a post storage preparation is required. See an authorized Can-Am dealer for proper procedures.

TECHNICAL INFORMATION

VEHICLE IDENTIFICATION

The main components of your vehicle (engine and frame) are identified using different serial numbers. It may sometimes become necessary to locate these numbers for warranty purposes or to trace your vehicle in the event of loss. These numbers are also required by the authorized Can-Am dealer to complete warranty claims properly. No warranty will be allowed by BRP if the engine identification number (EIN) or vehicle identification number (VIN) is removed, mutilated or altered in any way. We strongly recommend that you take note of all the serial numbers on your vehicle and supply them to your insurance company.

Engine and Vehicle Identification Number Location

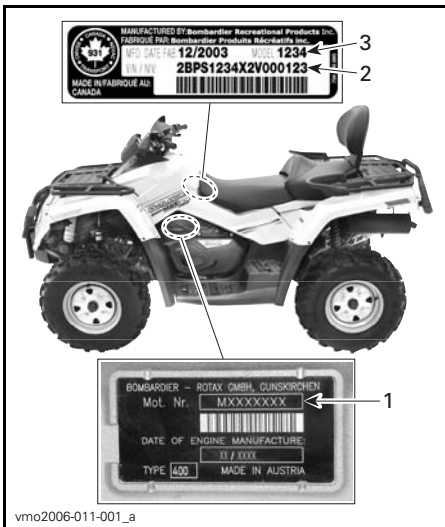

TYPICAL — ALL MODELS

1. E.I.N. (Engine Identification Number)
2. V.I.N. (Vehicle Identification Number)
3. Model

NOISE EMISSION CONTROL SYSTEM REGULATION

USA and Canada Only

Tampering with Noise Control System Is Prohibited!

U.S. Federal law and Canadian provincial laws may prohibit the following acts or the causing there of:

1. The removal or rendering inoperative by any person other than for purposes of maintenance, repair or replacement of any device or element of design incorporated into any new vehicle for the purpose of noise control prior to its sale or delivery to the ultimate purchaser or while it is in use or
2. The use of the vehicle after such device or element of design has been removed or rendered inoperative by any person.

Among those Acts Presumed to Constitute Tampering Are the Acts Listed Below:

1. Removal or alteration or the puncturing of the muffler or any engine component which conducts removal of engine exhaust gases.
2. Removal or alteration or the puncturing of any part of the intake system.
3. Replacing any moving parts of the vehicle or parts of the exhaust or intake system, with parts other than those specified by the manufacturer.
4. Lack of proper maintenance.

The EC-Declaration of Conformity does not appear in this version of the Operator's Guide.

Please refer to the printed version that was delivered with your vehicle.

SPECIFICATIONS

All Models except 800R X xc

MODEL		OUTLANDER 500	OUTLANDER 650	OUTLANDER 800R
ENGINE				
Engine type		ROTAX V490	ROTAX V660	ROTAX V810
		4-stroke, Single Over Head Camshaft (SOHC), liquid cooled		
Number of cylinders		2		
Number of valves		8 valves (mechanical adjustment)		
Bore		82 mm (3.23 in)		91 mm (3.58 in)
Stroke		47.3 mm (1.86 in)	61.5 mm (2.42 in)	
Displacement		499.6 cm ³ (30.5 in ³)	649.6 cm ³ (39.64 in ³)	799.9 cm ³ (48.81 in ³)
Compression ratio		10.7:1	10.3:1	
Maximum HP		7400 RPM	7700 RPM	7250 RPM
Lubrication	Type		Wet sump. Replaceable oil filter	
	Oil filter		BRP Rotax paper type, replaceable	
	Engine oil	Capacity (oil change with filter)	2.2 L (2.3 qt (U.S. liq.))	
		Recommended	For the summer season, use XPS SYNTHETIC BLEND OIL (SUMMER GRADE) (P/N 293 600 121) For the winter season, use XPS SYNTHETIC OIL (WINTER GRADE) (P/N 293 600 112) see <i>ENGINE OIL VISCOSITY CHART</i>	
Exhaust system		Spark arrestor approved by USDA Forest Service		
Air filter		Synthetic paper filter with foam		
COOLING SYSTEM				
Coolant		Type	Ethyl glycol/water mix (50% coolant, 50% water). Use premixed coolant sold by BRP (P/N 219 700 362) or coolant specifically designed for aluminum engines	
		Capacity	2.5 L (2.6 qt (U.S. liq.))	

SPECIFICATIONS

MODEL		OUTLANDER 500	OUTLANDER 650	OUTLANDER 800R
ELECTRICAL SYSTEM				
Magneto generator output (except XT, XT-P and LTD)		400 W		
Magneto generator output (XT, XT-P and LTD models)		650 W		
Ignition system type		IDI (Inductive Discharge Ignition)		
Ignition timing		Not adjustable		
Spark plug	Quantity	2		
	Make and type	NGK DCPR8E		
	Gap	0.6 mm to 0.7 mm (.024 in to .028 in)		
Engine RPM limiter setting	Forward	8000 RPM		
	Reverse	3200 RPM		
Battery	Type	Dry battery type		
	Voltage	12 volts		
	Nominal rating	18 A•h		
	Power starter output	0.7 KW		
Headlight		2 x 35 W		
Taillight		7/29 W		
Indicator lamps		LEDS, 0.7 V approximately (each)		
Fuses	Front fuse box	Ignition coils	5 A	
		Fan	20 A	
		Fuel injectors	5 A	
		Speedometer/speed sensor/taillight	7.5 A	
		Fuel pump	7.5 A	
		Engine control module (ECM)	5 A	
		Accessories	20 A	
		Air controlled suspension (ACS) (if applicable)	20 A	
	Rear fuse holder	Main	30 A	
		Fan/Accessories	30 A (40 A for LTD models)	
		Dynamic power steering (DPS) (if applicable)	40 A	

MODEL			OUTLANDER 500	OUTLANDER 650	OUTLANDER 800R
FUEL SYSTEM					
Fuel delivery		Type	Electronic Fuel Injection (EFI), Dell'Orto 46 mm throttle body, 1 injector per cylinder		
Fuel pump		Type	Electrical (in fuel tank)		
		Model	Bosch		
Idle speed			1250 ± 50 RPM (not adjustable)		
Fuel	Type		Regular unleaded gasoline		
	Octane no.	Inside North America	87 ((R+M)/2) or higher		
		Outside North America	92 RON or higher		
Fuel tank capacity			16.3 L (4.3 U.S. gal.)		
Remaining fuel in fuel tank when display light turns ON			± 2 L (.5 U.S. gal.)		
CVT TRANSMISSION					
Type			CVT (Continuously Variable Transmission)		
Engagement RPM			1750 ± 100 RPM		
GEARBOX					
Type			Dual range (HI-LO) with park, neutral and reverse		
Gearbox oil		Capacity	400 ml (14 U.S. oz)		
		Recommended	XPS chaincase oil		
DRIVE SYSTEM					
Front drive			Shaft driven/auto-lock differential (shear pump)		
Front drive ratio			3.6:1		
Rear drive			Shaft driven/locked differential		
Rear drive ratio			3.6:1		
Differential oil		Capacity	Front	500 ml (17 U.S. oz)	
			Rear	250 ml (8.5 U.S. oz)	
		Recommended	BRP differential oil (P/N 293 600 043) or synthetic oil 75W90 (API GL5)		
CV joint grease			CV joint grease (P/N 293 550 019)		
Propeller shaft grease			XPS synthetic grease (P/N 293 550 010)		

SPECIFICATIONS

MODEL		OUTLANDER 500	OUTLANDER 650	OUTLANDER 800R
STEERING SYSTEM				
Turning radius	1-UP	2.1 m (7 ft)		
	2-UP	2.4 m (7.9 ft)		
Total toe (vehicle on ground)		0 mm (0 in)		
FRONT SUSPENSION				
Suspension type		MacPherson	Double A-arm	
Suspension travel		178 mm (7 in)	203 mm (8 in)	
Shock absorber	Qty	2		
	Type	Oil		
Front preload adjustment		—	5 settings	
REAR SUSPENSION (except ACS)				
Suspension type		TTI™ independent		
Suspension travel		229 mm (9 in)		
Shock absorber	Qty	2		
	Type	Oil		
Rear preload adjustment		5 settings		
REAR SUSPENSION (ACS)				
Suspension type		—	—	TTI™ independent
Shock absorber type		—	—	High pressure gas shock
Pneumatic pressure range		—	—	0.35 bar to 6.90 bar (5 PSI to 100 PSI)
Ride height adjustment		—	—	6 preset modes

MODEL		OUTLANDER 500	OUTLANDER 650	OUTLANDER 800R
BRAKES				
Front brake	Type	Hydraulic, 2 discs		
Rear brake	Type	Hydraulic, single disc		
Brake fluid	Capacity	180 ml (6 U.S. oz)		
	Type	DOT 4		
Parking brake		Hydraulic lock-4 wheels		
Caliper		Floating		
Brake pad material	Front	Organic		
	Rear	Metallic		
Minimum brake pad thickness		1 mm (.039 in)		
Minimum brake disc thickness	Front	3.5 mm (.138 in)		
	Rear	4.3 mm (.169 in)		
Maximum brake disc warpage		0.2 mm (.008 in)		
TIRES				
Pressure	Front	Maximum	48.3 kPa (7 PSI)	
		Minimum	34.5 kPa (5 PSI)	
	Rear	Maximum	48.3 kPa (7 PSI)	
		Minimum	34.5 kPa (5 PSI)	
Minimum tire thread depth		3 mm (.118 in)		
Size	Front	25 x 8 x 12	26 x 8 x 12	
	Rear	25 x 11 x 12	26 x 10 x 12	
WHEELS				
Size	Front	12 x 6 (in)		
	Rear	12 x 7.5 (in)		
Wheel nuts torque	Steel Wheel	70 N•m ± 7 N•m (52 lbf•ft ± 5 lbf•ft)		
	Aluminum Wheel	100 N•m ± 10 N•m (74 lbf•ft ± 7 lbf•ft)		

SPECIFICATIONS

MODEL		OUTLANDER 500	OUTLANDER 650	OUTLANDER 800R
DIMENSION				
Overall length	1-UP	218 cm (86 in)		
	2-UP	239 cm (94 in)		
Overall width		117 cm (46 in)		
Overall height		114 cm (45 in)		
Wheelbase	1-UP	130 cm (51 in)		
	2-UP	150 cm (59 in)		
Wheel track	Front	96.5 cm (38 in)		
	Rear	91.4 cm (36 in)		
Ground clearance		27.9 cm (11 in)	30.5 cm (12 in)	30.5 cm (12 in)
LOADING CAPACITY AND WEIGHT				
Weight	1-UP	293 kg (646 lb)	299 kg (659 lb)	301 kg (664 lb)
	2-UP	312 kg (688 lb)	322 kg (710 lb)	323 kg (712 lb)
Weight distribution	Front/rear	1-UP	51/49	
		2-UP	48/52	
Rear storage box (included with rear rack weight)		10 kg (22 lb)		
Rack	Front	45 kg (99 lb)		
	Rear (including rear storage box and tongue weight)	90 kg (198 lb)		
Total vehicle load allowed (including driver, all other loads and added accessories)	1-UP	235 kg (518 lb)		
	2-UP	272 kg (600 lb)		
Gross vehicle weight rating	1-UP	553 kg (1,219 lb)	584 kg (1,287 lb)	
	2-UP	558 kg (1,230 lb)	649 kg (1,431 lb)	
Towing capacity		591 kg (1,303 lb)		
Tongue capacity (included with rear rack weight)		23 kg (51 lb)		

800R X xc Models

MODEL		OUTLANDER 800R X XC	
ENGINE			
Engine type		4-stroke, Single Over Head Camshaft (SOHC), liquid cooled	
Number of cylinders		2	
Number of valves		8 valves (mechanical adjustment)	
Bore		91 mm (3.58 in)	
Stroke		61.5 mm (2.42 in)	
Displacement		799.9 cm ³ (48.81 in ³)	
Compression ratio		10.3:1	
Maximum Horsepower RPM		7250 RPM	
Lubrication	Type	Wet sump. Replaceable oil filter	
	Oil filter	BRP Rotax® paper type, replaceable	
	Engine oil	Capacity (oil change with filter)	2.2 L (2.3 qt (U.S. liq.))
		Recommended	For the summer season, use XPS SYNTHETIC BLEND OIL (SUMMER GRADE) (P/N 293 600 121). For the winter season, use XPS SYNTHETIC OIL (WINTER GRADE) (P/N 293 600 112). See <i>OIL VISCOSITY CHART</i>
Exhaust system		Spark arrestor approved by USDA Forest Service	
Air filter		Synthetic paper filter with foam	
COOLING SYSTEM			
Coolant	Type	Ethyl glycol/water mix (50% coolant, 50% water). Use premixed coolant sold by BRP (P/N 219 700 362) or coolant specifically designed for aluminum engines	
	Capacity	2.5 L (2.6 qt (U.S. liq.))	

SPECIFICATIONS

MODEL		OUTLANDER 800R X XC	
ELECTRICAL SYSTEM			
Magneto generator output		650 W	
Ignition system type		IDI (Inductive Discharge Ignition)	
Ignition timing		Not adjustable	
Spark plug	Quantity	2	
	Make and type	NGK DCPR8E	
	Gap	0.6 mm to 0.7 mm (.024 in to .028 in)	
Engine RPM limiter setting	Forward	8000 RPM	
	Reverse	3200 RPM	
Battery	Type	Dry battery type	
	Voltage	12 volts	
	Nominal rating	18 A•h	
	Power starter output	0.7 KW	
Headlight		2 x 35 W	
Taillight		7/29 W	
Indicator lamps		LEDS, 0.7 V approximately (each)	
Fuses	Front fuse box	Ignition coils	5 A
		Fan	20 A
		Fuel injectors	5 A
		Speedometer/speed sensor/taillight	7.5 A
		Fuel pump	7.5 A
		Engine control module (ECM)	5 A
		Accessories	20 A
	Rear fuse holder	Main	30 A
		Fan/Accessories	30 A
		Dynamic power steering (DPS)	40 A

MODEL		OUTLANDER 800R X XC	
FUEL SYSTEM			
Fuel delivery		Type	Electronic Fuel Injection (EFI), Dell'Orto 46 mm throttle body, 1 injector per cylinder
Fuel pump		Model	Electrical (in fuel tank)
Idle speed			1250 ± 50 RPM (not adjustable)
Fuel	Type		Regular unleaded gasoline
	Minimum octane	Inside North America	87 (R+M)/2 or higher
		Outside North America	92 RON or higher
Fuel tank capacity			16.3 L (4 U.S. gal.)
Remaining fuel in fuel tank when display light turns ON			± 2 L (.5 U.S. gal.)
CVT TRANSMISSION			
Type			CVT (Continuously Variable Transmission)
Engagement RPM			1600 ± 100 RPM
GEARBOX			
Type			Dual range (HI-LO) with park, neutral and reverse
Gearbox oil	Capacity		400 ml (14 U.S. oz)
	Recommended		XPS chaincase oil (P/N 413 801 900)
DRIVE SYSTEM			
Differential oil	Capacity	Front	500 ml (17 U.S. oz)
		Rear	250 ml (8.5 U.S. oz)
	Recommended		BRP differential oil (P/N 293 600 043) or synthetic oil 75W 90 (API GL5)
Front drive			Shaft driven/single Auto-lock differential (pump driven)
Front drive ratio			3.6:1
Rear drive			Shaft driven/single differential
Rear drive ratio			3.6:1
CV joint grease			CV joint grease (P/N 293 550 019)
Propeller shaft grease			XPS synthetic grease (P/N 293 550 010)

SPECIFICATIONS

MODEL		OUTLANDER 800R X XC
STEERING		
Turning radius		2.1 m (7 ft)
Total toe (vehicle on ground)		0 mm (0 in)
Camber angle		0°
Front sway bar		Yes
SUSPENSION		
<i>FRONT</i>		
Suspension type		Double A-Arm
Suspension travel		216 mm (8.5 in)
Shock absorber	Qty	2
	Type	HPG Clicker
<i>REAR</i>		
Suspension type		TTI™ independent
Suspension travel		mm (in)
Shock absorber		229 mm (9 in)
Shock absorber	Qty	2
	Type	HPG Clicker
BRAKES		
Front brake	Type	Hydraulic, 2 discs
Rear brake	Type	Hydraulic, single disc
Brake fluid	Capacity	250 ml (8.5 U.S. oz)
	Type	DOT 4
Parking brake		LH brake lever includes a lock on rear wheels
Caliper		Floating
Brake pad material	Front	Metallic
	Rear	Metallic
Minimum bake pad thickness		1 mm (.039 in)
Minimum brake disc thickness	Front	4.3 mm (.169 in)
	Rear	4.3 mm (.169 in)
Maximum brake disc warpage		0.2 mm (.008 in)

MODEL		OUTLANDER 800R X XC
TIRES AND WHEELS		
<i>TIRES</i>		
Pressure	Front	Maximum: 48.3 kPa (7 PSI) Minimum: 34.5 kPa (5 PSI)
	Rear	Maximum: 48.3 kPa (7 PSI) Minimum: 34.5 kPa (5 PSI)
Minimum tire thread depth		3 mm (.118 in)
Size	Front	25 x 8 x 12 (in)
	Rear	25 x 10 x 12 (in)
<i>WHEELS</i>		
Size	Front	12 x 6 (in) Beadlock wheels
	Rear	12 x 7.5 (in) Beadlock wheels
Wheel nuts torque		100 N•m ± 10 N•m (74 lbf•ft ± 7 lbf•ft)
DIMENSIONS		
Overall length		218 cm (86 in)
Overall width		117 cm (46 in)
Overall height		114 cm (45 in)
Wheelbase		129.5 cm (51 in)
Wheel track	Front	96.5 cm (38 in)
	Rear	91.4 cm (36 in)
Ground clearance		30.5 cm (12 in)
LOADING CAPACITY AND WEIGHT		
Dry weight		338 kg (745 lb)
Weight distribution	Front/rear	51/49
Rear storage box		3.7 L (1 U.S. gal.)
Rack	Front	45 kg (99 lb)
	Rear	90 kg (198 lb)
Total vehicle load allowed (including driver, all other loads and added accessories)		235 kg (518 lb)
Gross vehicle weight rating		584 kg (1,287 lb)

***This page is
intentionally blank***

TROUBLESHOOTING

TROUBLESHOOTING GUIDELINES

ENGINE DOES NOT TURN

1. Ignition switch is in the OFF position.
 - Place switch to the ON position.
2. Emergency engine stop switch.
 - Make sure that emergency engine stop switch is in ON position.
3. Transmission is not set on PARK or NEUTRAL.
 - Set transmission either in PARK or in NEUTRAL or press the brake lever.
4. Burnt fuse.
 - Check main fuse condition.
5. Weak battery or loose connections.
 - Check charging system fuse.
 - Check connections and terminals condition.
 - Have the battery checked.
 - Contact an authorized Can-Am dealer.
6. Wrong ignition key, multifunction gauge display shows INVALID KEY.
 - Use the proper key for this vehicle.

ENGINE TURNS OVER BUT FAILS TO START

1. Flooded engine (spark plug wet when removed).
 - (Drowned mode) If the engine does not start and it is fuel-flooded, this special mode can be activated to prevent fuel injection and to cut ignition while cranking. Proceed as follows:
 - Insert key in ignition switch and turn to ON position.
 - Press completely and HOLD throttle lever.
 - Press the engine START button.The engine should be cranked for 20 seconds. Release engine START button.
Release throttle lever and start/crank engine again to allow starting.
 - If it does not work:**
 - Clean the spark plug caps area then remove them.
 - Remove the spark plugs (tools are supplied in tool kit).
 - Crank engine several times.
 - Install new spark plugs if possible or clean and dry spark plugs.
 - Start engine as explained above.If engine continues to flood, see an authorized Can-Am dealer.
 - NOTE:** Make sure to verify that there is no fuel in engine oil, if so, replace engine oil.
2. No fuel to the engine (spark plug dry when removed).
 - Check fuel tank level.
 - A failure of the fuel pump may have occurred.
 - Contact an authorized Can-Am dealer.

ENGINE TURNS OVER BUT FAILS TO START (cont'd)

3. Spark plug/ignition (no spark).

- *Check main fuse condition.*
- *Remove spark plug then reconnect to ignition coil.*
- *Check that ignition switch and/or emergency engine stop switch is/are at the ON position.*
- *Start engine with spark plug grounded to the engine away from spark plug hole. If no spark appears, replace spark plug.*
- *If trouble persists, contact an authorized Can-Am dealer.*

4. Multifunction gauge CHECK ENGINE indicator lamp is on and display shows CHECK ENGINE.

- *Contact an authorized Can-Am dealer.*

5. Engine is under a protection (limp home) mode.

- *Multifunction gauge CHECK ENGINE indicator lamp is on and display shows CHECK ENGINE, contact an authorized Can-Am dealer.*

ENGINE LACKS ACCELERATION OR POWER

1. Fouled or defective spark plug.

- *Refer to ENGINE TURNS OVER BUT FAILS TO START.*

2. Lack of fuel to engine.

- *Refer to ENGINE TURNS OVER BUT FAILS TO START.*

3. Engine is overheating. (CHECK ENGINE indicator light will turn on and HI TEMP will appear in the multifunction display.)

- *Refer to ENGINE OVERHEATS.*

4. Air filter/housing clogged or dirty.

- *Check air filter and clean if necessary.*
- *Check deposits in air filter housing drain.*
- *Check the position of the air intake tube.*

5. CVT dirty or worn-out.

- *Contact an authorized Can-Am dealer.*

6. Engine is under a protection (limp home) mode.

- *Check multifunction gauge display for messages.*
- *Multifunction gauge CHECK ENGINE indicator lamp is on and display shows CHECK ENGINE or LIMP HOME, contact an authorized Can-Am dealer.*

ENGINE OVERHEATS

1. Low coolant in cooling system.

- *Check engine coolant, refer to ENGINE COOLANT in MAINTENANCE section.*

ENGINE OVERHEATS (cont'd)

2. Dirty radiator fins.

- *Clean radiator fins, refer to RADIATOR in MAINTENANCE section.*

3. Cooling fan inoperative.

- *Check cooling fan fuse, refer to MAINTENANCE section. If the fuse is good, contact an authorized Can-Am dealer.*

ENGINE BACKFIRE

1. Exhaust system leakage.

- *Contact an authorized Can-Am dealer.*

2. Engine is running too hot.

- *Refer to ENGINE LACKS ACCELERATION OR POWER.*

3. Ignition timing is incorrect or there is an ignition system failure.

- *Contact an authorized Can-Am dealer.*

ENGINE MISFIRE

1. Fouled/ defective/ worn spark plug.

- *Clean/verify spark plug and heat range. Replace as required.*

2. Water in fuel.

- *Drain fuel system and refill with fresh fuel.*

VEHICLE CANNOT REACH FULL SPEED

1. Engine.

- *Refer to ENGINE LACKS ACCELERATION OR POWER.*

2. Parking brake.

- *Ensure parking brake is completely removed.*

3. Air filter/housing plugged or dirty.

- *Check air filter and clean if necessary.*
- *Check deposits in air filter housing drain.*
- *Check the position of the air intake tube.*

4. CVT dirty or worn-out.

- *Contact an authorized Can-Am dealer.*

5. Engine is under a protection (limp home) mode.

- *Check multifunction gauge display for messages.*
- *Multifunction gauge CHECK ENGINE indicator lamp is on and display shows CHECK ENGINE or LIMP HOME, contact an authorized Can-Am dealer.*

TRANSMISSION LEVER IS HARD TO MOVE

1. Transmission gears are in a position that prevents the transmission lever to work.
 - *Rock the vehicle back and forth to move the gears in the transmission and allow the transmission lever to be set.*
2. CVT dirty or worn-out.
 - *Contact an authorized Can-Am dealer.*

THE RPM INCREASES BUT THE VEHICLE DOES NOT MOVE

1. The transmission is on PARK or NEUTRAL position.
 - *Select the R, HI or LO position.*
2. CVT dirty or worn-out.
 - *Contact an authorized Can-Am dealer.*
3. Water in the CVT housing.
 - *Contact an authorized Can-Am dealer.*

MULTIFUNCTION GAUGE MESSAGES

MESSAGE	PILOT LAMP(S) ON	DESCRIPTION
INVALID KEY	Check engine	Indicates that you have used the wrong ignition key, use the proper key for this vehicle. It is also possible that the ignition key has a bad contact, remove and clean key.
PARK BRAKE	Parking brake	Is displayed when parking brake is applied for more than 15 seconds (while riding).
LO BATT	Check engine	Low battery voltage, check battery voltage and charging system.
HI BATT	Check engine	High battery voltage, check battery voltage and charging system.
LOW OIL ⁽¹⁾	Check engine	Engine low oil pressure, stop engine immediately.
HI TEMP	Check engine	Engine is overheating, refer to <i>ENGINE OVERHEATS</i> in <i>TROUBLESHOOTING</i> section.
LIMP HOME	Check engine	Serious fault on the engine that can change the normal operation of the engine, CHECK ENGINE indicator lamp will also blink, refer to <i>TROUBLESHOOTING</i> section.
CHECK ENGINE	Check engine	Engine fault, CHECK ENGINE indicator lamp will also be ON, refer to <i>TROUBLESHOOTING</i> section.
MAINTENANCE SOON ⁽²⁾	Check engine	Periodic maintenance required. See an authorized Can-Am dealer.
NO ECM COMMUNICATION	Check engine	Communication error between speedometer and engine control module (ECM), contact an authorized Can-Am dealer.
AIR FAULT	Check engine	Indicates that the ACS suspension does not work properly. See an authorized Can-Am dealer.
DPS FAULT	Check engine	Indicates that the DPS (Dynamic Power Steering) does not work properly. See an authorized Can-Am dealer.

NOTICE ⁽¹⁾ If the message and the check engine light stay on after engine starting, stop engine. Check engine oil level. Refill if necessary. If the oil level is good, see an authorized Can-Am dealer. Do not use the vehicle until repaired.

⁽²⁾ Message must be erased by an authorized Can-Am dealer.

WARRANTY

BRP LIMITED WARRANTY USA AND CANADA: 2011 CAN-AM™ ATV

1) SCOPE OF THE LIMITED WARRANTY

Bombardier Recreational Products Inc. ("BRP")* warrants its 2011 Can-Am ATV sold by authorized Can-Am ATV dealers (as hereinafter defined) in the fifty United States and Canada from defects in material or workmanship for the period and under the conditions described below. This limited warranty will become null and void if: (1) the ATV was used for racing or any other competitive activity, at any point, even by a previous owner; or (2) the ATV has been altered or modified in such a way so as to adversely affect its operation, performance or durability, or has been altered or modified to change its intended use.

All genuine Can-Am ATV parts and accessories, installed by an authorized BRP dealer at the time of delivery of the 2011 Can-Am ATV, carry the same warranty as that of the Can-Am ATV.

2) LIMITATIONS OF LIABILITY

THIS WARRANTY IS EXPRESSLY GIVEN AND ACCEPTED IN LIEU OF ANY AND ALL OTHER WARRANTIES, EXPRESSED OR IMPLIED, INCLUDING WITHOUT LIMITATION ANY WARRANTY OF MERCHANTABILITY OR FITNESS FOR A PARTICULAR PURPOSE TO THE EXTENT THAT THEY CANNOT BE DISCLAIMED, THE IMPLIED WARRANTIES ARE LIMITED IN DURATION TO THE LIFE OF THE EXPRESS WARRANTY INCIDENTAL AND CONSEQUENTIAL DAMAGES ARE EXCLUDED FROM COVERAGE UNDER THIS WARRANTY SOME STATES/PROVINCES DO NOT ALLOW FOR THE DISCLAIMERS, LIMITATIONS AND EXCLUSIONS IDENTIFIED ABOVE, AS A RESULT, THEY MAY NOT APPLY TO YOU. THIS WARRANTY GIVES YOU SPECIFIC RIGHTS, AND YOU MAY ALSO HAVE OTHER LEGAL RIGHTS WHICH MAY VARY FROM STATE TO STATE, OR PROVINCE TO PROVINCE.

Neither the distributor, any BRP dealer nor any other person has been authorized to make any affirmation, representation or warranty regarding the product, other than those contained in this limited warranty, and if made, shall not be enforceable against BRP.

BRP reserves the right to modify this warranty at any time, being understood that such modification will not alter the warranty conditions applicable to the products sold while this warranty is in effect.

3) EXCLUSIONS – ARE NOT WARRANTED

The following are not warranted under any circumstances:

- Normal wear and tear;
- Routine maintenance items, tune ups, adjustments;
- Damage caused by failure to provide proper maintenance and/or storage, as described in the Operator's Guide;

- Damage resulting from removal of parts, improper repairs, service, maintenance, modifications or use of parts not manufactured or approved by BRP or resulting from repairs done by a person that is not an authorized servicing Can-Am ATV dealer;
- Damage caused by abuse, abnormal use, neglect or operation of the product in a manner inconsistent with the recommended operation described in the Can-Am ATV Operator's Guide;
- Damage resulting from accident, submersion, fire, theft, vandalism or any act of God;
- Operation with fuels, oils or lubricants which are not suitable for use with the product (see the Operator's Guide);
- Damages from rust, corrosion or exposure to the elements;
- Damage resulting from water or snow ingestion;
- Incidental or consequential damages, or damages of any kind including without limitation towing, storage, telephone, rental, taxi, inconvenience, insurance coverage, loan payments, loss of time, loss of income.

4) WARRANTY COVERAGE PERIOD

This warranty will be in effect from (1) the date of delivery to the first retail consumer or (2) the date the product is first put into use, whichever occurs first and for a period of:

SIX (6) CONSECUTIVE MONTHS, for private use or commercial use owners, except that emission-related components installed on EPA certified ATVs registered in the USA are covered for 5000 km or thirty (30) consecutive months whichever comes first; and evaporative emission related components are warranted for twenty-four (24) consecutive months. To obtain a list of the current warranted emission-related components, please see an authorized Can-Am ATV dealer.

The repair or replacement of parts or the performance of service under this warranty does not extend the life of this warranty beyond its original expiration date.

5) CONDITIONS TO HAVE WARRANTY COVERAGE

This warranty coverage is available **only** if **each** of the following conditions has been fulfilled:

- The 2011 Can-Am ATV must be purchased as new and unused by its first owner from a Can-Am ATV dealer authorized to distribute Can-Am ATVs in the country in which the sale occurred ("Can-Am ATV dealer");
- The BRP specified pre-delivery inspection process must be completed and documented;
- The 2011 Can-Am ATV must have undergone proper registration by an authorized Can-Am ATV dealer;

- The 2011 Can-Am ATV must be purchased in the country in which the purchaser resides;
- Routine maintenance outlined in the Operator's Guide must be timely performed in order to maintain warranty coverage. BRP reserves the right to make warranty coverage contingent upon proof of proper maintenance.

BRP will not honor this limited warranty to any private use owner or commercial use owner if the preceding conditions have not been met. Such limitations are necessary in order to allow BRP to preserve both the safety of its products, and also that of its consumers and the general public.

6) WHAT TO DO TO OBTAIN WARRANTY COVERAGE

The customer must cease using the ATV upon the appearance of an anomaly. The customer must notify a servicing BRP dealer within two (2) days of the appearance of a defect, and provide it with reasonable access to the product and reasonable opportunity to repair it. The customer must also present to the authorized BRP dealer, proof of purchase of the product and must sign the repair/work order prior to starting the repair in order to validate the warranty repair. All parts replaced under this limited warranty become the property of BRP.

7) WHAT BRP WILL DO

BRP's obligations under this warranty are limited to, at its sole discretion, repairing parts found defective under normal use, maintenance and service, or replacing such parts with new genuine Can-Am ATV parts without charge for parts and labor, at any authorized BRP dealer during the warranty coverage period under the conditions described herein. BRP's responsibility is limited to making the required repairs or replacements of parts. No claim of breach of warranty shall be cause for cancellation or rescission of the sale of the ATV to the owner.

In the event that service is required outside of the country of original sale, the owner will bear responsibility for any additional charges due to local practices and conditions, such as, but not limited to, freight, insurance, taxes, license fees, import duties, and any and all other financial charges, including those levied by governments, states, territories and their respective agencies.

BRP reserves the right to improve or modify products from time to time without assuming any obligation to modify products previously manufactured.

8) SUPPLIER WARRANTIES

A GPS receiver may be supplied by BRP as standard equipment on certain 2011 Can-Am ATV's. The GPS receiver is covered by the limited warranty issued by the GPS receiver's manufacturer and is not covered by this limited warranty. Please contact the following distributors if in Canada or the manufacturer if in the USA:

In the USA:

Garmin International Inc.

U.S.: 913 397-8200

U.S. Toll Free: 1 800 800-1020

Website: www.garmin.com

In Canada (one or the other):

Raytech Électronique

Tel.: 450 975-1015

Fax: 800 975-0025 / 450 975-0817

Contact: raytech@raytech.qc.ca

Web Site: www.raytech.qc.ca

Coord. GPS: N45o35.25' - W73o42.95'

Naviclub Ltd

Tel.: 418 835-9279

Fax: 418 835-6681

Contact: naviclub@naviclub.com

Web Site: www.naviclub.com

Your 2011 Can-Am ATV could be originally equipped with Carlisle⁺ or ITP⁺ branded ATV tires. The tires are warranted separately by the tire manufacturer and are not covered by this limited warranty. Please contact the manufacturer or ask your authorized Can-Am ATV dealer for assistance.

Carlisle Tire & Wheel Company

23 Windham Boulevard

Aiken SC 29805

Warranty Information:

USA: 1 800 260-7959

Canada: 1 800 265-6155

Quebec: 1 877 997-4999

9) TRANSFER

If the ownership of a product is transferred during the warranty coverage period, this warranty shall also be transferred and be valid for the remaining coverage period provided that BRP is notified of such transfer of ownership in the following way:

1. The former owner contacts BRP (at the phone number provided below) or an authorized BRP dealer and gives the coordinates of the new owner; or
2. BRP or an authorized BRP dealer receives a proof that the former owner agreed to the transfer of ownership, in addition to the coordinates of the new owner.

10) CONSUMER ASSISTANCE

In the event of a controversy or a dispute in connection with this limited warranty, BRP suggests that you try to resolve the issue at the dealership level. We recommend discussing the issue with the authorized dealer's service manager or owner.

If the issue has not yet been resolved, please submit your complaint in writing or call the appropriate number below:

In Canada

BOMBARDIER RECREATIONAL PRODUCTS INC.

CAN-AM ATV

Customer Assistance Center

75 J.-A. Bombardier Street

Sherbrooke QC J1L 1W3

Tel.: 819 566-3366

In USA

BRP US INC.

CAN-AM ATV

Customer Assistance Center

7575 Bombardier Court

Wausau WI 54401

Tel.: 715 848-4957

* In the USA, products are distributed and serviced by BRP US Inc.

© 2009 Bombardier Recreational Products Inc. All rights reserved.

™ trademark of Bombardier Recreational Products Inc. or its affiliates.

† Carlisle and ITP are trademarks owned by or licensed to Carlisle Tire & Wheel Company.

BRP INTERNATIONAL LIMITED WARRANTY: 2011 CAN-AM™ ATV

1) SCOPE OF THE LIMITED WARRANTY

Bombardier Recreational Products Inc. ("BRP")* warrants its 2011 Can-Am ATV sold by Can-Am ATV distributors or dealers authorized by BRP to distribute Can-Am ATVs ("Can-Am ATV Distributor/Dealer") outside of the fifty United States, Canada and states that are members of the European Economic Area ("EEA") (which is comprised of the member states of the European Union plus Norway, Iceland and Liechtenstein) from defects in material or workmanship for the period and under the conditions described below.

All genuine Can-Am ATV parts and accessories, installed by an authorized Can-Am ATV Distributor/Dealer at the time of delivery of the 2011 Can-Am ATV, carry the same warranty as that of the Can-Am ATV.

This limited warranty will become null and void if: (1) The ATV was used for racing or any other competitive activity, at any point, even by a previous owner; or (2) the ATV has been altered or modified in such a way so as to adversely affect its operation, performance or durability, or has been altered or modified to change its intended use.

2) LIMITATIONS OF LIABILITY

THIS WARRANTY IS EXPRESSLY GIVEN AND ACCEPTED IN LIEU OF ANY AND ALL OTHER WARRANTIES, EXPRESSED OR IMPLIED, INCLUDING WITHOUT LIMITATION ANY WARRANTY OF MERCHANTABILITY OR FITNESS FOR A PARTICULAR PURPOSE TO THE EXTENT THAT THEY CANNOT BE DISCLAIMED, THE IMPLIED WARRANTIES ARE LIMITED IN DURATION TO THE LIFE OF THE EXPRESS WARRANTIES INCIDENTAL AND CONSEQUENTIAL DAMAGES ARE EXCLUDED FROM COVERAGE UNDER THIS WARRANTY SOME JURISDICTIONS DO NOT ALLOW FOR THE DISCLAIMERS, LIMITATIONS AND EXCLUSIONS IDENTIFIED ABOVE, AS A RESULT, THEY MAY NOT APPLY TO YOU. THIS WARRANTY GIVES YOU SPECIFIC RIGHTS, AND YOU MAY ALSO HAVE OTHER LEGAL RIGHTS WHICH MAY VARY FROM COUNTRY TO COUNTRY.

Neither the Can-Am ATV Distributor/Dealer nor any other person has been authorized to make any affirmation, representation or warranty regarding the product, other than those contained in this limited warranty, and if made, shall not be enforceable against BRP.

BRP reserves the right to modify this warranty at any time, being understood that such modification will not alter the warranty conditions applicable to the products sold while this warranty is in effect.

3) EXCLUSIONS – ARE NOT WARRANTED

The following are not warranted under any circumstances:

- Normal wear and tear;
- Routine maintenance items, tune ups, adjustments;

- Damage caused by failure to provide proper maintenance and/or storage, as described in the Operator's Guide;
- Damage resulting from removal of parts, improper repairs, service, maintenance, modifications or use of parts not manufactured or approved by BRP or resulting from repairs done by a person that is not an authorized servicing Can-Am ATV Distributor/Dealer;
- Damage caused by abuse, abnormal use, neglect or operation of the product in a manner inconsistent with the recommended operation described in the Operator's Guide;
- Damage resulting from accident, submersion, fire, theft, vandalism or any act of God;
- Operation with fuels, oils or lubricants which are not suitable for use with the product (see the Operator's Guide);
- Damage resulting from rust, corrosion or exposure to the elements;
- Damage resulting from water or snow ingestion;
- Incidental or consequential damages, or damages of any kind including without limitation towing, storage, telephone, rental, taxi, inconvenience, insurance coverage, loan payments, loss of time, loss of income.

4) WARRANTY COVERAGE PERIOD

This warranty will be in effect from (1) the date of delivery to the first retail consumer or (2) the date the product is first put into use, whichever occurs first and for a period of:

SIX (6) CONSECUTIVE MONTHS for private use or commercial use.

The repair or replacement of parts or the performance of service under this warranty does not extend the life of this warranty beyond its original expiration date.

5) CONDITIONS TO HAVE WARRANTY COVERAGE

This warranty coverage is available **only** if **each** of the following conditions has been fulfilled:

- The 2011 Can-Am ATV must be purchased as new and unused by its first owner from a Can-Am ATV Distributor/Dealer authorized to distribute Can-Am ATVs in the country in which the sale occurred;
- The BRP specified pre-delivery inspection process must be completed and documented;
- The product must have undergone proper registration by an authorized Can-Am ATV Distributor/Dealer;
- The 2011 Can-Am ATV must be purchased in the country or union of countries in which the purchaser resides; and
- Routine maintenance outlined in the Operator's Guide must be timely performed in order to maintain warranty coverage. BRP reserves the right to make warranty coverage contingent upon proof of proper maintenance.

BRP will not honor this limited warranty to any private use owner or commercial use owner if the preceding conditions have not been met. Such limitations are necessary in order to allow BRP to preserve both the safety of its products, and also that of its consumers and the general public.

6) WHAT TO DO TO OBTAIN WARRANTY COVERAGE

The customer must cease using the ATV upon the appearance of an anomaly. The customer must notify a servicing Can-Am ATV Distributor/Dealer within two (2) days of the appearance of a defect, and provide it with reasonable access to the product and reasonable opportunity to repair it. The customer must also present to the authorized Can-Am ATV Distributor/Dealer proof of purchase of the product and must sign the repair/work order prior to starting the repair in order to validate the warranty repair. All parts replaced under this limited warranty become the property of BRP.

7) WHAT BRP WILL DO

BRP's obligations under this warranty are limited to, at its sole discretion, repairing parts found defective under normal use, maintenance and service; or replacing such parts with new genuine Can-Am ATV parts without charge for parts and labour, at any authorized Can-Am ATV Distributor/Dealer during the warranty coverage period under the conditions described herein. BRP's responsibility is limited to making the required repairs or replacements of parts. No claim of breach of warranty shall be cause for cancellation or rescission of the sale of the Can-Am ATV to the owner.

In the event that service is required outside of the country of original sale, the owner will bear responsibility for any additional charges due to local practices and conditions, such as, but not limited to, freight, insurance, taxes, license fees, import duties, and any and all other financial charges, including those levied by governments, states, territories and their respective agencies.

BRP reserves the right to improve or modify products from time to time without assuming any obligation to modify products previously manufactured.

8) TRANSFER

If the ownership of a product is transferred during the warranty coverage period, this limited warranty subject to its terms and conditions shall also be transferred and be valid for the remaining coverage period provided BRP or an authorized Can-Am ATV Distributor/Dealer receives a proof that the former owner agreed to the transfer of ownership, in addition to the coordinates of the new owner.

9) CONSUMER ASSISTANCE

1. In the event of a controversy or a dispute in connection with this limited warranty, BRP suggests that you try to resolve the issue at the Can-Am ATV Dealer level. We recommend discussing the issue with the service manager or owner. You will find your Can-Am ATV Distributor/Dealer's coordinates on our website at www.brp.com.
2. If further assistance is required, the Can-Am ATV Distributor service department should be contacted in order to resolve the matter.
3. If the matter still remains unresolved then contact BRP by writing to us at the address listed below.

For countries within Europe, Middle East, Africa, Russia & CIS, please contact our European office:

BRP EUROPE N.V.

Customer Assistance Center
Skaldenstraat 125
9042 Gent
Belgium
Tel.: +32-9-218-26-00

For Scandinavian countries, please contact our Finland office:

BRP FINLAND OY

Service Department
Isoaavantie 7
FIN-96320 Rovaniemi
Finland
Tel.: +358 16 3208 111

For all other countries, please contact your local Can-Am ATV Distributor/Dealer (visit our website at www.brp.com for contact information), or contact our North America office at:

BOMBARDIER RECREATIONAL PRODUCTS INC.

Customer Assistance Center
75 J.-A. Bombardier Street
Sherbrooke QC J1L 1W3
Tel.: 819 566-3366

* For the territory covered by this limited warranty, products are distributed and serviced by Bombardier Recreational Products Inc. or its affiliates.

© 2009 Bombardier Recreational Products Inc. All rights reserved. TM Trademark of Bombardier Recreational Products Inc. or its affiliates.

™ Trademark of Bombardier Recreational Products Inc. or its affiliates.

BRP LIMITED WARRANTY FOR THE EUROPEAN ECONOMIC AREA: 2011 CAN-AM™ ATV

1) SCOPE OF THE LIMITED WARRANTY

Bombardier Recreational Product Inc. ("BRP")* warrants its new and unused model-year 2011 Can-Am ATVs sold by Can-Am ATV distributors or dealers authorized by BRP to distribute Can-Am ATVs ("Can-Am ATV Distributor/Dealer") in the states that are members of the European Economic Area ("EEA") (which is comprised of the member states of the European Union plus Norway, Iceland and Liechtenstein) from defects in material or workmanship for the period and under the conditions described below.

All genuine Can-Am ATV parts and accessories, installed by an authorized Can-Am ATV Distributor/Dealer at the time of delivery of the 2011 Can-Am ATV, carry the same warranty as that of the ATV.

This limited warranty will become null and void if: (1) The ATV was used for racing or any other competitive activity, at any point, even by a previous owner; or (2) the ATV has been altered or modified in such a way so as to adversely affect its operation, performance or durability, or has been altered or modified to change its intended use.

2) LIMITATIONS OF LIABILITY

THIS WARRANTY IS EXPRESSLY GIVEN AND ACCEPTED IN LIEU OF ANY AND ALL OTHER WARRANTIES, EXPRESSED OR IMPLIED, INCLUDING WITHOUT LIMITATION ANY WARRANTY OF MERCHANTABILITY OR FITNESS FOR A PARTICULAR PURPOSE TO THE EXTENT THAT THEY CANNOT BE DISCLAIMED, THE IMPLIED WARRANTIES ARE LIMITED IN DURATION TO THE LIFE OF THE EXPRESS WARRANTIES INCIDENTAL AND CONSEQUENTIAL DAMAGES ARE EXCLUDED FROM COVERAGE UNDER THIS WARRANTY SOME JURISDICTIONS DO NOT ALLOW FOR THE DISCLAIMERS, LIMITATIONS AND EXCLUSIONS IDENTIFIED ABOVE, AS A RESULT, THEY MAY NOT APPLY TO YOU. THIS WARRANTY GIVES YOU SPECIFIC RIGHTS, AND YOU MAY ALSO HAVE OTHER LEGAL RIGHTS WHICH MAY VARY FROM COUNTRY TO COUNTRY.

Neither the Can-Am ATV Distributor/Dealer nor any other person has been authorized to make any affirmation, representation or warranty regarding the product, other than those contained in this limited warranty, and if made, shall not be enforceable against BRP.

BRP reserves the right to modify this warranty at any time, being understood that such modification will not alter the warranty conditions applicable to the products sold while this warranty is in effect.

3) EXCLUSIONS – ARE NOT WARRANTED

The following are not warranted under any circumstances:

- Normal wear and tear;
- Routine maintenance items, tune ups, adjustments;

- Damage caused by failure to provide proper maintenance and/or storage, as described in the Operator's Guide;
- Damage resulting from removal of parts, improper repairs, service, maintenance, modifications or use of parts not manufactured or approved by BRP or resulting from repairs done by a person that is not an authorized servicing Can-Am ATV Distributor/Dealer;
- Damage caused by abuse, abnormal use, neglect or operation of the product in a manner inconsistent with the recommended operation described in the Operator's Guide;
- Damage resulting from accident, submersion, fire, theft, vandalism or any act of God;
- Operation with fuels, oils or lubricants which are not suitable for use with the product (see the Operator's Guide);
- Damage resulting from rust, corrosion or exposure to the elements;
- Damage resulting from water or snow ingestion;
- Water or snow ingestion;
- Incidental or consequential damages, or damages of any kind including without limitation towing, storage, telephone, rental, taxi, inconvenience, insurance coverage, loan payments, loss of time, loss of income.

4) WARRANTY COVERAGE PERIOD

This warranty will be in effect from (1) the date of delivery to the first retail consumer or (2) the date the product is first put into use, whichever occurs first and for a period of:

TWENTY-FOUR (24) CONSECUTIVE MONTHS for private use.

SIX (6) CONSECUTIVE MONTHS for commercial use or rental use.

The product is used commercially when it is used in connection with any work or employment that generates income during any part of the warranty period. The product is also used commercially when, at any point during the warranty period, it is licensed for commercial use.

The repair or replacement of parts or the performance of service under this warranty does not extend the life of this warranty beyond its original expiration date.

Note that the duration and any other modalities of the warranty coverage are subject to the applicable national or local legislation in your country.

5) CONDITIONS TO HAVE WARRANTY COVERAGE

This warranty coverage is available **only** if **each** of the following conditions has been fulfilled:

- The 2011 Can-Am ATV must be purchased as new and unused by its first owner from a Can-Am ATV Distributor/Dealer authorized to distribute Can-Am ATVs in the country in which the sale occurred;
- The BRP specified pre-delivery inspection process must be completed and documented;

- The product must have undergone proper registration by an authorized Can-Am ATV Distributor/Dealer;
- The 2011 Can-Am ATV must be purchased in the EEA; and
- Routine maintenance outlined in the Operator's Guide must be timely performed in order to maintain warranty coverage. BRP reserves the right to make warranty coverage contingent upon proof of proper maintenance.

BRP will not honor this limited warranty to any private use owner or commercial use owner if the preceding conditions have not been met. Such limitations are necessary in order to allow BRP to preserve both the safety of its products, and also that of its consumers and the general public.

6) WHAT TO DO TO OBTAIN WARRANTY COVERAGE

The customer must cease using the ATV upon the appearance of an anomaly. The customer must notify a servicing Can-Am ATV Distributor/Dealer within two (2) months of the appearance of a defect and provide it with reasonable access to the product and reasonable opportunity to repair it. The customer must also present to the authorized Can-Am ATV Distributor/Dealer, proof of purchase of the product and must sign the repair/work order prior to starting the repair in order to validate the warranty repair. All parts replaced under this limited warranty become the property of BRP.

Note that the notification period is subject to the applicable national or local legislation in your country.

7) WHAT BRP WILL DO

BRP's obligations under this warranty are limited to, at its sole discretion, repairing parts found defective under normal use, maintenance and service, or replacing such parts with new genuine Can-Am ATV parts without charge for parts and labor, at any authorized Can-Am ATV Distributor/Dealer during the warranty coverage period under the conditions described herein. BRP's responsibility is limited to making the required repairs or replacements of parts. No claim of breach of warranty shall be cause for cancellation or rescission of the sale of the Can-Am ATV to the owner.

In the event that service is required outside of the EEA, the owner will bear responsibility for any additional charges due to local practices and conditions, such as, but not limited to, freight, insurance, taxes, license fees, import duties, and any and all other financial charges, including those levied by governments, states, territories and their respective agencies.

BRP reserves the right to improve or modify products from time to time without assuming any obligation to modify products previously manufactured.

8) TRANSFER

If the ownership of a product is transferred during the warranty coverage period, this limited warranty shall also be transferred and be valid for the remaining coverage period provided BRP or an authorized Can-Am ATV Distributor/Dealer receives a proof that the former owner agreed to the transfer of ownership, in addition to the coordinates of the new owner.

9) CONSUMER ASSISTANCE

1. In the event of a controversy or a dispute in connection with this limited warranty, BRP suggests that you try to resolve the issue at the Can-Am ATV Dealer level. We recommend discussing the issue with the Can-Am ATV Distributor/Dealer's service manager or owner. You will find your Can-Am ATV Distributor/Dealer's coordinates on our website at www.brp.com.
2. If further assistance is required, the Can-Am ATV Distributor's service department should be contacted in order to resolve the matter.
3. If the matter still remains unresolved then contact BRP at the address listed below.

For countries within Europe, Middle East, Africa, Russia & CIS, please contact our European office:

BRP EUROPE N.V.

Customer Assistance Center
Skaldenstraat 125
9042 Gent
Belgium
Tel.: +32-9-218-26-00

For Scandinavian countries, please contact our Finland office:

BRP FINLAND OY

Service Department
Isoaavantie 7
FIN-96320 Rovaniemi
Finland
Tel.: +358 16 3208 111

For all other countries, please contact your local Can-Am ATV Distributor/Dealer (visit our website at www.brp.com for contact information), or contact our North America office at:

BOMBARDIER RECREATIONAL PRODUCTS INC.

Customer Assistance Center

75 J.-A. Bombardier Street

Sherbrooke QC J1L 1W3

Tel.: 819 566-3366

* For the territory covered by this limited warranty, products are distributed and serviced by Bombardier Recreational Products Inc. or its affiliates.

© 2009 Bombardier Recreational Products Inc. All rights reserved.

™ Trademark of Bombardier Recreational Products Inc. or its affiliates.

ADDITIONAL TERMS AND CONDITIONS FOR FRANCE ONLY

The following terms and conditions are applicable to products sold in France only: The seller shall deliver goods that are complying with the contract and shall be responsible for defects existing upon delivery. The seller shall also be responsible for defects resulting from packaging, assembling instructions or the installation when it is its responsibility per the contract or if accomplished under its responsibility. To be compliant with the contract, the good shall:

1. Be fit for normal use for goods similar thereto and, if applicable:
 - Correspond to the description provided by the seller and have the qualities presented to the buyer through sample or model;
 - Have the qualities that a buyer may legitimately expect considering the public declarations of the seller, the manufacturer of its representative, including in advertising or labeling; or
2. Have the characteristics mutually agreed upon as between the parties or be fit for the specific use intended by the buyer and brought to the attention of the seller and which accepted.

The action for failure to comply is prescribed after two years after delivery of the goods. The seller is responsible for the warranty for hidden defects of the good sold if such hidden defects are rendering the good unfit for the intended use, or if they diminish its use in such a way that the buyer would not have acquired the good or would have given a lesser price, had he known. The action for such hidden defects shall be taken by the buyer within 2 years of the discovery of the defect.

CUSTOMER INFORMATION

PRIVACY INFORMATION

BRP wishes to inform you that your coordinates will be used for safety and warranty related purposes. Furthermore, BRP and its affiliates may use its customer list to distribute marketing and promotional information about BRP and related products.

To exercise your right to consult or correct your data, or to be removed from the addressee-list for direct marketing, please contact BRP.

By E-mail: privacyofficer@brp.com

By mail: BRP
Senior Legal Counsel-Privacy Officer
726 St-Joseph
Valcourt QC
Canada
J0E 2L0

CHANGE OF ADDRESS/OWNERSHIP

If your address has changed or if you are the new owner of the ATV, be sure to notify BRP by either:

- Mailing one of the change of address cards on the following pages
- North America only: Calling at 715 848-4957 (USA) or 819 566-3366 (Canada)
- Notifying an authorized Can-Am dealer.

In case of change of ownership, please join a proof that the former owner agreed to the transfer.

Notifying BRP, even after the expiration of the limited warranty, is very important as it enables BRP to reach the ATV owner if necessary, like when safety recalls are initiated. It is the owner's responsibility to notify BRP.

STOLEN UNITS: If your personal ATV is stolen, you should notify BRP or an authorized Can-Am dealer. We will ask you to provide your name, address, phone number, the vehicle identification number and the date it was stolen.

North America

BOMBARDIER RECREATIONAL PRODUCTS INC.

Warranty Department
75 J.-A. Bombardier Street
Sherbrooke QC J1L 1W3
Canada

Scandinavian countries

BRP FINLAND OY

Service Department
Isoaavantie 7
FIN-96320 Rovaniemi

Other countries in the world

BRP EUROPEAN DISTRIBUTION

Warranty Department
Chemin de Messidor 5-7
1006 Lausanne
Switzerland

***This page is
intentionally blank***

CHANGE OF ADDRESS CHANGE OF OWNERSHIP 

VEHICLE IDENTIFICATION NUMBER

Model Number

Vehicle Identification Number (V.I.N.)

OLD ADDRESS
OR PREVIOUS OWNER:

NAME

NO.

STREET

APT

CITY

STATE/PROVINCE

ZIP/POSTAL CODE

COUNTRY

TELEPHONE

NEW ADDRESS
OR NEW OWNER:

NAME

NO.

STREET

APT

CITY

STATE/PROVINCE

ZIP/POSTAL CODE

COUNTRY

TELEPHONE

E-MAIL ADDRESS

V00A2F

CHANGE OF ADDRESS CHANGE OF OWNERSHIP 

VEHICLE IDENTIFICATION NUMBER

Model Number

Vehicle Identification Number (V.I.N.)

OLD ADDRESS
OR PREVIOUS OWNER:

NAME

NO.

STREET

APT

CITY

STATE/PROVINCE

ZIP/POSTAL CODE

COUNTRY

TELEPHONE

NEW ADDRESS
OR NEW OWNER:

NAME

NO.

STREET

APT

CITY

STATE/PROVINCE

ZIP/POSTAL CODE

COUNTRY

TELEPHONE

E-MAIL ADDRESS

V00A2F

CHANGE OF ADDRESS <input type="checkbox"/>		CHANGE OF OWNERSHIP <input type="checkbox"/>		
VEHICLE IDENTIFICATION NUMBER				
<input type="text"/>	<input type="text"/>	<input type="text"/>	<input type="text"/>	<input type="text"/>
Model Number		Vehicle Identification Number (V.I.N.)		
OLD ADDRESS OR PREVIOUS OWNER:		NAME		
		NO.	STREET	APT
		CITY	STATE/PROVINCE	ZIP/POSTAL CODE
		COUNTRY	TELEPHONE	
NEW ADDRESS OR NEW OWNER:		NAME		
		NO.	STREET	APT
		CITY	STATE/PROVINCE	ZIP/POSTAL CODE
		COUNTRY	TELEPHONE	
		E-MAIL ADDRESS		

V00A2F

CHANGE OF ADDRESS <input type="checkbox"/>		CHANGE OF OWNERSHIP <input type="checkbox"/>		
VEHICLE IDENTIFICATION NUMBER				
<input type="text"/>	<input type="text"/>	<input type="text"/>	<input type="text"/>	<input type="text"/>
Model Number		Vehicle Identification Number (V.I.N.)		
OLD ADDRESS OR PREVIOUS OWNER:		NAME		
		NO.	STREET	APT
		CITY	STATE/PROVINCE	ZIP/POSTAL CODE
		COUNTRY	TELEPHONE	
NEW ADDRESS OR NEW OWNER:		NAME		
		NO.	STREET	APT
		CITY	STATE/PROVINCE	ZIP/POSTAL CODE
		COUNTRY	TELEPHONE	
		E-MAIL ADDRESS		

V00A2F

ATV MODEL No. _____

VEHICLE
IDENTIFICATION NUMBER (V.I.N.) _____

ENGINE
IDENTIFICATION NUMBER (E.I.N.) _____

Owner: _____

NAME

No.

STREET

APT

CITY

STATE/PROVINCE

ZIP/POSTAL CODE

Purchase Date _____
YEAR MONTH DAY

Warranty Expiry Date _____
YEAR MONTH DAY

To be completed by the dealer at the time of the sale.

DEALER IMPRINT AREA

V00A2IL

Please verify with your dealer to ensure your vehicle has been registered with BRP.

While reading this Operator's Guide, remember that:

⚠ WARNING

Indicates a potential hazard that, if not avoided, could result in serious injury or death.