



**EVINRUDE**®



## Operator's Guide

**4, 6 HORSEPOWER**

**MODEL VERSION: "AB"**

E4R4, E4RL4, E6R4, E6RL4, E6RX4

216791



 **WARNING**

**California Proposition 65**

**This engine contains or exhaust chemicals known to the state of California to cause cancer, birth defects or other reproductive harm.**

---

** READ THIS MANUAL BEFORE USING THE OUTBOARD MOTOR. FAILURE TO FOLLOW THE INSTRUCTIONS AND SAFETY PRECAUTIONS IN THIS MANUAL CAN RESULT IN SERIOUS INJURY OR DEATH. KEEP THIS MANUAL IN A SAFE LOCATION FOR FUTURE REFERENCE.**

Copyright 2015 BRP US Inc. All rights reserved. No part of this manual may be reproduced or transmitted in any form or by any means without the expressed written permission of BRP US Inc.

# **Your Evinrude 4-Stroke Outboard**

## **OWNER REGISTRATION AND IDENTIFICATION**

Upon purchasing this product, be sure that the WARRANTY CARD is correctly and completely filled out and mailed to the addressee noted there on. This WARRANTY CARD identifies you as the legal owner of the product and serves as your warranty registration.

TO THE EXTENT PERMITTED BY APPLICABLE LAW, YOUR OUTBOARD WILL NOT BE COVERED BY THE APPLICABLE LIMITED WARRANTY, IF THIS PROCEDURE IS NOT FOLLOWED.

## **PRE-DELIVERY CHECK**

Be sure that the product has been checked by an authorized Evinrude dealer before you take delivery.

## **Limited Warranty**

Please refer to the BRP Limited warranty provided to you with this product, the terms and conditions of which, as amended from time to time, are incorporated by reference into the manual.



**READ THIS MANUAL BEFORE USING THE OUTBOARD. FAILURE TO FOLLOW THE INSTRUCTIONS AND SAFETY PRECAUTIONS IN THIS MANUAL CAN RESULT IN SERIOUS INJURY OR DEATH. KEEP THIS MANUAL IN A SAFE LOCATION FOR FUTURE REFERENCE.**

## Product References, Illustrations and Specifications

BRP reserves the right to make changes at any time, without notice, to features, specifications and model availability, and to change any specification or part at any time without incurring any obligation to update older models. The information in the Guide is based on the latest specifications available at the time of publication.

Photographs and illustrations used in this Guide might not depict actual models or equipment but are intended as representative views for reference only.

Certain features of systems discussed in this Guide might not be found on all models in all marketing areas.

### ***Owner's Identification***

**United States and Canada** — At the time of purchase, your Dealer will complete your outboard registration forms. Your portion provides proof of ownership and date of purchase.

**Outside United States and Canada** — See your Dealer or distributor for details.

### **Model and Serial Numbers**

The model and serial numbers appear on a plate attached to the stern bracket or swivel bracket. Record your outboard's:

Model Number \_\_\_\_\_

Serial Number \_\_\_\_\_

Purchase Date \_\_\_\_\_

Ignition Key Number \_\_\_\_\_

### **Stolen Outboards**

**United States and Canada** — Report stolen outboards to your local dealer or distributor.

**Outside United States and Canada** — Report the theft to the Bombardier Recreational Products distributor where the outboard was registered.

### **Technical Literature**

BRP offers technical literature specifically for your outboard. A service manual, a parts catalog, or an extra Operator's Guide can be purchased from your selling Dealer. For the name and location of the nearest Evinrude Dealer in the United States and Canada visit [www.evinrude.com](http://www.evinrude.com).

ENOM00005-A

**Serial Number**

In the space below, please record the outboard motor's serial number (indicated both on the bottom cowl and on the cylinder block). The serial number will be needed when ordering parts, and when making technical or warranty inquiries.

**Serial Number:**

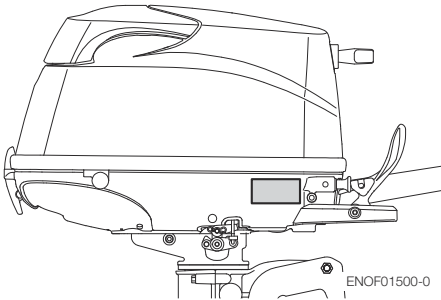

Serial Number:

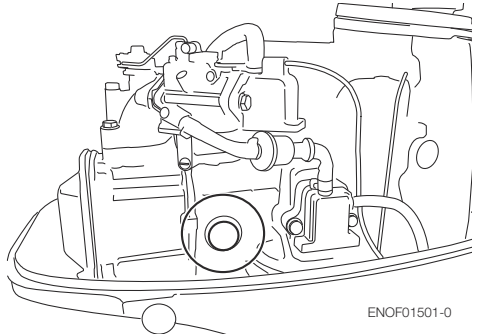

Date of purchase:

---

ENOM00007-0

**NOTICE: DANGER/WARNING/CAUTION/Note**

Before installing, operating or otherwise handling your outboard motor, be sure to thoroughly read and understand this Owner's Manual and carefully follow all of the instructions. Of particular importance is information preceded by the words "DANGER," "WARNING," "CAUTION," and "Note." Always pay special attention to such information to ensure safe operation of the outboard motor at all times.

ENOW00001-0

 **DANGER**

**Failure to observe will result in severe personal injury or death, and possibly property damage.**

---

ENOW00002-0

 **WARNING**

**Failure to observe could result in severe personal injury or death, or property damage.**

---

ENOW00003-0

 **CAUTION**

**Failure to observe could result in personal injury or property damage.**

---

ENON00001-0

**Note**

This instruction provides special information to facilitate the use or maintenance of the outboard motor or to clarify important points.

---

# CONTENTS

<b>1. GENERAL SAFETY INFORMATION</b>	<b>10</b>
<b>2. SPECIFICATIONS</b>	<b>12</b>
<b>3. PARTS NAME</b>	<b>13</b>
<b>4. LABEL LOCATIONS</b>	<b>15</b>
<b>5. INSTALLATION</b>	<b>19</b>
1. Mounting the outboard motor on boat	19
2. Altitude adjustment kit requirement	20
3. Remote control device installation (option)	21
4. Battery installation	21
<b>6. PRE-OPERATING PREPARATIONS</b>	<b>23</b>
1. Fuel handling	23
2. Fuel filling	24
3. Engine oil recommendation	26
4. Break-In	27
5. Warning system	28
<b>7. ENGINE OPERATION</b>	<b>30</b>
Before starting	30
1. Fuel feeding	30
2. Starting the engine	32
3. Warming up the engine	35
4. Forward, reverse, and acceleration	35
5. Stopping the engine	37
6. Steering	38
7. Trim angle	38
8. Tilt up and down	40
9. Shallow water operation	41
<b>8. REMOVING AND CARRYING THE OUTBOARD MOTOR</b>	<b>43</b>
1. Removing the outboard motor	43
2. Carrying the outboard motor	43
3. Trailering	44
<b>9. ADJUSTMENT</b>	<b>46</b>
1. Steering friction	46
2. Throttle grip friction	46
<b>10. INSPECTION AND MAINTENANCE</b>	<b>47</b>
1. Daily Inspection	48
2. Periodic Inspection	53
3. Off-season storage	63
4. Pre-season check	66
5. Submerged outboard motor	66
6. Cold weather precautions	67
7. Striking underwater object	67
<b>11. TROUBLESHOOTING</b>	<b>68</b>

<b>12. TOOL KIT AND SPARE PARTS .....</b>	<b>70</b>
<b>13. PROPELLER TABLE .....</b>	<b>71</b>



# INDEX

<b>1 GENERAL SAFETY INFORMATION</b>	<b>1</b>
.....	
<b>2. SPECIFICATIONS</b>	<b>2</b>
.....	
<b>3. PARTS NAME</b>	<b>3</b>
.....	
<b>4. LABEL LOCATIONS</b>	<b>4</b>
.....	
<b>5. INSTALLATION</b>	<b>5</b>
.....	
<b>6. PRE-OPERATING PREPARATIONS</b>	<b>6</b>
.....	
<b>7. ENGINE OPERATION</b>	<b>7</b>
.....	
<b>8. REMOVING AND CARRYING THE OUTBOARD MOTOR</b>	<b>8</b>
.....	
<b>9. ADJUSTMENT</b>	<b>9</b>
.....	
<b>10.INSPECTION AND MAINTENANCE</b>	<b>10</b>
.....	
<b>11.TROUBLESHOOTING</b>	<b>11</b>
.....	
<b>12.TOOL KIT AND SPARE PARTS</b>	<b>12</b>
.....	
<b>13.PROPELLER TABLE</b>	<b>13</b>
.....	

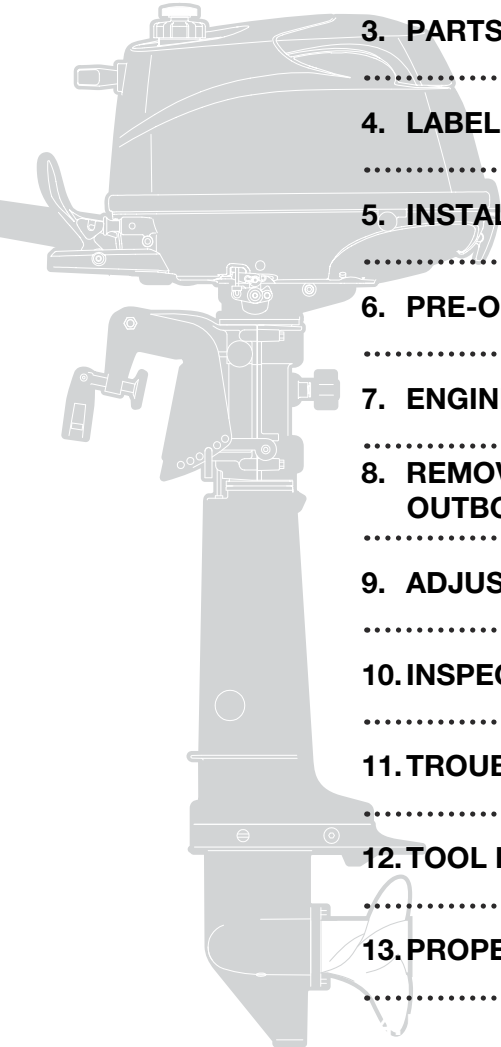

# GENERAL SAFETY INFORMATION

ENOM00009-0

## SAFE OPERATION OF BOAT

As the operator/driver of the boat, you are responsible for the safety of those aboard and those in other boats around yours, and for following local boating regulations. You should be thoroughly knowledgeable on how to correctly operate the boat, outboard motor, and accessories. To learn about the correct operation and maintenance of the outboard motor, please read through this manual carefully.

It is very difficult for a person standing or floating in the water to take evasive action should he or she see a power boat heading in his/her direction, even at a slow speed. Therefore, when your boat is in the immediate vicinity of people in the water, the outboard motor should be shifted to neutral and shut off.

ENOW00005-0

### WARNING

**SERIOUS INJURY IS LIKELY IF A PERSON IN THE WATER MAKES CONTACT WITH A MOVING BOAT, GEAR HOUSING, PROPELLER, OR ANY SOLID DEVICE RIGIDLY ATTACHED TO A BOAT OR GEAR HOUSING.**

ENOM00008-A

## EMERGENCY STOP SWITCH

The Emergency Stop Switch will stall the outboard motor when the stop switch lanyard is pulled off. This stop switch lanyard has to be attached to the operator of the outboard motor to minimize or prevent injuries from the propeller in case the operator falls overboard.

It is operator's responsibility to use the Emergency Stop Switch Lanyard.

ENOW00004-A

### WARNING

**Accidental activation of the Emergency Stop Switch (such as the tether being pulled out in heavy seas) could cause passengers to lose their balance and even fall overboard, or it could result in loss of power in heavy seas, strong currents, or high winds. Loss of control while mooring is another potential hazard.**

**To minimize accidental activation of the Emergency Stop Switch, the 500 mm (20 inch.) stop switch lanyard is coiled and can be extended to a full 1300 mm (51 inch.).**

ENOM00800-A

## PERSONAL FLOATATION DEVICE

As the operator/driver and passenger of the boat, you are responsible to wear a PFD (Personal Floatation Device) while on the boat.

ENOM00010-0

## **SERVICING, REPLACEMENT PARTS & LUBRICANTS**

We recommend that only an authorized service shop perform service or maintenance on this outboard motor. Be sure to use genuine parts, genuine lubricants, or recommended lubricants.

ENOM00011-A

## **MAINTENANCE**

As the owner of this outboard motor, you should be acquainted with correct maintenance procedures following maintenance section of this manual (See page 48). It is the operator's responsibility to perform all safety checks and to ensure that all lubrication and maintenance instructions are complied with for safe operation. Please comply with all instructions concerning lubrication and maintenance. You should take the engine to an authorized dealer or service shop for periodic inspection at the prescribed intervals.

Correct periodic maintenance and proper care of this outboard motor will reduce the chance of problems and limit overall operating expenses.

### **Carbon Monoxide Poisoning Hazard**

Exhaust gas contains carbon monoxide, a colorless and odorless gas which can be fatal if inhaled for any length of time.

Never start or operate the engine indoors or in any space which is not well ventilated.

### **Gasoline**

Gasoline and its vapors are very flammable and can be explosive. Use extreme care when handling gasoline. You should be thoroughly knowledgeable on how to correctly handle gasoline by reading this manual.

# SPECIFICATIONS

EENOM00401-BR

## 4, 6

2

Item	MODEL	4R (D) (Dual Tank)		6R (S) (Separate Tank)
Overall Length	mm (in)	783 (30.8)		
Overall Width	mm (in)	343 (13.5)		
Overall Height S-L-XL	mm (in)	1067 (42.0) · 1194 (47.0) · 1321 (52.0)		1039 (40.9) · 1166 (45.9) · 1293 (50.9)
Transom Height S-L-UL	mm (in)	435 (17.1)	562 (22.1)	689 (27.1)
Weight	S kg (lb)	26.1 (57.5)		25.6 (56.4)
	L kg (lb)	26.6 (58.6)		26.1 (57.5)
	XL kg (lb)	27.1 (59.8)		26.6 (58.6)
Output	kW (ps)	4 : 2.9 (4) 6 : 4.4 (6)		
Max. Operating Range	rpm	4 : 4500–5500		6: 5000–6000
Idle Speed in Forward Gear	rpm	1100		
Idle Speed in Neutral Gear	rpm	1300		
Engine Type		4-Stroke		
Number of Cylinder		1		
Bore × Stroke	mm (in)	59 × 45 (2.32 × 1.77)		
Piston Displacement	mL (Cu in)	123 (7.5)		
Exhaust System		Through hub exhaust		
Cooling System		Water cooling		
Engine Lubrication		Trochoid pump		
Starting System		Manual starter		
Ignition System		Ignitor		
Spark Plug		NGK DCPR6E		
Trim Position		6		
Engine Oil	mL (fl.oz.)	API SF, SG, SH or SJ FCW 10W-30/40, Approx. 450 (15.2)		
Gear Oil	mL (fl.oz.)	Genuine Gear Oil or API GL5, SAE #80-90, Approx. 195 (6.6)		
Fuel		Unleaded regular gasoline : Pump posted 87 Octane (research octane rating of 91)		
Fuel Tank Capacity	L (US gal)	*1.15 (0.30) Integral	12 (3.17) Separate	
Gear Reduction Ratio		2.15 (13 : 28)		
Emission Control System		EM (Engine modification)		
Operator Sound Pressure (ICOMIA 39/94) dB (A)		81.6		
Hand Vibration Level (ICOMIA 38/94) m/sec <sup>2</sup>		7.2		

\*:In case of dual fuel tank system, use it together with 12 L separate tank.

Remark: Specifications subject to change without notice.

Power rated in accordance with NMMA procedures and using ICOMIA standard 28/23.

# PARTS NAME

ENOM00402-A

## R

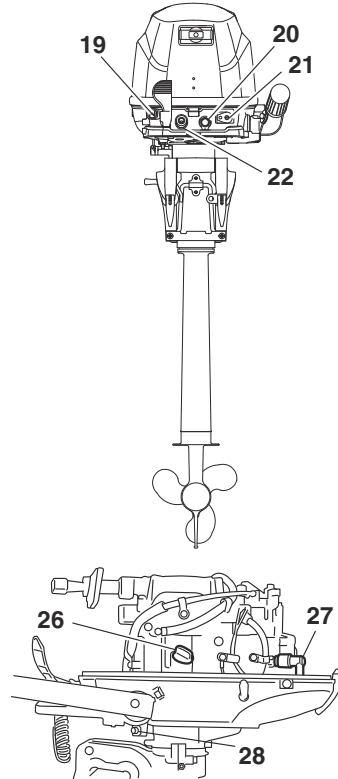
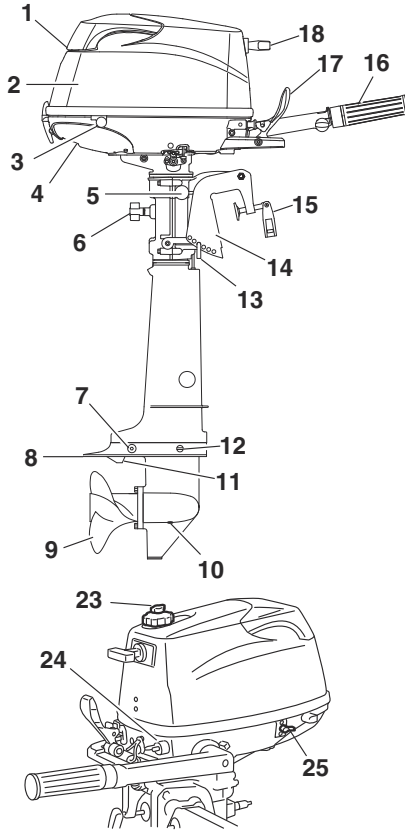

ENOF01502-0

- |                                    |                          |
|------------------------------------|--------------------------|
| <b>1</b> Tilt Handle               | <b>13</b> Thrust Rod     |
| <b>2</b> Top Cowl                  | <b>14</b> Clamp Bracket  |
| <b>3</b> Bottom Cowl               | <b>15</b> Clamp Screw    |
| <b>4</b> Cooling Water Check Port  | <b>16</b> Throttle Grip  |
| <b>5</b> Tilt Lever                | <b>17</b> Shift Lever    |
| <b>6</b> Steering Adjustment Screw | <b>18</b> Starter Handle |
| <b>7</b> Anode                     | <b>19</b> Choke Knob     |
| <b>8</b> Anti Ventilation Plate    | <b>20</b> Stop Switch    |
| <b>9</b> Propeller                 | <b>21</b> Fuel Connector |
| <b>10</b> Oil Plug (Lower) (Fill)  | <b>22</b> Warning Lamp   |
| <b>11</b> Water Inlet              | <b>23</b> Air Vent Screw |
| <b>12</b> Oil Plug (Upper) (Level) | <b>24</b> Fuel Connector |

- |                                  |
|----------------------------------|
| <b>25</b> Fuel Cock              |
| <b>26</b> Engine Oil Filter Cap  |
| <b>27</b> Spark Plug             |
| <b>28</b> Engine Oil Drain Screw |

3

ENOM00822-0

## Remote control box & Fuel tank

3

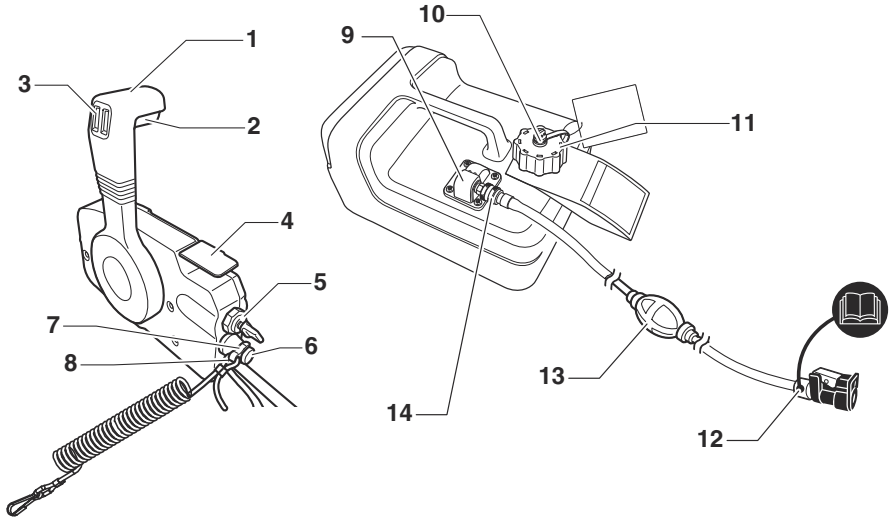

ENOF01404-A

- |                       |                                    |
|-----------------------|------------------------------------|
| 1 Control Lever       | 9 Fuel gauge                       |
| 2 Neutral lock arm    | 10 Air vent screw                  |
| 3 PTT switch          | 11 Fuel tank cap                   |
| 4 Free throttle lever | 12 Fuel connector (Engine side)    |
| 5 Main switch         | 13 Primer bulb                     |
| 6 Stop switch         | 14 Fuel connector (Fuel tank side) |
| 7 Stop switch lock    |                                    |
| 8 Stop switch lanyard |                                    |

# ■ LABEL LOCATIONS

ENOM00019-A

## Warning label locations

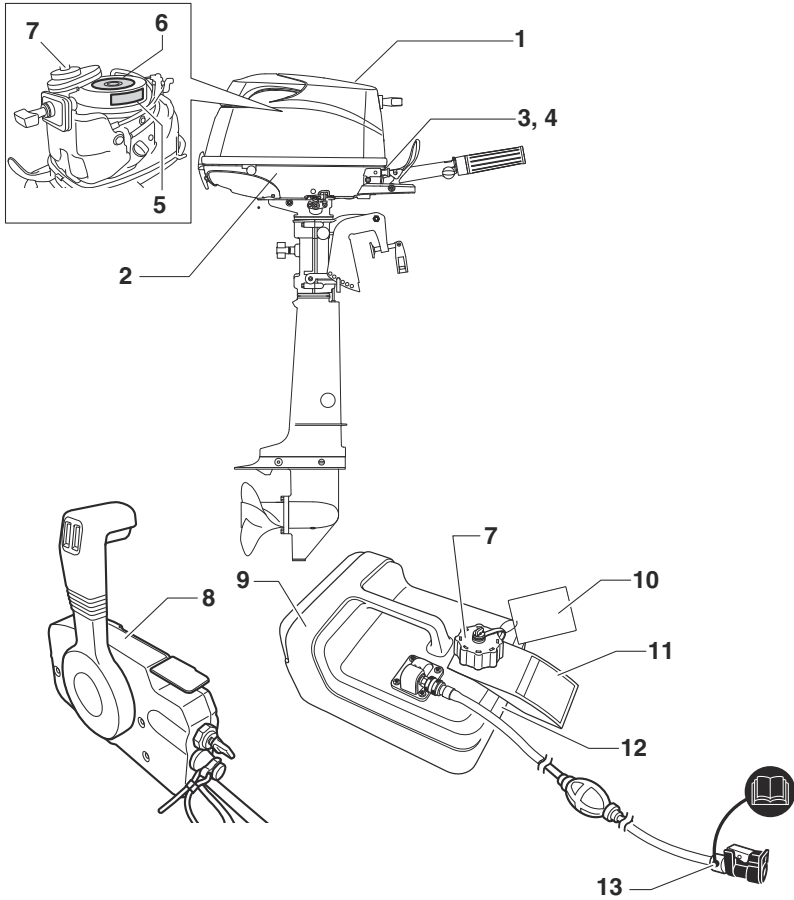

ENOF01503-A

## 16 LABEL LOCATIONS

- Warning label regarding owner's manual, top cowl, engine stop switch, engine oil level and unleaded gasoline.



ENOF00005-0

- Warning label regarding position of outboard motor when setting down.



ENOF00006-0

- Warning label regarding oil pressure (See page 28).



ENOF00131-0

- Warning label regarding stop switch (See page 37)



ENOF00131-B

- Warning label regarding emergency starting (See page 33).



ENOF00128-0

- Warning label regarding rotating parts, electrical shock and high temperature.

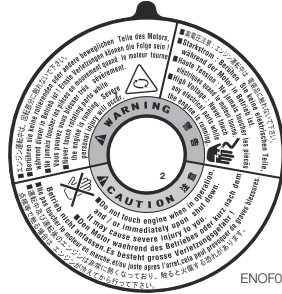

ENOF00129-0

- Warning regarding fuel tank cap (See page 24).

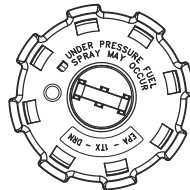

ENOF00012-0

- Warning label regarding engine stop switch.



ENOF00008-0



9. Warning regarding gasoline (See page 24).



REMOVE FROM BOAT  
FOR FILLING

ENOF00005-S

12. Warning regarding gasoline (See page 24).



ENOF00005-L

10. Warning tag regarding instructions of the fuel tank cap (See page 24).



ENOF00010-0

13. Warning mark regarding of fuel connector (See page 24).



ENOF00005-J

11. Warning tag regarding instructions of the fuel tank cap (See page 24).



ENOF00011-0

ENOM00019-A

## ECI (Emission Control Information) decal locations

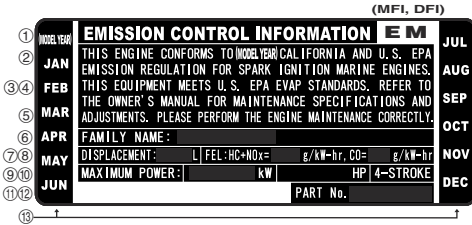

- ① EMISSION CONTROL INFORMATION
- ② THIS ENGINE CONFORMS TO (MODEL YEAR) CALIFORNIA AND U.S. EPA EMISSION REGULATION FOR SPARK IGNITION MARINE ENGINES.
- ③ THIS EQUIPMENT MEETS U.S. EPA EVAP STANDARDS.
- ④ REFER TO THE OWNER'S MANUAL FOR MAINTENANCE SPECIFICATIONS AND ADJUSTMENTS.
- ⑤ PLEASE PERFORM THE ENGINE MAINTENANCE CORRECTLY
- ⑥ FAMILY NAME
- ⑦ DISPLACEMENT
- ⑧ EMISSION LIMIT
- ⑨ MAXIMUM POWER
- ⑩ OUTPUT
- ⑪ MANUFACTURE NAME
- ⑫ PART No.
- ⑬ MODEL YEAR AND MONTH

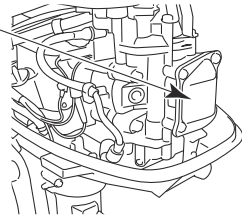

ENOF01504-A

4

### EPA Emissions Regulations

Outboards sold by BRP US Inc.s in the United States are certified to the United States Environmental Protection Agency as conforming to the requirements of the regulations for the control of air pollution from new outboard engines. This certification is contingent on certain adjustments being set to factory standards. For this reason, the factory procedure for servicing the product must be strictly followed and, wherever practicable, returned to the original intent of the design.

**Maintenance, replacement, or repair of the emission control devices and systems may be performed by any marine engine repair establishment or individual.**

Engines are labeled with an Emission Con-

trol Information decal as permanent evidence of EPA certification.

### Emissions Warranty Coverage WARRANTY INFORMATION

#### Four Stroke Outboard Limited Warranty

Canadian and California residents who have purchased an outboard motor from a Canadian and California dealer receive additional warranty coverage for specific emissions related components. To fully understand your warranty coverage please read our standard warranty statement and the Emission Warranty Statement provided by your dealer.

# INSTALLATION

ENOM00024-B

## 1. Mounting the outboard motor on boat

ENOW00006-0

### WARNING

Most boats are rated and certified in terms of their maximum allowable horsepower, as shown on the boat's certification plate. Do not equip your boat with an outboard motor that exceeds this limit. If in doubt, contact your dealer.

Do not operate the outboard motor until it has been securely mounted on the boat in accordance with the instructions below.

ENOW00009-0

### WARNING

- Mounting the outboard motor without following this manual can lead to unsafe conditions such as poor maneuverability, lack of control or fire.
- Loose clamp screws and/or mounting bolts can lead to the release or displacement of the outboard motor, possibly resulting in lost of control and/or serious personal injury. Be sure that fasteners are tightened to the specified torque (30 Nm (3.0 kgf) 13 ft-lb). Check the fasteners for tightness from time to time.
- Be sure to use outboard mounting fasteners included in the outboard motor package or their equivalents in terms of size, material, quality and strength. Tighten fasteners to the specified torque (30 Nm (3.0 kgf) 13 ft-lb). Test cruise to check if fasteners are tightened securely.
- Outboard motor mounting must be performed by trained service person(s) using lift or hoist with sufficient capacity.

Keep the outboard motor in a vertical position when mounting.

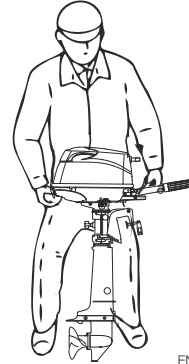

ENOF01505-0

5

ENOM00025-0

### Position ... Above keel line

Set engine at center of boat.

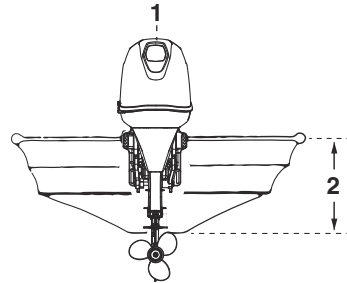

ENOF01141-0

1. Center of boat
2. Boat transom

ENOM00026-0

### Transom matching

Be sure that the anti ventilation plate of the outboard motor is 5–25 mm (0.2–1 in) below the bottom of hull.

If the above condition cannot be met due to the shape of the bottom of your boat, please consult your authorized dealer.

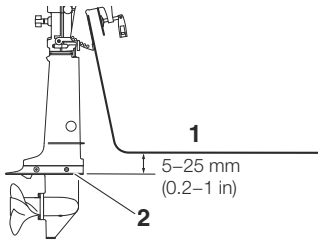

ENOF01506-0

- 1. Bottom of hull
- 2. Anti ventilation plate

ENOW00007-0

**CAUTION**

5

- Before beginning the running test, check that the boat with maximum capacity loading floats on the water in a proper attitude. Check the position of water surface on the driveshaft housing. If the water surface is near the bottom cowling, in high waves, water may enter the engine cylinders.
- Incorrect outboard motor mounting height or existence of underwater object(s), such as hull bottom design, bottom surface conditions or underwater accessories, can cause water spray possibly reaching the engine through an opening of the bottom cowling during cruising. Exposing the engine to such conditions for extended periods can lead to severe engine damage.
- Tighten the bolts sufficiently, otherwise falling down of outboard could be happened.

ENOM00830-A

**Mounting bolts**

**Manual tilt type**

1. To attach the outboard motor to the boat, tighten the clamp screws by turning their handles. Also, use the bolts to secure the outboard motor brackets on transom board. Secure the outboard motor with a rope to prevent loss overboard.

ENON00002-0

**Note**

A rope is not included in the standard accessories.

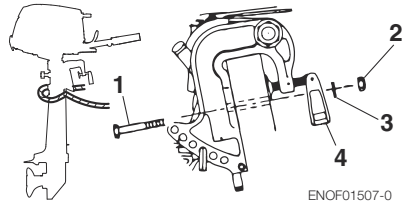

ENOF01507-0

- 1. Bolt (8 x 85)
- 2. Nut
- 3. Washer
- 4. Clamp screw

ENOM00726-A

**2. Altitude adjustment kit requirement**

**High altitude:**

When engine operates at high altitude engine may need to have a high altitude kit installed. Otherwise, operating the engine at high altitude may increase its emissions and decrease fuel efficiency and performance. Contact authorized BRPEvinerude dealer for more detail.

ENOM00840-0

### 3. Remote control device installation (option)

ENOW00850-0

#### Remote control box location

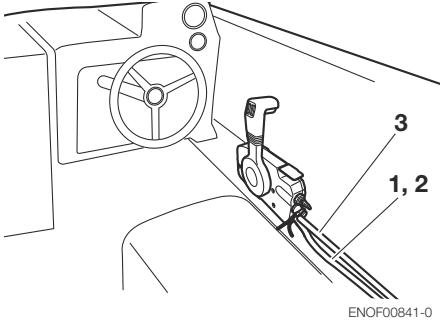

ENOF00841-0

Install the remote control box in a position where it is easy to reach and operate the controls.

Make sure there are no obstacles that can interfere with the operation of the remote control cable.

1. Shift cable
2. Throttle cable
3. Cable harness B

ENOW00850-0

#### Remote control cable length

ENOW00100-A

### CAUTION

Be careful not to loop the remote control cables to a diameter of 406 mm (16 inches) or less. Otherwise, it affects the service life of the cable.

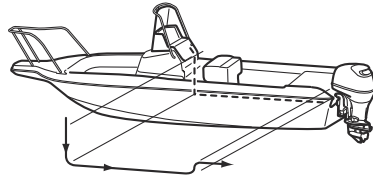

ENOF00842-0

Measure the distance from the remote control box to the outboard motor where the remote control cable should be routed. Prepare a cable that is 300-450mm (11.8-17.7in) longer than the measured distance. Temporarily pull the cable along the intended cable route to check its length is sufficient.

Connect the remote control cable to the engine, then run the cable to the remote control box, making sure it is not sharply bent, too taut and free from obstructions that could interfere with steering.

ENOM00029-A

### 4. Battery installation

ENOW00012-0

### WARNING

Battery electrolyte contains sulfuric acid and thus is hazardous, causing a burn if it comes in contact with your skin, or poisonous if swallowed.

Keep battery and electrolyte away from reach of children

When handling the battery, be sure to:

- Read all warnings shown on the battery case
- Prevent electrolyte from coming in contact with any part of your body. Contact can cause serious burn or, if it comes in

contact with your eye, loss of sight. Use safety glasses and rubber gloves.

In case battery electrolyte comes in contact with:

- Skin, flush thoroughly with water.
- Eye, flush thoroughly with water, and then seek immediate medical treatment.

In case battery electrolyte is swallowed:

- Seek immediate medical treatment.

ENOW00013-B

### WARNING

Battery generates explosive hydrogen gas.

Be sure to:

- Charge the battery in a well-ventilated place.
- Place the battery away from any source of fire, sparks and open flames such as burners or welding equipment.
- Do not charge the battery when the electrolyte level is low. Otherwise, the battery will be damaged and may cause malfunction.

ENOW00014-0

### CAUTION

- Make sure that the battery leads do not get stuck between the outboard motor and boat when turning, etc.
- The starter motor may fail to operate if the leads are incorrectly connected.
- Be sure to correctly connect the (+) and (-) leads. If not, the charging system will be damaged.
- Do not disconnect the battery leads from battery while the engine is operating, the electrical parts could be damaged.
- Always use a fully charged battery.

ENOW00015-0

### CAUTION

Do not use a battery that is not recommended. Use of a battery not recom-

mended can lead to poor performance of, and/or damage to, the electrical system.

ENON00006-A

### Note

Recommended battery: 12V 40AH/5HR, 350 (Cold Cranking Amps (CCA), In case of cold whether: 12V 70AH/5HR (650CCA)) Specifications and features of batteries vary among the manufacturers. Consult the manufacturer for details.

\* The battery should be purchased separately and is not supplied with the outboard motor.

1. Connect the battery cable to the leads that come from the bottom cowl.
2. Place the battery box in a convenient position away from possible water spray. Securely fasten both the box and the battery so they do not shake loose.
3. Connect the positive lead (+) to the positive terminal (+) of the battery, and then connect the negative lead (-). When disconnecting the battery always remove the negative lead (-) first. After connecting the positive terminal (+), securely place a cap on it to prevent short circuits.

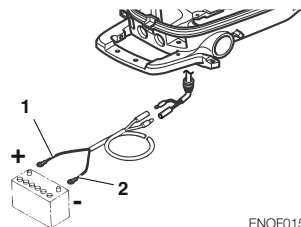

ENOF01508-0

1. Battery cord (red)
2. Battery cord (black)

# PRE-OPERATING PREPARATIONS

ENOM00030-A

## 1. Fuel handling

ENOW000017-0

### CAUTION

**Use of improper gasoline can damage your engine. Engine damage resulting from the use of improper gasoline is considered misuse of the engine, and damage caused thereby will not be covered under the limited warranty.**

ENOM00031-A

## FUEL RATING

Evinerude engines will operate satisfactorily when using a major brand of unleaded gasoline meeting the following specifications:

**USA and Canada** — having a posted pump Octane Rating of 87 (R+M)/2 minimum. Premium gasoline (92 [R+M]/2 Octane) is also acceptable. Do not use leaded gasoline.

**Outside USA and Canada** — Use unleaded gasoline with declared octane rating of 91 RON or over. Use of premium gasoline of 98 RON is also allowed.

ENOM00032-A

## GASOLINES CONTAINING ALCOHOL

The fuel system components on your Evinerude engine will withstand up to 10% ethyl alcohol (hereinafter referred to as the "ethanol"), content in the gasoline. But if the gasoline in your area contains ethanol, you should be aware of certain adverse effects that can occur. Increasing the percentage of ethanol in the fuel can also worsen these adverse effects. Some of

these adverse effects are caused because the ethanol in the gasoline can absorb moisture from the air, resulting in a separation of the water/ethanol from the gasoline in the fuel tank.

These may cause increased:

- Corrosion of metal parts
- Deterioration of rubber or plastic parts
- Fuel permeation through rubber fuel lines
- Starting and operating difficulties

If the use of gasoline containing alcohol is inevitable, or presence of alcohol is suspected in the gasoline, it is recommended to add a filter that has water separating capability, and check the fuel system for leaks and mechanical parts for corrosion and abnormal wear more frequently.

And, in case any of such abnormality is found, discontinue the use of such gasoline and contact our dealer immediately.

If the outboard motor will only be used infrequently, please see the remarks on fuel deterioration in the STORAGE chapter (P 63) for additional information.

ENOW00020-0

### CAUTION

**When operating a Evinerude engine on gasoline containing alcohol, storage of gasoline in the fuel tank for long periods should be avoided. Long periods of storage, common to boats, create unique problems. In cars, alcohol blend fuels normally are consumed before they can absorb enough moisture to cause trouble, but boats often sit idle long enough for phase separation to take place. In addition, internal corrosion may take place during stor-**

age if alcohol has washed protective oil films from internal components.

ENOW00018-0

**WARNING**

Fuel leakage can cause fire or explosion, potentially leading to severe injury or loss of life. Every fuel system part should be checked periodically, and especially after long term storage, for fuel leak, change of hardness of rubber, expansion and/or corrosion of metals. In case any indication of fuel leakage or degradation of fuel part is found, replace relevant part immediately before continuing operation.

ENOM00043-B

6

## 2. Fuel filling

ENOW00019-0

**WARNING**

Do not fill the fuel tank over capacity. The rise of gasoline temperature may cause gasoline to expand which, if overfilled, may leak through air vent screw when it is open. Leaking gasoline is a dangerous fire hazard.

ENOW00028-A

**WARNING**

Consult an authorized dealer for details on handling gasoline, if necessary.

Gasoline and its vapors are very flammable and can be explosive.

When carrying a fuel tank containing gasoline:

- Close the fuel tank cap and air vent screw of fuel tank cap, or gasoline vapor will be emitted through the air vent screw, creating a fire hazard.
- Do not smoke.

When or before refueling:

- Be sure to remove the static electricity charged in your body before refueling.
- The sparks due to static electricity may cause explosion of flammable gasoline.
- Stop the engine, and do not start the engine during refueling.
- Do not smoke.
- Be careful not to overfill fuel tank. Wipe up any spilled gasoline immediately.

When or before cleaning the gasoline tank:

- Dismount fuel tank from the boat.
- Place the fuel tank away from every source of ignition, such as sparks or open flames.
- Do the work outdoors or in a well ventilated area.
- Wipe off gasoline well immediately if spilled.

After cleaning gasoline tank:

- Wipe off gasoline well immediately if spilled.
- If the fuel tank is disassembled for cleaning, reassemble carefully. Imperfect assembly may cause a fuel leak, possibly leading to fire or explosion.
- Dispose aged or contaminated gasoline in accordance with local regulations.

ENOW00029-A



**WARNING**

When opening fuel tank cap, be sure to follow the procedure described below. Fuel could blast out through the fuel tank cap in case the cap is loosened by using another procedure when internal pressure of fuel tank is raised by heat from sources such as sun light.

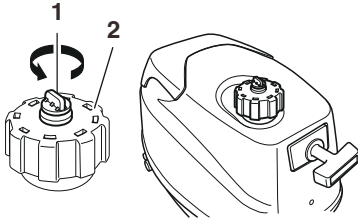

**1. When using integral tank**

Full open the air vent screw on the tank cap and release internal pressure.



ENOF00420-A

1. Two turns the air vent screw
2. Fuel tank cap

**When using separate tank**

1. Full open the air vent screw on the tank cap and release internal pressure.

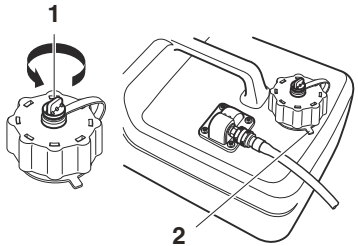

ENOF00421-0

1. Air vent screw
2. Fuel tank cap

**2. When using integral tank**

Open the fuel tank cap slowly.

**When using separate tank**

Loosen the tank cap until it contacts the tab lock and release internal pressure completely. After that, press down the tab lock and open the tank cap.

**3. When using integral tank**

Remove top cowl and fill the fuel not to over the full mark.

**When using separate tank**

Fill the fuel carefully not to over flow.

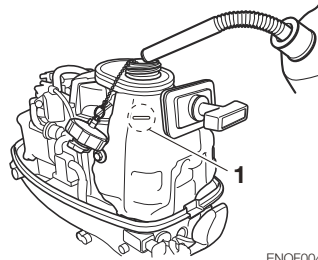

ENOF00418-0

1. Full mark

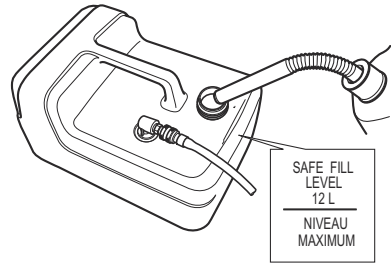

ENOF00419-A

4. After filling the tank, close the fuel tank cap until two clicks sound is heard.

ENOM00037-A

### 3. Engine oil recommendation

ENOW00022-A

**CAUTION**

The engine oil is drained for shipping from the factory. Be sure to fill the engine to the proper level before starting engine. (To properly fill the engine with oil follow the instructions, See page 49)

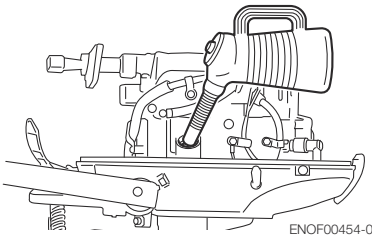

6

Use only high quality 4-stroke engine oil to insure performance and prolonged engine life.

The SAE oil viscosity 10W-30 or 10W-40 FC-W outboard motor engine oil is recommended.

You can also use oils that carry the API rating of SH, SJ, or SL. Select the appropriate viscosity, based on atmospheric temperature, from the chart below.

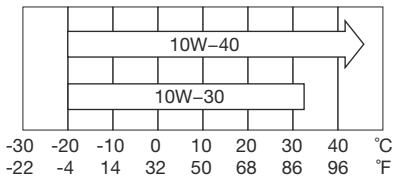

ENOF00208-0

ENOW0002A-A

**CAUTION**

Use of engine oils that do not meet these requirements will result in reduced engine life, and other engine problems.

JENOM00033-A

## 4. Break-In

Your new outboard motor and lower unit require break-in for the moving components according to the conditions described in the following time table.

Please refer to ENGINE OPERATION section (See page 30) to learn how to correctly start and operate the outboard motor.

ENOW00024-A

 **WARNING**

**Do not operate the outboard motor in closed area or area with no forced ventilation.**

**Exhaust gas emitted by this outboard motor contains carbon monoxide that will cause death if inhaled continuously. Inhaling the gas initially causes symptoms such as feeling of sickness, drowsiness and headache.**

**During operation of the outboard motor:**

- **Keep peripheral area well ventilated.**

- **Always attempt to stay on the windward side of emission.**

ENOW00023-0

 **CAUTION**

**Operating the outboard motor without break-in can shorten service life of the product.**

**If any abnormality is experienced during the break-in:**

- **Discontinue the operation immediately.**
- **Have the dealer check the product and take proper action(s) if necessary.**

ENON00008-0

**Note**

Proper break-in allows outboard motor to deliver it full performance for longer service life.

	1-10 min	10 min - 2 hrs	2-3 hrs	3-10 hrs	After 10 hrs
Throttle Position	Idle	Less than 1/2 throttle	Less than 3/4 throttle	3/4 throttle	Full throttle available
Speed		Approx. 3000 rpm max	Full throttle run allowed for 1 min every 10 min	Approx. 4000 rpm. Full throttle run allowed for 2 min every 10 min	

ENOM00039-0

## 5. Warning system

If outboard motor encounters an abnormal condition of fault, the warning horn will emit a continuous beep or intermittent short beeps and the warning lamp (LED) will synchronize with the horn and engine speed will be limited (engine will not be stopped).

See next page for conditions which will lead to an abnormal condition or fault.

ENOM00040-D

6

## Location of warning lamp

### ■ Warning lamp (LED)

Tiller handle models: Located on the bottom cowl.

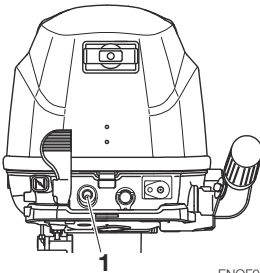

ENOF00415-0

1. Warning lamp

ENOM00041-D

### Warning indicators, faults and remedy

Warning indicators			Description of faults	Remedy
Sound	Lamp (LED)	ESG		
-	On for several sec.l		Normal system test when start up	
Continuous	ON	ON	Engine speed exceeds maximum allowable RPM	<b>1</b>
Continuous	ON	-	Low oil pressure <sup>*1</sup>	<b>2</b>

Remarks

\*1: In this case, oil pressure switch is "ON".

#### High speed ESG (Electronic Safety Governor)

High speed ESG is a device to prevent over revolution of the engine. If the load to the engine becomes light for some reason, it runs at a higher speed than the usual. In such the case, the buzzer sounds and the ESG is activated not to ignite the spark plug, therefore, the engine speed varies and be controlled under 6300rpm.

#### Remedy

1. Reduce the throttle to less than half opening, and move to safe place quickly, and stop the engine.  
Check the propeller for bent or damaged blades.  
Consult an authorized dealer if engine shows the same result even after replacing propeller with new one.
2. Move to safe place quickly, and stop the engine.  
Check the engine oil level, and add engine oil if necessary.  
Consult your dealer if the engine oil level is too low or too high.

ENOW00025-B



**High speed ESG ON: Engine speed will be limited to 6300 rpm and engine will run rough until throttle is reduced.**

# ENGINE OPERATION

ENOM00042-0

## Before starting

ENOW00022-A

### CAUTION

The engine oil is drained for shipping from the factory. Be sure to fill the engine to the proper level before starting engine. (To properly fill the engine with oil follow the instructions. See page 49)

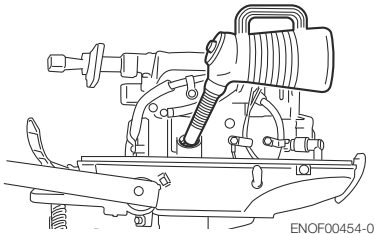

ENOF00454-0

7

ENOW00027-B

### CAUTION

Before starting engine for the first time after reassembling engine or off-season storage, disconnect stop switch lock and crank approximately 10 times in order to prime the oil pump.

ENOM00044-B

## 1. Fuel feeding

ENOW00029-A

### WARNING

When opening fuel tank cap, be sure to follow the procedure described below. Fuel could blast out through the fuel tank cap in case the cap is loosened by using another procedure when internal pressure of fuel

tank is raised by heat from sources such as sun light.

ENOW00030-B

### WARNING

When using EPA approval fuel tank, only use a primer bulb/hose assembly that has a Fuel Demand Valve (FDV) installed in the fuel hose or a sealing mechanism in the fuel connector as shown below.

FDV and fuel connector that has an sealing mechanism prevent pressurized fuel spillage when the fuel connector is connected to the engine.



ENOF00035-0

1. FDV in fuel hose
2. Sealing mechanism in fuel connector
3. Identification

Do **NOT** use a primer bulb/hose assembly that does not contain a Fuel Demand Valve or a sealing mechanism as shown below: otherwise fuel spillage may occur when the connector is connected to the engine.



ENOF00036-0

Do not connect fuel connector except when operating engine. Fuel leakage is a fire or explosion hazard, which can cause serious injury or death.

ENOW00403-0

**CAUTION**

When separate tank is used for dual tank model, be sure to open air vent of integral tank as well as air vent of separate tank. If air vent of integral tank that contains fuel is closed, swelling of air in the tank by heat from engine can cause increase of internal pressure of the tank dangerously.

1. Full open the air vent screw on the tank cap.
2. **When using integral tank**  
Open the fuel tank cap slowly and release internal pressure completely. After that, close the fuel tank cap  
**When using separate tank**  
Loosen the tank cap until contacts the tab lock and release internal pressure completely. After that, close the fuel tank cap.
3. Set fuel cock lever to which you would like to use.

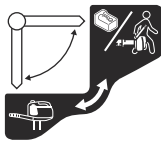

ENOF00422-0

ENOW00404-0

**CAUTION**

When using integral tank, disconnect fuel connector.

4. If you use a separate tank, connect the fuel connector to the engine side with pushing fuel connector lever. And then, connect the fuel connector to the fuel tank side.

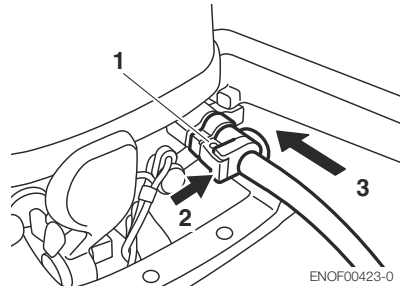

ENOF00423-0

1. Fuel connector
2. Push
3. Insert

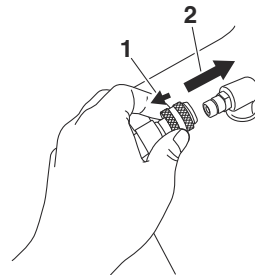

ENOF00861-A

1. Pull
2. Insert

5. Squeeze primer bulb until it becomes stiff to feed fuel to vapor separator. Direct arrow mark upward when priming.



ENOF00862-0

1. Engine side
2. Fuel tank side

Do not squeeze primer bulb while engine running or when the outboard motor is tilted up. Otherwise, fuel could overflow.

ENOM00045-C

## 2. Starting the engine

ENOW00036-A

**CAUTION**

When the engine is started in the test tank, to avoid over heating and water pump damage, be sure the water level is at least 10 cm (4 in.) above the anti ventilation plate.

Run the engine only at idling.

And be sure to remove the propeller, when starting the engine in the test tank. (See page 58)

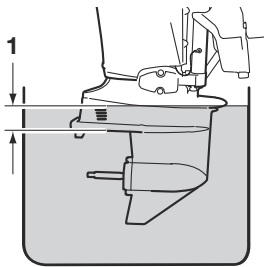

ENOF00863-0

1. Over 10 cm (4 in.)

ENOW00036-B

**CAUTION**

Be sure to stop engine immediately if cooling water check port is not discharging water, and check if cooling water intake is blocked. Operating engine could lead to overheating potentially leading to engine damage. Consult an authorized dealer if the cause cannot be found.

ENOW00032-B

**CAUTION**

Do not try to crank after engine has started.

This model is provided with start in gear

protection.

ENON00010-0

### Note

Start-in-gear protection prevents engine from starting at other than neutral shift. In-gear starting of engine will move the boat immediately, potentially leading to falling down or causing passenger(s) to be thrown overboard.

### Tiller handle type

1. Be sure to install the stop switch lock to the stop switch, and attach the stop switch lanyard securely to the operator or to the operator's PFD (Personal Flo-tation Device.)

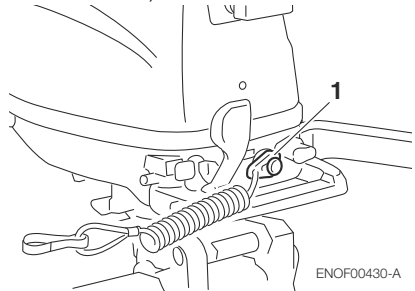

ENOF00430-A

1. Stop switch lock
2. Set the control lever in the Neutral position.

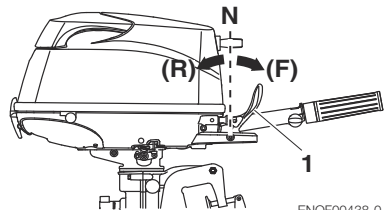

ENOF00438-0

1. Shift lever



3. Set the throttle grip to START position.

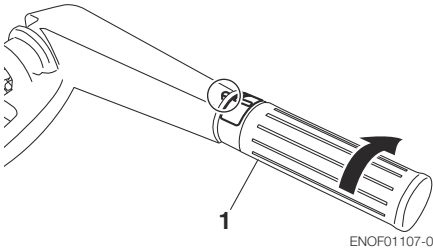

1. Throttle grip
4. Set the control lever in the Neutral position.

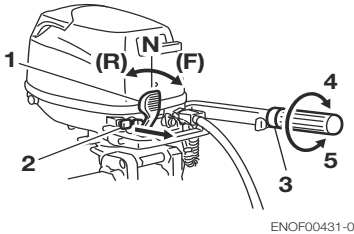

1. Shift lever
2. Choke knob
3. Throttle grip
4. SLOW
5. HIGH

5. Pull the choke knob fully.

ENON00501-0

**Note**

Choke is not necessary when the engine is warm. Set the throttle grip to "RE-START" position.

ENON00502-0

**Note**

If engine does not start with 4 or 5 times starting operation, push the knob back and restart.

6. Pull the starter handle slowly until you feel engagement, keep pulling till you feel less resistance. Then pull it quickly. repeat if necessary until started.

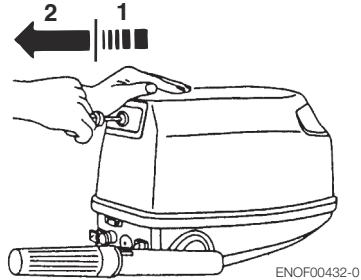

1. Slowly
2. Quickly

ENOM00042-A

**Emergency starting**

ENOW00099-A

**WARNING**

**When the emergency starter rope is used for starting engine;**

- **Start in gear protection does not work. Be sure to shift is at neutral position. Otherwise the engine will move the boat immediately and cause personal injury.**
- **Be careful that your clothes or other items do not get caught in the rotating engine parts.**
- **To prevent accident and injury by rotating parts, do not re-attach flywheel cover and the top cowl after the engine has been started.**
- **Do not pull starter rope if any bystander is behind. The action can injure the bystander.**
- **Attach engine stop switch lanyard to clothing or any part of body like arm before starting engine.**

1. Remove the top cowl.

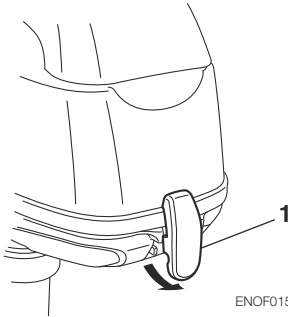

2. Disconnect the rink of the starter lock rod.

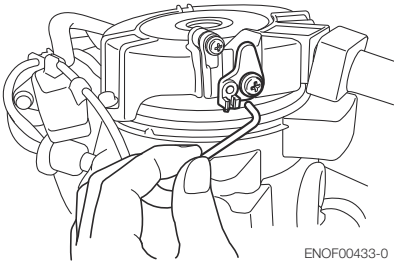

3. Remove the bolts (3 pcs) and remove the recoil starter.

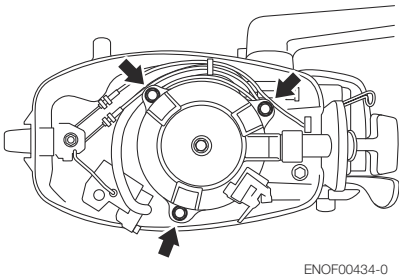

4. Insert the knotted end of the starter rope into the notch in the flywheel and wind the rope around the flywheel several turns clockwise.

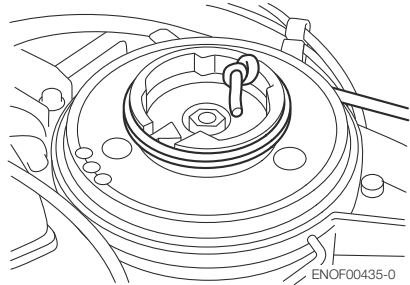

5. Tie a loop in the another end of the emergency starter rope and attach socket wrench that is included in the tool kit.

ENOW00860-0

**CAUTION**

**Be sure to keep the harness away from the rotation parts.**

6. Be sure to install the stop switch lock to the stop switch, and attach the stop switch lanyard securely to the operator or to the operator's PFD (Personal Flo-tation Device.)
7. Set the control lever in the Neutral position.
8. Pull the starter handle slowly until you feel engagement, keep pulling till you feel less resistance. Then pull it quickly.

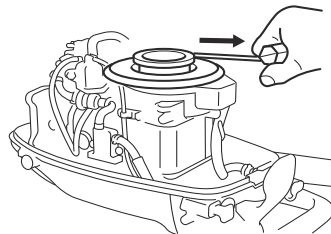

- After engine starts, do not reinstall fly-wheel cover and top cowl.

ENOM00043-A

### 3. Warming up the engine

ENOW00932-0

#### CAUTION

**Be sure to check that cooling water is coming out of the cooling water check port during warm up.**

Warm the engine at low engine speeds for about

3 minutes : above 41°F (5 °C )

5 minutes at 2000 rpm : below 41°F (5 °C )

This allows the lubricating oil to circulate to all parts of the engine. Operating the engine without warm up shortens the engine's life.

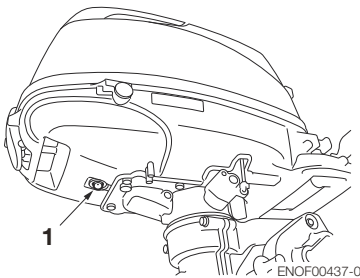

1. Cooling water check port

ENOM00044-0

### Engine speeds

Idling speed after warming up.

Remark: In case of cold engine starting, idling speed is increased about 400 rpm for several minutes.

Clutch in (In gear)	Clutch off (Out of gear)
1100 rpm	13000 rpm

ENOM00046-A

### 4. Forward, reverse, and acceleration

ENOW00037-0

#### WARNING

**Before shifting into forward or reverse, make sure that boat is properly moored and outboard motor can be steered fully to the right and left. Make sure that no swimmer(s) is ahead or astern of the boat.**

ENOW00038-A

#### WARNING

- Attach other end of emergency stop switch lanyard to the operator's PFD (Personal Flotation device) or arm and keep it attached during cruising.
- Do not attach the tether to a part of clothing that can be torn easily when pulled.
- Arrange the tether so that will not be caught by any object when pulled.
- Be careful not to pull the tether accidentally during cruising. Unintentional stop of engine can cause loss of control of outboard motor. Rapid loss of engine power can lead to falling down or causing passenger(s) to be thrown overboard.

7

ENOW00042-0

#### WARNING

- Do not shift into Reverse during planing, or control will be lost leading to serious personal injury, boat may swamp, and/or hull may be damaged.
- Do not shift into Reverse during cruising, or control may be lost, falling down or causing passenger(s) to be thrown overboard. Leading to serious personal injury, and steering system and/or shifting mechanism may be damaged.

ENOW00861-0

**WARNING**

Do not shift at high boat speed, or control may be lost, falling down or causing passenger(s) to be thrown overboard. Leading to serious personal injury.

ENOW00862-0

**CAUTION**

Gear and clutch damage may occur if shifting at high engine speed. Engine must be in the slow idle position before shifting is attempted.

ENOW00863-0

**CAUTION**

Idle speed may be higher during warming up of engine. If shifted to Forward or Reverse during warming up, it may be difficult to shift back to neutral. In such case, stop engine, shift to neutral, and restart engine to warm up.

ENON00014-0

**Note**

Frequent shifting to forward or reverse can accelerate wear or degradation of parts. In such case, replace gear oil earlier than the period specified.

ENOW00864-0

**CAUTION**

Do not increase engine speed unnecessarily when the shift is in neutral and reverse, or engine damage may occur.

ENOM00890-A

**Tiller handle type**

ENOW00867-0

**WARNING**

Sudden acceleration and deceleration may cause passenger(s) to be thrown overboard or falling down.

ENOW00865-A

**CAUTION**

Do not force to shift when the throttle grip is not in the fully closed position, otherwise, steering system and/or shifting mechanism may be damaged.

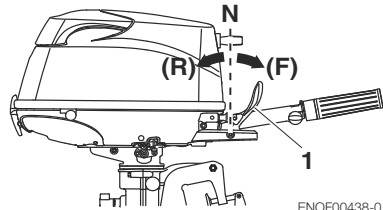

ENOF00438-0

1. Shift lever

**Forward**

1. Turn the throttle grip to reduce engine speed.
2. When the engine reaches trolling (or idling) speed, quickly pull the shift lever to the Forward position.

**Reverse**

1. Turn the throttle grip to reduce engine speed.
2. When the engine reaches trolling (or idling) speed, quickly pull the shift lever to the Reverse position.

**Acceleration**

ENOW00867-0

**WARNING**

**Sudden acceleration and deceleration may cause passenger(s) to be thrown overboard or falling down.**

Open throttle grip gradually.

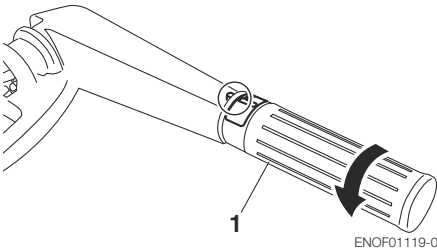

1. Throttle grip

ENOM00049-A

**5. Stopping the engine**

ENOW00868-0

**WARNING**

**Be careful not to remove engine stop switch lanyard from engine accidentally while boat is running. Sudden stop of engine can cause loss of steering control. It can also cause loss of boat speed, possibly leading the crew(s) and or objects on the boat to be thrown forward due to inertial force.**

**Tiller handle type**

1. Turn the throttle grip to the slow position.

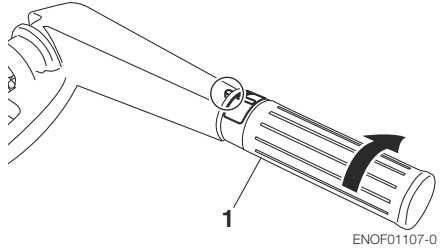

1. Throttle grip
2. Put the shift lever in the Neutral position.  
Run the engine for 2-3 minutes at idling speed for cooling down if it has been running at full speed.
3. Push the stop switch.

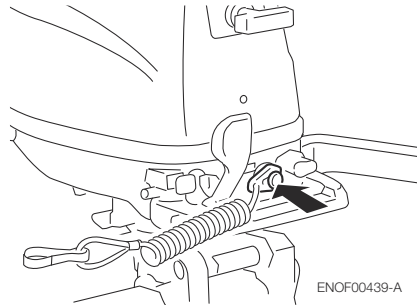

ENOW00869-0

**WARNING**

**After stopping the engine:**

- Close the air vent screw on the fuel tank cap.
- Disconnect the fuel connector of the engine and the fuel tank.
- Disconnect the battery cord, after each use.

**Emergency engine stopping**

Remove stop switch lock to stop the engine.

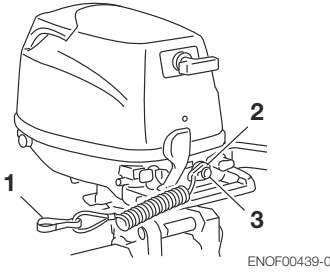

- 1. Hock
- 2. Stop switch lock
- 3. Stop switch

ENOM00910-0

**Spare emergency stop switch lock**

A spare emergency stop switch lock is provided in the tool bag.

When used as described, the emergency stop switch clip and emergency stop switch lanyard system stops the engine if the operator falls away from the controls.

When an operator falls into water, be sure to use emergency stop switch lock of the spare.

Be sure to confirm the spare stop switch lock is in the tool bag before begin to operate.

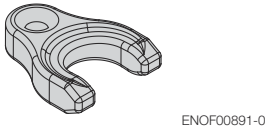

7

ENOM00920-A

**6. Steering**

ENOW00870-0



**Sudden steering may cause passenger(s) to be thrown overboard or falling down.**

**Tiller handle type**

**Right turn**

Move the tiller handle to the left

**Left turn**

Move the tiller handle to the right.

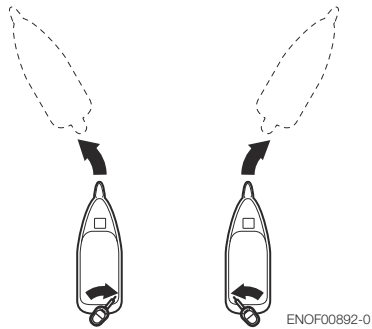

ENOM00050-0

**7. Trim angle**

ENOW00043-A



- **Adjust the trim angle when the engine is stopped.**
- **Do not put hand or finger in between outboard motor body and clamp bracket when adjusting trim angle to prevent injury in case the outboard motor body falls.**
- **Unsuitable trim position can cause loss of control of boat. When testing a trim position, run boat slow initially to see if it can be controlled safely.**

ENOW00044-0

 **WARNING**

Excessive trim up or down may lead to unstable boat operation, potentially causing the steering difficulty that leads to accident during cruising.

- Do not cruise at high speed if improper trim position is suspected. Stop the boat and readjust trim angle before continuing cruise.
- For outboard motor model with PTT switch on the bottom cowl, do not operate the switch during cruising, or control of boat may be lost.

The trim angle of the outboard motor can be adjusted to suit the transom angle of the hull, and load conditions. Choose an appropriate trim angle that will allow the anti-ventilation plate to run parallel to the water surface during operation.

ENOM00052-0

**Proper trim angle**

The position of the thrust rod is correct if the hull is horizontal during operation.

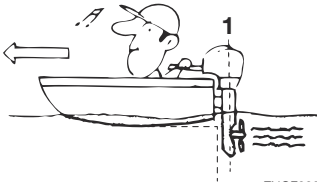

ENOF00051-1

1. Perpendicular to the water surface

ENOM00053-A

**Improper trim angle (bow rises too high)**

Set the thrust rod (or priset knob) lower if the bow of the boat rises above horizontal.



ENOF00052-0

ENOM00054-0

**Improper trim angle (bow dips into the water)**

Set the thrust rod (or priset knob) higher if the bow of the boat is below horizontal.



ENOF00053-0

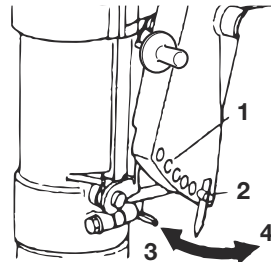

ENOF00440-0

1. Trim angle adjustment hole
2. Thrust rod
3. Higher
4. Lower

**Trim angle adjustment (Manual tilt type)**

The transom angle adjustment

1. Stop the engine.
2. Shift into neutral.

3. Raise the outboard motor to the tilt up position.
4. Change the thrust rod position as following picture.

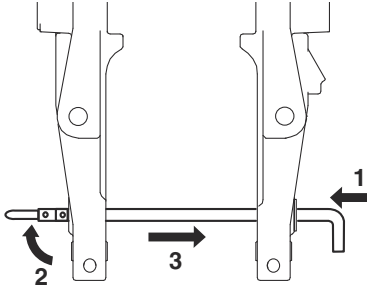

ENOF01238-0

1. Push in
2. Rise the stopper
3. Pull out
5. Reinstall the thurst rod securely.
6. Gentry lower the outboard.

7

ENOM00060-A

## 8. Tilt up and down

ENOW00055-0

### WARNING

Do not tilt up or down outboard motor when swimmer(s) or passenger is near to prevent them from being caught between outboard motor body and clamp bracket in case the outboard motor body falls.

ENOW00048-0

### WARNING

When tilting up or down, be careful not to place your hand between the swivel bracket and the stern bracket.

Be sure to tilt the outboard motor down slowly.

ENOW00056-A

### WARNING

When tilting up outboard motor with fuel joint for over a few minutes, be sure to disconnect fuel hose, or fuel may leak, potentially catching fire.

ENOW00057-0

### CAUTION

Do not tilt up outboard motor while engine operates, or no cooling water may be fed, leading to engine seizure due to overheating.

ENON00921-0

### Note

Before tilting the outboard motor up, after stopping the motor leave it in the running position for about a minute to allow water to drain from inside the engine.

ENOM00423-0

### Tilt up

With the shift lever in Forward, fully tilt the motor up toward you by holding the tilt handle provided at the rear of the top cowl. Then slightly lower the motor for locking in the up position.

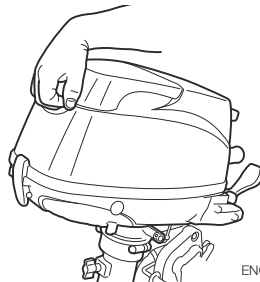

ENOF00441-0



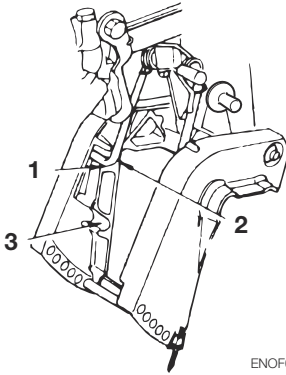

ENOF00442-0

1. Tilt up position
2. Tilt stopper
3. Shallow water running position

ENOM00424-0

**Tilt down**

Slightly tilt the motor up, and pull the tilt lever toward you to release the tilt-lock. Then lower the motor slowly.

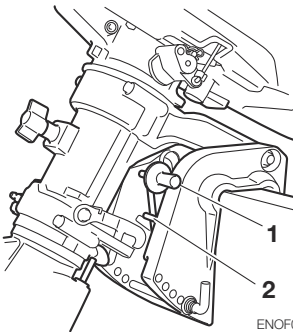

ENOF00443-0

1. Tilt lever
2. Tilt stopper

ENOM00068-A

**9. Shallow water operation**

ENOW00051-0

**WARNING**

During shallow water operation, be careful not to place your hand between the swivel

bracket and the clamp bracket. Be sure to tilt the outboard motor down slowly.

ENOW00053-0

**CAUTION**

While in shallow water drive position, do not operate the outboard motor in Reverse. Operate the outboard motor at slow speed and keep the cooling water intake submerged.

ENOW00054-A

**CAUTION**

Do not overtilt outboard motor when driving shallow water, or air may be sucked through water inlet, potentially leading to engine overheating.

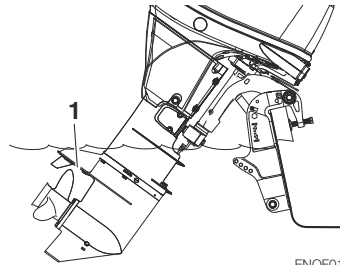

ENOF01144-A

1. Water inlet

**Manual tilt type**

**Shallow water running position:**

1. With the shift lever in Neutral or Forward, tilt the motor up slowly by about 40° and then lower the tilt lever for setting at the shallow water running position.

**Return to normal running position:**

2. Tilt the motor up fully and then return the motor down slowly to the normal running position.

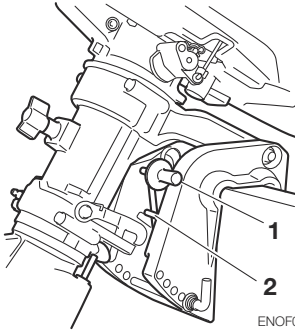

ENOF00443-0

1. Tilt lever
2. Tilt stopper

# REMOVING AND CARRYING THE OUTBOARD MOTOR

ENOM00070-C

## 1. Removing the outboard motor

ENOW00064-0

### CAUTION

Engine may be hot immediately after operating and could cause burns if touched. Allow engine to cool down before attempting to carry the outboard.

1. Stop the engine.
2. Remove the top cowl.
3. Disconnect the fuel connector, the remote control cables and the battery cords from the outboard motor.
4. Remove the outboard motor from boat and completely drain the water from the gear case.

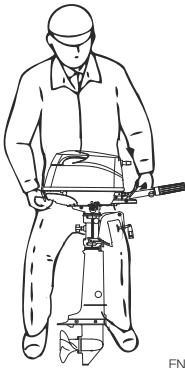

ENOF01505-0

ENOM00071-A

## 2. Carrying the outboard motor

ENOW00933-0

### WARNING

Be sure to disconnect fuel connector except when operating engine.

Fuel leakage is a fire or explosion hazard, which can cause serious injury or death.

ENOW00065-0

### WARNING

Close air vent screw of fuel tank before carrying or storing outboard motor and fuel tank, or fuel may leak, potentially catching fire.

ENOW00066-0

### CAUTION

- Do not give a shock to an outboard motor during transportation. It becomes a cause of breakage.
- Do not carry or store outboard motor in any of positions described below. Otherwise, engine damage or property damage could result from leaking oil.

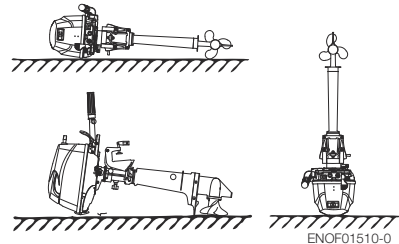

Keep the outboard motor in a vertical position when carrying.

The optional outboard motor stand is recommended for keeping the outboard motor vertical both during transport and storage.

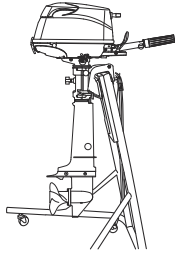
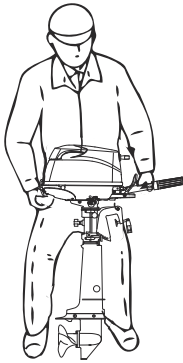

ENOF01511-0

ENON00021-A

**Note**

- If the outboard motor must be laid down be sure drain the fuel and engine oil, then the port side faces down as shown in the drawing above.
- Elevate power unit 2 inches to 4 inches if traveling to avoid oil spillage.

8

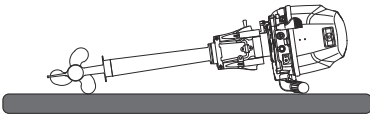

ENOF01512-0

ENOM00072-A

**3. Trailing**

ENOW00072-0

**CAUTION**

Trailing in the tilted position may cause damage to the outboard motor, boat, etc.

ENOW00073-A

**WARNING**

Be sure to disconnect fuel connector except when operating engine.

Fuel leakage is a fire or explosion hazard, which can cause serious injury or death.

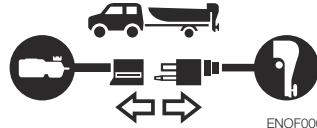

ENOF00075-1

ENOW00068-0

**WARNING**

Close air vent screw of fuel tank and fuel cock before carrying or storing outboard motor and fuel tank, or fuel may leak, potentially catching fire.

ENOW00071-0

**CAUTION**

The tilt support device supplied on your outboard motor is not intended for towing. It is intended to support the outboard motor while the boat is docked, beached, etc.

ENOW00072-A

**CAUTION**

When trailering the outboard motor should be in a vertical (normal running) position, fully down. Trailering in the tilted position may cause damage to the outboard motor, boat, etc.

If trailering with outboard motor fully down is not available (the gear case skeg is too close to the road in a vertical position), fix the outboard motor securely using a device (like a transom saver bar) in the tilted position.

When transporting a boat on a trailer with the outboard motor still attached, disconnect the fuel line from the outboard motor beforehand and keep the outboard motor in the normal running position or on a transom saver bar.

### Tiller handle type

To prevent the outboard motor from moving when it is attached on a boat during transport on a trailer, properly tighten the steering friction (page 46).

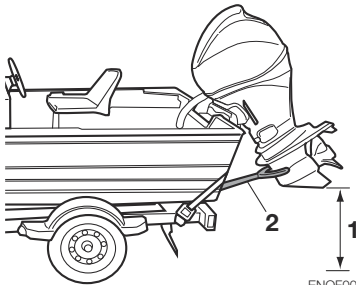

ENOF00073-A

1. Ground clearance should be provided sufficiently.
2. Transom saver bar

ENOW00067-0



## WARNING

**Do not go under outboard motor tilted up even if it is supported by support bar, or accidental fall of outboard motor could lead to severe personal injury.**

# ADJUSTMENT

ENOM00073-0

## 1. Steering friction

### Tiller handle type

ENOW00074-A

#### WARNING

**Do not overtighten the steering friction lever it could result in difficulty of movement resulting in the loss of control causing an accident and could lead to severe injury.**

Adjust this lever to achieve the desired steering friction (drag) on the tiller handle. Move lever towards (A) to tighten friction and move lever towards (B) to loosen friction.

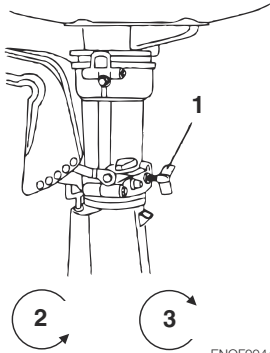

ENOF00444-0

1. Steering friction lever
2. Lighter
3. Heavier

EENOM00074-A

## 2. Throttle grip friction

ENOW00074-B

#### WARNING

**Do not overtighten the throttle adjustment screw or it could result in difficulty of movement resulting in the loss of control**

**causing an accident and could lead to severe injury.**

Friction adjustment of the throttle grip can be made with the throttle adjustment screw.

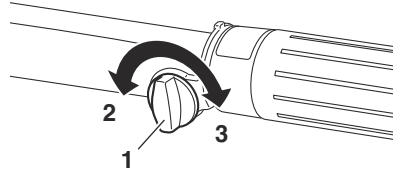

ENOF00445-0

1. Heavier
2. Lighter
3. Throttle friction adjustment screw

# INSPECTION AND MAINTENANCE

ENOM00077-0

## Care of your outboard motor

To keep your outboard motor in the best operating condition, it is very important that you perform daily and periodic maintenance as suggested in the maintenance schedules that follow.

ENOW00077-0



### CAUTION

- **Your personal safety and that of your passengers depends on how well you maintain your outboard motor. Carefully observe all of the inspection and maintenance procedures described in this section.**
  - **The maintenance intervals shown in the checklist apply to an outboard motor in normal use. If you use your outboard motor under severe conditions such as frequent full-throttle operation, frequent operation in brackish water, or for commercial use, maintenance should be performed at shorter intervals. If in doubt, consult your dealer for advice.**
  - **We strongly recommend that you use only genuine replacement parts on your outboard motor. Damage to your outboard motor arising from the use of other than genuine parts is not covered under the warranty.**
-

ENOM00428-0

# 1. Daily Inspection

Perform the following checks before and after use.

ENOW00078-0



**Do not use outboard motor if any abnormality is found during pre-operation check or it could result in severe damage to the motor or severe personal injury.**

Item	Points to Check	Remedy
<b>Fuel System</b>	<ul style="list-style-type: none"> <li>• Check the amount of fuel in the tank.</li> <li>• Check for debris or water in the fuel filters.</li> <li>• Check the rubber hoses for fuel leakage.</li> </ul>	Replenish Clean or replace Replace
<b>Fuel Tank and Cap</b>	<ul style="list-style-type: none"> <li>• Check for crack, leakage, damage in the fuel tank and cap.</li> <li>• Check for crack, damage in the gasket and tether.</li> <li>• Check for leakage at full close.</li> <li>• Check for ratchet performance.</li> </ul>	Replace Replace Replace Replace
<b>Engine Oil</b>	<ul style="list-style-type: none"> <li>• Check the oil level.</li> </ul>	Fill to the upper level mark on dipstick
<b>Electrical Equipment</b>	<ul style="list-style-type: none"> <li>• Check that the main switch functions normally.</li> <li>• Check that the battery electrolyte level and specific gravity are normal.</li> <li>• Check for loose connections on the battery terminal.</li> <li>• Check that the stop switch functions normally and make sure the lock plate is there.</li> <li>• Check cords for loose connections and damage.</li> <li>• Check the spark plugs for dirt, wear and carbon build-up.</li> </ul>	Replace Replenish or recharge Retighten Remedy or replace Correct or replace Clean or replace
<b>Throttle System</b>	<ul style="list-style-type: none"> <li>• Check carburetor linkage is working normally when turning the throttle grip.</li> </ul>	Correct
<b>Recoil Starter</b>	<ul style="list-style-type: none"> <li>• Check the rope for wear and chafing.</li> <li>• Check the ratchet engagement.</li> </ul>	Replace Correct or replace
<b>Clutch and Propeller System</b>	<ul style="list-style-type: none"> <li>• Check that clutch engages correctly when operating the shift lever.</li> <li>• Visually Check propeller for bent or damaged blades.</li> <li>• Check the propeller nut is tightened and the split pin is present.</li> </ul>	Adjust Replace
<b>Installation of Motor</b>	<ul style="list-style-type: none"> <li>• Check all the bolts attaching the motor to the boat.</li> <li>• Check the thrust rod installation.</li> </ul>	Tighten
<b>Cooling Water</b>	<ul style="list-style-type: none"> <li>• Check that cooling water is discharged from the cooling water check port after the engine has started.</li> </ul>	Repair
<b>Tools and Spares</b>	<ul style="list-style-type: none"> <li>• Check that there are tools and spare parts for replacing spark plugs, the propeller, etc.</li> <li>• Check that you have the spare rope.</li> </ul>	
<b>Steering Devices</b>	<ul style="list-style-type: none"> <li>• Check the operation of the steering handle.</li> </ul>	Repair
<b>Other parts</b>	<ul style="list-style-type: none"> <li>• Check if the anode is securely installed.</li> <li>• Check the anode for corrosion and deformation.</li> </ul>	Repair if necessary Replace



ENOM00081-A

**Oil level checking**

If the oil level is low, or too high, the life of the engine will be shortened significantly.

1. Stop the engine and set it in a vertical position.
2. Remove the top cowl.
3. Remove the dipstick after 5 minutes engine has stopped.
4. Wipe oil off the oil dipstick with a clean rag.
5. Put in the dipstick.
6. Take out the dipstick and check the oil level.
7. Return the dipstick.

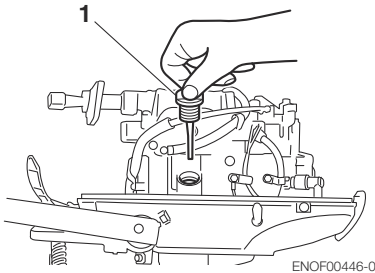

1. Oil filler cap (Dipstick)

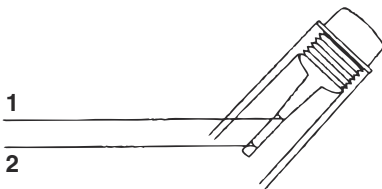

1. Upper lever 450 mL
2. Lower lever 350 mL

ENON00024-0

**Note**

The oil level should be checked when the engine is cold.

ENON00025-0

**Note**

Consult with an authorized dealer if the engine oil is milky color, or appears contaminated.

ENOM00082-A

**Engine oil replenishing**

ENOW00079-A

**CAUTION**

- Do not add engine oil of brand and grade other than existing one. In case engine oil of other brand or grade is added, drain all oil and ask dealer for treatment.
- In case other than engine oil such as gasoline is put in the oil chamber, empty the chamber and ask dealer for treatment.
- When replenishing engine oil, be careful not to allow entry of foreign matters such as dust and water into oil chamber.
- Wipe off engine oil well immediately if spilled and dispose of it in accordance with local fire prevention and environment protection regulations.
- Do not replenish engine oil over upper limit. If overfilled, remove oil to upper limit. If engine oil is over the upper limit, it can leak potentially leading to engine damage.

If the oil level is low, or at lowest mark, add recommended oil to the middle dipstick mark.

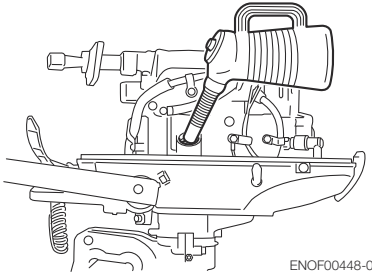

ENOF00448-0

ENOM00083-0

### Washing outboard motor

ENOW00081-0

#### ⚠ WARNING

**Do not start engine without removing propeller, or accidentally turning propeller could cause personal injury.**

ENOW00082-0

#### ⚠ WARNING

**Never start or operate the engine indoors or in any space which is not well ventilated. Exhaust gas contains carbon monoxide, a colorless and odorless gas which can be fatal if inhaled for any length of time.**

ENOW00920-0

#### ⚠ CAUTION

**When washing the outboard motor, be careful not to spray the water inside of the top cowl, especially electrical components.**

ENON00026-0

#### Note

It is recommended to check chemical properties of water on which your outboard motor is regularly used.

If outboard motor is used in salt water, brackish water or water with a high acidic

level, use fresh water to remove salt, chemicals or mud from exterior and cooling water passage after every cruising or before storing outboard motor for long time. Before flushing, remove the propeller and the forward thrust holder.

ENOM00085-A

### Flushing attachment

ENOW00922-0

#### ⚠ CAUTION

**To prevent the engine from starting when you are near the propeller, remove the stop switch lock.**

1. Tilt down the outboard motor.
2. Remove the water plug from the gear case, and screw in the flushing attachment.
3. Connect a water hose. Turn on the water and adjust the flow (Be sure to seal the water inlet, located in the gear case with tape).
4. Put the shift lever in the neutral position and start the engine.  
Continue flushing the outboard motor for 3 to 5 minutes at idling.
5. Stop the engine and water supply. Remove the flushing attachment and tape. After the flushing, be sure to reattach the water plug.

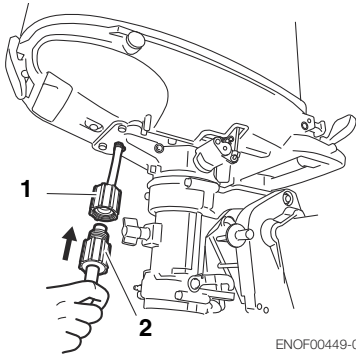

ENOF00449-0

1. Flushing attachment (option)
2. Gardenhose (commercial available)

ENOM00085-A

**Flushing by test tank**

ENOW00081-0

**WARNING**

Do not start engine without removing propeller, or accidentally turning propeller could cause personal injury.

ENOW00082-0

**WARNING**

Never start or operate the engine indoors or in any space which is not well ventilated. Exhaust gas contains carbon monoxide, a colorless and odorless gas which can be fatal if inhaled for any length of time.

ENOW00036-A

**CAUTION**

When the engine is started in the test tank, to avoid over heating and water pump damage, be sure the water level is at least 10 cm (4 in.) above the anti ventilation plate.

And be sure to remove the propeller, when starting the engine in the test tank. (See page 58)

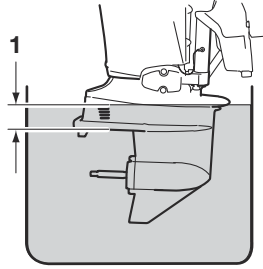

ENOF00863-0

1. Over 10 cm (4 in.)

ENOM00950-0

**Fuse replacement (for SP type)**

ENOW00923-0

**CAUTION**

Before replacing a fuse, disconnect the battery cable from the battery negative (-) terminal. Failure to do so may cause a short-circuit.

ENOW00924-0



**CAUTION**

Never use a fuse with a rating that exceeds the specified rating as this could cause serious damage to the electrical system.

If a blown fuse is detected, try to determine the cause for this and correct it. If the cause for the problem is not corrected, the fuse will likely blow again.

If the fuse continues to blow, request an authorized BRP dealer to inspect the out-board motor.

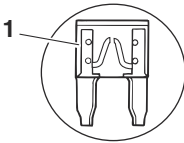
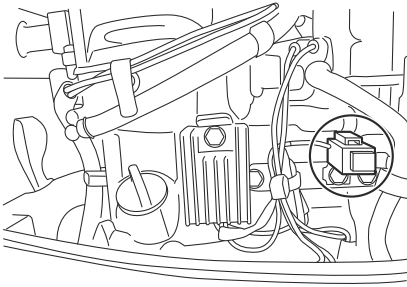
1. Stop the engine and disconnect the battery cable from the battery negative (-) terminal.
2. Remove the engine cover.
3. Remove the fuse box lid.
4. Remove the fuse and check it. If the fuse is blown, replace it with a fuse of the same specified rating. The out-board motor is supplied with spare fuses in the spare fuse holder.



**10**

1. Blown fuse

ENOF01524-0

ENOM00431-0

## 2. Periodic Inspection

It is important to inspect and maintain your outboard motor regularly. At each interval on the chart below, be sure to perform the indicated servicing. Maintenance intervals should be determined according to the number of hours or number of months, whichever comes first.

Description		Inspection intervals				Inspection procedure	Remarks
		First 20 hours of 1 month	Every 50 hours of 3 months	Every 100 hours of 6 months	Every 200 hours of 1 year		
Fuel System	Carburetor <sup>*1</sup>			●	●	Strip, Clean, and adjust.	
	Fuel filter	●	●	●	●	Check and clean or Replace if necessary.	Entire cartridge
	Piping/Hoses <sup>*2</sup>	●	●	●	●	Check and clean or Replace if necessary.	
	Fuel tank <sup>*2</sup>	●		●	●	Clean	
	Fuel tank cap <sup>*2</sup>	●	●	●	●	Check and clean or Replace if necessary.	
	Fuel pump <sup>*1</sup>	●	●	●	●	Check and clean or Replace if necessary.	Disassemble and check each 300 hours.
Ignition	Spark plug	●		●	●	Check gaps. Remove carbon deposits or Replace if necessary.	0.8–0.9 mm (0.031–0.035 in)
	Ignition timing <sup>*1</sup>	●		●	●	Check timing.	
Starting System	Starter rope	●	●	●	●	Check for wear or chafing.	
Engine	Engine oil	Replace ●		Replace ●	Replace ●	Replace if necessary.	
	Valve Clearance <sup>*1</sup>	●		●	●	Check & adjust.	IN: 0.06–0.14 mm (0.0024–0.0055 in) EX: 0.11–0.19 mm (0.0043–0.0075 in)
	Thermostat <sup>*1</sup>			●	●	Check and Replace if necessary.	
Lower Unit	Propeller	●	●	●	●	Check for bent blades, damage, wear.	
	Gear oil	Replace ●	●	Replace ●	Replace ●	Change or replenish-oil and check for water leaks.	195 mL (6.6 fl.oz)
	Water pump <sup>*1</sup>		●	●	●	Check for wear or damage.	Replace impeller every 12 months.
Warning System <sup>*1</sup>			●	●	●	Check function.	
Bolts and Nuts		●	●	●	●	Retighten	
Sliding and Rotating Parts. Grease Nipples		●	●	●	●	Apply and pump in grease.	
Outer Equipment		●	●	●	●	Check for corrosion.	
Anode			●	●	●	Check for corrosion and deformation.	Replace if necessary.

\*1: Have this handled by your dealer.

\*2: In USA, you have to use EPA approved part.

ENON00030-0

**Note**

Your outboard motor should receive careful, and complete inspection at 300 hours. This is the best time for major maintenance procedures to be carried out.

ENOM00091-A

**Engine oil replacement**

ENOW00091-0

**CAUTION**

You may be injured due to high engine temperatures if you fill engine oil just after stopping. Changing engine oil should be done after the engine has been cooled.

ENOW00092-A

**CAUTION**

- Do not overfill engine oil, or engine oil could leak and/or engine could be damaged. If engine oil level is over upper limit marks of oil gauge, drain oil to level lower than upper limit.
- Be sure that outboard motor is in upright and level position when checking or changing oil.
- Stop engine immediately if low oil pressure warning lamp is lit or oil leak is found, or engine could be severely damaged. Consult dealer.
- Wipe off engine oil well immediately if spilled and dispose of it in accordance with local fire prevention and environment protection regulations.

ENOW00090-0

**CAUTION**

Use of engine oils that do not meet these requirements will result in reduced engine life, and other engine problems.

ENOW00933-0

**CAUTION**

Engine oil mixed with dust or water will dramatically shorten the life of the engine.

**To change engine oil:**

Be sure to use recommended engine oil (see page 12).

1. Stop the engine and allow it to cool.
2. Turn the steering on the outboard motor left.
3. Put a oil drain pan under the oil drain screw.
4. Remove the oil drain screw and completely drain oil from the engine.

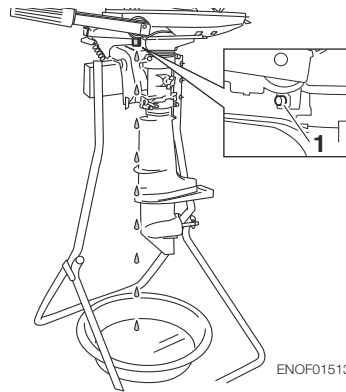

ENOF01513-0

1. Drain hole

- Tighten the oil drain screw with applying oil on the sealing surface of screw. (Use new oil drain washer)

Oil drain screw specified torque  
**18Nm (13 ft-lb, 1.8 kgf-m)**

ENON00028-A  
**Note**

If a torque-wrench is not available when you are fitting a oil filter, a good estimate of the correct torque is 3/4 to 1 a turn past finger-tight. Have the oil filter adjusted to the correct torque as soon as possible with a torque-wrench.

- Reset the engine in a vertical position.
- Repeat 3 to 7 procedures two or three times to drain the oil completely.
- Remove the top cowl and the oil filler cap.
- Fill the engine through filler port with recommended oil (see chart below) to the middle of dipstick mark.
- Tighten the oil filler cap.

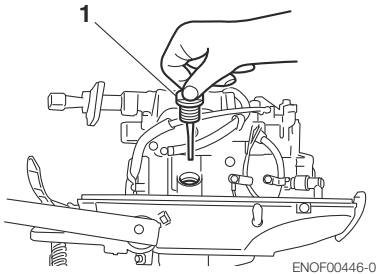

- Oil filler cap (Dipstick)

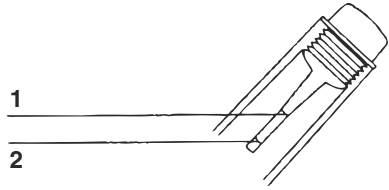

ENOF00447-0

- Upper limit (Max.)
- Lower limit (Min.)

ENON00920-0  
**Note**

Use only recommended engine oil (See page 12)

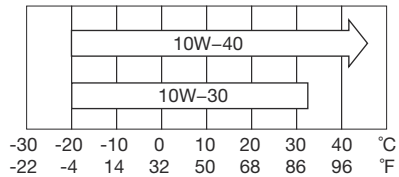

ENOF00208-0

Oil volume needed for complete oil replacement
450 mL (0.48 US qt.)

ENOW00925-0

**CAUTION**

**Wipe off engine oil well immediately if spilled and dispose of it in accordance with local fire prevention and environment protection regulations.**

ENON00031-0  
**Note**

- If any amount of water is found in engine oil, making it milky white, consult dealer.
- If engine oil is contaminated with fuel, emitting strong fuel smell, consult dealer.

- Some oil dilution is normal if engine is idled or trolled for long periods, especially in cooler water temperatures.

ENOM00093-A

### Fuel filters and fuel tank cleaning

ENOW00093-A

**⚠ WARNING**

**Gasoline and its vapors are very flammable and can be explosive.**

- Do not start this procedure while engine is operating or hot even after stopping it.
- Place fuel filter away from every source of ignition such as sparks or open flames.
- Wipe off gasoline well immediately if spilled and dispose of it in accordance with local fire prevention and environment protection regulations.
- Install fuel filter with all related parts in place, or fuel leak could occur, leading to catching fire or explosion.
- Check fuel system regularly for leakage.
- Contact authorized dealer for fuel system services. Services by unqualified person could lead to engine damage.

Fuel filters are provided inside the fuel tank and engine.

2. Fuel filter
3. Fuel pump
4. Fuel pipe

ENOM00096-A

### Fuel filter (for fuel tank)

Water or dirt in the fuel tank will cause engine performance problems.

Check and clean the tank at specified times or after the outboard motor has been stored for a long period of time (over three months).

1. Remove the fuel pickup elbow of the fuel tank by turning it counterclockwise
2. Clean the fuel filter and check the O-ring. Replace it if necessary.
3. Reassemble all parts.

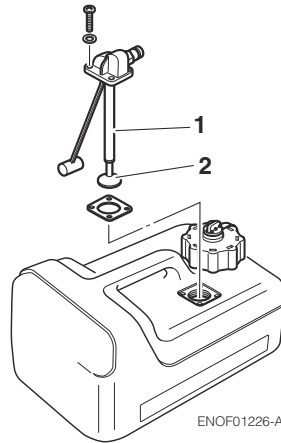

ENOF01226-A

1. Fuel pick up
2. Filter

10

ENOM00094-0

### Fuel filter (for engine)

1. Replace the fuel filter provided inside of engine cover if there is water or dirt inside.

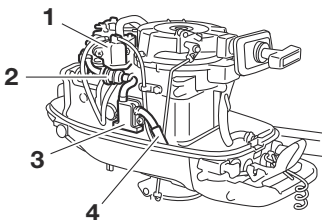

ENOF00455-0

1. Carburetor



ENOM00098-A

**Gear oil replacement**

ENOW00094-0

**WARNING**

- **Be sure that outboard motor is secured to transom or service stand, or accidental drop or fall of outboard motor could lead to severe personal injury.**
- **Be sure to lock outboard motor if it is tilted up, or accidental fall of outboard motor could lead to severe personal injury.**
- **Do not go under outboard motor tilted up and locked, or accidental fall of outboard motor could lead to severe personal injury.**

1. Tilt down the outboard motor.
2. Remove the oil plugs (lower and upper), and completely drain the gear oil into a pan.

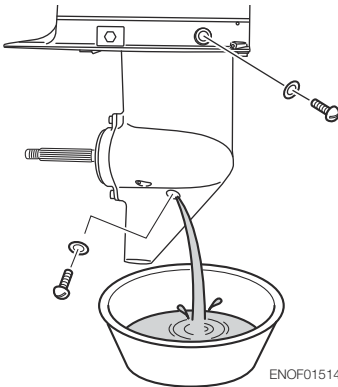

3. Insert the oil tube nozzle into the lower oil plug hole, and fill with gear oil by squeezing the oil tube until oil flows out of the upper plug hole and bubbles is disappeared to remove the air.

ENON00033-0

**Note**

Use genuine gear oil or the recommended one (API GL-5: SAE #80 to #90).  
Required volume: approx. 195 mL (6.6 fl.Oz).

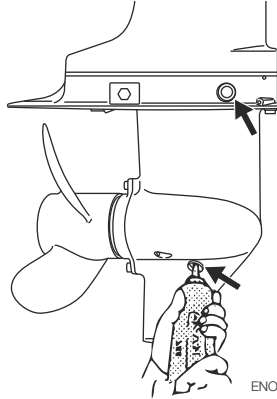

4. Install the upper oil plug, and then remove oil tube nozzle and install the lower oil plug.

ENOW00095-0

**CAUTION**

**Do not reuse oil plug gasket. Always use new gasket and tighten oil plug properly to prevent entry of water into lower unit.**

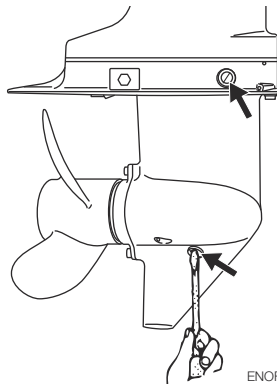

ENOW00928-0

**CAUTION**

Wipe off gear oil well immediately if spilled and dispose of it in accordance with local fire prevention and environment protection regulations.

ENON00032-0

**Note**

If water in the oil, giving it a milky colored appearance. Contact your dealer.

ENON00033-0

**Note**

Use genuine gear oil or the recommended one (API GL-5: SAE #80 to #90).  
Required volume: approx. 320 mL (10.8 fl.Oz).

ENOM00086-A

**Propeller replacement**

ENOW00084-0

**WARNING**

- Do not begin propeller removal and installation procedure with spark plug caps attached, shift in forward or reverse, main switch at other than "OFF", engine stop switch lock attached to the switch, and starter key attached, or engine could accidentally start leading to serious personal injury. Disconnect battery cable if possible.
- The propeller edge is thin and sharp. Wear the groves during replacement to protect your hands.

ENOW00086-0



**CAUTION**

- Do not install propeller without thrust holder, or propeller boss could be damaged.
- Do not reuse split pin.

- After installing split pin, spread the pin apart to prevent it from falling out which could lead to the propeller coming off during operation.

A worn-out or bent propeller will lower the motor's performance, and cause engine trouble.

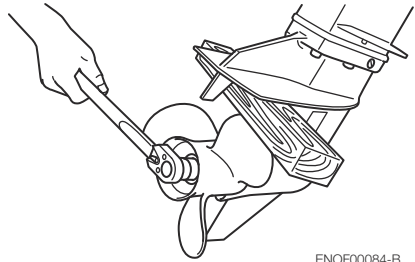
1. Put a piece of wood block between propeller blade and anti-ventilation plate to hold propeller.



ENOF00084-B

2. Remove the split pin, propeller nut and washer.
3. Remove the propeller and thrust holder.
4. Apply water proof grease to the propeller shaft before installing a new propeller.
5. Install the thrust holder, propeller, stopper, washer and propeller nut onto the shaft.

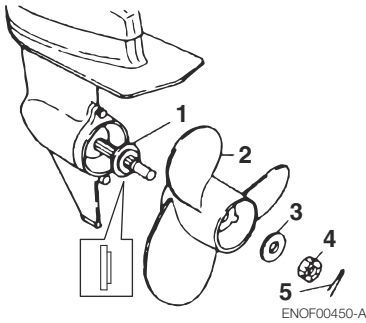

1. Propeller
  2. Thrust holder
  3. Washer
  4. Propeller nut
  5. Split pin
6. Tighten the propeller nut to specified torque, and align one of grooves to propeller shaft hole.

Propeller nut torque:

**12 Nm (9 ft-lb, 1.2 kgf-m)**

7. Install a new split pin into the nut hole and bend it.



ENOF00084-D

ENOM00087-A

### Spark plugs replacement

ENOW00087-0

#### **WARNING**

- Do not reuse spark plug with damaged insulation, or sparks can leak through crack, potentially leading to electric shock, explosion and/or fire.
- Do not touch spark plugs immediately after stopping engine as they will be hot

**and could cause severe burns if touched. Allow motor to cool down first.**

ENOW00929-0

#### **CAUTION**

**Use only the recommended spark plugs. Spark plugs which have an different heat range may cause engine damage.**

If the spark plug(s) is fouled, has carbon build up, or is worn, it should be replaced. When reusing spark plugs, remove dirt from the electrodes and adjust spark gap to specification.

1. Stop the engine.
2. Remove the top cowl.
3. Remove the spark plug caps.
4. Remove the spark plugs by turning it counter-clockwise, using a 5/8" (16 mm) socket wrench and handle that is provided in tool bag.
5. Inspect the spark plug. Replace the spark plug if the electrodes are worn or if the insulators are cracked or chipped.
6. Measure the spark plug electrode gap with a wire type feeler gauge. The gap should be 0.8-0.9 mm (0.031-0.035 inches). If the gap is different, replace the spark plug with a new one. Use spark plug NGK DCPR-6E.

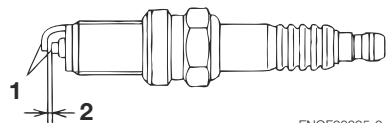

ENOF00085-0

1. Electrode
2. Spark gap (0.8–0.9 mm, 0.031–0.035 in)

7. Install the spark plug by hand and turn it carefully to avoid cross-threading.
8. Tighten the spark plug to the specified torque.

ENON00028-0

**Note**

- **Spark plug torque:  
18.0 Nm (13.3 ft-lb) [1.84 kgf-m]**

If a torque-wrench is not available when you are fitting a spark plug, a good estimate of the correct torque is 1/4 to 1/2 a turn past finger-tight. Have the spark plug adjusted to the correct torque as soon as possible with a torque-wrench.

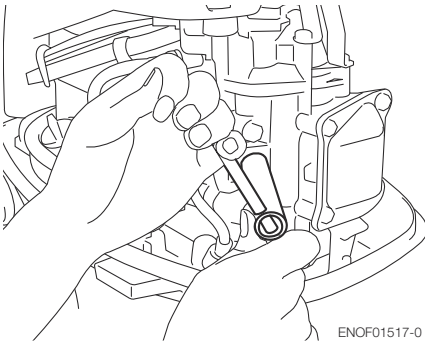

ENOM00088-A

## Anode replacement

A sacrificial anode protects the outboard motor from electrolytic corrosion. Anode is located on the gear case, cylinder etc.. When the anode is eroded more than 1/3 of original size, replace it.

ENON00029-0

### Notes

- Never grease or paint the anode.
- At each inspection re-tighten the anode attaching bolt. As it is likely to be subjected to electrolytic corrosion.

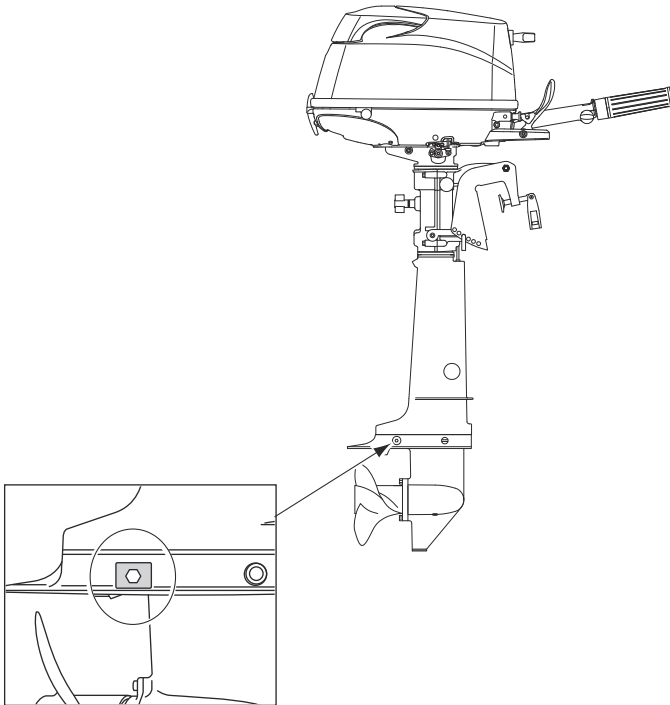

ENOM00960-0

### Grease point

Apply water proof grease to the parts shown below.

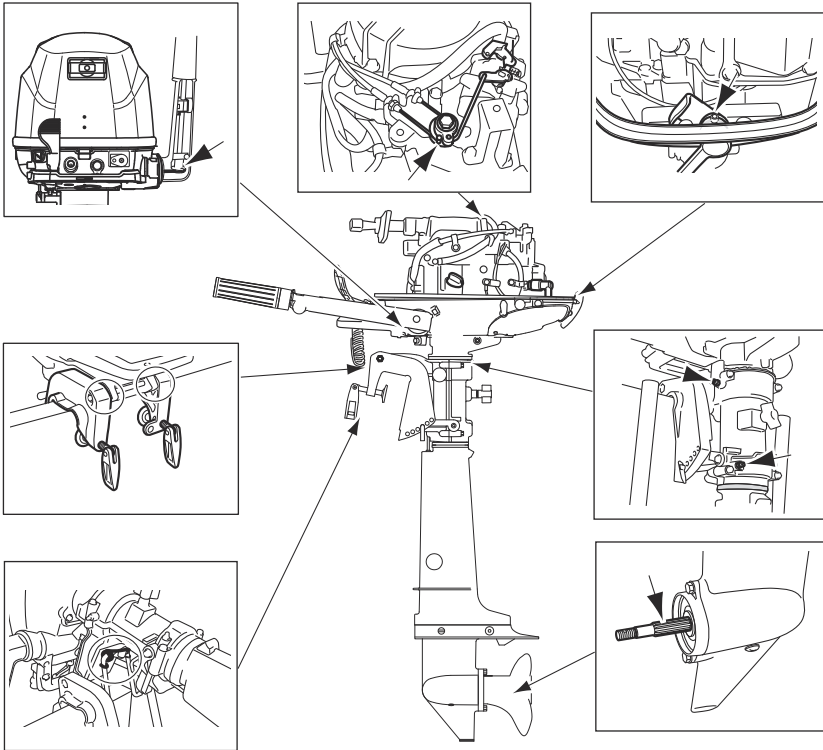

ENOM00100-A

### 3. Off-season storage

ENOW00934-0

**WARNING**

- **Be sure to disconnect fuel connector except when operating engine.**
- **Fuel leakage is a fire or explosion hazard, which can cause serious injury or death.**

ENOW00097-0

**WARNING**

**Be sure to use cloth to remove fuel remaining in the cowl and dispose of it in accordance with local fire prevention and environment protection regulations.**

Before you put your outboard motor in storage, it is a good opportunity to have it serviced and prepared by your dealer.

Be sure to use fuel stabilizer while running the motor before storage. (See page 64)

ENOM00101-A

### Engine

1. Wash the engine exterior and flush the cooling water system thoroughly with fresh water. Drain the water completely.  
Wipe off any surface water with an oily rag.
2. Remove the fuel hose from the outboard motor.
3. Drain all fuel from the fuel hoses, fuel pump and carburetor (See page 65), and clean these parts.  
Keep in mind that if gasoline is kept in the carburetor for a long time, gum and varnish will develop, causing the float valve to stick, restricting the fuel flow.

4. Remove the spark plugs and put a tea-spoon of engine oil or spray storage oil into the combustion chamber through the spark plug holes.
5. Turn the starter motor several turns to lubricate inside the cylinder.

ENOW00930-0

**WARNING**

- **Be sure to remove stop switch lock to prevent ignited the spark plugs.**
  - **Put a cloth to spark plug hole and wipe up any spilled engine oil, when cranking the outboard motor.**
6. Change the engine oil (See page 54).
  7. Change the gear oil in the gear case (See page 57).
  8. Apply grease to grease point (See page 62).

9. Stand the outboard motor up vertically in a dry place.

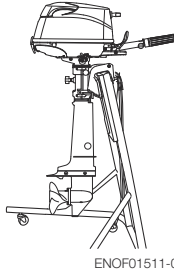
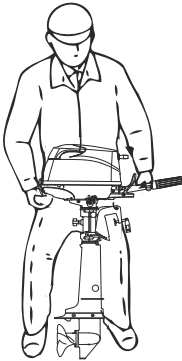

ENOF01511-0

ENOW00066-0

**CAUTION**

**Do not carry or store outboard motor in any of positions described below. Otherwise, engine damage or property damage could result from leaking oil.**

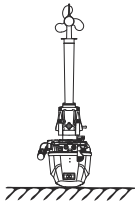
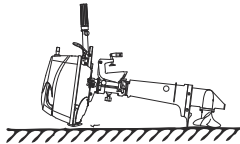
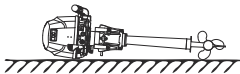

ENOF01510-0

ENON00021-A

**Note**

- If the outboard motor must be laid down be sure drain the fuel and engine oil, then the outboard motor on a cushion as shown in the drawing below (See page 64 and 43).
- Elevate power unit 2 inches to 4 inches if traveling to avoid oil spillage.

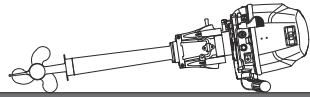

ENOF01512-0

ENOM00950-0

**Adding a fuel stabilizer**

When adding a fuel stabilizer additive (commercially available), first fill the fuel tank with fresh fuel. If the fuel tank is only partially filled, air in the tank can cause the fuel to deteriorate during storage.

1. Before adding fuel stabilizer additive, drain the carburetor (See page 65).
2. Follow the instructions on the label when adding the fuel stabilizer additive.
3. After adding the additive, let the outboard motor run in the water for 10 minutes to make sure any old fuel in the fuel system has been completely replaced by the fuel with additive.
4. Turn the engine OFF

ENON00891-0

**Note**

If your motor is used occasionally, it is recommended to use a good fuel stabilizer in every tank of fuel and keep the container full to reduce condensation and evaporation.



ENOM00970-0

**Fuel system draining**

ENOW00028-A

**⚠ WARNING**

**For details on handling fuel, contact an authorized dealer.**

**Fuel and fuel vapors are extremely flammable and can be explosive.**

- If fuel is spilled, wipe it up immediately.
- Keep the fuel tank well away from sources of ignition, e.g. sparks or open flames
- Perform all work outdoors or in a well ventilated place.

ENOW00097-0

**⚠ WARNING**

**Be sure to use cloth to remove fuel remaining in the cowl and dispose of it in accordance with local fire prevention and environment protection regulations.**

1. Disconnect the fuel hose from the outboard motor.
2. Remove the top cowl.
3. Place an approved fuel container under the drain screw and use a funnel to avoid spilling fuel.
4. Loosen the carburetor drain screw.
5. Tilt up the outboard motor until fuel flows out of the drain hole.
6. Leave the outboard motor in this position until all fuel has been drained.
7. When thoroughly drained, retighten the drain screw securely.

8. Check the drained fuel for the presence of water or other contaminants. If either is present, reassemble the outboard motor, refill the carburetor with fuel, and then drain the fuel again. Repeat this procedure until no water or other contaminants are present in the drained fuel.

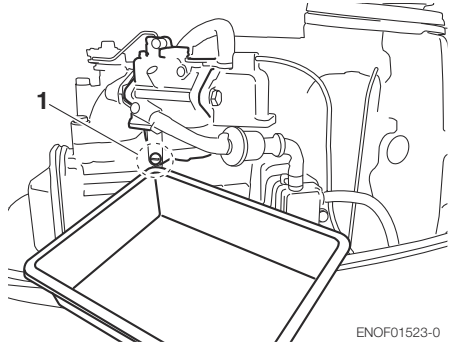

ENOF01523-0

1. Carburetor drain screw

ENOM00102-0

**Battery**

ENOW00931-A

**⚠ WARNING**

- Place the battery away from any source of fire, sparks and open flames such as burners or welding equipment.
- Place the battery away from fuel tank. Accidental sparks of battery may cause explosion of gasoline.

1. Disconnect the battery cables and be sure to remove the negative terminal first.
2. Wipe off any chemical deposits, dirt, or grease.
3. Apply grease to the battery terminals.
4. Charge the battery completely before storing it for the winter.

5. Recharge the battery once a month to prevent it from discharging and the electrolyte from deteriorating.
6. Store the battery in a dry place.

ENOM00104-A

#### 4. Pre-season check

The following steps must be taken when first using the engine after winter storage.

1. Check that the shift and throttle function properly. (Be sure to turn the propeller shaft when checking the shift function or else the shift linkage may be damaged.)
2. Check the electrolyte level, and measure the voltage and specific gravity of the battery.

Specific Gravity at 20°	Terminal Voltage (V)	Charge Condition
1.120	10.5	Fully discharged
1.160	11.1	1/4 charged
1.210	11.7	1/2 charged
1.250	12	3/4 charged
1.280	13.2	Fully charged

3. Check that the battery is secure and the battery cables are properly installed.
4. Change the engine oil (See page 54).
5. Before starting the engine, disconnect stop switch lock and crank approximately 10 times in order to prime the oil pump.
6. Fill fuel tank completely.
7. Start the engine and warm up the engine for 3 minutes in the "NEUTRAL" position.
8. Run the engine for 5 minutes at the slowest speed.

9. Run the engine for 10 minutes at half throttle. The oil used for storage inside the engine will be circulated out to assure optimum performance.

ENOM00105-C

#### 5. Submerged outboard motor

ENOW00098-0



**Do not attempt to start submerged outboard motor immediately after it is recovered, or engine could be severely damaged.**

After taking your outboard motor out of the water, immediately take it to your dealer. The following are the emergency measures to be taken for a submerged outboard motor, if you can not take it your dealer right away.

1. Wash the outboard motor with fresh water to remove salt or dirt.
2. Remove the engine oil drain screw and completely drain water and oil from the engine.
3. Remove the spark plugs, and completely drain the water from the engine by pulling recoil starter several times. Replace oil to the correct level. The oil and filter may need to be changed again after running a short period to get all moisture completely out of the crankcase.
4. Inject a sufficient amount of engine oil through the spark plug holes. Pull the recoil starter rope several times to circulate the oil throughout the outboard motor.

ENOM00106-A

## 6. Cold weather precautions

If you moor your boat in cold weather at temperatures below 0°C (32°F), there is the danger of remained water freezing in the cooling water pump, which may damage the pump, impeller, etc. To avoid this problem, submerge the lower half of the outboard motor into the water.

ENOM00107-A

## 7. Striking underwater object

ENOW00935-0

 **CAUTION**

**Striking the sea bottom or an underwater object may severely damage the outboard motor.**

Follow the procedure below and consult a dealer as soon as possible.

1. Stop the engine immediately.
2. Check the control system, gear case, boat transom etc.
3. Return to the nearest harbor slowly and carefully.
4. Consult a dealer check the outboard motor before operation again.

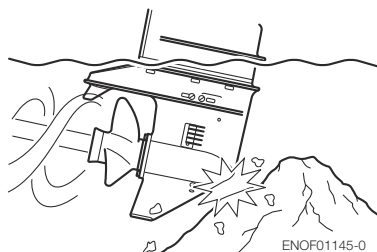

# TROUBLESHOOTING

ENOM00436-0

If you encounter a problem, consult the check list below to determine the cause and to take the proper action.

An authorized dealer will always be happy to provide any assistance and information.

	Engine failing to start	Engine starting but stopping soon	Poor idling	Poor acceleration	Engine speed abnormally high	Engine speed abnormally low	Boat speed low	Overheating of engine	Warning lamp ON	Possible cause
FUEL SYSTEM	•	•								Empty fuel tank
	•	•	•	•		•	•	•		Incorrect connection of fuel system
	•	•	•	•		•	•	•		Air entering fuel line
	•	•	•	•		•	•	•		Deformed or damaged fuel hose
	•	•	•	•		•	•	•		Closed air vent on fuel tank
	•	•	•	•		•	•	•		Clogged fuel filter, fuel pump, or carburetor
			•	•		•	•	•		Use of improper engine oil
	•	•	•	•			•	•		Use of improper gasoline
	•	•	•	•						Excessive supply of fuel
ELECTRICAL SYSTEM						•	•	•		Poor carburetor adjustment
	•	•	•	•		•	•	•		Spark plug other than specified
	•	•	•	•		•	•			Dirt, soot, etc. on spark plug
	•	•	•	•		•	•			No Spark or weak spark
	•									Short circuit of engine stop switch
	•		•	•			•	•		Ignition timing incorrect
	•									Lock plate not fitted
	•									Disconnection of wire or loose ground connection
COMPRESSION & OIL SYSTEM		•	•	•		•	•			Low compression
			•					•		Carbon deposits in the combustion chamber
				•			•			Incorrect valve clearance
								•		Low oil pressure/level

		Engine failing to start	Engine starting but stopping soon	Poor idling	Poor acceleration	Engine speed abnormally high	Engine speed abnormally low	Boat speed low	Overheating of engine	Warning lamp ON	Possible cause
ENGINE OIL SYSTEM							●		●	●	Low oil level
									●	●	Use of improper oil
							●		●	●	Oil deterioration
							●		●	●	Clogged oil strainer
							●		●	●	Faulty oil pump
OTHERS	●			●	●		●	●			Incorrect adjustment of throttle link
								●	●		Insufficient cooling water flow, clogged or defective pump
				●				●	●		Faulty thermostat
					●	●		●	●		Cavitation or ventilation
					●	●	●	●	●		Incorrect propeller selection
				●	●	●	●	●	●		Damaged or bent propeller
					●	●		●	●		Improper thrust rod position
					●	●	●	●	●		Unbalanced load on boat
				●	●	●	●	●		Transom too high or too low	

# TOOL KIT AND SPARE PARTS

ENOM00437-0

	Items	Quantity	Remark
Service tools	Tool bag	1	
	Pliers	1	
	Socket wrench	1	10 × 13 mm
	Socket wrench	1	16 mm
	Socket wrench handle	1	
	Screwdrivers	1	Cross-and straight-point
	Screwdriver handle	1	
Spare parts	Emergency starter rope	1	1000 mm
	Spark plug	1	NGK: DCPR6E
	Split pin	1	
	Stop switch lock	1	
Parts Packaged with Engine	Fuel tank	1	12 L
	Primer bulb	1 set	

# PROPELLER TABLE

ENOM00438-0

Use a genuine propeller.

A propeller must be selected so that the engine rpm measured at wide open throttle while cruising is within the recommended range.

4: 4500–5500 rpm

5: 4500–5500 rpm

6: 5000–6000 rpm

	Propeller Mark	Propeller Size (Diameter × pitch)		Standard propeller on the model		
		inch	mm	4	5	6
<b>Light boats</b>	9	7.9 × 9.0	200 × 229			
	8	7.8 × 8.0	198 × 203		S, L	S, L
<b>Heavy boats</b>	7	7.8 × 7.0	198 × 178	S, L		
	6	7.9 × 6.0	200 × 152			*UL

S: Short shaft

L: Long shaft

UL: Extra long shaft

\*: SP model

# Product Warranty Information

## BOMBARDIER RECREATIONAL PRODUCTS LIMITED WARRANTY FOR 2015 EVINRUDE OUTBOARD ENGINES SOLD IN THE UNITED STATES AND CANADA

### 1. SCOPE OF THE LIMITED WARRANTY

Bombardier Recreational Products\* ("BRP") warrants its 2015 *Evinrude*® outboard engines sold by authorized *Evinrude* dealers in the fifty United States and Canada ("Product") from defects in material or workmanship for the period and under the conditions described below.

### 2. EXCLUSIONS — The following are not warranted under any circumstances:

- Replacement of parts due to normal wear and tear;
- Routine maintenance parts and services including but not limited to: maintenance requirements, engine and lower unit oil changes, lubrication, valve and linkage adjustments and replacement of fuses, zinc anodes, thermostats, timing belts, starter motor bushings, trim motor brushes, filters, propellers, propeller bushings and spark plugs;
- Damage caused by improper or lack of installation, maintenance, winterization and/or storage, failure to follow the procedures and recommendations in the Operator's Guide;
- Damage resulting from removal of parts, improper repairs, service, maintenance, or modification, or use of parts or accessories not manufactured or approved by BRP, which in its reasonable judgment, are either incompatible with Product or adversely affect its operation, performance, or durability, or resulting from repairs done by a person that is not an authorized Dealer;
- Damage caused by abuse, misuse, abnormal use, neglect, racing, improper operation or operation of the Product in a manner inconsistent with the recommended operation described in the Operator's Guide;
- Damage resulting from external damage, accident, submersion, water ingestion, fire, theft, vandalism or any act of God;
- Operation without proper fuel, oil or lubrication, or with fuels, oils or lubricants which are not suitable for use with the Product (see the Operator's Guide);
- Damage resulting from rust or corrosion;
- Damage caused from cooling system blockage by foreign material;
- Damage resulting from sand or debris in the water pump;
- Cosmetic or paint changes due to exposure to the elements.
- This warranty will be voided in its entirety and rendered null and void where:
  - Product has been altered or modified in such a way so as to adversely affect its operation, performance or durability, or change its intended use, horsepower or emission levels; or
  - Product is or has been used for racing at any point, even by a prior owner.

### 3. LIMITATIONS OF LIABILITY

**ALL WARRANTIES, EXPRESSED OR IMPLIED, INCLUDING WITHOUT LIMITATION ANY WARRANTY OF MERCHANTABILITY OR FITNESS FOR A PARTICULAR PURPOSE ARE LIMITED IN DURATION TO THE LIFE OF THE EXPRESS LIMITED WARRANTY.**

**ALL INCIDENTAL, CONSEQUENTIAL, DIRECT, INDIRECT OR OTHER DAMAGES OF ANY KIND ARE EXCLUDED FROM COVERAGE UNDER THIS WARRANTY INCLUDING, BUT NOT LIMITED TO:** expense for gasoline, expense for transporting Product to and from Dealer, removal of Product from a boat and reinstallation, mechanic's travel time, in-and-out of water charges, slip or dock fees, trailering or towing, storage, telephone, cell phone, fax or telegram charges, rental of a like or replacement Product or boat during warranty services or down time, taxi, travel, lodging, loss of or damage to personal property, inconvenience, cost of insurance coverage, loan payments, loss of time, loss of income, revenue or profits, or loss of enjoyment or use of Product.

**SOME STATES, PROVINCES, OR JURISDICTIONS DO NOT ALLOW FOR THE DISCLAIMERS, LIMITATIONS OF INCIDENTAL OR CONSEQUENTIAL DAMAGES, OR OTHER EXCLUSIONS IDENTIFIED ABOVE. AS A RESULT, THEY MAY NOT APPLY TO YOU. THIS WARRANTY GIVES YOU SPECIFIC RIGHTS, AND YOU MAY ALSO HAVE OTHER LEGAL RIGHTS WHICH MAY VARY FROM STATE TO STATE, OR PROVINCE TO PROVINCE.**

No distributor, Dealer or any other person is authorized to make any affirmation, representation or warranty regarding Product other than those contained in this limited warranty and, if made, shall not be enforceable against BRP. BRP reserves the right to modify this warranty at any time, being understood that such modification will not alter the warranty conditions applicable to the Products sold while this warranty is in effect.



#### 4. WARRANTY COVERAGE PERIOD

This limited warranty will be in effect from the date of delivery to the first retail consumer or the date the Product is first put to use, whichever occurs first, for a period of:

THIRTY-SIX (36) CONSECUTIVE MONTHS for private, recreational use; or

TWELVE (12) CONSECUTIVE MONTHS for commercial use, except that exhaust emission-related components are warranted for sixty (60) consecutive months or one hundred seventy five (175) hours of engine use, whichever occurs first; and evaporative emission related components are warranted for twenty-four (24) consecutive months. The Product is used commercially when it is used in connection with any work or employment that generates income, during any part of the warranty period. The Product is also used commercially when, at any point during the warranty period, it is installed on a boat that has commercial tags or is licensed for commercial use. Please see your Authorized *Evinrude* Outboard Engine Dealer for emission-related service.

In cases where the delivery date is not established to BRP's satisfaction, the date of sale will be used to determine the warranty start date.

The repair or replacement of parts or the performance of service to Product under this warranty does not extend the life of this limited warranty beyond its original expiration date. All *Evinrude/Johnson® Genuine Parts* and accessories installed by an authorized dealer at the time of sale, including but not limited to propellers, bear the standard BRP parts and accessories one-year limited warranty.

California residents who purchased or warranty-registered a Product in California should refer to BRP's California Emissions Control Warranty Statement.

#### 5. CONDITIONS TO HAVE WARRANTY COVERAGE

This warranty coverage is available only on *Evinrude* outboard engines purchased as new and unused from a dealer authorized to distribute *Evinrude* products in the country in which the sale occurred ("Dealer"), and then only after the BRP specified pre-delivery inspection process has been completed and documented by the purchaser and Dealer. Warranty coverage only becomes available upon proper registration of Product by Dealer or owner.

Only the original purchaser and any subsequent owners who reside in the United States and Canada and have purchased Product from a U.S. or Canadian Dealer are eligible for warranty registration and warranty coverage hereunder. Such limitations are necessary in order to allow BRP to protect the safety of its products, its consumers, and the general public.

As outlined in the Operator's Guide, timely routine required maintenance must be performed to maintain warranty coverage. BRP may require proof of proper maintenance prior to authorizing warranty coverage.

#### 6. WHAT TO DO TO OBTAIN WARRANTY COVERAGE

The registered owner must notify an authorized Dealer within two (2) days of the appearance of a defect. Owner must bring Product, including any defective part therein, to Dealer promptly after the appearance of the defect, and in any event, within the warranty period, and must provide Dealer with reasonable opportunity to repair the defect. The expenses of transporting Product to and from Dealer for warranty service are to be borne by the owner.

If the Product has not previously been registered, the owner may also be required to present proof of purchase to Dealer for warranty repairs. Owner is required to sign the repair/work order prior to the start of the repair in order to validate the warranty repair.

All parts replaced under this warranty become the property of BRP.

## 7. WHAT BRP WILL DO

BRP's obligations under this warranty are limited to, at its sole discretion, repairing or replacing parts of Product found to be defective in material or workmanship, in the reasonable judgment of BRP. Such repair or replacement of parts will be done without charge for parts and labor, at any authorized Dealer. BRP's responsibility is limited to making the required repairs or replacements of parts with new or BRP-certified re-manufactured parts. No claim of breach of warranty shall be cause for cancellation or rescission of the sale of Product to owner.

In the event that warranty service is required outside of the fifty United States or Canada, owner will bear responsibility for any additional charges due to local practices and conditions, such as, but not limited to, freight, insurance, taxes, license fees, import duties, and any and all other financial charges, including those levied by governments, states, territories and their respective agencies.

BRP reserves the right to improve, modify or change Products from time to time without assuming any obligation to modify Products previously manufactured.

## 8. TRANSFER

If the ownership of Product is transferred during the warranty coverage period, this warranty shall also be transferred and be valid for the remaining coverage period provided that the former or new owner promptly contacts BRP or Dealer and gives the name and address of the new owner.

## 9. CONSUMER ASSISTANCE

- In the event of a controversy or dispute in connection with this BRP limited warranty, BRP recommends that you first try to resolve the issue at the dealership level by discussing the issue with Dealer's service manager or owner;
- If further assistance is required, please contact BRP US Inc. / Outboard Engines Division, After Sales Support, P.O Box 597, Sturtevant, WI 53177, 1-847-689-7090.

## **BOMBARDIER RECREATIONAL PRODUCTS LIMITED WARRANTY FOR 2015 EVINRUDE OUTBOARD ENGINES SOLD OUTSIDE THE UNITED STATES AND CANADA**

For a copy of the Limited Warranty, see your Bombardier Recreational Products ("BRP") distributor/dealer authorized to distribute Evinrude products in the country in which the sale occurs.

If further assistance is required, please contact BRP US Inc. / Outboard Engines Division, After Sales Support, P.O Box 597, Sturtevant, WI 53177, or the affiliate of BRP where the Product was registered for warranty.

\* Engines sold in Canada are distributed and serviced by Bombardier Recreational Products Inc.

Limited Warranty Revision US/CA March 2011

# California Emission Control Warranty Statement

Your Evinrude 4-Stroke outboard has a special environmental label required by the California Air Resources Board. The label has one, two, three, or four stars. A hangtag, provided with your outboard, describes the meaning of the star rating system.

## *The Star Label Means Cleaner Marine Engines*



## The Symbol for Cleaner Marine Engines:

- Cleaner Air and Water
- Better Fuel Economy
- Longer Emission Warranty

### **One Star – Low Emission**

The one-star label identifies Personal Watercraft, Outboard, Sterndrive and Inboard engines that meet the Air Resource Board's Personal Watercraft and Outboard marine engine 2001 exhaust emission standards. Engines meeting these standards have 75% lower emissions than conventional carbureted two-stroke engines. These engines are equivalent to the U.S. EPA's 2006 standards for marine engines.

### **Two Stars – Very Low Emission**

The two-star label identifies Personal Watercraft, Outboard, Sterndrive and Inboard engines that meet the Air Resources Board's Personal Watercraft and Outboard marine engine 2004 exhaust emission standards. Engines meeting these standards have 20% lower emissions than One Star – Low Emission engines.

### **Three Stars – Ultra Low Emission**

The three-star label identifies engines that meet the Air Resources Board's Personal Watercraft and Outboard marine engine 2008 exhaust emission standards or the Sterndrive and Inboard marine engine 2003 exhaust emission standards. Engines meeting these standards have 65% lower emissions than One Star – Low Emission engines.

### **Four Stars – Super Ultra Low Emission**

The four-star label identifies engines that meet the Air Resources Board's Sterndrive and Inboard marine engine 2009 exhaust emission standards. Personal Watercraft and Outboard marine engines may also comply with these standards. Engines meeting these standards have 90% lower emission than One Star – Low Emission engines.

For more information: Cleaner Watercraft – Get the Facts  
1-800-END-SMOG  
[www.arb.ca.gov](http://www.arb.ca.gov)

## **YOUR EMISSION CONTROL WARRANTY RIGHTS AND OBLIGATION**

The California Air Resources Board and Bombardier Recreational Products ("BRP") are pleased to explain the emission control system warranty on your 2015 Evinrude 4-Stroke outboard. In California, new outboard engines must be designed, built, and equipped to meet the State's stringent anti-smog standards. BRP must warrant the emission control system on your outboard for the periods of time listed below provided there has been no abuse, neglect, or improper maintenance of your outboard.

Your emission control system may include parts such as the carburetor or fuel injection system, the ignition system, and catalytic converter. Also included may be hoses, belts, connectors, and other emission-related assemblies.

Where a warrantable condition exists, BRP will repair your outboard at no cost to you including diagnosis, parts, and labor provided that such work is performed by an authorized BRP dealer.

**Manufacturer’s Limited Warranty Coverage**

This emission limited warranty covers Evinrude outboards certified and produced by BRP for sale in California, that are originally sold in California to a California resident, or subsequently warranty-registered to a California resident. The BRP U.S. and Canada limited warranty conditions for Evinrude outboards are still applicable to these models with the necessary modifications.

Select emission control parts of your Evinrude 4-Stroke outboard are warranted from the date of purchase by the first retail consumer or the date the product is first put to use, whichever occurs first, for a period of: 4 years, or for 250 hours of use, whichever occurs first.

However, warranty coverage based on the hourly period is only permitted for outboards equipped with the appropriate hour meters or their equivalent. If any emission-related part on your engine is defective under warranty, the part will be repaired or replaced by BRP. Parts covered are:

<b>1. Electrical System</b>	<b>5. Air Induction System</b>	<b>6. Fuel System</b>
Ignition Control Module	Timing Chain/Belt and Tensioner	Fuel Pump
Spark Plugs, Boots and/or Wires	Camshaft	Carburetor and Internal Parts
Ignition Coils	Throttle Linkage	Accelerator Pump
Wiring Harness	Intake Manifold	Choke System
<b>2. Exhaust System</b>	<b>3. Sensors</b>	Crankcase Ventilation System
Engine Holder	Cylinder Temperature Sensor	Fuel Lines Fittings and Clamps
Oil Pan	<b>4. Gaskets</b>	<b>7. Other</b>
Exhaust Housing	All Emission Component Gaskets	Thermostat
Exhaust Valves		

The emission warranty covers damage to other engine components that is caused by the failure of a warranted part.

The BRP Operator’s Guide provided contains written instructions for the proper maintenance and use of your outboard. All emission warranty parts are warranted by BRP for the entire warranty period of the outboard, unless the part is scheduled for replacement as required maintenance in the Operator’s Guide.

Emission warranty parts that are scheduled for replacement, as required maintenance, are warranted by BRP for the period of time before the first scheduled replacement date for that part. Emission warranty parts that are scheduled for regular inspection but not regular replacement are warranted by BRP for the entire warranty period of the outboard. Any emission warranty part repaired or replaced under the terms of this warranty statement is warranted by BRP for the remainder of the warranty period of the original part. All parts replaced under this limited warranty become the property of BRP.

Maintenance receipts and records should be transferred to each subsequent owner of the outboard.

**Owner’s Warranty Responsibilities**

As the outboard owner, you are responsible for the performance of the required maintenance listed in your Operator’s Guide. BRP recommends that you retain all receipts covering maintenance on your outboard, but BRP cannot deny warranty solely for the lack of receipts or your failure to ensure the performance of all scheduled maintenance.

As the outboard owner, you should however be aware that BRP may deny you warranty coverage if your outboard or a part has failed due to abuse, neglect, improper maintenance, or unapproved modifications. You are responsible for presenting your outboard to an authorized BRP dealer as soon as a problem exists. The warranty repairs will be completed in a reasonable amount of time, not to exceed 30 days.

For any questions regarding your warranty rights and responsibilities or for the name and location of the nearest authorized BRP dealer, contact BRP US Inc. / Outboard Engines Division, After Sales Support, P.O. Box 597, Sturtevant, WI 53177, 1-847-689-7090 or visit [www.evinrude.com](http://www.evinrude.com).

# Product Warranty Information

## **BRP LIMITED WARRANTY FOR 2015 EVINRUDE OUTBOARD ENGINES USED IN EUROPEAN UNION MEMBER STATES, TURKEY, AUSTRALIA, NEW ZEALAND AND JAPAN**

### **1. SCOPE OF THE LIMITED WARRANTY**

Bombardier Recreational Products Inc. ("BRP") warrants its Evinrude® outboard engines that are sold by authorized Evinrude distributors / dealers and exclusively used, during the warranty period, in European Union member states, Turkey, Australia, New Zealand or Japan ("Product") from defects in material or workmanship for the period and under the conditions described below. For the purpose of this limited warranty.

All Evinrude/Johnson® Genuine Parts and accessories, including but not limited to propellers, gauges, oil tanks, remote controls, wiring and key switches that are installed by an authorized distributor / dealer at the time of sale, whether or not shipped with Product, bear the standard BRP limited warranty for Evinrude/Johnson Genuine Parts and accessories. See your authorized distributor / dealer for a full copy of such limited warranty.

### **2. WARRANTY COVERAGE PERIOD**

This limited warranty will be in effect from the date of purchase by the first retail consumer or the date the Product is first put to use, whichever occurs first, for a period of:

36 CONSECUTIVE MONTHS for private, recreational use; or

12 CONSECUTIVE MONTHS OR 750 HOURS OF OPERATION as determined by Product's Engine Management Module (EMM), whichever occurs first, for commercial use. The Product is used commercially when it is used in connection with any work or employment that generates income, during any part of the warranty period. The Product is also used commercially when, at any point during the warranty period, it is installed on a boat that has commercial tags or is licensed for commercial use.

The repair or replacement of parts or the performance of service to Product under this warranty does not extend the life of this limited warranty beyond its original expiration date.

### **3. CONDITIONS TO HAVE WARRANTY COVERAGE**

This warranty coverage is available only if each of the following conditions has been fulfilled:

- a. Evinrude outboard engines must be purchased as new and unused by its first owner from a BRP distributor / dealer authorized to distribute Evinrude products in the country in which the sale occurred (hereinafter "Distributor / Dealer"),
- b. and then only after the BRP specified pre delivery inspection process has been completed and documented by the purchaser and Distributor / Dealer.
- c. The product must have undergone proper registration of Product by an authorized BRP Distributor / Dealer.
- d. The Evinrude products must be purchased in the country or union of countries in which the purchaser resides.
- e. Routine maintenance outlined in the operator's guide must be timely performed in order to make warranty coverage contingent upon proof of proper maintenance.

BRP will not honour this limited warranty to any private use owner or commercial use owner if the preceding conditions have not been met. Such limitations are necessary in order to allow BRP to protect the safety of its products, its consumers, and the general public.

As outlined in the Operator's Guide, timely routine required maintenance must be performed to maintain warranty coverage. BRP may require proof of proper maintenance prior to authorizing warranty coverage.

#### 4. WHAT TO DO TO OBTAIN WARRANTY COVERAGE

Registered owner ("Owner") must notify within 2 months an authorized Distributor / Dealer of the appearance of a defect. Owner must bring Product, including any defective part therein, to Distributor / Dealer promptly after the appearance of the defect, and in any event, within the warranty period, and must provide Distributor / Dealer with reasonable opportunity to repair the defect. The expenses of transporting Product to and from Distributor / Dealer for warranty service are to be borne by the Owner.

The Owner must also present proof of purchase to the authorized BRP Distributor / Dealer for warranty repairs. Owner is required to sign the repair/work order prior to the start of the repair in order to validate the warranty repair.

All parts replaced under this warranty become the property of BRP.

Note that the notification period is subject to the applicable national or local legislation in your country.

#### 5. WHAT BRP WILL DO

BRP's obligations under this warranty are limited to, at its sole discretion, repairing or replacing parts of Product found to be defective in material or workmanship, in the reasonable judgment of BRP. Such repair or replacement of parts will be done without charge for parts and labour, at any authorized Distributor / Dealer, under the conditions described above.

BRP's responsibility is limited to making the required repairs or replacements of parts. No claim of breach of warranty shall be cause for cancellation or rescission of the sale of Product to Owner.

In the event that warranty service is required outside of country of original sale, Owner will bear responsibility for any additional charges due to local practices and conditions, such as, but not limited to, freight, insurance, taxes, license fees, import duties, and any and all other financial charges, including those levied by governments, states, territories and their respective agencies.

BRP reserves the right to improve, modify or change Products from time to time without assuming any obligation to modify Products previously manufactured.

#### 6. EXCLUSIONS -The following are not warranted under any circumstances:

- Replacement of parts due to normal wear and tear;
- Routine maintenance parts and services including but not limited to: maintenance requirements, lower unit oil change, lubrication, linkage adjustments and replacement of fuses, zinc anodes, thermostats, starter motor bushings, trim motor brushes, filters and spark plugs;
- Damage caused by improper installation or lack of maintenance, winterization and/or storage, failure to follow the procedures and recommendations in the Operator's Guide;
- Damage resulting from removal of parts, improper repairs, service, maintenance, or modification, or use of parts or accessories not manufactured or approved by BRP, which in its reasonable judgment, are either incompatible with Product or adversely affect its operation, performance, or durability, or resulting from repairs done by a person that is not an authorized Distributor / Dealer;
- Damage caused by abuse, misuse, abnormal use, neglect, racing, improper operation or operation of the Product in a manner inconsistent with the recommended operation described in the Operator's Guide;
- Damage resulting from accident, submersion, water ingestion, fire, theft, vandalism or any act of God;
- Operation with fuels, oils or lubricants which are not suitable for use with the Product (see the Operator's Guide);
- Damage resulting from rust or corrosion;
- Damage caused from cooling system blockage by foreign material;
- Damage resulting from sand or debris in the water pump; or
- Cosmetic or paint changes due to exposure to the elements.

This warranty will be voided in its entirety and rendered null and void where:

- Product has been altered or modified in such a way so as to adversely affect its operation, performance or durability, or has been altered or modified to change its intended use; or
- Product is or has been used for racing or any other competitive activity, at any point, even by a prior owner.

## 7. LIMITATIONS OF LIABILITY

**ALL WARRANTIES, EXPRESSED OR IMPLIED, INCLUDING WITHOUT LIMITATION ANY WARRANTY OF MERCHANTABILITY OR FITNESS FOR A PARTICULAR PURPOSE ARE LIMITED IN DURATION TO THE LIFE OF THE EXPRESS LIMITED WARRANTY.**

**ALL INCIDENTAL, CONSEQUENTIAL, DIRECT, INDIRECT OR OTHER DAMAGES OF ANY KIND ARE EXCLUDED FROM COVERAGE UNDER THIS WARRANTY INCLUDING, BUT NOT LIMITED TO:**

expense for gasoline, expense for transporting Product to and from Distributor / Dealer, removal of Product from a boat and reinstallation, mechanic's travel time, in-and-out of water charges, slip or dock fees, trailering or towing, storage, telephone, cell phone, fax or telegram charges, rental of a like or replacement Product or boat during warranty services or down time, taxi, travel, lodging, loss of or damage to personal property, inconvenience, cost of insurance coverage, loan payments, loss of time, loss of income, revenue or profits, or loss of enjoyment or use of Product.

SOME COUNTRIES, PROVINCES, OR JURISDICTIONS DO NOT ALLOW FOR THE DISCLAIMERS, LIMITATIONS OF INCIDENTAL OR CONSEQUENTIAL DAMAGES, OR OTHER EXCLUSIONS IDENTIFIED ABOVE. AS A RESULT, THEY MAY NOT APPLY TO YOU. THIS WARRANTY GIVES YOU SPECIFIC RIGHTS, AND YOU MAY ALSO HAVE OTHER LEGAL RIGHTS WHICH MAY VARY FROM COUNTRY TO COUNTRY, OR PROVINCE TO PROVINCE.

Neither the Distributor any BRP Distributor / Dealer nor any other person has been authorized to make any affirmation, representation or warranty regarding Product other than those contained in this limited warranty and, if made, shall not be enforceable against BRP.

BRP reserves the right to modify this warranty at any time, being understood that such modification will not alter the warranty conditions applicable to the Products sold while this warranty is in effect.

## 8. TRANSFER

If the ownership of Product is transferred during the warranty coverage period, this warranty shall also be transferred and be valid for the remaining coverage period provided that the former or new Owner promptly contacts BRP or Distributor / Dealer and gives the name and address of the new Owner.

## 9. CONSUMER ASSISTANCE

In the event of a controversy or dispute in connection with this BRP limited warranty, BRP recommends that you first try to resolve the issue at the distributorship / dealership level by discussing the issue with Distributor's / Dealer's service manager or owner;

You can also locate A BRP office or distributor through our website at [www.brp.com](http://www.brp.com).

If further assistance is required, please contact the Customer Support Services of a BRP affiliate at one of the following numbers, depending on your location:

Australia and New Zealand - Telephone 612-9794-6600, Fax 612-9794-6697

Europe, Turkey, Cyprus - Telephone (41) 21 318 78 00, Fax (41) 21 318 78 61

Japan - Telephone (65) 622-767-55, Fax (65) 622-629-32

Limited Warranty Revision EU March 2011

# Product Warranty Information

## **BRP LIMITED WARRANTY FOR 2015 EVINRUDE OUTBOARD ENGINES USED IN AFRICA, MIDDLE EAST, LATIN AMERICA, PACIFIC ISLANDS, ASIA, ALBANIA, FORMER YUGOSLAVIAN REPUBLIC OF MACEDONIA, SERBIA AND MONTENEGRO, BOSNIA AND HERZEGOVINA AND THE COMMONWEALTH OF INDEPENDENT STATES**

### **1. SCOPE OF THE LIMITED WARRANTY**

Bombardier Recreational Products Inc. ("BRP") warrants its Evinrude® outboard engines ("Product") from defects in material or workmanship for the period and under the conditions described below, when they are sold by authorized Evinrude distributors / dealers and used, at any point during the warranty period, in the following territories:

- Africa,
- Middle East (excluding Turkey),
- Latin America (including but not limited to the Caribbean Islands, Bahamas and Bermuda),
- Pacific Islands (excluding Hawaii),
- Asia (excluding Japan),
- Albania, Former Yugoslavian Republic of Macedonia, Serbia and Montenegro,
- Bosnia and Herzegovina, or
- Commonwealth of Independent States (former Soviet Union) (excluding Lithuania, Latvia and Estonia)

All Evinrude/Johnson® Genuine Parts and accessories, including but not limited to propellers, gauges, oil tanks, remote controls, wiring and key switches that are installed by an authorized distributor / dealer at the time of sale, whether or not shipped with Product, bear the standard BRP limited warranty for Evinrude/Johnson Genuine Parts and accessories. See your authorized distributor / dealer for a full copy of such limited warranty.

### **2. EXCLUSIONS - ARE NOT WARRANTED:**

The following are not warranted under any circumstances:

- Replacement of parts due to normal wear and tear;
- Routine maintenance parts and services including but not limited to: maintenance requirements, lower unit oil change, lubrication, linkage adjustments and replacement of fuses, zinc anodes, thermostats, starter motor bushings, trim motor brushes, filters and spark plugs;
- Damage caused by improper installation or lack of maintenance, winterization and/or storage, failure to follow the procedures and recommendations in the Operator's Guide;
- Damage resulting from removal of parts, improper repairs, service, maintenance, or modification, or use of parts or accessories not manufactured or approved by BRP, which in its reasonable judgment, are either incompatible with Product or adversely affect its operation, performance, or durability, or resulting from repairs done by a person that is not an authorized Distributor / Dealer;
- Damage caused by abuse, misuse, abnormal use, neglect, racing, improper operation or operation of the Product in a manner inconsistent with the recommended operation described in the Operator's Guide;
- Damage resulting from accident, submersion, water ingestion, fire, theft, vandalism or any act of God;
- Operation with fuels, oils or lubricants which are not suitable for use with the Product (see the Operator's Guide);
- Damage resulting from rust or corrosion;
- Damage caused from cooling system blockage by foreign material;
- Damage resulting from sand or debris in the water pump; or
- Cosmetic or paint changes due to exposure to the elements.

This warranty will be voided in its entirety and rendered null and void where:

- Product has been altered or modified in such a way so as to adversely affect its operation, performance or durability, or has been altered or modified to change its intended use; or
- Product is or has been used for racing or any other competitive activity, at any point, even by a prior owner.



### 3. LIMITATIONS OF LIABILITY

THIS WARRANTY IS EXPRESSLY GIVEN AND ACCEPTED IN LIEU OF ANY AND ALL OTHER WARRANTIES, EXPRESSED OR IMPLIED, INCLUDING WITHOUT LIMITATION ANY WARRANTY OF MERCHANTABILITY OR FITNESS FOR A PARTICULAR PURPOSE. TO THE EXTENT THAT THEY CANNOT BE DISCLAIMED, THE IMPLIED WARRANTIES ARE LIMITED IN DURATION TO THE LIFE OF THE EXPRESS LIMITED WARRANTY.

ALL INCIDENTAL, CONSEQUENTIAL, DIRECT, INDIRECT OR OTHER DAMAGES OF ANY KIND ARE EXCLUDED FROM COVERAGE UNDER THIS WARRANTY INCLUDING, BUT NOT LIMITED TO: expense for gasoline, expense for transporting Product to and from Distributor / Dealer, removal of Product from a boat and reinstallation, mechanic's travel time, in-and-out of water charges, slip or dock fees, trailering or towing, storage, telephone, cell phone, fax or telegram charges, rental of a like or replacement Product or boat during warranty services or down time, taxi, travel, lodging, loss of or damage to personal property, inconvenience, cost of insurance coverage, loan payments, loss of time, loss of income, revenue or profits, or loss of enjoyment or use of Product.

SOME STATES/PROVINCES DO NOT ALLOW FOR THE DISCLAIMERS, LIMITATIONS AND EXCLUSIONS IDENTIFIED ABOVE, AS A RESULT, THEY MAY NOT APPLY TO YOU. THIS WARRANTY GIVES YOU SPECIFIC RIGHTS, AND YOU MAY ALSO HAVE OTHER LEGAL RIGHTS WHICH MAY VARY FROM STATE TO STATE, OR PROVINCE TO PROVINCE.

Neither the Distributor / Dealer, any BRP dealer nor any other person is authorized to make any affirmation, representation or warranty regarding Product other than those contained in this limited warranty and, if made, shall not be enforceable against BRP.

BRP reserves the right to modify this warranty at any time, being understood that such modification will not alter the warranty conditions applicable to the Products sold while this warranty is in effect.

### 4. WARRANTY COVERAGE PERIOD

This limited warranty will be in effect from the date of purchase by the first retail consumer or the date the Product is first put to use, whichever occurs first, for a period of:

36 CONSECUTIVE MONTHS OR 750 HOURS OF OPERATION as determined by Product's Engine Management Module (EMM), whichever occurs first, for private, recreational use; or

12 CONSECUTIVE MONTHS OR 750 HOURS OF OPERATION as determined by Product's Engine Management Module (EMM), whichever occurs first, for commercial use. The Product is used commercially when it is used in connection with any work or employment that generates income, during any part of the warranty period. The Product is also used commercially when, at any point during the warranty period, it is installed on a boat that has commercial tags or is licensed for commercial use.

The repair or replacement of parts or the performance of service to Product under this warranty does not extend the life of this limited warranty beyond its original expiration date.

### 5. CONDITIONS TO HAVE WARRANTY COVERAGE

This warranty coverage is available only if each of the following conditions has been fulfilled:

- a. The Evinrude outboard engines must be purchased as new and unused by its first owner from a BRP distributor / dealer authorized to distribute Evinrude products in the country in which the sale occurred ("Distributor /Dealer").
- b. The BRP specified pre delivery inspection process must be completed and documented by the purchaser and Distributor / Dealer.
- c. The product must have undergone proper registration by an authorized BRP distributor/dealer.
- d. The Evinrude outboard engines must be purchased in the country or union of countries in which the purchaser resides.
- e. Product routine maintenance outlined in the Operator's Guide must be timely performed in order to maintain warranty coverage. BRP reserves the right to make warranty coverage contingent upon proof of proper maintenance.

BRP will not honour this limited warranty to any private owner use owner or commercial use owner if the preceding conditions have not been met. Such limitations are necessary in order to allow BRP to protect the safety of its products, its consumers, and the general public.

## 6. WHAT TO DO TO OBTAIN WARRANTY COVERAGE

Registered owner ("Owner") must notify a servicing BRP authorized Distributor / Dealer within two (2) days of the appearance of a defect. Owner must bring Product, including any defective part therein, to the authorized BRP Distributor / Dealer promptly after the appearance of the defect, and in any event, within the warranty period, and must provide BRP Distributor / Dealer with reasonable opportunity to repair the defect. The expenses of transporting Product to and from Distributor/ Dealer for warranty service are to be borne by the Owner.

The Owner must also present proof of purchase to the authorized BRP Distributor / Dealer for warranty repairs and must sign the repair/work order prior to the start of the repair in order to validate the warranty repair.

All parts replaced under this warranty become the property of BRP.

## 7. WHAT BRP WILL DO

BRP's obligations under this warranty are limited to, at its sole discretion, repairing or replacing parts of Product found to be defective in material or workmanship, in the reasonable judgment of BRP. Such repair or replacement of parts will be done without charge for parts and labour, at any authorized Distributor / Dealer. BRP's responsibility is limited to making the required repairs or replacements of parts. No claim of breach of warranty shall be cause for cancellation or rescission of the sale of Product to Owner.

In the event that warranty service is required outside of country of original sale, Owner will bear responsibility for any additional charges due to local practices and conditions, such as, but not limited to, freight, insurance, taxes, license fees, import duties, and any and all other financial charges, including those levied by governments, states, territories and their respective agencies.

BRP reserves the right to improve, modify or change Products from time to time without assuming any obligation to modify Products previously manufactured.

## 8. TRANSFER

If the ownership of Product is transferred during the warranty coverage period, this warranty shall also be transferred and be valid for the remaining coverage period provided that the former or new Owner promptly contacts BRP or Distributor / Dealer and gives the name and address of the new Owner.

## 9. CONSUMER ASSISTANCE

In the event of a controversy or dispute in connection with this BRP limited warranty, BRP recommends that you first try to resolve the issue at the authorized BRP distributorship / dealership level by discussing the issue with Distributor's / Dealer's service manager or owner;

You can also locate A BRP office or distributor through our website at [www.brp.com](http://www.brp.com).

If further assistance is required, please contact the Customer Support Services of a BRP affiliate at one of the following numbers, depending on your location:

Asia - Telephone (65) 622-767-55, Fax (65) 622-629-32

Africa, Middle East, Albania, Former Yugoslavian Republic of Macedonia, Serbia and Montenegro, Bosnia and Herzegovina and Commonwealth of Independent States (former Soviet Union)  
-Telephone (41) 21 318 78 00, Fax (41) 21 318 78 61

Latin America (excluding Brazil) - Telephone 954-846-1442, Fax 954-846-1478

Brazil - Telephone 55 (19) 3246-2100, Fax 55 (19) 3246-3800

Pacific Islands - Telephone 612-9794-6600, Fax 612-9794-6697

Limited Warranty Revision Asia/Latin Am March 2011

## Readiness Test

The Operator's Readiness Test...

1. Did you read this Guide from front cover to rear cover?
2. Are you ready to take responsibility for the safe operation of your boat and outboard?
3. Do you understand all the safety precautions and instructions contained in this Guide?
4. Do you understand that this Guide contains essential information to help prevent personal injury and damage to equipment?
5. Are you ready to follow the recommendations in this Guide and take a boating safety course before you operate your boat and outboard?
6. Do you know who to ask if you have any questions about your boat and outboard?
7. Do you know your local marine traffic laws?
8. Do you understand that human error can be caused by carelessness, fatigue, overload, preoccupation, unfamiliarity of operator with the product, drugs and alcohol, just to name a few?



### **WARNING**

**It is impossible for this Guide to cover every hazardous situation you may encounter; however, your understanding of and adherence to essential information contained in this Guide will build good judgment when boating. Always be alert and careful: a good foundation for safety.**

## Frequently Asked Questions

*What fuel octane is recommended for my Evinrude 4-Stroke outboard?*

Evinrude 4-Stroke outboards require a minimum octane of 87 (U.S.). Use of higher octane fuels is not harmful, but also not necessary.

*What kind of oil does my Evinrude 4-Stroke outboard require?*

Evinrude/Johnson Ultra 4-Stroke outboard oil is recommended for use in Evinrude 4-Stroke outboards.

If Evinrude/Johnson Ultra 4-Stroke outboard oil is not available, use a high quality SAE 10W-30, or 10W-40 oil with the NMMA certification FC-W, or with API rating SF, SG, SH, SJ, SI, SM.

Choose 10W-30, or 10W-40 oil based on ambient operating temperature. Refer to Oil Requirements on page 19.

*Where should I take my Evinrude 4-Stroke outboard for service?*

For repairs covered under warranty, you must take your Evinrude 4-Stroke outboard to an authorized dealer. BRP-approved dealers and distributors have received the necessary training to properly service your outboard. Contact BRP for an authorized Evinrude dealer near you.

*Can I order replacement parts and accessories for my Evinrude 4-Stroke outboard?*

Yes. When replacement parts are required, use Evinrude/Johnson Genuine Parts or parts with equivalent characteristics, including type, strength, and material. Using substandard parts could result in injury or product malfunction. Your dealer can order the parts and accessories you desire.

*Do I need to complete any paperwork when I move or sell my Evinrude 4-Stroke outboard?*

Yes. In order to maintain contact with you or the new Evinrude 4-Stroke owner, BRP requests you complete the form outlining Change of Address / Change of Ownership. This will ensure you or the new owner is made aware of any product announcements and keep the warranty coverage up-to-date.

*What do I need to do before storing my Evinrude 4-Stroke outboard for the winter?*

Winterization is minimal. Refer to Off Season Storage for step-by-step instructions to store your Evinrude 4-Stroke outboard for the off-season.



# Change of Address / Change of Ownership

If your address has changed or if there has been a change of ownership, be sure to fill out and mail the form provided on this page.

This notification is necessary for your own safety even after expiration of the original warranty, since BRP will be in a position to contact you if correction to your outboard is required. Outside the U.S. and Canada, this card should be sent to the Bombardier Recreational Products division where the outboard was registered. Please contact your Dealer or Distributor.



Change of Address  Change of Ownership

Model number

Serial Number

Old Address / Previous Owner

Last name

First name  M.I.

Address

City  State

Zip code  Country

Phone number

Signature \_\_\_\_\_ Date \_\_\_\_\_

New Address / New Owner

Type of Use  Recreational  Commercial  Government

Last name

First name  M.I.

Address

City  State

Zip code  Country

Phone number

Signature \_\_\_\_\_ Date \_\_\_\_\_

Dealer Information

Dealer name

Dealer number

Phone number

Contact name

In the U.S. or Canada, mail completed form to: BRP US Inc. / Outboard Engines Division  
 After Sales Support  
 P.O. Box 597  
 Sturtevant, WI 53177



## Confirmation of Receipt

Your Dealer

Name:	_____
Address:	_____
	_____

Upon delivery of your new Evinrude /Johnson outboard, complete and sign the form below.

Your Dealer will take receipt of the form for their records.

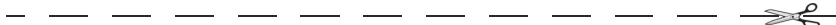

Receipt

Name:	_____
Address:	_____
	_____
Owner of Model No:	_____
Serial No:	_____
	(To be completed by customer or selling Dealer)
<p>The Dealer named on this document has instructed me on the operation, maintenance, safety features and warranty policy, all of which I understand and agree to be bound with. I am also satisfied with the pre-delivery set-up and inspection of my Evinrude /Johnson outboard. I have also received a copy of the Operator's Guide.</p>	
Signature:	_____
Date:	_____



# MEMO

A series of horizontal dashed lines for writing.







**EVINRUDE®**

SPEND MORE TIME ON THE WATER™

