

# 2005

# Johnson®

## 4 Stroke

## 4/5/6 HORSEPOWER

R4, RL4



**WARNING**  
Read this Operator Guide thoroughly. It contains important safety information. When operating your boat, always have this Operator Guide onboard.

# Our First Words to the Owner/Operator

This Operator's Guide is an essential part of your *Johnson* outboard. It contains pertinent information which, if followed, will provide you with a thorough understanding needed for proper operation, maintenance, care and above all safety!

The safety section of this Guide comes first because it is our first priority and it should be yours too. It is strongly recommended that you read this Guide from front cover to rear cover. Following this recommendation will assure the completeness of the information that is essential to your safety, the safety of any passengers and other boaters. An Operator's Readiness Test has been prepared on the last page of this Guide.

Be safe! All passengers should be familiar with the proper operation of your boat and *Johnson* outboard. Be certain they fully understand and respect the controls and operation. Each operator is responsible for the safety of all passengers and other boaters. Please make safety your first priority and complete a boating safety course through your local Coast Guard, Power Squadron, Red Cross or State Boating Law Agency.

The pleasures of owning and operating a *Johnson* outboard can be significant. We strongly believe the rewards for following our recommendations will be worthwhile. Remember that YOU are the key to safety. Good safety practices not only protect you but also protect the people around you.

Having fun is what it's all about and, with your cooperation, the pertinent information in this Guide can ensure a safe and enjoyable experience.

Enjoy the great outdoors on the water...



## WARNING



**Be careful! Human error is caused by many factors: carelessness, fatigue, overload, preoccupation, unfamiliarity of operator with the product, drugs and alcohol to name a few. Damage to your boat and outboard can be fixed in a short period of time, but injury or death has a lasting effect.**

**For your safety and the safety of others, read this Guide from cover to cover and follow all safety warnings and recommendations. Do not disregard any of the safety precautions and instructions.**

**Anyone operating your boat should first read and understand this Guide before they operate your boat and motor.**

The following trademarks are the property of BRP US Inc. or its affiliates:

*Evinrude®*

*Johnson®*

*Evinrude®/Johnson® Genuine Parts*

*2+4® fuel conditioner*

*Evinrude®/Johnson® 4-Stroke outboard oil*

*Hi-Vis™ gearcase lubricant*

*Evinrude®/Johnson® Ultra™ 4-Stroke synthetic blend oil*

*Triple-Guard® grease*

*Evinrude®/Johnson® anti-corrosion spray*

*Ultra-HPF™ gearcase lubricant*

99011-91J03-BBD

# Contents

<b>GENERAL INFORMATION</b> .....	<b>2</b>
SAFETY — THE RIGHT PLACE TO GET STARTED .....	2
PRODUCT REFERENCES, ILLUSTRATIONS AND SPECIFICATIONS .....	4
BRP US INC. LIMITED WARRANTY FOR 2005 JOHNSON 4-STROKE OUTBOARD ENGINES SOLD IN THE UNITED STATES AND CANADA .....	5
BRP US INC. LIMITED WARRANTY FOR 2005 JOHNSON 4-STROKE OUTBOARD ENGINES SOLD OUTSIDE THE UNITED STATES AND CANADA .....	8
CALIFORNIA EMISSION CONTROL WARRANTY STATEMENT .....	9
FEATURES .....	12
ENGINE SPECIFICATIONS .....	14
EMERGENCY STOP SWITCH .....	15
<b>FUEL AND OIL</b> .....	<b>16</b>
FUEL .....	16
OIL .....	17
ADDITIVES .....	17
FUEL SYSTEM .....	17
BREAK-IN (10 HOURS) .....	18
<b>ENGINE STARTING</b> .....	<b>19</b>
BEFORE START-UP .....	19
ENGINE STOPPING .....	21
SHIFTING AND SPEED CONTROL .....	22
EMERGENCY STARTING .....	22
<b>OPERATION</b> .....	<b>24</b>
MOTOR ANGLE ADJUSTMENT .....	24
TILTING .....	24
SHALLOW-WATER DRIVE .....	25
MOORING .....	25
FLUSHING .....	26
ENGINE OVERHEATING .....	27
TRAILERING .....	28
IMPACT DAMAGE .....	28
STORING .....	29
CARRYING AND TRANSPORTING .....	29
SPECIAL OPERATING CONDITIONS .....	30
<b>MAINTENANCE</b> .....	<b>31</b>
ENGINE EMISSIONS INFORMATION .....	31
10-HOUR INSPECTION .....	32
OFF-SEASON STORAGE .....	32
PRE-SEASON SERVICE .....	33
CRANKCASE OIL .....	34
ADJUSTMENTS .....	35
LUBRICATION .....	36
BREATHER AND FUEL LINE .....	38
SPARK PLUGS .....	38
PROPELLER .....	39
ANTICORROSION ANODES .....	39
TROUBLE CHECK CHART .....	40
ENGINE MAINTENANCE AND INSPECTION SCHEDULE .....	41
<b>INSTALLATION</b> .....	<b>43</b>
TRANSOM HEIGHT AND SHAFT LENGTH .....	43
INSTALLING THE ENGINE .....	44

# GENERAL INFORMATION

## SAFETY — THE RIGHT PLACE TO GET STARTED

This Operator's Guide contains essential information to help prevent personal injury and damage to equipment. It will acquaint the operator and passengers with the *Evinrude/Johnson* outboard and its controls, operation, maintenance and boating safety measures. Make sure all operators read, understand and follow the contents. This Guide should be kept in a waterproof bag with the product at all times during operation. If the product ownership is transferred, this Guide should be forwarded to the subsequent owners.

This Operator's Guide uses the following signal words identifying important safety messages. These safety alert signal words mean:

**ATTENTION!**  
**BECOME ALERT!**  
**YOUR SAFETY IS INVOLVED!**

A responsible, educated boater will fully appreciate the pleasures of boating and will be a safe boater. Boating Safety Classes are conducted by the U.S. Coast Guard Auxiliary, the U.S. Power Squadron and some Red Cross Chapters. For information about classes, call toll free 1-800-336-BOAT. For additional information about boating safety and regulations call: U.S. Coast Guard Boating Safety Hotline 1-800-368-5647. Outside North America please contact your Dealer or distributor for details about boating safety.

## SAFETY MEASURES — General

⚠ To fully appreciate the pleasures, enjoyment and excitement of boating there are some basic rules that should be observed and followed by any boater. Some rules may be new to you and others may be common sense or obvious... irrespective, take them seriously! Failure to follow this safety information and safe boating rules could result in injury to you, your passengers or other water users.

⚠ Become completely familiar with the control and operation of your boat and motor before embarking on your first trip or taking on a passenger(s). If you have not had the opportunity to do so with your Dealer, practice driving in a suitable area and feel the response of each control. Be familiar with all controls before applying the throttle above idle speed. As the operator, you are in control and responsible for safe operation.

## SAFETY MEASURES — Operation

⚠ Be sure at least one of your passengers knows how to handle your boat in case of an emergency.

⚠ All passengers should know the location of emergency equipment and how to use it.

⚠ All safety equipment and personal flotation devices must be in good condition and suitable for your type of boat. Always comply with the regulations that apply to your boat.

⚠ Contact with rotating propeller is likely to result in serious injury or death. Do not allow anyone near a propeller, even when the engine is off. Propeller blades can be sharp and can continue to turn even after the engine is shut off. Always shut off the engine when boat is near people in the water.

### **DANGER**

Indicates an imminently hazardous situation which, if not avoided, **WILL** result in death or serious injury.

### **WARNING**

Indicates a potentially hazardous situation which, if not avoided, **CAN** result in severe injury or death.

### **CAUTION**

Indicates a potentially hazardous situation which, if not avoided, **MAY** result in minor or moderate personal injury or property damage. It also may be used to alert against unsafe practices.

**IMPORTANT:** Identifies information that will help prevent damage to machinery and appears next to information that controls correct assembly and operation of the product.

Although the mere reading of such information does not eliminate the hazard, the understanding and application of the information will promote the correct use of your outboard engine.

⚠ Whenever running the engine, assure there is proper ventilation to avoid carbon monoxide (CO), which is odorless, colorless, and tasteless, and can lead to unconsciousness, brain damage, or death if inhaled in sufficient concentrations. CO accumulation can occur while docked, anchored, or underway, and in many confined areas such as the boat cabin, cockpit, swim platform, and heads. It can be worsened or caused by weather, mooring and operating conditions, and other boats. Avoid exhaust fumes from your engine or other boats, provide proper ventilation, shut off your engine when not needed, and be aware of the risk of backdrafting and conditions that create CO accumulation. In high concentrations, CO can be fatal within minutes. Lower concentrations are just as lethal over long periods of time.

⚠ Proceed with caution and at very low speed in shallow water. Grounding or abrupt stops may result in injury. Also be alert for debris and objects in the water.

⚠ Be familiar with the waters you are operating in. The gearcase of this outboard extends below the water surface and could potentially come in contact with underwater obstructions. Contact with underwater obstructions may result in loss of control and personal injury.

⚠ Avoid standing up or shifting weight suddenly in light weight boats.

⚠ Keep your passengers seated in seats. The boat's bow, gunwale, transom and seat backs are not intended for use as seats.

⚠ Insist on the use of personal flotation devices, approved by the U.S. Coast Guard, by all passengers when boating conditions are hazardous, and by children and nonswimmers at all times.

⚠ Respect no wake zones, rights of other water users and the environment. As the "skipper" and owner of a boat you are responsible for damage to other boats caused by the wake of your boat. Allow no one to throw refuse overboard.

⚠ Know the marine traffic laws and obey them.

⚠ Remember, gasoline fumes are flammable and explosive. Always adhere to the fueling procedure contained in this Operator's Guide and those given to you by the fueling station. Always verify fuel level before use and during the ride. Apply the principle of 1/3 fuel to destination, 1/3 back and 1/3 reserve fuel supply. Do not carry spare fuel or flammable liquids in any storage or engine compartments.

⚠ Do not operate your boat if you are under the influence of drugs or alcohol.

⚠ High performance boats have a high power-to-weight ratio. If you are not experienced in the operation of a high performance boat, do not attempt to operate one at, or near, its top speed until you have gained that experience.

⚠ For more information, see your *Evinrude/Johnson Dealer* for a copy of **Introduction to High Performance Boating**, P/N 335763.

## **SAFETY MEASURES — Installation and Maintenance**

### **Outboard Installation**

⚠ The outboard must be correctly installed. Failure to correctly install the outboard could result in serious injury, death or property damage. We strongly recommend that your Dealer install your outboard to ensure proper installation.

⚠ Do not overpower your boat by using an engine that exceeds the horsepower indicated on the boat's capacity plate. Overpowering could result in loss of control. If your boat has no capacity plate, contact your Dealer or the boat's manufacturer.

### **Maintenance**

⚠ When replacement parts are required, use *Evinrude/Johnson® Genuine Parts* or parts with equivalent characteristics, including type, strength and material. Using substandard parts could result in injury or product malfunction.

⚠ Only perform service procedures which are detailed in this Operator's Guide. Attempting to perform maintenance or repair on your outboard if you are not familiar with the correct service and safety procedure could cause personal injury or death. Further information can be obtained from your authorized *Evinrude/Johnson Dealer*. In many instances proper tools and training are required for certain service or repair procedures.

⚠ Maintain your boat and engine in top condition at all times. Adhere to the **Engine Maintenance and Inspection Schedule**.

⚠ Operate your boat and outboard prudently and have fun. Do not forget that all persons must assist other boaters in case of emergency.

⚠ Prevent injury from contact with rotating propeller; remove propeller before flushing or before performing any maintenance.

## PRODUCT REFERENCES, ILLUSTRATIONS AND SPECIFICATIONS



### WARNING



**When replacement parts are required, use *Evinrude/Johnson Genuine Parts* or parts with equivalent characteristics, including type, strength and material. Using standard parts could result in injury or product malfunction.**

BRP US Inc. reserves the right to make changes at any time, without notice, to features, specifications and model availability. The right is also reserved to change any specification or part at any time without incurring any obligation to update older models. The information in the Guide is based on the latest specifications available at the time of publication.

Photographs and illustrations used in this Guide might not depict actual models or equipment but are intended as representative views for reference only. The continuing accuracy of this Guide cannot be guaranteed.

Certain features of systems discussed in this Guide might not be found on all models in all marketing areas.

#### Owner's Identification

**North America** — At the time of purchase, your Dealer will complete your outboard registration forms. Your portion provides proof of ownership and date of purchase.

**Outside North America** — See your Dealer or distributor for details.

#### Model and Serial Numbers

The model and serial numbers appear on a plate attached to the stern bracket or swivel bracket. Record your outboard's:

Model Number \_\_\_\_\_

Serial Number \_\_\_\_\_

Purchase Date \_\_\_\_\_

Ignition Key Number \_\_\_\_\_

#### Stolen Outboards

**North America** — Report your outboard as stolen to Customer and Dealer Support Services, 250 Sea Horse Drive, Waukegan, IL 60085 U.S.A. Give the outboard's model and serial numbers and enclose a copy of the police report.

**Outside North America** — Report the theft to the Bombardier Recreational Products distributor where the outboard was registered.

#### Technical Literature

BRP US Inc. offers technical literature specifically for your outboard. A service manual, a parts catalog, or an extra Operator's Guide can be purchased from your selling Dealer. For the name and location of the nearest *Evinrude/Johnson* Dealer in the United States and Canada visit [www.evinrude.com](http://www.evinrude.com) or [www.johnson.com](http://www.johnson.com).

#### Declaration of Conformity

BRP US Inc. declares that the outboard to which this Operator's Manual applies conforms to the essential requirements outlined in **CE Machinery Directive 98-37-EC**, as amended.

# BRP US INC. LIMITED WARRANTY FOR 2005 *JOHNSON* 4-STROKE OUTBOARD ENGINES SOLD IN THE UNITED STATES AND CANADA

## **1. SCOPE OF THE LIMITED WARRANTY**

BRP US Inc. warrants its 2005 *Johnson*® 4-stroke outboard engines sold by authorized *Johnson* dealers in the fifty United States and Canada ("Product") from defects in material or workmanship for the period and under the conditions described below.

## **2. WARRANTY COVERAGE PERIOD**

This limited warranty will be in effect from the date of purchase by the first retail consumer or the date the Product is first put to use, whichever occurs first, for a period of:

THIRTY-SIX (36) CONSECUTIVE MONTHS for private, recreational use; or

TWELVE (12) CONSECUTIVE MONTHS for commercial use, except that emission-related components providing input to emission controls (e.g. sensors) are warranted for twenty-four (24) months or two hundred (200) hours of engine use, whichever occurs first. The Product is used commercially when it is used in connection with any work or employment that generates income, during any part of the warranty period. The Product is also used commercially when, at any point during the warranty period, it is installed on a boat that has commercial tags or is licensed for commercial use.

The repair or replacement of parts or the performance of service to Product under this warranty does not extend the life of this limited warranty beyond its original expiration date. All *Evinrude/Johnson Genuine Parts* and accessories installed by an authorized dealer at the time of sale, including but not limited to propellers, bear the standard BRP US Inc. parts and accessories one-year limited warranty.

California residents who purchased or warranty-registered a Product in California should refer to BRP US Inc.'s California Emissions Control Warranty Statement.

## **3. CONDITIONS TO HAVE WARRANTY COVERAGE**

This warranty coverage is available only on *Johnson* 4-stroke outboard engines purchased as new and unused from a dealer authorized to distribute *Johnson* products in the country in which the sale occurred ("Dealer"), and then only after the BRP US Inc. specified pre-delivery inspection process has been completed and documented by the purchaser and Dealer. Warranty coverage only becomes available upon proper registration of Product by Dealer or owner.

Only the original purchaser and any subsequent owners who reside in the United States and Canada and have purchased Product from a U.S. or Canadian Dealer are eligible for warranty registration and warranty coverage hereunder. Such limitations are necessary in order to allow BRP US Inc. to protect the safety of its products, its consumers, and the general public.

As outlined in the Operator's Guide, timely routine required maintenance must be performed to maintain warranty coverage. BRP US Inc. may require proof of proper maintenance prior to authorizing warranty coverage.

#### **4. WHAT TO DO TO OBTAIN WARRANTY COVERAGE**

The registered owner must notify an authorized Dealer within two (2) days of the appearance of a defect. Owner must bring Product, including any defective part therein, to Dealer promptly after the appearance of the defect, and in any event, within the warranty period, and must provide Dealer with reasonable opportunity to repair the defect. The expenses of transporting Product to and from Dealer for warranty service are to be borne by the owner.

If the Product has not previously been registered, the owner may also be required to present proof of purchase to Dealer for warranty repairs. Owner is required to sign the repair/work order prior to the start of the repair in order to validate the warranty repair.

All parts replaced under this warranty become the property of BRP US Inc.

#### **5. WHAT BRP US INC. WILL DO**

BRP US Inc.'s obligations under this warranty are limited to, at its sole discretion, repairing or replacing parts of Product found to be defective in material or workmanship, in the reasonable judgment of BRP US Inc. Such repair or replacement of parts will be done without charge for parts and labor, at any authorized Dealer. BRP US Inc.'s responsibility is limited to making the required repairs or replacements of parts with new or BRP US Inc.-certified re-manufactured parts. No claim of breach of warranty shall be cause for cancellation or rescission of the sale of Product to owner.

In the event that warranty service is required outside of the fifty United States or Canada, owner will bear responsibility for any additional charges due to local practices and conditions, such as, but not limited to, freight, insurance, taxes, license fees, import duties, and any and all other financial charges, including those levied by governments, states, territories and their respective agencies.

BRP US Inc. reserves the right to improve, modify or change Products from time to time without assuming any obligation to modify Products previously manufactured.

#### **6. EXCLUSIONS - The following are not warranted under any circumstances:**

- Replacement of parts due to normal wear and tear;
- Routine maintenance parts and services including but not limited to: maintenance requirements, engine and lower unit oil changes, lubrication, valve and linkage adjustments and replacement of fuses, zinc anodes, thermostats, timing belts, starter motor bushings, trim motor brushes, filters, propellers, propeller bushings and spark plugs;
- Damage caused by improper or lack of installation, maintenance, winterization and/or storage, failure to follow the procedures and recommendations in the Operator's Guide;
- Damage resulting from removal of parts, improper repairs, service, maintenance, or modification, or use of parts or accessories not manufactured or approved by BRP US Inc., which in its reasonable judgment, are either incompatible with Product or adversely affect its operation, performance, or durability, or resulting from repairs done by a person that is not an authorized Dealer;
- Damage caused by abuse, misuse, abnormal use, neglect, racing, improper operation or operation of the Product in a manner inconsistent with the recommended operation described in the Operator's Guide;
- Damage resulting from external damage, accident, submersion, water ingestion, fire, theft, vandalism or any act of God;
- Operation without proper fuel, oil or lubrication or with fuels, oils or lubricants which are not suitable for use with the Product (see the Operator's Guide);
- Damage resulting from rust or corrosion;
- Damage caused from cooling system blockage by foreign material;
- Damage resulting from sand or debris in the water pump;
- Cosmetic or paint changes due to exposure to the elements.

This warranty **will be voided in its entirety and rendered null and void** where:

- Product has been altered or modified in such a way so as to adversely affect its operation, performance or durability, or change its intended use, horsepower or emission levels; or
- Product is or has been used for racing at any point, even by a prior owner.



## **7. LIMITATIONS OF LIABILITY**

**ALL WARRANTIES, EXPRESSED OR IMPLIED, INCLUDING WITHOUT LIMITATION ANY WARRANTY OF MERCHANTABILITY OR FITNESS FOR A PARTICULAR PURPOSE ARE LIMITED IN DURATION TO THE LIFE OF THE EXPRESS LIMITED WARRANTY.**

**ALL INCIDENTAL, CONSEQUENTIAL, DIRECT, INDIRECT OR OTHER DAMAGES OF ANY KIND ARE EXCLUDED FROM COVERAGE UNDER THIS WARRANTY INCLUDING, BUT NOT LIMITED TO:** expense for gasoline, expense for transporting Product to and from Dealer, removal of Product from a boat and reinstallation, mechanic's travel time, in-and-out of water charges, slip or dock fees, trailering or towing, storage, telephone, cell phone, fax or telegram charges, rental of a like or replacement Product or boat during warranty services or down time, taxi, travel, lodging, loss of or damage to personal property, inconvenience, cost of insurance coverage, loan payments, loss of time, loss of income, revenue or profits, or loss of enjoyment or use of Product.

**SOME STATES, PROVINCES, OR JURISDICTIONS DO NOT ALLOW FOR THE DISCLAIMERS, LIMITATIONS OF INCIDENTAL OR CONSEQUENTIAL DAMAGES, OR OTHER EXCLUSIONS IDENTIFIED ABOVE. AS A RESULT, THEY MAY NOT APPLY TO YOU. THIS WARRANTY GIVES YOU SPECIFIC RIGHTS, AND YOU MAY ALSO HAVE OTHER LEGAL RIGHTS WHICH MAY VARY FROM STATE TO STATE, OR PROVINCE TO PROVINCE.**

No distributor, Dealer or any other person is authorized to make any affirmation, representation or warranty regarding Product other than those contained in this limited warranty and, if made, shall not be enforceable against BRP US Inc. BRP US Inc. reserves the right to modify this warranty at any time, being understood that such modification will not alter the warranty conditions applicable to the Products sold while this warranty is in effect.

## **8. TRANSFER**

If the ownership of Product is transferred during the warranty coverage period, this warranty shall also be transferred and be valid for the remaining coverage period provided that the former or new owner promptly contacts BRP US Inc. or Dealer and gives the name and address of the new owner.

## **9. CONSUMER ASSISTANCE**

- In the event of a controversy or dispute in connection with this BRP US Inc. limited warranty, BRP US Inc. recommends that you first try to resolve the issue at the dealership level by discussing the issue with Dealer's service manager or owner;
- If further assistance is required, please contact the BRP US Inc. Customer Support Services, 250 Sea Horse Drive, Waukegan, IL, 60085, 1-847-689-7090.

Revision March 2004

\* Engines sold in Canada are distributed and serviced by Bombardier Recreational Products Inc.

**BRP US INC. LIMITED WARRANTY FOR 2005 JOHNSON 4-STROKE OUTBOARD  
ENGINES SOLD OUTSIDE THE UNITED STATES AND CANADA**

For a copy of the Limited Warranty, see your BRP US Inc. distributor/dealer authorized to distribute *Johnson* 4-Stroke products in the country in which the sale occurs.

If further assistance is required, please contact BRP US Inc. Customer Support Services, 250 Sea Horse Drive, Waukegan, Illinois, 60085, or the affiliate of Bombardier Recreational Products Inc. where the Product was registered for warranty.

# CALIFORNIA EMISSION CONTROL WARRANTY STATEMENT

Your *Johnson* 4-stroke outboard has a special environmental label required by the California Air Resources Board. The label has one, two, three, or four stars. A hangtag, provided with your outboard, describes the meaning of the star rating system.

## *The Star Label means Cleaner Marine Engines*



### **The Symbol for Cleaner Marine Engines:**

#### **Cleaner Air and Water**

For a healthier lifestyle and environment.

#### **Better Fuel Economy**

Burns up to 30 to 40 percent less gas and oil than conventional carbureted two-stroke engines, saving money and resources.

#### **Longer Emission Warranty**

Protects consumer for worry free operation.

### ***One Star – Low Emission***

The one-star label identifies Personal Watercraft, Outboard, Sterndrive and Inboard engines that meet the Air Resource Board's Personal Watercraft and Outboard marine engine 2001 exhaust emission standards. Engines meeting these standards have 75% lower emissions than conventional carbureted two-stroke engines. These engines are equivalent to the U.S. EPA's 2006 standards for marine engines.

### ***Two Stars – Very Low Emission***

The two-star label identifies Personal Watercraft, Outboard, Sterndrive and Inboard engines that meet the Air Resources Board's Personal Watercraft and Outboard marine engine 2004 exhaust emission standards. Engines meeting these standards have 20% lower emissions than One Star – Low Emission engines.

### ***Three Stars – Ultra Low Emission***

The three-star label identifies engines that meet the Air Resources Board's Personal Watercraft and Outboard marine engine 2008 exhaust emission standards or the Sterndrive and Inboard marine engine 2003 exhaust emission standards. Engines meeting these standards have 65% lower emissions than One Star – Low Emission engines.

### ***Four Stars – Super Ultra Low Emission***

The four-star label identifies engines that meet the Air Resources Board's Sterndrive and Inboard marine engine 2009 exhaust emission standards. Personal Watercraft and Outboard marine engines may also comply with these standards. Engines meeting these standards have 90% lower emission than One Star – Low Emission engines.

For more information: Cleaner Watercraft – Get the Facts

1-800-END-SMOG

[www.arb.ca.gov](http://www.arb.ca.gov)

## ***YOUR EMISSION CONTROL WARRANTY RIGHTS AND OBLIGATION***

The California Air Resources Board and BRP US Inc. are pleased to explain the emission control system warranty on your *Johnson* 4-stroke outboard. In California, new outboard engines must be designed, built, and equipped to meet the State's stringent anti-smog standards. BRP US Inc. must warrant the emission control system on your outboard for the periods of time listed below provided there has been no abuse, neglect, or improper maintenance of your outboard.

Your emission control system may include parts such as the carburetor or fuel injection system, the ignition system, and catalytic converter. Also included may be hoses, belts, connectors, and other emission-related assemblies.

Where a warrantable condition exists, BRP US Inc. will repair your outboard at no cost to you including diagnosis, parts, and labor provided that such work is performed by an authorized BRP US Inc. dealer.

## **Manufacturer's Limited Warranty Coverage**

This emission limited warranty covers *Johnson* 4-stroke outboards certified and produced by BRP US Inc. for sale in California, that are originally sold in California to a California resident, or subsequently warranty-registered to a California resident. The BRP US Inc. U.S. and Canada limited warranty conditions for *Johnson* 4-stroke outboards are still applicable to these models with the necessary modifications.

Select emission control parts of your *Johnson* 4-stroke outboard are warranted from the date of purchase by the first retail consumer or the date the product is first put to use, whichever occurs first, for a period of: 4 years, or for 250 hours of use, whichever occurs first.

However, warranty coverage based on the hourly period is only permitted for outboards equipped with the appropriate hour meters or their equivalent. If any emission-related part on your engine is defective under warranty, the part will be repaired or replaced by BRP US Inc.

Parts covered are:

<b>Component</b>	<b>Carbureted</b>	<b>SPFI</b>
Thermostat	X	X
<b>Electrical System</b>		
Engine/Ignition Control Module	X	X
Spark Plugs, Boots, and/or Wires	X	X
Ignition Coils	X	X
Wiring Harness	X	X
<b>Exhaust System</b>		
Engine Holder	X	X
Oil Pan	X	X
Exhaust Housing	X	X
Exhaust Valves	X	X
<b>Fuel System</b>		
Fuel Pump(s)	X	X
Fuel Injectors		X
Vapor Separator		X
Carburetor and Internal Parts	X	
Accelerator Pump	X	
Choke System	X	
Crankcase Ventilation System Components	X	X
Fuel Lines, Fittings, Clamps	X	X
<b>Air Induction System</b>		
Timing Chain/Belt and Tensioner	X	X
Camshaft and Followers	X	X
Intake Valves	X	X
Electronic Dash Pot System		X
Throttle Body Assembly		X
Idle Air Control		X
Closed Throttle Position Switch		X
Throttle Linkage	X	X
Intake Manifold	X	X
<b>Sensors</b>		
Air Temperature Sensor		X
Cam Position Sensor		X
Crankshaft Position Sensor	X	X
Throttle Position Sensor		X
Exhaust Temp Sensor		X
Intake Manifold Pressure Sensor		X
Cylinder Temperature Sensor	X	X
<b>Gaskets</b>		
All Emission Component Gaskets	X	X

The emission warranty covers damage to other engine components that is caused by the failure of a warranted part.

The BRP US Inc. Operator's Guide provided contains written instructions for the proper maintenance and use of your outboard. All emission warranty parts are warranted by BRP US Inc. for the entire warranty period of the outboard, unless the part is scheduled for replacement as required maintenance in the Operator's Guide.

Emission warranty parts that are scheduled for replacement, as required maintenance, are warranted by BRP US Inc. for the period of time before the first scheduled replacement date for that part. Emission warranty parts that are scheduled for regular inspection but not regular replacement are warranted by BRP US Inc. for the entire warranty period of the outboard. Any emission warranty part repaired or replaced under the terms of this warranty statement is warranted by BRP US Inc. for the remainder of the warranty period of the original part. All parts replaced under this limited warranty become the property of BRP US Inc.

Maintenance receipts and records should be transferred to each subsequent owner of the outboard.

### ***Owner's Warranty Responsibilities***

As the outboard owner, you are responsible for the performance of the required maintenance listed in your Operator's Guide. BRP US Inc. recommends that you retain all receipts covering maintenance on your outboard, but BRP US Inc. cannot deny warranty solely for the lack of receipts or your failure to ensure the performance of all scheduled maintenance.

As the outboard owner, you should however be aware that BRP US Inc. may deny you warranty coverage if your outboard or a part has failed due to abuse, neglect, improper maintenance, or unapproved modifications.

You are responsible for presenting your outboard to an authorized BRP US Inc. dealer as soon as a problem exists. The warranty repairs will be completed in a reasonable amount of time, not to exceed 30 days.

For any questions regarding your warranty rights and responsibilities or for the name and location of the nearest authorized BRP US Inc. dealer, contact BRP US Inc. Customer Support Services, 250 Sea Horse Drive, Waukegan, IL 60085, 1-847-689-7090 or visit **[www.johnson.com](http://www.johnson.com)**.

## FEATURES

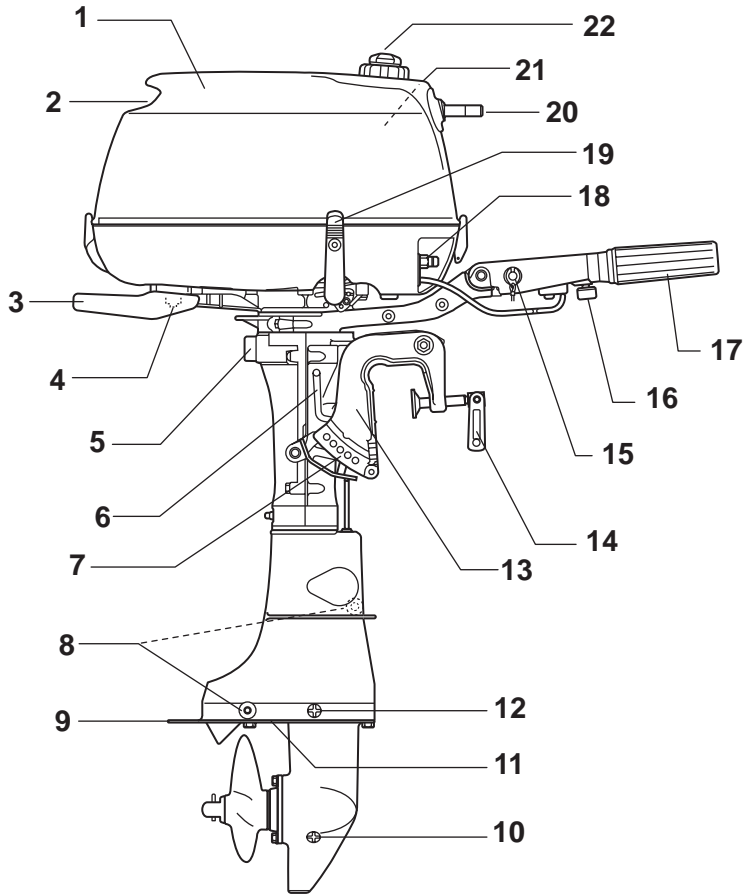

Item	Description	Item	Description
1	Motor Cover	12	Lubricant Level Plug
2	Tilt Grip	13	Clamp Bracket
3	Rear Handle	14	Clamp Screw
4	Water Pump Indicator / Flushing Port	15	Emergency Stop Switch / STOP Button & Lanyard
5	Steering Friction	16	Throttle Friction
6	Tilt Lock Lever	17	Throttle Grip
7	Angle Adjustment Rod	18	Fuel Connector <sup>(1)</sup>
8	Anti-Corrosion Anodes	19	Shift Lever
9	Anti-Ventilation Plate	20	Starter Handle
10	Lubricant Drain/Fill Plug	21	Built-in Fuel Tank
11	Water Intake	22	Fuel Tank Vent

(1) 5 and 6 HP models only.

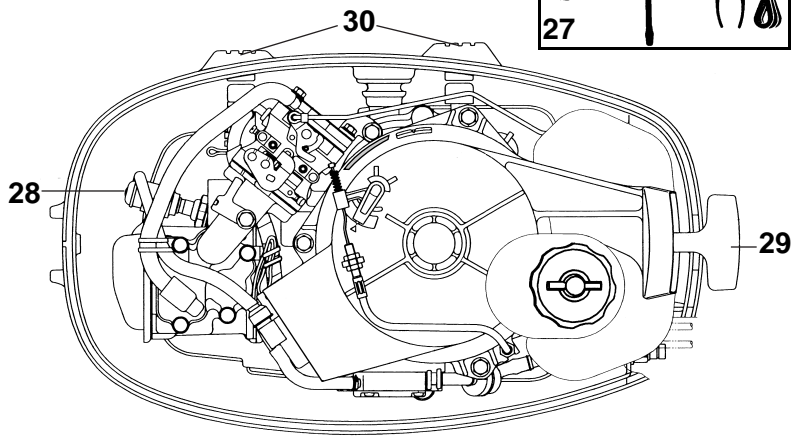
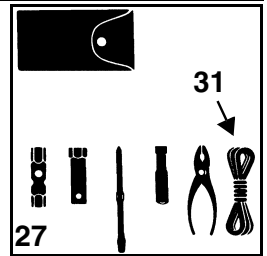
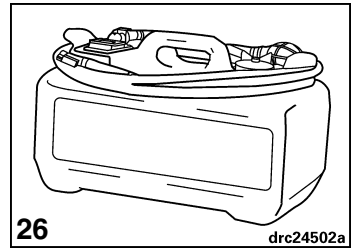
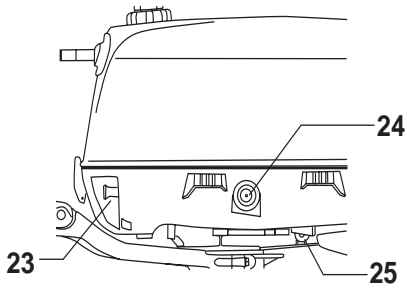

Item	Description	Item	Description
23	Choke Knob	28	Spark Plug
24	Oil Inspection Window	29	Starter Grip
25	Fuel Shut Off Valve	30	Engine Cover Bumpers
26	Fuel Tank <sup>(1)</sup>	31	Emergency Starter Cord
27	Tool Kit		

(1) Not supplied in all marketing areas.

## ENGINE SPECIFICATIONS

<b>4, 5, 6 Models</b>	
Displacement	8.4 cu. in. (138 cc)
Engine Type	Four-Cycle, In-line, 1 Cylinder
Full Throttle Operating Range	<b>4</b> - 4000 to 5000 RPM <b>5</b> - 4500 to 5500 RPM <b>6</b> - 4750 to 5750 RPM
Power <sup>(1)</sup>	<b>4</b> - 4 HP (2.9 kw) @ 4500 RPM <b>5</b> - 5 HP (3.7 kw) @ 5000 RPM <b>6</b> - 6 HP (4.5 kw) @ 5250 RPM
Idle RPM in Gear <sup>(2)</sup>	1150 ± 50
Ignition Timing – Idle <sup>(1)</sup> W.O.T.	Not Adjustable Not Adjustable
Exhaust Emission Control System: per SAE J1930 <sup>(1)</sup>	EM (Engine Modification)
Fuel Requirements <sup>(1)</sup>	87 Pump Posted AKI (90 RON) – Refer to <b>Fuel and Oil</b>
Crankcase – Oil Capacity Filter	<i>Evinrude@Johnson@ Ultra™</i> 4-Stroke synthetic blend oil – Refer to <b>Fuel and Oil</b> 23.7 fl. oz. (0.7 Liter) See your Dealer
Starting	Rope
Spark Plug <sup>(1)</sup> Torque	Refer to ECI Label 11 to 14 ft. lbs. (15 to 19 N-m)
Gearcase - Lubricant Capacity	<i>Evinrude/Johnson Ultra-HPF™</i> gearcase lubricant 6.4 fl. oz. (189 ml)
Propeller	7 1/2 x 6 1/2
Fuel Tank (built in) Fuel Tank (portable) <sup>(3)</sup>	Capacity – 0.4 U.S. Gallons (1.5 Liters) Capacity – 3 U.S. Gallons (11.4 Liters)
Weight	<b>S</b> - 55.1 lbs. (26 kg) <b>L</b> - 57.3 lbs. (27 kg)
Transom Height	<b>S</b> - 14 1/2 to 15 in. (368 to 381 mm) <b>L</b> - 19 1/2 to 20 in. (495 to 508 mm)
Sound at Driver's Ear (L <sub>PA</sub> ) ICOMIA 39.94	<b>4</b> - 78.9 dB(A) <b>5</b> - 80.5 dB(A) <b>6</b> - 80.8 dB(A)
Vibration at Tiller (arms)	Less than 2.5 m/s <sup>2</sup>

(1) Rated following the standards of ICOMIA 28.83, ISO 3046, and NMMA.

(2) Emission Control Information.

(3) Not supplied in all marketing areas.



## EMERGENCY STOP SWITCH

If equipped, the emergency stop switch is on the steering handle. Use of the emergency stop feature is highly recommended on all boats.

Connect the clip to the emergency stop switch. Snap the lanyard to a **secure** place on the operator's clothing or life vest — not where it might tear away instead of activating the stop switch. Disconnecting the clip and lanyard will stop the engine and prevent the boat from becoming a runaway if the driver moves beyond the range of the lanyard. If the lanyard is too long, it can be shortened by knotting or looping it. **DO NOT** cut or retie the lanyard.

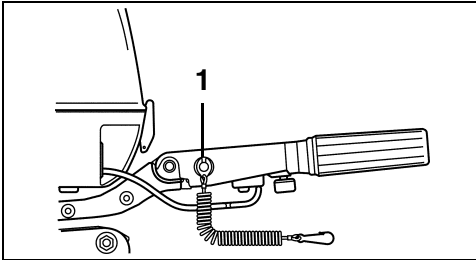

1. Emergency STOP switch

An extra clip is provided on the emergency stop lanyard — another person can insert it in the stop switch and start the motor in an emergency.



## WARNING



**Avoid knocking or pulling the clip off the stop switch during normal boating. The resulting unexpected loss of forward motion can throw occupants forward, causing injury.**

**Your emergency stop switch can be effective only when in good working condition. At each outing, inspect clip and lanyard for cuts, breaks, or wear. Replace worn or damaged parts.**

**Keep the lanyard free from obstructions and entanglements.**

**At each outing, test the system's operation. With the engine running, remove the clip from the switch by pulling the lanyard. If the engine does not stop running, see your Dealer.**

# FUEL AND OIL

## FUEL

## Minimum Octane



### WARNING



**Gasoline is extremely flammable and highly explosive under certain conditions. Follow the instructions in this section explicitly. Improper handling of fuel could result in property damage, serious injury, or death.**

**Always turn off the engine before fueling.**

**Never permit anyone other than an adult to refill the fuel tank.**

**Do not fill the fuel tank all the way to the top, or fuel may overflow when it expands due to heating by the sun.**

**Remove portable fuel tanks from the boat before fueling.**

**Always wipe off any fuel spillage.**

**Do not smoke, or allow open flames or sparks, or use electrical devices such as cellular phones in the vicinity of a fuel leak or while fueling.**

**Always work in a well ventilated area.**

Your outboard is certified to operate on unleaded automotive gasoline with an octane rating equal to or higher than that specified in **Minimum Octane** chart. When using gasoline that contains MTBE or alcohol, follow these guidelines:

Using unleaded gasoline that contains methyl tertiary butyl ether (MTBE) is acceptable **ONLY** if the MTBE content does not exceed 15% by volume.

Using alcohol-extended fuels is acceptable **ONLY** if the alcohol content does not exceed:

10% ethanol by volume; or

5% methanol with 5% cosolvents by volume

Inside the U.S.

87 (R+M)/2 AKI

Outside the U.S.

91 RON

Your outboard has been designed to operate using the above fuels; however, be aware of the following:

The boat's fuel system may have different requirements regarding the use of alcohol fuels. Refer to the boat's owner Guide.

Alcohol attracts and holds moisture that can cause corrosion of metallic parts in the fuel system.

Alcohol blended fuel can cause engine performance problems.

**IMPORTANT:** Always use fresh gasoline. Gasoline will oxidize and weather; the result is loss of octane, volatile compounds, and the production of gum and varnish deposits which can damage the outboard.



### WARNING



**Leaking fuel is a fire and explosion hazard. All parts in the fuel system should be inspected frequently and replaced if signs of deterioration or leakage are found. Inspect the fuel system each time you refuel, each time you remove the engine cover, and annually.**

## OIL

Your 4-stroke engine requires oil in the crankcase.

**Evinrude/Johnson Ultra 4-Stroke synthetic blend oil is recommended for this outboard engine.** It allows for extended oil change intervals and is best for high load applications. *Evinrude/Johnson Ultra 4-Stroke synthetic blend oil* delivers ultra viscosity stability, sludge protection, friction reducing properties, and superior corrosion protection.

If *Evinrude/Johnson Ultra 4-Stroke synthetic blend oil* is unavailable, you may use *Evinrude/Johnson® 4-Stroke outboard oil*. This oil provides excellent wear and corrosion resistance under normal operating conditions. For your engine's oil capacity, refer to **Engine Specifications**.

**IMPORTANT:** Failure to follow this recommendation could void the engine warranty if a lubrication-related failure occurs.

## ADDITIVES

**IMPORTANT:** Only use fuel additives approved by BRP US Inc. for your outboard. Use of other fuel additives can result in poor performance or engine damage.

**Evinrude/Johnson 2+4® fuel conditioner** will help prevent gum and varnish deposits from forming in fuel system components and will remove moisture from the fuel system. It can be used continuously and should be used during any period when your engine is not being operated on a regular basis. Its use will reduce spark plug fouling, fuel system icing, and fuel system component deterioration.

## FUEL SYSTEM



### WARNING



**If your motor is equipped with a quick-disconnect fuel hose, disconnect the fuel hose from the motor and from the fuel tank when the motor is not being used for a period of time. Disconnecting the hose will avert fuel leaks in the hose or at the engine.**

**IMPORTANT:** Fuel distribution hoses in the boat must deliver fuel at the rate of flow needed by the engine. Minimum inside diameter of fuel hoses must be 5/16 in. (8 mm).

Fuel systems with built-in tanks, particularly those that include antisiphon valves and filter/primer units, may have restrictions that will not allow the engine fuel pump to deliver sufficient fuel under all conditions. This can result in a loss of performance and possible **engine damage**. If a performance problem exists, see your Dealer.

To avoid difficulty when restarting, never run the engine with the fuel hose disconnected, or run the engine out of fuel.

## BREAK-IN (10 HOURS)

**IMPORTANT: 4-Stroke outboards are shipped without oil in the crankcase. You must add oil to the crankcase before starting the engine for the first time.** It is recommended you add *Evinrude/Johnson* 4-Stroke outboard oil. Refer to **Changing the Oil** for acceptable substitute lubricants.

Follow this procedure to protect your new outboard during its initial hours of operation. Careful break-in allows internal engine components to “seat” properly, resulting in maximum engine performance.

Failure to carefully follow the break-in procedures can result in engine damage.

High speed operation without sufficient engine warm-up can result in engine damage.

Perform the **10-Hour** break-in procedure with the boat and engine in the water, using an appropriate propeller.

DO NOT perform break-in using a flushing device.

DO NOT start-up or run the engine out of water.

DO NOT leave a running engine unattended.

**IMPORTANT:** Before the start-up of your new engine:

- Read **Engine Starting, Engine Stopping and Speed Control.**
- Check the crankcase oil level. Refer to **Crankcase Oil.**
- Perform prelaunch checks of all equipment.
- Check the gearcase lubricant level. Refer to **Lubrication.**

Launch the boat and start the engine according to the procedures in **Engine Starting.**

- Verify water pump operation often. Look for a steady stream of water from the water pump indicator. If the stream of water stops, shut off the engine to prevent damage. Find and correct the cause, or see your Dealer before you continue.
- Verify shift function by shifting into gear and observing that the boat moves and that the movement is in the same direction as the shifter.
- Change the RPM often. Avoid holding a throttle setting longer than 15 minutes.
- Check the crankcase oil level often. Add oil if needed.

**First 10 minutes of operation** — Operate engine in gear at idle only.

**Balance of First 2 hours of operation** — Operate in gear below 3000 RPM or 1/2 throttle only.

With easy planing boats, use full throttle to quickly accelerate boat onto plane. Immediately reduce throttle to one-half as soon as the boat is on plane. BE SURE boat remains on plane at this throttle setting.

**Third hour of operation** — Run the engine in gear at various speeds up to 4000 RPM or 3/4 throttle only.

**Balance of first 10 hours of operation** — Run the engine in gear at various engine speeds including full throttle, but remain at full throttle no longer than 5 minutes.

Change the engine speed every 5 minutes.

**DO NOT** exceed recommended maximum engine RPM. Refer to **Engine Specifications.**

# ENGINE STARTING



## DANGER



**DO NOT** run the engine indoors or without adequate ventilation or permit exhaust fumes to accumulate in confined areas. Engine exhaust contains carbon monoxide which, if inhaled, can cause serious brain damage or death.



## WARNING



The engine cover is a machinery guard. **DO NOT** operate your outboard with the cover off unless you are performing maintenance, and then be careful to keep hands, hair, and clothing clear of all moving parts. Contact with moving parts could cause injury.



## WARNING



Contact with a rotating propeller is likely to result in serious injury or death. Assure the engine and prop area is clear of people and objects before starting engine or operating boat. Do not allow anyone near a propeller, even when the engine is off. Blades can be sharp and the propeller can continue to turn even after the engine is off. Always shut off the engine when near people in the water.

## BEFORE START-UP

Verify crankcase oil level before start-up. Refer to **Crankcase Oil**.

Review and follow **Break-In (10 hours)** if the engine is new.

You **MUST** supply water to the engine before attempting to start it. Engine damage can occur quickly. Refer to **Engine Overheating** or **Flushing**.

Be sure the engine is in the normal operating position. Refer to **Tilting**.

### **Built-In Fuel Tank**

Open the vent screw on the fuel tank cap.

- Clockwise to close.
- Counterclockwise to open.

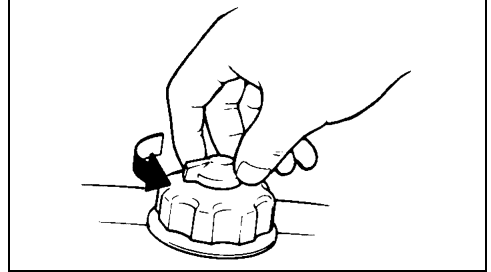

Turn the fuel shut-off valve aft. Fuel will flow from the built-in tank.

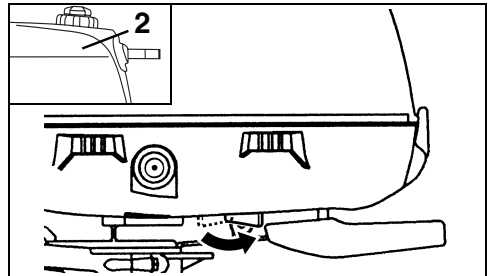

1. Fuel shut-off valve
2. Built-in tank

### **Portable Fuel Tank (5 and 6 HP Models)**

Connect the fuel hose to the fuel connector.

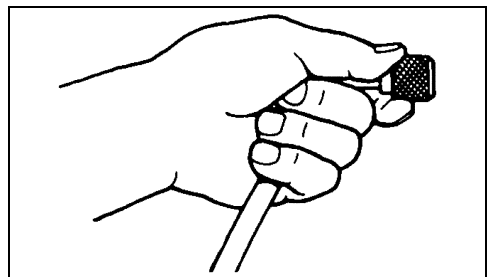

If equipped, open vent screw on fuel tank's filler cap.

Squeeze fuel primer bulb, outlet end up, until firm.

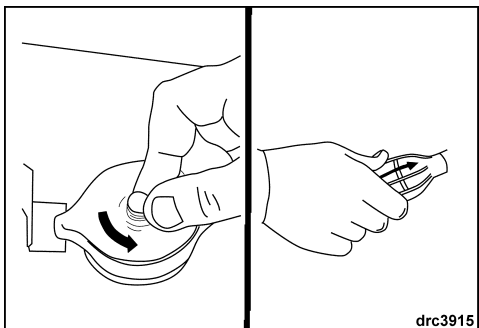

drc3915

Turn the fuel cock lever forward. Fuel will flow to the carburetor from the portable tank.

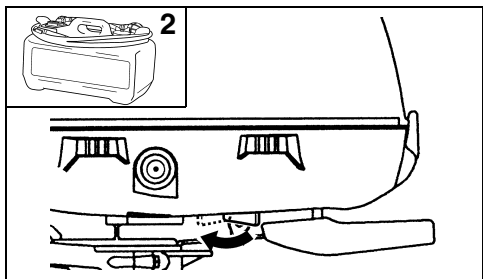

1. Fuel shut-off valve
2. Portable tank

### Switching from Portable to Built-In Tank

Follow these steps to switch to using the built-in tank after the portable fuel tank becomes empty.

- 1) Disconnect the fuel line of the portable tank from the fuel connector on the outboard.
- 2) Pour fuel into the built-in tank and wait 20 seconds before starting.
- 3) Turn the fuel cock lever aft. Fuel will flow to the carburetor from the built-in tank.

### All Models

If equipped, attach the clip and lanyard assembly to the emergency stop switch / STOP button. Snap the lanyard to **secure** place on your clothing or life vest.

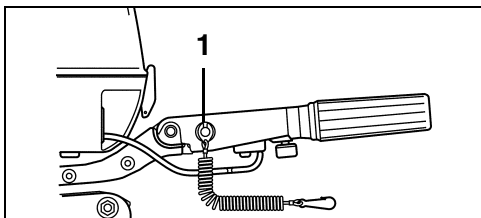

1. Emergency stop switch / STOP button

Move the shift lever to NEUTRAL.

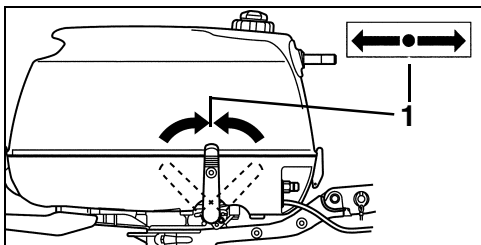

1. NEUTRAL

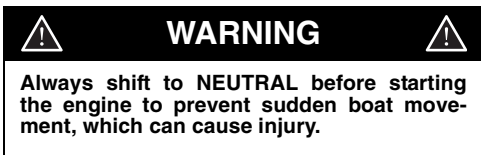

### Start-up (Cold Engine)

Pull the choke knob fully out. Twist the throttle grip to START position.

### Start-up (Warm Engine)

Align the arrow mark on the throttle grip with the START position. Do not use the choke.

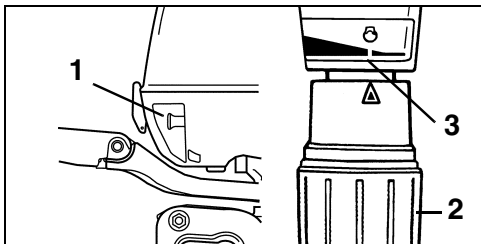

1. Choke knob
2. Throttle grip
3. Start position

While seated, grasp the starter handle and pull slowly until the starter engages, then pull hard. Allow the starter cord to rewind slowly.

If your engine doesn't start after three pull, push the choke knob in and repeat the starting procedure. Refer to **Trouble Check Chart**, if necessary.

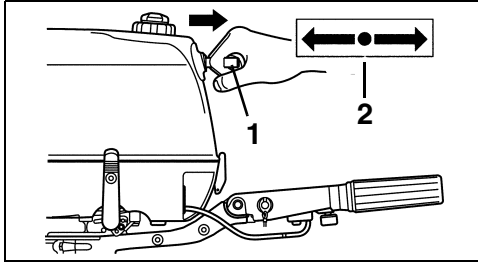

1. Starter handle
2. NEUTRAL

### **After Engine Starts**

Gradually, push the choke in after the engine is warm.

Check the water pump indicator. A steady stream of water indicates the water pump is working. If a steady stream of water from the water pump indicator is not visible, stop the engine. Refer to **Engine Overheating**.

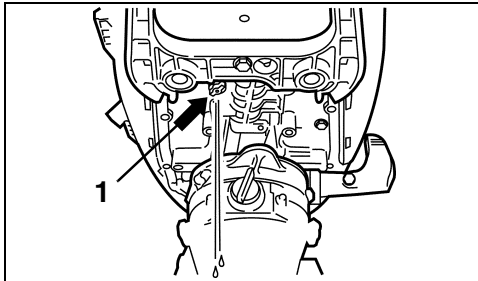

1. Water pump indicator

## **ENGINE STOPPING**

Twist the throttle grip to IDLE position or slower.

Move the shift lever to NEUTRAL.

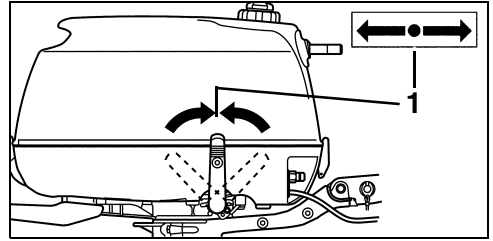

1. NEUTRAL

Press the stop button until the engine stops running.

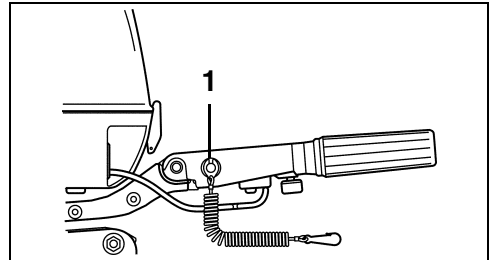

1. Emergency STOP switch / STOP button

## SHIFTING AND SPEED CONTROL

**IMPORTANT:** Carefully check the function of all control and engine systems before leaving the dock. **DO NOT** shift the engine into FORWARD or REVERSE while it is shut OFF.

### Shifting

With the engine running, twist the throttle grip to IDLE position.

Move the shift lever briskly and completely FORWARD or REVERSE.

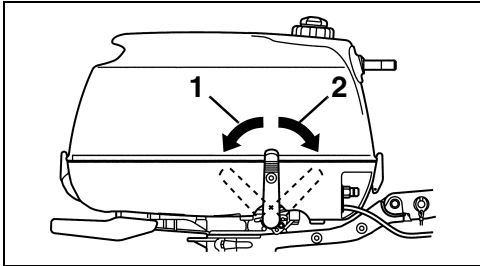

1. REVERSE
2. FORWARD

Before shifting into NEUTRAL while boating, twist the throttle grip to IDLE position, then wait until the engine slows to idle and the boat slows.



### WARNING



Exercise caution and use minimal speed when operating the boat in reverse. Be sure the shift lever is in desired position before accelerating.

### Speed Control

With the engine running, twist the throttle grip:

- Counterclockwise to increase speed
- Clockwise to decrease speed

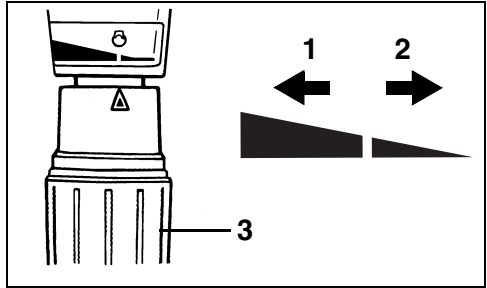

1. Increase speed
2. Decrease speed
3. Throttle grip

## EMERGENCY STARTING



### WARNING



When using Emergency Starting procedures, the start-in-neutral-only feature is inoperative. Make sure shift lever is in NEUTRAL position to prevent injuries from unexpected boat movement when the engine starts.

The engine cover is a machinery guard. To prevent injury from moving engine components, keep hands, clothes, and hair clear of powerhead.

Prevent electric shock by keeping clear of the ignition coils and spark plug leads when the motor is being started or is running. Shock can cause serious personal injury under certain conditions.

**DO NOT** turn flywheel by hand. Use starter cord only.



Move the shift lever to NEUTRAL.

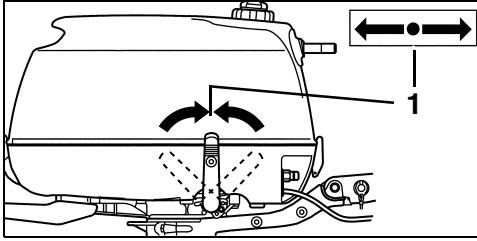

1. NEUTRAL

Remove the engine cover.

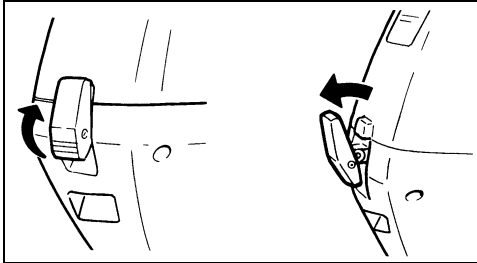

Remove the bolts securing the recoil starter in place.

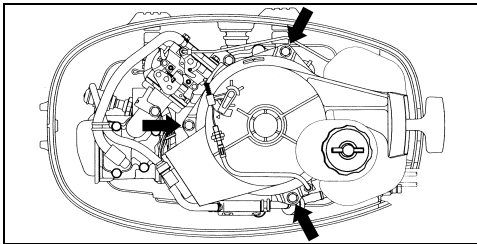

Loosen the lock nut, take off the NSI cable from the bracket, and separate the end of the cable from the cam.

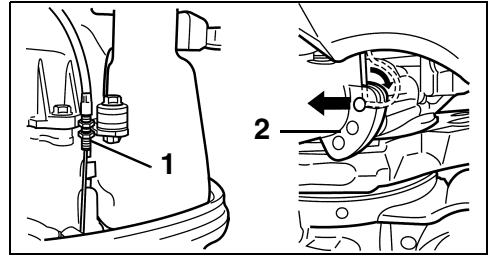

1. Lock nut  
2. Cam

Lift off the recoil starter assembly.

Tie a knot in one end of the emergency starter cord. Tie the other end around the screwdriver handle in the tool kit.

Connect clip to the emergency stop switch / STOP button.

Place knot of starter cord in notch on flywheel pulley. Wrap cord around pulley clockwise.

Follow the starting procedure in **Engine Starting**.

While seated, pull hard on emergency starting cord quickly and completely. Repeat, if necessary.

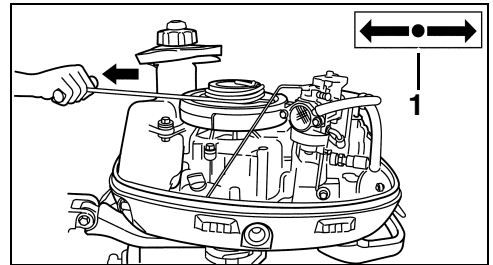

1. NEUTRAL

After starting, run the engine in NEUTRAL with the throttle at the START position for two minutes. Then reduce speed to an idle.

DO NOT attempt to replace manual starter or engine cover while engine is running. If equipped, attach emergency stop switch's lanyard to a secure place on your clothing.

Proceed to nearest harbor for service.

# OPERATION

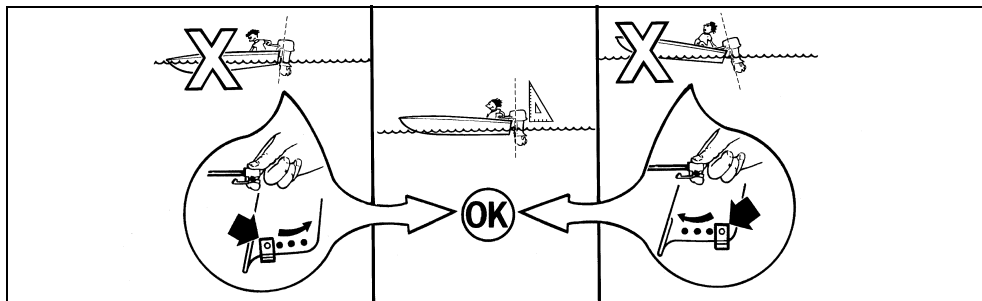

## DANGER



**DO NOT** run the engine indoors or without adequate ventilation or permit exhaust fumes to accumulate in confined areas. Engine exhaust contains carbon monoxide which, if inhaled, can cause serious brain damage or death.



## WARNING



**DO NOT** place your hands near the mounting bracket or under the motor when tilting, or they could be crushed if the motor slips from your grasp.



## WARNING



**Contact with a rotating propeller is likely to result in serious injury or death. Assure the engine and prop area is clear of people and objects before starting engine or operating boat. Do not allow anyone near a propeller, even when the engine is off. Blades can be sharp and the propeller can continue to turn even after the engine is off. Always shut off the engine when near people in the water.**

### Tilt Up

Move the shift lever to NEUTRAL. Grip the tilt grip on the back of the motor cover and tilt the motor all the way up until it is automatically locked in the UP position by the tilt lock lever.

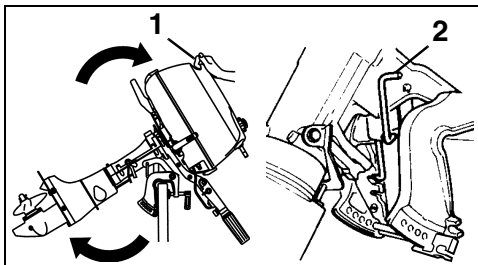

1. Tilt grip
2. Tilt lock lever

## MOTOR ANGLE ADJUSTMENT

Motor should be perpendicular to the water when the boat is underway at full speed. This adjustment can only be determined by water testing the boat. Set angle adjustment for your normal load.

Place motor in full tilt position. Refer to **Tilting**.

Move angle adjusting rod as shown.

## TILTING

**IMPORTANT:** Use the tilt grip to tilt your motor. Do not use the tiller handle to raise or lower the motor.

### Tilt Lock Lever

The tilt lock lever is used to hold the motor in the full tilt up position and shallow-water drive position.



## WARNING



**Be sure to turn the fuel lever forward before tilting up the motor, or fuel will continue to flow from the built-in tank and fuel may leak out. When using a separate fuel tank (if equipped), disconnect the fuel line whenever you leave the motor tilted up for a long period of time, or fuel may leak out.**

## Tilt Down

Grasp tilt grip on engine cover and raise motor slightly. Pull up on the tilt lock lever. Slowly lower motor to its normal operating position.

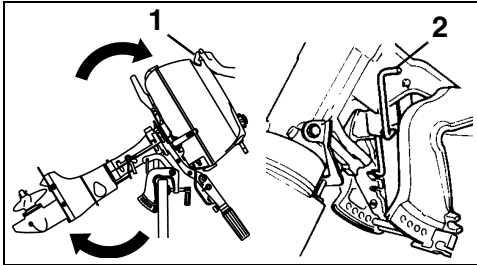

1. Tilt grip
2. Tilt lock lever

## SHALLOW-WATER DRIVE

There are two shallow-water drive positions. Use whichever is appropriate, depending on the depth of the water.

Slow the engine and shift to NEUTRAL before engaging or disengaging shallow-water drive.

Slowly tilt the outboard up until you hear it make a “click” sound.

Slowly lower the outboard. It will stop in a position that is slightly tilted up from the normal trim angle.

**WARNING**

**When using the shallow-water drive bracket, the tilt lock feature will not work. Operate your motor in FORWARD and ONLY at slow speed. The motor can tilt up forcibly and drop suddenly if it hits an underwater object or if you shift to REVERSE and apply throttle. You could lose control.**

To lower the outboard back down, pull the motor slightly toward you, pull up on the tilt lock lever and slowly let the motor down.

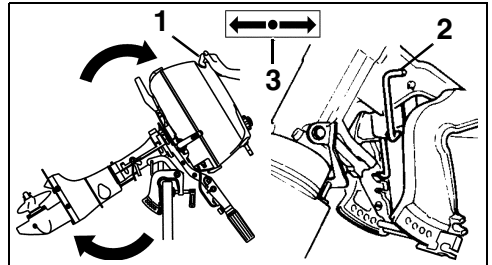

1. Tilt grip
2. Tilt lock lever
3. NEUTRAL

**IMPORTANT:** Check often that water intakes are completely submerged and the water pump indicator is discharging a steady stream of water.

## MOORING

You may moor your boat with the motor’s gearcase out of the water by using its tilt feature. Depending on the model, refer to **Tilting**.

## FLUSHING



### DANGER



**DO NOT run the engine indoors or without adequate ventilation or permit exhaust fumes to accumulate in confined areas. Engine exhaust contains carbon monoxide which, if inhaled, can cause serious brain damage or death.**

See your Dealer for a flushing device designed to fit your engine. Follow manufacturer's instructions for installing and using it.



### WARNING



**Prevent injury from contact with rotating propeller; remove the propeller before flushing.**

## Outboard — Running

- 1) Place the engine in vertical position in a well-ventilated area with good drainage.
- 2) Remove the plug from the flushing port.
- 3) Install flushing device and garden hose.
- 4) Cover the water intake hole with tape.
- 5) Place the shift lever in NEUTRAL with the propeller removed.
- 6) Start the water — keep pressure between 20 to 40 psi (140 to 300 kPa).

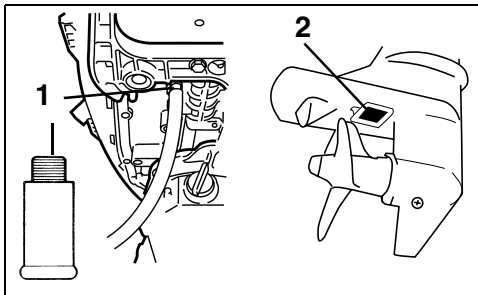

1. Flushing device
  2. Tape
- 7) Start the engine — **run it at idle only** and flush it for at least five minutes.
  - 8) Shut OFF the engine, then turn off the water.
  - 9) Remove the tape and reinstall the flushing port.
  - 10) Leave the outboard in vertical position long enough to completely drain the powerhead.

## ENGINE OVERHEATING

**IMPORTANT:** Do not run your engine — even for a brief start-up — without supplying water to it. Refer to **Flushing**.

While boating, the engine's water intake must stay completely submerged and unobstructed. Observe proper transom height and trim angle. While the engine is running, the engine's water pump indicator must discharge a steady stream of water. Check the indicator often, especially when operating in weeds, muddy and debris-laden water, at extreme trim angles, or in shallow water drive (if equipped).

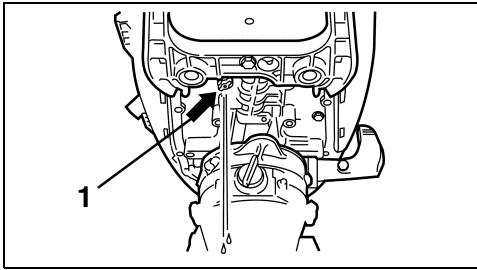

1. Water pump indicator

If the stream from the water pump indicator becomes intermittent or stops, reduce speed to idle and:

Shift to NEUTRAL;

SHUT OFF the engine;

Tilt the motor up;

Clean the intake screen of any blockage;

Clean the water pump indicator of any blockage;

Lower the motor; and

Restart the engine and run at idle.

**IF** cleaning the screen and indicator does not restore the water pump indicator's steady discharge, SHUT OFF the engine and do not attempt to operate it. See your Dealer.

**IF** cleaning the screen and indicator does restore the water pump indicator's steady discharge, continue to idle the engine until it cools.

**IMPORTANT:** You must restore cooling to the engine to avoid serious engine damage.

After any overheat, have your Dealer:

Torque the cylinder head screws.

Inspect the water pump for excessive wear or damage.

Inspect the thermostats.

Inspect the engine for leaks.

Check engine oil level.

## TRAILERING

Trailer your boat with the motor in a vertical position. If your trailer does not provide adequate road clearance, the motor can be trailered by using an accessory trailering bracket. See your Dealer.

DO NOT use the tilt lock lever when trailering.

**IMPORTANT:** Whenever using an accessory trailering bracket, the motor must be restrained. Bouncing during transport will damage the motor and boat's transom.

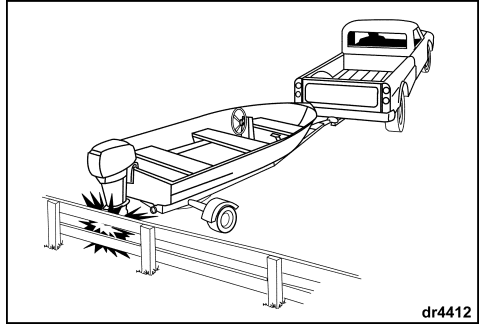
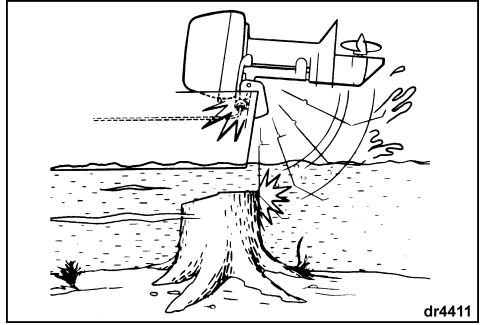
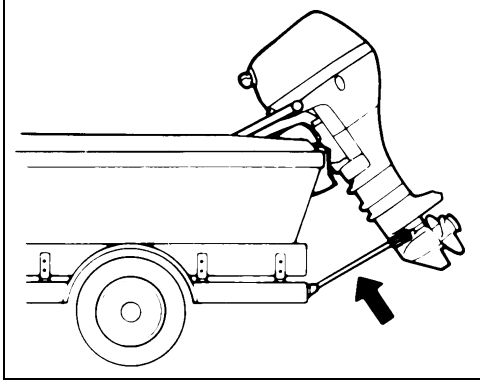

## IMPACT DAMAGE

Your engine can be damaged from impact with underwater objects. Such impacts can result in serious damage to your engine and injury to boat occupants from the engine or its parts entering the boat. Occupants can also be ejected or injured by falling against portions of the boat as a result of rapid deceleration following impacts. When boating in unfamiliar, shallow, or debris-laden waters, seek information on safe boating areas and navigation hazards from a reliable local source. Reduce your speed and keep a sharp lookout!

If you hit any object, stop immediately and examine the engine for loosening of attaching hardware and clamp screws, if equipped. Inspect for damage to swivel and stern brackets, steering components, and components in the area of impact. Also, examine the boat for structural damage. Tighten any loosened hardware. If the collision occurred in the water, proceed slowly to harbor. Before boating again, have your Dealer thoroughly inspect all components.



### WARNING



Failure to inspect for damage could result in sudden, unexpected component failure, loss of boat control, and personal injury. Unrepaired damage could reduce your boat and engine's ability to resist future impacts.

## STORING

If you must tilt the motor to remove it from the water, lower it and allow the cooling system to drain completely as soon as you clear the launch area.

Between uses, store your motor in a vertical position.

For recommendations on extended periods of storage, refer to **Off-Season Storage**.

## CARRYING AND TRANSPORTING

If you will be laying the engine down, minimize the potential for fuel spillage by letting it run "out of gas" before you remove it from the boat.

Make sure that the engine has stopped completely.

Turn the fuel shut off valve forward.

If equipped, remove the fuel hose from the motor.

Drain the gasoline from the carburetor by removing the motor cover and loosening the carburetor drain screw. Drain the gasoline into a suitable container.

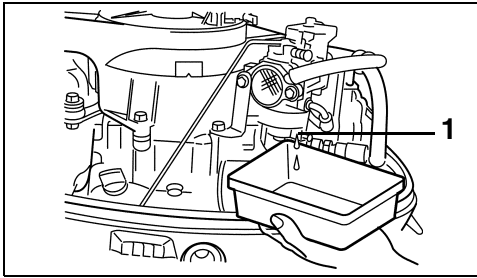

1. Carburetor drain screw

After draining, retighten the drain screw.



Stand the motor vertically and drain water from the lower unit.

## Horizontal transport

Drain the gasoline from the carburetor.

Raise the tiller handle and rest it on a padded surface on its **port** side. Protect the engine cover from damage.

After removing the engine from the boat, position it upright until the cooling system stops draining.

Keep the powerhead higher than the gearcase at all times, or any water remaining in exhaust passages could travel to the cylinders and cause serious damage.

**IMPORTANT:** Do not rest the engine before the cooling water has drained completely, as water may enter the cylinder through the exhaust port and cause problems.

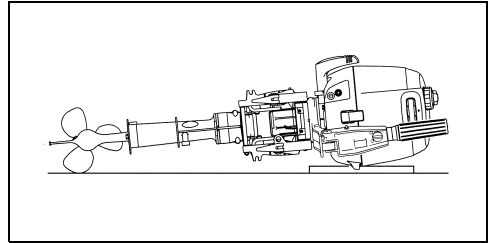

**IMPORTANT:** Do not let the gearcase of the outboard sit higher than the powerhead during transporting or storing. Water may drain into the powerhead, causing damage to the engine.

## SPECIAL OPERATING CONDITIONS

### **Salt Water**

Flush the engine internally after use in salt, polluted, or brackish water to help prevent mineral deposits from clogging cooling passages. Your outboard has a built-in flushing port to facilitate flushing. Refer to **Flushing**.

During use in salt or brackish water, additional anodic protection for the boat and outboard may be required.

During long periods of mooring, tilt the gearcase out of the water — except in freezing temperatures. Upon removal from salt water, leave it in a vertical position until its cooling system has drained.

### **Weedy Water**

Weeds block water intakes and cause your outboard to overheat. Weeds on the propeller create vibration and reduce boat speed.

Run at slow speeds and in REVERSE frequently to clear weeds from the propeller and water intakes. Check the water pump indicator often.

If REVERSE operation does not clear away weeds, SHUT OFF the engine. Remove weeds from propeller area and water intakes before operating at high speed.

### **Boat Bottom and Engine External Finish**

The condition of your boat's bottom affects performance. A covering of marine growth reduces speed. For maximum performance, keep the boat's running surface clean by wiping it dry after each use and washing it occasionally.

After operating your outboard, rinse it with fresh water and wipe it dry. Apply *Evinrude®/Johnson®* anti-corrosion spray to any surface subject to corrosion, but avoid the anticorrosion anode(s).

Periodically, wash the entire boat and outboard with soapy water and apply a coat of automotive wax. Leave the engine cover in place when washing the outboard.

### **High Altitude**

If your boat at altitudes above 3000 ft. (900 m), your engine might benefit from a lower pitched propeller, different carburetor calibration, or both. See your Dealer.

**IMPORTANT:** To avoid permanent powerhead damage, be sure that an engine modified for high altitude operation is properly identified and returned to original calibration and propeller size if operated below 3000 ft. (900 m).

### **Shallow Water**

**IMPORTANT:** Serious engine damage will occur if the gearcase is allowed to drag on the waterway bottom.

### **Freezing Weather**

DURING operation in freezing weather, keep the gearcase submerged at all times.

Upon removing your motor from the water, leave it in a vertical position until its cooling system is drained.

**IMPORTANT:** Water that has leaked into the gearcase, or remained in the cooling system or other components can freeze, causing serious engine damage.

### **Submerged Engine**

If your engine has been under water, **have it serviced immediately upon recovery**. If immediate service is unavailable, resubmerge it in fresh water to avoid prolonged exposure to the atmosphere.

After submersion, all boat and engine electrical, fuel, and oiling systems must be inspected for signs of water intrusion. Your Dealer should perform this service.

### **Under Tow**

Should you require a tow from another boat:

- Shift your engine to NEUTRAL;
- Tilt its gearcase out of the water; and
- Off-load all persons into another boat.

Keep towing speed slower than planing speed.



---

# MAINTENANCE

**Maintenance, replacement, or repair of the emission control devices and systems may be performed by any marine SI (spark ignition) engine repair establishments or individual.**

## ENGINE EMISSIONS INFORMATION

### ***Manufacturer's Responsibility***

Beginning with 1999 model year engines, manufacturers of marine engines must determine the exhaust emission levels for each engine horsepower family and certify these engines with the United States of America Environmental Protection Agency (EPA). An emissions control information label, showing emission levels and engine specifications, must be placed on each engine at the time of manufacture.

### ***Dealer's Responsibility***

When performing service on all *Johnson* outboards that carry an emissions control information label, adjustments must be kept within published factory specifications.

Replacement or repair of any emission related component must be executed in a manner that maintains emission levels within the prescribed certification standards.

Dealers are not to modify the engine in any manner that would alter the horsepower or allow emission levels to exceed their predetermined factory specifications.

Exceptions include manufacturer's prescribed changes, such as altitude adjustments.

### ***Owner Responsibility***

The owner/operator is required to have engine maintenance performed to maintain emission levels within prescribed certification standards.

The owner/operator is not to, and should not allow anyone to, modify the engine in any manner that would alter the horsepower or allow emissions levels to exceed their predetermined factory specifications.

Tampering with the carburetor to change horsepower or modify emission levels beyond factory settings or specifications will void the product warranty.

### **EPA Emission Regulations**

All new 2002 and more recent *Johnson* outboards manufactured by BRP US Inc. are certified to the EPA as conforming to the requirements of the regulations for the control of air pollution from new watercraft marine spark ignition engines. This certification is contingent on certain adjustments being set to factory standards. For this reason, the factory procedure for servicing the product must be strictly followed and, whenever practicable, returned to the original intent of the design. The responsibilities listed above are general and in no way a complete listing of the rules and regulations pertaining to the EPA requirements on exhaust emissions for marine products. For more detailed information on this subject, you may contact the following locations:

#### **VIA U.S. POSTAL SERVICE:**

Office of Mobile Sources  
Engine Programs and Compliance Division  
Engine Compliance Programs  
Group (6403J)  
401 M St. NW  
Washington, DC 20460

#### **VIA EXPRESS or COURIER MAIL:**

Office of Mobile Sources  
Engine Programs and Compliance Division  
Engine Compliance Programs  
Group (6403J)  
501 3rd. St. NW  
Washington, DC 20001

#### **EPA INTERNET WEB SITE:**

[www.epa.gov](http://www.epa.gov)



## **WARNING**



**Only perform service procedures which are detailed in this Operator's Guide. Attempting to perform maintenance or repair on your outboard if you are not familiar with the correct service and safety procedures could cause injury or death.**

## 10-HOUR INSPECTION

After 10 hours of operation, your new engine will be broken in and its mechanical parts will have seated. At that time, all systems should be checked and any adjustments needed should be made.

Your Dealer will perform this 10-Hour Inspection at your request and expense (based on local rates), according to what your engine needs — refer to **Engine Maintenance and Inspection Schedule, 10-Hour Inspection** for a partial list.

Follow consistent preventive maintenance by having your Dealer check and service your engine once a year or after each 100 hours of operation, whichever comes first.

## OFF-SEASON STORAGE

You must protect against natural environmental conditions that can be damaging to an outboard motor. Temperature and humidity changes while your outboard motor is not in use can cause corrosion of internal engine parts when they are not protected. Fuel remaining in your fuel tank and in the engine will oxidize and weather which can result in loss of octane and can cause gum deposits in the fuel system. Your warranty does not cover engine failure caused by these conditions. We strongly recommend that you have your Dealer prepare your outboard for the off-season.

To do the off-season storage preparations yourself, gather the supplies and perform the following steps:

*2+4 Fuel Conditioner*

*Triple-Guard® grease*

*Ultra-HPF gearcase lubricant*

*Storage Fogging Oil spray can*

*Evinrude/Johnson Ultra 4-Stroke synthetic blend oil*

Stabilize the engine's fuel supply with *2+4 Fuel Conditioner* during the last hours of operation to ensure proper stabilization, **following instructions on the container for mixture. Be sure to run the engine long enough for the treated fuel to reach the engine.**

**IMPORTANT:** Provide a water supply to the engine and start it. Run the engine at idle only.

To run the engine on a flusher, refer to **Flushing**.

**Oil** — Start the engine and run it at least five minutes to warm the crankcase oil.

Stop the engine and drain the crankcase while the engine is warm. Refill it with *Evinrude/Johnson Ultra 4-Stroke synthetic blend oil*. Refer to **Crankcase Oil**. Restart the engine and run it for a few minutes to circulate the fresh oil.

**IMPORTANT:** It is very important that the bearing surfaces be coated with clean oil before entering a period of storage, so be sure you run the engine after changing the oil.

Stop the engine and turn off the water. Disconnect the flushing device.

**Spark Plugs** — Remove and examine them. Spray fogging oil into the plug holes. Slowly rotate the flywheel several rotations by hand to distribute the oil and to drain the water from the water pump. Clean and reinstall the spark plugs, or discard and replace them, if necessary. Refer to **Spark Plugs**.

**Fuel filter(s)** — Clean or change.

**Ignition, oil, and fuel systems** — Check for misplaced leads and damaged or deteriorated parts. Be sure starter solenoid terminal boot and all connectors are in place.

**Screws, bolts, nuts** — Tighten any that are loose.



### WARNING



**Prevent injury from moving engine components. Before starting the engine:**

**Shift it to NEUTRAL.**

**Keep hands, clothes, and hair clear of powerhead.**

**Remove the propeller if you use a flushing device.**

**Propeller** — Remove and examine. If damaged, see your Dealer. Clean the propeller shaft and lubricate it. Refer to **Propeller**.

**Lubrication** — Refer to **Lubrication** to drain and refill the gearcase and for lubricating points on the engine.



Touch up painted surfaces and wax the engine's exterior. Store the engine on the boat (or an engine stand) in a vertical, self-draining position.

If you cannot store the engine in the recommended vertical position, be sure the cooling system is drained completely.

**IMPORTANT:** Never place the gearcase higher than the powerhead. Any water remaining in the exhaust passages can run into the cylinders and cause serious damage.

If you remove an "installed" engine, examine all hardware you loosened or removed from the engine and its steering, throttle, and shift systems. Replace damaged or missing parts with *Evinrude/Johnson Genuine Parts*, or equivalent.

**Portable fuel tank** — Disconnect the hose from the tank. Remove the hose from the engine if the fitting is a quick-disconnect. If not, and the hose is secured to the engine, leave it connected. Secure the hose to protect it.

 **WARNING** 

**Store fuel tanks in a well-ventilated area, away from heat and open flame. Prevent escape of liquid or vapors which could accidentally ignite. Close the filler cap vent screw, if equipped. Be sure the disconnected fuel hose does not drip.**

## PRE-SEASON SERVICE

Remove your outboard from storage and prepare it for a season of reliable service by performing a general check and a few preventive maintenance procedures.

Examine all loosened or removed hardware and any steering, throttle, and shift systems. Replace damaged or missing parts with *Evinrude/Johnson Genuine Parts* or equivalent.

 **WARNING** 

**Failure to carefully reattach the outboard and its control systems with factory-specified hardware can result in sudden, unexpected loss of boat control.**

**Engine Oil** — Check the engine oil level. Refer to **Crankcase Oil**.

With the propeller removed, check the gearcase for leakage. If leakage is evident, the gearcase seals should be replaced. See your Dealer.

**Anticorrosion anodes** — Check condition. Refer to **Anticorrosion Anodes**.

Install the propeller unless you will run the engine on a flusher for your pre-season servicing. If so, install the propeller after you shut OFF the engine and disconnect the flusher. Refer to **Flushing**.

Refer to **Propeller** to install the propeller.

 **WARNING** 

**Prevent accidental contact with a rotating propeller; always remove it when using a flusher to run the engine.**

Top off fuel tank with fresh fuel.

Follow **Engine Starting** and start the engine. Let it idle while you:

Observe running quality — if poor, refer to **Trouble Check Chart** or see your Dealer.

Observe water pump operation. Water must flow from the water pump indicator in a steady stream. If it does not, shut OFF the engine and investigate. Refer to **Engine Overheating**.

Stop the engine and check the fuel system for leaks.

 **WARNING** 

**Failure to check for fuel leakage could allow a leak to go undetected, resulting in fire or explosion.**

## CRANKCASE OIL

### Initial Fill

**IMPORTANT:** 4-Stroke outboards are shipped without oil in the crankcase. You must add oil to the crankcase before starting the engine for the first time. It is recommended you add *Evinrude/Johnson* 4-Stroke outboard oil. Refer to **Changing the Oil** for acceptable substitute lubricants.

BEFORE filling the crankcase for the first time, be sure it is empty by checking the dipstick. Refer to **Checking**.

After the first 10 hours of operation, replace the break-in lubricant with *Evinrude/Johnson Ultra* 4-Stroke synthetic blend oil. Refer to **10-Hour Inspection**.

### Checking

Check the oil level when the engine is cold to ensure an accurate reading.

- 1) Place the engine in a vertical position.
- 2) Check the oil level through the oil level inspection window.
- 3) The oil window should be completely full.

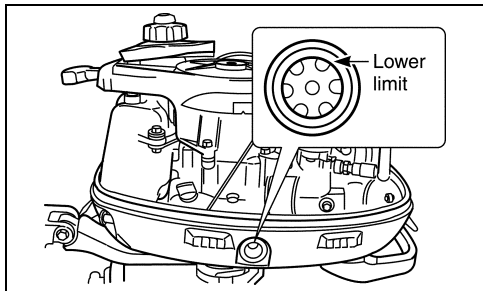

**IMPORTANT:** Operating the engine with too much or too little oil in the crankcase will damage it.

### Changing the Oil

Refer to **Engine Maintenance and Inspection Schedule** for frequency.

After the first 10 hours of operation, replace the break-in lubricant with *Evinrude/Johnson Ultra* 4-Stroke synthetic blend oil. Refer to **10-Hour Inspection**.

If *Evinrude/Johnson Ultra* 4-Stroke synthetic blend oil is temporarily unavailable, you may use *Evinrude/Johnson* 4-Stroke outboard oil or an equivalent FC-W-approved 10W-40 or 10W-50 oil.

Drain (or siphon) the old oil after running the engine to warm it. Warm oil flows more quickly and completely, containing more suspended sludge than cold oil. If you change the oil only once a season, time the work so the engine contains clean oil during storage.



### CAUTION



Used motor oil may be harmful. Avoid prolonged and repeated skin contact. Wash affected skin with soap and water.

- 1) With engine shut OFF, place the engine in a vertical position and remove the upper engine cover.
- 2) Unscrew and remove the oil fill cap.

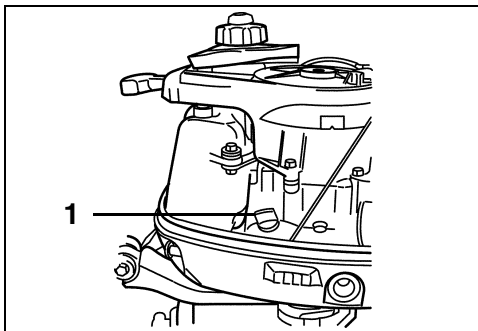

1. Oil fill cap

- 3) Fully steer the outboard to the starboard side.
- 4) Hold a suitable container under the oil drain screw. Remove the screw and drain the reservoir. Before you reinstall the screw, replace the gasket with a new one. Reinstall the screw and tighten it securely.

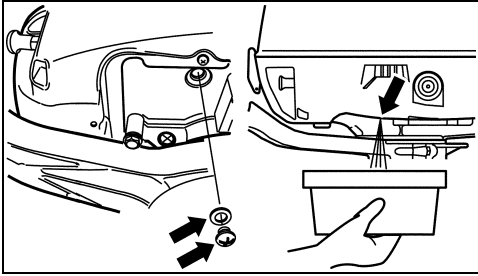

- 5) Pour the recommended oil into the oil fill until it reaches the upper mark on the dipstick. Refer to **Engine Specifications** for crankcase capacity.
- 6) Replace the oil fill cap and clean any spilled oil off the engine and your skin.
- 7) Reinstall the upper cover.
- 8) Supply water to the cooling system and run the engine at idle to check for leaks, especially around the oil filter, drain screw and oil fill cap. Correct any problems.
- 9) Stop the engine and recheck crankcase oil level using the dipstick. Add oil as indicated.

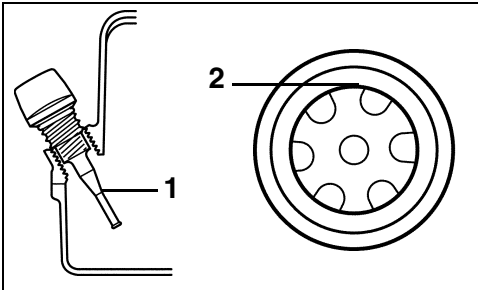

1. Upper limit
2. Lower limit

Dispose of used oil in a reasonable manner following all local regulations.

## ADJUSTMENTS

### Throttle Friction

Adjust until a slight drag is felt when accelerating or decelerating only. **DO NOT** overtighten. If adjustment is necessary, turn the adjustment screw:

- Clockwise to increase friction
- Counterclockwise to decrease friction

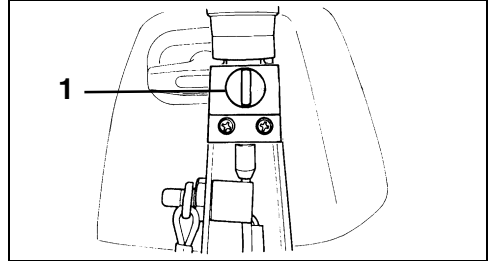

1. Throttle friction screw

### Steering Friction

The steering friction was set on your new motor before it left the factory. After the first 10 hours of service, check to see that it is still correct; a slight drag should be felt when turning the motor. If adjustment is necessary, turn the adjustment screw:

- Clockwise to increase friction
- Counterclockwise to decrease friction

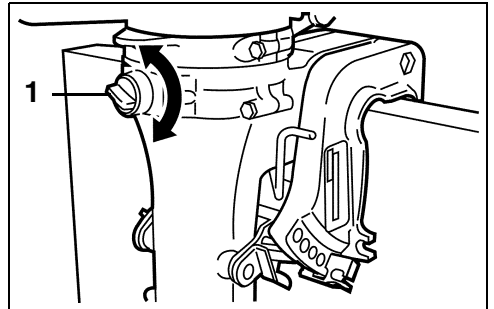

1. Steering friction screw



## WARNING



**DO NOT** overtighten for “hands-off” steering. Reduced steering control could result.

## LUBRICATION

### Gearcase

Replace gearcase lubricant after first 10 hours of operation. Check level and condition of lubricant after next 50 hours of operation. Add lubricant if necessary.

Thereafter, check level and condition of lubricant every 50 hours. Replace lubricant every 100 hours of operation or once each season, whichever occurs first. Refill with *Ultra-HPF* gearcase lubricant. If not available, *Hi-Vis™* or other marine gearcase lube can be used, however, long term durability may be affected with continued use. See your Dealer.

**IMPORTANT:** The recommended gear lubricants include special additives for marine applications. Do not use automotive gear lubricants, 2-stroke or 4-stroke engine oil, or any other oil or grease for gearcase applications.

With motor in normal operating position:

- 1) Remove drain/fill plug and lubricant level plug from side of gearcase and completely drain gearcase of old lubricant.
- 2) Examine drained lubricant for metal filings, milky appearance, or black color with burnt odor. If old lubricant has any of those characteristics, see your Dealer. If drained lubricant is in good condition, continue.

- 3) Place tube of lubricant in drain/fill hole and fill slowly until lubricant appears at lubricant level hole. See **Engine Specifications** for gearcase capacity.
- 4) Install lubricant level plug before removing tube from drain/fill hole. Drain/fill plug can then be installed without loss of lubricant.
- 5) Securely tighten both plugs.

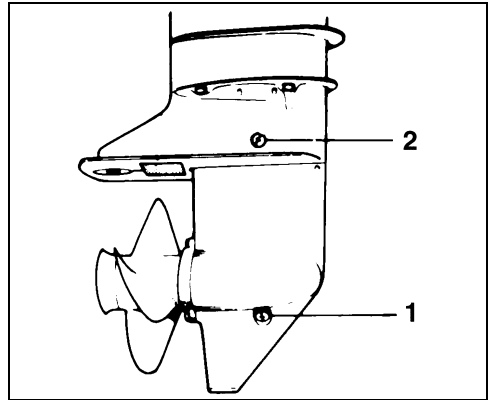

1. Drain/fill plug
2. Lubricant level plug

**IMPORTANT:** To avoid insufficient injection of lubricant, check the gear oil level 10 minutes after filling. If the oil level is low, slowly inject the lubricant up to the correct level.

### Lubrication Points

Refer to **Engine Maintenance and Inspection Schedule** for lubrication frequency and recommended lubricant.

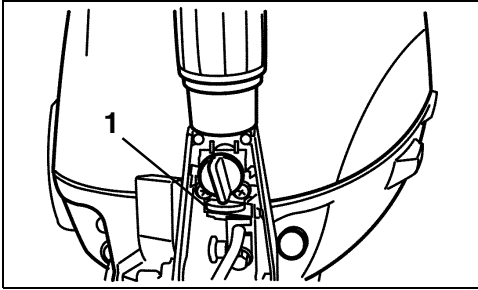

1. Throttle linkage

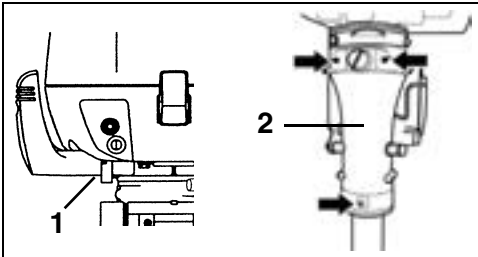

1. Shift lever  
2. Steering bracket

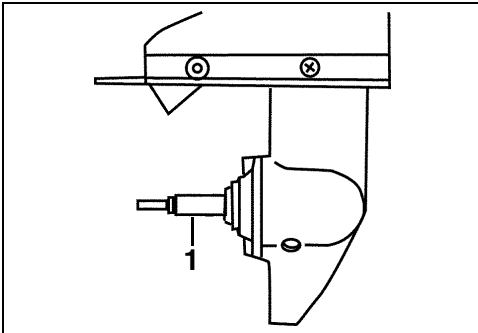

1. Propeller shaft

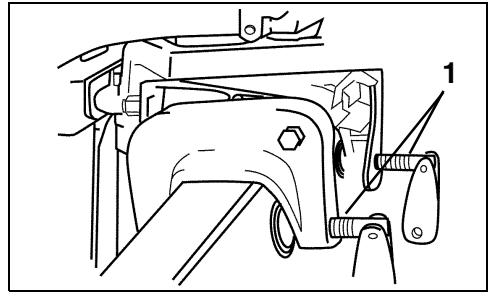

1. Clamp screws

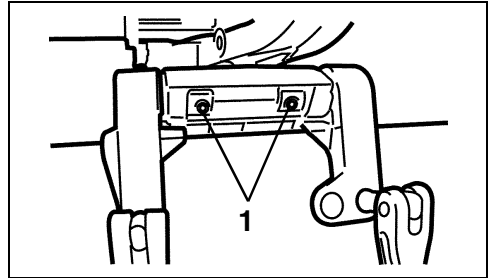

1. Swivel bracket

## BREATHER AND FUEL LINE

Inspect the breather and fuel line for leaks, cracks, swelling, or other damage. If the breather and fuel line are damaged in any way, they must be replaced. See your Dealer.

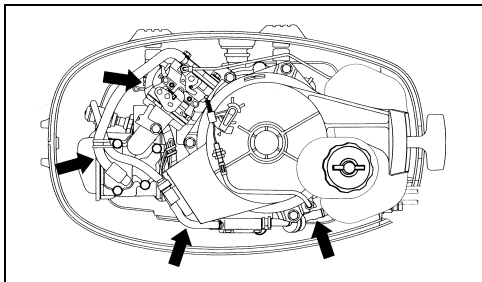

## SPARK PLUGS



### WARNING



The ignition system presents a serious shock hazard. The primary circuit operates in excess of 250 volts; the secondary circuit operates in excess of 25,000 volts. Use caution to avoid injury from shock or injury resulting from your reaction to shock. Do not handle primary or secondary ignition components while the engine is cranking or running.

Inspect spark plugs periodically. Replace if electrodes are badly worn, insulators are cracked, or if they are badly fouled.

To remove spark plugs, twist and remove all spark plug leads. Unscrew spark plug from cylinder head.

To install spark plugs, wipe spark plug seats clean with a clean rag. Install spark plugs finger tight, then tighten to specified torque. Refer to **Engine Specifications**.

**IMPORTANT:** Avoid engine damage by installing spark plugs into COOL cylinder head and not over-tightening.

Before installing the spark plug lead, apply a light coat of *Triple-Guard* grease to the ribbed portion of the spark plug. This will help prevent corrosion between the spring terminal and the spark plug.



### WARNING



Leaking fuel is a fire and explosion hazard. All parts in the fuel system should be inspected frequently and replaced if signs of deterioration or leakage are found. Inspect the fuel system each time you refuel, each time you remove the engine cover, and annually.

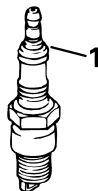

CO2333

1. Ribbed portion of the spark plug



## PROPELLER



### WARNING



**To avoid accidental starting of engine while changing propellers, twist and remove all spark plug leads.**

**IMPORTANT:** Apply *Triple-Guard* grease to the entire propeller shaft before installing the propeller. At least annually, remove the propeller and check for debris. Clean the shaft and regrease it before reinstalling a propeller.

### Installation

- 1) Install the stopper on the shaft.
- 2) Slide the propeller onto the shaft.
- 3) Install propeller nut and tighten securely.
- 4) Align the hole in propeller nut with hole in propeller shaft. Insert the cotter pin and bend its ends over to lock in place.

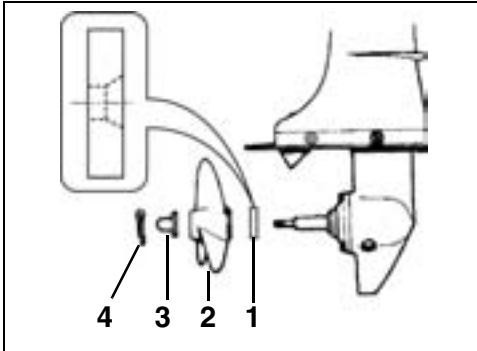

1. Stopper
2. Propeller
3. Propeller nut
4. Cotter pin

### Repair

If your propeller hits a solid object, the impact is partially absorbed by the rubber bushing in the hub to help prevent damage to the engine. A strong impact can damage the hub and propeller blades. Damage to blades can cause unusual and excessive vibration. Damage to the hub can cause excessive engine RPM with little forward movement.

**IMPORTANT:** Avoid or limit operation using a damaged propeller. Carry a spare propeller.

Keep your propeller in good condition. Use a file to smooth slight damage to blade edges. See your Dealer for repair of serious damage.

### ANTICORROSION ANODES

Your motor is equipped with one or more anodes that protect it from galvanic corrosion. Refer to **Features** for anode location. Disintegration of the anode is normal and indicates it is working. Check each anode periodically. Replace anodes smaller than 2/3 their original size. See your Dealer for replacements.

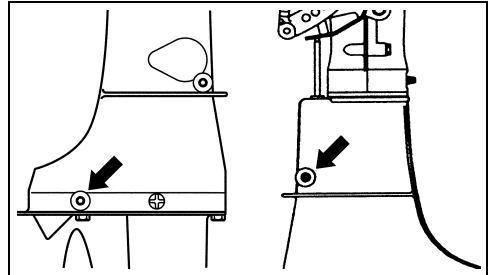

Galvanic corrosion destroys underwater metal parts and can occur in fresh or salt water; however, salt, brackish and polluted waters will accelerate corrosion.

Metal-based antifouling paint on the boat or motor and the use of improperly installed shore power in the area of your moored boat will also accelerate corrosion.

**IMPORTANT:** NEVER paint the anode, its fasteners, or its mounting surface. Painting will reduce its corrosion protection.

## TROUBLE CHECK CHART

**IMPORTANT: If you are unable to identify or solve the problem, contact your Dealer.**

SYMPTOM	POSSIBLE CAUSE
Engine will not start	<ul style="list-style-type: none"> <li>• Not following starting instructions. Refer to <b>Engine Starting Section</b>.</li> <li>• Fuel tank empty.</li> <li>• Fuel hose disconnected, kinked.</li> <li>• Fuel system contaminated with water or dirt.</li> <li>• Fuel filter obstructed.</li> <li>• COLD ENGINE: Engine not choked</li> <li>• WARM ENGINE: Engine flooded. Disconnect fuel hose at engine, push in choke or primer, crank engine. If it starts, run until cleared. If it fails to start, wait a few moments and try again.</li> <li>• Spark plugs incorrect. Refer to <b>Engine Specifications</b>.</li> <li>• Spark plugs improperly gapped, carboned, burned or wet.</li> <li>• Ignition system component failure.</li> </ul>
Engine will not idle properly	<ul style="list-style-type: none"> <li>• Motor angle excessive.</li> <li>• Spark plugs damaged or incorrect. Refer to <b>Engine Specifications</b>.</li> <li>• Fuel system contaminated with water or dirt.</li> </ul>
Engine loses power	<ul style="list-style-type: none"> <li>• Spark plugs damaged or incorrect. Refer to <b>Engine Specifications</b>.</li> <li>• Fuel filter obstructed.</li> <li>• Fuel system contaminated with water or dirt.</li> <li>• Water intakes obstructed and cooling system not operating correctly. Refer to <b>Engine Overheating</b>.</li> </ul>
Engine vibrates excessively	<ul style="list-style-type: none"> <li>• Propeller shaft bent.</li> <li>• Propeller fouled and restricted, blades bent or broken.</li> <li>• Fuel system contaminated with water or dirt.</li> <li>• Engine mount(s) damaged.</li> <li>• Steering friction screw loose.</li> </ul>
Engine runs, but makes little or no progress	<ul style="list-style-type: none"> <li>• Propeller hub loose, slipping.</li> <li>• Propeller blades bent or missing.</li> <li>• Propeller shaft bent.</li> <li>• Propeller fouled and restricted.</li> </ul>

## ENGINE MAINTENANCE AND INSPECTION SCHEDULE

Routine maintenance is necessary for all mechanized products. Periodic maintenance contributes to the product's life span. The following maintenance chart provides guidelines for engine maintenance and inspection scheduled to be performed by you and/or by an authorized Dealer. The schedule should be adjusted according to operating conditions and use.

The recommended lubricants have been formulated to protect bearings, gears and engine components. They must be used to avoid damage caused by improper lubrication.

**IMPORTANT:** Schedules for rental operations, commercial applications or high hour use will require greater frequency of inspection and maintenance.

Engine Maintenance and Inspection Schedule					
Description	Engine Care Product	Frequency			
		Each Use	10-Hour Inspection	Every 50 Hours or 6 months	Every 100 Hours or Annually
Swivel bracket, inspect and lubricate <sup>(1)</sup>	7	Every 60 days / Every 30 in Saltwater			
Throttle linkage, inspect and lubricate <sup>(1)</sup>	7	Every 60 days / Every 30 in Saltwater			
Clamp screws, lubricate <sup>(1)</sup>	7	Every 60 days / Every 30 in Saltwater			
Shift lever, lubricate <sup>(1)</sup>	7	Every 60 days / Every 30 in Saltwater			
Steering bracket, lubricate <sup>(1)</sup>	7	Every 60 days / Every 30 in Saltwater			
Lubrication and corrosion protection for metallic components	4	Every 60 days / Every 30 in Saltwater			
Anticorrosion anodes and bonding wires, verify operation		O	D		
Water intake screens, verify condition		O	D		
Overboard water pump indicator, verify operation		O	D		
Steering friction check, adjust/tighten		O	D		
Throttle and shift operation, verify function		O	D		
Emergency stop circuit and lanyard, verify function		O	D		
Crankcase oil level, check		O	D		
Flush cooling system		O			
Clamp screws, tighten		O			
Emergency start cord, onboard and inspect		O			
Operator's Guide, onboard		O			
Engine upper and lower motor covers, clean and wax				O	
Operator's Guide, review					O
Fuel components, inspect and repair leaks <sup>(2)</sup>			D	D	
Fastener inspection, tighten loosened components			D	D	
Thermostat, verify operation <sup>(2)</sup>			D		D
Engine to transom mounting hardware, re-torque			D		D
Electrical and ignition wires and connections, inspect			D		D
Gearcase lubricant replace	5		D		D
Powerhead synchronization and linkage, inspect <sup>(2)</sup>			D		D
Crankcase oil, replace	11		D		D
Crankcase oil filter, replace			D		D

## Engine Maintenance and Inspection Schedule

Description	Engine Care Product	Frequency				
		Each Use	10-Hour Inspection	Every 50 Hours or 6 months	Every 100 Hours or Annually	Every 200 Hours or Biannually
Valve tappet clearance, inspect <sup>(2)</sup>			D			D
Gearcase lubricant, inspect fill level and condition of lube	5			D		
Spark plugs, replace <sup>(2)</sup>					D	
Propeller shaft, inspect and lubricate	7				D	
Decarbonize	10				D	
Driveshaft splines, inspect and lubricate	8					D
Water pump, inspect and replace						D
Breather and fuel line, replace						D
Carburetor, inspect						D
Fuel filter, replace						D
Ignition timing, check						D

(1) Also recommended at 10-Hour Inspection

(2) Emission-related component

**D** Dealer Performed Service

**O** Operator Performed Service

**4** *Evinrude/Johnson* anti-corrosion spray or *Evinrude/Johnson* "6 in 1" multi-purpose lubricant

**5** *Ultra-HPF* gearcase lubricant

**6** Power Trim/Tilt Fluid

**7** *Triple-Guard* grease

**8** *Evinrude/Johnson Molylube* P/N 175356

**9** Starter Bendix Lube Only P/N 337016

**10** *Evinrude/Johnson* engine tuner

**11** *Evinrude/Johnson Ultra 4-Stroke* synthetic blend oil

# INSTALLATION



## WARNING



Your engine must not exceed the maximum horsepower indicated on the boat's capacity plate. Such overpowering can cause loss of control. Contact your Dealer or the boat's manufacturer if your boat lacks a capacity plate.

Boats designed for remote-steered engines might be overpowered by a tiller-steered engine of the maximum rated horsepower. Ask your Dealer or boat manufacturer if you are unsure about your boat's suitability.

Incorrectly matched boat and engine transom heights can cause boat instability and loss of control. Refer to Transom Height and Shaft Length.

Prevent lateral movement and possible engine loss by using the mounting hardware supplied or hardware of sufficient size, strength, and quality. Refer to Installing the Engine.

A mounting surface that is damaged or too thin to support your engine while underway might fail during operation, causing you to lose control. Be sure the boat's transom or mounting bracket is structurally sound and between 1 5/8 in. (41 mm) and 2 3/4 in. (70 mm) in thickness.

## TRANSOM HEIGHT AND SHAFT LENGTH

The transom height dimension listed in **Engine Specifications**, is the height of the boat transom your engine needs. This dimension is measured at the transom centerline, perpendicular to the bottom of the boat.

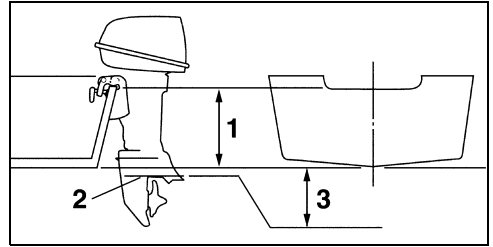

1. Transom Height
2. Anti-ventilation Plate
3. Final position - 0 to 1 in. (0 to 25 mm)

Use this procedure to determine whether or not the boat's transom height is correct for the engine's shaft length:

Set the motor on the boat's transom and adjust the angle so the anti-ventilation plate is parallel with the boat bottom. Refer to **Motor Angle Adjustment**.

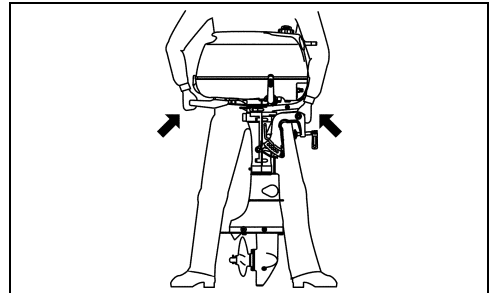

The resulting position of the anti-ventilation plate must be 0 to 1 in. (0 to 25 mm) below the boat's bottom.

**IMPORTANT:** If the anti-ventilation plate falls outside the 0 to 1 in. (0 to 25 mm) range, the installation is not considered normal. The motor shaft length must be changed or the boat's transom must be modified.

Lower than recommended – serious powerhead damage could result from water entry into the lower engine cover or overloading from an under-revving propeller at wide open throttle.

Higher than recommended – serious powerhead damage could result from inadequate cooling or an over-revving propeller. Propeller ventilation (slip-page) often occurs, resulting in poor boat performance.

On a specialty hull, non-planing hull, or on a boat with a curved transom, these guidelines might not apply. See your Dealer for special installation information.

## INSTALLING THE ENGINE

Center the engine on the boat's transom (or mounting bracket) and tighten the clamp screws by hand, NOT with tools. See your Dealer for an accessory transom plate to protect the boat's transom.

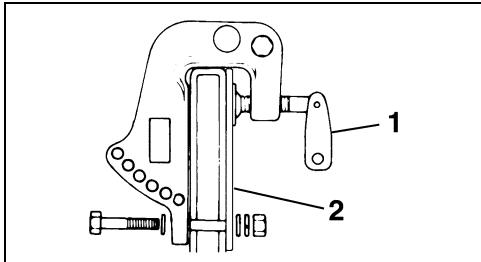

1. Clamp screws
2. Accessory transom plate

Bolt your engine to the boat's transom using 8 mm bolts, washers, lock washers, and nuts.



After positioning the engine, use the stern brackets as a template for location and size of holes to drill in the transom.

Drill two holes of the proper size through the transom. Be sure to drill holes at right angles to the transom.

Apply a good waterproof caulk generously behind the heads and to the shanks of the mounting bolts before inserting them and to the surfaces of washers that contact the transom. Avoid RTV silicone and polyurethane sealants as they can be dissolved by gasoline.

Secure the engine with the mounting hardware positioned as shown.

After 30 minutes of operation, retighten clamp screws by hand. **DO NOT** use tools to tighten clamp screws. Check clamp screws regularly.

	<b>WARNING</b>	
<b>When replacing bolts, screws, and other fasteners, use <i>Evinrude/Johnson Genuine Parts</i> or parts of equivalent strength and material.</b>		

# CHANGE OF ADDRESS / CHANGE OF OWNERSHIP

If your address has changed or if there has been a change of ownership, be sure to fill out and mail the card provided on this page.

Such notification is likewise necessary for your own safety even after expiration of the original warranty, since BRP US Inc. will be in a position to contact you if correction to your outboard becomes necessary.

Outside the U.S. and Canada, this card should be sent to the Bombardier Recreational Products division where the outboard was registered. Please contact your Dealer or distributor.



Change of address

Change of ownership

Model number

Serial Number

## Old address / Previous owner

Last name

First name  M.I.

Address

City  State

Zip code  Country

Phone number

Signature \_\_\_\_\_ Date \_\_\_\_\_

## New address / New owner

Last name

First name  M.I.

Address

City  State

Zip code  Country

Phone number

Signature \_\_\_\_\_ Date \_\_\_\_\_

000063

AFFIX  
STAMP  
HERE

**BRP US Inc.**  
***Evinrude / Johnson***  
**Dealer Support Services**  
**250 Seahorse Drive**  
**Waukegan, IL 60085**



# Operator's Guide Confirmation of Receipt

## Your Dealer

Name:	_____
	_____
Address:	_____
	_____
	_____

Upon delivery of your new *Evinrude/Johnson* Outboard, complete and sign the form hereunder. Your Dealer will take receipt of the form for their records.

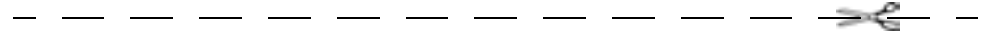

## Receipt

Name:	_____
	_____
Address:	_____
	_____
	_____
Owner of Model No:	_____
Serial No:	_____
	(To be completed by customer or selling Dealer)
<p>The Dealer named on this document has instructed me on the operation, maintenance, safety features and warranty policy, all of which I understand and agree to be bound with. I am also satisfied with the predelivery set-up and inspection of my <i>Evinrude/Johnson</i> Outboard. I have also received a copy of the Operator's Guide.</p>	
Signature:	_____
Date:	_____

**BRP US Inc.**

# Readiness Test and a Final Word to the Owner/Operator

The Operator's Readiness Test...

1. Did you read this Guide from front cover to rear cover?
2. Are you ready to take responsibility for the safe operation of your boat and motor?
3. Do you understand all the safety precautions and instructions contained in this Guide?
4. Do you understand that this Guide contains essential information to help prevent personal injury and damage to equipment?
5. Are you ready to follow the recommendations in this Guide and take a boating safety course before you operate your boat and motor?
6. Do you know who to ask if you have any questions about your boat and motor?
7. Do you know your local marine traffic laws?
8. Do you understand that human error can be caused by carelessness, fatigue, overload, preoccupation, unfamiliarity of operator with the product, drugs and alcohol, just to name a few?



## WARNING



**It is impossible for this Guide to cover every hazardous situation you may encounter; however, your understanding of and adherence to essential information contained in this Guide will build good judgment when boating. Always be alert and careful: a good foundation for safety.**



5 0 3 5 7 5 1

