

can-am[®]

CAN-AM WINCH

USER'S GUIDE

Includes Safety, Use and Maintenance Information

⚠ WARNING

Read this User's Guide thoroughly. It contains important safety information.
Keep this User's Guide in the vehicle at all times.

219002430

Original Instructions

⚠ WARNING

Disregarding any of the safety precautions and instructions contained in the User's Guide and on product safety labels could cause injury including the possibility of death.

TM® Trademarks of BRP or its affiliates.

This is a non-exhaustive list of trademarks that are the property of Bombardier Recreational Products Inc. or its affiliates:

Can-Am®

All rights reserved. No parts of this manual may be reproduced in any form without the prior written permission of Bombardier Recreational Products Inc.

©Bombardier Recreational Products Inc. (BRP) 2024

Deutsch	Dieses Handbuch ist möglicherweise in Ihrer Landessprache verfügbar. Bitte wenden Sie sich an Ihren Händler oder besuchen Sie: www.operatorsguides.brp.com
English	This guide may be available in your language. Check with your dealer or go to: www.operatorsguides.brp.com
Español	Es posible que este manual esté disponible en su idioma. Consulte a su distribuidor o visite: www.operatorsguides.brp.com
Français	Ce guide peut être disponible dans votre langue. Vérifier avec votre concessionnaire ou aller à: www.operatorsguides.brp.com
Italiano	Questa guida potrebbe essere disponibile nella propria lingua. Contattare il concessionario o consultare: www.operatorsguides.brp.com
中文	本手册可能有您的语种的翻译版本。请向经销商询问，或者登录 www.operatorsguides.brp.com 查询。
日本語	このガイドは、言語によって翻訳版が用意されています。ディーラーに問い合わせるか、次のアドレスでご確認ください： www.operatorsguides.brp.com
Nederlands	Deze handleiding kan beschikbaar zijn in uw taal. Vraag het aan uw dealer of ga naar: www.operatorsguides.brp.com
Norsk	Denne boken kan finnes tilgjengelig på ditt eget språk. Kontakt din forhandler eller gå til: www.operatorsguides.brp.com
Português	Este manual pode estar disponível em seu idioma. Fale com sua concessionária ou visite o site: www.operatorsguides.brp.com
Русский	Воспользуйтесь руководством на вашем языке. Узнайте о его наличии у дилера или на странице по адресу www.operatorsguides.brp.com
Suomi	Käyttöohjekirja voi olla saatavissa omalla kielelläsi. Tarkista jälleenmyyjältä tai käy osoitteessa: www.operatorsguides.brp.com
Svenska	Denna bok kan finnas tillgänglig på ditt språk. Kontakta din återförsäljare eller gå till: www.operatorsguides.brp.com

Covered Winch Models
Can-Am HD 2500 Can-Am HD 3500 Can-Am HD 4500

In Canada, products are distributed and serviced by Bombardier Recreational Products Inc. (BRP).

In the USA, products are distributed and serviced by BRPUS Inc.

In the European Economic Area (which is comprised of the member states of the European Union plus the United Kingdom, Norway, Iceland and Liechtenstein), the Commonwealth of the Independent States (including Ukraine and Turkmenistan) and Turkey, products are distributed and serviced by BRP European Distribution S.A. and other affiliates or subsidiaries of BRP.

For all other countries, products are distributed and serviced by Bombardier Recreational Products Inc. (BRP) or its affiliates.

TABLE OF CONTENTS

GENERAL INFORMATION

GENERAL INFORMATION	6
Know Before you Go	6
Safety Messages	6
About this User's Guide	6

SAFETY INFORMATION

GENERAL PRECAUTIONS	10
Avoid Injuries	10
Accessories and Modifications	10
SAFE OPERATION - RESPONSIBILITIES	11
Owner - Be Responsible	11
Operator - Be Qualified and Responsible	11
INSPECTION BEFORE EACH USE	12
Inspection Check List	12
PREPARE TO USE YOUR WINCH	13
Protective Gear	13
Rigging	13
AVOID ACCIDENTS	14
Avoid Injuries	14
Avoid Winch Damage	14
Avoid Breakout of the Rope or the Cable	15
Avoid the Release of the Rope or the Cable	15
Avoid Hook Damage	16
MOVING LOADS AND DOING WORK	17
Proper Rigging	17
Winching	17
IMPORTANT ON-PRODUCT LABELS	20
Safety Label	20

WINCH INFORMATION

COMPONENTS	26
Switch	27
Synthetic Rope or Wire Cable	27
Rope or Cable Guide	27
Motor	27
Brake	27
Free-spool	28
Hook	28
Hand Strap	28
Hook Stopper	28
Winch Remote Control Switch (if equipped)	28
Winch Solenoid	28

MAINTENANCE

WINCH CARE **30**
 Post-Operation Care 30
STORAGE **31**

COMPLIANCE INFORMATION

EU - DECLARATION OF CONFORMITY **34**
UK - DECLARATION OF CONFORMITY **35**
DISPOSAL REQUIREMENTS UNDER WEEE REGULATIONS **36**
 For private households: Information on Disposal for Users of WEEE 36
 For professional users in the European Union 36
 For disposal in countries outside of the European Union 36

TECHNICAL SPECIFICATIONS

SPECIFICATIONS **38**
 Can-AM HD 2500 38
 Can-AM HD 3500 38
 Can-AM HD 4500 38

TROUBLESHOOTING

TROUBLESHOOTING GUIDELINES **40**
 Troubleshooting 40

WARRANTY

BRP LIMITED WARRANTY USA AND CANADA: CAN-AM WINCH **44**
BRP INTERNATIONAL LIMITED WARRANTY: CAN-AM WINCH **45**
BRP LIMITED WARRANTY FOR THE EUROPEAN ECONOMIC AREA, THE COMMONWEALTH OF THE INDEPENDENT STATES AND TURKEY: CAN-AM WINCH **46**

CUSTOMER INFORMATION

DATA PRIVACY INFORMATION **48**
CONTACT US **50**
 Asia Pacific 50
 Europe, Middle East and Africa 50
 Latin America 51
 North America 51
CHANGE OF ADDRESS AND OWNERSHIP **52**

GENERAL INFORMATION

GENERAL INFORMATION

Congratulations on your purchase of a new Can-Am® winch. It's backed by the BRP limited warranty and a network of authorized Can-Am Off-road dealers ready to provide the parts, accessories or service you may require.

Your dealer is committed to your satisfaction. If you need more information, please ask your dealer.

Know Before you Go

To learn how to reduce the risk of accident for you or bystanders, read this User's Guide before you operate the winch.

Also, read all safety labels on your vehicle, winch or accessories.

Failure to follow the warnings contained in this User's Guide can result in **SERIOUS INJURY** or **DEATH**.

WARNING

To avoid severe injury or death or important components damages.

- Never use the winch cable/rope to retain a vehicle during trailering.
- Never ride with the winch cable/rope attached to a load or another vehicle.
- Only use the winch to help a stuck vehicle (snow, mud, etc.).
- Always refer to the winch manufacturer's instruction before pulling loads.

Safety Messages

The types of safety messages, what they look like and how they are used in this guide are explained as follows:

The safety alert symbol  indicates a potential injury hazard.

WARNING

Indicates a potential hazard which, if not avoided, could result in serious injury or death.

CAUTION

Indicates a hazardous situation which, if not avoided, could result in minor or moderate injury.

NOTICE

Indicates an instruction which, if not followed, could result in severely damaged vehicle components or other property.

About this User's Guide

This User's Guide has been prepared to acquaint the owner/operator of a new winch with the various controls, maintenance and safe operating instructions. It is indispensable for the proper use of the product.

Keep this User's Guide in the vehicle as you can refer to it for things such as maintenance, troubleshooting and instructing others.

Note that this guide is available in several languages. In the event of any discrepancy, the English version shall prevail.

If you want to view and/or print an extra copy of your User's Guide, simply visit the following website

www.operatorsguides.brp.com.

The information contained in this document is correct at the time of publication.

BRP, however, maintains a policy of continuous improvement of its products without imposing upon itself any obligation to install them on products previously manufactured.

Due to late changes, some differences between the manufactured product and the descriptions and/or specifications in this guide may occur.

BRP reserves the right at any time to discontinue or change specifications, designs, features, models or equipment without incurring any obligation upon itself.

This User's Guide should remain with the vehicle when it is sold.

This page is intentionally blank

SAFETY INFORMATION

GENERAL PRECAUTIONS

Avoid Injuries

All moving components may create hazardous situations, which can be avoided when following proper usage of the winch.

Refer to all instructions in this guide to help you proceed in a safe manner, but always remain aware of dangers specific to your application.

Each situation has its own risks.

Accessories and Modifications

Any modifications or addition of accessories may affect the proper operation of your winch.

Ask your authorized Can-Am Off-road dealer for suitable available accessories for your winch.

 WARNING
--

Never attempt to modify the winch electrical system. Risk of fires, or risk of electrocution.
--

SAFE OPERATION - RESPONSIBILITIES

WARNING

Unsafe utilization of the winch without proper precautions may lead to an accident, serious injuries, such as amputations, cuts or burns.

Owner - Be Responsible

Read this User's Guide.

Always inspect and confirm the safe operating condition of your winch prior to winching.

Never allow anyone to operate the winch unless this person is responsible and has experience with winching. Consider supervising new operators.

Discuss the safety information with anyone who will be using the winch. Be sure that everyone understands the signs for proper winching.

Operator - Be Qualified and Responsible

Read this User's Guide.

Become completely familiar with the operational controls.

Never use this winch with drugs or alcohol, or if tired or ill. These slow reaction time and impair judgment.

INSPECTION BEFORE EACH USE

Always inspect and confirm the safe operating condition of your winch before usage.

WARNING

Perform a thorough inspection before each use to detect any potential problem that could occur during operation. The inspection can help you monitor component wear and deterioration before they become a problem. Correct any problem that you discover to reduce the risk of an accident.

Inspection Check List

What to Do Before Using the Winch

ITEMS TO BE INSPECTED	INSPECTION TO PERFORM	✓
Cleanliness	Thoroughly clean all winch area, including pulling rope or cable out for cleaning. Avoid strong detergents.	
Synthetic rope	Verify if rope has any damage, replace if damaged.	
Wire cable	Look for kinks, tight loops, or broken wire strands	
Roller fairlead	Ensure area is clean, remove any obstructions, verify there is no damage or bends and that rollers run smoothly	
Hook	Verify hook is not crooked or damaged, and that hook latch closes properly	
Hand strap	Ensure hand strap is present. Always use hand strap to avoid injury.	
Switch condition	Ensure no cracks or exposed wires	
Motor operation	Ensure the motor works properly, also verify free spool works properly	
Battery condition	Ensure battery will have sufficient charge for operating the winch. When possible let engine idle while using the winch.	
	Ensure terminal screws are properly tightened.	
Solenoid condition	Ensure terminal nuts are properly tightened.	

PREPARE TO USE YOUR WINCH

Protective Gear

Eye Protection

Use good quality safety goggles while operating the winch.

Do not use tinted glasses at night as they impair the ability to discern color.

Gloves

Full-fingered leather work gloves protect hands from cuts and lacerations. Gloves that fit snugly will improve grip on the rope without binding to the rope while winching.

Rigging

It is important to carry the appropriate rigging at all times on your vehicle.

Sling

Use good quality sling rated for more than the maximum rating of the winch.

The sling eyelets must fit properly with the hook, with the hook latch closed.

Pulley Block

Use good quality pulley block rated for more than the maximum rating of the winch.

Use pulley block to allow good angle of pull, or increase the pull capacity.

Tree Protection Strap

Use good quality tree protection strap rated for more than the maximum rating of the winch.

Shackle

Use good quality shackles rated for more than the maximum rating of the winch.

Ensure the shackles close and lock securely.

AVOID ACCIDENTS

Avoid Injuries

This winch can produce a considerable amount of pulling force.

Never use the winch in a condition that will result in dangerous situations

- Always inspect equipment before usage. Replace defective components.
- Always respect the maximum load capacity of the winch, including a safety factor.
- Always wear adequate protective gear.
- Never use the winch to lift objects or people.
- Always use the hand strap to manipulate the hook and rope/cable.
- Never put your hand on the rope/cable while winching.
- Ensure all components are in good working order.
- Never stay in the rope/cable trajectory area.
- Ensure good communication between workers and understand signs for winch operation.
- The operator must be able to see the entire work zone at all times.
- The rigging accessories are in good condition and appropriate for the work to be performed, including a safety factor.
- Always use rigging that is rated at least as much as the maximum load of the winch.
- The rigging must be properly done.
- No bystanders should be allowed in the work zone.

WARNING

**Always stay clear of the rope or cable trajectory.
A sweater or jacket suspended to the midpoint of the rope or cable will ensure the rope or cable will direct downwards in case of a rope breakout.**

WARNING

Never put fingers in the hook or hand between hook and roller fairlead. A convenient hand strap is installed onto the hook.

WARNING

Never use the winch as a lifting device or a hoist.

Avoid Winch Damage

This winch can produce a considerable amount of pulling force.

Never use the winch in a condition that will result in winch damage.

- Always respect the maximum load capacity of the winch, including a safety factor
- Never install the winch on another location than the one described in the instruction sheet or as factory installed on your Can-Am vehicle.
- Never modify the original equipment
- Ensure all components are in good working order
- Do not use continuously as motor will overheat, or circuit breakers will trip.
- Listen and observe carefully when using winch, to prevent overloading the winch

- The operator must be able to see the entire work zone at all times
- The rigging must be properly done
- The use of a winch remote (if equipped) allows to stay out of the working zone and have a better view of the situation

Avoid Breakout of the Rope or the Cable

This winch can produce a considerable amount of pulling force to the rope or cable.

Any rope or cable breakout may become hazardous to you or bystanders.

Never use the winch in a condition that will result in rope or cable breakout.

- Always inspect the rope or the cable for any damage. Replace if required.
- The rope or the cable must be strong enough for the work to be performed, including a safety factor.
- Never route the rope or the cable so it rubs against a surface.
- Never loop the rope or the cable and attach it to itself, always use a good condition sling suited for the load.
- The rope or the cable must be in good working condition.
- The use of a winch remote (if equipped) allows to stay out of the working zone and have a better view of the situation.
- The operator must be able to see the entire work zone at all times.
- The rigging accessories must be in good condition and appropriate for the work to be performed, including a safety factor.
- The rigging must be properly done.
- No bystanders should be allowed in the work zone.

WARNING

**Always stay clear of the rope or cable trajectory.
A sweater or jacket suspended to the midpoint of the rope or cable will ensure the rope or cable will direct downwards in case of a rope breakout.**

Avoid the Release of the Rope or the Cable

When in tension, a release of the rope or the cable may become hazardous to you or bystanders.

Never use the winch in a condition that will result in rope or cable release.

- The clutch spool must be completely engaged to ensure the winch will not release when loaded.
- Always ensure there is still at least eight turns of rope or cable around the spool.
- The object to be winched must be safely immobilized once winching has been done.
- Never disengage the spool lock while the rope or cable is under tension.
- The tension in the rope or cable must be released once the winched object has been secured.
- The operator must be able to see the entire work zone at all times.

- No bystanders should be allowed in the work zone.

 **WARNING**

**Always stay clear of the rope or cable trajectory.
A sweater or jacket suspended to the midpoint of the rope or cable will ensure the rope or cable will direct downwards in case of a rope breakout.**

Avoid Hook Damage

Never use the winch in a condition that will result in hook damage.

- Always attach the sling to the hook so the load applied is in the center of the hook.
- The hook latch must be closed.
- The load must be applied correctly for the hook and the rope or the cable.
- The rigging accessories must be in good condition and appropriate for the work to be performed, including a safety factor.
- The rigging must be properly done.
- No bystanders should be allowed in the work zone.

MOVING LOADS AND DOING WORK

Proper Rigging

Your winch can help you perform a number of different tasks.

Rigging accessories are recommended to perform adequate and safe usage of your winch.

To prevent possible injury, follow the instructions and warnings from the rigging accessory manufacturer.

Always respect the load limits.

Always be aware that inappropriate rigging may result in serious injury or death.

Among all rigging equipment available, you should consider having at least the following equipment on your vehicle.

- Winch remote
- Sling
- Pulley block
- Tree protection strap
- Shackles

WARNING

Adequate rigging helps avoid rope breaking out or releasing from anchor point.

Pulling Your Vehicle From a Fixed Point

WARNING

The selection of an appropriate anchor point is critical to avoid an accident.

Pulling an Object or Using Your Vehicle as a Recovery Vehicle

WARNING

Safely securing your vehicle to avoid movement is critical to avoid an accident.

Winching

WARNING

Do not exceed the load limits of the winch.

Load Limit of the Winch		
Can-Am HD 2500	1 134 kg (2,500 lb)	Always allow a safety factor
Can-Am HD 3500	1 587 kg (3,500 lb)	
Can-Am HD 4500	2 041kg (4,500 lb)	

The following signs are a general guideline for safely communicating with the person performing the winch controls. Most importantly avoid any confusion by reviewing the signs you will use with your teammate before usage.

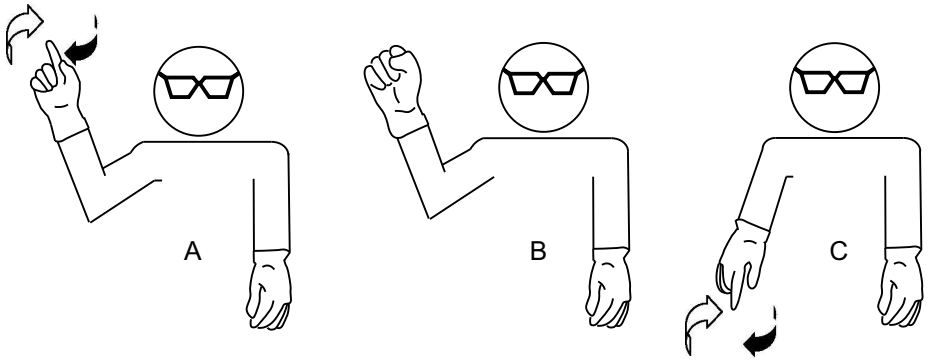

A. Winch-in. Index and arm up, making hand rotations

B. STOP. Arm up and closing fist

C. Winch-out. Index and arm down, making hand rotations

1. Observe the surrounding environment. Plan ahead for your safest strategy.
2. Ensure no bystanders are at risk.
3. Ensure good understanding of the plan and good communication between teammates for winching.
4. Become familiar and use standard signs for winching.
5. Take up any slack in the rope or cable and also the rigging before winching.
6. Once all slack is removed, verify your installation for safety, and suspend a sweater or a jacket in the middle of the rope or cable.
7. Proceed slowly and carefully.
8. Once winching is complete, secure the winched item, then remove the tension from the rope or cable and undo rigging.
9. After use, ensure to maintain a small tension on the rope or cable while winching in.
 - With the help of an assistant: have other person maintain a tension in the rope or cable while staying at least 1.84 m (6 ft) away from the vehicle.
 - Hold the rope or cable tight without letting it slide in your gloves
 - Proceed by alternating one arm after the other.
 - Once your rear hand gets close to the hook, have the operator stop, grab the hand strap and continue until rope or cable is safely stowed.
 - If proceeding alone, either pull a load to maintain tension in the rope or cable, or use the remote (if equipped) in one hand and the rope or cable in the other, while staying as far from the hawse or fairlead as possible.
 - Then activate-deactivate the winch one arm length at a time. Once you get close to the hook, stop the winch, grab the hand strap and continue until the rope is safely stowed.

10. When winching in, ensure the rope or cable loops are tight and sufficiently spread on the drum to avoid jams, rope or cable damage or sudden release of the rope or cable.

Vehicle Settings When Winching

It is recommended to maintain the pulling vehicle running at idle when winching to prevent battery drainage.

Pulling vehicle has to be properly blocked to avoid movement during winching.

If driver is operating winch from the vehicle (inside switch), ensure vehicle is stable, then apply brakes to secure the vehicle in place.

IMPORTANT ON-PRODUCT LABELS

Safety Label

Read and understand all the safety labels on your winch assembly.

These labels are affixed for the safety of the operator and bystanders.

The following labels should be considered permanent parts of the winch assembly. If missing or damaged, they can be replaced free of charge. See an authorized Can-Am Off-road dealer.

NOTE:

In the event of any discrepancy between this guide and the winch assembly, the safety labels on the winch have precedence over the labels in this guide.

Winch Label

HD 2500



OR



HD 3500



OR



HD 3500S

can-am

HD 3500 S

12VDC
 1587 kg (3500 lb)
 Synthetic rope 50 ft, 7/32" diameter
 Gear ratio 140:1
 Fairlead - 4-way roller
 BRP PN 710007362



UK
CE
DK
CA

8614

OR

can-am

HD 3500 S

12VDC
 1587 kg (3500 lb)
 Synthetic rope 50 ft, 3/16" diameter
 Gear ratio 140:1
 Fairlead - hawse
 BRP PN 710010022



UK
CE
CA

10268

HD 4500 - 4-way Roller Fairlead, Wire Cable

can-am

HD 4500

12VDC
 2041 kg (4500 lb)
 Steel rope 43 ft, 15/64" diameter
 Gear ratio 191:1
 Fairlead - 4-way roller
 BRP PN 710006993



UK
CE
DK
CA

8221

OR

can-am

HD 4500

12VDC
 2041 kg (4500 lb)
 Steel rope 43 ft, 15/64" diameter
 Gear ratio 191:1
 Fairlead - 4-way roller
 BRP PN 710007979



UK
CE
DK
CA

8849

HD 4500 - 4-way Roller
Fairlead, Synthetic Rope

can-am

HD 4500

12VDC
2041 kg (4500 lb)
Steel rope 43 ft, 15/64" diameter
Gear ratio 191:1
Fairlead : 4-way roller
BRP PN 710007030



8239

HD 4500S - Aluminum Hawse

can-am

HD 4500 S

12VDC
2041 kg (4500 lb)
Synthetic rope 50 ft, 1/4" diameter
Gear ratio 191:1
Fairlead : Aluminium hawse
BRP PN 710006990



8222

Hawse or Roller Fairlead Label

⚠ WARNING

Locate and read the User's guide. Improper use can result in SEVERE INJURY or DEATH. Follow all instructions and warnings.
 Never put your fingers into the hook.
 Always use the hand strap to manipulate the hook and rope.
 Avoid putting your hand between hook and hawse or roller fairlead. You can crush your fingers.
 Never use the winch to lift objects or people.

Hand Strap Label

⚠ WARNING

Do not remove the hand strap from the hook.
 Always use the hand strap to manipulate the hook and rope.

This page is intentionally blank

WINCH INFORMATION

COMPONENTS

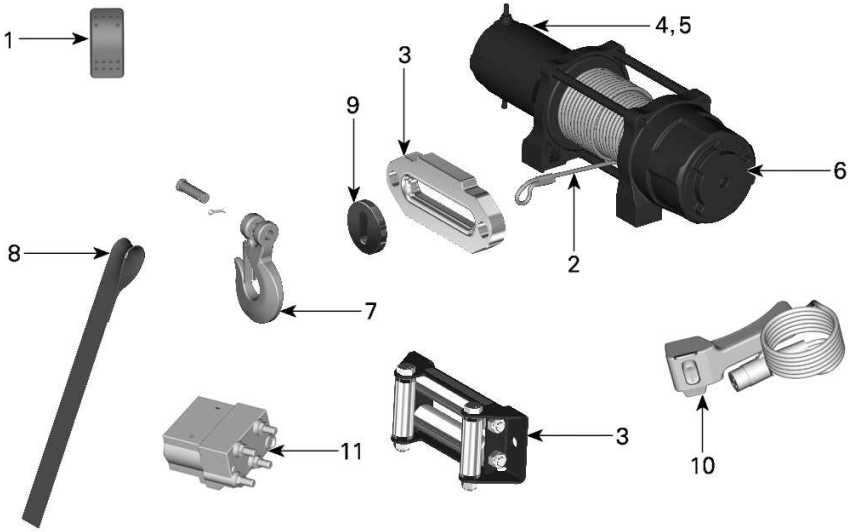

1. Switch
2. Synthetic rope or wire cable
3. Rope or Cable Guide
4. Motor
5. Brake
6. Free-spool
7. Hook
8. Hand Strap
9. Hook Stopper
10. Remote control switch
11. Winch Solenoid

Switch

The winch can be activated by a winch control switch on your vehicle.

Depending on the version of the kit, a remote control switch may be included with the winch accessory kit.

The remote control switch can also be purchased separately if needed.

Synthetic Rope or Wire Cable

⚠ WARNING

A damaged rope or cable may break suddenly and project objects at high speed or release the retaining force suddenly. Never use a damaged rope or a damaged cable.

Synthetic Rope

Synthetic rope can be used in wet or muddy applications.

If the rope has a large number of broken fibers, or shiny sections or compressed sections, replace it.

NOTICE

Never use a synthetic rope with a roller fairlead. It was designed to be used with hawse rope guide.

Wire Cable

A wire cable can be used as general purpose winching operations.

If the cable is kinked, has tight loops, or has broken wire strands, replace it.

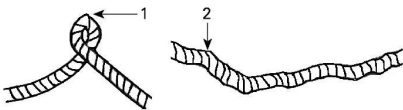

1. Tight loop
2. Kinks

NOTICE

Never use wire cable with hawse rope guide. It was designed to be used with roller fairlead.

Rope or Cable Guide

Aluminum Hawse

A synthetic rope is matched with the aluminum hawse.

Roller Fairlead

A wire cable is matched with the roller fairlead.

Motor

NOTICE

Proper use and maintenance of the winch will be determinant in the life expectancy of your winch motor.

⚠ CAUTION

The gear ratio of the motor determines the number of motor revolutions for 1 spool revolution. Therefore the speed of the pull-in or pull-out will vary with how much rope is wound around the spool.

Brake

The winch motor is equipped with a brake to reduce the amount of pull-out when the winch switch is not activated anymore.

Depending on winch usage the brake will wear out until the winch is out of order.

Signs of brake fatigue is the decrease of brake pull-out capacity. This is a good indication of the end of life of the winch.

BRP does not supply these internal components. The winch assembly needs to be replaced.

Free-spool

Your winch comes equipped with a free-spool mechanism.

Simply turn the free-spool knob located at the end of the winch clockwise to disengage the brake. This allows to pull the rope without using the winch motor.



FREE-SPOOL LABEL

Always make sure to engage the brake before winching in.

Hook

Your winch comes equipped with a hook.

⚠ WARNING

Never exceed hook capacity. Always ensure strap is properly attached to hook and hook latch is closed. Never remove hand strap from hook.

Hand Strap

Your winch comes equipped with a hand strap for safe operation.

Use the hand strap to avoid hand injuries.

⚠ WARNING

Always use the hand strap to pull the rope or the cable.

Hook Stopper

A hook stopper is installed to avoid damage to the winch, the hook, or the guide when pulling rope or cable in.

Avoid pulling the rope or the cable further than necessary.

The hook should just lean against the stopper.

Winch Remote Control Switch (if equipped)

The use of a winch remote control helps staying out of the working zone and have a better view of the situation.

Depending the version of the kit, a remote control switch may be included with the winch accessory kit.

The remote control switch can also be purchased separately if needed.

Winch Solenoid

The winch solenoid controls the current supplied from the battery to the winch motor.

MAINTENANCE

WINCH CARE

Post-Operation Care

Thoroughly clean the winch and its components after each ride.

Pull-out the rope or the cable to clean and inspect for damage.

Pull-in the rope or the cable for storage.

Verify all other components for damage. Replace as required.

STORAGE

If the vehicle is to be remain inactive for more than 21 days, disconnect the BLACK (-) cable of the battery.

Clean winch before storage.

Store in a dry and/or well ventilated environment to avoid corrosion.

This page is intentionally blank

COMPLIANCE INFORMATION

EU - DECLARATION OF CONFORMITY

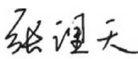
Manufacturer	Manufactured by: Zhejiang Nowvow Mechanical and Electrical Corp., Ltd NO.1689 Xianyuan Road, Jinhua, Zhejiang, China P.C: 321017
Product	Model: <u>Electric Planetary Winch</u> Winch load :2500/3500/4500lbs Serial No(s). 715006414,520002120, 710009072,710009939, 715007439,710007071, 710010022,710009410, 715006415,715007440, 710010021 710007072,710007362, 715006416,715006417, 715006441,715006442, 710006993,710006990, 710007030,710007979,
The person authorized to compile the technical file	BRP-Rotax GmbH Co. KG, Rotaxstrasse 1,Gunskirchen, A-4623, Austria +43 7246 6010
The object of the declaration described above is in conformity with the relevant Union harmonisation legislation	This declaration of conformity is issued under the sole responsibility of the manufacturer. 2006/42/EC 2014/30/EU 2011/65/EU 2012/19/EU EN ISO 12100:2010; EN 14492-1:2006+ A1:2009+ AC:2010 EN 55014-1:2017;EN 55014-2:2015
Signature & Title:  Zhang Litian <u>General Manager</u>	Date: in Zhejiang <u>07/03/2023</u>

UK - DECLARATION OF CONFORMITY

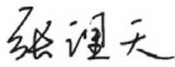
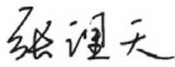
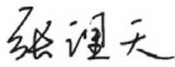
<p>Manufacturer</p>	<p>Manufactured by: Zhejiang Nowvow Mechanical and Electrical Corp., Ltd NO.1689 Xianyuan Road, Jinhua, Zhejiang, China P.C: 321017</p>		
<p>Product</p>	<p>Model: <u>Electric Planetary Winch</u></p> <p>Winch load :<u>2500/3500/4500lbs</u></p> <p>Serial No(s). 715006414,520002120, 710009072,710009939, 715007439,710007071, 710010022,710009410, 715006415,715007440, 710010021 710007072,710007362, 715006416,715006417, 715006441,715006442, 710006993,710006990, 710007030,710007979,</p>		
<p>The person authorized to compile the technical file</p>	<p>BRP UK Ltd., (BWM A accountants Limited) Suite 5.1, 12 Tithebarn Street, Liverpool, L2 2DT</p>		
<p>The object of the declaration described above is in conformity with the relevant Union harmonisation legislation</p>	<p>This declaration of conformity is issued under the sole responsibility of the manufacturer.</p> <p>SI 2008/1597 SI 2016/1091 SI 2012/3032 SI 2013/3113 EN ISO 12100:2010;EN 14492-1:2006+A1:2009+AC:2010 EN 55014-1:2017;EN 55014-2:2015</p>		
<table border="0" style="width: 100%;"> <tr> <td style="width: 50%; vertical-align: top;"> <p>Signature & Title:</p>  <p>Zhang Litian <u>General Manager</u></p> </td> <td style="width: 50%; vertical-align: top;"> <p>Date:</p> <p>in Zhejiang</p> <p><u>07/03/2023</u></p> </td> </tr> </table>		<p>Signature & Title:</p>  <p>Zhang Litian <u>General Manager</u></p>	<p>Date:</p> <p>in Zhejiang</p> <p><u>07/03/2023</u></p>
<p>Signature & Title:</p>  <p>Zhang Litian <u>General Manager</u></p>	<p>Date:</p> <p>in Zhejiang</p> <p><u>07/03/2023</u></p>		

DISPOSAL REQUIREMENTS UNDER WEEE REGULATIONS

For private households: Information on Disposal for Users of WEEE

This symbol on the product(s) and / or accompanying documents means that used electrical and electronic equipment (WEEE) should not be mixed with general household waste.

For proper treatment, recovery and recycling, please take this product(s) to designated collection points where it will be accepted free of charge.

Alternatively, in some countries, you may be able to return your products to your local retailer upon purchase of an equivalent new product.

Disposing of this product correctly will help save valuable resources and prevent any potential negative effects on human health and the environment, which could otherwise arise from inappropriate waste handling.

Please contact your local authority for further details of your nearest designated collection point. Penalties may be applicable for incorrect disposal of this waste, in accordance with your national legislation.

For professional users in the European Union

If you wish to discard electrical and electronic equipment (EEE), please contact your dealer or supplier for further information.

For disposal in countries outside of the European Union

This symbol is only valid in the European Union (EU). If you wish to discard this product please contact your local authorities or dealer and ask for the correct method of disposal.

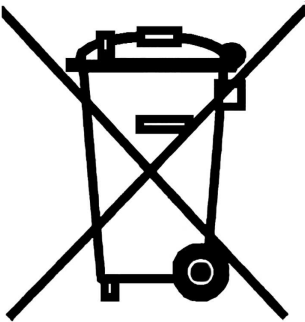

TECHNICAL SPECIFICATIONS

SPECIFICATIONS

Can-AM HD 2500

Weight	8.5 kg (19 lb)
Power	0.8 kW (1.1 hp)
Motor drive ratio	140:1
Load capacity (pulling)	1134 kg (2,500 lb)

Can-AM HD 3500

Weight	10 kg (22 lb)
Power	1.1 kW (1.5 hp)
Motor drive ratio	140:1
Load capacity (pulling)	1587 kg (3,500 lb)

Can-AM HD 4500

Weight	Synthetic rope	8.5 kg (19 lb)
	Wire cable	10 kg (22 lb)
Power		1.2 kW (1.6 hp)
Motor drive ratio		191:1
Load capacity (pulling)		2041 kg (4,500 lb)

TROUBLESHOOTING

TROUBLESHOOTING GUIDELINES

Troubleshooting

1. MOTOR DOES NOT TURN OR DOES NOT TURN BOTH WAYS

Poor connection

- *Verify if there are loose connections both at the solenoid location and at the winch itself.*
- *Check for broken wires.*
- *Check for corrosion.*

Defective winch remote button.

- *Contact an authorized Can-Am Off-road dealer to have switch replaced.*

Contact breakers have tripped

- *Allow several minutes to cool down before trying again.*

Freespool is engaged

- *Make sure to engage the brake so that the winch motor is coupled to the drum.*

2. MOTOR LACKS POWER

Weak battery

- *Check fault message in cluster.*
- *Check battery connections and terminals condition.*
- *Have the battery checked by an authorized Can-Am Off-road dealer.*

Motor is damaged

- *Have the winch replaced.*

3. MOTOR OVERHEATS

Winch was used for a long period.

- *Allow motor and circuit breakers to cool down.*

Motor is damaged

- *Have the winch replaced.*

4. WINCH WILL NOT RETAIN THE LOAD APPLIED

Load is above capacity

- *Reduce load as much as possible.*
- *Use a block to double the line with a pulley block.*

Internal brake damage

- *Have the winch replaced.*

This page is intentionally blank

WARRANTY

BRP LIMITED WARRANTY USA AND CANADA: CAN-AM WINCH

Bombardier Recreational Products Inc. ("BRP") warrants its Can-Am winch sold by authorized Can-Am Off-road dealers and/or distributors in the United States of America and in Canada from defects in material or workmanship for the period and under the conditions described below.

Factory Installed On Your New BRP Vehicle

Normal vehicle warranty will apply to this accessory.

Please refer to your specific unit's BRP Operator's Guide for details.

Use other than which the product is designed for will void the product limited warranty.

Installed by Your Authorized Dealer / Distributor On Your New or Used BRP Vehicle

For a period of **TWELVE (12) months** (unless otherwise stipulated or required by law) starting from the date of the retail sale, this limited warranty covers Parts, Accessories, and labour. BRP will repair or replace genuine BRP Parts and Accessories found defective in material and/or workmanship - further to normal use and service. Labour and collateral damages to the vehicle may be covered only if the failed part or accessory was installed by a BRP authorized Off-road dealer / distributor.

Use other than which the product is designed for will void the product limited warranty.

Not Installed By Your Authorized Dealer / Distributor

For a period of **TWELVE (12) months** (unless otherwise stipulated or required by law) starting from the date of the retail sale, BRP will repair or replace BRP genuine Parts and Accessories if found defective in material and/or workmanship further to normal use and service. Labour and collateral damages to the vehicle are not covered if the failed part or accessory was not installed by a BRP authorized dealer / distributor.

Use other than which the product is designed for will void the product limited warranty.

BRP INTERNATIONAL LIMITED WARRANTY: CAN-AM WINCH

Bombardier Recreational Products Inc. ("BRP") warrants its Can-Am winch sold by Can-Am Off-road dealers and/or distributors authorized to distribute Can-Am winch outside of the United States of America, Canada, member states of the European Economic Area (which is comprised of the states of the European Union plus the United Kingdom, Norway, Iceland and Liechtenstein), Turkey, member states of the Commonwealth of Independent States (including Ukraine and Turkmenistan) from defects in material or workmanship for the period and under the conditions described below.

Factory Installed On Your New BRP Vehicle

Normal vehicle warranty will apply to this accessory.

Please refer to your specific unit's BRP Operator's Guide for details.

Use other than which the product is designed for will void the product limited warranty.

Installed by Your Authorized Dealer / Distributor On Your New or Used BRP Vehicle

For a period of **TWELVE (12) months** (unless otherwise stipulated or required by law) starting from the date of the retail sale, this limited warranty covers Parts, Accessories, and labour. BRP will repair or replace genuine BRP Parts and Accessories found defective in material and/or workmanship - further to normal use and service. Labour and collateral damages to the vehicle may be covered only if the failed part or accessory was installed by a BRP authorized Off-road dealer / distributor.

Use other than which the product is designed for will void the product limited warranty.

Not Installed By Your Authorized Dealer / Distributor

For a period of **TWELVE (12) months** (unless otherwise stipulated or required by law) starting from the date of the retail sale, BRP will repair or replace BRP genuine Parts and Accessories if found defective in material and/or workmanship further to normal use and service. Labour and collateral damages to the vehicle are not covered if the failed part or accessory was not installed by a BRP authorized dealer / distributor.

Use other than which the product is designed for will void the product limited warranty.

BRP LIMITED WARRANTY FOR THE EUROPEAN ECONOMIC AREA, THE COMMONWEALTH OF THE INDEPENDENT STATES AND TURKEY: CAN-AM WINCH

Bombardier Recreational Products Inc. ("BRP") warrants its Can-Am winch sold by Can-Am Off-road dealers and/or distributors authorized to distribute Can-Am winch in member states of the European Economic Area (which is comprised of the states of the European Union plus the United Kingdom, Norway, Iceland and Liechtenstein), in member states of the Commonwealth of Independent States (including Ukraine and Turkmenistan) and Turkey from defects in material or workmanship for the period and under the conditions described below.

Factory Installed On Your New BRP Vehicle

Normal vehicle warranty will apply to this accessory.

Please refer to your specific unit's BRP Operator's Guide for details.

Use other than which the product is designed for will void the product limited warranty.

Installed by Your Authorized Dealer / Distributor On Your New or Used BRP Vehicle

For a period of **TWELVE (12) months** (unless otherwise stipulated or required by law) starting from the date of the retail sale, this limited warranty covers Parts, Accessories, and labour. BRP will repair or replace genuine BRP Parts and Accessories found defective in material and/or workmanship - further to normal use and service. Labour and collateral damages to the vehicle may be covered only if the failed part or accessory was installed by a BRP authorized Off-road dealer / distributor.

Use other than which the product is designed for will void the product limited warranty.

Not Installed By Your Authorized Dealer / Distributor

For a period of **TWELVE (12) months** (unless otherwise stipulated or required by law) starting from the date of the retail sale, BRP will repair or replace BRP genuine Parts and Accessories if found defective in material and/or workmanship further to normal use and service. Labour and collateral damages to the vehicle are not covered if the failed part or accessory was not installed by a BRP authorized dealer / distributor.

Use other than which the product is designed for will void the product limited warranty.

CUSTOMER INFORMATION

DATA PRIVACY INFORMATION

Bombardier Recreational Products inc., its affiliates and subsidiaries (“BRP”) is committed to protecting your privacy and support a general policy of openness about how we collect, use and disclose your personal information in the course of managing our relationship with you. **More details can be found by visiting BRP’s Privacy Policy at: <https://brp.com/en/privacy-policy.html> or by scanning the QR Code below.**

Please be assured that we have appropriate security measures in place to ensure that your personal information is protected against loss and unauthorized access.

Your personal information that may be collected by BRP, directly from you or from authorized dealers or authorized third parties, includes:

- **Contact, Demographic & Registration Information** (e.g., name, full address, phone number, email, gender, ownership history, language of communication)
- **Vehicle Information** (e.g., serial number, purchase and delivery date, unit usage, vehicle location and movements)
- **Third Party Information** (e.g., information received from BRP partners, joint-marketing activities information, social media)
- **Technological Information** (e.g., IP address, type of device, operating system, browser type, webpages you view, cookies and similar technologies when you use BRP or dealers’ websites or mobile application)
- **Interaction with BRP Information** (e.g., information collected when you call BRP’s in-house sales representatives, buy items on a BRP web Site, sign up for BRP emails, participate in BRP-sponsored contests and sweepstakes or attend BRP-sponsored events)
- **Transactional Information** (e.g., information necessary to handle returns, payment information when you purchase our products or services through our websites or mobile applications and other issues related to your purchase of BRP products)

This information may be used and processed for the following purposes:

- Safety & Security
- Customer Support for Sales & After Sales (e.g., complete or follow up with you about your purchase or maintenance)
- Registration & Warranty
- Communication (e.g., sending you a BRP satisfaction survey)
- Online Behavioural Advertising, Profiling and Location-Based Services (e.g., offer customized experience)
- Compliance & Dispute Resolution
- Marketing & Advertising
- Assistance (e.g., help with any delivery issues, handle returns, and other issues related to your purchase of BRP products).

We also may use personal information to generate aggregated or statistical data that no longer identifies you personally.

Your personal information may be disclosed to the following: BRP, BRP’s authorized dealerships, distributors, service providers, advertising & market research partners and other authorized third parties.

We may receive information about you from diverse sources, including third parties, such as BRP’s authorized dealerships and partners, with whom we offer

services or engage in joint-marketing activities. We may also receive information about you from social media platforms such as Facebook and Twitter, when you interact with us on those platforms.

Depending on the circumstances, your personal information may be communicated outside the region where you reside. Your personal information is retained only for as long as necessary for the purpose for which we obtained it and according to our retention policies.

To exercise your data privacy rights (e.g. right of access, right of rectification), to withdraw your consent in order to be removed from the address list for marketing purposes or for the satisfaction survey or for general data privacy questions, please contact BRP's Data Protection Officer at or by mail at **privacyofficer@brp.com** or by mail at:
BRP Legal Service, 726 St-Joseph, Valcourt, Quebec, Canada, J0E 2L0.

When BRP processes your personal information, they do so in compliance with its Privacy Policy available at: <https://www.brp.com/en/privacy-policy.html> or by using the following QR Code.



CONTACT US

www.brp.com

Asia Pacific

BRP Asia

107D and 107E, 17/F, Tower 1,
Grand Century Place, Mongkok,
Kowloon, Hong Kong

Australia

Level 26
477 Pitt Street
Sydney, NSW 2020

China

上海市徐汇区衡山路10号6号楼301
Rm 301, Building 6,
No.10 Heng Shan Rd,
Shanghai, China

Japan

21F Shinagawa East One Tower
2-16-1 Konan, Minato-ku-ku,
Tokyo 108-0075

New Zealand

Suite 1.6, 2-8 Osborne Street,
Newmarket, Auckland 2013

Europe, Middle East and Africa

Belgium

Oktrooi plein 1
9000 Gent

Czech Republic

Stefanikova 43a
Prague 5
150 00

Germany

Itterpark 11
40724 Hilden

Finland

Isoaavantie 7
PL 8040
96101 Rovaniemi

France

Arteparc Bâtiment B
Route de la côte d'Azur,

13 590 Meyreuil

Norway

Ingvald Ystgaardsvei 15
N-7484 Trondheim
Salg, marketing, ettermarked

Sweden

Spinnvägen 15
903 61 Umeå
Sweden 90821

Switzerland

Avenue d'Ouchy 4-6
1006 Lausanne

Latin America

Brazil

Av. James Clerck Maxwell, 230
Campinas, Sao Paulo
CEP 13069-380

Mexico

Av. Ferrocarril 202
Parque Industrial Querétaro
Santo Rosa Jauregui, Querétaro
C.P. 76220

North America

Canada

3200A, rue King Ouest,
Suite 300
Sherbrooke (Québec) J1L 1C9

United States of America

10101 Science Drive
Sturtevant, Wisconsin
53177

CHANGE OF ADDRESS AND OWNERSHIP

If your address has changed or if you are the new owner of the vehicle, be sure to notify BRP by either:

- Notifying an authorized Can-Am dealer.
- **North America Only:** calling at 1 888 272-9222.
- Mailing one of the change of address cards on the following pages at one of the BRP addresses indicated in the *Contact Us* section of this guide.

In case of change of ownership, please join a proof that the former owner agreed to the transfer.

Notifying BRP, even after the expiration of the limited warranty, is very important as it enables BRP to reach the vehicle owner if necessary, like when safety recalls are initiated. It is the owner's responsibility to notify BRP.

STOLEN UNITS: If your personal vehicle is stolen, you should notify BRP or an authorized Can-Am dealer. We will ask you to provide your name, address, phone number, the vehicle identification number and the date it was stolen.

CHANGE OF ADDRESS CHANGE OF OWNERSHIP 

VEHICLE IDENTIFICATION NUMBER

--	--	--	--	--	--	--	--	--	--	--	--	--	--	--	--	--	--	--

Model Number Vehicle Identification Number (V.I.N.)

OLD ADDRESS OR PREVIOUS OWNER:

NAME

NO. STREET APT

CITY STATE/PROVINCE ZIP/POSTAL CODE

COUNTRY TELEPHONE

NEW ADDRESS OR NEW OWNER:

NAME

NO. STREET APT

CITY STATE/PROVINCE ZIP/POSTAL CODE

COUNTRY TELEPHONE

E-MAIL ADDRESS

CHANGE OF ADDRESS CHANGE OF OWNERSHIP 

VEHICLE IDENTIFICATION NUMBER

--	--	--	--	--	--	--	--	--	--	--	--	--	--	--	--	--	--	--

Model Number Vehicle Identification Number (V.I.N.)

OLD ADDRESS OR PREVIOUS OWNER:

NAME

NO. STREET APT

CITY STATE/PROVINCE ZIP/POSTAL CODE

COUNTRY TELEPHONE

NEW ADDRESS OR NEW OWNER:

NAME

NO. STREET APT

CITY STATE/PROVINCE ZIP/POSTAL CODE

COUNTRY TELEPHONE

E-MAIL ADDRESS

This page is
intentionally blank

This page is
intentionally blank

NOTE: _____

NOTE: _____

NOTE: _____

NOTE: _____

NOTE: _____

NOTE: _____

NOTE: _____

NOTE: _____

NOTE: _____

NOTE: _____

Model No. _____

VEHICLE

IDENTIFICATION NUMBER (V.I.N.) _____

ENGINE

IDENTIFICATION NUMBER (E.I.N.) _____

Owner: _____

NAME

No.

STREET

APT

CITY

STATE/PROVINCE

ZIP/POSTAL CODE

Purchase Date _____

YEAR

MONTH

DAY

Warranty Expiry Date _____

YEAR

MONTH

DAY

To be completed by the dealer at the time of the sale.

DEALER IMPRINT AREA

⚠ WARNING

TO REDUCE THE RISK OF SERIOUS INJURY PR DEATH, read this User's Guide and safety labels.

AVOID INJURIES

- All moving components may create hazardous situations, which can be avoided when following proper usage of the winch. Refer to all instructions in this guide to help you proceed in a safe manner, but always remain of dangers specific to your application. Each situation has it own risks.

OPERATE RESPONSIBLY

- Always inspect and confirm the safe operation condition of your which prior to winching.
- Never allow anyone to operate the winch unless this person is responsible and has experience with winching. Consider supervising new operators.
- Discuss the safety information with anyone who will be using the winch. Be sure that everyone understandings the signs for proper winching.

BE QUALIFIED AND RESPONSIBLE

- Become completely familiar with the operational controls.
- Never use this winch with drugs or alcohol, or if tired or ill. These slow reaction time and impair judgment.

®TM and the BRP logo are trademarks of BOMBARDIER RECREATIONAL PRODUCTS INC. or its affiliates.

©2024 BOMBARDIER RECREATIONAL PRODUCTS INC. ALL RIGHTS RESERVED.

www.brp.com

ALUMACRAFT®

CAN-AM®

LYNX®

MANITOU®

QUINTREX®

ROTAX®

SEA-DOO®

SKI-DOO®