

can-am[®]

OUTLANDER MAX 6X6 SERIES

OPERATOR'S GUIDE

Includes Safety, Use and Maintenance Information

NOISE

⚠ WARNING

Read this operator's guide thoroughly. It contains important safety information.
Minimum recommended operator age: 16 or older.
Keep this operator's guide with the vehicle at all times.

219002212

Original Instructions

⚠ WARNING

YOUR VEHICLE CAN BE HAZARDOUS TO OPERATE. A collision or roll-over can occur quickly, if you fail to take proper precautions, even during routine maneuvers such as turning and driving on hills or over obstacles. For your safety, understand and follow all the warnings contained in this operator's guide and on the labels on your vehicle. Failure to follow these warnings can result in **SEVERE INJURY OR DEATH.** Keep this operator's guide with the vehicle at all times.

⚠ WARNING

Disregarding any of the safety precautions and instructions contained in the Operator's Guide, Safety video and on product safety labels could cause injury including the possibility of death.

⚠ WARNING

This vehicle may exceed the performance of other vehicles you may have ridden in the past. Take time to familiarize yourself with your new vehicle.

CALIFORNIA PROPOSITION 65 WARNING

⚠ WARNING

Operating, servicing and maintaining an off-road vehicle can expose you to chemicals including engine exhaust, carbon monoxide, phthalates, and lead, which are known to the State of California to cause cancer and birth defects or other reproductive harm. To minimize exposure, avoid breathing exhaust, do not idle the engine except as necessary, service your vehicle in a well-ventilated area and wear gloves or wash your hands frequently when servicing your vehicle. For more information go to www.p65warnings.ca.gov/products/passenger-vehicle.

™® Trademarks of BRP or its affiliates.

This is a non-exhaustive list of trademarks that are the property of Bombardier Recreational Products Inc. or its affiliates:

Can-Am®

D.E.S.S.™

DPST™

Outlander™

ROTAX®

TTI™

XPST™

All rights reserved. No parts of this Manual may be reproduced in any form without the prior written permission of Bombardier Recreational Products Inc.

©Bombardier Recreational Products Inc. (BRP) 2021

Deutsch	Dieses Handbuch ist möglicherweise in Ihrer Landessprache verfügbar. Bitte wenden Sie sich an Ihren Händler oder besuchen Sie: www.operatorsguides.brp.com
English	This guide may be available in your language. Check with your dealer or go to: www.operatorsguides.brp.com
Español	Es posible que este manual esté disponible en su idioma. Consulte a su distribuidor o visite: www.operatorsguides.brp.com
Français	Ce guide peut être disponible dans votre langue. Vérifier avec votre concessionnaire ou aller à: www.operatorsguides.brp.com
Italiano	Questa guida potrebbe essere disponibile nella propria lingua. Contattare il concessionario o consultare: www.operatorsguides.brp.com
中文	本手册可能有您的语种的翻译版本。请向经销商询问，或者登录 www.operatorsguides.brp.com 查询。
日本語	このガイドは、言語によって翻訳版が用意されています。ディーラーに問い合わせるか、次のアドレスでご確認ください： www.operatorsguides.brp.com
Nederlands	Deze handleiding kan beschikbaar zijn in uw taal. Vraag het aan uw dealer of ga naar: www.operatorsguides.brp.com
Norsk	Denne boken kan finnes tilgjengelig på ditt eget språk. Kontakt din forhandler eller gå til: www.operatorsguides.brp.com
Português	Este manual pode estar disponível em seu idioma. Fale com sua concessionária ou visite o site: www.operatorsguides.brp.com
Русский	Воспользуйтесь руководством на вашем языке. Узнайте о его наличии у дилера или на странице по адресу www.operatorsguides.brp.com
Suomi	Käyttöohjekirja voi olla saatavissa omalla kielelläsi. Tarkista jälleenmyyjältä tai käy osoitteessa: www.operatorsguides.brp.com
Svenska	Denna bok kan finnas tillgänglig på ditt språk. Kontakta din återförsäljare eller gå till: www.operatorsguides.brp.com

Covered Models
Outlander MAX 6x6 650 DPS Outlander MAX 6x6 1000 XT

In Canada, products are distributed and serviced by Bombardier Recreational Products Inc. (BRP).

In the USA, products are distributed and serviced by BRP US Inc.

In the European Economic Area (which is comprised of the member states of the European Union plus the United Kingdom, Norway, Iceland and Liechtenstein), the Commonwealth of the Independent States (including Ukraine and Turkmenistan) and Turkey, products are distributed and serviced by BRP European Distribution S.A. and other affiliates or subsidiaries of BRP.

For all other countries, products are distributed and serviced by Bombardier Recreational Products Inc. (BRP) or its affiliates.

While reading this Operator's Guide, remember that:



WARNING

Indicates a potential hazard which, if not avoided, could result in serious injury or death.

TABLE OF CONTENTS

GENERAL INFORMATION

GENERAL INFORMATION	10
Know Before you Go	10
Safety Messages	11
About this Operator's Guide.....	11

SAFETY INFORMATION

GENERAL PRECAUTIONS	14
Avoid Carbon Monoxide Poisoning.....	14
Avoid Gasoline Fires and Other Hazards	14
Avoid Burns from Hot Parts	14
Accessories and Modifications.....	14
SPECIAL SAFETY MESSAGES	16
2-UP Models – Driver's Responsibilities	18
2-UP Models – Passenger's Responsibility.....	18
OPERATION WARNINGS	19
Physical Limitations of the Passenger	20
Carrying More than one (1) Passenger	21
Passenger(s) to sit on Front Rack or Rear Flat Bed	22
Vehicle on Public Streets, Roads or Highways	23
Vehicle on Paved Surfaces.....	24
Riding Without Protective gear.....	25
Wheelies, Jumps and Other Stunts	27
Unfamiliar Terrain	29
Operating on Excessively Rough, Slippery or Loose Terrain	30
Turning Improperly.....	31
Excessively Steep Hills	32
Climbing Hills	33
Down a Hill.....	34
Stalling, Rolling Backwards or Dismounting While Climbing a Hill	36
Operating Over Obstacles	37
Skidding or Sliding	38
Deep or Fast Flowing Water	39
Operating in Reverse	40
Tire Pressure	41
Improper Modifications.....	42
Loading, Carrying or Towing Cargo	43
PRE-RIDE INSPECTION	44
Pre-Ride Inspection Check List.....	44
RIDING THE VEHICLE	47
Riding Gear.....	48
Carrying a Passenger	48
Recreational Riding	49
Environment.....	49
Design Limitation	50
Off-Road Operation	50
Riding Techniques.....	50
MOVING LOADS AND DOING WORK	59
Working with Your Vehicle.....	59

Carrying Loads	59
IMPORTANT ON-PRODUCT LABELS (CANADA/UNITED STATES)	64
Safety Hang Tag	64
Safety Labels	65
Compliance Labels	80
Technical Information Labels	80
REPORTING SAFETY DEFECTS	82

VEHICLE INFORMATION

PRIMARY CONTROLS	84
Handlebar	85
Throttle Lever	85
Brake Lever	85
Parking Brake Lever	85
Brake Pedal	86
Engine Stop Switch	86
RF D.E.S.S. Key and Post	87
Ignition Switch and Keys	87
SECONDARY CONTROLS	89
Throttle Lever Control Housing	90
Shift Lever	90
Multifunction Switch	91
Horn Button	93
EQUIPMENT	94
Operator's Seat	95
Passenger's Seat	95
Grab Handles (2-UP Models)	96
Footpegs	96
12-Volt Power Outlet	97
Glove Box	97
Tool Kit	98
Winch	98
Cargo Bed Tilt Release Handle	99
Rear Storage Compartment	100
Trailer Hitch	101
Cargo Box Anchoring Hooks	101
Recovery Hook	101
Side Wall	101
MULTIFUNCTION GAUGE (LCD)	105
Multifunction Gauge Description	105
Multifunction Gauge Modes	106
Navigating in the LCD Gauge	107
Gauge Setup	108
4.5" DIGITAL DISPLAY	110
Multifunction Display	110
Indicator Lamps	111
Settings	112
FUEL	114
Fuel Requirements	114
Vehicle Fueling Procedure	115

BREAK-IN PERIOD	116
Operation During Break-In.....	116
BASIC PROCEDURES	117
Waking Up the Electrical System	117
Starting the Engine	117
Changing Gear Selection	117
Stopping the Engine and Parking the Vehicle.....	117
SPECIAL PROCEDURES	119
Flooded Engine	119
Water Into the CVT	119
Water Into the Air Filter Housing	119
Vehicle is Turned Over.....	120
Vehicle is Immersed in Water	120
TUNE YOUR RIDE	122
Usage of Unlockable Stabilizer Bar	122
Suspension Adjustment	122
Dynamic Power Steering (DPS) Assist Level Adjustment (Models with DPS)	123
TRANSPORTING THE VEHICLE	125
Using Vehicle Power to Climb Onto Trailering Equipment	125
Using a Winch to Pull Vehicle Onto Trailering Equipment.....	126
Securing vehicle for transport	126
Getting Vehicle Out of Trailer.....	127

MAINTENANCE

MAINTENANCE SCHEDULE	130
EPA Regulation - Canadian and USA Vehicles	130
Severe Dusty Conditions.....	130
Maintenance Schedule Legend.....	131
Maintenance Schedule.....	131
MAINTENANCE PROCEDURES	135
Resetting the Message: Maintenance Required	135
Engine Air Filter.....	135
CVT Air Filter.....	138
Engine Oil	139
Engine Oil Filter.....	141
Fuel Vent Breather Filter	142
Radiator.....	143
Engine Coolant.....	143
Muffler and Spark Arrester.....	146
Gearbox.....	147
Throttle Cable.....	149
Spark Plugs.....	151
CVT Cover	151
Drive Belt	153
Drive and Driven Pulleys	154
Battery	154
Fuses	155
Lights.....	157
Drive Shaft Bellow and Protector.....	158
Wheel Bearing.....	159

Wheels and Tires	159
Steering	160
Suspension	160
Brakes	161
VEHICLE CARE	164
Post-Operation Care	164
Vehicle Cleaning and Protection	164
STORAGE AND PRESEASON PREPARATION	165

TECHNICAL INFORMATION

VEHICLE IDENTIFICATION	168
Vehicle Identification Number	168
Engine Identification Number (EIN)	168
Compliance Label	168
Radio Frequency Digitally Encoded Security System (RF D.E.S.S. key) ..	169
RADIO FREQUENCY DIGITALLY ENCODED SECURITY SYSTEM (RF D. E.S.S. KEY)	170
NOISE EMISSION CONTROL SYSTEM REGULATION (CANADA/UNITED STATES)	171
EC-DECLARATION OF CONFORMITY	172
EAC DECLARATION OF CONFORMITY	173

TECHNICAL SPECIFICATIONS

TECHNICAL SPECIFICATIONS	176
---------------------------------------	------------

TROUBLESHOOTING

TROUBLESHOOTING GUIDELINES	184
Engine Does Not Turn	184
Engine Turns Over But Fails To Start	184
Engine Lacks Acceleration or Power	185
Engine Overheats	186
Engine Backfire	186
Engine Misfire	186
Vehicle Cannot Reach Full Speed	186
Shift Lever Is Hard To Move	187
The RPM Increases But The Vehicle Does Not Move	187
Reduced Power Steering Assist	187

MULTIFUNCTION GAUGE (LCD) MESSAGES 189
 DIGITAL DISPLAY MESSAGES..... 191

WARRANTY

BRP LIMITED WARRANTY USA AND CANADA: 2022 CAN-AM® ATV .. 194
 US EPA EMISSION - RELATED WARRANTY 198
 CALIFORNIA EVAPORATIVE EMISSIONS CONTROL WARRANTY
 STATEMENT 201
 BRP INTERNATIONAL LIMITED WARRANTY: 2022 CAN-AM® ATV 204
 BRP LIMITED WARRANTY FOR THE EUROPEAN ECONOMIC AREAS,
 THE COMMONWEALTH OF THE INDEPENDENT STATES AND TURKEY:
 2022 CAN-AM® ATV 208
 MAINTENANCE RECORDS..... 212

CUSTOMER INFORMATION

PRIVACY INFORMATION..... 218
 CONTACT US 219
 Asia 219
 Europe..... 219
 North America 219
 Oceania 219
 South America..... 219
 CHANGE OF ADDRESS AND OWNERSHIP 220

This page is intentionally blank

GENERAL INFORMATION

GENERAL INFORMATION

Congratulations on your purchase of a new Can-Am® ATV vehicle. It's backed by the BRP limited warranty and a network of authorized Can-Am Off-road dealers ready to provide the parts, accessories or service you may require.

At delivery, you were informed of the warranty coverage and signed the Pre-delivery Check List to ensure your new vehicle was prepared to your entire satisfaction.

Your dealer is committed to your satisfaction. If you need more information, please ask your dealer.

Know Before you Go

To learn how to reduce the risk of accident for you or bystanders, read this Operator's Guide before you operate the vehicle.

Also, read all safety labels on your vehicle and watch the *Safety Video* located at:

<https://can-am.brp.com/off-road/safety>

Or use the following QR code.



This vehicle is for off-road use only. It is mainly for general recreational use but it may also be used for utility purposes.

Failure to follow the warnings contained in this Operator's Guide can result in **SERIOUS INJURY** or **DEATH**.

Age Recommendation

This vehicle is a category G, always follow this age recommendation:

- A person under 16 years old should never operate this vehicle.
- Passenger on 2-UP models must be capable of keeping his feet on the footrests and his hands on grab handles at all times when seated on this vehicle.

Training Course

Never operate this vehicle without proper instruction. **Take a training course.** All operators should receive training from a certified instructor.

For more information about ATV safety, contact an authorized Can-Am Off-road dealer to find out about available training courses nearest you.

In the United States, call the Specialty Vehicle Institute of America (SVIA) at 1 800 887-2887 or in Canada, the Canada Safety Council (CSC) at 1 613 739-1535.

Safety Messages

The types of safety messages, what they look like and how they are used in this guide are explained as follows:

The safety alert symbol  indicates a potential injury hazard.

WARNING

Indicates a potential hazard which, if not avoided, could result in serious injury or death.

CAUTION

Indicates a hazardous situation which, if not avoided, could result in minor or moderate injury.

NOTICE

Indicates an instruction which, if not followed, could result in severely damaged vehicle components or other property.

About this Operator's Guide

This Operator's Guide has been prepared to acquaint the owner/operator of a new vehicle with the various vehicle controls, maintenance and safe operating instructions. It is indispensable for the proper use of the product.

Keep this Operator's Guide in the vehicle as you can refer to it for things such as maintenance, troubleshooting and instructing others.

Note that this guide is available in several languages. In the event of any discrepancy, the English version shall prevail.

If you want to view and/or print an extra copy of your Operator's Guide, simply visit the following website:

www.operatorsguides.brp.com

The information contained in this document is correct at the time of publication. BRP, however, maintains a policy of continuous improvement of its products without imposing upon itself any obligation to install them on products previously manufactured. Due to late changes, some differences between the manufactured product and the descriptions and/or specifications in this guide may occur. BRP reserves the right at any time to discontinue or change specifications, designs, features, models or equipment without incurring any obligation upon itself.

This Operator's Guide should remain with the vehicle when it is sold.

While reading this Operator's Guide, remember that:



WARNING

Indicates a potential hazard which, if not avoided, could result in serious injury or death.

SAFETY INFORMATION

GENERAL PRECAUTIONS

Avoid Carbon Monoxide Poisoning

All engine exhaust contains carbon monoxide, a deadly gas. Breathing carbon monoxide can cause headaches, dizziness, drowsiness, nausea, confusion and eventually death.

Carbon monoxide is a colorless, odorless, tasteless gas that may be present even if you do not see or smell any engine exhaust. Deadly levels of carbon monoxide can collect rapidly, and you can quickly be overcome and unable to save yourself. Also, deadly levels of carbon monoxide can linger for hours or days in enclosed or poorly ventilated areas. If you experience any symptoms of carbon monoxide poisoning, leave the area immediately, get fresh air and seek medical treatment.

To prevent serious injury or death from carbon monoxide:

- Never run the vehicle in poorly ventilated or partially enclosed areas such as garages, carports or barns. Even if you try to ventilate engine exhaust with fans or open windows and doors, carbon monoxide can rapidly reach dangerous levels.
- Never run the vehicle outdoors where engine exhaust can be drawn into a building through openings such as windows and doors.

Avoid Gasoline Fires and Other Hazards

Gasoline is extremely flammable and highly explosive. Fuel vapors can spread and be ignited by a spark or flame many feet away from the engine. To reduce the risk of fire or explosion, follow these instructions:

- Use only an approved red gasoline container to store fuel.
- The container must be firmly secured to the cargo box and placed so that it does not touch the ground in the event of an overturning. BRP LinQ containers are highly recommended.
- Never fill a gasoline container on the vehicle. An electrical static discharge may ignite the fuel.
- For refueling, strictly adhere to instructions in *Fuel*.
- Never start or operate the engine if the fuel cap is not properly installed.

Gasoline is poisonous and can cause injury or death.

- Never siphon gasoline by mouth.
- If you swallow gasoline, get any in your eye(s), or inhale gasoline vapor, see your doctor immediately.

If gasoline spills on you, wash with soap and water and change your clothes.

Avoid Burns from Hot Parts

Certain components like brake rotors and exhaust components become hot during operation. Avoid contact with those parts during and shortly after operation to avoid burn wounds.

Accessories and Modifications

Any modifications or addition of accessories approved by BRP may affect the handling of your vehicle. It is important to take the time to get familiar with the

vehicle once modifications are made to understand how to adapt your driving behavior accordingly.

Avoid installing equipment not specifically approved by BRP for the vehicle and avoid unauthorized modifications. These modifications and equipment have not been tested by BRP and may create hazards. For example, they could:

- Create a loss of control and increase risk of crash
- Cause overheating or short circuits increasing the risk of fire or burn injuries
- Affect the protection features provided by the vehicle.

Your vehicle may also become illegal to ride.

As an example, installing an additional GPS or cell phone support may prevent the driving capabilities of the vehicle and increase the risk of a loss of control.

Ask your authorized BRP dealer for suitable available accessories for your vehicle.

SPECIAL SAFETY MESSAGES

THIS VEHICLE IS NOT A TOY AND CAN BE HAZARDOUS TO OPERATE.

- This vehicle handles differently from other vehicles including motorcycles and cars. A collision or rollover can occur quickly, if you fail to take proper precautions, even during routine maneuvers such as turning and driving on hills or over obstacles.

SEVERE INJURY OR DEATH can result if you do not comply with the following instructions:

- Read this Operator's Guide and all on-product safety labels carefully and follow the operating procedures described. Watch and pay attention to the safety video before operating the vehicle.
- Always follow this age recommendation: A person under 16 years old should never operate this vehicle.
- Never carry a passenger on this vehicle unless you are operating a 2-UP model. Passenger(s) affect balance and steering and increase risk of losing control.
- This vehicle is not designed to ride on paved surfaces; if you must shortly use the vehicle on such surfaces, avoid abrupt inputs to steering, accelerator and brakes. Reduce your speed.
- This vehicle is not designed for riding on roads or highways (in most places it is an illegal practice). Riding your vehicle on roads or highways could cause a collision with another vehicle.
- Never take place on this vehicle without wearing an approved helmet of the proper size and other required riding gears. Refer to *Riding Gear* in *Riding the Vehicle* for detailed information.
- Never use this vehicle if you are tired, ill or with drugs or alcohol. Your reaction time and judgement is greatly affected under these conditions.
- Never attempt wheelies, jumps, or other stunts.
- Never operate at excessive speeds. Always go at a speed that is proper for the terrain, visibility, and operating conditions, and your experience.
- Always go slowly and be extra careful when operating on unfamiliar terrain. Always be alert to changing terrain conditions when operating this vehicle.
- Never operate on excessively rough, slippery or loose terrain until you have learned and practiced the skills necessary to control this vehicle on such terrain. Always be especially cautious on these kinds of terrain.
- Always follow proper procedures for turning as described in *Riding Techniques* in this Operator's Guide.
- Never operate this vehicle on hills too steep for the vehicle or for your abilities.
- Always follow proper procedures for climbing hills as described in *Riding Techniques* in this Operator's Guide. Check the terrain carefully before you start up any hill. Never climb hills with excessively slippery or loose surfaces.
- Always follow proper procedures for going down hills and for braking on hills as described in *Riding Techniques* in this Operator's Guide. Check the terrain carefully before you start down any hill.
- Always follow proper procedures for crossing the side of a hill as described in *Riding Techniques* in this Operator's Guide. Avoid hills with excessively slippery or loose surfaces.
- Always use proper procedures if you stall or roll backwards when climbing a hill. To avoid stalling, use low gear and maintain a steady speed when climbing a hill. If you stall or roll backwards, follow the driving technique procedures as described in *Riding Techniques* in this Operator's Guide.

- Always check for obstacles before operating in a new area. Never attempt to operate over large obstacles, such as large rocks or fallen trees. Always follow proper procedures when operating over obstacles as described in *Riding Techniques* in this Operator's Guide.
- Always be careful when skidding or sliding. Learn to safely control skidding or sliding by practicing at low speeds and on level smooth terrain. On extremely slippery surfaces, such as ice, go slowly and be very cautious in order to reduce the chance of skidding out of control. If you are operating a 2-UP model and have a passenger on-board, never attempt skidding or sliding; overturn or passenger ejection may occur.
- Never operate this vehicle through deep or fast flowing water. Water should never exceed footrests. Remember that wet brakes may have reduced stopping ability. Test your brakes after leaving water, mud or snow. If necessary, apply them several times to let friction dry out the pads.
- Always keep in mind that braking distance is readily affected by but not limited to; weather and terrain conditions, braking system and tire conditions, vehicle speed and attitude, and vehicle load including towing. Remember to adjust your driving accordingly.
- Always be sure there are no obstacles or people behind the vehicle when you operate in reverse. When it is safe to proceed in reverse, go slowly. Take into account that on a 2-UP model the passenger can obstruct your view.
- BRP recommends sitting on your ATV when operating in reverse. Avoid standing up. Your weight could shift forward against throttle lever, causing an unexpected acceleration and may lead to a loss of control.
- Never exceed the stated load limits for this vehicle including operator, passenger (2-UP models) and all other loads and added accessories. Cargo should be properly distributed and securely attached. Reduce speed and follow instructions in this guide for carrying cargo or pulling a trailer. Allow greater distance for braking.
- Always inspect and confirm the safe operating condition of your vehicle prior to ride. Refer to *Pre-ride Inspection*. Always follow the maintenance schedules as described in this Operator's Guide. Refer to *Maintenance* section.
- Never operate the vehicle if the controls do not function normally.
- Always maintain proper tire pressure. When replacing tires, use only the recommended tire size and type. For tire information, refer to *Technical Specifications* in this guide.
- Riding your vehicle too fast for your skills or the conditions may result in injury. Apply only enough throttle to proceed safely. Statistics show that high speed turns usually result in mishaps and injury. Always remember that this vehicle is heavy! Its pure weight alone may entrap you should it fall resulting in injury.
- This vehicle is not designed for jumping, nor can it fully absorb the high impact energy generated during manoeuvres such as jumping which, can be passed on to you, the operator. Performing wheelies can cause the vehicle to flip over onto you. Both practices have a high risk for you and should be avoided at all times.
- The tires of this vehicle are not suited for paved road use.
- This vehicle is not designed for jumping, nor can it fully absorb the high impact energy generated during manoeuvres such as jumping which, can be passed on to you, the operator. Performing wheelies can cause the vehicle to flip over onto you. Both practices have a high risk for you and your passenger (2-UP models) and should be avoided at all times.

2-UP Models – Driver’s Responsibilities

Driver must:

- Not forget is responsible for the safety of the passenger.
- Inform the passenger concerning the basic rules for a safe ride.
- Instruct the passenger to read the vehicle’s safety labels and to watch the *safety video*.
- Always practice the maneuvers described in this Operator’s Guide without and with a passenger. Greater skills are required with a passenger.
- Always remember that the vehicle handling and stability may be affected when riding with a passenger. Safely reduce speed. Use proper judgement. If in doubt, do not attempt and disembark the passenger before executing any maneuver.
- Always remember that the vehicle braking distance may be longer when riding with a passenger. Allow greater distance for braking.
- Never carry passenger on a 2-UP model if the passenger seat is not properly installed.
- Never carry more than one (1) passenger. Do not allow passenger to sit anywhere else than the designated passenger’s seat.
- Never carry a passenger if you judge his ability or judgement insufficient to concentrate on the terrain conditions and adapt accordingly.
- Never carry a passenger who has used drugs or alcohol, or is tired or ill. These slow reaction time and impair judgment.

2-UP Models – Passenger’s Responsibility

Passenger must:

- Be capable of resting his feet on the footrests and his hands on grab handles when seated on this vehicle.
- Never take place on this vehicle without wearing an approved helmet (including a chin guard) that fits properly. The passenger should also wear eye protection (goggles or face shield), gloves, boots, long sleeved shirt or jacket, and long pants.
- Be seated on the designated passenger’s seat.
- Always keep hands on grab handles and feet on the footrests during operation. Never hold on to the operator.
- Never get up during vehicle operation. An excessive movement could cause loss of control.
- Pay attention to vehicle and operator movements.
- Not wait and tell the driver to slow down or stop if you feel uncomfortable or insecure for any reason.

OPERATION WARNINGS

The following warning and their format have been requested by the United States Consumer Product Safety Commission and are required to be in the Operator's Guide for all ATVs.

The following illustrations are general representations only. Your model may differ.

Operating Vehicle Without Proper Instruction

⚠ WARNING



POTENTIAL HAZARD

Operating this vehicle without proper instruction.

WHAT CAN HAPPEN

The risk of an accident is greatly increased if the operator does not know how to operate this vehicle properly in different situations and on different types of terrain.

HOW TO AVOID THE HAZARD

Beginners and inexperienced operators should complete a training course. They should then regularly practice the skills learned during the course as well as the operating techniques described in this Operator's Guide.

For more information about a training course, contact an authorized Can-Am dealer.

Age Recommendations

⚠ WARNING



POTENTIAL HAZARD

Failure to follow the age recommendations for this vehicle.

WHAT CAN HAPPEN

A lack of respect for this age recommendation can lead to severe injury or death of the child.

Even though a child may be within the age group for which this vehicle is recommended, he may not have the skills, abilities, or judgment needed to operate this vehicle safely and may be involved in a serious accident.

HOW TO AVOID THE HAZARD

No one under 16 should operate this vehicle.

Physical Limitations of the Passenger

⚠ WARNING



POTENTIAL HAZARD

Failure to respect the physical limitations of the passenger on 2-UP models.

WHAT CAN HAPPEN

A passenger that cannot completely lean his feet on footrests can be ejected when riding on uneven terrain.

HOW TO AVOID THE HAZARD

The passenger must be capable of keeping his feet on the footrests and his hands on grab handles at all times when he is seated on the vehicle.

Carrying More than one (1) Passenger

WARNING



POTENTIAL HAZARD

Carrying more than one (1) passenger on this vehicle.

WHAT CAN HAPPEN

Carrying more than one (1) passenger reduces your ability to balance and control this vehicle.

Could cause an accident, resulting in harm to you and/or your passengers.

HOW TO AVOID THE HAZARD

Never carry more than one (1) passenger. Even with a long seat that provides unrestricted operator movement, the vehicle is not designed nor intended to carry more than one (1) operator and one (1) passenger.

The passenger must use the designated passenger's seat when he is seated on the vehicle with feet firmly planted on footrests and always hold on to the grab handles.

Passenger(s) to sit on Front Rack or Rear Flat Bed

⚠ WARNING



POTENTIAL HAZARD

Allowing passenger(s) to sit on front rack or rear flat bed on this vehicle.

WHAT CAN HAPPEN

Allowing a passenger could:

- Impair vehicle stability which could lead to a loss of control.
- Result in injury to passenger(s) from impact on hard surfaces.
- Cause an accident, resulting in harm to you and/or your passenger(s).

HOW TO AVOID THE HAZARD

Never allow any passenger to sit on front rack or rear flat bed on this vehicle.

Vehicle on Public Streets, Roads or Highways

WARNING



POTENTIAL HAZARD

Operating this vehicle on public streets, roads or highways.

WHAT CAN HAPPEN

You can collide with another vehicle.

HOW TO AVOID THE HAZARD

Never operate this vehicle on any public street, road or highway, even a dirt or gravel one. In many states it is illegal to operate this vehicle on public streets, roads and highways.

Vehicle on Paved Surfaces

 **WARNING**



POTENTIAL HAZARD

Operating this vehicle on paved surfaces.

WHAT CAN HAPPEN

The tires are designed for off-road use only, not for use on pavement. Paved surfaces may seriously affect handling and control of this vehicle, and may cause the vehicle to go out of control.

HOW TO AVOID THE HAZARD

Never operate this vehicle on any paved surfaces, including sidewalks, driveways, parking lots and streets.

Riding Without Protective gear

⚠ WARNING



POTENTIAL HAZARD

Riding this vehicle without wearing an approved helmet, eye protection and protective gear. On 2-UP models, passenger should also have an approved helmet with a rigid chin guard.

WHAT CAN HAPPEN

- Riding without an approved helmet increases the chances of a severe head injury or death in the event of an accident.
- Riding without eye protection can result in an accident and increases the chances of a severe injury in the event of an accident.
- Riding without protective gear increases the chances of severe injury in the event of an accident.

HOW TO AVOID THE HAZARD

Always wear an approved helmet that fits properly. You should also wear:

- Eye protection (goggles or face shield)
- Rigid chin guard
- Gloves and boots
- Long sleeved shirt or jacket
- Long pants.

Drugs or Alcohol

WARNING



V50A670

POTENTIAL HAZARD

Using this vehicle with drugs or alcohol.

WHAT CAN HAPPEN

Could cause the passenger to fall off (2-UP models).

Could seriously affect your judgment.

Could cause you to react more slowly.

Could affect your balance and perception.

Could result in an accident or death.

HOW TO AVOID THE HAZARD

The operator and the passenger (2-UP models) should never use this vehicle with drugs or alcohol.

Excessive Speeds

WARNING

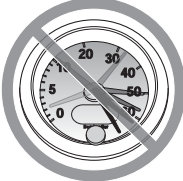

V50A670

POTENTIAL HAZARD

Operating this vehicle at excessive speeds.

WHAT CAN HAPPEN

Increases your chances of losing control of the vehicle, which can result in an accident.

HOW TO AVOID THE HAZARD

Always travel at a speed which is appropriate for the terrain, visibility and operating conditions, and your experience.

On 2-UP models, the vehicle handling, stability and braking distance may be affected when riding with a passenger. Safely reduce speed when riding with a passenger. Allow greater distance for braking.

Wheelies, Jumps and Other Stunts

WARNING



POTENTIAL HAZARD

Attempting wheelies, jumps and other stunts.

WHAT CAN HAPPEN

Increases the chance of an accident, including an overturn.

HOW TO AVOID THE HAZARD

Never attempt stunts, such as wheelies or jumps. Do not try to show off.

Vehicle Inspection

WARNING

POTENTIAL HAZARD

Failure to inspect the vehicle before operating.

Failure to properly maintain the vehicle.

WHAT CAN HAPPEN

Increases the possibility of an accident or equipment damage.

HOW TO AVOID THE HAZARD

Always inspect your vehicle prior to ride to make sure the vehicle is in safe operating condition.

Always follow the maintenance schedule described in this Operator's Guide.

Frozen Waterways

WARNING

POTENTIAL HAZARD

Riding on frozen waterways.

WHAT CAN HAPPEN

Breaking through the ice can lead to severe injury or death.

HOW TO AVOID THE HAZARD

Never ride this vehicle on a frozen surface before you are sure the ice is thick enough and sound enough to support the vehicle and its load, as well as the force that is created by a moving vehicle.

Proper Position on the Vehicle

WARNING



POTENTIAL HAZARD

Removing hands from handlebars for the operator and from grab handles for the passenger (2-UP models), or feet from the footrests during operation.

WHAT CAN HAPPEN

Removing even one hand or foot can reduce your ability to control the vehicle or could cause you to lose your balance and fall off the vehicle. If you remove a foot from the footrests, your foot or leg may come into contact with the rear wheels, which could injure you or cause an accident.

HOW TO AVOID THE HAZARD

Operator must always keep both hands on the handlebars and passenger (2-UP models) on grab handles. Both feet (operator and passenger on 2-UP models) must rest on the footrests during vehicle operation.

Unfamiliar Terrain

WARNING



POTENTIAL HAZARD

Failure to use extra care when operating this vehicle on unfamiliar terrain.

WHAT CAN HAPPEN

You can come upon hidden rocks, bumps, or holes, without enough time to react.

Could result in the vehicle overturning, passenger ejection (2-UP models) or loss of control.

HOW TO AVOID THE HAZARD

Go slowly and be extra careful when operating on unfamiliar terrain.

Always be alert to changing terrain conditions when operating the vehicle.

Do not forget, on 2-UP models, the operator is responsible for the safety of his passenger. Safely reduce speed when riding with a passenger.

Operating on Excessively Rough, Slippery or Loose Terrain

⚠ WARNING



POTENTIAL HAZARD

Failure to use extra care when operating on excessively rough, slippery or loose terrain.

WHAT CAN HAPPEN

Could cause loss of traction or vehicle control, which could result in an accident, including an overturn or passenger ejection (2-UP models).

HOW TO AVOID THE HAZARD

Do not operate on excessively rough, slippery or loose terrain until you have learned and practiced the skills necessary to control this vehicle on such terrain.

Always be especially cautious on these kinds of terrain.

Do not forget, on 2-UP models, the operator is responsible for the safety of the passenger. In doubt, disembark him before operating on these terrains.

Turning Improperly

WARNING



POTENTIAL HAZARD

Turning improperly.

WHAT CAN HAPPEN

Vehicle could go out of control, causing a collision or an overturn or a passenger ejection (2-UP models).

HOW TO AVOID THE HAZARD

Always follow proper procedures for turning as described in this Operator's Guide. Practice turning at low speeds before attempting to turn at faster speeds.

Do not forget, on 2-UP models, the operator is responsible for the safety of the passenger. Never perform this maneuver with a passenger. Always remember that the vehicle handling, stability and braking distance may be affected when riding with a passenger.

Do not turn at excessive speed.

Excessively Steep Hills

⚠ WARNING



POTENTIAL HAZARD

Operating on excessively steep hills.

WHAT CAN HAPPEN

The vehicle can overturn more easily on extremely steep hills than on level surfaces or small hills.

HOW TO AVOID THE HAZARD

Never operate this vehicle on hills too steep for the vehicle or for your abilities.

Practice, without and with passenger (2-UP models), on smaller hills before attempting larger hills.

Always remember that, on 2-UP models, even if this vehicle can climb some steep hills, it is not recommended to climb such hills with a passenger; always disembark him before attempting this maneuver. Show good judgement.

Climbing Hills

WARNING



POTENTIAL HAZARD

Climbing hills improperly.

WHAT CAN HAPPEN

Could cause loss of control, passenger ejection (2-UP models) or cause vehicle to overturn.

HOW TO AVOID THE HAZARD

Always follow proper procedures for climbing hills as described in this Operator's Guide.

Always check the terrain carefully before you start up any hill. Do not forget, on 2-UP models, the operator is responsible for the safety of the passenger. In doubt, disembark him before climbing hill. Always remember that the vehicle handling, stability and braking distance may be affected when riding with a passenger.

Never climb hills with excessively slippery or loose surfaces.

Shift your weight forward (operator and passenger on 2-UP models).

Never open the throttle suddenly or make sudden gear changes. The vehicle could flip over backwards.

Never go over the top of any hill at high speed. An obstacle, a sharp drop, or another vehicle or person could be on the other side of the hill.

Down a Hill

⚠ WARNING



POTENTIAL HAZARD

Going down a hill improperly.

WHAT CAN HAPPEN

Could cause loss of control, passenger ejection (2-UP models) or cause vehicle to overturn.

HOW TO AVOID THE HAZARD

Always follow proper procedures for going down hills as described in this Operator's Guide.

NOTE:

A special technique is required when braking as you go down a hill.

Always check the terrain carefully before you start down any hill. Do not forget, on 2-UP models, the operator is responsible for the safety of the passenger. In doubt, disembark him before going down hill. Always remember that the vehicle handling, stability and braking distance may be affected when riding with a passenger.

Shift your weight backward (operator and passenger on 2-UP models).

Never go down a hill at high speed.

Avoid going down a hill at an angle which would cause the vehicle to lean sharply to one side. Go straight down the hill where possible.

Crossing or Turning on Hills

WARNING



POTENTIAL HAZARD

Improperly crossing hills or turning on hills.

WHAT CAN HAPPEN

Could cause loss of control, passenger ejection (2-UP models) or cause vehicle to overturn.

HOW TO AVOID THE HAZARD

Never attempt this maneuver on 2-UP models when the passenger is on board. Always disembark him before executing.

Never attempt to turn the vehicle around on any hill until you have mastered the turning technique as described in this Operator's Guide on level ground. Be very careful when turning on any hill.

Avoid crossing the side of a steep hill if possible.

When crossing the side of a hill:

Always follow proper procedures as described further in this Operator's Guide.

Avoid hills with excessively slippery or loose surfaces.

Operator and passenger (2-UP models) must shift weight to the uphill side of the vehicle.

Stalling, Rolling Backwards or Dismounting While Climbing a Hill

WARNING



POTENTIAL HAZARD

Stalling, rolling backwards or improperly dismounting while climbing a hill.

WHAT CAN HAPPEN

Could result in vehicle overturning.

HOW TO AVOID THE HAZARD

Use low gear and maintain steady speed when climbing a hill.

If you lose all forward speed:

Operator and passenger (2-UP models) must keep their weight uphill.

Never open the throttle suddenly or make sudden gear changes. The vehicle could flip over backwards.

Apply the brakes.

Lock parking brake after you have stopped.

Disembark on uphill side, or to a side if pointed straight uphill (passenger first on 2-UP models).

If you begin rolling backwards:

Operator and passenger (2-UP models) must keep their weight uphill.

Never open the throttle suddenly or make sudden gear changes. The vehicle could flip over backwards.

Never apply the rear brake while rolling backwards.

Apply the front brake gradually.

When fully stopped, apply rear brake as well and lock parking brake.

Disembark on uphill side, or to a side if pointed straight uphill (passenger first on 2-UP models).

Turn the vehicle around and remount, following the procedure described further in this Operator's Guide.

Operating Over Obstacles

WARNING



POTENTIAL HAZARD

Improperly operating over obstacles.

WHAT CAN HAPPEN

Could cause loss of control (passenger ejection on 2-UP models), or a collision.

Could cause the vehicle to overturn.

HOW TO AVOID THE HAZARD

Before operating in a new area, check for obstacles.

Never attempt to ride over large obstacles, such as large rocks or fallen trees.

On 2-UP models, the operator is responsible for the safety of his passenger. In doubt, disembark him before riding over obstacles. Always remember that the vehicle handling and stability may be affected when riding with a passenger.

When you go over obstacles, always follow proper procedures as described in this Operator's Guide.

Skidding or Sliding

⚠ WARNING



POTENTIAL HAZARD

Skidding or sliding improperly.

WHAT CAN HAPPEN

You may lose control of this vehicle.

You may also regain traction unexpectedly, which may cause the vehicle to overturn or passenger ejection (2-UP models).

HOW TO AVOID THE HAZARD

Learn to safely control skidding or sliding by practicing at low speeds and on level smooth terrain.

On 2-UP models, never slide or skid with passenger. Always remember that the vehicle handling and stability may be affected when riding with a passenger.

On extremely slippery surfaces, such as ice, go slowly and be very cautious in order to reduce the chance of skidding or sliding out of control.

Deep or Fast Flowing Water

WARNING



POTENTIAL HAZARD

Operating this vehicle through deep or fast flowing water.

WHAT CAN HAPPEN

Tires may float, causing loss of traction and loss of control, which could lead to an accident.

HOW TO AVOID THE HAZARD

Never operate this vehicle in fast flowing water or in deep water.

Check water depth and current before you attempt to cross any water.

Water should not go above footrests.

Remember that wet brakes may have reduced stopping ability. Test your brakes after leaving water. If necessary, apply them several times to let friction dry out the pads.

Operating in Reverse

⚠ WARNING



POTENTIAL HAZARD

Improperly operating in reverse.

WHAT CAN HAPPEN

You could hit an obstacle or person behind the vehicle, resulting in serious injury.

HOW TO AVOID THE HAZARD

When you select reverse gear, make sure there are no obstacles or people behind the vehicle. When it is safe to proceed, go slowly. On 2-UP models, take account that the passenger can obstruct your view.

Tire Pressure

WARNING



POTENTIAL HAZARD

Operating this vehicle with improper tires, or with improper or uneven tire pressure.

WHAT CAN HAPPEN

Use of improper tires on this vehicle, or operation of this vehicle with improper or uneven tire pressure, may cause loss of control, tire blow outs, tire to move around on its rim, and increases the risk of an accident.

HOW TO AVOID THE HAZARD

Always use the size and type of tires specified in this Operator's Guide for this vehicle.

Always maintain proper tire pressure as described in this Operator's Guide.

Always replace wheels or tires that are damaged.

Improper Modifications

⚠ WARNING



POTENTIAL HAZARD

Operating this vehicle with improper modifications.

WHAT CAN HAPPEN

Improper installation of accessories or modification of this vehicle may cause changes in handling which in some situations could lead to an accident.

HOW TO AVOID THE HAZARD

Never modify this vehicle through improper installation or use of accessories. All parts and accessories added to this vehicle should be approved by BRP and should be installed and used according to instructions. If you have questions, consult an authorized Can-Am dealer.

NEVER install a passenger seat (1-UP models) or use the racks to carry a passenger.

Modification of the vehicle to increase speed and performance may violate the terms and conditions of your vehicle limited warranty. In addition, certain modifications including the removal of engine or exhaust components are illegal under most laws.

Loading, Carrying or Towing Cargo

⚠ WARNING



POTENTIAL HAZARD

Overloading this vehicle, carrying or towing cargo improperly.

WHAT CAN HAPPEN

Could cause changes in vehicle handling which could lead to an accident.

HOW TO AVOID THE HAZARD

Never exceed the stated load capacity for this vehicle including operator and passenger (2-UP models) as well as other loads and added accessories.

Cargo should be properly distributed and securely attached.

Reduce speed when carrying cargo or pulling a trailer. Allow greater distance for braking.

Always follow the instructions in this Operator's Guide for carrying cargo or pulling a trailer.

Transporting Flammable or Dangerous Material

⚠ WARNING



V02M610

POTENTIAL HAZARD

Transporting flammable or dangerous material can lead to explosions.

WHAT CAN HAPPEN

This can cause serious injury or death.

HOW TO AVOID THE HAZARD

Never transport flammable or dangerous material.

PRE-RIDE INSPECTION

WARNING

Perform a pre-ride inspection before each ride to detect any potential problem that could occur during operation. The pre-ride inspection can help you monitor component wear and deterioration before they become a problem. Correct any problem that you discover to reduce the risk of a breakdown or crash.

Before using this vehicle, the operator should always perform the following pre-ride inspection check list.

Pre-Ride Inspection Check List

What to Do Before Starting the Engine (Key OFF)

Items to be Inspected	Inspection to Perform	✓
Engine oil	Check engine oil level.	
Coolant	Check coolant level.	
Brake fluid	Check brake fluid level	
Leaks	Check for any leaks under vehicle	
Throttle lever	Activate throttle lever several times to ensure it operates freely. It must return to idle position when released	
Parking brake	Apply parking brake and check if it operates properly	
Tires	Check tire pressure and condition. Refer to the <i>Tire Pressure and Maximum Load</i> label and adjust according to load.	
Wheels	Check wheels for damage and for abnormal play, and check lug nuts are tightened. Tighten wheel beadlock bolts (if equipped). Refer to <i>Wheels and Tires</i> in <i>Maintenance Procedures</i> for torque specification.	
Radiator	Check cleanliness of the radiator	
Drive shaft bellows	Check drive shaft bellows and protectors condition	
Seat(s)	Check if operator seat is in place and properly latched	
	Check if passenger seat or the glove box are in place and properly latched (2-UP Models)	
	Check the passenger backrest and grab handles condition (2-UP Models)	

Items to be Inspected	Inspection to Perform	✓
Cargo	If you transport a cargo, respect the load capacity. Refer to <i>Loading the Cargo Racks</i> . Ensure cargo is properly secured to the racks	
	If you are pulling a trailer or another equipment: <ul style="list-style-type: none"> – Check hitch and trailer ball condition – Respect the tongue capacity and towing capacity as indicated on the label affixed to the hitch or refer to <i>Technical Specifications</i>. – Ensure trailer is properly secured to hitch. 	
Storage compartment	Check if rear storage compartment is properly latched	
Chassis and suspension	Check underneath vehicle for any debris on chassis or suspension components and clean them properly	
Engine air filter	Inspect and clean engine air filter	
CVT air filter	Inspect and clean CVT air filter	

What to Do Before Starting the Engine (Key ON)

Items to be Inspected	Inspection to Perform	✓
Digital display	Check operation of indicator lamps in digital display(during first few seconds of key ON).	
	Check for messages on digital display.	
Lights	Check operation and cleanliness of headlights and taillight.	
	Check operation of low and high beams.	
	Check operation of brake light.	
Fuel level	Check the fuel level.	
Horn	Check operation of the horn (If equipped).	

What to Do After the Engine is Started

Items to be Inspected	Inspection to Perform	✓
Steering	Check if steering operates freely by completely turning it from side to side	
Shift lever	Check operation of shift lever (P, R, N, H and L)	
4WD/6WD selector	Check operation of 4WD/6WD selector	
Brakes	Drive forward slowly a few feet and apply brake lever and brake pedal individually. The brakes must fully apply. Lever and pedal must fully return when released	
Engine stop switch	Check that the engine stop switch is working properly	
RF D.E.S.S. Post	Check if D.E.S.S. post is working properly by pulling the D.E.S.S. key from the D.E.S.S. post and stopping the engine	

RIDING THE VEHICLE

To fully appreciate the pleasures and excitement of riding this vehicle, there are some basic rules and tips that you **MUST** follow. Some may be new to you while others may be common sense or obvious.

Please take the time to study this Operator's Guide and all on-product safety labels as well as the *Safety video* located at <https://can-am.brp.com/off-road/safety>. They more completely describe what you should know about this vehicle before riding it.

Whether you are a new user or an experienced rider, it is important for your personal safety that you know the controls and features of this vehicle. Equally important is knowing how to properly ride.

This is a high performance ATV for off-road use only. Inexperienced riders may overlook risks and be surprised by the specific behavior of this ATV in any terrain condition.

We recommend following the age recommendation indicated on the safety label affixed on the unit. Even though a person may be within the age group for which this vehicle is recommended, he may not have the skills, abilities, or judgment needed to operate this vehicle safely and may be involved in a serious accident.

Individuals with cognitive or physical impairments or who are high risk takers have an increased exposure to overturns or collisions which may result in injury including death.

Not all vehicles are the same. Each has its own unique performance characteristics, controls and features. Each will ride and handle differently.

Become completely familiar with the operational controls and the general operation of the vehicle before venturing into off road conditions. Practice driving in a suitable area free of hazards and feel the response of each control. Drive at low speeds. Higher speeds require greater experience, knowledge and suitable riding conditions.

Riding conditions vary from place to place. Each is subject to weather conditions which may radically change from time to time and from season to season.

Riding on sand is different than riding on snow or through forests or marshes. Each location may require a greater degree of awareness and skill. Show good judgement. Always proceed with caution. Please do not take any unnecessary risks that could leave you stranded or possibly injured.

Never assume that the vehicle will go everywhere safely. Sudden changes in terrain caused by holes, depressions, banks, softer or harder "ground" or other irregularities may cause the vehicle to topple or become unstable. To avoid this, slow down and always observe the terrain ahead. If the vehicle does begin to topple or tip over, the best advice is to immediately get off **AWAY** from the direction of the tip over!

We encourage you to have an Annual Safety Inspection of your vehicle. Please contact an authorized BRP dealer for further details. Though not required, it is recommended that an authorized BRP dealer performs the preseason preparation of your vehicle. Each visit to your authorized BRP dealer is a great opportunity for your dealer to verify if your vehicle is included in any safety campaign.

We also urge you to visit your authorized BRP dealer in a timely manner if you become aware of any safety related campaigns.

See an authorized BRP dealer for available accessories you may require.

Riding Gear

Actual weather conditions should help you decide how to dress. Dress for the coldest weather expected. Thermal underwear next to the skin also provides a good insulation. It is important that the operator always wears the appropriate protective riding gear and apparel, including an approved helmet, eye protection, boots, gloves, a long sleeved shirt and pants. This type of clothing will provide you protection from some of the minor hazards you may encounter en route. The operator must never wear loose clothing such as a scarf that may get entangled in the vehicle or on tree branches and shrubs. Depending on conditions, anti-fogging goggles or sunglasses may be required. Different colored lenses available for goggles or sunglasses help you distinguish terrain variations. Sunglasses should only be worn during the daytime.

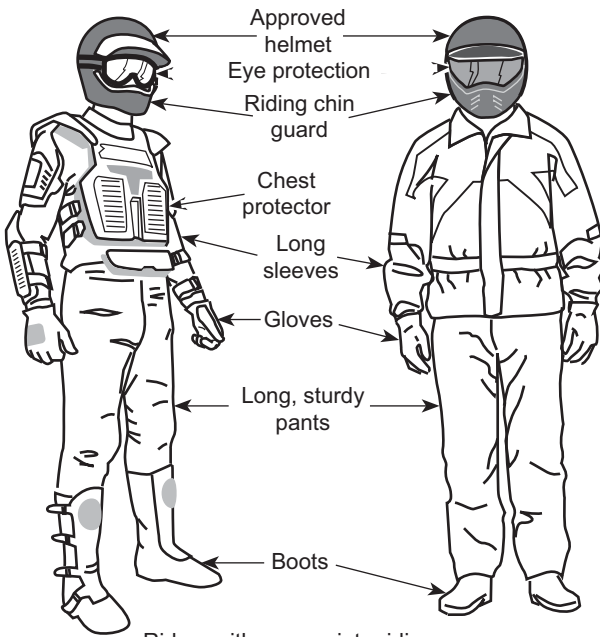

Riders with appropriate riding gear

Carrying a Passenger

This vehicle is designed specifically to carry an operator and ONE (1) passenger only. The passenger must be seated on the designated passenger's seat and hold on to the grab handles at all times. NEVER install other passenger's seat other than the one recommended by BRP. Do not use the racks or their location to carry passenger(s). Carrying more than one (1) passenger may affect the stability and your control of the vehicle. When the passenger seat is not installed

and the glove box is equipped in its place, the vehicle becomes a ONE-RIDER vehicle (1-UP model) and NO PASSENGER must be allowed on it.

Recreational Riding

Respect the rights and limitations of others. Stay away from areas designated for other types of off road use. This includes snowmobile trails, equestrian trails, cross country ski trails, mountain bike trails, etc. Never assume there are no other users on the trail. Always stay to the complete right of the trail and do not zig-zag to one side of the trail then the other. Be prepared to stop or pull off to the side if another trail user appears in front of you.

Join a local ATV club. It will provide you with a map and advice or inform you where you can ride. If a club does not exist in your area, help to start one. Group riding and club activities provide a pleasurable, social experience.

Always keep a safe distance from other riders. Your judgment of speed, terrain conditions, weather, mechanical condition of your vehicle and the “trust in judgment” you have in others around you will help you make a better choice of appropriate safe distance. This vehicle, like any other motorized vehicle, cannot stop “on a dime”. Allow greater distance for braking. On 2-UP models, the vehicle handling, stability and braking distance may be affected when riding with a passenger. Safely reduce speed when riding with a passenger.

Before you ride, tell someone where you are planning to travel and your expected time of return.

Depending on the length of your ride, carry additional tools, drinking water, food and emergency equipment. Find out where you can get additional gasoline and oil. Be prepared for the possible conditions you may encounter.

First aid kit	Adjustable wrench
Mobile phone	Knife
Friction tape	Flashlight
A rope	Colored lens goggles
Spare light bulbs	Trail map
Provided tool kit	Snack

Environment

One of the benefits of this vehicle is that it can take you off the beaten path away from most communities. However, you should always respect nature and the rights of others to enjoy it. Do not ride in environmentally sensitive areas. Do not drive over forest crops or shrubs, nor cut down trees or take down fencing, nor spin your wheels and destroy the terrain. “Tread Lightly”.

This vehicle can cause OHV wildfires if debris builds up near the exhaust or other engine hot spots and ignites then falls off into dry grass. Avoid riding in wet areas, through muskeg or tall grass, where debris can build up. Should you ride

in those areas, inspect and remove all debris from your engine and hot spots. Refer to *vehicle care* for details.

Chasing wildlife is in many areas illegal. Wildlife can die of exhaustion after being chased by a motorized vehicle. If you encounter animals on the trail, stop and observe quietly and with caution. It will be one of the better memories of your life.

Observe the rule “what you take in, carry out”. Do not litter. Do not start campfires unless you have permission to do so, and then only away from dry areas. The hazards you may create on the trail may cause injury to others or yourself, even at a later date.

Respect farm lands. Always obtain the permission of the landowner before riding on private land. Respect crops, farm animals and property lines.

Finally, do not pollute streams, lakes or rivers and do not modify the engine or exhaust system, or remove any of its components as it will alter the vehicle emissions.

Design Limitation

Although the vehicle is exceptionally rugged for its class, it is still a light vehicle by definition and its operation must be restricted to its proper purpose.

The addition of weight to any part of the vehicle changes its gravitational stability and modifies its performance.

Off-Road Operation

The very nature of off-road operation is dangerous. Any terrain, which has not been specially prepared to carry vehicles, presents an inherent danger where terrain substance, shape and steepness are unpredictable. The terrain itself presents a continual element of danger, which must be knowingly accepted by anyone venturing over it.

An operator who takes a vehicle off-road should always exercise the utmost care in selecting the safest path and keeping close watch on the terrain ahead of him. The vehicle should never be operated by anyone who is not completely familiar with the driving instructions applicable to the vehicle, nor should it be operated on steep or treacherous terrain.

Riding Techniques

Information in this guide is limited. Increase your knowledge and improve your skills by following a certified training course.

Care, caution, experience and driving skill are the best precautions against the hazards of vehicle operation.

Respect and follow all posted trail signs. They are there to help you and others.

In off-road operation, power and traction, not speed, are important. Never drive faster than visibility and your own ability to select a safe route permits.

Constantly watch the terrain ahead for sudden changes in slopes or obstacles, such as rocks or stumps, that may cause loss of stability, resulting in tip over or rollover.

It is also wise to know the terrain condition on the other side of a hill or bank. All too often there exists a sharp drop-off that is impossible to negotiate or descend.

Whenever there is the slightest doubt that the vehicle can safely negotiate an obstacle or a particular piece of terrain, always choose an alternate route.

Always use proper riding techniques to avoid vehicle overturns on hills and rough terrain and in turns.

Body Position

To maintain proper control, it is strongly advised that you keep your hands on the handlebar and within easy reach of all controls. The same holds true for your feet on the footpegs. To minimize the possibility of a leg or foot injury, keep your feet on the footpegs at all times. Do not direct your toes outwards nor extend your feet out to assist in turning as they can be hit or be snagged on passing obstacles, or may come into contact with the wheels.

Even though there is a suspension on this vehicle, there are “washboard” or rough terrain conditions that will make you feel uncomfortable and can even cause a back injury. “Posting” or riding in a crouched position will often be required. Slow down and allow your flexed legs to absorb part of the impact energy.

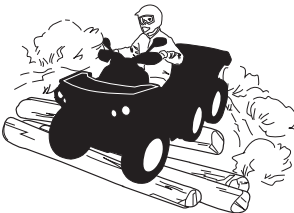

The passenger must keep his hands on the grab handles and his feet on footrests at all times.

The passenger must synchronize his movements with the operator.

Crossing Roads

If you have to cross a road, ensure to have complete visibility on both sides for incoming traffic and decide on exit point on other side of road. Drive in a straight line toward that point. Do not make sharp direction changes or abrupt accelerations as it may result in a rollover situation. Do not travel on sidewalks or bicycle trails as they are designated specifically for those uses.

Turning

Practice turning at low speeds before attempting to turn at faster speeds.

Keep both hands on handlebars and feet on footpegs.

Maintain a constant speed or a slight acceleration during turn.

To reduce the risk of rollovers:

- Use care when turning.
 - Do not turn the handlebar too far or too fast for your speed and environment. Adjust steering inputs accordingly.
 - Slow down before entering a turn. Avoid hard braking during a turn.
 - Avoid sudden or hard acceleration when turning, even from a stop or low speed.
- Never attempt donuts, skids, slides, fishtails, jumps, or other stunts. If vehicle starts to skid or slide, steer in the direction of the skid or slide. Never slam the brakes and lock the wheels.
- Avoid paved surfaces. This vehicle is not designed to operate on paved surfaces and is more likely to roll over. If you must drive on pavement, turn gradually, go slowly, and avoid abrupt acceleration and braking.

Avoid sudden inputs to steering, throttle or brakes while turning.

⚠ WARNING

Do not attempt turns at excessive speed.



If you do get into a slide or skid, it may help to turn the handlebar in the direction of the skid until you regain control. Never jam the brakes and lock the wheels.

⚠ WARNING

The tires of this vehicle are not suited for paved road use. Also this vehicle is not equipped with a rear differential (rear wheels are always turning at the same speed). For these reasons, pavement may seriously affect the handling and control of the vehicle.

Braking

Always keep both hands on handlebars and feet on footpegs when braking.

Practice braking to get familiar with the brake response.

- Do it at low speed first, then increase the speed.
- Practice braking in straight line at different speeds and different braking force.
- Practice emergency braking; optimal braking is obtained in straight line, with high force applied, without locking the wheels.

Remember, braking distance depends on vehicle speed, load and the type of surface. Also, the tires and brakes conditions play a major role.

NOTE:

If going forward the vehicle weight is transferred to the front wheels when braking. To obtain greater stopping efficiency, the brake system distributes more braking force to the front wheels. This will affect vehicle handling and steering control when braking vigorously. Take it into account when braking.

BRAKE LEVER: When using, the brake lever will operate the front and rear brakes in 4x6 and 6x6 mode.

BRAKE PEDAL:

- 4x6 mode: In this mode, the brake pedal operates only the rear brakes.
- 6x6 mode: While this mode is selected, the brake pedal operates both front and rear brakes.

Reverse Operation

When operating in reverse, check that the path behind the vehicle is free of people or obstacles. Proceed slowly and avoid sharp turns.

When riding on a 2-UP model, take into account that the passenger can obstruct your view. Disembark the passenger if necessary.

We recommend sitting on your ATV when operating in reverse. Avoid standing up. Your weight could shift forward against throttle lever, causing an unexpected acceleration.

⚠ WARNING

Unexpected acceleration when the ATV is operated in reverse can cause a loss of control.

Obstacles

Obstacles in the “trail” should be traversed with caution. This includes loose rocks, fallen trees, slippery surfaces, fences, posts, and embankments and depressions. You should avoid them whenever possible. Remember that some obstacles are too large or dangerous to cross and should be avoided. Small rocks or fallen trees may be safely crossed approach at a 90° angle. Stand on the footrests while keeping your knees flexed. Adjust speed without losing momentum and do not “gun” the throttle. Hold handlebar (operator) or grab handles (passenger on 2-UP models) firmly. Place body weight rearwards (operator and passenger 2-UP models) and proceed. Do not try to lift the vehicle front wheels off the ground. Be aware that the object may be slippery or may move while crossing.

When riding on 2-UP models, the operator is responsible for the safety of the passenger; in doubt, disembark the passenger before proceeding.

Uphill Driving

The passenger must synchronize his movements with the operator. The passenger must remain seated at all times.

Do not forget, the operator is responsible for the safety of the passenger. In doubt, disembark the passenger before climbing a hill.

Before trying to climb a hill, keep these things in mind. Hill Climbing should only be attempted by experienced operators. Start on shallow slopes. Always drive straight uphill. Operator and passenger must keep their body weight forward, towards the top of the hill. Keep feet on the footrests, shift the ATV into a lower gear and accelerate before you start to climb. Try to keep a steady speed and go easy on the throttle to avoid acceleration. Abrupt slope or terrain variation or rolling one wheel over an obstacle could have a big impact on the stability as it will lift the front of the vehicle increasing the risk of tipping over. Some hills are too steep to safely stop or recover from after an unsuccessful climbing attempt. Try to avoid steep inclines. If you're not careful, you could tip over when going up hills. If the hill is too steep and you cannot proceed or the vehicle begins to roll backwards, apply the parking brake, being careful not to slide. Ask the passenger to dismount first, dismount on the left side then use the "K" turn (while walking back, next to the vehicle on the up hill side and with a hand on the brake lever, slowly back the rear of the vehicle toward the top of the hill then drive downhill). Always walk or dismount on the upside of the slope while keeping clear of the vehicle and its rotating wheels. Do not try to hold on to the vehicle if it begins to topple. Stay clear. Do not ride over the crest of the hill at high speed. Obstacles, including sharp drop-offs, may exist. The passenger should get on the vehicle only when the vehicle has returned to a safe location.

Vehicle Behaviors

Due to configuration, this vehicle has excellent climbing ability, so much so that it is possible to tip over before traction is lost. For example, it is common to encounter terrain situations where the top of the hill has eroded to a point that the hill peak rises very sharply. The vehicle can readily negotiate such a condition, however, in doing so, when the front of the vehicle is driven to a point that the vehicle's balance moves rearward, a tip over can occur.

The same situation may apply if an embedded object causes the front of the vehicle to climb more than desired. If such a situation occurs take an alternate route. Be aware of side hilling dangers when doing so. Refer to *Side Hilling*.



Downhill Driving



The operator is responsible for the safety of the passenger; in doubt, disembark the passenger before proceeding.

Always remember that the vehicle handling, stability and braking distance may be affected when riding with a passenger.

The passenger must synchronize his movements with the operator. The passenger must remain seated at all times.

Operator and passenger must keep their body weight rearwards. Apply the brake gradually to prevent skidding. Do not “coast” down the slope using solely engine compression or in neutral gear. Try to avoid steep inclines. If you're not careful, you could tip over when going down hills.

Vehicle Behaviors

This vehicle can climb slopes that are steeper than it can safely descend. Therefore, it is essential to ensure that a safe route exists to descend a slope before you climb it.

Side Hilling

This is one of the **most risky** types of riding since it may drastically change the balance of the vehicle. It should be avoided whenever possible. However, if it is necessary to do so, it is important that you **ALWAYS** keep your body weight on the upside of the slope and be prepared to dismount on that side should the vehicle begin to topple.

Avoid all objects or depressions that will intensify the raising of one side of the vehicle higher than the other, thus causing rollover.

⚠ WARNING

Do not try to stop or save the vehicle from damage.

⚠ WARNING

Be careful when loading and transporting liquid reservoirs. They can affect vehicle stability when side hilling by pulling downhill and increasing the risk of a roll over.



The passenger must synchronize his movements with the operator. The passenger must remain seated at all times.

The operator is responsible for the safety of the passenger; in doubt, disembark the passenger before proceeding.

Drop-Offs

This vehicle will “bottom-out” and usually stop if either the front or rear wheels are driven over a drop-off. If the drop is sharp or deep, the vehicle will nose dive and tip over.

When riding on a 2-UP model, the operator is responsible for the safety of the passenger; in doubt, disembark the passenger before proceeding.

⚠ WARNING

Avoid negotiating drop-offs. Reverse and select an alternate route.

Crossing Water

Water can be a unique hazard. If it is too deep the vehicle may “float” and topple. Check the water depth and current before you attempt to cross any water. Water should not go above the footrest. Be wary of slippery surfaces such as rocks, grass, logs, etc., both in the water and on its banks. A loss of traction may occur. Do not attempt to enter the water at high speed. The water will act as a brake and could throw you off the vehicle, on the ground.



Wet brakes will affect the braking ability of your vehicle. Make sure you dry the brakes by applying them several times after the vehicle leaves the water, mud or snow. Allow greater distance for braking.

Mud or marsh lands may be encountered near water. Be prepared for sudden “holes” or changes in depth. Similarly so, be watchful of hazards such as rocks, logs, etc., partially covered by vegetation.

Riding on Ice

If your route crosses frozen waterways, make sure the ice is thick enough and sound enough to support the total weight of yourself, your passenger (2-UP models), the vehicle and its load. Be ever watchful of open water it is a sure indication that the ice thickness will vary.

On 2-UP models, the operator is responsible for the safety of the passenger; in doubt, do not attempt to cross.

Ice will also affect the control of the vehicle. Slow down and do not “gun” the throttle. This will only result in spinning of the tires and possible tip over of the vehicle or passenger ejection (2-UP models). Avoid rapid braking. This again will possibly result in an uncontrolled slide and tip over of the vehicle or passenger ejection (2-UP models). Slush should be avoided at all times since it could block the operation or controls of the vehicle.

Riding on Snow Covered Surfaces

When performing the pre-ride inspection, pay special attention to locations on the vehicle where snow and/or ice accumulations may obstruct visibility of the taillight and reflectors, clog ventilation openings, block the radiator and fan, and interfere with the movement of control levers, switches and brake pedal. Before starting with your ATV check the steering, throttle and brake lever and pedal controls for interference free operation.

Whenever an ATV is ridden on a snow covered drive path the tire grip is generally reduced causing the vehicle to react differently to control inputs from the operator. On low grip surfaces, the steering responses are not as crisp and precise, stopping distances are lengthened and acceleration becomes sluggish. Slow down and do not "gun" the throttle. This will only result in spinning of the tires and possibly in an over steering slide of the vehicle. Avoid hard braking. This will possibly result in a straight line slide of the vehicle. Again, the best advice is to safely reduce speed in anticipation of a maneuver so to give yourself time and distance to regain total vehicle control before it spins out of your control.

As you drive your ATV over a loose snow covered surface, snow dust will be picked up in the wake turbulence of the moving vehicle and transported to contact and accumulate or melt on some exposed components including rotating parts like brake discs. Water, snow or ice may affect the response time of the brake system of your ATV. Even when not required to reduce vehicle speed apply brakes frequently to prevent ice or snow accumulation and to dry brake pads and discs. While doing so in low risk driving situations you will test for grip level and keep yourself alerted to how the vehicle reacts to your control inputs. Always keep brake pedal, footrests, floor boards, brake and throttle levers free of snow and ice. Frequently wipe snow off seat, hand grips, headlights, taillights and reflectors.

The depth of the snow cover may hide rocks, tree stumps or other objects and if it is wet may totally impede the driveability as the vehicle becomes bogged down or completely loses traction in slushy snow. Look far ahead and always be watchful of any visible clues that might indicate the presence of such obstacles. In doubt steer clear. Avoid driving on any frozen body of water before checking that the ice will safely support the ATV, its riders and its load of cargo. Remember that a given thickness of ice may be sufficient to support a snowmobile but not an ATV of an identical weight because of the smaller load bearing surface of the four tire contact patches as compared to that of a snowmobile track and skis.

To maximize comfort and avoid frostbite, always wear clothing and ATV protective equipment appropriate for the weather conditions you will be exposed to during your ride.

At the end of each ride it is a good practice to clean the vehicle body and all moving components (brakes, steering components, drivelines, controls, radiator fan etc.) from any snow or ice accumulations. Wet snow will turn to ice during the shut down period and become more difficult to remove at the next pre-ride inspection.

Riding in snow may reduce the brakes stopping capability. Safely reduce speed and allow greater distance for braking. Snow projection may cause ice build up

or snow accumulation on brake components and controls. Apply brakes frequently to prevent ice or snow accumulation.

Riding on Sand

Riding on sand or sand dunes is another unique experience, but there are some basic precautions that should be observed. Wet, deep or fine sand may create a loss of traction and cause the vehicle to slide, drop off or become “bogged” down. If this occurs look for a firmer base. Again, the best advice is to slow down and be watchful of the conditions. Slow down even more when riding with one or more passengers.

When riding in sand dunes it is advisable to equip the vehicle with an antenna type safety flag. This will help make your location more visible to others over the next sand dune. Proceed carefully should you see another safety flag ahead. Since the antenna type safety flag can snag and rebound on your body if caught, do not use it in areas where there are low hanging branches or obstacles. Always remember when riding that the vehicle handling and stability may be affected when riding with one or more passengers..

Riding on Loose Stones

Riding on loose stones or gravel is very similar to riding on ice. They will affect the steering of vehicle possibly causing it to slide or tip over especially at high speeds (resulting in operator and passenger ejection (2-UP models).

Again, the best advice is to slow down and be watchful of the conditions. When you ride with a passenger (2-UP models), slow down even more.

In addition, braking distance may be affected. Remember that “gunning” the throttle or sliding may cause loose stones to be ejected rearwards into the path of another rider. Never do it deliberately.

MOVING LOADS AND DOING WORK

Working with Your Vehicle

Your vehicle can help you perform a number of different LIGHT tasks ranging from snow removal to pulling wood or carrying cargo. A variety of accessories are available from your authorized Can-Am Off-road dealer. To prevent possible injury, follow the instructions and warnings that accompany the accessory. Always respect the load limits of the vehicle.

Overloading the vehicle can overstress the components and cause failure. Avoid overexerting yourself if you lift or pull heavy loads or manually push the vehicle.

WARNING

Mounted machinery must be lowered on the ground before leaving the tractor.

Carrying Loads

Any load carried on the vehicle will affect the handling, stability and braking distance of the vehicle. Do not exceed the load limits of the vehicle, including the weight of operator, cargo, accessories and trailer tongue weight. Always be aware that the "load" may slide or fall off and create an accident. Avoid loads that may protrude sideways and get snagged or caught in brush or other obstacles. Avoid covering and obstructing the headlights or taillight with the cargo.

Always be aware that the "load" may slide or fall off and cause an accident.

WARNING

The vehicle handling, stability and braking distance are affected when loading racks and using the vehicle. Correct loading and weight distribution are therefore important. Never overload, tow or carry cargo improperly. Always ensure the cargo is safely secured and properly distributed on the rack(s) before operating the vehicle. Safely reduce speed according to terrain conditions when carrying cargo or pulling a trailer, and avoid hills and rough terrain. Allow greater distance for braking. Always secure cargo as low as possible on the rack(s) to reduce the effect of a higher center of gravity. Failure to follow the recommendations here could cause changes in vehicle handling which could lead to an accident.

Maximum Load Table

Total load allowed	460 kg (1,015 lb)	Includes weight of operator, passenger, cargo, accessories and trailer tongue weight.
Front load allowed	45 kg (100 lb)	Evenly distributed.
Rear cargo load allowed	318 kg (700 lb)	Evenly distributed. Includes rear cargo bed, lower cargo box and tongue load.

Please note that in the previous table there is a reference to the accessories as being part of the total load allowed. The following table shows the weight of some OEM accessory packages that NEED to be considered in the equation.

Examples of Accessories Package Weight	
Model	Weight
Flat bed	0 kg (0 lb)
Side wall	15 kg (33 lb)

To reduce the risk to lose control or the load carried, follow these recommendations.

Examples of suitable vehicle total loads				
Operator and passenger	Cargo box load	Accessories	Tongue weight	Total vehicle load
92 kg (203 lb)	250 kg (551 lb)	50 kg (110 lb)	68 kg (150 lb)	460 kg (1,015 lb)

Vehicle Settings When Carrying Load

When the total load exceeds 234 kg (515 lb), including weight of operator, cargo, accessories and trailer tongue weight, inflate the tires according to load, refer to *Tire Pressure and Maximum Load*.

When carrying heavy loads in cargo bed/box or pulling a trailer:

- Adjust the suspension accordingly
- Position the shift lever to L (Low) position.

Loading the Front Cargo Rack

NOTICE

When loading or unloading, do not exceed the weight limit of 45 kg (100 lb) for front load.

Load cargo as low as possible – a higher load can raise the vehicle's center of gravity, which can reduce stability. Position cargo on the rack as evenly distributed as possible.

Secure the load on the cargo rack. Do not secure cargo to the cage or other part of the vehicle. If it is not properly secured, a load may slide or fall off, possibly striking occupants or bystanders; or it may shift during riding, affecting the handling of the vehicle.

Objects that are high may affect visibility for the driver and may act as projectiles in case of an accident. Loads that protrude sideways can get snagged or caught in bush, branches or other obstacles. Avoid covering and obstructing the brake lights with the cargo. Ensure no cargo protrudes outside the cargo rack and that cargo will not interfere with your visibility or control of the vehicle.

Do not overload cargo rack.

Never carry gasoline container(s) or any dangerous liquids on the cargo rack.

Loading the Cargo Bed

NOTICE

When loading or unloading, do not exceed the weight limit of 50 kg (110 lb) on lower tailgate.

Load cargo as low as possible – a higher load can raise the vehicle's center of gravity, which can reduce stability. Position cargo toward the front and center of the cargo bed and as evenly distributed as possible.

Secure the load to the tie down hooks inside cargo bed. Use only the tie down hooks on the bottom of the cargo bed; do not secure cargo to the cage or other part of the vehicle. If it is not properly secured, a load may slide or fall off, possibly striking operator or bystanders; or it may shift during riding, affecting the handling of the vehicle.

Objects that are higher than the walls of the cargo bed may affect visibility for the driver and may act as projectiles in case of an accident. Loads that protrude sideways can get snagged or caught in bush, branches or other obstacles. Avoid covering and obstructing the brake lights with the cargo. Ensure no cargo protrudes outside the box and that cargo will not interfere with your visibility or control of the vehicle.

Do not overload cargo bed.

Maximum Rear Cargo Loads		
Lower cargo load	318 kg (700 lb)	Evenly distributed. Including the rear cargo bed, lower cargo box and tongue load.
Rear cargo load	273 kg (602 lb)	Evenly distributed on floor separator.

Maximum Tailgate Weight Capacity		
Upper tailgate	100 kg (220 lb)	<p>Load can only be applied to the tailgate when the accessory support bracket is installed.</p> <p>Only while loading cargo into cargo bed.</p> <p>Never operate with tailgate open.</p>
Lower tailgate	50 kg (110 lb)	<p>Only while loading cargo into cargo box.</p> <p>Never operate with tailgate open.</p>

⚠ WARNING

Never operate the vehicle with an open tailgate.

Tilting the Cargo Bed

The cargo bed can be tilted to ease unloading. Use release handle on right side of Cargo bed to unlock.

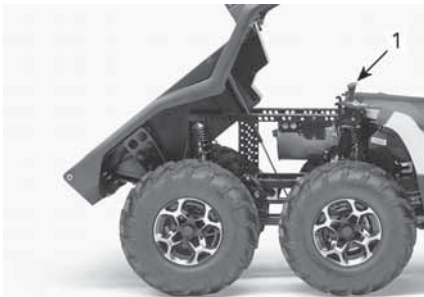

1. Cargo bed release handle

NOTICE

Always turn off engine when tilting the cargo bed.

⚠ WARNING

- Always ensure no one is standing behind the cargo bed before you actuate the release handle.
- The load weight may affect the operation of the cargo bed tilting feature (tilting or lowering).
- Always take care when opening the cargo bed, as the muffler could be hot.

Be very careful with the operation of the cargo bed as the load may have moved during transport.

To lower the cargo bed, simply push it down into place and secure with hairpin clip.

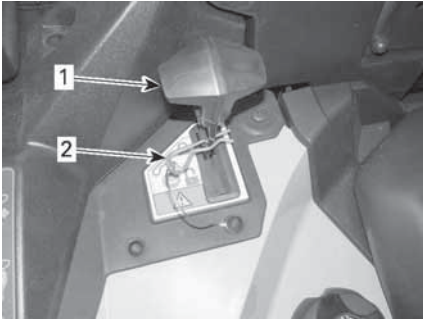

1. Release handle
2. Hairpin clip

⚠ WARNING

- Keep yourself and others clear of the cargo bed and vehicle frame junction when lowering cargo bed.
- Ensure to properly latch the cargo bed before riding.
- Secure cargo bed with hairpin clip
- Make sure you do not leave objects between lifted cargo bed and vehicle frame to ensure proper latching of the cargo bed when lowered.

IMPORTANT ON-PRODUCT LABELS (CANADA/ UNITED STATES)

Safety Hang Tag

This vehicle comes with a hang tag and labels containing important safety information.

Any person who rides this vehicle should read and understand this information before riding.

G

GENERAL USE MODEL

THIS ATV IS FOR
RECREATIONAL USE OR UTILITY USE.

NO OPERATOR UNDER AGE 16

TRAINING COURSES TO TEACH
ATV RIDING SKILLS ARE AVAILABLE.
FOR INFORMATION CONTACT
YOUR DEALER.
MAKE SURE TO WATCH SAFETY VIDEO.

CHECK WITH YOUR DEALER TO
FIND OUT ABOUT STATE OR LOCAL
LAWS REGARDING ATV
OPERATION.

THIS HANGTAG IS NOT TO BE REMOVED BEFORE SALE.

704905098



WARNING

Improper ATV use can result in SEVERE INJURY or DEATH



ALWAYS USE
AN APPROVED
HELMET AND
PROTECTIVE
GEAR FOR DRIVER
AND PASSENGER.



NEVER USE
ON PUBLIC
ROADS.



NEVER CARRY
MORE THAN
1 PASSENGER.



NEVER USE WITH
DRUGS OR
ALCOHOL.

NEVER operate:

- without proper ATV training or instructions.
- at speeds too fast for your skills or the conditions.
- on public roads - a collision can occur with another vehicle.
- with a passenger unless passenger seat is securely in place.

THE OPERATOR MUST ALWAYS:

- use proper riding techniques to avoid overturns on hills and rough terrain and in turns.
- avoid paved surfaces - pavement may seriously affect handling and control.
- reduce speed and use extra caution at all times when carrying a passenger - dismount passenger when conditions require.
- make sure passenger reads and understands this label and passenger safety label.

LOCATE AND READ OPERATOR'S GUIDE.
FOLLOW ALL INSTRUCTIONS & WARNINGS.

Safety Labels

Read and understand all the safety labels on your vehicle.

These labels are affixed to the vehicle for the safety of the operator, passenger (2-UP) or bystanders.

The safety labels on your vehicle should be considered permanent parts of the vehicle. If missing or damaged, they can be replaced free of charge. See an authorized Can-Am Off-road dealer.





NOTE:

In the event of any discrepancy between this guide and the vehicle, the safety labels on the vehicle have precedence over the labels in this guide.

General Warning Label

⚠ WARNING

Improper ATV use can result in SEVERE INJURY or DEATH

			
ALWAYS USE AN APPROVED HELMET AND PROTECTIVE GEAR FOR DRIVER AND PASSENGER.	NEVER USE ON PUBLIC ROADS.	NEVER CARRY MORE THAN 1 PASSENGER.	NEVER USE WITH DRUGS OR ALCOHOL.

NEVER operate :

- without proper ATV training or instructions.
- at speeds too fast for your skills or the conditions.
- on public roads - a collision can occur with another vehicle.
- with a passenger unless passenger seat is securely in place.



THE OPERATOR MUST **ALWAYS** :

- use proper riding techniques to avoid overturns on hills and rough terrain and in turns.
- avoid paved surfaces - pavement may seriously affect handling and control.
- reduce speed and use extra caution at all times when carrying a passenger - dismount passenger when conditions require.
- make sure passenger reads and understands this label and passenger safety label.

Read and understand all safety labels, locate and read operator's guide and watch the safety video using the QR code link or visit Can-am web site before operation.

LOCATE AND READ OPERATOR'S GUIDE.
FOLLOW ALL INSTRUCTIONS & WARNINGS.

Patent: www.bhp.com/en/about/bhp/patent.html



8020

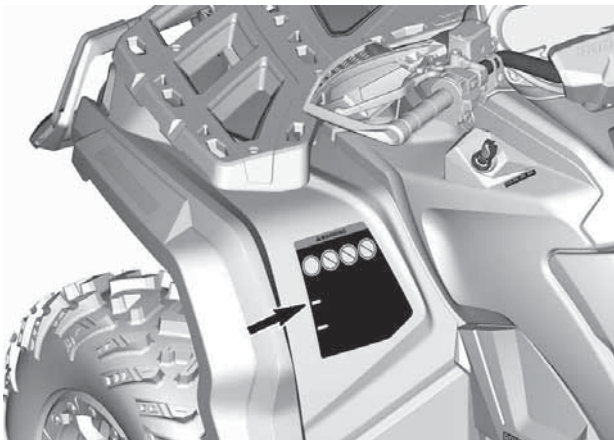

Recommended Age – Warning Label

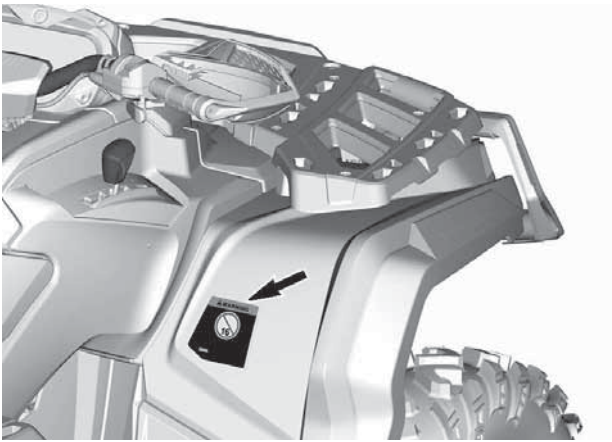

Passenger Warning Label

! WARNING

PASSENGER SAFETY

To reduce the risk of SEVERE INJURY or DEATH



NEVER CARRY MORE THAN 1 PASSENGER.



NEVER USE WITH DRUGS OR ALCOHOL.

NEVER carry a passenger too small to firmly plant feet on footrests and securely grasp hand holds.

THE PASSENGER MUST ALWAYS:

- use an approved helmet and protective gear.
- securely grasp hand holds and plant feet firmly on footrests while seated in the passenger seat
- tell operator to slow down or stop if uncomfortable get off and walk if conditions require.



704907198



Passenger's Seat Installation – Warning Label**⚠ WARNING**

Always make sure to properly install passenger seat or glove box in place before riding.

TO INSTALL PASSENGER SEAT

- . Ensure that the latch lever is in the open position by pulling it towards the front of seat.
- . Using a forward motion, insert both front tabs of the seat into the vehicle anchor housings.
- . Rotate downwards to engage the rear latch.
- . Close the latch lever by pushing it rearwards to secure the seat in position.
- . Check if the seat is firmly secured in position before using it.

TO INSTALL GLOVE BOX

- Open glove box cover and turn handle to the unlock position.
- Align and insert glove box latching system into this vehicle's "LINQ" opening.
- Turn handle to the lock position.
- Close cover and verify if glove box is locked in position.



FOR MORE DETAILS REFER TO OPERATOR'S GUIDE

704905700

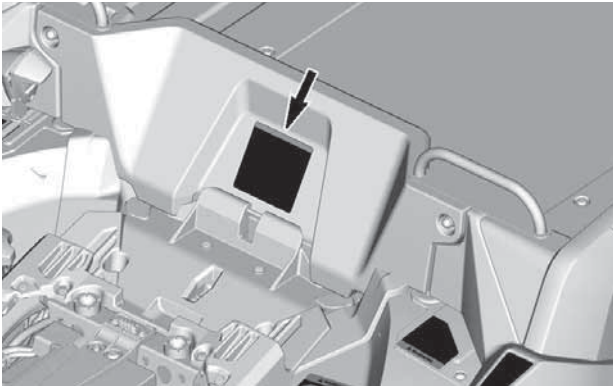

Tire Pressure and Maximum Load - Warning Label

WARNING

Improper tire pressure or overloading can cause loss of control, resulting in SEVERE INJURY or DEATH.

ALWAYS maintain proper tire pressure according to the load on the vehicle. Refer to table.

NEVER underinflate tire as it could cause the tire to dislodge from the rim.

NEVER exceed the vehicle load capacity of 460 kg (1015 lb) including weight of rider(s), cargo, accessories and trailer tongue weight.

ATV LOADING and TRAILER TOWING

- Cargo or passenger loading or trailer towing can affect stability and handling. Load must be properly distributed on racks.
- When loaded with cargo or towing a trailer:
 - reduce speed.
 - allow more distance to stop.

LOAD	COLD TIRE PRESSURE
UP TO 234 kg (515 lb)	FRONT : 34.5 kPa (5 psi) CENTER: 34.5 kPa (5 psi) REAR : 34.5 kPa (5 psi)
FROM 234 kg (515 lb)	FRONT : 48.3 kPa (7 psi) CENTER: 48.3 kPa (7 psi) REAR : 48.3 kPa (7 psi)
UP TO 460 kg (1015 lb)	FRONT : 48.3 kPa (7 psi) CENTER: 48.3 kPa (7 psi) REAR : 48.3 kPa (7 psi)



704907200

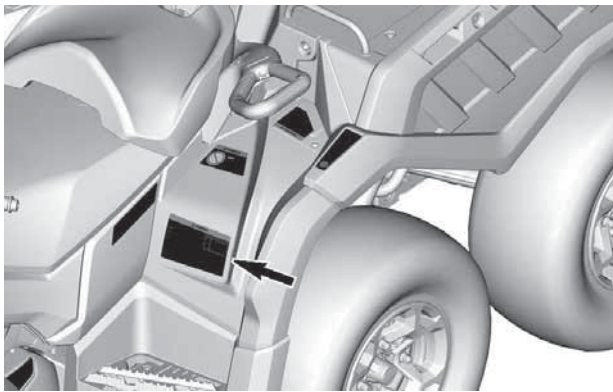

Maximum Rack Loading - Warning Label



No On-Road Use - Warning Label

⚠ WARNING

This vehicle is an all terrain vehicle and is not intended for use on public roads. 704905680

⚠ AVERTISSEMENT

Ce véhicule est un véhicule tout terrain qui n'est pas destiné à être utilisé sur les voies publiques.

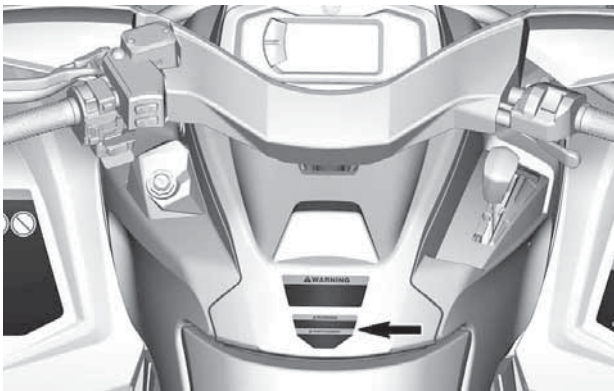

Vehicle Performance - Warning Label

! WARNING

Get familiar with this ATV; it may exceed the performance of other ATVs you may have ridden in the past.

This is a high performance ATV for off road use only. Inexperienced riders may overlook risks and be surprised by the specific behavior of this ATV in any terrain condition.

704905707

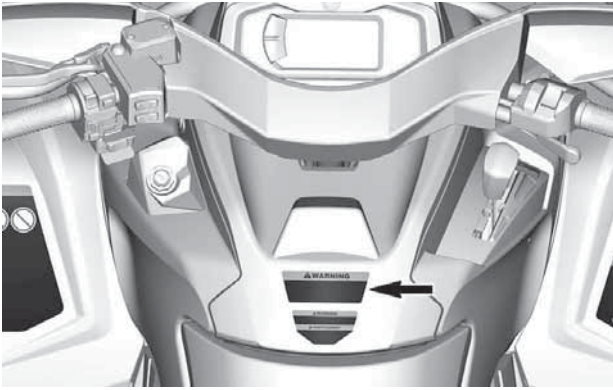

Rear Cargo Load Warning Label

WARNING



. Locate and read operator's guide. Overloading can cause loss of control, resulting in **SEVERE INJURY** or **DEATH**.

. **NEVER** carry a passenger on this carrier.

. **NEVER** exceed the load capacity of 460 kg (1,015 lb) including weight of rider(s), cargo, accessories, and trailer tongue weight.

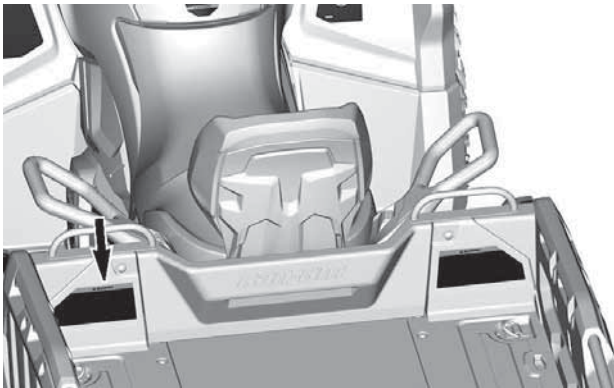

. **NEVER** exceed the load capacity of 318kg (700 lb) on the lower cargo box.

704905308



Cargo Bed Operation Warning Label

⚠ WARNING

. Locate and read operator's guide.

NEVER:

- . Carry a passenger on the cargo bed.

ALWAYS:

- . Secure locking handles using the safety pin.
- . Remove containers from vehicle before fueling.



704904602

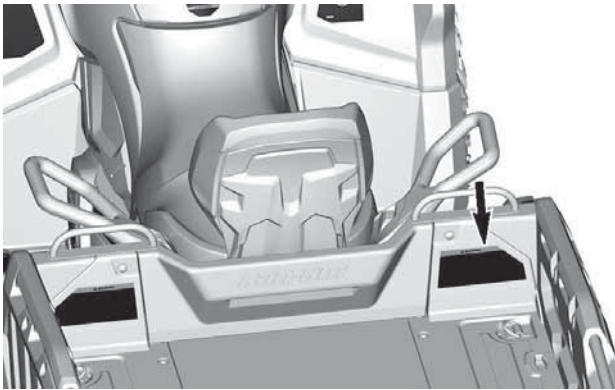

Pulling Load Warning Label

⚠ WARNING



NEVER sit on cargo bed



NEVER attach here or on the cargo bed to pull a load. This can cause the vehicle to tip over.
ALWAYS use the trailer hitch or the recovery hook to pull a load.

704904603

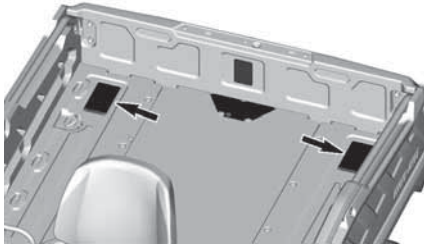

Towing and Loading – Warning Label

⚠ WARNING

Improper loading of a trailer may cause loss of vehicle control, resulting in severe injury or death.

- Maximum towing mass (unbraked or inertibraked): 750 kg (1654 lb)
- Maximum tongue mass (unbraked or inertibraked): 75 kg (165 lb)

7406



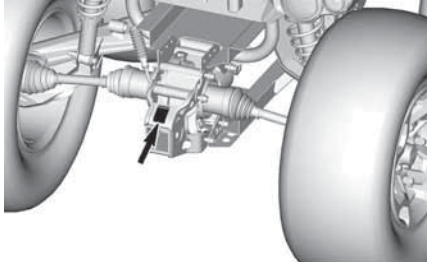

Shifting Procedure – Notice Label

NOTICE

- This VEHICLE MUST be stopped before shifting lever.
 - ALWAYS apply foot brake to shift from Park (P) and Neutral (N).
- 704905695



Possible Burn - Warning Pictogram



Coolant Hot - Warning Label

⚠ WARNING

Do not open when HOT.

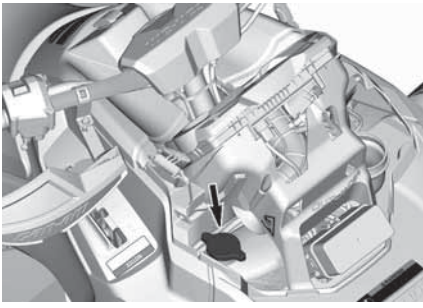

Tailgate Load Warning Label

! WARNING



NEVER sit on tail gate.

MAX 100 kg
(220 lb)



NEVER exceed the load capacity of 100 kg (220 lb) on tail gate.

704904605

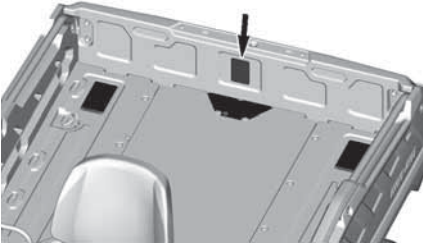

Pinch Point Warning Label



PINCH POINT
Keep clear when lowering cargo bed.

! WARNING

704904609



Locking Release Handle – Warning Label

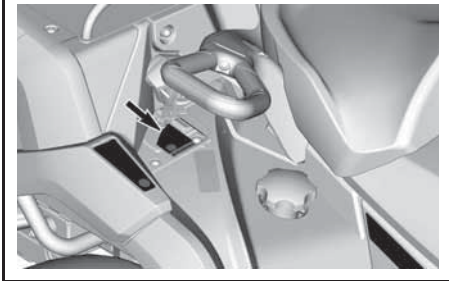
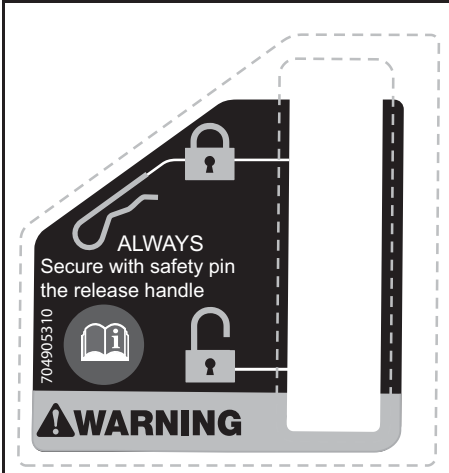

Do Not Stand Here- Warning Pictogram

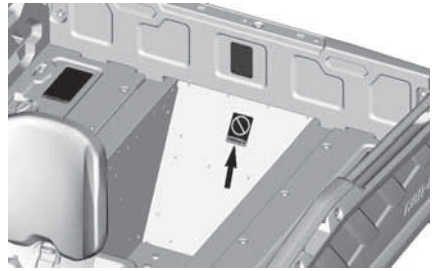

Compliance Labels

These labels indicate vehicle's compliance.

Located under the operator's seat.

Applicable when equivalent to a model certified to US EPA standards

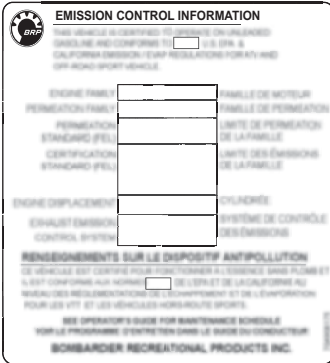

This label is located on the rear fender, near the fuel cap.

Bombardier Recreational Products Inc. certifies that this ATV complies with ANSI / SVIA-1-2017 standard and is subject to an approved ATV Action Plan submitted by BRP and on file with the U.S. Consumer Product Safety Commission.



9074

Technical Information Labels

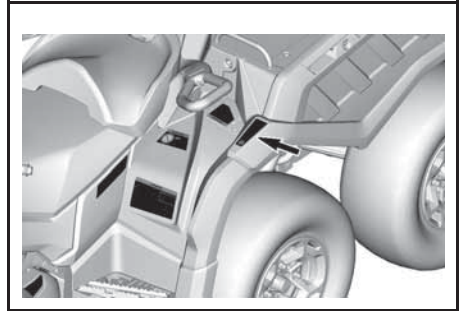
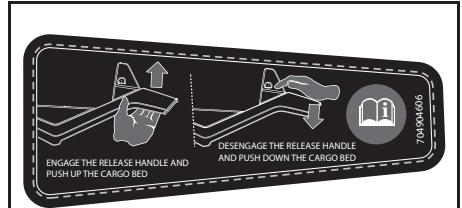
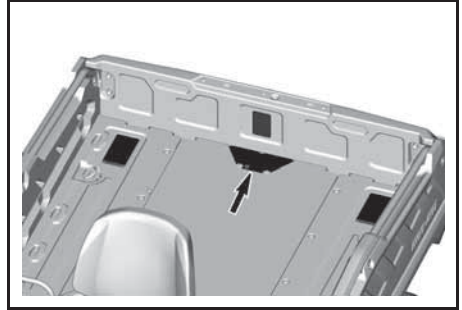
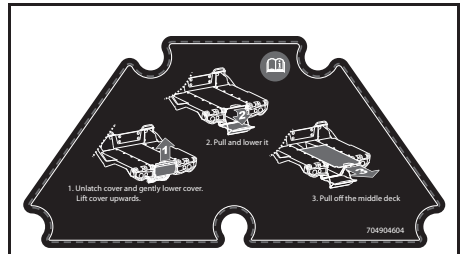

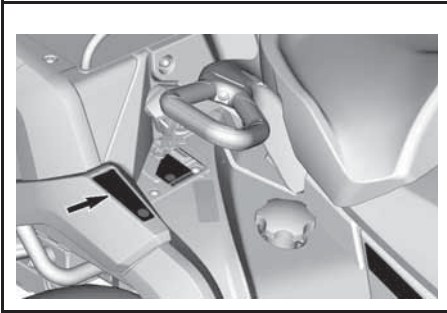
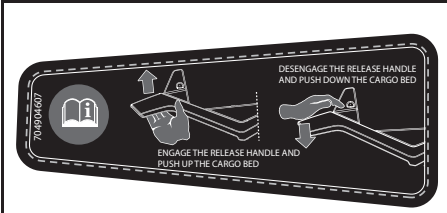

This label is located under the operator's seat, on the upper frame member.

AIR FILTER MAINTENANCE

MAINTENANCE MUST BE PERFORMED AS SPECIFIED IN THE OPERATOR'S GUIDE. AIR FILTER MAINTENANCE SHOULD INCREASE IN FREQUENCY IN MORE SEVERE (DUSTY) CONDITIONS.

ENTRETIEN DU FILTRE À AIR

L'ENTRETIEN DOIT ÊTRE EFFECTUÉ TEL QUE SPÉCIFIÉ DANS LE GUIDE DU CONDUCTEUR. ENTRETIEN LE FILTRE À AIR PLUS SOUVENT DANS DES CONDITIONS PLUS EXTRÊMES (MILIEUX POUSSIÉREUX). 707800373

REPORTING SAFETY DEFECTS

In Canada, if you believe that your vehicle has a defect which could cause a crash or could cause injury or death, you should immediately inform Transport Canada in addition to notifying Bombardier Recreational Products Inc.

If Transport Canada receives similar complaints, it may open an investigation, and if it finds that a safety defect exists in a group of vehicles, it may order a recall and remedy campaign. However, Transport Canada cannot become involved in any individual problems between you, your dealer or Bombardier Recreational Products Inc.

To contact Transport Canada:



819-994-3328 (Gatineau-Ottawa area or internationally)
Toll free : 1 800-333-0510 (in Canada)



Transport Canada - ASFAD
330 Sparks Street
Ottawa, ON
K1A 0N5



<https://www.tc.gc.ca/recalls>

VEHICLE INFORMATION

PRIMARY CONTROLS

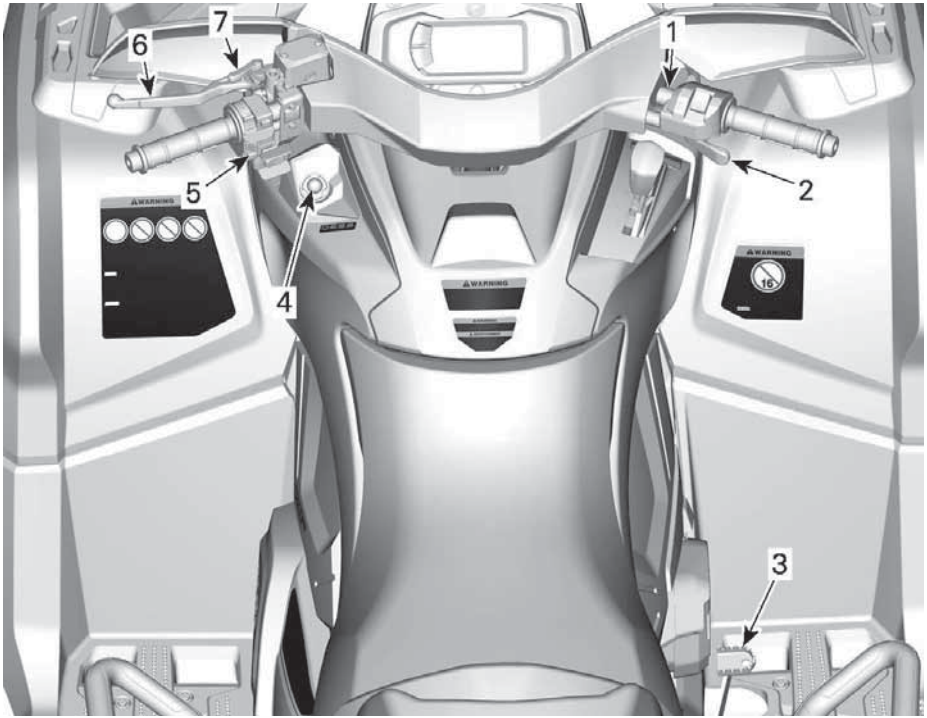

1. Handlebar
2. Throttle lever
3. Brake pedal
4. RF D.E.S.S. post or Ignition switch
5. Engine Stop Switch
6. Brake lever
7. Parking brake lever

While reading this Operator's Guide, remember that:

WARNING

Indicates a potential hazard which, if not avoided, could result in serious injury or death.

Handlebar

The handlebar controls the steering of the vehicle.

As the handlebar is rotated to right or left, the front wheels are turned in this direction to steer the vehicle.

WARNING

Fast reverse while turning, could result in loss of stability and control.

Throttle Lever

The throttle lever is located on the RH side of the handlebar.

The throttle lever controls the engine speed.

To increase or maintain vehicle speed, press the throttle lever with your right thumb.

To decrease vehicle speed, release the throttle lever.

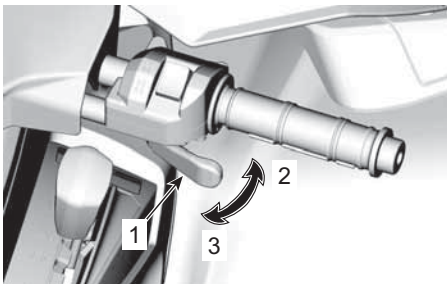

1. Throttle lever
2. To accelerate
3. To decelerate

Brake Lever

The brake lever is located on the LH side of the handlebar.

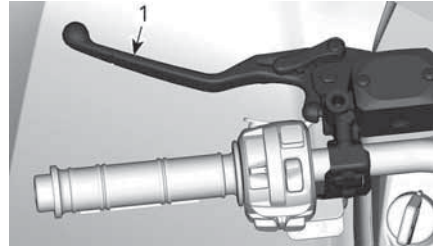

1. Brake lever

The brake lever function is to slow down or stop the vehicle.

When the brake lever is compressed, the front and rear brakes are applied.

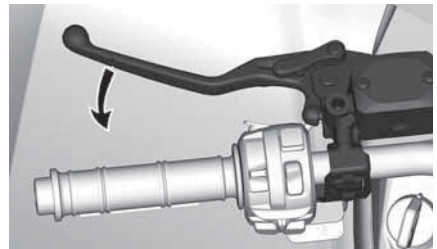

Braking effect is proportional to the force applied on the lever.

Parking Brake Lever

The parking brake lever is located on the LH side of the handlebar.

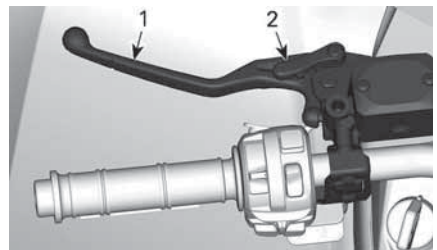

TYPICAL

1. Brake lever
2. Parking brake lever

The parking brake function is to maintain brakes to all wheels to prevent vehicle from moving when parked.

⚠ WARNING

Always use the parking brake and engage the PARK position on the shift lever when the vehicle is not in operation.

To engage the parking brake proceed as shown:

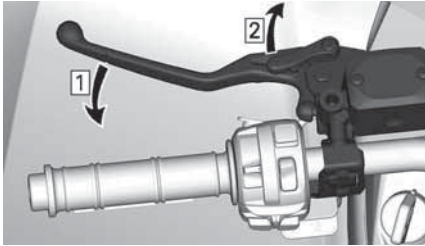

1. Apply brakes
2. Lock brakes

NOTE:

The parking brake lever can be set to several positions.

NOTICE

When the parking brake is applied, make sure the vehicle stays securely in place.

To release the parking brake, simply squeeze the brake lever. It should return to the rest position.

⚠ WARNING

Make sure parking brake is released before operating the vehicle. If parking brake is left ON while riding, it may cause damage to the brake system and cause loss of braking capacity and/or fire.

Brake Pedal

The brake pedal is located on the RH side footrest.



1. Brake pedal

When the brake pedal is pressed down, the rear brake is applied.

When released, the brake pedal should return to its original position.

Braking effect is proportional to the force applied on the pedal.

NOTE:

The brake will have also an effect on front wheels through the drive train when 4WD is engaged.

Should the brake lever system fail, the rear brake can be used by depressing the brake pedal.

Engine Stop Switch

The engine stop switch is located at the middle of the multifunction switch.

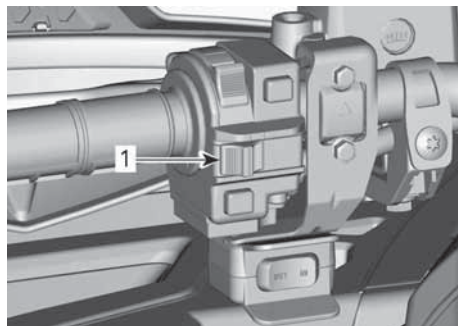

1. Engine stop switch

This switch can be used to stop the engine and as an emergency control.

To stop engine, fully release throttle lever then set the engine stop switch to the STOP position.

While the engine can be stopped by turning the ignition key to OFF position or by removing the D.E.S.S. key, we recommend the engine be stopped by setting the engine stop switch to the STOP position.

RF D.E.S.S. Key and Post

D.E.S.S. Key

These keys contain an electronic circuit that gives it a unique electronic serial number.

The D.E.S.S. system reads the key code and allows engine starting for keys it recognizes.

This vehicle can be operated using 2 different types of key programming:

- Normal
- Performance

Refer to your authorized Can-Am Off-road dealer for complete information.

The vehicle is delivered with 1 performance key.

NOTE:

Additional keys are available from your dealer as an accessory.

⚠ WARNING

Rollovers, tipovers, collisions and loss of control resulting in serious injury or death are possible with the performance or normal key. Using the normal key is not a substitute for the operator being prepared, qualified, and operating with care.

Performance Key

The performance key allows the user to access the full torque of the engine

as well as the top speed of the vehicle.

This may be useful for riders who prefer crisper throttle response, and for environments where higher speeds and greater acceleration are appropriate.

For example, in wide-open straight trails, operators may prefer the performance key.

Normal Key

The normal key limits the vehicle rate of acceleration and/or the vehicle speed to 70 km/h (43 MPH).

⚠ WARNING

On steep downhills, the engine speed limiter may not prevent the vehicle from accelerating beyond this speed.

This key may be useful for riders who prefer more gradual acceleration, or for riding in environments where full speed and high acceleration are not desirable.

For example, in narrow, winding trails, operators may prefer a normal key.

D.E.S.S. Flexibility

The D.E.S.S. of your vehicle can be programmed by your authorized Can-Am Off-road dealer to accept up to 8 different keys.

If you have more than one D.E.S.S. equipped Can-Am vehicle, each can be programmed by your authorized Can-Am Off-road dealer to accept the other vehicle D.E.S.S. keys.

Ignition Switch and Keys

The ignition switch is located on the LH side of the central panel below the handlebar.

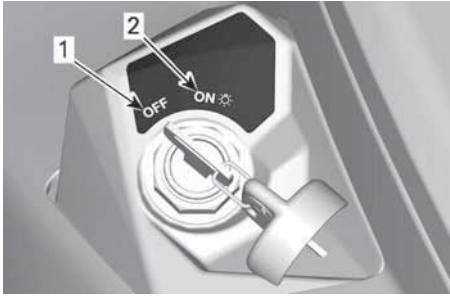

IGNITION SWITCH POSITIONS

1. OFF
2. ON with lights

OFF

The key can be inserted or removed in this position only.

In OFF position, the electrical system of the vehicle is disabled.

The engine is shut down by turning the ignition switch to OFF position.

While the engine can be stopped by turning the ignition key to OFF position, we recommend the engine be stopped by setting the engine stop switch to the STOP position.

When turning the key to OFF position, the vehicle electrical system will take a few seconds to shut down.

ON with Lights

When the key is turned in this position, the electrical system of the vehicle is activated.

The gauge should wake-up.

The vehicle lights are turned on.

The engine can be started.

Basic Ignition Key

The vehicle is delivered with two basic ignition keys.

SECONDARY CONTROLS

Some features may not apply to your model or could be optional.



1. Throttle lever control housing
2. Shifter lever
3. Winch switch
4. Multifunction switch

While reading this Operator's Guide, remember that:

WARNING

Indicates a potential hazard which, if not avoided, could result in serious injury or death.

Throttle Lever Control Housing

4WD/6WD Selector Switch

The 4WD/6WD selector is located on the RH side of the handlebar.

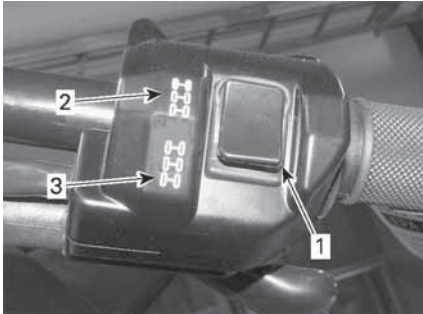

TYPICAL

1. Selector
2. 6WD position
3. 4WD position

This switch selects 4 wheel drive or 6 wheel drive mode when the vehicle is stopped and the engine is running.

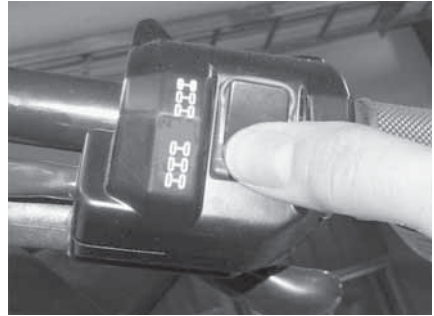

4WD MODE - TYPICAL

The 6WD mode is engaged when the switch is pushed upwards.



6WD MODE - TYPICAL

NOTICE
The vehicle must be stopped to engage or disengage 4WD/6WD switch. Mechanical damage may occur if switch is engaged or disengaged while driving.

The 4WD mode is engaged when the switch is pushed downwards. The vehicle is then rear wheel drive only.

Shift Lever

The shift lever is located on the RH side of the vehicle near steering column.



SHIFT LEVER LOCATION

The shift lever is used to change the gearbox position.

The shift lever has 5 positions:

Shift Lever Positions	
Position	Gear
P	Park
R	Reverse
N	Neutral
H	High range (forward)
L	Low range (forward)



SHIFT PATTERN

The vehicle must be stopped and brakes applied prior to selecting any gear.

NOTICE

This gearbox is not designed to shift while vehicle is moving.

Park

The park position locks the gearbox to help prevent vehicle movement.

⚠ WARNING

Always use the PARK (P) position when the vehicle is not in operation. The vehicle can roll if the shift lever is not set to P (PARK).

Reverse

The reverse position allows the vehicle to go backwards.

NOTE:

In reverse operation, the engine's RPM is limited, thus limiting the vehicle reverse speed.

⚠ WARNING

When driving downhill in reverse, gravity can increase the vehicle speed above the set limited reverse speed.

Neutral

The neutral position disengages the gearbox.

⚠ WARNING

Always use the PARK (P) position when the vehicle is not in operation. The vehicle can roll if the shift lever is set to N (NEUTRAL).

High Range (Forward)

This position selects the high speed range of the gearbox. It is the normal driving speed range. It allows the vehicle to reach its maximum speed.

Low Range (Forward)

This position selects the low speed range of the gearbox. It allows the vehicle to move slowly with maximum torque at the wheels.

NOTICE

Use the low speed range to pull a trailer, carry heavy cargo, go over obstacles, riding in mud or drive uphill and downhill.

Multifunction Switch

The multifunction switch is located on the LH side of the handlebar.

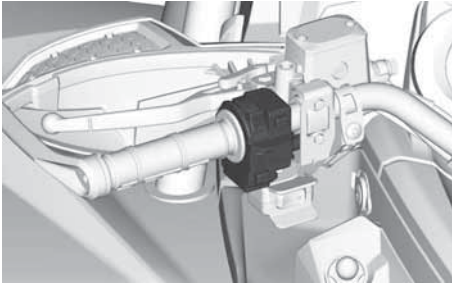

Headlight Switch



1. Light OFF
2. Low beam and taillight
3. High beam and taillight

Engine Start Button

The engine start button is located at the top of the multifunction switch.

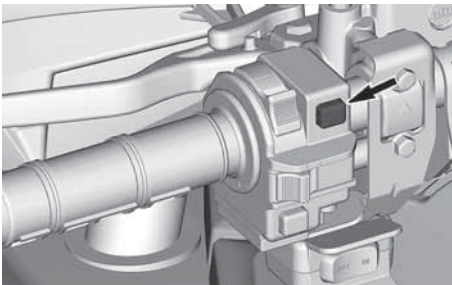

When depressed and held, it starts the engine.

Refer to *Starting the Engine* in the *Basic Procedures* section for complete starting procedure.

Override/DPS Button

This button is located at the bottom of the multifunction switch.

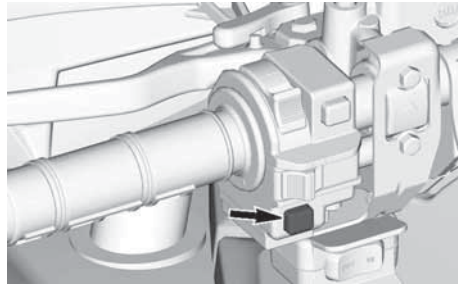

It has 2 functions.

- Activate the override function
- Change DPS modes.

Override Function

This function allows to bypass the engine speed limiter when the vehicle is used in reverse or in the 4WDLock mode.

In 4WDLock, the override mode will allow to reach an other speed limitation:

- 60 km/h (37 MPH) in HIGH or LOW gear
- 25 km/h (16 MPH) in reverse.

⚠ WARNING

Make sure the area around the vehicle is clear before using the override mode.

The override mode must be used only at low speed and when the vehicle is caught in mud or other soft terrain.

Do not use the override mode when driving normally in reverse, this would result in excessive speed,

Do not use the override mode when driving normally in 4WDLock, otherwise a loss of control could occur.

To engage the override function, proceed as follows:

1. Ensure that the vehicle is completely stopped.
2. Press and hold the override/DPS button then press the throttle lever gradually.

NOTE:

When using the override function, the gauge will scroll an **OVERRIDE** message to confirm that the function is activated.

3. To disengage the override function, simply release the override/DPS button.

DPS Function

This button is also used to change the Dynamic Power Steering (DPS) mode.

For complete information on DPS modes, refer to *Tune Your Ride*.

Horn Button

Vehicle Sold in Finland Only

The horn button is located under the left multifunction switch.

Press on the horn button to activate the horn.



EQUIPMENT

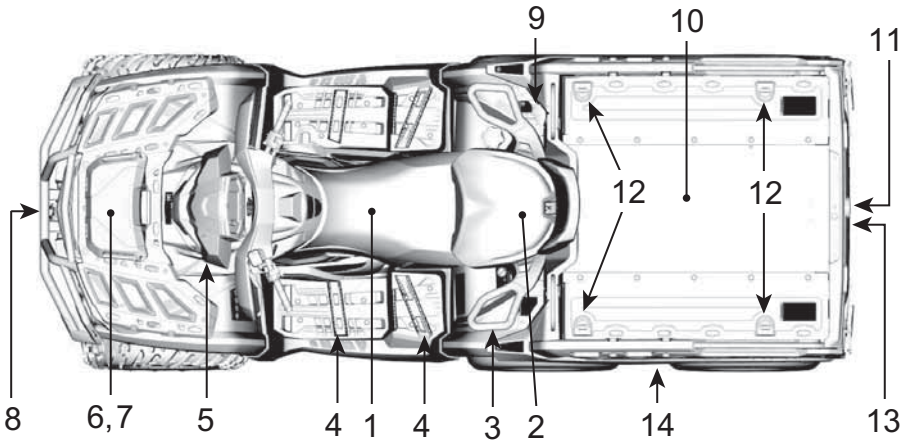

1. Operator's seat
2. Passenger's seat
3. Grab handles
4. Footpegs
5. 12-volt power outlet
6. Glove box
7. Tool kit
8. Winch
9. Cargo bed tilt release handle
10. Rear storage compartment
11. Trailer hitch
12. Cargo box anchoring hooks
13. Recovery hook
14. Side walls and tailgate

While reading this Operator's Guide, remember that:



WARNING

Indicates a potential hazard which, if not avoided, could result in serious injury or death.

Operator's Seat

The seat is designed for an operator only.

WARNING

Never allow anyone to seat as a passenger on this vehicle.

Removing the Seat

1. Push the seat latch upward. This latch is located underneath the rear of seat.



1. *Seat latch*
2. Pull seat upward then rearward.
3. Continue lifting movement until you can release the front retaining device then completely remove seat.

Installing the Seat

1. Insert front tabs of seat into steel hooks of frame.
2. When seat rests in its position, firmly push seat down to latch.

NOTE:

A distinctive snap will be felt. Double check that the seat is secure by giving it a tug to confirm proper latching.

WARNING

Confirm that the operator's seat is properly locked in position by pulling back and up several times.

Passenger's Seat

WARNING

Never operate the vehicle without passenger's seat or glove box (if equipped) installed.

The passenger's seat is designed for a passenger only. The integrated backrest supports his back during the ride.



1. *Integrated backrest*
2. *Grab handle*
3. *Passenger's seat*

Removing the Passenger's Seat

1. To unlock latch, pull the passenger's seat latch lever toward the front of the seat.

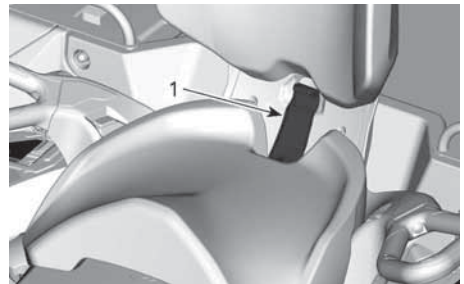

1. *Seat handle*
2. While maintaining latch lever pulled towards the front, apply downward pressure on the back of latch lever to clear rear latch from pin and toggle seat towards front using backrest.
3. Pull seat rearward and up out of location to clear the front tabs.

Installing the Passenger's Seat

1. Ensure the latch lever is in the open position by pulling it towards the front of seat.
2. Using a forward motion, insert both front tabs of the seat into the vehicle anchor housings.



3. On models with passenger's heated grip and/or heated visor, connect the electrical connector located under the seat.
4. Rotate downwards to engage the rear latch.
5. Close the latch lever by pushing it rearwards to secure seat in position.
6. Check if the seat is firmly secured in position before using it.

⚠ WARNING

It is of the utmost importance for the passenger's safety that you confirm that the passenger's seat is properly locked in position by pulling back and up several times.

Grab Handles (2-UP Models)

The grab handles are located on the RH and LH side of the passenger's seat.

They must be used by the passenger to hold on firmly during vehicle operation.

⚠ WARNING

The passenger must always hold on to the passenger grab handles, not the operator. He must also have both feet resting firmly against the footrests.

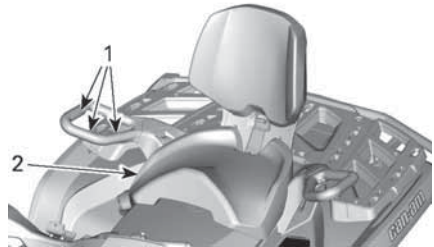

TYPICAL

1. Grab handles
2. Passenger's seat

Footpegs

The operator footpegs are located on the RH and LH side of the vehicle.

1-UP Models



1. Operator's LH footpeg

⚠ WARNING

Operator must have both feet on footpegs at all times during vehicle operation.

2-UP Models

The passenger footpegs are located on the RH and LH side of the vehicle behind the operator footpegs.

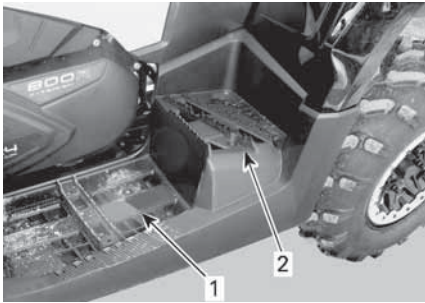

1. Operator's LH footpeg
2. Passenger's LH footpeg

⚠ WARNING

Passenger must have both feet on footpegs at all time during vehicle operation.

12-Volt Power Outlet

Convenient for handheld spotlight or other portable equipment.

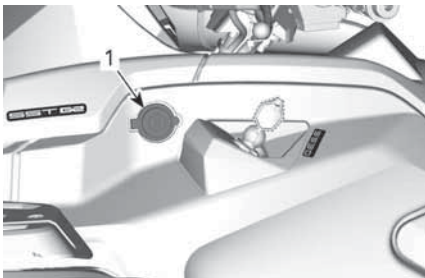

1. 12 V power outlet

Remove protective cap to use. Always reinstall it after use to protect against weather.

Glove Box



1. Glove box

Installing the Glove Box

1. Open glove box cover and turn latch to the unlock position.
2. Align and insert glove box latching system into the vehicle's "LINQ" opening.

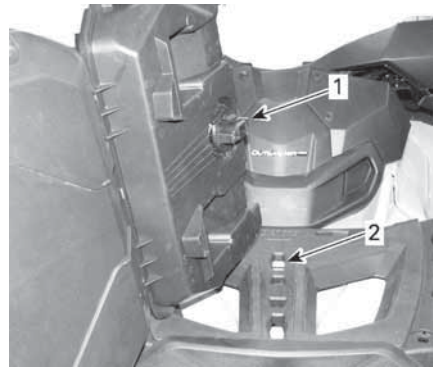

1. Glove box latch
2. "LINQ" opening
3. Turn latch to the lock position.

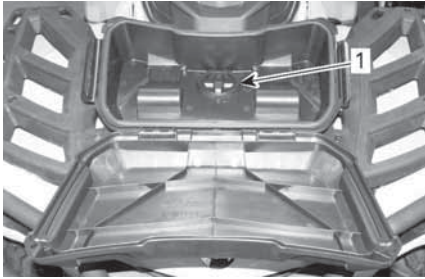

1. Latch
4. Close cover and verify if glove box is locked in position.

Removing the Glove Box

1. Unlock latch on each side of glove box and open lid.
2. Turn latch counter clockwise to unlock.

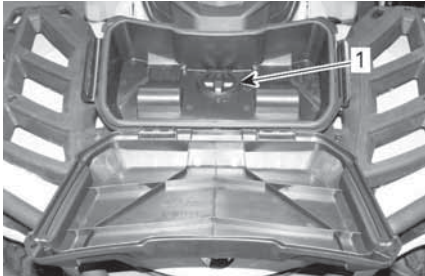

1. Latch
3. Remove glove box.

Tool Kit

The tool kit is located in the glove box. It contains tools for basic maintenance.



1. Glove box

Maintenance, repairs and adjustments which are not described in this *Operator's guide* require the use of special tools and exact technical data. For such work, you should contact your dealer who has specially trained personnel to help you.

Winch

⚠ WARNING

To avoid severe injury or death or important components damages.

- Never use the winch cable/rope to retain a vehicle during trailering.
- Never ride with the winch cable/rope attached to a load or another vehicle.
- Only use the winch to help a stuck vehicle (snow, mud, etc.).
- Always refer to the winch manufacturer's instruction before pulling loads.

The winch can be actuated using the winch control switch or with the remote control (sold separately).

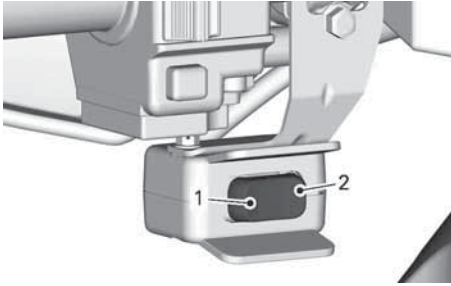

1. OUT
2. IN

A roller fairlead is used to prevent damages to the vehicle and guide the wire rope into the winch.

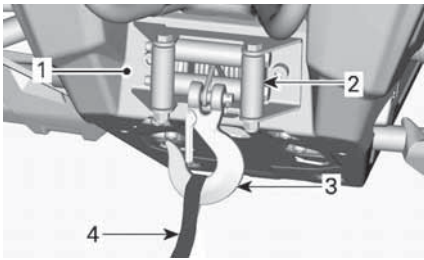

1. Winch
2. Roller fairlead
3. Winch hook
4. Hook strap

NOTE:

Using the winch intensively over a long period of time may discharge the battery.

The following tips will help to reduce the risk of discharging the battery:

Unwind manually: Unlock the cable using the handle then pull on the hook strap to unreel.

It is recommended to let the engine run while winching or rewinding. Do not stop the engine immediately after winching to let battery recharge.

Also, when winching for more than 30 seconds, it is recommended to increase engine RPM in the range of

3000 RPM to increase charging power to the battery.

NOTICE

Make sure vehicle is in NEUTRAL (N) before increasing engine RPM.

Refer to the winch manufacturer's instruction, supplied with the vehicle, for more information about the winch.

Cargo Bed Tilt Release Handle

The latching mechanism of the cargo bed can be actuated from right side of the vehicle through a release handle.

To Tilt Cargo Bed

Release the hairpin clip.

Pull cargo bed release handle and at the same time lift edge of the cargo bed.

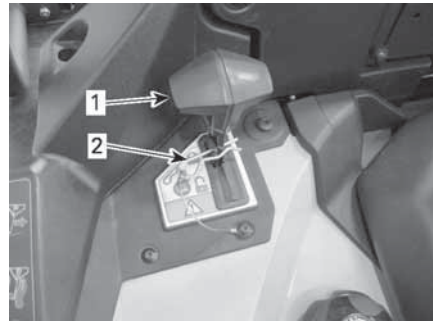

1. Cargo bed release handle
2. Hairpin clip

To Lower Cargo Bed

To lower the cargo bed, simply push it down into place and secure with hairpin clip.

Refer to *Carrying Loads* in the *SAFETY* information section.

Rear Storage Compartment

Convenient location to carry personal articles.



1. Rear storage compartment hatch

⚠ WARNING

Always engage the PARK position on the shift lever before opening cover. Never leave any heavy or loose breakable objects in the storage area. Always latch cover before riding.

To Open Rear Storage Compartment

To Open Storage Compartment Hatch

Unlatch storage compartment hatch.

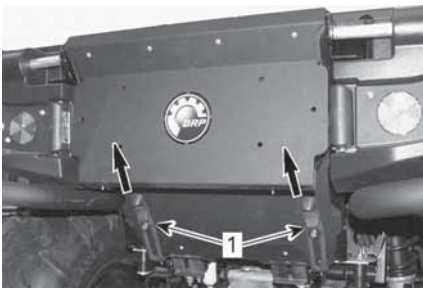

PULL LATCHES UPWARDS

1. Rubber latches

Lift and tilt it rearwards.

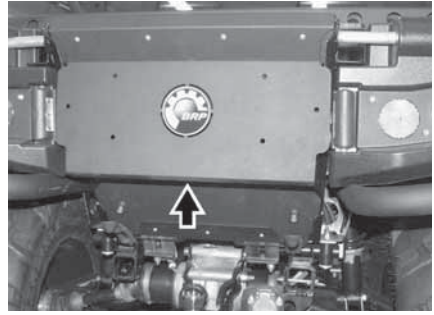

To Open Storage Compartment Cover

Pull, lift and remove the storage compartment cover.

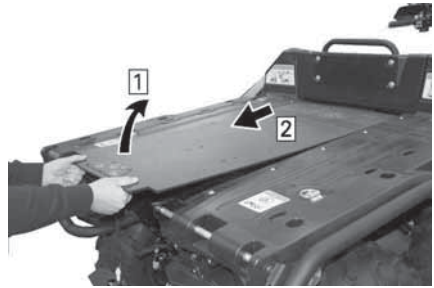

To Close Rear Storage Compartment

To Close Storage Compartment Hatch

Gently pull, lift and push hatch into place.

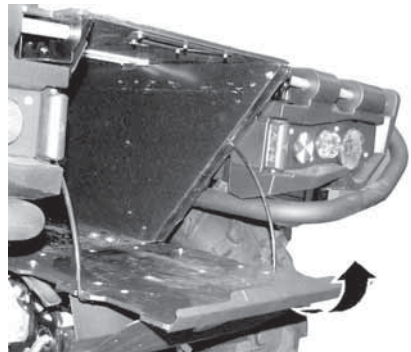

Lock latches.

To Close Storage Compartment Cover

Reverse from opening procedure.

Trailer Hitch

Convenient hitch to install a ball to tow a trailer or other equipment. Use only the ball type hitch certified by BRP. Refer to *Technical Specifications* for carrying loads and towing recommendations.

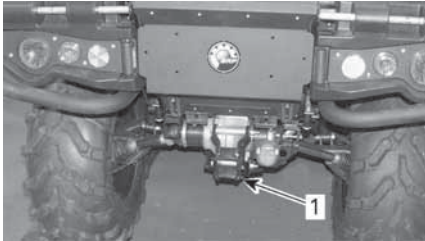

TYPICAL

1. Trailer hitch

⚠ WARNING

Ensure to install the proper ball size that matches the equipment you will tow.

NOTE:

Follow manufacturer's instructions for proper attachment.

Cargo Box Anchoring Hooks

To provide anchoring point to secure cargo inside the cargo bed, 4 anchoring hooks are located inside the cargo area.

Recovery Hook

Convenient hook that can be use to recover a stuck ATV.

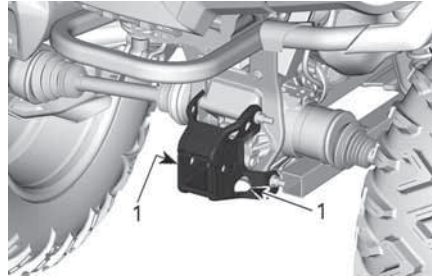

1. Recovery hook

Side Wall



Side Walls and Tail Gate Removal

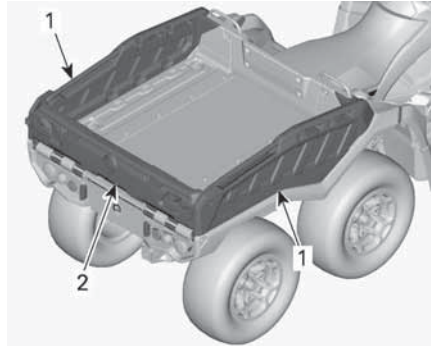

1. Side wall
2. Tail gate

1. Open tail gate latches.

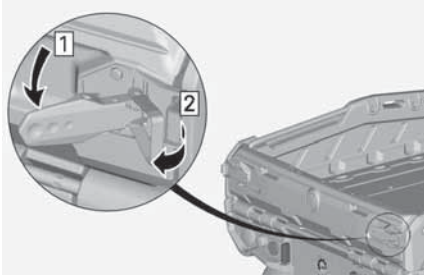

2. Lower tail gate.

NOTE:

Do not remove tail gate yet.

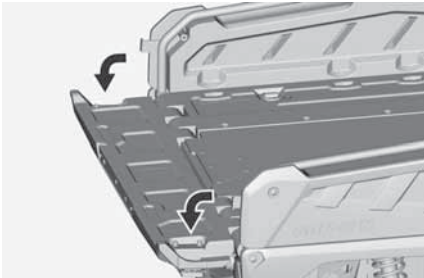

3. Remove locking handle hairpin clips from both sides.

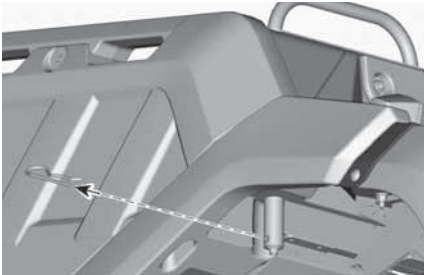

4. Remove locking handles from both sides.

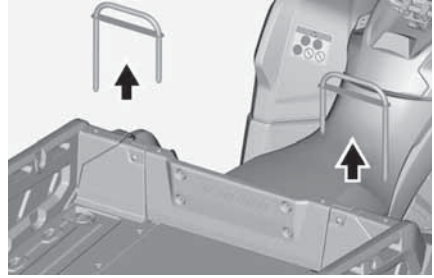

5. Lift side wall up and remove it.

Repeat on other side.

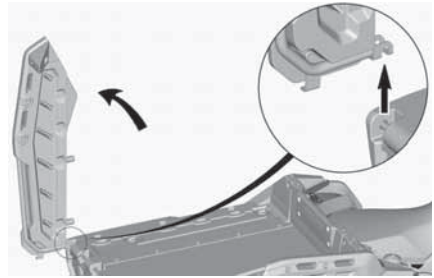

⚠ WARNING
Make sure to remove the side walls before tail gate.

6. Remove tail gate.

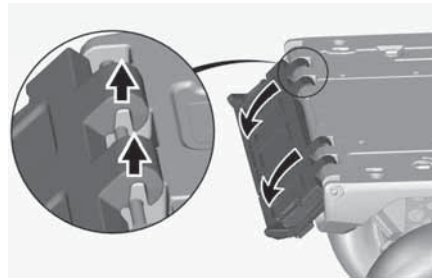

7. Replace locking handles in their original position.

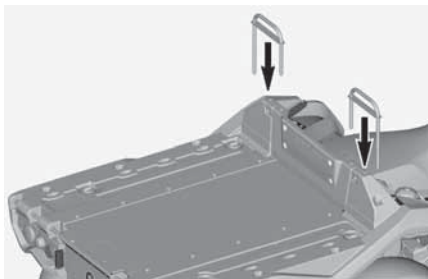

8. Secure with hairpin clip.

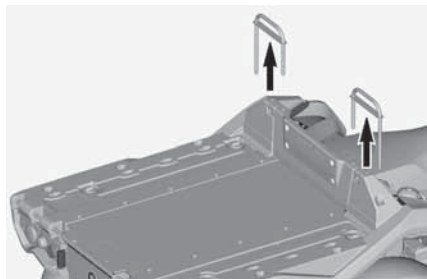

3. Place side wall on flat bed and lower it on its place.

Repeat on other side.

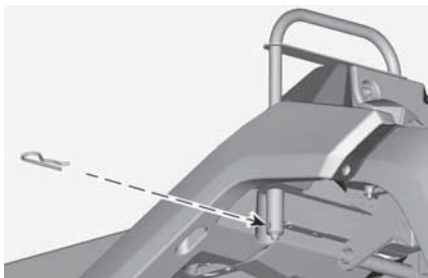

Side Walls and Tail Gate Installation

1. Remove locking handle hairpin clips from both sides.

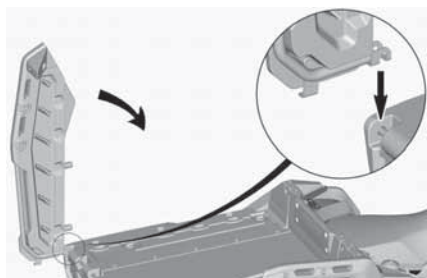

4. Place locking handles.

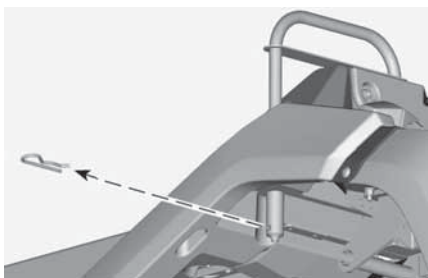

2. Remove locking handles.

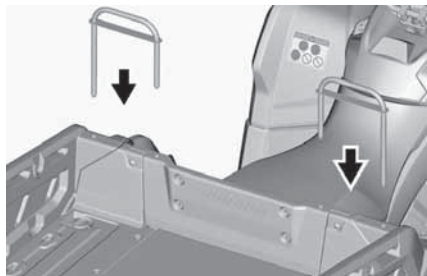

5. Secure with hairpin clip.

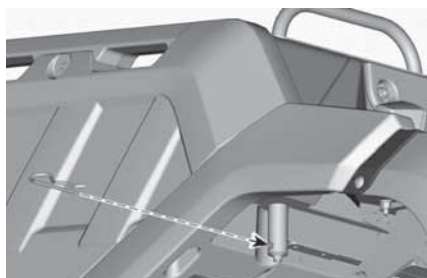

6. Install tail gate.

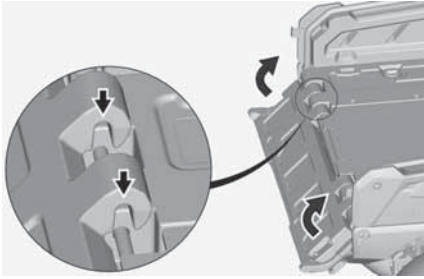

⚠ WARNING

Make sure you do not leave any objects or hands between lifted tail gate and side walls to ensure proper latching of the tail gate.

7. Close tail gate latches.

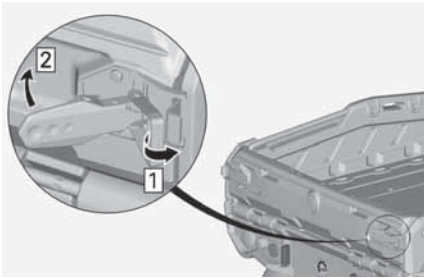

⚠ WARNING

Make sure you do not leave hands between latches and tail gate.

MULTIFUNCTION GAUGE (LCD)

The multifunction gauge is located in the gauge support.

⚠ WARNING

Reading the multifunction gauge display can distract from the operation of the vehicle, particularly from constantly scanning the environment.

Multifunction Gauge Description

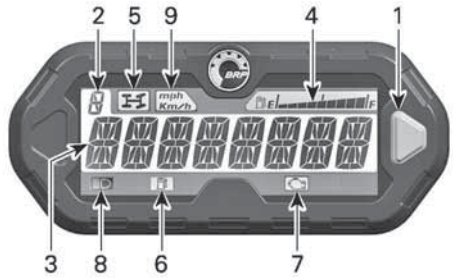

1. Selector button
2. Gearbox position display
3. Main screen
4. Fuel level display
5. 4WD indicator lamp
6. Low fuel level indicator lamp
7. Check engine indicator lamp
8. High beam indicator lamp
9. MPH, Km/h indicator lamp

Selector Button

The selector button is used to navigate or change settings in the multifunction gauge.

Gearbox Position Display

This display shows the selected gearbox position.



1. Gearbox position

Display	Function
P	Park
R	Reverse
N	Neutral
H	High range
L	Low range

Main Screen

The main screen is used to display numerous functions of the multifunction gauge.

Refer to *Multifunction Gauge Modes* for the different available modes.

Fuel Level Display

Bar gauge that continuously indicates the level of fuel in the fuel tank while riding.

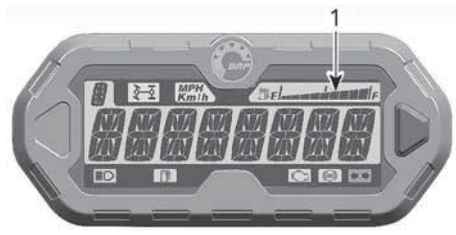

1. Fuel level display

4WD Indicator Lamp

When this indicator is ON, it indicates the 4WD mode is selected.

Low Fuel Level Indicator Lamp

When this indicator  is ON, it indicates that there is approximately 5 l (1.3 gal (liq., US)) of fuel left in fuel tank.

Check Engine Indicator Lamp

When this indicator  is ON, it indicates an engine fault code, look for a message at the LCD display.

When this indicator blinks, it indicates that the LIMP HOME mode is activated.

Refer to *Troubleshooting* for more details.

High Beam Indicator Lamp

When this indicator  is ON, it indicates that high beam is selected on the headlights.

KM/H or MPH Indicator Lamp

The proper lamp (^{mph}/_{Km/h}) turns ON to indicate the unit the speedometer uses.

Multifunction Gauge Modes

Speedometer Mode

In this mode, the main screen displays the actual vehicle speed in km/h or in MPH.



Tachometer Mode

In this mode, the main screen the actual engine speed in revolutions per minute (RPM).



Combined Mode

In this mode, the main screen displays both the vehicle speed and the engine speed (RPM).



1. Vehicle speed
2. Engine speed (RPM)

Odometer (OD)

Odometer records the total distance travelled either in miles or kilometers.



Clock

Displays current time.



Refer to *Gauge Setup* to set current time.

Trip Meter (TP)

The trip meter records the travelled distance since it has been reset.

Distance travelled is displayed either in kilometers or miles.



Press and HOLD the selector button for 2 seconds to reset the trip meter.

Trip Hour Meter (TH)

The trip hour meter records vehicle running time when the electrical system is activated. It can be used to establish traveling time between 2 places.



Press and HOLD the selector button for 2 seconds to reset the hour meter.

Engine Hour Meter (EH)

The engine hour meter records engine running time.



Message Display Mode

If an abnormal engine condition occurs, a message may scroll across the main screen in conjunction with a pilot lamp.

Refer to *Troubleshooting* for details.

Fault Code Mode

Switch to HI beam and select engine hour meter display mode.

Press and hold mode button while switching high and low beam (three cycles) to access diagnostic fault codes.

Navigating in the LCD Gauge

Temporary Display Mode

In the temporary display mode, the following functions are available:

- Odometer
- Clock
- Trip meter (resettable)
- Trip Hour meter (resettable)
- Engine hour meter.

Press and release selector button to change the default display mode to the temporary mode.

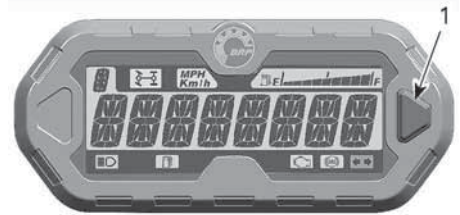

1. Selector button

The gauge will display the selected mode for 10 seconds then will return to the normal display mode.

While in a resettable mode, push and HOLD selector button for 2 seconds to reset it.

Default Display Mode

After vehicle startup, the default display mode is either:

- Vehicle speed
- Engine revolutions per minute (RPM)
- Both parameters simultaneously (combined mode).

To change from one display to the other, proceed as follows.

1. Install D.E.S.S. key on D.E.S.S. post.
2. Wait until the "greeting message" has been displayed.
3. Press and release selector button once to display OD (odometer).
4. Press the selector button again, this time for 2 seconds.

This will change the Mode to either Speed, RPM or Combined.



5. To select another mode, repeat steps 3 and 4 until the desired mode is displayed

Driving Modes (If equipped)

Some models are equipped with a driving mode selector.



1. Driving mode selector

A message of the selected mode will be displayed at activation and deactivation as follow:

Drive mode	Message at activation
SPORT	SPORT mode
NORMAL	NORMAL mode
ECO	ECO mode

Gauge Setup

Clock Setting Using Gauge Selector Button

1. Select the clock display.



1. Selector button

2. Time

2. Press and HOLD selector button. The display will flash.
3. Choose the 12-hour (12H) or 24-hour (24H) format by pressing button.

4. If the 12-hour format was selected, choose Am (A) or Pm (P) by pressing button.
5. Choose hour first digit by pressing button.
6. Choose hour second digit by pressing button.
7. Choose minutes first digit by pressing button.
8. Choose minutes second digit by pressing button.

NOTE: The gauge will display the current time for 10 seconds then will return to the normal display mode.

Unit Selection (km/h vs MPH)

The speedometer, odometer and trip meter are factory preset in **miles** but it is possible to change them to **kilometer** reading.

Contact an authorized Can-Am off-road dealer.

Language Selection

The gauge display language can be changed.

Refer to an authorized Can-Am off-road dealer for language availability and setup the gauge to your preference.

4.5" DIGITAL DISPLAY

Multifunction Display

Lower Display

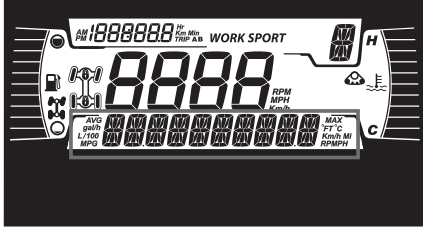

May display the following:

- RPM
- Speed
- Engine Temperature
- Battery Voltage
- Settings
- Messages

Use LOWER (MENU) button to change the displayed information.

The SPEED display shows the Maximum and the averaged speed.



1. Upper button
2. Lower button

Left Lateral Display

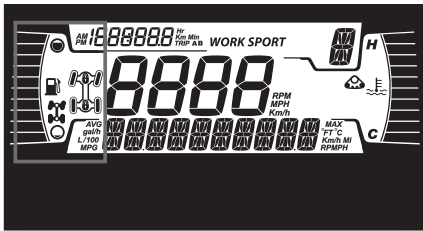

The left lateral display includes:

- Fuel level indicator
- 4X6 / 6X6 telltale

- Track Kit active

Icon	Description
	4x6 icon
	6x6 icon (except European Community countries)
	6x6 icon for European community
	Track kit icon

Right Lateral Display

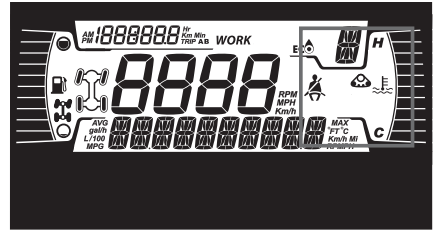

The right lateral display includes:

- Engine Temperature
- Track Kit active

When a track kit is installed, a message will scroll in the lower display.

Central Display

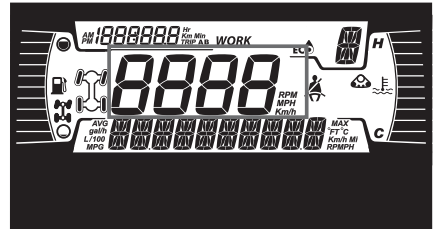

Display the vehicle speed in km/h or MPH.

Transmission Position Display

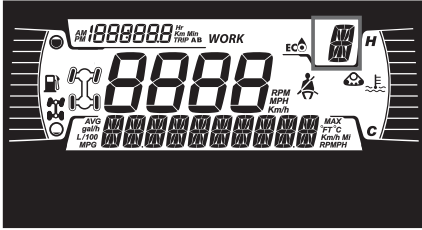

This display shows gear position of gearbox:

- P (Park)
- R (Reverse)
- N (Neutral)
- H (High Range)
- L (Low Range)
- - (Invalid Range)

Trip Display

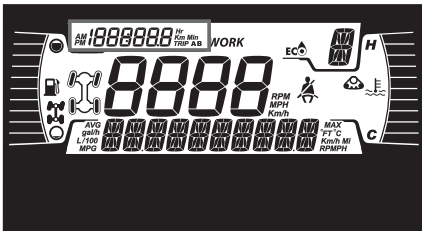

This display shows trip informations:

- Cumulative distance odometer
- Trip A
- Trip B
- Vehicle hour meter
- Clock

Use UPPER button to change the displayed information.

Hold UPPER button to reset Trip A/B meters.

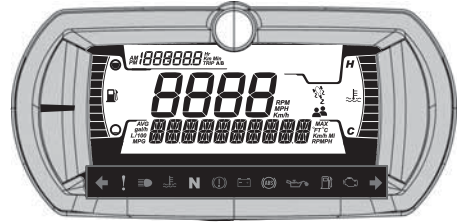

Indicator Lamps

Warning and Telltale Lights





WARNING and Telltale Lights

	GREEN - Flashers (T Category models only)
	Hazard Warning Flasher (if equipped) - All front and rear turn signals will flash
	ORANGE - Vehicle Malfunction
	BLUE - High Beam
	RED - The engine temperature is too high.
	GREEN - Neutral
	RED - Parking brake is engaged or malfunction of the brake system
	RED - The battery voltage too low or problem with the electrical system
	ORANGE - Malfunction of the ABS system (T Category models only)
	RED - Low oil pressure Normally ON when engine is OFF

WARNING and Telltale Lights	
	ORANGE - Low fuel level
	<p>ORANGE Turn on: Malfunction of the vehicle emissions control system Blink: Engine problems, the limp home mode is activated. Have the vehicle serviced immediately.</p>

Icons and Indicators - Digital Display

Icons and Indicators	
<i>SPORT</i>	– Denotes SPORT mode is selected.
<i>WORK</i>	– Denotes WORK mode is selected.
	<ul style="list-style-type: none"> – When lit, indicates that a maintenance is required. – See your authorized Can-Am Off-road dealer or person of your own choosing for the maintenance.
	<ul style="list-style-type: none"> – Track kit active (when installed). – Available on all models except models of the T Category.
	<ul style="list-style-type: none"> – Denotes Speed Limiter is selected. – When this option is available.

Settings

The buttons to navigate through menus are located on the left side of the LCD display.

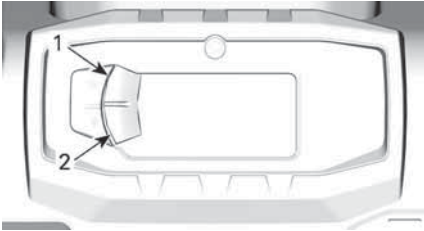
**TYPICAL**

1. Upper button
2. Lower button

Setup

Using LOWER button, select **SETTINGS** and hold to enter setting menu.

Maintenance Reset

To reset the maintenance message, refer to *Resetting the Message: Maintenance Required* in the *Maintenance Procedures* section.

NOTE: Available only when the maintenance is due (after every 100 engine hours).

Fault Codes

Available only when at least one code is activated.

Using LOWER button, select **CODES** and hold to see active fault codes.

Fault codes will be scrolled on the Lower Display.

Reset Stats

Using LOWER button, select **RESET STAT** and hold to reset.

Unit Selection

This multifunction gauge is factory preset in Imperial units but it is possible to change it to Metric units.

Using LOWER button, select **UNITS** and hold button to change units.

Setting Clock

All of the following action must be performed using the LOWER button.

1. Select **CLOCK** and hold to adjust clock.
2. Press the button to select clock display.
3. Push and hold the button for 1 second.
4. Press the button to select 12:00 AM PM or 24:00 time base.
5. Push and hold the button to acknowledge selection.
6. Press the button to change hours (hours flash).
7. Push and hold the button to acknowledge hour selection.
8. Press the button to switch to minutes (minutes flash).
9. Push and hold the button to acknowledge minutes selection.

Setting Language

The gauge display language can be changed.

Refer to an authorized Can-Am Off-road dealer for language availability and to setup the gauge to your preference.

Setting Brightness

The brightness of the LCD display can be adjusted.

Using LOWER button, select **BRIGHTNESS** and hold button to change brightness.

Using LOWER button, adjust brightness then push and hold the button to acknowledge selection.

FUEL

While reading this Operator's Guide, remember that:



WARNING

Indicates a potential hazard which, if not avoided, could result in serious injury or death.

Fuel Requirements

NOTICE

Always use fresh gasoline. Gasoline will oxidize; the result is loss of octane, volatile compounds, and the production of gum and varnish deposits which can damage the fuel system.

Alcohol fuel blending varies by country and region. Your vehicle has been designed to operate using the recommended fuels, however, be aware of the following:

- Use of fuel containing alcohol above the percentage specified by government regulations is not recommended and can result in the following problems in the fuel system components:
 - Starting and operating difficulties.
 - Deterioration of rubber or plastic parts.
 - Corrosion of metal parts.
 - Damage to internal engine parts.
- Inspect frequently for the presence of fuel leaks or other fuel system abnormalities if you suspect the presence of alcohol in gasoline exceeds the current government regulations.
- Alcohol blended fuels attract and hold moisture which may lead to fuel phase separation and can result in engine performance problems or engine damage.

Recommended Fuel

The gasoline must have the following minimum octane requirements:

1000R engines

Premium unleaded gasoline with an AKI (R+M)/2 octane rating of 91, or a RON octane rating of 95

All other engines

Common unleaded gasoline with an AKI (R+M)/2 octane rating of 87, or an RON octane rating of 92

Use unleaded gasoline containing MAXIMUM 10% ethanol.

E10

NOTICE

Never experiment with other fuels. Engine or fuel system damages may occur with the use of an inadequate fuel.

NOTICE

Do NOT use fuel from fuel pumps labeled E85.

Use of fuel labeled E15 is prohibited by U.S. EPA Regulations.

Vehicle Fueling Procedure

⚠ WARNING

- Fuel is flammable and explosive under certain conditions.
- Never use an open flame to check fuel level.
- Never smoke or allow flame or spark in vicinity.
- Always work in a well-ventilated area.
- Vehicle must be on a level surface to perform fueling.

1. Stop engine.

⚠ WARNING

Always stop engine before refueling.

2. Have operator and/or passenger get off vehicle.

⚠ WARNING

Do not allow anyone to remain in the vehicle while fueling. If there is a fire or explosion during fueling, a vehicle occupant could be unable to quickly leave the area.

3. Unscrew slowly the fuel reservoir cap counterclockwise to remove it.

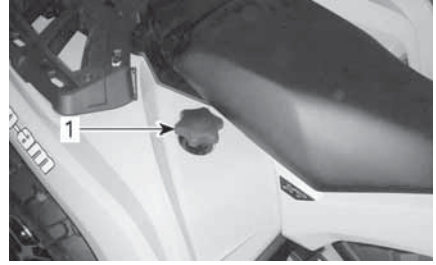

1. Fuel reservoir cap

⚠ WARNING

If a differential pressure condition is noticed (whistling sound heard when loosening fuel reservoir cap) have vehicle inspected and/or repaired before further operation.

4. Insert the spout into the filler neck.
5. Pour fuel slowly so that air can escape from the tank and prevent fuel flow back. Be careful not to spill fuel.
6. Stop filling when the fuel reaches the bottom of filler neck. **Do not overfill.**

⚠ WARNING

Never top up the fuel tank before placing the vehicle in a warm area. As temperature increases, fuel expands and may overflow.

7. Fully tighten fuel reservoir cap clockwise.

⚠ WARNING

Always wipe off any fuel spillage from the vehicle.

BREAK-IN PERIOD

While reading this Operator's Guide, remember that:



WARNING

Indicates a potential hazard which, if not avoided, could result in serious injury or death.

Operation During Break-In

A break-in period of 10 operating hours or 300 km (200 mi) is required for the vehicle.

Engine

During the break-in period:

- Avoid full throttle operation.
- Avoid pressing the throttle lever more than 3/4 of the stroke.
- Avoid sustained accelerations.
- Avoid prolonged cruising speeds.
- Avoid engine overheating.

However, brief accelerations and speed variations contribute to a good break-in.

Brakes



WARNING

New brakes will not operate at their maximum efficiency until their break-in is completed. Braking performance may be reduced, so use extra caution.

Belt

A new belt requires a break in period of 50 km (30 mi).

During the break-in period:

- Avoid strong acceleration and deceleration.
- Avoid pulling a load.
- Avoid high speed cruising.

BASIC PROCEDURES

Waking Up the Electrical System

Press and release the START button for less than half a second and the electrical system will turn ON:

- For 30 seconds, **without** powering any equipment:
 - With the D.E.S.S. key not installed or ignition key in the OFF position, **OR**
 - With the Engine Stop switch sets to the STOP position
- For 10 minutes, powering equipment:
 - With the D.E.S.S. key installed or the ignition key in the ON position, **AND**
 - With the Engine Stop switch sets to the RUN position.

The electrical system will be shut-down after 30 seconds if either the D.E.S.S. key or the ignition key is removed **OR** the Engine Stop switch is set to the STOP position.

NOTICE
Waking up the electrical system repeatedly or using electrical equipment will discharge the battery and you may not be able to start the engine.

Starting the Engine

The shift lever must be set to PARK or NEUTRAL.

NOTE:

For your convenience, an override mode allows the engine to be started with the shift lever in any position. Press and hold the brake lever or the brake pedal while pressing the engine start button.

Insert key in ignition switch and turn to ON position or ensure D.E.S.S. key is installed on D.E.S.S. post.

Set the engine stop switch to RUN.

Press the engine start button and hold until the engine starts.

NOTICE
If engine does not start after a few seconds, do not hold the start position more than 10 seconds. Refer to <i>Troubleshooting</i>.

Release the engine start button immediately when the engine has started.

NOTE:

If the battery is dead, engine cannot be started. Have the battery re-charged or replaced.

Changing Gear Selection

Apply brakes and immobilize vehicle, then select the desired shift lever position.

Release brakes.

NOTICE
When changing gear selection, always completely stop the vehicle and apply the brakes prior to shifting. Damage to the gearbox may occur.

Gradually press the throttle lever to increase engine speed and thus engaging the continuously variable transmission (CVT).

At the opposite, when the throttle lever is released, the engine speed decreases.

Stopping the Engine and Parking the Vehicle

 WARNING
Avoid parking on steep slope as the vehicle may roll away.

⚠ WARNING

Always put the vehicle in PARK when stopped or parked to prevent rolling.

⚠ WARNING

Avoid parking in places where hot parts can start a fire.

When stopped or parked, always bring shift lever to PARK position. This is especially important when parking on a slope. On very steep inclines or if the vehicle is carrying a cargo, the wheels should be blocked using rocks or bricks (or ideally, wheel chocks).

Select the flattest terrain available for parking.

Release throttle and use brakes to completely stop the vehicle.

Set shift lever in PARK position.

Apply the parking brake.

Push the engine stop switch to OFF position.

Turn key in ignition switch to OFF position or use the vehicle engine stop switch to stop the vehicle.

Remove key from ignition switch or remove D. E. S. S. key from D. E. S. S. post.

SPECIAL PROCEDURES

Flooded Engine

If the engine does not start and it is fuel-flooded, this special mode can be activated to prevent fuel injection and to cut ignition while cranking. Proceed as follows:

1. Move shift lever in park position.
2. Install key on D.E.S.S. post or turn the ignition key in ON position.
3. Press completely and HOLD throttle lever.
4. Press the engine START button for 20 seconds.
5. Release throttle lever.
6. Press the START button again to allow starting.

If the engine does not start:

1. Unplug injector electrical connector
2. Clean the spark plug caps area then remove them.
3. Remove the spark plugs.
4. Crank engine several times.
5. Install new spark plugs if possible or clean and dry spark plugs.
6. Start engine as explained above.

If engine continues to flood, see an authorized Can-Am Off-road dealer.

NOTICE

Verify that there is no fuel in engine oil. If so, replace engine oil.

Water Into the CVT

The CVT drain plug is located on the rear portion of the CVT cover. It is accessible from the rear LH fender.

Inspect the CVT drain plug to validate if water is present.

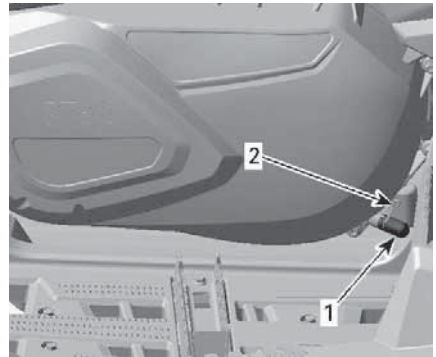

NEAR LH FOOTREST

1. Drain plug
2. Spring clamp

NOTICE

If water entered your CVT while in a muddy environment, limit vehicle usage and bring your vehicle to your nearest authorized Can-Am dealer for a proper CVT cleaning procedure.

If water is present, remove CVT drain plug to expel water.

Reinstall the drain plug and secure it using the spring clamp.

NOTE:

Make sure hose is properly inserted on CVT cover nipple.

NOTICE

See an authorized Can-Am Off-road dealer to have the CVT inspected and cleaned.

Water Into the Air Filter Housing

Remove the LH side panel.

Inspect the drain reservoir underneath the air filter housing to validate if water is present.

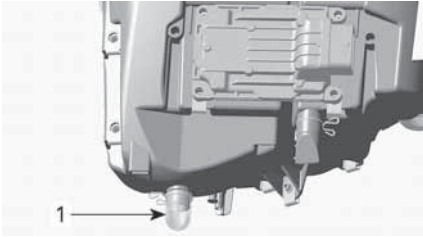
**TYPICAL**

1. Air filter housing drain reservoir

If water is present, press clamp and remove reservoir to drain water from air filter housing.

If one of the following conditions is met, bring the vehicle to your nearest authorized Can-Am Off-road dealer to have the vehicle serviced:

- If more than 50 ml (2 fl oz (US)) of water (approximately 5 drain reservoirs) is found in the air filter housing.
- If any deposits are present in the drain reservoir.

In such a case, the vehicle must be serviced for:

- Vents
- CVT air filter cleaning
- CVT cleaning
- Fuel tank breather replacement
- Lubricant inspection and replacement as required (engine, gearbox and rear final drive).

NOTICE

Failure to have vehicle serviced may lead to permanent damage to the following components but not limited to:

- Engine and gearbox
- Fuel pump
- CVT
- Front differential
- Rear final drive.

Vehicle is Turned Over

When vehicle is turned over or stays tilted on the side, put the vehicle back on its wheel.

Inspect vehicle for damages.

⚠ WARNING

**Never operate the vehicle if damaged.
Refer to an authorized Can-Am Off-road dealer.**

If vehicle has no damage, refer to *Maintenance Procedures* and inspect the following.

- Inspect air filter housing for oil accumulation, if any oil is found, clean air filter and air filter housing.
- Check engine oil level and refill if necessary.
- Check engine coolant level and refill if necessary.
- Check gearbox oil level and refill if necessary.
- Check rear final drive oil level and refill if necessary.
- Start engine. If the oil pressure light stays on, stop engine immediately. See an authorized Can-Am Off-road dealer.

Whenever the vehicle is turned over, it should be inspected by an authorized Can-Am Off-road dealer.

Vehicle is Immersed in Water

Should the vehicle become immersed, immediately stop the engine. Do not use:

- Any electrical equipments
- Winch (if equipped)

It will be necessary to take the vehicle to an authorized Can-Am Off-road dealer as soon as possible. **NEVER ATTEMPT TO START THE ENGINE!**

NOTICE

Immersion of the vehicle can cause serious damage if the correct restart procedure is not followed.

As soon as vehicle is pulled out of water, carry out the following:

- Drain air filter housing, refer to *Water Into the Air Filter Housing*.
- Drain CVT, refer to *Water Into the CVT*.

NOTICE

The vehicle should be serviced as soon as possible by an authorized Can-Am Off-road dealer.

TUNE YOUR RIDE

While reading this Operator's Guide, remember that:

WARNING

Indicates a potential hazard which, if not avoided, could result in serious injury or death.

WARNING

Suspension adjustment could affect vehicle handling. Always take time to familiarize yourself with the vehicle's behavior after any suspension adjustment has been made.

Following are guidelines to fine-tune suspension.

Use suspension adjustment tool provided in the tool kit.

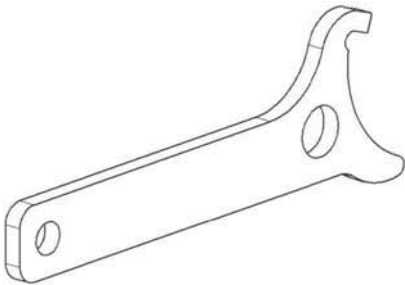

Usage of Unlockable Stabilizer Bar

Keep stabilizer bar locked on both sides when driving on flat terrain. It will reduce the tilting of the vehicle on winding trails.

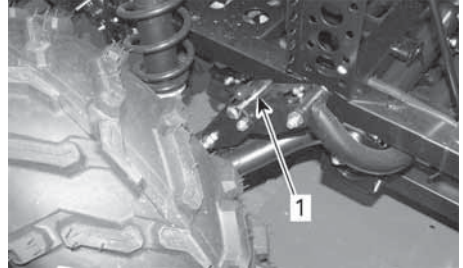

1. Stabilizer bar pin locked

Unlock stabilizer bar from both sides for off-road operations and when operating at high speed on bumpy trails.

It will provide independent travel of the suspension which will help to keep more wheels in contact with the ground and provide improved traction.

Stabilizer bar parts may be damaged if stabilizer bar is used at high speeds on bumpy trails.

Removed stabilizer bar pins can be stored in glove box.

WARNING

Reduce your speed when carrying cargo and turn gradually. Avoid hills and rough terrain. Allow more distance for braking. This vehicle may require additional stopping distance if carrying heavy loads, especially on inclined surfaces.

Suspension Adjustment

Suspension adjustment and loading can have an effect on your vehicle handling and comfort.

Choice of suspension adjustments vary with driver's weight, personal preference, riding speed and field condition.

NOTE:

Factory settings are suitable for almost all conditions. Take into consideration that an increase in ground clearance can affect the handling of the vehicle.

Front Suspension factory Preload Settings	
Model	Factory Setting
All models	Cam position 3

Rear Suspension Factory Preload Settings	
Model	Factory Setting
All models	Cam position 3

Spring Preload Adjustment

⚠ WARNING

The left and right shock adjustment on front or rear suspension must always be set to the same position.

Never adjust one shock only. Uneven adjustment can cause poor handling and loss of stability, which could lead to an accident.

Shorten the springs for a firmer ride and rough conditions.

Lengthen the springs for a softer ride and smooth conditions.

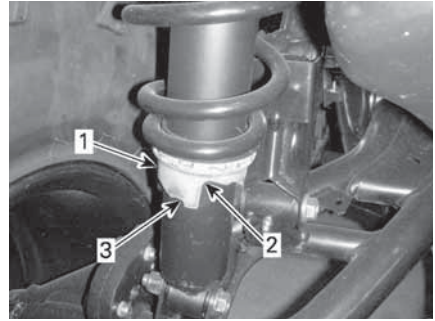

TYPICAL

1. Adjustment cam
2. Softer adjustment
3. Firmer adjustment

Dynamic Power Steering (DPS) Assist Level Adjustment (Models with DPS)

The DPS mode cannot be changed if the transmission lever is set to REVERSE.

The tri-mode Dynamic Power Steering (DPS) offers easy steering assistance to the rider. The level of assistance will automatically adapt according to the vehicle's speed and rider's demand, in order to provide maximum steering power at lower speed where the demand is normally higher. As speed increases, the assistance is progressively reduced to keep maximum steering feel and precision to the rider.

It is possible to choose between three modes of assistance: Minimum, Medium and Maximum. Each mode will continue to automatically adapt to the vehicle's speed and rider's demand, so it does not require to be changed when riding. These modes are used to set the level of assistance to match each rider's preferences.

The following DPS modes are preset in the vehicle.

DPS MODE	
DPS MAX.	Maximum steering assist
DPS MED.	Medium steering assist
DPS MIN.	Minimum steering assist

To change the DPS mode using the multifunction switch, the engine must be running. Wake up the electrical system is not enough to do this procedure.

To see which DPS mode is activated.

- Do a short press (1 second) on the DPS button.

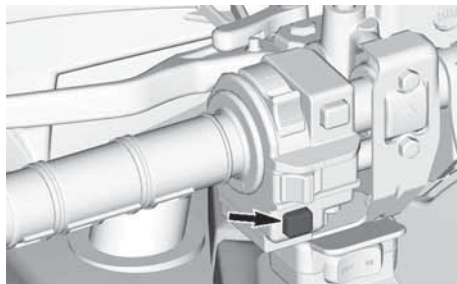

- Repress on the same button to return to previous screen.

To change the DPS mode.

- Do a short press (1 second) on the DPS button to see which DPS mode is activated.
- Do a long press (2 seconds) on the DPS button to select another mode. Repeat until the desired mode is activated.

NOTE: It is also possible to change the DPS mode by doing a long press on either the LOWER button of the cluster or on the TRIP/MENU switch (depending your model). To do this, the engine does not need to be running, but the electrical system must be awake.

TRANSPORTING THE VEHICLE

When contacting a towing or transporting service, be sure to ask if they have a flatbed trailer, loading ramp or power ramp to safely lift the vehicle and tie-down straps. Ensure the vehicle is properly transported as specified in this section.

NOTICE

Do not tow this vehicle — towing can seriously damage the vehicle's drive system.

NOTICE

Avoid using chains to tie the vehicle — they may damage the surface finish or plastic components.

WARNING

To avoid severe injury or death or important components damages.

- Never use the winch cable/rope to retain a vehicle during trailering.
- Never ride with the winch cable/rope attached to a load or another vehicle.
- Only use the winch to help a stuck vehicle (snow, mud, etc.).
- Always refer to the winch manufacturer's instruction before pulling loads.

WARNING

Make sure no loose objects are present inside vehicle during vehicle transportation.

WARNING

Always transport the vehicle facing forward to avoid damaging the windshield or other components. Parts may detach during transport.

WARNING

Before attempting to mount vehicle onto a platform or a trailer, make sure to respect the following safety precautions.

SAFETY PRECAUTIONS

Carrying equipment	The carrying item (platform or trailer or flat bed) must be of appropriate dimensions and capacity to safely support and transport the vehicle.
Hauling vehicle	Do not exceed vehicle hauling capacity and specifications. Ensure the trailer or platform is properly secured to the hauling vehicle hitch.
Visibility	Ensure you have a good visibility during the entire maneuver.
Terrain	The hauling vehicle and trailer must be on a leveled surface. Use wheel chocks on trailer and hauling vehicle to avoid any movement.
Ramps	Use ramps with proper rating and secure ramps to the trailer or platform. Avoid steep ramps.
Bystanders	Always make sure bystanders are not close to the vehicle or the trailering equipment while climbing up.

Using Vehicle Power to Climb Onto Trailering Equipment

When vehicle can climb on its own power, proceed as follows;

1. Wear protective gear.
2. Fasten seat belt.
3. Use low gear only (if equipped).
4. If vehicle has 4WD option, use it.
5. When driving remain seated at all times.
6. Ensure proper alignment on rails or platform.
7. Start from a sufficient distance from the trailer to align the vehicle in a straight line with the ramps. Never attempt to turn while getting closer to the ramp. Rear wheels might not be aligned once you get to the ramp and vehicle may fall off.
8. Slowly climb the front wheels onto the ramp to verify alignment.
9. Back off the vehicle, verify ramps are still secure, then proceed at proper speed.
10. Carefully drive vehicle onto platform or trailer. Use sufficient speed to climb without spinning or abruptly accelerating. Avoid acceleration while on ramps to prevent ramps movement.
11. If trailer is inclined towards front, simply let vehicle roll in without acceleration.
12. Once vehicle is climbed, put shift lever to Park. Apply brake locking mechanism (if equipped).

When vehicle cannot move on its own power, or in case overshooting is a risk or if any dangerous condition prevents for embarking on its own power, proceed using a winch;

Using a Winch to Pull Vehicle Onto Trailering Equipment

When vehicle cannot climb on its own power, proceed as follows;

WARNING

Have the help of an assistant. One person should be in vehicle to have access to vehicle steering, brakes and winch switch, while the other person controls the environment and safety of the maneuver.

WARNING

Ensure the winch hook can be safely attached to a proper anchoring point. Use proper rigging.

NOTE:

If vehicle can be started safely, let engine idle during winching to avoid draining the battery.

1. Place shift lever to NEUTRAL (N).
2. If the vehicle is equipped with a winch, use the winch to roll the vehicle on the platform.
3. If the vehicle is not equipped with a winch, proceed as follows:
 1. Attach strap to lower front bumper anchor.
 2. Attach the strap to the winch cable of the towing vehicle.
 3. Pull the vehicle on the flatbed trailer with the winch.
4. Put shift lever to Park. Apply brake locking mechanism (if equipped).

Securing vehicle for transport

When transporting this vehicle, secure it to a trailer or in pickup box with

suitable tie-downs. Use of ordinary ropes is not recommended.

⚠ WARNING

To avoid severe injury or death or important components damages.

- Never use the winch cable/rope to retain a vehicle during trailering.
- Never ride with the winch cable/rope attached to a load or another vehicle.
- Only use the winch to help a stuck vehicle (snow, mud, etc.).
- Always refer to the winch manufacturer's instruction before pulling loads.

⚠ WARNING

Do not tow this vehicle behind a car or other vehicle. Use a trailer. Never tip this vehicle on end for transporting. The vehicle must be in its normal operating position (on all wheels).

Remember to:

- Unload vehicle racks before transportation.
- Set shift lever to PARK position.
- Set the parking brake.
- Secure the vehicle by the front and rear tie-down points.



TYPICAL

1. Front tie-down point location

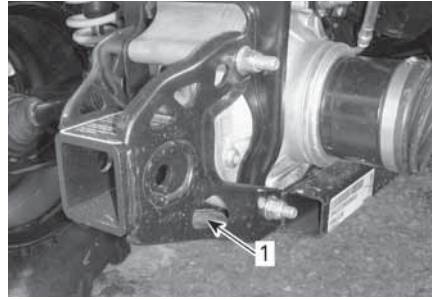

TYPICAL

1. Rear tie-down point location

NOTICE

Securing vehicle at other locations may damage the vehicle.

Getting Vehicle Out of Trailer

⚠ WARNING

Vehicle may have moved during transport. Ensure vehicle is properly aligned with ramps before proceeding.

⚠ WARNING

Visibility will be greatly reduced when backing off from the trailer. Have the help of an assistant to ensure proper alignment and safe environment.

This page is intentionally blank

MAINTENANCE

MAINTENANCE SCHEDULE

Maintenance is very important for keeping your vehicle in safe operating condition. The vehicle should be serviced as per the maintenance schedule.

Proper maintenance is the owner's responsibility. A warranty claim may be denied if, among other things, the owner or operator caused the problem through improper maintenance or use.

Perform periodic checks and follow the maintenance schedule. **The maintenance schedule does not exempt the pre-ride inspection.**

Verifying fault codes, as first maintenance step, is a good practice and is highly recommended.

WARNING

Failure to properly maintain the vehicle according to the maintenance schedule and procedures can make it unsafe to operate.

EPA Regulation - Canadian and USA Vehicles

A repair shop or person of the owner's choosing may maintain, replace, or repair emission control devices and systems. These instructions do not require components or service by BRP or authorized Can-Am Off-road dealers.

Although an authorized Can-Am Off-road dealer has an in-depth technical knowledge and tools to service your vehicle, the emission-related warranty is not conditioned on the use of an authorized Can-Am Off-road dealer or any other establishment with which BRP has a commercial relationship.

Proper maintenance is the owner's responsibility. A warranty claim may be denied if, among other things, the owner or operator caused the problem through improper maintenance or use.

For emission-related warranty claims, BRP is limiting the diagnosis and repair of emission-related parts to the authorized Can-Am Off-road dealers. For more information, please refer to the *US EPA Emission-Related Warranty* contained in the *Warranty* section.

You must follow the instructions for fuel requirements in the fueling section of this manual. Even if gasoline containing greater than ten volume percent ethanol is readily available, the US EPA issued a prohibition against the use of gasoline containing greater than 10 vol% ethanol that applies to this vehicle. The use of gasoline containing greater than 10 vol% ethanol with this engine may harm the emission control system.

Severe Dusty Conditions

Air Filter Maintenance Guideline

Air filter maintenance should be adjusted according to riding conditions.

Air filter maintenance must be increased in frequency in the following dusty conditions:

- Riding on dry sand
- Riding on dry dirt covered surfaces
- Riding on snow covered surfaces

- Riding on dry gravel roads or similar conditions.

Riding in a group under these conditions increases the frequency of the air filter maintenance.

NOTE:

An accessory pre-filter should be used to avoid snow accumulation when the vehicle is used in such conditions. Contact an authorized Can-Am dealer for details.

Maintenance Schedule Legend

Operation in trail riding conditions
Operation in severe riding conditions (dusty or muddy) or carrying heavy loads condition

Maintenance Schedule

Make sure to perform proper maintenance at recommended intervals as indicated in the tables. Some items of the maintenance schedule must be performed in function of the calendar, regardless of the distance or time of operation.

Every 1 500 km (1,000 mi) or 50 hours (whichever comes first)
Every 750 km (500 mi) or 25 hours (whichever comes first)
Perform all items indicated in the <i>Pre-Ride Inspection</i>
Check fault codes
Verify and clean engine air filter. Replace as needed
Verify battery connections
Lubricate rear propeller shaft joints
Inspect tie rod ends and ball joints for play and bellows condition
Lubricate front suspension arm bushings
Lubricate front and rear stabilizer bar bushings
Inspect the drive shaft bellows and protectors
Inspect brake pads. Replace as needed
Inspect wheel bearings for abnormal play
Inspect and clean CVT air filter. Replace as needed. (If equipped)

**Every 1 500 km (1,000 mi) or
50 hours (whichever comes first)**

**Every 750 km (500 mi) or
25 hours (whichever comes first)**

Tighten wheel beadlock bolts (If equipped)

Lubricate lower shock absorber spherical bearings (Limited, X xc and XT-P models)

Lubricate upper shock absorber spherical bearings (Limited models)

**Every 3 000 km (2,000 mi) or
100 hours (whichever comes first)**

**Every 1 500 km (1,000 mi) or
50 hours (whichever comes first)**

Perform all items indicated in the *Pre-Ride Inspection*

Check fault codes

Adjust valve clearance

Clean muffler spark arrester

Verify and clean throttle body

Replace fuel vent breather filter

Verify CVT drive belt and clean CVT pulleys

Lubricate the one way bearing of the drive pulley

The following must be performed at least once a year:

Change engine oil and filter

Lubricate throttle cable

Inspect and clean brake system

Inspect battery condition

Verify steering system for abnormal play

Verify front differential and rear final drive oil level and look for contamination

Verify gearbox oil level and look for contamination

Perform at the first 3 000 km (2,000 mi) and at 6 000 km (4,000 mi) then follow the regular schedule

Perform at the first 1 500 km (1,000 mi) and at 3 000 km (2,000 mi) then follow the regular schedule

Replace gearbox oil

Clean the vehicle speed sensor (VSS)

Every 6 000 km (4,000 mi) or 200 hours (whichever comes first)

Every 3 000 km (2,000 mi) or 100 hours (whichever comes first)

Perform all items indicated in the *Pre-Ride Inspection*

Check fault codes

Verify the cooling system

Test engine coolant strength

Verify fuel system for leaks (including evaporative emission system components if equipped)

Verify fuel pump pressure

Replace canister vent pre-filter (evaporative emission system component), if equipped

Replace spark plugs

Replace front differential oil

Replace rear final drive oil

Replace gearbox oil

Inspect input and output shaft seals (gearbox, differential and final drive)

Clean vehicle speed sensor

Clean and lubricate lower and upper steering column half bushings

The following must be performed every 2 years:

Replace the brake fluid

Every 12 000 km (8,000 mi) or
5 years (whichever comes first)

Every 6 000 km (4,000 mi) or
5 years (whichever comes first)

Replace engine coolant

MAINTENANCE PROCEDURES

This section includes instructions for basic maintenance procedures.

Due to the complexity of some of the maintenance procedures, good mechanical skills are required.

If you are not comfortable with these procedures, do not hesitate to contact an authorized Can-Am off-road dealer, repair shop or person of your own choosing.

⚠ WARNING
Unless otherwise indicated, the engine must be stopped and the key always removed before performing any maintenance

⚠ WARNING
Should removal of a locking device be required (e.g. lock tab, self-locking fastener, etc.) , always replace it with a new one.

Resetting the Message: Maintenance Required Multifunction Gauge (LCD)

1. From the main display (vehicle speed), press SET and HOLD.
2. Alternate between LOW beam and HIGH beam 3 times inside 2 seconds.
3. Release the SET button.

Digital Display

1. Using the LOWER button (4.5" digital display) or the MENU button (7.6" digital display), select **RES MAIN** in **SETTINGS**.
2. Hold the button to reset the maintenance message.

Engine Air Filter

Air Filter Maintenance Guideline

As with any ATV, air filter maintenance is critical to ensure proper engine performance and life span.

Air filter maintenance should be adjusted according to riding conditions.

Air filter maintenance must be increased in frequency and oil must be added to the foam filter for the following dusty conditions:

- Riding on dry sand.
- Riding on dry dirt covered surfaces.
- Riding on dry gravel trails or similar conditions.
- Riding in areas with high concentration of seeds or crop husks.
- Riding in severe snow conditions.

Riding in a group, under these conditions, increases the frequency of the air filter maintenance.

An accessory pre-filter for "dusty conditions" may be used. Contact an authorized Can-Am dealer for details.

Removing the Engine Air Filter

NOTICE
Never remove or modify any component in the air filter housing. Otherwise, engine performance degradation or damage can occur. The engine is calibrated to operate specifically with these components.

1. Remove seat.
2. Lift rear portion of console upwards until the studs are released from the grommets.

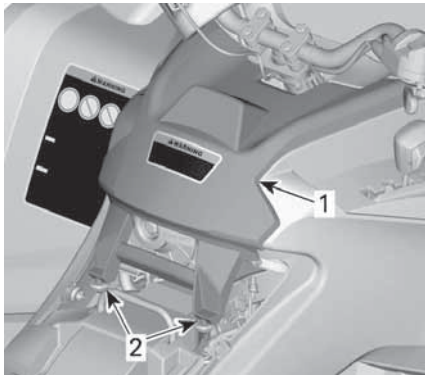

TYPICAL

1. Console
2. Studs and grommets
3. Pull console rearwards.
4. Rotate air filter cover counterclockwise to remove.

NOTE:

A socket wrench may be used to ease removal.



1. Air filter cover
5. Remove air filter.



Inspecting and Draining the Engine Air Filter Housing

1. Remove LH side panel.
2. Drain air filter housing inlet drain tube.

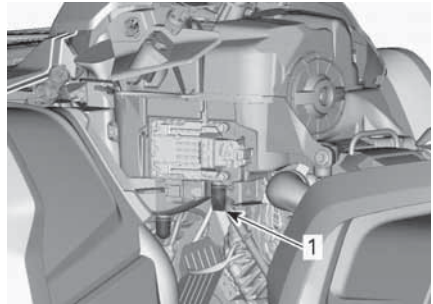

TYPICAL

1. Air filter housing inlet drain tube
3. Check air filter dirty chamber for cleanliness.
 - If any debris or water are found, clean air filter chamber using a vacuum cleaner.

NOTICE

Do not blow compressed air into air filter chamber.

4. Check air filter drain tube (clean chamber).
 - If any debris or water are found, refer to *Special Procedures*.
 - Investigate for contamination source.

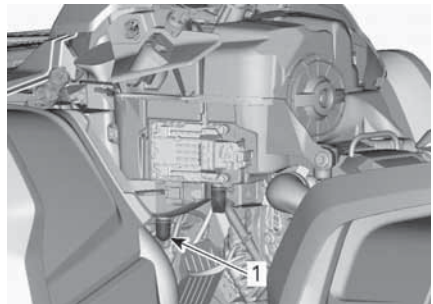

TYPICAL

1. Air filter drain tube

Cleaning and Oiling the Engine Air Filter

Cleaning the Paper Filter

1. Ensure that the foam filter is removed from paper filter.
2. Tap out heavy dust from the paper filter.

This will allow dirt and dust to get out of the paper filter.

NOTE:

Paper filter have a limited life span; replace filter if too dirty or clogged.

NOTICE

It is not recommended to blow compressed air on the paper element; this could damage the paper fibers and reduce its filtration ability when used in dusty environments. If engine air filter is too dirty and cannot be cleaned following the recommended procedure, it should be replaced.

NOTICE

Do not wash the paper filter with any cleaning solution.

Cleaning the Foam Filter

1. Spray the foam filter inside and out with a good air filter cleaner and follow manufacturer's instructions.



TYPICAL

2. Dry the foam filter completely.

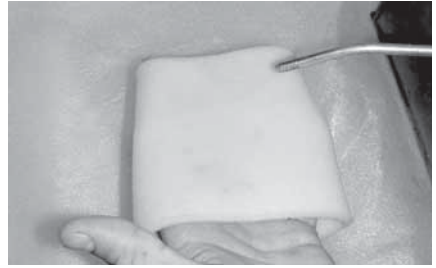

TYPICAL

NOTE:

A second application may be necessary for heavily soiled elements.

Oiling the Foam Filter

1. Make sure filter is clean. Refer to *Cleaning the Foam Filter*.
2. Spray an air filter oil on the foam filter previously dried.



TYPICAL

3. Let stand for 3 to 5 minutes.
4. Remove any excess of oil that could transfer to the paper filter by wrapping the foam filter into an absorbent cloth and squeezing gently. This will also ensure a full oil coverage on foam filter.
5. Reinstall the foam filter over the paper filter.

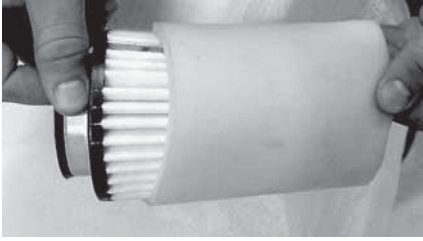

TYPICAL

6. Slightly grease plastic body of filter for ease of installation and future removal.

Installing the Engine Air Filter

1. Reinstall oiled foam filter on paper air filter.
2. Slightly grease O-ring seal and plastic body of air filter.
3. Install air filter as the reverse of removal.
4. Ensure air filter cover is properly locked onto the air filter housing. See indications on filter cover and housing.

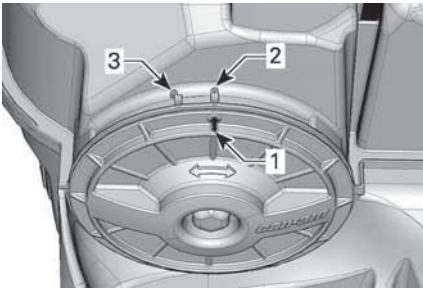

1. Cover position arrow
2. Locked
3. Unlocked

5. Install console as the reverse of removal. However, pay attention to the following.
 - Align console front tabs with slots, then push console forward.
 - Then align and insert studs with grommets on rear portion of console until studs engage with grommets.

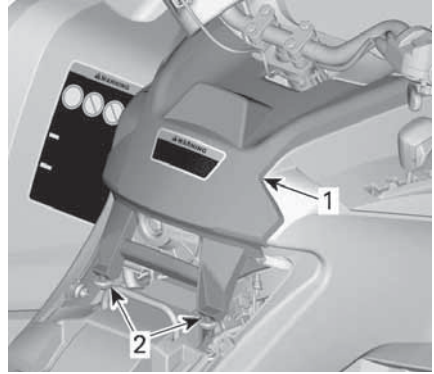

TYPICAL

1. Console
2. Studs and grommets
6. Reinstall the seat.

CVT Air Filter

Removing the CVT Air Filter

1. Remove the gauge support.

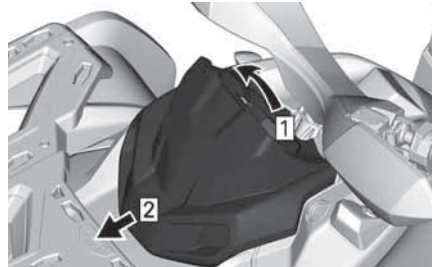

1. Pull up
2. Slide
2. Push on tabs (3) and remove air filter.

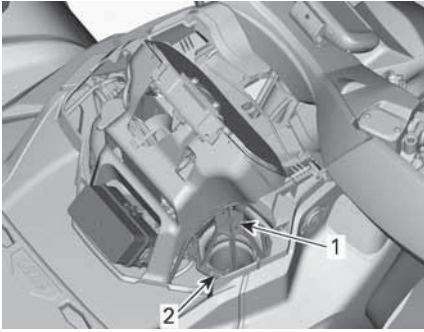

1. CVT air filter
2. Tab

Cleaning the CVT Air Filter

1. Spray filter inside and out with a good air filter cleaner and follow manufacturer's instructions.
2. Dry filter completely.

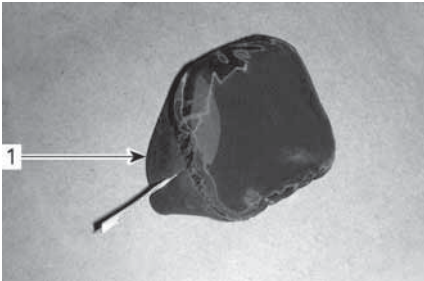

1. CVT air filter (slip-on type)



1. CVT air filter (clip-on type)
3. Clean inside the CVT air inlet end.

Installing the CVT Air Filter
Models with Slip-On Air Filter

Install air filter on CVT inlet by stretching its sides.

Models with Clip-On Air Filter

Install air filter on CVT by inserting tabs in their slots and push on air filter until it clicks.

All Models

Install the gauge support.

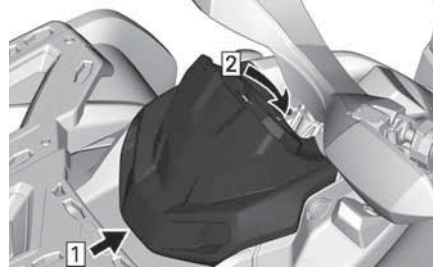

1. Hook
2. Engage retaining tab

Engine Oil

Verifying the Engine Oil Level

NOTICE

Operating the engine/gearbox with an improper level may severely damage engine/gearbox.

NOTICE

Check the oil level when the engine is cold.

1. Place vehicle on a level surface.
2. Clean dipstick area to avoid foreign particles falling down in the engine.

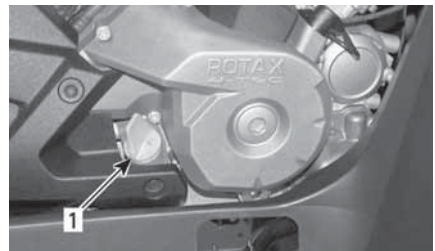

TYPICAL - RH SIDE OF ENGINE

1. Dipstick

3. Unscrew dipstick then remove it and wipe clean.
4. Reinstall dipstick, screw in it completely.
5. Remove and check oil level. It should be near or equal to the upper mark.

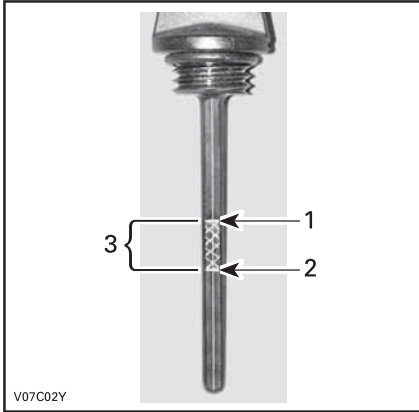

V07C02Y

TYPICAL

1. Full
2. Add
3. Operating range

If the level is between marks, reinstall the dipstick.

If the level is below the lower mark, add oil as follow:

- Place a funnel into the dipstick hole.
- Add a small amount of recommended oil and recheck oil level.
- Continue to add oil until the level reaches the upper mark.

NOTICE

Do not overfill. Wipe off any spillage.

6. Properly tighten dipstick.

Recommended Engine Oil

Rotax® engines were developed and validated using the XPS™ oil.

BRP recommends the use of its XPS engine oil or an equivalent at all time.

Damages caused by the use of an oil not suitable for the engine may not be covered by the BRP Limited Warranty.

XPS Recommended Engine Oil

General purpose	XPS 4T 5W40 Synthetic blend oil
Cold temperature	XPS 4T 0W40 Synthetic oil
Warm temperature	XPS 4T 10W50 Synthetic oil

If the recommended XPS Engine Oil Is Not Available

Use a 4-stroke SAE engine oil meeting or exceeding the following lubricant industry specifications.

Always check the API service label certification on the oil container, it must contain at least one of the indicated standards.

- API service classification SJ, SL, SM or SN

Changing the Engine Oil

CAUTION

The engine oil can be very hot. Wait until engine oil is warm.

NOTICE

Engine oil and oil filter must be replaced at the same time.

1. Ensure vehicle is on a level surface.
2. Bring engine to its normal operating temperature and stop it.
3. Remove dipstick.
4. Clean the oil drain plug area.

5. Place a drain pan under the oil drain plug area.
6. Unscrew magnetic drain plug and discard the gasket ring.

⚠ CAUTION

The engine oil can be very hot.

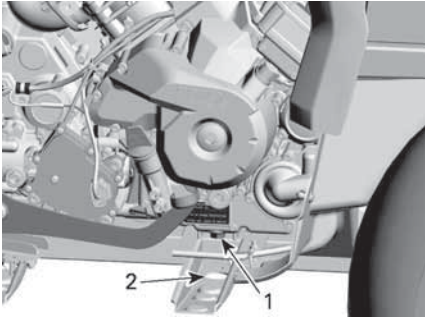

1. *Magnetic drain plug*
2. *Access through the frame*
7. Allow enough time for oil to flow out of engine and oil filter.
8. Replace the oil filter, refer to *Engine Oil Filter*.
9. Clean the magnetic drain plug from metal shavings and residue.

NOTICE

Presence of debris gives an indication of internal engine damages.

10. Install a NEW gasket ring on the magnetic drain plug.

NOTICE

Never use the gasket ring a second time. Always replace by a new one.

11. Install and tighten magnetic drain plug.

Tightening Torque	
M12 drain plug	20 ± 2 Nm (15 ± 1 lbf-ft)
M18 drain plug	30 ± 2 Nm (22 ± 1 lbf-ft)

12. Refill engine at the proper level with the recommended oil.

Refer to *Technical Specifications* for oil capacity.

13. Start engine and let idle for a few minutes.
14. Ensure oil filter area and oil drain plug areas are not leaking.
15. Stop engine.
16. Wait a while to allow oil to flow down to crankcase then check oil level.
17. Refill as necessary.
18. Dispose of oil as per your local environmental regulations.

Engine Oil Filter

Removing the Oil Filter

Clean oil filter area.

Remove oil filter cover.

Remove oil filter.

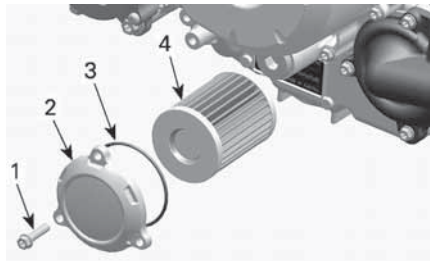

TYPICAL

1. *Oil filter screw*
2. *Oil filter cover*
3. *O-ring*
4. *Oil filter*

Installing the Oil Filter

1. Check and clean the oil filter inlet and outlet area for dirt and other contaminations.

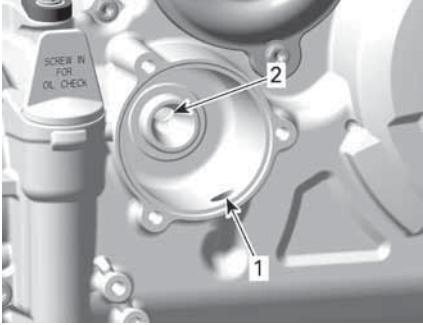

1. Inlet bore from the oil pump to the oil filter
2. Outlet bore to the engine oil providing system
2. Install a NEW O-ring on oil filter cover.
3. Install the new filter into the cover.
4. Apply engine oil on O-ring and grease on the end of filter.

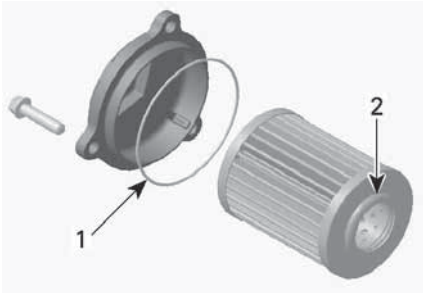

1. Slightly oil
2. Slightly oil

NOTICE

Pay attention to avoid pinching the O-ring during filter and cover installation.

5. Install the cover on the engine.
6. Tighten oil filter cover screws to recommended specification.

Tightening Torque

Oil filter cover screws	10 ± 1 Nm (89 ± 9 lbf-in)
-------------------------	------------------------------

7. Wipe off any oil spillage on engine.

Fuel Vent Breather Filter

Replacing the Fuel Vent Breather Filter

The fuel vent breather filter is located under the rear fender between the fuel tank neck and the seat.

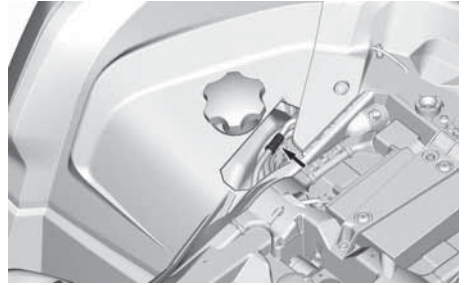

1. By the rear right-hand wheel arch, unplug hoses from the filter.

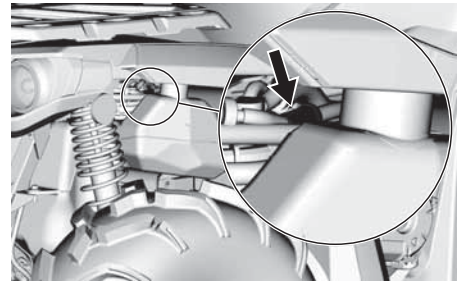

2. Remove and discard the filter.
3. Install the new filter with the arrow pointing towards the rear of the vehicle.

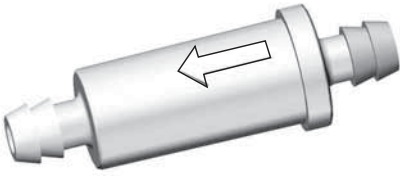

4. Make sure hoses are well plugged.

Radiator

Inspecting the Radiator

1. Periodically check the radiator area for cleanliness.

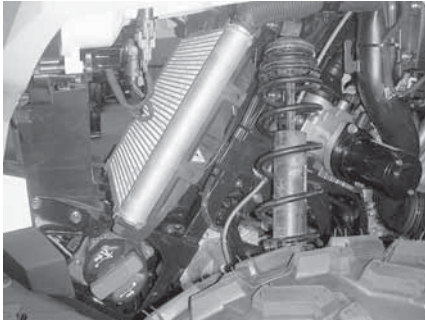

TYPICAL

2. Inspect radiator and hoses for leaks or any damage.
3. Inspect radiating fins. They must be clean, free of mud, dirt, leaves and any other deposit that would prevent the radiator to cool properly.
4. Remove as much deposits as you can with your hands.

NOTE:

Inner fenders can be removed to ease cleaning.

If water is available in proximity, try rinsing the radiating fins.

⚠ CAUTION

Never clean radiator with your hands when it is hot. Let the radiator cool down before cleaning.

NOTICE

Be careful not to damage the radiating fins when cleaning. Do not use any object/tool that could damage the fins. The fins are purposely thin parts to allow efficient cooling. When hosing, use low pressure only. Never use a HIGH PRESSURE washer.

5. See an authorized Can-Am Off-road dealer, repair shop or person of your own choosing to check the performance of the cooling system.

Engine Coolant

Verifying the Engine Coolant Level

⚠ WARNING

Check coolant level with engine cold. Never add coolant in cooling system when engine is hot.

NOTE:

A cooling system that frequently requires coolant is the indication of leaks or engine problems. See an authorized Can-Am Off-road dealer.

1. Place vehicle on a level surface.
2. Remove the gauge support.

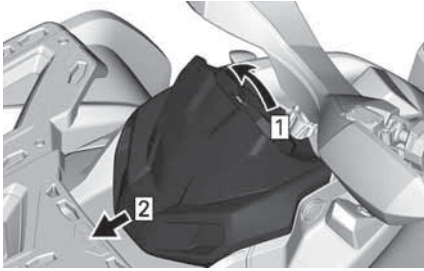

1. Pull up
2. Slide
3. Remove the coolant reservoir cap.

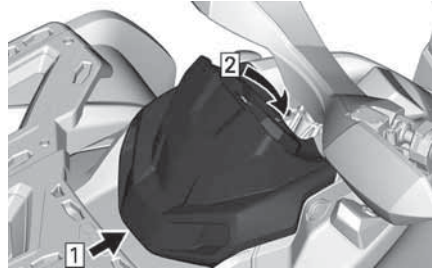

1. Hook
2. Engage retaining tab

Recommended Engine Coolant

⚠ WARNING

Do not remove the coolant reservoir cap if engine is hot.

XPS Recommended Engine Coolant
XPS Extended life pre-mixed coolant
If the Recommended XPS Engine Coolant Is Not Available
Distilled water and antifreeze solution (50% distilled water, 50% antifreeze)

4. With vehicle on a level surface, liquid should be between MIN. and MAX. level marks of coolant reservoir.

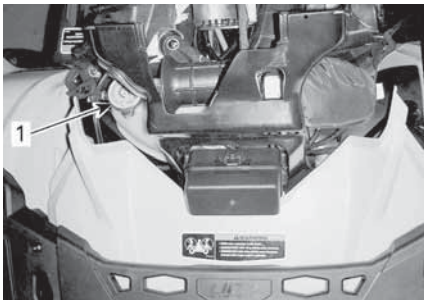

1. Engine coolant reservoir

NOTE:

When checking level at temperature lower than 20 °C (68 °F), it may be slightly lower than MIN. mark.

5. Add coolant if required.

NOTE: Use a funnel to avoid spillage. **Do not overfill.**

6. Properly reinstall and tighten reservoir cap.
7. Reinstall gauge support.

NOTICE

Always use ethylene-glycol anti-freeze containing corrosion inhibitors specifically for internal combustion aluminum engines.

Engine Coolant Replacement

Draining the Cooling System

1. Remove the gauge support.

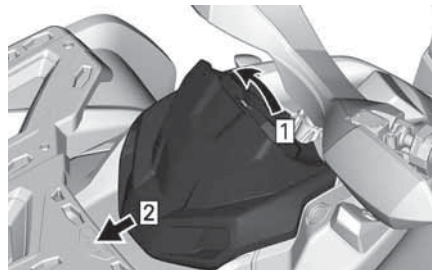

1. Pull up
2. Slide
2. Remove the coolant reservoir cap.

⚠ WARNING

In order to avoid potential burns, do not remove the pressure cap or loosen the coolant drain plug if the engine is hot.



1. Engine coolant reservoir cap

3. Unscrew partially the coolant drain plug and drain the coolant into a suitable container.

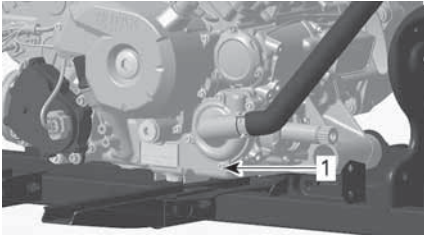

1. Coolant drain plug
650 Engines

4. Disconnect the lower radiator hose and drain the remaining coolant into a suitable container.

NOTE:

Take note of the position of the hose clamp on the lower radiator hose at the radiator.

5. Reinstall radiator hose as noted prior to removal.

All Engines

6. Reinstall cooling system drain plug with a new sealing ring.
7. Tighten the coolant drain plug.

Tightening Torque

Drain plug	10± 1 Nm (89 ± 9 lbf-in)
------------	-----------------------------

8. Bleed cooling system, refer to *Filling and Bleeding the Cooling System*.

Filling and Bleeding the Cooling System

1. Unscrew bleed screws above both front and rear cylinders.

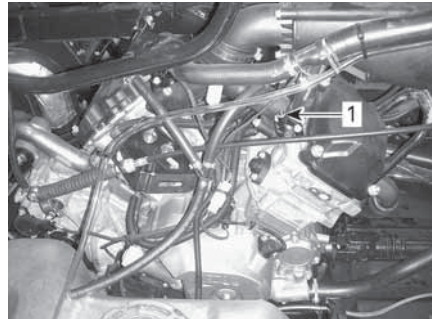

TYPICAL

1. Front cylinder bleed screw

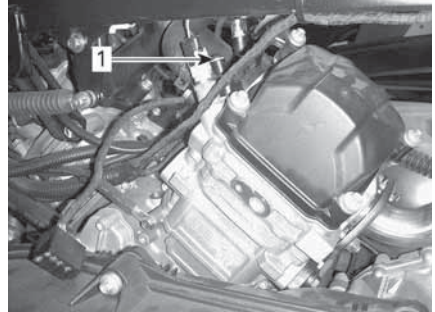

TYPICAL

1. Rear cylinder bleed screw
2. Fill the cooling system until coolant comes out of the bleed screw(s).

650 Models

3. Squeeze the top of the coolant hose between the radiator and coolant pump several times until all air is bled from the highest point of the hose.

All Models

4. Install the bleed screw using a **NEW** gasket rings and tighten to specification.

Tightening torque	
Bleed screws	5.0 ± 0.6 Nm (44 ± 5 lbf-in)

5. Continue adding coolant until system is full up to the pressure cap.
6. Refill coolant tank up to MAX level mark.
7. Run engine at idle with the radiator cap off. Slowly add coolant if necessary.
8. At this point, wait until engine reaches normal operating temperature.
9. Depress the throttle lever two or three times; then add coolant if required.
10. Stop the engine and let it cool down.
11. Install coolant reservoir cap.
12. Inspect all connections for leaks and check coolant level in the reservoir.

Muffler and Spark Arrester

Cleaning and Inspecting the Muffler Spark Arrester

NOTE:

Spark arrester screen replacement is required only when damaged.

⚠ CAUTION
Let exhaust system cool down before proceeding with cleaning and inspection.

1. Remove the muffler cover. Discard retaining screws.

NOTICE
Do not use impact tool for any screw removal.

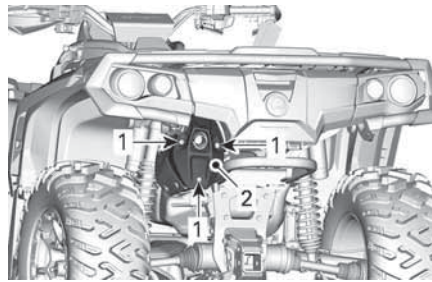

TYPICAL

1. Screws
 2. Cover
2. Remove and discard the tail pipe retaining screws.

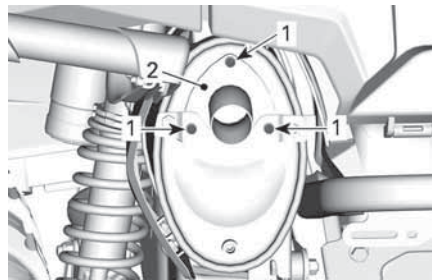

TYPICAL

1. Screws
 2. Tail pipe
3. Remove exhaust tail pipe, gasket (discard) and spark arrester.

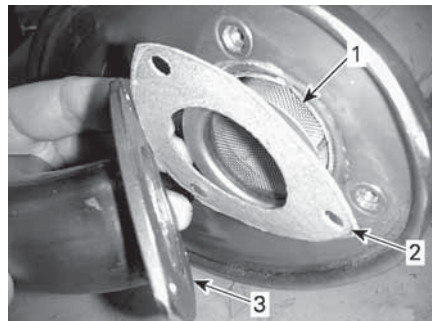

TYPICAL

1. Spark arrester
 2. Gasket
 3. Exhaust tail pipe
4. Remove carbon deposits from the spark arrester using a brush.

NOTICE

Use a metallic soft brush and be careful to avoid damaging spark arrester mesh.

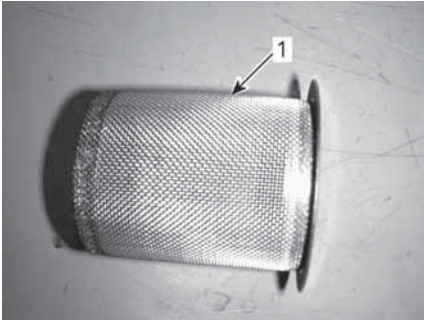

- 1. Clean spark arrester
- 5. Inspect mesh of spark arrester for any damage. Replace as required.

NOTE:

Spark arrester screen replacement is required only when damaged

- 6. Inspect spark arrester chamber in muffler. Clean any debris as required.
- 7. Install new gasket, tail pipe and new retaining screws.
- 8. Reinstall muffler cover with new retaining screws. Tighten to specification.

Tightening torque	
Tail pipe screws	11 ± 1 Nm (97 ± 9 lbf-in)
Cover screws	

Gearbox

Verifying The Gearbox Oil Level

NOTICE

Check level and refill if necessary. Do not overfill. Operating the gearbox with an improper level may severely damage gearbox. Wipe off any spillage.

- 1. Place the vehicle on a level surface.
- 2. Select NEUTRAL position.
- 3. Apply the parking brake.

NOTE:

Check the gearbox oil level when engine is cold and not running.

- 4. Remove the gearbox oil level plug.

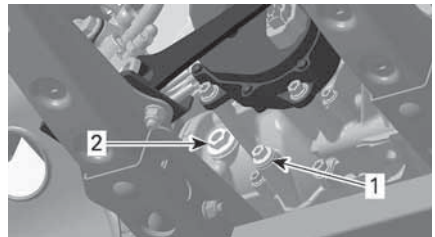

TYPICAL

- 1. Drain plug
- 2. Oil level plug
- 5. Check the level. The oil should be level with the bottom of the oil level hole.
- 6. Refill as required until gearbox oil level flows through oil level hole.

Recommended Gearbox Oil

The XPS oil is specially formulated to meet the lubrication requirements of this gearbox. BRP strongly recommends the use of its XPS oil.

XPS Recommended Gearbox oil
XPS 75W140 Synthetic gear oil
If the Recommended XPS Gearbox Oil Is Not Available
Use a gearbox oil meeting or exceeding the following lubricant industry specifications. – 75W 140 API GL-5 synthetic gear oil

NOTICE

Do not use another type of oil when servicing.

Changing the Gearbox Oil

Draining the Gearbox Oil

1. Ensure vehicle is on a level surface.
2. Bring engine to its normal operating temperature and stop it.

NOTE: Running the engine at idle is not sufficient, vehicle gearbox must be operated.

3. Clean the areas around the drain and level plugs.

⚠ CAUTION

The gearbox and the gearbox oil can be very hot.

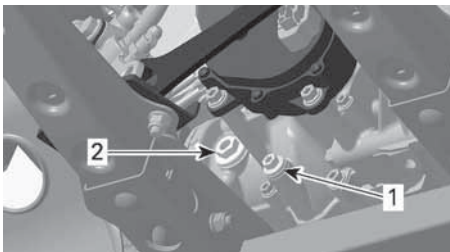

1. Drain plug
2. Oil level plug
4. Place a drain pan underneath the drain and level plugs.

5. Remove the magnetic drain plug.
6. Discard the sealing ring.
7. Remove the oil level plug and its O-ring.
8. Wait a while to allow oil to flow out of the gearbox.

NOTE:
To completely drain the gearbox, place a jack under the left footrest and tilt the vehicle toward the right side. When the gearbox is empty, install the drain plug and replace the vehicle on the ground.

9. Clean the magnetic drain plug from metal shavings and residue.

NOTICE

Presence of debris gives an indication of internal gearbox damages.

10. Install a NEW sealing washer on the magnetic drain plug.

NOTICE

Never use the sealing washer a second time. Always replace by a new one.

11. Install and tighten magnetic drain plug.

Tightening torque	
Magnetic drain plug	20 ± 2 Nm (15 ± 1 lbf-ft)

12. Dispose of oil as per your local environmental regulations.

Filling the Gearbox Oil

1. With the oil level plug, add recommended gearbox oil through the oil level hole until the level reach the bottom of the hole.
2. Install the oil level plug with its O-ring.

Tightening torque	
Oil level plug	5 ± 0.6 Nm (44 ± 5 lbf-in)

Throttle Cable

Lubricating the Throttle Cable

The throttle cable must be lubricated with a silicone based lubricant or an equivalent.

⚠ WARNING
<p>Always use a silicone-based lubricant. Using another lubricant (like a water-based lubricant) could cause the throttle lever/cable to become sticky and stiff.</p>

1. Separate the housing.

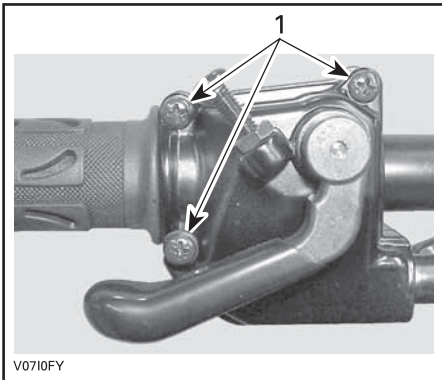

1. Remove these screws
2. Slide rubber protector back to expose throttle cable adjuster.

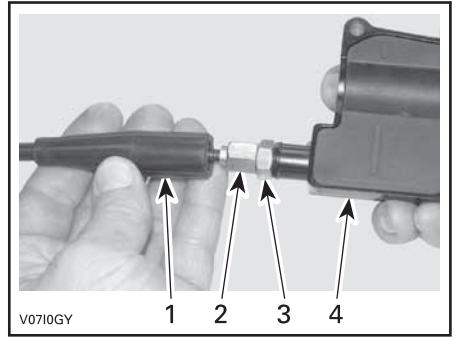

1. Cable protector
 2. Throttle cable adjuster
 3. Lock nut
 4. Throttle lever housing
3. Screw in the throttle cable adjuster.
 4. Remove inner housing protector.

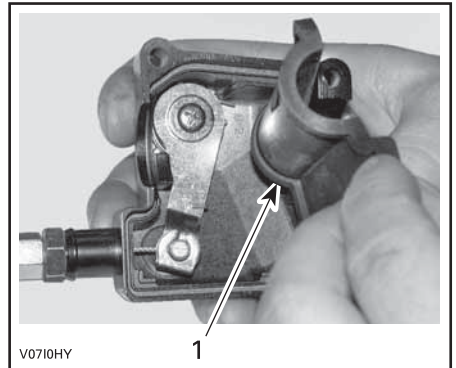

1. Inner housing protector
5. Remove the cable from the throttle lever housing.

NOTE:

Slide cable in clip slot and remove the end of cable from clip.

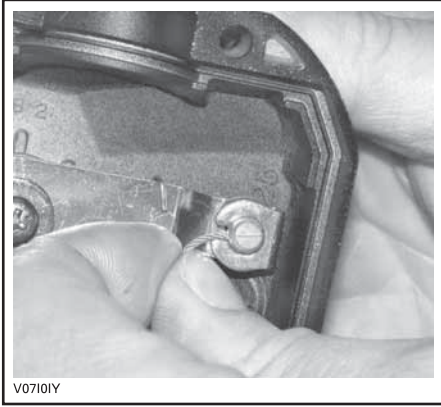

V0710IY

6. Remove the throttle body side cover.

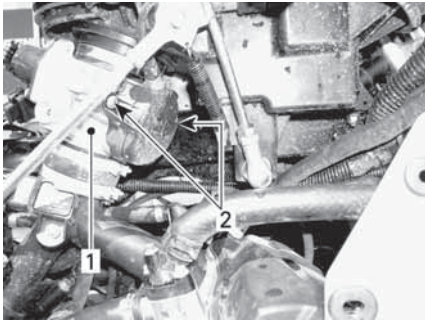

1. Throttle body
2. Side cover screws

7. Insert the needle of the lubricant can in the end of throttle cable adjuster.
8. Place a rag around the throttle cable adjuster to prevent the lubricant from splashing.



V0710JY

TYPICAL

9. Add lubricant until it runs out at throttle body end of the throttle cable.
10. Reinstall and adjust the cable.

Adjusting the Throttle Cable

1. Slide rubber protector back to expose throttle cable adjuster.

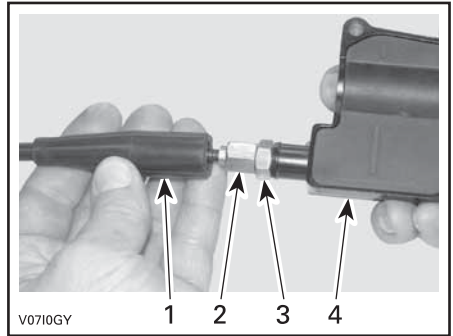

V0710GY

1. Cable protector
 2. Throttle cable adjuster
 3. Lock nut
 4. Throttle lever housing
2. Loosen lock nut then turn the adjuster to obtain correct throttle lever free play.
 3. Measure throttle free play at the tip of throttle lever.

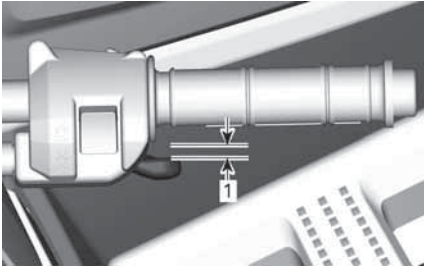

1. 2 mm.079 in
4. Tighten lock nut and reinstall protector.
5. With the shift lever on PARK position, start the engine.
6. Check if the throttle cable is adjusted correctly by turning handlebar fully to the right then fully to the left. If the engine RPM increases, readjust the throttle lever free play.

Spark Plugs

Removing the Spark Plug

Remove the side panels to reach the spark plug areas.

1. Unplug the spark plug cable.
2. Unscrew spark plugs one turn.
3. Clean spark plugs and cylinder heads with pressurized air if possible.
4. Unscrew spark plugs completely using a spark plug socket, then remove them.

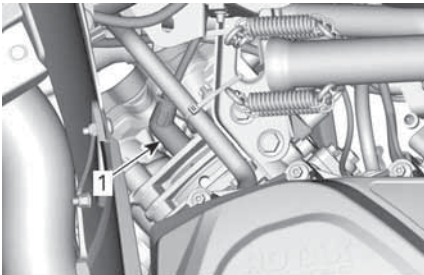

RH SIDE — REAR CYLINDER

1. Spark plug

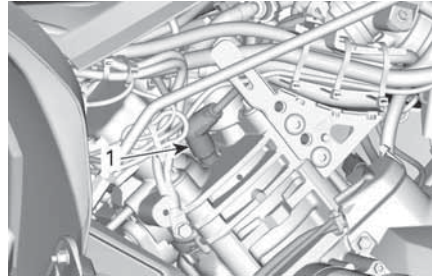

LH SIDE — FRONT CYLINDER

1. Spark plug
- ### Installing the Spark Plug

1. Prior to installation, make sure that contact surfaces of cylinder heads and spark plugs are free of grime.
2. Using a feeler gauge, set the electrode gap as specified in *Technical Specifications*.
3. Apply a small of lubricant over spark plug threads to prevent a possible seizure.

Cooper based anti-seize lubricant

4. Screw spark plugs into cylinder heads by hand and tighten with a torque wrench and a proper socket.

NOTICE

Do not overtighten spark plugs, engine damage can occur.

Tightening torque	
650 engines	20 ± 2 Nm (15 ± 2 lbf-ft)
850 and 1000R engines	11 ± 1 Nm (97 ± 9 lbf-in)

CVT Cover

For a better understanding, some illustrations are taken with engine out of vehicle. To perform the following

instructions, it is not necessary to remove engine.

⚠ WARNING

Never touch CVT while engine is running.
Never drive vehicle when CVT cover is removed.

⚠ CAUTION

Engine must be cool before cover is removed.

NOTICE

This CVT is lubrication free.
Never lubricate any components except drive pulley bearing.

Accessing the CVT Cover

The CVT cover is located on the LH side of the vehicle.

Remove the following:

- LH side and extension panels
- LH footboard panel.

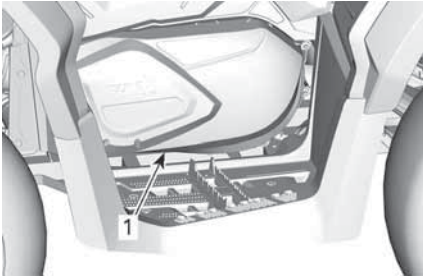

TYPICAL

- 1. CVT cover

Removing the CVT Cover

1. Disconnect the inlet and outlet air cooling ducts from the CVT cover.
2. Remove all CVT cover retaining screws.
3. Remove the center top screw last to support the cover during removal.

NOTICE

Do not use an impact tool to remove CVT cover screws.

4. Remove the CVT cover and its gasket.

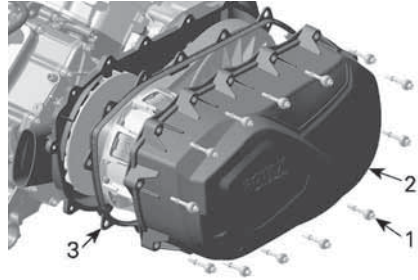

1. CVT cover screw
2. CVT cover
3. Gasket

Installing the CVT Cover

1. Position the cover against the engine.
2. Install the center top screw of first.

NOTICE

Do not use an impact tool to install CVT cover screws.

3. Tighten the CVT cover screws as per following sequence.



Tightening torque

CVT cover screws	7 ± 0.8 Nm (62 ± 7 lbf-in)
------------------	-------------------------------

4. Install the inlet and outlet air cooling ducts.

Drive Belt

Inspecting the Drive Belt

1. Inspect drive belt for cracks, fraying or abnormal wear. Replace if necessary.
2. Check drive belt width at cord level. Replace if the belt is out of the specification.

Drive Belt Width	
Service limit	30 mm (1.181 in)

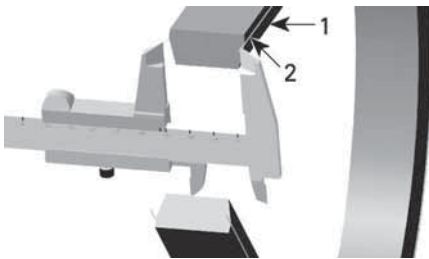

1. Drive belt
2. Cord in drive belt

Removing the Drive Belt

NOTICE

In case of a drive belt failure, the CVT cover, drain reservoir and air outlet must be cleaned and inspected for obstruction.

1. Remove the CVT Cover.
2. Open the driven pulley.

Puller/locking tool (529036098)	
--	---

3. Screw tool in the threaded hole of driven pulley and tighten to open the pulley.

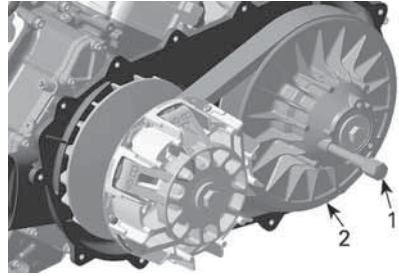

1. Puller/locking tool
2. Fixed sheave of driven pulley
4. Slide the belt over the top edge of fixed sheave to remove it.

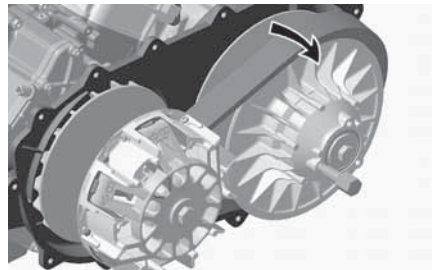

Installing the Drive Belt

For installation, reverse the removal procedure. Pay attention to the following details.

The maximum drive belt life span is obtained when the drive belt has the proper rotation direction.

1. Install drive belt so that the arrow printed on belt is pointing towards front of the vehicle, viewed from top.

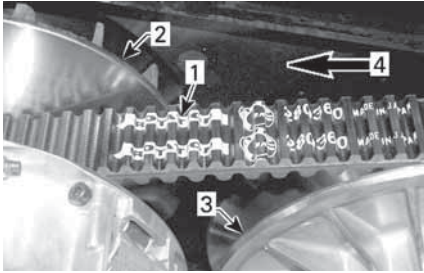

1. Arrow printed on belt
 2. Drive pulley (front)
 3. Driven pulley (rear)
 4. Rotation direction
2. Turn the driven pulley until the lowest portion of the cogs on the external surface of drive belt is even with the driven pulley edge.

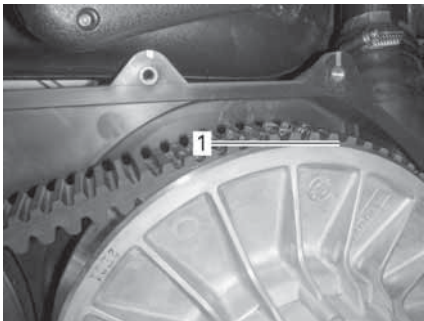

1. Lowest portion of cogs even with external surface of drive belt

Drive and Driven Pulleys

Inspecting the Drive and Driven Pulleys

This inspection must be performed by an authorized Can-Am Off-road dealer, repair shop, or person of your own choosing for maintenance, repair, or replacement.

Drive Pulley

Inspect the bushings and rollers of the sliding sheave of the drive pulley, replace worn parts.

Driven Pulley

Inspect the bushings of the cam and of the sliding sheave of the driven pulley, replace worn parts.

Battery

⚠ CAUTION

Never charge a battery while installed in vehicle.

These vehicles are equipped with a VRLA battery (Valve Regulated Lead Acid). It is a maintenance-free type battery, there is no need to add water to adjust electrolyte level.

NOTICE

Never remove the battery sealing cap.

Removing the Battery

1. Disconnect BLACK (-) cable first then RED (+) cable.

NOTICE

Always disconnect BLACK (-) battery cable first.

2. Remove retaining screws, battery holding strap then pull the battery out of frame.

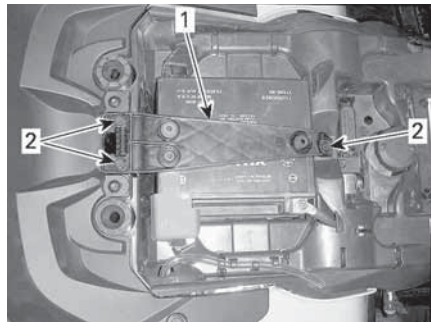

1. Battery holding strap
2. Retaining screws

Cleaning the Battery

1. Clean battery, battery casing and battery posts using a solution of baking soda and water.
2. Remove corrosion from battery cable terminals and battery posts using a firm wire brush.

Installing the Battery

1. The installation is the reverse of the removal procedure.

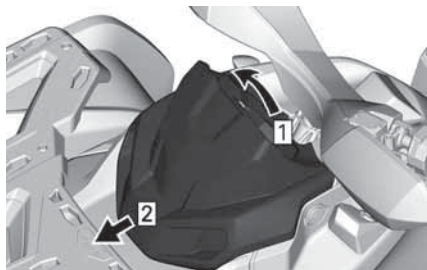

1. Pull up
2. Slide

NOTICE

Always connect RED (+) battery cable first.

NOTE:

Check inside fuse box cover to know fuses location.

Fuses

Fuses Location

The main fuse box is located under the gauge support.

The holder of the following fuse are located behind the rear of the right side panel.

Battery/voltage regulator fuse	40 A
DPS fuse	40 A
ABS	40 A

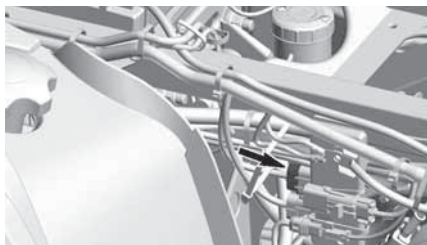

Main Fuse Box Description

Models Equipped with an Mechanical Throttle Control (MTC)

No.	Description	Rating
RY1	Cooling fan relay	—
RY2	Main relay	—
RY3	Accessory relay	—
RY4	Fuel pump relay	

RY8	Brake	—
F4	Cluster/Relays	10A
F5	Injectors/Ignition coils	10A
F8	Starter solenoid/ Key switch	10A
F9	Cooling fan	20A
F12	Headlamp/Accessories	20A

Models Equipped with an Electronic Throttle Control (ETC)

No.	Description	Rating
RY1	Cooling fan relay	—
RY2	Main relay	—
RY3	Lights relay	—
RY5	Accessory relay	—
RY6	Brake relay	—
F1	Start switch	10A
F2	Lights	30A
F3	ACC 1	20A
F4	ACC2	20A
F5	Fuel Pump/Injectors/ Ignition coils/EVAP	10A
F6	Cluster/Relays/DPS/ Speed limiter	10A
F7	Brake lights/Tail lights	10A
F8	D.E.S.S/ECM	10A
F9	2WD/4WD	10A
F12	Cooling fan (resettable)	25A

Lights

⚠ CAUTION

Always turn the ignition switch to OFF position before replacing a defective bulb.

Always check light operation after replacement.

Headlight Bulb Replacement

⚠ WARNING

Improper bulb installation, may cause its dislodgement from the headlight housing. In this situation, the bulb could enter into contact with the headlight housing, lens or any other parts located in this area, resulting in parts melting and/or fire hazard.

NOTICE

Never touch glass portion of a halogen bulb with bare fingers, it shortens its operating life. If glass is touched, clean it with isopropyl alcohol which will not leave a film on the bulb.

Unplug connector from bulb.

Rotate light bulb counterclockwise to release it from light housing.

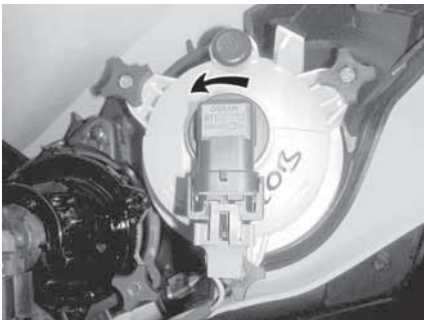

INSIDE FRONT FENDER

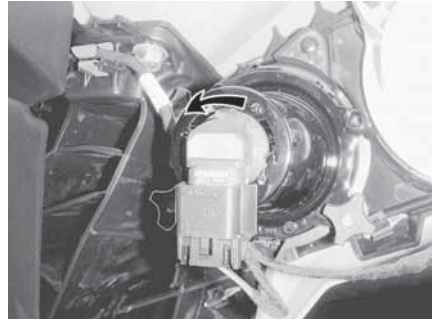

Pull out bulb.

Properly reinstall removed parts in the reverse order of their removal.

Validate headlights operation.

Headlight Beam Aiming

Turn adjustment knobs to adjust beam height to your convenience.

NOTE:

Adjust headlights evenly.

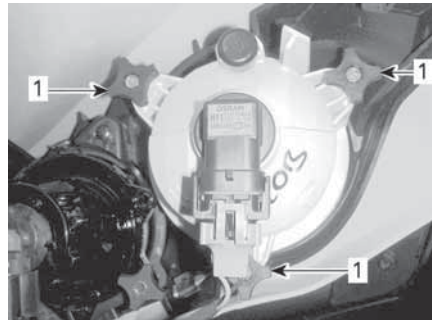

LOW BEAM ADJUSTMENT

1. Adjustment knobs

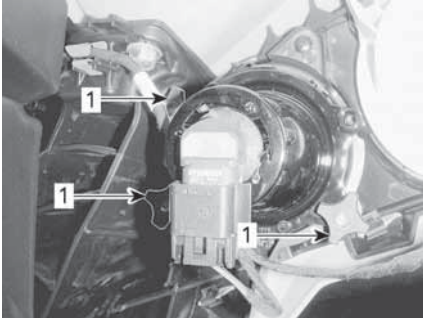

HIGH BEAM ADJUSTMENT

1. Adjustment knobs

Taillight Bulbs Replacement

Remove screws securing taillight assembly.

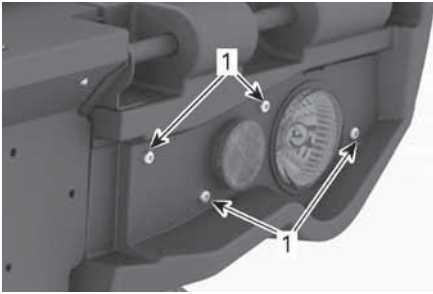

1. Taillight retaining screws

Pull taillight out of its location.

Unplug connector from bulb.

Rotate light bulb counterclockwise to remove it from taillight.

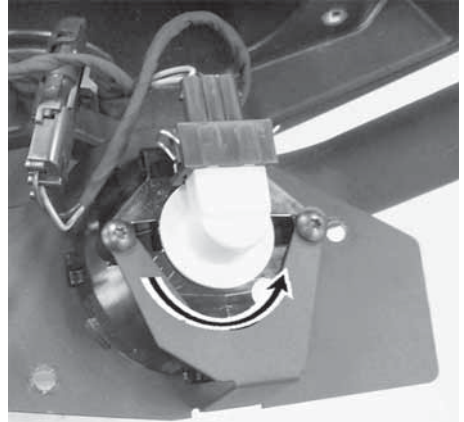

Remove bulb socket from taillight.

The installation is the reverse of the removal procedure.

Drive Shaft Bellow and Protector

Inspecting the Drive Shaft Bellow and Protector

Visually inspect drive shaft protectors and bellows conditions.

Check protectors for damage or rubbing against shafts.

Check bellows for cracks, tears, leaking grease etc.

Repair or replace damaged parts as necessary.

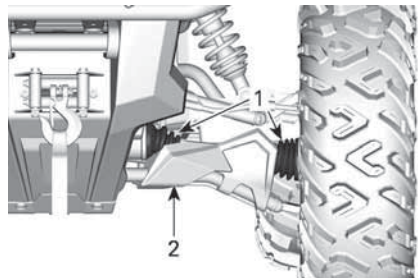

TYPICAL — FRONT OF VEHICLE

1. Drive shaft bellows
2. Protector

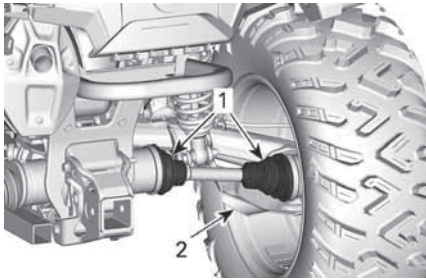

TYPICAL — REAR OF VEHICLE

1. Drive shaft bellows
2. Protector

Wheel Bearing

Inspecting the Wheel Bearing

1. Place vehicle on a level surface.
2. Apply the parking brake.
3. Lift and support vehicle.
4. Secure vehicle on jack stands.
5. Push and pull the wheels from the upper edge to feel the play.
6. See an authorized Can-Am Off-road dealer if there is an abnormal play.



TYPICAL

Wheels and Tires

Tire Pressure

⚠ WARNING

Tire pressure greatly affects vehicle handling and stability. Insufficient pressure may cause tire to deflate and rotate on wheel. Overpressure may burst the tire. Always follow recommended pressure. **NEVER** set tire pressure below minimum. It could cause the tire to dislodge from the rim.

Check pressure when tires are cold before using the vehicle. Tire pressure changes with temperature and altitude. Recheck pressure if one of these conditions has changed.

Refer to the *Tire Pressure and Maximum Load* decal for proper tire pressure.

NOTE:

Although the tires are specifically designed for off-road use, a flat may still occur. Therefore, it is recommended to carry a tire gauge, tire pump and a repair kit.

Tire Inspection

Check tire for damage and wear. Replace if necessary.

⚠ WARNING

Do not rotate tires. The front and rear tires have a different size. The left and right tires have different unidirectional tread patterns.

Tire Replacement

Tire replacement should be performed by an authorized Can-Am Off-road dealer, a repair shop or a person of your choosing.

⚠ WARNING

Replace tires only with the same type and size as original tires. For unidirectional tread pattern, ensure that the tires are installed in the correct direction of rotation. Tires should be replaced, by an experienced person, in accordance with tire industry standards and tools.

Removing the Wheel

1. Place vehicle on a level surface.
2. Apply the parking brake.
3. Loosen lug nuts then lift vehicle.
4. Secure vehicle on jack stands.
5. Remove lug nuts, then remove wheel.

Installing the Wheel

1. At installation, it is recommended to apply anti-seize lubricant on threads.
2. If tires are unidirectional, make sure to install wheel according to tire rotation.
3. Carefully tighten lug nuts in a criss-cross sequence then tighten to specification.

Tightening torque	
Wheel lug nut	80 ± 5 Nm (59 ± 4 lbf-ft)

NOTE:

Occasionally, wheel lug nuts should be removed to apply anti-seize lubricant on studs to ease future removal. This is particularly important when vehicle is used in salt-water environment or in mud. Remove one nut at a time, lubricate then retorque.

NOTICE

Always use the recommended wheel lug nuts for the type of wheel. Using a different lug nut could cause damages to the rim or studs.

Steering

Inspecting Tie-Rod Ends

1. Place vehicle on a level surface.
2. Apply parking brake.
3. Lift vehicle.
4. Secure vehicle on jack stands.
5. Inspect tie-rod bellows for cracks.
6. Push and pull the wheels from the front or rear edge to feel the play.
7. See an authorized Can-Am Off-road dealer if there is an abnormal play or the bellow is cracked.

⚠ WARNING

The tie-rod end must be replaced if the bellow is cracked or shows an abnormal play.

Suspension

Lubricating the Front Suspension

1. Lubricate front stabilizer bar bushing and suspension arms at grease fittings.

XPS Synthetic suspension grease

Lubricating the Rear Suspension

1. Lubricate rear stabilizer bar links and pivot bushing at grease fittings.

XPS Synthetic suspension grease

Inspecting the Suspension

See an authorized Can-Am Off-road dealer, a repair shop or person of your choosing if any problem is detected.

Shock Absorbers

1. Inspect shock absorber for oil leaks or other damage.
2. Check tightness of fasteners.
3. See an authorized Can-Am Off-road dealer as necessary.

Ball Joints

1. Place vehicle on a level surface.
2. Apply parking brake.
3. Lift vehicle.
4. Secure vehicle on jack stands.
5. Inspect ball joint bellow for cracks.
6. Push and pull the wheels from the upper and lower edge to feel the play.
7. See an authorized Can-Am Off-road dealer if there is an abnormal play or the boot is cracked.



TYPICAL

⚠ WARNING

The ball joint must be replaced if the bellow is cracked or it shows an abnormal play.

Front Suspension Arms

1. Check suspension arms for cracks, bending or other damage.
2. See an authorized Can-Am Off-road dealer as necessary.

Rear Trailing Arms

1. Check trailing arms for distortion, cracks or bending.
2. See an authorized Can-Am Off-road dealer if any problem is detected.

Brakes

Verifying the Front Brake Reservoir Level

1. Turn steering in the straight-ahead position to ensure reservoir is level.
2. Check the brake fluid level, the reservoir is full when the fluid reaches of the top of window.
3. Visually inspect lever boot condition.
4. Check for cracks, tears, etc. Replace if damaged.

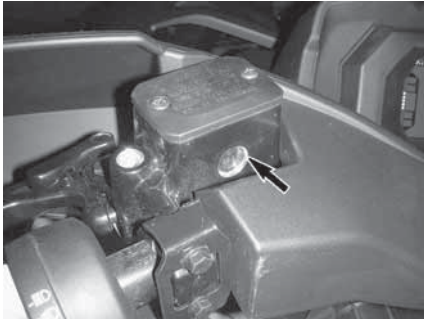

TYPICAL

Verifying the Rear Reservoir Level

1. Remove the seat.
2. With vehicle on a level surface, liquid should be between MIN. and MAX. level marks of brake pedal fluid reservoir.

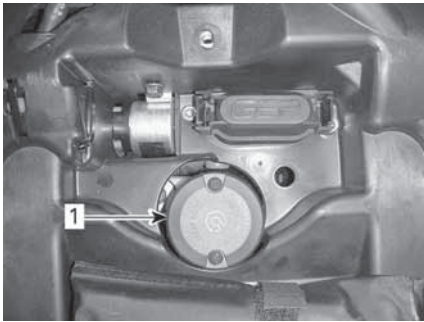

1. Rear brake fluid reservoir

Adding Brake Fluid

1. Clean filler cap.

⚠ WARNING
Clean filler cap before removing to avoid brake system contamination.

2. Remove reservoir cap.
3. Add fluid as required using a clean funnel. **Do not overfill.**

NOTICE
Brake fluid can damage plastic and painted surface. Wipe off and clean any spillage.

4. Reinstall reservoir cap.

NOTE:

Ensure filler cap diaphragm is pushed inside the cap before closing the brake fluid reservoir.

5. On front reservoir, tighten screws to specification.

Tightening torque	
Brake fluid reservoir screws	1.3 ± 0.1 Nm (12 ± 1 lbf-in)

Recommended Brake Fluid

Always use brake fluid meeting the specification DOT 4 only.

⚠ WARNING
To avoid serious damage to the braking system, do not use fluids other than the recommended one, nor mix different fluids for topping up.

Inspecting the Brake System

⚠ WARNING
The brake fluid replacement or brake system maintenance and repairs should be performed by an authorized Can-Am Off-road dealer.

⚠ CAUTION
The brakes can be very hot after prolonged use of the vehicle and can cause burns. Wait for the brakes to cool down.

The brake inspection, maintenance and repair should be performed by an authorized Can-Am Off-road dealer.

1. However, verify the following between visits to your dealer:
 - Brake fluid level

- Brake system for fluid leaks
- Brake cleanliness.

VEHICLE CARE

Post-Operation Care

When vehicle is used in salt-water environment (beach area, launching and loading boats... etc.), rinsing the vehicle with fresh water is necessary to preserve the vehicle and its components.

1. Lubricate the metallic parts at the end of each operating day.

Lubricant and anti-corrosive

2. Also, when vehicle is operated in muddy conditions, rinse the vehicle carefully to preserve the vehicle and its components.

Vehicle Cleaning and Protection

NOTICE

Never use a high pressure washer to clean the vehicle. USE LOW PRESSURE ONLY (like a garden hose).

Pay attention to certain areas where mud or debris can accumulate and potentially cause wear, interferences or promote corrosion.

Wash the vehicle with a soapy water solution.

NOTICE

Never clean polypropylene body parts with any petroleum base cleaning products, as it will alter the glossy finish.
--

Non Compatible Cleaning Products

Material Type	Non-compatible Cleaning Products
Polypropylene	<ul style="list-style-type: none">- Any petroleum base cleaning products- XPS ATV finishing spray- XPS ATV cleaning kit (it contains the above XPS ATV Finishing Spray)

Compatible Cleaning Products

Material Type	Compatible Cleaning Product
Polypropylene	<ul style="list-style-type: none">- XPS ATV wash- Soapy water

STORAGE AND PRESEASON PREPARATION

When a vehicle is not in use for more than 4 months, proper storage is a necessity.

If the vehicle is to be remain inactive for more than 21 days, disconnect the BLACK (-) cable of the battery.

The use of a low amperage trickle charger is recommended to keep battery fully charged.

Before using your vehicle after storage, a preparation is required.

See an authorized Can-Am Off-road dealer, a repair shop, or a person of your own choosing to have your vehicle prepared properly.

While reading this Operator's Guide, remember that:



WARNING

Indicates a potential hazard which, if not avoided, could result in serious injury or death.

This page is intentionally blank

TECHNICAL INFORMATION

VEHICLE IDENTIFICATION

The main components of your vehicle (engine and frame) are identified using different serial numbers. It may sometimes become necessary to locate these numbers for warranty purposes or to trace your vehicle in the event of loss. These numbers are also required by the authorized Can-Am off-road dealer to complete warranty claims properly. We strongly recommend that you take note of all the serial numbers on your vehicle and supply them to your insurance company.

Vehicle Identification Number



TYPICAL

1. VIN Label - On the frame under the seat

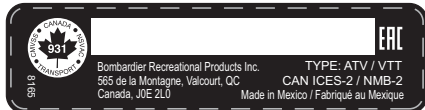

TYPICAL - VIN LABEL

Engine Identification Number (EIN)

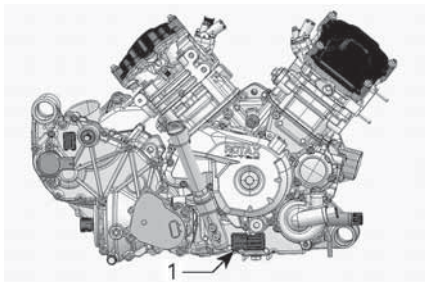

TYPICAL - RH SIDE OF ENGINE

1. Engine Identification Number (EIN)

Compliance Label

Regulation (EU) 2016/1628 applicable for Non-Road Mobile Machineries

Vehicles who comply to Regulation (EU) 2016/1628 (NRMM) are identified on the engine valve cover as well as on the frame under the seat.

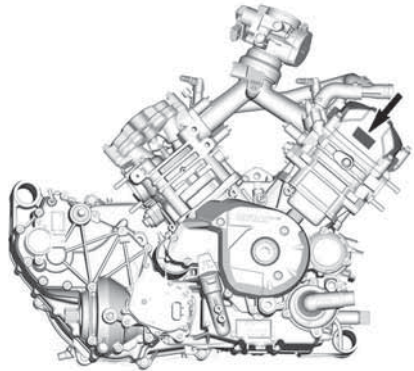

TYPICAL

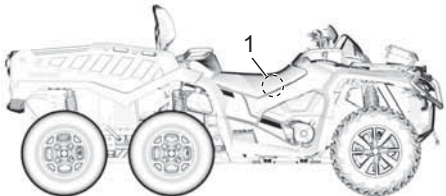

1. NRMM Label - On the frame under the seat

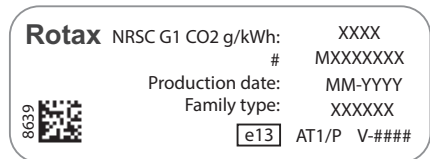

TYPICAL - NRMM IDENTIFICATION LABEL

NOTE:

Tampering with the engine or its components voids the EU type-approval of that particular engine.

Radio Frequency Digitally Encoded Security System (RF D.E.S.S. key)

This device complies with FCC Part 15 and Industry Canada license exempt RSS standard(s). Operation is subject to the following two conditions: (1) this device may not cause interference, and (2) this device must accept any interference, including interference that may cause undesired operation of the device.

Changes or modifications not expressly approved by the party responsible for compliance could void the user's authority to operate the equipment.

IC Registration Number:
12006A-M01456

FCC ID: 2ACERM01456

We, the party responsible for compliance, declare under our sole responsibility that the device is in conformity with the provisions of the following Council Directive: 2014/53/EU. To which this declaration relates is in conformity with the essential requirements and other relevant requirements. The product is in conformity with the following directives, harmonized standards and regulations: Radio Equipment Directive (RED) 2014/53/EU and Harmonized Standards: EN 300 330-2, EN 60950-1.

RADIO FREQUENCY DIGITALLY ENCODED SECURITY SYSTEM (RF D.E.S.S. KEY)

This device complies with FCC Part 15 and Industry Canada license exempt RSS standard(s). Operation is subject to the following two conditions: (1) this device may not cause interference, and (2) this device must accept any interference, including interference that may cause undesired operation of the device.

Changes or modifications not expressly approved by the party responsible for compliance could void the user's authority to operate the equipment.

IC Registration Number: 12006A-M01456

FCC ID: 2ACERM01456

We, the party responsible for compliance, declare under our sole responsibility that the device is in conformity with the provisions of the following Council Directive: 2014/53/EU. To which this declaration relates is in conformity with the essential requirements and other relevant requirements. The product is in conformity with the following directives, harmonized standards and regulations: Radio Equipment Directive (RED) 2014/53/EU and Harmonized Standards: EN 300 330-2, EN 60950-1.

NOISE EMISSION CONTROL SYSTEM REGULATION (CANADA/UNITED STATES)

Tampering with Noise Control System Is Prohibited!

U. S. Federal law and Canadian provincial laws may prohibit the following acts or the causing there of:

1. The removal or rendering inoperative by any person other than for purposes of maintenance, repair or replacement of any device or element of design incorporated into any new vehicle for the purpose of noise control prior to its sale or delivery to the ultimate purchaser or while it is in use or
2. The use of the vehicle after such device or element of design has been removed or rendered inoperative by any person.

Among those Acts Presumed to Constitute Tampering Are the Acts Listed Below:

1. Removal or alteration or the puncturing of the muffler or any engine component which conducts removal of engine exhaust gases.
2. Removal or alteration or the puncturing of any part of the intake system.
3. Replacing any moving parts of the vehicle or parts of the exhaust or intake system, with parts other than those specified by the manufacturer.
4. Lack of proper maintenance.

EC-DECLARATION OF CONFORMITY



ADVENTURE BY DESIGN

565 de la Montagne Street
Valcourt (Québec) J0E 2L0
Canada

www.brp.com

EU Declaration of Conformity

Authorized Representative: BRP Europe N.V., Skaldenstraat 125, Gent, Belgium, 9042

This declaration of conformity is issued under the sole responsibility of the manufacturer.

The undersigned, representing the manufacturer, hereby declares that model year 2022 All Terrain Vehicles (ATVs) marked with the CE mark and a 17-character vehicle identification number (VIN) structured as 3JBxxxxxxNxxxxxxx under commercial names Can-am Outlander and Can-am Renegade comply with all the relevant provisions of the following Directives and Regulations:

Machinery Directive 2006/42/EC as amended up to and including Reg. 2019/1243/EU	ISO 12100:2010 & EN 15997:2011
Non-Road Mobile Machinery (NRMM) Regulation (EU) 2016/1628 on gaseous pollutants	Category ATS, Stage V emissions limits
Electromagnetic Compatibility (EMC) Directive 2014/30/EU as amended up to and including Reg. (EU) 2018/1139	CISPR 12:2007/A1:2009 & IEC 61000-6-1:2005 or UN R10.04 or later version
Battery Directive 2006/66/EC as amended up to and including Dir. (EU) 2018/849	
Radio Equipment (RED) Directive 2014/53/EU as amended up to and including Reg. 2018/1139 (If fitted with radio frequency (RF) D.E.S.S. key)	EN 300 330-2 & EN 60950-1

Renald Plante, Eng.
Director, Product Development, Can-Am ATV & Spyder
Bombardier Recreational Products Inc.

Valcourt, QC, Canada

February 22nd, 2021

SKI-DOO LYNX SEA-DOO Evinrude ROTAX CAN-AM

EAC DECLARATION OF CONFORMITY

**Left blank for Eurasian Conformity
mark where applicable**

This page is intentionally blank

TECHNICAL SPECIFICATIONS

TECHNICAL SPECIFICATIONS

ENGINE			
Engine type		ROTAX®, 4-stroke, 2 cylinders (V-twin), liquid cooled	
Valve train		4 valves/cylinder (mechanical adjustment), single overhead camshaft (SOHC) with timing chain	
Valve clearance		Intake	0.06 to 0.14 mm (.0024 to .0055 in)
		Exhaust	0.11 to 0.19 mm (.0043 to .0075 in)
Bore		650	82 mm (3.23 in)
		1000	91 mm (3.58 in)
Stroke		650	61.5 mm (2.42 in)
		1000	75 mm (2.95 in)
Displacement		650	650 cm ³ (39.7 in ³)
		1000	976 cm ³ (59.6 in ³)
Exhaust system		Spark arrestor approved by USDA Forest Service	
Air filter		Synthetic paper filter with foam	

LUBRICATION SYSTEM				
Type		Wet sump. Replaceable cartridge oil filter		
Oil filter		BRP Rotax paper type, replaceable		
Engine oil		Capacity (oil change with filter)	2.0 l (2.1 qt (liq., US))	
		Recommended XPS oil	General purpose	XPS 4T 5W40 Synthetic blend oil
			Cold temperature	XPS 4T 0W40 Synthetic oil
			Warm temperature	XPS 4T 10W50 Synthetic oil
Alternate oil if XPS products are not available		5W40 or 10W50 motor oil that meets the requirements for API service classification SJ, SL, SM or SN		

COOLING SYSTEM			
Coolant	Recommended XPS coolant		XPS extended life pre-mixed coolant
	Alternate if XPS product is not available		Ethyl glycol / water mix (50%/50%). or coolant specifically designed for aluminum engines
	Capacity	650	3.4 l (.9 gal (liq.,US))
1000		3.5 l (.92 gal (liq.,US))	

TRANSMISSION	
Type	CVT (Continuously Variable Transmission), sub-transmission with L/H/N/R/P, standard engine braking
Engagement RPM	1800 RPM

GEARBOX		
Type	Dual range (HI-LO) with park, neutral and reverse	
Gearbox oil	Capacity	450 ml (15.22 fl oz (US))
	Recommended XPS oil	XPS 75W140 Synthetic gear oil
	Alternate if XPS product is not available	75W140 API GL-5 synthetic gear oil

ELECTRICAL SYSTEM		
Magneto generator output		650 W @ 6000 RPM
Ignition system type		IDI (Inductive Discharge Ignition)
Ignition timing		Not adjustable
Spark plug	Quantity	2
	Make and type	NGK DCPR8E or equivalent

ELECTRICAL SYSTEM		
	Gap	0.8 to 0.9 mm (.031 to .035 in)
Engine RPM limiter setting	Forward	8000 RPM
	Reverse	15 km/h (9 MPH) (without override)
Battery	Type	Maintenance free
	Voltage	12 volts
	Nominal rating	18 A•h
	Power starter output	0.7 KW
Headlights	High	2 x 60 W (HB3)
	Low	2 x 55 W (H11)
Taillights		2 x 5/21 W
Fuses		Refer to <i>Fuses</i> in <i>Maintenance</i>

FUEL SYSTEM		
Fuel delivery		Electronic Fuel Injection (EFI), 46 mm throttle body, 1 injector per cylinder
Fuel pump	Type	Electrical (in fuel tank)
Idle speed		1400 ± 100 RPM (not adjustable)
Fuel	Type	Regular unleaded gasoline Refer to <i>Fuel Requirement</i>
	Minimum octane rating	87 Pump Posted AKI (92 RON or 95 E10 RON)
Fuel tank capacity		20.5 l (5.4 gal(liq.,US))
Fuel remaining when low fuel light turns ON		± 5 l (1.3 gal(liq.,US))

DRIVE SYSTEM	
Drive system type	Selectable 4WD/6WD
Front drive	Visco-Lok † QE auto-locking front differential
Front drive ratio	3.6:1
Rear drive	Straight bevel gear / Shaft driven final drive

DRIVE SYSTEM		
Rear drive ratio		3.6:1
Front differential oil	Capacity	500 ml 17 fl oz (US)
	Recommended XPS oil	XPS 75W90 Synthetic gear oil
	Alternate if XPS product is not available	75W90 API GL-5 synthetic gear oil
Middle drive oil	Capacity	400 ml (13.53 fl oz (US))
	Recommended XPS oil	XPS 75W140 Synthetic gear oil
	Alternate if XPS product is not available	75W140 API GL-5 synthetic gear oil
Rear final drive oil	Capacity	300 ml (10.2 fl oz (US))
	Recommended XPS oil	XPS 75W140 Synthetic gear oil
	Alternate if XPS product is not available	75W140 API GL-5 synthetic gear oil
CV joint grease		XPS CV joint grease or an equivalent
Propeller shaft grease		XPS Propeller shaft grease or an equivalent

STEERING	
Camber angle (vehicle on ground)	0°

FRONT SUSPENSION		
Suspension type		Double suspension-arm with dive-control geometry and external stabilizer bar
Suspension travel		23.3 cm (9.2 in)
Shock absorber	Qty	2
	Type	Oil
Preload adjustment type		5 positions cam

MIDDLE AND REAR SUSPENSION		
Suspension type	Middle	Torsional Trailing arm Independent (TTI)

MIDDLE AND REAR SUSPENSION		
	Rear	Torsional Trailing arm Independent (TTI) with quick release external stabilizer bar
Suspension travel		25.1 cm (9.9 in)
Shock absorber	Qty	4
	Type	Oil
Preload adjustment type		5 position cam

BRAKES		
Front brake	Qty	2
	Type	214 mm cross drilled disc brakes with hydraulic twin-piston calipers
Rear brake	Qty	2
	Type	214 mm cross drilled disc brake with hydraulic twin-piston caliper
Brake fluid	Capacity	260 ml (8.8 fl oz (US))
	Type	DOT 4
Caliper		Floating twin pistons (2 x 26 mm)
Brake pad material		Organic
Minimum brake pad thickness		1 mm (.04 in)
Minimum brake disc thickness		4.0 mm (.157 in)
Maximum brake disc warpage		0.2 mm (.01 in)

TIRES		
Pressure		Recommended tire inflation pressure is found on the Tire Label. Refer to appropriate <i>Important On-Product Labels</i> section for its location.
Minimum tire thread depth		3 mm (.118 in)
Size	Front	26x8-12 (205/90-12)

TIRES		
	Middle and Rear	26x10-12 (255/70-12)

WHEELS		
Type		Cast aluminum
Rim size	Front	30,5 x 15,2 cm (12 x 6 in)
	Middle and Rear	30,5 x 19,1 cm (12 x 7.5 in)
Wheel offset	Front	41.2 mm (1.62 in)
	Middle and Rear	51 mm (2.01 in)
Wheel lug nut torque		80 ± 5 Nm (59 ± 4 lbf-ft)

DIMENSIONS		
Overall length		317 cm (124.8 in)
Overall width		123 cm (48.5 in)
Overall height		140 cm (55.3 in)
Wheelbase		228 cm (89.8 in)
Wheel track	Front	102.6 cm (40 in)
	Rear	97.4 cm (38 in)
Ground clearance		27.9 cm (11 in)

WEIGHT AND LOADING CAPACITY		
Dry weight	650	531 kg (1,170 lb)
	1000	580 kg (1,278.7 lb)
Weight distribution (front/middle/rear)		22/38/40
Front rack capacity		45 kg (100 lb)
Cargo bed		318 kg (700 lb) of which, at least, 45 kg (100 lb)
Total vehicle load allowed (including driver,, all other loads and added accessories)		460 kg (1,015 lb)
Towing capacity	Canada and United States	750 kg1,654 lb
	All other countries	850 kg (1,874 lb)

WEIGHT AND LOADING CAPACITY		
Tongue capacity	Canada and United States	75 kg (165 lb)
	All other countries	68 kg (150 lb)
Rear storage capacity (Dual-level cargo box with sidewalls and tailgate)		70 l (18.5 gal (liq.,US))

TROUBLESHOOTING

TROUBLESHOOTING GUIDELINES

Engine Does Not Turn

- 1. D.E.S.S. key is not installed on D.E.S.S. post.**
 - *Securely install D.E.S.S. key to D.E.S.S. post.*
- 2. Engine stop switch.**
 - *Make sure that engine stop switch is in ON position.*
- 3. Transmission is not set on PARK or NEUTRAL.**
 - *Set transmission either in PARK or in NEUTRAL or press the brake lever.*
 - *Press the brake lever*
- 4. Burnt fuse.**
 - *Check main fuse condition.*
- 5. Weak battery or loose connections.**
 - *Check charging system.*
 - *Check connections and terminals condition.*
 - *Have the battery checked.*
 - *Contact an authorized Can-Am Off-road dealer.*
- 6. The digital display shows BAD KEY.**
 - *Wrong D.E.S.S. key, use the proper key for this vehicle.*
- 7. Weak starter or loose connections.**
 - *Check starter connections.*
 - *Check starter relay.*

Engine Turns Over But Fails To Start

- 1. Flooded engine (spark plug wet when removed).**
 - *Refer to Flooded Engine in Special Procedures.*
- 2. No fuel to the engine (spark plug dry when removed).**
 - *Check fuel tank level.*
 - *Check fuel pump fuse and relay.*
 - *A failure of the fuel pump may have occurred.*
 - *If engine does not start, seek service from an authorized Can-Am Off-road dealer, repair shop, or person of your own choosing for maintenance, repair, or replacement. Please refer to the US EPA Emission-related Warranty contained herein for information about warranty claims.*
- 3. Spark plug/ignition (no spark).**
 - *Check injectors/ignition fuse condition.*
 - *Remove spark plug then reconnect to ignition coil.*
 - *Start engine with spark plug grounded to the engine away from spark plug hole. If no spark appears, replace spark plug.*

- *If trouble persists, seek service from an authorized Can-Am Off-road dealer, repair shop or person of your own choosing for maintenance, repair or replacement. Please refer to the US EPA Emission-related warranty contained herein for information about warranty claims.*
- 4. CHECK ENGINE indicator lamp is on and the digital display shows CHECK ENGINE.**
 - *Seek service from an authorized Can-Am Off-road dealer, repair shop or person of your own choosing for maintenance, repair or replacement. Please refer to the US EPA Emission-related warranty contained herein for information about warranty claims.*
 - 5. Engine is under a protection mode (limp home).**
 - *The CHECK ENGINE indicator lamp is on and the digital display shows CHECK ENGINE, seek service from an authorized Can-Am Off-road dealer, repair shop or person of your own choosing for maintenance, repair or replacement. Please refer to the US EPA Emission-related warranty contained herein for information about warranty claims.*

Engine Lacks Acceleration or Power

- 1. Fouled or defective spark plug.**
 - *Refer to Engine Turns Over But Fails To Start.*
- 2. Lack of fuel to engine.**
 - *Refer to Engine Turns Over But Fails To Start.*
- 3. Engine is overheating. (CHECK ENGINE indicator light will turn on and HI TEMP will appear in the digital display.)**
 - *Refer to Engine Overheats.*
- 4. Air filter/housing clogged or dirty.**
 - *Check air filter and clean if necessary.*
 - *Check deposits in air filter housing drain.*
 - *Check the position of the air intake tube.*
- 5. CVT dirty or worn-out.**
 - *Contact an authorized Can-Am Off-road dealer.*
- 6. Engine is under a protection (limp home) mode.**
 - *Check digital display for messages.*
 - *The CHECK ENGINE indicator lamp is on and the digital display shows CHECK ENGINE or LIMP HOME, seek service from an authorized Can-Am Off-road dealer, repair shop or person of your own choosing for maintenance, repair or replacement. Please refer to the US EPA Emission-related warranty contained herein for information about warranty claims.*

Engine Overheats

1. Low coolant in cooling system.

- Check engine coolant, refer to *Verifying the Engine Coolant in Maintenance Procedures*.

2. Dirty radiator fins.

- Clean radiator fins, refer to *Inspecting the Radiator in Maintenance Procedures*.

3. Cooling fan inoperative.

- Check cooling fan fuse or relay, refer to *Fuses in Maintenance Procedures*. If the fuse is good, seek service from an authorized Can-Am Off-road dealer, repair shop or person of your own choosing for maintenance, repair or replacement. Please refer to the US EPA Emission-related Warranty contained herein for information about warranty claims.

Engine Backfire

1. Exhaust system leakage.

- Seek service from an authorized Can-Am Off-road dealer, repair shop or person of your own choosing for maintenance, repair or replacement. Please refer to the US EPA Emission-related Warranty contained herein for information about warranty claims.

2. Engine is running too hot.

- Refer to *Engine Lacks Acceleration Or Power*.

3. Ignition timing is incorrect or there is an ignition system failure.

- Seek service from an authorized Can-Am Off-road dealer, repair shop or person of your own choosing for maintenance, repair or replacement. Please refer to the US EPA Emission-related Warranty contained herein for information about warranty claims.

Engine Misfire

1. Fouled/defective/worn spark plug.

- Clean/verify spark plug and heat range. Replace as required.

2. Water in fuel.

- Drain fuel system and refill with fresh fuel.

Vehicle Cannot Reach Full Speed

1. Engine problems.

- Refer to *Engine Lacks Acceleration Or Power*.

2. Parking brake applied.

- *Ensure parking brake is completely removed.*

3. Air filter/housing plugged or dirty.

- *Check air filter and clean if necessary.*
- *Check deposits in air filter housing drain.*
- *Check the position of the air intake tube.*

4. CVT dirty or worn-out.

- *Contact an authorized Can-Am Off-road dealer.*

5. Engine is under a protection mode (limp home).

- *Check digital display for messages.*
- *The CHECK ENGINE indicator lamp is on and the digital display shows CHECK ENGINE or LIMP HOME, seek service from an authorized Can-Am Off-road dealer, repair shop or person of your own choosing for maintenance, repair or replacement. Please refer to the US EPA Emission-related Warranty contained herein for information about warranty claims.*

Shift Lever Is Hard To Move**1. Transmission gears are in a position that prevents the shift lever to work.**

- *Rock the vehicle back and forth to move the gears in the transmission and allow the shift lever to be set.*

2. CVT dirty or worn-out.

- *Contact an authorized Can-Am Off-road dealer.*

The RPM Increases But The Vehicle Does Not Move**1. The transmission is on PARK or NEUTRAL position.**

- *Select the R, HI or LO position.*

2. CVT dirty or worn-out.

- *Contact an authorized Can-Am Off-road dealer.*

3. Water in the CVT housing.











- *Contact an authorized Can-Am Off-road dealer.*

Reduced Power Steering Assist**1. When DPS is subjected to sustained severe steering conditions, the assistance provided by the DPS motor may be reduced to protect the system.**

- *Once the load is reduced, the normal steering assistance will return.*

- 2. The CHECK ENGINE indicator lamp is ON and the digital display shows CHECK DPS**
 - *Seek service from an authorized Can-Am Off-road dealer, repair shop or person of your own choosing for maintenance, repair or replacement.*

MULTIFUNCTION GAUGE (LCD) MESSAGES













Message	Pilot lamp(s) ON	Description
BAD KEY		Indicates that you have used the wrong ignition key or D.E.S.S. key, use the proper key for this vehicle. It is also possible that the key has a bad contact, remove and clean key.
DESS KEY NOT RECOGNIZED		Indicates that there possibly is a bad contact, remove and clean key.
PARK BRAKE	None	Message displayed when parking brake is applied for more than 15 seconds (while riding).
LO BATT		Low battery voltage, check battery voltage and charging system.
HI BATT		High battery voltage, check battery voltage and charging system.
LOW OIL ⁽¹⁾		Engine low oil pressure, stop engine immediately.
HI TEMP		Engine is overheating, refer to <i>ENGINE OVERHEATS</i> in <i>Troubleshooting</i>
LIMP HOME		Serious fault on the engine that can change the normal operation of the engine, CHECK ENGINE indicator lamp will also blink, refer to <i>Troubleshooting</i> .
CHECK ENGINE		Engine fault, CHECK ENGINE indicator lamp will also be ON, refer to <i>Troubleshooting</i> .
NO ECM COMMUNICATION		Communication error between speedometer and engine control module (ECM)
CHECK DPS		Indicates that the Dynamic Power Steering (DPS) does not work properly. See an authorized Off-road Can-Am dealer.





MAINTENANCE REQUIRED	None	Displayed in gauge when vehicle is due for a maintenance
TPS FAULT PRESS OVERRIDE BUTTON TO LIMP HOME		Throttle position sensor does not work properly. Seek service from an authorized OFF-road Can-Am dealer, repair shop or person of your own choosing for maintenance, repair or replacement. Please refer to the US EPA Emissions-related warranty contained herein for information about warranty claims.

NOTICE

(1) If the message and the check engine light stays on after engine starting, stop engine. Check engine oil level. Refill if necessary. If the oil level is good, seek service from an authorized Can-Am off-road dealer, repair shop or person of your own choosing for maintenance, repair or replacement. Please refer to the US EPA Emissions-related warranty contained herein for information about warranty claims. Do not use the vehicle until repaired.

DIGITAL DISPLAY MESSAGES

Message	Pilot lamp(s) ON	Beeper	Description
BAD KEY		None	Indicates that you have used the wrong ignition key or D.E.S.S. key, use the proper key for this vehicle. It is also possible that the key has a bad contact, remove and clean key.
DESS KEY NOT RECOGNIZED		None	Indicates that there possibly is a bad contact, remove and clean key.
PARK BRAKE		None	Is displayed when parking brake is applied for more than 15 seconds (while riding).
LO BATT		None	Low battery voltage, check battery voltage and charging system.
HI BATT		None	High battery voltage, check battery voltage and charging system.
LOW OIL (1)		Single - long	Engine low oil pressure, stop engine immediately.
No oil		Buzzer 2 seconds ON and 15 minutes OFF	No engine oil, stop engine immediately.
HI TEMP		Single - long	Engine is overheating, refer to <i>ENGINE OVERHEATS</i> in <i>Troubleshooting</i>
LIMP HOME		Single - long	Serious fault on the engine that can change the normal operation of the engine, CHECK ENGINE indicator lamp will also blink, refer to <i>Troubleshooting</i> .
CHECK ENGINE		None	Engine fault, CHECK ENGINE indicator lamp will also be ON, refer to <i>Troubleshooting</i> .
NO ECM COMMUNICATION		None	Communication error between speedometer and engine control module (ECM)
CHECK DPS		None	Indicates that the Dynamic Power Steering (DPS) does not work properly. See an authorized Off-road Can-Am dealer.

MAINTENANCE REQUIRED		None	Displayed in gauge when vehicle is due for a maintenance
TPS FAULT PRESS OVERRIDE BUTTON TO LIMP HOME		None	Throttle position sensor does not work properly. Seek service from an authorized OFF-road Can-Am dealer, repair shop or person of your own choosing for maintenance, repair or replacement. Please refer to the US EPA Emissions-related warranty contained herein for information about warranty claims.
FRONT DIFFERENTIAL LOCK -LOCK ACTIVATION		Single - short	The front differential lock is activated.
FRONT DIFFERENTIAL LOCK -UNLOCK	None	Double - short	The front differential lock is unlocked.
SPORT MODE ACTIVE	<i>SPORT</i>	Single - short	The SPORT mode is now selected.
SPEED LIMITER ACTIVE		Single - short	The speed limiter is activated.

NOTICE

(1) If the message and the check engine light stays on after engine starting, stop engine. Check engine oil level. Refill if necessary. If the oil level is good, seek service from an authorized Can-Am off-road dealer, repair shop or person of your own choosing for maintenance, repair or replacement. Please refer to the US EPA Emissions-related warranty contained herein for information about warranty claims. Do not use the vehicle until repaired.

WARRANTY

BRP LIMITED WARRANTY USA AND CANADA: 2022 CAN-AM® ATV

1) SCOPE OF THE LIMITED WARRANTY

Bombardier Recreational Products Inc. ("BRP") warrants its 2022 Can-Am ATV sold by authorized Can-Am ATV dealers (as hereinafter defined) in the United States of America ("USA") and in Canada from defects in material or workmanship for the period and under the conditions described below. This limited warranty will become null and void if: (1) the ATV was used for racing or any other competitive activity, at any point, even by a previous owner; or (2) the ATV has been altered or modified in such a way so as to adversely affect its operation, performance or durability, or has been altered or modified to change its intended use.

Non-factory installed parts and accessories are not covered under this limited warranty.

Please refer to the applicable parts and accessories limited warranty text.

2) LIMITATIONS OF LIABILITY

THIS WARRANTY IS EXPRESSLY GIVEN AND ACCEPTED IN LIEU OF ANY AND ALL OTHER WARRANTIES, EXPRESSED OR IMPLIED, INCLUDING WITHOUT LIMITATION ANY WARRANTY OF MERCHANTABILITY OR FITNESS FOR A PARTICULAR PURPOSE TO THE EXTENT THAT THEY CANNOT BE DISCLAIMED, THE IMPLIED WARRANTIES ARE LIMITED IN DURATION TO THE LIFE OF THE EXPRESS WARRANTY. INCIDENTAL AND CONSEQUENTIAL DAMAGES ARE EXCLUDED FROM COVERAGE UNDER THIS WARRANTY SOME STATES/PROVINCES DO NOT ALLOW FOR THE DISCLAIMERS, LIMITATIONS AND EXCLUSIONS IDENTIFIED ABOVE, AS A RESULT, THEY MAY NOT APPLY TO YOU. THIS WARRANTY GIVES YOU SPECIFIC RIGHTS, AND YOU MAY ALSO HAVE OTHER LEGAL RIGHTS WHICH MAY VARY FROM STATE TO STATE, OR PROVINCE TO PROVINCE.

Neither the distributor, any BRP dealer nor any other person has been authorized to make any affirmation, representation or warranty regarding the product, other than those contained in this limited warranty, and if made, shall not be enforceable against BRP.

BRP reserves the right to modify this limited warranty at any time, being understood that such modification will not alter the warranty conditions applicable to the products sold while this warranty is in effect.

3) EXCLUSIONS—ARE NOT WARRANTED

The following are not warranted under any circumstances:

- Normal wear and tear;
- Routine maintenance items, tune ups, adjustments;
- Damage caused by failure to provide proper maintenance and/or storage, as described in the Operator's Guide;
- Damage resulting from removal of parts, improper repairs, service, maintenance, modifications or use of parts not manufactured or approved by BRP or resulting from repairs done by a person that is not an authorized servicing Can-Am ATV dealer;

- Damage caused by abuse, abnormal use, neglect or operation of the product in a manner inconsistent with the recommended operation described in the Can-Am ATV Operator's Guide;
- Damage resulting from accident, submersion, fire, theft, vandalism or any act of God;
- Operation with fuels, oils or lubricants which are not suitable for use with the product (see the Operator's Guide);
- Damages from rust, corrosion or exposure to the elements;
- Damage resulting from water or snow ingestion;
- Incidental or consequential damages, or damages of any kind including without limitation towing, storage, telephone, rental, taxi, inconvenience, insurance coverage, loan payments, loss of time, loss of income.

4) WARRANTY COVERAGE PERIOD

This limited warranty will be in effect from (1) the date of delivery to the first retail consumer or (2) the date the product is first put into use, whichever occurs first and for the applicable period below:

- SIX (6) CONSECUTIVE MONTHS, for private use or commercial use owners.
- For emission-related components; please also refer to the US EPA EMISSION-RELATED WARRANTY contained herein.
- For evaporative emission-related components of California models equipped with evaporative emission control system produced by BRP for sale in the State of California that are originally sold to a resident or subsequently warranty registered to a resident in the State of California, please also refer to the CALIFORNIA EVAPORATIVE EMISSIONS CONTROL WARRANTY STATEMENT contained herein.

The repair or replacement of parts or the performance of service under this warranty does not extend the life of this warranty beyond its original expiration date.

5) CONDITIONS TO HAVE WARRANTY COVERAGE

This warranty coverage is available only if each of the following conditions has been fulfilled:

- The 2022 Can-Am ATV must be purchased as new and unused by its first owner from a Can-Am ATV dealer authorized to distribute Can-Am ATVs in the country in which the sale occurred ("Can-Am ATV dealer");
- The BRP specified pre-delivery inspection process must be completed and documented and signed by the purchaser;
- The 2022 Can-Am ATV must have undergone proper registration by an authorized Can-Am ATV dealer;
- The 2022 Can-Am ATV must be purchased in the country in which the purchaser resides;
- Routine maintenance outlined in the Operator's Guide must be timely performed in order to maintain warranty coverage. BRP reserves the right to make warranty coverage contingent upon proof of proper maintenance.

BRP will not honor this limited warranty to any private use owner or commercial use owner if one of the preceding conditions has not been met. Such limitations

are necessary in order to allow BRP to preserve both the safety of its products, and also that of its consumers and the general public.

6) WHAT TO DO TO OBTAIN WARRANTY COVERAGE

The customer must cease using the Can-Am ATV upon the appearance of an anomaly.

The customer must notify a servicing BRP dealer within three (3) days of the appearance of a defect, and provide it with reasonable access to the product and reasonable opportunity to repair it.

The customer must also present to the authorized BRP dealer, proof of purchase of the product and must sign the repair/work order prior to starting the repair in order to validate the warranty repair.

All parts replaced under this limited warranty become the property of BRP.

7) WHAT BRP WILL DO

BRP's obligations under this warranty are limited to, at its sole discretion, repairing parts found defective under normal use, maintenance and service, or replacing such parts with new genuine Can-Am ATV parts without charge for parts and labor, at any authorized BRP dealer during the warranty coverage period under the conditions described herein. No claim of breach of warranty shall be cause for cancellation or rescission of the sale of the Can-Am ATV to the owner.

In the event that service is required outside of the country of original sale, the owner will bear responsibility for any additional charges due to local practices and conditions, such as, but not limited to, freight, insurance, taxes, license fees, import duties, and any and all other financial charges, including those levied by governments, states, territories and their respective agencies.

BRP reserves the right to improve or modify products from time to time without assuming any obligation to modify products previously manufactured.

8) ADDITIONAL SUPPLIER WARRANTIES

A GPS receiver may be supplied by BRP as standard equipment on certain 2022 Can-Am ATV's. The GPS receiver is covered under BRP's limited warranty policy. Additional warranty coverage if offered by the GPS receiver "supplier" that is longer than BRP's limited warranty is to be dealt by the dealer or consumer directly with the GPS receiver "supplier".

9) TRANSFER

If the ownership of a product is transferred during the warranty coverage period, this limited warranty, subject to its terms and conditions, shall also be transferred and be valid for the remaining coverage period provided BRP or an authorized Can-Am ATV Distributor/Dealer receives a proof that the former owner agreed to the transfer of ownership, in addition to the coordinates of the new owner.

10) CONSUMER ASSISTANCE

In the event of a controversy or a dispute in connection with this limited warranty, BRP suggests that you try to resolve the issue at the dealership level. We

recommend discussing the issue with the authorized dealer's service manager or owner.

If the matter still remains unresolved, contact BRP by filling out the customer contact form at **www.brp.com** or contact BRP by mail at one of the addresses listed under the CONTACT US section of this guide.

US EPA EMISSION - RELATED WARRANTY

Bombardier Recreational Products Inc. ("BRP") warrants to the ultimate purchaser and each subsequent purchaser that this new vehicle, including all parts of its exhaust emission control system and its evaporative emission control system, meets two conditions:

1. It is designed, built, and equipped so it conforms at the time of sale to the ultimate purchaser with the requirements of 40 CFR 1051 and 40 CFR 1060.
2. It is free from defects in materials and workmanship that may keep it from meeting the requirements of 40 CFR 1051 and 40 CFR 1060.

Where a warrantable condition exists, BRP will repair or replace, as it elects, any part or component with a defect in materials or workmanship that would increase the engine's emissions of any regulated pollutant within the stated warranty period at no cost to the owner, including expenses related to diagnosing and repairing or replacing emission-related parts. All defective parts replaced under this warranty become the property of BRP.

For all emission-related warranty claims, BRP is limiting the diagnosis and repair of emission-related parts to the authorized Can-Am dealers, unless for emergency repairs as required by item 2 of the following list.

As a certifying manufacturer, BRP will not deny emission-related warranty claims based on any of the following:

1. Maintenance or other service BRP or BRP's authorized facilities performed.
2. Engine/equipment repair work that an operator performed to correct an unsafe, emergency condition attributable to BRP as long as the operator tries to restore the engine/equipment to its proper configuration as soon as possible.
3. Any action or inaction by the operator unrelated to the warranty claim.
4. Maintenance that was performed more frequently than BRP specify.
5. Anything that is BRP fault or responsibility.
6. The use of any fuel that is commonly available where the equipment operates unless BRP written maintenance instructions state that this fuel would harm the equipment's emission control system and operators can readily find the proper fuel. See maintenance information section and fuel requirements of fueling section.

Emission-Related Warranty Period

The emission-related warranty is valid for the following period whichever comes

	HOURS	MONTHS	KILOMETERS
Exhaust emission-related components	500	30	5000
Evaporative emission-related components	N/A	24	N/A

Components Covered

The emission-related warranty covers all components whose failure would increase an engine's emissions of any regulated pollutant, including the following listed components:

1. For exhaust emissions, emission-related components include any engine parts related to the following systems:
 - Air-induction system
 - Fuel system
 - Ignition system
 - Exhaust gas recirculation systems.
2. The following parts are also considered emission-related components for exhaust emissions:
 - After treatment devices
 - Crankcase ventilation valves
 - Sensors
 - Electronic control units.
3. The following parts are considered emission-related components for evaporative emissions:
 - Fuel tank
 - Fuel cap
 - Fuel line
 - Fuel line fittings
 - Clamps*
 - Pressure relief valves*
 - Control valves*
 - Control solenoids*
 - Electronic controls*
 - Vacuum control diaphragms*
 - Control cables*
 - Control linkages*
 - Purge valves
 - Vapor hoses
 - Liquid/vapor separator
 - Carbon canister
 - Canister mounting brackets
 - Carburetor purge port connector.

NOTE: *As related to the evaporative emission control system.

4. Emission-related components also include any other part whose only purpose is to reduce emissions or whose failure will increase emissions without significantly degrading engine/equipment performance.

Limited Applicability

As a certifying manufacturer, BRP may deny emission-related warranty claims for failures that have been caused by the owner's or operator's improper maintenance or use, by accidents for which the manufacturer has no responsibility, or by acts of God. For example, an emission-related warranty claim need not be honored for failures that have been directly caused by the operator's abuse of the engine/equipment or the operator's use of the engine/equipment in a manner for which it was not designed and are not attributable to the manufacturer in anyway.

If you have any question regarding your warranty rights and responsibility or for the name and location of the nearest authorized BRP dealer, you should contact BRP by filling out the customer contact form at www.brp.com or contact BRP by mail at one of the addresses listed under the CONTACT US section of this guide, or call at 1-888-272-9222.

CALIFORNIA EVAPORATIVE EMISSIONS CONTROL WARRANTY STATEMENT

The warranty periods begin on the date the new Off-Highway Recreational Vehicle ("OHRV") is delivered to an ultimate purchaser.

Bombardier Recreational Products Inc. ("BRP") warrants to the ultimate purchaser and each subsequent purchaser that the OHRV is:

1. Designed, built, and equipped so as to conform, at the time of sale, with all applicable laws, rules and regulations; and
2. Free from defects in materials and workmanship that may cause the failure of a warranted part. All replacement parts must be identical in all material respects to that part as described in BRP's Executive Order of Certification application.

The warranty on emissions-related parts function as follows:

1. Repair or replacement of any warranted part must be performed at no charge to the OHRV owner, at a warranty station, except in the case of a temporary repair when a warranted part or a warranty station is not reasonably available to the OHRV owner. In the event a temporary repair is permitted, repairs may be performed at any available service establishment, or by the owner, using any replacement part. BRP must reimburse the owner for his or her expenses including diagnostic charges for such temporary repair or replacement, not to exceed BRP's suggested retail price for all warranted parts replaced and labor charges based on BRP's recommended time allowance for the warranty repair and the geographically appropriate hourly labor rate.
2. The lack of availability of warranted parts or the incompleteness of repairs within a reasonable time period, not to exceed 30 days from the time the OHRV is initially presented to the warranty station for repair, will qualify the need for a temporary repair.
3. Any warranted part which is not scheduled for replacement as part of maintenance in the written instructions must be warranted for the warranty period defined below. If any such part fails during the warranty period, it must be repaired or replaced by BRP. Any such part repaired or replaced under warranty must be fully warranted.
4. Any warranted part which is scheduled only for regular inspection in the written instructions must be warranted for the warranty period defined below. A statement in such written instructions to the effect of "repair or replace as necessary" does not reduce the period of warranty coverage. Any such part repaired or replaced under warranty is warranted for the remaining warranty period.
5. Any warranted part which is scheduled for replacement as part of maintenance in the written instructions is warranted for the period of time prior to the first scheduled replacement point for that part. If the part fails before the first scheduled replacement point, the part will be repaired or replaced by BRP. Any such part repaired or replaced under warranty is warranted for the remainder of the period prior to the first scheduled replacement point for the part.
6. Warranty services or repairs are provided at all manufacturer dealerships that are owned by the manufacturer or franchised to service the subject OHRVs.
7. The OHRV owner will not be charged for diagnostic labor which leads to the determination that a warranted part is, in fact, defective, provided that such diagnostic work is performed at a warranty station.

8. BRP is liable for damages to other vehicle components proximately caused by a failure, under warranty, of any warranted part.
9. Any replacement part designated by BRP may be used in warranty repairs provided without charge to the OHRV owner. Such use will not reduce the warranty obligations of BRP, except that BRP will not be liable for repair or replacement of any replacement part which is not a warranted part.
10. Any add-on or modified part exempted by the Air Resources Board from the prohibitions of section 27156 of the California Vehicle Code may be used on an OHRV. Such use, in and of itself, will not be grounds for disallowing a warranty claim. BRP is not liable to warrant failures of warranted parts caused by the use of an add-on or modified part (s) unless such part (s) are also warranted.

Conditions and exclusions:

- BRP may deny you warranty coverage if your OHRV or a part has failed directly due to abuse, neglect, improper maintenance or unapproved modifications.

Your Warranty Rights And Obligations

The California Air Resources Board is pleased to explain the evaporative emissions control system warranty on your 2022 All-Terrain Vehicle. In California, new off-highway recreational vehicles must be designed, built, and equipped to meet the State's stringent anti-smog standards. BRP must warrant the evaporative emissions control system on your All-Terrain Vehicle for the periods of time listed below provided there has been no abuse, neglect, improper maintenance, or unapproved modification of your All-Terrain Vehicle.

Your evaporative emissions control system may include parts such as the carburetor or fuel-injection system, fuel tank, fuel hoses, carbon canister, and engine computer. Also included may be hoses, belts, connectors and other evaporative emissions-related assemblies. Where a warrantable condition exists, Bombardier Recreational Products Inc. will repair your All-Terrain Vehicle at no cost to you including diagnosis, parts and labor.

OHRV Manufacturer's Warranty Coverage

The warranty period for this OHRV is 60 months, or 5000 miles, or 500 hours, whichever comes first.

Parts covered:

1. Canister Mounting Bracket(s)
2. Carbon Canister
3. Purge Port Connector
4. Clamp(s)*
5. Electronic Control*
6. Fuel Cap
7. Filler Neck
8. Filler Neck Hose
9. Fuel Line(s)
10. Fuel Line Fitting(s)
11. Fuel Tank
12. Pressure Relief Valve(s)*

13. Purge Valve(s)
14. Check Valve(s)*
15. Vapor Hose(s)
16. Flow Reducer
17. Filter(s)*
18. All other parts not listed that may affect the evaporative emissions control system

NOTE: *As related to the evaporative emission control system.

If any evaporative emissions-related part on your All-Terrain Vehicle is defective the part will be repaired or replaced by Bombardier Recreational Products Inc.

Owner's Warranty Responsibilities

As the All-Terrain Vehicle owner, you are responsible for the performance of the required maintenance listed in your owner's manual. Bombardier Recreational Products Inc. recommends that you retain all receipts covering maintenance on your All-Terrain Vehicle, but Bombardier Recreational Products Inc. cannot deny warranty solely for the lack of receipts or for failure to ensure the performance of a scheduled maintenance.

As an owner you are responsible for presenting your All-Terrain Vehicle to a Bombardier Recreational Products Inc. dealer as soon as a problem exists. The warranty repairs should be completed in a reasonable time, not to exceed 30 days.

As an All-Terrain Vehicle owner, you should also be aware that Bombardier Recreational Products Inc. may deny you warranty coverage if your All-Terrain Vehicle or a part has failed due to abuse, neglect, improper maintenance or unapproved modifications.

If you have any questions regarding your warranty rights and responsibilities, you should contact:

- Bombardier Recreational Products Inc. at 1-888-272-9222 or,
- The California Air Resources Board at 9528 Telstar Avenue, El Monte, CA 91731.

BRP INTERNATIONAL LIMITED WARRANTY: 2022 CAN-AM® ATV

1) SCOPE OF THE LIMITED WARRANTY

Bombardier Recreational Products Inc. ("BRP") warrants its 2022 Can-Am ATV sold by Can-Am ATV distributors or dealers authorized by BRP to distribute Can-Am ATVs ("Can-Am ATV Distributor/Dealer") outside of the United States of America ("USA"), Canada, member states of the European Economic Area (which is comprised of the member states of the European Union plus the United Kingdom, Norway, Iceland and Liechtenstein) ("EEA"), Turkey, member states of the Commonwealth of the Independent States (including Ukraine and Turkmenistan) ("CIS") and Turkey, from defects in material or workmanship for the period and under the conditions described below.

Non-factory installed parts and accessories are not covered under this limited warranty.

Please refer to the applicable parts and accessories limited warranty text.

This limited warranty will become null and void if: (1) The ATV was used for racing or any other competitive activity, at any point, even by a previous owner; or (2) the ATV has been altered or modified in such a way so as to adversely affect its operation, performance or durability, or has been altered or modified to change its intended use.

2) LIMITATIONS OF LIABILITY

TO THE EXTENT PERMITTED BY LAW, THIS WARRANTY IS EXPRESSLY GIVEN AND ACCEPTED IN LIEU OF ANY AND ALL OTHER WARRANTIES, EXPRESSED OR IMPLIED, INCLUDING WITHOUT LIMITATION ANY WARRANTY OF MERCHANTABILITY OR FITNESS FOR A PARTICULAR PURPOSE. TO THE EXTENT THAT THEY CANNOT BE DISCLAIMED, THE IMPLIED WARRANTIES ARE LIMITED IN DURATION TO THE LIFE OF THE EXPRESS WARRANTY. INCIDENTAL AND CONSEQUENTIAL DAMAGES ARE EXCLUDED FROM COVERAGE UNDER THIS WARRANTY. SOME JURISDICTIONS DO NOT ALLOW FOR THE DISCLAIMERS, LIMITATIONS AND EXCLUSIONS IDENTIFIED ABOVE, AS A RESULT, THEY MAY NOT APPLY TO YOU. THIS WARRANTY GIVES YOU SPECIFIC RIGHTS AND YOU MAY ALSO HAVE OTHER LEGAL RIGHTS WHICH MAY VARY FROM COUNTRY TO COUNTRY. (FOR PRODUCTS PURCHASED IN AUSTRALIA SEE CLAUSE 4 BELOW).

Neither the Can-Am ATV Distributor/Dealer nor any other person has been authorized to make any affirmation, representation or warranty regarding the product, other than those contained in this limited warranty, and if made, shall not be enforceable against BRP.

BRP reserves the right to modify this warranty at any time, being understood that such modification will not alter the warranty conditions applicable to the products sold while this warranty is in effect.

3) EXCLUSIONS – ARE NOT WARRANTED

The following are not warranted under this limited warranty under any circumstances:

- Normal wear and tear;
- Routine maintenance items, tune ups, adjustments;
- Damage caused by negligence or failure to provide proper maintenance and/or storage, as described in the Operator's Guide;
- Damage resulting from removal of parts, improper repairs, service, maintenance, modifications or use of parts or accessories not manufactured or approved by BRP which in its reasonable judgement are either incompatible with the product or adversely affect its operation, performance and durability, or resulting from repairs done by a person that is not an authorized servicing Can-Am ATV Distributor/Dealer;
- Damage caused by abuse, abnormal use, neglect, racing or operation of the product in a manner inconsistent with the recommended operation described in the Operator's Guide;
- Damage resulting from accident, submersion, fire, snow or water ingestion, theft, vandalism or any act of God;
- Operation with fuels, oils or lubricants which are not suitable for use with the product (see the Operator's Guide);
- Damage resulting from rust, corrosion or exposure to the elements;
- Incidental or consequential damages, or damages of any kind including without limitation towing, storage, transportation expenses, telephone, rental, taxi, inconvenience, insurance coverage, loan payments, loss of time, loss of income; or time missed for downtime experience due to service work.

4) WARRANTY COVERAGE PERIOD

This warranty will be in effect from (1) the date of delivery to the first retail consumer or (2) the date the product is first put into use, whichever occurs first and for a period of:

- SIX (6) CONSECUTIVE MONTHS for private use or commercial use.

In AUSTRALIA and NEW-ZEALAND only, this warranty will be in effect from (1) the date of delivery to the first retail consumer or (2) the date the product is first put into use, whichever occurs first, and for a period of (1) TWENTY-FOUR (24) CONSECUTIVE MONTHS or (2) a total use of FIFTEEN THOUSAND (15 000) kilometers, whichever occurs first, for private use or commercial use.

The repair or replacement of parts or the performance of service under this warranty does not extend the life of this warranty beyond its original expiration date.

Note that the duration and any other modalities of the warranty coverage are subject to the applicable national or local legislation in the customer's country.

FOR PRODUCTS SOLD IN AUSTRALIA ONLY

Nothing in these Warranty terms and conditions should be taken to exclude, restrict or modify the application of any condition, warranty, guarantee, right or remedy conferred or implied under the Competition and Consumer Act 2010 (Cth), including the Australian Consumer Law or any other law, where to do so would contravene that law, or cause any part of these terms and conditions to be void. The benefits given to you under this limited warranty are in addition to other rights and remedies that you have under Australian law.

Our goods come with guarantees that cannot be excluded under the Australian Consumer Law. You are entitled to a replacement or refund for a major failure

and for compensation for any other reasonably foreseeable loss or damage. You are also entitled to have the goods repaired or replaced if the goods fail to be of acceptable quality and the failure does not amount to a major failure.

5) CONDITIONS TO HAVE WARRANTY COVERAGE

This warranty coverage is available only if each of the following conditions has been fulfilled:

- The 2022 Can-Am ATV must be purchased as new and unused by its first owner from a Can-Am ATV Distributor/Dealer authorized to distribute Can-Am ATVs in the country in which the sale occurred;
- The BRP specified pre-delivery inspection process must be completed and documented;
- The product must have undergone proper registration by an authorized Can-Am ATV Distributor/Dealer;
- The 2022 Can-Am ATV must be purchased in the country or union of countries in which the purchaser resides; and
- Routine maintenance outlined in the Operator's Guide must be timely performed in order to maintain warranty coverage. BRP reserves the right to make warranty coverage contingent upon proof of proper maintenance.

BRP will not honour this limited warranty to any private use owner or commercial use owner if one of the preceding conditions has not been met. Such limitations are necessary in order to allow BRP to preserve both the safety of its products, and also that of its consumers and the general public.

6) WHAT TO DO TO OBTAIN WARRANTY COVERAGE

The customer must cease using the ATV upon the appearance of an anomaly. The customer must notify a servicing Can-Am ATV Distributor/Dealer within two (2) days of the appearance of a defect, and provide it with reasonable access to the product and reasonable opportunity to repair it. The customer must also present to the authorized Can-Am ATV Distributor/Dealer proof of purchase of the product and must sign the repair/work order prior to starting the repair in order to validate the warranty repair. All parts replaced under this limited warranty become the property of BRP.

Note that the notification period is subject to the applicable national or local legislation in customer's country.

7) WHAT BRP WILL DO

To the extent permitted by law, BRP's obligations under this warranty are limited to, at its sole discretion, repairing parts found defective under normal use, maintenance and service, or replacing such parts with new genuine Can-Am ATV parts without charge for parts and labour, at any authorized Can-Am ATV Distributor/Dealer during the warranty coverage period under the conditions described herein. BRP's responsibility is limited to making the required repairs or replacements of parts. No claim of breach of warranty shall be cause for cancellation or rescission of the sale of the Can-Am ATV to the owner. You may have other legal rights which may vary from country to country.

In the event that service is required outside of the country of original sale, the owner will bear responsibility for any additional charges due to local practices and conditions, such as, but not limited to, freight, insurance, taxes, license fees, import duties, and any and all other financial charges, including those levied by governments, states, territories and their respective agencies.

BRP reserves the right to improve or modify products from time to time without assuming any obligation to modify products previously manufactured.

8) TRANSFER

If the ownership of a product is transferred during the warranty coverage period, this warranty shall also be transferred and be valid for the remaining coverage period provided BRP or an authorized Can-Am ATV Distributor/Dealer receives a proof that the former owner agreed to the transfer of ownership, in addition to the coordinates of the new owner.

9) CONSUMER ASSISTANCE

In the event of a controversy or a dispute in connection with this limited warranty, BRP suggests that you try to resolve the issue at the Can-Am ATV Distributor/Dealer level. We recommend discussing the issue with the authorized Can-Am ATV Distributor/Dealer's service manager or owner.

If the matter still remains unresolved, contact BRP by filling out the customer contact form at **www.brp.com** or contact BRP by mail at one of the addresses listed under the CONTACT US section of this guide.

BRP LIMITED WARRANTY FOR THE EUROPEAN ECONOMIC AREAS, THE COMMONWEALTH OF THE INDEPENDENT STATES AND TURKEY: 2022 CAN-AM® ATV

1) SCOPE OF THE LIMITED WARRANTY

Bombardier Recreational Products Inc. ("BRP") warrants its 2022 Can-Am ATVs sold by distributors or dealers authorized by BRP to distribute Can-Am ATVs ("Can-Am ATV Distributor/Dealer") in member states of the European Economic Area (which is comprised of the member states of the European Union plus the United Kingdom, Norway, Iceland and Liechtenstein) ("EEA"), in member states of the Commonwealth of the Independent States (including Ukraine and Turkmenistan) ("CIS") and Turkey from defects in material or workmanship for the period and under the conditions described below.

Non-factory installed parts and accessories are not covered under this limited warranty.

Please refer to the applicable parts and accessories limited warranty text.

This limited warranty will become null and void if: (1) The ATV was used for racing or any other competitive activity, at any point, even by a previous owner; or (2) the ATV has been altered or modified in such a way so as to adversely affect its operation, performance or durability, or has been altered or modified to change its intended use.

2) LIMITATIONS OF LIABILITY

TO THE EXTENT PERMITTED BY LAW, THIS WARRANTY IS EXPRESSLY GIVEN AND ACCEPTED IN LIEU OF ANY AND ALL OTHER WARRANTIES, EXPRESSED OR IMPLIED, INCLUDING WITHOUT LIMITATION ANY WARRANTY OF MERCHANTABILITY OR FITNESS FOR A PARTICULAR PURPOSE. TO THE EXTENT THAT THEY CANNOT BE DISCLAIMED, THE IMPLIED WARRANTIES ARE LIMITED IN DURATION TO THE LIFE OF THE EXPRESS WARRANTY. INCIDENTAL AND CONSEQUENTIAL DAMAGES ARE EXCLUDED FROM COVERAGE UNDER THIS WARRANTY. SOME JURISDICTIONS DO NOT ALLOW FOR THE DISCLAIMERS, LIMITATIONS AND EXCLUSIONS IDENTIFIED ABOVE, AS A RESULT, THEY MAY NOT APPLY TO YOU. THIS WARRANTY GIVES YOU SPECIFIC RIGHTS AND YOU MAY ALSO HAVE OTHER LEGAL RIGHTS WHICH MAY VARY FROM COUNTRY TO COUNTRY.

Neither the Can-Am ATV Distributor/Dealer nor any other person has been authorized to make any affirmation, representation or warranty regarding the product, other than those contained in this limited warranty, and if made, shall not be enforceable against BRP.

BRP reserves the right to modify this warranty at any time, being understood that such modification will not alter the warranty conditions applicable to the products sold while this warranty is in effect.

3) EXCLUSIONS – ARE NOT WARRANTED

The following are not warranted under this limited warranty under any circumstances:

- Normal wear and tear;
- Routine maintenance items, tune ups, adjustments;
- Damage caused by negligence or failure to provide proper maintenance and/or storage, as described in the Operator's Guide;
- Damage resulting from removal of parts, improper repairs, service, maintenance, modifications or use of parts or accessories not manufactured or approved by BRP which in its reasonable judgement are either incompatible with the product or adversely affect its operation, performance and durability, or resulting from repairs done by a person that is not an authorized servicing Can-Am ATV Distributor/Dealer;
- Damage caused by abuse, abnormal use, neglect, racing or operation of the product in a manner inconsistent with the recommended operation described in the Operator's Guide;
- Damage resulting from accident, submersion, fire, snow or water ingestion, theft, vandalism or any act of God;
- Operation with fuels, oils or lubricants which are not suitable for use with the product (see the Operator's Guide);
- Damage resulting from rust, corrosion or exposure to the elements;
- Incidental or consequential damages, or damages of any kind including without limitation towing, transportation expenses, storage, telephone, rental, taxi, inconvenience, insurance coverage, loan payments, loss of time, loss of income or time missed for downtime experience due to service work.

4) WARRANTY COVERAGE PERIOD

This warranty will be in effect from (1) the date of delivery to the first retail consumer or (2) the date the product is first put into use, whichever occurs first and for a period of:

1. TWENTY-FOUR (24) CONSECUTIVE MONTHS for private use.
2. SIX (6) CONSECUTIVE MONTHS for commercial use or rental use.

The product is used commercially when it is used in connection with any work or employment that generates income during any part of the warranty period. The product is also used commercially when, at any point during the warranty period, it is licensed for commercial use.

The repair or replacement of parts or the performance of service under this warranty does not extend the life of this warranty beyond its original expiration date.

Note that the duration and any other modalities of the warranty coverage are subject to the applicable national or local legislation in the customer's country.

5) CONDITIONS TO HAVE WARRANTY COVERAGE

This warranty coverage is available only if each of the following conditions has been fulfilled:

- The 2022 Can-Am ATV must be purchased as new and unused by its first owner from a Can-Am ATV Distributor/Dealer authorized to distribute Can-Am ATVs in the country in which the sale occurred;
- The BRP specified pre-delivery inspection process must be completed and documented;
- The product must have undergone proper registration by an authorized Can-Am ATV Distributor/Dealer;

- The 2022 Can-Am ATV must be purchased within the EEA by an EEA resident, in the CIS for residents of the countries comprised in such area and in Turkey for residents of Turkey; and
- Routine maintenance outlined in the Operator's Guide must be timely performed in order to maintain warranty coverage. BRP reserves the right to make warranty coverage contingent upon proof of proper maintenance.

BRP will not honour this limited warranty to any private use owner or commercial use owner if one of the preceding conditions has not been met. Such limitations are necessary in order to allow BRP to preserve both the safety of its products, and also that of its consumers and the general public.

6) WHAT TO DO TO OBTAIN WARRANTY COVERAGE

The customer must cease using the ATV upon the appearance of an anomaly. The customer must notify a servicing Can-Am ATV Distributor/Dealer within two (2) months of the appearance of a defect and provide it with reasonable access to the product and reasonable opportunity to repair it. The customer must also present to the authorized Can-Am ATV Distributor/Dealer, proof of purchase of the product and must sign the repair/work order prior to starting the repair in order to validate the warranty repair. All parts replaced under this limited warranty become the property of BRP.

Note that the notification period is subject to the applicable national or local legislation in customer's country.

7) WHAT BRP WILL DO

To the extent permitted by law, BRP's obligations under this warranty are limited to, at its sole discretion, repairing parts found defective under normal use, maintenance and service, or replacing such parts with new genuine Can-Am ATV parts without charge for parts and labour, at any authorized Can-Am ATV Distributor/Dealer during the warranty coverage period under the conditions described herein. BRP's responsibility is limited to making the required repairs or replacements of parts. No claim of breach of warranty shall be cause for cancellation or rescission of the sale of the Can-Am ATV to the owner. You may have other legal rights which may vary from country to country.

In the event that service is required outside of the EEA, CIS or Turkey, the owner will bear responsibility for any additional charges due to local practices and conditions, such as, but not limited to, freight, insurance, taxes, license fees, import duties, and any and all other financial charges, including those levied by governments, states, territories and their respective agencies.

BRP reserves the right to improve or modify products from time to time without assuming any obligation to modify products previously manufactured.

8) TRANSFER

If the ownership of a product is transferred during the warranty coverage period, this warranty shall also be transferred and be valid for the remaining coverage period provided BRP or an authorized Can-Am ATV Distributor/Dealer receives a proof that the former owner agreed to the transfer of ownership, in addition to the coordinates of the new owner.

9) CONSUMER ASSISTANCE

In the event of a controversy or a dispute in connection with this limited warranty, BRP suggests that you try to resolve the issue at the Can-Am ATV Distributor/Dealer level. We recommend discussing the issue with the authorized Can-Am ATV Distributor/Dealer's service manager or owner.

If the matter still remains unresolved, contact BRP by filling out the customer contact form at www.brp.com or contact BRP by mail at one of the addresses listed under the CONTACT US section of this guide.

10) ADDITIONAL TERMS AND CONDITIONS FOR FRANCE

The following terms and conditions are applicable to products sold in France only.

The seller shall deliver goods that are complying with the contract and shall be responsible for defects existing upon delivery. The seller shall also be responsible for defects resulting from packaging, assembling instructions or the installation when it is its responsibility per the contract or if accomplished under its responsibility. To be compliant with the contract, the good shall:

1. Be fit for normal use for goods similar thereto and, if applicable:
 - Correspond to the description provided by the seller and have the qualities presented to the buyer through sample or model;
 - Have the qualities that a buyer may legitimately expect considering the public declarations of the seller, the manufacturer of its representative, including in advertising or labeling; or
2. Have the characteristics mutually agreed upon as between the parties or be fit for the specific use intended by the buyer and brought to the attention of the seller and which accepted by the seller.

The action for failure to comply is prescribed after two years after delivery of the goods. The seller is responsible for the warranty for hidden defects of the good sold if such hidden defects are rendering the good unfit for the intended use, or if they diminish its use in such a way that the buyer would not have acquired the good or would have given a lesser price, had he known. The action for such hidden defects shall be taken by the buyer within 2 years of the discovery of the defect.

MAINTENANCE RECORDS

Send photocopy of maintenance record to BRP if needed.

Pre-delivery	
Serial number: _____ Mileage / km: _____ Hours: _____ Date: _____ Dealer no: _____ Notes: _____ _____	Signature/Print: _____
Refer to vehicle Pre-Delivery Bulletin for detailed installation procedures	

FIRST inspection	
Mileage / km: _____ Hours: _____ Date: _____ Dealer no: _____ Notes: _____ _____	Signature/Print: _____
For maintenance schedule refer to Maintenance Information section of this operator's guide	

Service	
Mileage / km: _____ Hours: _____ Date: _____ Dealer no: _____ Notes: _____ _____	Signature/Print: _____
For maintenance schedule refer to Maintenance Information section of this operator's guide	

Service	
Mileage / km: _____ Hours: _____ Date: _____ Dealer no: _____ Notes: _____ _____	Signature/Print: _____
For maintenance schedule refer to Maintenance Information section of this operator's guide	

Service	
Mileage / km: _____ Hours: _____ Date: _____ Dealer no: _____ Notes: _____ _____	Signature/Print: _____
For maintenance schedule refer to Maintenance Information section of this operator's guide	

Service	
Mileage / km: _____ Hours: _____ Date: _____ Dealer no: _____ Notes: _____ _____	Signature/Print: _____
For maintenance schedule refer to Maintenance Information section of this operator's guide	

Service

Mileage / km: _____

Hours: _____

Date: _____

Dealer no: _____

Notes: _____

Signature/Print: _____

For maintenance schedule refer to Maintenance Information section of this operator's guide

Service

Mileage / km: _____

Hours: _____

Date: _____

Dealer no: _____

Notes: _____

Signature/Print: _____

For maintenance schedule refer to Maintenance Information section of this operator's guide

Service

Mileage / km: _____

Hours: _____

Date: _____

Dealer no: _____

Notes: _____

Signature/Print: _____

For maintenance schedule refer to Maintenance Information section of this operator's guide

Service	
Mileage / km: _____ Hours: _____ Date: _____ Dealer no: _____ Notes: _____ _____	Signature/Print: _____
For maintenance schedule refer to Maintenance Information section of this operator's guide	

Service	
Mileage / km: _____ Hours: _____ Date: _____ Dealer no: _____ Notes: _____ _____	Signature/Print: _____
For maintenance schedule refer to Maintenance Information section of this operator's guide	

Service	
Mileage / km: _____ Hours: _____ Date: _____ Dealer no: _____ Notes: _____ _____	Signature/Print: _____
For maintenance schedule refer to Maintenance Information section of this operator's guide	

Service

Mileage / km: _____

Hours: _____

Date: _____

Dealer no: _____

Notes: _____

Signature/Print: _____

For maintenance schedule refer to Maintenance Information section of this operator's guide

Service

Mileage / km: _____

Hours: _____

Date: _____

Dealer no: _____

Notes: _____

Signature/Print: _____

For maintenance schedule refer to Maintenance Information section of this operator's guide

Service

Mileage / km: _____

Hours: _____

Date: _____

Dealer no: _____

Notes: _____

Signature/Print: _____

For maintenance schedule refer to Maintenance Information section of this operator's guide

CUSTOMER INFORMATION

PRIVACY INFORMATION

BRP wishes to inform you that your coordinates will be used for safety and warranty related purposes. Furthermore, BRP and its affiliates may use its customer list to distribute marketing and promotional information about BRP and related products.

To exercise your right to consult or correct your data, or to be removed from the addressee-list for direct marketing, please contact BRP.

By E-mail:
privacyofficer@brp.com

By mail:
BRP Legal Service
726 St-Joseph
Valcourt QC
Canada
J0E 2L0

CONTACT US

www.brp.com

Asia

Room 4609, Tower 2,
Grand Gateway 3 Hong Qiao
Road Shanghai,
China 200020

21F Shinagawa East One Tower
2-16-1 Konan, Minatoku-ku,
Tokyo 108-0075
Japan

Europe

Oktrooiplein 1/402
9000 Gent
Belgium

Itterpark 11
D-40724 Hilden
Germany

ARTEPARC Bâtiment B
Route de la côte d'Azur, Le Canet
13590 Meyreuil
France

Ingvold Ystgaardsvei 15
N-7484 Trondheim
Norway

Isoaavantie 7
PL 8040
96101 Rovaniemi

Spinnvägen 15
903 61 Umeå
Sweden

Avenue d'Ouchy 4-6
1006 Lausanne
Switzerland

North America

565 de la Montagne Street
Valcourt (Québec) J0E 2L0
Canada

Sa De Cv, Av. Ferrocarril 202
Parque Ind. Querétaro, Lote2-B
76220
Santa Rosa Jáuregui, Qro., Mexico

Sturtevant, Wisconsin, U.S.A.

10101 Science Drive
Sturtevant, Wisconsin
53177
U.S.A.

Oceania

6 Lord Street
Lakes Business Park
Botany, NSW 2019
Australia

3B Echelon Place, East Tamaki,
Auckland 2013,
New Zealand

South America

Rua James Clerck Maxwell, 230
TechnoPark Campinas SP 13069-380
Brazil

CHANGE OF ADDRESS AND OWNERSHIP

If your address has changed or if you are the new owner of the vehicle, be sure to notify BRP by either:

- Notifying an authorized Can-Am dealer.
- **North America Only:** calling at 1 888 272-9222.
- Mailing one of the change of address cards on the following pages at one of the BRP addresses indicated in the *Contact Us* section of this guide.

In case of change of ownership, please join a proof that the former owner agreed to the transfer.

Notifying BRP, even after the expiration of the limited warranty, is very important as it enables BRP to reach the vehicle owner if necessary, like when safety recalls are initiated. It is the owner's responsibility to notify BRP.

STOLEN UNITS: If your personal vehicle is stolen, you should notify BRP or an authorized Can-Am dealer. We will ask you to provide your name, address, phone number, the vehicle identification number and the date it was stolen.

This page is
intentionally blank

This page is
intentionally blank

NOTE: _____

Model No. _____

VEHICLE

IDENTIFICATION NUMBER (V.I.N.) _____

ENGINE

IDENTIFICATION NUMBER (E.I.N.) _____

Owner: _____

NAME

No.

STREET

APT

CITY

STATE/PROVINCE

ZIP/POSTAL CODE

Purchase Date _____

YEAR

MONTH

DAY

Warranty Expiry Date _____

YEAR

MONTH

DAY

To be completed by the dealer at the time of the sale.

DEALER IMPRINT AREA

WARNING

THIS VEHICLE CAN BE HAZARDOUS TO OPERATE. A collision or rollover can occur quickly, even during routine maneuvers such as turning and driving on hills or over obstacles, if you fail to take proper precautions.

SEVERE INJURY OR DEATH can result if you do not follow these instructions:

- BEFORE YOU OPERATE THIS VEHICLE, READ THIS OPERATOR'S GUIDE, ALL ON PRODUCT SAFETY LABELS AND WATCH THE SAFETY VIDEO.



- NEVER OPERATE THIS VEHICLE WITHOUT PROPER INSTRUCTIONS. Complete a certified training course.
- DO NOT EXCEED VEHICLE SEATING CAPACITY
- FOR 1 UP MODELS, NEVER CARRY A PASSENGER. You increase your risk of losing control if you carry a passenger.

- NEVER OPERATE THIS VEHICLE ON A PAVED SURFACE. You increase your risk of losing control if you operate this vehicle on pavement.
- NEVER OPERATE THIS VEHICLE ON PUBLIC ROADS. You can collide with another vehicle if you operate this vehicle on a public road.
- OPERATOR AND PASSENGER (MAX models) SHOULD ALWAYS WEAR AN APPROVED HELMET, eye protection, and protective clothing.
- NEVER USE WITH DRUGS OR ALCOHOL. They slow reaction time and impair judgment.
- NEVER OPERATE THIS VEHICLE AT EXCESSIVE SPEEDS. You increase your risk of losing control if you operate this vehicle at speeds too fast for the terrain, visibility conditions, or your experience.
- NEVER ATTEMPT WHEELIES, JUMPS, OR OTHER STUNTS.

®TM AND THE BRP LOGO ARE TRADEMARKS OF BOMBARDIER RECREATIONAL PRODUCTS INC. OR ITS AFFILIATES.

©2021 BOMBARDIER RECREATIONAL PRODUCTS INC. ALL RIGHTS RESERVED.

www.brp.com

SKI-DOO®
LYNX®

SEA-DOO®
EVINRUDE®

CAN-AM®
ROTAX®