

SEA·DOO®



2008

Sport Boats
OPERATOR'S GUIDE
Includes SAFETY, VEHICLE
and MAINTENANCE INFORMATION

180 CHALLENGER* 180 CHALLENGER*SE

⚠ WARNING

Read this guide thoroughly. It contains important safety information.
Minimum recommended operator's age: 16 years old.
Do not remove this *Operator's Guide* from the boat.

2 0 4 6 3 0 3 6 7

SAFETY WARNING

Disregarding any of the safety precautions and instructions contained in this Operator's Guide, the *SAFETY VIDEO* and the on-product warning labels could cause injury, including the possibility of death. The operator has the responsibility to inform passenger(s) of safety precautions.

This Operator's Guide and *SAFETY VIDEO* should remain with the boat at the time of resale.



CHALLENGER*

* Trademark of Bombardier Inc. used under license.

The following trademarks are the property of Bombardier Recreational Products Inc. or its affiliates.

Sea-Doo®

ROTAX™

DOIN'IT ON YOUR NEW SEA-DOO SPORT BOATS

Congratulations, you are now the proud owner of a Sea-Doo Sport Boats. Whether you are an experienced boater or are new to the sport of boating, we ask you to take the time to view the *SAFETY VIDEO* provided with the boat, to read this Operator's Guide on-product warning/caution labels and familiarize yourself with the contents. This guide contains pertinent information which, if followed, will provide you with the necessary knowledge to help you fully enjoy the pleasures of this boat.

We strongly recommend that any boat operator complete a safety boating course. Check with your local Coast Guard or Power and Sail Squadron in your area for course availability. More serious boaters may want to obtain *CHAPMAN PILOTING* by Elbert S. Maloney, available at most book stores.

When introducing your family or friends to the sport, be sure they fully understand the controls and operation of the boat and the importance of courteous, responsible riding.

Each boat operator has a responsibility to ensure the safety of his/her passenger(s) and of other water users. Please follow all safety instructions and operate your boat with care.

We encourage you to have an Annual Safety Inspection of your boat. Please contact your authorized Sea-Doo Sport Boats dealer for further details.

Finally, we invite you to visit your authorized Sea-Doo Sport Boats dealer for regular safety maintenance as well as any boating accessories you may require.

Have fun and... Bon Voyage.

Please keep this guide on board. This guide should remain with the boat at time of resale.

If you want to view and/or print an extra copy of your Operator's Guide, simply visit the following website www.operatorsguide.brp.com. Also note that the guide is available in several languages.

TABLE OF CONTENTS

FOREWORD	7
----------------	---

SAFETY INFORMATION

GENERAL	10
TRAILERING	11
SAFE BOATING CHECKLIST	12
SAFETY EQUIPMENT	15
CARBON MONOXIDE AND BOATING	21
SAFETY LANYARD	25
SAFE BOATING PRACTICES	26
PASSENGER SAFETY	27
RULES OF THE ROAD	28
FUELING PROCEDURE	31
VOLUNTARY INSPECTIONS	32
SAFE BOATING COURSES	33
WATER SPORTS	34

VEHICLE INFORMATION

REGISTRATION NUMBER LOCATION	38
LOCATION OF THE IMPORTANT LABELS	39
IDENTIFICATION NUMBERS	43
CONTROLS, COMPONENTS AND INSTRUMENTS	44
Overview	44
1) DESS™ Post (engine cut-out switch)	48
2) Steering Wheel	48
3) Throttle/Shifter Controller	49
4) Start/Stop Switch	50
5) Navigation Lights Switch	50
6) Bilge Pump Switch	51
7) Bilge Air Blower Switch	51
8) Information Center Gauge	52
9) Bilge Drain Plugs	54
10) Grab Handles	54
11) Rear Grab Handles	54
12) Swim Platform	54
13) Ladder	55
14) Seats	55
15) Cup Holders	55
16) Deck Storage Compartment	55

17) Rear Storage Compartment	56
18) Jet Pump Water Intake	57
19) Bow Lights	57
20) Stern Light Socket.....	57
21) Mooring Cleats	58
22) Deck	58
23) Fuel Tank Cap	58
24) Deck Drain	59
25) Engine Oil Filling Cap	59
26) Flushing Connector.....	59
27) Ventilation Ducts	59
28) Bow/Stern Eyelets	60
29) Jet Pump Nozzle	60
30) Reverse Gate	60
31) Scupper Valve.....	60
32) Fuel Tank Vent	60
33) Water Sport Towing Attachments	61
34) Main Battery Cut-Off Switch	63
35) AM/FM Radio/CD Player	63
36) 12-Volt Jack	63
37) Fuses	64
38) Horn Switch.....	64
39) Deck Lights Switch.....	64
40) Glovebox	64
41) Bow Seats.....	65
42) Bow Seat Storage Compartments.....	65
43) Bow Filler Cushion	65
44) Rear Seat Storage Compartments.....	66
45) Passenger Storage Compartment	66
46) Engine Cover.....	66
47) Port Bilge Access.....	66
48) Removable Cooler.....	67
49) AM/FM Radio/CD Player Remote Control	67
50) Bimini Top	67
LIQUIDS.....	69
Recommended Fuel	69
Recommended Engine Oil.....	69
Engine Oil Level.....	69
Engine Coolant.....	71
BREAK-IN PERIOD.....	72
PRE-OPERATION CHECKS	73
Hull	74
Jet Pump Water Intake.....	74
Bilge	75
Battery	75
Fuel Tank and Engine Oil Level.....	75
Engine Compartment.....	75

Fire Extinguisher	75
Steering System	75
Throttle System	75
Shifter System	75
DESS Post and Engine Start/Stop Switch	76
Storage Compartment Covers	76
OPERATING INSTRUCTIONS	77
Launching/Loading	77
Principle of Operation	77
Boarding from a Dock	79
Boarding from the Water	79
Starting	80
Rough Water or Poor Visibility Operation	81
Crossing Waves	81
Stopping/Docking	81
Beaching	81
Shutting Off the Engine	82
Post-Operation Care	82
Additional Care for Foul Water or Salt Water Use	82
SPECIAL PROCEDURES	84
Jet Pump Water Intake and Impeller Cleaning	84
Capsized Boat	84
Submerged Boat/ Water-Flooded Engine	84
Fuel-Flooded Engine	85
Towing the Boat in Water	86
TROUBLESHOOTING	88
SPECIFICATIONS	93

MAINTENANCE INFORMATION

10-HOUR INSPECTION	98
PERIODIC MAINTENANCE CHART	99
MAINTENANCE PROCEDURES	103
General	103
Engine Emissions Information	103
Lubrication	104
Throttle Cable	105
Engine Oil Change and Oil Filter Replacement	105
Coolant Replacement	106
Fuel Injection System	106
Steering Alignment	106
Shifter Lever	106
Deck Drain	106
Fuses	106
Bilge Air Blower	108
Navigation Light Bulb Replacement	109

Sacrificial Anodes	110
General Inspection and Cleaning	111
STORAGE AND PRESEASON PREPARATION	112

WARRANTY INFORMATION

BRP LIMITED WARRANTY FOR MODEL YEAR 2008 SEA-DOO® SPORT BOATS SOLD IN THE UNITED STATES AND CANADA	120
CALIFORNIA AND NEW YORK EMISSION CONTROL WARRANTY STATEMENT FOR MODEL-YEAR 2008 SEA-DOO® SPORT BOATS WITH 4-TEC™ 1503 NORMALLY ASPIRATED (NA) AND 4-TEC™ 1503 SUPERCHARGED INTERCOOLED (SCIC) ENGINE(S)	125
BRP INTERNATIONAL LIMITED WARRANTY FOR MODEL YEAR 2008 SEA-DOO® SPORT BOATS.....	129
BRP EUROPEAN UNION MEMBER STATES LIMITED WARRANTY FOR MODEL YEAR 2008 SEA-DOO® SPORT BOATS	133
DECLARATION CE OF CONFORMITY	137
PRIVACY OBLIGATION/DISCLAIMER	139
CHANGE OF ADDRESS/OWNERSHIP	141

FOREWORD

This Operator's Guide has been prepared to acquaint the owner/operator or passenger of this boat with the various controls, maintenance and safe riding instructions. It is indispensable for the proper use of the product, and should be kept in a waterproof bag in the boat at all times. Make sure you read and understand the content of this document.

For any questions pertaining to the warranty and its application, please consult an authorized Sea-Doo Sport Boats dealer.

Hazard Statements

As you read this Operator's Guide, please note the hazard warnings which alert you to safety precautions related to unsafe conditions or operating procedures.

This guide uses the following symbols and words to emphasize particular information.



The safety alert symbol is recognized around the world. In this manual, it means read this information carefully! Be sure you understand the consequences of the hazards and how to avoid them. Failure to follow the recommendations in a hazard communication statement may result in property damage, personal injury, or death.

People often refer to a hazard statement as a warning in a general sense. This manual uses three kinds of "warnings" depending on the likely effect of a hazard (minor injury, severe injury, death).

WARNING

Identifies a potentially or imminently hazardous situation which, if not avoided, **COULD** result in serious personal injuries including the possibility of death or substantial property damage.

CAUTION: This signal word indicates a potentially hazardous situation which, if not avoided, may result in minor or moderate personal injury or property damage. It may also be used to alert against unsafe practices.

NOTE: Indicates supplementary information needed to fully complete an instruction relating to equipment operation and/or maintenance procedures.

Although the mere reading of such information does not eliminate the hazard, the understanding and application of the information will promote correct and safe use of the boat.

The warnings in this supplement do not and cannot address every conceivable situation. Always use common sense! If a procedure, method, tool, or part is not specifically recommended, you must satisfy yourself that it is safe for you and others and that your boat will not be damaged or made unsafe as a result of your decision.

Advisory Statements

Advisory statements alert you to conditions that affect equipment operation, maintenance, and servicing practices.

An **IMPORTANT** statement indicates a procedure intended to prevent damage to equipment or associated components.

The information and components/system descriptions contained in this supplement are correct at the time of publication. Bombardier Recreational Products (BRP) however, maintains a policy of continuous improvement of its products without imposing upon itself any obligation to install them on products previously manufactured.

Because of our ongoing commitment to product quality and innovation, BRP reserves the right at any time to discontinue or change specifications, designs, features, models or equipment without incurring obligation.

The illustrations in this document show the typical construction of the different assemblies and may not reproduce the full detail or exact shape of the parts. However, they represent parts that have the same or similar function.

It is understood that this guide may be translated into another language. In the event of any discrepancy, the English version shall prevail.

Specifications are given in the SI metric system with the SAE U.S. equivalent in parenthesis. Where precise accuracy is not required, some conversions are rounded off for easier use.

A *SHOP MANUAL* can be obtained for complete service, maintenance and more repair information.

SAFETY INFORMATION

GENERAL

Your safety and that of your passengers and fellow boaters is YOUR responsibility. Before launching your boat, you should completely read and understand this Operator's Guide, product warnings and labels, the *SAFETY VIDEO* and other information provided with your boat or by your dealer. Heed and follow all warnings, safety precautions and operating procedures.

BRP strongly recommends that you take an approved boating safety course. Always operate your boat in compliance with safe boating rules, and with consideration, courtesy and common sense. Failure to do so could result in injury, including the possibility of death, to you, your passengers, others you lend your boat to, or other water users.

TRAILERING

Refer to the trailer instructions for proper capacity, operation, maintenance, accessories and warranty.

Check the regulations in your area concerning towing a trailer, especially the following rules:

- brake system
- tow vehicle weight
- mirrors.

NOTE: An optional brake system is available for your trailer, contact Karavan Trailers (www.karavantrailers.com).

Take the following precautions when trailering the boat:

Tie the boat to both bow and stern (front/rear) eyelets so that it is firmly retained on the trailer.

- Remove stern light (if installed).
- Ensure that ski post is pushed down (**on so equipped models**).
- Ensure all storage compartment covers are properly latched.
- Close bimini top (if so equipped).
- A Sea-Doo cover can protect the boat, particularly before driving on dirt roads, to prevent dirt entry through the air intake openings.

Observe trailering safety precautions.

CAUTION: Always ensure rear storage compartment lid is closed and securely fastened **before** trailering.

SAFE BOATING CHECKLIST

When leaving on a cruise, whether for an hour or for several days, go through the following *SAFE BOATING CHECKLIST*.

Reminders Regarding Operation...

- The performance of this boat may significantly exceed that of other boats you may have operated. Become completely familiar with the controls and operation of this boat before embarking on your first trip or taking on a passenger(s). If you have not had the opportunity to do so, practice driving solo in a suitable traffic-free area and feel the response of each control. Be fully familiar with all controls before accelerating above idle speed. Do not assume that all boats handle identically. Each model differs, often substantially.
- Always keep in mind that as the throttle lever is returned to the idle position, less directional control is available. To turn the boat, both steering and throttle are necessary.
- Like any other boat, this boat has no brake. Stopping distance will vary depending on initial speed, load, wind, and water conditions. Practice stopping and docking in a safe, traffic-free area to have an idea of how long it will take to stop the boat under varying conditions. Do not release the throttle when trying to steer away from objects. You need throttle to steer. Do not use the boat's reverse to stop.
- Do not start or operate the boat if any person is not properly seated in a seat intended for use when underway (not the sun deck or swim platform) or if a person is nearby in the water.
- The boat's jet thrust can cause injury. Always accelerate slowly, and decelerate in a controlled fashion.
- Observe the instructions on all safety labels. They are there to help assure that you have a safe and enjoyable outing.
- Riding with passenger(s) or pulling other boats, tubes, a skier or a wake boarder makes the boat handle differently and requires greater skill.
- Certain boats may come equipped with tow eyelets, a ski pole or a wakeboard tower which can be used to attach a tow rope for a skier, tube or wakeboarder. Do not use these attachment points or any other portion of the boat to tow a parasail or another craft. Personal injury or severe damage may occur.
- In shallow water, proceed with caution and at very low speeds. Grounding or abrupt stops may result in injury to you, your passengers or others. The jet pump may pick up debris and throw it rearward causing a risk of injuring people or damaging the jet pump or other property.
- Engine exhaust contains carbon monoxide (CO), which can cause injury or death if inhaled in sufficient quantities. Do not operate the boat in a confined area or allow CO to accumulate in or around the boat, or in enclosed or sheltered areas. Such as when docked, or when rafting. Be aware of risk of CO from exhaust of other boats.
- Educate all occupants about the risks and symptoms of CO accumulation and CO poisoning, particularly from engine and generator exhaust. Educate them about where engine exhaust outlets (and generator outlets if so equipped) are located. Regularly inspect exhaust and generator system and outlets for component failures or obstructions.

- Combustion engines need air to operate; consequently this boat can not be totally watertight. Any maneuvers such as figure eights that cause the upper deck to be under water may cause severe engine problems due to water ingestion. Refer to the *SPECIAL PROCEDURES* and *WARRANTY INFORMATION* sections contained in this Operator's Guide.
- Respect no wake zones, the rights of other water users and the environment. As the "skipper" and owner of a boat, you are responsible for damage to other boats caused by the wake of your boat. Do not let anyone throw refuse overboard.
- Between sunset and sunrise, use the boat's navigation lights and reduce speed. Do not operate the boat in reduced visibility.
- Do not add accessories or equipment that may adversely affect visibility or alter control of the boat.
- The skipper should personally take the helm during storms.
- Be sure you have the minimum required safety equipment, PFDs and any additional gear needed for your cruise.
- Check that all lifesaving equipment, including fire extinguisher, is in safe operating condition and easily accessible. Show all passengers where this equipment is, and make sure they know how to use it.
- Keep an eye on the weather. Check local weather broadcasts before departure. Be alert to changing conditions.
- Keep accurate and up-to-date charts of the boating area on board. Before getting underway, check water conditions in the planned boating area.
- Before departure, file a Float Plan with a responsible person ashore.
- Keep enough fuel on board for the planned trip. Always verify fuel level before use and during the ride. Apply the principle of 1/3 of the fuel to reach your destination, 1/3 to return, and keep 1/3 in reserve. Allow for changes due to adverse weather or other delays.

Before Getting Underway...

- Always perform the pre-operation checks as specified in this Operator's Guide.
- Do not exceed the payload or passenger capacities for this boat, which are listed on the capacity plate and in the specifications. Overloading can affect maneuverability, stability and performance. Also, heavy seas reduce capacity. A payload or person capacity plate is not an excuse for failure to use common sense or good judgment.
- Regularly inspect the boat, the hull, engine, safety equipment, and all other boating gear and keep them in safe operating condition.

Operators and Passengers...

- Never operate a boat while under the influence of drugs or alcohol. It is a Federal offense. Allow only qualified drivers to operate your boat. Remember that sun, wind, alcohol, drugs, fatigue or illness may impair your judgement and reaction time.
- At least one passenger should be able to operate the boat in case the operator is unexpectedly unable to do so.
- Operation of this boat by a person under 16 years of age or a person with a disability that impairs vision, reaction time, judgment, or operation of the controls is NOT recommended.

- Always use the safety lanyard when operating the boat and ensure that all passengers are familiar with its use.
- Ensure that any operator and all passengers know how to swim and how to re-board the boat from the water. If a passenger does not know how to swim, ensure that passenger wears a PFD at all times and take extra precautions when boating.

SAFETY EQUIPMENT

An operator and the boat's passenger(s) should have ready access to shatterproof glasses should riding conditions or personal preference warrant.

Wind, water spray and speed may cause a person's eyes to water and create blurred vision.

As the owner of the boat, you are responsible for assuring that all required safety equipment is aboard. You should also consider supplying additional equipment as needed for your safety and that of your passengers. Check state and local regulations and call the U.S. Coast Guard Boating Safety Information Line at 1 800 368-5647 for information about required safety equipment.

Required Safety Equipment

Safety equipment required by federal regulations is mandatory. Personal flotation devices must be fitted to the people wearing them. If local regulations require additional equipment, it must be approved by the U.S. Coast Guard (USCG). Minimum requirements include the following:

- personal flotation devices (PFDs)
- fire extinguisher (class B-1)
- visual distress signals (VDS)
- navigation lights
- sound producing devices (horn, air horn or whistle).

A cellular telephone in a waterproof bag or container has also been found to be beneficial to boaters when in distress or just for contacting someone on shore.

Personal Flotation Devices (PFDs)

Federal regulations require that you have at least one Coast Guard approved personal flotation device (PFD) for each person in a recreational boat and require that all children under 13 years of age wear a PFD at all times when the boat is underway, except when below deck or in an enclosed cabin. You may not use your boat unless all PFDs are in serviceable condition, readily accessible, legibly marked with the Coast Guard approval number, and of an appropriate size (within the weight range and chest size marked on the PFD) for each person on board.

A PFD provides buoyancy to help keep your head above the water and to help you remain in a satisfactory position while in the water. Body weight and age should be considered when selecting a PFD. The buoyancy provided by the PFD should support your weight in water. The size of the PFD should be appropriate for the wearer. Body weight and chest size are common methods used to size PFDs. It is your responsibility to ensure that you have the proper number and types of PFDs on board to comply with federal and local regulations and that your passengers know where they are and how to use them.

PFD Types

Five types of PFDs have been approved by the U.S. Coast Guard.

PFD Type I, Wearable has the greatest required buoyancy. Its design allows for turning most unconscious persons in the water from face down position to a vertical or slightly backward, face-up position. It can greatly increase the chances of survival. Type I is most effective for all waters, especially offshore when rescue may be delayed. It is also the most effective in rough waters.

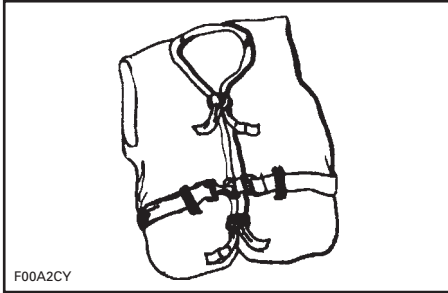

TYPE I — WEARABLE

PFD Type II, Wearable turns its wearer in the same way as Type I, but not as effectively. The Type II does not turn as many persons under the same conditions as a Type I. You may prefer to use this PFD where there is a probability of quick rescue such as in areas where other people are commonly involved in water activities.

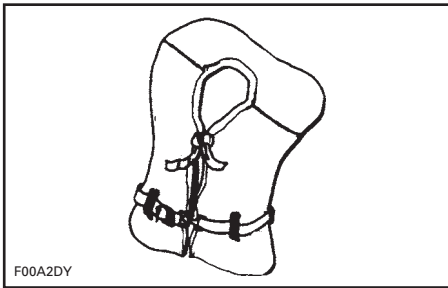

TYPE II — WEARABLE

PFD Type III, Wearable allows wearers to place themselves in a vertical or slightly backward position. It does not turn the wearer. It maintains the wearer in a vertical or slightly backward position and has no tendency to turn the wearer face down. It has the same buoyancy as a Type II PFD and may be appropriate in areas where other people are commonly involved in water activities.

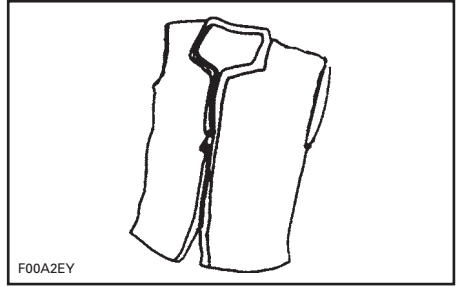

TYPE III — WEARABLE

PFD Type IV, Throwable is required in addition to the PFDs previously discussed. The most common Type IV PFD is a buoyant cushion or ring buoy. It is designed to be thrown to a person in the water, grasped and held by the user until he or she is rescued. A Type IV PFD should always be in serviceable condition and immediately available for use. Grasping this PFD may be difficult if the rescue is delayed or if the user is overcome by hypothermia (loss of body heat).

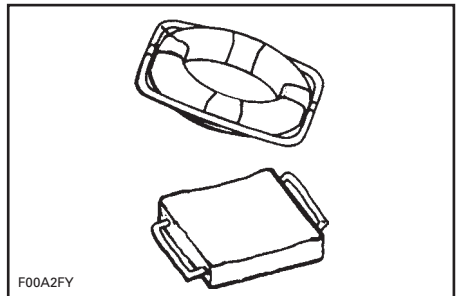

TYPE IV — THROWABLE

PFD Type V, Wearable must be worn. When inflated, it provides buoyancy equivalent to Type I, II or III PFDs. When it is deflated, however, it may not support some people.

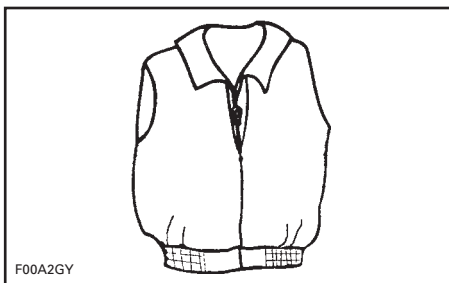

TYPE V — WEARABLE

PFD Pointers

The purpose of a PFD is to help save your life. If you want it to support you when you are in the water, it needs to fit, float, and be in good condition.

- Try the PFD on and adjust it until it fits comfortably in and out of the water. Mark your PFD if you are the only wearer.
- To make sure the PFD works, wear it in the water. This will show you how it works and give you confidence when you use it.
- Teach children how to put a PFD on and allow them to try it in the water. That way, they know what the PFD is for and how it works. They will feel more comfortable with it if they suddenly find themselves in the water.
- If the PFD is wet, allow it to dry thoroughly before storing it. Do not dry it in front of a radiator or heater. Store it in a well-ventilated area.
- Keep PFDs away from sharp objects which can tear the fabric or puncture the flotation pads.
- For their own safety and the safety of others, all non-swimmers, poor swimmers, and small children should wear PFD's at all times whether the boat is stationary or moving.

- Check the PFD frequently to make sure that it is not torn, that flotation pads have no leaks, and that all seams and joints are securely sewn.
- If a PFD contains kapok, the kapok fibers may become waterlogged and lose their buoyancy after the vinyl inserts are punctured. If the kapok becomes hard or if it is soaked with water, replace it. It may not work when you need it.

Hypothermia

Hypothermia, the loss of body heat to the water, is a significant cause of deaths in boating accidents. After an individual has succumbed to hypothermia, he or she will lose consciousness and then drown.

PFDs can increase survival time because of the insulation they provide.

Naturally, the warmer the water, the less insulation one will require. When operating in cold water (below 4.4°C (40°F)) consideration should be given to using a coat or jacket style PFD as they cover more of the body than the vest style PFDs.

Some points to remember about hypothermia protection:

1. While afloat in the water, do not attempt to swim unless it is to reach a nearby boat, fellow survivor, or a floating object on which you can lean or climb. Unnecessary swimming increases the rate of body heat loss. In cold water, drown-proof methods that require putting your head in the water are not recommended. Keep your head out of the water. This will greatly lessen heat loss and increase your survival time.
2. Keep a positive attitude about your survival and rescue. This will improve your chances of extending your survival time until rescue. Your will to live does make a difference!

3. If there is more than one person in the water, huddling is recommended while waiting to be rescued. This action tends to reduce the rate of heat loss and thus increase the survival time.
4. Always wear your PFD. It won't help you fight off the effects of hypothermia if you don't have it on when you go into the water.

Fire Extinguishers

As the owner of the boat, you are responsible for supplying a fire extinguisher approved by the U.S. Coast Guard. Boats less than 7.9 m (26 ft) are required to carry one (1) B-1 type hand portable fire extinguisher unless the boat is equipped with a fixed fire extinguishing system in the engine compartment.

Hand-held portable fire extinguishers should be mounted in readily accessible locations away from the engine compartment. All persons aboard should know the location and proper operation of the fire extinguisher(s).

NOTE: Don't test fire extinguishers by squirting small amounts of the extinguishing compound. The extinguisher might not work when you really need it!

Visual Distress Signal Devices

Visual distress signal devices approved by the U.S. Coast Guard are required on all recreational boats operating on coastal waters and on boats owned in the United States when they are operating on the high seas. Coastal waters include territorial seas and those waters directly connected to the Great Lakes and the territorial seas up to a point where the waters are less than 3.2 km (2 mi) wide. Visual distress signal equipment may be of the pyrotechnic or non-pyrotechnic type. Regulations prohibit display of visual distress signals on the water under any circumstances except when assistance is required to prevent immediate or potential danger to persons on board a vessel.

The equipment must be approved by the U.S. Coast Guard, be in serviceable condition, and be stowed in a readily accessible location. Equipment having a date for serviceable life must be within the specified usage date shown.

Careful selection and proper stowage of visual distress equipment is very important if children are aboard.

WARNING

Fire! In case of fire, do not open engine compartment. Turn off engine. Using portable CO₂ fire extinguisher, continuously discharge entire contents at base of fire.

DAY USE ONLY
Three orange smoke signals (one hand held and two floating) or one orange flag with black square and disk.
NIGHT USE ONLY
One S-O-S electric distress light.
DAY AND NIGHT USE
Three flares of the hand held, meteor or parachute type.

Sound Signaling Devices

NOTE: No single signaling device is appropriate for all purposes. Consider keeping various types of equipment on board.

Boats less than 7.9 m (26 ft) in length are required to carry a hand, mouth, or power operated horn or whistle. It must produce a blast of two second duration and audible at a distance of at least 800 m (1/2 mi).

Following are standard whistle signals:

- one prolonged blast (warning signal)
- one short blast (pass on my port side)
- two short blasts (pass on my starboard side)
- three short blasts (engines in reverse)
- five or more blasts (danger signal).

Navigation Lights

Navigation lights are intended to keep other vessels informed of your presence and course. If you are out on the water between sunset and sunrise, you are required to display appropriate navigation lights.

Additional Recommended Equipment

It is recommended that you acquire additional equipment for safe, enjoyable cruising. This list, which is not all inclusive, includes items you should consider acquiring.

Basic Gear

- flashlight
- mooring lines
- compass
- oar or paddle
- distress signals
- first aid kit
- dock fenders
- VHF radio
- EPIRB (Electronic Position Indicating Radio Beacon)
- boat hook
- extra warm clothing
- charts
- sunblock
- tow line
- second anchor and line
- dewatering device (pump or bailer)
- emergency supply of drinking water and food.

Tools

- spark plug wrench
- hammer
- screwdrivers
- jackknife
- pliers
- electrician's tape
- adjustable wrench
- lubricating oil
- duct tape.

For additional tools, see your dealer.

Spare Parts

- extra bulbs
- extra fuses
- extra drain plug
- spark plugs
- spare wire.

For additional parts, see your dealer.

CARBON MONOXIDE AND BOATING

Burning a material containing carbon produces carbon monoxide (CO), an odorless and colorless gas. Because CO weighs the same as air, it can spread throughout an enclosed space unnoticed because you cannot see it or smell it. Any device used to burn carbon-based materials on a boat can be a source of CO. Common sources of CO include internal combustion engines.

CO reacts with the blood to reduce the ability of the blood to carry oxygen. The reduced oxygen supply to body tissues results in death of the tissue. Prolonged exposure can cause brain damage or death. In high concentrations, CO can be fatal within minutes. The effects of CO in lower concentrations are cumulative and can be just as lethal over long periods of time.

Symptoms of CO poisoning include: Itchy and watering eyes, flushed appearance, throbbing temples, inability to think coherently, ringing in the ears, tightness across the chest, headaches, drowsiness, nausea, dizziness, fatigue, vomiting, collapse, and convulsions. If any of these symptoms are evident, begin treatment immediately. Prompt action can make the difference between life and death.

- Evacuate the area and move the victim to fresh air.
- Administer oxygen if available and get medical help.
- Open all canvas enclosures to ventilate the area.
- Investigate the source of CO and take immediate corrective action.
- Be especially aware of other CO sources which may be near boat.

Carbon Monoxide Accumulation

Following are examples of possible situations where CO may accumulate within your boat while docked, anchored, or underway. Become familiar with these examples and their precautions to prevent personal injury or death.

WARNING

Exhaust fumes! Generator or hull exhaust from other vessels while either docked or anchored can emit poisonous CO gas and cause excessive accumulation within cabin and cockpit areas. Be alert for generator exhaust from your vessel or other vessels alongside. Exhaust outlets near a pier, dock, seawall or outlets blocked by any other means can cause excessive accumulation of poisonous CO gas within cockpit area.

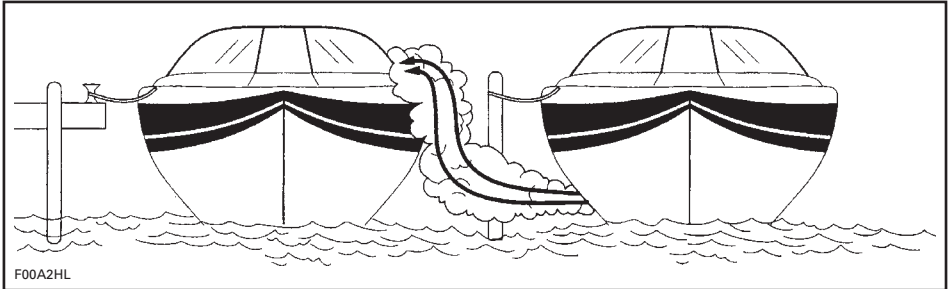

VESSEL ALONGSIDE

WARNING

Engine exhaust fumes contain carbon monoxide (CO) which can accumulate in and around the boat (under bimini top, in cockpit, etc.). CO can be harmful or fatal if inhaled. Assure there is adequate ventilation whenever running engine(s).

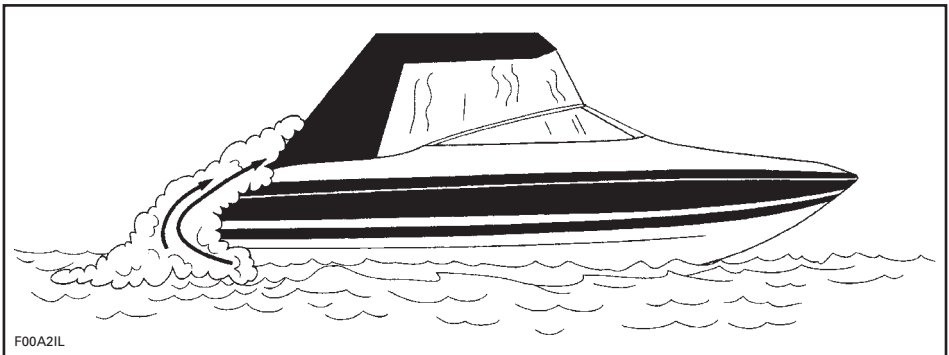

WHILE UNDERWAY (BACKDRAFTING)

While underway, CO concentrations can increase by backdrafting or “the station wagon effect”. Backdrafting is caused by factors such as relative wind direction, speed, or the bow being too high. To prevent this, open canvas whenever possible to provide positive airflow through the hull.

Boat houses, seawalls, and other boats in close proximity or confined areas can contribute to increased CO levels. Operators must be aware that operation, mooring, and anchoring in an area with other boats puts them in jeopardy of CO accumulation from other sources. Likewise, a boat operator must be aware of how exhaust from his boat will affect others. Operation of the engines while moored may cause CO accumulation in your boat and those around you.

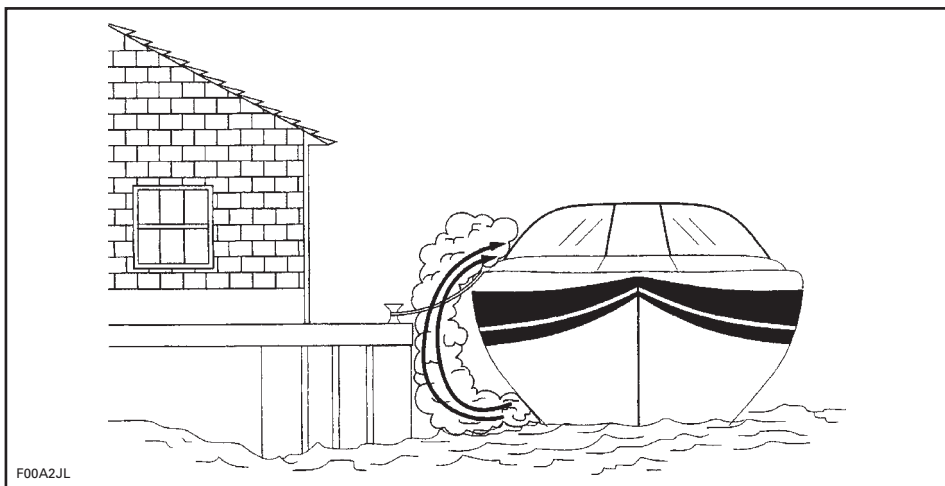

CONFINED AREAS

Be sure to provide adequate ventilation. If the windshield has vents, open them before getting underway to increase positive air flow and decrease the chances of CO accumulation.

WARNING

Backdrafting! Under certain conditions, moving air currents can direct poisonous CO fumes into boat. These fumes can accumulate to dangerous levels without proper airflow. Provide adequate ventilation, redistribute the load or bring boat out of high bow angle.

Even with the best boat design and construction, CO may still accumulate in enclosed or confined areas under certain conditions. Continually observe passengers for symptoms of CO poisoning.

Do NOT Operate your Boat without Performing the Following Checklist:

Each Boating Day

OPERATION	✓
Make sure you and your passengers know where exhaust outlets are located on the vessel	
Educate all passengers about the symptoms of CO poisoning and where CO may accumulate	
When docked or rafting with another boat, be aware of exhaust emissions from the other boat	
Confirm that water flows from the exhaust outlet when the engine(s) is (are) started	
Listen for any change in exhaust sound, which could indicate an exhaust component failure	
Test the operation of each CO alarm by pressing the test button (if so equipped)	

CO Detector

It is strongly recommended that you have CO detectors installed in boats with canvas enclosures. Monitors are available from your dealer. Monitors should be professionally installed and calibrated.

NOTE: A CO detector is not a gas fuel vapor detector. Gas fuel vapor detectors do not monitor the buildup of CO in an enclosed area.

SAFETY LANYARD

This safety device automatically stops the engine if the lanyard is attached to the operator and the operator falls from the control station.

The safety lanyard clip must be securely attached to the operator's PFD, clothing, arm, or leg. Be sure to attach the lanyard clip to a place where it is free of obstructions and to something that will move with the operator if he or she leaves the helm station. If the engine shuts down because the DESS key attached to the safety lanyard was removed, the key must be reinstalled on the DESS post before the engine can be restarted.

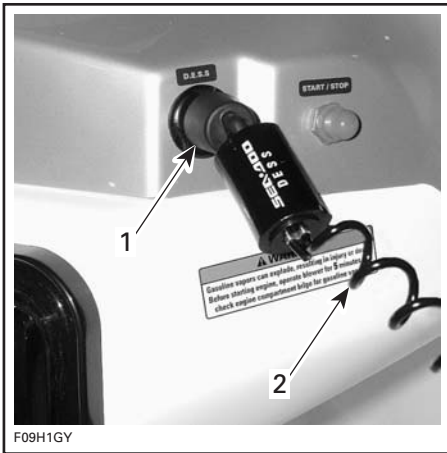

TYPICAL

1. DESS key installed on DESS post
2. Safety lanyard attached to operator

WARNING

Always use the safety lanyard when operating your boat. Keep DESS post free from obstructions that could interfere with its operation. Do not modify or bypass its safety features. The proper use of the safety lanyard can prevent a runaway boat situation which otherwise could cause severe personal injury or death.

SAFE BOATING PRACTICES

YOU are responsible for your own safety, the safety of your passengers, and the safety of fellow boaters.

Drugs and Alcohol

Do not use drugs or drink alcohol while operating a boat. Like driving a car, driving a boat requires sober, attentive care. Operating a boat while intoxicated or under the influence of drugs is not only dangerous, but it is also a Federal offense carrying a significant penalty. These laws are vigorously enforced. The use of drugs and alcohol, singly or in combination, decreases reaction time, impedes judgment, impairs vision, and inhibits your ability to safely operate a boat.

- Do not use the boat in weather or sea conditions beyond the skill or experience of the operator or the comfortable capability of the boat or passengers.
- Be sure at least one other passenger is familiar with the operation and safety aspects of the boat in case of an emergency.
- Make sure that passengers and gear do not obstruct the operator's view or ability to move.
- Do not exceed the maximum engine power rating stated on the certification plate attached to the boat.
- Observe all safety signs and warnings both inside the boat and in the immediate boating area.

WARNING

Alcohol consumption and boating do not mix! Operating under the influence endangers the lives of your passengers and other boaters. Federal laws prohibit operating a boat under the influence of alcohol or drugs.

Safe Operation

For safety reasons and proper care, always perform *DAILY PRE-OPERATION CHECKS* as specified in your Operator's Guide before operating your boat. Safe operation means that you do not misuse your boat nor do you allow your passengers to do so. Safe operation means using good judgment at all times. It includes, without limitation, the following actions:

- Load the boat within the limits listed on the capacity plate. Balance loads bow to stern and port to starboard.
- Maintain boat speed at or below the local legal limit. Avoid excessive speed or speeds not appropriate for operating conditions.

PASSENGER SAFETY

Before getting underway, show all passengers where emergency and safety equipment is stowed, and explain how to use it. Everyone aboard should wear rubber-soled shoes which resist slipping on wet surfaces. While underway, passengers should remain seated inside the deck rails. Don't allow passengers to drag their feet or hands in the water. Always use handholds and other safety hardware to prevent falls. All non-swimmers, poor swimmers, and children should wear a PFD at all times. Federal regulations require that children under 13 years of age wear a PFD when the boat is underway unless they are in an enclosed cabin or below deck.

First Aid

As a boat operator, you should be familiar with basic first aid procedures that may be needed while you are far from help. Fish hook accidents or minor cuts and abrasions may be the most serious mishaps on board a boat, but you should also learn the proper procedures and be ready to deal with the truly serious problems like excessive bleeding, hypothermia, and burns. First aid literature and courses are available through most Red Cross chapters.

Operation by Minors

Minors should always be supervised by an adult whenever operating a boat. Many states have laws regarding the minimum age and licensing requirements of minors. Be sure to contact the state boating authorities for information. BRP recommends a minimum operator age of 16 years old.

RULES OF THE ROAD

As a responsible boater, you will comply with the *RULES OF THE ROAD*, the marine traffic laws enforced by the U.S. Coast Guard. Navigating a boat is much the same as driving an automobile. Operating either one responsibly means complying with a set of rules intended to prevent accidents. Just as you assume other car drivers know what they are doing, other boaters assume you know what you are doing.

Operating a boat can be compared with driving unmarked highways and roads. To prevent collisions or avoid other boaters, a system of operating rules must be followed. It's not only common sense... it's the law!

Check local and federal boating laws applicable to the waterways where you intend to use your boat. Learn the local rules of the road. Know and understand the applicable navigation system (such as buoys and signs).

Know the waters in which the boat is to be operated. Current, tides, rapids, hidden obstacles, wakes and waves etc. can affect safe operation. It is not advisable to operate the boat in rough or inclement weather.

Generally keep to your right and safely avoid other craft by keeping a safe distance from other craft, people and objects.

Crossing

Give right of way to craft ahead and to your right. Never cross in front of another craft.

RED light (give way to the other craft).

GREEN light (you have the right of way).

Meeting Head-On

Keep right.

Passing

Give right of way to other craft and keep clear.

Navigation System

Navigational aids, such as signs or buoys, can help you identify safe waters. Buoys will indicate whether you should keep to the right (starboard) or to the left (port) of the buoy or to which channel you can continue. They may also indicate whether you are entering a restricted or controlled area such as a no wake or speed zone. They may also indicate hazards or pertinent boating information. Markers may be located on shore or on the water. They can also indicate speed limits, no power craft or boating, anchorage and other useful information. (The shape of each type of marker will provide assistance).

Make sure you know and understand the navigation system applicable to the waterways where you intend to use the boat.

Collision Avoidance

- Do not decrease throttle when trying to steer away from objects. You need throttle to steer.
- Always keep a constant lookout for other water users, other craft or objects, especially when turning. Be alert for conditions that may limit your visibility or block your vision of others.
- Respect the rights of other recreationists and/or bystanders and always keep a safe distance from all other craft, people and objects.
- Do not wake or wave jump, ride the surf line or attempt to spray or splash others with your boat. You may misjudge the ability of the boat or your own driving skills and strike a boat or person.

- This boat has the capability of turning more sharply than other boats. However, unless in an emergency, do not negotiate sharp, high speed turns. Such maneuvers make it hard for others to avoid you or understand where you are going. Also, you and/or your passenger(s) could be thrown from the boat.
- Like any other boat, this boat has no brake. Stopping distance will vary depending on initial speed, load, wind, and water conditions. Practice stopping and docking in a safe, traffic free area to have an idea of how long it will take to stop the boat under varying conditions.
- Maintaining or increasing speed may be necessary to avoid a collision.

Safe Riding

- Always keep in mind that as the throttle lever is returned to idle position, less directional control is available, and when the engine is off, directional control is lost. You need throttle to steer.
- While your boat has the capacity of operating at high speeds, it is strongly recommended that high speed operation only be applied when ideal conditions exist and are permitted. Higher speed operation requires a higher degree of skill and increases the risk of severe injuries.
- In shallow water, proceed with caution and at very low speeds. Grounding or abrupt stops may result in injury. Debris may also be picked up and be thrown rearward by the jet pump onto people or property.
- Do not use the boat's reverse, to stop. You or your passenger(s) could be violently ejected forward or even off the boat onto the hazard.

Operator/Passenger Awareness

- Do not start or operate the boat if anyone is seated on the sun deck or swim platform, or is nearby in the water. Water and/or debris exiting jet thrust nozzle can cause severe injury.
- The operator and passenger(s) should be properly seated before starting or moving the boat. All passenger(s) should be instructed to use the handholds or seat straps provided.
- When accelerating a boat with a passenger(s), whether from a complete stop or while underway, always do so progressively. Fast acceleration may cause your passenger(s) to lose their balance or grip and strike something in the boat or fall out of the boat. Make sure that your passenger(s) know of, or anticipate, any rapid acceleration.

Maneuverability of the Boat/Towing

- Do not overload the boat or take on more passengers than designated for the particular boat. Overloading can affect maneuverability, stability and performance.
- Avoid adding on accessories or equipment which may alter your control of the boat.
- Riding with a passenger(s) or pulling a tube, skier or wakeboarder makes the boat handle differently and requires greater skill.
- Always respect the safety and comfort of your passenger(s) and person being towed on skis, wakeboard or other towables.

- Always carry an observer when pulling a tube, skier or wakeboarder, proceed with only as much speed as required and follow the observer's instructions. Unless absolutely necessary, do not make tight, sharp turns. Keep a safe distance from the docks, other swimmers, craft or objects.
- Use a tow rope of sufficient length and size and make sure it is adequately secured to your boat. Some boats are equipped or can be fitted with a specially designed towing mechanism. It can become a hazard should someone fall on it.

Don't Forget:

- Ride smart from the start and we all win!

FUELING PROCEDURE

Regarding Fuel

- Remember that fuel and gasoline fumes are flammable and explosive under certain conditions. Be very careful when fueling and adhere to the fueling procedures described below in this Operator's Guide and those given to you by the marina. Always stop the engine before fueling and never allow anyone to remain in the boat while fueling. Each time you fill up, assure that the engine compartment is free of gasoline vapors, and inspect fuel lines for leaks and hose deterioration.
- Do not smoke or allow open flames or sparks in the vicinity.
- Know the capacity of the fuel tank. Avoid fueling at night except under well-lit conditions. Gas spills are not noticeable in the dark. Do not carry spare fuel or flammable liquids in any of the storage or engine compartments.

Procedure

WARNING

Follow these safe boating fueling instructions explicitly.

- Turn off engine.
- Do not allow anyone to remain on the boat.
- Tie boat securely to the fueling pier.
- Use bilge blower for a minimum of 5 minutes.
- Turn off bilge air blower, bilge pump and any other devices that could produce a spark.
- Ensure engine cover is closed to prevent fumes from entering the engine compartment.
- Have a fire extinguisher close at hand.
- Insert the spout into the filler neck.

- Pour fuel slowly so that air can escape from the tank and prevent fuel flowback. Be careful not to spill fuel.
- Stop filling when the fuel reaches the bottom of filler neck. **Do not overfill.** Fully tighten fuel tank cap.

WARNING

Always stop the engine before refueling. Fuel is flammable and explosive under certain conditions. Always work in a well ventilated area. Do not smoke or allow open flames or sparks in the vicinity. Fuel tank may be pressurized. Slowly turn cap when opening. Never use an open flame to check fuel level. When fueling, keep boat level. Do not overfill or top off the fuel tank and leave boat in the sun. As temperature increases, fuel expands and might overflow. Always wipe off any fuel spillage from the boat. Periodically verify fuel system.

VOLUNTARY INSPECTIONS

State boating officials in many states or the U.S. Coast Guard Auxiliaries offer courtesy inspections to check out your boat. They will check for compliance with safety standards and required safety equipment. You may voluntarily consent to one of these inspections, and you are allowed time to make corrections without prosecution. Check with the appropriate state agency or the Coast Guard Auxiliary for details.

SAFE BOATING COURSES

The local U.S. Coast Guard Auxiliary and the U.S. Power Squadrons offer comprehensive safe boating classes several times a year. You may contact the BOAT/U.S. Foundation at 1 800 336-BOAT (2628) or, in Virginia, 1 800 245-BOAT (2628), for a course schedule in your area. Also contact the local U.S. Coast Guard Auxiliary or Power Squadron Flotilla for the time and place of their next scheduled class. A boating safety course is recommended and may be required in your province or state.

WATER SPORTS

WARNING

Avoid personal injury! Your boat is not designed for and should not be used for pulling parasails, kites, gliders, or any device which can become airborne. Use boat only for appropriate water sports.

WARNING

Teak surfing is extremely dangerous to participants due to their proximity to the rear of the boat where direct contact with the exhaust fumes from the boat engine is the highest. Carbon monoxide poisoning can occur and result in mental disorientation, dizziness, drowsiness, and loss of consciousness. The combination of carbon monoxide exposure and non-use of a life jacket (PFD) make this new water recreation activity an incredibly dangerous and potentially deadly sport.

Water skiing, wakeboarding, or riding a towed, inflatable apparatus are some of the more popular water sports. Taking part in any water sport requires increased safety awareness by the participant and the boat operator. If you have never pulled someone behind your boat before, it is a good idea to spend some hours as an observer, working with and learning from an experienced driver. It is also important to be aware of the skill and experience of the person being pulled. Always have a second person on board to observe the person in the water so the driver can concentrate on operating the boat.

Both the boat operator and observer should monitor the location of the towrope when participating in water sports. A slack tow rope can become entangled with person(s) or objects in the boat or in the water, particularly when making a tight turn or circling, and cause serious personal injury.

Everyone participating in a water sport should observe these guidelines:

- Allow only capable swimmers to take part in any water sport.
- Always wear a personal flotation device (PFD) approved by the U.S. Coast Guard. Wearing a properly designed PFD helps a stunned or unconscious person stay afloat. A **Type IV** water-ski vest is an approved and practical PFD.
- Have a second person aboard to observe the person being towed and inform the driver about the participant's hand signals. The driver must give full attention to operating the boat and the waters ahead.
- Be considerate to others you share the water with.
- Never allow a person to “teak surf” behind your boat. Do not tow a person in any water sport on a short tow rope such that the person inhales exhaust fumes in concentration. Inhalation of concentrated exhaust fumes, which contain carbon monoxide, can result in CO poisoning, personal injury and death.
- Give immediate attention to a person who has fallen. He or she is vulnerable in the water alone and may not be seen by other boaters.
- Approach a person in the water from the lee side (opposite the direction of the wind). Turn off the motor before coming close to the person.
- Turn off engine and anchor the boat before swimming.

- Participate in water sports only in safe areas. Stay away from other boats, channels, beaches, restricted areas, swimmers, and heavily traveled waterways and underwater obstructions.
- Swim only in areas designated as safe for swimming. These are usually marked with a swim area buoy. Do not swim alone or at night.



SWIM AREA BUOY

- Do not water ski between sunset and sunrise. It is illegal in most states.
- Do not drive the boat directly behind a water skier, tuber or wakeboarder. At 40 km (25 mi) per hour, the boat will overtake a person who falls in the water 60 m (200 ft) in front of your boat in about 5 seconds.
- Shut engine off and remove ignition key when anyone is in the water nearby.
- Stay at least 45 m (150 ft) away from areas marked by a diver down float.

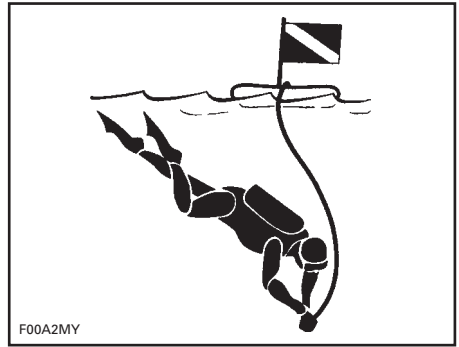

DIVER DOWN FLOAT

⚠ WARNING

Avoid personal injury! Do not allow anyone near the jet pump or intake grate, even when the engine is off. Items such as long hair, loose clothing or personal flotation device straps can become entangled in moving parts resulting in serious injury or drowning. In shallow water, shells, sand, pebbles or other objects could be drawn up by the jet pump and be thrown rearward.

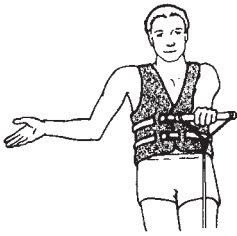

FASTER -
Palm of one hand pointing upward.



SLOWER -
Palm pointing down.



SPEED OK -
Arm upraised with thumb and finger joined to form circle.

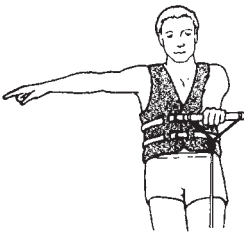

RIGHT TURN -
Arm outstretched pointing to the right.

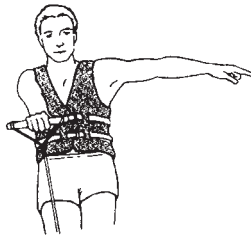

LEFT TURN -
Arm outstretched pointing to the left.



RETURN TO DROP-OFF AREA -
Arm at 45 degree from body pointing down to water and swinging.



CUT MOTOR -
Finger drawn across throat.

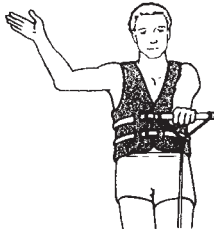

STOP -
Hand up, palm forward, policeman style.



SKIER OK.
AFTER THE FALL -
Hands clenched together overhead.

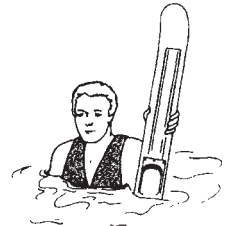

PICK ME UP OR FALLEN SKIER,
WATCH OUT -
One ski extended vertically out of water.

F00A2NL

SKIING SIGNALS

For more information about water skiing, please contact the American Water Ski Association, 1251 Holy Cow Road, Polk City, FL 33868 (1 863 324-4341).

INTERNET WEB SITE: www.usawaterski.org/

E-Mail: usawaterski@usawaterski.org

VEHICLE INFORMATION

REGISTRATION NUMBER LOCATION

All boats are required by federal law to be registered and legally numbered.

Due to space availability for proper display of registration number, refer to the following illustration for location. The registration number must appear on each side of the boat.



F23L01L

TYPICAL

1. Registration number location

LOCATION OF THE IMPORTANT LABELS

The following labels are on your boat. If missing or damaged, they can be replaced free of charge. See an authorized Sea-Doo Sport Boats dealer. Please read the following labels carefully before operating your boat.

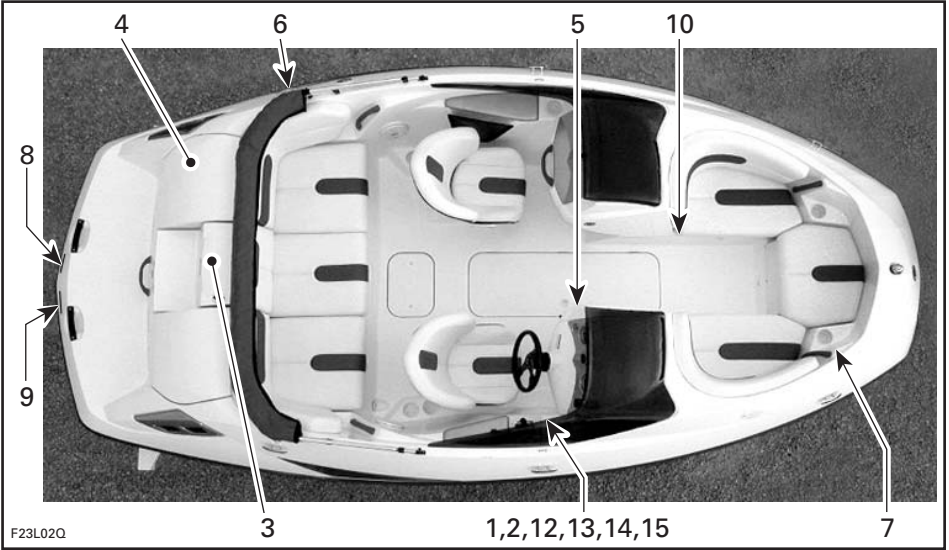

TYPICAL

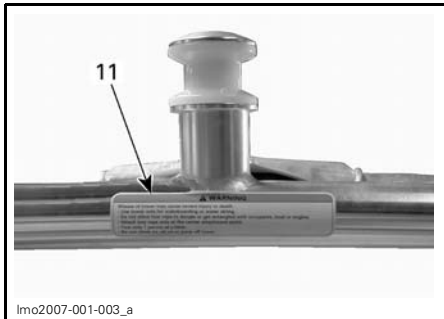

WAKE TOWER — OPTIONAL

Label 1

⚠ WARNING

Read and follow warning labels and operator's guide before operation. Severe injury or death can result from ignoring warnings or improper use of this sport boat. The performance of this sport boat may significantly exceed that of other boats you may have operated.

- Check throttle/shifter and steering operation and position before starting engine(s).
- Directional control is reduced with decreasing speed and lost when engine is off.
- Do not splash others or jump waves or wakes.
- Occupants should always wear approved PFD and recommended protective clothing.
- Do not operate if passengers are not properly seated and using handgrips, or if visibility is obstructed. Do not allow passenger(s) to ride on any portion of the boat not designated in the operator's guide as a seat for use when underway.
- Properly attach safety lanyard to your PFD.
- Keep a safe distance from all other water users. Be aware of and observe all applicable laws and regulations.

F13L1UL

Label 2

MADE IN U.S.A., BOMBARDIER MOTOR CORPORATION OF AMERICA
U.S. COAST GUARD
MAXIMUM CAPACITIES
8 PERSONS OR xxx KG/xxxx LBS.
xxx KG/xxxx LBS. PERSONS, GEAR
THIS BOAT COMPLIES WITH U.S. AND CANADIAN COAST GUARD
SAFETY STANDARDS IN EFFECT ON THE DATE OF CERTIFICATION
CE BOAT DESIGN CATEGORY: C
mo2008-002-010_en

Label 4

⚠ WARNING

- Remove battery from boat before charging.
- Do not overcharge battery.
- Improper charging of battery can cause explosion.

F13L1MY

Label 3

⚠ WARNING / AVERTISSEMENT
CHECKING ENGINE OIL LEVEL
Vehicle must be level to perform verification. Bring engine to normal operating temperature then let idle for 30 seconds. Stop engine, wait for at least 30 sec. and check oil level using the dipstick. **Caution:** Never let the engine run out of the water without cooling through the flush kit connection as it may damage the engine. Oil may be hot.
VÉRIFICATION DU NIVEAU D'HUILE DU MOTEUR
Avec la motomarine à niveau et à température normale d'utilisation, laissez le moteur tourner au ralenti 30 secondes. Arrêtez le moteur, attendez au moins 30 sec. et vérifiez le niveau d'huile. **Attention:** Ne pas laisser tourner le moteur hors de l'eau sans faire circuler de l'eau par le raccord de rinçage. L'huile peut être chaude.
F18L10Y

Label 5

⚠ WARNING

Gasoline vapors can explode, resulting in injury or death. Before starting engine, operate blower for 5 minutes and check engine compartment bilge for gasoline vapors.

F13L1SY

Label 6

⚠ WARNING

- Avoid serious injury or death from fire or explosion.**
- Before fueling, stop engine and keep boat level.
 - Open fuel cap slowly to relieve pressure.
 - Do not overfill.
 - Regularly inspect fuel system for leaks.
 - Use regular unleaded gasoline and check oil level.

F13L1NY

Label 7

⚠ WARNING

**Avoid Serious Or Fatal Injury.
Do Not Occupy Seat When Speed
Exceeds 5 M.P.H.**

F00L3BY

Label 8

⚠ WARNING

Avoid serious personal injury or death.

- Turn off engine(s) before using swim platform.
- Keep people, clothing and hair away from jet nozzle(s) or intake grate(s) to avoid entanglement, drowning and carbon monoxide poisoning.

F13L10Y

Label 9

⚠ WARNING

Carbon monoxide (CO) can cause brain damage or death.

Engine and generator exhaust contains odorless and colorless carbon monoxide gas. Signs of carbon monoxide poisoning include nausea, headache, dizziness, drowsiness, and lack of consciousness.

Get fresh air if anyone shows signs of carbon monoxide poisoning.

See Owner's Manual for information regarding carbon monoxide poisoning.

20490162S

lmo2007-002-001

Label 10



F10L3EY

Label 11

⚠ WARNING

Misuse of tower may cause severe injury or death.

- Use tower only for wakeboarding or water skiing.
- Do not allow tow rope to dangle or get entangled with occupants, boat or engine.
- Attach tow rope only at the center attachment point.
- Tow only 1 person at a time.
- Do not climb on, sit on or jump off tower.

F13L1PL

WAKE TOWER — OPTIONAL

Label 12

BRP US Inc.

EMISSION CONTROL INFORMATION

This vehicle is certified to operate on unleaded gasoline and conforms to 20XX U.S. EPA & CALIFORNIA EMISSION regulations for marine SI engines.

BRP US Inc.

RENSEIGNEMENTS SUR LE DISPOSITIF ANTIPOLLUTION

Ce véhicule est certifié pour fonctionner à l'essence sans plomb et il répond aux normes 20XX de l'EPA des É.-U. & RÉGLEMENTATIONS CALIFORNIENNES pour les moteurs marins à étincelles (SI).

Engine family

XXXX

Famille de moteur

FEL

XX g/kW-hr HC+NOx

Limite des émissions de la famille

Engine displacement

XXX cc

Cylindrée

Exhaust emissioncontrol system:

Spark plug type

NGK

Système de contrôle des Émissions

Spark plug gap

XX mm

Type de bougie

Power

XX kw

Écartement des électrodes

SEE OPERATORS GUIDE FOR MAINTENANCE SPECIFICATIONS.

VOIR MANUEL DE L'OPÉRATEUR POUR LES SPÉCIFICATIONS DE MAINTENANCE.

smo2006-002-014_a

Label 13

UNDERWAY SEATING POSITIONS

MAXIMUM PERSONS

8

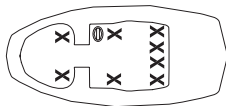

F23L04Y

Label 14

⚠ WARNING

Securely lock windshield door in the opened or closed position before getting underway and at all times while boat is in motion.

F21L25L

180 CHALLENGER

Label 15

⚠ DANGER

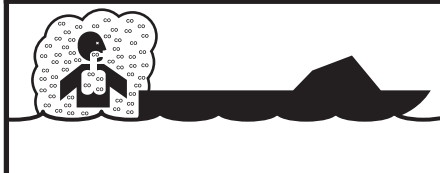

Carbon monoxide (CO) can cause brain damage or death.

Engine and generator exhaust contains odorless and colorless carbon monoxide gas.

Carbon monoxide will be around the back of the boat when engines or generators are running.

Move to fresh air if you feel nausea, headache, dizziness, or drowsiness.

204901626

lmo2007-002-002

IDENTIFICATION NUMBERS

The main components of the boat (hull and engine) are identified by different serial numbers. It may sometimes become necessary to locate these numbers for warranty purposes or to trace the boat in the event of theft.

Hull

The Hull Identification Number (H.I.N.) is located on the right side of the transom.



TYPICAL

1. Hull Identification Number (H.I.N.)

Engine

The Engine Identification Number (E.I.N.) is located on the upper crankcase on MAGNETO side.

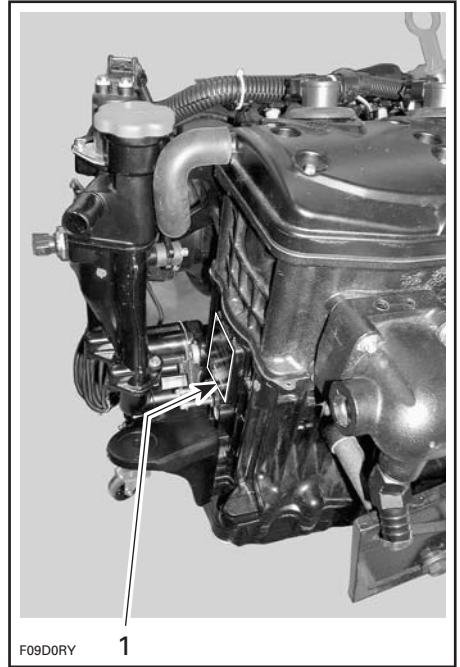

1. Engine Identification Number (E.I.N.)

CONTROLS, COMPONENTS AND INSTRUMENTS

NOTE: Some controls/instruments/equipment do not apply or are optional on some models. In these cases their reference numbers are deliberately missing in the illustrations.

Overview

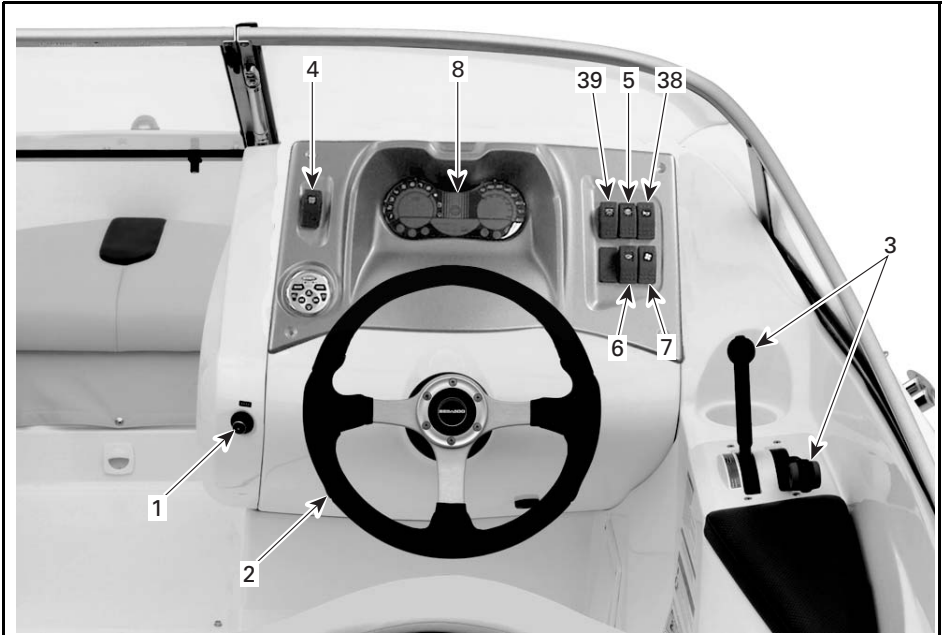

lmo2008-002-012_a

COCKPIT VIEW

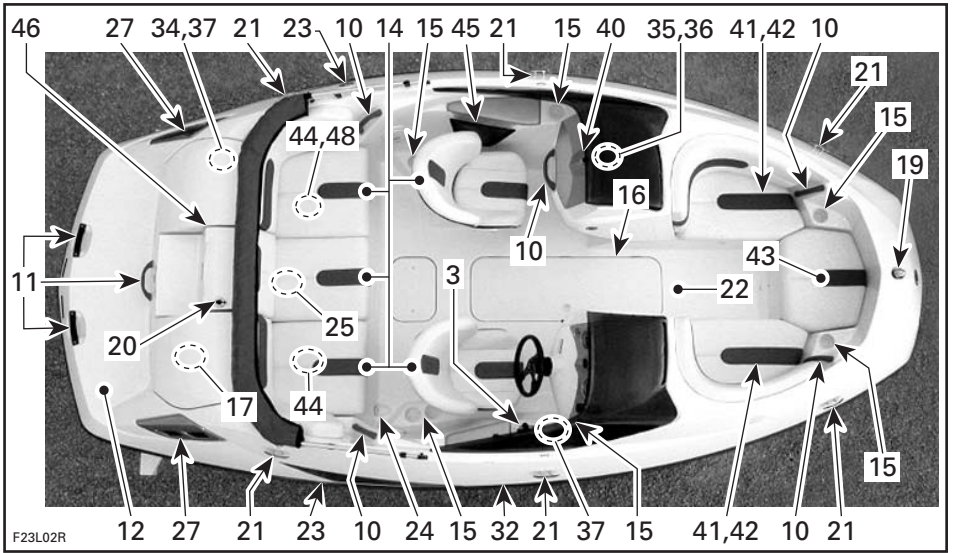

TYPICAL

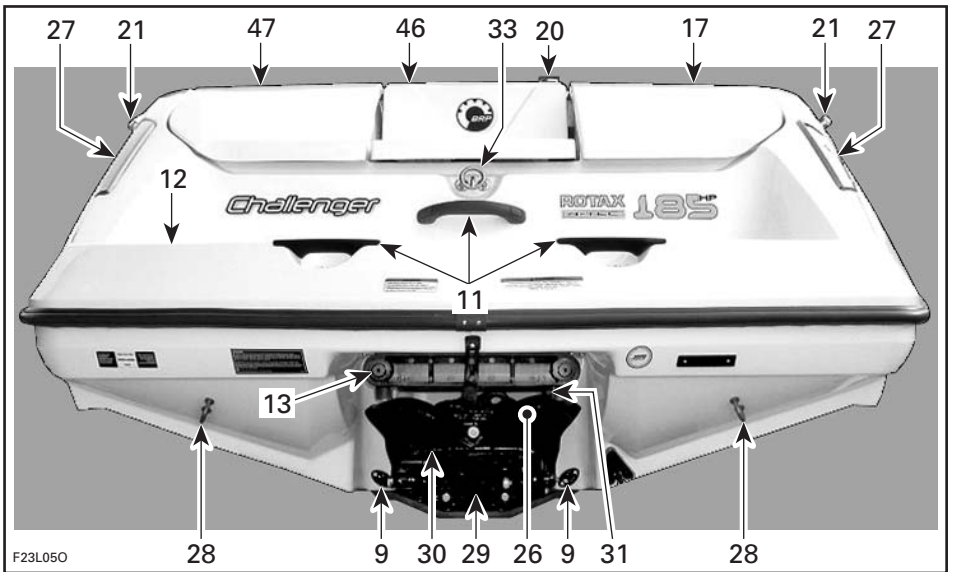

TYPICAL



TYPICAL

1. DESS Post (engine cut-out switch)
2. Steering Wheel
3. Throttle/Shifter Controller
4. Start/Stop Switch
5. Navigation Lights Switch
6. Bilge Pump Switch
7. Bilge Air Blower Switch
8. Information Center Gauge
9. Bilge Drain Plugs
10. Grab Handles
11. Rear Grab Handles
12. Swim Platform
13. Ladder
14. Seats
15. Cup Holders
16. Deck Storage Compartment
17. Rear Storage Compartment
18. Jet Pump Water Intake
(not shown)
19. Bow Lights
20. Stern Light Socket
21. Mooring Cleats
22. Deck
23. Fuel Tank Cap
24. Deck Drain
25. Engine Oil Filling Cap
26. Flushing Connector
27. Ventilation Ducts
28. Bow/Stern Eyelets
29. Jet Pump Nozzle
30. Reverse Gate
31. Scupper Valve
32. Fuel Tank Vent
33. Water Sport Towing Attachments
34. Main Battery Cut-Off Switch
35. AM/FM Radio/CD Player
36. 12-Volt Jack
37. Fuses
38. Horn Switch
39. Deck Lights Switch
40. Glovebox
41. Bow Seats
42. Bow Seat Storage Compartments
43. Bow Filler Cushion
44. Rear Seat Storage Compartments
45. Passenger Storage Compartment
46. Engine Cover
47. Port Bilge Access
48. Removable Cooler
49. AM/FM Radio/CD Player Remote
Control
50. Bimini Top

1) DESS™ Post (engine cut-out switch)

⚠ WARNING

Always use safety lanyard when operating your boat to help prevent a runaway boat and reduce the risk of personal injury or death. Remove the DESS key when stopped to help prevent accidental starting.

The DESS key should be securely snapped onto the Digitally Encoded Security System (DESS™) post to allow engine starting.

Two short beeps should sound indicating the system is ready to allow engine starting. Otherwise, refer to *TROUBLESHOOTING* section for the *MONITORING SYSTEM CODED SIGNALS*.

Pulling the key from the DESS post stops the engine.

⚠ WARNING

Should the DESS key become loose or fails to remain on the DESS post, replace it immediately.

Always attach the safety lanyard to the operator's Personal Flotation Device and snap the key to the DESS post to be able to start the engine.

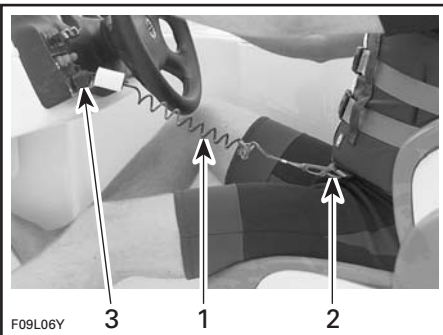

TYPICAL

1. Safety lanyard
2. Secure lanyard clip to PFD
3. Snap key to DESS post

⚠ WARNING

Directional control is reduced when throttle is decreased and lost when engine is off. Always remove DESS key when boat is not in operation.

⚠ WARNING

Do not lubricate the DESS post.

⚠ WARNING

While the engine can be stopped using the start/stop switch, good driving habits recommend that the DESS key also be disconnected when stopped.

Additional Information on the Digitally Encoded Security System (DESS)

The DESS key contains an electronic circuit that gives it a unique electronic serial number.

To have additional DESS keys programmed for your boat, refer to an authorized Sea-Doo Sport Boats dealer.

If the engine is stopped with the start/stop switch while the key remains on the DESS post, it can be restarted anytime by only pressing the start/stop switch during a period of approximately 10 minutes while the system remains under power. After this delay, it is necessary to remove and reinstall the key on the DESS post.

2) Steering Wheel

The steering wheel controls the direction of the boat. Turning the steering wheel clockwise steers the boat to the right and inversely.

3) Throttle/Shifter Controller

Throttle Lever

When pushed forward, the boat accelerates. When fully pulled back, engine returns to idle speed and the boat is gradually stopped by water drag.

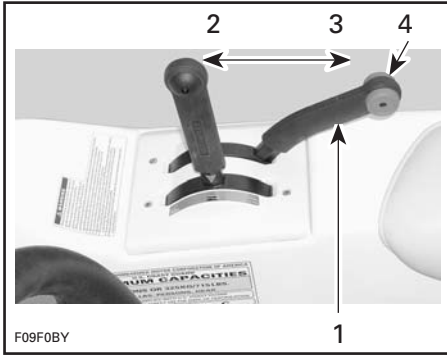

TYPICAL

1. Throttle lever
2. Increase speed
3. Decrease speed
4. Idle speed position

Shifter Lever

A 3-position lever:

- forward
- neutral
- reverse.

In order to shift, throttle lever must be fully pulled back to idle speed position.

Shifter must be in neutral position to allow engine starting.

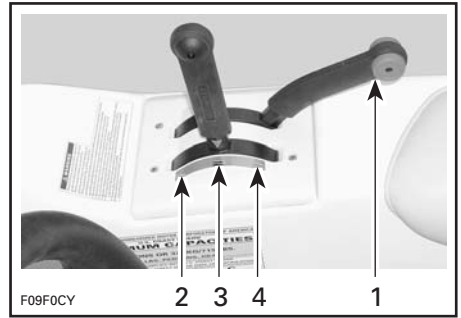

TYPICAL

1. Throttle lever must be fully pulled back (idle speed) to shift
2. Forward
3. Neutral
4. Reverse

CAUTION: Do not force lever. Ensure throttle lever is in idle position.

NOTE: To ease shifter use, line up the shifter arrow with the appropriate dot (Forward/Neutral/Reverse).

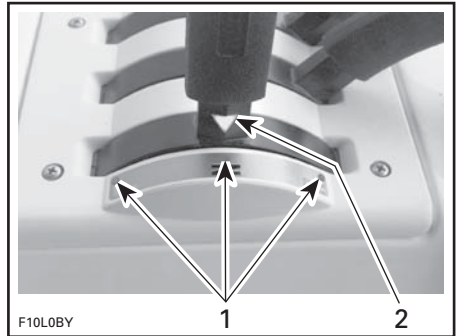

TYPICAL

1. Dots besides shifting position
2. Arrow on shifter

WARNING

Shifter lever should only be used when the engine is idling and boat is completely stopped.

WARNING

Only use reverse at slow speed and for the shortest time possible. Always ensure the path behind is clear of objects and persons including children playing in shallow water.

CAUTION: Never rev the engine at high RPM in reverse.

4) Start/Stop Switch

Dual function START/STOP switch, used to start as well as to stop engine.

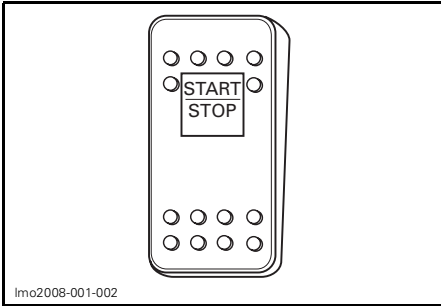

START/STOP SWITCH

Starting

WARNING

Engine exhaust fumes contain carbon monoxide (CO) which can accumulate in and around the boat (under bimini top, in cockpit, etc.). CO can be harmful or fatal if inhaled. Assure there is adequate ventilation whenever running engine(s).

Shifter must be in neutral position and the DESS key must be on the DESS post to allow engine starting.

To start engine, press and hold the start/stop switch. Release immediately after engine is started.

Stopping

WARNING

While engine can be stopped by pressing the start/stop switch, we strongly recommend the engine be stopped by removing the DESS key. This will install good habits.

Pressing switch when engine is running will stop the engine.

WARNING

Directional control is not available when engine is stopped.

5) Navigation Lights Switch

A 3-position NAV/OFF/ANC switch.

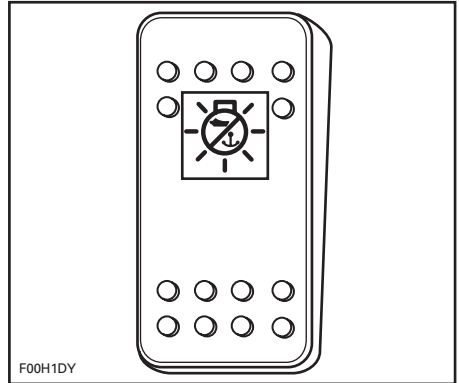

NAVIGATION LIGHTS SWITCH

ANC: Turns on the anchorage light when the boat is anchored. Only the stern light is lit.

OFF: Turns off all lights.

NAV: Turns on both bow and stern lights and illuminates the gauges.

WARNING

Navigation lights should always be used between sunset and sunrise. Ensure the stern light is installed. See *STERN LIGHT SOCKET* in this section for location and installation.

6) Bilge Pump Switch

A 2-position OFF/ON switch.

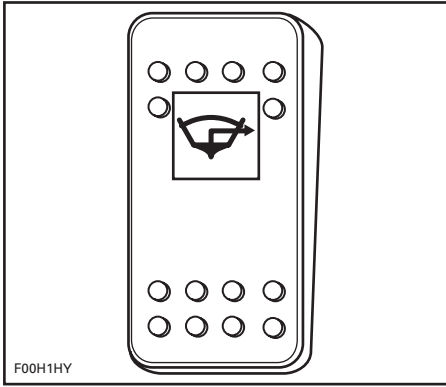

BILGE PUMP SWITCH

Turn to ON position when manual operation of the bilge pump is required (after cleaning, storage, etc.).

Turn switch to OFF when finished.

CAUTION: Do not operate for prolonged time if the bilge is dry: battery drainage will occur and pump will be damaged.

The bilge pump may be operated without the DESS key on its post.

CAUTION: Always turn pump OFF when bilge is dry or before operating the engine above idle. Bilge pump will then switch to automatic mode.

Automatic Bilge Pump

The automatic bilge pump evacuates water from the bilge. A water sensor detects the water, activating the pump. After the water is pumped out, the pump shuts-off automatically. This automatic mode is working at all times: with/without DESS key on its post and with/without engine running.

CAUTION: When the main battery cut-off switch is turned OFF while boat is moored, the automatic bilge pump will start if water comes up in the bilge.

7) Bilge Air Blower Switch

A 2-position OFF/ON switch.

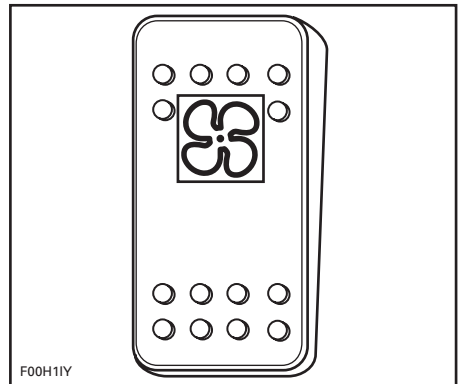

BILGE AIR BLOWER SWITCH

When turned on, the blower ventilates the engine compartment.

WARNING

Gasoline vapors can explode, resulting in injury or death. Always use blower for a minimum of 5 minutes before starting engine, then turn it OFF above idle speed. Use of the bilge blower should never replace "smelling" for gasoline vapors.

CAUTION: Using the bilge blower for a prolonged time when the engine is not running will discharge the battery.

Blower should be turned off during boat operation.

8) Information Center Gauge

This is a multifunction gauge that supplies several real time useful information to the driver either in English, French or Spanish. See an authorized Sea-Doo Sport Boats dealer for unit settings.

At start-up, all LCD segments and indicator lights will turn on for 3 seconds each time the information center is activated (when DESS key is installed). This allows the driver to validate they are all working properly.

NOTE: Gauge is illuminated whenever the navigation lights are used.

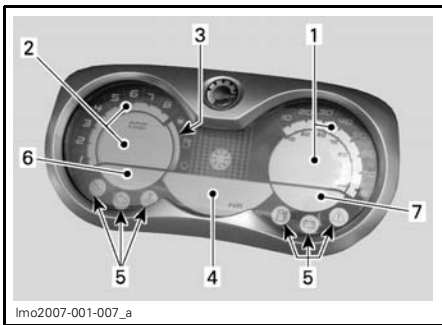

1. Speedometer
2. Tachometer
3. Fuel level
4. Information display
5. Indicator lights
6. Water depth display
7. Water temperature display

Speedometer

Speedometer indicates the speed of the boat in miles per hour (MPH) or kilometers per hour (km/h).

Tachometer

Tachometer indicates the revolutions per minute (RPM) of the engine. Multiply by 1000 to obtain the actual revolutions.

Fuel Level

Bar gauge that continuously indicates the amount of fuel left in the fuel tank while riding.

Information Display

Compass

Displays the cardinal points to indicate the orientation of the boat.

WARNING

Use the compass as a guide only. Not to be used for navigation purposes.

Hourmeter (HR)

Displays the time in hours of the boat usage.

Message Code

Displays a message code whenever one of the following circumstances occurs. The abbreviations between parenthesis here are the codes displayed.

(H-TEMP)

Engine or exhaust system overheating.

CAUTION: If the monitoring beeper continuously sounds, stop engine as soon as possible.

Turn off engine as soon as possible. Check oil and coolant levels and refill if necessary. Refer to *LIQUIDS*.

If engine still overheats, refer to *ENGINE OVERHEATS* in *TROUBLESHOOTING*.

(OIL)

Low or high oil pressure in the engine.

Check oil level as soon as possible.

If lamp remains ON contact an authorized Sea-Doo Sport Boats dealer.

CAUTION: Never run engine out of oil. Serious engine damage will occur.

(12 V LOW)

Low battery voltage.

Before the battery becomes too discharged to start the engines, the **low/high battery voltage** indicator light will come on.

When the indicator light is ON, you should discontinue all use of electrical accessories immediately and start the engine in order to recharge the battery.

(12 V HI)

High battery voltage.

See an authorized Sea-Doo Sport Boats dealer.

(FUEL-LOW)

Low fuel level.

Fill up fuel tank as soon as possible.

(MAINT)

Maintenance reminder.

NOTE: When the boat is due for a maintenance inspection, the message MAINT will blink. After servicing, your authorized Sea-Doo Sport Boats dealer will clear it.

(CHK ENG)

Check engine.

NOTE: If a fault occurs, this system generates numbered fault codes (P-XXXX) that are displayed through the information center. In case of a failure, you may call your authorized Sea-Doo Sport Boats dealer and he would be able to assist you to obtain the code descriptions to help troubleshooting.

(SENSOR)

Sensor failure (boat electronic equipment).

See an authorized Sea-Doo Sport Boats dealer.

(KEY)

Invalid DESS key.

Indicates that you have used the wrong DESS key, use the proper key for this boat.

(L KEY)

DESS learning key active.

Additional Information

A beeper will sound and indicator light will blink depending on the fault occurring to catch the driver attention when necessary.

Except for low liquid levels, which can be corrected by refilling, it is recommended to see an authorized Sea-Doo dealer when other messages occur.

Indicator Lights

NOTE: Refer to *MESSAGE CODE* above for additional information regarding messages.

Low oil pressure (OIL)



Check engine (CHK ENG)



Engine or exhaust system overheating (H-TEMP)



Low fuel level (FUEL-LOW)



Low/high battery voltage
(12 V LOW/HI)



Maintenance reminder (MAINT)



Water Depth Display

SE Models

Display the water depth under the hull within 0 to 50 meters (0 to 170 feet).

NOTE: Under certain conditions, the gauge may stop displaying. The gauge ability to display the depth depends on the usage conditions.

Water Temperature Display

Displays the water temperature of the water surface in degrees Celsius (°C) or Fahrenheit (°F).

9) Bilge Drain Plugs

Once boat is on trailer, unscrew the drain plugs, block the wheels and raise the bow slightly with the trailer jack (if so equipped) so that the water can flow out of the bilge.

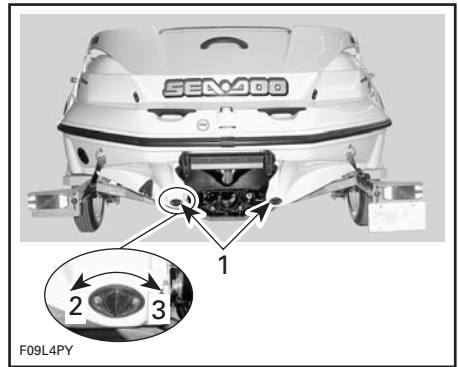

TYPICAL
1. Drain plugs
2. Loosen
3. Tighten

10) Grab Handles

Grab handles provide a handhold for the passengers.

Although grab handles are provided, never perform maneuvers that place a passenger or the driver at risk for being ejected or thrown out of their seat.

CAUTION: Never use the grab handles to pull anything or to lift the boat.

Refer to components location illustrations at the beginning of this section for grab handle locations.

11) Rear Grab Handles

Provide a handhold for boarding when needed.

CAUTION: Never use the grab handle to tow anything or to lift the boat.

12) Swim Platform

Provides an anti-skid surface for easy boarding from rear of the boat.

⚠️ WARNING

Do not start or operate the boat if a person is seated on the platform. Engine must be off when using swim platform. Keep away from jet or intake grate.

13) Ladder



lmo2008-002-001_a

1. Retractable ladder

Located under the swim platform, the ladder helps in reboarding the boat.

⚠️ WARNING

Engine should be OFF when using ladder. Keep limbs away from jet or intake grate. Only one person at a time on the ladder. Never use the ladder for pulling, towing, diving or jumping, boarding a boat that is out of the water or any other purpose other than a ladder.

Pull latches to unlock the ladder.

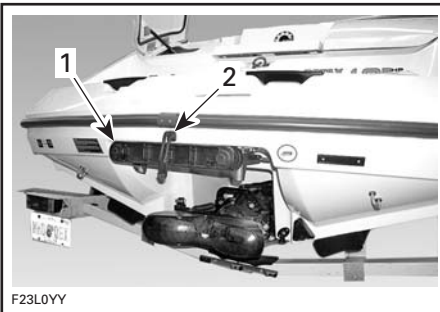

F23L0YY

TYPICAL

1. Retractable ladder
2. Latch

Slide ladder toward rear, then push down.



F23L0ZY

TYPICAL — LADDER LOWERED

To store ladder, lift horizontally, slide toward front and refasten latch.

14) Seats

Each passenger should be seated while underway.

⚠️ WARNING

Allow no one to sit on edge of the boat or to stand up while in operation. Seat/grab handles should be used in rough waters.

15) Cup Holders

Convenient locations for non-alcoholic beverages.

⚠️ WARNING

Never operate boat while under the influence of alcoholic beverages while aboard. Do not keep bottles, cans etc. in cup holders while riding at high speed and/or on rough water.

16) Deck Storage Compartment

The deck storage compartment is a convenient location for water-skis, paddles, anchor and rope, etc.

⚠ WARNING

Never leave any heavy or loose breakable objects in the storage basket. Never operate the boat with the storage compartment cover open.

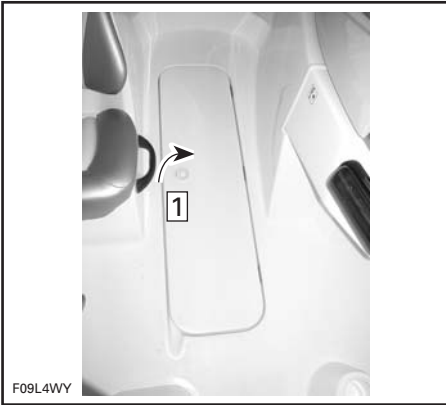

TYPICAL
Step 1: Pull latch and lift cover

Lift the latch ring and open cover gently until stopped by retaining spring.

When completely opened, the cover remains in that position on calm water.

To close, gently push on the side of the spring to release it and lower the cover.



TYPICAL
1. Gently push here to release the spring

17) Rear Storage Compartment

Starboard Rear Storage Compartment

Located behind the rear starboard passenger seat.

Pull latch to open storage cover.



1. Lift latch

The gas assist cylinder will hold the storage cover open.

⚠ WARNING

Always close cover before getting underway.

18) Jet Pump Water Intake

Water is drawn up by the impeller through this opening. The grate minimizes entry of foreign objects into the propulsion system.

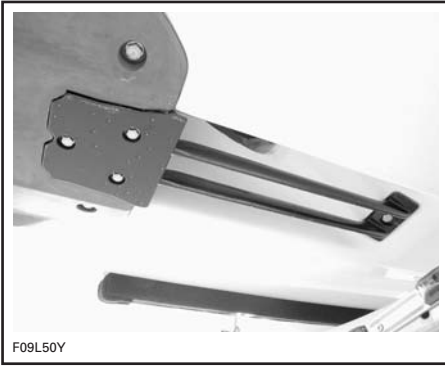

TYPICAL

WARNING

Keep away from intake grate while engine is on. Items such as long hair, loose clothing or personal flotation device straps can become entangled in moving parts resulting in severe injury or drowning.

19) Bow Lights

Mandatory red/green lights. See *LIGHT SWITCH* as mentioned earlier in this section.

20) Stern Light Socket

Located on the engine cover, for installation of mandatory white stern light.

It is recommended to keep stern light in ski locker compartment at all times except when needed.

Installation

- Release stern light storage lock as shown.

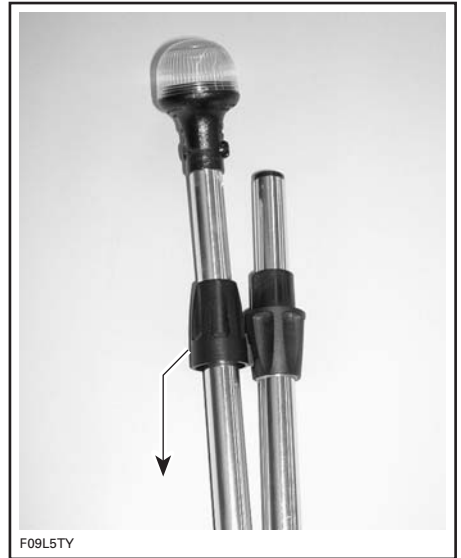

SLIDE THIS DIRECTION

- Thread onto folding joint as shown below.

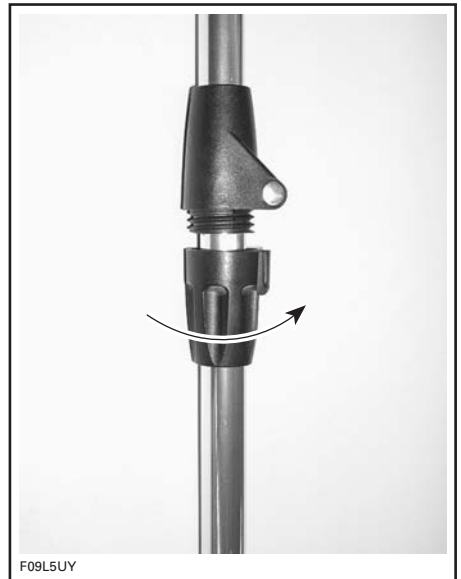

- Lift connector cap.
- Insert post in connector hole. Ensure to align hole keyway with post screw head.

- Firmly push downward to engage terminals.
- Push lock ring downward. Turn until locked. It may be necessary to slightly turn it to allow its insertion in the hole.
- Check light operation. See *NAVIGATION LIGHT SWITCH* as mentioned earlier in this section.

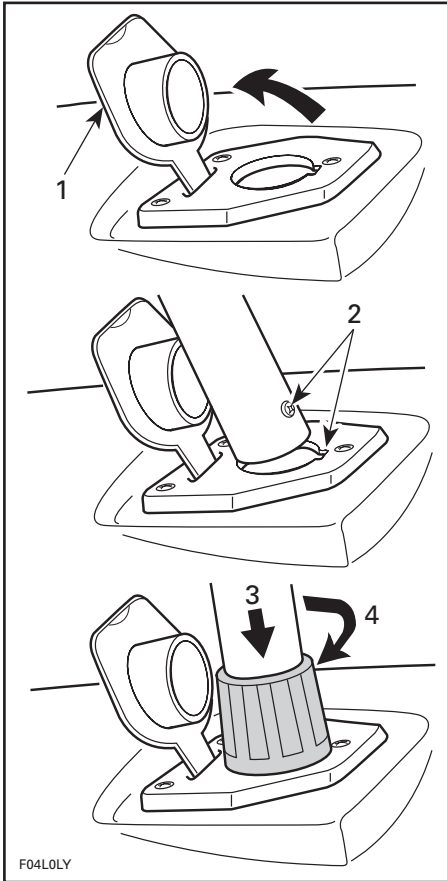

TYPICAL

1. Lift
2. Align screw in groove
3. Push downward
4. Turn to lock

CAUTION: Ensure dielectric grease is present in connector area of light to prevent corrosion.

Removal and storage of light is the reverse of installation.

21) Mooring Cleats

When mooring to a dock, it is recommended to secure the boat with both front and rear cleats. The use of dock lines with sealed air fenders is recommended to protect your boat.

CAUTION: Never use mooring cleats to pull anything or to lift the boat.

22) Deck

Flat surface of boat, should be kept clean and clear.

23) Fuel Tank Cap

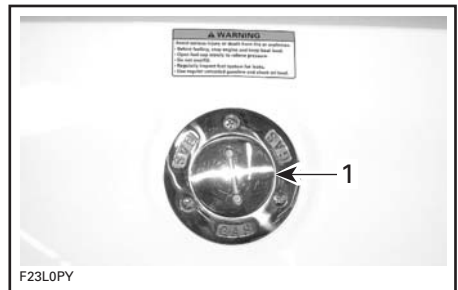

1. Fuel tank cap

Unscrew the cap counterclockwise to allow fuel tank filling. Fully tighten when finished.

⚠ WARNING

Never use a lit match or open flame to check fuel level.

WARNING

Always stop the engine before refueling. Fuel is flammable and explosive under certain conditions. Always work in a well ventilated area. Do not smoke or allow open flames or sparks in the vicinity. Fuel tank may be pressurized. Slowly turn cap when opening. Never use an open flame to check fuel level. When fueling, keep boat level. Do not overfill or top off the fuel tank and leave boat in the sun. As temperature increases, fuel expands and might overflow. Always wipe off any fuel spillage from the boat. Periodically verify fuel system.

24) Deck Drain

Located below the driver's seat, the deck drain provides water drainage from rain, deck washing, water splashing, etc. Keep clean to avoid clogging.

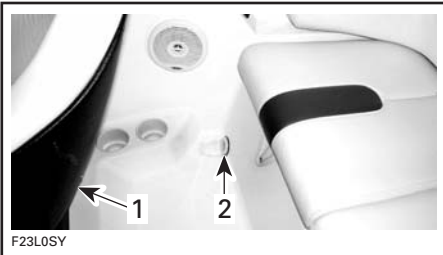

TYPICAL

1. Driver's seat
2. Deck drain

25) Engine Oil Filling Cap

Located in the engine compartment, on the engine. It allows adding oil in the engine when required.

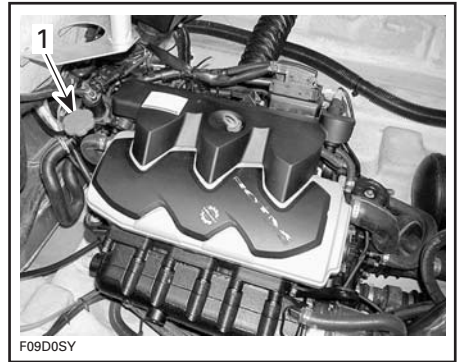

TYPICAL

1. Oil filling cap

Refer to *LIQUIDS* for more details.

26) Flushing Connector

Engine is provided with a flushing connector on jet pump support.

Refer to *STORAGE AND PRESEASON PREPARATION* section for proper use.

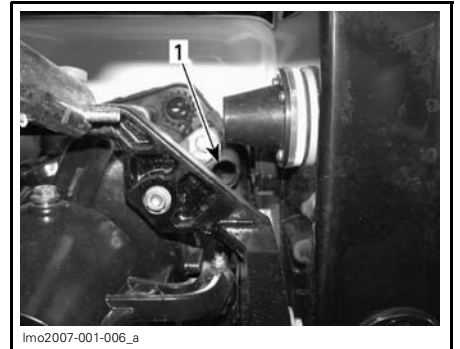

TYPICAL

1. Flushing connector

27) Ventilation Ducts

Located at both ends of the swim platform, the ventilation ducts supply air to the engine and ventilate engine compartment. Ventilation ducts should never be obstructed.

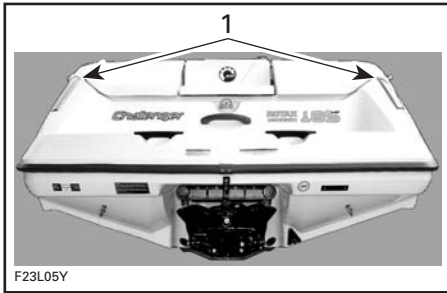

F23L05Y

TYPICAL

1. Ventilation ducts

28) Bow/Stern Eyelets

Eyelets can be used for mooring, towing and as a tie-down point during transportation.



F09L55Y

TYPICAL

1. Stern eyelet
2. Bow eyelet

29) Jet Pump Nozzle

The jet pump nozzle provides directional control when engine is running, turning side to side via input from the steering wheel.

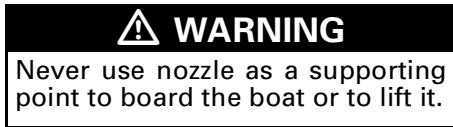

Refer to *PROPULSION* under *PRINCIPLE OF OPERATION*.

30) Reverse Gate

When selecting the neutral or reverse position with the shifter lever, the reverse gate moves up or down to the desired position.

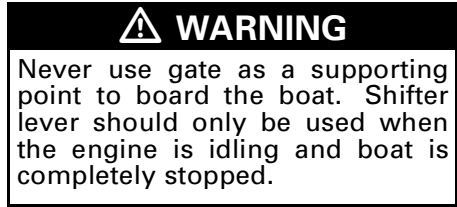

31) Scupper Valve

Location where water drains out from the deck. Keep clean to avoid clogging.

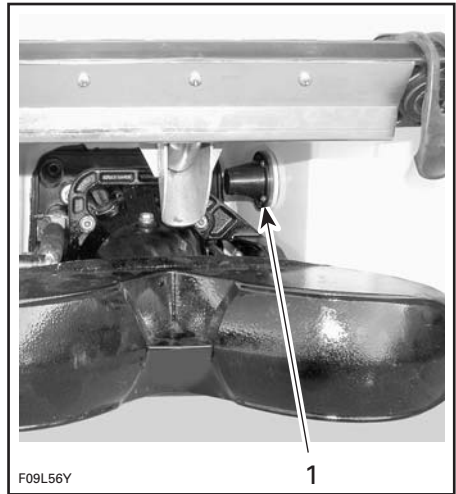

F09L56Y

TYPICAL

1. Scupper valve

32) Fuel Tank Vent



F23L00Y

TYPICAL

1. Fuel tank vent

Vent allows fuel vapor and pressure release from fuel tank.

⚠ WARNING

Never use a lit match or open flame close to vent. Follow the *FUELING PROCEDURE* instructions in the *SAFETY INFORMATION* section.

33) Water Sport Towing Attachments

Please read and often refer to *WATER SPORTS* information in the *SAFETY INFORMATION* section at the front of this guide.

⚠ WARNING

“Teak Surfing” is extremely dangerous to participants due to their proximity to the rear of the boat where direct contact with the exhaust fumes from the boat engine is the highest. Carbon monoxide poisoning can occur and result in mental disorientation, dizziness, drowsiness, and loss of consciousness. The combination of carbon monoxide exposure and non-use of a life jacket (PFD) make this new water recreation activity an incredibly dangerous and potentially deadly sport.

⚠ WARNING

When pulling a tube, skier or wakeboarder, always have an observer, proceed with only as much speed as required, and follow the observer's instructions.

Tow Hook

Used to pull skiers and other appropriate water toys.

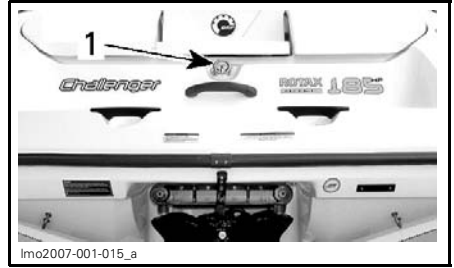

TYPICAL

1. Tow hook

Towing Tower

Optional

⚠ WARNING

Pulling a tube, skier or wakeboarder makes the boat handle differently and requires greater skill. Unless absolutely necessary, do not make tight, sharp turns. Keep a safe distance from docks, swimmers, other craft or objects. Be advised that serious injury can result if the tow rope becomes slack during a tight turn or when circling. The rope could become wrapped around the neck or limbs of a person.

The towing tower is for skiing/wakeboarding.

CAUTION: Always tow the boat with the towing tower fastened in the upright position to avoid damage to the boat. Tower must be secured and bolted in upright position when boat is operated. Periodically check that bolts and knobs are in place and tight. Check clearance height around docks, shore, overhanging objects, bridges and power lines. The tower must not be used as a tie-down or tie-off point.

To clean tower, use mineral spirits and a clean soft cloth.

To prepare tower for storage, remove knobs from each side of tower.



TYPICAL — KNOBS LOCATION

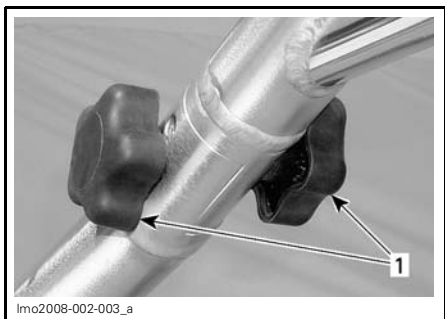

1. Knobs

NOTE: This procedure may require two people.

Carefully lower each rear support arm towards the rear and side of the boat.

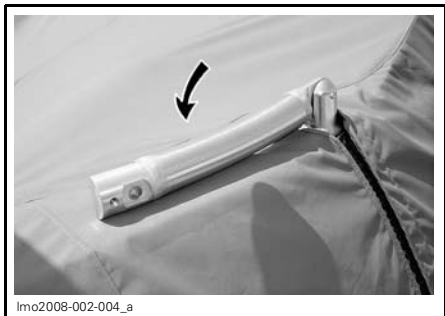

PERFORM FOR EACH SIDE

Carefully lower tower onto deck.

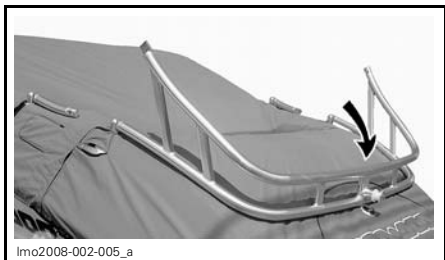

Erection of tower is reverse of this procedure.

Tower Removal

NOTE: Removal of the tower will require 4 people. Remove tower only from upright position.

Using a 6.35 mm (1/4 in) hexagonal tip, remove bolts from tower attachment points.



ATTACHMENT POINTS

Carefully maneuver tower away from boat and place on a level surface.

Save bolts for later reinstallation.

Installation (from off boat)

NOTE: Installation of the tower will require 4 people.

Carefully lift tower assembly and position on boat with someone at each attachment point of tower unit.

Apply Loctite 243 (P/N 293 800 059) to threads of bolts and install bolts into attachment points. Torque bolts to 35 N•m (26 lbf•ft) to complete installation of tower.

34) Main Battery Cut-Off Switch

The switch allows a complete power cut-out of the electrical system.

This switch is located in the port bilge access compartment.

When in OFF position, ALL electrical equipment and electronics will be OFF, **except** the bilge pump. The bilge pump will operate automatically with the battery switch in the OFF position.

Switch must be in the ON position to allow the use of electrical components and to start the engine.

CAUTION: Stop engine before switching to the OFF position.

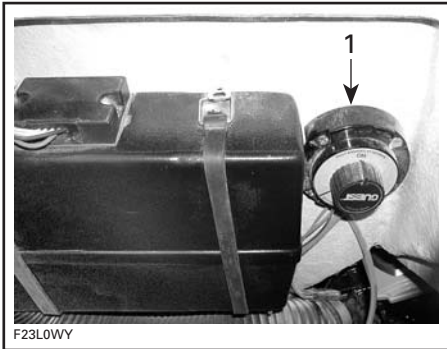

TYPICAL — MAIN BATTERY CUT-OFF SWITCH

1. Battery cut-off switch in ON position

It is recommended to set this switch to the OFF position whenever performing maintenance in the engine compartment, on the electrical system, for transportation or during short term storage.

CAUTION: When the main battery cut-off switch is turned OFF while boat is moored, the automatic bilge pump will start if water comes up in the bilge.

35) AM/FM Radio/CD Player



TYPICAL — RADIO/CD PLAYER

Refer to *MANUFACTURER'S GUIDE* for complete explanation of features and controls.

CAUTION: Using the radio/CD player for a prolonged time without engine running may discharge the battery.

36) 12-Volt Jack

A 12-volt jack is provided to power temporary accessories such as a cellular phone or other 12-volt portable devices.



LOCATED IN THE GLOVEBOX

1. 12-volt jack

Lift protective cap to expose jack.

CAUTION: Using the accessory jack for a prolonged time without engine running may discharge the battery.

CAUTION: Close protective cap when jack is not in use to protect against weather.

⚠ WARNING

Never operate the boat with the glovebox cover open.

37) Fuses

The electrical system is protected with fuses. Refer to *MAINTENANCE INFORMATION* section for details.

38) Horn Switch

A 2-position push type switch.

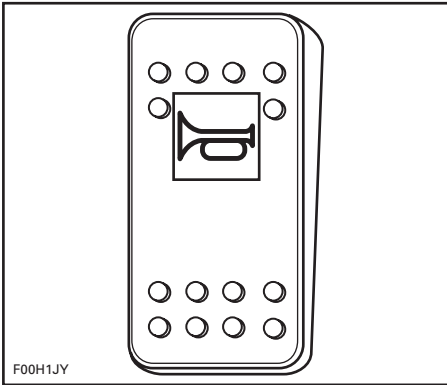

F00H1JY

HORN SWITCH

Press and hold the switch to activate the horn.

Release the switch to stop horn.

39) Deck Lights Switch

A 2-position OFF/ON switch.

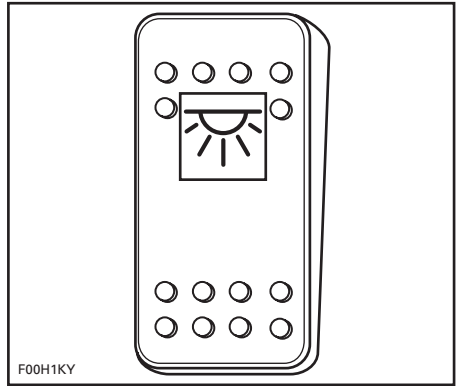

F00H1KY

DECK LIGHT SWITCH

Press switch to ON position to turn on the deck lights.

Press switch to OFF position to turn off the deck lights.

CAUTION: Using the deck lights for a prolonged time when the engine is not running will discharge the battery.

40) Glovebox

Located on the port console, the glovebox provides a convenient, lockable storage space for keys, wallet, etc.

To open glovebox, press latch button and pull. To close glovebox, lift door and push forward until latched.



F23L0EY

TYPICAL

WARNING

Never operate the boat with the glovebox cover open.

41) Bow Seats

Located at the front of the boat, they are provided as a sun seat.

WARNING

No passenger should use the most forward seat in the bow area if it faces backwards unless the boat is stopped or under idle speed.

42) Bow Seat Storage Compartments

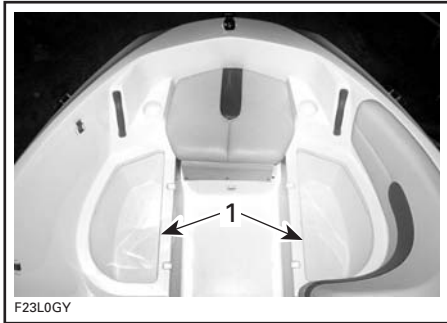

TYPICAL

1. Bow storage compartments

Located under the bow seat cushions, the bow seat storage compartments are provided for securing extra PFD's, rope, etc.

Unsnap and lift bow cushions to access storage areas.

Installation of bow cushions is the reverse of removal.

43) Bow Filler Cushion

The bow seat filler cushion is located under the front bow seat cushion.

Unsnap the front bow seat cushion and remove.

Pull the bow seat filler cushion from its storage position.

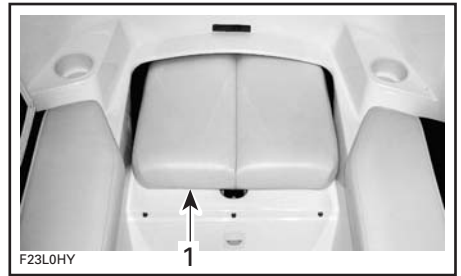

1. Filler cushion

Remove the support bars from their storage position beneath the bow seat filler cushion.

Unsnap the two side bow seat cushions, lift each cushion slightly to position the support bars.

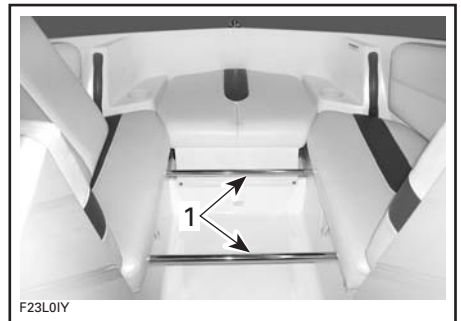

1. Support bars installed

Reposition front bow seat cushion and fasten with the snap.

Position bow seat filler cushion to create a comfortable lounging area while boat is stopped.



TYPICAL

44) Rear Seat Storage Compartments

Located beneath the rear port and starboard seat cushions, these compartments are convenient for storing a cooler, or additional articles.

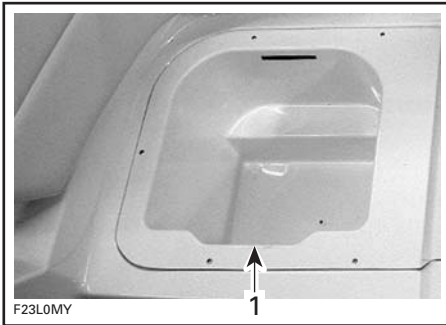

1. Starboard side shown



COOLER

1. Port side shown

45) Passenger Storage Compartment



1. Passenger storage area

Located at the port side of the boat next to the front passenger seat, this storage area provides quick, easy access for small articles.

46) Engine Cover

Pull upwards on the latch below the rear center seat cushion and lift engine cover lid.

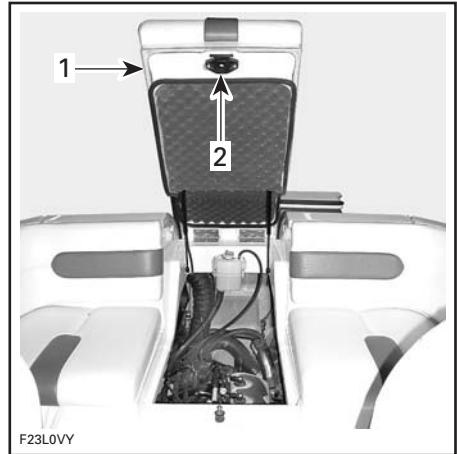

1. Engine cover/center cushion
2. Latch

The gas assist cylinders will complete the opening and hold the cover open.

47) Port Bilge Access

Located at the port rear of the boat.

This area allows access to the battery, the main battery cut-off switch and various fuses.

Lift latch to open storage cover.

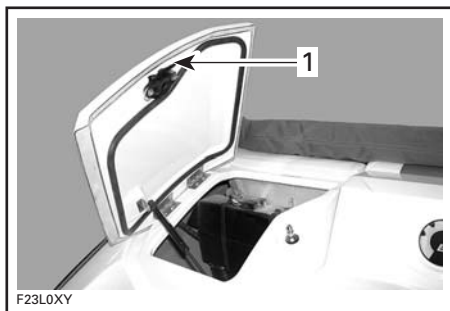

1. Latch

The gas assist cylinder will hold the storage cover open.

WARNING

Always close cover before getting underway.

Also see *MAINTENANCE INFORMATION* section.

48) Removable Cooler

A 15 liter (16 quart) removable cooler is provided for keeping sandwiches and non-alcoholic beverages cold.

It is located in the starboard rear seat storage compartment, and will also fit in the port rear seat storage compartment.



COOLER

1. Port side shown

49) AM/FM Radio/CD Player Remote Control

SE Models



RADIO REMOTE CONTROL

A remote control for the AM/FM Radio/CD Player is included as standard equipment and is located on the dashboard.

Please refer to included *MANUFACTURER'S INSTRUCTION SHEET* for remote control operation.

50) Bimini Top

SE Models

The bimini top is convenient for protection against inclement weather or sunshine.

WARNING

- Avoid body contact with bimini top.
- Hold down straps are under tension.
- Do not use bimini top as a support.
- Operate boat only at low speeds if bimini top is in use.
- Top can break or dislodge causing a risk of personal injury or interference with boat operation.

Opening Bimini Top

Unzip and remove cover.

Store cover in a storage area.

Detach straps from bimini top.

Models without Tower

Lift bimini top to vertical position.

Pull front portion of canvas towards the front of the boat and fasten front straps to eyelets.

Pull rear portion of canvas towards the rear of the boat and fasten rear straps to eyelets.

Adjust center structural tubes at the same position on both sides to support center of canvas.

Adjust front structural tubes at the same position on both sides to support front portion of canvas.

Adjust front and rear straps tension as needed.

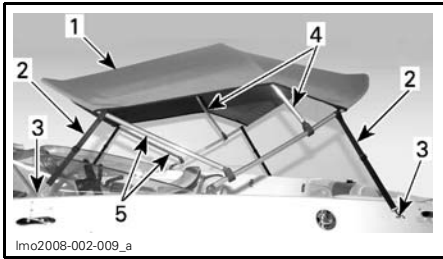

WITHOUT TOWER

1. Canvas
2. Straps
3. Eyelets
4. Center structural tubes
5. Front structural tubes

Models with Tower

Pull bimini top towards the front of the boat until canvas is stretched.

Fasten straps to eyelets on body of boat.

Adjust center structural tubes at the same position on both sides to support center of canvas.

Adjust straps tension as needed.



WITH TOWER

1. Canvas
2. Straps
3. Eyelets
4. Center structural tubes

Closing/Storing Bimini Top

NOTE: If canvas of bimini top has been splashed by salt water, rinse canvas with cold fresh water. At any time when canvas is wet, let dry before installing cover and storage.

Unhook front straps.

Unhook rear straps, if applicable.

Lower center structural tubes.

Fold bimini top carefully.

Tilt bimini top towards the rear of boat.

Install protective cover.

Place bimini top straps inside cover and slowly zip while packing canvas inside cover.

LIQUIDS

CAUTION: Carefully follow the instructions of this section. Failure to do so may reduce the engine's life and/or performance.

Recommended Fuel

Use unleaded gasoline or oxygenated fuel containing a maximum total of 10% of ethanol or methanol or both. The gasoline used must have the following recommended octane number.

CAUTION: Never experiment with other fuels or fuel ratios. The use of unrecommended fuel can result in boat performance deterioration and damage to critical parts in the fuel system and engine components.

Inside North America

OCTANE NUMBER		
(87 (RON + MON)/2)		
(91 (RON + MON)/2)	▼	▼
ENGINES	91	87
215 HP Supercharged Intercooled	X ⁽¹⁾	X

⁽¹⁾ Recommended for optimum performance.

Outside North America

OCTANE NUMBER		
92 RON		
95 RON	▼	▼
ENGINES	95	92
215 HP Supercharged Intercooled	X ⁽¹⁾	X

⁽¹⁾ Recommended for optimum performance.

Recommended Engine Oil

Recommended Oil

Use XP-S 10W 40 4-stroke oil (P/N 219 700 346) or an equivalent approved by BRP.

The same oil lubricates both the engine and the supercharger clutch.

XP-S 10W 40 4-stroke oil (P/N 219 700 346) has been thoroughly tested to be free of any additives that could impair the functionality of the supercharger clutch.

NOTE: Use of any oil that is not recommended may void BRP's limited warranty.

Synthetic Oil

CAUTION: NEVER use synthetic oil in these engines. This would impair the proper operation of the supercharger clutch. Do not add any additives to the recommended oil. Beware that oils not recommended by BRP may contain additives (friction modifiers that may cause inappropriate slippage of the supercharger and eventually lead to premature wear. For this reason, oils other than XP-S 10W 40 4-stroke oil (P/N 219 700 346) or an approved equivalent are not recommended.

Engine Oil Level

CAUTION: Check level frequently and refill if necessary. Do not overfill. Operating the engine with an improper oil level may severely damage engine. Wipe off any spillage.

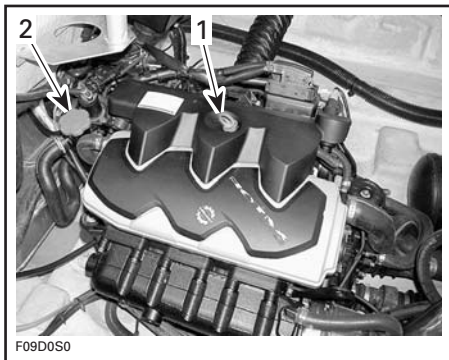

TYPICAL
 1. Dipstick
 2. Oil cap

Boat must be level.

Oil level can be checked either with boat in water or out of water.

If Boat Out of the Water

If the boat is out of the water and on a trailer, block the wheels and raise the bow slightly with the trailer jack (if so equipped) until the bumper rail is level.

Install a garden hose to the flushing connector. Refer to *EXHAUST SYSTEM FLUSHING* in *STORAGE AND PRESEASON PREPARATION* and follow the procedure.

CAUTION: Never run engine without supplying water to the exhaust system when boat is out of water. Failure to supply water to the exhaust system may severely damage exhaust system.

CAUTION: Never run engine longer than 5 minutes. Drive line seal has no cooling when boat is out of water.

Procedure

It is of the utmost importance to follow this procedure in order to obtain an accurate reading of the engine oil level.

⚠ WARNING
 Engine oil may be hot. Certain components in the engine compartment may be very hot. Direct contact may result in skin burn.

Ensure engine is at normal operating temperature.

Let engine **idle** for **30 seconds** before stopping.

Stop engine.

Wait at least 30 seconds.

Pull dipstick out and wipe clean.

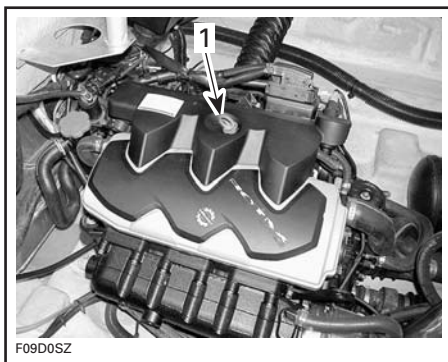

TYPICAL
 1. Dipstick

Reinstall dipstick, push in completely.

Remove dipstick and read oil level. It should be between marks.

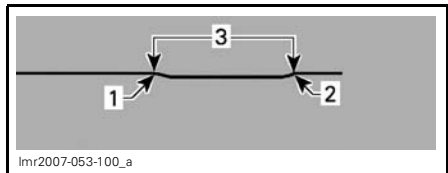

1. Full
 2. Add
 3. Operating range

Otherwise, add oil up to have the level between marks as required.

To add oil, unscrew oil cap. Place a funnel into the opening and add the recommended oil to the proper level.

Do not overfill.

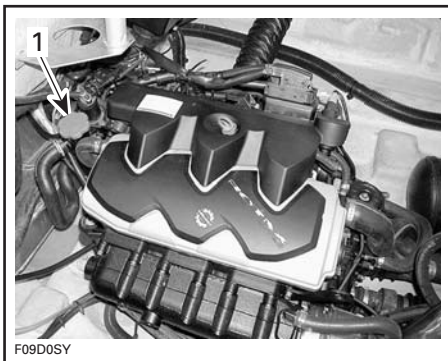

TYPICAL
1. Oil cap

NOTE: Every time oil is added in engine, the complete procedure explained above must be done. Otherwise, you will have a false oil level reading.

Properly reinstall oil cap and dipstick.

Engine Coolant

Recommended Coolant

Always use ethylene-glycol antifreeze containing corrosion inhibitors specifically for internal combustion aluminum engines.

NOTE: When available, it is recommended to use biodegradable antifreeze compatible with internal combustion aluminum engines. This will contribute to protect the environment.

Cooling system must be filled with water and antifreeze solution (50% water, 50% antifreeze).

BRP sells premixed coolant with freezing protection up to - 52°C (- 62°F) (P/N 219 700 362).

To prevent antifreeze deterioration, always use the same brand. Never mix different brands unless cooling system is completely flushed and refilled. Refer to an authorized Sea-Doo Sport Boats dealer.

Coolant Level

WARNING

Check coolant level with engine cold. Never add coolant in cooling system when engine is hot.

With boat on a level surface, liquid should be between MIN. and MAX. level marks of coolant reservoir when engine is cold.

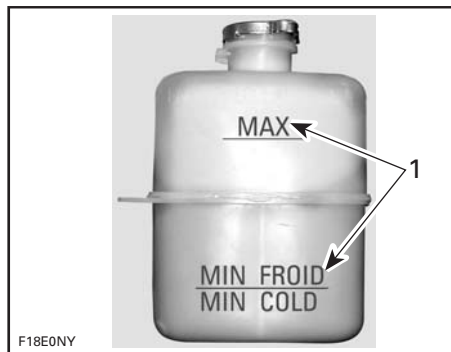

1. Level between marks when engine is cold

NOTE: The boat is considered level when it is in water. When on a trailer, block the wheels and raise the bow slightly with the trailer jack (if so equipped) until the bumper rail is level.

Add coolant to have the level between marks as required. Use a funnel to avoid spillage. **Do not overfill.**

Properly reinstall and tighten filler cap.

NOTE: A cooling system that frequently requires coolant is the indication of leaks or engine problems. See an authorized Sea-Doo Sport Boats dealer.

BREAK-IN PERIOD

CAUTION: Carefully follow the instructions of this section. Failure to do so may reduce the engine's life and/or performance.

With Sea-Doo Sport Boats powered by Rotax engines, a break-in period of 10 hours is required before continuous operation at full throttle.

To achieve a good break-in, throttle lever should not be advanced more than 3/4 opening, however, brief acceleration and speed variations contribute to a good break-in.

CAUTION: Continued wide open throttle runs and prolonged cruising without speed variations should be avoided. This can cause engine damage during the break-in period.

NOTE: Never add oil in fuel tank.

PRE-OPERATION CHECKS

WARNING

The pre-operation check is very important before operating the boat. Always check the proper operation of critical controls, safety features and mechanical components before starting. If not done as specified here, severe injury or death might occur. Bring all safety equipment required by local laws.

Some of the following items may not have been previously covered in this guide, however they will be described in the *MAINTENANCE INFORMATION* or *SPECIAL PROCEDURES* section. Please refer to these portions to have more detailed information.

WARNING

Engine should be off and the DESS key must always be removed from the DESS post before verifying any of the following. Only start boat once all items have been checked and operate properly.

SUMMARY

ITEM	OPERATION	✓
Hull	Inspect for damage.	
Jet pump water intake	Inspect/clean.	
Bilge	Drain. Ensure plugs are secured.	
Battery	Inspect tightness of cables and retaining straps. Verify sufficient charge.	
Main battery cut-off switch	Ensure it is in the ON position.	
Navigation lights	Check operation.	
Fuel tank	Refill.	
Engine compartment	Verify fuel exhaust components.	
Fire extinguisher	Inspect condition/mounting.	
Steering	Check operation.	
Throttle/shifter system	Check operation.	
Bilge blower and bilge pump	Check operation.	
DESS post and engine start/stop switch	Check operation.	
Mandatory safety boating equipment	Check operation.	
Storage compartment covers	Ensure they are closed and latched.	
Sacrificial anodes	Verify condition (replace when 50% corroded).	
Engine oil level	Refill as needed.	
Cooling system coolant level	Refill as needed.	

Hull

Inspect hull for cracks or damage.

Jet Pump Water Intake

Remove weeds, shells, debris or anything else that could restrict the flow of water and damage the cooling system or propulsion unit. Clean as necessary. If any obstruction cannot be removed, refer to an authorized Sea-Doo Sport Boats dealer for servicing.

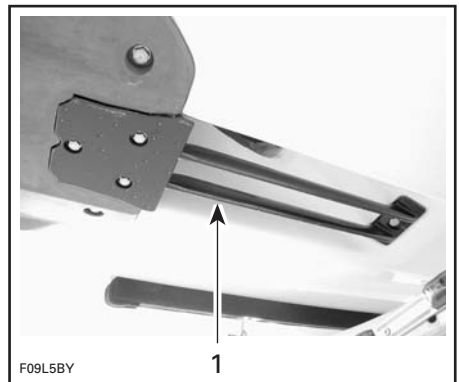

TYPICAL
1. Inspect this area

Inspect leading edges of the impeller for nicks or bends, which will greatly reduce performance of the boat.

Bilge

If water is present in the bilge, turn on pump switch to empty the bilge.

When on a trailer, block the wheels, unscrew the drain plugs and raise the bow slightly with the trailer jack (if so equipped) so that water can flow out of the bilge.

WARNING

Make sure drain plugs are properly secured before launching the boat in water.

Battery

WARNING

Verify tightness of battery cables to their posts and condition of retaining straps/fasteners. Do not charge or boost battery while installed in engine compartment.

Fuel Tank and Engine Oil Level

With the boat level, fill the fuel tank.

Check the oil level and refill as necessary as per *LIQUIDS* section.

Check fuel tank retaining straps/fasteners.

Engine Compartment

WARNING

If any leaks or gasoline odors are present, do not start the engine. Consult an authorized Sea-Doo Sport Boats dealer.

WARNING

In order to avoid potential burns, do not remove the coolant reservoir cap if engine is still hot.

Fire Extinguisher

Make sure fire extinguisher is full, in good condition and well secured.

Steering System

Have another person help check steering operation for free movement. When the steering is centered, the jet pump nozzle should be in the straight ahead position. Ensure the jet pump nozzle pivots easily while steering is turned.

WARNING

Check steering and corresponding steering nozzle operation before starting engine.

Throttle System

Check throttle lever for free and smooth operation.

WARNING

Check throttle lever operation before starting the engine.

Shifter System

Check that reverse gate moves freely. With shifter lever in forward position, the gate must be in upward position. With the shifter lever in neutral position, gate must be in middle position. With shifter lever in reverse position, gate must be in downward position.

WARNING

Verify the reverse gate lock.

To verify the reverse gate lock, move shifter to FORWARD position.

Pull backwards on the reverse gate.

The reverse gate lock is working if the reverse gate stays in the up position.

CAUTION: If the reverse gate does not stay in the up position when the shifter is at FORWARD, do not operate the boat further, see an authorized Sea-Doo Sport Boats dealer.

DESS Post and Engine Start/Stop Switch

Ensure that switches operate properly.

WARNING

If engine does not shut-off when pushing engine start/stop switch or by disconnecting the DESS key from the DESS post, do not operate the boat further, see an authorized Sea-Doo Sport Boats dealer. Only start boat once all items have been checked and operate properly.

Storage Compartment Covers

Ensure they are closed and latched.

OPERATING INSTRUCTIONS

⚠ WARNING

Always perform *PRE-OPERATION CHECKS* before operating the boat. Become thoroughly familiar with all controls and the function of each. Should any control or instruction be not fully understood, refer to an authorized Sea-Doo Sport Boats dealer.

Launching/Loading

CAUTION: Before launching the boat, ensure the main battery cut-off switch is turned ON and the bilge plugs are fully screwed into place.

When finished loading the boat on trailer, turn the main battery cut-off switch to OFF.

Remove bilge plugs to drain bilge when boat is on trailer.

Principle of Operation

Propulsion

The engine is directly coupled to a drive shaft which, in turn, rotates an impeller. This impeller rotates within a housing drawing water in from beneath the boat. Water is then forced by the impeller through a venturi. The venturi pressurizes and accelerates the water, producing thrust to move the boat. Pushing the throttle lever forward increases engine speed and therefore boat speed.

When the shifter lever is pushed forward, the boat moves forward. Pulled back in the reverse position, the boat moves backwards. The middle position is neutral and the boat is at the minimum thrust for most conditions. Neutral and reverse are achieved by means of a gate, which is installed on the jet pump venturi housing. This gate directs the water flow to obtain the desired direction.

⚠ WARNING

When the shifter is in neutral position, the impeller is turning.

⚠ WARNING

Shifter lever should only be used when the engine is idling and boat is stopped.

⚠ WARNING

When an engine is to be started, the operator and passengers should always be sitting in the boat with the shifter lever in neutral position and throttle lever in idle position.

Throttle/Shifter Controller

FORWARD

The shifter lever should be in the forward position in order for the boat to advance.

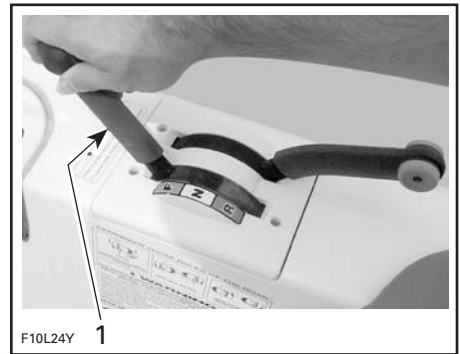

TYPICAL

1. Shifter lever in forward position

CAUTION: Do not force lever, insure throttle lever is in idle position before shifting.

NEUTRAL

To obtain neutral, pull shifter lever to the upright position. Reverse gate will be in the middle position, directing half of the thrust toward the front of the boat to minimize movement.

WARNING

When the shifter is in neutral position, the impeller is turning.

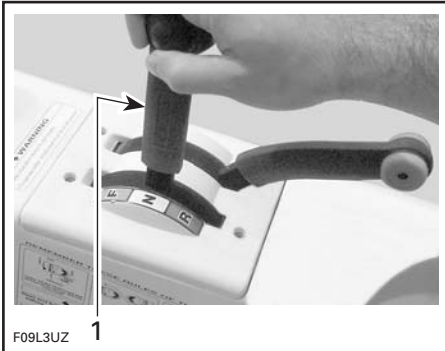

TYPICAL

1. Shifter lever in neutral position

REVERSE

To obtain reverse, pull shifter lever completely to the rear. Reverse gate will be in downward position, directing all the thrust toward the front of the boat.



TYPICAL — SHIFTER LEVER IN REVERSE POSITION

NOTE: To obtain maximum efficiency and control from the reverse, increase engine speed to slightly above idle. Too much RPM will create water turbulence and reduce reverse efficiency.

Steering

Turning the steering pivots the jet pump nozzle which controls the boat direction. Turning the steering wheel clockwise will turn the boat to the right and inversely.



TYPICAL — RIGHT-HAND TURN

Above idle speed, throttle must be applied to turn the boat.

WARNING

Throttle must be applied and steering turned to change the direction of the boat at speed. Steering efficiency will differ depending on the number of passengers, load and water conditions.

A jet propelled boat needs some throttle applied in order to turn. Practice in a safe area applying the throttle and turning away from an imaginary object. This is a good collision avoidance practice.

Using Reverse

The boat behaves differently when using reverse. The steering response is the opposite of forward operation. So, turning the steering wheel clockwise will turn the back of the boat to the left and inversely. Use throttle moderately. Too much RPM will create water turbulence and reduce reverse efficiency. At first outing, carefully practice this maneuver away from anything with which you might collide.

WARNING

Become fully familiar with this feature during your first ride and before carrying passengers.

In reverse position, turn the steering wheel in the opposite direction that you want to move the rear of the boat.

For example, to steer the rear of the boat to the left side, turn the steering wheel to the right side.

Boarding from a Dock

As with any boat, boarding should be done carefully and engine must not be running.

When boarding from a dock, slowly place one foot on the boat deck nearest to the dock and then move the other foot inside the boat. Push the boat away from the dock.

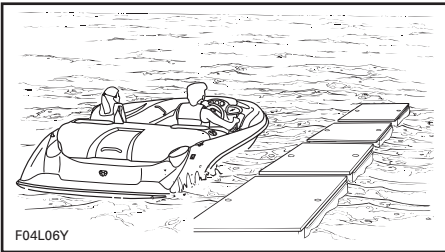

TYPICAL

CAUTION: Although the boat requires only 30 cm (1 ft) of water to float, the engine should be started with at least 90 cm (3 ft) of water below the hull. If the depth of water is less than 90 cm (3 ft) and the engine is running, the impeller is turning and debris can be drawn from the bottom and damage the propulsion system.

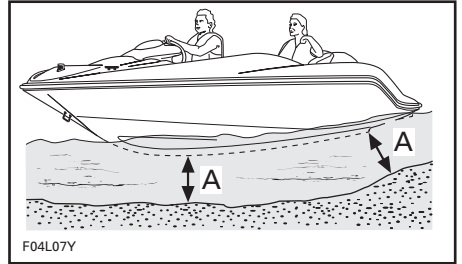

TYPICAL
A. 90 cm (3 ft)

Boarding from the Water

WARNING

Inexperienced riders should practice how to get aboard close to shore first before venturing into deep water.

WARNING

Engine should not be running while boarding. Never use propulsion components as a supporting point to board the boat.

Swim to the rear of the boat.

Release the rubber stays on one-step ladder pulling ladder out and down into boarding position. Grip the grab handle and pull yourself up until your knee can reach the swim platform.

⚠ WARNING

Never leave ladder in down position when engine is running or boat is in motion. Always secure ladder with rubber stays when not in use.

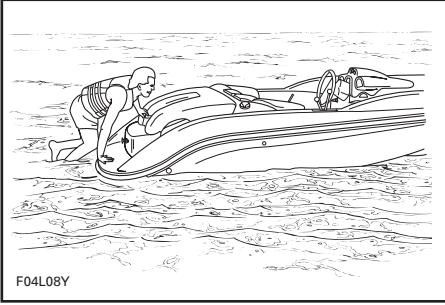

TYPICAL

When you can reach the engine cover grab handle, grip it and continue to pull yourself upward to place your knee on the swim platform.

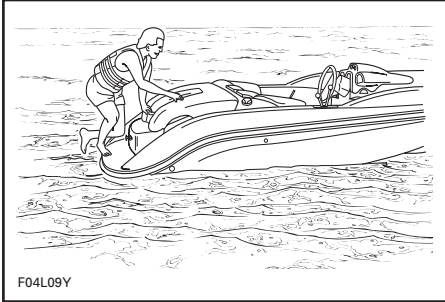

TYPICAL

Continue to climb on engine cover to reach the deck.

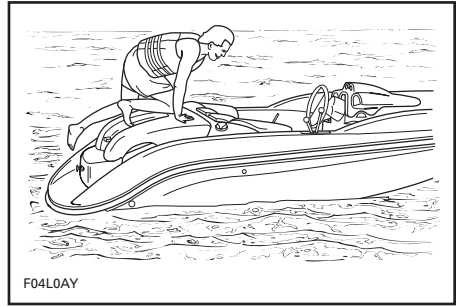

TYPICAL

CAUTION: Do not leave ladder hanging when operating the boat. Before operating the boat, always fasten the ladder in place using the latch.

⚠ WARNING

Do not start engine until all passengers are properly seated.

Starting

⚠ WARNING

Engine exhaust fumes contain carbon monoxide (CO) which can accumulate in and around the boat (under Bimini top, in cockpit, etc.). CO can be harmful or fatal if inhaled. Assure there is adequate ventilation whenever running engine.

⚠ WARNING

Always activate bilge blower 5 minutes minimum before starting the engine to allow the bilge blower to ventilate the bilge.

CAUTION: Bilge blower must be turned off during Sport Boats operation.

WARNING

Do not touch electrical parts or jet pump area when engine is running. Attach the safety lanyard to your PFD and snap the DESS key to the DESS post before starting the engine.

NOTE: If you hear some beeper signals other than 2 short beeps, it indicates a particular condition that must be corrected. Refer to chart in the *TROUBLESHOOTING* section for the meaning of the coded signal.

Grip steering wheel with your right hand and place both feet on the floorboard. Turn off bilge blower.

Start engine. Check tachometer to monitor engine.

WARNING

Before starting, the operator and passengers should always be properly seated.

CAUTION: To avoid starter motor overheating, the cranking period should not exceed 5 - 10 seconds and a rest period of 30 seconds should be observed between cranking cycles to let the starter cool down and its mechanism disengage.

Leaving the Shore

With throttle lever at idle position, move shifter lever to the desired direction.

Slowly accelerate to reach deeper water. Do not apply full throttle until engine is warm.

WARNING

In shallow water, shells, sand, pebbles or other objects could be drawn up by the jet pump and thrown rearward.

Rough Water or Poor Visibility Operation

Avoid operation in these conditions. If you must do so, proceed with caution and prudence using minimum speed. Turn on navigation lights if necessary.

Crossing Waves

Reduce speed when crossing waves. Always be prepared to steer and balance as necessary.

When crossing wakes, always keep a safe distance from boat ahead.

WARNING

When crossing wakes, slow down. Operator and passenger(s) can brace themselves by posting. Do not jump waves or wakes.

Stopping/Docking

The boat is slowed by water drag. The stopping distance will vary depending on weight, speed, water surface condition, presence and direction of wind and current.

The operator should become familiarized with the stopping distance under different conditions.

Reduce speed to idle. Shift to neutral, reverse or forward as required when approaching a dock then shut off the engine just before coming alongside.

WARNING

Directional control is reduced when throttle is decreased and lost when engine is off.

Beaching

CAUTION: It is not recommended to run the boat onto the beach.

Come slowly to the beach and shut off the engine using the DESS key when water depth is 90 cm (3 ft) under the hull, then pull the boat to the beach. Ensure that all accessories are OFF.

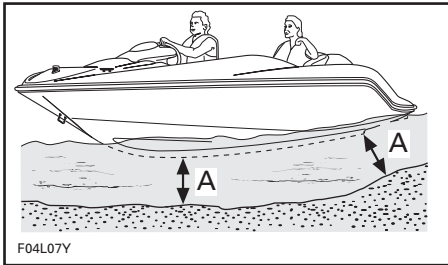

A. 90 cm (3 ft) of water under the hull

⚠ WARNING

In shallow water, shells, sand, pebbles or other objects could be drawn up by the jet pump and thrown rearward.

As necessary, the exhaust system should be flushed before restarting, in order to remove sand or shell accumulation which may clog the water passages. Refer to *STORAGE AND PRESEASON PREPARATION* and look for *EXHAUST SYSTEM FLUSHING*.

Shutting Off the Engine

To shut off the engine, completely pull back throttle lever then remove the DESS key or press the engine start/stop switch.

Always remove the DESS key from the DESS post.

⚠ WARNING

Should the engine be shut off, boat directional control is not available. Never leave the DESS key connected on the DESS post when boat is not in operation to avoid unauthorized use by children, theft or others.

Post-Operation Care

⚠ WARNING

Allow engine to cool before performing any maintenance.

General Care

Once boat is on trailer, unscrew the drain plugs, block the wheels and raise the boat up at the bow with the trailer jack (if so equipped) to allow water to drain.

Remove any remaining water in the engine compartment (bilge, engine, etc.) with clean dry rags. This is particularly important in salt water use.

Remove the boat from the water every day to prevent growth of marine organisms.

Anticorrosion Treatment

To prevent corrosion, spray a corrosion inhibitor (salt water resistant) such as XP-S Lube lubricant or equivalent over metallic components in engine compartment.

NOTE: Engine fogging should be done with XP-S Lube lubricant whenever the boat is to be stored for few days or a long period.

Apply dielectric grease (salt water resistant) on battery posts and cable connectors.

CAUTION: Never leave rags or tools in the engine compartment or in the bilge.

Additional Care for Foul Water or Salt Water Use

When the boat is operated in foul water and particularly in salt water, additional care must be taken to protect the boat and its components. Rinse trailer and boat's hull/bilge area with fresh water.

Flushing the exhaust system **with fresh water** is essential to neutralize corroding effects of salt or other chemical products present in water. It will help to remove sand, salt, shells or other particles in water jackets and/or hoses.

Flushing should be performed when the boat is not expected to be used further the same day or when the boat is stored for any extended time.



WARNING

Perform this operation in a well ventilated area.

Refer to *EXHAUST SYSTEM FLUSHING* in *STORAGE AND PRESEASON PREPARATION* section for procedure.

CAUTION: Failure to perform proper care such as: boat rinsing, exhaust system flushing and anticorrosion treatment, when used in salt water, will result in damage to the boat and its components. Never leave the boat stored in direct sunlight.

In coastal areas, special care should also be taken on stainless steel or chrome parts like grab handles, mooring cleats, fuel cap and navigation lights. Rinse with fresh water. Clean with a good car chrome polish. Protect with a good car or fiberglass wax.

SPECIAL PROCEDURES

Jet Pump Water Intake and Impeller Cleaning

WARNING

Keep away from intake grate while engine is on. Items such as long hair, loose clothing or personal flotation device straps can become entangled in moving parts resulting in severe injury or drowning.

Weeds, shells or debris can get caught on the intake grate, drive shaft and/or impeller. A clogged water intake may cause troubles such as:

1. **Cavitation:** Engine speed is high but boat moves slowly due to reduced jet thrust; jet pump components may be damaged.
2. **Overheating:** Since the jet pump operation controls the flow of water to cool the exhaust system, a clogged intake will cause the engine to overheat and damage internal engine components.

The clogged area can be cleaned as follows:

In-water cleaning: Pull the DESS key from DESS post to stop engine. Let the boat stop by itself. Wait a while to allow weeds or other debris to escape from grate. It may be necessary to repeat the procedure.

In severe conditions if the above method does not work, the following can be performed:

- With engine running, put shifter lever in reverse position and vary throttle setting quickly several times.
- Try accelerating again.

Most of the time, debris will escape from the propulsion system.

Out of water cleaning: If the system is still clogged, shut off the engine by removing the DESS key.

WARNING

Always remove the DESS key from the DESS post to prevent accidental engine starting before cleaning the jet pump area.

From underneath boat, manually clean water intake area. If the system is still clogged, refer to an authorized Sea-Doo Sport Boats dealer for servicing.

CAUTION: Avoid operation in weeded areas. If unavoidable, vary speed. Weeds tend to entangle more at steady and slow speeds. Inspect water intake grate for damage. Refer to an authorized Sea-Doo Sport Boats dealer for repair as necessary.

Capsized Boat

This boat is designed so that it should not turn over easily due to its long and wide dimensions. If the boat ever capsizes, remember that it will continue to float. It is usually best to remain with it, so you will be more easily located by others.

WARNING

When boat is capsized, do not attempt to restart the engine. Operator and passengers should always wear approved personal flotation devices.

Submerged Boat/ Water-Flooded Engine

To limit damages to the engine, perform the following procedure as soon as possible.

Drain bilge.

If it was submerged in **salt water**, spray bilge and all components with fresh water using a garden hose to stop the salt corroding effect.

CAUTION: Never try to crank or start the engine. Water trapped in intake manifold would flow towards the engine and may cause severe damage to the engine.

Bring the boat to be serviced by an authorized Sea-Doo Sport Boats dealer as soon as possible.

CAUTION: The longer the delay before you have the engine serviced, the greater the damage will be to the engine. Failure to have the engine properly serviced **will** cause severe engine damage.

Fuel-Flooded Engine

If engine is fuel-flooded and does not start, this special mode can be activated to prevent fuel injection and ignition while cranking. Proceed as follows to activate it.

- Stop the engine
- Set throttle lever in idle position.
- Set shifter lever in neutral position.
- Install DESS key on DESS post.
- From engine compartment, manually rotate throttle lever into fully opened position and HOLD.

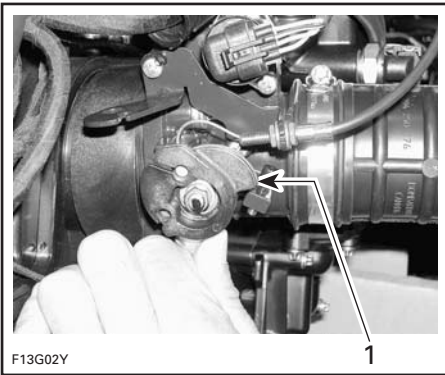

TYPICAL
1. Fully-open position

- Ask someone to press the start/stop switch to crank engine while still HOLDING the throttle lever in fully-opened position. The drowned mode is now on.
- Crank engine several times.

CAUTION: Do not hold the start switch more than 30 seconds. A rest period should be observed between the cranking cycles to let the starter cool down. Pay attention not to discharge the battery.

- Release engine start/stop switch.
- Release throttle lever and start/crank engine again to allow starting.

NOTE: Releasing throttle lever will bring back to its normal mode.

If it does not work:

Disconnect ignition coil connectors.

All three ignition coils are located on the cylinder head directly on the spark plugs.

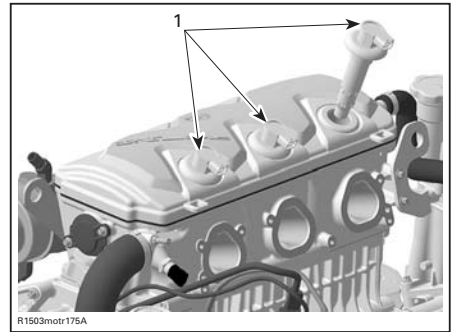

1. Ignition coils



smr05-015-001

DISCONNECT IGNITION COIL CONNECTORS

WARNING

When disconnecting coil from spark plug, always disconnect coil from main harness first. Never check for engine ignition spark from an open coil and/or spark plug in the engine compartment as spark may cause fuel vapor to ignite.

Remove ignition coils.

CAUTION: Ensure there is no dirt in coil holes before removing the spark plugs. Otherwise, dirt would fall into cylinder and will damage the internal components.

Remove spark plugs.

NOTE: After loosening the spark plugs, a coil may be used to pull the spark plugs out. Simply bring the coil down to spark plug and "hook" it to then extract spark plug.

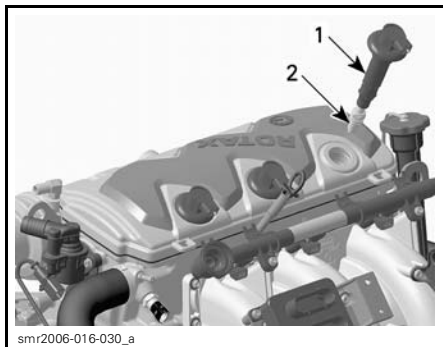

smr2006-016-030_a

1. Ignition coil
2. Spark plug

Install new spark plugs if available, or dry spark plugs using a rag.

Reinstall spark plugs and ignition coils. Reconnect ignition coil connector.

NOTE: After installation, ensure the seal seats properly with the engine top surface.

Start engine as explained above. If engine continues to flood, see an authorized Sea-Doo Sport Boats dealer.

CAUTION: Never run engine without supplying water to the exhaust system when boat is out of water.

Towing the Boat in Water

Special precautions should be taken when towing a Sea-Doo Sport Boats in water.

Maximum recommended towing speed is 24 km/h (15 MPH).

When towing your Sport Boats in water, pinch the water supply hose from the impeller housing to the exhaust manifold with a large hose pincher (P/N 529 032 500).

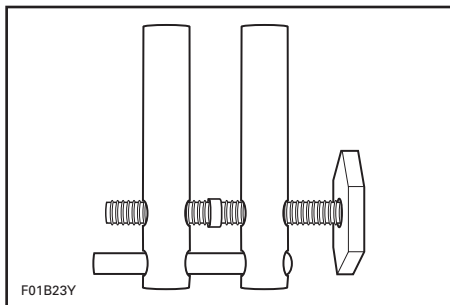

This will prevent the exhaust system from filling which may lead to water being injected into and filling the engine. Without the engine running there isn't any exhaust pressure to carry the water out the exhaust outlet.

CAUTION: Failure to do this may result in damage to the engine. If your Sea-Doo Sport Boats must be towed in water and you do not have a hose pincher, be sure to stay well below the maximum towing speed of 24 km/h (15 MPH).

Snugly install the hose pincher on the water supply hose as shown.

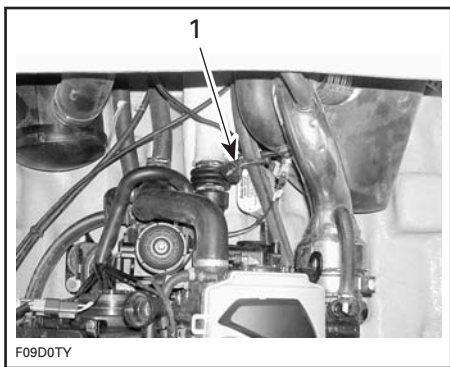

TYPICAL

1. Hose pincher

CAUTION: When finished towing the Sport Boats, hose pincher must be removed before operating it. Failure to do so will result in damage to the engine.

TROUBLESHOOTING

The following information is provided to help in diagnosing the probable source of simple troubles. You may be able to solve many of these problems rather quickly, but others may require the skills of a mechanical technician. In such a case, consult an authorized Sea-Doo Sport Boats dealer for servicing.

Monitoring System Coded Signals

2 SHORT (while installing DESS key on DESS post).

1. **Everything is correct with the DESS KEY (good contact and the right key).**
 - *Engine can be started normally.*

1 LONG (while installing DESS key on DESS post or when pressing start/stop switch in some cases).

1. **Shifter lever not in Neutral position.**
 - *Move shifter lever to Neutral position.*
2. **Bad connection between DESS key and DESS post.**
 - *Remove and reinstall the DESS key on the DESS post. Two short beeps should be heard which indicate the system is ready again to allow engine starting.*
3. **Wrong key.**
 - *Use the DESS key that has been programmed for the boat. If it does not work, refer to an authorized Sea-Doo Sport Boats dealer.*
4. **Dirty DESS key.**
 - *Clean.*
5. **Improper operation of Interface or defective wiring harness.**
 - *Refer to an authorized Sea-Doo Sport Boats dealer.*

4 SHORT BEEPS (while pressing start/stop switch with DESS key already installed).

1. **Shifter is NOT in neutral.**
 - *Place shifter in neutral. While moving the shifter, 1 short beep indicates you reached the neutral position.*

1 SHORT BEEP (while moving shifter to neutral).

1. **Confirmation that shifter is now in neutral.**
 - *Engine is now ready to be started.*

4 SHORT BEEPS AT DIFFERENT INTERVAL.

1. **DESS key has been left on its post without starting engine or after engine was stopped.**
 - *To prevent battery discharge, remove the key from its post.*

CONTINUOUSLY BEEPS.

1. **High engine coolant temperature.**
 - *Refer to ENGINE OVERHEATS further in this section.*

CONTINUOUSLY BEEPS. (cont'd)

2. High exhaust temperature.

- Refer to *ENGINE OVERHEATS* further in this section.

3. Low or high engine oil pressure.

- Check oil level as soon as possible. If it does not work, contact an authorized Sea-Doo Sport Boats dealer.

Charging System

BATTERY IS REGULARLY DISCHARGED.

1. Check battery condition.

- Charge or install new battery.

2. Check charging system fuse.

- Replace fuse if necessary and have charging system checked by an authorized Sea-Doo Sport Boats dealer.

Nothing is Working in the Electrical System

NO BEEPS ARE HEARD WHEN INSTALLING THE DESS KEY ON DESS POST.

1. Main battery cut-off switch is turned OFF.

- Verify and turn ON.

2. Battery discharged or missing.

- Charge or install new battery.

WARNING

See your authorized Sea-Doo Sport Boats dealer to have the battery charged or replaced. Do not charge or boost the battery while installed in the engine compartment. Electrolyte is poisonous and capable of causing severe burns.

Engine will not Start

ENGINE DOES NOT TURN OVER AND THE MONITORING BEEPER SOUNDS.

1. Refer to *MONITORING SYSTEM CODED SIGNALS* above.

ENGINE DOES NOT TURN OVER.

1. Safety lanyard removed.

- Install cap over DESS post.

2. Burnt fuse.

- Check wiring then replace fuse.

3. Discharged battery.

- Refer to an authorized Sea-Doo Sport Boats dealer.

ENGINE DOES NOT TURN OVER. (cont'd)

4. Battery connections, corroded or loose.

- Refer to an authorized Sea-Doo Sport Boats dealer.

5. Water flooded engine.

- Refer to an authorized Sea-Doo Sport Boats dealer.

ENGINE SLOWLY TURNS.

1. Discharged or weak battery.

- Refer to an authorized Sea-Doo Sport Boats dealer.

ENGINE TURNS OVER.

1. Fuel tank empty or water contaminated.

- Refill or siphon and fill with fresh fuel.

2. Fuel filter clogged or water contaminated.

- Clean, check fuel tank for water.

3. Fuel flooded engine.

- Refer to FUEL-FLOODED ENGINE in SPECIAL PROCEDURE.

4. Fouled/defective spark plugs.

- Replace.

Engine Misfires, Runs Irregularly

WEAK SPARK.

1. Fouled worn spark plugs.

- Replace.

2. Faulty ignition component.

- Refer to an authorized Sea-Doo Sport Boats dealer.

LEAN FUEL MIXTURE.

1. Fuel: Level too low, stale or water contaminated.

- Siphon and/or refill.

2. Fuel filter, clogged or water contaminated.

- Refer to an authorized Sea-Doo Sport Boats dealer.

Engine Overheats

CAUTION: If the monitoring beeper continuously sounds, **stop engine immediately.**

MONITORING BEEPER CONTINUOUSLY SOUNDS.

1. Check oil and coolant levels.

- Refill if necessary.

2. Clogged jet pump water intake.

- Clean, perform the JET PUMP WATER INTAKE AND IMPELLER CLEANING PROCEDURE.

MONITORING BEEPER CONTINUOUSLY SOUNDS. (cont'd)

3. Incorrect type of fuel or oil.

- *Siphon and refill.*

4. Clogged exhaust system.

- *Flush exhaust system with garden hose. Perform the EXHAUST SYSTEM FLUSHING in STORAGE AND PRESEASON PREPARATION section.*

If engine still overheats, refer to an authorized Sea-Doo Sport Boats dealer for servicing.

Engine Continually Backfires

1. Faulty ignition component.

- *Refer to an authorized Sea-Doo Sport Boats dealer.*

2. Overheated engine.

- *See ENGINE OVERHEATS above.*

WEAK SPARK.

1. Fouled, worn spark plugs.

- *Replace.*

Engine Pinging or Knocking

1. Poor quality gasoline/low octane.

- *Use well known quality and recommended gasoline.*

2. Spark plug heat range too high.

- *Use recommended spark plugs.*

Engine Lacks Acceleration or Power

1. Weak spark/incorrect fuel mixture.

- *Refer to ENGINE MISFIRES above.*

2. Water in fuel.

- *Siphon and replace.*

3. Overheated engine.

- *See ENGINE OVERHEATS above.*

Boat cannot Reach Top Speed

1. Jet pump water intakes clogged.

- *Clean.*

2. Damaged impeller.

- *Replace. Refer to an authorized Sea-Doo Sport Boats dealer.*

Abnormal Noise from Propulsion System

1. Weeds or debris jammed around impeller.

– *Clean and check for damage.*

2. Damaged impeller shaft or drive shaft.

– *Refer to an authorized Sea-Doo Sport Boats dealer.*

SPECIFICATIONS

MODEL		180 CHALLENGER 215 HP
ENGINE		
Engine type		Rotax 1503 4-TEC, 4-stroke, Single Over Head Camshaft (SOHC)
Exhaust system		Water cooled/water injected (opened loop). Direct flow from jet pump
Lubrication	Type	Dry sump (2 oil pumps). Replaceable oil filter. Water-cooled oil cooler
	Oil type	XP-S 10W 40 4-stroke oil (P/N 219 700 346) or an equivalent approved by BRP
Number of cylinders		3
Displacement		1493.8 cm ³ (91 in ³)
Induction type		Supercharger intercooled
Maximum HP RPM		± 50 RPM 8000
COOLING		
Type		Liquid cooled. Closed circuit (see also <i>EXHAUST SYSTEM</i>)
Coolant		Ethylene-glycol and distilled water (50%/50%). Use premix coolant from BRP or a coolant specially formulated for aluminum engines
ELECTRICAL		
Magneto generator output		360 W @ 6000 RPM
Ignition system type		DI (Digital Inductive)
Ignition timing		Not adjustable
Spark plug	Make and type	NGK DCPR8E
	Gap	0.7 - 0.8 mm (.028 to .031 in)
Starting system		Electric starter
Engine RPM limiter setting		8000 RPM

MODEL		180 CHALLENGER 215 HP
ELECTRICAL (cont'd)		
Battery		⁽¹⁾ Not supplied. 12 V group 24, marine starting battery with top-mounted, round taper type battery post
Fuses (engine)	F1: Fuel pump	10 A
	F2: Cylinder 3, ignition coil and injection	10 A
	F3: ECM	5 A
	F4: Cylinder 1, ignition coil and injection	10 A
	F5: Cylinder 2, ignition coil and injection	10 A
	F6: Gauge	2 A
Fuses (VCM)	F1: Accessories	10 A
	F2: Radio	10 A
	F3: Blower	7.5 A
	F4: Bilge pump	3 A
	F5: NAV lights	3 A
	F6: Courtesy lights (if so equipped)	5 A
Fuses (boat)	VCM	2 x 20 A
	EFB	15 A
	Charging system	30 A
	Automatic bilge pump	3 A
	Radio memory	1 A

MODEL		180 CHALLENGER 215 HP
FUEL SYSTEM		
Fuel injection type		Rotax EMS (engine management system). Multipoint Fuel Injection. Single throttle body 52 mm
Fuel	RECOMMENDED FOR OPTIMUM PERFORMANCE	
	Type	Premium unleaded gasoline
	Minimum octane number	Inside North America: (91 (RON + MON)/2) Outside North America: 95 RON
	MINIMUM ALLOWED	
	Type	Regular unleaded gasoline
Minimum octane number	Inside North America: (87 (RON + MON)/2) Outside North America: 92 RON	
PROPULSION		
Jet pump type		Axial flow single stage
Jet pump grease		Jet pump bearing grease (P/N 293 550 032) sold by BRP
Transmission		Direct drive
Pivoting angle of direction (nozzle)		20°
Minimum required water level for jet pump		90 cm (3 ft) underneath the lowest rear portion of hull
Additional information: Do not mix different brands or oil types.		
DIMENSIONS		
Overall length		5.36 m (17 ft 7 in)
Beam		2.49 m (8 ft 2 in)
Draft		30.5 cm (12 in)
Weight	No tower	892 kg (1913 lb) SE: 897 kg (1968 lb)
	With tower	877 kg (1933 lb) SE: 902 kg (1988 lb)
Seating capacity		8
Load limit (passengers + luggage) (based on calm water operation)		8 passengers OR 653 kg (1440 lb)
Dead rise		20°

MODEL		180 CHALLENGER 215 HP
DIMENSIONS (on trailer)		
Length (with swing-away tongue folded)		5.68 m (18 ft 8 in)
Width		2.49 m (8 ft 2 in)
Height	No tower	1.95 m (6 ft 5 in)
	Tower down	SE: 2 m (6 ft 7 in)
	Tower up	SE: 2.57 m (8 ft 5 in)
Gross weight		1290 kg (2843 lb) SE: 1315 kg (2898 lb)
CAPACITIES		
Engine oil		3 L (3.2 U.S. qt.)/oil change w/filter 4.5 L (4.8 U.S. qt) total
Cooling system (coolant)		5.5 L (5.8 U.S. qt) total
Fuel tank (including reserve)		79.5 L (21 U.S. gal)
MATERIALS		
Hull		Composite FRP
Fuel tank		Polyethylene
Seat	Base	Polyethylene
	Foam	Polyethylene

⁽¹⁾ Recommended: Exide R-24-130, 12 V, 25 A•h (130 minutes reserve) or R-24-160 (160 minutes) or equivalent.

BRP reserves the right to make changes in design and specifications and/or to make additions to, or improvements in its products without imposing any obligation upon itself to install them on its products previously manufactured.

MAINTENANCE INFORMATION

10-HOUR INSPECTION

NOTE: The 10-hour inspection is at the expense of the boat owner.

It is highly recommended that after the first 10 hours of operation, the boat be checked by an authorized Sea-Doo Sport Boats dealer. This inspection will also provide the opportunity to discuss the unanswered questions you may have encountered during the first hours of operation.

We recommend that this inspection be signed by an authorized Sea-Doo Sport Boats dealer.

Date of 10-hour inspection

Authorized dealer signature

Dealer code

PERIODIC MAINTENANCE CHART

The schedule should be adjusted according to operating conditions and use. Intensive use of boat will require greater frequency of inspection and maintenance.

A: ADJUST C: CLEAN I: INSPECT L: LUBRICATE R: REPLACE O: OPERATOR D: DEALER	FIRST 10 HOURS						TO BE PERFORMED BY LEGEND
	EVERY 25 HOURS						
	EVERY 50 HOURS						
	EVERY 100 HOURS OR PRESEASON						
	EVERY 200 HOURS OR 2 YEARS						
	PART/TASK						
GENERAL							
Corrosion protection	L ⁽¹⁾		L	L		O	(1) Every 10 hours in salt water use.
Fire extinguisher	Daily inspection					O	
ENGINE							
Engine oil and filter (including cover's O-rings)	R			R ⁽²⁾		D	(2) Replace for storage period or after 100 hours of use whichever comes first.
Engine oil level (refill as needed)	Daily inspection					O	
Rubber mounts	I		I			D	
Supercharger drive gear, shaft and lock washer (if so equipped)					I	D	
Supercharger slipping moment (if so equipped)					I	D	
EXHAUST SYSTEM							
Exhaust system fasteners, hoses and components condition ⁽³⁾	I	I		I		D	(3) Emission-related component. (5) Daily flushing in salt water or foul water use. (6) Perform at storage period of after 100 hours of use whichever comes first (more often in salt water use).
Exhaust system flushing	(5) (6)					O	
Leak from exhaust system components (such as rust and/or black streaking, water leaks or corroded/cracked fittings)		I				O	
COOLING SYSTEM							
Hose and fasteners	I		I	I		D	—
Coolant	I				R	D	
Coolant level	Daily inspection					O	

A: ADJUST C: CLEAN I: INSPECT L: LUBRICATE R: REPLACE O: OPERATOR D: DEALER	FIRST 10 HOURS						TO BE PERFORMED BY LEGEND
	EVERY 25 HOURS						
	EVERY 50 HOURS						
	EVERY 100 HOURS OR PRESEASON						
	EVERY 200 HOURS OR 2 YEARS						
	PART/TASK						
FUEL SYSTEM							
Throttle cable	I			I ⁽⁶⁾		D	(3) Emission-related component. (6) Perform at storage period of after 100 hours of use whichever comes first (more often in salt water use). (7) IMPORTANT: When use in salt water, the throttle body lubrication is highly recommended after every 10 hours of use. Failure to perform lubrication will result in damage to the throttle body.
Fuel injection system sensors	I			I		D	
Throttle body and fuel lines fastener tightening	I		I	I		D	
Throttle position sensor (TPS) ⁽³⁾	I			I		D	
Throttle body (IMPORTANT: see ⁽⁷⁾)	I			L		O/D	
Fuel lines, connections, pressure relief valve and fuel system leak test ⁽³⁾	I			I		D	
Fuel tank straps	I			I		O	
AIR INTAKE SYSTEM							
Air intake silencer fit/tightness	I			I		O	—
ELECTRICAL SYSTEM							
Spark plug ⁽³⁾	I			I	R	D	(1) Every 10 hours in salt water use. (3) Emission-related component. (8) Daily checked.
Electrical connections and fastening (ignition system, starting system, fuel injectors etc.)	I			I		D	
ECM and VCM connectors (visual inspection without disconnecting)				I ⁽¹⁾		O	
EMS fault code reading ⁽³⁾	I			I		D	
Digitally Encoded Security System (DESS)	I			I		D	
Monitoring beeper	Daily inspection					O	
Battery and fasteners ⁽⁸⁾	I			I		O/D	
Main battery cut-off switch	I	I		I		D	
Operation and condition of lights	Daily inspection					O	

A: ADJUST C: CLEAN I: INSPECT L: LUBRICATE R: REPLACE O: OPERATOR D: DEALER	FIRST 10 HOURS						TO BE PERFORMED BY LEGEND
	EVERY 25 HOURS						
	EVERY 50 HOURS						
	EVERY 100 HOURS OR PRESEASON						
	EVERY 200 HOURS OR 2 YEARS						
PART/TASK							LEGEND
ELECTRICAL SYSTEM (cont'd)							
Bilge blower and bilge pump operation	Daily inspection					O	—
Battery condition/charging and installation			I			D	
STEERING SYSTEM							
Steering cable and connections	I			I		D	—
Steering nozzle bushings	I			I		D	
PROPULSION SYSTEM							
Drive shaft corrosion protection				L (6)		D	(4) Inspect each month (more often in salt water) and change when necessary. (6) Perform at storage period of after 100 hours of use whichever comes first (more often in salt water use).
Carbon ring and rubber boot (drive shaft)	I		I			D	
Shifter system, cable and connections	I			I		D	
Drive shaft/impeller splines				I, L		D	
Impeller boot	I			I		D	
Impeller shaft seal, sleeve and O-ring				I (6)		D	
Impeller and wear ring clearance	I		I			D	
Sacrificial anode	(4)					O	

A: ADJUST C: CLEAN I: INSPECT L: LUBRICATE R: REPLACE O: OPERATOR D: DEALER	FIRST 10 HOURS						
	EVERY 25 HOURS						
	EVERY 50 HOURS						
	EVERY 100 HOURS OR PRESEASON						
	EVERY 200 HOURS OR 2 YEARS						
	TO BE PERFORMED BY						
PART/TASK	LEGEND						
HULL/BODY							
Ride plate and water intake grate	Daily inspection					0	(1) Every 10 hours in salt water use.
Windscreen and fasteners	I	I		I		0	
Ride shoes condition	I			I		0	
Storage compartment cover locks	(1)			I, L		0	
Deck drains/scupper valve	Daily inspection					0	
Drain plug (inside bilge), check for obstructions	I			I		0	
Hull	Daily inspection					O/D	
Ski/wakeboard post and fasteners	I		I			0	
Towing tower, ensure all mounting points and connections are fastened and tight	Before each use					0	

NOTE: Some items are included in the *PRE-OPERATION CHECKS* and not necessarily repeated in this chart.

MAINTENANCE PROCEDURES

General

- ⚠ Only perform servicing procedures which are detailed in this guide. Further assistance or information can be obtained from your authorized Sea-Doo Sport Boats dealer. In many instances proper tools and training are required for certain servicing or repair procedures.
- ⚠ Maintain the boat and equipment in top condition at all times. Adhere to the prescribed maintenance schedules. An annual inspection of the boat is always a good recommendation to follow.
- ⚠ The bilge must be kept clean of oil, water or other foreign materials.
- ⚠ Do not attempt to lift the boat without special equipment and training.
- ⚠ The engine and the corresponding components identified in this guide should not be utilized on product(s) other than for those they were designed. Maintenance procedures and specified tightening torque must be strictly adhered to. Never attempt repairs unless the appropriate tools are available. Each boat is designed with parts dimensioned in both the metric and the imperial systems. When replacing fasteners, make sure to use only those recommended by BRP. If required, contact your authorized Sea-Doo Sport Boats dealer for further servicing information.
- ⚠ Operate your boat prudently and have fun. Don't forget that all persons must assist other boaters in an emergency.

Engine Emissions Information

Maintenance, replacement, or repair of the emission control devices and systems may be performed by any marine SI (spark ignition) engine repair establishment or individual.

Manufacturer's Responsibility

Beginning with 1999 model year engines, manufacturers of marine engines must determine the exhaust emission levels for each engine horsepower family and certify these engines with the United States of America Environmental Protection Agency (EPA). An emissions control information label, showing emission levels and engine specifications, must be placed on each boat at the time of manufacture.

Dealer's Responsibility

When performing service on all 1999 and more recent Sea-Doo Sport Boats carrying an emissions control information label, adjustments must be kept within published factory specifications.

Replacement or repair of any emission related component must be executed in a manner that maintains emission levels within the prescribed certification standards.

Dealers are not to modify the engine in any manner that would alter the horsepower or allow emission levels to exceed their predetermined factory specifications.

Exceptions include manufacturer's prescribed changes, such as altitude adjustments for example.

Owner Responsibility

The owner/operator is required to have engine maintenance performed to maintain emission levels within prescribed certification standards.

The owner/operator is not to, and should not allow anyone to modify any engine in a manner that would alter the horsepower or allow emission levels to exceed predetermined factory specifications.

EPA Emission Regulations

All new 1999 and more recent Sea-Doo Sport Boats manufactured by BRP are certified to the EPA as conforming to the requirements of the regulations for the control of air pollution from new boat engines. This certification is contingent on certain adjustments being set to factory standards. For this reason, the factory procedure for servicing the product must be strictly followed and, whenever practicable, returned to the original intent of the design.

The responsibilities listed above are general and in no way a complete listing of the rules and regulations pertaining to the EPA requirements on exhaust emissions for marine products. For more detailed information on this subject, you may contact the following locations:

REGULAR U.S. POSTAL MAIL:

1200 Pennsylvania Ave. NW
Mail Code 6403J
Washington D.C. 20460

FOR ALL COURIER SERVICES:

U.S. Environmental Protection Agency
Office of Transportation and Air Quality
1310 L Street NW
Washington D.C. 20005

INTERNET WEB SITE:

<http://www.epa.gov/otaq/>

E-MAIL:

otaqpublicweb@epa.gov

WARNING

Only perform procedures as detailed in this guide. It is recommended that the assistance of an authorized Sea-Doo Sport Boats dealer be periodically obtained on other components/systems not covered in this guide. Unless otherwise specified, engine must not be running, the DESS key must be removed from the DESS post and the main battery cut-off switch must be turned OFF for all maintenance procedures. Never use jet pump components to lift the boat. Certain components in the engine compartment may be very hot. Direct contact may result in skin burn. When operating the engine while the boat is out of the water, the heat exchangers may become very hot. Avoid any contact with heat exchangers as burns may occur.

Lubrication

Throttle Body

Lubricate throttle body with XP-S Lube or an equivalent.

Use fitting for that purpose provided on the throttle body.

Make sure to spray lubricant at least 3 to 5 seconds for proper lubrication.

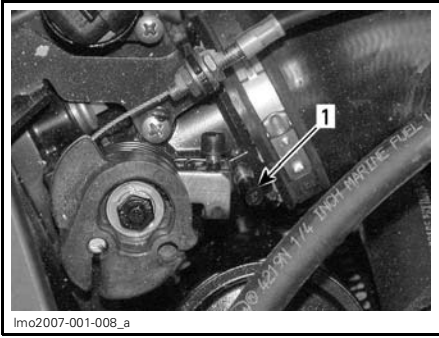

lmo2007-001-008_a

REMOVE CAP

1. Plastic cap

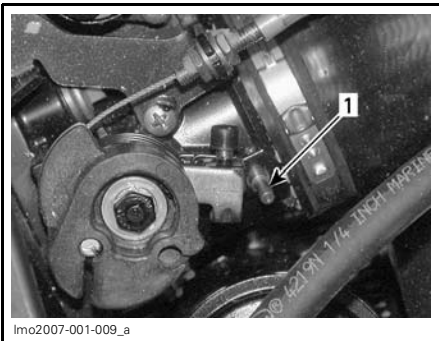

lmo2007-001-009_a

1. Lubrication fitting

Electrical Connections

As necessary, apply dielectric grease on battery posts and all exposed cable connectors including stern light connectors on mast and boat as needed.

CAUTION: Do not lubricate connectors of the VCM (Vehicle Control Module), the EFB (Engine Fuse Block) and the ECM (Engine Control Module).

Additional Moving Mechanism

XP-S Lube lubricant will help to prevent corrosion and keep proper operation of moving mechanisms.

Lubrication of the following items should be performed every 50 hours in fresh water use but every 10 hours in salt water use.

Rear Storage Compartment Cover Mechanism and Hinges

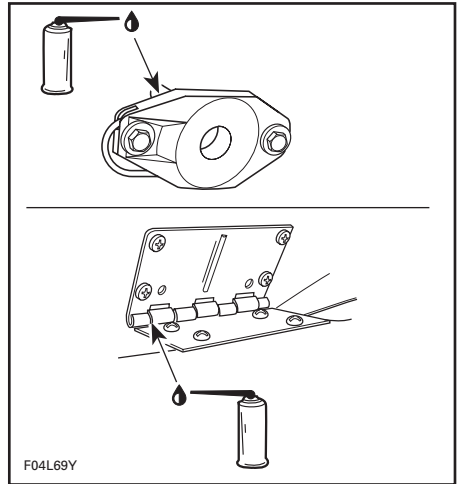

TYPICAL

Reverse Gate

Lubricate pivot points and mechanism on both sides of each gate.

Rear Storage Compartment Cover Cylinders

Lubricate rod of cylinders.

Throttle Cable

Move the throttle lever forward and rearward once. It must operate smoothly. Refer to an authorized Sea-Doo Sport Boats dealer if adjustment is necessary.

WARNING

Do not alter or tamper with throttle cable adjustment or routing.

Engine Oil Change and Oil Filter Replacement

The oil change and filter replacement should be performed by an authorized Sea-Doo Sport Boats dealer.

Coolant Replacement

The coolant replacement should be performed by an authorized Sea-Doo Sport Boats dealer.

Fuel Injection System

The fuel injection system inspection should be performed by an authorized Sea-Doo Sport Boats dealer. Fuel system pressurization should be conducted at the same time.

Steering Alignment

When the steering is aimed in straight ahead position, the jet pump nozzle should be in the same direction to allow the Sport Boats to run in a straight line.

Refer to an authorized Sea-Doo Sport Boats dealer if an adjustment is necessary.

WARNING

Ensure the steering operates freely from side to side.

Shifter Lever

When shifter lever is in forward position, reverse gate should be in an upward position and locked. With the shifter lever in neutral position, reverse gate should be in intermediate position. When shifter lever is in reverse position, reverse gate should be in downward position. Refer to an authorized Sea-Doo Sport Boats dealer if an adjustment is necessary.

WARNING

Ensure the shifter lever operates freely.

Deck Drain

Remove any obstruction(s) from deck drain outlet.

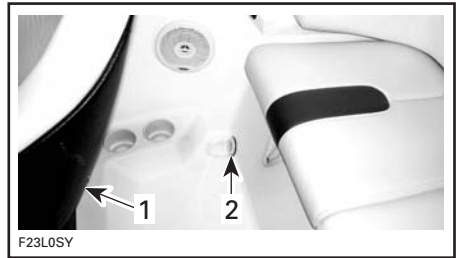

TYPICAL

1. Driver's seat
2. Deck drain hole

Fuses

If a fuse is defective, replace by one of the same rating.

WARNING

Do not use a higher rated fuse as this can cause severe damage. If a fuse has blown, the source of malfunction should be determined and corrected before restarting. See an authorized Sea-Doo Sport Boats dealer for servicing.

Main Fuses

If nothing at all is working, check that the battery cut-off switch is in ON position.

Also, check main fuses connected to main battery cut-off switch inside port rear storage compartment.

NOTE: There are spare fuses inside Engine Fuse Block (EFB) and Vehicle Control Module (VCM) fuse cover.



lmr2007-065-050_a

**TYPICAL — BEHIND BATTERY
CUT-OFF SWITCH**

- 1. 2 x 20 A: VCM
- 3 A: automatic bilge pump
- 1 A: radio memory

Engine Accessory Fuses

Fuses for engine-related components, Engine Control Module (ECM) or information center gauge are integrated in the Engine Fuse Block (EFB), which is located in the engine compartment.



lmr2005-050-004_a

EFB

- 1. 10 A: Fuel pump
- 2. 10 A: Cylinder 3, ignition coil and injection
- 3. 5 A: ECM
- 4. 10 A: Cylinder 1, ignition coil and injection
- 5. 10 A: Cylinder 2, ignition coil and injection
- 6. 2 A: Gauge

Squeeze cover locking tabs and pull cover out to access fuses.

Use the cover tabs to remove the fuse.

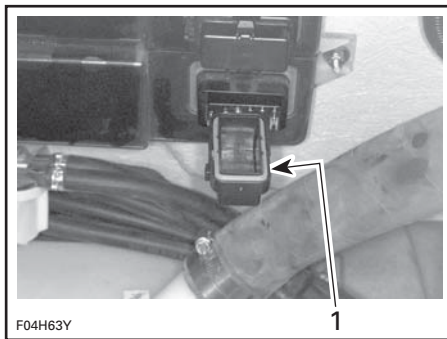

F04H63Y

TYPICAL

- 1. Slide cover tabs each side of fuse then pull fuse out

When finished, ensure seal is properly placed in cover.

Carefully position cover on fuse block then firmly push until you hear a snapping sound for each locking tab.

Fuses for the engine electrical system are located below the solenoid.

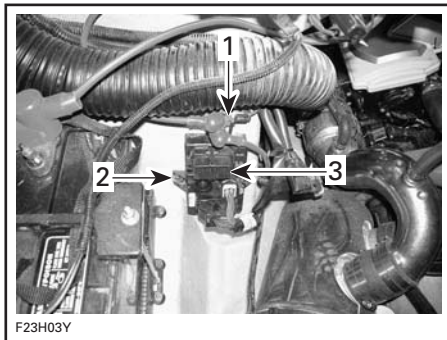

F23H03Y

TYPICAL

- 1. Fuses below solenoid
- 30 A: Charging system
- 15 A: EFB
- 2. Engine Fuse Block (EFB)
- 3. Engine electrical system fuses

Vehicle Accessory Fuses

Fuses for the vehicle electrical system are integrated in the Vehicle Control Module (VCM), which is located in the starboard gunwale near the driver's seat as shown below.

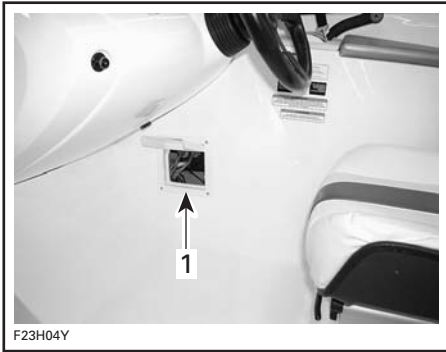

TYPICAL
1. Vehicle Control Module (VCM)

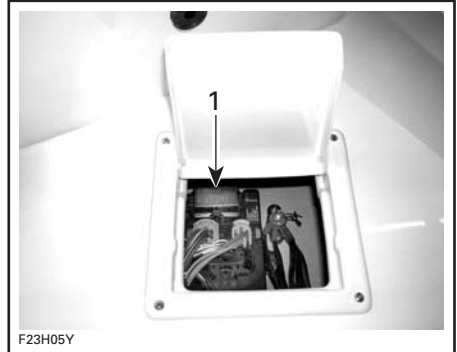

TYPICAL
1. Fuse cover



VCM
1. 10 A: Accessories
2. 10 A: Radio
3. 7.5 A: Blower
4. 3 A: Bilge pump
5. 3 A: NAV lights
6. 5 A: Courtesy lights

To remove fuse cover, squeeze cover locking tabs and pull cover out to access fuses.

Use the cover tabs to remove the fuse.

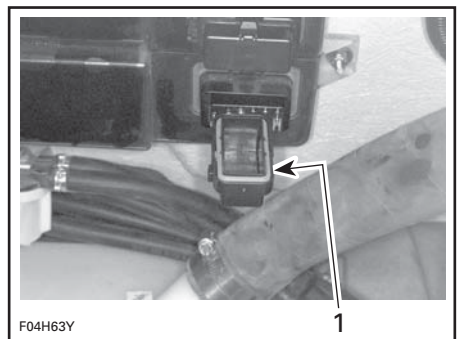

TYPICAL
1. Slide cover tabs each side of fuse then pull fuse out

When finished, ensure seal is properly placed in cover.

Carefully position cover on fuse block then firmly push until you hear a snapping sound for each locking tab.

Bilge Air Blower

Verify bilge air blower for proper operation. It is located beneath starboard ventilation duct in engine compartment.

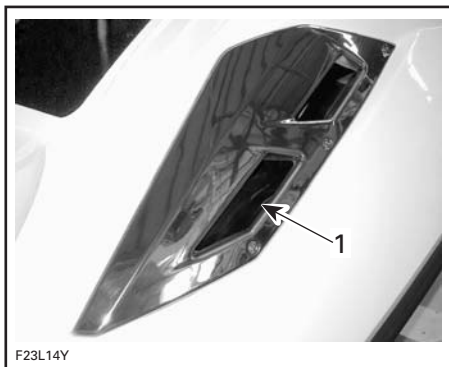

F23L14Y

TYPICAL

1. Blower duct

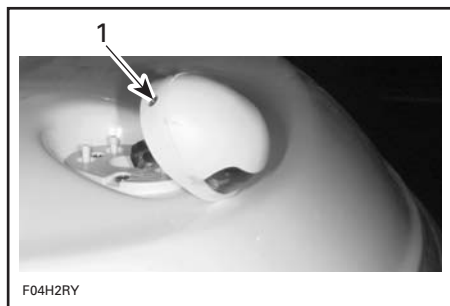

F04H2RY

TYPICAL

1. Remove this screw

⚠ WARNING

If bilge blower does not operate properly, refer to an authorized Sea-Doo Sport Boats dealer before starting the boat.

Navigation Light Bulb Replacement

Bow Light

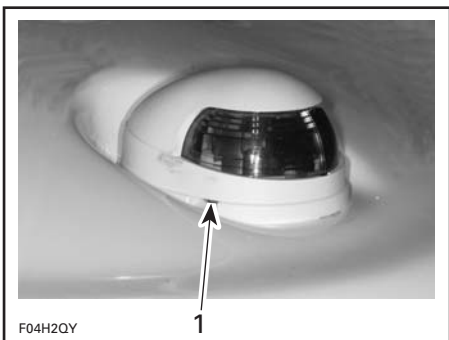

F04H2QY

TYPICAL

1. Gently pry here with a screwdriver

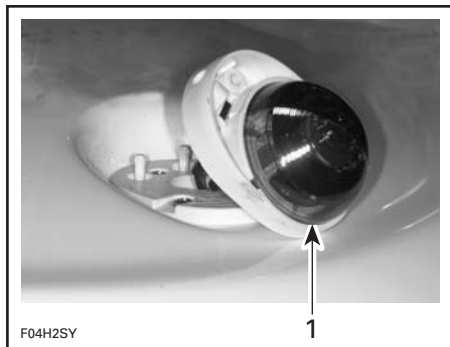

F04H2SY

TYPICAL

1. Pull lens out

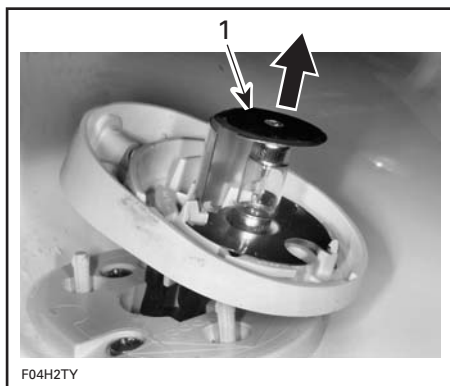

F04H2TY

TYPICAL

1. Lift and remove bulb

The assembly is essentially the reverse of removal procedures. However, pay particular attention to the following:

Apply dielectric grease on bulb contact surface.

When installing the bulb under the upper terminal plate, it is possible that the bulb remains loose. The cover will compress the terminal plate against the bulb at reinstallation.

Stern Light

Unscrew lens counterclockwise and pull it out.

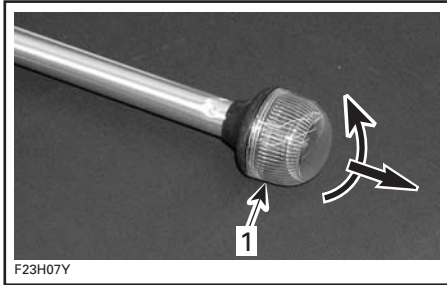

TYPICAL

1. Unscrew then pull

Pull bulb to remove it.

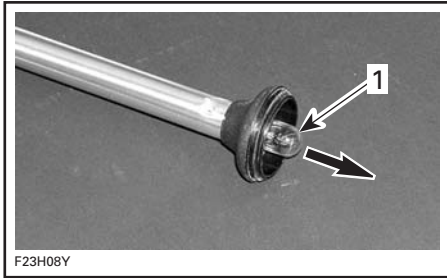

TYPICAL

1. Pull bulb out

Apply dielectric grease on new bulb contact surface.

Assembly is the reverse of removal procedure.

Sacrificial Anodes

Corrosion of metal parts, especially those exposed to saltwater, is common for boats. Corrosion can be caused by stray electric currents from shore power installations, improperly grounded AC lines and circuits, and poorly insulated DC powered equipment from boats moored nearby. Corrosion is accelerated when electric current is present.

Sacrificial anodes are attached to certain parts of this boat to reduce corrosion. The anode corrodes, rather than the part to which the anode is attached.

Change each anode when 50% by weight has corroded away.

Anodes are attached at the following locations:

- ride shoe/cooling plate
- pump housing
- reverse gate support
- steering nozzle
- reverse gate.

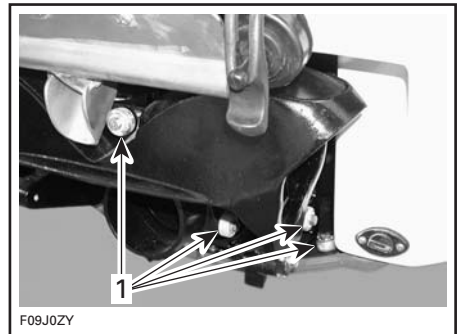

TYPICAL

1. Anode installation shown

NOTE: Inspect anodes each time boat is to be launched. Do **NOT** paint anodes or apply protective coatings.

General Inspection and Cleaning

Inspection

Check engine compartment for any damage and the fuel system for leaks. Also check battery for electrolyte leaks. Ensure all hose clamps are properly secured and no hose is cracked, kinked or presenting any other damage.

WARNING

If at any time, gasoline leaks/odors are found, do not start the engine. Have the boat serviced by an authorized Sea-Doo Sport Boats dealer.

Inspect mufflers, battery and fuel tank fastening devices. Check electrical connections for corrosion and tightness.

Inspect hull and jet pump water intake grate for damage. Replace or repair damaged parts.

Cleaning

Twice a year, the bilge should be cleaned with hot water and detergent or bilge cleaner to remove any possible fuel/oil/electrolyte deposits and mildew.

Occasionally, wash the body with hot water and soap (only use mild detergent). Remove any marine organisms from engine and/or hull. Apply non-abrasive wax.

CAUTION: Never clean fiberglass and plastic parts with strong detergent, degreasing agent, paint thinner, acetone, etc.

Wash windscreen with Heavy Duty Cleaner (P/N 293 110 001) and water. For fine scratches and scuff marks removal, use a windshield polisher for acrylic, lucite, polycarbonate and similar materials.

Stains may be removed from seats and fiberglass with Knight's Spray-Nine[†] or the equivalent.

Respect the environment by ensuring fuel, oil or cleaning solutions do not drain into the waterways.

[†] Knight's Spray Nine is a registered trademark of Knight Oil Corporation.

STORAGE AND PRESEASON PREPARATION

It is recommended that the boat be taken to an authorized Sea-Doo Sport Boats dealer for proper storage, however you can perform the following operations with a minimum of tools.

NOTE: Leave drain plug(s) out during storage period.

CAUTION: Do not run the engine during the storage period.

WARNING

Because fuel and oil are flammable, have an authorized Sea-Doo Sport Boats dealer inspect the fuel and oil systems integrity as specified in the *PERIODIC MAINTENANCE CHART*.

Propulsion System

Jet Pump

Clean jet pump by spraying water in its inlet and outlet and then apply a coating of XP-S Lube (P/N 293 600 016) or equivalent.

WARNING

Always remove safety lanyard cap from post to prevent unexpected engine starting before cleaning the jet pump area. Engine must not be running for this operation.

Fuel System

Fuel Stabilizer

BRP fuel stabilizer (P/N 413 408 600) (or equivalent) can be added in fuel tank to prevent fuel deterioration and fuel system gumming. Follow stabilizer manufacturer's instructions for proper use.

CAUTION: Fuel stabilizer should be added before engine lubrication to ensure fuel system components are protected against varnish deposits.

Fill up fuel tank completely. Ensure there is no water inside fuel tank.

CAUTION: Should any water be trapped inside fuel tank, severe internal damage will occur to the fuel injection system.

WARNING

Always stop the engine before refueling. Fuel is flammable and explosive under certain conditions. Always work in a well ventilated area. Do not smoke or allow open flames or sparks in the vicinity. Fuel tank may be pressurized. Slowly turn cap when opening. Never use an open flame to check fuel level. When fueling, keep boat level. Do not overfill or top off the fuel tank and leave boat in the sun. As temperature increases, fuel expands and might overflow. Always wipe off any fuel spillage from the boat. Periodically verify fuel system.

Throttle Body Lubrication

Lubricate throttle body with XP-S Lube or an equivalent.

Use fitting for that purpose provided on the throttle body.

Make sure to spray lubricant at least 3 to 5 seconds for proper lubrication.

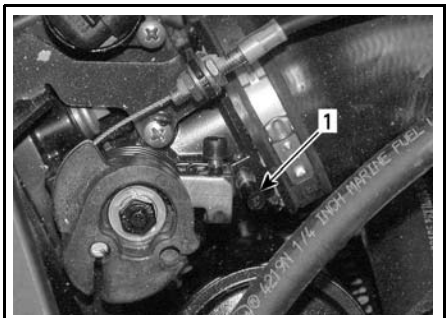

Imo2007-001-008_a

REMOVE CAP
1. Plastic cap

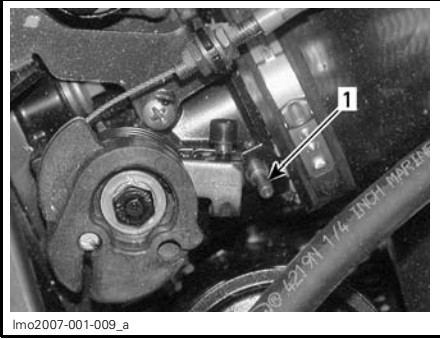

1. Lubrication fitting

Engine Oil and Filter Replacement

The oil and oil filter change should be performed by an authorized Sea-Doo Sport Boats dealer.

Exhaust System Flushing

Flushing the exhaust system with fresh water is essential to neutralize corroding effects of salt or other chemical products present in water. It will help to clean up sand, salt, shells or other particles in water jackets (exhaust system and intercooler (if so equipped)) and/or hoses.

CAUTION: Failure to flush the system, when necessary, will severely damage engine intercooler and/or exhaust system. Make sure engine operates during entire procedure.

WARNING

Perform these operations in a well ventilated area. Certain components in the engine compartment may be very hot. Direct contact may result in skin burn. Do not touch any electrical part or jet pump area when engine is running.

WARNING

When operating the engine while the boat is out of the water, the heat exchanger in the ride plate may become very hot. Avoid any contact with ride plate as burns may occur.

Connect a garden hose to connector located at the rear of boat on jet pump support. **Do not open water tap yet.**

NOTE: The optional flushing connector adapter (P/N 295 500 473) can be used with a quick connect adapter to ease garden hose installation.

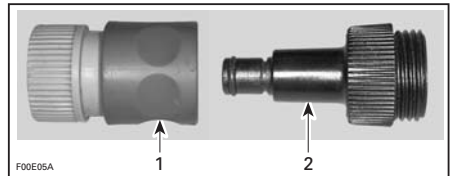

1. Quick connect adapter
2. Flushing connector adapter

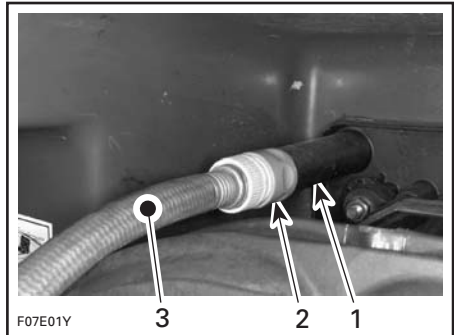

TYPICAL

1. Flushing connector
2. Quick connect adapter and flushing connector adapter (optional, not mandatory)
3. Garden hose

To flush the exhaust system, start the engine **then** immediately open the water tap.

CAUTION: Always start the engine before opening the water tap. Open water tap immediately after engine is started to prevent overheating.

CAUTION: Never run engine without supplying water to the exhaust system when boat is out of water.

Run the engine about 20 seconds at a fast idle between 4000 - 5000 RPM.

CAUTION: Never run engine longer than 5 minutes. Drive line seal has no cooling when boat is out of water.

Ensure water flows out of jet pump while flushing. Otherwise, refer to an authorized Sea-Doo Sport Boats dealer for servicing.

Close the water tap, then stop the engine.

CAUTION: Always close the water tap before stopping the engine.

Disconnect the garden hose.

CAUTION: Remove flushing connector adapter after operation (if used).

Leave all compartments open to air dry.

Engine Internal Lubrication

Connect a garden hose to cool the exhaust system as explained in *EXHAUST SYSTEM FLUSHING* above.

Bring engine to normal operating temperature.

CAUTION: Properly follow the instructions given in the *EXHAUST SYSTEM FLUSHING* procedure.

Close the water tap, then stop the engine.

Pull engine access panel upward to remove it.

Remove dipstick.

Remove engine cover.

Reinstall dipstick.

Disconnect ignition coil connectors.

WARNING

When disconnecting coil from spark plug, always disconnect coil from main harness first. Never check for engine ignition spark from an open coil and/or spark plug in the engine compartment as spark may cause fuel vapor to ignite.

IMPORTANT: Never cut the locking ties of ignition coil connectors. This would allow mixing the wires between cylinders.

Remove ignition coils.

CAUTION: Ensure there is no dirt in coil holes before removing the spark plugs. Otherwise, dirt would fall into cylinder and will damage the internal components.

Remove spark plugs.

NOTE: After loosening the spark plugs, a coil may be used to pull the spark plugs out. Simply bring the coil down to spark plug and "hook" it to then extract spark plug.

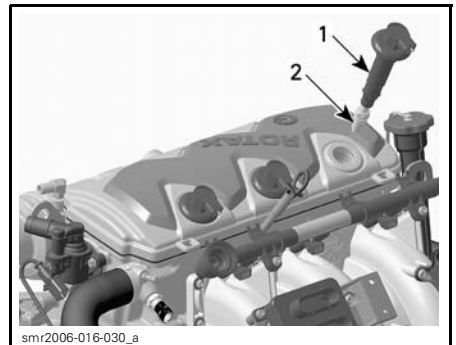

1. Ignition coil
2. Spark plug

Spray XP-S Lube lubricant or equivalent, in spark plug holes.

To prevent fuel to be injected and also to cut the ignition at the engine cranking, proceed as follows.

From the engine compartment, have a second person hold throttle bell crank in fully opened position.

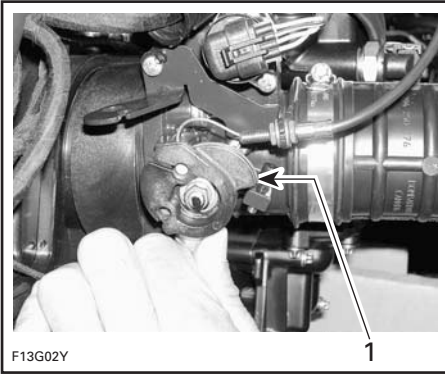

F13G02Y

TYPICAL

1. Fully-opened position

Crank the engine a few turns to distribute the oil on cylinder wall.

Apply anti-seize lubricant on spark plug threads then reinstall them.

NOTE: After installation, ensure the seal seats properly with the engine top surface.

Reinstall ignition coils. Reconnect ignition coil connectors.

To reinstall engine cover, remove dipstick, push engine cover downward until it snaps.

Reinstall dipstick.

NOTE: It is recommended to fog the engine valves with XP-S Lube lubricant. Contact your authorized Sea-Doo Sport Boats dealer.

Intercooler and Exhaust Manifold

The exhaust system is self draining, but the intercooler and exhaust manifold need the following protection.

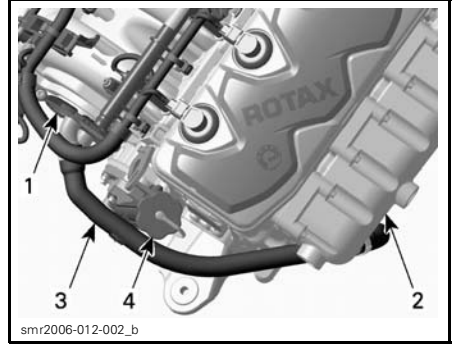

smr2006-012-002_b

1. Intercooler
2. Exhaust manifold
3. Intercooler outlet hose
4. Engine oil filling cap

- Remove both hoses from intercooler.

NOTE: Some clamps are removable and reusable; others must be cut and replaced.

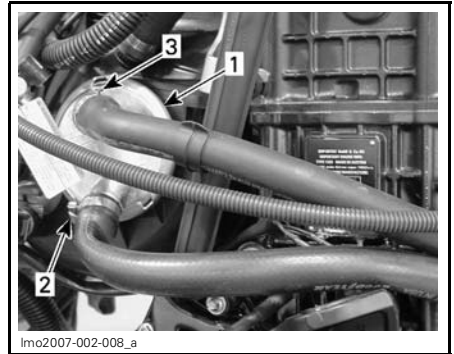

lmo2007-002-008_a

1. Intercooler
2. Inlet hose clamp (reusable)
3. Outlet hose clamp (replace)

- Let the intercooler drain, then reconnect the bottom hose.
- By using a funnel and a small hose, pour approximately 200 mL (6.76 oz U.S.) of antifreeze into the intercooler through the outlet nipple.

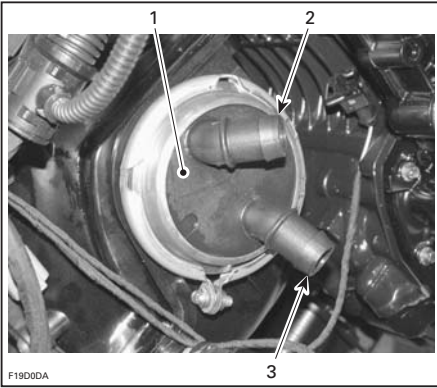

TYPICAL

1. Intercooler
2. Outlet nipple
3. Inlet nipple

- Reconnect the intercooler top hose and secure with a new clamp.
- Disconnect the manifold top water outlet hose from the exhaust pipe.

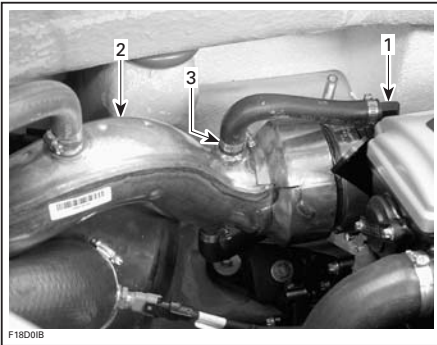

1. Exhaust manifold
2. Exhaust pipe
3. Water outlet hose clamp (reusable)

- Install a funnel at the end of water outlet hose, then pour approximately 300 mL (10.14 oz U.S.) of antifreeze into the exhaust manifold.
- Reconnect the upper water outlet hose and secure with existing clamp.

CAUTION: It is highly recommended to pour antifreeze into the intercooler and exhaust manifold. Failure to do so, may cause severe damage to these components.

CAUTION: Use only **undiluted antifreeze (100% concentration)**. The premixed antifreeze available from BRP is NOT suitable for this particular application. Its concentration will be reduced when mixed with remaining water trapped in water jackets.

NOTE: When available, it is recommended to use biodegradable antifreeze compatible with internal combustion aluminum engines. This will contribute to protect the environment.

NOTE: The engine will not have to run during this operation but should have been ran before, to exhaust as much water as possible, from cooling system components.

Battery

For battery removal, cleaning and storage, contact your authorized Sea-Doo Sport Boats dealer.

Engine Cooling System

Antifreeze is to be replaced every 200 hours or every 2 years to prevent antifreeze deterioration.

The antifreeze replacement and a density test should be performed by an authorized Sea-Doo Sport Boats dealer.

CAUTION: Improper antifreeze mixture might allow freezing of the liquid in the cooling system if boat is stored in area where freezing point is reached. This would seriously damage the engine. Failure to replace the antifreeze every 200 hours or every 2 years may allow its degradation that could result in poor cooling when engine will be used.

WARNING

In order to avoid potential burns, do not remove the coolant reservoir cap if engine is still hot.

Boat Cleaning/Repair

Wash the body and the trailer with soap and water solution (only use mild detergent). Rinse thoroughly with fresh water. Remove any marine organisms from the hull.

CAUTION: Never clean apparent fiberglass and plastic parts with strong detergent, degreasing agent, paint thinner, acetone, etc.

Stains may be removed from seats and fiberglass with Knight's Spray-Nine or the equivalent.

If repairs are needed to the body or to the hull contact your authorized Sea-Doo Sport Boats dealer. For paint touch up to mechanical parts use BRP spray paint. For minor Gelcote[†] repairs, a repair kit is available from Gelcote International (www.gelcote.ca). Replace damaged labels/decals.

Once boat is on trailer, unscrew the drain plug, block the wheels and raise the bow slightly with the trailer jack (if so equipped) to allow water to drain. Clean the bilge with hot water and detergent or with bilge cleaner. Rinse thoroughly. Unscrew drain plugs, block wheels and raise the bow with the trailer jack (if so equipped) to drain bilge.

Finalizing Storage Preparation

Apply a non-abrasive wax to body.

The engine storage cover should be left partially opened during storage (detach the gas shocks from the cover to prevent full opening).

On so equipped models, remove storage tray. Place it on deck.

Using a flat screwdriver, lift tab as shown below.



TYPICAL — LIFT TAB

Detach shock end. Detach other side. Block and leave engine cover lid open slightly.

This will avoid engine compartment condensation and possible corrosion.

Reattach shock ends to engine cover lid before operating boat.

If the boat is to be stored outside, cover it with a vented opaque tarpaulin to prevent UV (ultraviolet) rays and grime from affecting the plastic components, boat finish, as well as preventing dust accumulation.

CAUTION: Never leave the boat stored in direct sunlight. UV radiation will dull finishes. The boat must never be left in water for storage. Make sure to turn off main battery cut-off switch.

[†] Gelcote is a trademark of Gelcote International.

For the storage period, it is necessary to make certain the drain plugs are unscrewed and unobstructed, then block the wheels and slightly raise the bow with the trailer jack (if so equipped) so drainage can take place.

Preseason Preparation

Use the *PERIODIC MAINTENANCE CHART* at the beginning of *MAINTENANCE INFORMATION* section and refer to the *PRESEASON* column.

Since technical skills and special tools are required, some operations should be performed by an authorized Sea-Doo Sport Boats dealer.

WARNING

Observe all **WARNINGS** and **CAUTIONS** mentioned throughout this guide which are pertinent to the item being checked. When component conditions seem less than satisfactory, replace with genuine BRP parts or approved equivalents.

NOTE: It is highly recommended that an authorized Sea-Doo Sport Boats dealer perform the annual safety inspection and factory campaigns in addition to the pre-season preparation all at the same time.

WARNING

Only perform procedure as detailed in this guide. It is recommended that the assistance of an authorized dealer be periodically obtained on other components/systems not covered in this guide. Unless otherwise specified, engine must not be running and the main battery cut-off switch must be turned OFF for all maintenance procedures.

WARRANTY INFORMATION

BRP LIMITED WARRANTY FOR MODEL YEAR 2008 SEA-DOO® SPORT BOATS SOLD IN THE UNITED STATES AND CANADA

1) SCOPE

BRP US Inc.* ("BRP") warrants its new and unused Model Year 2008 Sea-Doo® Sport Boats ("Sport Boat") sold by authorized BRP dealers in the fifty United States and Canada ("dealer") from defects in material and workmanship for the period and under the conditions below.

All genuine BRP parts and accessories, installed by an authorized BRP dealer (as hereinafter defined) at the time of delivery of the 2008 Sea-Doo® Sport Boat, carry the same warranty as that of the Sport Boat.

Clarion[†] audio components installed as original equipment on Sport Boats are warranted separately by Clarion. If such an audio component is installed on your Sea-Doo® Sport Boat, please contact the manufacturer or ask your authorized BRP dealer for warranty coverage information and assistance.

For USA:

Clarion Corporation of America
661 West Redondo Beach Boulevard
Gardena, CA 90247
Phone: 800 347-8933
Fax: 310 217-4380

For Canada:

Clarion Canada Inc.
2239 Winston Park Drive
Oakville, ON L6H 5R1
Phone: 800 668-5612
Fax: 800 387-7122

Use of the product for racing or any other competitive activity, at any point, even by a previous owner, will render this warranty null and void.

2) EXCLUSIONS – ARE NOT WARRANTED

The following are not warranted under any circumstances:

- Replacement of parts due to normal wear and tear;
- Routine maintenance parts and services, including but not limited to adjustments, oil, lubricant and coolant changes, spark plug replacement, water pumps and the like;
- Damage caused by improper or lack of maintenance or storage, or failure to follow the procedures and recommendations in the Operator's Guide;
- Damage resulting from removal of parts, improper repairs, service, maintenance, or modification, or use of parts or accessories not manufactured or approved by BRP, which in its reasonable judgement, are either incompatible with Sport Boats or adversely affect its operation, performance, or durability, or resulting from repairs done by a person that is not an authorized BRP dealer;
- Damage caused by abuse, misuse, abnormal use, neglect, racing, improper operation or operation of the Sport Boat in a manner inconsistent with the recommended operation described in the Operator's Guide;
- Damages resulting from external damage, submersion, water or foreign object ingestion, accident, fire, theft, vandalism or any act of God;
- Operation with fuel, oils or lubricants that are not suitable for the Sport Boat (see Operator's Guide);
- Damage from rust, corrosion or exposure to the elements;

- Damage from cooling system or jet pump blockage by foreign material;
- Incidental or consequential damages, or damages of any kind including without limitation towing, storage, telephone, rental, taxi, inconvenience, insurance coverage, loan payments, loss of time, loss of income; and
- Damage to gel coat finish including but not limited to cosmetic gel coat finish defects, blisters, starrng, crazing; and fiberglass delaminating caused by blisters, crazing, spyder or hairline cracks or exposure to the elements.

3) LIMITATIONS OF LIABILITY

THIS WARRANTY IS EXPRESSLY GIVEN AND ACCEPTED IN LIEU OF ANY AND ALL OTHER WARRANTIES, EXPRESSED OR IMPLIED, INCLUDING WITHOUT LIMITATION ANY WARRANTY OF MERCHANTABILITY OR FITNESS FOR A PARTICULAR PURPOSE. TO THE EXTENT THAT THEY CANNOT BE DISCLAIMED, THE IMPLIED WARRANTIES ARE LIMITED IN DURATION TO THE LIFE OF THE EXPRESS WARRANTY. INCIDENTAL AND CONSEQUENTIAL DAMAGES ARE EXCLUDED FROM COVERAGE UNDER THIS WARRANTY. SOME STATES/PROVINCES DO NOT ALLOW FOR THE DISCLAIMERS, LIMITATIONS AND EXCLUSIONS IDENTIFIED ABOVE, AS A RESULT, THEY MAY NOT APPLY TO YOU. THIS WARRANTY GIVES YOU SPECIFIC RIGHTS, AND YOU MAY ALSO HAVE OTHER LEGAL RIGHTS WHICH MAY VARY FROM STATE TO STATE, OR PROVINCE TO PROVINCE.

Neither the distributor, any BRP dealer nor any other person has been authorized to make any affirmation, representation or warranty regarding the product, other than those contained in this limited warranty, and if made, shall not be enforceable against BRP.

BRP reserves the right to modify this warranty at any time, being understood that such modification will not alter the warranty conditions applicable to the products sold while this warranty is in effect.

4) WARRANTY COVERAGE DURATION

This limited warranty will be in effect from the date of delivery to the first retail consumer or the date the Sport Boat is first put to use, whichever occurs first, for a period of:

- TWELVE (12) CONSECUTIVE MONTHS for private, recreational use, except that the deck and hull fiberglass structure are covered for SIXTY (60) CONSECUTIVE MONTHS;
- FOUR (4) CONSECUTIVE MONTHS for commercial use, except that the deck and hull fiberglass structure is covered for TWELVE (12) CONSECUTIVE MONTHS. A Sport Boat is used commercially when it is used in connection with generating income or any work or employment during any part of the warranty period. A Sport Boat is also used commercially when, at any point during the warranty period, it has commercial tags or is licensed for commercial use.

The emission-related components included in the chart below, that are installed on EPA certified Sea-Doo® Sport Boats (see list below) registered in the USA are covered for TWENTY-FOUR (24) CONSECUTIVE MONTHS OR 200 HOURS OF ENGINE USE, whichever occurs first. If the 200 hours of engine use are reached during the regular warranty coverage period, the emission-related components are still covered by BRP's standard warranty until the end of regular coverage period.

The EPA certified 2008 Sea-Doo® Sport Boats are those equipped with:

- 4-TEC™ 1503 normally aspirated (NA) engine(s)
- 4-TEC™ 1503 supercharged intercooled (SCIC) engine(s).

Emission-related components:

- Throttle Position Sensor (TPS)
- Air Temperature Sensor (ATS)
- Air Pressure Sensor (APS)

For Sport Boats produced by BRP for sale in the states of California or New York, that are originally sold to a resident or subsequently warranty registered to a resident in the state of California or New York, please also refer to the applicable California and New York Emissions Control Warranty Statement.

The repair or replacement of parts or the performance of service to a Sport Boat under this warranty does not extend the life of this limited warranty beyond its original expiration date.

5) CONDITIONS TO HAVE WARRANTY COVERAGE

This warranty coverage is available only if each of the following conditions has been fulfilled:

- a) The 2008 Sea-Doo® Sport Boats must be purchased as new and unused by its first owner from a BRP distributor/dealer authorized to distribute Sea-Doo® Sport Boats products in the country in which the sale occurred ("BRP distributor/dealer");
- b) The BRP specified pre-delivery inspection process must be completed and documented;
- c) The product must have undergone proper registration by an authorized BRP distributor/dealer;
- d) The 2008 Sea-Doo® Sport Boats must be purchased in the country or union of countries in which the purchaser resides.
- e) Routine maintenance outlined in the Operator's Guide must be timely performed in order to maintain warranty coverage. BRP reserves the right to make warranty coverage contingent upon proof of proper maintenance.

BRP will not honor this limited warranty to any private use owner or commercial use owner if the preceding conditions have not been met. Such limitations are necessary in order to allow BRP to preserve both the safety of its products, and also that of its consumers and the general public.

6) WHAT TO DO TO OBTAIN WARRANTY COVERAGE

The customer must notify a servicing BRP dealer within two (2) days of the appearance of a defect, and provide it with reasonable access to the product and reasonable opportunity to repair it. The customer must also present to the authorized BRP dealer, proof of purchase of the product and must sign the repair/work order prior to starting the repair in order to validate the warranty repair. All parts replaced under this limited warranty become the property of BRP.

7) WHAT BRP WILL DO

BRP's obligations under this warranty are limited to, at its sole discretion, repairing parts found defective under normal use, maintenance and service, or replacing such parts with new genuine BRP parts without charge for parts and labor, at any authorized BRP dealer during the warranty coverage period.

BRP reserves the right to improve or modify products from time to time without assuming any obligation to modify products previously manufactured.

8) TRANSFER

If the ownership of a product is transferred during the warranty coverage period, this warranty shall also be transferred and be valid for the remaining coverage period provided that BRP is notified of such transfer of ownership in the following way:

- a) The former owner contacts BRP (at the phone number provided below) or an authorized BRP dealer and gives the coordinates of the new owner; or
- b) BRP or an authorized BRP dealer receives a proof that the former owner agreed to the transfer of ownership, in addition to the coordinates of the new owner.

9) CONSUMER ASSISTANCE

- a) In the event of a controversy or a dispute in connection with this limited warranty, BRP suggests that you try to resolve the issue at the dealership level. We recommend discussing the issue with the authorized BRP Dealer's service manager or owner.
- b) If the issue has not yet been resolved, please submit your complaint in writing or call the appropriate number below:

In Canada

BOMBARDIER RECREATIONAL PRODUCTS INC.

Consumer Services Group
75, J.-A. Bombardier Street
Sherbrooke, Québec J1L 1W3
Tel.: 819 566-3366

In USA

BRP US INC.

Consumer Services Group
7575 Bombardier Court
Wausau WI 54401
Tel.: 715 848-4957

*In Canada, products are distributed and serviced by Bombardier Recreational Products Inc.

© 2007 Bombardier Recreational Products Inc. All rights reserved.

® Registered trademark of Bombardier Recreational Products Inc. or its affiliates.

‡ is a trademark of Clarion.

CALIFORNIA AND NEW YORK EMISSION CONTROL WARRANTY STATEMENT FOR MODEL-YEAR 2008 SEA-DOO® SPORT BOATS WITH 4-TEC™ 1503 NORMALLY ASPIRATED (NA) AND 4-TEC™ 1503 SUPERCHARGED INTERCOOLED (SCIC) ENGINE(S)

For California, your 2008 Sea-Doo® Sport Boat ("Sport Boat") has a special environmental label required by the California Air Resources Board. The label has 1, 2, 3 or 4 stars. A hangtag, provided with your Sport Boat, describes the meaning of the star rating system.

The Star Label Means Cleaner Marine Engines

The symbol for cleaner marine engines:



F18L3CQ



Cleaner Air and Water

For a healthier lifestyle and environment.

Better Fuel Economy

Burns up to 30 - 40 percent less gas and oil than conventional carbureted two-stroke engines, saving money and resources.

Longer Emission Warranty

Protects consumer for worry free operation.

One Star - Low Emission

The one-star label identifies personal watercraft, outboard, stern drive and in-board engines that meet the Air Resources Board's Personal Watercraft and Outboard marine engine 2001 exhaust emission standards. Engines meeting these standards have 75% lower emissions than conventional carbureted two-stroke engines. These engines are equivalent to the U.S. EPA's 2006 standards for marine engines.

Two Stars - Very Low Emission

The two-star label identifies personal watercraft, outboard, stern drive and in-board engines that meet the Air Resources Board's Personal Watercraft and Outboard marine engine 2004 exhaust emission standards. Engines meeting these standards have 20% lower emissions than One Star - Low-Emission engines.

Three Stars - Ultra Low Emission

The three-star label identifies engines that meet the Air Resources Board's Personal Watercraft and Outboard marine engine 2008 exhaust emission standards or the Stern drive and Inboard marine engine 2003 exhaust emission standards. Engines meeting these standards have 65% lower emissions than One Star – Low Emission engines.

Four Stars - Super Ultra Low Emission

The four-star label identifies engines that meet the Air Resources Board's Stern-drive and Inboard marine engine 2009 exhaust emission standards. Personal Watercraft and Outboard marine engines may also comply with these standards. Engines meeting these standards have 90% lower emissions than One Star – Low Emission engines.

For more information: Cleaner Watercraft - Get the Facts 1 800 END-SMOG
www.arb.ca.gov

Your Emission Control Warranty Rights and Obligations

The California Air Resources Board and BRP US Inc. ("BRP") are pleased to explain the emission control system warranty on your Model Year 2008 Sea-Doo® Sport Boat. In California, new Sport Boat engines must be designed, built and equipped to meet the State's stringent anti-smog standards. BRP must warrant the emission control system on your Sport Boat engine for the periods of time listed below provided there has been no abuse, neglect or improper maintenance of your Sport Boat engine.

Your emission control system may include parts such as the fuel injection system, the ignition system and catalytic converter. Also included may be hoses, belts, connectors and other emission related assemblies.

Where a warrantable condition exists, BRP will repair your Sport Boat engine at no cost to you including diagnosis, parts and labor provided that such work is performed by an authorized BRP dealer.

Manufacturer's Limited Warranty Coverage

This emission limited warranty covers Model Year 2008 Sea-Doo® Sport Boats certified and produced by BRP for sale in California, that are originally sold in California to a California resident or subsequently warranty registered to a California resident. The BRP limited warranty conditions for Sea-Doo® Sport Boats are still applicable to these models with the necessary modifications. Select emission control parts of your 2008 Sea-Doo® Sport Boat are warranted from the date of delivery to the first retail consumer for a period of 4 years, or for 250 hours of use, whichever occurs first. However, warranty coverage based on the hourly period is only permitted for Sport Boat equipped with the appropriate hour meters or their equivalent. If any emission-related part on your engine is defective under warranty, the part will be repaired or replaced by BRP.

Parts Covered for a Model Year 2008 Sea-Doo® Sport Boat Equipped with 4-TEC™ 1503 normally aspirated (NA) and 4-TEC™ 1503 supercharged intercooled (SCIC) engine(s):

Digital Linear Actuator (low idle control)	All Fuel System Components
Throttle Position Sensor	Spark Plugs
Intake Manifold Air Pressure Sensor	Ignition Coils
Intake Manifold Air Temperature Sensor	Piston and Rings
Engine Temperature Sensor	Intake and Exhaust Valve Gear/Train
Knock Sensor	Valves, Valve Guides and Valve Guide Sealing
Emission Control Unit	Crankcase Ventilation Valve
Injectors	Wire Harness and Connectors
Fuel Pressure Regulator	Emission Related Seals, Gaskets and Hoses
Intake Manifold	Exhaust Manifold
Intercooler (if equipped)	Supercharger (if equipped)

The emission warranty covers damage to other engine components that is caused by the failure of a warranted part. The BRP Operator's Guide provided contains written instructions for the proper maintenance and use of your sport boat. All emission warranty parts are warranted by BRP for the entire warranty period of the sport boat, unless the part is scheduled for replacement as required maintenance in the Operator's Guide.

Emission warranty parts that are scheduled for replacement, as required maintenance, are warranted by BRP for the period of time before the first scheduled replacement date for that part. Emission warranty parts that are scheduled for regular inspection, but not regular replacement, are warranted by BRP for the entire warranty period of the sport boat. Any emission warranty part repaired or replaced under the terms of this warranty statement is warranted by BRP for the remainder of the warranty period of the original part. All parts replaced under this limited warranty become the property of BRP. Maintenance receipts and records should be transferred to each subsequent owner of the Sport Boat.

Owner's Warranty Responsibilities

As the owner of a 2008 Sea-Doo® Sport Boat, you are responsible for the performance of the required maintenance listed in your Operator's Guide. BRP recommends that you retain all receipts covering maintenance your sport boat engine, but BRP cannot deny warranty solely for the lack of receipts or your failure to ensure the performance of all scheduled maintenance. As the owner of a Sea-Doo® Sport Boat, you should however be aware that BRP may deny you warranty coverage if your engine(s) or a part has failed due to abuse, neglect, improper maintenance or unapproved modifications. You are responsible for presenting your engine to an authorized BRP Dealer as soon as a problem exists. The warranty repairs will be completed in a reasonable amount of time, not to exceed 30 days. If you have any questions regarding your warranty rights and responsibilities or for the name and location of the nearest authorized BRP Dealer you should contact the Customer Assistance Center at 1 715 848-4957.

BRP INTERNATIONAL LIMITED WARRANTY FOR MODEL YEAR 2008 SEA-DOO® SPORT BOATS

1) SCOPE

BRP US Inc. ("BRP")* warrants its new and unused Model Year 2008 Sea-Doo® Sport Boats ("Sport Boat") sold by authorized BRP distributors/dealers outside of the fifty United States, Canada and states members of the European Union ("distributor/dealer"), will be free from defects in material and workmanship for the period and under the conditions below.

All genuine BRP parts and accessories, installed by an authorized BRP dealer (as hereinafter defined) at the time of delivery of the 2008 Sea-Doo Sport Boat, carry the same warranty as that of the Sport Boat.

Use of the product for racing or any other competitive activity, at any point, even by a previous owner, will render this warranty null and void.

2) EXCLUSIONS – ARE NOT WARRANTED

The following are not warranted under any circumstances:

- Replacement of parts due to normal wear and tear;
- Routine maintenance parts and services, including but not limited to adjustments, oil, lubricant and coolant changes, spark plug replacement, water pumps and the like;
- Damage caused by improper or lack of maintenance or storage, or failure to follow the procedures and recommendations in the Operator's Guide;
- Damage resulting from removal of parts, improper repairs, service, maintenance, or modification, or use of parts or accessories not manufactured or approved by BRP, which in its reasonable judgment, are either incompatible with Sport Boats or adversely affect its operation, performance, or durability, or resulting from repairs done by a person that is not an authorized BRP distributor/dealer;
- Damage caused by abuse, misuse, abnormal use, neglect, racing, improper operation or operation of the Sport Boat in a manner inconsistent with the recommended operation described in the Operator's Guide;
- Damages resulting from external damage, submersion, water or foreign object ingestion, accident, fire, theft, vandalism or any act of God;
- Operation with fuel, oils or lubricants that are not suitable for the Sport Boat (see Operator's Guide);
- Damage from rust, corrosion or exposure to the elements;
- Damage from cooling system or jet pump blockage by foreign material;
- Incidental or consequential damages, or damages of any kind including without limitation towing, storage, telephone, rental, taxi, inconvenience, insurance coverage, loan payments, loss of time, loss of income; and
- Damage to gel coat finish including but not limited to cosmetic gel coat finish defects, blisters, starring, crazing; and fiberglass delaminating caused by blisters, crazing, spyder or hairline cracks or exposure to the elements.

3) LIMITATIONS OF LIABILITY

THIS WARRANTY IS EXPRESSLY GIVEN AND ACCEPTED IN LIEU OF ANY AND ALL OTHER WARRANTIES, EXPRESSED OR IMPLIED, INCLUDING WITHOUT LIMITATION ANY WARRANTY OF MERCHANTABILITY OR FITNESS FOR A PARTICULAR PURPOSE. TO THE EXTENT THAT THEY CANNOT BE DISCLAIMED, THE IMPLIED WARRANTIES ARE LIMITED IN DURATION TO THE LIFE OF THE EXPRESS WARRANTIES. INCIDENTAL AND CONSEQUENTIAL DAMAGES ARE EXCLUDED FROM COVERAGE UNDER THIS WARRANTY. SOME STATES/PROVINCES DO NOT ALLOW FOR THE DISCLAIMERS, LIMITATIONS AND EXCLUSIONS IDENTIFIED ABOVE, AS A RESULT, THEY MAY NOT APPLY TO YOU. THIS WARRANTY GIVES YOU SPECIFIC RIGHTS, AND YOU MAY ALSO HAVE OTHER LEGAL RIGHTS WHICH MAY VARY FROM STATE TO STATE, OR PROVINCE TO PROVINCE.

Neither the distributor, any BRP Distributor/Dealer nor any other person has been authorized to make any affirmation, representation or warranty regarding the product, other than those contained in this limited warranty, and if made, shall not be enforceable against BRP.

BRP reserves the right to modify this warranty at any time, being understood that such modification will not alter the warranty conditions applicable to the products sold while this warranty is in effect.

4) WARRANTY COVERAGE DURATION

This limited warranty will be in effect from the date of delivery to the first retail consumer or the date the Sport Boat is first put to use, whichever occurs first, for a period of:

- TWELVE (12) CONSECUTIVE MONTHS for private, recreational use, except for the deck and hull fiberglass structure are covered for SIXTY (60) CONSECUTIVE MONTHS;
- FOUR (4) CONSECUTIVE MONTHS for commercial use, except for the deck and hull fiberglass structure is covered for TWELVE (12) CONSECUTIVE MONTHS. A Sport Boat is used commercially when it is used in connection with generating income or any work or employment during any part of the warranty period. A Sport Boat is also used commercially when, at any point during the warranty period, it has commercial tags or is licensed for commercial use.

The repair or replacement of parts or the performance of service to a Sport Boat under this warranty does not extend the life of this limited warranty beyond its original expiration date.

5) CONDITIONS TO HAVE WARRANTY COVERAGE

This warranty coverage is available only if each of the following conditions has been fulfilled:

- a) The 2008 Sea-Doo® Sport Boats must be purchased as new and unused by its first owner from a BRP distributor/dealer authorized to distribute Sea-Doo® Sport Boats products in the country in which the sale occurred ("BRP distributor/dealer");
- b) The BRP specified pre-delivery inspection process must be completed and documented;

- c) The product must have undergone proper registration by an authorized BRP distributor/dealer;
- d) The 2008 Sea-Doo® Sport Boats must be purchased in the country or union of countries in which the purchaser resides.
- e) Routine maintenance outlined in the Operator's Guide must be timely performed in order to maintain warranty coverage. BRP reserves the right to make warranty coverage contingent upon proof of proper maintenance.

BRP will not honor this limited warranty to any private use owner or commercial use owner if the preceding conditions have not been met. Such limitations are necessary in order to allow BRP to preserve both the safety of its products, and also that of its consumers and the general public.

6) WHAT TO DO TO OBTAIN WARRANTY COVERAGE

The customer must notify a servicing BRP Distributor/Dealer within two (2) days of the appearance of a defect, and provide it with reasonable access to the product and reasonable opportunity to repair it. The customer must also present to the authorized BRP Distributor/Dealer, proof of purchase of the product and must sign the repair/work order prior to starting the repair in order to validate the warranty repair. All parts replaced under this limited warranty become the property of BRP.

7) WHAT BRP WILL DO

BRP's obligations under this warranty are limited to, at its sole discretion, repairing parts found defective under normal use, maintenance and service, or replacing such parts with new genuine BRP parts without charge for parts and labor, at any authorized BRP Distributor/Dealer during the warranty coverage period.

BRP reserves the right to improve or modify products from time to time without assuming any obligation to modify products previously manufactured.

8) TRANSFER

If the ownership of a product is transferred during the warranty coverage period, this warranty shall also be transferred and be valid for the remaining coverage period provided BRP or an authorized BRP Distributor/Dealer receives a proof that the former owner agreed to the transfer of ownership, in addition to the co-ordinates of the new owner.

9) CONSUMER ASSISTANCE

- a) In the event of a controversy or a dispute in connection with this limited warranty, BRP suggests that you try to resolve the issue at the dealership level. We recommend discussing the issue with the authorized dealer's service manager or owner.
- b) If further assistance is required, the distributor's service department should be contacted in order to resolve the matter. You will find your distributor's coordinates on www.brp.com.
- c) If the matter still remains unresolved then contact BRP by writing to us at the address listed below.

For countries within Europe, Middle East, Africa, Russia & CIS, please contact our European office:

BRP EUROPE N.V.

Consumer Service Center
Skaldenstraat 125
9042 Gent
Belgium
Tel.: + 32-9-218-26-00

For Scandinavian countries, please contact our Finland office:

BRP FINLAND OY

Service Department
Ahjotie 30
Fin-96320 Rovaniemi
Finland
Tel.: + 358 16 3208 111

For all other countries, please contact your local distributor or our North America office:

BOMBARDIER RECREATIONAL PRODUCTS INC.

Consumer Services Group
75, J.-A. Bombardier Street
Sherbrooke, Québec J1L 1W3
Tel.: 819 566-3366

* For the territory covered by this limited warranty, products are distributed and serviced by Bombardier Recreational Products Inc. or its affiliates.

© 2007 Bombardier Recreational Products Inc. All rights reserved.

® Registered trademark of Bombardier Recreational Products Inc. or its affiliates.

BRP EUROPEAN UNION MEMBER STATES LIMITED WARRANTY FOR MODEL YEAR 2008 SEA-DOO® SPORT BOATS

1) SCOPE OF THE LIMITED WARRANTY

BRP US Inc. ("BRP")* warrants its new and unused model-year 2008 Sea-Doo® Sport Boats sold by authorized BRP distributors/dealers ("Distributors/Dealers") in the European Union member states from defects in material or workmanship for the period and under the conditions described below.

All genuine Sea-Doo® Sport Boats parts and accessories, installed by an authorized BRP Distributors/Dealers at the time of delivery of the 2008 Sea-Doo® sport boats, carry the same warranty as that of the Sport boats.

Use of the product for racing or any other competitive activity, at any point, even by a previous owner, will render this warranty null and void.

2) EXCLUSIONS – ARE NOT WARRANTED

The following are not warranted under any circumstances:

- Replacement of parts due to normal wear and tear;
- Routine maintenance parts and services, including but not limited to adjustments, oil, lubricant and coolant changes, spark plug replacement, water pumps and the like;
- Damage caused by improper or lack of maintenance or storage, or failure to follow the procedures and recommendations in the Operator's Guide;
- Damage resulting from removal of parts, improper repairs, service, maintenance, or modification, or use of parts or accessories not manufactured or approved by BRP, which in its reasonable judgment, are either incompatible with Sport Boats or adversely affect its operation, performance, or durability, or resulting from repairs done by a person that is not an authorized BRP distributor/dealer;
- Damage caused by abuse, misuse, abnormal use, neglect, racing, improper operation or operation of the Sport Boat in a manner inconsistent with the recommended operation described in the Operator's Guide;
- Damages resulting from external damage, submersion, water or foreign object ingestion, accident, fire, theft, vandalism or any act of God;
- Operation with fuel, oils or lubricants that are not suitable for the Sport Boat (see Operator's Guide);
- Damage from rust, corrosion or exposure to the elements;
- Damage from cooling system or jet pump blockage by foreign material;
- Incidental or consequential damages, or damages of any kind including without limitation towing, storage, telephone, rental, taxi, inconvenience, insurance coverage, loan payments, loss of time, loss of income; and
- Damage to gel coat finish including but not limited to cosmetic gel coat finish defects, blisters, starring, crazing; and fiberglass delaminating caused by blisters, crazing, spyder or hairline cracks or exposure to the elements.

3) LIMITATIONS OF LIABILITY

THIS WARRANTY IS EXPRESSLY GIVEN AND ACCEPTED IN LIEU OF ANY AND ALL OTHER WARRANTIES, EXPRESSED OR IMPLIED, INCLUDING WITHOUT LIMITATION ANY WARRANTY OF MERCHANTABILITY OR FITNESS FOR A PARTICULAR PURPOSE. TO THE EXTENT THAT THEY CANNOT BE DISCLAIMED, THE IMPLIED WARRANTIES ARE LIMITED IN DURATION TO THE LIFE OF THE EXPRESS WARRANTY. INCIDENTAL AND CONSEQUENTIAL DAMAGES ARE EXCLUDED FROM COVERAGE UNDER THIS WARRANTY. SOME JURISDICTIONS DO NOT ALLOW FOR THE DISCLAIMERS, LIMITATIONS AND EXCLUSIONS IDENTIFIED ABOVE, AS A RESULT, THEY MAY NOT APPLY TO YOU. THIS WARRANTY GIVES YOU SPECIFIC RIGHTS, AND YOU MAY ALSO HAVE OTHER LEGAL RIGHTS WHICH MAY VARY FROM COUNTRY TO COUNTRY.

Neither the distributor, any BRP distributor/dealer nor any other person has been authorized to make any affirmation, representation or warranty regarding the product, other than those contained in this limited warranty, and if made, shall not be enforceable against BRP.

BRP reserves the right to modify this warranty at any time, being understood that such modification will not alter the warranty conditions applicable to the products sold while this warranty is in effect.

4) WARRANTY COVERAGE PERIOD

This warranty will be in effect from the date of delivery to the first retail consumer or the date the product is first put into use, whichever occurs first and for a period of:

TWENTY-FOUR (24) CONSECUTIVE MONTHS for private use owners and TWELVE (12) CONSECUTIVE MONTHS for commercial use owners.

The repair or replacement of parts or the performance of service under this warranty does not extend the life of this warranty beyond its original expiration date.

Note that the duration and any other modalities of the warranty coverage are subject to the applicable national or local legislation in your country.

5) CONDITIONS TO HAVE WARRANTY COVERAGE

This warranty coverage is available only if each of the following conditions has been fulfilled:

- a) The 2008 Sea-Doo® Sport Boats must be purchased as new and unused by its first owner from a BRP distributor/dealer authorized to distribute Sea-Doo® Sport Boats products in the country in which the sale occurred ("BRP distributor/dealer");
- b) The BRP specified pre-delivery inspection process must be completed and documented;
- c) The product must have undergone proper registration by an authorized BRP distributor/dealer;
- d) The 2008 Sea-Doo® Sport Boats must be purchased in the country or union of countries in which the purchaser resides.
- e) Routine maintenance outlined in the Operator's Guide must be timely performed in order to maintain warranty coverage. BRP reserves the right to make warranty coverage contingent upon proof of proper maintenance.

BRP will not honor this limited warranty to any private use owner or commercial use owner if the preceding conditions have not been met. Such limitations are necessary in order to allow BRP to preserve both the safety of its products, and also that of its consumers and the general public.

6) WHAT TO DO TO OBTAIN WARRANTY COVERAGE

The customer must notify a servicing BRP distributor/dealer within two (2) months of the appearance of a defect, and provide it with reasonable access to the product and reasonable opportunity to repair it. The customer must also present to the authorized BRP distributor/dealer, proof of purchase of the product and must sign the repair/work order prior to starting the repair in order to validate the warranty repair. All parts replaced under this limited warranty become the property of BRP.

Note that the notification period is subject to the applicable national or local legislation in your country.

7) WHAT BRP WILL DO

BRP's obligations under this warranty are limited to, at its sole discretion, repairing parts found defective under normal use, maintenance and service, or replacing such parts with new genuine sport boat parts without charge for parts and labor, at any authorized BRP distributor/dealer during the warranty coverage period.

BRP reserves the right to improve or modify products from time to time without assuming any obligation to modify products previously manufactured.

8) TRANSFER

If the ownership of a product is transferred during the warranty coverage period, this warranty shall also be transferred and be valid for the remaining coverage period provided BRP or an authorized BRP distributor/dealer receives a proof that the former owner agreed to the transfer of ownership, in addition to the coordinates of the new owner.

9) CONSUMER ASSISTANCE

- a) In the event of a controversy or a dispute in connection with this limited warranty, BRP suggests that you try to resolve the issue at the dealership level. We recommend discussing the issue with the authorized Distributor/Dealer's service manager or owner.
- b) If further assistance is required, the distributor's service department should be contacted in order to resolve the matter. You will find your distributor's coordinates on www.brp.com.
- c) If the matter still remains unresolved then contact BRP at the address listed below.

For countries within Europe, Middle East, Africa, Russia & CIS, please contact our European office:

BRP EUROPE N.V.

Consumer Service Center
Skaldenstraat 125
9042 Gent
Belgium
Tel.: + 32-9-218-26-00

For Scandinavian countries, please contact our Finland office:

BRP FINLAND OY

Service Department
Ahjotie 30
Fin-96320 Rovaniemi
Finland
Tel.: + 358 16 3208 111

For all other countries, please contact your local distributor or our North America office:

BOMBARDIER RECREATIONAL PRODUCTS INC.

Consumer Services Group
75, J.-A. Bombardier Street
Sherbrooke, Québec J1L 1W3
Tel.: 819 566-3366

* For the territory covered by this limited warranty, products are distributed and serviced by Bombardier Recreational Products Inc. or its affiliates.

© 2007 Bombardier Recreational Products Inc. All rights reserved.

® Registered trademark of Bombardier Recreational Products Inc. or its affiliates.

The EC-Declaration of Conformity does not appear in this version of the Operator's Guide.

Please refer to the printed version that was delivered with your vehicle.

Homologation and Certification

These boats comply with the following standards:

STANDARD	TYPE OF CERTIFICATION
United States Coast Guard	Self certification
Canadian Coast Guard	Self certification
Russian Maritime Register of Shipping	Certify by Russian Maritime Register of Shipping 8, Dvortsovaya Nab., 191186 St. Petersburg, Russia
Directive 89/336/CEE of the council relating to electromagnetic compatibility	Internal production control plus control carried out on the responsibility of a competent body. Competent body: UTAC Autodrome de Linas-Montlhéry, B.P. 212 91311 Montlhéry cedex, France
Directive 2003/44/EC of the European Parliament and of the council relating to recreational craft	Internal production control plus control carried out on the responsibility of a notified body. Notified body: International Marine Certification Institute Trèves centre, rue de Trèves 45 1040 Brussels, Belgium

PRIVACY OBLIGATION/DISCLAIMER

We wish to inform you that your coordinates will be used for safety and warranty purposes. Sometimes, we also use the coordinates of our clients to inform them about our products and to present them offers. Should you prefer not to receive information on our products, services and offers, please let us know by writing to the address below.

Also note that, from time to time, carefully selected and trustworthy organizations may be permitted to use the coordinates of our clients to promote quality products and services. If you prefer not to have your name and address released, please let us know by writing to the address below:

In Canada

BOMBARDIER RECREATIONAL PRODUCTS INC.

Warranty Department
75, J.-A. Bombardier Street
Sherbrooke, Québec J1L 1W3
Fax Number: 819 566-3590

In USA

BRP US INC.

Warranty Department
7575 Bombardier Court
Wausau WI 54401
Tel.: 715 848-4957

Other countries in the world

BRP EUROPEAN DISTRIBUTION

Warranty Department
Chemin de Messidor 5-7
1006 Lausanne Switzerland
Fax Number: + 41213187801

CHANGE OF ADDRESS/OWNERSHIP

If your address has changed or if you are the new owner of the boat, be sure to notify BRP by either:

- mailing one of the following card below;
- **North America only:** calling at 715 848-4957 (USA) or 819 566-3366 (Canada);
- contacting an authorized BRP distributor/dealer.

In case of change of ownership, please join a proof that the former owner agreed to the transfer.

Notifying BRP, even after the expiration of the limited warranty, is very important as it enables BRP to reach the boat owner if necessary, like when safety recalls are initiated. It is the owner’s responsibility to notify BRP.

STOLEN UNITS: In the event that your boat is stolen, you should notify your area’s distributor warranty department of such. We will ask you to provide your name, address, phone number, Hull Identification Number and date it was stolen.

In North America

BOMBARDIER RECREATIONAL PRODUCTS INC.
 Warranty Department
 75, J.-A. Bombardier Street
 Sherbrooke, Québec J1L 1W3
 Canada

Other countries in the world

BRP EUROPEAN DISTRIBUTION
 Warranty Department
 Chemin de Messidor 5-7
 1006 Lausanne
 Switzerland



CHANGE OF ADDRESS <input type="checkbox"/>	CHANGE OF OWNERSHIP <input type="checkbox"/>																													
VEHICLE IDENTIFICATION NUMBER																														
<table border="1" style="width:100%; border-collapse: collapse;"> <tr><td style="width:30px; height:20px;"> </td><td style="width:30px; height:20px;"> </td><td style="width:30px; height:20px;"> </td></tr> </table> <p style="text-align:center; margin-top: 0;">Model Number</p>				<table border="1" style="width:100%; border-collapse: collapse;"> <tr><td style="width:20px; height:20px;"> </td><td style="width:20px; height:20px;"> </td><td style="width:20px; height:20px;"> </td><td style="width:20px; height:20px;"> </td><td style="width:20px; height:20px;"> </td><td style="width:20px; height:20px;"> </td><td style="width:20px; height:20px;"> </td><td style="width:20px; height:20px;"> </td><td style="width:20px; height:20px;"> </td><td style="width:20px; height:20px;"> </td><td style="width:20px; height:20px;"> </td><td style="width:20px; height:20px;"> </td><td style="width:20px; height:20px;"> </td><td style="width:20px; height:20px;"> </td><td style="width:20px; height:20px;"> </td><td style="width:20px; height:20px;"> </td><td style="width:20px; height:20px;"> </td><td style="width:20px; height:20px;"> </td><td style="width:20px; height:20px;"> </td><td style="width:20px; height:20px;"> </td><td style="width:20px; height:20px;"> </td><td style="width:20px; height:20px;"> </td><td style="width:20px; height:20px;"> </td><td style="width:20px; height:20px;"> </td><td style="width:20px; height:20px;"> </td><td style="width:20px; height:20px;"> </td></tr> </table> <p style="text-align:center; margin-top: 0;">Vehicle Identification Number (V.I.N.)</p>																										
<table style="width:100%;"> <tr> <td style="width:40%; vertical-align: top;"> OLD ADDRESS OR PREVIOUS OWNER: </td> <td style="border-top: 1px solid black; vertical-align: top;">NAME</td> </tr> <tr> <td style="border-top: 1px solid black;"></td> <td style="border-top: 1px solid black; vertical-align: top;">NO. STREET APT</td> </tr> <tr> <td style="border-top: 1px solid black;"></td> <td style="border-top: 1px solid black; vertical-align: top;">CITY STATE/PROVINCE ZIP/POSTAL CODE</td> </tr> <tr> <td style="border-top: 1px solid black;"></td> <td style="border-top: 1px solid black; vertical-align: top;">COUNTRY TELEPHONE</td> </tr> <tr> <td style="vertical-align: top; padding-top: 20px;">NEW ADDRESS OR NEW OWNER:</td> <td style="border-top: 1px solid black; vertical-align: top; padding-top: 20px;">NAME</td> </tr> <tr> <td style="border-top: 1px solid black;"></td> <td style="border-top: 1px solid black; vertical-align: top; padding-top: 20px;">NO. STREET APT</td> </tr> <tr> <td style="border-top: 1px solid black;"></td> <td style="border-top: 1px solid black; vertical-align: top; padding-top: 20px;">CITY STATE/PROVINCE ZIP/POSTAL CODE</td> </tr> <tr> <td style="border-top: 1px solid black;"></td> <td style="border-top: 1px solid black; vertical-align: top; padding-top: 20px;">COUNTRY TELEPHONE</td> </tr> </table>		OLD ADDRESS OR PREVIOUS OWNER:	NAME		NO. STREET APT		CITY STATE/PROVINCE ZIP/POSTAL CODE		COUNTRY TELEPHONE	NEW ADDRESS OR NEW OWNER:	NAME		NO. STREET APT		CITY STATE/PROVINCE ZIP/POSTAL CODE		COUNTRY TELEPHONE													
OLD ADDRESS OR PREVIOUS OWNER:	NAME																													
	NO. STREET APT																													
	CITY STATE/PROVINCE ZIP/POSTAL CODE																													
	COUNTRY TELEPHONE																													
NEW ADDRESS OR NEW OWNER:	NAME																													
	NO. STREET APT																													
	CITY STATE/PROVINCE ZIP/POSTAL CODE																													
	COUNTRY TELEPHONE																													

V00A2F

BOAT MODEL No. _____

HULL IDENTIFICATION NUMBER (H.I.N.) _____

ROTAX ENGINE IDENTIFICATION NUMBER (E.I.N.) _____

Owner: _____
NAME

No. STREET APT

CITY STATE/PROVINCE ZIP/POSTAL CODE

Purchase Date _____
YEAR MONTH DAY

Warranty Expiry Date _____
YEAR MONTH DAY

To be completed by the dealer at the time of the sale.

DEALER IMPRINT AREA

F00A35L

Please verify with your selling dealer to ensure your SEA-DOO sport boat has been registered with BRP.

204 630 367

CA

OPERATOR'S GUIDE, 180 CHALLENGER, SE / ENGLISH
GUIDE DU CONDUCTEUR, 180 CHALLENGER, SE / ANGLAIS

FAIT AU / MADE IN CANADA

U/M:P.C.