

# SEA-DOO®



# 2007

**Sport Boats**

## **OPERATOR'S GUIDE**

Includes **SAFETY, VEHICLE**  
and **MAINTENANCE INFORMATION**

**150 SPEEDSTER™**  
**180 CHALLENGER\***



 **WARNING**

Read this guide thoroughly. It contains important safety information.  
Minimum recommended operator's age: 16 years old.  
Do not remove this *Operator's Guide* from the boat.

204 630 354

## **SAFETY WARNING**

Disregarding any of the safety precautions and instructions contained in this Operator's Guide, the *SAFETY VIDEO* and the on-product warning labels could cause injury, including the possibility of death. The operator has the responsibility to inform passenger(s) of safety precautions.

This Operator's Guide and *SAFETY VIDEO* should remain with the boat at the time of resale.



CHALLENGER\*

\* Trademark of Bombardier Inc. used under license.

The following trademarks are the property of Bombardier Recreational Products Inc. or its affiliates.

Sea-Doo®

ROTAX™

SPEEDSTER™

---

# DOIN'IT ON YOUR NEW SEA-DOO SPORT BOATS

Congratulations, you are now the proud owner of a Sea-Doo Sport Boats. Whether you are an experienced boater or are new to the sport of boating, we ask you to take the time to view the *SAFETY VIDEO* provided with the boat, to read this Operator's Guide on-product warning/caution labels and familiarize yourself with the contents. This guide contains pertinent information which, if followed, will provide you with the necessary knowledge to help you fully enjoy the pleasures of this boat.

We strongly recommend that any boat operator complete a safety boating course. Check with your local Coast Guard or Power and Sail Squadron in your area for course availability. More serious boaters may want to obtain *CHAPMAN PILOTING* by Elbert S. Maloney, available at most book stores.

When introducing your family or friends to the sport, be sure they fully understand the controls and operation of the boat and the importance of courteous, responsible riding.

Each boat operator has a responsibility to ensure the safety of his/her passenger(s) and of other water users. Please follow all safety instructions and operate your boat with care.

We encourage you to have an Annual Safety Inspection of your boat. Please contact your authorized Sea-Doo Sport Boats dealer for further details.

Finally, we invite you to visit your authorized Sea-Doo Sport Boats dealer for regular safety maintenance as well as any boating accessories you may require.

Have fun and... Bon Voyage.

**Please keep this guide on board. This guide should remain with the boat at time of resale.**

If you want to view and/or print an extra copy of your Operator's Guide, simply visit the following website [www.operatorsguide.brp.com](http://www.operatorsguide.brp.com). Also note that the guide is available in several languages.

---

# TABLE OF CONTENTS

FOREWORD .....	7
----------------	---

## ***SAFETY INFORMATION***

GENERAL .....	10
TRAILERING .....	11
SAFE BOATING CHECKLIST .....	12
SAFETY EQUIPMENT .....	15
CARBON MONOXIDE AND BOATING .....	21
SAFETY LANYARD .....	25
SAFE BOATING PRACTICES .....	26
PASSENGER SAFETY .....	27
RULES OF THE ROAD .....	28
FUELING PROCEDURE .....	31
VOLUNTARY INSPECTIONS .....	32
SAFE BOATING COURSES .....	33
WATER SPORTS .....	34

## ***VEHICLE INFORMATION***

REGISTRATION NUMBER LOCATION .....	38
LOCATION OF THE IMPORTANT LABELS .....	39
IDENTIFICATION NUMBERS .....	44
CONTROLS, COMPONENTS AND INSTRUMENTS .....	45
Overview .....	45
1) DESS™ Post (engine cut-out switch) .....	50
2) Steering Wheel .....	50
3) Throttle/Shifter Controller .....	51
4) Start/Stop Button .....	52
5) Navigation Lights Switch .....	52
6) Bilge Pump Switch .....	53
7) Bilge Air Blower Switch .....	53
8) Information Center Gauge .....	54
9) Bilge Drain Plugs .....	56
10) Grab Handles .....	56
11) Rear Grab Handles .....	57
12) Swim Platform .....	57
13) Ladder .....	57
14) Seats .....	58
15) Front Boarding Step .....	58
16) Spotter Seat .....	58

17) Cup Holders .....	58
18) Front Storage Compartment .....	58
19) Deck Storage Compartment .....	59
20) Rear Storage Compartment .....	60
21) Jet Pump Water Intake .....	61
22) Bow Lights .....	61
23) Stern Light Socket.....	61
24) Mooring Cleats .....	63
25) Deck .....	63
26) Fuel Tank Cap .....	63
27) Deck Drain .....	64
28) Engine Oil Filling Cap .....	64
29) Flushing Connector.....	64
30) Ventilation Ducts .....	65
31) Bow/Stern Eyelets .....	65
32) Jet Pump Nozzle .....	65
33) Reverse Gate .....	65
34) Scupper Valve.....	66
35) Fuel Tank Vent .....	66
36) Water Sport Towing Attachments .....	66
37) Main Battery Cut-Off Switch .....	70
38) AM/FM Radio/CD Player.....	71
39) 12-Volt Jack .....	71
40) Fuses .....	71
41) Horn Switch.....	71
42) Deck Lights Switch.....	72
43) Glovebox .....	72
44) Bow Seats.....	72
45) Bow Seat Storage Compartments.....	73
46) Bow Filler Cushion (if so equipped) .....	73
47) Rear Seat Storage Compartments.....	73
48) Passenger Storage Compartment .....	74
49) Engine Cover.....	74
50) Port Bilge Access.....	74
51) Removable Cooler.....	75
52) Radio/CD Cut-Off Switch .....	75
53) AM/FM Radio/CD Player Remote Control .....	75
<b>LIQUIDS.....</b>	<b>76</b>
Fuel.....	76
Engine Oil.....	76
Engine Coolant .....	78
<b>BREAK-IN PERIOD.....</b>	<b>80</b>
<b>PRE-OPERATION CHECKS .....</b>	<b>81</b>
Hull .....	82
Jet Pump Water Intake.....	82
Bilge .....	83
Battery .....	83

Fuel Tank and Engine Oil Level .....	83
Engine Compartment .....	83
Fire Extinguisher .....	83
Steering System .....	83
Throttle System .....	83
Shifter System .....	83
DESS Post and Engine Start/Stop Button .....	84
Storage Compartment Covers .....	84
<b>OPERATING INSTRUCTIONS .....</b>	<b>85</b>
Launching/Loading .....	85
Principle of Operation .....	85
Boarding from a Dock .....	86
Boarding from the Water .....	86
Starting .....	87
Rough Water or Poor Visibility Operation .....	88
Crossing Waves .....	88
Stopping/Docking .....	88
Beaching .....	88
Shutting Off the Engine .....	89
Post-Operation Care .....	89
Additional Care for Foul Water or Salt Water Use .....	89
<b>SPECIAL PROCEDURES .....</b>	<b>91</b>
Jet Pump Water Intake and Impeller Cleaning .....	91
Capsized Boat .....	91
Submerged Boat/ Water-Flooded Engine .....	91
Fuel-Flooded Engine .....	92
Towing the Boat in Water .....	93
<b>TROUBLESHOOTING .....</b>	<b>95</b>
<b>SPECIFICATIONS .....</b>	<b>100</b>

## ***MAINTENANCE INFORMATION***

<b>10-HOUR INSPECTION .....</b>	<b>108</b>
<b>PERIODIC MAINTENANCE CHART .....</b>	<b>109</b>
<b>MAINTENANCE PROCEDURES .....</b>	<b>112</b>
General .....	112
Engine Emissions Information .....	112
Lubrication .....	113
Throttle Cable .....	115
Engine Oil Change and Oil Filter Replacement .....	115
Coolant Replacement .....	115
Fuel Injection System .....	115
Steering Alignment .....	115
Shift Lever .....	115
Deck Drain .....	115
Fuses .....	116

Bilge Air Blower.....	118
Navigation Light Bulb Replacement .....	119
Sacrificial Anodes .....	121
General Inspection and Cleaning.....	122
<b>STORAGE AND PRESEASON PREPARATION .....</b>	<b>123</b>

***WARRANTY INFORMATION***

<b>BRP LIMITED WARRANTY FOR MODEL YEAR 2007 SEA-DOO® SPORT BOATS SOLD IN THE UNITED STATES AND CANADA .....</b>	<b>130</b>
<b>CALIFORNIA AND NEW YORK EMISSION CONTROL WARRANTY STATEMENT FOR MODEL-YEAR 2007 SEA-DOO® SPORT BOATS WITH 4-TEC™ ENGINES OR 4-TEC IC ENGINES.....</b>	<b>135</b>
<b>BRP INTERNATIONAL LIMITED WARRANTY FOR MODEL YEAR 2007 SEA-DOO® SPORT BOATS.....</b>	<b>139</b>
<b>BRP EUROPEAN UNION MEMBER STATES LIMITED WARRANTY FOR MODEL YEAR 2007 SEA DOO® SPORT BOATS .....</b>	<b>143</b>
<b>DECLARATION CE OF CONFORMITY .....</b>	<b>147</b>
<b>PRIVACY INFORMATION.....</b>	<b>149</b>
<b>CHANGE OF ADDRESS/OWNERSHIP .....</b>	<b>150</b>





---

# FOREWORD

This Operator's Guide has been prepared to acquaint the owner/operator or passenger of this boat with the various controls, maintenance and safe riding instructions. It is indispensable for the proper use of the product, and should be kept in a waterproof bag in the boat at all times. Make sure you read and understand the content of this document.

For any questions pertaining to the warranty and its application, please consult an authorized Sea-Doo Sport Boats dealer.

## Hazard Statements

As you read this Operator's Guide, please note the hazard warnings which alert you to safety precautions related to unsafe conditions or operating procedures.

This guide uses the following symbols to emphasize particular information.



The safety alert symbol is recognized around the world. In this manual, it means read this information carefully! Be sure you understand the consequences of the hazards and how to avoid them. Failure to follow the recommendations in a hazard communication statement may result in property damage, personal injury, or death.

People often refer to a hazard statement as a warning in a general sense. This manual uses three kinds of "warnings" depending on the likely effect of a hazard (minor injury, severe injury, death).

## WARNING

Identifies a potentially or imminently hazardous situation which, if not avoided, **COULD** result in serious personal injuries including the possibility of death or substantial property damage.

**CAUTION:** This signal word indicates a potentially hazardous situation which, if not avoided, may result in minor or moderate personal injury or property damage. It may also be used to alert against unsafe practices.

**NOTE:** Indicates supplementary information needed to fully complete an instruction relating to equipment operation and/or maintenance procedures.

Although the mere reading of such information does not eliminate the hazard, the understanding and application of the information will promote correct and safe use of the boat.

The warnings in this supplement do not and cannot address every conceivable situation. Always use common sense! If a procedure, method, tool, or part is not specifically recommended, you must satisfy yourself that it is safe for you and others and that your boat will not be damaged or made unsafe as a result of your decision.

## Advisory Statements

Advisory statements alert you to conditions that affect equipment operation, maintenance, and servicing practices.

An **IMPORTANT** statement indicates a procedure intended to prevent damage to equipment or associated components.

The information and components/system descriptions contained in this supplement are correct at the time of publication. Bombardier Recreational Products (BRP) however, maintains a policy of continuous improvement of its products without imposing upon itself any obligation to install them on products previously manufactured.

Because of our ongoing commitment to product quality and innovation, BRP reserves the right at any time to discontinue or change specifications, designs, features, models or equipment without incurring obligation.

The illustrations in this document show the typical construction of the different assemblies and may not reproduce the full detail or exact shape of the parts. However, they represent parts that have the same or similar function.

It is understood that this guide may be translated into another language. In the event of any discrepancy, the English version shall prevail.

Specifications are given in the SI metric system with the SAE U.S. equivalent in parenthesis. Where precise accuracy is not required, some conversions are rounded off for easier use.

A *SHOP MANUAL* can be obtained for complete service, maintenance and more repair information.

# ***SAFETY INFORMATION***

---

## GENERAL

Your safety and that of your passengers and fellow boaters is YOUR responsibility. Before launching your boat, you should completely read and understand this Operator's Guide, product warnings and labels, the *SAFETY VIDEO* and other information provided with your boat or by your dealer. Heed and follow all warnings, safety precautions and operating procedures.

BRP strongly recommends that you take an approved boating safety course. Always operate your boat in compliance with safe boating rules, and with consideration, courtesy and common sense. Failure to do so could result in injury, including the possibility of death, to you, your passengers, others you lend your boat to, or other water users.

---

## TRAILERING

Refer to the trailer instructions for proper capacity, operation, maintenance, accessories and warranty.

Check the regulations in your area concerning towing a trailer, especially the following rules:

- brake system
- tow vehicle weight
- mirrors.

**NOTE:** An optional brake system is available for your trailer, contact Karavan Trailers ([www.karavantrailers.com](http://www.karavantrailers.com)).

Take the following precautions when trailering the boat:

Tie the boat to both bow and stern (front/rear) eyelets so that it is firmly retained on the trailer.

- Remove stern light (if installed).
- Ensure that ski post is pushed down (**on so equipped models**).
- Ensure all storage compartment covers are properly latched.
- A Sea-Doo cover can protect the boat, particularly before driving on dirt roads, to prevent dirt entry through the air intake openings.

Observe trailering safety precautions.

**CAUTION:** Always ensure rear storage compartment lid is closed and securely fastened **before** trailering.

---

# SAFE BOATING CHECKLIST

When leaving on a cruise, whether for an hour or for several days, go through the following *SAFE BOATING CHECKLIST*.

## Reminders Regarding Operation...

- The performance of this boat may significantly exceed that of other boats you may have operated. Become completely familiar with the controls and operation of this boat before embarking on your first trip or taking on a passenger(s). If you have not had the opportunity to do so, practice driving solo in a suitable traffic-free area and feel the response of each control. Be fully familiar with all controls before accelerating above idle speed. Do not assume that all boats handle identically. Each model differs, often substantially.
- Always keep in mind that as the throttle lever is returned to the idle position, less directional control is available. To turn the boat, both steering and throttle are necessary.
- Like any other boat, this boat has no brake. Stopping distance will vary depending on initial speed, load, wind, and water conditions. Practice stopping and docking in a safe, traffic-free area to have an idea of how long it will take to stop the boat under varying conditions. Do not release the throttle when trying to steer away from objects. You need throttle to steer. Do not use the boat's reverse to stop.
- Do not start or operate the boat if any person is not properly seated in a seat intended for use when underway (not the sun deck or swim platform) or if a person is nearby in the water.
- The boat's jet thrust can cause injury. Always accelerate slowly, and decelerate in a controlled fashion.
- Observe the instructions on all safety labels. They are there to help assure that you have a safe and enjoyable outing.
- Riding with passenger(s) or pulling other boats, tubes, a skier or a wake boarder makes the boat handle differently and requires greater skill.
- Certain boats may come equipped with tow eyelets, a ski pole or a wakeboard tower which can be used to attach a tow rope for a skier, tube or wakeboarder. Do not use these attachment points or any other portion of the boat to tow a parasail or another craft. Personal injury or severe damage may occur.
- In shallow water, proceed with caution and at very low speeds. Grounding or abrupt stops may result in injury to you, your passengers or others. The jet pump may pick up debris and throw it rearward causing a risk of injuring people or damaging the jet pump or other property.
- Engine exhaust contains carbon monoxide (CO), which can cause injury or death if inhaled in sufficient quantities. Do not operate the boat in a confined area or allow CO to accumulate in or around the boat, or in enclosed or sheltered areas. Such as when docked, or when rafting. Be aware of risk of CO from exhaust of other boats.
- Educate all occupants about the risks and symptoms of CO accumulation and CO poisoning, particularly from engine and generator exhaust. Educate them about where engine exhaust outlets (and generator outlets if so equipped) are located. Regularly inspect exhaust and generator system and outlets for component failures or obstructions.

- Combustion engines need air to operate; consequently this boat can not be totally watertight. Any maneuvers such as figure eights that cause the upper deck to be under water may cause severe engine problems due to water ingestion. Refer to the *SPECIAL PROCEDURES* and *LIMITED WARRANTY* sections contained in this Operator's Guide.
- Respect no wake zones, the rights of other water users and the environment. As the "skipper" and owner of a boat, you are responsible for damage to other boats caused by the wake of your boat. Do not let anyone throw refuse overboard.
- Between sunset and sunrise, use the boat's navigation lights and reduce speed. Do not operate the boat in reduced visibility.
- Do not add accessories or equipment that may adversely affect visibility or alter control of the boat.
- The skipper should personally take the helm during storms.
- Be sure you have the minimum required safety equipment, PFDs and any additional gear needed for your cruise.
- Check that all lifesaving equipment, including fire extinguisher, is in safe operating condition and easily accessible. Show all passengers where this equipment is, and make sure they know how to use it.
- Keep an eye on the weather. Check local weather broadcasts before departure. Be alert to changing conditions.
- Keep accurate and up-to-date charts of the boating area on board. Before getting underway, check water conditions in the planned boating area.
- Before departure, file a Float Plan with a responsible person ashore.
- Keep enough fuel on board for the planned trip. Always verify fuel level before use and during the ride. Apply the principle of 1/3 of the fuel to reach your destination, 1/3 to return, and keep 1/3 in reserve. Allow for changes due to adverse weather or other delays.

## **Before Getting Underway...**

- Always perform the pre-operation checks as specified in this Operator's Guide.
- Do not exceed the payload or passenger capacities for this boat, which are listed on the capacity plate and in the specifications. Overloading can affect maneuverability, stability and performance. Also, heavy seas reduce capacity. A payload or person capacity plate is not an excuse for failure to use common sense or good judgment.
- Regularly inspect the boat, the hull, engine, safety equipment, and all other boating gear and keep them in safe operating condition.

## **Operators and Passengers...**

- Never operate a boat while under the influence of drugs or alcohol. It is a Federal offense. Allow only qualified drivers to operate your boat. Remember that sun, wind, alcohol, drugs, fatigue or illness may impair your judgement and reaction time.
- At least one passenger should be able to operate the boat in case the operator is unexpectedly unable to do so.
- Operation of this boat by a person under 16 years of age or a person with a disability that impairs vision, reaction time, judgment, or operation of the controls is NOT recommended.

- Always use the safety lanyard when operating the boat and ensure that all passengers are familiar with its use.
- Ensure that any operator and all passengers know how to swim and how to re-board the boat from the water. If a passenger does not know how to swim, ensure that passenger wears a PFD at all times and take extra precautions when boating.



---

## SAFETY EQUIPMENT

An operator and the boat's passenger(s) should have ready access to shatterproof glasses should riding conditions or personal preference warrant.

Wind, water spray and speed may cause a person's eyes to water and create blurred vision.

As the owner of the boat, you are responsible for assuring that all required safety equipment is aboard. You should also consider supplying additional equipment as needed for your safety and that of your passengers. Check state and local regulations and call the U.S. Coast Guard Boating Safety Information Line at 1 800 368-5647 for information about required safety equipment.

### Required Safety Equipment

Safety equipment required by federal regulations is mandatory. Personal flotation devices must be fitted to the people wearing them. If local regulations require additional equipment, it must be approved by the U.S. Coast Guard (USCG). Minimum requirements include the following:

- personal flotation devices
- fire extinguisher
- visual distress signal
- navigation lights
- bell or whistle.

A cellular telephone in a waterproof bag or container has also been found to be beneficial to boaters when in distress or just for contacting someone on shore.

### Personal Flotation Devices (PFDs)

Federal regulations require that you have at least one Coast Guard approved personal flotation device (PFD) for each person in a recreational boat and require that all children under 13 years of age wear a PFD at all times when the boat is underway, except when below deck or in an enclosed cabin. You may not use your boat unless all PFDs are in serviceable condition, readily accessible, legibly marked with the Coast Guard approval number, and of an appropriate size (within the weight range and chest size marked on the PFD) for each person on board.

A PFD provides buoyancy to help keep your head above the water and to help you remain in a satisfactory position while in the water. Body weight and age should be considered when selecting a PFD. The buoyancy provided by the PFD should support your weight in water. The size of the PFD should be appropriate for the wearer. Body weight and chest size are common methods used to size PFDs. It is your responsibility to ensure that you have the proper number and types of PFDs on board to comply with federal and local regulations and that your passengers know where they are and how to use them.

### PFD Types

Five types of PFDs have been approved by the U.S. Coast Guard.

PFD Type I, Wearable has the greatest required buoyancy. Its design allows for turning most unconscious persons in the water from face down position to a vertical or slightly backward, face-up position. It can greatly increase the chances of survival. Type I is most effective for all waters, especially offshore when rescue may be delayed. It is also the most effective in rough waters.

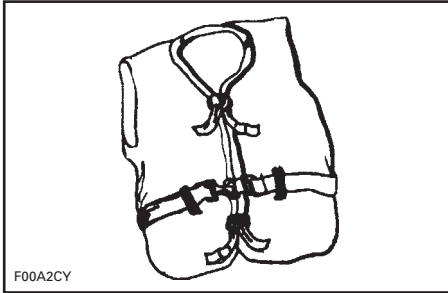

*TYPE I — WEARABLE*

PFD Type II, Wearable turns its wearer in the same way as Type I, but not as effectively. The Type II does not turn as many persons under the same conditions as a Type I. You may prefer to use this PFD where there is a probability of quick rescue such as in areas where other people are commonly involved in water activities.

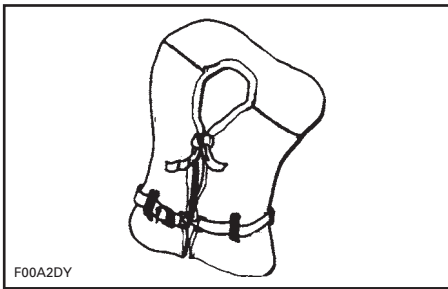

*TYPE II — WEARABLE*

PFD Type III, Wearable allows wearers to place themselves in a vertical or slightly backward position. It does not turn the wearer. It maintains the wearer in a vertical or slightly backward position and has no tendency to turn the wearer face down. It has the same buoyancy as a Type II PFD and may be appropriate in areas where other people are commonly involved in water activities.

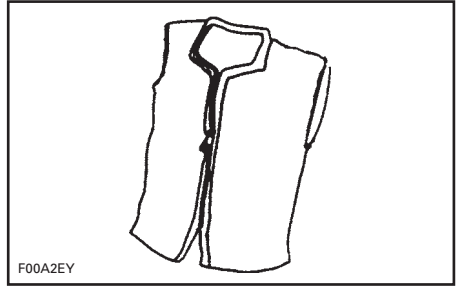

*TYPE III — WEARABLE*

PFD Type IV, Throwable is required in addition to the PFDs previously discussed. The most common Type IV PFD is a buoyant cushion or ring buoy. It is designed to be thrown to a person in the water, grasped and held by the user until he or she is rescued. A Type IV PFD should always be in serviceable condition and immediately available for use. Grasping this PFD may be difficult if the rescue is delayed or if the user is overcome by hypothermia (loss of body heat).

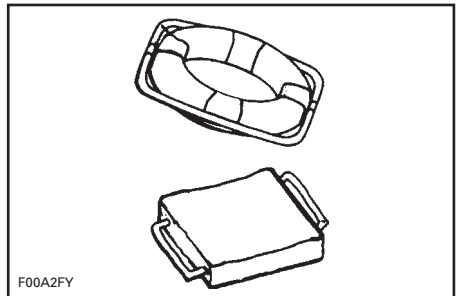

*TYPE IV — THROWABLE*

PFD Type V, Wearable must be worn. When inflated, it provides buoyancy equivalent to Type I, II or III PFDs. When it is deflated, however, it may not support some people.

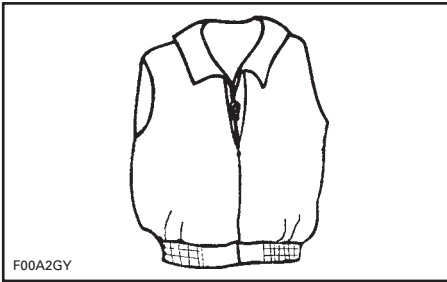

*TYPE V — WEARABLE*

### **PFD Pointers**

The purpose of a PFD is to help save your life. If you want it to support you when you are in the water, it needs to fit, float, and be in good condition.

- Try the PFD on and adjust it until it fits comfortably in and out of the water. Mark your PFD if you are the only wearer.
- To make sure the PFD works, wear it in the water. This will show you how it works and give you confidence when you use it.
- Teach children how to put a PFD on and allow them to try it in the water. That way, they know what the PFD is for and how it works. They will feel more comfortable with it if they suddenly find themselves in the water.
- If the PFD is wet, allow it to dry thoroughly before storing it. Do not dry it in front of a radiator or heater. Store it in a well-ventilated area.
- Keep PFDs away from sharp objects which can tear the fabric or puncture the flotation pads.
- For their own safety and the safety of others, all non-swimmers, poor swimmers, and small children should wear PFD's at all times whether the boat is stationary or moving.

- Check the PFD frequently to make sure that it is not torn, that flotation pads have no leaks, and that all seams and joints are securely sewn.
- If a PFD contains kapok, the kapok fibers may become waterlogged and lose their buoyancy after the vinyl inserts are punctured. If the kapok becomes hard or if it is soaked with water, replace it. It may not work when you need it.

### **Hypothermia**

Hypothermia, the loss of body heat to the water, is a significant cause of deaths in boating accidents. After an individual has succumbed to hypothermia, he or she will lose consciousness and then drown.

PFDs can increase survival time because of the insulation they provide.

Naturally, the warmer the water, the less insulation one will require. When operating in cold water (below 4.4°C (40°F)) consideration should be given to using a coat or jacket style PFD as they cover more of the body than the vest style PFDs.

Some points to remember about hypothermia protection:

1. While afloat in the water, do not attempt to swim unless it is to reach a nearby boat, fellow survivor, or a floating object on which you can lean or climb. Unnecessary swimming increases the rate of body heat loss. In cold water, drown-proof methods that require putting your head in the water are not recommended. Keep your head out of the water. This will greatly lessen heat loss and increase your survival time.
2. Keep a positive attitude about your survival and rescue. This will improve your chances of extending your survival time until rescue. Your will to live does make a difference!

3. If there is more than one person in the water, huddling is recommended while waiting to be rescued. This action tends to reduce the rate of heat loss and thus increase the survival time.
4. Always wear your PFD. It won't help you fight off the effects of hypothermia if you don't have it on when you go into the water.

## Fire Extinguishers

As the owner of the boat, you are responsible for supplying a fire extinguisher approved by the U.S. 4.8 to less than 7.9 m (16 - 26 ft) are required to carry one (1) B-1 type hand portable fire extinguisher unless the boat is equipped with a fixed fire extinguishing system in the engine compartment.

Hand-held portable fire extinguishers should be mounted in readily accessible locations away from the engine compartment. All persons aboard should know the location and proper operation of the fire extinguisher(s).

**NOTE:** Don't test fire extinguishers by squirting small amounts of the extinguishing compound. The extinguisher might not work when you really need it!

## Visual Distress Signal Devices

Visual distress signal devices approved by the U.S. Coast Guard are required on all recreational boats operating on coastal waters and on boats owned in the United States when they are operating on the high seas. Coastal waters include territorial seas and those waters directly connected to the Great Lakes and the territorial seas up to a point where the waters are less than 3.2 km (2 mi) wide. Visual distress signal equipment may be of the pyrotechnic or non-pyrotechnic type. Regulations prohibit display of visual distress signals on the water under any circumstances except when assistance is required to prevent immediate or potential danger to persons on board a vessel.

The equipment must be approved by the U.S. Coast Guard, be in serviceable condition, and be stowed in a readily accessible location. Equipment having a date for serviceable life must be within the specified usage date shown.

Careful selection and proper stowage of visual distress equipment is very important if children are aboard.

### **WARNING**

**Fire! In case of fire, do not open engine compartment. Turn off engine. Using portable CO<sub>2</sub> fire extinguisher, continuously discharge entire contents at base of fire.**

<b>DAY USE ONLY</b>
Three orange smoke signals (one hand held and two floating) or one orange flag with black square and disk.
<b>NIGHT USE ONLY</b>
One S-O-S electric distress light.
<b>DAY AND NIGHT USE</b>
Three flares of the hand held, meteor or parachute type.

## Sound Signaling Devices

**NOTE:** No single signaling device is appropriate for all purposes. Consider keeping various types of equipment on board.

Boats less than 7.9 m (26 ft) in length are required to carry a hand, mouth, or power operated horn or whistle. It must produce a blast of two second duration and audible at a distance of at least 800 m (1/2 mi).

Following are standard whistle signals:

- one prolonged blast (warning signal)
- one short blast (pass on my port side)
- two short blasts (pass on my starboard side)
- three short blasts (engines in reverse)
- five or more blasts (danger signal).

## Navigation Lights

Navigation lights are intended to keep other vessels informed of your presence and course. If you are out on the water between sunset and sunrise, you are required to display appropriate navigation lights.

## Additional Recommended Equipment

It is recommended that you acquire additional equipment for safe, enjoyable cruising. This list, which is not all inclusive, includes items you should consider acquiring.

### Basic Gear

- flashlight
- mooring lines
- compass
- oar or paddle
- distress signals
- first aid kit
- dock fenders
- VHF radio
- EPIRB (Electronic Position Indicating Radio Beacon)
- boat hook
- extra warm clothing
- charts
- sunblock
- tow line
- second anchor and line
- dewatering device (pump or bailer)
- emergency supply of drinking water and food.

### Tools

- spark plug wrench
- hammer
- screwdrivers
- jackknife
- pliers
- electrician's tape
- adjustable wrench
- lubricating oil
- duct tape.

For additional tools, see your dealer.

## **Spare Parts**

- extra bulbs
- extra fuses
- extra drain plug
- spark plugs
- spare wire.

For additional parts, see your dealer.

---

# CARBON MONOXIDE AND BOATING

Burning a material containing carbon produces carbon monoxide (CO), an odorless and colorless gas. Because CO weighs the same as air, it can spread throughout an enclosed space unnoticed because you cannot see it or smell it. Any device used to burn carbon-based materials on a boat can be a source of CO. Common sources of CO include internal combustion engines.

CO reacts with the blood to reduce the ability of the blood to carry oxygen. The reduced oxygen supply to body tissues results in death of the tissue. Prolonged exposure can cause brain damage or death. In high concentrations, CO can be fatal within minutes. The effects of CO in lower concentrations are cumulative and can be just as lethal over long periods of time.

Symptoms of CO poisoning include: Itchy and watering eyes, flushed appearance, throbbing temples, inability to think coherently, ringing in the ears, tightness across the chest, headaches, drowsiness, nausea, dizziness, fatigue, vomiting, collapse, and convulsions. If any of these symptoms are evident, begin treatment immediately. Prompt action can make the difference between life and death.

- Evacuate the area and move the victim to fresh air.
- Administer oxygen if available and get medical help.
- Open all canvas enclosures to ventilate the area.
- Investigate the source of CO and take immediate corrective action.
- Be especially aware of other CO sources which may be near boat.

## Carbon Monoxide Accumulation

Following are examples of possible situations where CO may accumulate within your boat while docked, anchored, or underway. Become familiar with these examples and their precautions to prevent personal injury or death.

### WARNING

**Exhaust fumes!** Generator or hull exhaust from other vessels while either docked or anchored can emit poisonous CO gas and cause excessive accumulation within cabin and cockpit areas. Be alert for generator exhaust from your vessel or other vessels alongside. Exhaust outlets near a pier, dock, seawall or outlets blocked by any other means can cause excessive accumulation of poisonous CO gas within cockpit area.

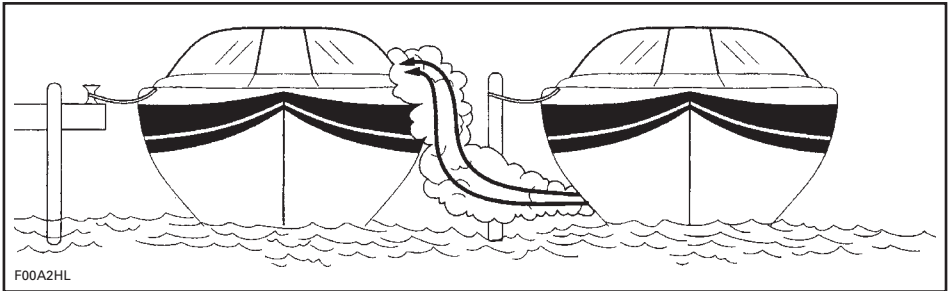

VESSEL ALONGSIDE

### WARNING

**Engine exhaust fumes contain carbon monoxide (CO)** which can accumulate in and around the boat (under Bimini top, in cockpit, etc.). CO can be harmful or fatal if inhaled. Assure there is adequate ventilation whenever running engine(s).

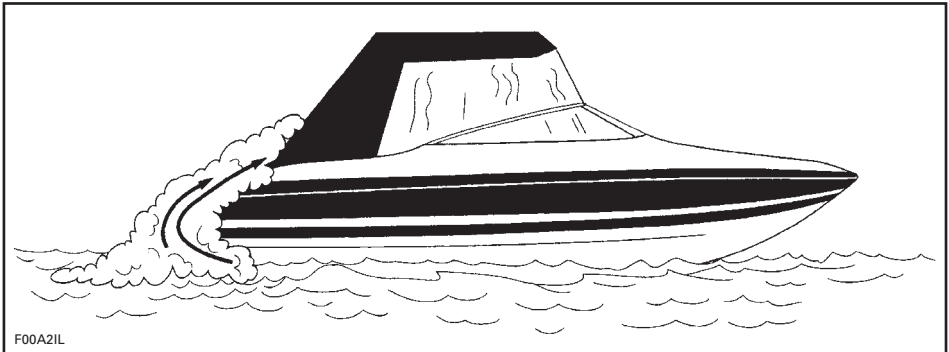

WHILE UNDERWAY (BACKDRAFTING)



While underway, CO concentrations can increase by backdrafting or “the station wagon effect”. Backdrafting is caused by factors such as relative wind direction, speed, or the bow being too high. To prevent this, open canvas whenever possible to provide positive airflow through the hull.

Boat houses, seawalls, and other boats in close proximity or confined areas can contribute to increased CO levels. Operators must be aware that operation, mooring, and anchoring in an area with other boats puts them in jeopardy of CO accumulation from other sources. Likewise, a boat operator must be aware of how exhaust from his boat will affect others. Operation of the engines while moored may cause CO accumulation in your boat and those around you.

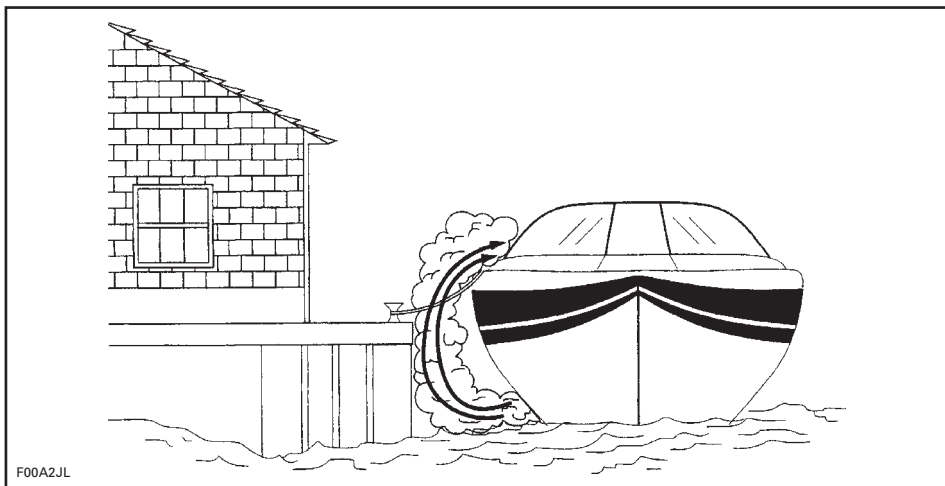

### CONFINED AREAS

Be sure to provide adequate ventilation. If the windshield has vents, open them before getting underway to increase positive air flow and decrease the chances of CO accumulation.

## **WARNING**

**Backdrafting!** Under certain conditions, moving air currents can direct poisonous CO fumes into boat. These fumes can accumulate to dangerous levels without proper airflow. Provide adequate ventilation, redistribute the load or bring boat out of high bow angle.

Even with the best boat design and construction, CO may still accumulate in enclosed or confined areas under certain conditions. Continually observe passengers for symptoms of CO poisoning.

# Do NOT Operate your Boat without Performing the Following Checklist:

Each Boating Day

OPERATION	✓
Make sure you and your passengers know where exhaust outlets are located on the vessel	
Educate all passengers about the symptoms of CO poisoning and where CO may accumulate	
When docked or rafting with another boat, be aware of exhaust emissions from the other boat	
Confirm that water flows from the exhaust outlet when the engine(s) is (are) started	
Listen for any change in exhaust sound, which could indicate an exhaust component failure	
Test the operation of each CO alarm by pressing the test button	

## CO Detector

It is strongly recommended that you have CO detectors installed in boats with canvas enclosures. Monitors are available from your dealer. Monitors should be professionally installed and calibrated.

**NOTE:** A CO detector is not a gas fuel vapor detector. Gas fuel vapor detectors do not monitor the buildup of CO in an enclosed area.

# SAFETY LANYARD

This safety device automatically stops the engine if the lanyard is attached to the operator and the operator falls from the control station.

The safety lanyard clip must be securely attached to the operator's PFD, clothing, arm, or leg. Be sure to attach the lanyard clip to a place where it is free of obstructions and to something that will move with the operator if he or she leaves the helm station. If the engine shuts down because the DESS key attached to the safety lanyard was removed, the key must be reinstalled on the DESS post before the engine can be restarted.

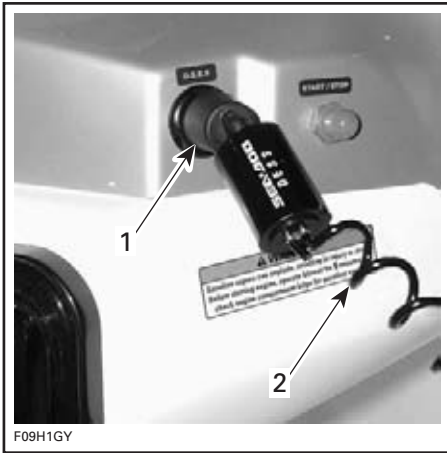

**TYPICAL**

- 1. DESS key installed on DESS post
- 2. Safety lanyard attached to operator

## **WARNING**

Always use the safety lanyard when operating your boat. Keep DESS post free from obstructions that could interfere with its operation. Do not modify or bypass its safety features. The proper use of the safety lanyard can prevent a runaway boat situation which otherwise could cause severe personal injury or death.

---

# SAFE BOATING PRACTICES

YOU are responsible for your own safety, the safety of your passengers, and the safety of fellow boaters.

## Drugs and Alcohol

Do not use drugs or drink alcohol while operating a boat. Like driving a car, driving a boat requires sober, attentive care. Operating a boat while intoxicated or under the influence of drugs is not only dangerous, but it is also a Federal offense carrying a significant penalty. These laws are vigorously enforced. The use of drugs and alcohol, singly or in combination, decreases reaction time, impedes judgment, impairs vision, and inhibits your ability to safely operate a boat.

- Do not use the boat in weather or sea conditions beyond the skill or experience of the operator or the comfortable capability of the boat or passengers.
- Be sure at least one other passenger is familiar with the operation and safety aspects of the boat in case of an emergency.
- Make sure that passengers and gear do not obstruct the operator's view or ability to move.
- Do not exceed the maximum engine power rating stated on the certification plate attached to the boat.
- Observe all safety signs and warnings both inside the boat and in the immediate boating area.

### **WARNING**

Alcohol consumption and boating do not mix! Operating under the influence endangers the lives of your passengers and other boaters. Federal laws prohibit operating a boat under the influence of alcohol or drugs.

## Safe Operation

For safety reasons and proper care, always perform *DAILY PRE-OPERATION CHECKS* as specified in your Operator's Guide before operating your boat. Safe operation means that you do not misuse your boat nor do you allow your passengers to do so. Safe operation means using good judgment at all times. It includes, without limitation, the following actions:

- Load the boat within the limits listed on the capacity plate. Balance loads bow to stern and port to starboard.
- Maintain boat speed at or below the local legal limit. Avoid excessive speed or speeds not appropriate for operating conditions.

---

## **PASSENGER SAFETY**

Before getting underway, show all passengers where emergency and safety equipment is stowed, and explain how to use it. Everyone aboard should wear rubber-soled shoes which resist slipping on wet surfaces. While underway, passengers should remain seated inside the deck rails. Don't allow passengers to drag their feet or hands in the water. Always use handholds and other safety hardware to prevent falls. All non-swimmers, poor swimmers, and children should wear a PFD at all times. Federal regulations require that children under 13 years of age wear a PFD when the boat is underway unless they are in an enclosed cabin or below deck.

### **First Aid**

As a boat operator, you should be familiar with basic first aid procedures that may be needed while you are far from help. Fish hook accidents or minor cuts and abrasions may be the most serious mishaps on board a boat, but you should also learn the proper procedures and be ready to deal with the truly serious problems like excessive bleeding, hypothermia, and burns. First aid literature and courses are available through most Red Cross chapters.

### **Operation by Minors**

Minors should always be supervised by an adult whenever operating a boat. Many states have laws regarding the minimum age and licensing requirements of minors. Be sure to contact the state boating authorities for information. BRP recommends a minimum operator age of 16 years old.

---

# RULES OF THE ROAD

As a responsible boater, you will comply with the *RULES OF THE ROAD*, the marine traffic laws enforced by the U.S. Coast Guard. Navigating a boat is much the same as driving an automobile. Operating either one responsibly means complying with a set of rules intended to prevent accidents. Just as you assume other car drivers know what they are doing, other boaters assume you know what you are doing.

Operating a boat can be compared with driving unmarked highways and roads. To prevent collisions or avoid other boaters, a system of operating rules must be followed. It's not only common sense... it's the law!

Check local and federal boating laws applicable to the waterways where you intend to use your boat. Learn the local rules of the road. Know and understand the applicable navigation system (such as buoys and signs).

Know the waters in which the boat is to be operated. Current, tides, rapids, hidden obstacles, wakes and waves etc. can affect safe operation. It is not advisable to operate the boat in rough or inclement weather.

Generally keep to your right and safely avoid other craft by keeping a safe distance from other craft, people and objects.

## Crossing

Give right of way to craft ahead and to your right. Never cross in front of another craft.

RED light (give way to the other craft).

GREEN light (you have the right of way).

## Meeting Head-On

Keep right.

## Passing

Give right of way to other craft and keep clear.

## Navigation System

Navigational aids, such as signs or buoys, can help you identify safe waters. Buoys will indicate whether you should keep to the right (starboard) or to the left (port) of the buoy or to which channel you can continue. They may also indicate whether you are entering a restricted or controlled area such as a no wake or speed zone. They may also indicate hazards or pertinent boating information. Markers may be located on shore or on the water. They can also indicate speed limits, no power craft or boating, anchorage and other useful information. (The shape of each type of marker will provide assistance).

Make sure you know and understand the navigation system applicable to the waterways where you intend to use the boat.

## Collision Avoidance

- Do not decrease throttle when trying to steer away from objects. You need throttle to steer.
- Always keep a constant lookout for other water users, other craft or objects, especially when turning. Be alert for conditions that may limit your visibility or block your vision of others.
- Respect the rights of other recreationists and/or bystanders and always keep a safe distance from all other craft, people and objects.
- Do not wake or wave jump, ride the surf line or attempt to spray or splash others with your boat. You may misjudge the ability of the boat or your own driving skills and strike a boat or person.

- This boat has the capability of turning more sharply than other boats. However, unless in an emergency, do not negotiate sharp, high speed turns. Such maneuvers make it hard for others to avoid you or understand where you are going. Also, you and/or your passenger(s) could be thrown from the boat.
- Like any other boat, this boat has no brake. Stopping distance will vary depending on initial speed, load, wind, and water conditions. Practice stopping and docking in a safe, traffic free area to have an idea of how long it will take to stop the boat under varying conditions.
- Maintaining or increasing speed may be necessary to avoid a collision.

## **Safe Riding**

- Always keep in mind that as the throttle lever is returned to idle position, less directional control is available, and when the engine is off, directional control is lost. You need throttle to steer.
- While your boat has the capacity of operating at high speeds, it is strongly recommended that high speed operation only be applied when ideal conditions exist and are permitted. Higher speed operation requires a higher degree of skill and increases the risk of severe injuries.
- In shallow water, proceed with caution and at very low speeds. Grounding or abrupt stops may result in injury. Debris may also be picked up and be thrown rearward by the jet pump onto people or property.
- Do not use the boat's reverse, to stop. You or your passenger(s) could be violently ejected forward or even off the boat onto the hazard.

## **Operator/Passenger Awareness**

- Do not start or operate the boat if anyone is seated on the sun deck or swim platform, or is nearby in the water. Water and/or debris exiting jet thrust nozzle can cause severe injury.
- The operator and passenger(s) should be properly seated before starting or moving the boat. All passenger(s) should be instructed to use the handholds or seat straps provided.
- When accelerating a boat with a passenger(s), whether from a complete stop or while underway, always do so progressively. Fast acceleration may cause your passenger(s) to lose their balance or grip and strike something in the boat or fall out of the boat. Make sure that your passenger(s) know of, or anticipate, any rapid acceleration.

## **Maneuverability of the Boat/Towing**

- Do not overload the boat or take on more passengers than designated for the particular boat. Overloading can affect maneuverability, stability and performance.
- Avoid adding on accessories or equipment which may alter your control of the boat.
- Riding with a passenger(s) or pulling a tube, skier or wakeboarder makes the boat handle differently and requires greater skill.
- Always respect the safety and comfort of your passenger(s) and person being towed on skis, wakeboard or other towables.

- Always carry an observer when pulling a tube, skier or wakeboarder, proceed with only as much speed as required and follow the observer's instructions. Unless absolutely necessary, do not make tight, sharp turns. Keep a safe distance from the docks, other swimmers, craft or objects.
- Use a tow rope of sufficient length and size and make sure it is adequately secured to your boat. Some boats are equipped or can be fitted with a specially designed towing mechanism. It can become a hazard should someone fall on it.

**Don't Forget:**

- Ride smart from the start and we all win!



---

# FUELING PROCEDURE

## Regarding Fuel

- Remember that fuel and gasoline fumes are flammable and explosive under certain conditions. Be very careful when fueling and adhere to the fueling procedures described below in this Operator's Guide and those given to you by the marina. Always stop the engine before fueling and never allow anyone to remain in the boat while fueling. Each time you fill up, assure that the engine compartment is free of gasoline vapors, and inspect fuel lines for leaks and hose deterioration.
- Do not smoke or allow open flames or sparks in the vicinity.
- Know the capacity of the fuel tank. Avoid fueling at night except under well-lit conditions. Gas spills are not noticeable in the dark. Do not carry spare fuel or flammable liquids in any of the storage or engine compartments.

## Procedure

### WARNING

Follow these safe boating fueling instructions explicitly.

- Turn off engine.
- Do not allow anyone to remain on the boat.
- Tie boat securely to the fueling pier.
- Have a fire extinguisher close at hand.
- Insert the spout into the filler neck.
- Pour fuel slowly so that air can escape from the tank and prevent fuel flowback. Be careful not to spill fuel.
- Stop filling when the fuel reaches the bottom of filler neck. **Do not overfill.** Fully tighten fuel tank cap.

### WARNING

Always stop the engine before refueling. Fuel is flammable and explosive under certain conditions. Always work in a well ventilated area. Do not smoke or allow open flames or sparks in the vicinity. Fuel tank may be pressurized. Slowly turn cap when opening. Never use an open flame to check fuel level. When fueling, keep boat level. Do not overfill or top off the fuel tank and leave boat in the sun. As temperature increases, fuel expands and might overflow. Always wipe off any fuel spillage from the boat. Periodically verify fuel system.

---

## **VOLUNTARY INSPECTIONS**

State boating officials in many states or the U.S. Coast Guard Auxiliaries offer courtesy inspections to check out your boat. They will check for compliance with safety standards and required safety equipment. You may voluntarily consent to one of these inspections, and you are allowed time to make corrections without prosecution. Check with the appropriate state agency or the Coast Guard Auxiliary for details.

---

## **SAFE BOATING COURSES**

The local U.S. Coast Guard Auxiliary and the U.S. Power Squadrons offer comprehensive safe boating classes several times a year. You may contact the BOAT/U.S. Foundation at 1 800 336-BOAT (2628) or, in Virginia, 1 800 245-BOAT (2628), for a course schedule in your area. Also contact the local U.S. Coast Guard Auxiliary or Power Squadron Flotilla for the time and place of their next scheduled class. A boating safety course is recommended and may be required in your province or state.

---

## WATER SPORTS

### WARNING

**Avoid personal injury!** Your boat is not designed for and should not be used for pulling parasails, kites, gliders, or any device which can become airborne. Use boat only for appropriate water sports.

### WARNING

**Teak surfing** is extremely dangerous to participants due to their proximity to the rear of the boat where direct contact with the exhaust fumes from the boat engine is the highest. Carbon monoxide poisoning can occur and result in mental disorientation, dizziness, drowsiness, and loss of consciousness. The combination of carbon monoxide exposure and non-use of a life jacket (PFD) make this new water recreation activity an incredibly dangerous and potentially deadly sport.

Water skiing, wakeboarding, or riding a towed, inflatable apparatus are some of the more popular water sports. Taking part in any water sport requires increased safety awareness by the participant and the boat operator. If you have never pulled someone behind your boat before, it is a good idea to spend some hours as an observer, working with and learning from an experienced driver. It is also important to be aware of the skill and experience of the person being pulled. Always have a second person on board to observe the person in the water so the driver can concentrate on operating the boat.

Both the boat operator and observer should monitor the location of the towrope when participating in water sports. A slack tow rope can become entangled with person(s) or objects in the boat or in the water, particularly when making a tight turn or circling, and cause serious personal injury.

Everyone participating in a water sport should observe these guidelines:

- Allow only capable swimmers to take part in any water sport.
- Always wear a personal flotation device (PFD) approved by the U.S. Coast Guard. Wearing a properly designed PFD helps a stunned or unconscious person stay afloat. A Type-IV water-ski vest is an approved and practical PFD.
- Have a second person aboard to observe the person being towed and inform the driver about the participant's hand signals. The driver must give full attention to operating the boat and the waters ahead.
- Be considerate to others you share the water with.
- Never allow a person to “teak surf” behind your boat. Do not tow a person in any water sport on a short tow rope such that the person inhales exhaust fumes in concentration. Inhalation of concentrated exhaust fumes, which contain carbon monoxide, can result in CO poisoning, personal injury and death.
- Give immediate attention to a person who has fallen. He or she is vulnerable in the water alone and may not be seen by other boaters.
- Approach a person in the water from the lee side (opposite the direction of the wind). Turn off the motor before coming close to the person.
- Turn off engine and anchor the boat before swimming.

- Participate in water sports only in safe areas. Stay away from other boats, channels, beaches, restricted areas, swimmers, and heavily traveled waterways and underwater obstructions.
- Swim only in areas designated as safe for swimming. These are usually marked with a swim area buoy. Do not swim alone or at night.



F00A2LY

SWIM AREA BUOY

- Do not water ski between sunset and sunrise. It is illegal in most states.
- Do not drive the boat directly behind a water skier, tuber or wakeboarder. At 40 km (25 mi) per hour, the boat will overtake a person who falls in the water 60 m (200 ft) in front of your boat in about 5 seconds.
- Shut engine off and remove ignition key when anyone is in the water nearby.
- Stay at least 45 m (150 ft) away from areas marked by a diver down float.

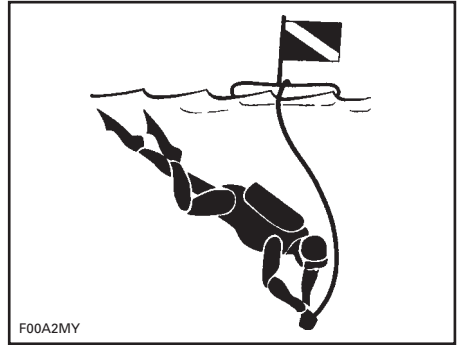

F00A2MY

DIVER DOWN FLOAT

**⚠ WARNING**

**Avoid personal injury!** Do not allow anyone near the jet pump or intake grate, even when the engine is off. Items such as long hair, loose clothing or personal flotation device straps can become entangled in moving parts resulting in serious injury or drowning. In shallow water, shells, sand, pebbles or other objects could be drawn up by the jet pump and be thrown rearward.

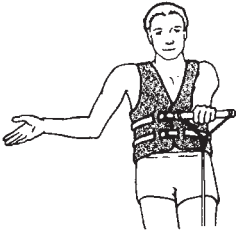

**FASTER -**  
Palm of one hand pointing upward.



**SLOWER -**  
Palm pointing down.



**SPEED OK -**  
Arm upraised with thumb and finger joined to form circle.

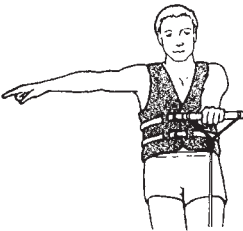

**RIGHT TURN -**  
Arm outstretched pointing to the right.

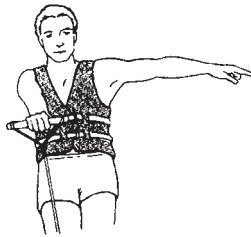

**LEFT TURN -**  
Arm outstretched pointing to the left.



**RETURN TO DROP-OFF AREA -**  
Arm at 45 degree from body pointing down to water and swinging.

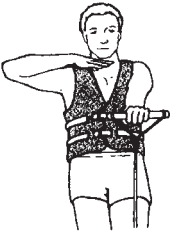

**CUT MOTOR -**  
Finger drawn across throat.

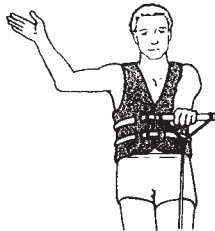

**STOP -**  
Hand up, palm forward, policeman style.



**SKIER OK. AFTER THE FALL -**  
Hands clenched together overhead.

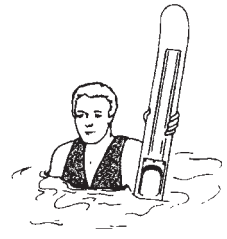

**PICK ME UP OR FALLEN SKIER, WATCH OUT -**  
One ski extended vertically out of water.

F00A2NL

### SKIING SIGNALS

For more information about water skiing, please contact the American Water Ski Association, 1251 Holy Cow Road, Polk City, FL 33868 (1 (863) 324-4341).

INTERNET WEB SITE: [www.usawaterski.org/](http://www.usawaterski.org/)

E-Mail: [usawaterski@usawaterski.org](mailto:usawaterski@usawaterski.org)

# ***VEHICLE INFORMATION***

---

## REGISTRATION NUMBER LOCATION

All boats are required by federal law to be registered and legally numbered. Due to space availability for proper display of registration number, refer to the following illustration for location. The registration number must appear on each side of the boat.

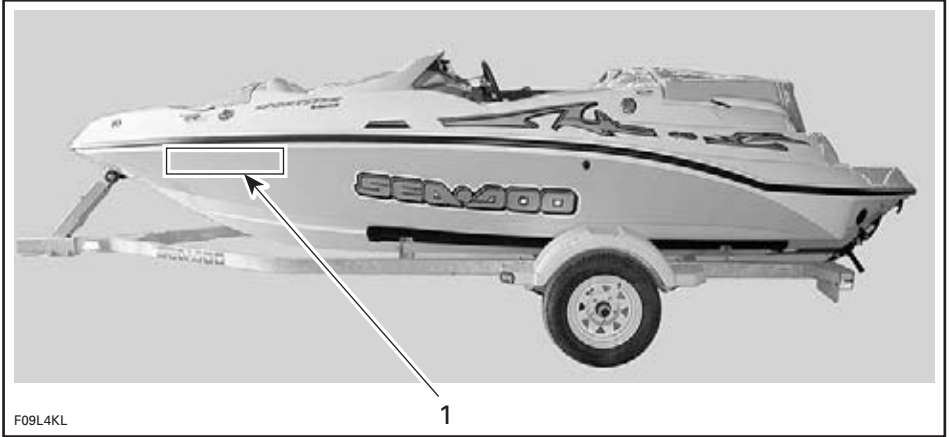

**TYPICAL — 150 SPEEDSTER**  
1. Registration number location



**TYPICAL — 180 CHALLENGER**  
1. Registration number location



# LOCATION OF THE IMPORTANT LABELS

The following labels are on your boat. If missing or damaged, they can be replaced free of charge. See an authorized Sea-Doo Sport Boats dealer. Please read the following labels carefully before operating your boat.

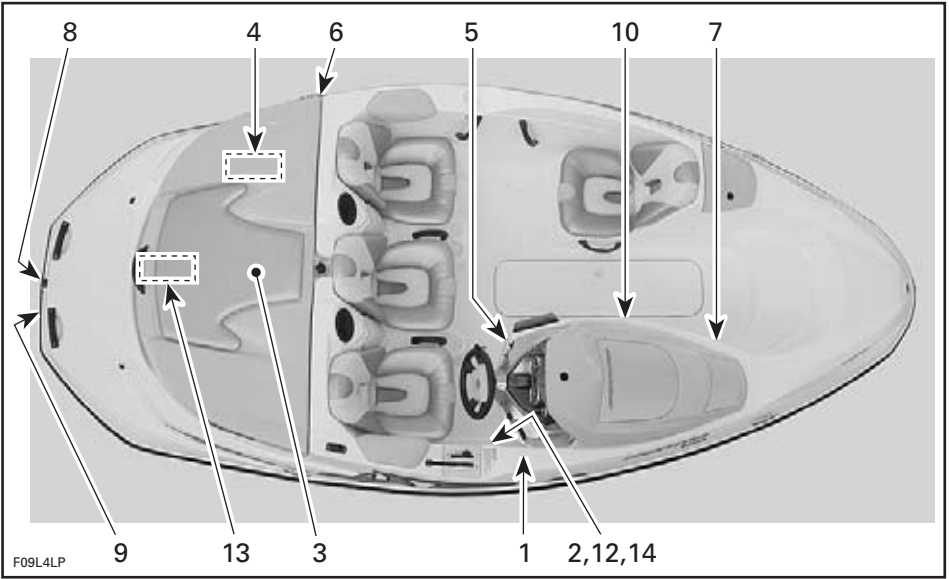

TYPICAL — 150 SPEEDSTER

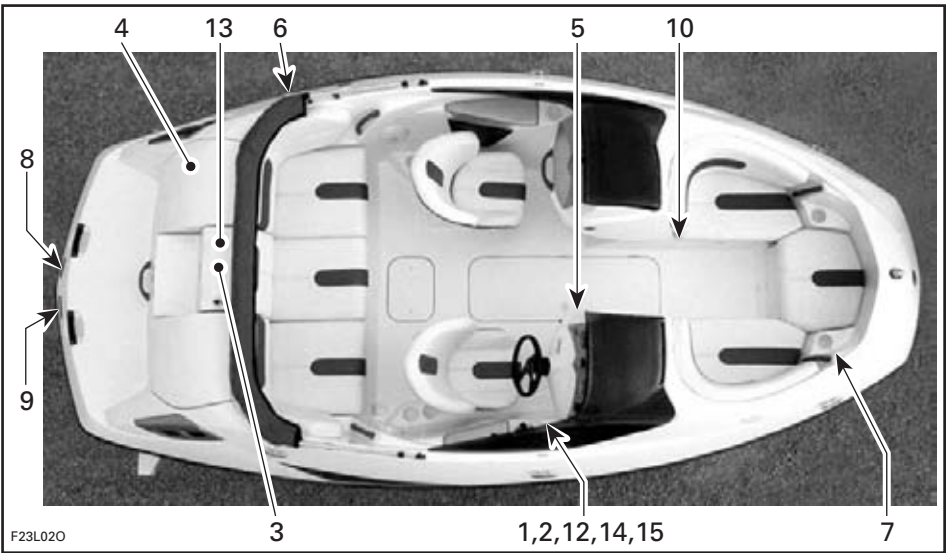

TYPICAL — 180 CHALLENGER

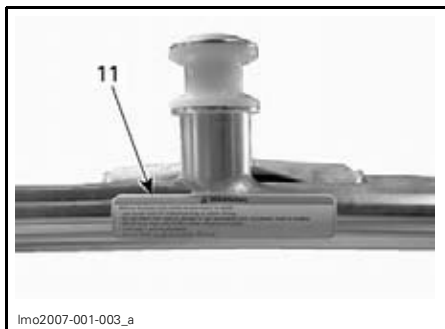

lmo2007-001-003\_a

WAKE TOWER — OPTIONAL

## Label 1

### **⚠ WARNING**

**Read and follow warning labels and operator's guide before operation. Severe injury or death can result from ignoring warnings or improper use of this sport boat. The performance of this sport boat may significantly exceed that of other boats you may have operated.**

- Check throttle/shifter and steering operation and position before starting engine(s).
- Directional control is reduced with decreasing speed and lost when engine is off.
- Do not splash others or jump waves or wakes.
- Occupants should always wear approved PFD and recommended protective clothing.
- Do not operate if passengers are not properly seated and using handgrips, or if visibility is obstructed. Do not allow passenger(s) to ride on any portion of the boat not designated in the operator's guide as a seat for use when underway.
- Properly attach safety lanyard to your PFD.
- Keep a safe distance from all other water users. Be aware of and observe all applicable laws and regulations.

F13L1UL

## Label 2

MADE IN U.S.A., BOMBARDIER MOTOR CORPORATION OF AMERICA  
U.S. COAST GUARD  
**MAXIMUM CAPACITIES**  
**4 PERSONS OR 325KG/715LBS**  
325 KG/715 LBS, PERSONS, GEAR

THIS BOAT COMPLIES WITH U.S. AND CANADIAN COAST GUARD  
SAFETY STANDARDS IN EFFECT ON THE DATE OF CERTIFICATION

CE BOAT DESIGN CATEGORY: **C**

F04LAHY

TYPICAL — 150 SPEEDSTER

MADE IN U.S.A., BOMBARDIER MOTOR CORPORATION OF AMERICA  
U.S. COAST GUARD  
**MAXIMUM CAPACITIES**  
**8 PERSONS OR 653 KG/1440 LBS.**  
653 KG/1440 LBS, PERSONS, GEAR

THIS BOAT COMPLIES WITH U.S. AND CANADIAN COAST GUARD  
SAFETY STANDARDS IN EFFECT ON THE DATE OF CERTIFICATION

CE BOAT DESIGN CATEGORY: **C**

F13L0DY

TYPICAL — 180 CHALLENGER

## Label 3

**⚠ WARNING / AVERTISSEMENT**  
**CHECKING ENGINE OIL LEVEL**  
Vehicle must be level to perform verification. Bring engine to normal operating temperature then let idle for 30 seconds. Stop engine, wait for at least 30 sec. and check oil level using the dipstick. **Caution:** Never let the engine run out of the water without cooling through the flush kit connection as it may damage the engine. Oil may be hot.

**VÉRIFICATION DU NIVEAU D'HUILE DU MOTEUR**  
Avec la motomarine à niveau et à température normale d'utilisation, laissez le moteur tourner au ralenti 30 secondes. Arrêtez le moteur, attendez au moins 30 sec. et vérifiez le niveau d'huile. **Attention:** Ne pas laisser tourner le moteur hors de l'eau sans faire circuler de l'eau par le raccord de rinçage. L'huile peut être chaude.

F18L10Y

TYPICAL

## Label 4

**⚠ WARNING**

- Remove battery from boat before charging.
- Do not overcharge battery.
- Improper charging of battery can cause explosion.

F13L1MY

## Label 5

**⚠ WARNING**

Gasoline vapors can explode, resulting in injury or death. Before starting engine, operate blower for **5** minutes and check engine compartment bilge for gasoline vapors.

F13L1SY

## Label 6

**⚠ WARNING**

Avoid serious injury or death from fire or explosion.

- Before fueling, stop engine and keep boat level.
- Open fuel cap slowly to relieve pressure.
- Do not overfill.
- Regularly inspect fuel system for leaks.
- Use regular unleaded gasoline and check oil level.

F13L1NY

## Label 7

**⚠ WARNING**

**Avoid Serious Or Fatal Injury.**  
**Do Not Occupy Seat When Speed Exceeds 5 M.P.H.**

F00L3BY

## Label 8

**⚠ WARNING**

Avoid serious personal injury or death.

- Turn off engine(s) before using swim platform.
- Keep people, clothing and hair away from jet nozzle(s) or intake grate(s) to avoid entanglement, drowning and carbon monoxide poisoning.

F13L1OY

## Label 9

<b>⚠ WARNING</b>	
	Carbon monoxide (CO) can cause brain damage or death.
	Engine and generator exhaust contains odorless and colorless carbon monoxide gas.
	Signs of carbon monoxide poisoning include nausea, headache, dizziness, drowsiness, and lack of consciousness.
	Get fresh air if anyone shows signs of carbon monoxide poisoning.
	See Owner's Manual for information regarding carbon monoxide poisoning.
<small>2041011-023</small>	

Imo2007-002-001

## Label 10



## Label 11

<b>⚠ WARNING</b>	
<b>Misuse of tower may cause severe injury or death.</b>	
<ul style="list-style-type: none"> <li>• Use tower only for wakeboarding or water skiing.</li> <li>• Do not allow tow rope to dangle or get entangled with occupants, boat or engine.</li> <li>• Attach tow rope only at the center attachment point.</li> <li>• Tow only 1 person at a time.</li> <li>• Do not climb on, sit on or jump off tower.</li> </ul>	
<small>F13L1PL</small>	

WAKE TOWER — OPTIONAL

## Label 12

<b>BRP US Inc.</b> <b>EMISSION CONTROL INFORMATION</b> This vehicle is certified to operate on unleaded gasoline and conforms to 200X U.S. EPA & CALIFORNIA EMISSION regulations for marine SI engines.	Engine family	XXXX	Famille de moteur
	FEL	XX g/kWh HC+NOx	Limite des émissions de la famille
<b>BRP US Inc.</b> <b>RENSEIGNEMENTS SUR LE DISPOSITIF ANTIPOLLUTION</b> Ce véhicule est certifié pour fonctionner à l'essence sans plomb et il répond aux normes 200X de l'EPA des É.-U. & RÉGLEMENTATIONS CALIFORNIENNES pour les moteurs marins à étincelles (SI).	Engine displacement	XXX cc	Cylindrée
	Exhaust emission control system		Système de contrôle des Émissions
<small>SEE OPERATORS GUIDE FOR MAINTENANCE SPECIFICATIONS.</small>	Spark plug type	NSK	Type de bougie
	Spark plug gap	XX mm	Écartement des électrodes
	Power	XX hp	Puissance
<small>VOIR MANUEL DE L'OPÉRATEUR POUR LES SPÉCIFICATIONS DE MAINTENANCE.</small>			

smo2006-002-014\_a

### Label 13

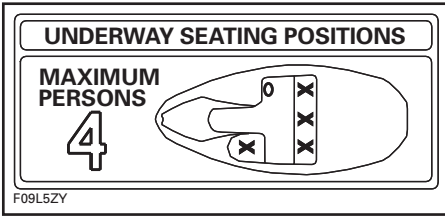

TYPICAL — 150 SPEEDSTER

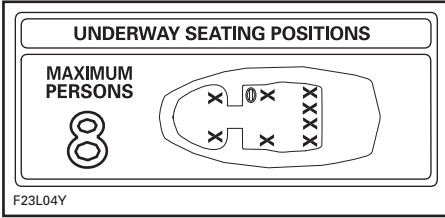

TYPICAL — 180 CHALLENGER

### Label 14



180 CHALLENGER

### Label 15

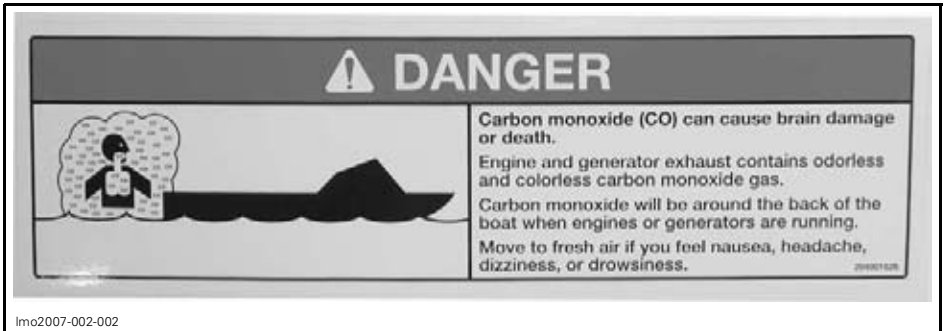

# IDENTIFICATION NUMBERS

The main components of the boat (hull and engine) are identified by different serial numbers. It may sometimes become necessary to locate these numbers for warranty purposes or to trace the boat in the event of theft.

## Hull

The Hull Identification Number (H.I.N.) is located on the right side of the transom.

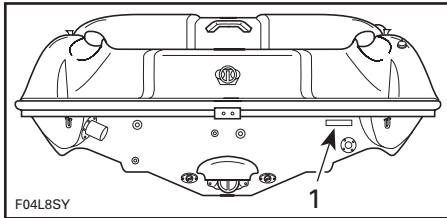

### TYPICAL

1. Hull Identification Number (H.I.N.)

## Engine

The Engine Identification Number (E.I.N.) is located on the upper crankcase on MAGNETO side.



1. Engine Identification Number (E.I.N.)

# CONTROLS, COMPONENTS AND INSTRUMENTS

NOTE: Some controls/instruments/equipment do not apply or are optional on some models. In these cases their reference numbers are deliberately missing in the illustrations.

## Overview

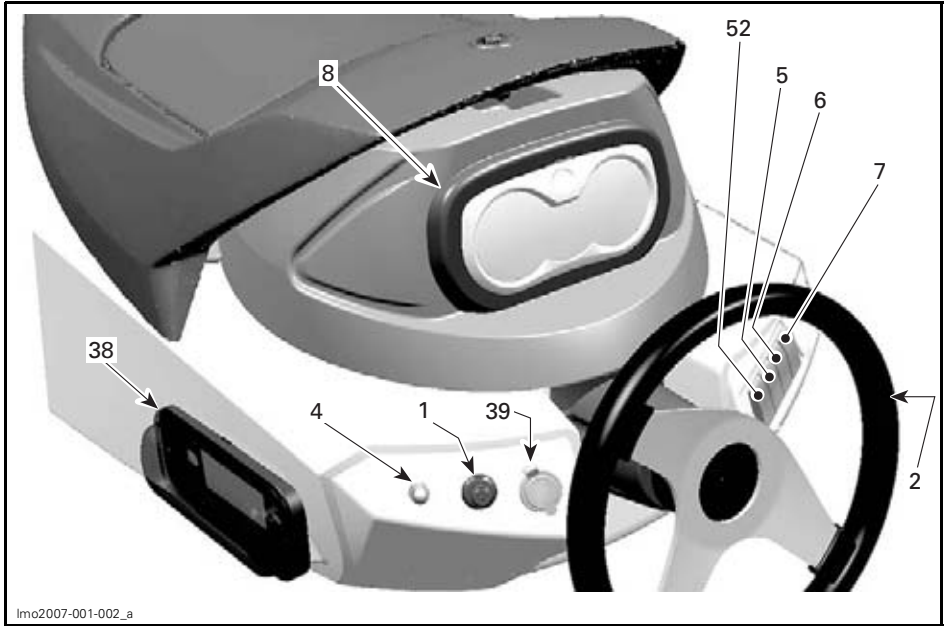

COCKPIT VIEW — 150 SPEEDSTER

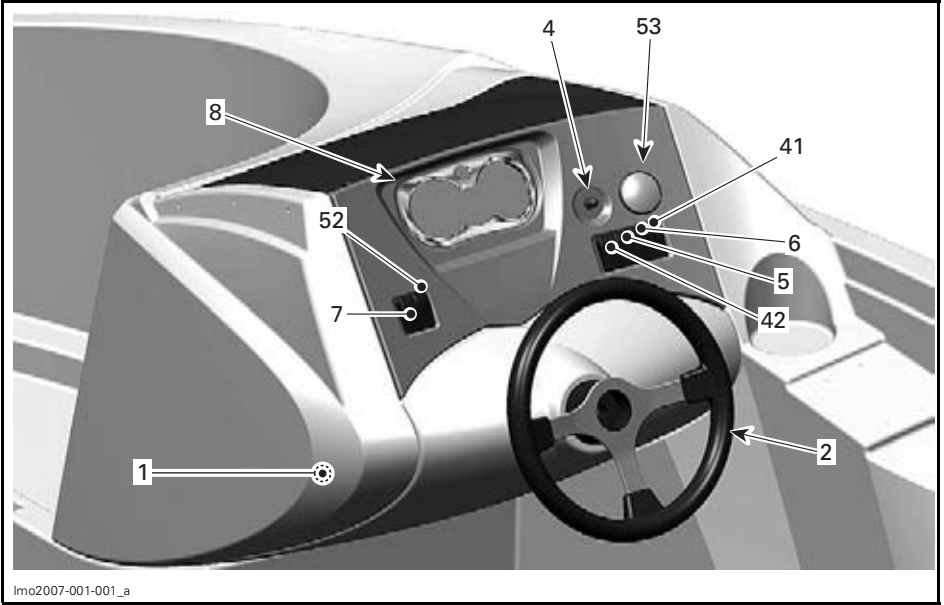

lmo2007-001-001\_a

COCKPIT VIEW — 180 CHALLENGER

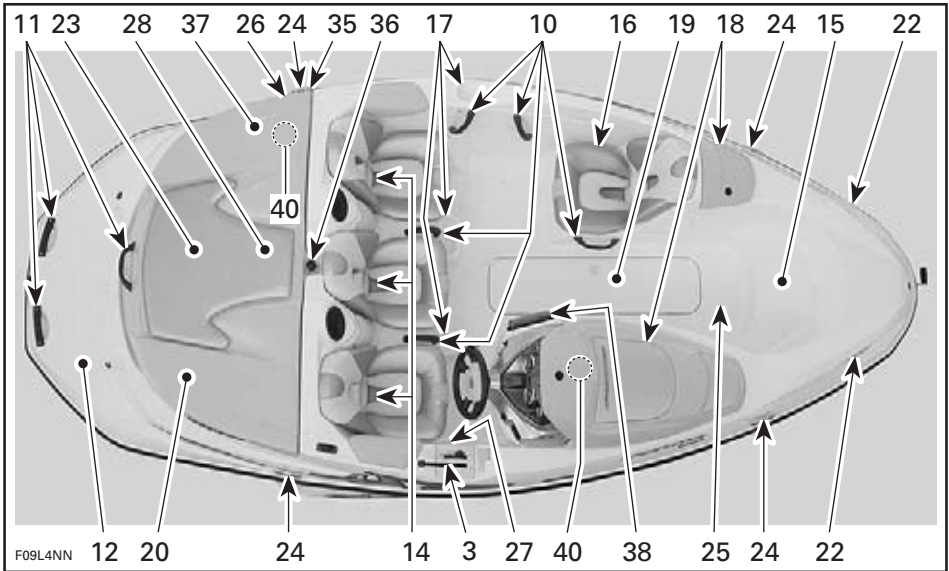

F09L4NN

TYPICAL — 150 SPEEDSTER



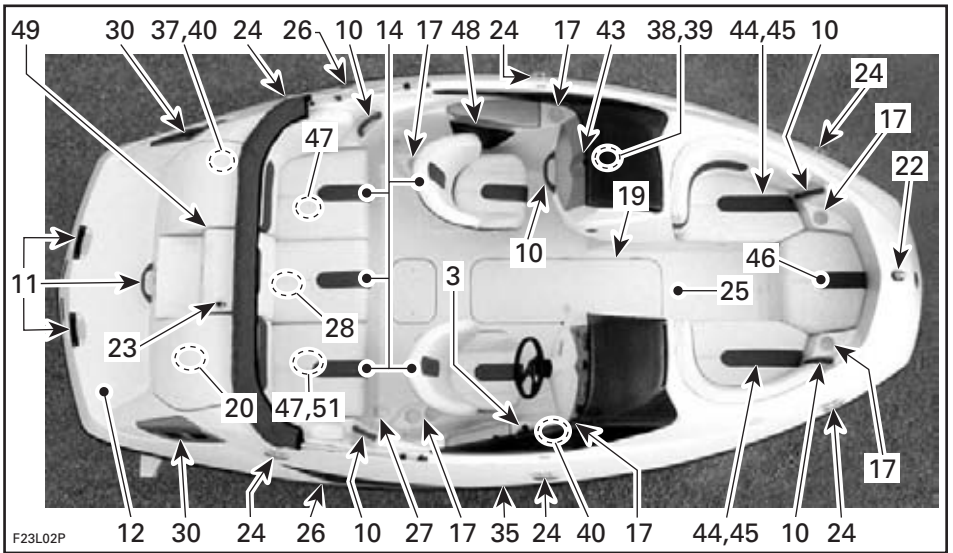

TYPICAL — 180 CHALLENGER

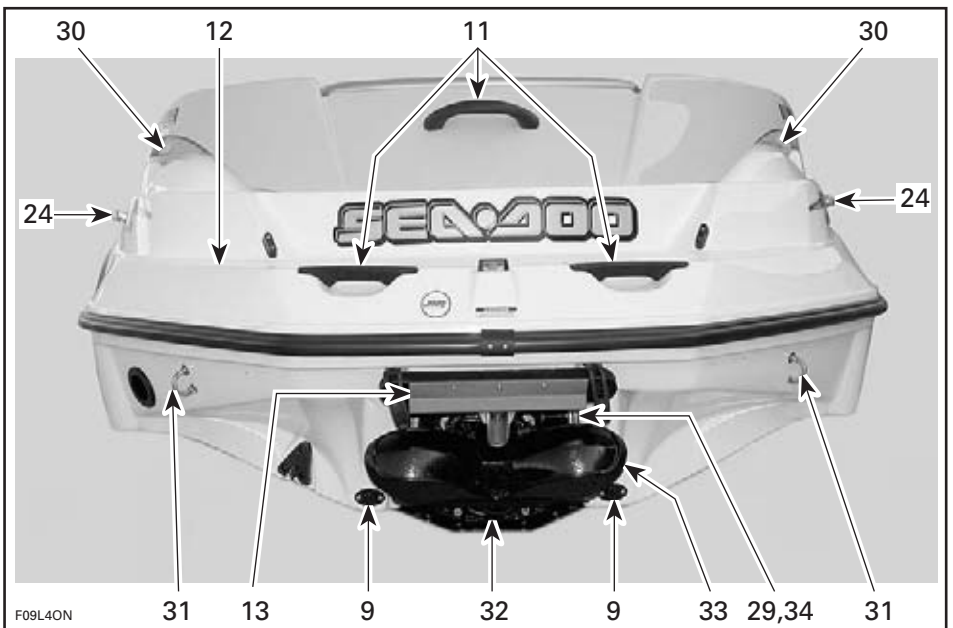

TYPICAL — 150 SPEEDSTER

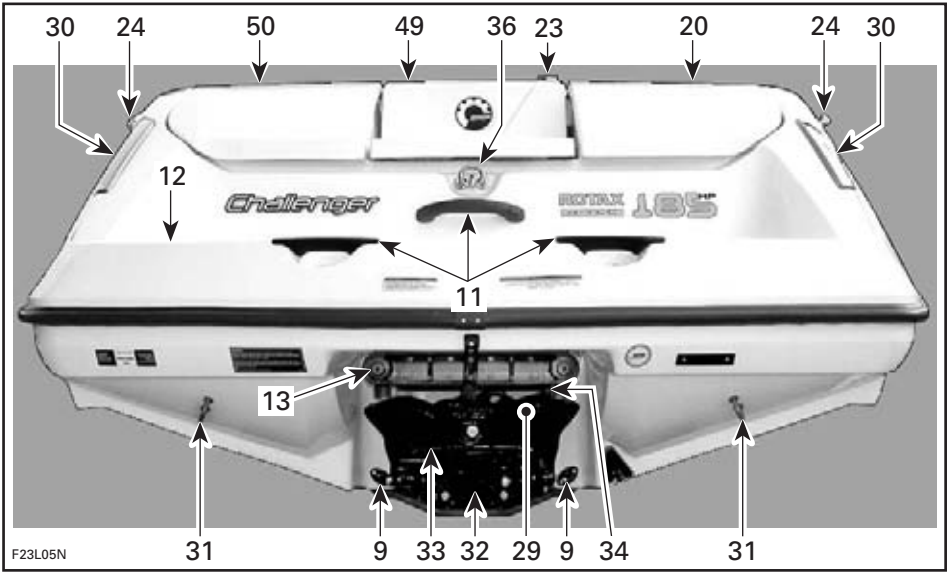

TYPICAL — 180 CHALLENGER

1. DESS Post (engine cut-out switch)
2. Steering Wheel
3. Throttle/Shifter Controller
4. Start/Stop Button
5. Navigation Lights Switch
6. Bilge Pump Switch
7. Bilge Air Blower Switch
8. Information Center Gauge
9. Bilge Drain Plugs
10. Grab Handles
11. Rear Grab Handles
12. Swim Platform
13. Ladder
14. Seats
15. Front Boarding Step (150 Speedster)
16. Spotter Seat (150 Speedster)
17. Cup Holders
18. Front Storage Compartment (150 Speedster)
19. Deck Storage Compartment
20. Rear Storage Compartment
21. Jet Pump Water Intake (not shown)
22. Bow Lights
23. Stern Light Socket
24. Mooring Cleats
25. Deck
26. Fuel Tank Cap
27. Deck Drain
28. Engine Oil Filling Cap
29. Flushing Connector
30. Ventilation Ducts
31. Bow/Stern Eyelets
32. Jet Pump Nozzle
33. Reverse Gate
34. Scupper Valve
35. Fuel Tank Vent
36. Water Sport Towing Attachments
37. Main Battery Cut-Off Switch
38. AM/FM Radio/CD Player
39. 12-Volt Jack
40. Fuses
41. Horn Switch
42. Deck Lights Switch
43. Glovebox
44. Bow Seats
45. Bow Seat Storage Compartments
46. Bow Filler Cushion (if so equipped)
47. Rear Seat Storage Compartments
48. Passenger Storage Compartment
49. Engine Cover
50. Port Bilge Access
51. Removable Cooler
52. Radio/CD Cut-Off Switch
53. AM/FM Radio/CD Player Remote Control

## 1) DESS™ Post (engine cut-out switch)

### **⚠ WARNING**

Always use safety lanyard when operating your boat to help prevent a runaway boat and reduce the risk of personal injury or death. Remove the DESS key when stopped to help prevent accidental starting.

The DESS key should be securely snapped onto the Digitally Encoded Security System (DESS™) post to allow engine starting.

Two short beeps should sound indicating the system is ready to allow engine starting. Otherwise, refer to *TROUBLESHOOTING* section for the *CODED SIGNALS CHART*.

Pulling the key from the DESS post stops the engine.

### **⚠ WARNING**

Should the DESS key become loose or fails to remain on the DESS post, replace it immediately.

Always attach the safety lanyard to the operator's Personal Flotation Device and snap the key to the DESS post to be able to start the engine.

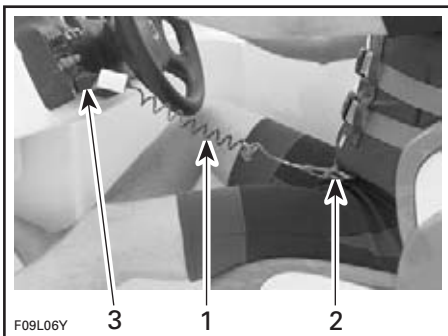

#### **TYPICAL**

1. Safety lanyard
2. Secure lanyard clip to PFD
3. Snap key to DESS post

### **⚠ WARNING**

Directional control is reduced when throttle is decreased and lost when engine is off. Always remove DESS key when boat is not in operation.

### **⚠ WARNING**

Do not lubricate the DESS post.

### **⚠ WARNING**

While the engine can be stopped using the start/stop button, good driving habits recommend that the DESS key also be disconnected when stopped.

## **Additional Information on the Digitally Encoded Security System (DESS)**

The DESS key contains an electronic circuit that gives it a unique electronic serial number.

To have additional DESS keys programmed for your boat, refer to an authorized Sea-Doo Sport Boats dealer.

If the engine is stopped with the start/stop button while the key remains on the DESS post, it can be restarted anytime by only pressing the start/stop button during a period of approximately 10 minutes while the system remains under power. After this delay, it is necessary to remove and reinstall the key on the DESS post.

## **2) Steering Wheel**

The steering wheel controls the direction of the boat. Turning the steering wheel clockwise steers the boat to the right and inversely.

### 3) Throttle/Shifter Controller

#### Throttle Lever

When pushed forward, the boat accelerates. When fully pulled back, engine returns to idle speed and the boat is gradually stopped by water drag.

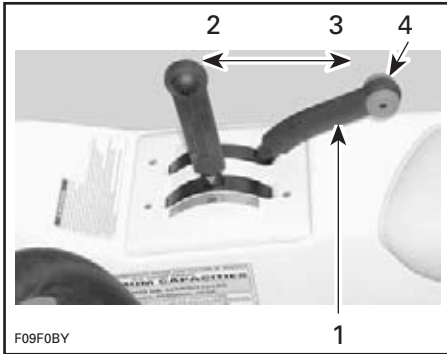

#### TYPICAL

1. Throttle lever
2. Increase speed
3. Decrease speed
4. Idle position speed

#### Shifter Lever

A 3-position lever:

- forward
- neutral
- reverse.

In order to shift, throttle lever must be fully pulled back to idle speed.

Shifter must be in neutral position to allow engine starting.

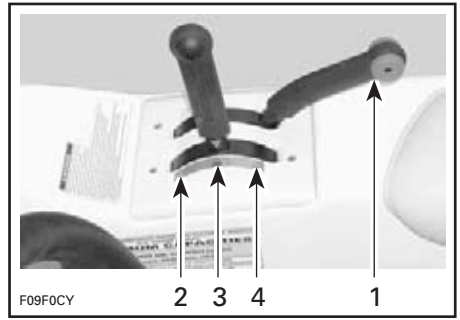

#### TYPICAL

1. Throttle lever must be fully pulled back (idle speed) to shift
2. Forward
3. Neutral
4. Reverse

**CAUTION:** Do not force lever. Ensure throttle lever is in idle position.

**NOTE:** To ease shifter use, line up the shifter arrow with the appropriate dot (Forward/Neutral/Reverse).

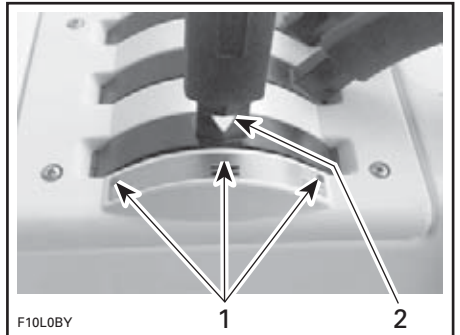

#### TYPICAL

1. Dots besides shifting position
2. Arrow on shifter

### **WARNING**

Shift lever should only be used when the engine is idling and boat is completely stopped.

## **WARNING**

Only use reverse at slow speed and for the shortest time possible. Always ensure the path behind is clear of objects and persons including children playing in shallow water.

**CAUTION:** Never rev the engine at high RPM in reverse.

### 4) Start/Stop Button

Dual function push switch, used to start as well as to stop engine.

#### Starting

## **WARNING**

Engine exhaust fumes contain carbon monoxide (CO) which can accumulate in and around the boat (under Bimini top, in cockpit, etc.). CO can be harmful or fatal if inhaled. Assure there is adequate ventilation whenever running engine(s).

Shifter must be in neutral position and the DESS key must be on the DESS post to allow engine starting.

To start engine, press and hold the start/stop button. Release immediately after engine is started.

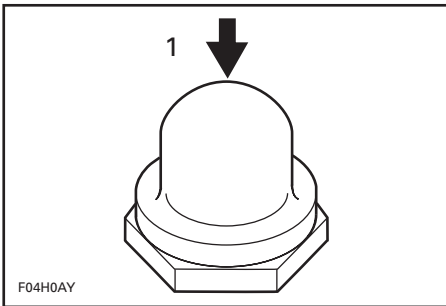

1. Start when engine is *NOT* running

### Stopping

## **WARNING**

While engine can be stopped by pressing the stop button, we strongly recommend the engine be stopped by removing the DESS key. This will install good habits.

Pressing button when engine is running will stop the engine.

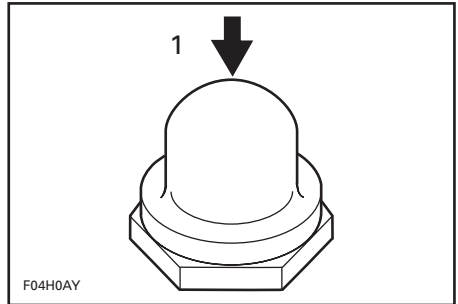

1. STOP when engine *IS* running

## **WARNING**

Directional control is not available when engine is stopped.

### 5) Navigation Lights Switch

A 3-position NAV/OFF/ANC switch.

ANC: Turns on the anchorage light when the boat is anchored. Only the stern light is lit.

OFF: Turns off all lights.

NAV: Turns on both bow and stern lights and illuminates the gauges.

## **WARNING**

Navigation lights should always be used between sunset and sunrise. Ensure the stern light is installed. See *REMOVABLE STERN LIGHT* in this section for location and installation.

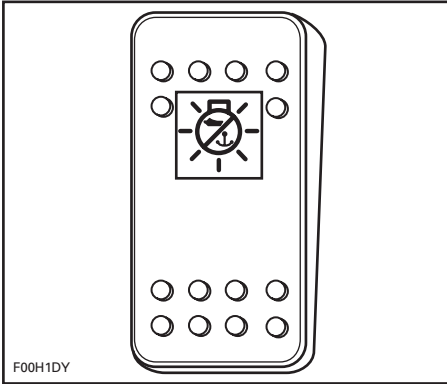

NAVIGATION LIGHTS SWITCH

### **6) Bilge Pump Switch**

A 2-position OFF/ON switch.

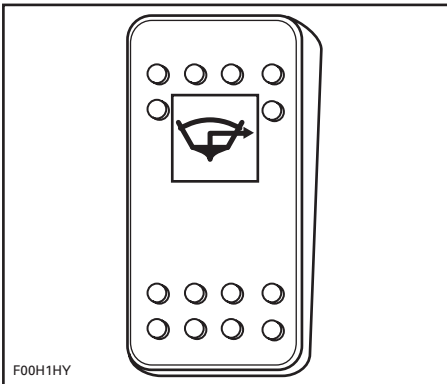

BILGE PUMP SWITCH

Turn to ON position when manual operation of the bilge pump is required (after cleaning, storage, etc.).

Turn switch to OFF when finished.

**CAUTION:** Do not operate for prolonged time if the bilge is dry: battery drainage will occur and pump will be damaged.

The bilge pump may be operated without the DESS key on its post.

**CAUTION:** Always turn pump OFF when bilge is dry or before operating the engine above idle. Bilge pump will then switch to automatic mode.

### **Automatic Bilge Pump**

The automatic bilge pump evacuates water from the bilge. A water sensor detects the water, activating the pump. After the water is pumped out, the pump shuts-off automatically. This automatic mode is working at all times: with/without DESS key on its post and with/without engine running.

**CAUTION:** When the main battery cut-off switch is turned OFF while boat is moored, the automatic bilge pump will start if water comes up in the bilge.

### **7) Bilge Air Blower Switch**

A 2-position OFF/ON switch. When turned on, the blower ventilates the engine compartment.

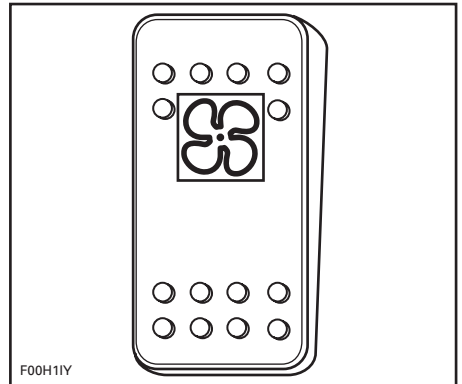

BILGE AIR BLOWER SWITCH

## **WARNING**

Gasoline vapors can explode, resulting in injury or death. Always use blower for a minimum of 5 minutes before starting engine, then turn it OFF above idle speed. Use of the bilge blower should never replace "smelling" for gasoline vapors.

**CAUTION:** Using the bilge blower for a prolonged time when the engine is not running will discharge the battery.

Blower should be turned off during boat operation.

## **8) Information Center Gauge**

This is a multifunction gauge that supplies several real time useful information to the driver either in English, French or Spanish. See an authorized Sea-Doo Sport Boats dealer for unit settings.

At start-up, all LCD segments and indicator lights will turn on for 3 seconds each time the information center is activated (when DESS key is installed). This allows the driver to validate they are all working properly.

**NOTE:** Gauge is illuminated whenever the navigation lights are used.

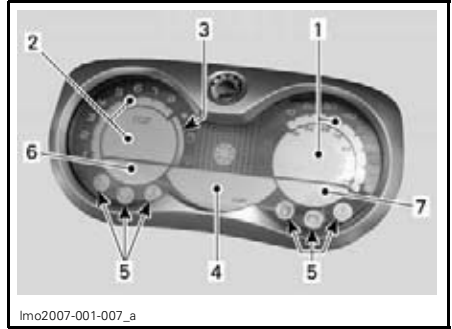

1. *Speedometer*
2. *Tachometer*
3. *Fuel level*
4. *Information display*
5. *Indicator lights*
6. *Water depth display*
7. *Water temperature display*

### **Speedometer**

Speedometer indicates the speed of the boat in miles per hour (MPH) or kilometers per hour (km/h).

### **Tachometer**

Tachometer indicates the revolutions per minute (RPM) of the engine. Multiply by 1000 to obtain the actual revolutions.

### **Fuel Level**

Bar gauge continuously indicates the amount of fuel in the fuel tank while riding. A low-fuel condition is also indicated on the information display as only one bar is displayed. See *MES-SAGE CODE* below.

### **Information Display**

#### **Compass**

Displays the cardinal points to indicate the orientation of the boat.

## **WARNING**

Use the compass as a guide only. Not to be used for navigation purposes.



## Hourmeter (HR)

Displays the time in hours of the boat usage.

## Message Code (Information Display)

Displays a message code whenever one of the following circumstances occurs. The abbreviations between parenthesis here are the code displayed.

### (H-TEMP)

Engine or exhaust system overheating.

**CAUTION:** If the monitoring beeper continuously sounds, stop engine as soon as possible.

Turn off engine as soon as possible. Check oil and coolant levels and refill if necessary. Refer to *LIQUIDS*

If engine still overheats, refer to *ENGINE OVERHEATS* in *TROUBLESHOOTING*.

### (OIL)

Low oil pressure.

The **oil light** turns on when the oil pressure is low or high in the engine. Check oil level as soon as possible. If lamp remains ON contact an authorized Sea-Doo Sport Boats dealer.

**CAUTION:** Never run engine out of oil. Serious engine damage will occur.

### (12 V LOW)

Low battery voltage.

Before the battery becomes too discharged to start the engines, the **volts** indicator light will come on.

When the indicator light is on, you should discontinue all use of electrical accessories immediately and start the engine in order to recharge the battery.

### (12 V HI)

High battery voltage.

See an authorized Sea-Doo Sport Boats dealer.

### (FUEL-LO)

Low fuel level.

Fill up fuel tank as soon as possible.

### (MAINT)

Maintenance reminder.

**NOTE:** When the boat is due for a maintenance inspection, the message MAINT will blink. After servicing, your authorized Sea-Doo Sport Boats dealer will clear it.

### (CHK ENG)

Check engine.

**NOTE:** If a fault occurs, this system generates numbered fault codes (P-XXXX) that are displayed through the information center. In case of a failure, you may call your authorized Sea-Doo Sport Boats dealer and he would be able to assist you to obtain the code descriptions to help troubleshooting.

### (SENSOR)

Sensor failure (boat electronic equipment).

See an authorized Sea-Doo Sport Boats dealer.

### (KEY)

Invalid DESS key.

Indicates that you have used the wrong DESS key, use the proper key for this boat.

### (L KEY)

DESS learning key active

## Additional Information

A beeper will sound and indicator light will blinks depending on the fault occurring to catch the driver attention when necessary.

Except for low liquid levels, which can be corrected by refilling, it is recommended to see an authorized Sea-Doo dealer when other messages occur.

## Indicator Lights

**NOTE:** Refer to *MESSAGE CODE* above for additional information regarding messages.

Low oil pressure (OIL)



Check engine (CHK ENG)



Engine or exhaust system overheating (H-TEMP)



Low fuel level (FUEL-LOW)



Low/high battery voltage (12 V LOW/HI)



Maintenance reminder (MAINT)



## Water Depth Display

### *If so Equipped*

Display the water depth under the hull within 0 to 50 meters (0 to 170 feet).

**NOTE:** Under certain conditions, the gauge may stop displaying. The gauge ability to display the depth depends on the usage conditions.

## Water Temperature Display

Displays the water temperature of the water surface in degrees Celsius (°C) or Fahrenheit (°F).

## 9) Bilge Drain Plugs

Once boat is on trailer, unscrew the drain plugs, block the wheels and raise the bow slightly with the trailer jack (if so equipped) so that the water can flow out of the bilge.

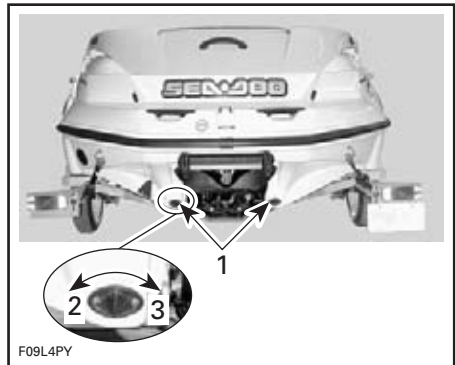

- TYPICAL**
1. Drain plugs
  2. Loosen
  3. Tighten

## 10) Grab Handles

Grab handles provide a handhold for the passengers.

Although grab handles are provided, never perform maneuvers that place a passenger or the driver at risk for being ejected or thrown out of their seat.

**CAUTION:** Never use the grab handles to pull anything or to lift the boat.

Refer to components location illustrations at the beginning of this section for grab handle locations.

## 11) Rear Grab Handles

Provide a handhold for boarding when needed.

**CAUTION:** Never use the grab handle to tow anything or to lift the boat.

## 12) Swim Platform

Provides an anti-skid surface for easy boarding from rear of the boat.

### **WARNING**

Do not start or operate the boat if a person is seated on the platform. Engine must be off when using swim platform. Keep away from jet or intake grate.

## 13) Ladder



*TYPICAL*

1. Retractable ladder

Located under the swim platform, the ladder helps in reboarding the boat.

### **WARNING**

Engine should be OFF when using ladder. Keep limbs away from jet or intake grate. Only one person at a time on the ladder. Never use the ladder for pulling, towing, diving or jumping, boarding a boat that is out of the water or any other purpose other than a ladder.

Pull latches to unlock the ladder.



*TYPICAL — 150 SPEEDSTER*

1. Latches

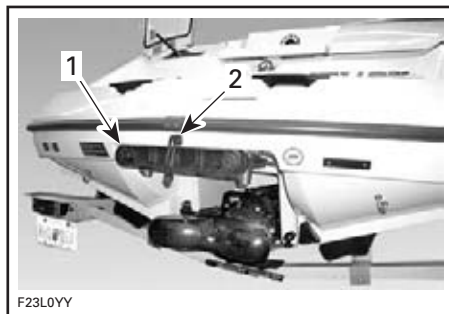

*TYPICAL — 180 CHALLENGER*

1. Retractable ladder

2. Latch

Slide ladder toward rear, then push down.



*TYPICAL — LADDER LOWERED — 150 SPEEDSTER*



F23L0ZY

TYPICAL — LADDER LOWERED —  
180 CHALLENGER

To store ladder, lift horizontally, slide toward front and refasten latch.

## 14) Seats

Each passenger should be seated while underway.

### WARNING

Allow no one to sit on edge of the boat or to stand up while in operation. Seat/grab handles should be used in rough waters.

## 15) Front Boarding Step

### *150 Speedster Only*

Located at front of boat, it is provided as a boarding step.

### WARNING

No passenger should use the boarding step as a seat except when the boat is stopped.

### WARNING

Avoid serious or fatal injury. Do not occupy seat when speed exceeds 5 MPH.

## 16) Spotter Seat

### *150 Speedster Only*

Located on the port side, rearward facing, this seat is provided to be used by the observer when towing a tube, skier or wakeboarder.

Use grab handles as necessary.

### WARNING

When pulling a tube, skier or wakeboarder, always have an observer while towing, proceed with only as much speed as required, and follow the observer's instructions.

## 17) Cup Holders

Convenient locations for non-alcoholic beverages.

### WARNING

Never operate boat while under the influence of alcoholic beverages while aboard. Do not keep bottles, cans etc. in cup holders while riding at high speed and/or on rough water.

## 18) Front Storage Compartment

### *150 Speedster Only*

A convenient watertight, lockable storage compartment with a removable basket to carry personal articles. The basket is the ideal location for spare spark plugs, first aid kit, etc.

### WARNING

Never leave any heavy or loose breakable objects in the storage basket. Never operate the boat with the storage compartment cover open.

Push the latch button downward to unlock storage compartment cover. Raise cover until stopped by the retaining device. The cover will remain in this position on calm water.

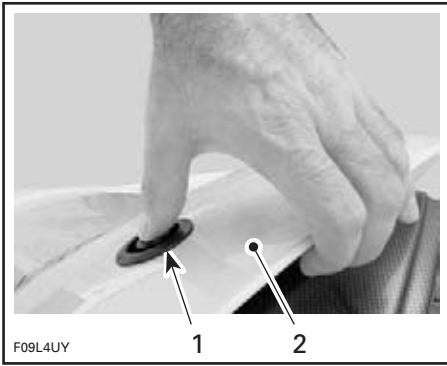

**TYPICAL**  
 1. Push lock button in  
 2. Lift up

The driver-side front compartment is provided with a holder to store an approved fire extinguisher.

The fire extinguisher (sold separately) should not be loose in the storage compartment.

The Operator's Guide should be kept in a waterproof bag and remain with the boat at all times.

**⚠ WARNING**

Do not remove the basket to use as additional storage area. Components can become entangled and cause serious operational hazards.

Push cover down to release mechanism then move down slowly. When bottomed on latch, firmly push cover to lock.

Periodically verify the lock pin tightness of storage cover. Tighten if needed and make sure storage cover latches properly.



**TYPICAL — SPOTTER SEAT STORAGE COMPARTMENT**

## 19) Deck Storage Compartment

The deck storage compartment is a convenient location for water-skis, paddles, anchor and rope, etc.

**⚠ WARNING**

Never leave any heavy or loose breakable objects in the storage basket. Never operate the boat with the storage compartment cover open.

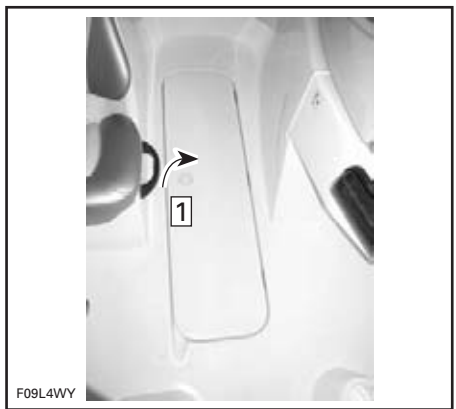

**TYPICAL**  
 Step 1: Pull latch and lift cover

Lift the latch ring and open cover gently until stopped by retaining spring.

When completely opened, the cover remains in that position on calm water. To close, gently push on the side of the spring to release it and lower the cover.



**TYPICAL**  
1. Gently push here to release the spring

## 20) Rear Storage Compartment

### 150 Speedster Models

#### Rear Storage Compartment

Convenient rear storage location to be used to carry large personal articles. Ideal location for spare Personal Flotation Device (PFD), towels, lunch etc.

Pull the latch lever located beneath the front storage compartment lid upward to release engine cover latch, and open engine cover gently until stopped.

The gas assist cylinder will complete the opening and hold cover open.

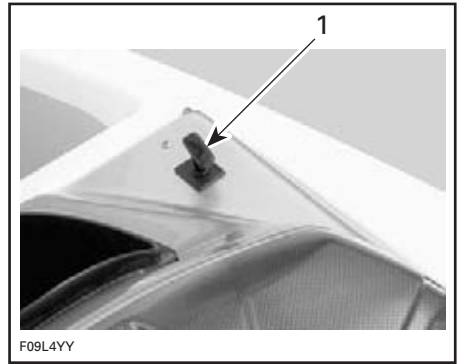

**TYPICAL**  
1. Pull latch handle upward

#### Storage Tray

**CAUTION:** In order to avoid damage, **MAXIMUM LOAD** on storage tray must not exceed 22.5 kg (50 lb).

The storage tray is removable to give access to the engine compartment. Grab the handle and lift in a rearward movement until opposite holders release.

### **WARNING**

When storage tray is lifted or removed, never touch any electrical part when starting engine or while in operation. Never leave any object, rag, tool, etc., in the engine compartment or in the bilge.

When reinstalling storage tray, ensure to properly locate it just below holders, gently lower tray then push it downward to lock.

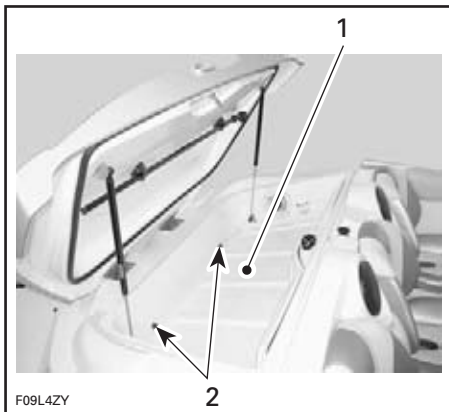

TYPICAL

1. Rear storage compartment tray
2. Tray under holders

Firmly close storage compartment cover to relatch.

### **⚠ WARNING**

Never leave any heavy or breakable objects in the storage compartment. Never operate the boat with the rear storage compartment cover open.

## **180 Challenger Models**

### **Starboard Rear Storage Compartment**

Located behind the rear starboard passenger seat.

Pull latch to open storage cover.



1. Lift latch

The gas assist cylinder will hold the storage cover open.

### **⚠ WARNING**

Always close cover before getting underway.

## **21) Jet Pump Water Intake**

Water is drawn up by the impeller through this opening. The grate minimizes entry of foreign objects into the propulsion system.

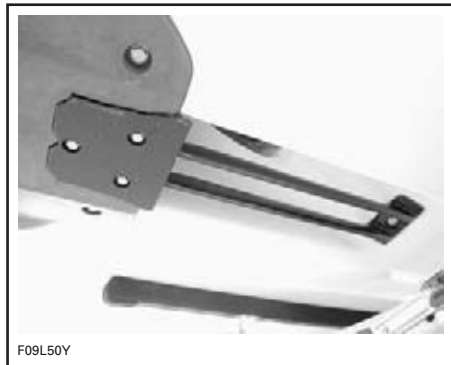

TYPICAL

### **⚠ WARNING**

Keep away from intake grate while engine is on. Items such as long hair, loose clothing or personal flotation device straps can become entangled in moving parts resulting in severe injury or drowning.

## **22) Bow Lights**

Mandatory red/green lights. See *LIGHT SWITCH* as mentioned earlier in this section.

## **23) Stern Light Socket**

### **150 Speedster Models**

For installation of mandatory white stern light.

It is recommended to keep stern light in rear storage compartment at all times except when needed.

To remove from storage cover, pull it out. Snap in place to store.

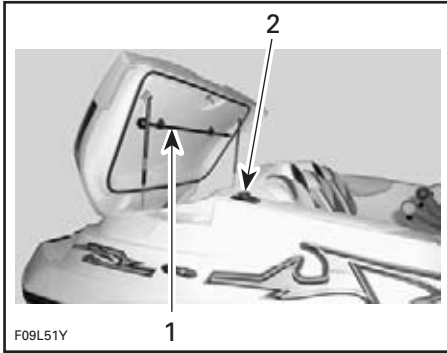

**TYPICAL**

1. Stern light storage location
2. Stern light operation position

**180 Challenger Models**

Located on the engine cover, for installation of mandatory white stern light.

It is recommended to keep stern light in ski locker compartment at all times except when needed.

**Installation**

**For Models Equipped with Folding Stern Light:**

- Release stern light storage lock as shown.

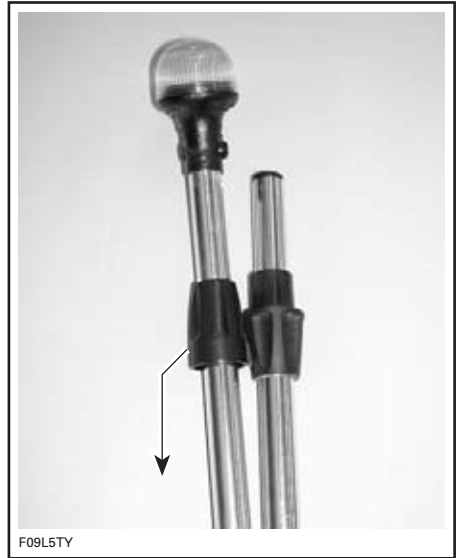

**SLIDE THIS DIRECTION**

- Thread onto folding joint as shown below.

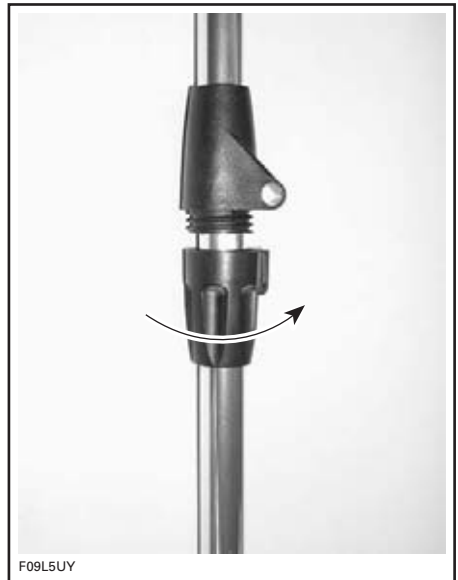

**All Models**

- Lift connector cap.



- Insert post in connector hole. Ensure to align hole keyway with post screw head.
- Firmly push downward to engage terminals.
- Push lock ring downward. Turn until locked. It may be necessary to slightly turn it to allow its insertion in the hole.
- Check light operation. See *LIGHT SWITCH* as mentioned earlier in this section.

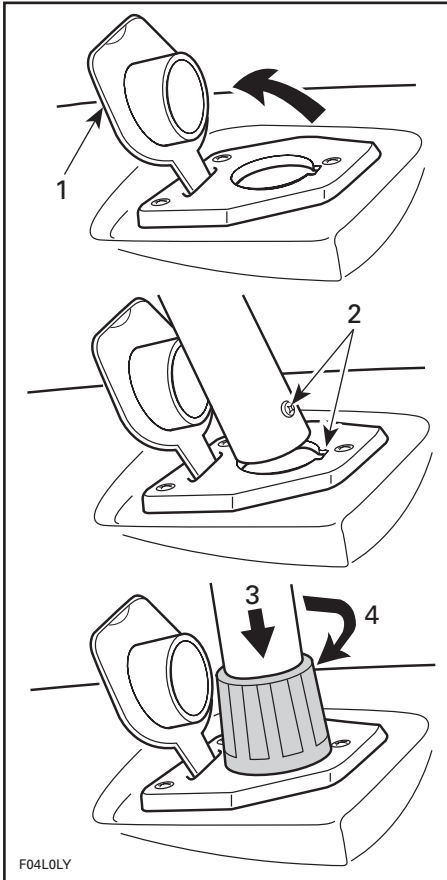

**TYPICAL**

1. Lift
2. Align screw in groove
3. Push downward
4. Turn to lock

**CAUTION:** Ensure dielectric grease is present in connector area of light to prevent corrosion.

Removal and storage of light is the reverse of installation.

**24) Mooring Cleats**

When mooring to a dock, it is recommended to secure the boat with both front and rear cleats. The use of dock lines with sealed air fenders is recommended to protect your boat.

**CAUTION:** Never use mooring cleats to pull anything or to lift the boat.

**25) Deck**

Flat surface of boat, should be kept clean and clear.

**26) Fuel Tank Cap**



1. Fuel tank cap

Unscrew the cap counterclockwise to allow fuel tank filling. Fully tighten when finished.

## **WARNING**

Always stop the engine before refueling. Fuel is flammable and explosive under certain conditions. Always work in a well ventilated area. Do not smoke or allow open flames or sparks in the vicinity. Fuel tank may be pressurized. Slowly turn cap when opening. Never use an open flame to check fuel level. When fueling, keep boat level. Do not overfill or top off the fuel tank and leave boat in the sun. As temperature increases, fuel expands and might overflow. Always wipe off any fuel spillage from the boat. Periodically verify fuel system.

### **27) Deck Drain**

Located below the driver's seat, the deck drain provides water drainage from rain, deck washing, water splashing, etc. Keep clean to avoid clogging.

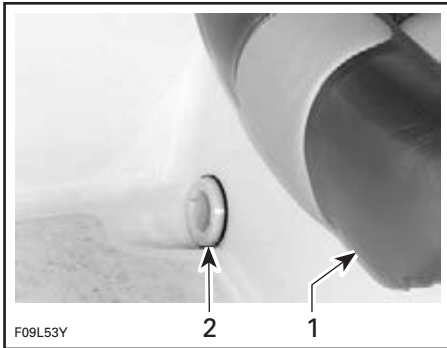

**TYPICAL — 150 SPEEDSTER**  
1. Driver's seat  
2. Deck drain

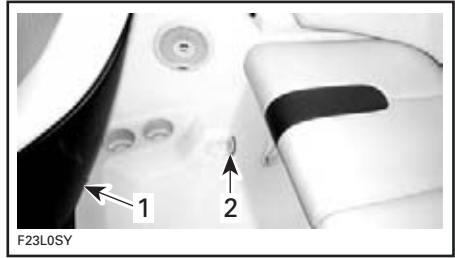

**TYPICAL — 180 CHALLENGER**  
1. Driver's seat  
2. Deck drain

### **28) Engine Oil Filling Cap**

Located in the engine compartment, on the engine(s). It allows adding oil in the engine(s) when required.

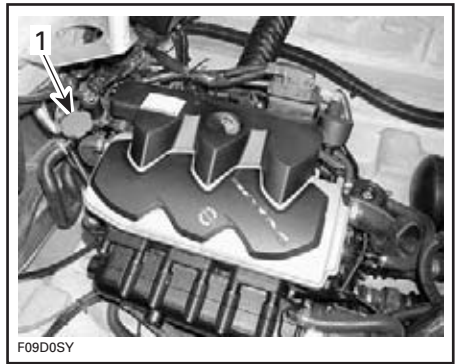

**TYPICAL**  
1. Oil filling cap

Refer to *LIQUIDS* for more details.

### **29) Flushing Connector**

Refer to *STORAGE AND PRESEASON PREPARATION* section for proper use.

**NOTE:** Engine is provided with a flushing connector on jet pump support.

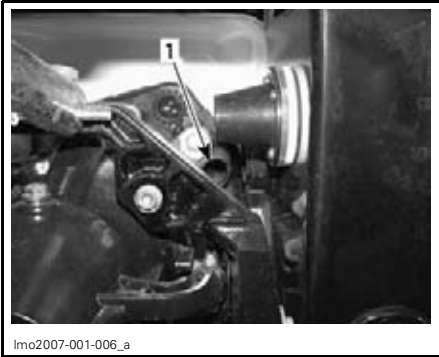

lmo2007-001-006\_a

**TYPICAL**

1. Flushing connector

### 30) Ventilation Ducts

#### 150 Speedster Models

Located beneath the engine compartment lid, the ventilation ducts supply air to the engine and ventilate engine compartment. Ventilation ducts should never be obstructed.

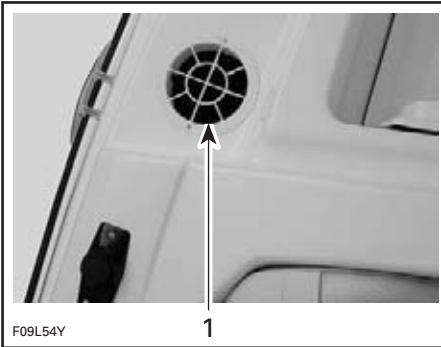

F09L54Y

1

**TYPICAL**

1. Ventilation duct

#### 180 Challenger Models

Located at both ends of the swim platform, the ventilation ducts supply air to the engine and ventilate engine compartment. Ventilation ducts should never be obstructed.

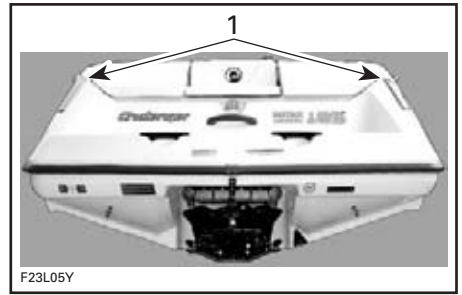

F23L05Y

**TYPICAL**

1. Ventilation ducts

### 31) Bow/Stern Eyelets

Eyelets can be used for mooring, towing and as a tie-down point during transportation.



F09L55Y

1

2

**TYPICAL**

1. Stern eyelet

2. Bow eyelet

### 32) Jet Pump Nozzle

The jet pump nozzle provides directional control when engine is running, turning side to side via input from the steering wheel.



**WARNING**

Never use nozzle as a supporting point to board the boat or to lift it.

Refer to *PROPULSION* under *PRINCIPLE OF OPERATION*.

### 33) Reverse Gate

When selecting the neutral or reverse position with the shift lever, the reverse gate moves up or down to the desired position.

**⚠ WARNING**

Never use gate as a supporting point to board the boat. Shift lever should only be used when the engine is idling and boat is completely stopped.

**34) Scupper Valve**

Location where water drains out from the deck. Keep clean to avoid clogging.

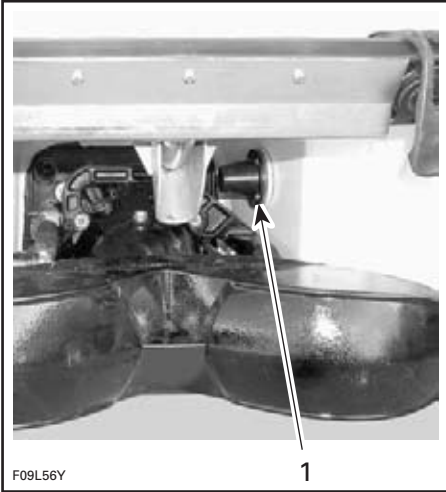

TYPICAL  
1. Scupper valve

**35) Fuel Tank Vent**

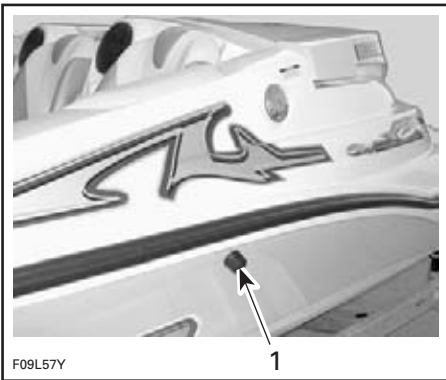

TYPICAL — 150 SPEEDSTER  
1. Fuel tank vent



TYPICAL — 180 CHALLENGER  
1. Fuel tank vent

Vent allows fuel vapor and pressure release from fuel tank.

**⚠ WARNING**

Never use a lit match or open flame close to vent. Follow the **FUELING PROCEDURE** instructions in the **SAFETY** section.

**36) Water Sport Towing Attachments**

Please read and often refer to **WATER SPORTS** information in the **SAFETY** section at the front of this guide.

**⚠ WARNING**

**“Teak Surfing”** is extremely dangerous to participants due to their proximity to the rear of the boat where direct contact with the exhaust fumes from the boat engine is the highest. Carbon monoxide poisoning can occur and result in mental disorientation, dizziness, drowsiness, and loss of consciousness. The combination of carbon monoxide exposure and non-use of a life jacket (PFD) make this new water recreation activity an incredibly dangerous and potentially deadly sport.

## Tow Hook

### **180 Challenger Models**

Used to pull skiers and other appropriate water toys.



**TYPICAL**  
1. Tow hook

## Ski Post

### **150 Speedster Models**

This boat comes equipped with a ski post. Use this post to pull a tube, water skier or wakeboarder.

Pull up the post to allow hooking a ski rope or other towables.

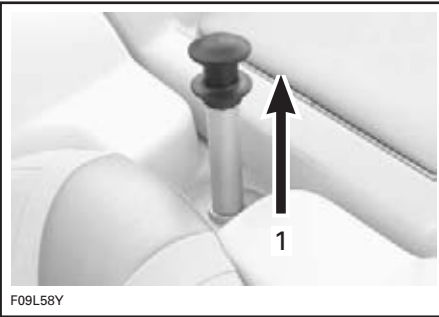

**TYPICAL**  
1. Lift ski post to use

Push down when finished.

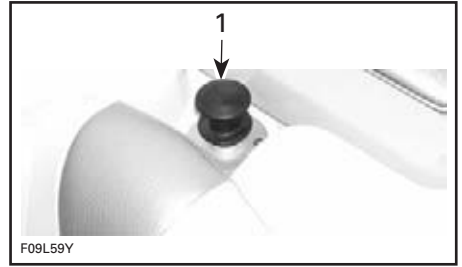

**TYPICAL**  
1. Ski post position when not used

**⚠ WARNING**

When pulling a tube, skier or wakeboarder, always have an observer, proceed with only as much speed as required, and follow the observer's instructions.

**CAUTION:** Never use the ski post to tow any other craft.

**⚠ WARNING**

Always have observer watch skier. Ensure ski post is fully extended and locked before use. Completely retract when not used.

## Towing Tower

### **On so Equipped Models**

**CAUTION:** Do NOT fold tower forward.

Attempting to fold the tower forward will damage the front tower mounts.

The towing tower is for skiing/wakeboarding.

**CAUTION:** Always tow the boat with the towing tower fastened in the upright position to avoid damage to the boat. Tower must be secured and bolted in upright position when boat is operated. Periodically check that bolts are in place and tight. Check clearance height around docks, shore, overhanging objects, bridges and power lines. The tower must not be used as a tie-down or tie-off point.

To clean tower, use mineral spirits and a clean soft cloth.

To prepare tower for storage, remove knobs, and remove bolts using an 8 mm Allen wrench, from each side of tower.

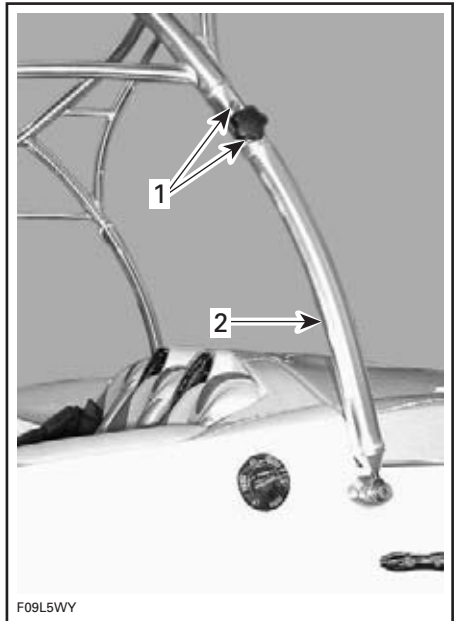

**PERFORM FOR EACH SIDE**

1. Remove bolt and knob
2. Lower to side of boat

Using knob previously removed, place through tower joint and screw into storage support blocks as shown in the following illustration.

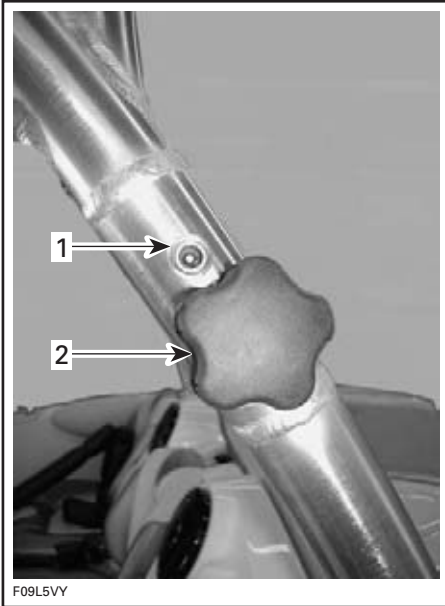

1. 8 mm bolt
2. Knob

**NOTE:** This procedure may require two people.

Carefully lower each rear support arm to side of the boat.

Storage support blocks are supplied to prevent damage to the deck.

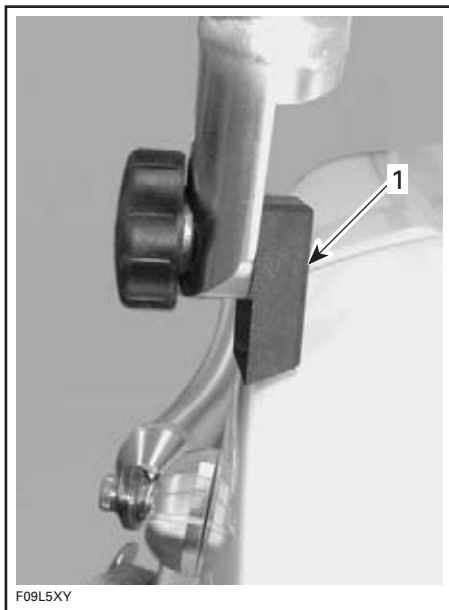

**TYPICAL**

1. Screw knob into this block

Repeat for other side and carefully lower tower onto deck.

Install straps by placing looped end over rear mooring cleats as shown in next illustration.

Wrap other end around tower tubing, close fasteners and pull up on loose end of strap to tighten.

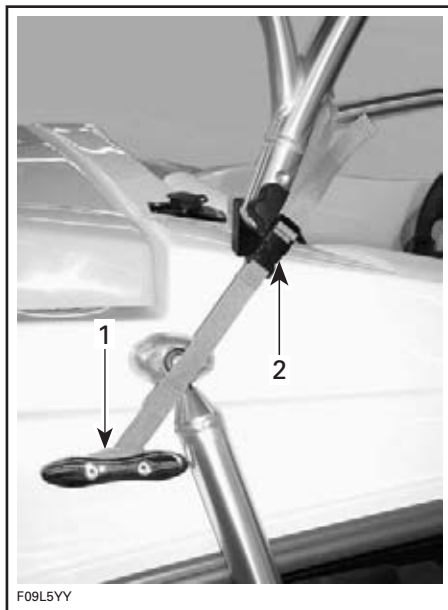

**TYPICAL**

1. Looped end
2. Fastener

Erection of tower is reverse of this procedure.

When installing 8 mm bolts into rear tower uprights, torque bolts to 35 N•m (25.8 lbf•ft).

Place storage support blocks and straps in glovebox or other secure storage for later use.

**Tower Removal**

**NOTE:** Removal of the tower will require 4 people. Remove tower only from upright position.

Using a 6.35 mm (1/4 in) hexagonal tip, remove bolts from tower attachment points.

Carefully maneuver tower away from boat and place on a level surface.

Save bolts for later reinstallation.

**Installation (from off boat)**

**NOTE:** Installation of the tower will require 4 people.

Carefully lift tower assembly and position on boat with someone at each attachment point of tower unit.

Apply Loctite 243 (P/N 293 800 059) to threads of bolts and install bolts into attachment points. Torque bolts to 35 N•m (25.8 lbf•ft) to complete installation of tower.

## **WARNING**

Pulling a tube, skier or wakeboarder makes the boat handle differently and requires greater skill. Unless absolutely necessary, do not make tight, sharp turns. Keep a safe distance from docks, swimmers, other craft or objects. Be advised that serious injury can result if the tow rope becomes slack during a tight turn or when circling. The rope could become wrapped around the neck or limbs of a person.

## **37) Main Battery Cut-Off Switch**

The switch allows a complete power cut-out of the electrical system.

### **150 Speedster Models**

The switch is located in the engine compartment.

### **180 Challenger Models**

This switch is located in the port bilge access compartment.

### **All Models**

When in OFF position, ALL electrical equipment and electronics will be OFF, **except** the bilge pump. The bilge pump will operate automatically with the battery switch in the OFF position.

Switch must be in the ON position to allow the use of electrical components and to start the engine.

**CAUTION:** Stop engine before switching to the OFF position.

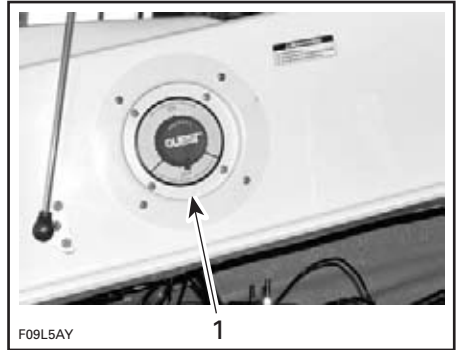

**TYPICAL — 150 SPEEDSTER — MAIN BATTERY CUT-OFF SWITCH**

1. Battery cut-off switch in OFF position

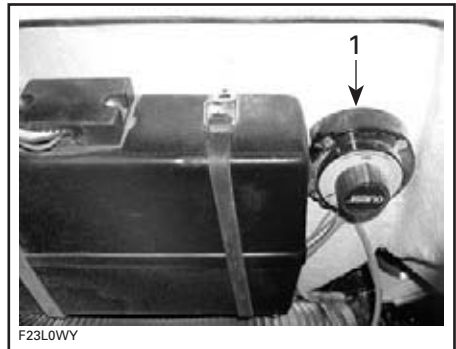

**TYPICAL — 180 CHALLENGER — MAIN BATTERY CUT-OFF SWITCH**

1. Battery cut-off switch in ON position

It is recommended to set this switch to the OFF position whenever performing maintenance in the engine compartment, on the electrical system, for transportation or during short term storage.

**CAUTION:** When the main battery cut-off switch is turned OFF while boat is moored, the automatic bilge pump will start if water comes up in the bilge.



### 38) AM/FM Radio/CD Player



TYPICAL — RADIO/CD PLAYER

Refer to *MANUFACTURER'S GUIDE* for complete explanation of features and controls.

**CAUTION:** Using the radio/CD player for a prolonged time without engine running may discharge the battery.

### 39) 12-Volt Jack

A 12-volt jack is provided to power temporary accessories such as a cellular phone or other 12-volt portable devices.



TYPICAL — LOCATED ON DRIVER'S CONSOLE — 150 SPEEDSTER  
1. 12-volt jack



LOCATED IN THE GLOVEBOX — 180 CHALLENGER  
1. 12-volt jack

Lift protective cap to expose jack.

**CAUTION:** Using the accessory jack for a prolonged time without engine running may discharge the battery.

**CAUTION:** Close protective cap when jack is not in use to protect against weather.

### 180 Challenger Only

#### **⚠ WARNING**

Never operate the boat with the glovebox cover open.

### 40) Fuses

The electrical system is protected with fuses. Refer to *MAINTENANCE* section for details.

### 41) Horn Switch

A 2-position push type switch.

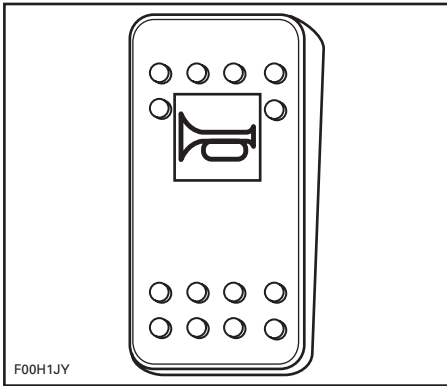

**HORN SWITCH**

Press and hold the switch to activate the horn.

Release the switch to stop horn.

**42) Deck Lights Switch**

A 2-position OFF/ON switch.

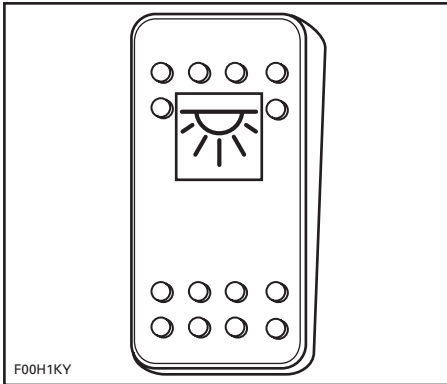

**DECK LIGHT SWITCH**

Press switch to ON position to turn on the deck lights.

Press switch to OFF position to turn off the deck lights.

**CAUTION:** Using the deck lights for a prolonged time when the engine is not running will discharge the battery.

**43) Glovebox**

Located on the port console, the glovebox provides a convenient, lockable storage space for keys, wallet, etc.

To open glovebox, press latch button and pull. To close glovebox, lift door and push forward until latched.



TYPICAL

**⚠ WARNING**  
Never operate the boat with the glovebox cover open.

**44) Bow Seats**

Located at the front of the boat, they are provided as a sun seat.

**⚠ WARNING**  
No passenger should use the most forward seat in the bow area if it faces backwards unless the boat is stopped or under idle speed.

## 45) Bow Seat Storage Compartments

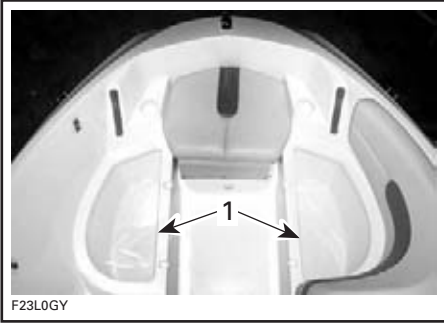

### TYPICAL

1. Bow storage compartments

Located under the bow seat cushions, the bow seat storage compartments are provided for securing extra PFD's, rope, etc.

Unsnap and lift bow cushions to access storage areas.

Installation of bow cushions is the reverse of removal.

## 46) Bow Filler Cushion (if so equipped)

The bow seat filler cushion is located under the front bow seat cushion.

Unsnap the front bow seat cushion and remove.

Pull the bow seat filler cushion from its storage position.

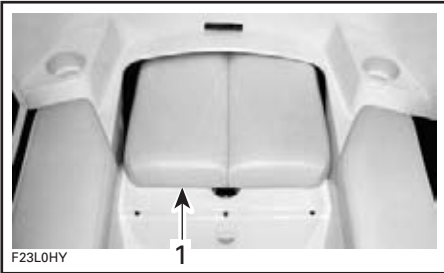

1. Filler cushion

Remove the support bars from their storage position beneath the bow seat filler cushion.

Unsnap the two side bow seat cushions, lift each cushion slightly to position the support bars.

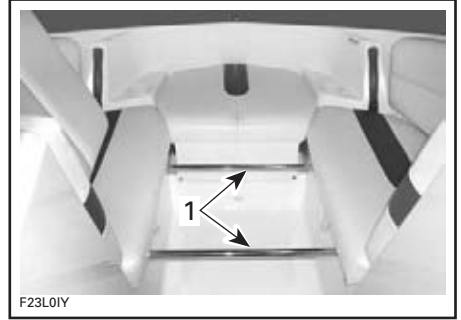

1. Support bars installed

Reposition front bow seat cushion and fasten with the snap.

Position bow seat filler cushion to create a comfortable lounging area while boat is stopped.



### TYPICAL

## 47) Rear Seat Storage Compartments

Located beneath the rear port and starboard seat cushions, these compartments are convenient for storing a cooler, or additional articles.

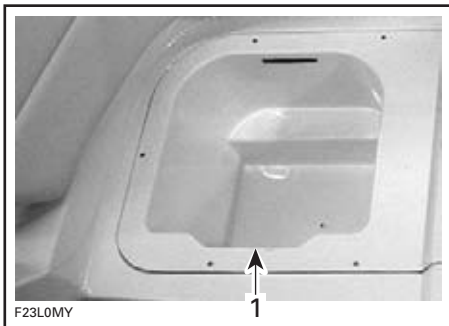

TYPICAL

1. Starboard side shown

## 48) Passenger Storage Compartment

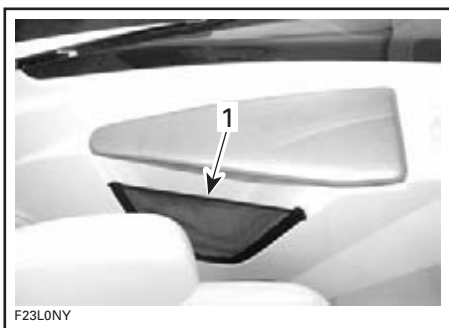

1. Passenger storage area

Located at the port side of the boat next to the front passenger seat, this storage area provides quick, easy access for small articles.

## 49) Engine Cover

Pull upwards on the latch below the rear center seat cushion and lift engine cover lid.

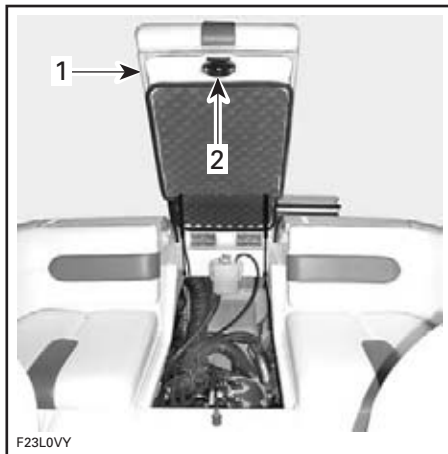

1. Engine cover/center cushion  
2. Latch

The gas assist cylinders will complete the opening and hold the cover open.

## 50) Port Bilge Access

Located at the port rear of the boat.

This area allows access to the battery, the main battery cut-off switch and various fuses.

Lift latch to open storage cover.

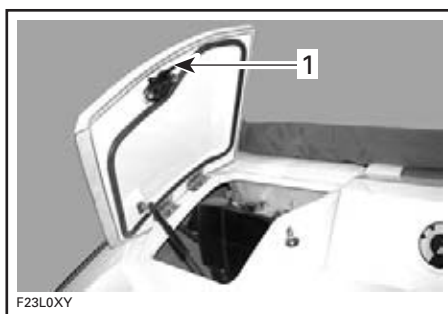

1. Latch

The gas assist cylinder will hold the storage cover open.

## WARNING

Always close cover before getting underway.

Also see *MAINTENANCE* section.

## **51) Removable Cooler**

A 15 liter (16 quart) removable cooler is provided for keeping sandwiches and non-alcoholic beverages cold.

It is located in the starboard rear seat storage compartment, and will also fit in the port rear seat storage compartment.

## **52) Radio/CD Cut-Off Switch**

Switch which cuts power to the radio from the driver's position to prevent battery drainage.

**CAUTION:** Using the radio/CD player for a prolonged time without engine running may discharge the battery.

## **53) AM/FM Radio/CD Player Remote Control**

### ***180 Challenger SE Only***

A remote control for the AM/FM Radio/CD Player is included as standard equipment and is located on the dashboard.

Please refer to included *MANUFACTURER'S INSTRUCTION SHEET* for remote control operation.

## LIQUIDS

**CAUTION:** Carefully follow the instructions of this section. Failure to do so may reduce the engine's life and/or performance.

### Fuel

#### ***Naturally-Aspirated Engine Models***

Use regular unleaded gasoline or oxygenated fuel containing a maximum total of 10% of ethanol or methanol or both. The gasoline used must have the following recommended minimum octane number.

LOCATION	OCTANE NUMBER
Inside North America	(87 (RON+MON)/2)
Outside North America	92 RON

#### ***Supercharged Engine Models***

It is recommended to use a premium unleaded gasoline with the following octane number for optimum performance.

LOCATION	OCTANE NUMBER
Inside North America	(91 (RON+MON)/2)
Outside North America	95 RON

As a minimum, regular unleaded gasoline with the following minimum octane number may be used.

LOCATION	OCTANE NUMBER
Inside North America	(87 (RON+MON)/2)
Outside North America	92 RON

### ***All Models***

**CAUTION:** Never experiment with other fuels or fuel ratios. The use of unrecommended fuel can result in boat performance deterioration and damage to critical parts in the fuel system and engine components.

### **Engine Oil**

#### **Recommended Oil**

This boat features a 4-stroke engine that requires 4-stroke motor oil for internal engine lubrication. Ensure to respect the following requirements.

#### ***Naturally-Aspirated Engines***

Sea-Doo Sport Boats featuring a 4-stroke engine without a supercharger require 4-stroke motor oil meeting the requirements for API service classification SM, SL or SJ. Always check the API service label on the oil container, it must contain at least one of the above standards.

XP-S 10W-40 4-stroke oil (P/N 219 700 346) sold by authorized Sea-Doo Sport Boats dealers meets those requirements.

**NOTE:** A synthetic oil meeting the same requirements may be used. The XP-S 5W-40 Synthetic 4-stroke oil (P/N 293 600 039) is suitable.

## Supercharged and Supercharged Intercooled Engines

Use XP-S 10W-40 4-stroke oil (P/N 219 700 346) or an equivalent approved by BRP. The same oil lubricates both the engine and the supercharger clutch. XP-S 10W-40 4-stroke oil (P/N 219 700 346) has been thoroughly tested to be free of any additives that could impair the functionality of the supercharger clutch.

**CAUTION:** NEVER use synthetic oil in these engines. This would impair the proper operation of the supercharger clutch. Do not add any additives to the recommended oil. Beware that oils not recommended by BRP may contain additives (friction modifiers that may cause inappropriate slippage of the supercharger and eventually lead to premature wear. For this reason, oils other than XP-S 10W-40 4-stroke oil (P/N 219 700 346) or an approved equivalent are not recommended.

### Oil Level

**CAUTION:** Check level frequently and refill if necessary. Do not overfill. Operating the engine with an improper oil level may severely damage engine. Wipe off any spillage.

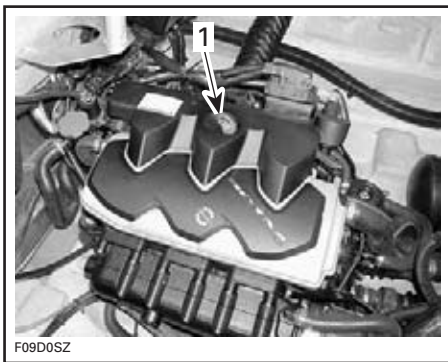

TYPICAL  
1. Dipstick

Check the oil level as follows:

**NOTE:** Before checking the oil level on this engine, it is necessary to let it idle for 30 seconds **before** shutting it off. Then it is necessary to wait 30 seconds before the oil can be checked. This is required to allow the oil to properly level out in the different oil chambers. Otherwise, you will have a false oil level reading.

- Boat must be level. Check oil level either with boat in water or out of water. Engine should be warm.

**CAUTION:** Never run engine without supplying water to the exhaust system when boat is out of water.

- If out of water and on a trailer, block the wheels and raise the bow slightly with the trailer jack (if so equipped) until the bumper rail is level. Install a garden hose to the flushing connector. Refer to *EXHAUST SYSTEM FLUSHING IN STORAGE AND PRESEASON PREPARATION* and follow the procedure.

**CAUTION:** Failure to supply water to the exhaust system, when engine is out of water, may severely damage exhaust system.

- Warm-up engine then let idle for 30 seconds before stopping.
- Stop engine.
- Wait at least 30 seconds then pull dipstick out and wipe clean.

### WARNING

Engine oil may be hot. Certain components in the engine compartment may be very hot. Direct contact may result in skin burn.

**CAUTION:** Never run engine longer than 5 minutes. Drive line seal has no cooling when boat is out of water.

- Reinstall dipstick, push in completely.

- Remove dipstick and read oil level. It should be between marks.

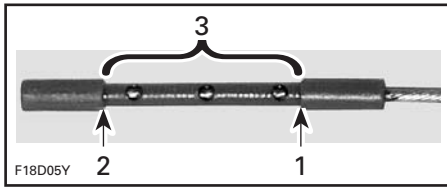

1. Full
2. Add
3. Operating range

- Otherwise, add oil up to have the level between marks as required.
- To add oil, unscrew oil cap. Place a funnel into the opening and add the recommended oil to the proper level. Do not overfill.

**NOTE:** Every time oil is added in engine, the complete procedure explained above must be done (engine restarted, idling for 30 seconds, 30 seconds waiting time and then, rechecking the oil level). This is required to allow the oil to properly transfer in the different oil chambers and to then level. Otherwise, you will have a false oil level reading.

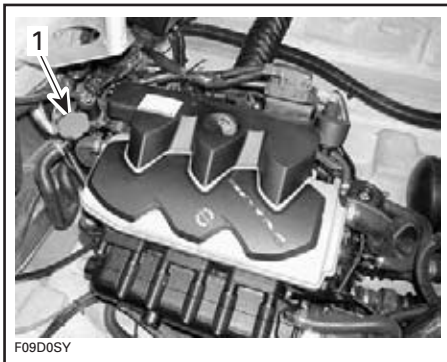

**TYPICAL**  
1. Oil cap

- Properly reinstall oil cap and dipstick.

## Engine Coolant

### Recommended Coolant

Always use ethylene-glycol antifreeze containing corrosion inhibitors specifically for internal combustion aluminum engines.

**NOTE:** When available, it is recommended to use biodegradable antifreeze compatible with internal combustion aluminum engines. This will contribute to protect the environment.

Cooling system must be filled with water and antifreeze solution (50% water, 50% antifreeze).

BRP sells premixed coolant with freezing protection up to - 52°C (- 62°F) (P/N 219 700 362).

To prevent antifreeze deterioration, always use the same brand. Never mix different brands unless cooling system is completely flushed and refilled. Refer to an authorized Sea-Doo Sport Boats dealer.

### Coolant Level

#### **WARNING**

Check coolant level with engine cold. Never add coolant in cooling system when engine is hot.

With boat on a level surface, liquid should be between MIN. and MAX. level marks of coolant reservoir when engine is cold.



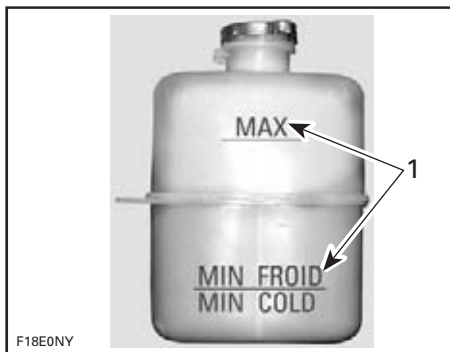

1. Level between marks when engine is cold

**NOTE:** The boat is considered level when it is in water. When on a trailer, block the wheels and raise the bow slightly with the trailer jack (if so equipped) until the bumper rail is level.

Add coolant to have the level between marks as required. Use a funnel to avoid spillage. **Do not overfill.**

Properly reinstall and tighten filler cap.

**NOTE:** A cooling system that frequently requires coolant is the indication of leaks or engine problems. See an authorized Sea-Doo Sport Boats dealer.

## Coolant Replacement

Refer to *MAINTENANCE* section.

### **WARNING**

In order to avoid potential burns, do not remove the radiator cap or loosen the engine drain plug if the engine is hot.

---

## BREAK-IN PERIOD

**CAUTION:** Carefully follow the instructions of this section. Failure to do so may reduce the engine's life and/or performance.

With Sea-Doo Sport Boats powered by Rotax engines, a break-in period of 10 hours is required before continuous operation at full throttle.

To achieve a good break-in, throttle lever should not be advanced more than 3/4, however, brief acceleration and speed variations contribute to a good break-in.

**CAUTION:** Continued wide open throttle runs and prolonged cruising without speed variations should be avoided. This can cause engine damage during the break-in period.

**NOTE:** Never add oil in fuel tank.

---

## PRE-OPERATION CHECKS

### **WARNING**

The pre-operation check is very important before operating the boat. Always check the proper operation of critical controls, safety features and mechanical components before starting. If not done as specified here, severe injury or death might occur. Bring all safety equipment required by local laws.

Some of the following items may not have been previously covered in this guide, however they will be described in the *MAINTENANCE* or *SPECIAL PROCEDURES* section. Please refer to these portions to have more detailed information.

### **WARNING**

Engine should be off and the DESS key must always be removed from the DESS post before verifying any of the following. Only start boat once all items have been checked and operate properly.

SUMMARY		
ITEM	OPERATION	✓
Hull	Inspect for damage.	
Jet pump water intake	Inspect/clean.	
Bilge	Drain. Ensure plugs are secured.	
Battery	Inspect tightness of cables and retaining straps. Verify sufficient charge.	
Main battery cut-off switch	Ensure it is in the ON position.	
Navigation lights	Check operation.	
Fuel tank	Refill.	
Engine compartment	Verify fuel exhaust components.	
Fire extinguisher	Inspect condition/mounting.	
Steering	Check operation.	
Throttle/shifter system	Check operation.	
Bilge blower and bilge pump	Check operation.	
DESS key/engine start/stop button	Check operation.	
Mandatory safety boating equipment	Check operation.	
Storage compartment covers	Ensure they are closed and latched.	
Sacrificial anodes	Verify condition (replace when 50% corroded).	
Engine oil level	Refill as needed.	
Cooling system coolant level	Refill as needed.	

## Hull

Inspect hull for cracks or damage.

## Jet Pump Water Intake

Remove weeds, shells, debris or anything else that could restrict the flow of water and damage the cooling system or propulsion unit. Clean as necessary. If any obstruction cannot be removed, refer to an authorized Sea-Doo Sport Boats dealer for servicing.

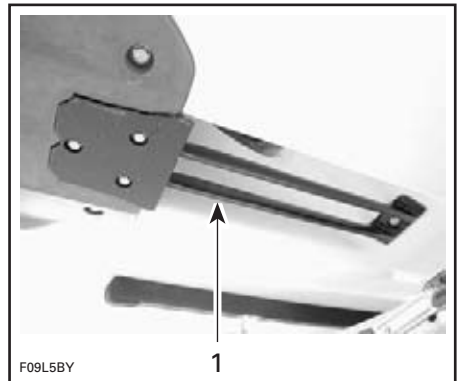

**TYPICAL**  
1. Inspect this area

Inspect leading edges of the impeller for nicks or bends, which will greatly reduce performance of the boat.

## Bilge

If water is present in the bilge, turn on pump switch to empty the bilge.

When on a trailer, block the wheels, unscrew the drain plugs and raise the bow slightly with the trailer jack (if so equipped) so that water can flow out of the bilge.

### **WARNING**

Make sure drain plugs are properly secured before launching the boat in water.

## Battery

### **WARNING**

Verify tightness of battery cables to their posts and condition of retaining straps/fasteners. Do not charge or boost battery while installed in engine compartment.

## Fuel Tank and Engine Oil Level

With the boat level, fill the fuel tank.

Check the oil level and refill as necessary as per *LIQUIDS* section.

Check fuel tank retaining straps/fasteners.

## Engine Compartment

### **WARNING**

If any leaks or gasoline odors are present, do not start the engine. Consult an authorized Sea-Doo Sport Boats dealer.

### **WARNING**

In order to avoid potential burns, do not remove the radiator cap or loosen the engine drain plug if an engine is still hot.

## Fire Extinguisher

Make sure fire extinguisher is full, in good condition and well secured.

## Steering System

Have another person help check steering operation for free movement. When the steering is centered, the jet pump nozzle should be in the straight ahead position. Ensure the jet pump nozzle pivots easily while steering is turned.

### **WARNING**

Check steering and corresponding steering nozzle operation before starting engine.

## Throttle System

Check throttle lever for free and smooth operation.

### **WARNING**

Check throttle lever operation before starting the engine.

## Shifter System

Check that reverse gate moves freely. With shift lever in forward position, the gate must be in upward position. With the shift lever in neutral position, gate must be in middle position. With shift lever in reverse position, gate must be in downward position.

### **WARNING**

Verify the reverse gate lock.

To verify the reverse gate lock, move shifter to FORWARD position.

Pull backwards on the reverse gate.

The reverse gate lock is working if the reverse gate stays in the up position.

**CAUTION:** If the reverse gate does not stay in the up position when the shifter is at FORWARD, do not operate the boat further, see an authorized Sea-Doo Sport Boats dealer.

## **DESS Post and Engine Start/Stop Button**

Ensure that switches operate properly.

### **WARNING**

If engine does not shut-off when pushing engine start/stop button or by disconnecting the DESS key from the DESS post, do not operate the boat further, see an authorized Sea-Doo Sport Boats dealer. Only start boat once all items have been checked and operate properly.

## **Storage Compartment Covers**

Ensure they are closed and latched.

# OPERATING INSTRUCTIONS

## **⚠ WARNING**

Always perform *PRE-OPERATION CHECKS* before operating the boat. Become thoroughly familiar with all controls and the function of each. Should any control or instruction be not fully understood, refer to an authorized Sea-Doo Sport Boats dealer.

## **Launching/Loading**

**CAUTION:** Before launching the boat, ensure the main battery cut-off switch is turned ON and the bilge plugs are fully screwed into place.

When finished loading the boat on trailer, turn the main battery cut-off switch to OFF.

Remove bilge plugs to drain bilge when boat is on trailer.

## **Principle of Operation**

### **Propulsion**

The engine is directly coupled to a drive shaft which, in turn, rotates an impeller. This impeller rotates within a housing drawing water in from beneath the boat. Water is then forced by the impeller through a venturi. The venturi pressurizes and accelerates the water, producing thrust to move the boat. Pushing the throttle lever forward increases engine speed and therefore boat speed.

When the shift lever is pushed forward, the boat moves forward. Pulled back in the reverse position, the boat moves backwards. The middle position is neutral and the boat is at the minimum thrust for most conditions. Neutral and reverse are achieved by means of a gate, which is installed on the jet pump venturi housing. This gate directs the water flow to obtain the desired direction.

## **⚠ WARNING**

When the shifter is in neutral position, the impeller is turning.

## **⚠ WARNING**

Shift lever should only be used when the engine is idling and boat is stopped.

## **⚠ WARNING**

When an engine is to be started, the operator and passengers should always be sitting in the boat with the shifter lever in neutral position and throttle lever in idle position.

## **Steering**

Turning the steering pivots the jet pump nozzle which controls the boat direction. Turning the steering wheel clockwise will turn the boat to the right and inversely.



*TYPICAL*

Above idle speed, throttle must be applied to turn the boat.

## WARNING

Throttle must be applied and steering turned to change the direction of the boat at speed. Steering efficiency will differ depending on the number of passengers, load and water conditions.

A jet propelled boat needs some throttle applied in order to turn. Practice in a safe area applying the throttle and turning away from an imaginary object. This is a good collision avoidance practice.

### Using Reverse

The boat behaves differently when using reverse. The steering response is the opposite of forward operation. So, turning the steering wheel clockwise will turn the back of the boat to the left and inversely. Use throttle moderately. Too much RPM will create water turbulence and reduce reverse efficiency. At first outing, carefully practice this maneuver away from anything with which you might collide.

## WARNING

Become fully familiar with this feature during your first ride and before carrying passengers.

### Boarding from a Dock

As with any boat, boarding should be done carefully and engine must not be running.

When boarding from a dock, slowly place one foot on the boat deck nearest to the dock and then move the other foot inside the boat. Push the boat away from the dock.

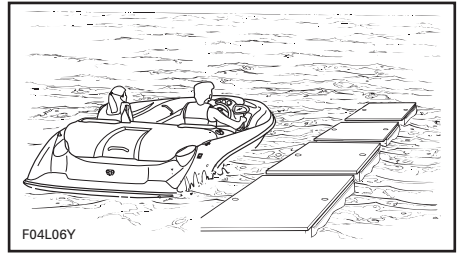

TYPICAL

**CAUTION:** Although the boat requires only 30 cm (1 ft) of water to float, the engine should be started with at least 90 cm (3 ft) of water below the hull. If the depth of water is less than 90 cm (3 ft) and the engine is running, the impeller is turning and debris can be drawn from the bottom and damage the propulsion system.

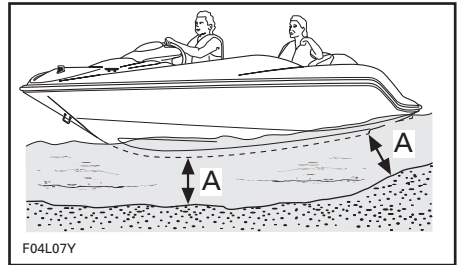

TYPICAL  
A. 90 cm (3 ft)

### Boarding from the Water

## WARNING

Inexperienced riders should practice how to get aboard close to shore first before venturing into deep water.

## WARNING

Engine should not be running while boarding. Never use propulsion components as a supporting point to board the boat.

Swim to the rear of the boat.



Release the rubber stays on one-step ladder pulling ladder out and down into boarding position. Grip the grab handle and pull yourself up until your knee can reach the swim platform.

**⚠ WARNING**

Never leave ladder in down position when engine is running or boat is in motion. Always secure ladder with rubber stays when not in use.

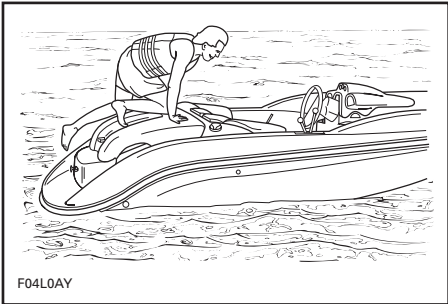

TYPICAL

**⚠ WARNING**

Do not start engine until all passengers are properly seated.

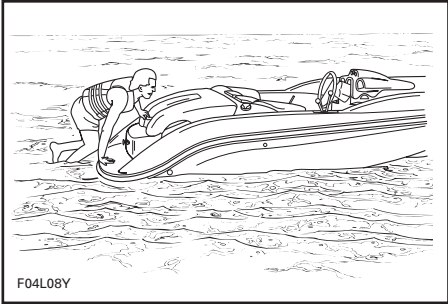

TYPICAL

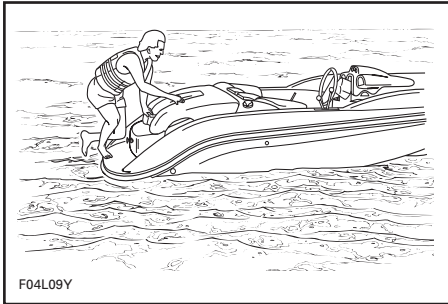

TYPICAL

### Starting

**⚠ WARNING**

Engine exhaust fumes contain carbon monoxide (CO) which can accumulate in and around the boat (under Bimini top, in cockpit, etc.). CO can be harmful or fatal if inhaled. Assure there is adequate ventilation whenever running engine.

**⚠ WARNING**

Always activate bilge blower 5 minutes minimum before starting the engine to allow the bilge blower to ventilate the bilge.

**⚠ WARNING**

Do not touch electrical parts or jet pump area when engine is running.

**⚠ WARNING**

Bilge blower must be turned off during Sport Boats operation.

Attach the safety lanyard to your PFD and snap the key to the DESS post before starting the engine.

**NOTE:** If you hear some beeper signals other than 2 short beeps, it indicates a particular condition that must be corrected. Refer to chart in the *TROUBLESHOOTING* section for the meaning of the coded signal.

Grip steering wheel with your right hand and place both feet on the floorboard. Turn off bilge blower.

Start engine. Check tachometer to monitor engine.

### **WARNING**

Before starting, the operator and passengers should always be properly seated.

**CAUTION:** To avoid starter motor overheating, the cranking period should not exceed 5 - 10 seconds and a rest period of 30 seconds should be observed between cranking cycles to let the starter cool down and its mechanism disengage.

### Leaving the Shore

With throttle lever at idle, move shifter to the desired direction.

Slowly accelerate to reach deeper water. Do not apply full throttle until the engine is warm.

### **WARNING**

In shallow water, shells, sand, pebbles or other objects could be drawn up by the jet pump and thrown rearward.

### **Rough Water or Poor Visibility Operation**

Avoid operation in these conditions. If you must do so, proceed with caution and prudence using minimum speed. Turn on navigation lights if necessary.

### **Crossing Waves**

Reduce speed when crossing waves. Always be prepared to steer and balance as necessary.

When crossing wakes, always keep a safe distance from boat ahead.

### **WARNING**

When crossing wakes, slow down. Operator and passenger(s) can brace themselves by posting. Do not jump waves or wakes.

### **Stopping/Docking**

The boat is slowed by water drag. The stopping distance will vary depending on weight, speed, water surface condition, presence and direction of wind and current.

The operator should become familiarized with the stopping distance under different conditions.

Reduce speed to idle. Shift to neutral, reverse or forward as required when approaching a dock then shut off the engine just before coming alongside.

### **WARNING**

Directional control is reduced when throttle is decreased and lost when engine is off.

When close to the dock, shut off the engine.

### **Beaching**

**CAUTION:** It is not recommended to run the boat onto the beach.

Come slowly to the beach and shut off the engine using the DESS key when water depth is 90 cm (3 ft) under the hull, then pull the boat to the beach. Ensure that all accessories are OFF.

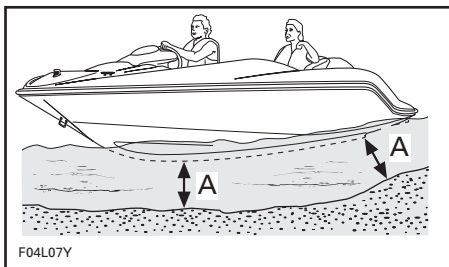

A. 90 cm (3 ft) of water under the hull

### **⚠ WARNING**

In shallow water, shells, sand, pebbles or other objects could be drawn up by the jet pump and thrown rearward.

As necessary, the exhaust system should be flushed before restarting, in order to remove sand or shell accumulation which may clog the water passages. Refer to *STORAGE AND PRESEASON PREPARATION* and look for *EXHAUST SYSTEM FLUSHING*.

## **Shutting Off the Engine**

To shut off the engine, completely pull back throttle lever then remove the DESS key or press the engine start/stop button.

Always remove the DESS key from the DESS post.

### **⚠ WARNING**

Should the engine be shut off, boat directional control is not available. Never leave the DESS key connected on the DESS post when boat is not in operation to avoid unauthorized use by children, theft or others.

## **Post-Operation Care**

### **⚠ WARNING**

Allow engine to cool before performing any maintenance.

## **General Care**

Once boat is on trailer, unscrew the drain plugs, block the wheels and raise the boat up at the bow with the trailer jack (if so equipped) to allow water to drain.

Remove any remaining water in the engine compartment (bilge, engine, etc.) with clean dry rags. This is particularly important in salt water use.

Remove the boat from the water every day to prevent growth of marine organisms.

## **Anticorrosion Treatment**

To prevent corrosion, spray a corrosion inhibitor (salt water resistant) such as XP-S Lube lubricant or equivalent over metallic components in engine compartment.

**NOTE:** Engine fogging should be done with XP-S Lube lubricant whenever the boat is to be stored for few days or a long period.

Apply dielectric grease (salt water resistant) on battery posts and cable connectors.

**CAUTION:** Never leave rags or tools in the engine compartment or in the bilge.

## **Additional Care for Foul Water or Salt Water Use**

When the boat is operated in foul water and particularly in salt water, additional care must be taken to protect the boat and its components. Rinse trailer and boat's hull/bilge area with fresh water.

Flushing the exhaust system with fresh water is essential to neutralize corroding effects of salt or other chemical products present in water. It will help to remove sand, salt, shells or other particles in water jackets and/or hoses.

Flushing should be performed when the boat is not expected to be used further the same day or when the boat is stored for any extended time.

 **WARNING**

Perform this operation in a well ventilated area.

Refer to *EXHAUST SYSTEM FLUSHING* in *STORAGE AND PRESEASON PREPARATION* section for procedure.

**CAUTION:** Failure to perform proper care such as: boat rinsing, exhaust system flushing and anticorrosion treatment, when used in salt water, will result in damage to the boat and its components. Never leave the boat stored in direct sunlight.

---

## SPECIAL PROCEDURES

### Jet Pump Water Intake and Impeller Cleaning

#### WARNING

Keep away from intake grate while engine is on. Items such as long hair, loose clothing or personal flotation device straps can become entangled in moving parts resulting in severe injury or drowning.

Weeds, shells or debris can get caught on the intake grate, drive shaft and/or impeller. A clogged water intake may cause troubles such as:

1. **Cavitation:** Engine speed is high but boat moves slowly due to reduced jet thrust; jet pump components may be damaged.
2. **Overheating:** Since the jet pump operation controls the flow of water to cool the exhaust system, a clogged intake will cause the engine to overheat and damage internal engine components.

The clogged area can be cleaned as follows:

**In-water cleaning:** Pull the DESS key from DESS post to stop engine. Let the boat stop by itself. Wait a while to allow weeds or other debris to escape from grate. It may be necessary to repeat the procedure.

In severe conditions if the above method does not work, the following can be performed:

- With engine running, put shift lever in reverse position and vary throttle setting quickly several times.
- Try accelerating again.

Most of the time, debris will escape from the propulsion system.

**Out of water cleaning:** If the system is still clogged, shut off the engine by removing the DESS key.

#### WARNING

Always remove the DESS key from the DESS post to prevent accidental engine starting before cleaning the jet pump area.

From underneath boat, manually clean water intake area. If the system is still clogged, refer to an authorized Sea-Doo Sport Boats dealer for servicing.

**CAUTION:** Avoid operation in weeded areas. If unavoidable, vary speed. Weeds tend to entangle more at steady and slow speeds. Inspect water intake grate for damage. Refer to an authorized Sea-Doo Sport Boats dealer for repair as necessary.

### Capsized Boat

This boat is designed so that it should not turn over easily due to its long and wide dimensions. If the boat ever capsizes, remember that it will continue to float. It is usually best to remain with it, so you will be more easily located by others.

#### WARNING

When boat is capsized, do not attempt to restart the engine. Operator and passengers should always wear approved personal flotation devices.

### Submerged Boat/ Water-Flooded Engine

To limit damages to the engine, perform the following procedure as soon as possible.

Drain bilge.

If it was submerged in **salt water**, spray bilge and all components with fresh water using a garden hose to stop the salt corroding effect.

**CAUTION:** Never try to crank or start the engine. Water trapped in intake manifold would flow towards the engine and may cause severe damage to the engine.

Bring the boat to be serviced by an authorized Sea-Doo Sport Boats dealer as soon as possible.

**CAUTION:** The longer the delay before you have the engine serviced, the greater the damage will be to the engine. Failure to have the engine properly serviced **will** cause severe engine damage.

## Fuel-Flooded Engine

If engine is fuel-flooded and does not start, this special mode can be activated to prevent fuel injection and ignition while cranking. Proceed as follows to activate it.

While engine is stopped:

- Set throttle lever in idle position.
- Set shift lever in neutral position.
- Install DESS key on DESS post.
- From engine compartment, manually rotate throttle lever into fully opened position and HOLD.

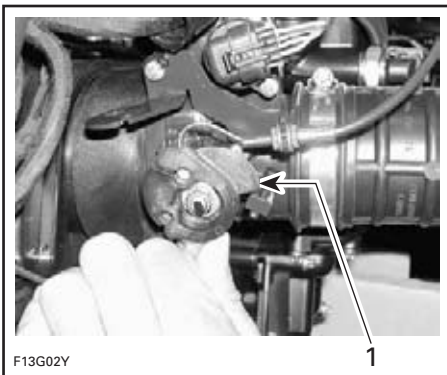

**TYPICAL**  
1. Fully-open position

- Ask someone to press the start/stop switch to crank engine while still HOLDING the throttle lever in fully-opened position. The drowned mode is now on.
- Crank engine several times.

**CAUTION:** Do not hold the start button more than 30 seconds. A rest period should be observed between the cranking cycles to let the starter cool down. Pay attention not to discharge the battery.

- Release engine start/stop switch.
- Release throttle lever and start/crank engine again to allow starting.

**NOTE:** Releasing throttle lever will bring back to its normal mode.

**If it does not work:**

Disconnect ignition coil connectors.

All three ignition coils are located on the cylinder head directly on the spark plugs.

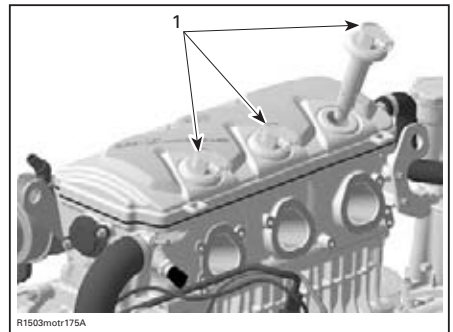

1. Ignition coils



smr05-015-001

### DISCONNECT IGNITION COIL CONNECTORS

## WARNING

When disconnecting coil from spark plug, always disconnect coil from main harness first. Never check for engine ignition spark from an open coil and/or spark plug in the engine compartment as spark may cause fuel vapor to ignite.

Remove ignition coils.

**CAUTION:** Ensure there is no dirt in coil holes before removing the spark plugs. Otherwise, dirt would fall into cylinder and will damage the internal components.

Remove spark plugs.

**NOTE:** After loosening the spark plugs, a coil may be used to pull the spark plugs out. Simply bring the coil down to spark plug and "hook" it to then extract spark plug.

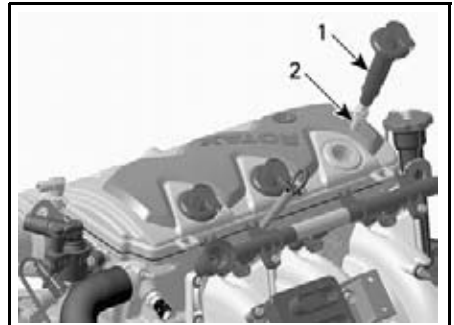

smr2006-016-030\_a

1. Ignition coil
2. Spark plug

Install new spark plugs if available, or dry spark plugs using a rag.

Reinstall spark plugs and ignition coils. Reconnect ignition coil connector.

**NOTE:** After installation, ensure the seal seats properly with the engine top surface.

Start engine as explained above. If engine continues to flood, see an authorized Sea-Doo Sport Boats dealer.

**CAUTION:** Never run engine without supplying water to the exhaust system when boat is out of water.

## Towing the Boat in Water

Special precautions should be taken when towing a Sea-Doo Sport Boats in water.

Maximum recommended towing speed is 24 km/h (15 MPH).

When towing your Sport Boats in water, pinch the water supply hose from the impeller housing to the exhaust manifold with a large hose pincher (P/N 529 032 500).

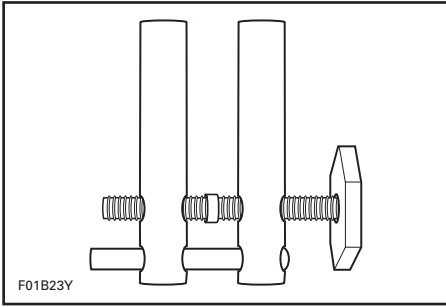

This will prevent the exhaust system from filling which may lead to water being injected into and filling the engine. Without the engine running there isn't any exhaust pressure to carry the water out the exhaust outlet.

**CAUTION:** Failure to do this may result in damage to the engine. If your Sea-Doo Sport Boats must be towed in water and you do not have a hose pincher, be sure to stay well below the maximum towing speed of 24 km/h (15 MPH).

Snugly install the hose pincher on the water supply hose as shown.

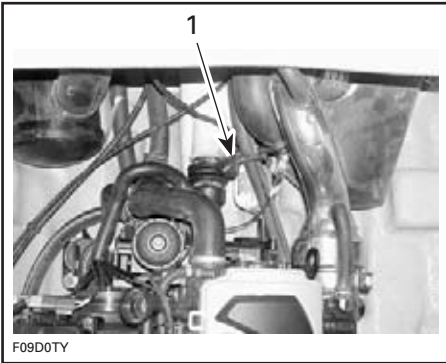

**TYPICAL**

1. Hose pincher

**CAUTION:** When finished towing the Sport Boats, hose pincher must be removed before operating it. Failure to do so will result in damage to the engine.



---

# TROUBLESHOOTING

The following information is provided to help in diagnosing the probable source of simple troubles. You may be able to solve many of these problems rather quickly, but others may require the skills of a mechanical technician. In such a case, consult an authorized Sea-Doo Sport Boats dealer for servicing.

## Monitoring System Coded Signals

---

### 2 SHORT (while installing DESS key on DESS post).

#### 1. Everything is correct with the DESS KEY (good contact and the right key).

- Engine can be started normally.

---

### 1 LONG (while installing DESS key on DESS post or when pressing start/stop button in some cases).

#### 1. Shifter lever not in Neutral position.

- Move shifter lever to Neutral position.

#### 2. Bad connection between DESS key and DESS post.

- Remove and reinstall the DESS key on the DESS post. Two short beeps should be heard which indicate the system is ready again to allow engine starting.

#### 3. Wrong key.

- Use the DESS key that has been programmed for the boat. If it does not work, refer to an authorized Sea-Doo Sport Boats dealer.

#### 4. Dirty DESS key.

- Clean.

#### 5. Improper operation of Interface or defective wiring harness.

- Refer to an authorized Sea-Doo Sport Boats dealer.

---

### 4 SHORT BEEPS (WHILE PRESSING START/STOP BUTTON WITH DESS KEY ALREADY INSTALLED).

#### 1. Shifter is NOT in neutral.

- Place shifter in neutral. While moving the shifter, 1 short beep indicates you reached the neutral position.

---

### 1 SHORT BEEP (WHILE MOVING SHIFTER TO NEUTRAL).

#### 1. Confirmation that shifter is now in neutral.

- Engine is now ready to be started.

---

### 4 SHORT BEEPS EVERY 3 SECONDS INTERVAL.

#### 1. DESS key has been left on its post without starting engine or after engine was stopped.

- To prevent battery discharge, remove the key from its post.

---

### CONTINUOUSLY BEEPS.

#### 1. High engine coolant temperature.

- Refer to ENGINE OVERHEATS further in this section.

## **CONTINUOUSLY BEEPS. (cont'd)**

---

### **2. High exhaust temperature.**

- Refer to ENGINE OVERHEATS further in this section.

### **3. Low or high engine oil pressure.**

- Check oil level as soon as possible. If it does not work, contact an authorized Sea-Doo Sport Boats dealer.

## **Charging System**

### **BATTERY IS REGULARLY DISCHARGED.**

---

#### **1. Check battery condition.**

- Charge or install new battery.

#### **2. Check charging system fuse.**

- Replace fuse if necessary and have charging system checked by an authorized Sea-Doo Sport Boats dealer.

## **Nothing is Working in the Electrical System**

### **NO BEEPS ARE HEARD WHEN INSTALLING THE DESS KEY ON DESS POST.**

---

#### **1. Main battery cut-off switch is turned OFF.**

- Verify and turn ON.

#### **2. Battery discharged or missing.**

- Charge or install new battery.

## **WARNING**

See your authorized Sea-Doo Sport Boats dealer to have the battery charged or replaced. Do not charge or boost the battery while installed in the engine compartment. Electrolyte is poisonous and capable of causing severe burns.

## **Engine will not Start**

### **ENGINE DOES NOT TURN OVER AND THE MONITORING BEEPER SOUNDS.**

---

#### **1. Refer to MONITORING SYSTEM CODED SIGNALS above.**

### **ENGINE DOES NOT TURN OVER.**

---

#### **1. Safety lanyard removed.**

- Install cap over DESS post.

#### **2. Burnt fuse.**

- Check wiring then replace fuse.

#### **3. Discharged battery.**

- Refer to an authorized Sea-Doo Sport Boats dealer.

## **ENGINE DOES NOT TURN OVER. (cont'd)**

---

### **4. Battery connections, corroded or loose.**

- Refer to an authorized Sea-Doo Sport Boats dealer.

### **5. Water flooded engine.**

- Refer to an authorized Sea-Doo Sport Boats dealer.

## **ENGINE SLOWLY TURNS.**

---

### **1. Discharged or weak battery.**

- Refer to an authorized Sea-Doo Sport Boats dealer.

## **ENGINE TURNS OVER.**

---

### **1. Fuel tank empty or water contaminated.**

- Refill or siphon and fill with fresh fuel.

### **2. Fuel filter clogged or water contaminated.**

- Clean, check fuel tank for water.

### **3. Fuel flooded engine.**

- Refer to FUEL-FLOODED ENGINE in SPECIAL PROCEDURE.

### **4. Fouled/defective spark plugs.**

- Replace.

## **Engine Misfires, Runs Irregularly**

### **WEAK SPARK.**

---

#### **1. Fouled worn spark plugs.**

- Replace.

#### **2. Faulty ignition component.**

- Refer to an authorized Sea-Doo Sport Boats dealer.

#### **3. Too much oil supplied to engine.**

- Improper oil pump adjustment, refer to an authorized Sea-Doo Sport Boats dealer.

### **LEAN FUEL MIXTURE.**

---

#### **1. Fuel: Level too low, stale or water contaminated.**

- Siphon and/or refill.

#### **2. Fuel filter, clogged or water contaminated.**

- Refer to an authorized Sea-Doo Sport Boats dealer.

### **RICH FUEL MIXTURE (HIGH FUEL CONSUMPTION).**

---

#### **1. Flame arrester dirty/clogged.**

- Clean or replace.

## **Engine Overheats**

**CAUTION:** If the monitoring beeper continuously sounds, **stop engine immediately.**

## **MONITORING BEEPER CONTINUOUSLY SOUNDS.**

---

### **1. Check oil and coolant levels.**

- *Refill if necessary.*

### **2. Clogged jet pump water intake.**

- *Clean, perform the JET PUMP WATER INTAKE AND IMPELLER CLEANING PROCEDURE.*

### **3. Incorrect type of fuel or oil.**

- *Siphon and refill.*

### **4. Clogged exhaust system.**

- *Flush exhaust system with garden hose. Perform the EXHAUST SYSTEM FLUSHING in STORAGE AND PRESEASON PREPARATION section.*

If engine still overheats, refer to an authorized Sea-Doo Sport Boats dealer for servicing.

## **Engine Continually Backfires**

### **1. Faulty ignition component.**

- *Refer to an authorized Sea-Doo Sport Boats dealer.*

### **2. Overheated engine.**

- *See ENGINE OVERHEATS above.*

## **WEAK SPARK.**

---

### **1. Fouled, worn spark plugs.**

- *Replace.*

## **Engine Pinging or Knocking**

### **1. Poor quality gasoline/low octane.**

- *Use well known quality and recommended gasoline.*

### **2. Spark plug heat range too high.**

- *Use recommended spark plugs.*

## **Engine Lacks Acceleration or Power**

### **1. Weak spark/incorrect fuel mixture.**

- *Refer to ENGINE MISFIRES above.*

### **2. Water in fuel.**

- *Siphon and replace.*

### **3. Overheated engine.**

- *See ENGINE OVERHEATS above.*

## **Boat cannot Reach Top Speed**

### **1. Jet pump water intakes clogged.**

- *Clean.*

### **2. Damaged impeller.**

- *Replace. Refer to an authorized Sea-Doo Sport Boats dealer.*

## **Abnormal Noise from Propulsion System**

### **1. Weeds or debris jammed around impeller.**

- *Clean and check for damage.*

### **2. Damaged impeller shaft or drive shaft.**

- *Refer to an authorized Sea-Doo Sport Boats dealer.*

# SPECIFICATIONS

MODEL		150 SPEEDSTER NA	150 SPEEDSTER BVIC
<b>ENGINE</b>			
Engine type		Rotax® 1503 4-TEC, 4-stroke, Single Over Head Camshaft (SOHC)	
Exhaust system		Water cooled/water injected (opened loop). Direct flow from jet pump	
Lubrication	Type	Dry sump (2 oil pumps). Replaceable oil filter. Water-cooled oil cooler	
	Oil type	10W40 4-stroke oil (API service classification SM, SL or SJ)	XP-S 10W40 4-stroke oil or an equivalent approved by BRP
Number of cylinders		3	
Displacement		1493.8 cm <sup>3</sup> (91 cu. in <sup>3</sup> )	
Induction type		Naturally-aspirated	Supercharger intercooled
Maximum HP RPM	± 50 RPM	7300	8000
<b>COOLING</b>			
Type		Liquid cooled. Closed circuit (see also <i>EXHAUST SYSTEM</i> )	
Coolant		Ethylene-glycol and distilled water (50%/50%). Use premix coolant from BRP or a coolant specially formulated for aluminum engines	
<b>ELECTRICAL</b>			
Magneto generator output		380 W @ 6000 RPM	
Ignition system type		Digital Inductive type	
Ignition timing		Not adjustable	
Spark plug	Make and type	NGK DCPR8E	
	Gap	0.7 - 0.8 mm (.028 to .031 in)	
Starting system		Electric starter	
Engine RPM limiter setting		7650 RPM	8200 RPM
Battery		Not supplied (1)	

MODEL		150 SPEEDSTER NA	150 SPEEDSTER BVIC
<b>ELECTRICAL (cont'd)</b>			
Fuses (engine)	F1: Fuel pump	10 A	
	F2: INJ and Ignition cyl. 3	10 A	
	F3: ECM	5 A	
	F4: INJ and Ignition cyl. 1	10 A	
	F5: INJ and Ignition cyl. 2	10 A	
	F6: Gauges	2 A	
Fuse (VCM)	F1: Accessories	10 A	
	F2: Radio	10 A	
	F3: Blower	7.5 A	
	F4: Bilge pump	3 A	
	F5: NAV lights	3 A	
	F6: Courtesy lights (if so equipped)	5 A	
Fuse (vehicle)	VCM	2 x 20 A	
	EFB	15 A	
	Charging system	30 A	
<b>FUEL SYSTEM</b>			
Fuel injection type		Rotax EMS (Engine Management System). Multipoint Fuel Injection. Single throttle body 52 mm	
Fuel	<b>RECOMMENDED FOR OPTIMUM PERFORMANCE</b>		
	Type	<b>Premium</b> unleaded gasoline	
	Minimum octane number	Inside North America: (91 (RON + MON)/2) Outside North America: 95 RON	
	<b>MINIMUM ALLOWED</b>		
	Type	<b>Regular</b> unleaded gasoline	
	Minimum octane number	Inside North America: (87 (RON + MON)/2) Outside North America: 92 RON	

<b>MODEL</b>		<b>150 SPEEDSTER NA</b>	<b>150 SPEEDSTER BVIC</b>
<b>PROPULSION</b>			
Jet pump type		Axial flow, single stage. Greased bearings	
Jet pump grease		Bearing grease (P/N 293 550 032)	
Transmission		Direct drive	
Pivoting angle of direction (nozzle)		20°	
Minimum required water level for jet pump		90 cm (3 ft) underneath the lowest rear portion of hull	
<b>DIMENSIONS</b>			
Overall length		4.67 m (184 in)	
Beam		2.16 m (85 in)	
Weight		658.6 kg (1452 lb) 676 kg (1503 lb) w/tower	
Seating capacity		7	
Load limit (passengers + luggage)		7 passengers OR 324.3 kg (715 lb) (based on calm water operation)	
Dead rise		20°	
<b>DIMENSIONS (ON TRAILER)</b>			
Height	No tower	1.17 m (46 in)	
	Tower down	2.06 m (81 in)	
	Tower up	2.54 m (100 in)	
<b>CAPACITIES</b>			
Engine oil		3 L (3.2 U.S. qt.) oil change w/filter 4.5 L (4.8 U.S. qt) total	
Engine cooling system		5.5 L (5.8 U.S. qt) total	
Fuel tank (including reserve)		79.5 L (21 U.S. gal)	
<b>MATERIALS</b>			
Hull		Composite FRP	
Fuel tank		Polyethylene	
Seat		Base: Polyethylene Foam: Polyurethane	

(1) Recommended: Exide R-24-130, 12 V, 25 A•h (130 minutes reserve) or R-24-160 (160 minutes) or equivalent.

BRP reserves the right to make changes in design and specifications and/or to make additions to, or improvements in its products without imposing any obligation upon itself to install them on its products previously manufactured.



MODEL		180 CHALLENGER BVIC
<b>ENGINE</b>		
Number of cylinders		3
Engine type		Rotax 1503 4-TEC, 4-stroke, Single Over Head Camshaft (SOHC)
Exhaust system		Water cooled/water injected (opened loop). Direct flow from jet pump
Lubrication	Type	Dry sump (2 oil pumps). Replaceable oil filter. Water-cooled oil cooler
	Oil type	XP-S 10W40 4-stroke oil or an equivalent approved by BRP
Number of cylinders		6
Displacement		1494 cm <sup>3</sup> (91.2 in <sup>3</sup> )
Induction type		Supercharger intercooled
Maximum HP RPM		± 50 RPM 8000 RPM
<b>COOLING</b>		
Type		Liquid cooled. Closed circuit (see also <i>EXHAUST SYSTEM</i> )
Coolant		Ethylene-glycol and distilled water (50%/50%). Use premix coolant from BRP or a coolant specially formulated for aluminum engines
<b>ELECTRICAL</b>		
Magneto generator output		380 W @ 6000 RPM
Ignition system type		Digital Inductive type
Ignition timing		Not adjustable
Spark plug	Make and type	NGK DCPR8E
	Gap	0.7 - 0.8 mm (.028 to .031 in)
Starting system		Electric starter
Engine RPM limiter setting		8200 RPM
Battery		Not supplied (1)

MODEL		180 CHALLENGER BVIC
<b>ELECTRICAL (cont'd)</b>		
Fuses (engine)	F1: Fuel pump	10 A
	F2: INJ and Ignition cyl 3	10 A
	F3: ECM	5 A
	F4: INJ and Ignition cyl 1	10 A
	F5: INJ and Ignition cyl 2	10 A
	F6: Gauges	2 A
Fuses (VCM)	F1: Accessories	10 A
	F2: Radio	10 A
	F3: Blower	7.5 A
	F4: Bilge pump	3 A
	F5: NAV lights	3 A
	F6: Courtesy lights (if so equipped)	5 A
Fuses (boat)	VCM	2 x 20 A
	EFB	15 A
	Charging system	30 A
<b>FUEL SYSTEM</b>		
Fuel injection type	Rotax EMS (engine management system). Multipoint Fuel Injection. Single throttle body 52 mm	
Fuel	<b>RECOMMENDED FOR OPTIMUM PERFORMANCE</b>	
	Type	Premium unleaded gasoline
	Minimum octane number	Inside North America: (91 (RON + MON)/2) Outside North America: 95 RON
	<b>MINIMUM ALLOWED</b>	
	Type	Regular unleaded gasoline
	Minimum octane number	Inside North America: (87 (RON + MON)/2) Outside North America: 92 RON

<b>MODEL</b>		<b>180 CHALLENGER BVIC</b>
<b>PROPULSION</b>		
Jet pump type	Axial flow, single stage. Greased bearings	
Jet pump grease	Bearing grease (P/N 293 550 032)	
Transmission	Direct drive	
Pivoting angle of direction (nozzle)	20°	
Minimum required water level for jet pump	90 cm (3 ft) underneath the lowest rear portion of hull	
<b>Additional information:</b> Do not mix different brands or oil types.		
<b>DIMENSIONS</b>		
Overall length	5.36 m (17 ft 7 in)	
Beam	2.49 m (8 ft 2 in)	
Weight	941.2 kg (2075 lb)	
Seating capacity	8	
Load limit (passengers + luggage)	8 passengers OR 653 kg (1440 lb) (based on calm water operation)	
Dead rise	20°	
<b>DIMENSIONS (ON TRAILER)</b>		
Length	6.2 m (20 ft 4 in)	
Height	No tower	1.96 m (6 ft 5 in)
	Tower down	2.01 m (6 ft 7 in)
	Tower up	2.56 m (8 ft 5 in)
Gross weight	1156.6 kg (2550 lb)	
<b>CAPACITIES</b>		
Engine oil	3 L (3.2 U.S. qt.)/oil change w/filter 4.5 L (4.8 U.S. qt) total	
Cooling system (coolant)	5.5 L (5.8 U.S. qt) total	
Fuel tank (including reserve)	79.5 L (21 U.S. gal)	

MODEL	180 CHALLENGER BVIC
<b>MATERIALS</b>	
Hull	Composite FRP
Fuel tank	Polyethylene
Seat	Base: Polyethylene Foam: Polyurethane

(1) Recommended: Exide R-24-130, 12 V, 25 A•h (130 minutes reserve) or R-24-160 (160 minutes) or equivalent.

BRP reserves the right to make changes in design and specifications and/or to make additions to, or improvements in its products without imposing any obligation upon itself to install them on its products previously manufactured.

# ***MAINTENANCE INFORMATION***

---

# 10-HOUR INSPECTION

**NOTE:** The 10-hour inspection is at the expense of the boat owner.

It is highly recommended that after the first 10 hours of operation, the boat be checked by an authorized Sea-Doo Sport Boats dealer. This inspection will also provide the opportunity to discuss the unanswered questions you may have encountered during the first hours of operation.

We recommend that this inspection be signed by an authorized Sea-Doo Sport Boats dealer.

---

Date of 10-hour inspection

---

Authorized dealer signature

---

Dealer code

# PERIODIC MAINTENANCE CHART

The schedule should be adjusted according to operating conditions and use. Intensive use of boat will require greater frequency of inspection and maintenance.

A: ADJUST C: CLEAN I: INSPECT L: LUBRICATE R: REPLACE  O: OPERATOR D: DEALER	FIRST 10 HOURS										<b>TO BE PERFORMED BY</b>  <b>LEGEND</b>
	EVERY 25 HOURS										
	EVERY 50 HOURS										
	EVERY 100 HOURS OR PRESEASON										
	EVERY 200 HOURS OR 2 YEAR										
	PART/TASK										
<b>GENERAL</b>											
Corrosion protection	L (1)			L	L					O	(1) Every 10 hours in salt water use.
Fire extinguisher	Daily inspection								O		
<b>ENGINE</b>											
Engine oil and filter (including cover's O-rings)	R					R (2)				D	(2) Replace for storage period or after 100 hours of use whichever comes first.
Engine oil level (refill as needed)	Daily inspection								O		
Rubber mounts	I			I						D	
Inspect supercharger drive gear, shaft and lock washer (if so equipped)									I	D	
Supercharger slipping moment (if so equipped)									I	D	
<b>EXHAUST SYSTEM</b>											
Exhaust system fasteners, hoses and components condition (3)	I	I				I				D	(3) Emission-related component. (5) Daily flushing in salt water or foul water use. (6) Perform at storage period of after 100 hours of use whichever comes first (more often in salt water use).
Exhaust system flushing	(5) (6)								O		
Leak from exhaust system components (such as rust and/or black streaking, water leaks or corroded/cracked fittings)			I							O	
<b>COOLING SYSTEM</b>											
Hose and fasteners	I			I	I					D	—
Coolant	I							R		D	
Coolant level	Daily inspection								O		

A: ADJUST C: CLEAN I: INSPECT L: LUBRICATE R: REPLACE  O: OPERATOR D: DEALER	FIRST 10 HOURS						TO BE PERFORMED BY
	EVERY 25 HOURS						
	EVERY 50 HOURS						
	EVERY 100 HOURS OR PRESEASON						
	EVERY 200 HOURS OR 2 YEAR						
	LEGEND						
PART/TASK							
<b>FUEL SYSTEM</b>							
Throttle cable	I			I <sup>(6)</sup>		D	(3) Emission-related component. (6) Perform at storage period of after 100 hours of use whichever comes first (more often in salt water use). (7) <b>IMPORTANT:</b> When use in salt water, the throttle body lubrication is highly recommended after every 10 hours of use. Failure to perform lubrication will result in damage to the throttle body.
Fuel injection system sensors	I			I		D	
Inspect fastener tightening (throttle body, fuel lines)	I		I	I		D	
Throttle position sensor (TPS) <sup>(3)</sup>	I			I		D	
Throttle body ( <b>IMPORTANT:</b> see <sup>(7)</sup> )	I			L		O/D	
Fuel lines, connections, pressure relief valve and fuel system leak test <sup>(3)</sup>	I			I		D	
Fuel tank straps	I			I		O	
<b>AIR INTAKE SYSTEM</b>							
Air intake silencer fit/tightness	I			I		O	—
<b>ELECTRICAL SYSTEM</b>							
Spark plug <sup>(3)</sup>	I			I	R	O	(1) Every 10 hours in salt water use. (3) Emission-related component. (8) Daily checked.
Electrical connections and fastening (ignition system, starting system, fuel injectors etc.)	I			I		D	
MPEM and ECM connectors (visual inspection without disconnecting)				I <sup>(1)</sup>		O	
EMS fault code reading <sup>(3)</sup>	I			I		D	
Digitally Encoded Security System (DESS)	I			I		D	
Monitoring beeper	Daily inspection					O	
Battery and fasteners <sup>(8)</sup>	I			I		O/D	
Main battery cut-off switch	I	I		I		D	
Operation and condition of lights	Daily inspection					O	
Bilge blower and bilge pump operation	Daily inspection					O	
Charge battery				I		D	



A: ADJUST C: CLEAN I: INSPECT L: LUBRICATE R: REPLACE  O: OPERATOR D: DEALER	FIRST 10 HOURS						LEGEND
	EVERY 25 HOURS						
	EVERY 50 HOURS						
	EVERY 100 HOURS OR PRESEASON						
	EVERY 200 HOURS OR 2 YEAR						
	TO BE PERFORMED BY						
PART/TASK							LEGEND
<b>STEERING SYSTEM</b>							
Steering cable and connections	I			I		D	—
Steering nozzle bushings	I			I		D	
<b>PROPULSION SYSTEM</b>							
Drive shaft corrosion protection				L (6)		D	(4) Inspect each month (more often in salt water) and change when necessary. (6) Perform at storage period of after 100 hours of use whichever comes first (more often in salt water use).
Carbon ring and rubber boot (drive shaft)	I		I			D	
Shifter system, cable and connections	I			I		D	
Drive shaft/impeller splines				I, L		D	
Impeller boot	I			I		D	
Impeller shaft seal, sleeve and O-ring				I (6)		D	
Impeller and wear ring clearance	I		I			D	
Sacrificial anode	(4)					O	
<b>HULL/BODY</b>							
Ride plate and water intake grate	Daily inspection						O
Windscreen and fasteners	I	I		I			O
Ride shoes condition	I			I			O
Storage compartment cover locks	(1)			I, L			O
Deck drains/scupper valve	Daily inspection						O
Drain plug (inside bilge), check for obstructions	I			I			O
Hull	Daily inspection						O/D
Ski/wakeboard post and fasteners	I		I				O
Towing tower, ensure all mounting points and connections are fastened and tight.	Before each use						O

**NOTE:** Some items are included in the *PRE-OPERATION CHECKS* and not necessarily repeated in this chart.

---

# MAINTENANCE PROCEDURES

## General

- ⚠ Only perform servicing procedures which are detailed in this guide. Further assistance or information can be obtained from your authorized Sea-Doo Sport Boats dealer. In many instances proper tools and training are required for certain servicing or repair procedures.
- ⚠ Maintain the boat and equipment in top condition at all times. Adhere to the prescribed maintenance schedules. An annual inspection of the boat is always a good recommendation to follow.
- ⚠ The bilge must be kept clean of oil, water or other foreign materials.
- ⚠ Do not attempt to lift the boat without special equipment and training.
- ⚠ The engine and the corresponding components identified in this guide should not be utilized on product(s) other than for those they were designed. Maintenance procedures and specified tightening torque must be strictly adhered to. Never attempt repairs unless the appropriate tools are available. Each boat is designed with parts dimensioned in both the metric and the imperial systems. When replacing fasteners, make sure to use only those recommended by BRP. If required, contact your authorized Sea-Doo Sport Boats dealer for further servicing information.
- ⚠ Operate your boat prudently and have fun. Don't forget that all persons must assist other boaters in an emergency.

## Engine Emissions Information

Maintenance, replacement, or repair of the emission control devices and systems may be performed by any marine SI (spark ignition) engine repair establishment or individual.

## Manufacturer's Responsibility

Beginning with 1999 model year engines, manufacturers of marine engines must determine the exhaust emission levels for each engine horsepower family and certify these engines with the United States of America Environmental Protection Agency (EPA). An emissions control information label, showing emission levels and engine specifications, must be placed on each boat at the time of manufacture.

## Dealer's Responsibility

When performing service on all 1999 and more recent Sea-Doo Sport Boats carrying an emissions control information label, adjustments must be kept within published factory specifications.

Replacement or repair of any emission related component must be executed in a manner that maintains emission levels within the prescribed certification standards.

Dealers are not to modify the engine in any manner that would alter the horsepower or allow emission levels to exceed their predetermined factory specifications.

Exceptions include manufacturer's prescribed changes, such as altitude adjustments for example.

## Owner Responsibility

The owner/operator is required to have engine maintenance performed to maintain emission levels within prescribed certification standards.

The owner/operator is not to, and should not allow anyone to modify any engine in a manner that would alter the horsepower or allow emission levels to exceed predetermined factory specifications.

## EPA Emission Regulations

All new 1999 and more recent Sea-Doo Sport Boats manufactured by BRP are certified to the EPA as conforming to the requirements of the regulations for the control of air pollution from new boat engines. This certification is contingent on certain adjustments being set to factory standards. For this reason, the factory procedure for servicing the product must be strictly followed and, whenever practicable, returned to the original intent of the design.

The responsibilities listed above are general and in no way a complete listing of the rules and regulations pertaining to the EPA requirements on exhaust emissions for marine products. For more detailed information on this subject, you may contact the following locations:

### REGULAR US POSTAL MAIL:

1200 Pennsylvania Ave. NW  
Mail Code 6403J  
Washington D.C. 20460

### FOR ALL COURIER SERVICES:

U.S. Environmental Protection Agency  
Office of Transportation and Air Quality  
1310 L Street NW  
Washington D.C. 20005

### INTERNET WEB SITE:

<http://www.epa.gov/otaq/>

E-Mail: [otaqpublicweb@epa.gov](mailto:otaqpublicweb@epa.gov)

## WARNING

Only perform procedures as detailed in this guide. It is recommended that the assistance of an authorized Sea-Doo Sport Boats dealer be periodically obtained on other components/systems not covered in this guide. Unless otherwise specified, engine must not be running, the DESS key must be removed from the DESS post and the main battery cut-off switch must be turned OFF for all maintenance procedures. Never use jet pump components to lift the boat. Certain components in the engine compartment may be very hot. Direct contact may result in skin burn. When operating the engine while the boat is out of the water, the heat exchangers may become very hot. Avoid any contact with heat exchangers as burns may occur.

## Lubrication

### Throttle Body

Lubricate throttle body with XP-S Lube or an equivalent.

Use fitting for that purpose provided on the throttle body.

Make sure to spray lubricant at least 3 to 5 seconds for proper lubrication.

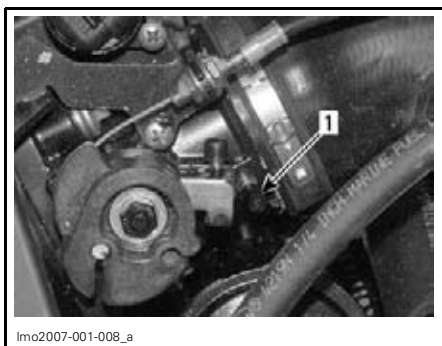

lmo2007-001-008\_a

**REMOVE CAP**  
1. Plastic cap

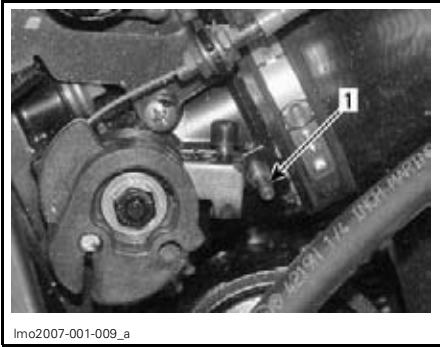

lmo2007-001-009\_a

1. Lubrication fitting

### Electrical Connections

As necessary, apply dielectric grease on battery posts and all exposed cable connectors including stern light connectors on mast and boat as needed.

**CAUTION:** Do not lubricate connectors of the VCM (Vehicle Control Module), the EFB (Engine Fuse Block) and the ECM (Engine Control Module).

### Additional Moving Mechanism

XP-S Lube lubricant will help to prevent corrosion and keep proper operation of moving mechanisms.

Lubrication of the following items should be performed every 50 hours in fresh water use but every 10 hours in salt water use.

### Rear Storage Compartment Cover Mechanism and Hinges

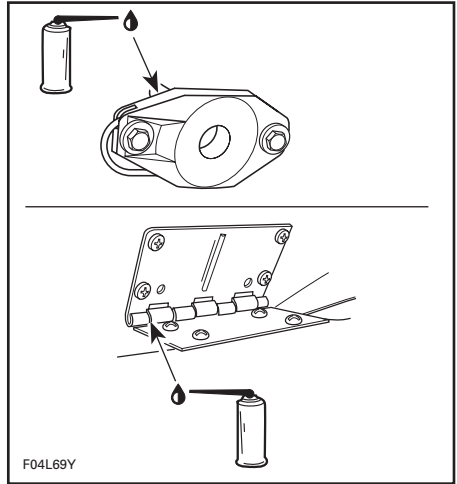

F04L69Y

TYPICAL

### Ski Post

#### If So Equipped

Lubricate ski post through all its length. Pull out then push in several times to distribute the lubricant.

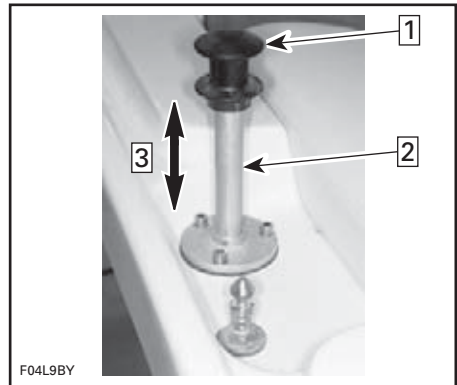

F04L9BY

TYPICAL

Step 1: Lift ski post to lubricate

Step 2: Lubricate here

Step 3: Move post up and down several times to distribute lubricant

### Reverse Gate

Lubricate pivot points and mechanism on both sides of each gate.

## Rear Storage Compartment Cover Cylinders

Lubricate rod of cylinders.

## Throttle Cable

Move the throttle lever forward and rearward once. It must operate smoothly. Refer to an authorized Sea-Doo Sport Boats dealer if adjustment is necessary.

### **WARNING**

Do not alter or tamper with throttle cable adjustment or routing.

## Engine Oil Change and Oil Filter Replacement

The oil change and filter replacement should be performed by an authorized Sea-Doo Sport Boats dealer.

## Coolant Replacement

The coolant replacement should be performed by an authorized Sea-Doo Sport Boats dealer.

## Fuel Injection System

The fuel injection system inspection should be performed by an authorized Sea-Doo Sport Boats dealer. Fuel system pressurization should be conducted at the same time.

## Steering Alignment

When the steering is aimed in straight ahead position, the jet pump nozzle should be in the same direction to allow the Sport Boats to run in a straight line.

Refer to an authorized Sea-Doo Sport Boats dealer if an adjustment is necessary.

### **WARNING**

Ensure the steering operates freely from side to side.

## Shift Lever

When shift lever is in forward position, reverse gate should be in an upward position and locked. With the shift lever in neutral position, reverse gate should be in intermediate position. When shift lever is in reverse position, reverse gate should be in downward position. Refer to an authorized Sea-Doo Sport Boats dealer if an adjustment is necessary.

### **WARNING**

Ensure the shift lever operates freely.

## Deck Drain

Remove any obstruction(s) from deck drain outlet.

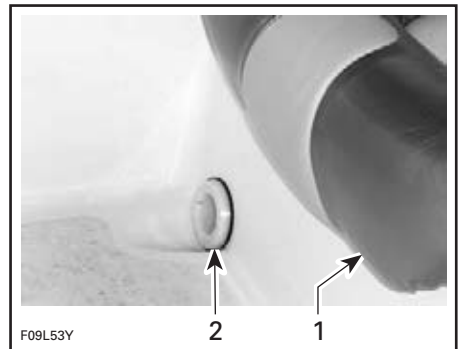

### **180 CHALLENGER**

1. Driver's seat
2. Deck drain hole

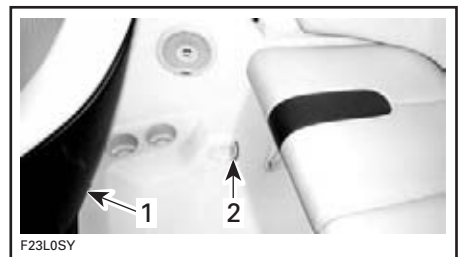

### **TYPICAL — 150 SPEEDSTER**

1. Driver's seat
2. Deck drain hole

## Fuses

### Accessories, Engine Electrical System and Gauges

If a fuse is defective, replace by one of the same rating.

#### **WARNING**

Do not use a higher rated fuse as this can cause severe damage. If a fuse has blown, the source of malfunction should be determined and corrected before restarting. See an authorized Sea-Doo Sport Boats dealer for servicing.

### 150 Speedster Models

If nothing at all is working, check that the battery cut-off switch in the engine compartment is in the ON position. Also, check main fuses, connected to battery cut-off switch inside gunwale.

**NOTE:** There are spare fuses in rubber holders attached to the top of the fuse block and the gauge interface.

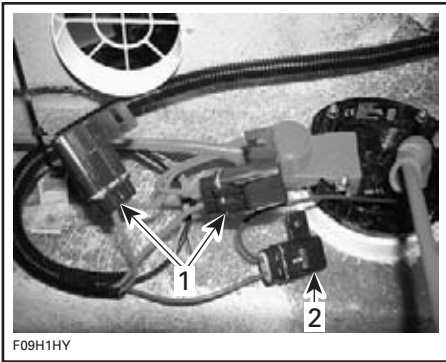

#### **TYPICAL**

1. Gauge interface fuses
2. Automatic bilge pump fuse

If an accessory, engine or gauge is not working, check its fuse condition.

Fuses for the electrical system of the engine are mounted in the fuse block, which is located in the engine compartment.

The main fuses for the engine electrical system are located near the solenoid, as shown below.

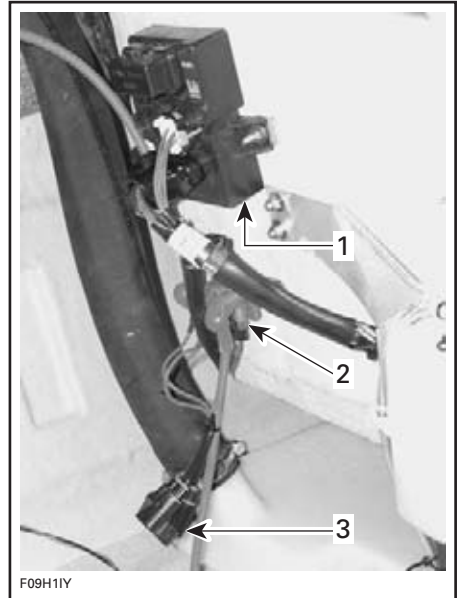

1. Engine fuse block
2. Solenoid
3. Engine electrical system main fuses

Fuses for the accessories and the gauges are mounted in the gauge interface, which is located ahead of the dash.

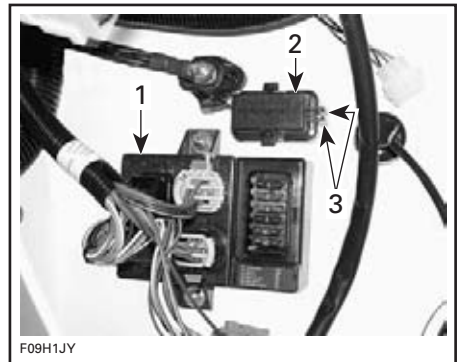

#### **TYPICAL**

1. Interface
2. Fuse cover
3. Use these tabs as a fuse puller

Squeeze cover locking tabs and pull cover out to access fuses.

Use the cover tabs to remove the fuse.

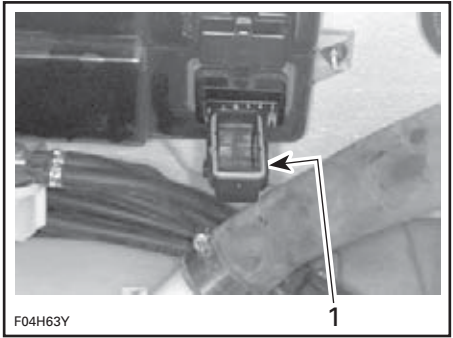

**TYPICAL**  
 1. Slide cover tabs each side of fuse then pull fuse out

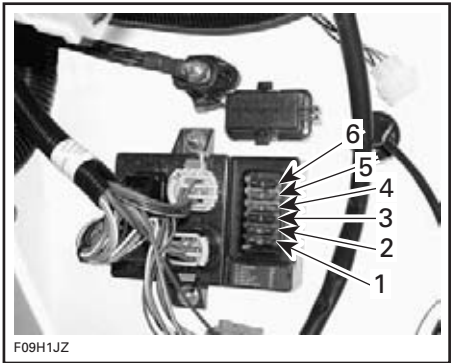

**TYPICAL — GAUGE INTERFACE**  
 1. Accessory  
 2. Radio  
 3. Blower  
 4. Bilge pump  
 5. Navigation lights  
 6. Courtesy lights

When finished, ensure seal is properly placed in cover.

Carefully position cover on fuse block then firmly push until you hear a snapping sound for each locking tab.

**180 Challenger Models**

If nothing at all is working, check that the battery cut-off switch in the engine compartment is in the ON position. Also, check main fuses, connected to battery cut-off switch inside port rear storage compartment.

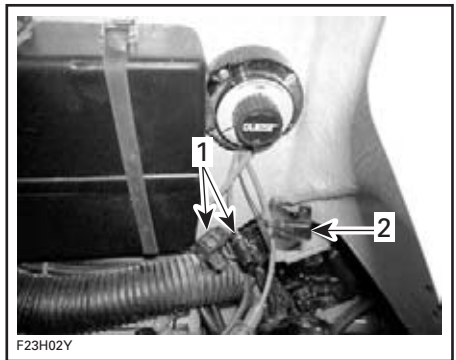

1. Main fuses  
 2. Automatic bilge pump fuse

Fuses for the electrical system of the engine are mounted in the fuse block, which is located in the engine compartment.

Fuses for the engine electrical system are located below the solenoid, as shown below.

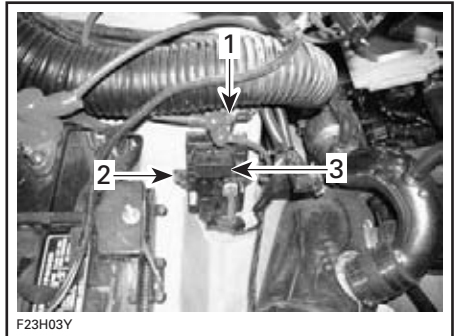

1. Solenoid  
 2. Engine fuse block  
 3. Engine electrical system fuses

**NOTE:** There are spare fuses inside the covers of the engine fuse block and the gauge interface.

The gauge interface is located in the starboard gunwale near the driver's seat as shown below.

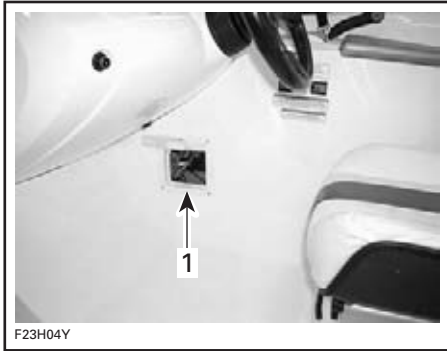

1. Gauge interface fuse access



**TYPICAL**  
1. Fuse cover

Squeeze cover locking tabs and pull cover out to access fuses.

Use the cover tabs to remove the fuse.

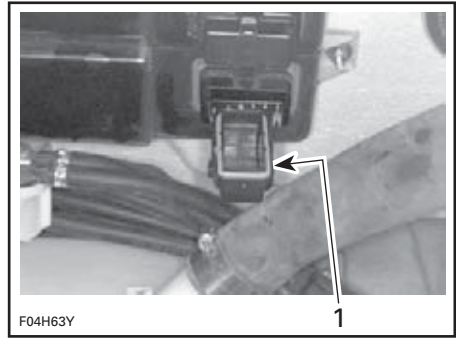

**TYPICAL**  
1. Slide cover tabs each side of fuse then pull fuse out

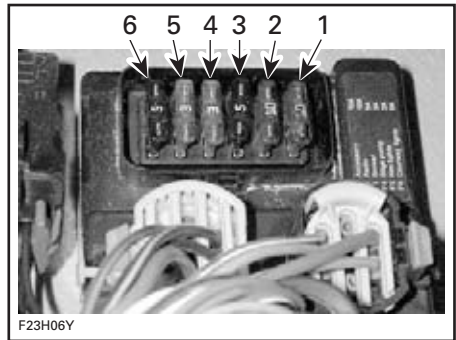

**TYPICAL — GAUGE INTERFACE**  
1. Accessory  
2. Radio  
3. Blower  
4. Bilge pump  
5. Navigation lights  
6. Courtesy lights

If an accessory, engine or gauge is not working, check its fuse condition.

When finished, ensure seal is properly placed in cover.

Carefully position cover on fuse block then firmly push until you hear a snapping sound for each locking tab.

## Bilge Air Blower

Verify bilge air blower for proper operation. It is located beneath starboard ventilation duct in engine compartment.



# Navigation Light Bulb Replacement

## Bow Light

### 150 Speedster Models

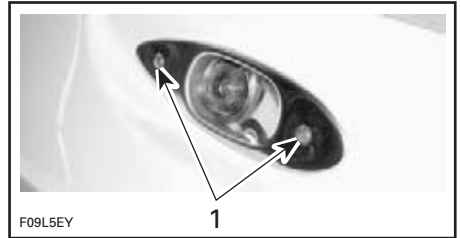

TYPICAL  
1. Remove these screws

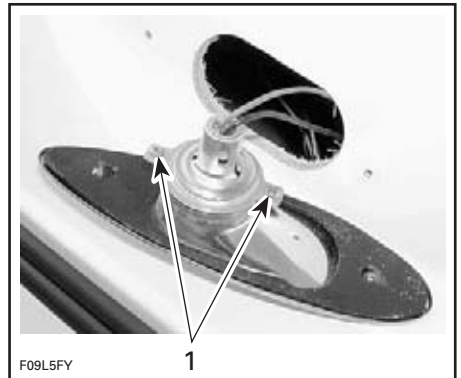

TYPICAL  
1. Remove these screws



TYPICAL — PUSH IN, TWIST AND REMOVE BULB

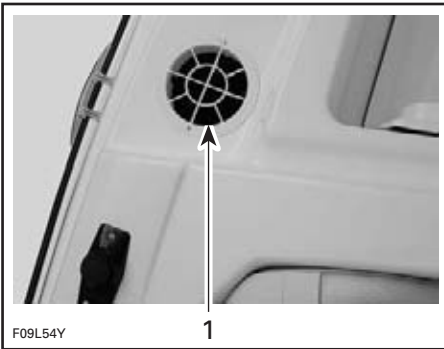

TYPICAL — 150 SPEEDSTER  
1. Blower duct

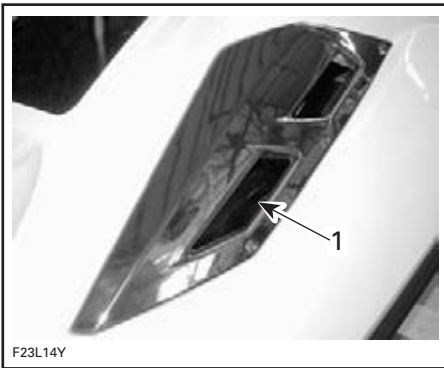

TYPICAL — 180 CHALLENGER  
1. Blower duct

## **WARNING**

If bilge blower does not operate properly, refer to an authorized Sea-Doo Sport Boats dealer before starting the boat.

Assembly is essentially the reverse of removal procedures. However, pay particular attention to the following:

Apply dielectric grease on bulb contact surface.

### **180 Challenger Models**

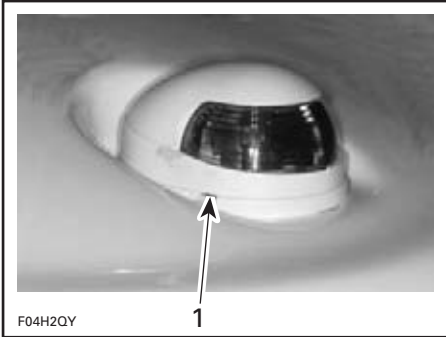

**TYPICAL**

1. Gently pry here with a screwdriver

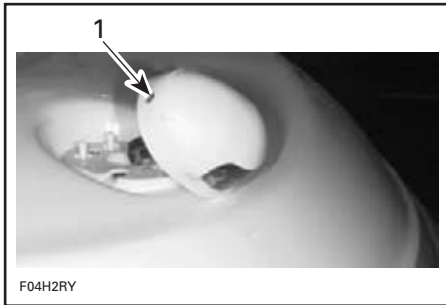

**TYPICAL**

1. Remove this screw

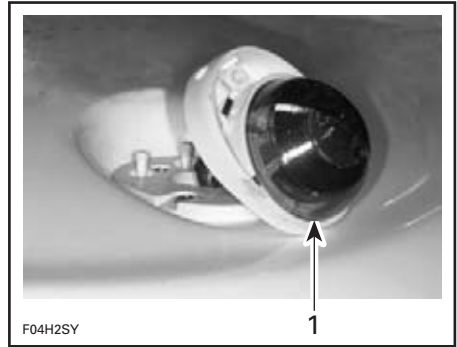

**TYPICAL**

1. Pull lens out

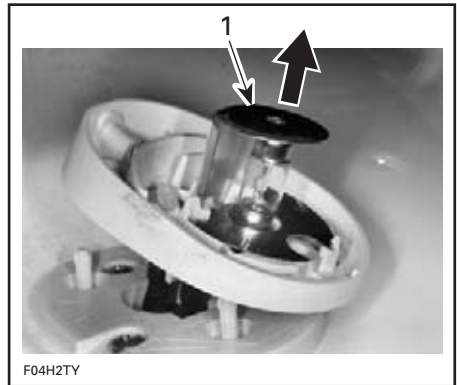

**TYPICAL**

1. Lift and remove bulb

The assembly is essentially the reverse of removal procedures. However, pay particular attention to the following:

Apply dielectric grease on bulb contact surface.

When installing the bulb under the upper terminal plate, it is possible that the bulb remains loose. The cover will compress the terminal plate against the bulb at reinstallation.

### **Stern Light**

Unscrew lens counterclockwise and pull it out.

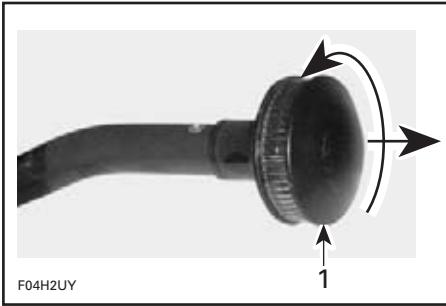

**TYPICAL — 150 SPEEDSTER**  
1. Unscrew then pull

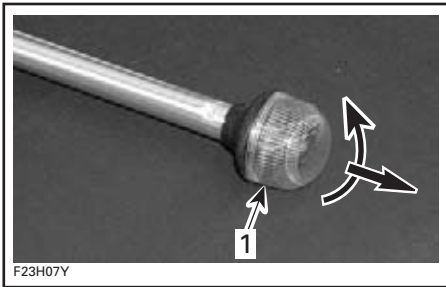

**TYPICAL — 180 CHALLENGER**  
1. Unscrew then pull

Pull bulb to remove it.

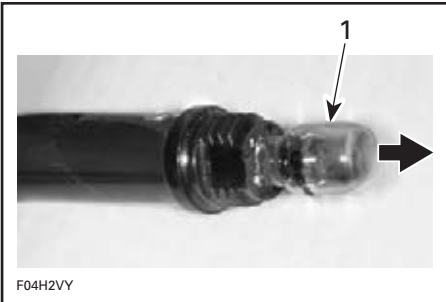

**TYPICAL — 150 SPEEDSTER**  
1. Pull bulb out

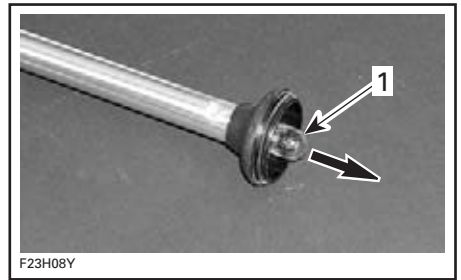

**TYPICAL — 180 CHALLENGER**  
1. Pull bulb out

Apply dielectric grease on new bulb contact surface.

Assembly is the reverse of removal procedure.

## Sacrificial Anodes

Corrosion of metal parts, especially those exposed to saltwater, is common for boats. Corrosion can be caused by stray electric currents from shore power installations, improperly grounded A.C. lines and circuits, and poorly insulated D.C. powered equipment from boats moored nearby. Corrosion is accelerated when electric current is present.

Sacrificial anodes are attached to certain parts of this boat to reduce corrosion. The anode corrodes, rather than the part to which the anode is attached.

Change each anode when 50% by weight has corroded away.

Anodes are attached at the following locations:

- ride shoe/cooling plate
- pump housing
- reverse gate support
- steering nozzle
- reverse gate.

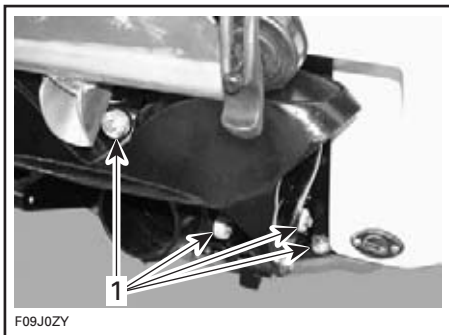

**TYPICAL**

1. Anode installation shown

**NOTE:** Inspect anodes each time boat is to be launched. Do **NOT** paint anodes or apply protective coatings.

## General Inspection and Cleaning

### Inspection

Check engine compartment for any damage and the fuel system for leaks. Also check battery for electrolyte leaks. Ensure all hose clamps are properly secured and no hose is cracked, kinked or presenting any other damage.

## ⚠ WARNING

If at any time, gasoline leaks/odors are found, do not start the engine. Have the boat serviced by an authorized Sea-Doo Sport Boats dealer.

Inspect mufflers, battery and fuel tank fastening devices. Check electrical connections for corrosion and tightness.

Inspect hull and jet pump water intake grate for damage. Replace or repair damaged parts.

## Cleaning

Twice a year, the bilge should be cleaned with hot water and detergent or bilge cleaner to remove any possible fuel/oil/electrolyte deposits and mildew.

Occasionally, wash the body with hot water and soap (only use mild detergent). Remove any marine organisms from engine and/or hull. Apply non-abrasive wax.

**CAUTION:** Never clean fiberglass and plastic parts with strong detergent, degreasing agent, paint thinner, acetone, etc.

Wash windscreen with Heavy Duty Cleaner (P/N 293 110 001) and water. For fine scratches and scuff marks removal, use a windshield polisher for acrylic, lucite, polycarbonate and similar materials.

Stains may be removed from seats and fiberglass with Knight's Spray-Nine<sup>†</sup> or the equivalent.

Respect the environment by ensuring fuel, oil or cleaning solutions do not drain into the waterways.

<sup>†</sup>Knight's Spray Nine is a registered trademark of Knight Oil Corporation.

---

## STORAGE AND PRESEASON PREPARATION

### WARNING

Because fuel and oil are flammable, have an authorized Sea-Doo Sport Boats dealer inspect the fuel and oil systems integrity as specified in the *PERIODIC MAINTENANCE CHART*.

### Storage

**NOTE:** Leave drain plug(s) out during storage period.

It is recommended that the boat be taken to an authorized Sea-Doo Sport Boats dealer for proper storage, however you can perform the following operations with a minimum of tools.

**CAUTION:** Do not run the engine during the storage period.

### Fuel System

Sea-Doo fuel stabilizer (or equivalent), can be added in fuel tank to prevent fuel deterioration and fuel system gumming. Follow stabilizer manufacturer's instructions for proper use.

**CAUTION:** Fuel stabilizer should be added before engine lubrication to ensure fuel system components are protected against varnish deposits.

### WARNING

Always stop the engine before refueling. Fuel is flammable and explosive under certain conditions. Always work in a well ventilated area. Do not smoke or allow open flames or sparks in the vicinity. Fuel tank may be pressurized. Slowly turn cap when opening. Never use an open flame to check fuel level. When fueling, keep boat level. Do not overfill or top off the fuel tank and leave boat in the sun. As temperature increases, fuel expands and might overflow. Always wipe off any fuel spillage from the boat. Periodically verify fuel system.

### Engine Oil and Filter Replacement

The oil and oil filter change should be performed by an authorized Sea-Doo Sport Boats dealer.

### Exhaust System Flushing

Clean jet pump by spraying water in its inlet and outlet and then apply a coating of XP-S Lube lubricant or equivalent.

### WARNING

When operating the engine while the boat is out of the water, the heat exchanger in the ride plate may become very hot. Avoid any contact with ride plate as burns may occur.

Connect a garden hose to connector located at the rear of boat on jet pump support. **Do not open water tap yet.**

**NOTE:** An optional quick connect adapter can be used (P/N 295 500 473). No hose pincher is required to flush engine.

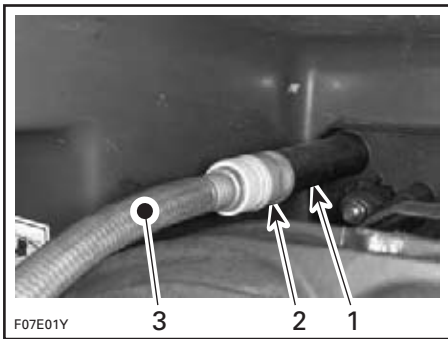

**TYPICAL**

1. Hose adapter
2. Quick connect adapter (optional, not mandatory)
3. Garden hose

To flush the exhaust system, start the engine then immediately open the water tap.

**⚠ WARNING**

Certain components in the engine compartment may be very hot. Direct contact may result in skin burn. Do not touch any electrical parts or jet pump area when engine is running.

**CAUTION:** Never flush a hot engine. Always start the engine before opening the water tap. Open water tap immediately after engine is started to prevent overheating.

Run the engine about 20 seconds at a fast idle between 4000 - 5000 RPM.

**CAUTION:** Never run engine without supplying water to the exhaust system when boat is out of water.

Ensure water flows out of jet pump while flushing. Otherwise, refer to an authorized Sea-Doo Sport Boats dealer for servicing.

**CAUTION:** Never run engine longer than 5 minutes. Drive line seal has no cooling when boat is out of water.

Close the water tap, then stop the engine.

**CAUTION:** Always close the water tap before stopping the engine.

Leave all compartments open to air dry.

**Engine Internal Lubrication**

Connect a garden hose to cool the exhaust system as explained in *EXHAUST SYSTEM FLUSHING* above.

Bring engine to normal operating temperature.

**CAUTION:** Properly follow the instructions given in the *EXHAUST SYSTEM FLUSHING* procedure.

Close the water tap, then stop the engine.

Pull engine access panel upward to remove it.

Remove dipstick.

Remove engine cover.

Reinstall dipstick.

Disconnect ignition coil connectors.

**⚠ WARNING**

When disconnecting coil from spark plug, always disconnect coil from main harness first. Never check for engine ignition spark from an open coil and/or spark plug in the engine compartment as spark may cause fuel vapor to ignite.

**IMPORTANT:** Never cut the locking ties of ignition coil connectors. This would allow mixing the wires between cylinders.

Remove ignition coils.

**CAUTION:** Ensure there is no dirt in coil holes before removing the spark plugs. Otherwise, dirt would fall into cylinder and will damage the internal components.

Remove spark plugs.

**NOTE:** After loosening the spark plugs, a coil may be used to pull the spark plugs out. Simply bring the coil down to spark plug and “hook” it to then extract spark plug.



1. Ignition coil
2. Spark plug

Spray XP-S Lube lubricant or equivalent, in spark plug holes.

To prevent fuel to be injected and also to cut the ignition at the engine cranking, proceed as follows.

From the engine compartment, have a second person hold throttle bell crank in fully opened position.

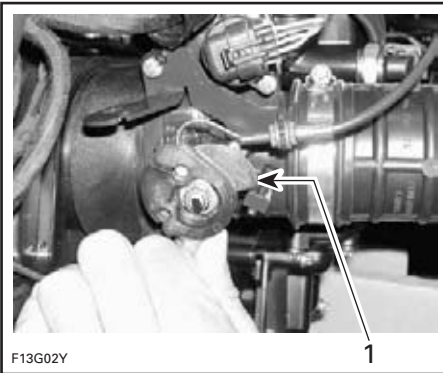

**TYPICAL**

1. Fully-opened position

Crank the engine a few turns to distribute the oil on cylinder wall.

Apply anti-seize lubricant on spark plug threads then reinstall them.

**NOTE:** After installation, ensure the seal seats properly with the engine top surface.

Reinstall ignition coils. Reconnect ignition coil connectors.

To reinstall engine cover, remove dipstick, push engine cover downward until it snaps.

Reinstall dipstick.

**NOTE:** It is recommended to fog the engine valves with XP-S Lube lubricant. Contact your authorized Sea-Doo Sport Boats dealer.

## Intercooler and Exhaust Manifold

### Models Equipped with Supercharger

The exhaust system is self draining, but the intercooler and exhaust manifold need the following protection.

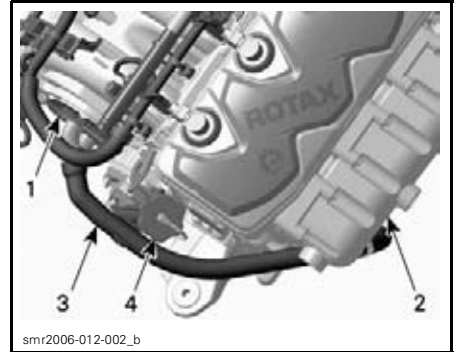

1. Intercooler
2. Exhaust manifold
3. Intercooler outlet hose
4. Engine oil filling cap

– Remove both intercooler hoses.

**NOTE:** Some clamps are removable and reusable; others must be cut and replaced.

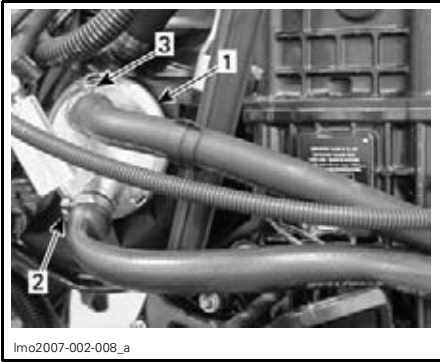

1. Intercooler
2. Inlet hose clamp (reusable)
3. Outlet hose clamp (replace)

- Let the intercooler drain, then reconnect the bottom hose.
- By using a funnel and a small hose, pour approximately 200 mL (6.76 oz U.S.) of antifreeze into the intercooler through the outlet nipple.

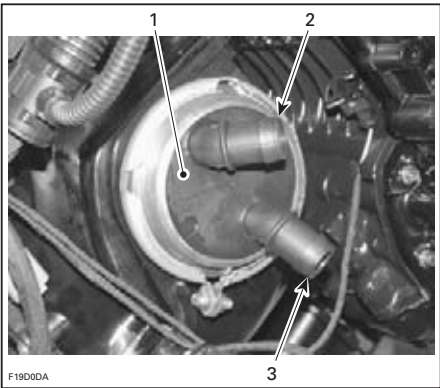

- TYPICAL**
1. Intercooler
  2. Outlet nipple
  3. Inlet nipple

- Reconnect the intercooler top hose and secure with a new clamp.
- Disconnect the manifold top water outlet hose from the exhaust pipe.

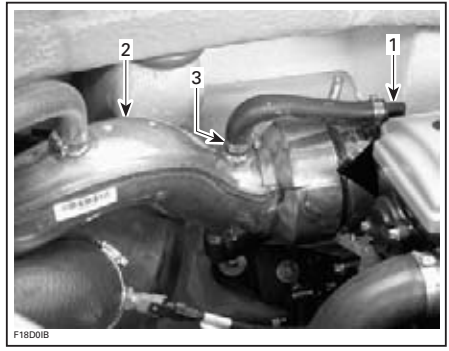

1. Exhaust manifold
2. Exhaust pipe
3. Water outlet hose clamp (reusable)

- Install a funnel at the end of water outlet hose, then pour approximately 300 mL (10.14 oz U.S.) of antifreeze into the exhaust manifold.
- Reconnect the upper water outlet hose and secure with existing clamp.

**CAUTION:** It is highly recommended to pour antifreeze into the intercooler and exhaust manifold. Failure to do so, may cause severe damage to these components.

**CAUTION:** Use only **undiluted antifreeze (100% concentration)**. The premixed antifreeze available from BRP is **NOT** suitable for this particular application. Its concentration will be reduced when mixed with remaining water trapped in water jackets.

**NOTE:** When available, it is recommended to use biodegradable antifreeze compatible with internal combustion aluminum engines. This will contribute to protect the environment.

**NOTE:** The engine will not have to run during this operation but should have been ran before, to exhaust as much water as possible, from cooling system components.

### Battery

Contact your authorized Sea-Doo Sport Boats dealer.



## Engine Cooling System

Antifreeze is to be replaced every 200 hours or every 2 years to prevent antifreeze deterioration.

The antifreeze replacement and a density test should be performed by an authorized Sea-Doo Sport Boats dealer.

**CAUTION:** Improper antifreeze mixture might allow freezing of the liquid in the cooling system if boat is stored in area where freezing point is reached. This would seriously damage the engine. Failure to replace the antifreeze for storage may allow its degradation that could result in poor cooling when engine will be used.

### **WARNING**

In order to avoid potential burns, do not remove the radiator cap or loosen the engine drain plug if engine is still hot.

## Boat Cleaning/Repair

Wash the body and the trailer with soap and water solution (only use mild detergent). Rinse thoroughly with fresh water. Remove any marine organisms from the hull.

**CAUTION:** Never clean apparent fiberglass and plastic parts with strong detergent, degreasing agent, paint thinner, acetone, etc.

Stains may be removed from seats and fiberglass with Knight's Spray-Nine or the equivalent.

<sup>†</sup>Gelcote is a trademark of Gelcote International.

If repairs are needed to the body or to the hull contact your authorized Sea-Doo Sport Boats dealer. For paint touch up to mechanical parts use BRP spray paint. For minor Gelcote<sup>†</sup> repairs, a repair kit is available from Gelcote International ([www.gelcote.ca](http://www.gelcote.ca)). Replace damaged labels/decals.

Once boat is on trailer, unscrew the drain plug, block the wheels and raise the bow slightly with the trailer jack (if so equipped) to allow water to drain. Clean the bilge with hot water and detergent or with bilge cleaner. Rinse thoroughly. Unscrew drain plugs, block wheels and raise the bow with the trailer jack (if so equipped) to drain bilge.

## Finalizing Storage Preparation

Apply a non-abrasive wax to body.

The engine storage cover should be left partially opened during storage (detach the gas shocks from the cover to prevent full opening).

On so equipped models, remove storage tray. Place it on deck.

Using a flat screwdriver, lift tab as shown below.



*TYPICAL — LIFT TAB*

Detach shock end. Detach other side. Block and leave engine cover lid open slightly.

This will avoid engine compartment condensation and possible corrosion.

Reattach shock ends to engine cover lid before operating boat.

If the boat is to be stored outside, cover it with a vented opaque tarpaulin to prevent UV (ultraviolet) rays and grime from affecting the plastic components, boat finish, as well as preventing dust accumulation.

**CAUTION:** Never leave the boat stored in direct sunlight. UV radiation will dull finishes. The boat must never be left in water for storage. Make sure to turn off main battery cut-off switch.

For the storage period, it is necessary to make certain the drain plugs are unscrewed and unobstructed, then block the wheels and slightly raise the bow with the trailer jack (if so equipped) so drainage can take place.

## Preseason Preparation

Use the *PERIODIC MAINTENANCE CHART* at the beginning of *MAINTENANCE INFORMATION* section and refer to the *PRESEASON* column.

Since technical skills and special tools are required, some operations should be performed by an authorized Sea-Doo Sport Boats dealer.

### **WARNING**

Observe all **WARNINGS** and **CAUTIONS** mentioned throughout this guide which are pertinent to the item being checked. When component conditions seem less than satisfactory, replace with genuine BRP parts or approved equivalents.

### **WARNING**

Only perform procedure as detailed in this guide. It is recommended that the assistance of an authorized dealer be periodically obtained on other components/systems not covered in this guide. Unless otherwise specified, engine must not be running and the main battery cut-off switch must be turned OFF for all maintenance procedures.

**NOTE:** It is highly recommended that an authorized Sea-Doo Sport Boats dealer perform the annual safety inspection and factory campaigns in addition to the pre-season preparation all at the same time.

# ***WARRANTY INFORMATION***

---

# **BRP LIMITED WARRANTY FOR MODEL YEAR 2007 SEA-DOO® SPORT BOATS SOLD IN THE UNITED STATES AND CANADA**

## **1) SCOPE**

BRP US Inc.\* ("BRP") warrants its new and unused Model Year 2007 Sea-Doo Sport Boats ("Sport Boat") sold by authorized BRP dealers in the fifty United States and Canada ("dealer") from defects in material and workmanship for the period and under the conditions below.

All genuine BRP parts and accessories, installed by an authorized BRP dealer (as hereinafter defined) at the time of delivery of the 2007 Sea-Doo Sport Boat, carry the same warranty as that of the Sport Boat.

Clarion<sup>†</sup> audio components installed as original equipment on Sport Boats are warranted separately by Clarion. If such an audio component is installed on your Sea-Doo Sport Boat, please contact the manufacturer or ask your authorized BRP dealer for warranty coverage information and assistance.

### **For USA:**

Clarion Corporation of America  
661 West Redondo Beach Boulevard  
Gardena, CA 90247  
Phone: (800) 347-8933  
Fax: (310) 217-4380

### **For Canada:**

Clarion Canada Inc.  
2239 Winston Park Drive  
Oakville, ON L6H 5R1  
Phone: (800) 668-5612  
Fax: (800) 387-7122

Use of the product for racing or any other competitive activity, at any point, even by a previous owner, will render this warranty null and void.

## **2) EXCLUSIONS – ARE NOT WARRANTED**

The following are not warranted under any circumstances:

- Replacement of parts due to normal wear and tear;
- Routine maintenance parts and services, including but not limited to adjustments, oil, lubricant and coolant changes, spark plug replacement, water pumps and the like;
- Damage caused by improper or lack of maintenance or storage, or failure to follow the procedures and recommendations in the Operator's Guide;
- Damage resulting from removal of parts, improper repairs, service, maintenance, or modification, or use of parts or accessories not manufactured or approved by BRP, which in its reasonable judgement, are either incompatible with Sport Boats or adversely affect its operation, performance, or durability, or resulting from repairs done by a person that is not an authorized BRP dealer;
- Damage caused by abuse, misuse, abnormal use, neglect, racing, improper operation or operation of the Sport Boat in a manner inconsistent with the recommended operation described in the Operator's Guide;
- Damages resulting from external damage, submersion, water or foreign object ingestion, accident, fire, theft, vandalism or any act of God;
- Operation with fuel, oils or lubricants that are not suitable for the Sport Boat (see Operator's Guide);
- Damage from rust, corrosion or exposure to the elements;

- Damage from cooling system or jet pump blockage by foreign material;
- Incidental or consequential damages, or damages of any kind including without limitation towing, storage, telephone, rental, taxi, inconvenience, insurance coverage, loan payments, loss of time, loss of income; and
- Damage to gel coat finish including but not limited to cosmetic gel coat finish defects, blisters, starrng, crazing; and fiberglass delaminating caused by blisters, crazing, spyder or hairline cracks or exposure to the elements.

### **3) WARRANTY COVERAGE DURATION**

This limited warranty will be in effect from the date of delivery to the first retail consumer or the date the Sport Boat is first put to use, whichever occurs first, for a period of:

- TWELVE (12) CONSECUTIVE MONTHS for private, recreational use, except that the deck and hull fiberglass structure are covered for SIXTY (60) CONSECUTIVE MONTHS;
- FOUR (4) CONSECUTIVE MONTHS for commercial use, except that the deck and hull fiberglass structure is covered for TWELVE (12) CONSECUTIVE MONTHS. A Sport Boat is used commercially when it is used in connection with generating income or any work or employment during any part of the warranty period. A Sport Boat is also used commercially when, at any point during the warranty period, it has commercial tags or is licensed for commercial use.

The emission-related components included in the chart below, that are installed on EPA certified Sea-Doo Sport Boats (see list below) registered in the USA are covered for TWENTY-FOUR (24) CONSECUTIVE MONTHS OR 200 HOURS OF ENGINE USE, whichever occurs first. If the 200 hours of engine use are reached during the regular warranty coverage period, the emission-related components are still covered by BRP's standard warranty until the end of regular coverage period.

The EPA certified 2007 Sea-Doo Sport Boats are those equipped with: 4-TEC® engines, and 4-TEC IC engines.

Emission-related components:

- Throttle Position Sensor (TPS)
- Air Temperature Sensor (ATS)
- Air Pressure Sensor (APS)

For Sport Boats produced by BRP for sale in the states of California or New York, that are originally sold to a resident or subsequently warranty registered to a resident in the state of California or New York, please also refer to the applicable California and New York Emissions Control Warranty Statement.

The repair or replacement of parts or the performance of service to a Sport Boat under this warranty does not extend the life of this limited warranty beyond its original expiration date.

#### **4) CONDITIONS TO HAVE WARRANTY COVERAGE**

This warranty coverage is available only on 2007 Sea-Doo Sport Boats purchased as new and unused by its first owner from a BRP dealer authorized to distribute BRP products in the country in which the sale occurred ("BRP dealer"), and then only after the BRP specified pre-delivery inspection process is completed and documented. Warranty coverage only becomes available upon proper registration of the product by an authorized BRP dealer. Moreover, this warranty coverage is only available if the Sea-Doo Sport Boat is purchased in the country in which the purchaser resides. BRP will not honor this limited warranty to any private use owner or commercial use owner if the preceding conditions have not been met. Such limitations are necessary in order to allow BRP to preserve both the safety of its products, and also that of its consumers and the general public.

Routine maintenance outlined in the Operator's Guide must be timely performed in order to maintain warranty coverage. BRP reserves the right to make warranty coverage contingent upon proof of proper maintenance.

#### **5) WHAT TO DO TO OBTAIN WARRANTY COVERAGE**

The customer must notify a servicing BRP dealer within two (2) days of the appearance of a defect, and provide it with reasonable access to the product and reasonable opportunity to repair it. The customer must also present to the authorized BRP dealer, proof of purchase of the product and must sign the repair/work order prior to starting the repair in order to validate the warranty repair. All parts replaced under this limited warranty become the property of BRP.

#### **6) WHAT BRP WILL DO**

BRP's obligations under this warranty are limited to, at its sole discretion, repairing parts found defective under normal use, maintenance and service, or replacing such parts with new genuine BRP parts without charge for parts and labor, at any authorized BRP dealer during the warranty coverage period.

BRP reserves the right to improve or modify products from time to time without assuming any obligation to modify products previously manufactured.

## **7) LIMITATIONS OF LIABILITY**

THIS WARRANTY IS EXPRESSLY GIVEN AND ACCEPTED IN LIEU OF ANY AND ALL OTHER WARRANTIES, EXPRESSED OR IMPLIED, INCLUDING WITHOUT LIMITATION ANY WARRANTY OF MERCHANTABILITY OR FITNESS FOR A PARTICULAR PURPOSE. TO THE EXTENT THAT THEY CANNOT BE DISCLAIMED, THE IMPLIED WARRANTIES ARE LIMITED IN DURATION TO THE LIFE OF THE EXPRESS WARRANTY. INCIDENTAL AND CONSEQUENTIAL DAMAGES ARE EXCLUDED FROM COVERAGE UNDER THIS WARRANTY. SOME STATES/PROVINCES DO NOT ALLOW FOR THE DISCLAIMERS, LIMITATIONS AND EXCLUSIONS IDENTIFIED ABOVE, AS A RESULT, THEY MAY NOT APPLY TO YOU. THIS WARRANTY GIVES YOU SPECIFIC RIGHTS, AND YOU MAY ALSO HAVE OTHER LEGAL RIGHTS WHICH MAY VARY FROM STATE TO STATE, OR PROVINCE TO PROVINCE.

Neither the distributor, any BRP dealer nor any other person has been authorized to make any affirmation, representation or warranty regarding the product, other than those contained in this limited warranty, and if made, shall not be enforceable against BRP.

BRP reserves the right to modify this warranty at any time, being understood that such modification will not alter the warranty conditions applicable to the products sold while this warranty is in effect.

## **8) TRANSFER**

If the ownership of a product is transferred during the warranty coverage period, this warranty shall also be transferred and be valid for the remaining coverage period provided that BRP is notified of such transfer of ownership in the following way:

- a) The former owner contacts BRP (at the phone number provided below) or an authorized BRP dealer and gives the coordinates of the new owner; or
- b) BRP or an authorized BRP dealer receives a proof that the former owner agreed to the transfer of ownership, in addition to the coordinates of the new owner.

## 9) CONSUMER ASSISTANCE

- a) In the event of a controversy or a dispute in connection with this limited warranty, BRP suggests that you try to resolve the issue at the dealership level. We recommend discussing the issue with the authorized BRP dealer's service manager or owner.
- b) If the issue has not yet been resolved, please submit your complaint in writing or call the appropriate number below:

### **In Canada:**

**BOMBARDIER RECREATIONAL  
PRODUCTS INC.**

SEA-DOO

CONSUMER SERVICES GROUP

VALCOURT QC J0E 2L0

Tel.: (819) 566-3366

### **In USA:**

**BRP US Inc.**

SEA-DOO

CONSUMER SERVICES GROUP

7575 BOMBARDIER COURT

WAUSAU WI 54401

Tel.: (715) 848-4957

\*In Canada, products are distributed and serviced by Bombardier Recreational Products Inc.

© 2006 Bombardier Recreational Products Inc. All rights reserved.

® Registered trademark of Bombardier Recreational Products Inc. or its subsidiaries.

‡ is a trademark of Clarion.



---

# CALIFORNIA AND NEW YORK EMISSION CONTROL WARRANTY STATEMENT FOR MODEL-YEAR 2007 SEA-DOO® SPORT BOATS WITH 4-TEC™ ENGINES OR 4-TEC IC ENGINES.

For California, your 2007 Sea-Doo Sport Boat ("Sport Boat") has a special environmental label required by the California Air Resources Board. The label has 1, 2, 3 or 4 stars. A hangtag, provided with your Sport Boat, describes the meaning of the star rating system.

## The Star Label Means Cleaner Marine Engines

The symbol for cleaner marine engines:



F18L3CQ

### Cleaner Air and Water

For a healthier lifestyle and environment.

### Better Fuel Economy

Burns up to 30 - 40 percent less gas and oil than conventional carbureted two-stroke engines, saving money and resources.

### Longer Emission Warranty

Protects consumer for worry free operation.

### One Star - Low Emission

The one-star label identifies personal watercraft, outboard, stern drive and in-board engines that meet the Air Resources Board's Personal Watercraft and Outboard marine engine 2001 exhaust emission standards. Engines meeting these standards have 75% lower emissions than conventional carbureted two-stroke engines. These engines are equivalent to the U.S. EPA's 2007 standards for marine engines.

### Two Stars - Very Low Emission

The two-star label identifies personal watercraft, outboard, stern drive and in-board engines that meet the Air Resources Board's Personal Watercraft and Outboard marine engine 2004 exhaust emission standards. Engines meeting these standards have 20% lower emissions than One Star - Low-Emission engines.

### **Three Stars - Ultra Low Emission**

The three-star label identifies engines that meet the Air Resources Board's Personal Watercraft and Outboard marine engine 2008 exhaust emission standards or the Stern drive and Inboard marine engine 2003 exhaust emission standards. Engines meeting these standards have 65% lower emissions than One Star - Low Emission engines.

### **Four Stars - Super Ultra Low Emission**

The four-star label identifies engines that meet the Air Resources Board's Stern-drive and Inboard marine engine 2008 exhaust emission standards. Personal Watercraft and Outboard marine engines may also comply with these standards. Engines meeting these standards have 90% lower emissions than One Star - Low Emission engines.

For more information: Cleaner Watercraft - Get the Facts 1 800 END-SMOG  
[www.arb.ca.gov](http://www.arb.ca.gov)

### **Your Emission Control Warranty Rights and Obligations**

The California Air Resources Board and BRP US Inc. ("BRP") are pleased to explain the emission control system warranty on your Model Year 2007 Sea-Doo Sport Boat. In California, new Sport Boat engines must be designed, built and equipped to meet the State's stringent anti-smog standards. BRP must warrant the emission control system on your Sport Boat engine for the periods of time listed below provided there has been no abuse, neglect or improper maintenance of your Sport Boat engine.

Your emission control system may include parts such as the fuel injection system, the ignition system and catalytic converter. Also included may be hoses, belts, connectors and other emission related assemblies.

Where a warrantable condition exists, BRP will repair your Sport Boat engine at no cost to you including diagnosis, parts and labor provided that such work is performed by an authorized BRP dealer.

### **Manufacturer's Limited Warranty Coverage**

This emission limited warranty covers Model Year 2007 Sea-Doo Sport Boats certified and produced by BRP for sale in California, that are originally sold in California to a California resident or subsequently warranty registered to a California resident. The BRP limited warranty conditions for Sea-Doo Sport Boats are still applicable to these models with the necessary modifications. Select emission control parts of your 2007 Sea-Doo Sport Boat are warranted from the date of delivery to the first retail consumer for a period of 4 years, or for 250 hours of use, whichever occurs first. However, warranty coverage based on the hourly period is only permitted for Sport Boat equipped with the appropriate hour meters or their equivalent. If any emission-related part on your engine is defective under warranty, the part will be repaired or replaced by BRP.

**Parts Covered for a Model Year 2007 Sea-Doo Sport Boat Equipped with 4-TEC® Engines and 4-TEC IC Engines:**

Digital Linear Actuator (low idle control)	All Fuel System Components
Throttle Position Sensor	Spark Plugs
Intake Manifold Air Pressure Sensor	Ignition Coils
Intake Manifold Air Temperature Sensor	Piston and Rings
Engine Temperature Sensor	Intake and Exhaust Valve Gear/Train
Knock Sensor	Valves, Valve Guides and Valve Guide Sealing
Emission Control Unit	Crankcase Ventilation Valve
Injectors	Wire Harness and Connectors
Fuel Pressure Regulator	Emission Related Seals, Gaskets and Hoses
Intake Manifold	Exhaust Manifold
Intercooler (if equipped)	Supercharger (if equipped)

The emission warranty covers damage to other engine components that is caused by the failure of a warranted part. The BRP Operator’s Guide provided contains written instructions for the proper maintenance and use of your Sport Boat. All emission warranty parts are warranted by BRP for the entire warranty period of the Sport Boat, unless the part is scheduled for replacement as required maintenance in the Operator’s Guide.

Emission warranty parts that are scheduled for replacement, as required maintenance, are warranted by BRP for the period of time before the first scheduled replacement date for that part. Emission warranty parts that are scheduled for regular inspection, but not regular replacement, are warranted by BRP for the entire warranty period of the Sport Boat. Any emission warranty part repaired or replaced under the terms of this warranty statement is warranted by BRP for the remainder of the warranty period of the original part. All parts replaced under this limited warranty become the property of BRP. Maintenance receipts and records should be transferred to each subsequent owner of the Sport Boat.

## **Owner's Warranty Responsibilities**

As the owner of a 2007 Sea-Doo Sport Boat, you are responsible for the performance of the required maintenance listed in your Operator's Guide. BRP recommends that you retain all receipts covering maintenance your Sport Boat engine, but BRP cannot deny warranty solely for the lack of receipts or your failure to ensure the performance of all scheduled maintenance. As the owner of a Sea-Doo Sport Boat, you should however be aware that BRP may deny you warranty coverage if your engine(s) or a part has failed due to abuse, neglect, improper maintenance or unapproved modifications. You are responsible for presenting your engine to an authorized BRP dealer as soon as a problem exists. The warranty repairs will be completed in a reasonable amount of time, not to exceed 30 days. If you have any questions regarding your warranty rights and responsibilities or for the name and location of the nearest authorized BRP dealer you should contact the Customer Assistance Center at 1-715-848-4957.

---

# **BRP INTERNATIONAL LIMITED WARRANTY FOR MODEL YEAR 2007 SEA-DOO® SPORT BOATS**

## **1) SCOPE**

BRP US Inc. ("BRP")\* warrants its new and unused Model Year 2007 Sea-Doo Sport Boats ("Sport Boat") sold by authorized BRP distributors/dealers outside of the fifty United States, Canada and states members of the European Union ("distributor/dealer"), will be free from defects in material and workmanship for the period and under the conditions below.

All genuine BRP parts and accessories, installed by an authorized BRP dealer (as hereinafter defined) at the time of delivery of the 2007 Sea-Doo Sport Boat, carry the same warranty as that of the Sport Boat.

Use of the product for racing or any other competitive activity, at any point, even by a previous owner, will render this warranty null and void.

## **2) EXCLUSIONS – ARE NOT WARRANTED**

The following are not warranted under any circumstances:

- Replacement of parts due to normal wear and tear;
- Routine maintenance parts and services, including but not limited to adjustments, oil, lubricant and coolant changes, spark plug replacement, water pumps and the like;
- Damage caused by improper or lack of maintenance or storage, or failure to follow the procedures and recommendations in the Operator's Guide;
- Damage resulting from removal of parts, improper repairs, service, maintenance, or modification, or use of parts or accessories not manufactured or approved by BRP, which in its reasonable judgment, are either incompatible with Sport Boats or adversely affect its operation, performance, or durability, or resulting from repairs done by a person that is not an authorized BRP distributor/dealer;
- Damage caused by abuse, misuse, abnormal use, neglect, racing, improper operation or operation of the Sport Boat in a manner inconsistent with the recommended operation described in the Operator's Guide;
- Damages resulting from external damage, submersion, water or foreign object ingestion, accident, fire, theft, vandalism or any act of God;
- Operation with fuel, oils or lubricants that are not suitable for the Sport Boat (see Operator's Guide);
- Damage from rust, corrosion or exposure to the elements;
- Damage from cooling system or jet pump blockage by foreign material;
- Incidental or consequential damages, or damages of any kind including without limitation towing, storage, telephone, rental, taxi, inconvenience, insurance coverage, loan payments, loss of time, loss of income; and
- Damage to gel coat finish including but not limited to cosmetic gel coat finish defects, blisters, starring, crazing; and fiberglass delaminating caused by blisters, crazing, spyder or hairline cracks or exposure to the elements.

### **3) WARRANTY COVERAGE DURATION**

This limited warranty will be in effect from the date of delivery to the first retail consumer or the date the Sport Boat is first put to use, whichever occurs first, for a period of:

- TWELVE (12) CONSECUTIVE MONTHS for private, recreational use, except for the deck and hull fiberglass structure are covered for SIXTY (60) CONSECUTIVE MONTHS;
- FOUR (4) CONSECUTIVE MONTHS for commercial use, except for the deck and hull fiberglass structure is covered for TWELVE (12) CONSECUTIVE MONTHS. A Sport Boat is used commercially when it is used in connection with generating income or any work or employment during any part of the warranty period. A Sport Boat is also used commercially when, at any point during the warranty period, it has commercial tags or is licensed for commercial use.

The repair or replacement of parts or the performance of service to a Sport Boat under this warranty does not extend the life of this limited warranty beyond its original expiration date.

### **4) CONDITIONS TO HAVE WARRANTY COVERAGE**

This warranty coverage is available only on 2007 Sea-Doo Sport Boats purchased as new and unused by its first owner from a BRP distributor/dealer authorized to distribute Sea-Doo Sport Boat products in the country in which the sale occurred ("BRP distributor/dealer"), and then only after the BRP specified pre-delivery inspection process is completed and documented. Warranty coverage only becomes available upon proper registration of the product by an authorized BRP distributor/dealer. Moreover, this warranty coverage is only available if the Sea-Doo Sport Boat is purchased in the country in which the purchaser resides. BRP will not honor this limited warranty to any private use owner or commercial use owner if the preceding conditions have not been met. Such limitations are necessary in order to allow BRP to preserve both the safety of its products, and also that of its consumers and the general public.

Routine maintenance outlined in the Operator's Guide must be timely performed in order to maintain warranty coverage. BRP reserves the right to make warranty coverage contingent upon proof of proper maintenance.

### **5) WHAT TO DO TO OBTAIN WARRANTY COVERAGE**

The customer must notify a servicing BRP distributor/dealer within two (2) days of the appearance of a defect, and provide it with reasonable access to the product and reasonable opportunity to repair it. The customer must also present to the authorized BRP distributor/dealer, proof of purchase of the product and must sign the repair/work order prior to starting the repair in order to validate the warranty repair. All parts replaced under this limited warranty become the property of BRP.

### **6) WHAT BRP WILL DO**

BRP's obligations under this warranty are limited to, at its sole discretion, repairing parts found defective under normal use, maintenance and service, or replacing such parts with new genuine BRP parts without charge for parts and labor, at any authorized BRP distributor/dealer during the warranty coverage period.

BRP reserves the right to improve or modify products from time to time without assuming any obligation to modify products previously manufactured.

## **7) LIMITATIONS OF LIABILITY**

THIS WARRANTY IS EXPRESSLY GIVEN AND ACCEPTED IN LIEU OF ANY AND ALL OTHER WARRANTIES, EXPRESSED OR IMPLIED, INCLUDING WITHOUT LIMITATION ANY WARRANTY OF MERCHANTABILITY OR FITNESS FOR A PARTICULAR PURPOSE. TO THE EXTENT THAT THEY CANNOT BE DISCLAIMED, THE IMPLIED WARRANTIES ARE LIMITED IN DURATION TO THE LIFE OF THE EXPRESS WARRANTIES. INCIDENTAL AND CONSEQUENTIAL DAMAGES ARE EXCLUDED FROM COVERAGE UNDER THIS WARRANTY. SOME STATES/PROVINCES DO NOT ALLOW FOR THE DISCLAIMERS, LIMITATIONS AND EXCLUSIONS IDENTIFIED ABOVE, AS A RESULT, THEY MAY NOT APPLY TO YOU. This warranty gives you specific rights, and you may also have other legal rights which may vary from state to state, or province to province.

Neither the distributor, any BRP distributor/dealer nor any other person has been authorized to make any affirmation, representation or warranty regarding the product, other than those contained in this limited warranty, and if made, shall not be enforceable against BRP.

BRP reserves the right to modify this warranty at any time, being understood that such modification will not alter the warranty conditions applicable to the products sold while this warranty is in effect.

## **8) TRANSFER**

If the ownership of a product is transferred during the warranty coverage period, this warranty shall also be transferred and be valid for the remaining coverage period provided BRP or an authorized BRP distributor/dealer receives a proof that the former owner agreed to the transfer of ownership, in addition to the coordinates of the new owner.

## **9) CONSUMER ASSISTANCE**

In the event of a controversy or a dispute in connection with this limited warranty, BRP suggests that you try to resolve the issue at the dealership level.

If further assistance is required, the distributor's service department should be contacted in order to resolve the matter.

If the matter still remains unresolved then contact BRP by writing to us at the address listed below.

### **For countries within Europe, Middle East, Africa, Russia & CIS, please contact our European office:**

**BRP EUROPE N.V.**

Consumer Service Center  
Skaldenstraat 125  
9042 Gent  
Belgium  
Tel.: + 32-9-218-26-00

### **For Scandinavian countries, please contact our Finland office:**

**BRP FINLAND OY**

Service Department  
Ahjotie 30  
Fin-96320 Rovaniemi  
Finland  
Tel.: + 358163208111

### **For all other countries, please contact your local distributor or, our North America office:**

**BOMBARDIER RECREATIONAL PRODUCTS INC.**

Consumer Services Group  
Valcourt QC J0E 2L0  
Tel.: 1-819-566-3366

You will find your distributor's coordinates on [www.brp.com](http://www.brp.com).

\* For the territory covered by this limited warranty, products are distributed and serviced by Bombardier Recreational Products Inc. or its affiliates.

© 2006 Bombardier Recreational Products Inc. All rights reserved.

® Registered trademark of Bombardier Recreational Products Inc. or its affiliates.



---

# **BRP EUROPEAN UNION MEMBER STATES LIMITED WARRANTY FOR MODEL YEAR 2007 SEA DOO® SPORT BOATS**

## **1) SCOPE OF THE LIMITED WARRANTY**

BRP US Inc. ("BRP")\* warrants its 2007 Sea-Doo Sport Boats from defects in material or workmanship for the period and under the conditions described below.

All genuine SEA-DOO® Sport Boat parts and accessories, installed by an authorized BRP distributor/dealer (as hereinafter defined) at the time of delivery of the 2007 Sea-Doo Sport Boats, carry the same warranty as that of the Sport Boats.

Use of the product for racing or any other competitive activity, at any point, even by a previous owner, will render this warranty null and void.

## **2) EXCLUSIONS – ARE NOT WARRANTED**

The following are not warranted under any circumstances:

- Replacement of parts due to normal wear and tear;
- Routine maintenance parts and services, including but not limited to adjustments, oil, lubricant and coolant changes, spark plug replacement, water pumps and the like;
- Damage caused by improper or lack of maintenance or storage, or failure to follow the procedures and recommendations in the Operator's Guide;
- Damage resulting from removal of parts, improper repairs, service, maintenance, or modification, or use of parts or accessories not manufactured or approved by BRP, which in its reasonable judgment, are either incompatible with Sport Boats or adversely affect its operation, performance, or durability, or resulting from repairs done by a person that is not an authorized BRP distributor/dealer;
- Damage caused by abuse, misuse, abnormal use, neglect, racing, improper operation or operation of the Sport Boat in a manner inconsistent with the recommended operation described in the Operator's Guide;
- Damages resulting from external damage, submersion, water or foreign object ingestion, accident, fire, theft, vandalism or any act of God;
- Operation with fuel, oils or lubricants that are not suitable for the Sport Boat (see Operator's Guide);
- Damage from rust, corrosion or exposure to the elements;
- Damage from cooling system or jet pump blockage by foreign material;
- Incidental or consequential damages, or damages of any kind including without limitation towing, storage, telephone, rental, taxi, inconvenience, insurance coverage, loan payments, loss of time, loss of income; and
- Damage to gel coat finish including but not limited to cosmetic gel coat finish defects, blisters, starrng, crazing; and fiberglass delaminating caused by blisters, crazing, splyder or hairline cracks or exposure to the elements.

### **3) WARRANTY COVERAGE PERIOD**

This warranty will be in effect from the date of delivery to the first retail consumer or the date the product is first put into use, whichever occurs first and for a period of:

TWENTY-FOUR (24) CONSECUTIVE MONTHS for private use owners and TWELVE (12) CONSECUTIVE MONTHS for commercial use owners.

The repair or replacement of parts or the performance of service under this warranty does not extend the life of this warranty beyond its original expiration date.

Note that the duration and any other modalities of the warranty coverage are subject to the applicable national or local legislation in your country.

### **4) CONDITIONS TO HAVE WARRANTY COVERAGE**

This warranty coverage is available only if each of the following conditions has been fulfilled:

- a) The 2007 Sea-Doo Sport Boats must be purchased as new and unused by its first owner from a BRP distributor/dealer authorized to distribute SEA-DOO® Sport Boat products in the country in which the sale occurred (“BRP distributor/dealer”);
- b) The BRP specified pre-delivery inspection process must be completed and documented;
- c) The product must have undergone proper registration by an authorized BRP distributor/dealer;
- d) The 2007 Sea-Doo Sport Boats must be purchased in the country or union of countries in which the purchaser resides.
- e) Routine maintenance outlined in the Operator’s Guide must be timely performed in order to maintain warranty coverage. BRP reserves the right to make warranty coverage contingent upon proof of proper maintenance.

BRP will not honor this limited warranty to any private use owner or commercial use owner if the preceding conditions have not been met. Such limitations are necessary in order to allow BRP to preserve both the safety of its products, and also that of its consumers and the general public.

### **5) WHAT TO DO TO OBTAIN WARRANTY COVERAGE**

The customer must notify a servicing BRP distributor/dealer within two (2) months of the appearance of a defect, and provide it with reasonable access to the product and reasonable opportunity to repair it. The customer must also present to the authorized BRP distributor/dealer, proof of purchase of the product and must sign the repair/work order prior to starting the repair in order to validate the warranty repair. All parts replaced under this limited warranty become the property of BRP.

Note that the notification period is subject to the applicable national or local legislation in your country.

## **6) WHAT BRP WILL DO**

BRP's obligations under this warranty are limited to, at its sole discretion, repairing parts found defective under normal use, maintenance and service, or replacing such parts with new genuine BRP parts without charge for parts and labor, at any authorized BRP distributor/dealer during the warranty coverage period.

BRP reserves the right to improve or modify products from time to time without assuming any obligation to modify products previously manufactured.

## **7) LIMITATIONS OF LIABILITY**

THIS WARRANTY IS EXPRESSLY GIVEN AND ACCEPTED IN LIEU OF ANY AND ALL OTHER WARRANTIES, EXPRESSED OR IMPLIED, INCLUDING WITHOUT LIMITATION ANY WARRANTY OF MERCHANTABILITY OR FITNESS FOR A PARTICULAR PURPOSE. TO THE EXTENT THAT THEY CANNOT BE DISCLAIMED, THE IMPLIED WARRANTIES ARE LIMITED IN DURATION TO THE LIFE OF THE EXPRESS WARRANTY. INCIDENTAL AND CONSEQUENTIAL DAMAGES ARE EXCLUDED FROM COVERAGE UNDER THIS WARRANTY. SOME JURISDICTIONS DO NOT ALLOW FOR THE DISCLAIMERS, LIMITATIONS AND EXCLUSIONS IDENTIFIED ABOVE, AS A RESULT, THEY MAY NOT APPLY TO YOU. THIS WARRANTY GIVES YOU SPECIFIC RIGHTS, AND YOU MAY ALSO HAVE OTHER LEGAL RIGHTS WHICH MAY VARY FROM COUNTRY TO COUNTRY, OR PROVINCE TO PROVINCE.

Neither the distributor, any BRP distributor/dealer nor any other person has been authorized to make any affirmation, representation or warranty regarding the product, other than those contained in this limited warranty, and if made, shall not be enforceable against BRP.

BRP reserves the right to modify this warranty at any time, being understood that such modification will not alter the warranty conditions applicable to the products sold while this warranty is in effect.

## **8) TRANSFER**

If the ownership of a product is transferred during the warranty coverage period, this warranty shall also be transferred and be valid for the remaining coverage period provided BRP or an authorized BRP distributor/dealer receives a proof that the former owner agreed to the transfer of ownership, in addition to the coordinates of the new owner.

## **9) CONSUMER ASSISTANCE**

In the event of a controversy or a dispute in connection with this limited warranty, BRP suggests that you try to resolve the issue at the dealership level. We recommend discussing the issue with the authorized distributor/dealer's service manager or owner.

If further assistance is required, the distributor's service department should be contacted in order to resolve the matter.

If the matter still remains unresolved then contact BRP at the address listed below.

### **For countries within Europe, Middle East, Africa, Russia & CIS, please contact our European office:**

#### **BRP EUROPE N.V.**

Consumer Service Center  
Skaldenstraat 125  
9042 Gent  
Belgium  
Tel.: + 32-9-218-26-00

### **For Scandinavian countries, please contact our Finland office:**

#### **BRP FINLAND OY**

Service Department  
Ahjotie 30  
Fin-96320 Rovaniemi  
Finland  
Tel.: + 358163208111

### **For all other countries, please contact your local distributor or, our North America office:**

#### **BOMBARDIER RECREATIONAL PRODUCTS INC.**

Consumer Services Group  
Valcourt QC J0E 2L0  
Tel.: 1-819-566-3366

You will find your distributor's coordinates on [www.brp.com](http://www.brp.com).

\* For the territory covered by this limited warranty, products are distributed and serviced by Bombardier Recreational Products Inc. or its affiliates.

© 2006 Bombardier Recreational Products Inc. All rights reserved.® Registered trademark of Bombardier Recreational Products Inc.

---

# DECLARATION CE OF CONFORMITY



## CE OF CONFORMITY

Application of Council Directives: Directive 2003/44/EC Recreational – craft

Relevant Directive(s): Directive 89/336/CEE Electromagnetic compatibility

Competent body for Directive 89/336/CEE: UTAC Autodrome de Linas-Monthl ry, B.P. 212 91311 Monthl ry cedex, France

Relevant Harmonized Standard(s): ISO 7840, ISO 8469, ISO 8665, ISO 8846, ISO 8848, ISO 8849, ISO 9094, ISO 9097, ISO 10087, ISO 10088, ISO 10133, ISO 10240, ISO 11105, ISO 11591, ISO 11592, ISO 12215, ISO 12216, ISO 13592, COLREGS, ABYC H-5, ABYC H-8

Manufacturers: BRP US Inc.

Manufacturers address: 451 E. Illinois Ave Benton, Illinois 62812-0394

Importers name: BRP European Distribution SA

Importers address: Chemin de Messidor 5-7  
1006 Lausanne  
Switzerland

Product type: Sport Boats, inshore category C

Notified body: International Marine Certification Institute  
Tr ves Centre, rue de Tr ves 45 1040  
Brussels, Belgium

EC certificate: BBOMB009: 220 Islandia SE  
BBOMB012: 205 Utopia  
BBOMB013: 150 Speedster (NA)  
BBOMB014: 200 Speedster  
BBOMB016: 150 Speedster SCIC  
BBOMB017: 150 Speedster Wake

I, the undersigned, hereby declare that the product specified above conforms to the above Directive(s) and Standard(s).

Name of signatory:

Fernando Garcia

Title of signatory on behalf of BRP US Inc.: Director – Public and Regulatory – Affairs

## Homologation and Certification

These boats comply with the following standards:

STANDARD	TYPE OF CERTIFICATION
United States Coast Guard	Self certification
Canadian Coast Guard	Self certification
Russian Maritime Register of Shipping	Certify by Russian Maritime Register of Shipping 8, Dvortsovaya Nab., 191186 St. Petersburg, Russia
Directive 89/336/CEE of the council relating to electromagnetic compatibility	Internal production control plus control carried out on the responsibility of a competent body.  Competent body: UTAC Autodrome de Linas-Monlhéry, B.P. 212 91311 Monlhéry cedex, France
Directive 2003/44/EC of the European Parliament and of the council relating to recreational craft	Internal production control plus control carried out on the responsibility of a notified body.  Notified body: International Marine Certification Institute Trèves centre, rue de Trèves 45 1040 Brussels, Belgium

---

# PRIVACY INFORMATION

We wish to inform you that your coordinates will be used for safety and warranty purposes. Sometimes, we also use the coordinates of our clients to inform them about our products and to present them offers. Should you prefer not to receive information on our products, services and offers, please let us know by writing to the address below.

Also note that, from time to time, carefully selected and trustworthy organizations may be permitted to use the coordinates of our clients to promote quality products and services. If you prefer not to have your name and address released, please let us know by writing to the address below:

**In Canada:**  
BOMBARDIER RECREATIONAL  
PRODUCTS INC.  
CONSUMER SERVICES GROUP  
VALCOURT QC J0E 2L0  
Tel.: (819) 566-3366

**In USA:**  
BRP US Inc.  
CONSUMER SERVICES GROUP  
7575 BOMBARDIER COURT  
WAUSAU WI 54401  
Tel.: (715) 848-4957

**For countries within Europe, Middle East, Africa, Russia & CIS, please contact our European office:**

**BRP EUROPE N.V.**

Consumer Service Center  
Skaldenstraat 125  
9042 Gent  
Belgium  
Tel.: + 32-9-218-26-00

**For Scandinavian countries, please contact our Finland office:**

**BRP FINLAND OY**

Service Department  
Ahjotie 30  
Fin-96320 Rovaniemi  
Finland  
Tel.: + 358163208111

**For all other countries, please contact your local distributor or, our North America office:**

**BOMBARDIER RECREATIONAL PRODUCTS INC.**

Consumer Services Group  
Valcourt QC J0E 2L0  
Tel.: 1-819-566-3366

You will find your distributor's coordinates on [www.brp.com](http://www.brp.com).

---

## CHANGE OF ADDRESS/OWNERSHIP

If your address has changed or if you are the new owner of the boat, be sure to notify BRP by either:

- mailing one of the following cards hereinafter using one of the following mailing addresses;
- **North America Only:** calling at (715) 848-4957 (USA) or (819) 566-3366 (Canada);
- contacting an authorized BRP distributor/dealer.

### MAILING ADDRESSES:

#### **In Canada:**

BOMBARDIER RECREATIONAL  
PRODUCTS INC.  
CONSUMER SERVICES GROUP  
VALCOURT QC J0E 2L0  
Tel.: (819) 566-3366

#### **In USA:**

BRP US Inc.  
CONSUMER SERVICES GROUP  
7575 BOMBARDIER COURT  
WAUSAU WI 54401  
Tel.: (715) 848-4957

**For countries within Europe, Middle East, Africa, Russia & CIS, please contact our European office:**

**BRP EUROPE N.V.**

Consumer Service Center  
Skaldenstraat 125  
9042 Gent  
Belgium  
Tel.: + 32-9-218-26-00

**For Scandinavian countries, please contact our Finland office:**

**BRP FINLAND OY**

Service Department  
Ahjotie 30  
Fin-96320 Rovaniemi  
Finland  
Tel.: + 358163208111

**For all other countries, please contact your local distributor or, our North America office:**

**BOMBARDIER RECREATIONAL PRODUCTS INC.**

Consumer Services Group  
Valcourt QC J0E 2L0  
Tel.: 1-819-566-3366

You will find your distributor's coordinates on [www.brp.com](http://www.brp.com).







**BOAT MODEL No.** \_\_\_\_\_

**HULL IDENTIFICATION NUMBER (H.I.N.)** \_\_\_\_\_

**ROTAX ENGINE IDENTIFICATION NUMBER (E.I.N.)** \_\_\_\_\_

**Owner:** \_\_\_\_\_  
NAME

\_\_\_\_\_  
No. STREET APT

\_\_\_\_\_  
CITY STATE/PROVINCE ZIP/POSTAL CODE

**Purchase Date** \_\_\_\_\_  
YEAR MONTH DAY

**Warranty Expiry Date** \_\_\_\_\_  
YEAR MONTH DAY

To be completed by the dealer at the time of the sale.

DEALER IMPRINT AREA

F00A35L

**Please verify with your selling dealer to ensure your SEA-DOO sport boat has been registered with BRP.**

204 630 354

CA

OPERATOR'S GUIDE, 150 SPEEDSTER, 180 CHALLENGER / ENGLISH  
GUIDE DU CONDUCTEUR, 150 SPEEDSTER, 180 CHALLENGER / ANGLAIS

FAIT AU / MADE IN CANADA

U/M:P.C.