

SEA-DOO®



Sport Boats

OPERATOR'S GUIDE

Includes SAFETY, VEHICLE and MAINTENANCE INFORMATION

SPORTSTER™ 4-TEC™ CHALLENGER* 180



 **WARNING**

Read this guide thoroughly.
It contains important safety information.
Do not remove this *Operator's Guide* from the
vehicle.

2006

204 630 344

SAFETY WARNING

Disregarding any of the safety precautions and instructions contained in this Operator's Guide, the *SAFETY VIDEOCASSETTE* and the on-product warning labels could cause injury, including the possibility of death. The operator has the responsibility to inform passenger(s) of safety precautions.

This Operator's Guide and *SAFETY VIDEOCASSETTE* should remain with the boat at the time of resale.



The following trademarks are the property of Bombardier Recreational Products Inc. or its affiliates.

Sea-Doo®

ROTAX™

BOMBARDIER* LUBE

Sportster™

4-TEC™

Doin'it on your new Sea-Doo sport boat

Congratulations, you are now the proud owner of a Sea-Doo sport boat. Whether you are an experienced boater or are new to the sport of boating, we ask you to take the time to view the *SAFETY VIDEOCASSETTE* provided with the boat, to read this Operator's Guide on-product warning/caution labels and familiarize yourself with the contents. This guide contains pertinent information which, if followed, will provide you with the necessary knowledge to help you fully enjoy the pleasures of this boat.

We strongly recommend that any boat operator complete a safety boating course. Check with your local Coast Guard or Power and Sail Squadron in your area for course availability. More serious boaters may want to obtain *CHAPMAN PILOTING* by Elbert S. Maloney, available at most book stores.

When introducing your family or friends to the sport, be sure they fully understand the controls and operation of the boat and the importance of courteous, responsible riding.

Each boat operator has a responsibility to ensure the safety of his/her passenger(s) and of other water users. Please follow all safety instructions and operate your boat with care.

We encourage you to have an Annual Safety Inspection of your boat. Please contact your authorized Sea-Doo sport boat dealer for further details.

Finally, we invite you to visit your authorized Sea-Doo sport boat dealer for regular safety maintenance as well as any boating accessories you may require.

Have fun and... Bon Voyage.

Please keep this guide on board. This guide should remain with the boat at time of resale.

TABLE OF CONTENTS

FOREWORD	7
Hazard Statements	7
Advisory Statements	7

SAFETY INFORMATION

SAFETY	10
Safe Boating Checklist	10
Safety Equipment.....	12
Carbon Monoxide and Boating	17
Lanyard Stop Switch/DESS	20
Safe Boating Practices	21
Passenger Safety	21
Rules of the Road.....	22
Water Sports	24

VEHICLE INFORMATION

REGISTRATION NUMBER LOCATION	30
LOCATION OF THE IMPORTANT LABELS	31
IDENTIFICATION NUMBERS	35
Hull	35
4-TEC Engine.....	35
CONTROLS, COMPONENTS AND INSTRUMENTS LOCATION	36
Cockpit	36
Overview	37
CONTROLS, COMPONENTS AND INSTRUMENT FUNCTIONS	41
1) Safety Lanyard/DESS™ Switch (engine cut-out switch)	41
2) Steering Wheel.....	42
3) Throttle/Shifter Controller	42
4) Start/Stop Button	43
5) Navigation Lights Switch.....	44
6) Bilge Pump Switch	45
7) Bilge Air Blower Switch	46
8) Fuel Gauge	46
9) Tachometer	46
10) Speedometer	47
11) Monitoring Gauge	47
12) Bilge Drain Plugs	48
13) Grab Handles	48
14) Rear Grab Handles	48
15) Swim Platform	49
16) Ladder	49
17) Seats.....	50

18) Front Boarding Step.....	50
19) Spotter Seat.....	50
20) Cup Holders.....	50
21) Front Storage Compartment.....	50
22) Deck Storage Compartment.....	51
23) Rear Storage Compartment.....	52
24) Jet Pump Water Intake.....	53
25) Bow Lights.....	53
26) Stern Light Socket.....	53
27) Mooring Cleats.....	55
28) Deck.....	55
29) Fuel Tank Cap.....	55
30) Deck Drain.....	56
31) Oil Fill Cap (on engine).....	56
32) Flushing Connector.....	56
33) Ventilation Ducts.....	57
34) Bow/Stern Eyelets.....	57
35) Jet Pump Nozzle.....	57
36) Reverse Gate.....	58
37) Scupper Valve.....	58
38) Fuel Tank Vent.....	58
39) Water Sport Towing Attachments.....	59
40) Main Battery Cut-Off Switch.....	62
41) AM/FM Radio/CD Player.....	63
42) 12-Volt Jack.....	63
43) Fuses.....	63
44) Inlet Clearance System (ICS) Switch.....	63
45) Horn Switch.....	64
46) Deck Lights Switch.....	65
47) Glovebox.....	65
48) Bow Seats.....	65
49) Bow Seat Storage Compartments.....	65
50) Bow Filler Cushion (if so equipped).....	65
51) Rear Seat Storage Compartments.....	66
52) Passenger Storage Compartment.....	67
53) Engine Cover.....	67
54) Port Bilge Access.....	67
55) Removable Cooler.....	67
FUEL AND LUBRICATION.....	68
Fueling Procedure.....	68
Recommended Fuel.....	68
Engine Oil.....	69
Engine Coolant.....	71
BREAK-IN PERIOD.....	72
10-Hour Inspection.....	72
PRE-OPERATION CHECKS.....	74
Hull.....	75

Jet Pump Water Intake.....	75
Bilge.....	76
Battery.....	76
Fuel Tank and Oil Level.....	76
Engine Compartment.....	76
Fire Extinguisher.....	76
Steering System.....	76
Throttle System.....	76
Shifter System.....	76
Safety Lanyard and Engine Start/Stop Button.....	77
Storage Compartment Covers.....	77
OPERATING INSTRUCTIONS.....	78
Launching/Loading.....	78
Trailing.....	78
Principle of Operation.....	78
Boarding from a Dock.....	79
Boarding from the Water.....	80
Starting.....	81
Rough Water or Poor Visibility Operation.....	81
Crossing Waves.....	81
Stopping/Docking.....	82
Beaching.....	82
POST-OPERATION CARE.....	83
General Care.....	83
Additional Care for Foul Water or Salt Water.....	83
Exhaust Cooling System Flushing.....	83
SPECIAL PROCEDURE.....	85
Engine Overheating.....	85
Jet Pump Water Intake and Impeller Cleaning.....	85
Capsized Boat.....	85
Submerged Boat/Water-Flooded Engine.....	86
Fuel-Flooded Engine.....	86
Towing the Boat in Water.....	86
Low-Charge Battery Condition.....	87
<i>MAINTENANCE INFORMATION</i>	
MAINTENANCE.....	90
Emission Component Maintenance.....	90
Engine Emissions Information.....	90
Lubrication.....	91
Periodic Inspection.....	92
Throttle Cable.....	92
Fuel and Oil Filters.....	93
Steering/Jet Pump Nozzle Adjustment.....	93
Reverse Gate.....	93
Deck Drain.....	93

Fuses.....	94
Bilge Air Blower.....	97
Navigation Light Bulb Replacement	97
Sacrificial Anode System.....	99
General Inspection and Cleaning.....	100
STORAGE AND PRESEASON PREPARATION	101
Storage.....	101
Fuel System	101
Engine Oil and Filter Replacement.....	101
Exhaust Cooling System Flushing and Engine Internal Lubrication	101
Preseason Preparation	104
Preseason Preparation Chart	105
TROUBLESHOOTING	106
PERIODIC INSPECTION CHART	111
SPECIFICATIONS	114

WARRANTY INFORMATION

BRP INTERNATIONAL LIMITED WARRANTY FOR MODEL YEAR 2006 SEA-DOO® SPORT BOATS.....	122
DECLARATION CE OF CONFORMITY	126
PRIVACY INFORMATION.....	129
CHANGE OF ADDRESS.....	131

FOREWORD

This Operator's Guide has been prepared to acquaint the owner/operator or passenger of this boat with the various controls, maintenance and safe riding instructions. It is indispensable for the proper use of the product, and should be kept in a waterproof bag in the boat at all times. Make sure you read and understand the content of this document.

For any questions pertaining to the warranty and its application, please consult an authorized Sea-Doo sport boat dealer.

Hazard Statements

As you read this Operator's Guide, please note the hazard warnings which alert you to safety precautions related to unsafe conditions or operating procedures.

This guide uses the following symbols to emphasize particular information.



The safety alert symbol is recognized around the world. In this manual, it means read this information carefully! Be sure you understand the consequences of the hazards and how to avoid them. Failure to follow the recommendations in a hazard communication statement may result in property damage, personal injury, or death.

People often refer to a hazard statement as a warning in a general sense. This manual uses three kinds of "warnings" depending on the likely effect of a hazard (minor injury, severe injury, death).

WARNING

Identifies a potentially or imminently hazardous situation which, if not avoided, **COULD** result in serious personal injuries including the possibility of death or substantial property damage.

CAUTION: This signal word indicates a potentially hazardous situation which, if not avoided, may result in minor or moderate personal injury or property damage. It may also be used to alert against unsafe practices.

NOTE: Indicates supplementary information needed to fully complete an instruction relating to equipment operation and/or maintenance procedures.

Although the mere reading of such information does not eliminate the hazard, the understanding and application of the information will promote correct and safe use of the boat.

The warnings in this supplement do not and cannot address every conceivable situation. Always use common sense! If a procedure, method, tool, or part is not specifically recommended, you must satisfy yourself that it is safe for you and others and that your boat will not be damaged or made unsafe as a result of your decision.

Advisory Statements

Advisory statements alert you to conditions that affect equipment operation, maintenance, and servicing practices.

An **IMPORTANT** statement indicates a procedure intended to prevent damage to equipment or associated components.

The information and components/system descriptions contained in this supplement are correct at the time of publication. Bombardier Recreational Products (BRP) however, maintains a policy of continuous improvement of its products without imposing upon itself any obligation to install them on products previously manufactured.

Because of our ongoing commitment to product quality and innovation, BRP reserves the right at any time to discontinue or change specifications, designs, features, models or equipment without incurring obligation.

The illustrations in this document show the typical construction of the different assemblies and may not reproduce the full detail or exact shape of the parts. However, they represent parts that have the same or similar function.

It is understood that this guide may be translated into another language. In the event of any discrepancy, the English version shall prevail.

Specifications are given in the SI metric system with the SAE U.S. equivalent in parenthesis. Where precise accuracy is not required, some conversions are rounded off for easier use.

A shop manual can be obtained for complete service, maintenance and more repair information.

SAFETY INFORMATION

SAFETY

Your safety and that of your passengers and fellow boaters is YOUR responsibility. Before launching your boat, you should completely read and understand this Operator's Guide, product warnings and labels, the *SAFETY VIDEOCASSETTE* and other information provided with your boat or by your dealer. Heed and follow all warnings, safety precautions and operating procedures.

BRP strongly recommends that you take an approved boating safety course. Always operate your boat in compliance with safe boating rules, and with consideration, courtesy and common sense. Failure to do so could result in injury, including the possibility of death, to you, your passengers, others you lend your boat to, or other water users.

Safe Boating Checklist

When leaving on a cruise, whether for an hour or for several days, go through the following Safe Boating Checklist.

Reminders Regarding Operation...

- The performance of this boat may significantly exceed that of other boats you may have operated. Become completely familiar with the controls and operation of this boat before embarking on your first trip or taking on a passenger(s). If you have not had the opportunity to do so, practice driving solo in a suitable traffic-free area and feel the response of each control. Be fully familiar with all controls before accelerating above idle speed. Do not assume that all boats handle identically. Each model differs, often substantially.
- Always keep in mind that as the throttle lever is returned to the idle position, less directional control is

available. To turn the boat, both steering and throttle are necessary.

- Like any other boat, this boat has no brake. Stopping distance will vary depending on initial speed, load, wind, and water conditions. Practice stopping and docking in a safe, traffic-free area to have an idea of how long it will take to stop the boat under varying conditions. Do not release the throttle when trying to steer away from objects. You need throttle to steer. Do not use the boat's reverse to stop.
- Do not start or operate the boat if any person is not properly seated in a seat intended for use when underway (not the sun deck or swim platform) or if a person is nearby in the water.
- The boat's jet thrust can cause injury. Always accelerate slowly, and decelerate in a controlled fashion.
- Observe the instructions on all safety labels. They are there to help assure that you have a safe and enjoyable outing.
- Riding with passenger(s) or pulling other boats, tubes, a skier or a wake boarder makes the boat handle differently and requires greater skill.
- Certain boats may come equipped with tow eyelets, a ski pole or a wakeboard tower which can be used to attach a tow rope for a skier, tube or wakeboarder. Do not use these attachment points or any other portion of the boat to tow a parasail or another craft. Personal injury or severe damage may occur.
- In shallow water, proceed with caution and at very low speeds. Grounding or abrupt stops may result in injury to you, your passengers or others. The jet pump may pick up debris and throw it rearward causing a risk of injuring people or damaging the jet pump or other property.

- Engine exhaust contains carbon monoxide (CO), which can cause injury or death if inhaled in sufficient quantities. Do not operate the boat in a confined area or allow CO to accumulate in or around the boat, or in enclosed or sheltered areas. Such as when docked, or when rafting. Be aware of risk of CO from exhaust of other boats.
- Educate all occupants about the risks and symptoms of CO accumulation and CO poisoning, particularly from engine and generator exhaust. Educate them about where engine exhaust outlets (and generator outlets if so equipped) are located. Regularly inspect exhaust and generator system and outlets for component failures or obstructions.
- Combustion engines need air to operate; consequently this boat can not be totally watertight. Any maneuvers such as figure eights that cause the upper deck to be under water may cause severe engine problems due to water ingestion. Refer to the *SPECIAL PROCEDURES* and *LIMITED WARRANTY* sections contained in this Operator's Guide.
- Respect no wake zones, the rights of other water users and the environment. As the "skipper" and owner of a boat, you are responsible for damage to other boats caused by the wake of your boat. Do not let anyone throw refuse overboard.
- Between sunset and sunrise, use the boat's navigation lights and reduce speed. Do not operate the boat in reduced visibility.
- Do not add accessories or equipment that may adversely affect visibility or alter control of the boat.
- The skipper should personally take the helm during storms.

Before Getting Underway...

- Always perform the pre-operation checks as specified in this Operator's Guide.
- Do not exceed the payload or passenger capacities for this boat, which are listed on the capacity plate and in the specifications. Overloading can affect maneuverability, stability and performance. Also, heavy seas reduce capacity. A payload or person capacity plate is not an excuse for failure to use common sense or good judgment.
- Regularly inspect the boat, the hull, engine, safety equipment, and all other boating gear and keep them in safe operating condition.
- Be sure you have the minimum required safety equipment, PFDs and any additional gear needed for your cruise.
- Check that all lifesaving equipment, including fire extinguisher, is in safe operating condition and easily accessible. Show all passengers where this equipment is, and make sure they know how to use it.
- Keep an eye on the weather. Check local weather broadcasts before departure. Be alert to changing conditions.
- Keep accurate and up-to-date charts of the boating area on board. Before getting underway, check water conditions in the planned boating area.
- Before departure, file a Float Plan with a responsible person ashore.
- Keep enough fuel on board for the planned trip. Always verify fuel level before use and during the ride. Apply the principle of 1/3 of the fuel to reach your destination, 1/3 to return, and keep 1/3 in reserve. Allow for changes due to adverse weather or other delays.

Operators and Passengers...

- Never operate a boat while under the influence of drugs or alcohol. It is a Federal offense. Allow only qualified drivers to operate your boat. Remember that sun, wind, alcohol, drugs, fatigue or illness may impair your judgement and reaction time.
- At least one passenger should be able to operate the boat in case the operator is unexpectedly unable to do so.
- Operation of this boat by a person under 16 years of age or a person with a disability that impairs vision, reaction time, judgment, or operation of the controls is NOT recommended.
- Always use the safety lanyard when operating the boat and ensure that all passengers are familiar with its use.
- Ensure that any operator and all passengers know how to swim and how to re-board the boat from the water. If a passenger does not know how to swim, ensure that passenger wears a PFD at all times and take extra precautions when boating.

Regarding Fuel and Fueling...

- Remember that fuel and gasoline fumes are flammable and explosive under certain conditions. Be very careful when fueling and adhere to the fueling procedures contained in this Operator's Guide and those given to you by the marina. Always stop the engine before fueling and never allow anyone to remain in the boat while fueling. Each time you fill up, assure that the engine compartment is free of gasoline vapors, and inspect fuel lines for leaks and hose deterioration.
- Do not smoke or allow open flames or sparks in the vicinity.
- Know the capacity of the fuel tank. Avoid fueling at night except under

well-lit conditions. Gas spills are not noticeable in the dark. Do not carry spare fuel or flammable liquids in any of the storage or engine compartments.

Safety Equipment

An operator and the boat's passenger(s) should have ready access to shatterproof glasses should riding conditions or personal preference warrant.

Wind, water spray and speed may cause a person's eyes to water and create blurred vision.

As the owner of the boat, you are responsible for assuring that all required safety equipment is aboard. You should also consider supplying additional equipment as needed for your safety and that of your passengers. Check state and local regulations.

Required Safety Equipment

Safety equipment required by federal regulations is mandatory. Personal flotation devices must be fitted to the people wearing them. Minimum requirements include the following:

- personal flotation devices
- fire extinguisher
- visual distress signal
- navigation lights
- bell or whistle.

A cellular telephone in a waterproof bag or container has also been found to be beneficial to boaters when in distress or just for contacting someone on shore.

Personal Flotation Devices (PFDs)

Federal regulations require that you have at least one Coast Guard approved personal flotation device (PFD) for each person in a recreational boat and require that all children under 13 years of age wear a PFD at all times when the boat is underway, except when below deck or in an enclosed cabin. You may not use your boat unless all PFDs are in serviceable condition, readily accessible, legibly marked with the Coast Guard approval number, and of an appropriate size (within the weight range and chest size marked on the PFD) for each person on board.

A PFD provides buoyancy to help keep your head above the water and to help you remain in a satisfactory position while in the water. Body weight and age should be considered when selecting a PFD. The buoyancy provided by the PFD should support your weight in water. The size of the PFD should be appropriate for the wearer. Body weight and chest size are common methods used to size PFDs. It is your responsibility to ensure that you have the proper number and types of PFDs on board to comply with federal and local regulations and that your passengers know where they are and how to use them.

PFD Types

Five types of PFDs have been approved by the U.S. Coast Guard.

PFD Type I, Wearable has the greatest required buoyancy. Its design allows for turning most unconscious persons in the water from face down position to a vertical or slightly backward, face-up position. It can greatly increase the chances of survival. Type I is most effective for all waters, especially offshore when rescue may be delayed. It is also the most effective in rough waters.

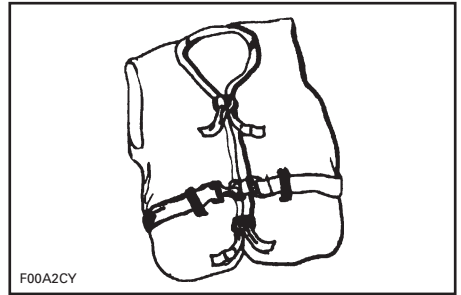

TYPE I — WEARABLE

PFD Type II, Wearable turns its wearer in the same way as Type I, but not as effectively. The Type II does not turn as many persons under the same conditions as a Type I. You may prefer to use this PFD where there is a probability of quick rescue such as in areas where other people are commonly involved in water activities.

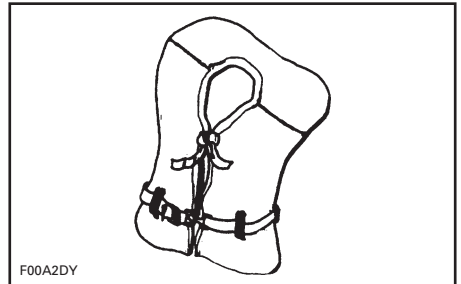

TYPE II — WEARABLE

PFD Type III, Wearable allows wearers to place themselves in a vertical or slightly backward position. It does not turn the wearer. It maintains the wearer in a vertical or slightly backward position and has no tendency to turn the wearer face down. It has the same buoyancy as a Type II PFD and may be appropriate in areas where other people are commonly involved in water activities.

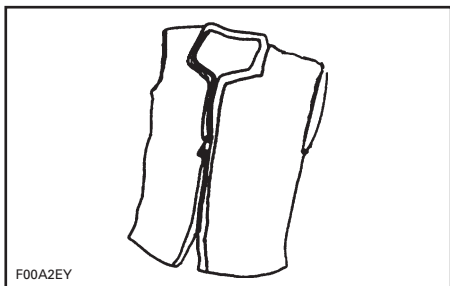

TYPE III — WEARABLE

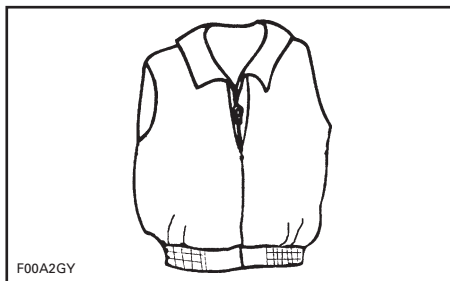

TYPE V — WEARABLE

PFD Type IV, Throwable is required in addition to the PFDs previously discussed. The most common Type IV PFD is a buoyant cushion or ring buoy. It is designed to be thrown to a person in the water, grasped and held by the user until he or she is rescued. A Type IV PFD should always be in serviceable condition and immediately available for use. Grasping this PFD may be difficult if the rescue is delayed or if the user is overcome by hypothermia (loss of body heat).

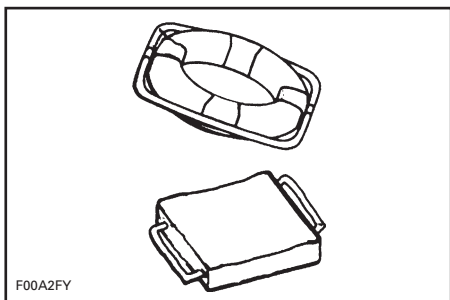

TYPE IV — THROWABLE

PFD Type V, Wearable must be worn. When inflated, it provides buoyancy equivalent to Type I, II or III PFDs. When it is deflated, however, it may not support some people.

PFD Pointers

The purpose of a PFD is to help save your life. If you want it to support you when you are in the water, it needs to fit, float, and be in good condition.

- Try the PFD on and adjust it until it fits comfortably in and out of the water. Mark your PFD if you are the only wearer.
- To make sure the PFD works, wear it in the water. This will show you how it works and give you confidence when you use it.
- Teach children how to put a PFD on and allow them to try it in the water. That way, they know what the PFD is for and how it works. They will feel more comfortable with it if they suddenly find themselves in the water.
- If the PFD is wet, allow it to dry thoroughly before storing it. Do not dry it in front of a radiator or heater. Store it in a well-ventilated area.
- Keep PFDs away from sharp objects which can tear the fabric or puncture the flotation pads.
- For their own safety and the safety of others, all non-swimmers, poor swimmers, and small children should wear PFD's at all times whether the boat is stationary or moving.
- Check the PFD frequently to make sure that it is not torn, that flotation pads have no leaks, and that all seams and joints are securely sewn.

- If a PFD contains kapok, the kapok fibers may become waterlogged and lose their buoyancy after the vinyl inserts are punctured. If the kapok becomes hard or if it is soaked with water, replace it. It may not work when you need it.

Hypothermia

Hypothermia, the loss of body heat to the water, is a significant cause of deaths in boating accidents. After an individual has succumbed to hypothermia, he or she will lose consciousness and then drown.

PFDs can increase survival time because of the insulation they provide.

Naturally, the warmer the water, the less insulation one will require. When operating in cold water (below 4.4°C (40°F)) consideration should be given to using a coat or jacket style PFD as they cover more of the body than the vest style PFDs.

Some points to remember about hypothermia protection:

1. While afloat in the water, do not attempt to swim unless it is to reach a nearby boat, fellow survivor, or a floating object on which you can lean or climb. Unnecessary swimming increases the rate of body heat loss. In cold water, drown-proof methods that require putting your head in the water are not recommended. Keep your head out of the water. This will greatly lessen heat loss and increase your survival time.
2. Keep a positive attitude about your survival and rescue. This will improve your chances of extending your survival time until rescue. Your will to live does make a difference!
3. If there is more than one person in the water, huddling is recommended while waiting to be rescued. This action tends to reduce

the rate of heat loss and thus increase the survival time.

4. Always wear your PFD. It won't help you fight off the effects of hypothermia if you don't have it on when you go into the water.

Fire Extinguishers

As the owner of the boat, you are responsible for supplying a fire extinguisher approved by the U.S. 4.8 to less than 7.9 m (16 - 26 ft) are required to carry one (1) B-1 type hand portable fire extinguisher unless the boat is equipped with a fixed fire extinguishing system in the engine compartment.

Hand-held portable fire extinguishers should be mounted in readily accessible locations away from the engine compartment. All persons aboard should know the location and proper operation of the fire extinguisher(s).

NOTE: Don't test fire extinguishers by squirting small amounts of the extinguishing compound. The extinguisher might not work when you really need it!

Visual Distress Signal Devices

Visual distress signal equipment may be of the pyrotechnic or non-pyrotechnic type. Regulations prohibit display of visual distress signals on the water under any circumstances except when assistance is required to prevent immediate or potential danger to persons on board a vessel.

The equipment must be approved, be in serviceable condition, and be stowed in a readily accessible location. Equipment having a date for serviceable life must be within the specified usage date shown.

Careful selection and proper stowage of visual distress equipment is very important if children are aboard.

WARNING

Fire! In case of fire, do not open engine compartment. Turn off engine. Using portable CO₂ fire extinguisher, continuously discharge entire contents at base of fire.

DAY USE ONLY

- Three orange smoke signals (one hand held and two floating) or one orange flag with black square and disk

NIGHT USE ONLY

- One S-O-S electric distress light

DAY AND NIGHT USE

- Three flares of the hand held, meteor or parachute type

Sound Signaling Devices

NOTE: No single signaling device is appropriate for all purposes. Consider keeping various types of equipment on board.

Boats less than 7.9 m (26 ft) in length are required to carry a hand, mouth, or power operated horn or whistle. It must produce a blast of two second duration and audible at a distance of at least 800 m (1/2 mi).

Following are standard whistle signals:

- one prolonged blast (warning signal)
- one short blast (pass on my port side)
- two short blasts (pass on my starboard side)
- three short blasts (engines in reverse)
- five or more blasts (danger signal).

Navigation Lights

Navigation lights are intended to keep other vessels informed of your presence and course. If you are out on the water between sunset and sunrise, you are required to display appropriate navigation lights.

Additional Recommended Equipment

It is recommended that you acquire additional equipment for safe, enjoyable cruising. This list, which is not all inclusive, includes items you should consider acquiring.

BASIC GEAR

- flashlight
- mooring lines
- compass
- oar or paddle
- distress signals
- first aid kit
- dock fenders
- VHF radio
- EPIRB (Electronic Position Indicating Radio Beacon)
- boat hook
- extra warm clothing
- charts
- sunblock
- tow line
- second anchor and line
- dewatering device (pump or bailer)
- emergency supply of drinking water and food.

TOOLS

- spark plug wrench
- hammer
- screwdrivers
- jackknife
- pliers
- electrician's tape
- adjustable wrench
- lubricating oil
- duct tape.

For additional tools, see your dealer.

SPARE PARTS

- extra bulbs
- extra fuses
- extra drain plug
- spark plugs
- spare wire.

For additional parts, see your dealer.

Carbon Monoxide and Boating

Burning a material containing carbon produces carbon monoxide (CO), an odorless and colorless gas. Because CO weighs the same as air, it can spread throughout an enclosed space unnoticed because you cannot see it or smell it. Any device used to burn carbon-based materials on a boat can be a source of CO. Common sources of CO include internal combustion engines.

CO reacts with the blood to reduce the ability of the blood to carry oxygen. The reduced oxygen supply to body tissues results in death of the tissue. Prolonged exposure can cause brain damage or death. In high concentrations, CO can be fatal within minutes. The effects of CO in lower concentrations are cumulative and can be just as lethal over long periods of time.

Symptoms of CO poisoning include: Itchy and watering eyes, flushed appearance, throbbing temples, inability to think coherently, ringing in the ears, tightness across the chest, headaches, drowsiness, nausea, dizziness, fatigue, vomiting, collapse, and convulsions. If any of these symptoms are evident, begin treatment immediately. Prompt action can make the difference between life and death.

- Evacuate the area and move the victim to fresh air.
- Administer oxygen if available and get medical help.

- Open all canvas enclosures to ventilate the area.
- Investigate the source of CO and take immediate corrective action.
- Be especially aware of other CO sources which may be near boat.

Carbon Monoxide Accumulation

Following are examples of possible situations where CO may accumulate within your boat while docked, anchored, or underway. Become familiar with these examples and their precautions to prevent personal injury or death.

WARNING

Exhaust fumes! Generator or hull exhaust from other vessels while either docked or anchored can emit poisonous CO gas and cause excessive accumulation within cabin and cockpit areas. Be alert for generator exhaust from your vessel or other vessels alongside. Exhaust outlets near a pier, dock, seawall or outlets blocked by any other means can cause excessive accumulation of poisonous CO gas within cockpit area.

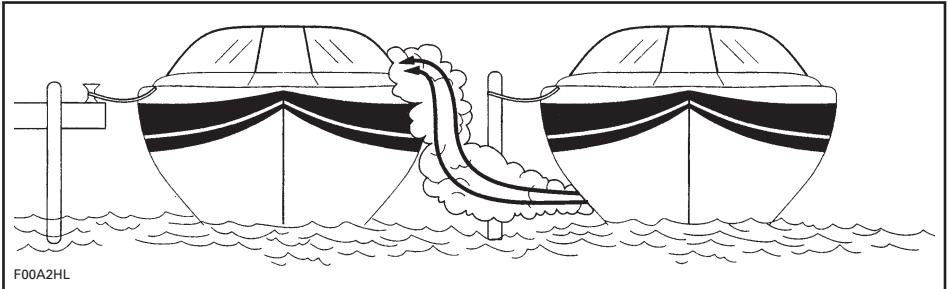

VESSEL ALONGSIDE

WARNING

Engine exhaust fumes contain carbon monoxide (CO) which can accumulate in and around the boat (under Bimini top, in cockpit, etc.). CO can be harmful or fatal if inhaled. Assure there is adequate ventilation whenever running engine(s).

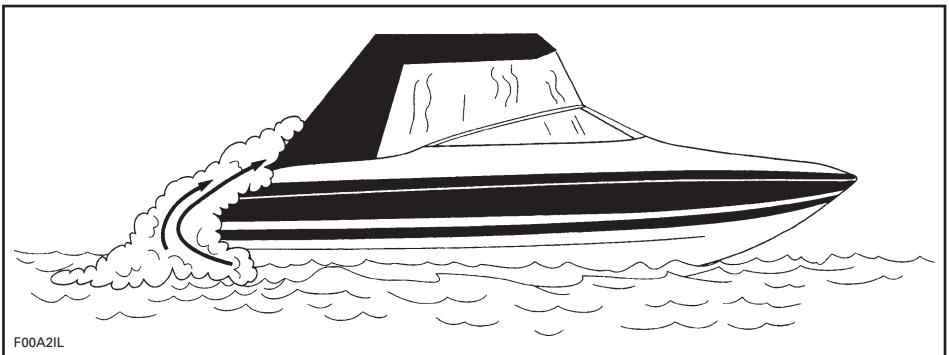

WHILE UNDERWAY (BACKDRAFTING)

While underway, CO concentrations can increase by backdrafting or “the station wagon effect”. Backdrafting is caused by factors such as relative wind direction, speed, or the bow being too high. To prevent this, open canvas whenever possible to provide positive airflow through the hull.

Boat houses, seawalls, and other boats in close proximity or confined areas can contribute to increased CO levels. Operators must be aware that operation, mooring, and anchoring in an area with other boats puts them in jeopardy of CO accumulation from other sources. Likewise, a boat operator must be aware of how exhaust from his boat will affect others. Operation of the engines while moored may cause CO accumulation in your boat and those around you.

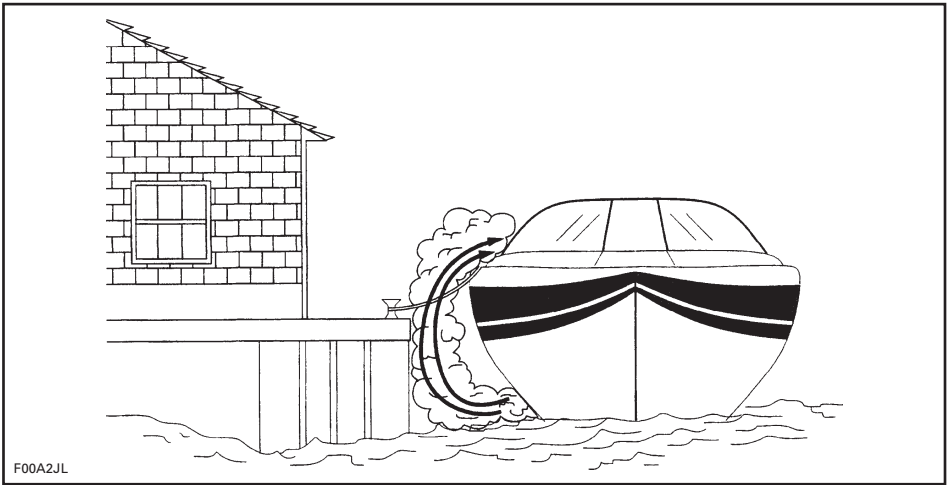

CONFINED AREAS

Be sure to provide adequate ventilation. If the windshield has vents, open them before getting underway to increase positive air flow and decrease the chances of CO accumulation.

⚠ WARNING

Backdrafting! Under certain conditions, moving air currents can direct poisonous CO fumes into boat. These fumes can accumulate to dangerous levels without proper airflow. Provide adequate ventilation, redistribute the load or bring boat out of high bow angle.

Even with the best boat design and construction, CO may still accumulate in enclosed or confined areas under certain conditions. Continually observe passengers for symptoms of CO poisoning.

Do NOT Operate your Boat without Performing the Following Checklist:

Each Boating Day

OPERATION	✓
Make sure you and your passengers know where exhaust outlets are located on the vessel	
Educate all passengers about the symptoms of CO poisoning and where CO may accumulate	
When docked or rafting with another boat, be aware of exhaust emissions from the other boat	
Confirm that water flows from the exhaust outlet when the engine(s) is (are) started	
Listen for any change in exhaust sound, which could indicate an exhaust component failure	
Test the operation of each CO alarm by pressing the test button	

CO Detector

It is strongly recommended that you have CO detectors installed in boats with canvas enclosures. Monitors are available from your dealer. Monitors should be professionally installed and calibrated.

NOTE: A CO detector is not a gas fuel vapor detector. Gas fuel vapor detectors do not monitor the buildup of CO in an enclosed area.

Lanyard Stop Switch/DESS

This safety device automatically stops the engine if the lanyard is attached to the operator and the operator falls from the control station.

The DESS post incorporates a shutoff switch, lanyard cap, lanyard, and lanyard clip. The lanyard clip must be securely attached to the operator's PFD, clothing, arm, or leg. Be sure to attach the lanyard clip to a place where it is free of obstructions and to something that will move with the operator if he or she leaves the helm station. If the engine shuts down because the lanyard cap was removed, the cap must be reinstalled on the DESS post before the engine can be restarted.

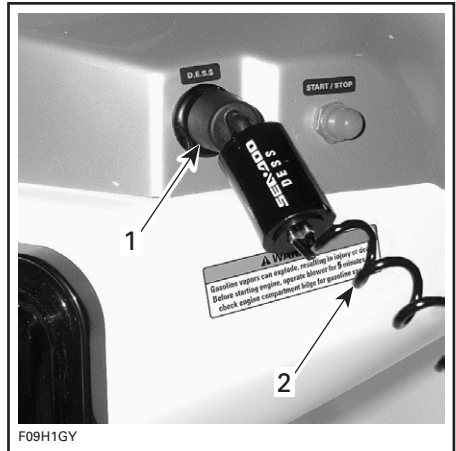

TYPICAL — IGNITION INTERRUPTER (STOP SWITCH) WITH LANYARD

1. DESS cap
2. Safety lanyard

⚠ WARNING

Always use the safety lanyard when operating your boat. Keep DESS post free from obstructions that could interfere with its operation. Do not modify or remove DESS or bypass its safety features. The proper use of the DESS can prevent a runaway boat situation which otherwise could cause severe personal injury or death.

Safe Boating Practices

YOU are responsible for your own safety, the safety of your passengers, and the safety of fellow boaters.

Drugs and Alcohol

Do not use drugs or drink alcohol while operating a boat. Like driving a car, driving a boat requires sober, attentive care. Operating a boat while intoxicated or under the influence of drugs is not only dangerous, but it is also a Federal offense carrying a significant penalty. These laws are vigorously enforced. The use of drugs and alcohol, singly or in combination, decreases reaction time, impedes judgment, impairs vision, and inhibits your ability to safely operate a boat.

WARNING

Alcohol consumption and boating do not mix! Operating under the influence endangers the lives of your passengers and other boaters. Federal laws prohibit operating a boat under the influence of alcohol or drugs.

Safe Operation

For safety reasons and proper care, always perform "Daily Pre-Operation Checks" as specified in your Operator's Guide before operating your boat. Safe operation means that you do not misuse your boat nor do you allow your passengers to do so. Safe operation means using good judgment at all times. It includes, without limitation, the following actions:

- Load the boat within the limits listed on the capacity plate. Balance loads bow to stern and port to starboard.
- Maintain boat speed at or below the local legal limit. Avoid excessive speed or speeds not appropriate for operating conditions.
- Do not use the boat in weather or sea conditions beyond the skill or

experience of the operator or the comfortable capability of the boat or passengers.

- Be sure at least one other passenger is familiar with the operation and safety aspects of the boat in case of an emergency.
- Make sure that passengers and gear do not obstruct the operator's view or ability to move.
- Do not exceed the maximum engine power rating stated on the certification plate attached to the boat.
- Observe all safety signs and warnings both inside the boat and in the immediate boating area.

Passenger Safety

Before getting underway, show all passengers where emergency and safety equipment is stowed, and explain how to use it. Everyone aboard should wear rubber-soled shoes which resist slipping on wet surfaces. While underway, passengers should remain seated inside the deck rails. Don't allow passengers to drag their feet or hands in the water. Always use handholds and other safety hardware to prevent falls. All non-swimmers, poor swimmers, and children should wear a PFD at all times. Federal regulations require that children under 13 years of age wear a PFD when the boat is underway unless they are in an enclosed cabin or below deck.

First Aid

As a boat operator, you should be familiar with basic first aid procedures that may be needed while you are far from help. Fish hook accidents or minor cuts and abrasions may be the most serious mishaps on board a boat, but you should also learn the proper procedures and be ready to deal with the truly serious problems like excessive bleeding, hypothermia, and burns. First aid literature and courses are available through most Red Cross chapters.

Operation by Minors

Minors should always be supervised by an adult whenever operating a boat. Many states have laws regarding the minimum age and licensing requirements of minors. Be sure to contact the state boating authorities for information. BRP recommends a minimum operator age of 16 years old.

Rules of the Road

As a responsible boater, you will comply with the "Rules of the Road". Navigating a boat is much the same as driving an automobile. Operating either one responsibly means complying with a set of rules intended to prevent accidents. Just as you assume other car drivers know what they are doing, other boaters assume you know what you are doing.

Operating a boat can be compared with driving unmarked highways and roads. To prevent collisions or avoid other boaters, a system of operating rules must be followed. It's not only common sense... it's the law!

Check local and federal boating laws applicable to the waterways where you intend to use your boat. Learn the local rules of the road. Know and understand the applicable navigation system (such as buoys and signs).

Know the waters in which the boat is to be operated. Current, tides, rapids, hidden obstacles, wakes and waves etc. can affect safe operation. It is not advisable to operate the boat in rough or inclement weather.

Remember these Rules of the Road Know the Right of Way Rules

Generally keep to your right and safely avoid other craft by keeping a safe distance from other craft, people and objects.

CROSSING

Give right of way to craft ahead and to your right. Never cross in front of another craft.

RED light (give way to the other craft).

GREEN light (you have the right of way).

MEETING HEAD-ON

Keep right.

PASSING

Give right of way to other craft and keep clear.

Navigation System

Navigational aids, such as signs or buoys, can help you identify safe waters. Buoys will indicate whether you should keep to the right (starboard) or to the left (port) of the buoy or to which channel you can continue. They may also indicate whether you are entering a restricted or controlled area such as a no wake or speed zone. They may also indicate hazards or pertinent boating information. Markers may be located on shore or on the water. They can also indicate speed limits, no power craft or boating, anchorage and other useful information. (The shape of each type of marker will provide assistance).

Make sure you know and understand the navigation system applicable to the waterways where you intend to use the boat.

Collision Avoidance

- Do not decrease throttle when trying to steer away from objects. You need throttle to steer.
- Always keep a constant lookout for other water users, other craft or objects, especially when turning. Be alert for conditions that may limit your visibility or block your vision of others.
- Respect the rights of other recreationists and/or bystanders and always keep a safe distance from all other craft, people and objects.
- Do not wake or wave jump, ride the surf line or attempt to spray or splash others with your boat. You may misjudge the ability of the boat or your own driving skills and strike a boat or person.
- This boat has the capability of turning more sharply than other boats. However, unless in an emergency, do not negotiate sharp, high speed turns. Such maneuvers make it hard for others to avoid you or understand where you are going. Also, you and/or your passenger(s) could be thrown from the boat.
- Like any other boat, this boat has no brake. Stopping distance will vary depending on initial speed, load, wind, and water conditions. Practice stopping and docking in a safe, traffic free area to have an idea of how long it will take to stop the boat under varying conditions.
- Maintaining or increasing speed may be necessary to avoid a collision.

Safe Riding

- Always keep in mind that as the throttle lever is returned to idle position, less directional control is available, and when the engine is off, di-

rectional control is lost. You need throttle to steer.

- While your boat has the capacity of operating at high speeds, it is strongly recommended that high speed operation only be applied when ideal conditions exist and are permitted. Higher speed operation requires a higher degree of skill and increases the risk of severe injuries.
- In shallow water, proceed with caution and at very low speeds. Grounding or abrupt stops may result in injury. Debris may also be picked up and be thrown rearward by the jet pump onto people or property.
- Do not use the boat's reverse, to stop. You or your passenger(s) could be violently ejected forward or even off the boat onto the hazard.

Operator/Passenger Awareness

- Do not start or operate the boat if anyone is seated on the sun deck or swim platform, or is nearby in the water. Water and/or debris exiting jet thrust nozzle can cause severe injury.
- The operator and passenger(s) should be properly seated before starting or moving the boat. All passenger(s) should be instructed to use the handholds or seat straps provided.
- When accelerating a boat with a passenger(s), whether from a complete stop or while underway, always do so progressively. Fast acceleration may cause your passenger(s) to lose their balance or grip and strike something in the boat or fall out of the boat. Make sure that your passenger(s) know of, or anticipate, any rapid acceleration.

Maneuverability of the Boat/Towing

- Do not overload the boat or take on more passengers than designated

for the particular boat. Overloading can affect maneuverability, stability and performance.

- Avoid adding on accessories or equipment which may alter your control of the boat.
- Riding with a passenger(s) or pulling a tube, skier or wakeboarder makes the boat handle differently and requires greater skill.
- Always respect the safety and comfort of your passenger(s) and person being towed on skis, wakeboard or other towables.
- Always carry an observer when pulling a tube, skier or wakeboarder, proceed with only as much speed as required and follow the observer's instructions. Unless absolutely necessary, do not make tight, sharp turns. Keep a safe distance from the docks, other swimmers, craft or objects.
- Use a tow rope of sufficient length and size and make sure it is adequately secured to your boat. Some boats are equipped or can be fitted with a specially designed towing mechanism. It can become a hazard should someone fall on it.

Don't Forget:

- Ride smart from the start and we all win!

Water Sports

WARNING

Avoid personal injury! Your boat is not designed for and should not be used for pulling parasails, kites, gliders, or any device which can become airborne. Use boat only for appropriate water sports.

WARNING

Teak surfing is extremely dangerous to participants due to their proximity to the rear of the boat where direct contact with the exhaust fumes from the boat engine is the highest. Carbon monoxide poisoning can occur and result in mental disorientation, dizziness, drowsiness, and loss of consciousness. The combination of carbon monoxide exposure and non-use of a life jacket (PFD) make this new water recreation activity an incredibly dangerous and potentially deadly sport.

Water skiing, wakeboarding, or riding a towed, inflatable apparatus are some of the more popular water sports. Taking part in any water sport requires increased safety awareness by the participant and the boat operator. If you have never pulled someone behind your boat before, it is a good idea to spend some hours as an observer, working with and learning from an experienced driver. It is also important to be aware of the skill and experience of the person being pulled. Always have a second person on board to observe the person in the water so the driver can concentrate on operating the boat.

Both the boat operator and observer should monitor the location of the towrope when participating in water sports. A slack tow rope can become entangled with person(s) or objects in the boat or in the water, particularly when making a tight turn or circling, and cause serious personal injury.

Everyone participating in a water sport should observe these guidelines:

- Allow only capable swimmers to take part in any water sport.
- Always wear an approved personal flotation device (PFD). Wearing a properly designed PFD helps a stunned or unconscious person

stay afloat. A Type-IV water-ski vest is an approved and practical PFD.

- Have a second person aboard to observe the person being towed and inform the driver about the participant's hand signals. The driver must give full attention to operating the boat and the waters ahead.
- Be considerate to others you share the water with.
- Never allow a person to "teak surf" behind your boat. Do not tow a person in any water sport on a short tow rope such that the person inhales exhaust fumes in concentration. Inhalation of concentrated exhaust fumes, which contain carbon monoxide, can result in CO poisoning, personal injury and death.
- Give immediate attention to a person who has fallen. He or she is vulnerable in the water alone and may not be seen by other boaters.
- Approach a person in the water from the lee side (opposite the direction of the wind). Turn off the motor before coming close to the person.
- Turn off engine and anchor the boat before swimming.
- Participate in water sports only in safe areas. Stay away from other boats, channels, beaches, restricted areas, swimmers, and heavily traveled waterways and underwater obstructions.
- Swim only in areas designated as safe for swimming. These are usually marked with a swim area buoy. Do not swim alone or at night.



SWIM AREA BUOY

- Do not water ski between sunset and sunrise. It is illegal in most states.
- Do not drive the boat directly behind a water skier, tuber or wakeboarder. At 40 km (25 mi) per hour, the boat will overtake a person who falls in the water 60 m (200 ft) in front of your boat in about 5 seconds.
- Shut engine off and remove ignition key when anyone is in the water nearby.
- Stay at least 45 m (150 ft) away from areas marked by a diver down float.

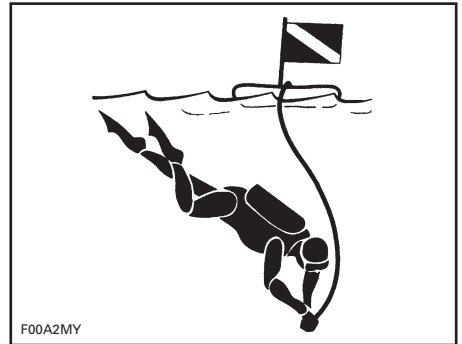

DIVER DOWN FLOAT

 **WARNING**

Avoid personal injury! Do not allow anyone near the jet pump or intake grate, even when the engine is off. Items such as long hair, loose clothing or personal flotation device straps can become entangled in moving parts resulting in serious injury or drowning. In shallow water, shells, sand, pebbles or other objects could be drawn up by the jet pump and be thrown rearward.

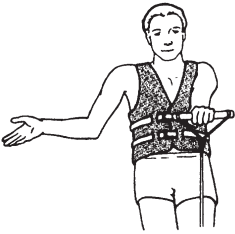

FASTER -
Palm of one hand pointing upward.



SLOWER -
Palm pointing down.



SPEED OK -
Arm upraised with thumb and finger joined to form circle.

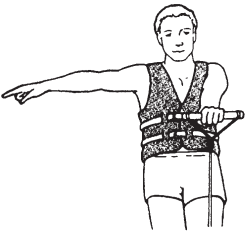

RIGHT TURN -
Arm outstretched pointing to the right.

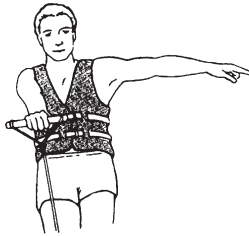

LEFT TURN -
Arm outstretched pointing to the left.



RETURN TO DROP-OFF AREA -
Arm at 45 degree from body pointing down to water and swinging.



CUT MOTOR -
Finger drawn across throat.



STOP -
Hand up, palm forward, policeman style.



SKIER OK. AFTER THE FALL -
Hands clenched together overhead.

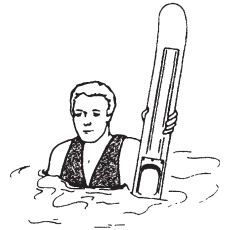

PICK ME UP OR FALLEN SKIER, WATCH OUT -
One ski extended vertically out of water.

F00A2NL

SKIING SIGNALS

VEHICLE INFORMATION

REGISTRATION NUMBER LOCATION

All boats are required by federal law to be registered and legally numbered. Due to space availability for proper display of registration number, refer to the following illustration for location. The registration number must appear on each side of the boat.

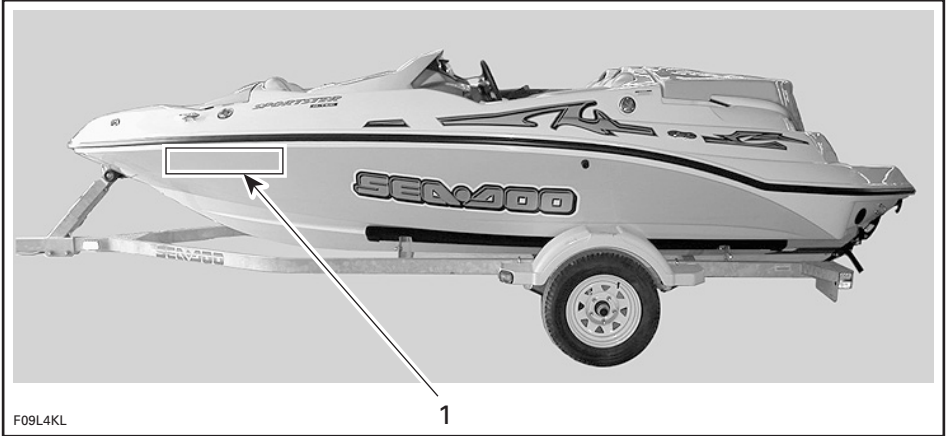

TYPICAL — SPORTSTER 4-TEC
1. Registration number location



TYPICAL — CHALLENGER 180
1. Registration number location

LOCATION OF THE IMPORTANT LABELS

The following labels are on your boat. If missing or damaged, they can be replaced free of charge. See an authorized Sea-Doo sport boat dealer.

Please read the following labels carefully before operating your boat.

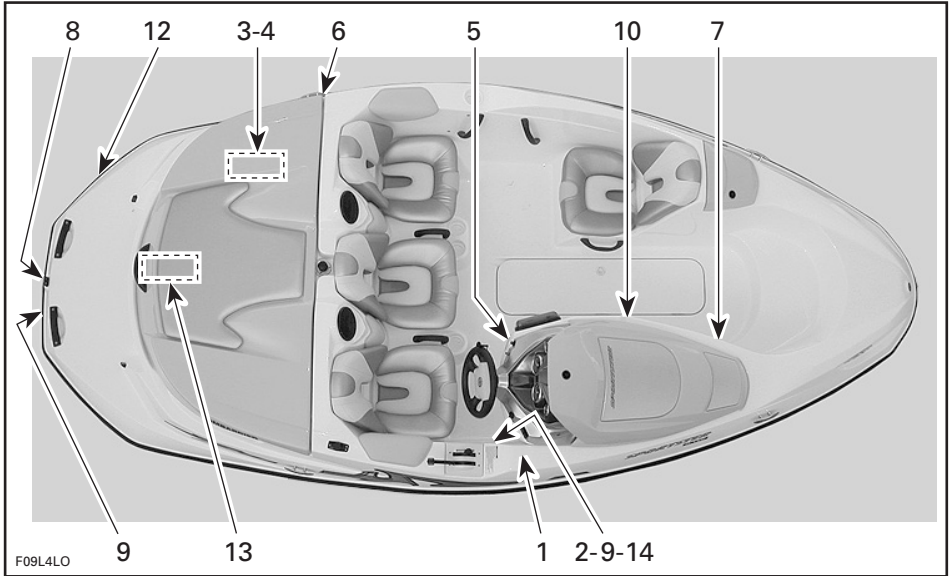

TYPICAL — SPORTSTER 4-TEC

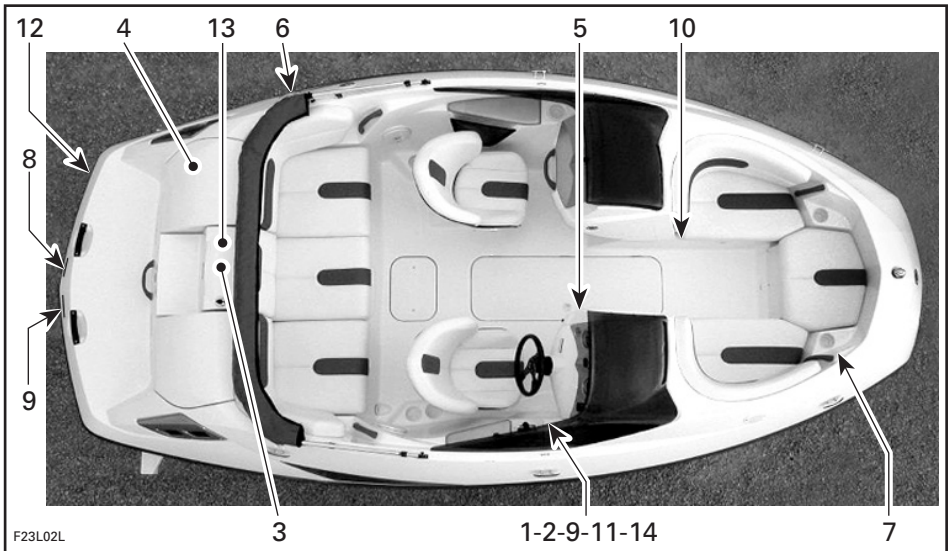

TYPICAL — CHALLENGER 180

Label 1

⚠ WARNING

Read and follow warning labels and operator's guide before operation. Severe injury or death can result from ignoring warnings or improper use of this sport boat. The performance of this sport boat may significantly exceed that of other boats you may have operated.

- Check throttle/shifter and steering operation and position before starting engine(s).
- Directional control is reduced with decreasing speed and lost when engine is off.
- Do not splash others or jump waves or wakes.
- Occupants should always wear approved PFD and recommended protective clothing.
- Do not operate if passengers are not properly seated and using handgrips, or if visibility is obstructed. Do not allow passenger(s) to ride on any portion of the boat not designated in the operator's guide as a seat for use when underway.
- Properly attach safety lanyard to your PFD.
- Keep a safe distance from all other water users. Be aware of and observe all applicable laws and regulations.

F13L1UL

Label 2



F04LAHY

TYPICAL — SPORTSTER 4-TEC

Label 3

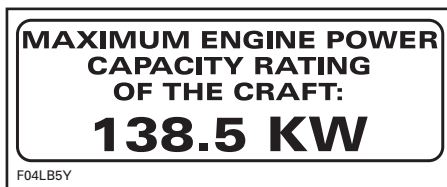

F04LB5Y

TYPICAL — SPORTSTER 4-TEC — REFER
TO ACTUAL LABEL ON BOAT



F13L0DY

TYPICAL — CHALLENGER 180

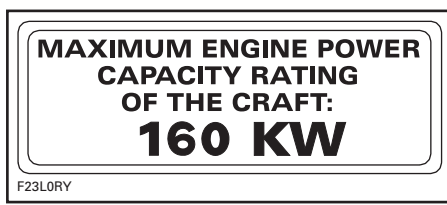

F23L0RY

TYPICAL — CHALLENGER 180 — REFER
TO ACTUAL LABEL ON BOAT

Label 4

⚠ WARNING

- Remove battery from boat before charging.
- Do not overcharge battery.
- Improper charging of battery can cause explosion.

F13L1MY

Label 7

⚠ WARNING

**Avoid Serious Or Fatal Injury.
Do Not Occupy Seat When Speed
Exceeds 5 M.P.H.**

F00L3BY

Label 5

⚠ WARNING

Gasoline vapors can explode, resulting in injury or death. Before starting engine, operate blower for 5 minutes and check engine compartment bilge for gasoline vapors.

F13L1SY

Label 8

⚠ WARNING

Avoid serious personal injury or death.

- Turn off engine(s) before using swim platform.
- Keep people, clothing and hair away from jet nozzle(s) or intake grate(s) to avoid entanglement, drowning and carbon monoxide poisoning.

F13L1OY

Label 6

⚠ WARNING

Avoid serious injury or death from fire or explosion.

- Before fueling, stop engine and keep boat level.
- Open fuel cap slowly to relieve pressure.
- Do not overfill.
- Regularly inspect fuel system for leaks.
- Use regular unleaded gasoline and check oil level.

F13L1NY

Label 9

⚠ WARNING

Engine exhaust fumes contain carbon monoxide (CO) which can accumulate in and around the boat (under bimini top, in cockpit, etc.). CO can be harmful or fatal if inhaled. Assure there is adequate ventilation whenever running engine(s).

F13L1QL

Label 10

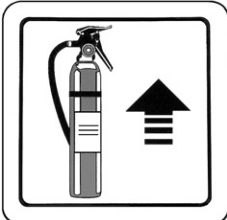

F10L3EY

Label 11

⚠ WARNING

Misuse of tower may cause severe injury or death.

- Use tower only for wakeboarding or water skiing.
- Do not allow tow rope to dangle or get entangled with occupants, boat or engine.
- Attach tow rope only at the center attachment point.
- Tow only 1 person at a time.
- Do not climb on, sit on or jump off tower.

F13L1PL

WAKE TOWER-OPTIONAL

Label 12

This product may be covered by one or more of the following US applications and/or patents and their non-US equivalents: 20040031431A1; 20040031430A1; 20030000449A1; 6,702,629; 6,701,863; 6,672,240; 6,601,528; 6,568,376; 6,544,086; 6,482,055; 6,428,371; 6,418,890; 6,415,759; 6,405,669; 6,390,869; 6,336,833; 6,332,422; 6,283,099; 5,690,520; 5,369,360; D490,766; D489,311; D485,798; D485,526; D483,315; D482,649; D469,053; D468,254; D467,860; D467,859; D465,446; D465,194; D464,601; D459,693; D409,555; D400,844.

SEA-DOO, ISLANDIA, UTOPIA, SPEEDSTER, SPORTSTER, ROTAX, 4-TEC and their associated graphic designs are trademarks of Bombardier Recreational Products Inc. or their affiliates. BOMBARDIER, CHALLENGER are trademarks of Bombardier Inc. used under license. ORBITAL and the ORBITAL logo are registered trademarks of Orbital Engine Company (Australia) Pty. Limited, used under license.



© & © 2000-2004 Bombardier Recreational Products Inc. All rights reserved.

F00L3CL

Label 13

EMISSION CONTROL INFORMATION

This engine is certified to operate on unleaded gasoline and conforms to XXXX U.S. EPA and California emission regulations for Marine SI Engines.

Engine Family:	XBXXM,XXXXR
FEL:	XXX g/kW-hr HC + NO _x
Engine Displacement:	XXX cc
Exhaust Emission Control System:	XX
Spark Plug Type:	XXX-XXXX-XX
Spark Plug Gap:	XXX in./XXX mm
Power:	XXXX kW

See operators guide for maintenance specifications

P/N 219 902 130

F04LCOY

Label 14

UNDERWAY SEATING POSITIONS

MAXIMUM PERSONS

4

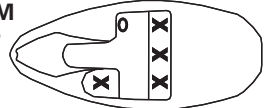

F09L5ZY

TYPICAL — SPORTSTER 4-TEC

UNDERWAY SEATING POSITIONS

MAXIMUM PERSONS

8

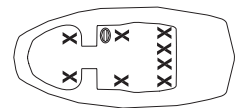

F23L04Y

TYPICAL — CHALLENGER 180

IDENTIFICATION NUMBERS

The main components of the boat (hull and engine) are identified by different serial numbers. It may sometimes become necessary to locate these numbers for warranty purposes or to trace the boat in the event of theft.

Hull

The Hull Identification Number (H.I.N.) is located on the right side of the transom.

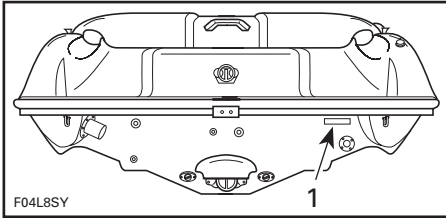

TYPICAL

1. Hull Identification Number (H.I.N.)

4-TEC Engine

The Engine Identification Number (E.I.N.) is located on the upper crankcase on MAGNETO side.

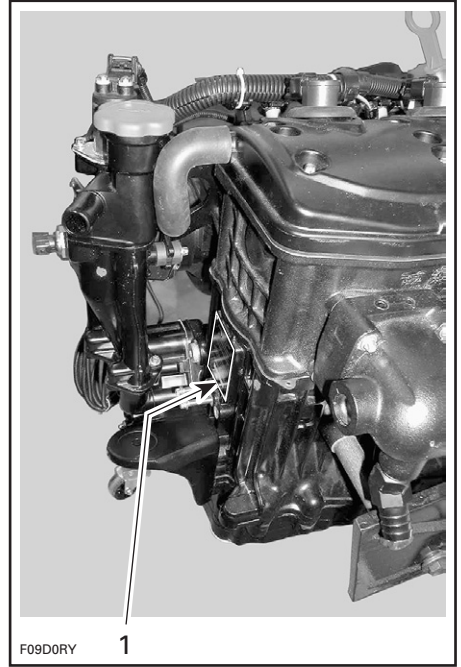

1. Engine Identification Number (E.I.N.)

CONTROLS, COMPONENTS AND INSTRUMENTS LOCATION

Cockpit

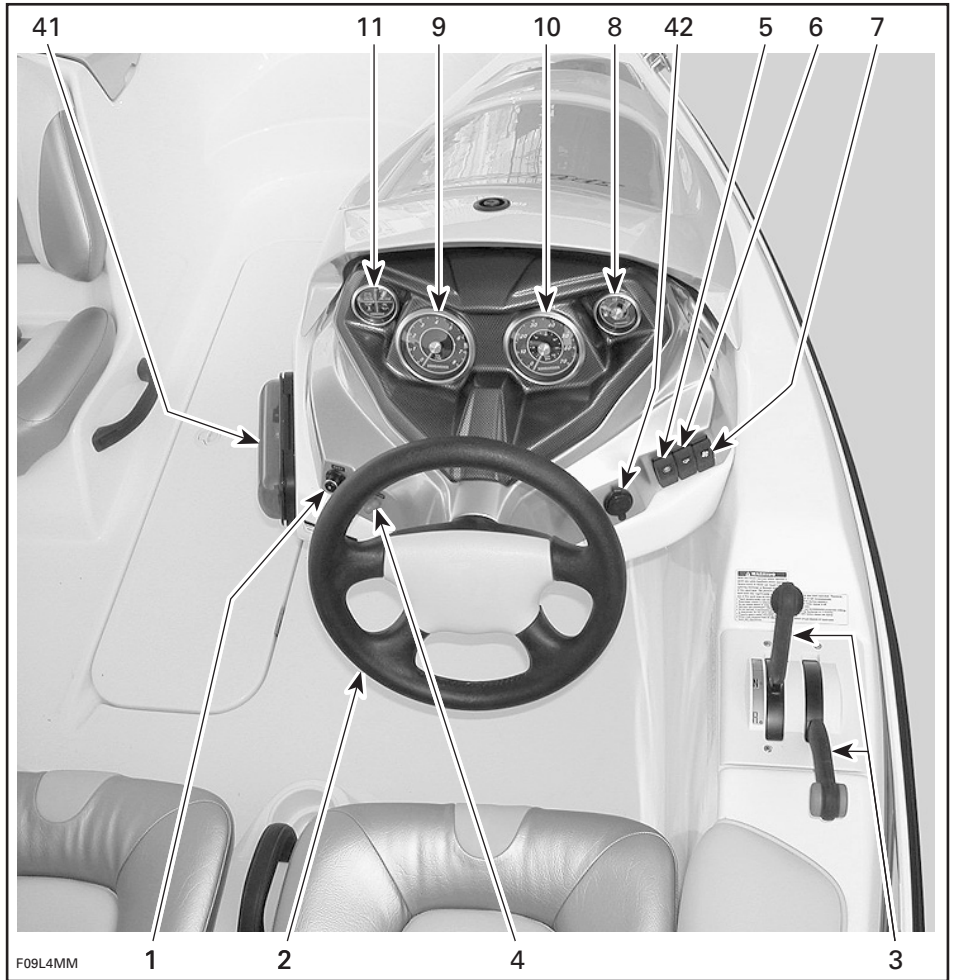

COCKPIT VIEW — SPORTSTER 4-TEC

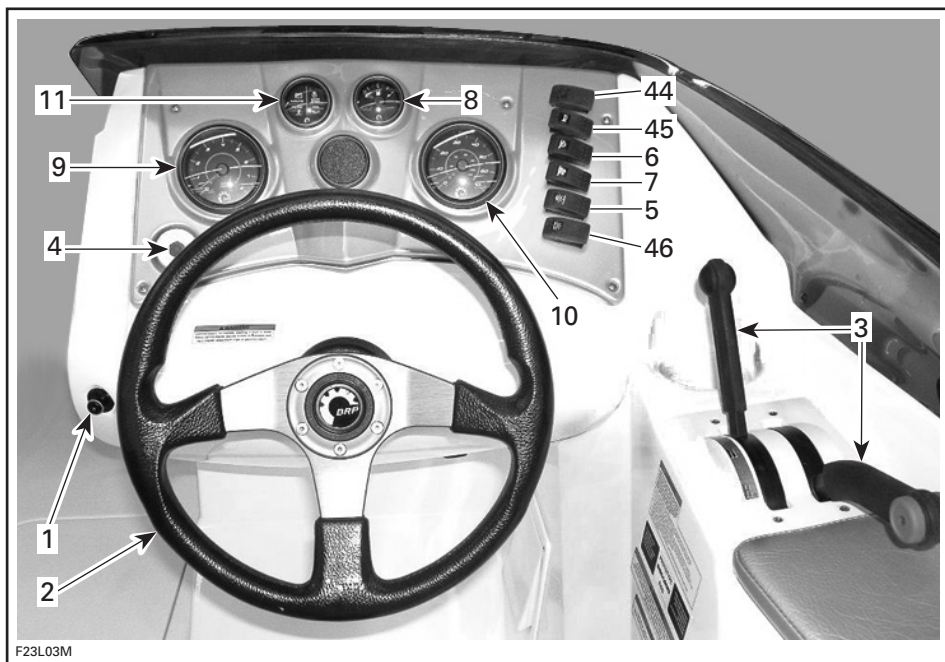

F23L03M

COCKPIT VIEW — CHALLENGER 180

Overview

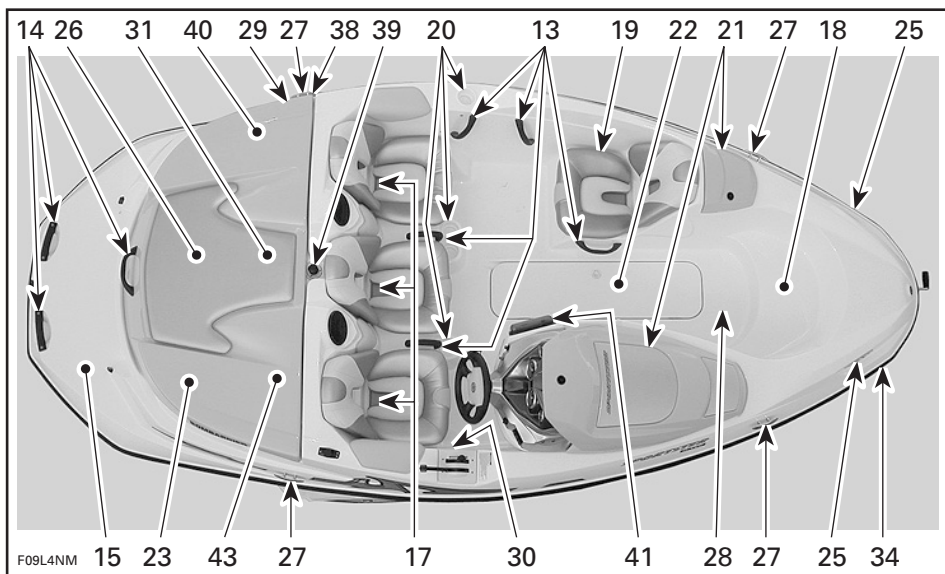

F09L4NM

TYPICAL — SPORTSTER 4-TEC

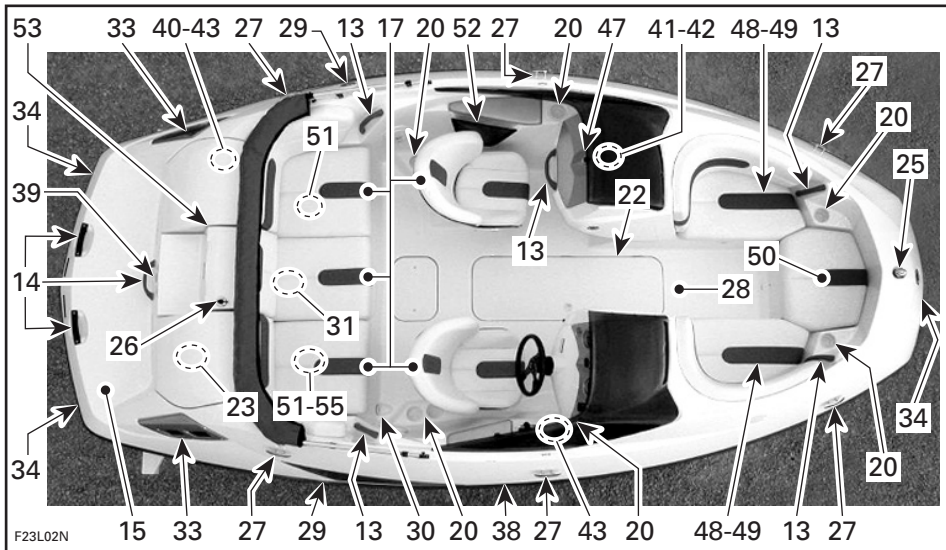

TYPICAL — CHALLENGER 180

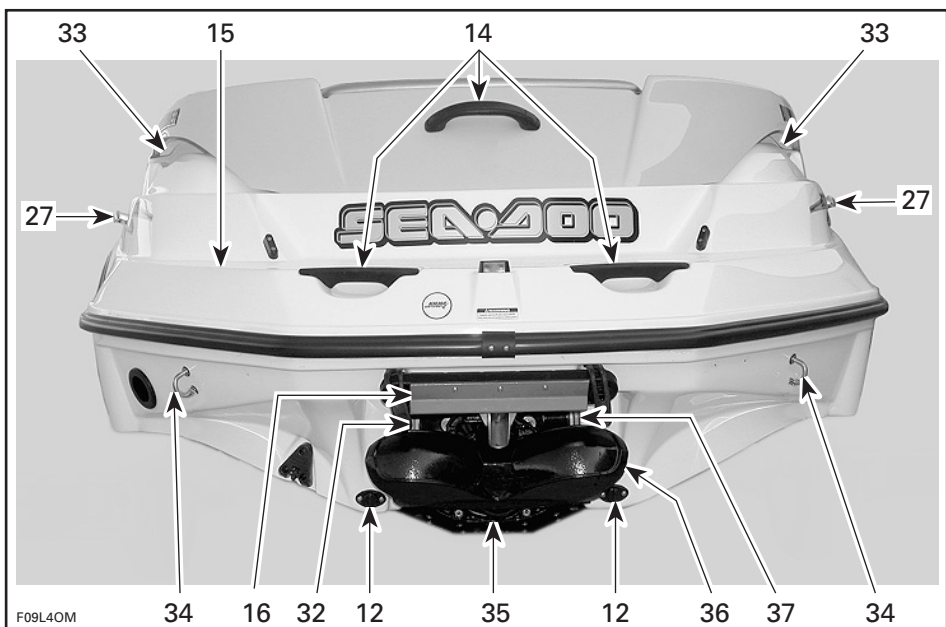

TYPICAL — SPORTSTER 4-TEC

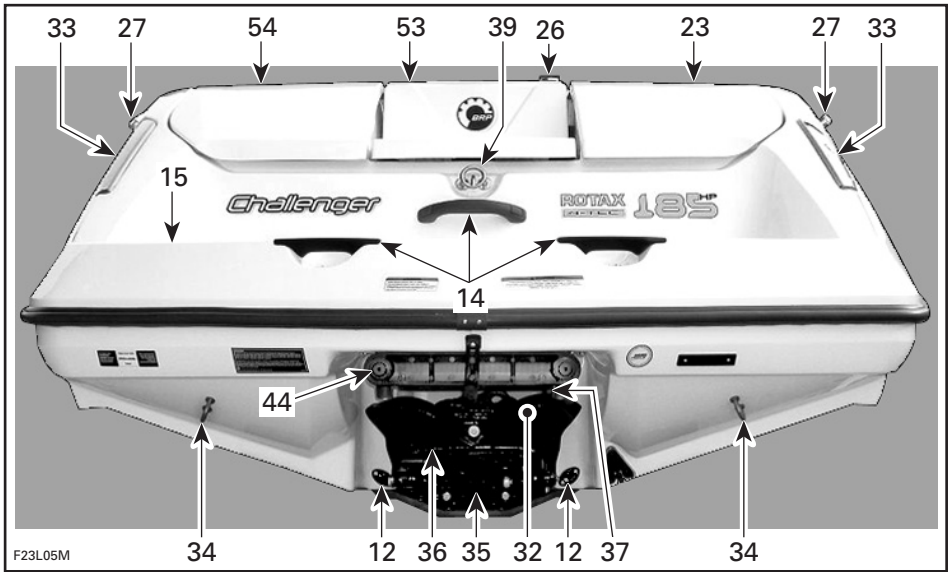

TYPICAL — CHALLENGER 180

1. Safety Lanyard/DESS Switch (engine cut-out switch)
 2. Steering Wheel
 3. Throttle/Shifter Controller
 4. Start/Stop Button
 5. Navigation Lights Switch
 6. Bilge Pump Switch
 7. Bilge Air Blower Switch
 8. Fuel Gauge
 9. Tachometer
 10. Speedometer
 11. Monitoring Gauge
 12. Bilge Drain Plugs
 13. Grab Handles
 14. Rear Grab Handles
 15. Swim Platform
 16. Ladder
 17. Seats
 18. Front Boarding Step (Sportster 4-TEC)
 19. Spotter Seat (Sportster 4-TEC)
 20. Cup Holders
 21. Front Storage Compartment (Sportster 4-TEC)
 22. Deck Storage Compartment
 23. Rear Storage Compartment
 24. Jet Pump Water Intake (not shown)
 25. Bow Lights
 26. Stern Light Socket
 27. Mooring Cleats
 28. Deck
 29. Fuel Tank Cap
 30. Deck Drain
 31. Oil Fill Cap (on engine)
 32. Flushing Connector
 33. Ventilation Ducts
 34. Bow/Stern Eyelets
 35. Jet Pump Nozzle
 36. Reverse Gate
 37. Scupper Valve
 38. Fuel Tank Vent
 39. Water Sport Towing Attachments
 40. Main Battery Cut-Off Switch
 41. AM/FM Radio/CD Player
 42. 12-Volt Jack
- NOTE:** The following items are for **Challenger 180 models only.**
43. Fuses
 44. Inlet Clearance System (ICS) Switch
 45. Horn Switch
 46. Deck Lights Switch
 47. Glovebox
 48. Bow Seats
 49. Bow Seat Storage Compartments
 50. Bow Filler Cushion (if so equipped)
 51. Rear Seat Storage Compartments
 52. Passenger Storage Compartment
 53. Engine Cover
 54. Port Bilge Access
 55. Removable Cooler

CONTROLS, COMPONENTS AND INSTRUMENT FUNCTIONS

1) Safety Lanyard/DESS™ Switch (engine cut-out switch)

⚠ WARNING

Always use safety lanyard when operating your boat to help prevent a runaway boat and reduce the risk of personal injury or death. Disconnect the safety lanyard when stopped to help prevent accidental starting.

The safety lanyard should be securely snapped onto the Digitally Encoded Security System (DESS™) post to be fully operational.

Pulling the safety lanyard cap from the DESS post stops the engine. Always attach the safety lanyard to the operator's Personal Flotation Device and snap the cap to the DESS post to be able to start the engine.

⚠ WARNING

Should the safety lanyard cap become loose or fails to remain on the DESS post, replace it immediately.

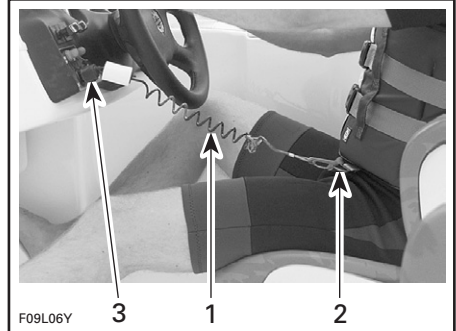

TYPICAL

1. Safety lanyard
2. Secure to PFD
3. Snap to DESS post

⚠ WARNING

Directional control is reduced when throttle is decreased and lost when engine is off. Always disconnect safety lanyard when boat is not in operation.

⚠ WARNING

Do not lubricate the DESS post.

⚠ WARNING

While the engine can be stopped using the start/stop button, good driving habits recommend that the safety lanyard also be disconnected when stopped.

Monitoring System

To assist you when using the boat, a system monitors some components and sends audible signals through a beeper to inform you of a particular condition. For coded signals, refer to the *TROUBLESHOOTING* section.

Digitally Encoded Security System (DESS)

The safety lanyard cap contains an electronic circuit that gives it a unique electronic serial number.

This safety lanyard cannot be used on another boat and conversely, the one from another boat cannot be used on your boat.

However, the DESS brings a great flexibility. You can buy an additional safety lanyard and have it programmed for your boat. To have additional safety lanyards programmed, refer to an authorized Sea-Doo sport boat dealer.

If the engine is stopped with the start/stop button while the safety lanyard remains on the DESS post, it can be restarted within approximately 10 minutes by pressing the start/stop button. After this delay, it is necessary to remove and reinstall lanyard cap on the DESS post. Two short beeps should sound indicating the system is ready again to allow engine starting. Otherwise, refer to *TROUBLESHOOTING* section for the *CODED SIGNALS CHART*.

2) Steering Wheel

The steering wheel controls the direction of the boat. Turning the steering wheel clockwise steers the boat to the right and inversely.

3) Throttle/Shifter Controller

Throttle Lever

When pushed forward, the boat accelerates. When fully pulled back, engine returns to idle speed and the boat is gradually stopped by water drag.

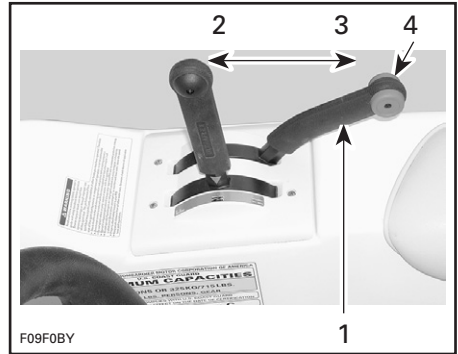

TYPICAL

1. Throttle lever
2. Increase speed
3. Decrease speed
4. Idle position speed

Shifter Lever

A 3-position lever:

- forward
- neutral
- reverse.

In order to shift, throttle lever must be fully pulled back to idle speed.

Shifter must be in neutral position to allow engine starting.

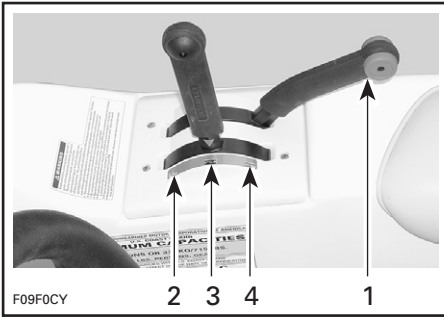

TYPICAL — SHIFT LEVER
 1. Throttle lever must be fully pulled back (idle speed) to shift
 2. Forward
 3. Neutral
 4. Reverse

CAUTION: Do not force lever. In-sure throttle lever is in idle position.
NOTE: To ease shifter use, line up the shifter arrow with the appropriate dot (Forward/Neutral/Reverse).

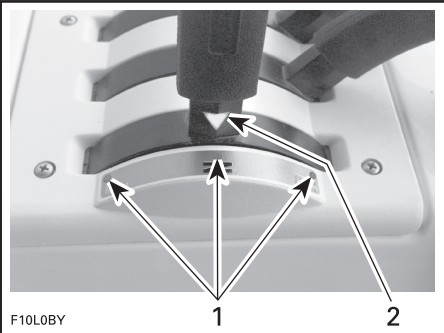

TYPICAL
 1. Dots besides shifting position
 2. Arrow on shifter

⚠ WARNING
 Shift lever should only be used when the engine is idling and boat is completely stopped.

⚠ WARNING

Only use reverse at slow speed and for the shortest time possible. Always ensure the path behind is clear of objects and persons including children playing in shallow water.

CAUTION: Never rev the engine at high RPM in reverse.

4) Start/Stop Button

Dual function push switch, used to start as well as to stop engine.

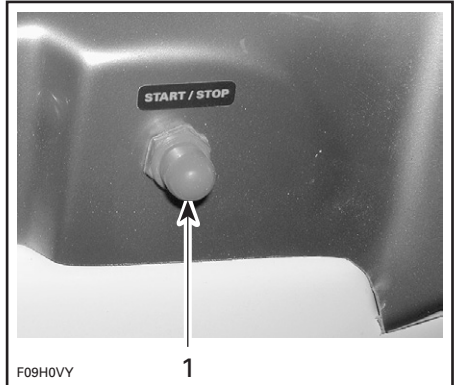

TYPICAL — SPORTSTER 4-TEC
 1. Start/stop button

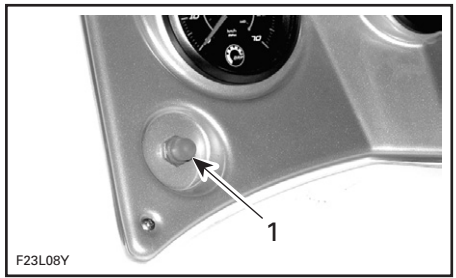

TYPICAL — CHALLENGER 180
 1. Start/stop button

Starting

WARNING

Engine exhaust fumes contain carbon monoxide (CO) which can accumulate in and around the boat (under Bimini top, in cockpit, etc.). CO can be harmful or fatal if inhaled. Assure there is adequate ventilation whenever running engine(s).

Shifter must be in neutral position and the safety lanyard must be on the DESS post to allow engine starting.

To start engine, press and hold the start/stop button. Release immediately after engine is started.

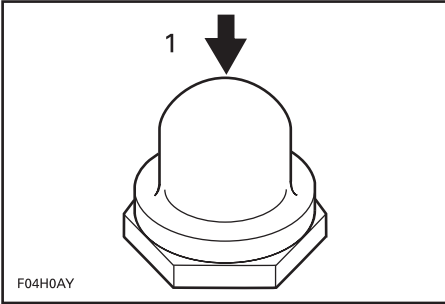

1. Start when engine is *NOT* running

Stopping

WARNING

While engine can be stopped by pressing the stop button, we strongly recommend the engine be stopped by removing the safety lanyard. This will install good habits.

Pressing button when engine is running will stop the engine.

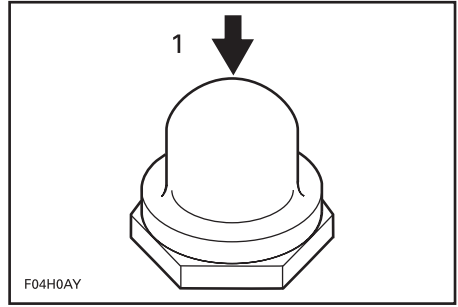

1. STOP when engine *IS* running

WARNING

Directional control is not available when engine is stopped.

5) Navigation Lights Switch

A 3-position NAV/OFF/ANC switch.

ANC: Turns on the anchorage light when the boat is anchored. Only the stern light is lit

OFF: Turns off all lights

NAV: Turns on both bow and stern lights and illuminates the gauges

WARNING

Navigation lights should always be used between sunset and sunrise. Ensure the stern light is installed. See *REMOVABLE STERN LIGHT* in this section for location and installation.

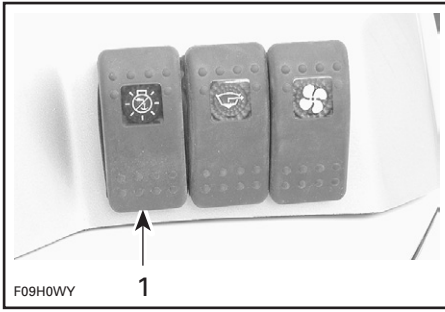

SPORTSTER 4-TEC

1. Navigation light switch

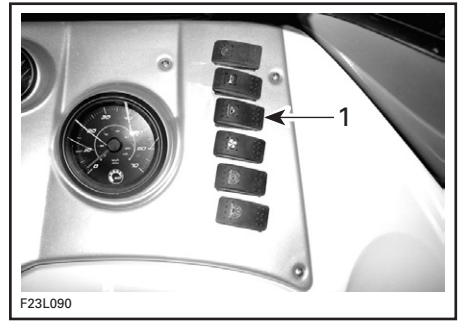

CHALLENGER 180

1. Bilge pump switch

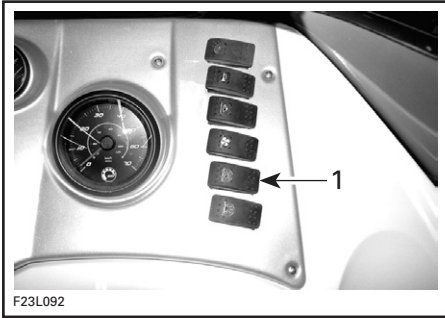

CHALLENGER 180

1. Navigation light switch

6) Bilge Pump Switch

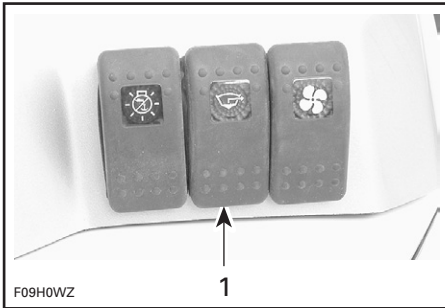

SPORTSTER 4-TEC

1. Bilge pump switch

A 2-position OFF/ON switch.

Turn to ON position when manual operation of the bilge pump is required (after cleaning, storage, etc.).

Turn switch to OFF when finished.

CAUTION: Do not operate for prolonged time if the bilge is dry: battery drainage will occur and pump will be damaged.

The bilge pump may be operated without the safety lanyard on its switch.

CAUTION: Always turn pump OFF when bilge is dry or before operating the engine above idle. Bilge pump will then switch to automatic mode.

Automatic Bilge Pump

The automatic bilge pump evacuates water from the bilge. A water sensor detects the water, activating the pump. After the water is pumped out, the pump shuts-off automatically. This automatic mode is working at all times - with/without safety lanyard on DESS post and with/without engine running.

CAUTION: When the main battery cut-off switch is turned OFF while boat is moored, the automatic bilge pump will start if water comes up in the bilge.

7) Bilge Air Blower Switch

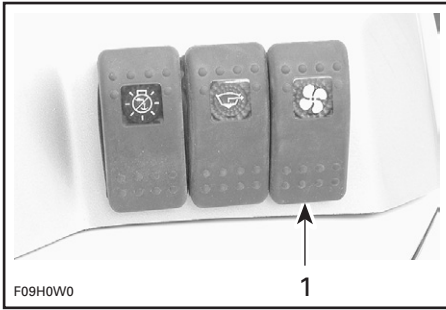

SPORTSTER 4-TEC
1. Bilge blower switch

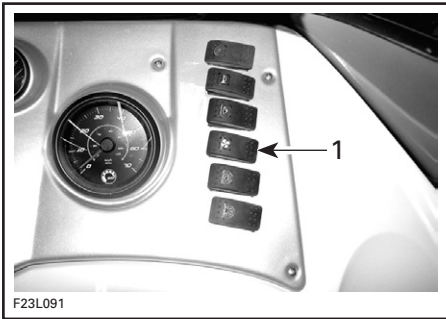

CHALLENGER 180
1. Bilge blower switch

A 2-position OFF/ON switch. When turned on, the blower ventilates the engine compartment.

⚠ WARNING

Always use blower for a minimum of 5 minutes before starting engine, then turn it OFF above idle speed. Use of the bilge blower should never replace "smelling" for gasoline vapors.

Using the bilge blower for a prolonged time when the engine is not running will discharge the battery.

Blower should be turned off during boat operation.

8) Fuel Gauge

Located in dashboard, this gauge continuously indicates the amount of fuel in fuel tank when engine is running.

The gauge is illuminated whenever the navigation lights are used.



TYPICAL — FUEL GAUGE

9) Tachometer

The tachometer indicates the revolutions per minute (RPM) of the engine. Multiply reading by 1000 to obtain actual RPM.

Gauge is illuminated whenever the navigation lights are used.



TYPICAL — TACHOMETER

10) Speedometer

The speedometer indicates the speed of the boat in miles per hour (MPH) and kilometers per hour (km/h).

The gauge is illuminated whenever the navigation lights are used.

A speed sensor mounted on the transom sends the signal to the speedometer.



F09H11Y

TYPICAL — SPEEDOMETER

11) Monitoring Gauge

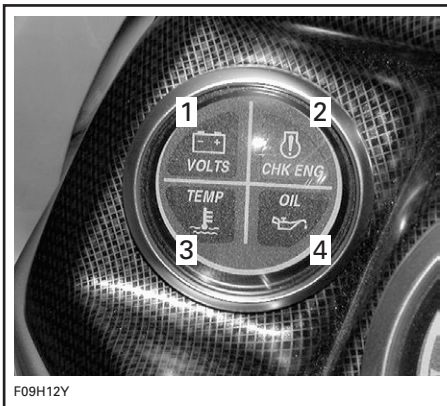

F09H12Y

TYPICAL

1. Battery
2. Engine
3. Temperature
4. Oil

Low Battery Warning Light

Before the battery becomes too discharged to start the engines, the volts indicator light will come on.

When the indicator light is on, you should discontinue all use of electrical accessories immediately and start the engine in order to recharge the battery.

Check Engine Light

When the ECM detects a fault code, the check engine light will come on and a beep may sound.

Turn engine off. Wait one (1) minute. Restart engine. If light remains lit, take boat to nearest authorized Sea-Doo sport boat dealer for servicing.

Engine Temperature Light

CAUTION: If the temperature indicator light comes on, stop engine as soon as possible.

Turn off engine as soon as possible. Check oil level and refill.

Check coolant levels. Refer to *LIQUIDS*. If engine still overheats, continue the following procedure.

Perform *JET PUMP WATER INTAKE AND IMPELLER CLEANING* procedure described in *SPECIAL PROCEDURES*.

When back to shore, flush exhaust cooling system. Refer to *POST-OPERATION CARE*.

Restart the engine. If this does not correct the situation, do not run the engine further. Refer to an authorized Sea-Doo sport boat dealer for servicing.

CAUTION: Running engine with low oil pressure may severely damage the engine.

Oil Pressure Light

The oil light turns on when the oil pressure is low or high in the engine. Check oil as soon as possible. If lamp remains ON contact an authorized Sea-Doo sport boat dealer.

CAUTION: Never run engine out of oil. Serious engine damage will occur.

WARNING

Always use blower for a minimum of 5 minutes before starting engine, then turn it OFF above idle speed. Use of the bilge blower should never replace "smelling" for gasoline vapors.

12) Bilge Drain Plugs

Once boat is on trailer, unscrew the drain plugs, block the wheels and raise the bow slightly with the trailer jack (if so equipped) so that the water can flow out of the bilge.

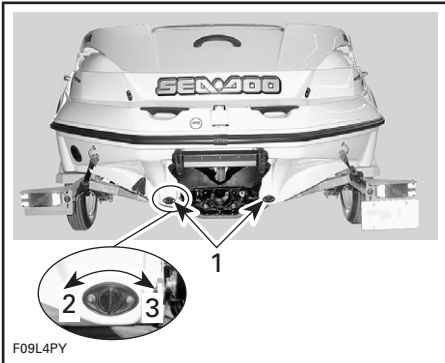

TYPICAL — SPORTSTER 4-TEC

1. Drain plugs
2. Loosen
3. Tighten

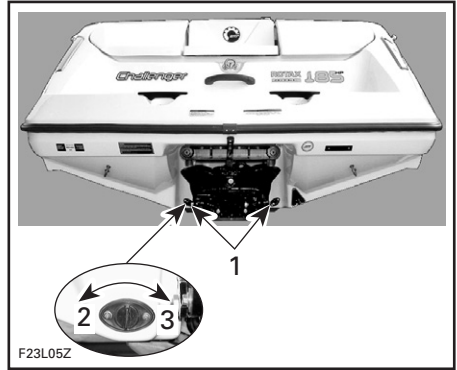

TYPICAL — CHALLENGER 180

1. Drain plugs
2. Loosen
3. Tighten

13) Grab Handles

Grab handles provide a handhold for the passengers.

Although grab handles are provided, never perform maneuvers that place a passenger or the driver at risk for being ejected or thrown out of their seat.

CAUTION: Never use the grab handles to pull anything or to lift the boat.

Refer to components location illustrations at the beginning of this section for grab handle locations.

14) Rear Grab Handles

Provide a handhold for boarding when needed.

CAUTION: Never use the grab handle to tow anything or to lift the boat.

Each passenger should be seated while underway.

WARNING

Allow no one to sit on edge of the boat or to stand up while in operation. Seat/grab handles should be used in rough waters.

15) Swim Platform

Provides an anti-skid surface for easy boarding from rear of the boat.

WARNING

Do not start or operate the boat if a person is seated on the platform. Engine must be off when using swim platform. Keep away from jet or intake grate.



TYPICAL — SPORTSTER 4-TEC
1. Latches

16) Ladder



TYPICAL
1. Retractable ladder

Located under the swim platform, the ladder helps in reboarding the boat.

WARNING

Engine should be OFF when using ladder. Keep limbs away from jet or intake grate. Only one person at a time on the ladder. Never use the ladder for pulling, towing, diving or jumping, boarding a boat that is out of the water or any other purpose other than a ladder.

Pull latches to unlock the ladder.

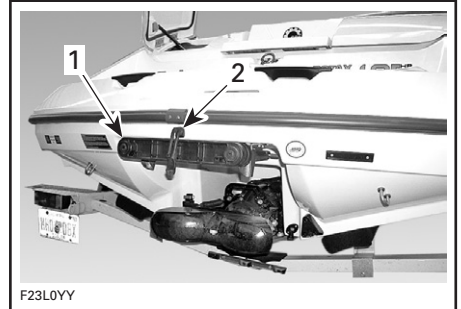

TYPICAL — CHALLENGER 180
1. Retractable ladder
2. Latch

Slide ladder toward rear, then push down.



**TYPICAL — LADDER LOWERED —
SPORTSTER 4-TEC**



F23L0ZY

TYPICAL — LADDER LOWERED —
CHALLENGER 180

To store ladder, lift horizontally, slide toward front and refasten latch.

17) Seats

Each passenger should be seated while underway.

WARNING

Allow no one to sit on edge of the boat or to stand up while in operation. Seat/grab handles should be used in rough waters.

18) Front Boarding Step

Sportster 4-TEC Only

Located at front of boat, it is provided as a boarding step.

WARNING

No passenger should use the boarding step as a seat except when the boat is stopped.

WARNING

Avoid serious or fatal injury. Do not occupy seat when speed exceeds 5 MPH.

19) Spotter Seat

Sportster 4-TEC Only

Located on the port side, rearward facing, this seat is provided to be used by the observer when towing a tube, skier or wakeboarder.

Use grab handles as necessary.

WARNING

When pulling a tube, skier or wakeboarder, always have an observer while towing, proceed with only as much speed as required, and follow the observer's instructions.

20) Cup Holders

Convenient locations for non-alcoholic beverages.

WARNING

Never operate boat while under the influence of alcoholic beverages while aboard. Do not keep bottles, cans etc. in cup holders while riding at high speed and/or on rough water.

21) Front Storage Compartment

Sportster 4-TEC Only

A convenient watertight, lockable storage compartment with a removable basket to carry personal articles. The basket is the ideal location for spare spark plugs, first aid kit, etc.

WARNING

Never leave any heavy or loose breakable objects in the storage basket. Never operate the boat with the storage compartment cover open.

Push the latch button downward to unlock storage compartment cover. Raise cover until stopped by the retaining device. The cover will remain in this position on calm water.

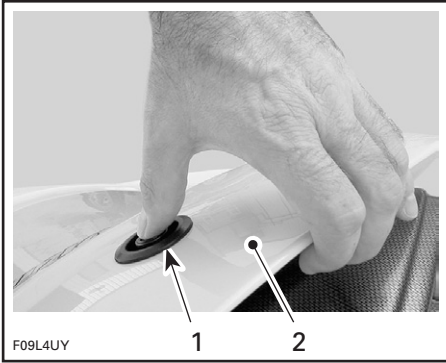

TYPICAL
 1. Push lock button in
 2. Lift up

The driver-side front compartment is provided with a holder to store an approved fire extinguisher.

The fire extinguisher (sold separately) should not be loose in the storage compartment.

The Operator's Guide should be kept in a waterproof bag and remain with the boat at all times.

⚠ WARNING
 Do not remove the basket to use as additional storage area. Components can become entangled and cause serious operational hazards.

Push cover down to release mechanism then move down slowly. When bottomed on latch, firmly push cover to lock.

Periodically verify the lock pin tightness of storage cover. Tighten if needed and make sure storage cover latches properly.



TYPICAL — SPOTTER SEAT STORAGE COMPARTMENT

22) Deck Storage Compartment

The deck storage compartment is a convenient location for water-skis, paddles, anchor and rope, etc.

⚠ WARNING
 Never leave any heavy or loose breakable objects in the storage basket. Never operate the boat with the storage compartment cover open.

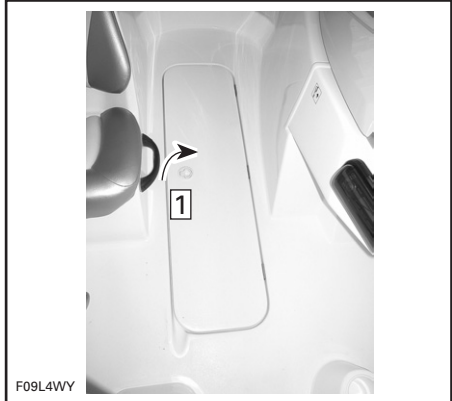

TYPICAL
 Step 1: Pull latch and lift cover

Lift the latch ring and open cover gently until stopped by retaining spring.

When completely opened, the cover remains in that position on calm water. To close, gently push on the side of the spring to release it and lower the cover.



TYPICAL
1. Gently push here to release the spring

23) Rear Storage Compartment

Sportster 4-TEC Models

Rear Storage Compartment

Convenient rear storage location to be used to carry large personal articles. Ideal location for spare Personal Flotation Device (PFD), towels, lunch etc.

Pull the latch lever located beneath the front storage compartment lid upward to release engine cover latch, and open engine cover gently until stopped.

The gas assist cylinder will complete the opening and hold cover open.

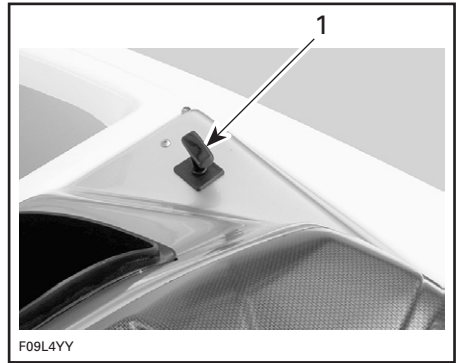

TYPICAL
1. Pull latch handle upward

Storage Tray

CAUTION: In order to avoid damage, **MAXIMUM LOAD** on storage tray must not exceed 22.5 kg (50 lb).

The storage tray is removable to give access to the engine compartment. Grab the handle and lift in a rearward movement until opposite holders release.

⚠ WARNING

When storage tray is lifted or removed, never touch any electrical part when starting engine or while in operation. Never leave any object, rag, tool, etc., in the engine compartment or in the bilge.

When reinstalling storage tray, ensure to properly locate it just below holders, gently lower tray then push it downward to lock.

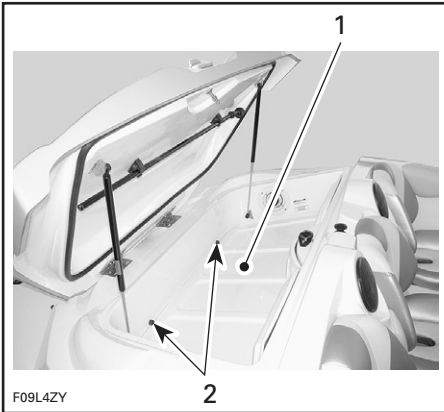

TYPICAL

1. Rear storage compartment tray
2. Tray under holders

Firmly close storage compartment cover to relatch.

⚠ WARNING

Never leave any heavy or breakable objects in the storage compartment. Never operate the boat with the rear storage compartment cover open.

Challenger 180 Models

Starboard Rear Storage Compartment

Located behind the rear starboard passenger seat.

Pull latch to open storage cover.



1. Lift latch

The gas assist cylinder will hold the storage cover open.

⚠ WARNING

Always close cover before getting underway.

24) Jet Pump Water Intake

Water is drawn up by the impeller through this opening. The grate minimizes entry of foreign objects into the propulsion system.

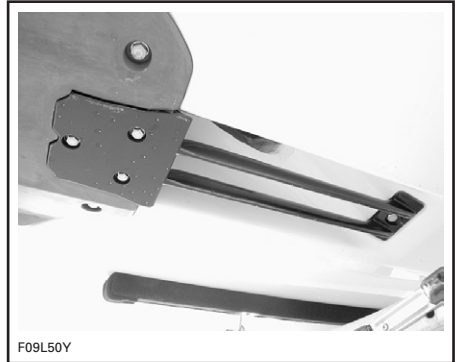

TYPICAL

⚠ WARNING

Keep away from intake grate while engine is on. Items such as long hair, loose clothing or personal flotation device straps can become entangled in moving parts resulting in severe injury or drowning.

25) Bow Lights

Mandatory red/green lights. See *LIGHT SWITCH* as mentioned earlier in this section.

26) Stern Light Socket

Sportster 4-TEC Models

For installation of mandatory white stern light.

It is recommended to keep stern light in rear storage compartment at all times except when needed.

To remove from storage cover, pull it out. Snap in place to store.

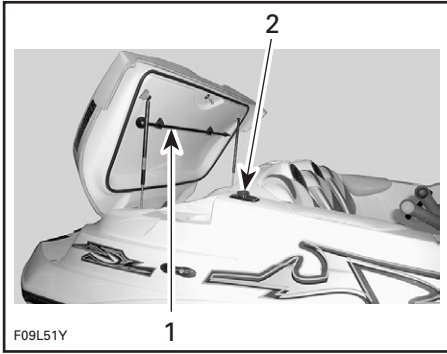

TYPICAL

1. Stern light storage location
2. Stern light operation position

Challenger 180 Models

Located on the engine cover, for installation of mandatory white stern light.

It is recommended to keep stern light in ski locker compartment at all times except when needed.

Installation

For Models Equipped with Folding Stern Light:

- Release stern light storage lock as shown.

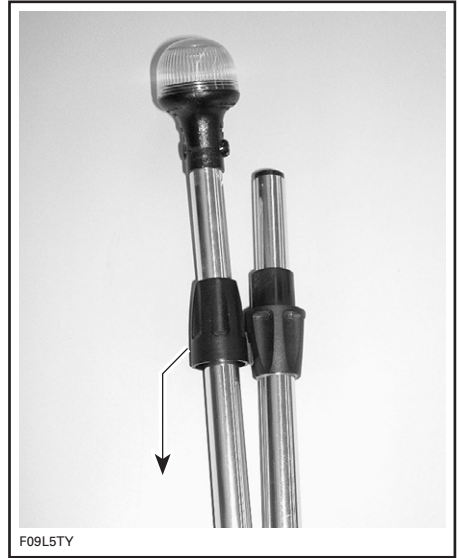

SLIDE THIS DIRECTION

- Thread onto folding joint as shown below.

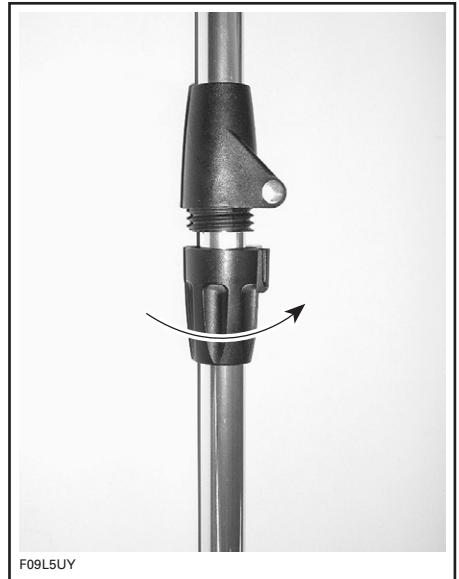

All Models

- Lift connector cap.

- Insert post in connector hole. Ensure to align hole keyway with post screw head.
- Firmly push downward to engage terminals.
- Push lock ring downward. Turn until locked. It may be necessary to slightly turn it to allow its insertion in the hole.
- Check light operation. See *LIGHT SWITCH* as mentioned earlier in this section.

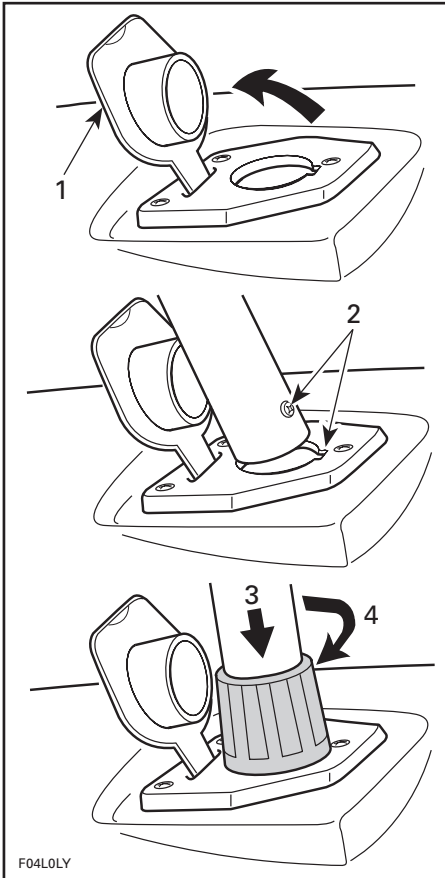

TYPICAL

1. Lift
2. Align screw in groove
3. Push downward
4. Turn to lock

CAUTION: Ensure dielectric grease is present in connector area of light to prevent corrosion.

Removal and storage of light is the reverse of installation.

27) Mooring Cleats

When mooring to a dock, it is recommended to secure the boat with both front and rear cleats. The use of dock lines with sealed air fenders is recommended to protect your boat.

CAUTION: Never use mooring cleats to pull anything or to lift the boat.

28) Deck

Flat surface of boat, should be kept clean and clear.

29) Fuel Tank Cap

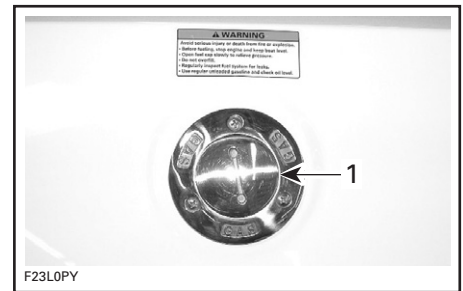

1. Fuel tank cap

Unscrew the cap counterclockwise to allow fuel tank filling. Fully tighten when finished.

WARNING

Always stop the engine before refueling. Fuel is flammable and explosive under certain conditions. Always work in a well ventilated area. Do not smoke or allow open flames or sparks in the vicinity. Fuel tank may be pressurized. Slowly turn cap when opening. Never use an open flame to check fuel level. When fueling, keep boat level. Do not overfill or top off the fuel tank and leave boat in the sun. As temperature increases, fuel expands and might overflow. Always wipe off any fuel spillage from the boat. Periodically verify fuel system.

30) Deck Drain

Located below the driver's seat, the deck drain provides water drainage from rain, deck washing, water splashing, etc. Keep clean to avoid clogging.

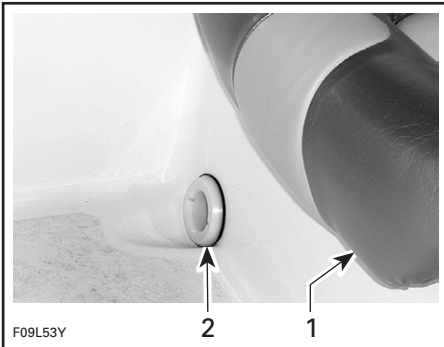

TYPICAL — SPORTSTER 4-TEC

1. Driver's seat
2. Deck drain

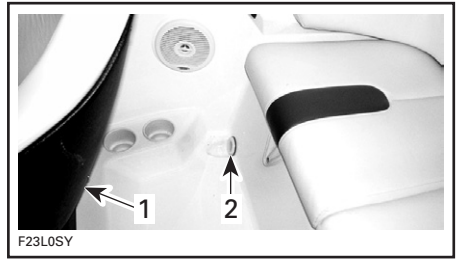

TYPICAL — CHALLENGER 180

1. Driver's seat
2. Deck drain

31) Oil Fill Cap (on engine)

The cap is located on the engine.

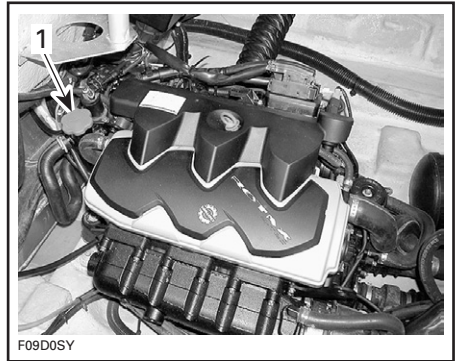

1. Oil fill cap

WARNING

Add oil to level mark. Do not overfill. Reinstall cap and fully tighten.

32) Flushing Connector

Refer to *POST-OPERATION CARE* section for proper use.

NOTE: Engine is provided with a flushing connector on jet pump support.

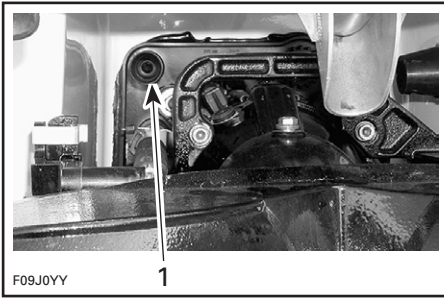

SPORTSTER 4-TEC
1. Flushing connector

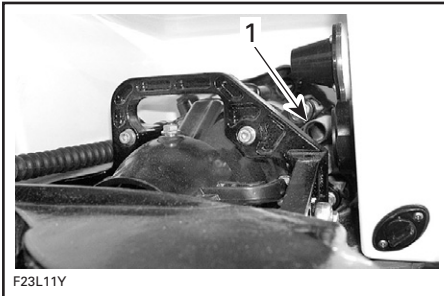

CHALLENGER 180
1. Flushing connector

33) Ventilation Ducts

Sportster 4-TEC Models

Located beneath the engine compartment lid, the ventilation ducts supply air to the engine and ventilate engine compartment. Ventilation ducts should never be obstructed.

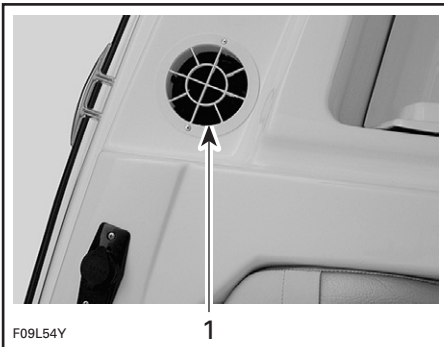

TYPICAL
1. Ventilation duct

Challenger 180 Models

Located at both ends of the swim platform, the ventilation ducts supply air to the engine and ventilate engine compartment. Ventilation ducts should never be obstructed.



TYPICAL
1. Ventilation ducts

34) Bow/Stern Eyelets

Eyelets can be used for mooring, towing and as a tie-down point during transportation.



TYPICAL
1. Stern eyelet
2. Bow eyelet

35) Jet Pump Nozzle

The jet pump nozzle provides directional control when engine is running, turning side to side via input from the steering wheel.

⚠ WARNING

Never use nozzle as a supporting point to board the boat or to lift it.

Refer to *PROPULSION* under *PRINCIPLE OF OPERATION*.

36) Reverse Gate

When selecting the neutral or reverse position with the shift lever, the reverse gate moves up or down to the desired position.

⚠ WARNING

Never use gate as a supporting point to board the boat. Shift lever should only be used when the engine is idling and boat is completely stopped.

37) Scupper Valve

This is where water from the deck drains out. Keep clean to avoid clogging.

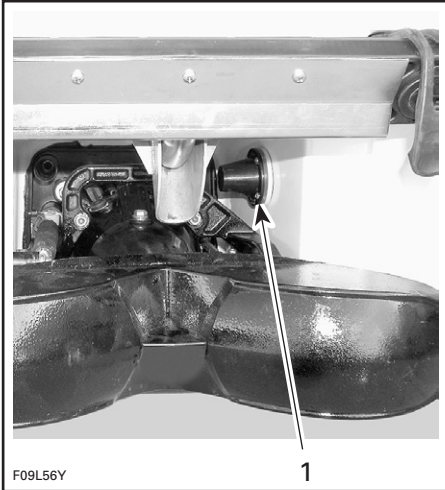

TYPICAL — SPORTSTER 4-TEC
1. Scupper valve

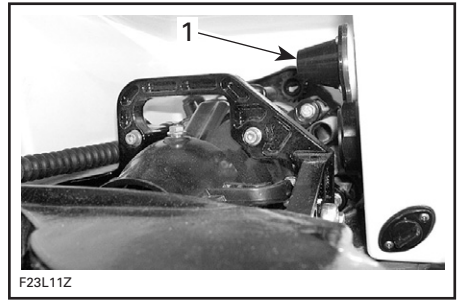

TYPICAL — CHALLENGER 180
1. Scupper valve

38) Fuel Tank Vent

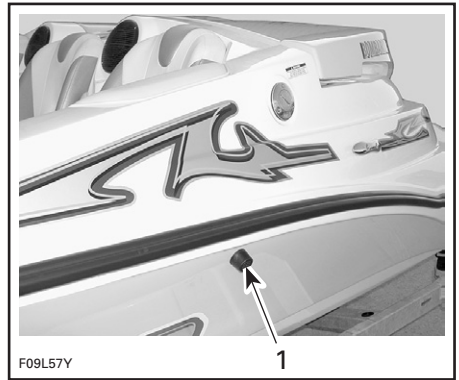

TYPICAL — SPORTSTER 4-TEC
1. Fuel tank vent



TYPICAL — CHALLENGER 180
1. Fuel tank vent

Vent allows fuel vapor and pressure release from fuel tank.

⚠ WARNING

Never use a lit match or open flame close to vent. Follow the *FUELING PROCEDURE* instructions in the *FUEL AND LUBRICATION* section.

39) Water Sport Towing Attachments

Please read and often refer to *WATER SPORTS* information in the *SAFETY* section at the front of this guide.

⚠ WARNING

“Teak Surfing” is extremely dangerous to participants due to their proximity to the rear of the boat where direct contact with the exhaust fumes from the boat engine is the highest. Carbon monoxide poisoning can occur and result in mental disorientation, dizziness, drowsiness, and loss of consciousness. The combination of carbon monoxide exposure and non-use of a life jacket (PFD) make this new water recreation activity an incredibly dangerous and potentially deadly sport.

Ski Post

Sportster 4-TEC Models

This boat comes equipped with a ski post. Use this post to pull a tube, water skier or wakeboarder.

Pull up the post to allow hooking a ski rope or other towables.

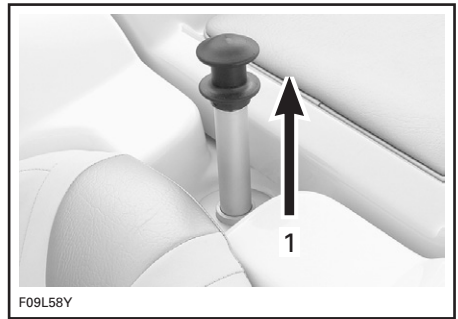

TYPICAL

1. Lift ski post to use

Push down when finished.

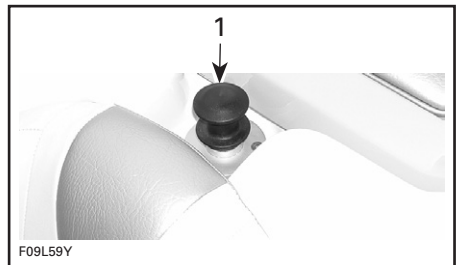

TYPICAL

1. Ski post position when not used

⚠ WARNING

When pulling a tube, skier or wakeboarder, always have an observer, proceed with only as much speed as required, and follow the observer's instructions.

CAUTION: Never use the ski post to tow any other craft.

⚠ WARNING

Always have observer watch skier. Ensure ski post is fully extended and locked before use. Completely retract when not used.

Towing Tower

On so Equipped Models

CAUTION: Do NOT fold tower forward.

Attempting to fold the tower forward will damage the front tower mounts. The towing tower is for skiing/wakeboarding.

CAUTION: Always tow the boat with the towing tower fastened in the upright position to avoid damage to the boat. Tower must be secured and bolted in upright position when boat is operated. Periodically check that bolts are in place and tight. Check clearance height around docks, shore, overhanging objects, bridges and power lines. The tower must not be used as a tie-down or tie-off point.

To clean tower, use mineral spirits and a clean soft cloth.

To prepare tower for storage, remove knobs, and remove bolts using an 8 mm Allen wrench, from each side of tower.

Carefully lower each rear support arm to side of the boat.

Storage support blocks are supplied to prevent damage to the deck.

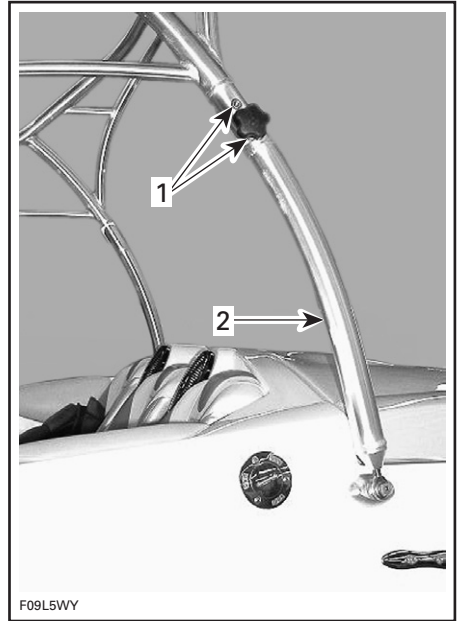

PERFORM FOR EACH SIDE

1. Remove bolt and knob
2. Lower to side of boat

Using knob previously removed, place through tower joint and screw into storage support blocks as shown in the following illustration.

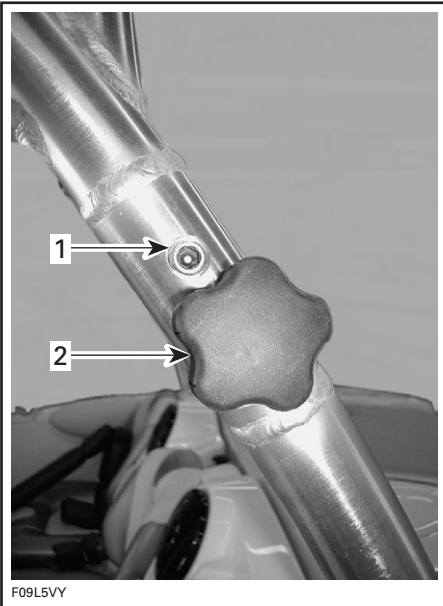

1. 8 mm bolt
2. Knob

NOTE: This procedure may require two people.

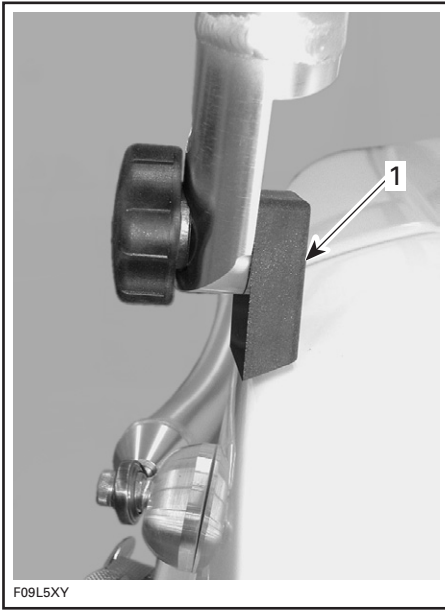

TYPICAL

1. Screw knob into this block

Repeat for other side and carefully lower tower onto deck.

Install straps by placing looped end over rear mooring cleats as shown in next illustration.

Wrap other end around tower tubing, close fasteners and pull up on loose end of strap to tighten.

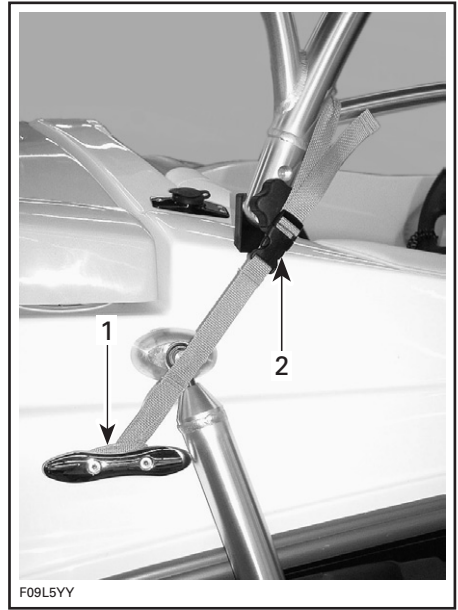

TYPICAL

1. Looped end
2. Fastener

Erection of tower is reverse of this procedure.

When installing 8 mm bolts into rear tower uprights, torque bolts to 35 N•m (25.8 lbf•ft).

Place storage support blocks and straps in glovebox or other secure storage for later use.

Tower Removal

NOTE: Removal of the tower will require 4 people. Remove tower only from upright position.

Using a 6.35 mm (1/4 in) hexagonal tip, remove bolts from tower attachment points.

Carefully maneuver tower away from boat and place on a level surface.

Save bolts for later reinstallation.

Installation (from off boat)

NOTE: Installation of the tower will require 4 people.

Carefully lift tower assembly and position on boat with someone at each attachment point of tower unit.

Apply Loctite 243 (P/N 293 800 059) to threads of bolts and install bolts into attachment points. Torque bolts to 35 N•m (25.8 lbf•ft) to complete installation of tower.

⚠ WARNING

Pulling a tube, skier or wakeboarder makes the boat handle differently and requires greater skill. Unless absolutely necessary, do not make tight, sharp turns. Keep a safe distance from docks, swimmers, other craft or objects. Be advised that serious injury can result if the tow rope becomes slack during a tight turn or when circling. The rope could become wrapped around the neck or limbs of a person.

40) Main Battery Cut-Off Switch

The switch allows a complete power cut-out of the electrical system.

Sportster 4-TEC Models

The switch is located in the engine compartment.

Challenger 180 Models

This switch is located in the port bilge access compartment.

All Models

When in OFF position, ALL electrical equipment and electronics will be OFF, **except** the bilge pump. The bilge pump will operate automatically with the battery switch in the OFF position.

Switch must be in the ON position to allow the use of electrical components and to start the engine.

CAUTION: Stop engine before switching to the OFF position.



TYPICAL — SPORTSTER 4-TEC — MAIN BATTERY CUT-OFF SWITCH

1. Battery cut-off switch in OFF position

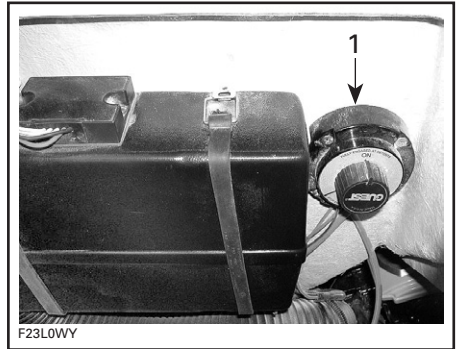

TYPICAL — CHALLENGER 180 — MAIN BATTERY CUT-OFF SWITCH

1. Battery cut-off switch in ON position

It is recommended to set this switch to the OFF position whenever performing maintenance in the engine compartment, on the electrical system, for transportation or during short term storage.

CAUTION: When the main battery cut-off switch is turned OFF while boat is moored, the automatic bilge pump will start if water comes up in the bilge.

41) AM/FM Radio/CD Player



TYPICAL — RADIO/CD PLAYER

Refer to *MANUFACTURER'S GUIDE* for complete explanation of features and controls.

CAUTION: Using the radio/CD player for a prolonged time without engine running may discharge the battery.

42) 12-Volt Jack

A 12-Volt jack is provided to power temporary accessories such as a cellular phone or other 12-Volt portable devices.

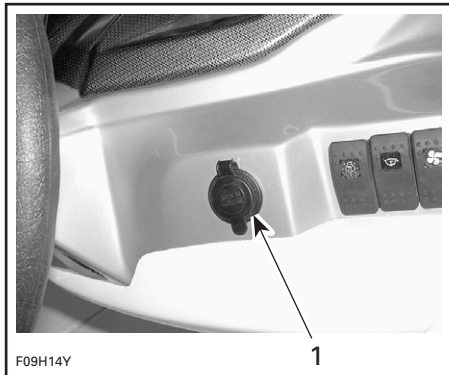

LOCATED ON DRIVER'S CONSOLE —
SPORTSTER 4-TEC
1. 12-Volt jack



LOCATED IN THE GLOVEBOX—
CHALLENGER 180
1. 12-Volt jack

Lift protective cap to expose jack.

CAUTION: Using the accessory jack for a prolonged time without engine running may discharge the battery.

CAUTION: Close protective cap when jack is not in use to protect against weather.

Challenger 180 Only

⚠ WARNING

Never operate the boat with the glovebox cover open.

43) Fuses

The electrical system is protected with fuses. Refer to *MAINTENANCE* section for details.

44) Inlet Clearance System (ICS) Switch

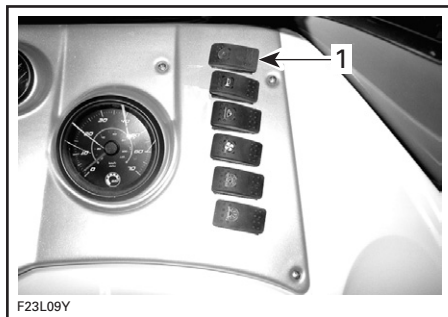

1. Inlet Clearance System (ICS) switch

The ICS switch allows the grate to open beneath the hull to dislodge weeds or accumulated debris near the water intake.

WARNING

Keep away from intake grate while engine is on. Items such as long hair, loose clothing or personal flotation device straps can become entangled in moving parts resulting in severe injury or drowning.

Weeds, shells or debris can get caught on the intake grate, drive shaft and/or impeller. A clogged water intake may cause troubles such as:

1. **Cavitation:** Engine speed is high but boat moves slowly due to reduced jet thrust; jet pump components may be damaged.
2. **Overheating:** Since jet pump operation controls the flow of water to cool the engine's exhaust, clogged intakes will cause the engine to overheat and damage internal engine components.

The clogged area can be cleaned as follows:

Inlet Clearance System (ICS): Place shifter in neutral position. Let the boat stop by itself then push the ICS button. This will lower the water intake grates to allow weeds or other debris to escape from grate. Grate will open and retract automatically with a 10-second delay before returning to the closed, or up position. It may be necessary to repeat the procedure.

After releasing ICS button, wait about **10 more seconds** before moving shifter into either forward or reverse to allow grates to return to the up position, completing the cycle.

CAUTION: Operating the boat with the water intake grate in lower position will cause damage to the ICS.

In severe conditions if the above method does not work, the following can be performed:

- With engine running, put shift lever in reverse position and vary throttles quickly several times.
- Try accelerating again.

Most of the time, debris will escape from the propulsion system.

Out of water cleaning: If the system is still clogged, shut off the engine by removing the safety lanyard.

WARNING

Always remove safety lanyard from DESS post to prevent accidental engine starting before cleaning the jet pump area.

From underneath boat, manually clean water intake area. If the system is still clogged, refer to an authorized Sea-Doo sport boat dealer for servicing.

CAUTION: Avoid operation in weeded areas. If unavoidable, vary speed. Weeds tend to entangle more at steady and slow speeds. Inspect water intake grate for damage. Refer to an authorized Sea-Doo sport boat dealer for repair as necessary.

45) Horn Switch

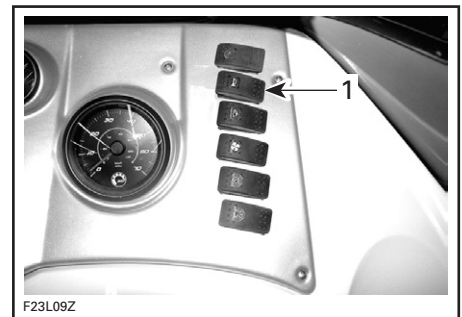

1. Horn switch

Press and hold the switch to activate the horn.

Release the switch to stop horn.

46) Deck Lights Switch

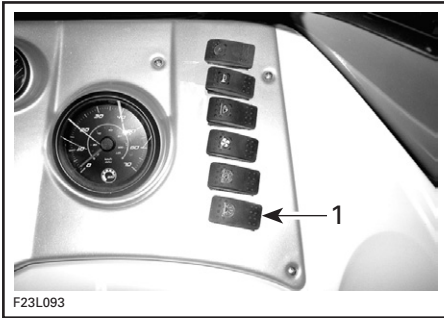

1. Deck light switch

Press switch to ON position to turn on the deck lights.

Press switch to OFF position to turn off the deck lights.

Using the deck lights for a prolonged time when the engine is not running will discharge the battery.

47) Glovebox

Located on the port console, the glovebox provides a convenient, lockable storage space for keys, wallet, etc.

To open glovebox, press latch button and pull. To close glovebox, lift door and push forward until latched.

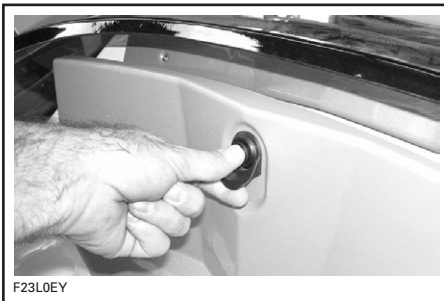

TYPICAL

WARNING

Never operate the boat with the glovebox cover open.

48) Bow Seats

Located at the front of the boat, they are provided as a sun seat.

WARNING

No passenger should use the most forward seat in the bow area if it faces backwards unless the boat is stopped or under idle speed.

49) Bow Seat Storage Compartments

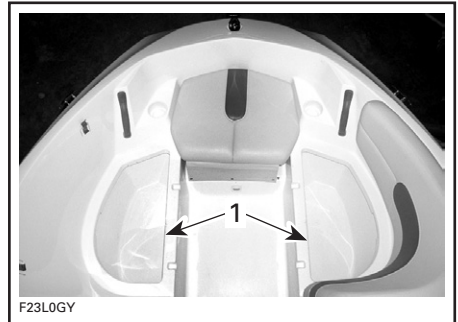

TYPICAL

1. Bow storage compartments

Located under the bow seat cushions, the bow seat storage compartments are provided for securing extra PFD's, rope, etc.

Unsnap and lift bow cushions to access storage areas.

Installation of bow cushions is the reverse of removal.

50) Bow Filler Cushion (if so equipped)

The bow seat filler cushion is located under the front bow seat cushion.

Unsnap the front bow seat cushion and remove.

Pull the bow seat filler cushion from its storage position.

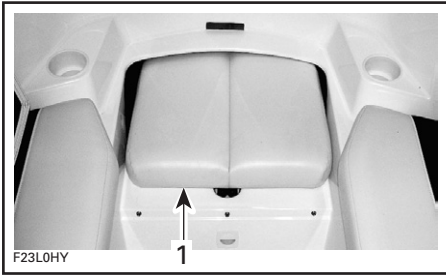

1. Filler cushion

Remove the support bars from their storage position beneath the bow seat filler cushion.

Unsnap the two side bow seat cushions, lift each cushion slightly to position the support bars.

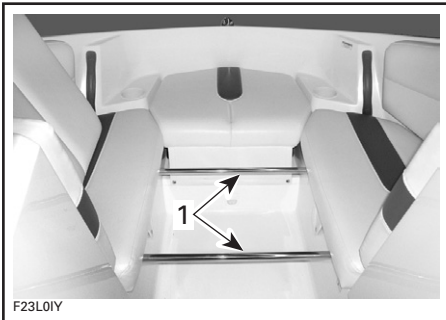

1. Support bars installed

Reposition front bow seat cushion and fasten with the snap.

Position bow seat filler cushion to create a comfortable lounging area while boat is stopped.

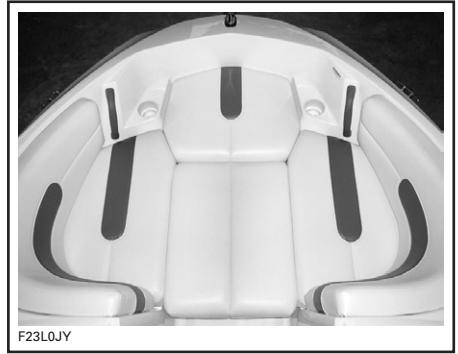

TYPICAL

51) Rear Seat Storage Compartments

Located beneath the rear port and starboard seat cushions, these compartments are convenient for storing a cooler, or additional articles.

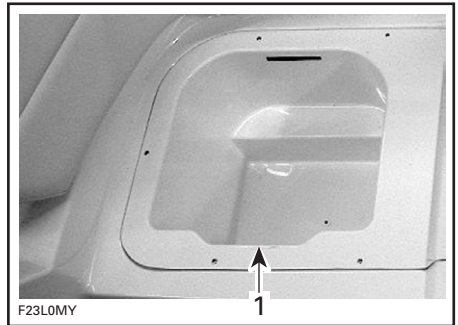

TYPICAL

1. Starboard side shown

52) Passenger Storage Compartment



1. Passenger storage area

Located at the port side of the boat next to the front passenger seat, this storage area provides quick, easy access for small articles.

53) Engine Cover

Pull upwards on the latch below the rear center seat cushion and lift engine cover lid.

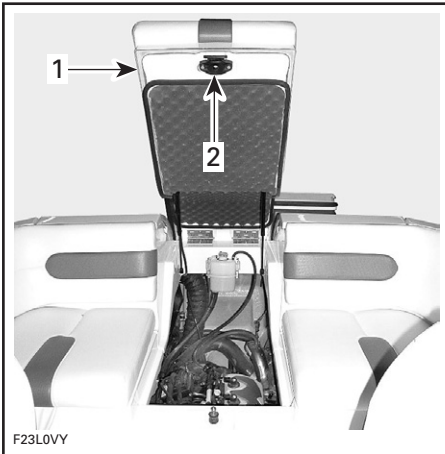

1. Engine cover/center cushion
2. Latch

The gas assist cylinders will complete the opening and hold the cover open.

54) Port Bilge Access

Located at the port rear of the boat.

This area allows access to the battery, the main battery cut-off switch and various fuses.

Lift latch to open storage cover.

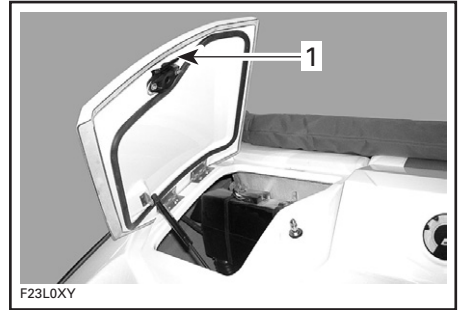

1. Latch

The gas assist cylinder will hold the storage cover open.

WARNING

Always close cover before getting underway.

Also see *MAINTENANCE* section.

55) Removable Cooler

A 15 liter (16 quart) removable cooler is provided for keeping sandwiches and non-alcoholic beverages cold.

It is located in the starboard rear seat storage compartment, and will also fit in the port rear seat storage compartment.

FUEL AND LUBRICATION

CAUTION: Carefully follow the instructions of this section. Failure to do so may reduce the engine's life and/or performance.

Fueling Procedure

WARNING

Follow these safe boating fueling instructions explicitly.

Turn off engine.

Do not allow anyone to remain on the boat.

Tie boat securely to the fueling pier.

Have a fire extinguisher close at hand.

Insert the spout into the filler neck.

Pour fuel slowly so that air can escape from the tank and prevent fuel flow-back. Be careful not to spill fuel.

Stop filling when the fuel reaches the bottom of filler neck. **Do not overfill.** Fully tighten fuel tank cap.

WARNING

Always stop the engine before refueling. Fuel is flammable and explosive under certain conditions. Always work in a well ventilated area. Do not smoke or allow open flames or sparks in the vicinity. Fuel tank may be pressurized. Slowly turn cap when opening. Never use an open flame to check fuel level. When fueling, keep boat level. Do not overfill or top off the fuel tank and leave boat in the sun. As temperature increases, fuel expands and might overflow. Always wipe off any fuel spillage from the boat. Periodically verify fuel system.

Recommended Fuel

Naturally-Aspirated Engine Models

Use regular unleaded gasoline or oxygenated fuel containing a maximum total of 10% of ethanol or methanol or both. The gasoline used must have the following recommended minimum octane number.

LOCATION	OCTANE NUMBER
Inside North America	87 Octane (RON+MON)/2
Outside North America	91 RON

Supercharged Engine Models

It is recommended to use a premium unleaded gasoline with the following octane number for optimum performance.

LOCATION	OCTANE NUMBER
Inside North America	90 Octane (RON+MON)/2
Outside North America	95 RON

As a minimum, regular unleaded gasoline with the following minimum octane number may be used.

LOCATION	OCTANE NUMBER
Inside North America	87 Octane (RON+MON)/2
Outside North America	91 RON

All Models

CAUTION: Never experiment with other fuels or fuel ratios. The use of unrecommended fuel can result in boat performance deterioration and damage to critical parts in the fuel system and engine components.

Engine Oil

Recommended Oil

This boat features a 4-stroke engine that requires 4-stroke motor oil for internal engine lubrication. Ensure to respect the following requirements.

NA Engines

Sea-Doo sport boats featuring a 4-stroke engine without a supercharger require 4-stroke motor oil meeting the requirements for API service classification SL, SJ or SH. Always check the API service label on the oil container to be sure it includes those letters.

XP-S 10W-40 4-stroke oil (P/N 219 700 346) sold by authorized Sea-Doo sport boat dealers meets those requirements.

Supercharged and Supercharged Intercooled Engines

Use XP-S 10W-40 4-stroke oil (P/N 219 700 346) or an equivalent approved by BRP. The same oil lubricates both the engine and the supercharger clutch. XP-S 10W-40 4-stroke oil (P/N 219 700 346) has been thoroughly tested to be free of any additives that could impair the functionality of the supercharger clutch.

CAUTION: Do not add any additives to the recommended oil. Beware that oils not recommended by BRP may contain additives (friction modifiers that may cause inappropriate slippage of the supercharger and eventually lead to premature wear. For this reason, oils other than XP-S 10W-40 4-stroke oil (P/N 219 700 346) or an approved equivalent are not recommended.

All Engines

CAUTION: Never use any two-stroke engine oil.

Oil Viscosity

The same oil is recommended for all seasons and all ambient temperatures.

Oil Level

CAUTION: Check level frequently and refill if necessary. Do not overfill. Operating the engine with an improper oil level may severely damage engine. Wipe off any spillage.

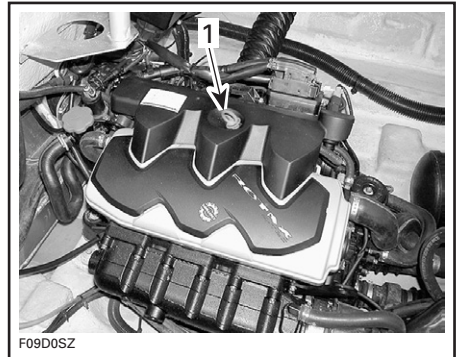

TYPICAL
1. Dipstick

Check the oil level as follows:

NOTE: Before checking the oil level on this engine, it is necessary to let it idle for 30 seconds **before** shutting it off. Then it is necessary to wait 30 seconds before the oil can be checked. This is required to allow the oil to properly level out in the different oil chambers. Otherwise, you will have a false oil level reading.

- Boat must be level. Check oil level either with boat in water or out of water. Engine should be warm.

CAUTION: Never run engine without supplying water to the exhaust cooling system when boat is out of water.

- If out of water and on a trailer, block the wheels and raise the bow slightly with the trailer jack (if so equipped) until the bumper rail is level. Install a garden hose to the flushing connector. Refer to *FLUSHING* in *POST-OPERATION CARE* and follow the procedure.

CAUTION: Failure to supply water to the exhaust cooling system, when engine is out of water, may severely damage engine and/or exhaust system.

- Warm-up engine then let idle for 30 seconds before stopping.
- Stop engine.
- Wait at least 30 seconds then pull dipstick out and wipe clean.

⚠ WARNING

Engine oil may be hot. Certain components in the engine compartment may be very hot. Direct contact may result in skin burn.

CAUTION: Never run engine longer than 5 minutes. Drive line seal has no cooling when boat is out of water.

- Reinstall dipstick, push in completely.
- Remove dipstick and read oil level. It should be between marks.

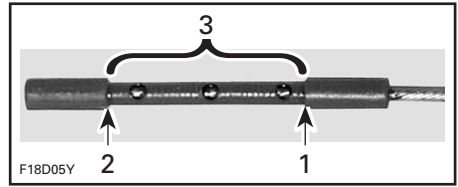

1. Full
2. Add
3. Operating range

- Otherwise, add oil up to have the level between marks as required.
- To add oil, unscrew oil cap. Place a funnel into the opening and add the recommended oil to the proper level. Do not overfill.

NOTE: Every time oil is added in engine, the complete procedure explained above must be done (engine restarted, idling for 30 seconds, 30 seconds waiting time and then, rechecking the oil level). This is required to allow the oil to properly transfer in the different oil chambers and to then level. Otherwise, you will have a false oil level reading.

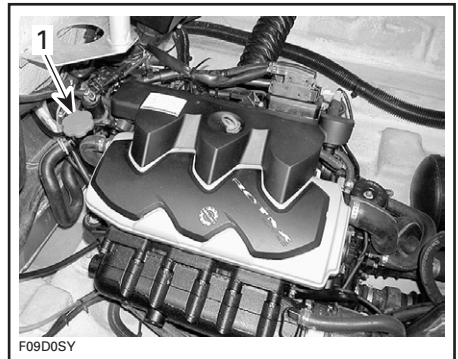

- TYPICAL**
1. Oil cap

- Properly reinstall oil cap and dipstick.

Engine Coolant

Recommended Coolant

Always use ethylene-glycol antifreeze containing corrosion inhibitors specifically for internal combustion aluminum engines.

NOTE: When available, it is recommended to use biodegradable antifreeze compatible with internal combustion aluminum engines. This will contribute to protect the environment.

Cooling system must be filled with water and antifreeze solution (50% water, 50% antifreeze).

BRP sells premixed coolant with freezing protection up to - 52°C (- 62°F) (P/N 219 700 362).

To prevent antifreeze deterioration, always use the same brand. Never mix different brands unless cooling system is completely flushed and refilled. Refer to an authorized Sea-Doo sport boat dealer.

Coolant Level

WARNING

Check coolant level with engine cold. Never add coolant in cooling system when engine is hot.

With boat on a level surface, liquid should be between MIN. and MAX. level marks of coolant reservoir when engine is cold.

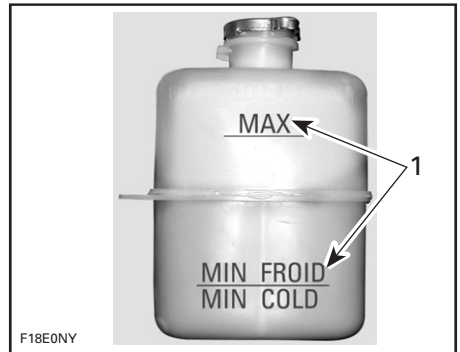

1. Level between marks when engine is cold

NOTE: The boat is considered level when it is in water. When on a trailer, block the wheels and raise the bow slightly with the trailer jack (if so equipped) until the bumper rail is level.

Add coolant to have the level between marks as required. Use a funnel to avoid spillage. **Do not overfill.**

Properly reinstall and tighten filler cap.

NOTE: A cooling system that frequently requires coolant is the indication of leaks or engine problems. See an authorized Sea-Doo sport boat dealer.

Coolant Replacement

Refer to *MAINTENANCE* section.

BREAK-IN PERIOD

CAUTION: Carefully follow the instructions of this section. Failure to do so may reduce the engine's life and/or performance.

With Sea-Doo sport boats powered by Rotax engines, a break-in period of 10 hours is required before continuous operation at full throttle.

To achieve a good break-in, throttle lever should not be advanced more than 3/4, however, brief acceleration and speed variations contribute to a good break-in.

CAUTION: Continued wide open throttle runs and prolonged cruising without speed variations should be avoided. This can cause engine damage during the break-in period.

NOTE: Never add oil in fuel tank.

10-Hour Inspection

NOTE: The 10-hour inspection is at the expense of the boat owner.

It is highly recommended that after the first 10 hours of operation, the boat be checked by an authorized Sea-Doo sport boat dealer. This inspection will also provide the opportunity to discuss the unanswered questions you may have encountered during the first hours of operation.

10-HOUR INSPECTION CHECK LIST	✓
Pressure test fuel system and inspect lines and fasteners	
Check cooling system coolant level (refill as needed)	
Check oil level in engine (refill as needed)	
Inspect ride shoe/coolant leaks	
Inspect fuel tank strap	
Inspect fuel injection system sensors	
Inspect ski tow/wakeboard tower (if so equipped) and fasteners	
Inspect hull	
Inspect drive shaft/oil seal	
Inspect engine supports and rubber engine mounts	
Inspect muffler and battery fastening devices	
Retighten exhaust system hose clamps	
Verify steering system	
Adjust steering cable (if required)	
Adjust shifter cable (if required)	
Ensure that throttle lever keeps the selected position. Adjust lever tension as necessary	
Inspect condition of hoses and clamps	
Verify operation of bilge pump and bilge blower	
Verify operation of DESS system and start/stop button	
Test monitoring beeper	
Inspect electrical connections (starter, battery, etc.)	
Inspect lighting system	
Torque jet pump retaining nuts	
Inspect condition of impeller, wear ring and wear ring clearance	
Inspect water intake grate/hull condition	
Inspect condition of sacrificial anodes	
Inspect seals and fasteners for tightness	
Inspect/clean exhaust drain tube	

We recommend that this inspection chart be signed by an authorized Sea-Doo sport boat dealer.

Date of 10-hour inspection

Authorized dealer signature

Dealer code

PRE-OPERATION CHECKS

WARNING

The pre-operation check is very important before operating the boat. Always check the proper operation of critical controls, safety features and mechanical components before starting. If not done as specified here, severe injury or death might occur. Bring all safety equipment required by local laws.

Some of the following items may not have been previously covered in this guide, however they will be described in the *MAINTENANCE* or *SPECIAL PROCEDURES* section. Please refer to these portions to have more detailed information.

WARNING

Engine should be off and the safety lanyard must always be removed from the DESS post before verifying any of the following. Only start boat once all items have been checked and operate properly.

SUMMARY		
ITEM	OPERATION	✓
Hull	Inspect for damage.	
Jet pump water intake	Inspect/clean.	
Bilge	Drain. Ensure plugs are secured.	
Battery	Inspect tightness of cables and retaining straps. Verify sufficient charge.	
Main battery cut-off switch	Ensure it is in the ON position.	
Navigation lights	Check operation.	
Fuel reservoir	Refill.	
Engine compartment	Verify fuel exhaust components.	
Fire extinguisher	Inspect condition/mounting.	
Steering	Check operation.	
Throttle/shifter system	Check operation.	
Bilge blower and bilge pump	Check operation.	
Safety lanyard/DESS/engine start/stop button	Check operation.	
Mandatory safety boating equipment	Check operation.	
Storage compartment covers	Ensure they are closed and latched.	
Sacrificial anodes	Verify condition (replace when 50% corroded).	
Engine oil level	Refill as needed.	
Cooling system coolant level	Refill as needed.	

Hull

Inspect hull for cracks or damage.

Jet Pump Water Intake

Remove weeds, shells, debris or anything else that could restrict the flow of water and damage the cooling system or propulsion unit. Clean as necessary. If any obstruction cannot be removed, refer to an authorized Sea-Doo sport boat dealer for servicing.

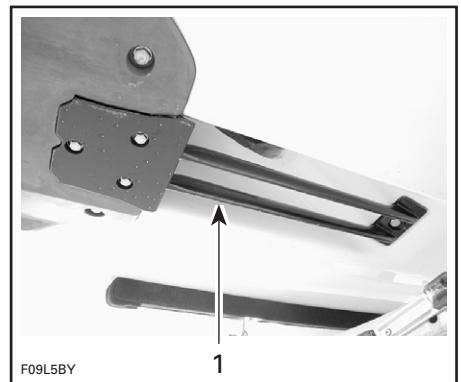

TYPICAL
1. Inspect this area

Inspect leading edges of the impeller for nicks or bends, which will greatly reduce performance of the boat.

Bilge

If water is present in the bilge, turn on pump switch to empty the bilge.

WARNING

Make sure drain plugs are properly secured before launching the boat in water.

Battery

WARNING

Verify tightness of battery cables to their posts and condition of retaining straps/fasteners. Do not charge or boost battery while installed in engine compartment.

Fuel Tank and Oil Level

With the boat level, fill the fuel tank.

Check the oil level and refill as necessary as per *ENGINE OIL* section.

Check fuel tank retaining straps/fasteners.

Engine Compartment

WARNING

If any leaks or gasoline odors are present, do not start the engine. Consult an authorized Sea-Doo sport boat dealer.

Fire Extinguisher

Make sure fire extinguisher is full, in good condition and well secured.

Steering System

Have another person help check steering operation for free movement. When the steering is centered, the jet pump nozzle should be in the straight ahead position. Ensure the jet pump nozzle pivots easily while steering is turned.

WARNING

Check steering and corresponding steering nozzle operation before starting engine.

Throttle System

Check throttle lever for free and smooth operation.

WARNING

Check throttle lever operation before starting the engine.

Shifter System

Check that reverse gate moves freely. With shift lever in forward position, the gate must be in upward position. With the shift lever in neutral position, gate must be in middle position. With shift lever in reverse position, gate must be in downward position.

WARNING

Verify the reverse gate lock.

To verify the reverse gate lock, move shifter to FORWARD position.

Pull backwards on the reverse gate.

The reverse gate lock is working if the reverse gate stays in the up position.

CAUTION: If the reverse gate does not stay in the up position when the shifter is at FORWARD, do not operate the boat further, see an authorized Sea-Doo sport boat dealer.

Safety Lanyard and Engine Start/Stop Button

Ensure that switch operates properly.

WARNING

If engine does not shut-off when pushing engine start/stop button or by disconnecting the safety lanyard, do not operate the boat further, see an authorized Sea-Doo sport boat dealer. Only start boat once all items have been checked and operate properly.

Storage Compartment Covers

Ensure they are closed and latched.

OPERATING INSTRUCTIONS

WARNING

Always perform PRE-OPERATION CHECKS before operating the boat. Become thoroughly familiar with all controls and the function of each. Should any control or instruction be not fully understood, refer to an authorized Sea-Doo sport boat dealer.

Launching/Loading

CAUTION: Before launching the boat, ensure the main battery cut-off switch is turned ON and the bilge plugs are fully screwed into place.

When finished loading the boat on trailer, turn the main battery cut-off switch to OFF.

Remove bilge plugs to drain bilge when boat is on trailer.

Trailer

Refer to the trailer instructions for proper capacity, operation, maintenance, accessories and warranty.

Check the regulations in your area concerning towing a trailer, especially the following rules:

- brake system
- tow vehicle weight
- mirrors.

NOTE: An optional brake system is available for your trailer, see an authorized Sea-Doo Sport Boat dealer.

Take the following precautions when trailering the boat:

Tie the boat to both bow and stern (front/rear) eyelets so that it is firmly retained on the trailer.

- Remove stern light (if installed).
- Ensure that ski post is pushed down (on so equipped models).

- Ensure all storage compartment covers are properly latched.
- A Sea-Doo cover can protect the boat, particularly before driving on dirt roads, to prevent dirt entry through the air intake openings.

Observe trailering safety precautions.

CAUTION: Always ensure rear storage compartment lid is closed and securely fastened **before** trailering.

Principle of Operation

Propulsion

The engine is directly coupled to a drive shaft which, in turn, rotates an impeller. This impeller rotates within a housing drawing water in from beneath the boat. Water is then forced by the impeller through a venturi. The venturi pressurizes and accelerates the water, producing thrust to move the boat. Pushing the throttle lever forward increases engine speed and therefore boat speed.

When the shift lever is pushed forward, the boat moves forward. Pulled back in the reverse position, the boat moves backwards. The middle position is neutral and the boat is at the minimum thrust for most conditions. Neutral and reverse are achieved by means of a gate, which is installed on the jet pump venturi housing. This gate directs the water flow to obtain the desired direction.

WARNING

When the boat is in neutral position, the impeller is turning.

WARNING

Shift lever should only be used when the engine is idling and boat is stopped.

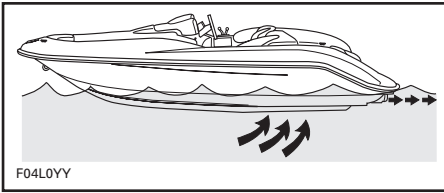

TYPICAL

⚠ WARNING

When an engine is to be started, the operator and passengers should always be sitting in the boat with the shifter lever in neutral position and throttle lever in idle position.

Steering

Turning the steering pivots the jet pump nozzle which controls the boat direction. Turning the steering wheel clockwise will turn the boat to the right and inversely.

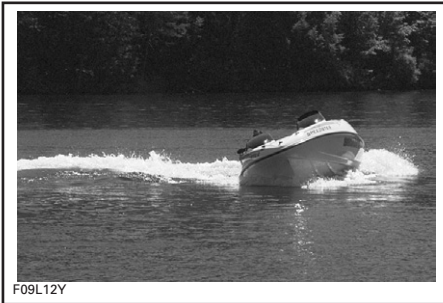

TYPICAL

Above idle speed, throttle must be applied to turn the boat.

⚠ WARNING

Throttle must be applied and steering turned to change the direction of the boat at speed. Steering efficiency will differ depending on the number of passengers, load and water conditions.

A jet propelled boat needs some throttle applied in order to turn. Practice in a safe area applying the throttle and turning away from an imaginary object. This is a good collision avoidance practice.

Using Reverse

The boat behaves differently when using reverse. The steering response is the opposite of forward operation. So, turning the steering wheel clockwise will turn the back of the boat to the left and inversely. Use throttle moderately. Too much RPM will create water turbulence and reduce reverse efficiency. At first outing, carefully practice this maneuver away from anything with which you might collide.

⚠ WARNING

Become fully familiar with this feature during your first ride and before carrying passengers.

Boarding from a Dock

As with any boat, boarding should be done carefully and engine must not be running.

When boarding from a dock, slowly place one foot on the boat deck nearest to the dock and then move the other foot inside the boat. Push the boat away from the dock.

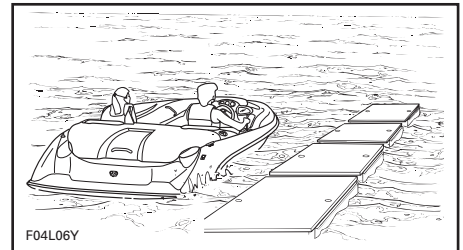

TYPICAL

CAUTION: Although the boat requires only 30 cm (1 ft) of water to float, the engine should be started with at least 90 cm (3 ft) of water below the hull. If the depth of water is less than 90 cm (3 ft) and the engine is running, the impeller is turning and debris can be drawn from the bottom and damage the propulsion system.

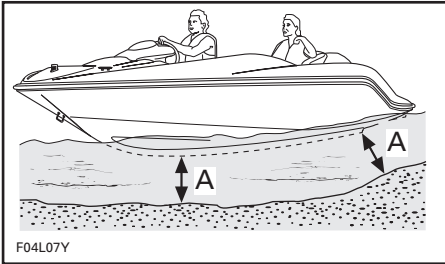

TYPICAL
A. 90 cm (3 ft)

Boarding from the Water

WARNING

Inexperienced riders should practice how to get aboard close to shore first before venturing into deep water.

WARNING

Engine should not be running while boarding. Never use propulsion components as a supporting point to board the boat.

Swim to the rear of the boat.
Release the rubber stays on one-step ladder pulling ladder out and down into boarding position. Grip the grab handle and pull yourself up until your knee can reach the swim platform.

WARNING

Never leave ladder in down position when engine is running or boat is in motion. Always secure ladder with rubber stays when not in use.

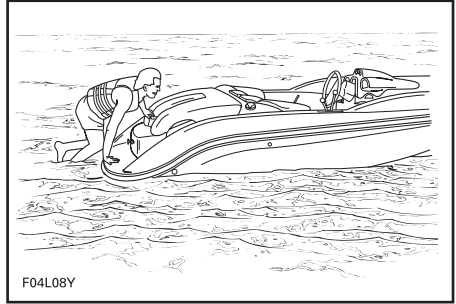

TYPICAL

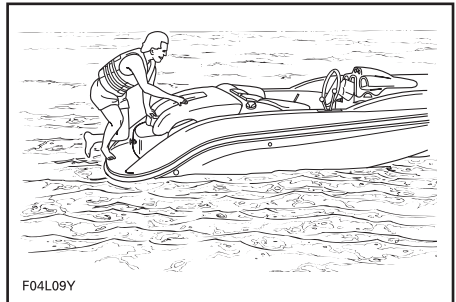

TYPICAL

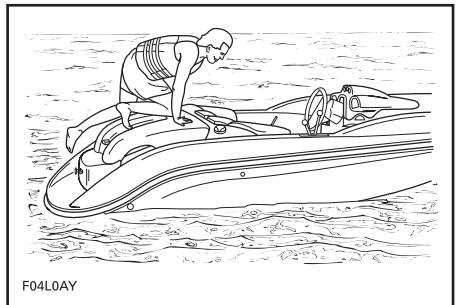

TYPICAL

 **WARNING**

Do not start engine until all passengers are properly seated.

Starting

 **WARNING**

Engine exhaust fumes contain carbon monoxide (CO) which can accumulate in and around the boat (under Bimini top, in cockpit, etc.). CO can be harmful or fatal if inhaled. Assure there is adequate ventilation whenever running engine.

 **WARNING**

Always activate bilge blower 5 minutes minimum before starting the engine to allow the bilge blower to ventilate the bilge.

 **WARNING**

Do not touch electrical parts or jet pump area when engine is running.

 **WARNING**

Bilge blower must be turned off during sport boat operation.

Attach the safety lanyard to your PFD and snap the cap to the DESS post before starting the engine.

NOTE: If you hear some beeper signals other than 2 short beeps, it indicates a particular condition that must be corrected. Refer to chart in the *TROUBLESHOOTING* section for the meaning of the coded signal.

Grip steering wheel with your right hand and place both feet on the floorboard. Turn off bilge blower.

Start engine. Check tachometer to monitor engine.

 **WARNING**

Before starting, the operator and passengers should always be properly seated.

CAUTION: To avoid starter motor overheating, the cranking period should not exceed 5 - 10 seconds and a rest period of 30 seconds should be observed between cranking cycles to let the starter cool down and its mechanism disengage.

Leaving the Shore

With throttle lever at idle, move shifter to the desired direction.

Slowly accelerate to reach deeper water. Do not apply full throttle until the engine is warm.

 **WARNING**

In shallow water, shells, sand, pebbles or other objects could be drawn up by the jet pump and thrown rearward.

Rough Water or Poor Visibility Operation

Avoid operation in these conditions. If you must do so, proceed with caution and prudence using minimum speed. Turn on navigation lights if necessary.

Crossing Waves

Reduce speed when crossing waves. Always be prepared to steer and balance as necessary.

When crossing wakes, always keep a safe distance from boat ahead.

 **WARNING**

When crossing wakes, slow down. Operator and passenger(s) can brace themselves by posting. Do not jump waves or wakes.

Stopping/Docking

The boat is slowed by water drag. The stopping distance will vary depending on weight, speed, water surface condition, presence and direction of wind and current.

The operator should become familiarized with the stopping distance under different conditions.

Reduce speed to idle. Shift to neutral, reverse or forward as required when approaching a dock then shut off the engine just before coming alongside.

WARNING

Directional control is reduced when throttle is decreased and lost when engine is off.

When close to the dock, shut off the engine.

Beaching

CAUTION: It is not recommended to run the boat onto the beach.

Come slowly to the beach and shut off the engine using the safety lanyard when water depth is 90 cm (3 ft) under the hull, then pull the boat to the beach. Ensure that all accessories are OFF.

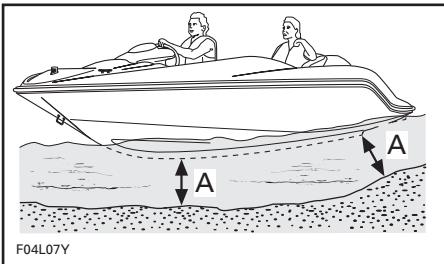

A. 90 cm (3 ft) of water under the hull

WARNING

In shallow water, shells, sand, pebbles or other objects could be drawn up by the jet pump and thrown rearward.

As necessary, the cooling system of the engine should be flushed before restarting, in order to remove sand or shell accumulation which may clog the water passages. Refer to *POST-OPERATION CARE* and look for *COOLING SYSTEM FLUSHING*.

Shutting Off the Engine

To shut off the engine, completely pull back throttle lever then remove safety lanyard or press the engine start/stop button.

Always remove safety lanyard from the DESS post.

WARNING

Should the engine be shut off, boat directional control is not available. Never leave the safety lanyard connected on the DESS post when boat is not in operation to avoid unauthorized use by children.

POST-OPERATION CARE

WARNING

Allow engine to cool before performing any maintenance.

General Care

Once boat is on trailer, unscrew the drain plugs, block the wheels and raise the boat up at the bow with the trailer jack (if so equipped) to allow water to drain.

Remove any remaining water in the engine compartment (bilge, engine, etc.) with clean dry rags. This is particularly important in salt water use.

Remove the boat from the water every day to prevent growth of marine organisms.

Additional Care for Foul Water or Salt Water

When the boat is operated in foul water and particularly in salt water, additional care must be taken to protect the boat and its components. Rinse trailer and boat's hull/bilge area with fresh water.

CAUTION: Failure to perform proper care such as: boat rinsing, cooling system flushing and anticorrosion treatment, when used in salt water, will result in damage to the boat and its components. Never leave the boat stored in direct sunlight.

Exhaust Cooling System Flushing

General

Flushing the exhaust cooling system with fresh water is essential to neutralize corroding effects of salt or other chemical products present in water. It will help to remove sand, salt, shells or other particles in water jackets and/or hoses.

Flushing should be performed when the boat is not expected to be used further the same day or when the boat is stored for any extended time.

WARNING

Perform this operation in a well ventilated area.

Proceed as follows:

Clean jet pump by spraying water in its inlet and outlet and then apply a coating of BOMBARDIER LUBE lubricant or equivalent.

WARNING

When operating the engine while the boat is out of the water, the heat exchanger in the ride plate may become very hot. Avoid any contact with ride plate as burns may occur.

Connect a garden hose to connector located at the rear of boat on jet pump support. **Do not open water tap yet.**

NOTE: An optional quick connect adapter can be used (P/N 295 500 473). No hose pincher is required to flush engine.

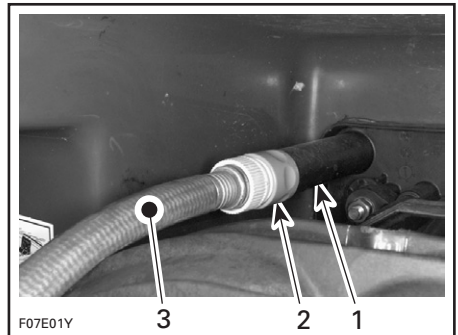

TYPICAL

1. Hose adapter
2. Quick connect adapter (optional, not mandatory)
3. Garden hose

Flushing

To flush the exhaust cooling system, start the engine **then** immediately open the water tap.

WARNING

Certain components in the engine compartment may be very hot. Direct contact may result in skin burn. Do not touch any electrical parts or jet pump area when engine is running.

CAUTION: Never flush a hot engine. Always start the engine before opening the water tap. Open water tap immediately after engine is started to prevent overheating.

Run the engine about 20 seconds at a fast idle between 4000 - 5000 RPM.

CAUTION: Never run engine without supplying water to the exhaust cooling system when boat is out of water.

Ensure water flows out of jet pump while flushing. Otherwise, refer to an authorized Sea-Doo sport boat dealer for servicing.

CAUTION: Never run engine longer than 5 minutes. Drive line seal has no cooling when boat is out of water.

Close the water tap, then stop the engine.

CAUTION: Always close the water tap before stopping the engine.

Leave all compartments open to air dry.

Anticorrosion Treatment

To prevent corrosion, spray a corrosion inhibitor (salt water resistant) such as BOMBARDIER LUBE lubricant or equivalent over metallic components in engine compartment.

NOTE: Engine fogging should be done with BOMBARDIER LUBE lubricant whenever the boat is to be stored for few days or a long period.

Apply dielectric grease (salt water resistant) on battery posts and cable connectors.

CAUTION: Never leave rags or tools in the engine compartment or in the bilge.

SPECIAL PROCEDURE

Engine Overheating

CAUTION: If the monitoring beeper continuously sounds, **stop engine immediately.**

Perform the *JET PUMP WATER INTAKE AND IMPELLER CLEANING PROCEDURE* in this section.

Flush cooling system, refer to *POST-OPERATION CARE*.

If engine still overheats, refer to an authorized Sea-Doo sport boat dealer for servicing.

Jet Pump Water Intake and Impeller Cleaning

WARNING

Keep away from intake grate while engine is on. Items such as long hair, loose clothing or personal flotation device straps can become entangled in moving parts resulting in severe injury or drowning.

Weeds, shells or debris can get caught on the intake grate, drive shaft and/or impeller. A clogged water intake may cause troubles such as:

1. **Cavitation:** Engine speed is high but boat moves slowly due to reduced jet thrust; jet pump components may be damaged.
2. **Overheating:** Since the jet pump operation controls the flow of water to cool the engine exhaust, a clogged intake will cause the engine to overheat and damage internal engine components.

The clogged area can be cleaned as follows:

In-water cleaning: Pull safety lanyard from DESS post to stop engine. Let the boat stop by itself. Wait a while to allow weeds or other debris to escape from grate. It may be necessary to repeat the procedure.

In severe conditions if the above method does not work, the following can be performed:

- With engine running, put shift lever in reverse position and vary throttle setting quickly several times.
- Try accelerating again.

Most of the time, debris will escape from the propulsion system.

Out of water cleaning: If the system is still clogged, shut off the engine by removing the safety lanyard.

WARNING

Always remove safety lanyard from switch to prevent accidental engine starting before cleaning the jet pump area.

From underneath boat, manually clean water intake area. If the system is still clogged, refer to an authorized Sea-Doo sport boat dealer for servicing.

CAUTION: Avoid operation in weeded areas. If unavoidable, vary speed. Weeds tend to entangle more at steady and slow speeds. Inspect water intake grate for damage. Refer to an authorized Sea-Doo sport boat dealer for repair as necessary.

Capsized Boat

This boat is designed so that it should not turn over easily due to its long and wide dimensions. If the boat ever capsizes, remember that it will continue to float. It is usually best to remain with it, so you will be more easily located by others.

WARNING

When boat is capsized, do not attempt to restart the engine. Operator and passengers should always wear approved personal flotation devices.

Submerged Boat/Water-Flooded Engine

To limit damages to the engine, perform the following procedure as soon as possible.

Drain bilge.

If it was submerged in **salt water**, spray bilge and all components with fresh water using a garden hose to stop the salt corroding effect.

CAUTION: Never try to crank or start the engine. Water trapped in intake manifold would flow towards the engine and may cause severe damage to the engine.

Bring the boat to be serviced by an authorized Sea-Doo sport boat dealer as soon as possible.

CAUTION: The longer the delay before you have the engine serviced, the greater the damage will be to the engine. Failure to have the engine properly serviced **will** cause severe engine damage.

Fuel-Flooded Engine

When the engine does not start after several attempts, the engine may be fuel-flooded. Proceed as follows.

Crank engine several times.

If it does not work:

Disconnect ignition coil connectors.

WARNING

When disconnecting coil from spark plug, always disconnect coil from main harness first. Never check for engine ignition spark from an open coil and/or spark plug in the engine compartment as spark may cause fuel vapor to ignite.

CAUTION: Ensure there is no dirt in coil holes before removing the spark plugs. Otherwise, dirt would fall into cylinder and will damage the internal components.

Remove ignition coils.

Remove spark plugs.

NOTE: After loosening the spark plugs, a coil may be used to pull the spark plugs out. Simply bring the coil down to spark plug and "hook" it to then extract spark plug.

Install new spark plugs if available, or dry spark plugs using a rag.

Reinstall spark plugs and ignition coils. Reconnect ignition coil connector.

NOTE: After installation, ensure the seal seats properly with the engine top surface.

Start engine as explained above. If engine continues to flood, see an authorized Sea-Doo sport boat dealer.

CAUTION: Never run engine without supplying water to the exhaust cooling system when boat is out of water.

Towing the Boat in Water

Special precautions should be taken when towing a Sea-Doo sport boat in water.

Maximum recommended towing speed is 24 km/h (15 MPH).

When towing your sport boat in water, pinch the water supply hose from the impeller housing to the exhaust manifold with a large hose pincher (P/N 529 032 500).

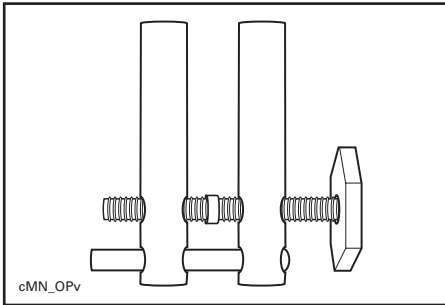

This will prevent the exhaust cooling system from filling which may lead to water being injected into and filling the engine. Without the engine running there isn't any exhaust pressure to carry the water out the exhaust outlet.

CAUTION: Failure to do this may result in damage to the engine. If your Sea-Doo sport boat must be towed in water and you do not have a hose pincher, be sure to stay well below the maximum towing speed of 24 km/h (15 MPH).

Snugly install the hose pincher on the water supply hose as shown.

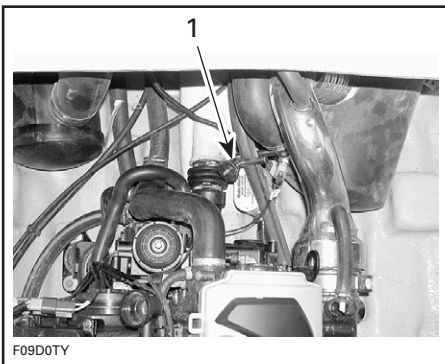

TYPICAL
1. Hose pincher

CAUTION: When finished towing the sport boat, hose pincher must be removed before operating it. Failure to do so will result in damage to the engine.

Low-Charge Battery Condition

WARNING

See your authorized Sea-Doo sport boat dealer to have it charged or replaced. Do not charge or boost the battery while installed in the engine compartment. Electrolyte is poisonous and capable of causing severe burns.

MAINTENANCE INFORMATION

MAINTENANCE

Emission Component Maintenance

Maintenance, replacement, or repair of the emission control devices and systems may be performed by any marine SI (spark ignition) engine repair establishment or individual.

- ⚠ Only perform servicing procedures which are detailed in this guide. Further assistance or information can be obtained from your authorized Sea-Doo sport boat dealer. In many instances proper tools and training are required for certain servicing or repair procedures.
- ⚠ Maintain the boat and equipment in top condition at all times. Adhere to the prescribed maintenance schedules. An annual inspection of the boat is always a good recommendation to follow.
- ⚠ The bilge must be kept clean of oil, water or other foreign materials.
- ⚠ Do not attempt to lift the boat without special equipment and training.
- ⚠ The engine and the corresponding components identified in this guide should not be utilized on product(s) other than for those they were designed. Maintenance procedures and specified tightening torque must be strictly adhered to. Never attempt repairs unless the appropriate tools are available. Each boat is designed with parts dimensioned in both the metric and the imperial systems. When replacing fasteners, make sure to use only those recommended by BRP. If required, contact your authorized Sea-Doo sport boat dealer for further servicing information.
- ⚠ Operate your boat prudently and have fun. Don't forget that all persons must assist other boaters in an emergency.

Engine Emissions Information

Manufacturer's Responsibility

Beginning with 1999 model year engines, manufacturers of marine engines must determine the exhaust emission levels for each engine horsepower family and certify these engines with the United States of America Environmental Protection Agency (EPA). An emissions control information label, showing emission levels and engine specifications, must be placed on each boat at the time of manufacture.

Dealer's Responsibility

When performing service on all 1999 and more recent Sea-Doo sport boats carrying an emissions control information label, adjustments must be kept within published factory specifications.

Replacement or repair of any emission related component must be executed in a manner that maintains emission levels within the prescribed certification standards.

Dealers are not to modify the engine in any manner that would alter the horsepower or allow emission levels to exceed their predetermined factory specifications.

Exceptions include manufacturer's prescribed changes, such as altitude adjustments for example.

Owner Responsibility

The owner/operator is required to have engine maintenance performed to maintain emission levels within prescribed certification standards.

The owner/operator is not to, and should not allow anyone to modify any engine in a manner that would alter the horsepower or allow emission levels to exceed predetermined factory specifications.

EPA Emission Regulations

All new 1999 and more recent Sea-Doo sport boats manufactured by BRP are certified to the EPA as conforming to the requirements of the regulations for the control of air pollution from new boat engines. This certification is contingent on certain adjustments being set to factory standards. For this reason, the factory procedure for servicing the product must be strictly followed and, whenever practicable, returned to the original intent of the design.

The responsibilities listed above are general and in no way a complete listing of the rules and regulations pertaining to the EPA requirements on exhaust emissions for marine products. For more detailed information on this subject, you may contact the following locations:

Internet: <http://www.epa.gov/otaq/>

E-Mail: otaqpublicweb@epa.gov

FOR ALL COURIER SERVICES:

U.S. Environmental Protection Agency
Office of Transportation and Air Quality
1310 L Street NW
Washington D.C. 20005

REGULAR US POSTAL MAIL:

1200 Pennsylvania Ave. NW
Mail Code 6403J
Washington D.C. 20460

WARNING

Only perform procedures as detailed in this guide. It is recommended that the assistance of an authorized Sea-Doo sport boat dealer be periodically obtained on other components/systems not covered in this guide. Unless otherwise specified, engine must not be running, the safety lanyard must be removed from the DESS post and the main battery cut-off switch must be turned OFF for all maintenance procedures. Never use jet pump components to lift the boat. Certain components in the engine compartment may be very hot. Direct contact may result in skin burn. When operating the engine while the boat is out of the water, the heat exchangers may become very hot. Avoid any contact with heat exchangers as burns may occur.

Lubrication

IMPORTANT: DO NOT lubricate DESS post. This will prevent proper electrical contact.

Anticorrosion Protection

Throttle Cable

Lubricate the throttle cable with BOMBARDIER LUBE lubricant every 25 hours of use (every 10 hours in salt water use).

Electrical Connections

As necessary, apply dielectric grease on battery posts and all exposed cable connectors including stern light connectors on mast and boat as needed.

CAUTION: Do not lubricate connectors of the Interface and the engine Electronic Control Unit (ECM ECU).

Additional Lubrication

BOMBARDIER LUBE lubricant will help to prevent corrosion and keep proper operation of moving mechanisms.

Lubrication of the following items should be performed every 50 hours in fresh water use but every 10 hours in salt water use.

Rear Storage Compartment Cover Mechanism and Hinges

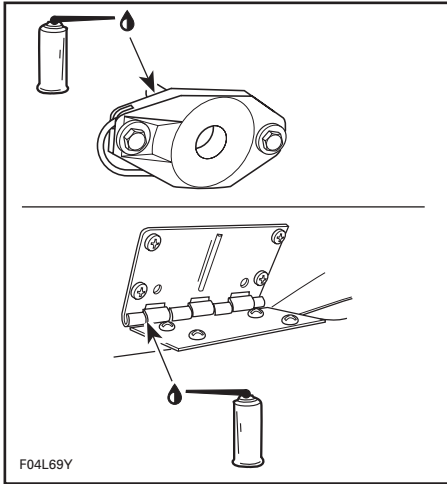

TYPICAL

Ski Post

On so Equipped Models

Lubricate ski post through all its length. Pull out then push in several times to distribute the lubricant.

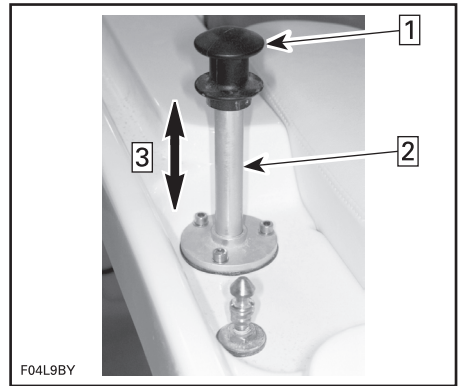

TYPICAL

Step 1: Lift ski post to lubricate

Step 2: Lubricate here

Step 3: Move post up and down several times to distribute lubricant

Reverse Gate

Lubricate pivot points.

Rear Storage Compartment Cover Cylinders

Lubricate rod of cylinders.

Periodic Inspection

Routine maintenance is necessary for all mechanized products. A periodic inspection contributes to the product's life span.

The periodic inspection chart at the end of this document gives guidelines for regular boat servicing schedule to be performed by you and/or by an authorized Sea-Doo sport boat dealer. The schedule should be adjusted according to operating conditions and use.

Throttle Cable

Move the throttle lever forward and rearward once. It must operate smoothly. Refer to an authorized Sea-Doo sport boat dealer if adjustment is necessary.

WARNING

Do not alter or tamper with throttle cable adjustment or routing.

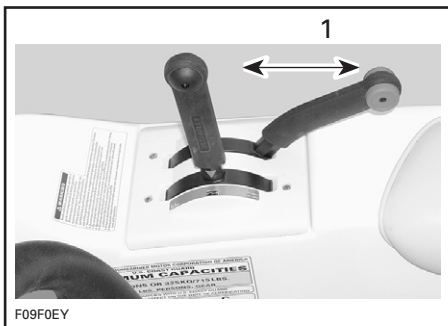

TYPICAL — THROTTLE LEVER

1. Must move smoothly

Fuel and Oil Filters

These filters must be replaced by an authorized Sea-Doo sport boat dealer annually. Fuel system pressurization should be conducted at the same time.

CAUTION: An obstructed oil filter will cause oil starvation resulting in serious engine damage.

Steering/Jet Pump Nozzle Adjustment

When the steering is aimed in straight ahead position, the jet pump nozzle should be in the same direction to allow the sport boat to run in a straight line.

Refer to an authorized Sea-Doo sport boat dealer if an adjustment is necessary.

WARNING

Ensure the steering/jet pump nozzle operates freely from side to side and is not stressing the steering cable.

Reverse Gate

When shift lever is in forward position, reverse gate should be in an upward position and locked. With the shift lever in neutral position, reverse gate should be in intermediate position. When shift lever is in reverse position, reverse gate should be in downward position. Refer to an authorized Sea-Doo sport boat dealer if an adjustment is necessary.

WARNING

Ensure the shifter/reverse gate operates freely and is not stressing the reverse cable.

Deck Drain

Remove any obstruction(s) from deck drain outlet.

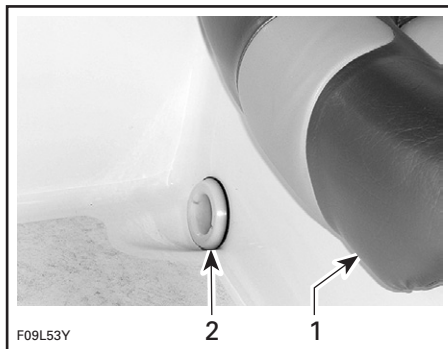

CHALLENGER 180

1. Driver's seat
2. Deck drain hole

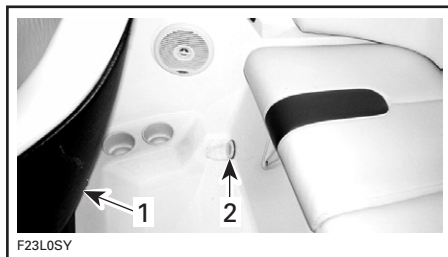

TYPICAL — SPORTSTER 4-TEC

1. Driver's seat
2. Deck drain hole

Fuses

Accessories, Engine Electrical System and Gauges

If a fuse is defective, replace by one of the same rating.

WARNING

Do not use a higher rated fuse as this can cause severe damage. If a fuse has blown, the source of malfunction should be determined and corrected before restarting. See an authorized Sea-Doo sport boat dealer for servicing.

Sportster 4-TEC Models

If nothing at all is working, check that the battery cut-off switch in the engine compartment is in the ON position. Also, check main fuses, connected to battery cut-off switch inside gunwale.

NOTE: There are spare fuses in rubber holders attached to the top of the fuse block and the gauge interface.

The main fuses for the engine electrical system are located near the solenoid, as shown below.

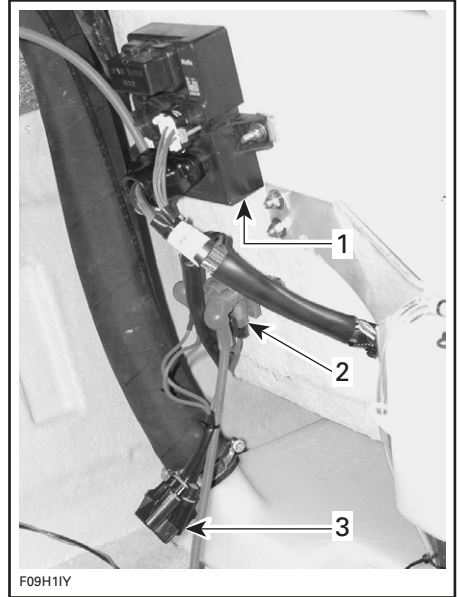

1. Engine fuse block
2. Solenoid
3. Engine electrical system main fuses

Fuses for the accessories and the gauges are mounted in the gauge interface, which is located ahead of the dash.

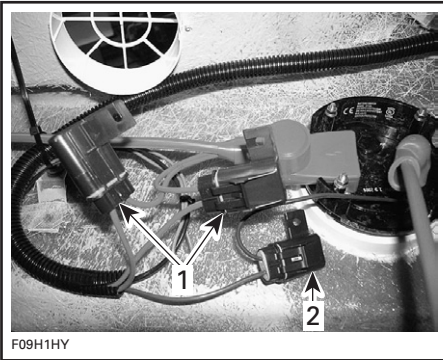

TYPICAL

1. Gauge interface fuses
2. Automatic bilge pump fuse

If an accessory, engine or gauge is not working, check its fuse condition.

Fuses for the electrical system of the engine are mounted in the fuse block, which is located in the engine compartment.

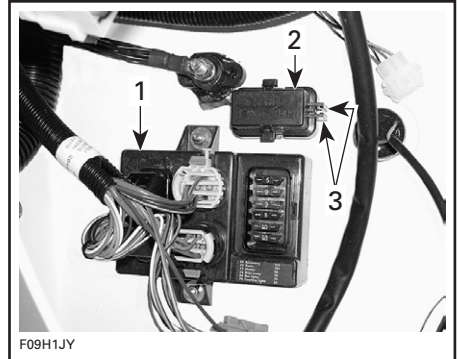

TYPICAL

1. Interface
2. Fuse cover
3. Use these tabs as a fuse puller

Squeeze cover locking tabs and pull cover out to access fuses.

Use the cover tabs to remove the fuse.

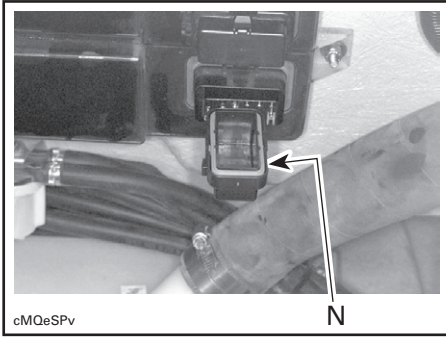

TYPICAL

1. Slide cover tabs each side of fuse then pull fuse out

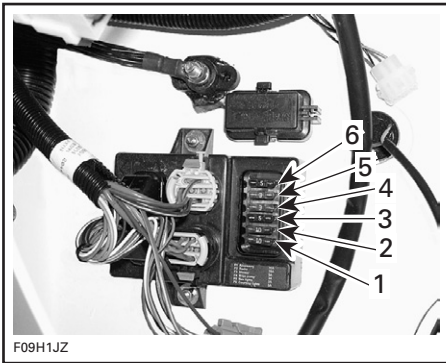

TYPICAL — GAUGE INTERFACE

1. Accessory
2. Radio
3. Blower
4. Bilge pump
5. Navigation lights
6. Courtesy lights

When finished, ensure seal is properly placed in cover.

Carefully position cover on fuse block then firmly push until you hear a snapping sound for each locking tab.

Challenger 180 Models

If nothing at all is working, check that the battery cut-off switch in the engine compartment is in the ON position. Also, check main fuses, connected to battery cut-off switch inside port rear storage compartment.

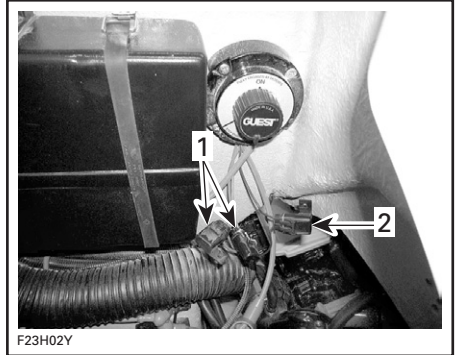

1. Main fuses
2. Automatic bilge pump fuse

Fuses for the electrical system of the engine are mounted in the fuse block, which is located in the engine compartment.

Fuses for the engine electrical system are located below the solenoid, as shown below.

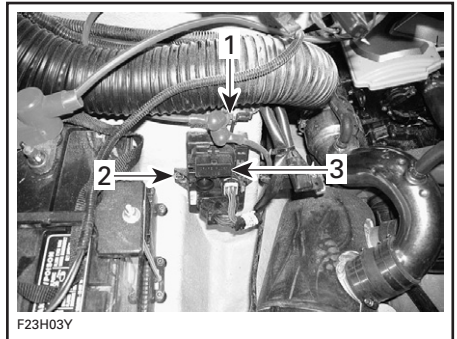

1. Solenoid
2. Engine fuse block
3. Engine electrical system fuses

NOTE: There are spare fuses inside the covers of the engine fuse block and the gauge interface.

The gauge interface is located in the starboard gunwale near the driver's seat as shown below.

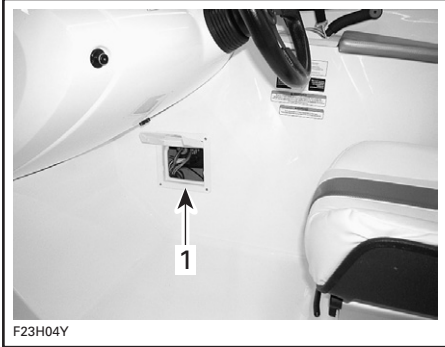

F23H04Y

1. Gauge interface fuse access



F23H05Y

TYPICAL

1. Fuse cover

Squeeze cover locking tabs and pull cover out to access fuses.

Use the cover tabs to remove the fuse.

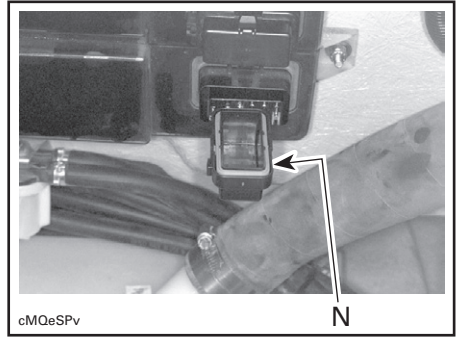

cMOeSPv

TYPICAL

1. Slide cover tabs each side of fuse then pull fuse out

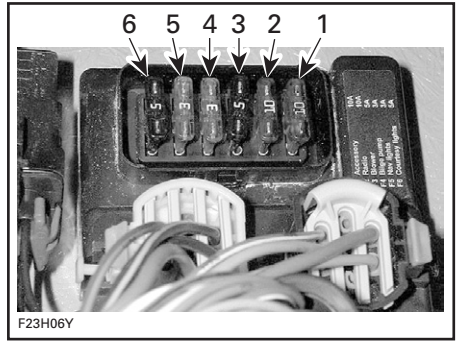

F23H06Y

TYPICAL — GAUGE INTERFACE

1. Accessory
2. Radio
3. Blower
4. Bilge pump
5. Navigation lights
6. Courtesy lights

If an accessory, engine or gauge is not working, check its fuse condition.

When finished, ensure seal is properly placed in cover.

Carefully position cover on fuse block then firmly push until you hear a snapping sound for each locking tab.

All Models

Charging System

If the battery is regularly discharged, check this fuse condition.

Fuses for the charging system are located near the starter relay in the engine compartment.

Bilge Air Blower

Verify bilge air blower for proper operation. It is located beneath starboard ventilation duct in engine compartment.

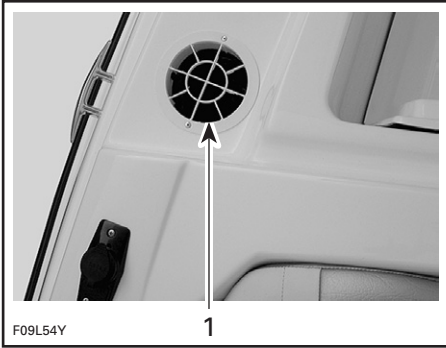

TYPICAL — SPORTSTER 4-TEC
1. Blower duct

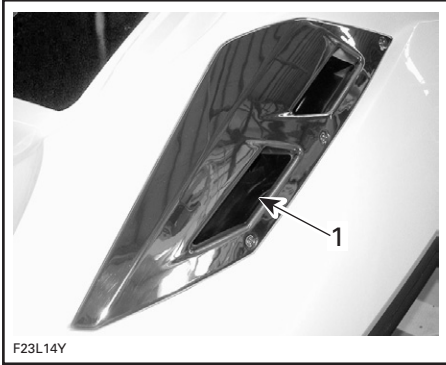

TYPICAL — CHALLENGER 180
1. Blower duct

WARNING

If bilge blower does not operate properly, refer to an authorized Sea-Doo sport boat dealer before starting the boat.

Navigation Light Bulb Replacement

Bow Light

Sportster 4-TEC Models

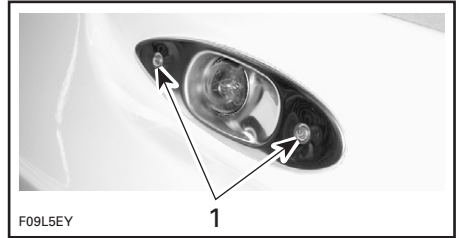

TYPICAL
1. Remove these screws

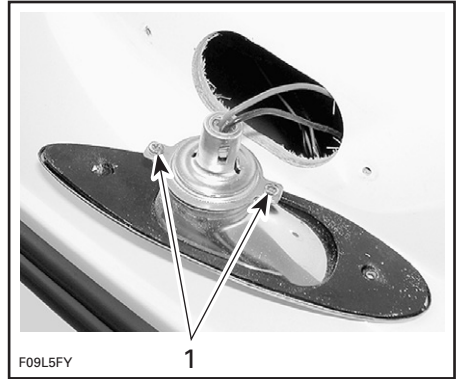

TYPICAL
1. Remove these screws



TYPICAL — PUSH IN, TWIST AND REMOVE BULB

Assembly is essentially the reverse of removal procedures. However, pay particular attention to the following:

Apply dielectric grease on bulb contact surface.

Challenger 180 Models

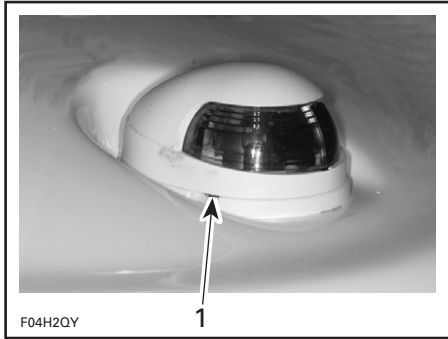

TYPICAL
1. Gently pry here with a screwdriver

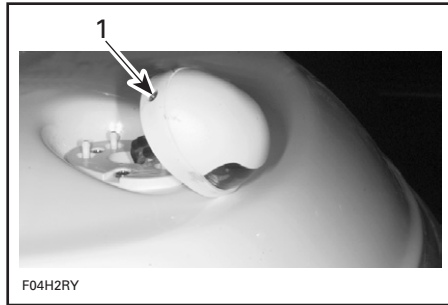

TYPICAL
1. Remove this screw

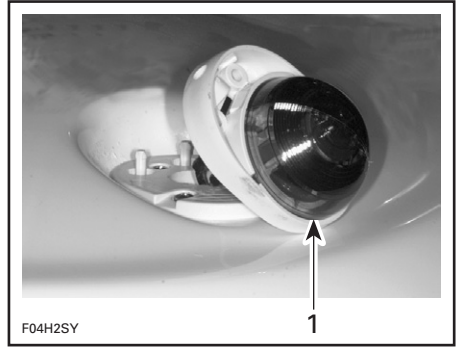

TYPICAL
1. Pull lens out

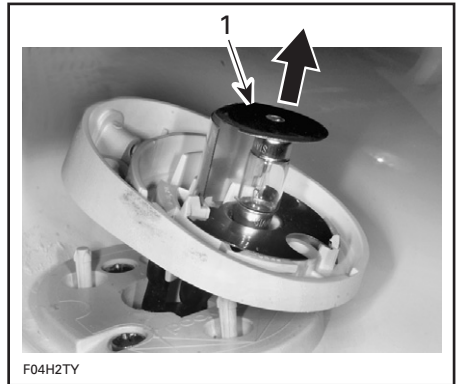

TYPICAL
1. Lift and remove bulb

The assembly is essentially the reverse of removal procedures. However, pay particular attention to the following:

Apply dielectric grease on bulb contact surface.

When installing the bulb under the upper terminal plate, it is possible that the bulb remains loose. The cover will compress the terminal plate against the bulb at reinstallation.

Stern Light

Unscrew lens counterclockwise and pull it out.

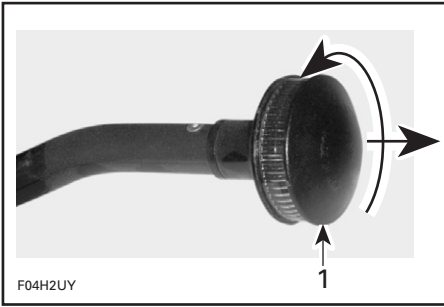

TYPICAL — SPORTSTER 4-TEC
 1. Unscrew then pull

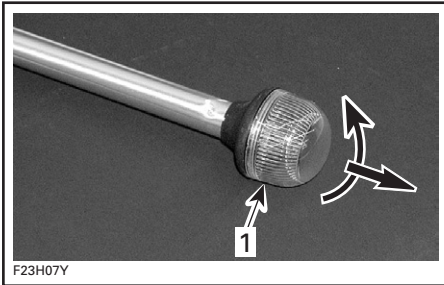

TYPICAL — CHALLENGER 180
 1. Unscrew then pull

Pull bulb to remove it.

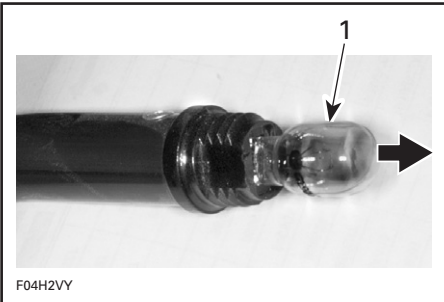

TYPICAL — SPORTSTER 4-TEC
 1. Pull bulb out

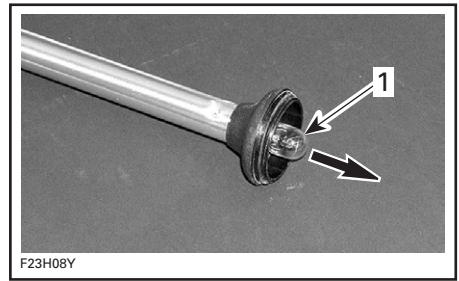

TYPICAL — CHALLENGER 180
 1. Pull bulb out

Apply dielectric grease on new bulb contact surface.

Assembly is the reverse of removal procedure.

Sacrificial Anode System

Corrosion of metal parts, especially those exposed to saltwater, is common for boats. Corrosion can be caused by stray electric currents from shore power installations, improperly grounded A.C. lines and circuits, and poorly insulated D.C. powered equipment from boats moored nearby. Corrosion is accelerated when electric current is present.

Sacrificial anodes are attached to certain parts of this boat to reduce corrosion. The anode corrodes, rather than the part to which the anode is attached.

Change each anode when 50% by weight has corroded away.

Anodes are attached at the following locations:

- ride shoe/cooling plate
- pump housing
- reverse gate support
- steering nozzle
- reverse gate.

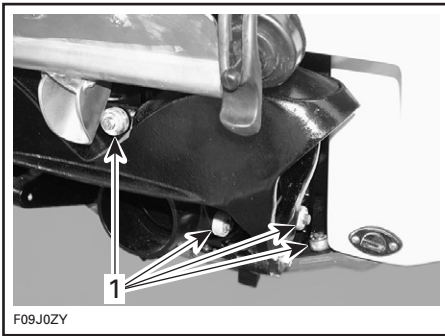

TYPICAL

1. Anode installation shown

NOTE: Inspect anodes each time boat is to be launched. Do **NOT** paint anodes or apply protective coatings.

General Inspection and Cleaning

Inspection

Check engine compartment for any damage and the fuel system for leaks. Also check battery for electrolyte leaks. Ensure all hose clamps are properly secured and no hose is cracked, kinked or presenting any other damage.

⚠ WARNING

If at any time, gasoline leaks/odors are found, do not start the engine. Have the boat serviced by an authorized Sea-Doo sport boat dealer.

Inspect mufflers, battery and fuel tank fastening devices. Check electrical connections for corrosion and tightness.

Inspect hull and jet pump water intake grate for damage. Replace or repair damaged parts.

Cleaning

Twice a year, the bilge should be cleaned with hot water and detergent or bilge cleaner to remove any possible fuel/oil/electrolyte deposits and mildew.

Occasionally, wash the body with hot water and soap (only use mild detergent). Remove any marine organisms from engine and/or hull. Apply non-abrasive wax.

CAUTION: Never clean fiberglass and plastic parts with strong detergent, degreasing agent, paint thinner, acetone, etc.

Wash windscreen with Bombardier cleaner (P/N 293 110 001) and water. For fine scratches and scuff marks removal, use a windshield polisher for acrylic, lucite, polycarbonate and similar materials.

Stains may be removed from seats and fiberglass with Knight's Spray-Nine[†] or the equivalent.

Respect the environment by ensuring fuel, oil or cleaning solutions do not drain into the waterways.

[†]Knight's Spray Nine is a registered trademark of Knight Oil Corporation.

STORAGE AND PRESEASON PREPARATION

WARNING

Because fuel and oil are flammable, have an authorized Sea-Doo sport boat dealer inspect the fuel and oil systems integrity as specified in the *PERIODIC INSPECTION CHART*.

Storage

NOTE: Leave drain plug(s) out during storage period.

It is recommended that the boat be taken to an authorized Sea-Doo sport boat dealer for proper storage, however you can perform the following operations with a minimum of tools.

CAUTION: Do not run the engine during the storage period.

Fuel System

Sea-Doo fuel stabilizer (or equivalent), can be added in fuel tank to prevent fuel deterioration and fuel system gumming. Follow stabilizer manufacturer's instructions for proper use.

CAUTION: Fuel stabilizer should be added before engine lubrication to ensure fuel system components are protected against varnish deposits.

WARNING

Always stop the engine before refueling. Fuel is flammable and explosive under certain conditions. Always work in a well ventilated area. Do not smoke or allow open flames or sparks in the vicinity. Fuel tank may be pressurized. Slowly turn cap when opening. Never use an open flame to check fuel level. When fueling, keep boat level. Do not overfill or top off the fuel tank and leave boat in the sun. As temperature increases, fuel expands and might overflow. Always wipe off any fuel spillage from the boat. Periodically verify fuel system.

Engine Oil and Filter Replacement

The oil and oil filter change should be performed by an authorized Sea-Doo sport boat dealer.

Exhaust Cooling System Flushing and Engine Internal Lubrication

Connect a garden hose to cool the exhaust system as explained in *FLUSHING* under *POST-OPERATION CARE*.

Bring engine to normal operating temperature.

CAUTION: Properly follow the instructions given in the *FLUSHING* procedure.

Close the water tap, then stop the engine.

Pull engine access panel upward to remove it.

Disconnect ignition coil connectors.

WARNING

When disconnecting coil from spark plug, always disconnect coil from main harness first. Never check for engine ignition spark from an open coil and/or spark plug in the engine compartment as spark may cause fuel vapor to ignite.

IMPORTANT: Never cut the locking ties of ignition coil connectors. This would allow mixing the wires between cylinders.

Remove ignition coils.

CAUTION: Ensure there is no dirt in coil holes before removing the spark plugs. Otherwise, dirt would fall into cylinder and will damage the internal components.

Remove spark plugs.

NOTE: After loosening the spark plugs, a coil may be used to pull the spark plugs out. Simply bring the coil down to spark plug and "hook" it to then extract spark plug.

Spray BOMBARDIER LUBE lubricant or equivalent, in spark plug holes.

To prevent fuel to be injected and also to cut the ignition at the engine cranking, proceed as follows.

From the engine compartment, have a second person hold throttle bell crank in fully opened position.

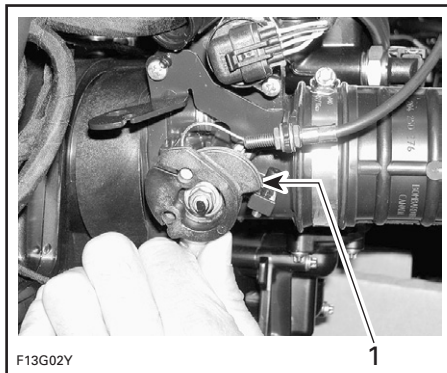

TYPICAL

1. Fully-opened position

Crank the engine a few turns to distribute the oil on cylinder wall.

Apply anti-seize lubricant on spark plug threads then reinstall them.

NOTE: After installation, ensure the seal seats properly with the engine top surface.

Reinstall ignition coils. Reconnect ignition coil connectors.

To reinstall engine cover, push it downward until it snaps.

Wipe up any residual water from the engine.

Disconnect the garden hose.

NOTE: It is recommended to fog the engine valves with BOMBARDIER LUBE lubricant. Contact your authorized Sea-Doo sport boat dealer.

Battery

Contact your authorized Sea-Doo sport boat dealer.

Engine Cooling System

Antifreeze is to be replaced every 100 hours or once per season to prevent antifreeze deterioration.

The antifreeze replacement and a density test should be performed by an authorized Sea-Doo sport boat dealer.

CAUTION: Improper antifreeze mixture might allow freezing of the liquid in the cooling system if boat is stored in area where freezing point is reached. This would seriously damage the engine. Failure to replace the antifreeze for storage may allow its degradation that could result in poor cooling when engine will be used.

Boat Cleaning/Repair

Wash the body and the trailer with soap and water solution (only use mild detergent). Rinse thoroughly with fresh water. Remove any marine organisms from the hull.

CAUTION: Never clean apparent fiberglass and plastic parts with strong detergent, degreasing agent, paint thinner, acetone, etc.

Stains may be removed from seats and fiberglass with Knight's Spray-Nine or the equivalent.

If repairs are needed to the body or to the hull contact your dealer. For paint touch up to mechanical parts use Bombardier spray paint. For minor Gelcote[†] repairs, a repair kit is available from Gelcote International (www.gelcote.ca). Replace damaged labels/decals.

Clean the bilge with hot water and detergent or with bilge cleaner. Rinse thoroughly. Unscrew drain plugs, block wheels and raise the bow with the trailer jack (if so equipped) to drain bilge.

Finalizing Storage Preparation

Apply a non-abrasive wax to body.

[†]Gelcote is a trademark of Gelcote International.

The engine storage cover should be left partially opened during storage (detach the gas shocks from the cover to prevent full opening).

On so equipped models, remove storage tray. Place it on deck.

Using a flat screwdriver, lift tab as shown below.



TYPICAL — LIFT TAB

Detach shock end. Detach other side. Block and leave engine cover lid open slightly.

This will avoid engine compartment condensation and possible corrosion.

Reattach shock ends to engine cover lid before operating boat.

If the boat is to be stored outside, cover it with a vented opaque tarpaulin to prevent UV (ultraviolet) rays and grime from affecting the plastic components, boat finish, as well as preventing dust accumulation.

CAUTION: Never leave the boat stored in direct sunlight. UV radiation will dull finishes. The boat must never be left in water for storage. Make sure to turn off main battery cut-off switch.

For the storage period, it is necessary to make certain the drain plugs are unscrewed and unobstructed, then block the wheels and slightly raise the bow with the trailer jack (if so equipped) so drainage can take place.

Preseason Preparation

Use the periodic inspection chart at the end of this document and refer to the *PRESEASON* column.

Since technical skills and special tools are required, some operations should be performed by an authorized Sea-Doo sport boat dealer.

WARNING

Observe all **WARNINGS** and **CAUTIONS** mentioned throughout this guide which are pertinent to the item being checked. When component conditions seem less than satisfactory, replace with genuine BRP parts or approved equivalents.

NOTE: It is highly recommended that an authorized Sea-Doo sport boat dealer perform the annual safety inspection and factory campaigns in addition to the pre-season preparation all at the same time.

Use the following chart.

Since technical skills and special tools are required, some operations should be performed by an authorized Sea-Doo sport boat dealer.

WARNING

Only perform procedure as detailed in this guide. It is recommended that the assistance of an authorized dealer be periodically obtained on other components/systems not covered in this guide. Unless otherwise specified, engine must not be running and the main battery cut-off switch must be turned OFF for all maintenance procedures.

Preseason Preparation Chart

NOTE: It is highly recommended that the dealer perform at the same time the annual safety inspection in addition to the pre-season preparation.

OPERATIONS	TO BE PERFORMED BY
Verify lubrication/corrosion protection	OPERATOR
Inspect condition of safety lanyard cap and post	DEALER
Verify battery condition, charge and reinstall	DEALER
Verify starter connections and routing ①	DEALER
Check engine oil level (add/replace as needed)	OPERATOR
Replace fuel filter	DEALER
Inspect condition of fuel line ①	DEALER
Pressure test fuel system ①	DEALER
Check fuel system fasteners	DEALER
Inspect steering system and low-speed steering control system ①	DEALER
Inspect throttle/shifter system ①	DEALER
Inspect deck drains/bilge pump/drain plugs	DEALER
Check fire extinguisher condition/mounting ①	OPERATOR

① Safety item covered in the annual safety inspection.

CAUTION: Only perform this operation in a well ventilated area. Garden hose must be installed or boat must be in water to cool engine. Running the engine without cooling water will damage exhaust hose interior and may damage engine.

TROUBLESHOOTING

The following chart is provided to help in diagnosing the probable source of simple troubles. You may be able to solve many of these problems rather quickly, but others may require the skills of a mechanical technician. In such a case, consult an authorized Sea-Doo sport boat dealer for servicing.

Nothing is Working in the Electrical System

OTHER OBSERVATION	POSSIBLE CAUSE	REMEDY
No beeps are heard when installing safety lanyard on DESS post.	<ul style="list-style-type: none">• Main battery cut-off switch is turned OFF.• Battery discharged or missing.	<ul style="list-style-type: none">• Verify and turn ON.• Charge or install new battery.

DESS Coded Signals

NUMBER OF BEEPS	POSSIBLE CAUSE	REMEDY
4 short (while pressing start/stop button with safety lanyard already installed).	<ul style="list-style-type: none">• Shifter is NOT in neutral.	<ul style="list-style-type: none">• Place shifter in neutral. While moving the shifter, 1 short beep indicates you reached the neutral position.
1 short (while moving shifter to neutral).	<ul style="list-style-type: none">• Confirmation that shifter is now in neutral.	<ul style="list-style-type: none">• Engine is now ready to be started.

Engine will not Start

OTHER OBSERVATION	POSSIBLE CAUSE	REMEDY
Engine does not turn over and the monitoring beeper sounds.	<ul style="list-style-type: none"> • Refer to <i>MONITORING BEEPER CODED SIGNALS</i> above. 	
Engine does not turn over.	<ul style="list-style-type: none"> • Safety lanyard removed. • Burnt fuse. • Discharged battery. • Battery connections, corroded or loose. • Water flooded engine. 	<ul style="list-style-type: none"> • Install cap over switch. • Check wiring then replace fuse. • Refer to an authorized Sea-Doo sport boat dealer. • Refer to an authorized Sea-Doo sport boat dealer. • Refer to an authorized Sea-Doo sport boat dealer.
Engine slowly turns.	<ul style="list-style-type: none"> • Discharged or weak battery. 	<ul style="list-style-type: none"> • Refer to an authorized Sea-Doo sport boat dealer.
Engine turns over.	<ul style="list-style-type: none"> • Fuel tank empty or water contaminated. • Fuel filter clogged or water contaminated. • Fuel flooded engine: <ul style="list-style-type: none"> – Fouled/defective spark plugs. 	<ul style="list-style-type: none"> • Refill or siphon and fill with fresh fuel. • Clean, check fuel tank for water. • Replace.

Engine Misfires, Runs Irregularly

OTHER OBSERVATION	POSSIBLE CAUSE	REMEDY
Weak spark.	<ul style="list-style-type: none"> Fouled worn spark plugs. Faulty ignition component. Too much oil supplied to engine. 	<ul style="list-style-type: none"> Replace. Refer to an authorized Sea-Doo sport boat dealer. Improper oil pump adjustment, refer to an authorized Sea-Doo sport boat dealer.
Lean fuel mixture.	<ul style="list-style-type: none"> Fuel: Level too low, stale or water contaminated. Fuel filter, clogged or water contaminated. 	<ul style="list-style-type: none"> Siphon and/or refill. Refer to an authorized Sea-Doo sport boat dealer.
Rich fuel mixture (high fuel consumption).	<ul style="list-style-type: none"> Flame arrester dirty/clogged. 	<ul style="list-style-type: none"> Clean or replace.

Engine Overheats

OTHER OBSERVATION	POSSIBLE CAUSE	REMEDY
Monitoring beeper continuously sounds.	<ul style="list-style-type: none"> Clogged jet pump water intake. Incorrect type of fuel or oil. Clogged coolant system. 	<ul style="list-style-type: none"> Clean. Siphon and refill. Flush cooling system with garden hose.

Engine Continually Backfires

OTHER OBSERVATION	POSSIBLE CAUSE	REMEDY
	<ul style="list-style-type: none"> Faulty ignition component. 	<ul style="list-style-type: none"> Refer to an authorized Sea-Doo sport boat dealer.
Weak spark.	<ul style="list-style-type: none"> Fouled, worn spark plugs. 	<ul style="list-style-type: none"> Replace.
Overheated engine.	<ul style="list-style-type: none"> See <i>ENGINE OVERHEATS</i>. 	

Engine Pinging or Knocking

OTHER OBSERVATION	POSSIBLE CAUSE	REMEDY
	<ul style="list-style-type: none"> Poor quality gasoline/low octane. Spark plug heat range too high. 	<ul style="list-style-type: none"> Use well known quality and recommended gasoline. Use recommended spark plugs.

Engine Lacks Acceleration or Power

OTHER OBSERVATION	POSSIBLE CAUSE	REMEDY
	<ul style="list-style-type: none"> Weak spark/incorrect fuel mixture. Water in fuel or oil. 	<ul style="list-style-type: none"> Refer to <i>ENGINE MISFIRES</i>. Siphon and replace.
Overheated engine.	<ul style="list-style-type: none"> See <i>ENGINE OVERHEATS</i>. 	

Boat cannot Reach Top Speed

OTHER OBSERVATION	POSSIBLE CAUSE	REMEDY
	<ul style="list-style-type: none"> Jet pump water intakes clogged. Damaged impeller. 	<ul style="list-style-type: none"> Clean. Replace. Refer to an authorized Sea-Doo sport boat dealer.

Abnormal Noise from Propulsion System

OTHER OBSERVATION	POSSIBLE CAUSE	REMEDY
	<ul style="list-style-type: none"> Weeds or debris jammed around impeller. Damaged impeller shaft or drive shaft. 	<ul style="list-style-type: none"> Clean and check for damage. Refer to an authorized Sea-Doo sport boat dealer.

Safety Lanyard Code Signals

2 SHORT (while installing safety lanyard on DESS post).

1. Everything is correct with the safety lanyard (good contact and the right lanyard cap).

- *Engine can be started normally.*

1 LONG (while installing safety lanyard on DESS post or when pressing start/stop button in some cases).

1. Shifter lever not in Neutral position.

- *Move shifter lever to Neutral position.*

2. Bad connection between safety lanyard cap and DESS post.

- *Remove and reinstall the safety lanyard on the DESS post. Two short beeps should be heard which indicate the system is ready again to allow engine starting.*

3. Wrong safety lanyard.

- *Use the safety lanyard that has been programmed for the boat. If it does not work, refer to an authorized Sea-Doo sport boat dealer.*

4. Dirty safety lanyard cap.

- *Clean.*

5. Improper operation of Interface or defective wiring harness.

- *Refer to an authorized Sea-Doo sport boat dealer.*

PERIODIC INSPECTION CHART

DESCRIPTION		FREQUENCY				
		TO BE PERFORMED BY				
		EVERY 100 HOURS OR PRESEASON				
		EVERY 50 HOURS				
		EVERY 25 HOURS				
FIRST 10 HOURS						
GENERAL	Check fire extinguisher condition/mounting ④	✓			✓②	0
	Verify lubrication/corrosion protection	①		✓	✓	0
ENGINE	Inspect condition and tightness of engine supports and rubber mounts	✓		✓		D
	Inspect exhaust system fasteners/hoses ④	✓		✓	✓	D
	Inspect, clean and adjust spark plugs	✓				D
	Replace spark plugs			✓		D
EXHAUST SYSTEM	Ensure exhaust clamps are in place and secure		✓			0
	Inspect exhaust system for leaking components (such as rust and/or black streaking, water leaks or corroded/cracked fittings)		✓			0
	Inspect exhaust hoses for burnt, cracked or deteriorated sections. Hoses should be pliable and free of kinks. Replace cracked, charred or deteriorated exhaust hoses if found ④		✓		✓	0/D
	Inspect metal exhaust components for cracking, rusting, leaking or loosening. Check cylinder head gasket, exhaust manifold, water injection elbow, and the threaded adapter nipple between the manifold and the elbow ④				✓	D
COOLING SYSTEM	Flushing ③				②	0
	Inspect hose and fastener condition	✓		✓	✓	D
	Inspect/clean exhaust drain tube	✓①	✓			D
	Check coolant levels				②	
	Replace coolant, purge system of air, and check coolant levels				✓	D
	Inspect cooling plates for leaks	②			✓	0/D

DESCRIPTION		FREQUENCY				
		TO BE PERFORMED BY				
		EVERY 100 HOURS OR PRESEASON				
		EVERY 50 HOURS				
		EVERY 25 HOURS				
		FIRST 10 HOURS				
FUEL SYSTEM	Inspect and lubricate throttle cables ④	①	✓		✓	D
	Inspect fuel filter and lines ④	✓	✓		✓	D
	Inspect fuel vent line		✓		✓	D
	Pressurize fuel system. Inspect hoses, tank and fittings for cracks and leaks ④	✓			✓	D
	Inspect fuel rails, high pressure hoses and fuel pump modules	✓			✓	D
	Inspect fastener tightening (throttle body, fuel lines) ④	✓		✓	✓	D
	Inspect fuel tank straps ④	✓			✓	O
LUBRICATION SYSTEM	Change oil and filter	✓			✓	D
	Check engine oil level (refill as needed)				②	O
ELECTRICAL SYSTEM	Test main battery cut-off switch ④	✓	✓		✓	D
	Verify operation and condition of lights	✓	✓		✓②	D
	Inspect bilge blower and bilge pump ④	✓	✓		✓②	D
	Inspect electrical connections (ignition system, electrical box(es), starting system, etc.) ④	✓	✓		✓	D
	Verify Digitally Encoded Security System (DESS) ④	✓			✓②	D
	Verify monitoring beeper	✓		✓	✓	D
	Verify battery cable tightness and hold down condition ④	✓		✓	✓②	D
	Charge battery				✓	D
	Inspect sacrificial anodes	✓①	✓			O
STEERING SYSTEM	Inspect and adjust cable ④	✓		✓	✓	D
PROPULSION SYSTEM	Inspect drive shaft floating seal condition			✓		D
	Adjust shifter system/cable ④	✓			✓	D
	Inspect jet pump reservoir grease level/condition				✓	D
	Impeller condition and impeller/wear ring clearance			✓		D
	Inspect condition of water intake grate			✓②		O

DESCRIPTION		FREQUENCY				
		TO BE PERFORMED BY				
		EVERY 100 HOURS OR PRESEASON				
		EVERY 50 HOURS				
		EVERY 25 HOURS				
FIRST 10 HOURS						
HULL AND BODY	Inspect and lubricate Inlet Clearance System (ICS)			✓		0
	Inspect hull condition ④	✓			✓②	0
	Inspect condition of ride shoes	✓			✓	0
	Lubricate storage compartment cover locks	①		✓		0
	Clean deck drains/scupper valve ④	✓	✓		✓②	0
	Check bilge pump for obstructions	✓			✓	0

NOTE: Some items are included in the *PRE-OPERATION CHECKS* and not necessarily repeated in this chart.

D: Dealer

O: Operator

① Every 10 hours in salt water use.

② Daily checked.

③ Daily flushing in salt water or foul water use.

④ Safety item covered in the annual safety inspection (owner's expenses).

SPECIFICATIONS

MODEL		SPORTSTER 4-TEC	SPORTSTER 4-TEC BVIC
ENGINE			
Engine type		Rotax® 1503 4-TEC, 4-stroke, Single Over Head Camshaft (SOHC), liquid cooled	
Number of cylinders		3	
Number of valves		12 valves with hydraulic lifters (no adjustment)	
Displacement		1493.8 cc (91 cu. in)	
Compression ratio		10.6 ± 0.4:1	8.5:1
Maximum HP RPM		7300 RPM	8000 RPM
Lubrication		Dry sump with replaceable oil filter	
Oil filter		Rotax	
Exhaust system		Water cooled, water injected with regulator	
Starting system		Electric start	
ELECTRICAL			
Magneto generator output		360 W @ 6000 RPM	
Ignition system type		DI (Digital Induction)	
Ignition timing		Not adjustable	
Spark plug	Make and type	NGK DCPR8E	
	Gap	0.75 mm (.030 in)	
Battery charging coil		0.1 - 1.0 Ω	
Ignition coil	Number of coils	3	
	Model type	Stick coil	
Engine RPM limiter setting		7650 RPM	8000 RPM
Battery		12 V, 30-A•h	

MODEL		SPORTSTER 4-TEC	SPORTSTER 4-TEC BVIC
Fuse	TOPS	10 A	
	Battery fuse	30 A	
	Cylinder 1, ignition coil and injection	10 A	
	Cylinder 2, ignition coil and injection	10A	
	Cylinder 3, ignition coil and injection	10 A	
	Electric bilge pump	3 A	
	Starting system, electric fuel pump	10 A	
	EMS, start/stop circuit	5 A	
	Main	30 A	
	Interface	5 A	
	Charging system	30 A	
FUEL SYSTEM			
Fuel injection type		Multisport sequential	
Fuel — Naturally-aspirated and Supercharged engine models		MINIMUM ALLOWED	RECOMMENDED FOR OPTIMUM PERFORMANCE
		Regular unleaded gasoline	Premium unleaded gasoline
		Inside North America: 87 (R+M)/2 Outside North America: 91 RON	Inside North America: 90 (R+M)/2 Outside North America: 95 RON
COOLING			
Engine		Liquid cooled, closed loop	
Coolant		Ethylene-glycol 50%/50% antifreeze/water-coolant containing corrosion inhibitors for internal combustion aluminum engines	
Exhaust		Water-cooled, open loop	

MODEL	SPORTSTER 4-TEC	SPORTSTER 4-TEC BVIC
PROPULSION		
Propulsion system	BOMBARDIER Formula pump	
Jet pump type	Axial flow, single stage. Greased bearings	
Transmission	Direct drive	
Grease type	Sea-Doo grease (P/N 293 550 032)	
Steering nozzle pivoting angle	26°	
Minimum required water level for jet pump	90 cm (3 ft)	
Additional information: Do not mix different brands or oil types.		
DIMENSIONS		
Number of passengers (driver included)	4	
Overall length	4.67 m (184 in)	
Overall width	2.16 m (85 in)	
Overall height (on trailer)	1.17 m (46 in) w/o tower 2.06 m (81 in) w/tower down 2.54 m (100 in) w/tower up	
Weight	658.6 kg (1452 lb) 676 kg (1503 lb) w/tower	
Dead rise	20°	
Load limit (passengers + luggage)	324.3 kg(715 lb)	
CAPACITIES		
Engine oil	3 L (3.2 U.S. qt.) oil change w/filter 4.5 L (4.75 U.S. qt) total	
Cooling system (coolant)	5.5 L (5.8 U.S. qt) total	
Fuel tank (including reserve)	79.5 L (21 U.S. gal)	

MODEL		CHALLENGER 180 BV	CHALLENGER 180 BVIC
ENGINE			
Engine type		Rotax® 1503 4-TEC, 4-stroke, Single Over Head Camshaft (SOHC), liquid cooled	
Number of cylinders		3	
Number of valves		12 valves with hydraulic lifters (no adjustment)	
Displacement		1493.8 cc (91 cu. in)	
Compression ratio		10.6:1	8.5:1
Lubrication		Dry sump with replaceable oil filter	
Oil filter		Rotax	
Exhaust system		Water cooled, water injected with regulator	
Starting system		Electric start	
ELECTRICAL			
Magneto generator output		360 W @ 6000 RPM	
Ignition system type		DI (Digital Induction)	
Ignition timing		Not adjustable	
Spark plug	Make and type	NGK DCPR8E	
	Gap	0.75 mm (.030 in)	
Battery charging coil		0.1 - 1.0 Ω	
Ignition coil	Number of coils	3	
	Model type	Stick coil	
Engine RPM limiter setting		7650 RPM	8000 RPM
Battery		12 V, 30-A•h	

MODEL		CHALLENGER 180 BV	CHALLENGER 180 BVIC
ELECTRICAL (cont'd)			
Fuse	TOPS	10 A	
	Battery fuse	30 A	
	Cylinder 1, ignition coil and injection	10 A	
	Cylinder 2, ignition coil and injection	10 A	
	Cylinder 3, ignition coil and injection	10 A	
	Electric bilge pump	3 A	
	Starting system, electric fuel pump	10A	
	EMS, start/stop circuit	5 A	
	Main	30 A	
	Interface	5 A	
	Charging system	30 A	
FUEL SYSTEM			
Fuel injection type		Multiport sequential	
Fuel — Supercharged engine models	MINIMUM ALLOWED	RECOMMENDED FOR OPTIMUM PERFORMANCE	
	Regular unleaded gasoline	Premium unleaded gasoline	
	Inside North America: 87 (R+M)/2 Outside North America: 91 RON	Inside North America: 91 (R+M)/2 Outside North America: 95 RON	
COOLING			
Engine		Liquid cooled, closed loop	
Coolant		Ethylene-glycol 50%/50% antifreeze/water- coolant containing corrosion inhibitors for internal combustion aluminum engines	
Exhaust		Water-cooled, open loop	

MODEL	CHALLENGER 180 BV	CHALLENGER 180 BVIC
PROPULSION		
Propulsion system	BOMBARDIER Formula pump	
Jet pump type	Axial flow, single stage. Greased bearings	
Transmission	Direct drive	
Grease type	Sea-Doo grease (P/N 293 550 032)	
Steering nozzle pivoting angle	26°	
Minimum required water level for jet pump	90 cm (3 ft)	
Additional information: Do not mix different brands or oil types.		
DIMENSIONS		
Number of passengers (driver included)	8	
Overall length/(on trailer)	5.36 m (17 ft 7 in)/(6.2 m (20 ft 4 in))	
Overall width	2.49 m (8 ft 2 in)	
Overall height on trailer	1.85 m (6 ft 1 in) w/o tower 2.01 m (6 ft 7 in) w/tower down 2.56 m (8 ft 5 in) w/tower up	
Dry Weight/(boat and trailer)	941.2 kg (2075 lb)/ 1156.6 kg (2550 lb) w/trailer	
Dead rise	20°	
Load limit (passengers + luggage)	653 kg (1440 lb)	
CAPACITIES		
Engine oil	3 L (3.2 U.S. qt.)/oil change w/filter 4.5 L (4.75 U.S. qt) total	
Cooling system (coolant)	5.5 L (5.8 U.S. qt) total	
Fuel tank (including reserve)	79.5 L (21 U.S. gal)	

BRP reserves the right to make changes in design and specifications and/or to make additions to, or improvements in its products without imposing any obligation upon itself to install them on its products previously manufactured.

WARRANTY INFORMATION

BRP INTERNATIONAL LIMITED WARRANTY FOR MODEL YEAR 2006 SEA-DOO® SPORT BOATS

1) SCOPE

Bombardier Recreational Products Inc. ("BRP") warrants its new and unused Model Year 2006 Sea-Doo sport boats ("Sport Boat") that are sold by authorized Sea-Doo sport boat Distributors/Dealers outside of the fifty United States and Canada ("Distributor/Dealer") from defects in material and workmanship for the period and under the conditions below.

If your Sport Boat comes equipped with a Rotax™ engine, the Rotax engine is also covered by this Limited Warranty under the terms hereof. If your Sport Boat came equipped with another engine, that engine is covered by the Limited Warranty issued by the manufacturer of that engine and is not covered by this Limited Warranty.

2) WARRANTY COVERAGE DURATION

This limited warranty will be in effect from the date of delivery to the first retail consumer or the date the Sport Boat is first put to use, whichever occurs first, for a period of:

- TWELVE (12) CONSECUTIVE MONTHS ¹ for private, recreational use, except that the deck and hull fiberglass structure are covered for SIXTY (60) CONSECUTIVE MONTHS;
- FOUR (4) CONSECUTIVE MONTHS for commercial use, except that: the deck and hull fiberglass structure is covered for Twelve (12) consecutive months. A Sport Boat is used commercially when it is used in connection with generating income or any work or employment during any part of the warranty period. A Sport Boat is also used commercially when, at any point during the warranty period, it has commercial tags or is licensed for commercial use.

All genuine accessories installed by an authorized BRP Distributor/Dealer at the time of delivery carry the same warranty as the Sport Boat. The repair or replacement of parts or the performance of service to a Sport Boat under this warranty does not extend the life of this limited warranty beyond its original expiration date.

1. The warranty is TWENTY FOUR (24) consecutive months if the product was sold in any of the member states of the European Union (EC directive 1999/44/EC). The warranty period, however, is FOUR (4) consecutive months if the product is used for commercial purposes.

3) CONDITIONS TO HAVE WARRANTY COVERAGE

This warranty coverage is available only in the country in which the sale occurred and only after the purchaser and Distributor/Dealer have: completed and documented the BRP specified pre-delivery inspection process; and properly registered the Sport Boat. Only the original purchaser and any subsequent owners who reside in the country where the sale occurred are eligible for warranty coverage hereunder. Such limitations are necessary in order to allow BRP to protect the safety of its products, consumers, and the general public. As outlined in the Operator's Guide, timely required maintenance must be performed to maintain warranty coverage. BRP may require proof of proper maintenance prior to authorizing warranty coverage.

4) WHAT TO DO TO OBTAIN WARRANTY COVERAGE

The owner must notify an authorized Distributor/Dealer within two (2) days of the appearance of the defect and must promptly bring the Sport Boat, including any defective part, to Distributor/Dealer (in any event, within the warranty period) and must provide Distributor/Dealer with reasonable opportunity to repair the defect. If the Sport Boat has not previously been registered, the owner may also be required to present proof of purchase for warranty repairs. Owner is required to sign the repair/work order prior to the start of the repair in order to validate the warranty repair. All parts replaced under this warranty become the property of BRP.

5) WHAT BRP WILL DO

BRP's obligations under this warranty are limited to, at BRP's sole discretion, repairing or replacing parts of the Sport Boat found to be defective in material or workmanship, in the reasonable judgment of BRP. Such repair or replacement of parts will be done without charge for parts and labor, at any authorized Sea-Doo Distributor/Dealer in the country where the Sport Boat was sold. BRP's responsibility is limited to making the required repairs or replacements of parts with genuine BRP parts. The expenses of transporting the Sport Boat to and from Distributor/Dealer for warranty service are to be borne by the owner. No claim of breach of warranty shall be cause for cancellation or rescission of the sale of the Sport Boat to owner. In the event that warranty service is required outside of the country where the Sport Boat was purchased, owner will bear responsibility for any additional charges due to local practices and conditions, such as, but not limited to, freight, insurance, taxes, license fees, import duties, and any and all other financial charges, including those levied by governments, states, territories and their respective agencies.

BRP reserves the right to improve, modify or change its Sport Boats from time to time without assuming any obligation to modify Sport Boats previously manufactured.

6) EXCLUSIONS — The following are not warranted under any circumstances

- Replacement of parts due to normal wear and tear;
- Routine maintenance parts and services, including but not limited to adjustments, oil, lubricant and coolant changes, spark plug replacement, water pumps, carburetor maintenance and the like;

- Damage caused by improper or lack of maintenance or storage, or failure to follow the procedures and recommendations in the Operator's Guide;
- Damage resulting from removal of parts, improper repairs, service, maintenance, or modification, or use of parts or accessories not manufactured or approved by BRP, which in its reasonable judgement, are either incompatible with Sport Boats or adversely affect its operation, performance, or durability, or resulting from repairs done by a person that is not an authorized BRP Distributor/Dealer;
- Damage caused by abuse, misuse, abnormal use, neglect, racing, improper operation or operation of the Sport Boat in a manner inconsistent with the recommended operation described in the Operator's Guide;
- Damages resulting from external damage, submersion, water or foreign object ingestion, accident, fire, theft, vandalism or any act of God;
- Operation with fuel, oils or lubricants that are not suitable for the Sport Boat (see Operator's Guide);
- Damage from rust, corrosion or exposure to the elements;
- Damage from cooling system or jet pump blockage by foreign material;
- Damage to gel coat finish including but not limited to cosmetic gel coat finish defects, blisters, starrng, crazing; and fiberglass delamination caused by blisters, crazing, spyder or hairline cracks or exposure to the elements.

This warranty will be voided in its entirety and rendered null and void where:

- The Sport Boat has been altered or modified in such a way so as to adversely affect its operation, performance or durability, or has been altered or modified to change its intended use; or
- The Sport Boat is or has been used for racing at any point, even by a prior owner.

7) LIMITATIONS OF LIABILITY

ALL WARRANTIES, EXPRESSED OR IMPLIED, INCLUDING WITHOUT LIMITATION ANY WARRANTY OF MERCHANTABILITY OR FITNESS FOR A PARTICULAR PURPOSE ARE LIMITED IN DURATION TO THE LIFE OF THE EXPRESS LIMITED WARRANTY. ALL INCIDENTAL, CONSEQUENTIAL, DIRECT, INDIRECT OR OTHER DAMAGES OF ANY KIND ARE EXCLUDED FROM COVERAGE UNDER THIS WARRANTY INCLUDING, BUT NOT LIMITED TO: expense for gasoline, expense for transporting Sport Boat to and from Distributor/ Dealer, mechanic's travel time, in-and-out of water charges, slip or dock fees, trailering or towing, storage, telephone, cell phone, fax or telegram charges, rental of a like or replacement boat during warranty services or down time, taxi, travel, lodging, loss of or damage to personal property, inconvenience, cost of insurance coverage, loan payments, loss of time, loss of income, revenue or profits, or loss of enjoyment or use of Sport Boat. SOME JURISDICTIONS DO NOT ALLOW FOR THE DISCLAIMERS, LIMITATIONS OF INCIDENTAL OR CONSEQUENTIAL DAMAGES, OR OTHER EXCLUSIONS IDENTIFIED ABOVE. AS A RESULT, THEY MAY NOT APPLY TO YOU. THIS WARRANTY GIVES YOU SPECIFIC RIGHTS, AND YOU MAY ALSO HAVE OTHER LEGAL RIGHTS WHICH MAY VARY WITH THE JURISDICTION.

No Distributor, Dealer or any other person is authorized to make any affirmation, representation or warranty regarding a Sport Boat other than those contained in this limited warranty and, if made, shall not be enforceable against BRP. BRP reserves the right to modify this warranty at any time, although such modification will not alter the warranty conditions applicable to Sport Boats sold while this warranty was in effect.

8) TRANSFER

If the ownership of a product is transferred during the warranty coverage period, this warranty shall also be transferred and be valid for the remaining coverage period provided that BRP is notified of such transfer of ownership in the following way:

BRP or an authorized BRP Distributor/Dealer receives a proof that the former owner agreed to the transfer of ownership, in addition to the co-ordinates of the new owner. The distributor will then forward this information directly to BRP.

9) CONSUMER ASSISTANCE

In the event of a controversy or a dispute in connection with this BRP LIMITED WARRANTY, BRP suggests that you try to resolve the issue at the dealership level. We recommend discussing the issue with the authorized dealer's service manager or owner.

If further assistance is required, the distributor's service department should be contacted in order to resolve the matter.

If the matter still remains unresolved then contact BRP by writing to us at the address listed below.

**BRP EUROPEAN DISTRIBUTION
CUSTOMER SERVICE
SWITZERLAND
TEL : +41 21 318 78 00**

DECLARATION CE OF CONFORMITY



DECLARATION **CE** OF CONFORMITY

Application of Council Directives: 94/25/CE — Recreational craft 89/336/CEE
— Electromagnetic compatibility

Standards to which conformity is declared: ISO 7840, ISO 8469, ISO 8665, ISO 8846, ISO 8848, ISO 8849, ISO 9094, ISO 9097, ISO 10087, ISO 10088, ISO 10133, ISO 10240, ISO 11105, ISO 11591, ISO 11592, ISO 12215, ISO 12216, ISO 13592, COLREGS, ABYC H-5, ABYC H-8

Manufacturer's name: BRP US Inc.

Manufacturer's address: 451 E. Illinois Ave Benton, Illinois 62812-0394

Importer's name: Société ANF — Industrie S.A.

Importer's address: 2, rue du Nouveau Bercy 94220 Charenton Paris, France

Notified body for Directive 94/25/CE: International Marine Certification Institute Trèves centre, rue de Trèves 45 1040 Brussels, Belgium

Competent body for Directive 89/336/CEE: UTAC Autodrome de Linas-Montlhéry, B.P. 212 91311 Montlhéry cedex, France

Type of equipment: Sport boats, inshore category C

Model names and numbers:

Model name

Model number(s)

I, the undersigned, hereby declare that the equipment specified above conforms to the above Directives and Standards.

Name of signatory: Fernando Garcia

Title of signatory on behalf of BRP US Inc.: Director - Public and Regulatory Affairs — Sea-Doo sport boats

Homologation and Certification

These boats comply with the following standards:

STANDARD	TYPE OF CERTIFICATION
United States Coast Guard	Self certification
Canadian Coast Guard	Self certification
Russian Maritime Register of Shipping	Certify by Russian Maritime Register of Shipping 8, Dvortsovaya Nab., 191186 St. Petersburg, Russia
Directive 89/336/CEE of the council relating to electromagnetic compatibility	Internal production control plus control carried out on the responsibility of a competent body. Competent body: UTAC Autodrome de Linas-Montlhéry, B.P. 212 91311 Montlhéry cedex, France
Directive 94/25/EC of the European Parliament and of the council relating to recreational craft	Internal production control plus control carried out on the responsibility of a notified body. Notified body: International Marine Certification Institute Trèves centre, rue de Trèves 45 1040 Brussels, Belgium

Operator's Guide Confirmation of Receipt

Your dealer

Name:	_____
Address:	_____

Will assist you and help you to resolve any problems you may have.

Upon delivery of your boat, complete and sign the form hereunder and forward it to your dealer in order to be covered by our warranty.

Warranty conditions are as detailed in the *WARRANTY* section of this guide.

----- Cut here

Receipt	
Name:	_____
Address:	_____
Owner of _____	Sport Boat model No. _____
HIN (to be completed by customer or selling dealer) _____	
This warranty begins _____ (date).	
The dealer named on this document has instructed me on the operation, maintenance, safety features and warranty policy, all of which I understand and agree to be bound with. I am also satisfied with the predelivery set-up and inspection of my Sea-Doo sport boat. I have also received a copy of the Operator's Guide and <i>SAFETY VIDEOCASSETTE</i> for my Sea-Doo sport boat.	
Signature:	_____
Date:	_____

PRIVACY INFORMATION

We wish to inform you that your coordinates will be used for safety and warranty purposes. Sometimes, we also use the coordinates of our clients to inform them about our products and to present them offers. Should you prefer not to receive information on our products, services and offers, please let us know by writing to the address below.

Also note that, from time to time, carefully selected and trustworthy organizations may be permitted to use the coordinates of our clients to promote quality products and services. If you prefer not to have your name and address released, please let us know by writing to the address below:

BRP European Distribution

Warranty Department

Chemin de Messidor 5-7

1006 Lausanne

Switzerland

Fax: +41 21 318 78 01

CHANGE OF ADDRESS

If your address has changed, be sure to fill out and mail the card provided on this page.

Such notification is likewise necessary for your own safety even after expiration of the original warranty, since BRP will be in a position to contact you if correction to your boat becomes necessary.

NOTE: This card is strictly for change of address only.

STOLEN UNITS

In the event that your boat is stolen, you should notify your area's distributor warranty department of such.

Please provide your name, address, phone number, Hull Identification Number and date it was stolen.

BRP will provide a list of stolen units to all authorized Sea-Doo sport boat dealers on a monthly basis to aid in recovery of such units to their owners.



CHANGE OF ADDRESS

CHANGE OF OWNERSHIP

VEHICLE IDENTIFICATION NUMBER

Model Number

Vehicle Identification Number (V.I.N.)

OLD ADDRESS
OR PREVIOUS OWNER:

NAME

NO.

STREET

APT

CITY

STATE/PROVINCE

ZIP/POSTAL CODE

COUNTRY

NEW ADDRESS
OR NEW OWNER:

NAME

NO.

STREET

APT

CITY

STATE/PROVINCE

ZIP/POSTAL CODE

COUNTRY

V00A2F

AFFIX
PROPER
POSTAGE



BRP European Distribution
Warranty Department
Chemin de Messidor 5-7
1006 Lausanne
Switzerland

V00A2G

AFFIX
PROPER
POSTAGE



BRP European Distribution
Warranty Department
Chemin de Messidor 5-7
1006 Lausanne
Switzerland

V00A2G

BOAT MODEL No. _____

HULL

IDENTIFICATION NUMBER (H.I.N.) _____

ROTAX ENGINE

IDENTIFICATION NUMBER (E.I.N.) _____

Owner: _____

NAME

No.

STREET

APT

CITY

STATE/PROVINCE

ZIP/POSTAL CODE

Purchase Date _____

YEAR

MONTH

DAY

Warranty Expiry Date _____

YEAR

MONTH

DAY

To be completed by the dealer at the time of the sale.

DEALER IMPRINT AREA

F00A35L

Please verify with your selling dealer to ensure your SEA-DOO sport boat has been registered with BRP.



204 630 344

CA

OPERATOR'S GUIDE, SPORTSTER 4-TEC, CHALLENGER 180 / ENGLISH
GUIDE DU CONDUCTEUR, SPORTSTER 4-TEC, CHALLENGER 180 / ANGLAIS

FAIT AU / MADE IN CANADA

U/M:P.C.

®™ AND THE BRP LOGO ARE TRADEMARKS OF BOMBARDIER RECREATIONAL PRODUCTS INC. OR ITS AFFILIATES.

* CHALLENGER IS A TRADEMARK OF BOMBARDIER INC. USED UNDER LICENSE.

©2005 BOMBARDIER RECREATIONAL PRODUCTS INC. ALL RIGHTS RESERVED. PRINTED IN CANADA.