

SEA-DOO®

Sport Boats

OPERATOR'S GUIDE

Includes SAFETY, VEHICLE and
MAINTENANCE INFORMATION

UTOPIA™



WARNING

Read this guide thoroughly.
It contains important safety information.
Do not remove this *Operator's Guide* from
the vehicle.

204 630 311



SAFETY WARNING

Disregarding any of the safety precautions and instructions contained in this *Operator's Guide*, the *Safety Videocassette* and the on-product warning labels could cause injury, including the possibility of death. The operator has the responsibility to inform passenger(s) of safety precautions.

This *Operator's Guide* and *Safety Videocassette* should remain with the craft at the time of resale.

BOMBARDIER
RECREATIONAL PRODUCTS



Gelcote[†] is a trademark of Gelcote International
Knight's Spray-Nine[†] is a trademark of Korkay System Ltd

The following trademarks are the property of Bombardier Inc. and/or its subsidiaries:

SEA-DOO®

BOMBARDIER-ROTAX®

BOMBARDIER LUBE®

Sea-Doo Synthetic Grease

Doin'it on your new Sea-Doo Sport Boat

Congratulations, you are now the proud owner of a Sea-Doo sport boat. Whether you are an experienced boater or are new to the sport of boating, we ask you to take the time to view the videocassette provided with the craft, to read this *Operator's Guide*, on-product warning/caution labels and familiarize yourself with the contents. These manuals contain pertinent information which, if followed, will provide you with the necessary knowledge to help you fully enjoy the pleasures of this craft.

We strongly recommend that any craft operator complete a safety boating course. Check with your local Coast Guard or Power and Sail Squadron in your area for course availability. More serious boaters may want to obtain *Chapman Piloting* by Elbert S. Maloney, available at most book stores.

When introducing your family or friends to the sport, be sure they fully understand the controls and operation of the craft and the importance of courteous, responsible riding.

Each operator has a responsibility to ensure the safety of his/her passenger(s) and of other water users. Please follow all safety instructions and operate your craft with care.

We encourage you to have an Annual Safety Inspection of your craft. Please contact your authorized Sea-Doo dealer for further details.

Finally, we urge you to visit your authorized Sea-Doo dealer regularly for regular and safety maintenance as well as any craft accessories you may require.

Have fun and... Bon Voyage.

Please keep this guide on board. This manual should remain with the craft at time of resale.

TABLE OF CONTENTS

FOREWORD	5
Hazard Statements.....	5
Advisory Statements.....	6
<i>SAFETY INFORMATION</i>	
SAFETY	8
Safe Boating Checklist.....	8
Safety Equipment.....	10
Carbon Monoxide and Boating.....	15
Lanyard Stop Switch.....	18
Safe Boating Practices.....	18
Passenger Safety.....	19
Rules of the Road.....	19
Voluntary Inspections.....	21
Safe Boating Courses.....	22
Water Sports.....	22
<i>VEHICLE INFORMATION</i>	
REGISTRATION NUMBER LOCATION	26
LOCATION OF THE IMPORTANT LABELS	27
IDENTIFICATION NUMBERS	31
Hull.....	31
Engine.....	31
CONTROLS COMPONENTS AND INSTRUMENTS LOCATION	32
Cockpit.....	32
Overview.....	33
CONTROLS, COMPONENTS AND INSTRUMENTS FUNCTIONS	36
1) Safety Lanyard (engine cut-out switch).....	36
2) Steering Wheel.....	36
3) Throttle/Shifter Lever.....	36
4) Ignition Switch.....	37
5) 12-Volt Accessory Jack.....	37
6) Navigation Light Switch.....	37
7) Bilge Pump Switch.....	38
8) Bilge Air Blower Switch.....	38
9) Horn Switch.....	39
10) Deck Light Switch.....	39
11) Fuel Gauge/Low Oil Level Pilot Lamp and Beeper.....	39
12) Tachometer.....	40
13) Speedometer.....	40
14) Windshield.....	40
15) Bilge Drain Plugs.....	40
16) Grab Handles.....	41
17) Rear Grab Handles.....	41
18) Swim Platform.....	41
19) Sun Deck.....	41
20) Seats.....	41
21) Bow Seats (if so equipped).....	42
22) Cup Holders.....	42
23) Rear Seat Storage Compartment.....	43
24) Rear Storage Compartment.....	43

25) Bimini Top	43
26) Side Panel/Tray Storage.....	45
27) Bow Anchor Locker.....	45
28) Cockpit Table	45
29) Jet Pump Water Intake.....	46
30) Bow and Stern Eyelets.....	47
31) Bow Light	47
32) Removable Stern Light Socket.....	47
33) Mooring Cleats	48
34) Deck	48
35) Fuel Tank Cap.....	48
36) Deck Drain(s).....	48
37) Main Oil Reservoir Cap.....	49
38) Flushing Connector	49
39) Ventilation Ducts	49
40) Jet Pump Nozzle.....	49
41) Reverse Gate.....	49
42) Retractable Ladder	50
43) Hydro-Surge Grate System.....	50
44) Fuel Tank Vent.....	50
45) Fuses.....	50
46) AM/FM Radio/CD Player.....	51
47) Glove Box	51
48) Water Bypass System.....	51
49) Main Battery Cut-Off Switch.....	51
50) Water Sport Towing Attachments.....	52
FUEL AND LUBRICATION.....	53
Fueling Procedure.....	53
Recommended Fuel	53
Recommended Oil.....	53
Main Oil Reservoir Level.....	54
Engine Mounted Oil Reservoir Level.....	54
BREAK-IN PERIOD	55
Engine.....	55
10-Hour Inspection	55
PRE-OPERATION CHECKS	56
Hull	57
Jet Pump Water Intake.....	57
Bilge.....	57
Battery	57
Fuel Tank/Oil Reservoirs	57
Engine Compartment.....	57
Fire Extinguisher	57
Steering System	57
Throttle/Shifter System.....	57
Inlet Grate	57
Safety Lanyard and Ignition Switch	58
Storage Compartment Covers.....	58
OPERATING INSTRUCTIONS.....	59
Launching/Loading.....	59
Trailerage	59
Principle of Operation	59
Boarding from a Dock.....	61
Boarding from the Water.....	62

Starting.....	63
Rough Water or Poor Visibility Operation.....	63
Crossing Waves.....	63
Stopping/Docking.....	64
Beaching.....	64
Shutting Off the Engine.....	64
POST-OPERATION CARE.....	65
General Care.....	65
Additional Care for Foul Water or Salt Water.....	65
SPECIAL PROCEDURE.....	66
Engine Overheating.....	66
Jet Pump Water Intake and Impeller Cleaning.....	66
Capsized Boat.....	66
Submerged Boat.....	66
Low-Charge Battery Condition.....	67
MAINTENANCE INFORMATION	
MAINTENANCE.....	70
Emission Component Maintenance.....	70
Engine Emissions Information.....	70
Lubrication.....	71
Periodic Inspection.....	72
PERIODIC INSPECTION CHART.....	73
Throttle/Shifter Lever Cable.....	75
Fuel and Oil Filters.....	75
Steering/Jet Pump Nozzle Adjustment.....	75
Reverse Gate.....	75
Deck Drain(s).....	75
Fuses.....	75
Bilge Air Blower.....	75
Navigation Light Bulb Replacement.....	76
General Inspection and Cleaning.....	77
STORAGE AND PRE-SEASON PREPARATION.....	78
Storage.....	78
Pre-Season Preparation.....	79
SPECIFICATIONS.....	80
SI METRIC INFORMATION.....	82
WARRANTY	
BOMBARDIER LIMITED WARRANTY FOR MODEL YEAR 2004 SEA-DOO® SPORT BOATS SOLD IN THE UNITED STATES AND CANADA.....	84
CALIFORNIA EMISSION CONTROL WARRANTY STATEMENT FOR MODEL YEAR 2004 SEA-DOO® SPORT BOATS EQUIPPED WITH A ROTAX® ENGINE(S).....	88
BOMBARDIER INTERNATIONAL LIMITED WARRANTY FOR MODEL YEAR 2004 SEA-DOO® SPORT BOATS.....	92
WEB SITES.....	96
LIST OF DISTRIBUTORS.....	98
DECLARATION CE OF CONFORMITY.....	99
Homologation and Certification.....	100
Operator's Guide Confirmation of Receipt.....	101
PRIVACY INFORMATION.....	102
CHANGE OF ADDRESS.....	103

FOREWORD

This *Operator's Guide* has been prepared to acquaint the owner/operator or passenger of this sport boat with the various sport boat controls, maintenance and safe riding instructions. It is indispensable for the proper use of the product, and should be kept in a waterproof bag in the sport boat at all times. Make sure you read and understand the content of this document.

For any questions pertaining to the warranty and its application, please consult an authorized Sea-Doo sport boat dealer.

Hazard Statements

As you read your Owners Manual and this supplement, please note the hazard warnings which alert you to safety precautions related to unsafe conditions or operating procedures.

This guide uses the following symbols to emphasize particular information.



The safety alert symbol is recognized around the world. In this manual, it means read this information carefully! Be sure you understand the consequences of the hazards and how to avoid them. Failure to follow the recommendations in a hazard communication statement may result in property damage, personal injury, or death.

People often refer to a hazard statement as a warning in a general sense. This manual uses three kinds of "warnings" depending on the likely effect of a hazard (minor injury, severe injury, death).

WARNING

Identifies a potentially or imminently hazardous situation which, if not avoided, **COULD** result in serious personal injuries including the possibility of death or substantial property damage.

CAUTION: This signal word indicates a potentially hazardous situation which, if not avoided, may result in minor or moderate personal injury or property damage. It may also be used to alert against unsafe practices.

NOTE: Indicates supplementary information needed to fully complete an instruction relating to equipment operation and/or maintenance procedures.

Although the mere reading of such information does not eliminate the hazard, the understanding and application of the information will promote correct and safe use of the sport boat.

The warnings in this supplement do not and cannot address every conceivable situation. Always use common sense! If a procedure, method, tool, or part is not specifically recommended, you must satisfy yourself that it is safe for you and others and that your boat will not be damaged or made unsafe as a result of your decision.

Advisory Statements

Advisory statements alert you to conditions that affect equipment operation, maintenance, and servicing practices.

An **IMPORTANT** statement indicates a procedure intended to prevent damage to equipment or associated components.

The information and components/system descriptions contained in this supplement are correct at the time of publication. Bombardier Motor Corporation of America (Bombardier) however, maintains a policy of continuous improvement of its products without imposing upon itself any obligation to install them on products previously manufactured.

Because of our ongoing commitment to product quality and innovation, Bombardier reserves the right at any time to discontinue or change specifications, designs, features, models or equipment without incurring obligation.

The illustrations in this document show the typical construction of the different assemblies and may not reproduce the full detail or exact shape of the parts. However, they represent parts that have the same or similar function.

It is understood that this guide may be translated into another language. In the event of any discrepancy, the English version shall prevail.

Specifications are given in the SI metric system with the SAE U.S. equivalent in parenthesis. Where precise accuracy is not required, some conversions are rounded off for easier use.

A *Shop Manual* can be obtained for complete service, maintenance and more repair information.

SAFETY INFORMATION

SAFETY

Your safety and that of your passengers and fellow boaters is YOUR responsibility. Before launching your boat, you should completely read and understand this *Operator's Guide*, product warnings and labels, the *Safety Videocassette* and other information provided with your craft or by your dealer. Heed and follow all warnings, safety precautions and operating procedures.

Bombardier strongly recommends that you take an approved boating safety course. Always operate your boat in compliance with safe boating rules, and with consideration, courtesy and common sense. Failure to do so could result in injury, including the possibility of death, to you, your passengers, others you lend your boat to, or other water users.

Safe Boating Checklist

When leaving on a cruise, whether for an hour or for several days, go through the following Safe Boating Checklist.

Reminders Regarding Operation...

- The performance of this sport boat may significantly exceed that of other craft you may have operated. Become completely familiar with the controls and operation of this sport boat before embarking on your first trip or taking on a passenger(s). If you have not had the opportunity to do so, practice driving solo in a suitable traffic-free area and feel the response of each control. Be fully familiar with all controls before accelerating above idle speed. Do not assume that all sport boats handle identically. Each model differs, often substantially.
- Always keep in mind that as the throttle lever is returned to the idle position, less directional control is available. To turn the craft, both steering and throttle are necessary.

- Like any other boat, this craft has no brake. Stopping distance will vary depending on initial speed, load, wind, and water conditions. Practice stopping and docking in a safe, traffic-free area to have an idea of how long it will take to stop the craft under varying conditions. Do not release the throttle when trying to steer away from objects. You need throttle to steer. Do not use the craft's reverse, if so equipped, to stop.
- Do not start or operate the sport boat if any person is not properly seated in a seat intended for use when underway (not the sun deck or swim platform) or if a person is nearby in the water.
- The sport boat's jet thrust can cause injury. Always accelerate slowly, and decelerate in a controlled fashion.
- Observe the instructions on all safety labels. They are there to help assure that you have a safe and enjoyable outing.
- Riding with passenger(s) or pulling other boats, tubes, a skier or a wakeboarder makes the craft handle differently and requires greater skill.
- Certain sport boats may come equipped with tow eyelets, a ski pole or a wake tower which can be used to attach a tow rope for a skier, tuber or wakeboarder. Do not use these attachment points or any other portion of the sport boat to tow a parasail or another craft. Personal injury or severe craft damage may occur.
- In shallow water, proceed with caution and at very low speeds. Grounding or abrupt stops may result in injury. The jet pump may pick up debris and throw it rearward causing a risk of injuring people or damaging the jet pump or other property.

- Engine exhaust contains carbon monoxide (CO), which can cause injury or death if inhaled in sufficient quantities. Do not operate the craft in a confined area or allow CO to accumulate in or around the craft, or in enclosed or sheltered areas.
- Combustion engines need air to operate; consequently this craft can not be totally watertight. Any maneuvers such as *figure eights* that cause the upper deck to be under water may cause severe engine problems due to water ingestion. Refer to the SPECIAL PROCEDURES and LIMITED WARRANTY sections contained in this *Operator's Guide*.
- Respect no wake zones, the rights of other water users and the environment. As the "skipper" and owner of a boat, you are responsible for damage to other boats caused by the wake of your craft. Do not let anyone throw refuse overboard.
- Between sunset and sunrise, use the sport boat's navigation lights and reduce speed. Do not operate the boat in reduced visibility.
- Do not add accessories or equipment that may adversely affect visibility or alter control of the sport boat.
- The skipper should personally take the helm during storms.
- Regularly inspect the boat, the hull, engine, safety equipment, and all other boating gear and keep them in safe operating condition.
- Be sure you have the minimum required safety equipment, PFDs and any additional gear needed for your cruise.
- Check that all lifesaving equipment, including fire extinguisher, is in safe operating condition and easily accessible. Show all passengers where this equipment is, and make sure they know how to use it.
- Keep an eye on the weather. Check local weather broadcasts before departure. Be alert to changing conditions.
- Keep accurate and up-to-date charts of the boating area on board. Before getting underway, check water conditions in the planned boating area.
- Before departure, file a Float Plan with a responsible person ashore.
- Keep enough fuel on board for the planned trip. Always verify fuel level before use and during the ride. Apply the principle of 1/3 of the fuel to reach your destination, 1/3 to return, and keep 1/3 in reserve. Allow for changes due to adverse weather or other delays.

Operators and Passengers...

Before Getting Underway...

- Always perform the pre-operation checks as specified in this *Operator's Guide*.
- Do not exceed the payload or passenger capacities for this sport boat, which are listed on the capacity plate and in the specifications. Overloading can affect maneuverability, stability and performance. Also, heavy seas reduce capacity. A payload or person capacity plate is not an excuse for failure to use common sense or good judgment.
- Never operate a boat while under the influence of drugs or alcohol. It is a Federal offense. Allow only qualified drivers to operate your boat. Remember that sun, wind, alcohol, drugs, fatigue or illness may impair your judgement and reaction time.
- At least one passenger should be able to operate the boat in case the operator is unexpectedly unable to do so.
- Operation of this craft by a person under 16 years of age or a person with a disability that impairs vision, reaction time, judgment, or operation of the controls is NOT recommended.

- Always use the lanyard stop switch when operating the boat and ensure that all passengers are familiar with its use.
- Ensure that any operator and all passengers know how to swim and how to re-board the sport boat from the water. If a passenger does not know how to swim, ensure that passenger wears a PFD at all times and take extra precautions when boating.

Regarding Fuel and Fueling...

- Remember that fuel and gasoline fumes are flammable and explosive under certain conditions. Be very careful when fueling and adhere to the fueling procedures contained in this *Operator's Guide* and those given to you by the marina. Always stop the engine before fueling and never allow anyone to remain in the craft while fueling. Each time you fill up, assure that the engine compartment is free of gasoline vapors, and inspect fuel lines for leaks and hose deterioration.
- Do not smoke or allow open flames or sparks in the vicinity.
- Know the capacity of the fuel tank. Avoid fueling at night except under well-lit conditions. Gas spills are not noticeable in the dark. Do not carry spare fuel or flammable liquids in any of the storage or engine compartments.

Safety Equipment

An operator and the craft's passenger(s) should have ready access to shatterproof glasses should riding conditions or personal preference warrant.

Wind, water spray and speed may cause a person's eyes to water and create blurred vision.

As the owner of the boat, you are responsible for assuring that all required safety equipment is aboard. You should also consider supplying additional equipment as needed for your safety and that of your passengers. Check state and local regulations and call the U.S. Coast Guard Boating Safety Hotline at 1 800 368-5647 for information about required safety equipment.

Required Safety Equipment

Most of the safety equipment required by federal regulations is provided as standard equipment. Personal flotation devices must be fitted to the people wearing them. If local regulations require additional equipment, it must be approved by the U.S. Coast Guard (USCG). Minimum requirements include the following:

- personal flotation devices
- fire extinguisher
- visual distress signal
- navigation lights
- bell or whistle.

A cellular telephone in a waterproof bag or container has also been found to be beneficial to boaters when in distress or just for contacting someone on shore.

Personal Flotation Devices (PFDs)

Federal regulations require that you have at least one Coast Guard approved personal flotation device (PFD) for each person in a recreational boat and require that all children under 13 years of age wear a PFD at all times when the boat is underway, except when below deck or in an enclosed cabin. You may not use your boat unless all PFDs are in serviceable condition, readily accessible, legibly marked with the Coast Guard approval number, and of an appropriate size (within the weight range and chest size marked on the PFD) for each person on board.

A PFD provides buoyancy to help keep your head above the water and to help you remain in a satisfactory position while in the water. Body weight and age should be considered when selecting a PFD. The buoyancy provided by the PFD should support your weight in water. The size of the PFD should be appropriate for the wearer. Body weight and chest size are common methods used to size PFDs. It is your responsibility to ensure that you have the proper number and types of PFDs on board to comply with federal and local regulations and that your passengers know where they are and how to use them.

PFD Types

Five types of PFDs have been approved by the U.S. Coast Guard.

PFD Type I, Wearable has the greatest required buoyancy. Its design allows for turning most unconscious persons in the water from face down position to a vertical or slightly backward, face-up position. It can greatly increase the chances of survival. Type I is most effective for all waters, especially offshore when rescue may be delayed. It is also the most effective in rough waters.

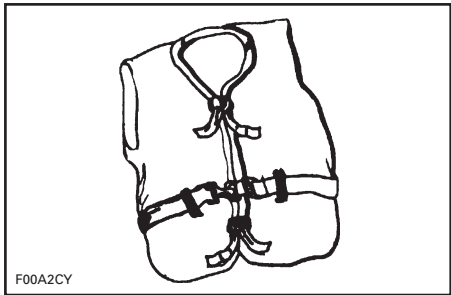

TYPE I — WEARABLE

PFD Type II, Wearable turns its wearer in the same way as Type I, but not as effectively. The Type II does not turn as many persons under the same conditions as a Type I. You may prefer to use this PFD where there is a probability of quick rescue such as in areas where other people are commonly involved in water activities.

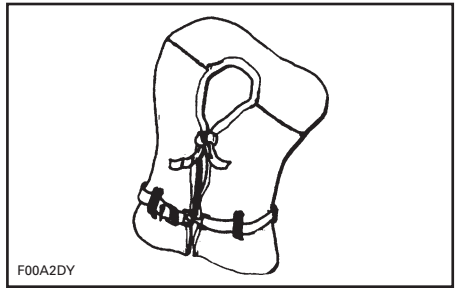

TYPE II — WEARABLE

PFD Type III, Wearable allows wearers to place themselves in a vertical or slightly backward position. It does not turn the wearer. It maintains the wearer in a vertical or slightly backward position and has no tendency to turn the wearer face down. It has the same buoyancy as a Type II PFD and may be appropriate in areas where other people are commonly involved in water activities.

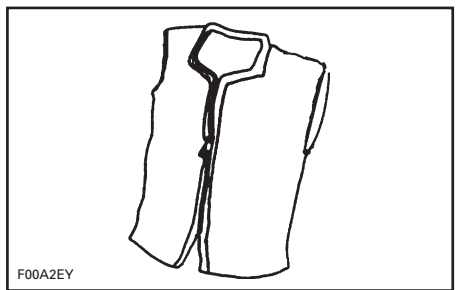

TYPE III — WEARABLE

PFD Type IV, Throwable is required in addition to the PFDs previously discussed. The most common Type IV PFD is a buoyant cushion or ring buoy. It is designed to be thrown to a person in the water, grasped and held by the user until he or she is rescued. A Type IV PFD should always be in serviceable condition and immediately available for use. Grasping this PFD may be difficult if the rescue is delayed or if the user is overcome by hypothermia (loss of body heat).

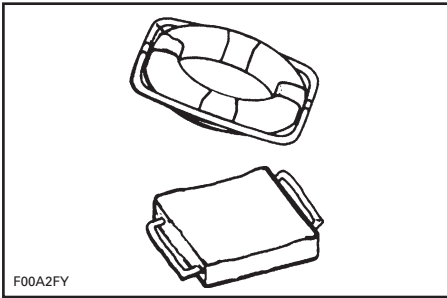

TYPE IV — THROWABLE

PFD Type V, Wearable must be worn. When inflated, it provides buoyancy equivalent to Type I, II or III PFDs. When it is deflated, however, it may not support some people.

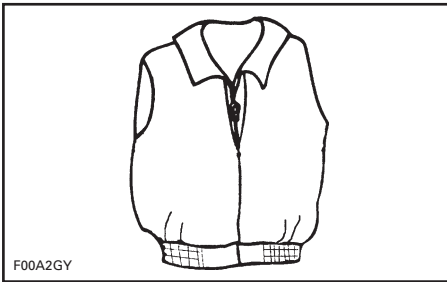

TYPE V — WEARABLE

PFD Pointers

The purpose of a PFD is to help save your life. If you want it to support you when you are in the water, it needs to fit, float, and be in good condition.

- Try the PFD on and adjust it until it fits comfortably in and out of the water. Mark your PFD if you are the only wearer.
- To make sure the PFD works, wear it in the water. This will show you how it works and give you confidence when you use it.
- Teach children how to put a PFD on and allow them to try it in the water. That way, they know what the PFD is for and how it works. They will feel more comfortable with it if they suddenly find themselves in the water.
- If the PFD is wet, allow it to dry thoroughly before storing it. Do not dry it in front of a radiator or heater. Store it in a well-ventilated area.
- Keep PFDs away from sharp objects which can tear the fabric or puncture the flotation pads.
- For their own safety and the safety of others, all non-swimmers, poor swimmers, and small children should wear PFD's at all times whether the boat is stationary or moving.
- Check the PFD frequently to make sure that it is not torn, that flotation pads have no leaks, and that all seams and joints are securely sewn.
- If a PFD contains kapok, the kapok fibers may become waterlogged and lose their buoyancy after the vinyl inserts are punctured. If the kapok becomes hard or if it is soaked with water, replace it. It may not work when you need it.

Hypothermia

Hypothermia, the loss of body heat to the water, is a significant cause of deaths in boating accidents. After an individual has succumbed to hypothermia, he or she will lose consciousness and then drown.

PFDs can increase survival time because of the insulation they provide.

Naturally, the warmer the water, the less insulation one will require. When operating in cold water (below 40°F) consideration should be given to using a coat or jacket style PFD as they cover more of the body than the vest style PFDs.

Some points to remember about hypothermia protection:

1. While afloat in the water, do not attempt to swim unless it is to reach a nearby craft, fellow survivor, or a floating object on which you can lean or climb. Unnecessary swimming increases the rate of body heat loss. In cold water, drown-proof methods that require putting your head in the water are not recommended. Keep your head out of the water. This will greatly lessen heat loss and increase your survival time.
2. Keep a positive attitude about your survival and rescue. This will improve your chances of extending your survival time until rescue. Your will-to-live does make a difference!
3. If there is more than one person in the water, huddling is recommended while waiting to be rescued. This action tends to reduce the rate of heat loss and thus increase the survival time.
4. Always wear your PFD. It won't help you fight off the effects of hypothermia if you don't have it on when you go into the water.

Fire Extinguishers

As the owner of the boat, you are responsible for supplying a fire extinguisher approved by the U.S. Coast Guard.

All Class 1 powerboats (16 to less than 26 feet (4.8 - 7.9 m)) are required to carry one (1) B-1 type hand portable fire extinguisher unless the boat is equipped with a fixed fire extinguishing system in the engine compartment.

Hand-held portable fire extinguishers should be mounted in readily accessible locations away from the engine compartment. All persons aboard should know the location and proper operation of the fire extinguisher(s).

NOTE: Don't test fire extinguishers by squirting small amounts of the extinguishing compound. The extinguisher might not work when you really need it!

Visual Distress Signal Devices

Visual distress signal devices approved by the U.S. Coast Guard are required on all recreational boats operating on coastal waters and on boats owned in the United States when they are operating on the high seas. Coastal waters include territorial seas and those waters directly connected to the Great Lakes and the territorial seas up to a point where the waters are less than two miles (3.2 km) wide. Visual distress signal equipment may be of the pyrotechnic or non-pyrotechnic type. Regulations prohibit display of visual distress signals on the water under any circumstances except when assistance is required to prevent immediate or potential danger to persons on board a vessel.

The equipment must be approved by the U.S. Coast Guard, be in serviceable condition, and be stowed in a readily accessible location. Equipment having a date for serviceable life must be within the specified usage date shown.

Careful selection and proper stowage of visual distress equipment is very important if children are aboard.

WARNING

Fire! In case of fire, do not open engine compartment. Turn off engine. Using portable C02 fire extinguisher, continuously discharge entire contents at base of fire.

DAY USE ONLY
<ul style="list-style-type: none"> • Three orange smoke signals (one hand held and two floating) or one orange flag with black square and disk
NIGHT USE ONLY
<ul style="list-style-type: none"> • One S-O-S electric distress light
DAY AND NIGHT USE
<ul style="list-style-type: none"> • Three flares of the hand held, meteor or parachute type

Sound Signaling Devices

NOTE: No single signaling device is appropriate for all purposes. Consider keeping various types of equipment on board.

Boats less than 26 feet (7.9 m) in length are required to carry a hand, mouth, or power operated horn or whistle. It must produce a blast of two second duration and audible at a distance of at least one-half (1/2) mile (800 m).

Following are standard whistle signals:

- one prolonged blast (warning signal)
- one short blast (pass on my port side)
- two short blasts (pass on my starboard side)
- three short blasts (engines in reverse)
- five or more blasts (danger signal).

Navigation Lights

Navigation lights are intended to keep other vessels informed of your presence and course. If you are out on the water between sunset and sunrise, you are required to display appropriate navigation lights.

Additional Recommended Equipment

It is recommended that you acquire additional equipment for safe, enjoyable cruising. This list, which is not all inclusive, includes items you should consider acquiring.

BASIC GEAR

- flashlight
- mooring lines
- compass
- oar or paddle
- distress signals
- first aid kit
- dock fenders
- VHF radio
- EPIRB (Electronic Position Indicating Radio Beacon)
- boat hook
- extra warm clothing
- charts
- sunblock
- tow line
- second anchor and line
- dewatering device (pump or bailer)
- emergency supply of drinking water and food.

TOOLS

- spark plug wrench
- hammer
- screwdrivers
- jackknife
- pliers
- electrician's tape
- adjustable wrench
- lubricating oil
- duct tape.

For additional tools, see your dealer.

SPARE PARTS

- extra bulbs
- extra fuses
- extra drain plug
- spark plugs
- spare wire.

For additional parts, see your dealer.

Carbon Monoxide and Boating

Burning a material containing carbon produces carbon monoxide (CO), an odorless and colorless gas. Because CO weighs the same as air, it can spread throughout an enclosed space unnoticed because you cannot see it or smell it. Any device used to burn carbon-based materials on a boat can be a source of CO. Common sources of CO include internal combustion engines.

CO reacts with the blood to reduce the ability of the blood to carry oxygen. The reduced oxygen supply to body tissues results in death of the tissue. Prolonged exposure can cause brain damage or death. In high concentrations, CO can be fatal within minutes. The effects of CO in lower concentrations are cumulative and can be just as lethal over long periods of time.

Symptoms of CO poisoning include: Itchy and watering eyes, flushed appearance, throbbing temples, inability to think coherently, ringing in the ears, tightness across the chest, headaches, drowsiness, nausea, dizziness, fatigue, vomiting, collapse, and convulsions. If any of these symptoms are evident, begin treatment immediately. Prompt action can make the difference between life and death.

- Evacuate the area and move the victim to fresh air.
- Administer oxygen if available and get medical help.
- Open all canvas enclosures to ventilate the area.
- Investigate the source of CO and take immediate corrective action.
- Be especially aware of other CO sources which may be near boat.

Carbon Monoxide Accumulation

Following are examples of possible situations where CO may accumulate within your boat while docked, anchored, or underway. Become familiar with these examples and their precautions to prevent personal injury or death.

WARNING

Exhaust Fumes! Generator or hull exhaust from other vessels while either docked or anchored can emit poisonous CO gas and cause excessive accumulation within cabin and cockpit areas. Be alert for generator exhaust from your vessel or other vessels alongside. Exhaust outlets near a pier, dock, seawall or outlets blocked by any other means can cause excessive accumulation of poisonous CO gas within cockpit area.

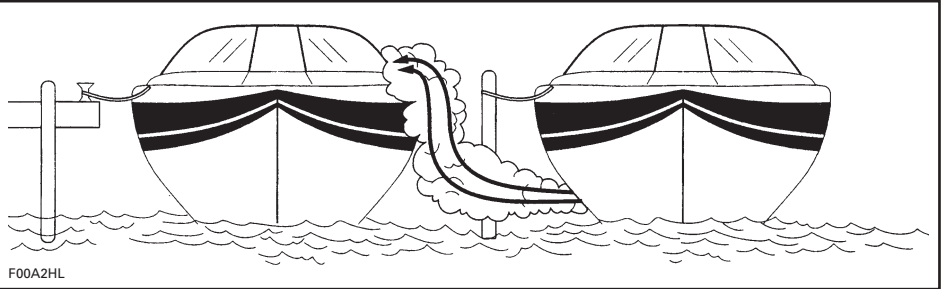

VESSEL ALONGSIDE

WARNING

Engine exhaust fumes contain carbon monoxide (CO) which can accumulate in and around the boat (under bimini top, in cockpit, etc.). CO can be harmful or fatal if inhaled. Assure there is adequate ventilation whenever running engine(s).

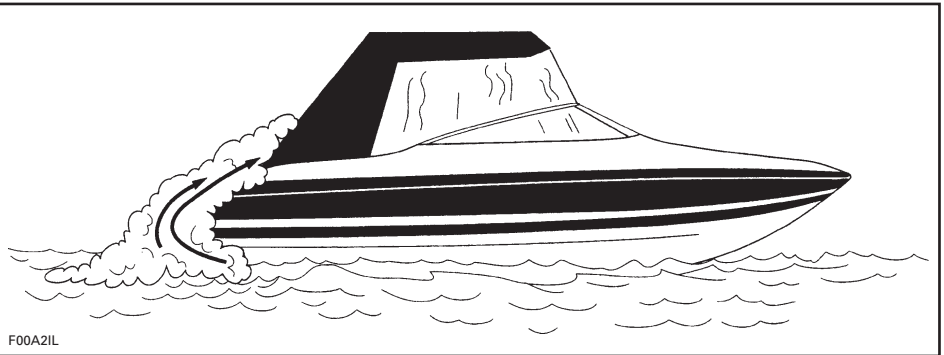

WHILE UNDERWAY (BACKDRAFTING)

While underway, CO concentrations can increase by backdrafting or “the station wagon effect”. Backdrafting is caused by factors such as relative wind direction, speed, or the bow being too high. To prevent this, open canvas whenever possible to provide positive airflow through the hull.

Boat houses, seawalls, and other boats in close proximity or confined areas can contribute to increased CO levels. Operators must be aware that operation, mooring, and anchoring in an area with other boats puts them in jeopardy of CO accumulation from other sources. Likewise, a boat operator must be aware of how exhaust from his boat will affect others. Operation of the engines while moored may cause CO accumulation in your boat and those around you.

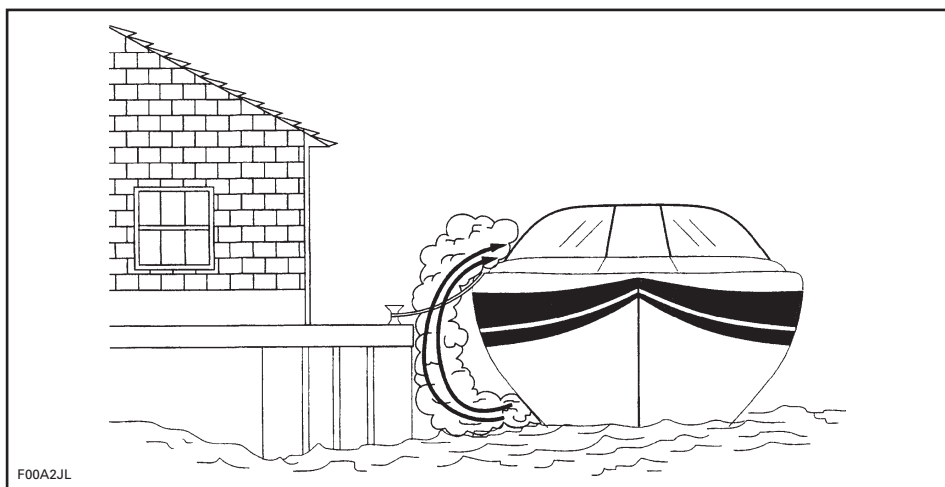

CONFINED AREAS

Be sure to provide adequate ventilation. If the windshield has vents, open them before getting underway to increase positive air flow and decrease the chances of CO accumulation.

WARNING

Backdrafting! Under certain conditions, moving air currents can direct poisonous CO fumes into boat. These fumes can accumulate to dangerous levels without proper airflow. Provide adequate ventilation, redistribute the load or bring boat out of high bow angle.

Even with the best boat design and construction, CO may still accumulate in enclosed or confined areas under certain conditions. Continually observe passengers for symptoms of CO poisoning.

CO Detector

It is strongly recommended that you have CO detectors installed in boats with canvas enclosures. Monitors are available from your dealer. Monitors should be professionally installed and calibrated.

NOTE: A CO detector is not a gas fuel vapor detector. Gas fuel vapor detectors do not monitor the buildup of CO in an enclosed area.

Lanyard Stop Switch

This safety device automatically stops the engine if the lanyard is attached to the operator and the operator falls from the control station. Refer to the engine manual for detailed information about using this switch.

The stop switch incorporates a shutoff switch, switch clip, lanyard, and lanyard clip. The lanyard clip must be securely attached to the operator's PFD, clothing, arm, or leg. Be sure to attach the lanyard to a place where it is free of obstructions and to something that will move with the operator if he or she leaves the helm station. If the engine shuts down because this switch was activated, the clip must be reinstalled on the interrupter switch before the engine can be restarted.

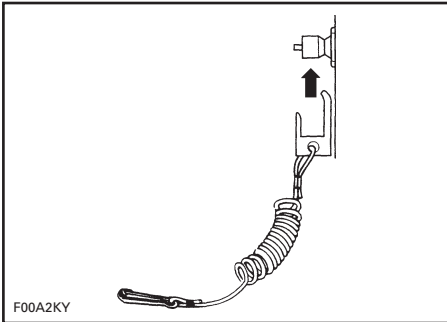

TYPICAL — IGNITION INTERRUPTER
(STOP SWITCH) WITH LANYARD

⚠ WARNING

Keep lanyard stop switch free from obstructions that could interfere with its operation. Do not modify or remove lanyard stop switch or bypass its safety features. The proper use of the lanyard stop switch can prevent a runaway boat situation which otherwise could cause severe personal injury or death.

Safe Boating Practices

YOU are responsible for your own safety, the safety of your passengers, and the safety of fellow boaters.

Drugs and Alcohol

Do not use drugs or drink alcohol while operating a boat. Like driving a car, driving a boat requires sober, attentive care. Operating a boat while intoxicated or under the influence of drugs is not only dangerous, but it is also a Federal offense carrying a significant penalty. These laws are vigorously enforced. The use of drugs and alcohol, singly or in combination, decreases reaction time, impedes judgment, impairs vision, and inhibits your ability to safely operate a boat.

⚠ WARNING

Alcohol consumption and boating do not mix! Operating under the influence endangers the lives of your passengers and other boaters. Federal laws prohibit operating a boat under the influence of alcohol or drugs.

Safe Operation

For safety reasons and proper care, always perform "Daily Pre-Operation Checks" as specified in your *Operator's Guide* before operating your craft. Safe operation means that you do not misuse your boat nor do you allow your passengers to do so. Safe operation means using good judgment at all times. It includes, without limitation, the following actions:

- Load the boat within the limits listed on the capacity plate. Balance loads bow to stern and port to starboard.
- Maintain boat speed at or below the local legal limit. Avoid excessive speed or speeds not appropriate for operating conditions.

- Do not use the boat in weather or sea conditions beyond the skill or experience of the operator or the comfortable capability of the boat or passengers.
- Be sure at least one other passenger is familiar with the operation and safety aspects of the boat in case of an emergency.
- Make sure that passengers and gear do not obstruct the operator's view or ability to move.
- Do not exceed the maximum engine power rating stated on the certification plate attached to the boat.
- Observe all safety signs and warnings both inside the boat and in the immediate boating area.

Passenger Safety

Before getting underway, show all passengers where emergency and safety equipment is stowed, and explain how to use it. Everyone aboard should wear rubber-soled shoes which resist slipping on wet surfaces. While underway, passengers should remain seated inside the deck rails. Don't allow passengers to drag their feet or hands in the water. Always use handholds and other safety hardware to prevent falls. All non-swimmers, poor swimmers, and children should wear a PFD at all times. Federal regulations require that children under 13 years of age wear a PFD when the boat is underway unless they are in an enclosed cabin or below deck.

First Aid

As a boat operator, you should be familiar with basic first aid procedures that may be needed while you are far from help. Fish hook accidents or minor cuts and abrasions may be the most serious mishaps on board a boat, but you should also learn the proper procedures and be ready to deal with the truly serious problems like excessive bleeding, hypothermia, and burns. First aid literature and courses are available through most Red Cross chapters.

Operation By Minors

Minors should always be supervised by an adult whenever operating a boat. Many states have laws regarding the minimum age and licensing requirements of minors. Be sure to contact the state boating authorities for information. Bombardier recommends a minimum operator age of 16 years old.

Rules of the Road

As a responsible boater, you will comply with the "Rules of the Road", the marine traffic laws enforced by the U.S. Coast Guard. Navigating a boat is much the same as driving an automobile. Operating either one responsibly means complying with a set of rules intended to prevent accidents. Just as you assume other car drivers know what they are doing, other boaters assume you know what you are doing.

Operating a craft can be compared with driving unmarked highways and roads. To prevent collisions or avoid other boaters, a system of operating rules must be followed. It's not only common sense...it's the law!

Check local and federal boating laws applicable to the waterways where you intend to use your craft. Learn the local rules of the road. Know and understand the applicable navigation system (such as buoys and signs).

Know the waters in which the craft is to be operated. Current, tides, rapids, hidden obstacles, wakes and waves etc. can affect safe operation. It is not advisable to operate the craft in rough or inclement weather.

Remember these Rules of the Road

Know the Right of Way Rules

Generally keep to your right and safely avoid other craft by keeping a safe distance from other craft, people and objects.

CROSSING

Give right of way to craft ahead and to your right. Never cross in front of a boat. RED light (give way to the other boat). GREEN light (you have the right of way).

MEETING HEAD-ON

Keep right.

PASSING

Give right of way to other craft and keep clear.

Navigation System

Navigational aids, such as signs or buoys, can help you identify safe waters. Buoys will indicate whether you should keep to the right (starboard) or to the left (port) of the buoy or to which channel you can continue. They may also indicate whether you are entering a restricted or controlled area such as a no wake or speed zone. They may also indicate hazards or pertinent boating information. Markers may be located on shore or on the water. They can also indicate speed limits, no power craft or boating, anchorage and other useful information. (The shape of each type of marker will provide assistance).

Make sure you know and understand the navigation system applicable to the waterways where you intend to use the craft.

Collision Avoidance

- Do not release throttle when trying to steer away from objects. You need throttle to steer.
- Always keep a constant lookout for other water users, other boats or objects, especially when turning. Be alert for conditions that may limit your visibility or block your vision of others.
- Respect the rights of other recreationists and/or bystanders and always keep a safe distance from all other craft, people and objects.
- Do not wake or wave jump, ride the surf line or attempt to spray or splash others with your craft. You may misjudge the ability of the craft or your own driving skills and strike a boat or person.
- This craft has the capability of turning more sharply than other boats. However, unless in an emergency, do not negotiate sharp, high speed turns. Such maneuvers make it hard for others to avoid you or understand where you are going. Also, you and/or your passenger(s) could be thrown from the craft.
- Like any other craft, this sport boat has no brake. Stopping distance will vary depending on initial speed, load, wind, and water conditions. Practice stopping and docking in a safe, traffic free area to have an idea of how long it will take to stop the craft under varying conditions.
- Maintaining or increasing speed may be necessary to avoid a collision.

Safe Riding

- Always keep in mind that as the throttle lever is returned to idle position, less directional control is available, and when the engine is off, directional control is lost. You need throttle to steer.
- While your craft has the capacity of operating at high speeds, it is strongly recommended that high speed operation only be applied when ideal conditions exist and are permitted. Higher speed operation requires a higher degree of skill and increases the risk of severe injuries.
- In shallow water, proceed with caution and at very low speeds. Grounding or abrupt stops may result in injury. Debris may also be picked up and be thrown rearward by the jet pump onto people or property.
- Do not use the craft's reverse, if so equipped, to stop. You or your passenger(s) could be violently ejected forward or even off the craft onto the hazard.

Operator/Passenger Awareness

- Do not start or operate the craft if anyone is seated on the sun deck or swim platform, or is nearby in the water. Water and/or debris exiting jet thrust nozzle can cause severe injury.
- The operator and passenger(s) should be properly seated before starting or moving the craft. All passenger(s) should be instructed to use the handholds or seat straps provided.
- When accelerating a sport boat with a passenger(s), whether from a complete stop or while underway, always do so progressively. Fast acceleration may cause your passenger(s) to lose their balance or grip and strike something in the craft or fall out of the craft. Make sure that your passenger(s) know of, or anticipate, any rapid acceleration.

Maneuverability of the Craft/Towing

- Do not overload the craft or take on more passengers than designated for the particular craft. Overloading can affect maneuverability, stability and performance.
- Avoid adding on accessories or equipment which may alter your control of the craft.
- Riding with a passenger(s) or pulling a tube, skier or wakeboarder makes the craft handle differently and requires greater skill.
- Always respect the safety and comfort of your passenger(s) and person being towed on skis, wakeboard or other water products.
- Always carry an observer when pulling a tube, skier or wakeboarder, proceed with only as much speed as required and follow the observer's instructions. Unless absolutely necessary, do not make tight, sharp turns. Keep a safe distance from the docks, other swimmers, craft or objects.
- Use a tow rope of sufficient length and size and make sure it is adequately secured to your craft. Some sport boats are equipped or can be fitted with a specially designed towing mechanism. It can become a hazard should someone fall on it.

Don't Forget:

- Ride smart from the start and we all win!

Voluntary Inspections

State boating officials in many states or the U.S. Coast Guard Auxiliaries offer courtesy inspections to check out your craft. They will check for compliance with safety standards and required safety equipment. You may voluntarily consent to one of these inspections, and you are allowed time to make corrections without prosecution. Check with the appropriate state agency or the Coast Guard Auxiliary for details.

Safe Boating Courses

The local U.S. Coast Guard Auxiliary and the U.S. Power Squadrons offer comprehensive safe boating classes several times a year. You may contact the BOAT/U.S. Foundation at 1 800 336-BOAT (2628) or, in Virginia, 1 800 245-BOAT (2628), for a course schedule in your area. Also contact the local U.S. Coast Guard Auxiliary or Power Squadron Flotilla for the time and place of their next scheduled class. A boating safety course is recommended and may be required in your province or state.

Water Sports

WARNING

Avoid Personal Injury! Your boat is not designed for and should not be used for pulling parasails, kites, gliders, or any device which can become airborne. Use boat only for appropriate water sports.

WARNING

“Teak Surfing” is extremely dangerous to participants due to their proximity to the rear of the boat where direct contact with the exhaust fumes from the boat engine is the highest. Carbon monoxide poisoning can occur and result in mental disorientation, dizziness, drowsiness, and loss of consciousness. The combination of carbon monoxide exposure and non-use of a life jacket (PFD) make this new water recreation activity an incredibly dangerous and potentially deadly sport.

Water skiing, wakeboarding, or riding a towed, inflatable apparatus are some of the more popular water sports. Taking part in any water sport requires increased safety awareness by the participant and the boat operator. If you have never pulled someone behind your boat before, it is a good idea to spend some hours as an observer, working with and learning from an experienced driver. It is also important to be aware of the skill and experience of the person being pulled. Always have a second person on board to observe the person in the water so the driver can concentrate on operating the boat.

Both the boat operator and observer should monitor the location of the tow-rope when participating in water-sports. A slack tow rope can become entangled with person(s) or objects in the boat or in the water, particularly when making a tight turn or circling, and cause serious personal injury.

Everyone participating in a water sport should observe these guidelines:

1. Allow only capable swimmers to take part in any water sport.
2. Always wear a personal flotation device (PFD) approved by the U.S. Coast Guard. Wearing a properly designed PFD helps a stunned or unconscious person stay afloat. A Type-IV water-ski vest is an approved and practical PFD.
3. Have a second person aboard to observe the person being towed and inform the driver about the participant's hand signals. The driver must give full attention to operating the boat and the waters ahead.
4. Be considerate to others you share the water with.
5. Give immediate attention to a person who has fallen. He or she is vulnerable in the water alone and may not be seen by other boaters.

6. Approach a person in the water from the lee side (opposite the direction of the wind). Turn off the motor before coming close to the person.
7. Turn off engine and anchor the boat before swimming.
8. Participate in water sports only in safe areas. Stay away from other boats, channels, beaches, restricted areas, swimmers, and heavily traveled waterways and underwater obstructions.
9. Swim only in areas designated as safe for swimming. These are usually marked with a swim area buoy. Do not swim alone or at night.



SWIM AREA BUOY

10. Do not water ski between sunset and sunrise. It is illegal in most states.
11. Do not drive the boat directly behind a water skier, tuber or wakeboarder. At 25 miles per hour, the boat will overtake a person who falls in the water 200 feet in front of your boat in about 5 seconds.

12. Shut engine off and remove ignition key when anyone is in the water nearby.
13. Stay at least 150 feet away from areas marked by a diver down float.

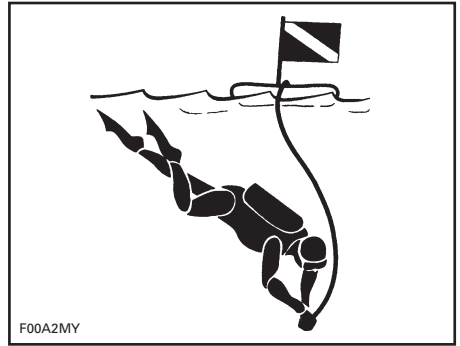

DIVER DOWN FLOAT

⚠ WARNING

Avoid Personal Injury! Do not allow anyone near the jet pump or intake grate, even when the engine is off. Items such as long hair, loose clothing or personal flotation device straps can become entangled in moving parts resulting in serious injury or drowning. In shallow water, shells, sand, pebbles or other objects could be drawn up by the jet pump and be thrown rearward.

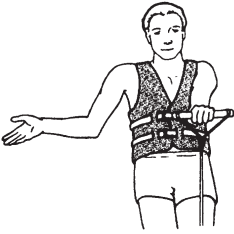

FASTER -
Palm of one hand pointing upward.



SLOWER -
Palm pointing down.



SPEEK OK -
Arm upraised with thumb and finger joined to form circle.

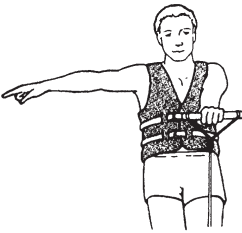

RIGHT TURN -
Arm outstretched pointing to the right.

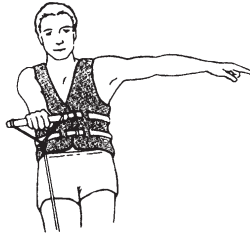

LEFT TURN -
Arm outstretched pointing to the left.



RETURN TO DROP-OFF AREA -
Arm at 45 degree from body pointing down to water and swinging.



CUT MOTOR -
Finger drawn across throat.



STOP -
Hand up, palm forward, policeman style.



SKIER OK. AFTER THE FALL -
Hands clenched together overhead.

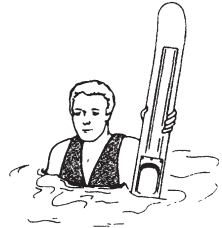

PICK ME UP OR FALLEN SKIER, WATCH OUT -
One ski extended vertically out of water.

F00A2NL

SKIING SIGNALS

For more information about water skiing, please contact the American Water Ski Association, 799 Overlook Drive, Winter Haven, FL 33884 (1 800 533-2972).

VEHICLE INFORMATION

REGISTRATION NUMBER LOCATION

All craft are required by federal law to be registered and legally numbered.

Due to space availability for proper display of registration number, refer to the following illustration for location. The registration number should appear on each side of the craft.



TYPICAL

1. Registration number location

LOCATION OF THE IMPORTANT LABELS

The following labels are on your craft. If missing or damaged, they can be replaced free of charge. See an authorized SEA-DOO sport boat dealer.

Please read the following labels carefully before operating this craft.

Utopia 185

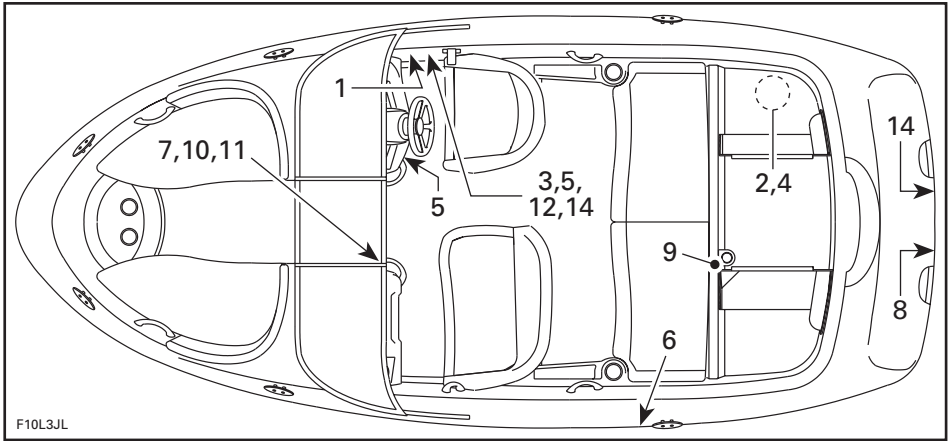

Utopia 205

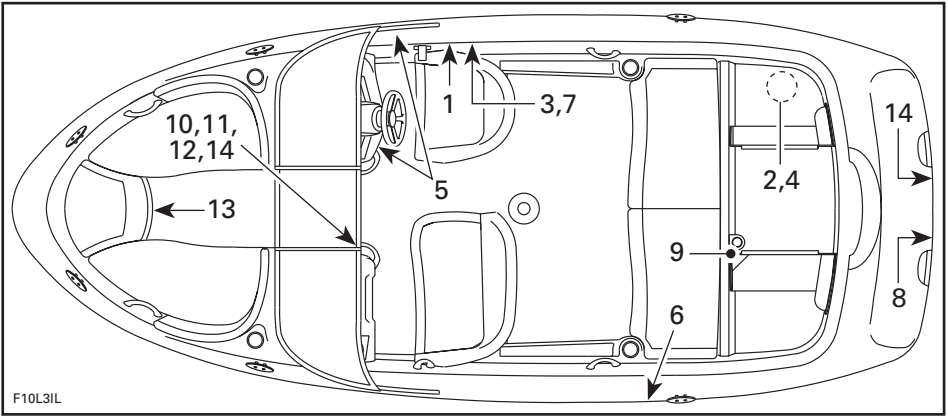

Label 1



TYPICAL — REFER TO ACTUAL LABEL ON CRAFT

Label 2

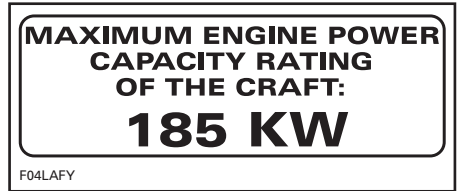

TYPICAL — REFER TO ACTUAL LABEL ON UTOPIA 185

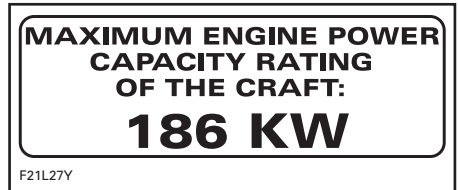

TYPICAL — REFER TO ACTUAL LABEL ON UTOPIA 205

Label 3

⚠ WARNING

Read and follow warning labels and operator's guide before operation. Severe injury or death can result from ignoring warnings or improper use of this sport boat. The performance of this sport boat may significantly exceed that of other boats you may have operated.

- Check throttle/shifter and steering operation and position before starting engine(s).
- Directional control is reduced with decreasing speed and lost when engine is off.
- Do not splash others or jump waves or wakes.
- Occupants should always wear approved PFD and recommended protective clothing.
- Do not operate if passengers are not properly seated and using handgrips, or if visibility is obstructed. Do not allow passenger(s) to ride on any portion of the boat not designated in the operator's guide as a seat for use when underway.
- Properly attach safety lanyard to your PFD.
- Keep a safe distance from all other water users. Be aware of and observe all applicable laws and regulations.

F13L1UL

Label 4

⚠ WARNING

- Remove battery from boat before charging.
- Do not overcharge battery.
- Improper charging of battery can cause explosion.

F13L1MY

Label 7

⚠ CAUTION

- Do not use bimini top as a support.
- Operate boat only at low speeds if bimini top is in use.
- Top can break or dislodge causing a risk of personal injury or interference with boat operation.

F04LCYY

Label 5

⚠ WARNING

Gasoline vapors can explode, resulting in injury or death. Before starting engine, operate blower for 5 minutes and check engine compartment bilge for gasoline vapors.

F13L1SY

Label 8

⚠ WARNING

- Avoid serious personal injury or death.**
- Turn off engine(s) before using swim platform.
 - Keep people, clothing and hair away from jet nozzle(s) or intake grate(s) to avoid entanglement, drowning and carbon monoxide poisoning.

F13L1OY

Label 6

⚠ WARNING

- Avoid serious injury or death from fire or explosion.**
- Before fueling, stop engine and keep boat level.
 - Open fuel cap slowly to relieve pressure.
 - Do not overfill.
 - Regularly inspect fuel system for leaks.
 - Use regular unleaded gasoline and check oil level.

F13L1NY

Label 9

OIL RECOMMENDATION

IMPORTANT!
DO NOT USE ROTAX INJECTION OIL.
USE MERCURY PRECISION PREMIUM PLUS OR QUICKSILVER PREMIUM PLUS 2-CYCLE OIL (NMMA TC-W3 CERTIFIED). THESE OILS CONTAIN ADDITIONAL UNIQUE ADDITIVES SPECIFICALLY DESIGNED FOR USE WITH THE M² JET DRIVE TO INCREASE ENGINE DURABILITY AND SUBSTANTIALLY REDUCE CARBON BUILDUP.
(Refer to M² Jet Drive Operator's Manual for further information)

F00L2IY

Label 10

⚠ WARNING
Lock driver seat in forward position so that seat faces steering wheel during operation and does not swivel.
F13L1TY

Label 11

⚠ WARNING
Securely lock windshield door in the opened or closed position before getting underway and at all times while boat is in motion.
F21L25L

Label 12

⚠ CAUTION
Latch engine cover before operating or towing boat. Open cover may be damaged or obstruct driver visibility.
F21L26L

Label 13

⚠ WARNING
Not a seat. Do not use as a seat while underway.
F13L1RY

Label 14

⚠ WARNING
Engine exhaust fumes contain carbon monoxide (CO) which can accumulate in and around the boat (under bimini top, in cockpit, etc.). CO can be harmful or fatal if inhaled. Assure there is adequate ventilation whenever running engine(s).
F13L1QL

IDENTIFICATION NUMBERS

The main components of the craft (engine and hull) are identified by different serial numbers. It may sometimes become necessary to locate these numbers for warranty purposes or to trace the craft in the event of theft.

Hull

The Hull Identification Number (H.I.N.) is located at right hand rear side of hull.

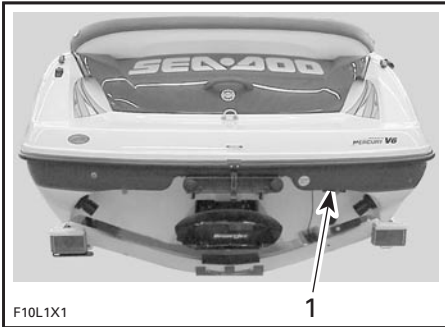

TYPICAL

1. Hull Identification Number (H.I.N.)

Engine

Refer to *M² Jet Drive Operator's Guide*.

CONTROLS COMPONENTS AND INSTRUMENTS LOCATION

Cockpit

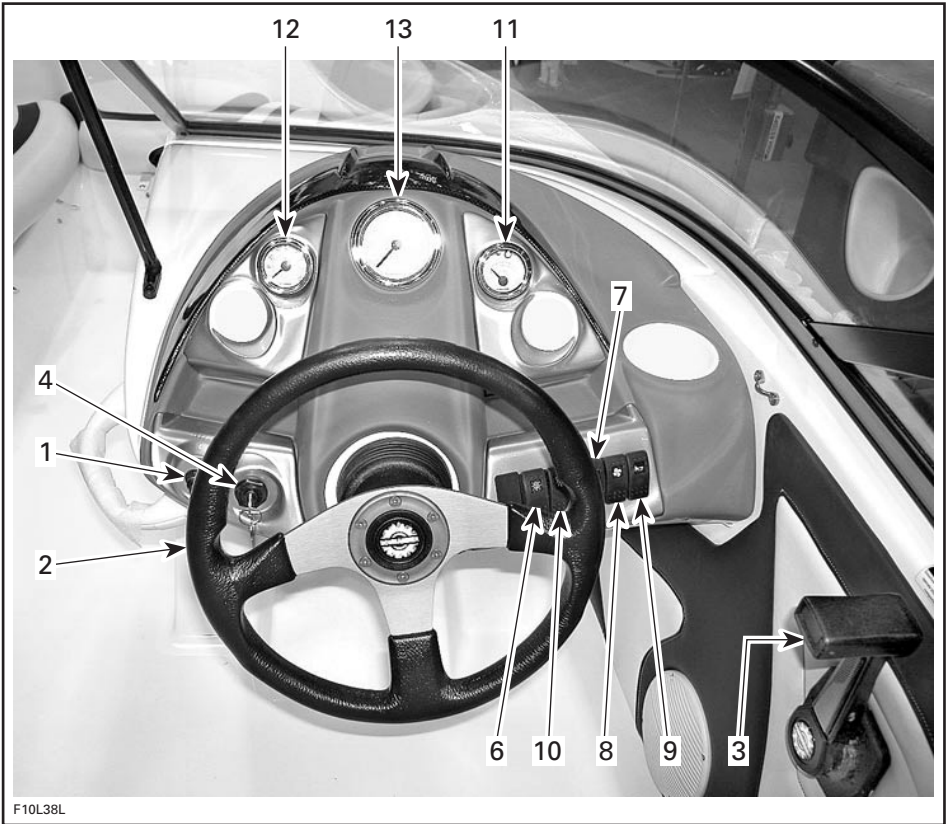

TYPICAL — COCKPIT VIEW UTOPIA 205

Overview

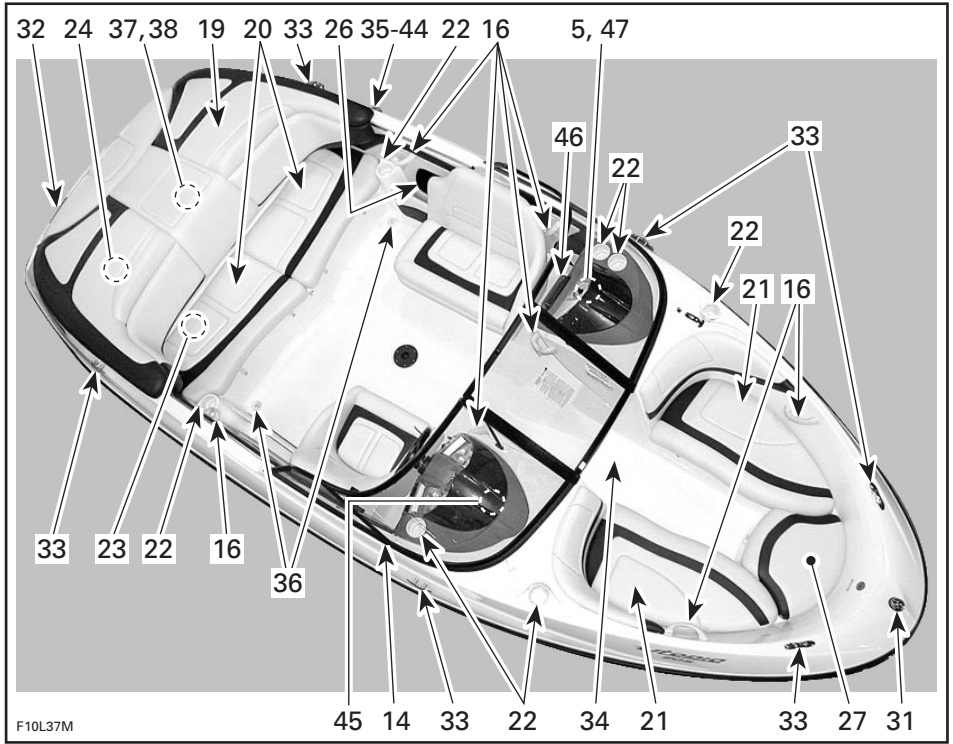

TYPICAL — TOP/SIDE VIEW UTOPIA 205

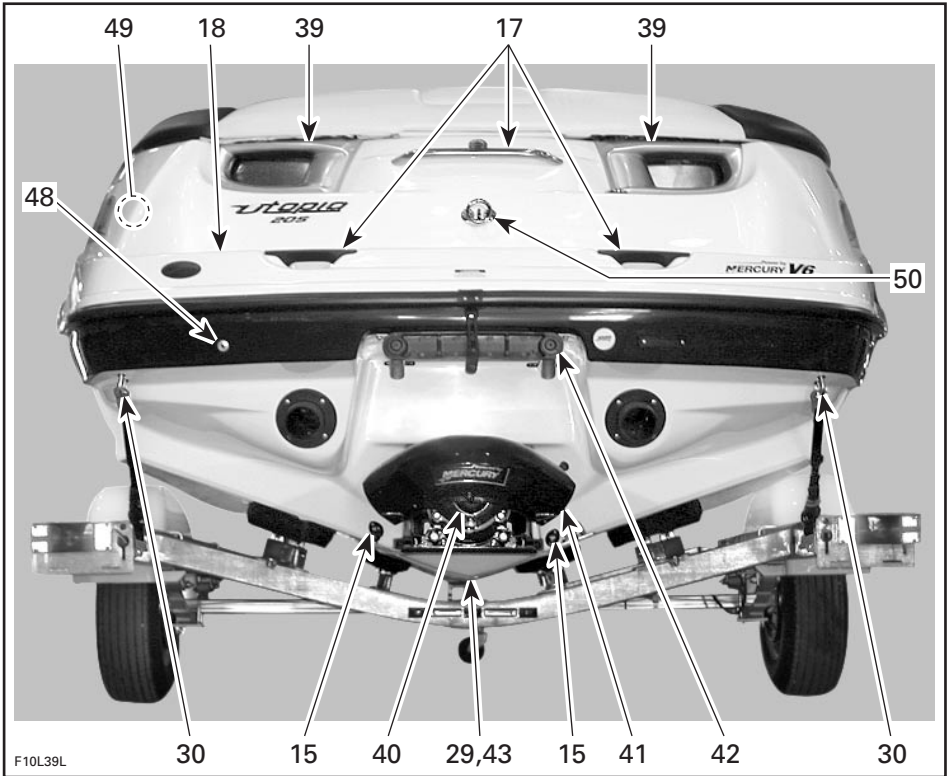

F10L39L

TYPICAL — REAR VIEW UTOPIA 205

1. Safety Lanyard (engine cut-out switch)
2. Steering Wheel
3. Throttle/Shifter Lever
4. Ignition Switch
5. 12-Volt Accessory Jack
6. Navigation Light Switch
7. Bilge Pump Switch
8. Bilge Air Blower Switch
9. Horn Switch
10. Deck Light Switch
11. Fuel Gauge/Low Oil Level Pilot Lamp and Beeper
12. Tachometer
13. Speedometer
14. Windshield
15. Bilge Drain Plugs
16. Grab Handles
17. Rear Grab Handles
18. Swim Platform
19. Sun Deck
20. Seats
21. Bow Seats (if so equipped)
22. Cup Holders
23. Rear Seat Storage Compartment
24. Rear Storage Compartment
25. Bimini Top (not shown)
26. Side Panel/Tray Storage
27. Bow Anchor Locker
28. Cockpit table (not shown)
29. Jet Pump Water Intake
30. Bow and Stern Eyelets
31. Bow Light
32. Removable Stern Light Socket
33. Mooring Cleats
34. Deck
35. Fuel Tank Cap
36. Deck Drain(s)
37. Main Oil Reservoir Cap
38. Flushing Connector
39. Ventilation Ducts
40. Jet Pump Nozzle
41. Reverse Gate
42. Retractable Ladder
43. Hydro-Surge Grate System
44. Fuel Tank Vent
45. Fuses
46. AM/FM Radio/CD Player
47. Glove Box
48. Water Bypass System
49. Main Battery Cut-Off Switch
50. Water Sport Towing Attachments

CONTROLS, COMPONENTS AND INSTRUMENTS FUNCTIONS

1) Safety Lanyard (engine cut-out switch)

The safety lanyard cap should be securely snapped onto its switch to be fully operational.

Pulling the safety lanyard cap from the switch stops the engine operation. Attach the safety lanyard to the operator's Personal Flotation Device (PFD) and snap the cap to the switch to be able to start the engine.

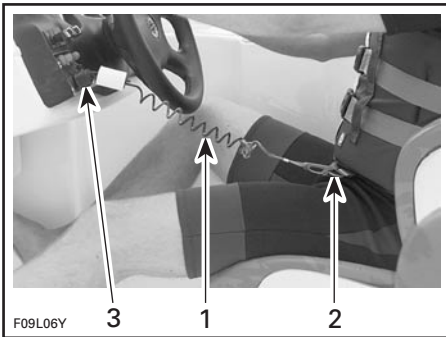

TYPICAL

1. Safety lanyard
2. Secure to PFD
3. Snap to safety lanyard switch

WARNING

Should the engine be stopped, craft directional control is lost. Always disconnect safety lanyard when craft is not in operation in order to prevent accidental engine starting or to avoid unauthorized use by children or others or theft.

2) Steering Wheel

The steering wheel controls the direction of the craft. Turning the steering wheel clockwise steers the craft to the right and inversely.

Low-Speed Steering Control Systems

Whenever the engine RPM is at idle and the steering wheel is approaching the end of its rotation, the engine speed will be slightly accelerated to increase the jet pump thrust and thus improving the steering control for low speed operation and when approaching/leaving a dock. Refer to OPERATING INSTRUCTIONS for more details.

3) Throttle/Shifter Lever

Shifter Lever

A 3-position lever:

- forward
- neutral
- reverse.

Throttle Lever

When pushed forward craft accelerates. When fully pulled back, engine return to idle speed and the craft is gradually stopped by water drag.

Throttle/shift lever must be in neutral position to allow engine starting.

WARNING

Only use reverse at slow speed and for the shortest time possible. Always ensure the path behind is clear of objects and persons including children playing in shallow water.

CAUTION: Never rev the engine at high RPM in reverse.

4) Ignition Switch



TYPICAL

1. Ignition switch



1. 12-Volt jack

CAUTION: Using the radio, electric cooler, cellular phone or portable television for a prolonged time without engine running may discharge the battery.

Starting and Stopping

WARNING

Engine exhaust fumes contain carbon monoxide (CO) which can accumulate in and around the boat (under bimini top, in cockpit, etc.). CO can be harmful or fatal if inhaled. Assure there is adequate ventilation whenever running engine(s).

Refer to *M² Jet Drive Operator's Guide* for complete detailed procedure.

WARNING

Directional control is lost when engine is off.

5) 12-Volt Accessory Jack

Located in the glove box. A 12-Volt jack to power temporary accessories such as an electric cooler, cellular phone or portable television.

6) Navigation Light Switch

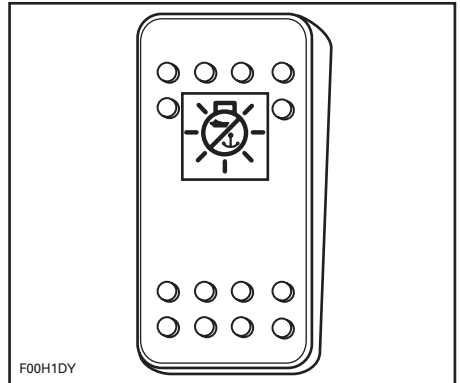

A 3-POSITION NAV/OFF/ANC PUSH TYPE SWITCH

Press switch to first position to turn on the stern light (anchorage position).

Press switch to second position to turn on the bow and stern lights.

Press to OFF position to turn off navigation lights.

NOTE: Switches and gauges are lit when navigation lights are turn on. Lights may be operated without the safety lanyard on its switch.

⚠ WARNING

Navigation lights should always be used between sunset and sunrise. Ensure the stern light is installed. See REMOVABLE STERN LIGHT in this section for location and installation.

7) Bilge Pump Switch

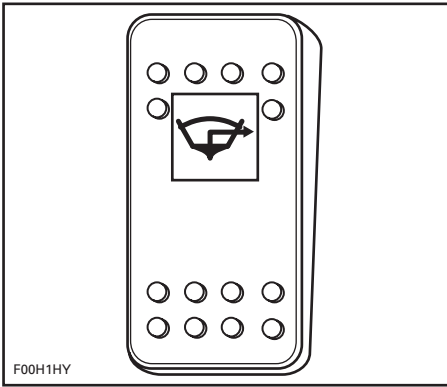

A 2-POSITION PUSH TYPE SWITCH

Press switch to ON position when a manual operation is required (after cleaning, storage, etc.).

Press to OFF position when bilge is dry.

CAUTION: Using the bilge pump for a prolonged time when the engine is not running will discharge the battery.

NOTE: The bilge pump may be operated without the safety lanyard on its switch.

CAUTION: Ensure to always turn pump OFF when bilge is dry or before operating the engine above idle. Bilge pump will then switch to automatic mode.

Automatic Bilge Pump

An automatic bilge pump will evacuate water from the bilge. A water sensor detects the water which activates the bilge pump. After the water is pumped out, the pump shuts-off automatically. This automatic mode is working at all times: with/without safety lanyard on its switch and with/without engine running.

8) Bilge Air Blower Switch

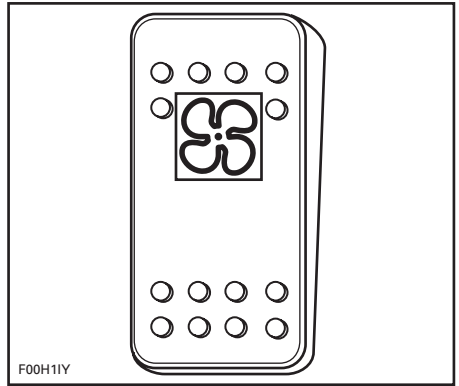

A 2-POSITION PUSH TYPE SWITCH

When ON, it ventilates the engine compartment.

⚠ WARNING

Always use blower for a minimum of 5 minutes prior to engine starting then, turn it OFF above idle speed. Use of the bilge blower should never replace "smelling" for gasoline vapors.

CAUTION: Using the bilge blower for a prolonged time when the engine is not running will discharge the battery.

Blower should be turned off during boat operation.

9) Horn Switch

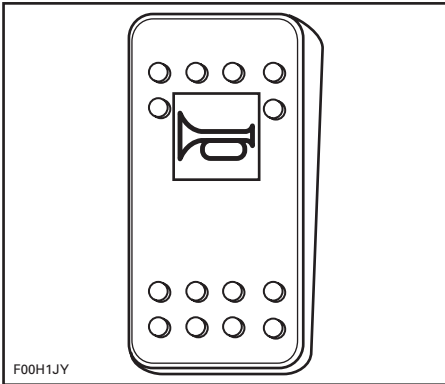

A 2-POSITION PUSH TYPE SWITCH

Press and hold the switch to activate horn.

Release the switch to stop horn.

10) Deck Light Switch

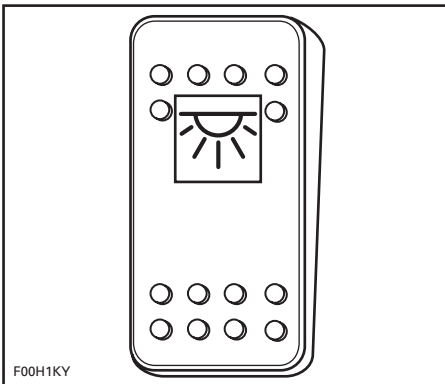

A 2-POSITION PUSH TYPE SWITCH

CAUTION: Using the deck lights for a prolonged time when the engine is not running will discharge the battery.

11) Fuel Gauge/Low Oil Level Pilot Lamp and Beeper

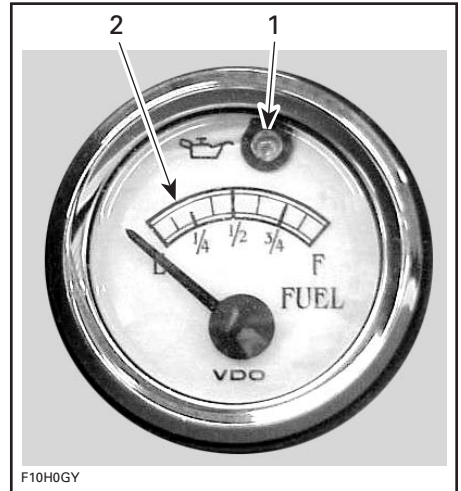

TYPICAL

1. Low injection oil level pilot lamp
2. Fuel level

Fuel Gauge

Located in dashboard, the analog gauge continuously indicates the amount of fuel in fuel tank when engine is running.

The gauge is illuminated whenever the navigation lights are used.

NOTE: The fuel level can also be verified without having engine running. With the safety lanyard removed from its switch, turn ignition switch to ON position; the gauge will be activated.

CAUTION: Always turn ignition switch to OFF position once fuel level has been checked.

Low Oil Level Pilot Lamp and Beeper

The pilot lamp and the beeper turn on when the oil level is low in engine mounted oil reservoir or if a wire/connector of this electrical circuit is not properly connected. Fill reservoirs as soon as possible or contact an authorized SEA-DOO sport boat dealer if light or beeper remain on.

CAUTION: Never run engine out of oil. Serious engine damage will occur.

12) Tachometer

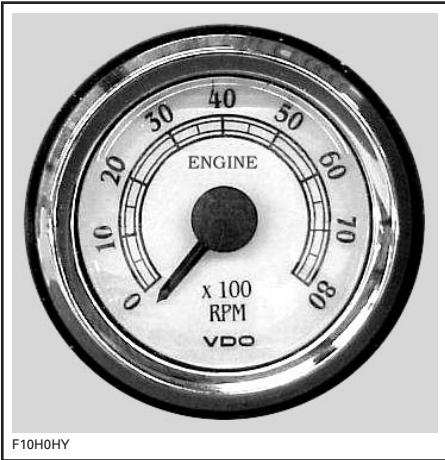

F10H0HY

TYPICAL

Analog tachometer indicates the revolutions per minute (RPM) of the engine. Multiply reading by 100 to obtain actual RPM.

The gauge is illuminated whenever the navigation lights are used.

13) Speedometer

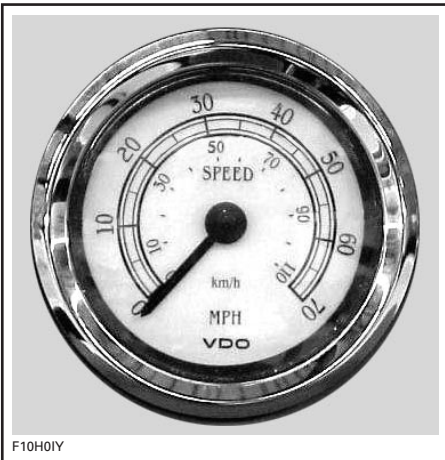

F10H0IY

TYPICAL

Analog speedometer indicates the speed of the craft in miles per hour (MPH) and kilometers per hour (km/h).

The gauge is illuminated whenever the navigation lights are used.

A speed sensor mounted on the hull near *M² Jet Drive* sends the signal to the speedometer.

14) Windshield

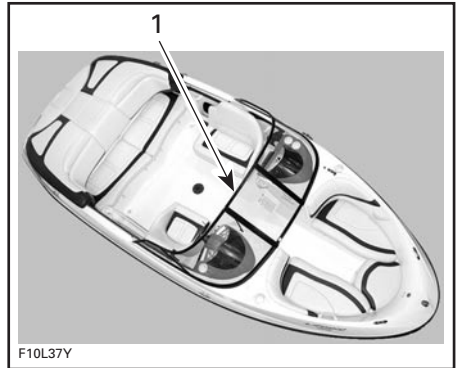

1. Windshield

To open windshield door, unlock both latches then open it, as shown in the following photo.

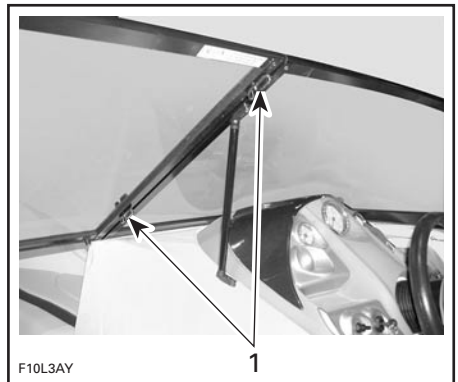

1. Unlock both latches

15) Bilge Drain Plugs

Should water be found in the bilge, it can be easily drained by unscrewing the drain plugs.

Tilt the craft slightly to the rear so that the water can completely flow out of the bilge.

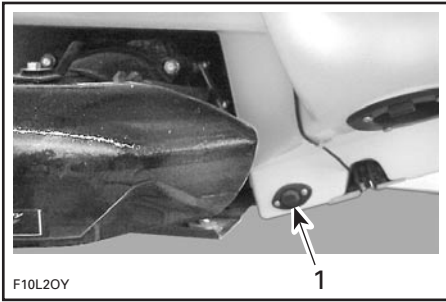

1. Bilge drain plug

16) Grab Handles

Provide a handhold for the passengers.

CAUTION: Never use the grab handles to pull anything or to lift the craft.

Refer to components location illustrations at the beginning of this section for grab handles location.

17) Rear Grab Handles

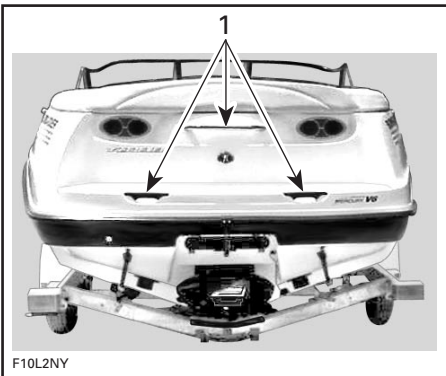

TYPICAL

1. Grab handles

Provides a handhold for boarding when needed.

CAUTION: Never use the grab handle to tow anything or to lift the craft.

18) Swim Platform

Provides an anti-skid surface for easy boarding from rear of craft.

⚠ WARNING

Do not start or operate the craft if a person is seated on the platform. Engine must be off when using swim platform. Keep away from jet or intake grate.

19) Sun Deck

A convenient space to rest or take some sun while anchored.

⚠ WARNING

Do not start or operate the craft if a person is seated on the sun deck.

20) Seats

Each passenger should be seated while underway.

⚠ WARNING

Allow no one to sit on edge of craft or to stand up while in operation. Seat/grab handles should be used in rough waters.

Front Seats

Swivel

Both front seats can swivel backward by pulling lever, as shown in the next photo.



PULL LEVER

⚠ WARNING

Always ensure front seat swivel is locked so that seat faces steering wheel before riding.

**21) Bow Seats
(if so equipped)**

Located at front of craft, they are provided as a sun seat.

⚠ WARNING

No passenger should use the most forward seat in the bow area if it faces backwards unless the craft is stopped or under idle speed.

Use grab handles as necessary.

NOTE: See item 27 – BOW ANCHOR LOCKER.

**Bow Seat Storage
Compartments**



To reinstall seat, ensure to position L-bracket first, push seat down then snap it.



1. Position L-bracket first

22) Cup Holders

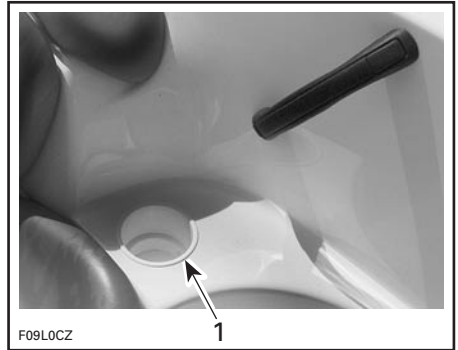

1. Cup holder

Convenient locations for non-alcoholic beverages.

⚠ WARNING

Do not drink alcoholic beverages while aboard. Do not keep bottles, cans etc. in cup holders while riding at speed and/or on rough waters.

23) Rear Seat Storage Compartment

The rear seat storage compartment is a convenient location for water-skis, paddles, anchor and rope, etc.

WARNING

Never leave any heavy or breakable objects in the storage compartment. Never operate the craft with the storage compartment cover open.

24) Rear Storage Compartment

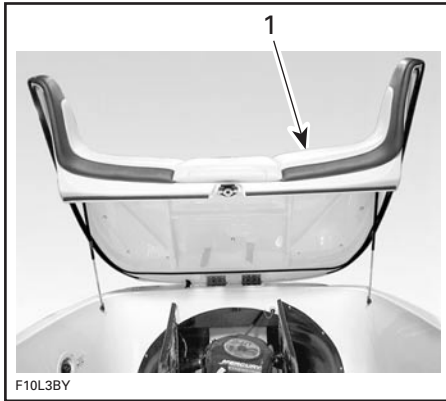

REAR STORAGE COMPARTMENT

1. Engine cover opened

Convenient rear storage location to be used to carry large personal articles. Ideal location for spare Personal Flotation Device (PFD), towels, lunch etc.

Pull latch to open engine cover.

The gas assist cylinders will ease opening and hold engine cover open.

WARNING

Never leave any heavy or breakable objects in the storage compartment. Never operate the craft with the engine cover open.

25) Bimini Top

The Bimini top is convenient for protection against inclement weather or sunshine.

WARNING

- Do not use Bimini top as a support.
- Operate boat only at low speeds if bimini top is in use.
- Top can break or dislodge causing a risk of personal injury or interference with boat operation.

Opening Bimini Top

Lift sun pad lid.

Slightly raise Bimini top above engine storage compartment and slide all the way to front of side rails.



1. Bimini pivot base pulled forward on rail

Unzip cover and remove. Store cover in a storage area.

Lift Bimini top to vertical position and connect front straps to eyelets on body of craft.



1. Hook strap to body eyelet

Pull canvas back and fasten rear straps to eyelets on body of craft.

Adjust strap tension as needed.

Close sun pad lid.

Closing/Storing Bimini Top

NOTE: If canvas of Bimini top has been splashed by salt water, rinse canvas with cold fresh water. At any time when canvas is wet, let dry prior to installing cover and storage.

Open sun pad lid.

Unhook rear straps.

Unhook front straps.

Before laying the Bimini top down, hold the top/front tube and pull the second and third tubes toward the top/front tube.

Tilt Bimini top back towards storage compartment.

Position the protective cover so that the zipper will be on the inner side of the Bimini top and the starting end of the zipper will be on starboard side of boat.

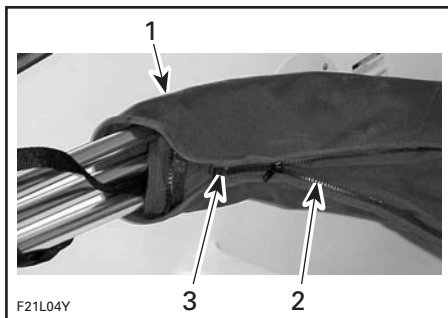

1. Bimini top at rear storage compartment area
2. Inner side of zipper
3. Start of zipper

Place Bimini top straps inside cover and slowly zip while packing canvas inside cover.

Slide Bimini top to the rear of side rail to store Bimini top underneath sun pad lid.

Close sun pad lid.

Removing Bimini Top from Boat

If it becomes necessary to remove Bimini top from boat, proceed as follows:

Open sun pad lid.

Remove fasteners at pivot point.

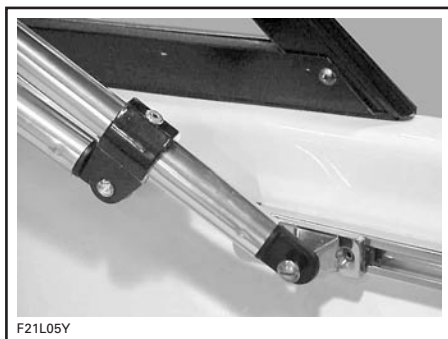

TYPICAL

With the assistance, carefully lift Bimini top and remove.

Reinstall pivot fasteners to prevent loss.

Installation is procedure in reverse, however, pay attention to Bimini top orientation for proper positioning.

Close sun pad lid.

Utopia 205 Only

26) Side Panel/Tray Storage

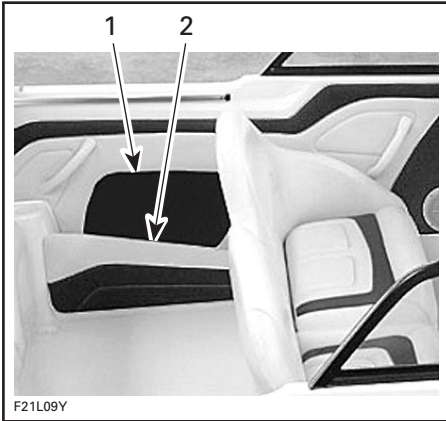

1. Side panel storage
2. Side tray storage

Located at the port and starboard sides of the craft, these storage areas provide quick, easy access for additional articles.

WARNING

Never leave any heavy or breakable objects in the storage compartment. Never operate the craft with the storage compartment cover open.

Utopia 205 Only

27) Bow Anchor Locker

Located under the forward bow cushion with storage for anchor and line.

WARNING

Not a seat. Do not use as a seat while underway.

WARNING

Never leave breakable objects in the anchor storage compartment. Never operate the craft with the anchor storage compartment cover open.

Utopia 205 Only

28) Cockpit Table

Conveniently stored atop the engine cover.



COCKPIT TABLE IN STORAGE POSITION

Swivel front seats into side-facing position.

Open sun pad lid.

Unclip table post and place in floor receptacle. Twist gently to ensure proper fit.

⚠ WARNING

When front seats are in side facing position and table post not installed, floor receptacle poses potential hazard. Use proper judgement.



COCKPIT TABLE INSTALLED

Close sun pad lid.

Cockpit Table Storage

Storage of cockpit table is the reverse of installation.

⚠ WARNING

Cockpit table must be properly stored before operating craft.

29) Jet Pump Water Intake

The water is drawn up by the impeller through this opening. It minimizes entry of foreign objects into the propulsion system.

⚠ WARNING

Keep away from intake grate while engine is on. Items such as long hair, loose clothing or personal flotation device straps can become entangled in moving parts resulting in severe injury or drowning.

Refer to *M² Jet Drive Operator's Guide* for more detailed information.



- 1. Floor receptacle
- 2. Table post

Loosen bungee straps to remove table top, and connect with table post.

30) Bow and Stern Eyelets

Bow Eyelet

Eyelets can be used for mooring, towing and as a tie-down point during transportation.

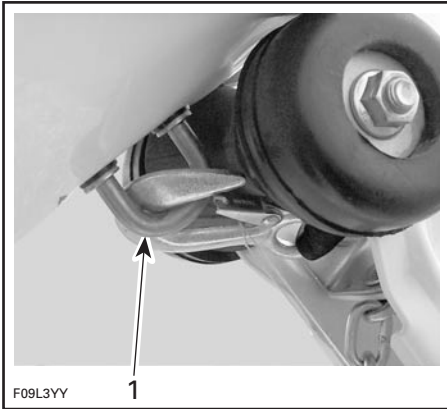

TYPICAL

1. Bow eyelet

Stern Eyelets

This eyelet allows a rope with a hook, a closes end or an open end to be attached.

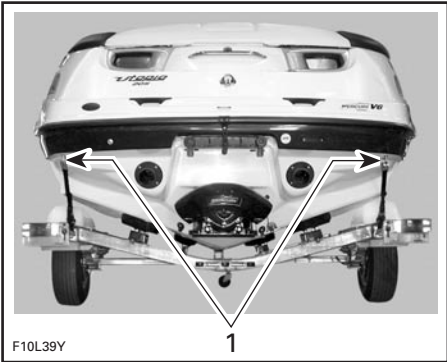

TYPICAL

1. Stern eyelets

31) Bow Light

Mandatory red/green light. See LIGHT SWITCH as mentioned earlier in this section.

32) Removable Stern Light

Mandatory white stern light.

It is recommended to keep it in rear seat storage compartment at all times except when needed.

To remove from storage compartment, pull it out. Snap in place to store again.

Installation

- Lift connector cap.
- Insert post in connector hole. Ensure to align hole keyway with post screw head.
- Firmly push downward to engage terminals.
- Push lock ring downward. Turn until locked. It may be necessary to slightly turn it to allow its insertion in the hole.
- Check light operation. See NAVIGATION LIGHT SWITCH as mentioned earlier in this section.

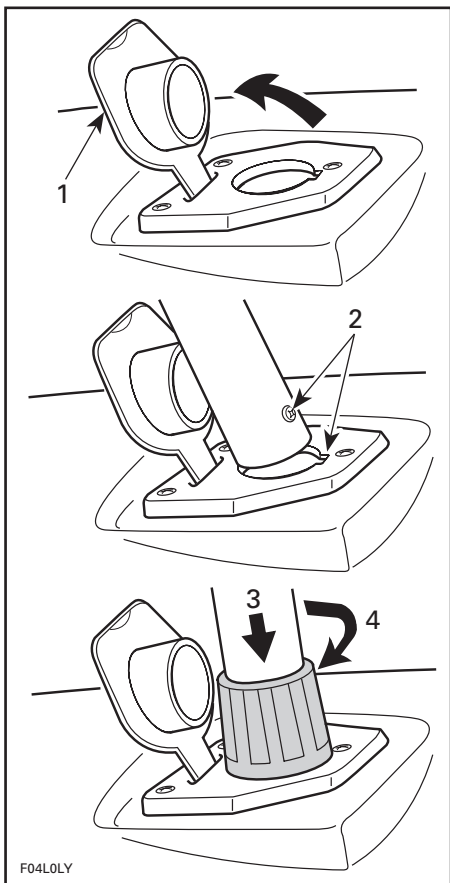

TYPICAL

1. Lift
2. Align screw in groove
3. Push downward
4. Turn to lock

CAUTION: Ensure dielectric grease is present in connector area of light to prevent corrosion.

33) Mooring Cleats

When mooring to a dock, it is recommended to secure with both front and rear cleats. The use of dock lines with sealed air fenders is recommended to protect your craft.

CAUTION: Never use mooring cleats to pull or lift the craft.

34) Deck

Flat surface of craft, should be kept clean and clear.

35) Fuel Tank Cap

Unscrew the cap counterclockwise. Reinstall cap and fully tighten after fueling.

⚠ WARNING

Always stop the engine before refueling. Fuel is flammable and explosive under certain conditions. Always work in a well ventilated area. Do not smoke or allow open flames or sparks in the vicinity. Fuel tank may be pressurized, slowly turn cap when opening. Keep craft level. Do not overfill or top off the fuel tank and leave craft in the sun. As temperature increases, fuel expands and might overflow. Always wipe off any fuel spillage from the craft. Never use an open flame to check fuel level.

36) Deck Drain(s)

It provides drainage of water from rain, deck washing, water splashing, etc.

Keep clean to avoid clogging.

37) Main Oil Reservoir Cap

Open the engine cover to expose the oil cap.



To add injection oil in the reservoir, unscrew the cap counterclockwise.

⚠ WARNING

Add oil to level mark. Do not overfill. Reinstall cap and fully tighten.

CAUTION: Oil system must be pressurized. Always ensure that reservoir caps are firmly tighten. Refer to *M² Jet Drive Operator's Guide* for recommended oil and complete reservoirs filling procedure.

38) Flushing Connector

Refer to *M² Jet Drive Operator's Guide* for proper use.

For your convenience, flushing connector is located under rear storage compartment lid. Lift cover, the flushing connector is on starboard side of the storage compartment, as shown in the next photo.

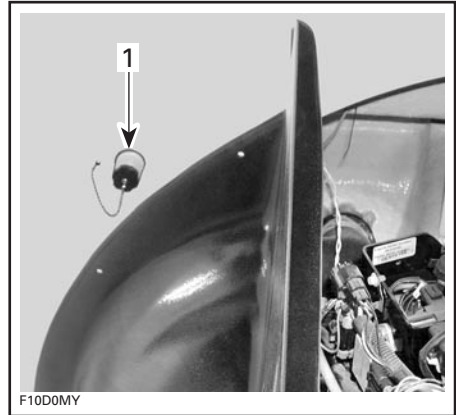

1. Flushing connector

39) Ventilation Ducts

This is where air flows to supply engine and ventilate engine compartment. They should never be obstructed.

40) Jet Pump Nozzle

Turns side to side via input from the steering wheel. This provides directional control when engine is running.

⚠ WARNING

Never use nozzle as a supporting point to board the craft or to lift it.

41) Reverse Gate

When selecting the neutral or reverse position with the throttle/shift lever, the reverse gate moves up or down to obtain the desired position.

⚠ WARNING

Never use gate as a supporting point to board the craft. Throttle/shift lever should only be used when the engine is idling and craft is completely stopped.

42) Retractable Ladder

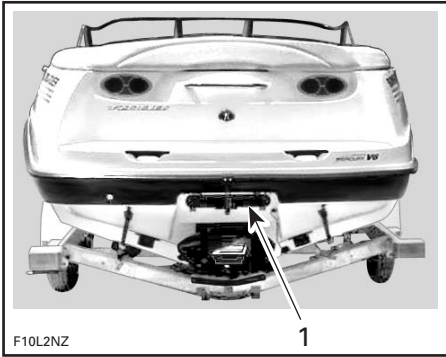

1. Retractable ladder

Located under swim platform. A convenient ladder to help reboarding the craft.

WARNING

Engine should be OFF when using ladder. Keep limbs away from jet or intake grate. Stay on center of the ladder. Only one person at the time on the ladder. Never use the ladder for pulling, towing, diving or jumping, boarding a craft that is out of water or any other purpose other than a ladder.

Pull latch to unlock the ladder.

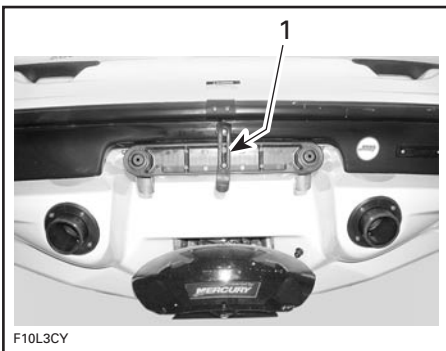

TYPICAL

1. Latch

Slide ladder toward rear, then push down.

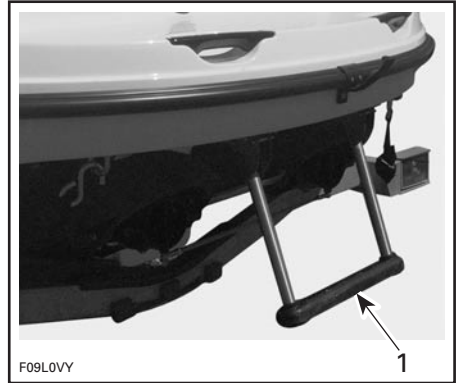

TYPICAL

1. Ladder lowered

To store ladder, lift horizontally completely then slide toward front.

43) Hydro-Surge Grate System

Refer to *M² Jet Drive Operator's Guide*.

44) Fuel Tank Vent

It allows fuel vapors and pressure to escape from fuel tank.

WARNING

Never use a lit match or open flame close to vent. Follow the FUELING PROCEDURE instructions in the FUEL AND LUBRICATION section.

45) Fuses

Craft electrical system fuses are located inside starboard console.

Refer to *M² Jet Drive Operator's Guide* for ENGINE ELECTRICAL SYSTEM.

46) AM/FM Radio/CD Player

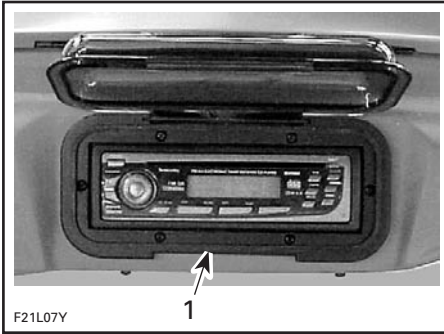

1. Radio/CD player

Refer to manufacturer's guide for complete explanation of features and controls.

CAUTION: Using the radio/CD player for a prolonged time without engine running may discharge the battery.

47) Glove Box

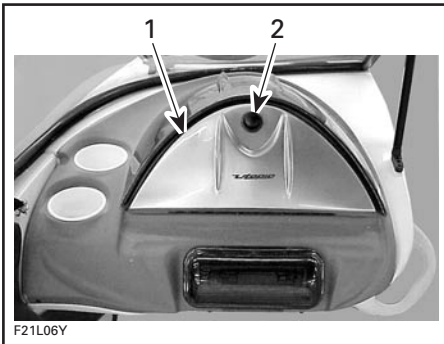

1. Glove box
2. Push button

Located on port console.

A small, convenient storage compartment for keys, wallet, etc.

To access the glove box, push button in and release. Turn knob either direction to open. To close, lift door and push forward until latched. Push button in to secure.

NOTE: Always relatch glove box.

WARNING

Never operate the craft with the glove box cover open.

48) Water Bypass System

At idle speed, there will not be a water flow through this outlet.

When engine is running above idle speed, water must flow through this hole. This allows air in engine water jacket to escape.



TYPICAL

1. Water bypass outlet

CAUTION: Should water not flow from the outlet a few seconds after engine starts and runs above idle, immediately stop engine and refer to POST-OPERATION CARE and look for COOLING SYSTEM FLUSHING or refer to an authorized SEA-DOO sport boat dealer for servicing.

49) Main Battery Cut-Off Switch

The switch is located in the engine compartment, close to battery. It is provided to allow a complete cut-out of the electrical system.

When in OFF position, ALL electrical equipment and electronics except the bilge pump, will not be powered and not working.

It must be in the ON position to allow the use of electrical components and to start the engine.

CAUTION: Stop engine before switching OFF.

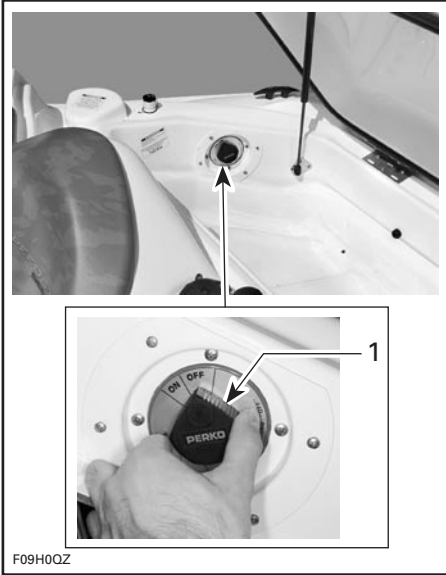

TYPICAL

1. Main battery cut-off switch

It is recommended to set in the OFF position whenever performing maintenance in the engine compartment, on the electrical system, for transportation and for short term storage on the trailer.

50) Water Sport Towing Attachments

Please read and often refer to **WATER SPORTS** information in the **SAFETY SECTION** at the front of this guide.

WARNING

“Teak Surfing” is extremely dangerous to participants due to their proximity to the rear of the boat where direct contact with the exhaust fumes from the boat engine is the highest. Carbon monoxide poisoning can occur and result in mental disorientation, dizziness, drowsiness, and loss of consciousness. The combination of carbon monoxide exposure and non-use of a life jacket (PFD) make this new water recreation activity an incredibly dangerous and potentially deadly sport.

Always have one person other than the operator as an observer.

CAUTION: Never use the ski tow to pull other boats.

WARNING

Riding when pulling a tube, skier or wakeboarder makes the craft handle differently and requires greater skill. Unless absolutely necessary, do not make tight, sharp turns. Keep a safe distance from the docks, swimmers, other craft or objects. Be advised that serious injury can result if the tow rope becomes slack during a tight turn or when circling. The rope could become wrapped around the neck or limbs of a person.

FUEL AND LUBRICATION

CAUTION: Scrupulously follow the instructions of this section. Failure to do so may reduce the engine's life and/or performance.

Fueling Procedure

WARNING

Follow these safe boating fueling instructions explicitly.

Do not allow anyone to remain on the craft.

Tie craft securely to the fueling pier.

Use bilge blower for a minimum of 5 minutes.

Turn off bilge air blower, bilge pump and any other devices that could produce a spark.

Ensure engine cover is closed to prevent fumes from entering the engine compartment.

Have a fire extinguisher close at hand.

Do not insert the spout too far in filler neck.

Pour fuel slowly so that air can escape from the tank and prevent fuel flowback.

Fill fuel tank to bottom of filler neck. **Do not overfill.** Fully tighten fuel tank cap.

WARNING

Always stop the engine before refueling. Fuel is flammable and explosive under certain conditions. Always work in a well ventilated area. Do not smoke or allow open flames or sparks in the vicinity. Fuel tank may be pressurized. Slowly turn cap when opening. Keep craft level. Do not overfill or top off the fuel tank and leave craft in the sun. As temperature increases, fuel expands and might overflow. Always remove any fuel spillage from the craft.

Recommended Fuel

Use regular unleaded gasoline with 87 octane (Ron + Mon)/2 specification.

Outside North America use **90 RON**.

NOTE: This craft features an oil injection system which does not require manual fuel/oil mixing. Do not mix oil with fuel except at engine break-in. Refer to *M² Jet Drive Operator's Guide* BREAK-IN PERIOD. Always check oil reservoir level when refueling.

Refer to *M² Jet Drive Operator's Guide* for more detailed information.

CAUTION: The use of a fuel other than regular unleaded fuel can result in craft performance deterioration and damage to fuel system and engine components. Never experiment with other fuels or fuel ratios. Never use fuel containing alcohol, methanol or similar products including naphtha.

Recommended Oil

WARNING

Add oil to level mark. Do not overfill. Reinstall cap and fully tighten.

Use Quicksilver or Mercury Precision Premium-Plus lubricants NMMA/BIA certified TC-W3 2-cycle outboard oil or equivalent.

Refer to *M² Jet Drive Operator's Guide* specifications for more detailed information.

Main Oil Reservoir Level

A sufficient amount of oil should be maintained in the reservoir.

NOTE: Always carry a spare 1 liter of oil.

The use of a funnel is recommended to pour the oil into the reservoir. Stop filling as soon as oil appears at approximately 13 mm (1/2 in) from top of reservoir. Do not overfill. Wipe off any oil spillage.

CAUTION: Always maintain a sufficient amount of oil in the oil reservoir. Check and refill every time you refuel. Do not overfill. If the engine runs out of oil, severe engine damage will occur. If the oil reservoir is found almost empty, refer to an authorized SEA-DOO sport boat dealer to have the oil injection system inspected.

CAUTION: Oil system must be pressurized. Always ensure that reservoir caps are firmly tighten. Refer to *M² Jet Drive Operator's Guide* for complete reservoirs filling procedure.

Engine Mounted Oil Reservoir Level

Refer to *M² Jet Drive Operator's Guide*.

BREAK-IN PERIOD

CAUTION: Scrupulously follow the instructions of this section. Failure to do so may reduce the engine's life and/or performance.

Engine

Refer to *M² Jet Drive Operator's Guide*.

10-Hour Inspection

It is highly recommended that after the first 10 hours of operation, the craft be checked by an authorized SEA-DOO sport boat dealer. This inspection will also provide the opportunity to discuss any unanswered questions you may have encountered during the first hours of operation.

The following chart should be used in conjunction with Mercury chart. Refer to *M² Jet Drive Operator's Guide*.

The 10-hour inspection is at the expense of the craft owner.

10-HOUR INSPECTION CHECK LIST	✓
Fuel system lines and fasteners	
Throttle cable adjustment if required	
Oil lines	
Muffler, battery and reservoir fastening devices	
Exhaust system hose clamps torque	
Steering system and low-speed steering control system	
Steering cable adjustment if required	
Throttle/shift cable adjustment if required	
Ensure that throttle/shift lever keep the selected position. Adjust lever friction as necessary	
Hose condition and fasteners	
Bilge pump and bilge blower	
Safety lanyard switch	
Monitoring beeper	
Electrical connections (starter, battery, etc.)	
Lighting system inspection	
Hull condition	
Inspection of fasteners for tightness	

We recommend that this inspection chart be signed by an authorized SEA-DOO sport boat dealer.

Date of 10-hour inspection

Authorized dealer signature

Dealer code

PRE-OPERATION CHECKS

WARNING

The pre-operation check is very important prior to operating the vehicle. Always check the proper operation of critical controls, safety features and mechanical components before starting. If not done as specified here, severe injury or death might occur. Bring all safety equipment required by local laws.

Some of the following items may not have been previously covered in this guide, however they will be described in the MAINTENANCE or SPECIAL PROCEDURES section. Please refer to these portions to have more detailed information.

Prior to operating the craft, verify the following:

WARNING

Engine should be off and the safety lanyard must always be removed from its switch prior to verifying any of the following. Only start craft once all items have been checked and operate properly.

SUMMARY

ITEM	OPERATION	✓
Safety lanyard ignition switch	Check operation.	
Hull	Inspect.	
Jet pump water intake	Inspect/clean.	
Bilge	Drain. Ensure plug is secured.	
Battery	Inspect tightness of cables and retaining straps.	
Main battery cut-off switch	Ensure it is in the ON position.	
Navigation lights	Check operation.	
Fuel tank and oil reservoirs	Refill.	
Engine compartment	Verify fuel/oil system components.	
Steering	Check operation.	
Throttle/shift lever system	Check operation.	
Bilge blower and bilge pump	Check operation.	
Mandatory safety boating equipment	Check operation.	
Storage compartment covers and engine cover	Ensure they are closed and latched.	

Hull

Inspect hull for cracks or damage.

Jet Pump Water Intake

Remove weeds, shells, debris or anything else that could restrict the flow of water and damage the cooling system or propulsion units. Clean as necessary. If any obstruction can not be removed, refer to an authorized SEA-DOO sport boat dealer for servicing.

Inspect leading edges of the impellers, if they have nicks or bends, performance will be greatly reduced.

Bilge

Should water be present in the bilge, use bilge pump or tilt the craft to the rear and unscrew drain plugs if craft is out of the water, as the case may be, to completely empty the bilge.

Secure bilge drain plugs.

WARNING

Make sure drain plugs are properly secured prior launching the craft in water.

Battery

WARNING

Verify tightness of battery cables to their posts and condition of retaining straps/fasteners. Do not boost battery while installed.

Fuel Tank/Oil Reservoirs

With the craft horizontal, fill the fuel tank to specified level.

Check the oil level and refill reservoir as necessary.

CAUTION: Oil system must be pressurized. Always ensure that reservoir caps are firmly tighten. Refer to *M² Jet Drive Operator's Guide* for complete reservoirs filling procedure.

Check fuel tank/oil reservoirs retaining straps/fasteners.

Engine Compartment

WARNING

Should any leak or gasoline odor be present, do not start the engine. Consult an authorized SEA-DOO sport boat dealer before use.

Fire Extinguisher

Make sure it is full, in good condition and well secured.

Steering System

Assisted by another person, check steering operation for free movement. When the steering is centered, the jet pump nozzle should be in the straight ahead position. Ensure the jet pump nozzle pivots easily when steering is turned.

WARNING

Check steering and corresponding steering nozzle operation before starting.

Throttle/Shifter System

Check reverse gate operation for free movement. With throttle/shift lever in forward position, the gate should be in upward position. With the throttle/shift lever in neutral position, gate should be in middle position. With throttle/shift lever in reverse position, gate should be in downward position.

WARNING

Verify the throttle/shift lever lock at neutral position.

Inlet Grate

Ensure inlet grate is not blocked or obstructed by any weeds or debris. Refer to *M² Jet Drive Operator's Guide*.

Safety Lanyard and Ignition Switch

Ensure that ignition switch operates properly.

Start engine and stop it using switch. See STARTING PROCEDURE.



WARNING

Only start craft once all items have been checked and operate properly.

Storage Compartment Covers

Ensure they are closed and latched.

OPERATING INSTRUCTIONS

WARNING

Always perform PRE-OPERATION CHECKS before operating the craft. Become thoroughly familiar with all controls and the function of each. Should any control or instruction be not fully understood, refer to an authorized SEA-DOO sport boat dealer.

Launching/Loading

CAUTION: Before launching the craft, ensure the main battery cut-off switch is turned ON and the bilge plugs are fully screwed.

After loading the craft, ensure the main battery cut-off switch is turned OFF and the bilge plugs are removed to drain bilge.

Trailing

Refer to the trailer or implement manufacturer instructions for proper capacity, operation, maintenance, accessories and warranty.

Check the regulations in your area concerning towing a trailer, especially the following rules:

- brake system
- tow vehicle weight
- mirrors.

NOTE: An optional brake system is available for your trailer, see an authorized SEA-DOO sport boat dealer.

Take the following precautions when trailing the craft:

Tie the craft to both bow and stern (front/rear) eyelets so that it is firmly retained on the trailer. Use additional tie-downs if necessary.

- Remove stern light (if installed).
- Ensure all storage compartment covers are properly latched.
- Ensure windshield door is securely locked in the closed position.
- A SEA-DOO cover can protect the craft, particularly before driving on dirt roads, to prevent dirt entry through the air intake opening(s).

Observe trailering safety precautions.

Principle of Operation

Propulsion

Engine is directly coupled to a drive shaft which, in turn, rotates an impeller. This impeller is accurately adjusted in a housing where the water is drawn up from underneath the craft. Then, the water flows through the impeller to a venturi. The venturi accelerates the water and produces thrust to move the craft. Pushing the throttle/shift lever forward increase engine speed and therefore craft speed.

WARNING

Whenever an engine is to be started, the operator and passengers should always be sitting in the craft with the throttle/shift lever in neutral position.

Throttle/Shift Lever

FORWARD

The throttle/shift lever should be in the forward position in order for the craft to advance.

To obtain forward, depress throttle/shift lever button then gradually push lever to increase craft speed.



FORWARD FULL THROTTLE POSITION

1. Throttle/shift lever button

NEUTRAL

To obtain neutral, pull throttle/shift lever halfway until it locks. The reverse gate will be in the middle position, directing half of the thrust toward the front of the craft to minimize craft movement.

⚠ WARNING

When the craft is in neutral position, the impeller is turning.



NEUTRAL POSITION

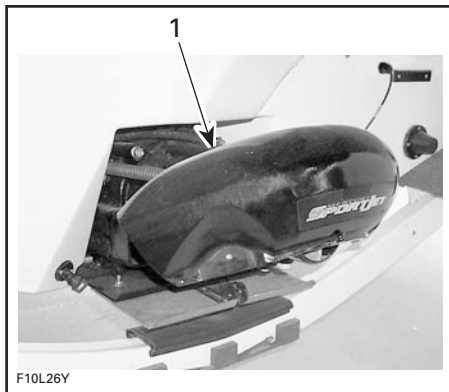

TYPICAL

1. Reverse gate in middle position

REVERSE

To obtain reverse, depress throttle/shift lever button then gradually pull lever. The reverse gate will be in downward position, directing all the thrust toward the front of the craft.



REVERSE FULL THROTTLE POSITION

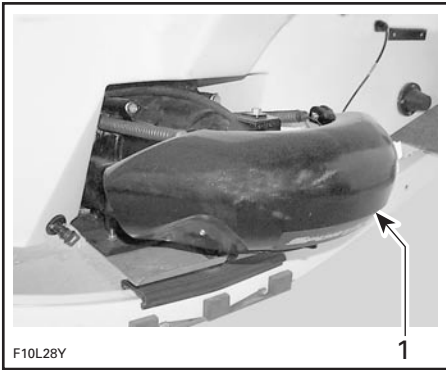

F10L28Y

1

TYPICAL

1. Reverse gate in downward position

NOTE: To obtain maximum efficiency and control from the reverse, increase engine speed to slightly above idle. Too much RPM will create water turbulence and reduce reverse efficiency.

In reverse position, turn the steering wheel in the opposite direction that you want to move the rear of the craft.

For example, to steer the rear of the craft to the left side, turn the steering wheel to the right side.

Steering

Turning the steering wheel pivots the jet pump nozzle which controls the craft direction. Turning the steering wheel clockwise will turn the craft to the right and inversely.

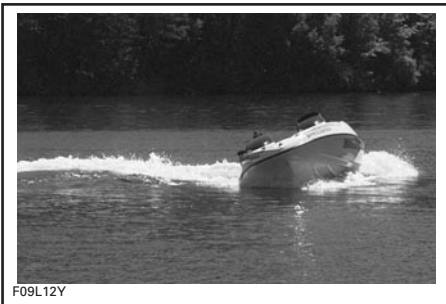

F09L12Y

TYPICAL

Above idle speed, the throttle must be applied to turn the craft.

⚠ WARNING

Throttle must be applied and steering turned to change the direction of the craft at speed. Steering efficiency will differ depending on the number of passengers, load and water conditions.

A craft needs some throttle to turn. Practice in a safe area applying the throttle and turning away from an imaginary object. This is a good collision avoidance practice.

Low-Speed Steering Control System

Whenever the engine RPM is at **IDLE AND** the steering wheel is approaching the end of its rotation, the engine speed will be slightly accelerated to increase the jet pump thrust. This helps steering control for low-speed navigation or when approaching/leaving a dock. For docking tips, refer to **STOPPING/ DOCKING** section below.

⚠ WARNING

Become fully familiar with this feature during your first ride and before carrying passengers.

Boarding from a Dock

As with any craft, boarding should be done carefully and engine should not be running.

When boarding from a dock, slowly place one foot on the craft deck nearest to the dock and then move the other foot inside the craft. Push the craft away from the dock.



F09L11Y

TYPICAL

CAUTION: Engine should be started with at least 90 cm (3 ft) of water below the hull.

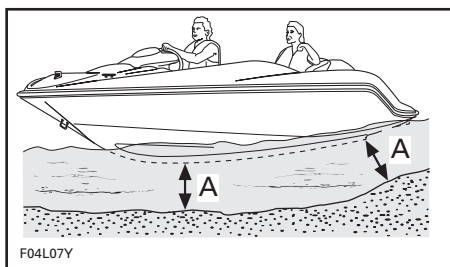

F04L07Y

TYPICAL

A. 90 cm (3 ft)

Boarding from the Water

WARNING

Inexperienced riders should practice how to get aboard close to shore first before venturing into deep water.

WARNING

Engine should not be running while boarding. Never use propulsion components as a supporting point to board the craft.

Swim to the rear of the craft.

Come close to rear of craft then unlatch and slide ladder toward rear. Grip swim platform grab handles.



F09L18Y

TYPICAL

Climb the ladder and pull yourself upward using the swim platform grab handles.



F09L15Y

TYPICAL

When you can reach the engine cover grab handle, grip it and continue to pull yourself upward to place one of your feet on the swim platform.



F09L16Y

TYPICAL

Continue to climb on engine cover and go down on the deck.



F09L17Y

TYPICAL

To store ladder, lift horizontally completely then slide toward front.

CAUTION: Do not leave ladder hanging when operating the boat. Before operating the craft, always lock the ladder using the latch.

WARNING

Do not start engine until all passengers are properly seated.

Starting

WARNING

Engine exhaust fumes contain carbon monoxide (CO) which can accumulate in and around the boat (under bimini top, in cockpit, etc.). CO can be harmful or fatal if inhaled. Assure there is adequate ventilation whenever running engine(s).

Always activate bilge blower 5 minutes minimum before starting the engine. The bilge blower will ventilate the bilge.

WARNING

Bilge blower must be turned off above idle speed.

WARNING

Do not touch electrical parts or jet pump area when engine is running.

Attach the safety lanyard to your PFD and snap the cap to its switch before starting the engine.

WARNING

Before starting, the operator and passengers should always be properly seated.

Grip steering wheel with your right hand and place both feet on the floorboard. Turn off bilge blower.

Starting Procedure

Refer to *M² Jet Drive Operator's Guide* for complete detailed procedure.

Rough Water or Poor Visibility Operation

Avoid operation in these conditions. If you must do so, proceed with caution and prudence using minimum speed. Turn on navigation lights if necessary.

Crossing Waves

Reduce speed. Always be prepared to steer and balance as necessary.

When crossing wakes, always keep a safe distance from boat ahead.

WARNING

When crossing wakes, slow down. Operator and passenger(s) can brace themselves by posting. Do not jump waves or wakes.

Stopping/Docking

The craft is slowed by water drag. The stopping distance will vary depending on the craft size, weight, speed, water surface condition, presence and direction of wind and current.

The operator should become familiarized with the stopping distance under different conditions.

Reduce speed to idle. Shift to neutral, reverse or forward as required.

WARNING

Directional control is reduced with decreasing speed and lost when engine is off.

Low-Speed Steering Control System

Reducing RPM to **IDLE** activates the low-speed steering control feature as described previously. For more details, refer to **LOW-SPEED STEERING CONTROL SYSTEM** in **TURNING** section above.

WARNING

Become familiar with this feature during your first ride and before carrying passengers.

Beaching

CAUTION: It is not recommended to run the craft to the beach.

Come slowly to the beach and shut off the engine using the safety lanyard when water depth is 90 cm (3 ft) under the hull, then pull the craft to the beach. Ensure that all accessories are OFF.



A. 90 cm (3 ft) of water under the hull

WARNING

In shallow water, shells, sand, pebbles or other objects could be drawn up by the jet pump and be thrown rearward and could damage the engine.

As necessary, the cooling system of the engine should be flushed before re-starting, to remove sand or shell accumulation which may clog the water passages. Refer to **POST-OPERATION CARE** and look for **COOLING SYSTEM FLUSHING**.

Shutting Off the Engine

Refer to *M² Jet Drive Operator's Guide*.

WARNING

Should the engine be stopped, craft directional control is lost. Always disconnect safety lanyard when craft is not in operation in order to prevent accidental engine starting or to avoid unauthorized use by children or others or theft.

POST-OPERATION CARE

WARNING

Allow engine to cool before performing any maintenance.

General Care

Should water be present in the bilge after use of bilge pump, unscrew the drain plug and tilt the craft to the rear in order to allow water to drain.

Wipe up any remaining fluid in the engine compartment (bilge, engine, etc.) with clean dry rags. This is particularly important in salt water use.

Remove the craft from the water every day to prevent marine organisms growth.

Additional Care for Foul Water or Salt Water

When the craft is operated in foul water and particularly in salt water, additional care must be taken to protect the craft and its components. Rinse trailer and craft's hull/bilge area with fresh water.

CAUTION: Failure to perform proper care such as: craft rinsing, cooling system flushing and anticorrosion treatment, when used in salt water, will result in damage to the craft and its components. Never leave the craft stored in direct sunlight.

Cooling System Flushing

General

Flushing the cooling system with fresh water is essential to neutralize corroding effects of salt or other chemical products present in water. It will help to remove sand, salt, shells or other particles in water jackets (engine, exhaust manifold, tuned pipe) and/or hoses.

Flushing should be performed when the craft is not expected to be used further the same day or when the craft is stored for any extended time.

WARNING

Perform this operation in a well ventilated area.

Flushing

1. Clean jet pump by spraying water in its inlet and outlet and then apply a coating of Bombardier lube lubricant or equivalent.
2. Open engine cover.
3. Connect a garden hose directly to the flushing connector. **Do not open the water tap yet.**

Refer to *M² Jet Drive Operator's Guide* for complete engine flushing procedure.

SPECIAL PROCEDURE

Engine Overheating

CAUTION: If the monitoring beeper continuously sounds, stop engine immediately.

Refer to *M² Jet Drive Operator's Guide*.

If engine still overheats, refer to an authorized SEA-DOO sport boat dealer for servicing.

Jet Pump Water Intake and Impeller Cleaning

Weeds, shells or debris can get caught on the intake grate, drive shaft and/or impeller. A clogged water intake may cause troubles such as:

1. **Cavitation:** Engine speed is high but craft moves slowly due to reduced jet thrust; jet pump components may be damaged.
2. **Overheating:** Since the jet pump operation controls the flow of water to cool the engine, a clogged intake will cause the engine to overheat and damage engine internal components.

The clogged area can be cleaned as described in *M² Jet Drive Operator's Guide*.

WARNING

Always remove safety lanyard cap from switch to prevent accidental engine starting before cleaning the jet pump area.

CAUTION: Avoid craft operation in weeded areas. If unavoidable, vary craft speed. Weeds tend to entangle more at steady and slow speeds. Inspect water intake grate for damage. Refer to an authorized SEA-DOO sport boat dealer for repair as necessary.

Capsized Boat

The boat is designed so that it should not turn over easily due to its length and width. If the boat ever capsizes, remember that it will continue to float, and it is usually best to remain with it, you will be more easily located by others.

WARNING

When boat is capsized, do not attempt to restart the engine. Operator and passengers should always wear approved personal flotation devices.

Submerged Boat

WARNING

DO NOT attempt to restart engine. See an authorized SEA-DOO sport boat dealer as soon as possible to service the engine.

Water Flooded Engine

In the event the engine cannot be serviced within a few hours, remove spark plug cables and connect them on the grounding device.

WARNING

Never crank engine with spark plugs removed unless spark plug cables are connected to the grounding device.

Remove spark plugs and dry them with a clean and dry cloth.

Cover spark plug holes with a rag.

Crank engine for approximately 10 seconds to allow water to escape from spark plug openings.

Spray BOMBARDIER LUBE lubricant or equivalent into spark plug holes.

Crank engine again.

Reinstall spark plugs.

Start engine normally.

Low-Charge Battery Condition

WARNING

See your authorized SEA-DOO sport boat dealer to have it charged or replaced. Do not charge or boost the battery while installed on the craft. Electrolyte is dangerous and capable of causing severe burns.

MAINTENANCE INFORMATION

MAINTENANCE

Emission Component Maintenance

Maintenance, replacement, or repair of the emission control devices and systems may be performed by any marine SI (spark ignition) engine repair establishment or individual.

- △ Only perform servicing procedures which are detailed in this guide. Further assistance or information can be obtained from your authorized Sea-Doo dealer. In many instances proper tools and training is required for certain servicing or repair procedures.
- △ Maintain the craft and equipment in top condition at all times. Adhere to the prescribed maintenance schedules. An annual inspection of the craft is always a good recommendation that should be followed.
- △ The bilge must be kept clean of oil, water or other foreign materials.
- △ Do not attempt to lift the craft without special equipment and training.
- △ The engine and the corresponding components identified in this guide should not be utilized on product(s) other than for those they were designed. Maintenance procedures and specified tightening torque must be strictly adhered to. Never attempt repairs unless the appropriate tools are available. These craft are designed with parts dimensioned in both the metric and the imperial systems. When replacing fasteners, make sure to use only those recommended by Bombardier. If required, contact your authorized Sea-Doo dealer for further servicing information.
- △ Operate your craft prudently and have fun. Don't forget that all persons must assist other boaters in an emergency.

Engine Emissions Information

Manufacturer's Responsibility

Beginning with 1999 model year engines, manufacturers of marine engines must determine the exhaust emission levels for each engine horsepower family and certify these engines with the United States of America Environmental Protection Agency (EPA). An emissions control information label, showing emission levels and engine specifications, must be placed on each vehicle at the time of manufacture.

Dealer's Responsibility

When performing service on all 1999 and more recent Sea-Doo sport boats that carry an emissions control information label, adjustments must be kept within published factory specifications.

Replacement or repair of any emission related component must be executed in a manner that maintains emission levels within the prescribed certification standards.

Dealers are not to modify the engine in any manner that would alter the horsepower or allow emission levels to exceed their predetermined factory specifications.

Exceptions include manufacturer's prescribed changes, such as altitude adjustments for example.

Owner Responsibility

The owner/operator is required to have engine maintenance performed to maintain emission levels within prescribed certification standards.

The owner/operator is not to, and should not allow anyone to modify the engine in any manner that would alter the horsepower or allow emissions levels to exceed their predetermined factory specifications.

EPA Emission Regulations

All new 1999 and more recent Sea-Doo sport boats manufactured by Bombardier are certified to the EPA as conforming to the requirements of the regulations for the control of air pollution from new sport boat engines. This certification is contingent on certain adjustments being set to factory standards. For this reason, the factory procedure for servicing the product must be strictly followed and, whenever practicable, returned to the original intent of the design.

The responsibilities listed above are general and in no way a complete listing of the rules and regulations pertaining to the EPA requirements on exhaust emissions for marine products. For more detailed information on this subject, you may contact the following locations:

VIA U.S. POSTAL SERVICE:

Office of Mobile Sources
Engine Programs and Compliance
Division
Engine Compliance Programs
Group (6403J)
401 M St. NW
Washington, DC 20460

VIA EXPRESS or COURIER MAIL:

Office of Mobile Sources
Engine Programs and Compliance
Division
Engine Compliance Programs
Group (6403J)
501 3rd St. NW
Washington, DC 20001

EPA INTERNET WEB SITE:

www.epa.gov

WARNING

Only perform procedures as detailed in this guide. It is recommended that the assistance of an authorized Sea-Doo dealer be periodically obtained on other components/systems not covered in this guide. Unless otherwise specified, engine must not be running, the safety lanyard must be removed from its post and the main battery cut-off switch must be turned OFF for all maintenance procedures. Never use jet pump components to lift the sport boat. Certain components in the engine compartment may be very hot. Direct contact may result in skin burn. When operating the engine while the sport boat is out of the water, the heat exchangers may become very hot. Avoid any contact with heat exchangers as burns may occur.

NOTE: Where applicable, maintenance procedure applies for both engine systems.

Lubrication

Anticorrosion Protection

Throttle Cable

Lubricate the throttle cable with BOMBARDIER LUBE lubricant or equivalent, every 25 hours of use (every 10 hours in salt water use).

Electrical Connections

As necessary, apply dielectric grease on battery posts and all exposed cable connectors including stern light connectors on mat and craft.

Additional Lubrication

BOMBARDIER LUBE lubricant or equivalent will help to prevent corrosion and maintain proper operation of moving mechanisms.

Lubrication of the following items should be performed every 50 hours in fresh water use but every 10 hours in salt water use.

Engine Cover Hinges

Use BOMBARDIER LUBE lubricant or equivalent on metal parts.

Engine Cover Cylinders

Lubricate rod of cylinders.

Periodic Inspection

Routine maintenance is necessary for all mechanized products. A periodic inspection contributes to the products life span.

The following maintenance chart gives guidelines for regular craft servicing schedule to be performed by you and/or by an authorized SEA-DOO sport boat dealer. The schedule should be adjusted according to operating conditions and use.

PERIODIC INSPECTION CHART

DESCRIPTION	FREQUENCY					TO BE PERFORMED BY
	FIRST 10 HOURS	EVERY 25 HOURS	EVERY 50 HOURS	EVERY 100 HOURS OR PRE-SEASON		
GENERAL						
Fire extinguisher condition/mounting ④	✓			✓ ②		O
Lubrication/corrosion protection	①		✓	✓		O
ENGINE						
Support and rubber mount condition/tightness	✓		✓			D
Exhaust system fasteners/hoses ④	✓		✓	✓		D
Counterbalance shaft oil level (if so equipped)			✓	✓		D
Spark plug inspection, cleaning and adjustment	✓					D
Spark plug replacement			✓			D
Ignition timing	✓			✓		D
EXHAUST SYSTEM						
Ensure exhaust clamps are in place and secure		✓				O
Inspect for leaking exhaust system components (such as rust and/or black streaking, water leaks or corroded/cracked fittings)		✓				O
Inspect exhaust hoses for burnt, cracked or deteriorated sections. Hoses should be pliable and free of kinks. Replace cracked, charred or deteriorated exhaust hoses if found ④		✓		✓		O/D
Ensure engine(s) and generator(s) are properly tuned and well-maintained ④				✓		O/D
Inspect metal exhaust components for cracking, rusting, leaking or loosening. Check cylinder head gasket, exhaust manifold, water injection elbow, and the threaded adapter nipple between the manifold and the elbow ④				✓		D
Clean, inspect, and confirm proper operation of the generator cooling water anti-siphon valve (if equipped) ④				✓		D
COOLING SYSTEM						
Hose condition and fasteners	✓		✓	✓		D
Inspect/clean engine drain tube	✓ ①	✓				D
Water flow regulator valve inspection				✓		D
FUEL SYSTEM						
Throttle cables, inspection/lubrication ④	①	✓		✓		D
Fuel filter and lines inspection ④	✓	✓		✓		D
Fuel filter replacement				✓		D
Fuel vent line pressure relief valve inspection		✓		✓		D
Fuel lines, check-valve and fuel system pressurization ④	✓	✓		✓		D
Fastener tightening (throttle body, fuel lines) ④	✓		✓	✓		D
Fuel tank straps ④	✓			✓		O
Fuel tank filling				✓ ②		O

DESCRIPTION	FREQUENCY				
	FIRST 10 HOURS	EVERY 25 HOURS	EVERY 50 HOURS	EVERY 100 HOURS OR PRE-SEASON	TO BE PERFORMED BY
LUBRICATION SYSTEM					
Oil lines inspection ④	✓	✓		✓	D
Oil filter replacement				✓	D
Oil filling				✓ ②	O
ELECTRICAL SYSTEM					
Main battery cut-off switch ④	✓	✓		✓	D
Lights condition/operation	✓	✓		✓ ②	D
Bilge blower and bilge pump inspection ④	✓	✓		✓ ②	D
Electrical connections (ignition system, electrical box(es), starting system, etc.) ④	✓	✓		✓	D
Digitally Encoded Security System ④⑤	✓			✓ ②	D
Monitoring beeper	✓		✓	✓	D
Battery tightness ④	✓		✓	✓ ②	D
Battery charging				✓	D
STEERING SYSTEM					
Inspection and cable adjustment ④	✓		✓	✓	D
LSC Low speed control		✓		✓	O/D
PROPULSION SYSTEM					
Drive shaft boot and spline condition ⑤			✓		D
Drive shaft floating seal C-clip position ⑤			✓		D
Shifter system/cable adjustment ④	✓			✓	D
Jet pump reservoir oil level/oil condition ⑥	REPLACE	✓		REPLACE	D
Jet pump cover pusher inspection ⑥				✓	D
Impeller condition and impeller/wear ring clearance			✓		D
Water intake grate condition			✓ ②		O
HULL AND BODY					
Inlet Clearance System (ICS) lubrication/condition			✓		O
Hull condition ④	✓			✓ ②	O
Ride shoe condition	✓			✓	O
Storage compartment cover locks lubrication	①		✓		O
Deck drains/scupper valve cleaning ④	✓	✓		✓ ②	O

NOTE: Some items are included in the PRE-OPERATION CHECKS and not necessarily repeated in this chart.

D: Dealer

O: Operator

① Every 10 hours in salt water use.

② Daily checked.

③ Daily flushing in salt water or foul water use.

④ Safety item covered in the annual safety inspection (owner's expenses).

⑤ For Rotax engine equipped models.

⑥ For M² jet engine refer to M² manual provided with the craft.

Throttle/Shifter Lever Cable

Activate the throttle/shifter lever throughout its full range of motion. It must operate smoothly. Refer to an authorized SEA-DOO sport boat dealer if adjustment is necessary.

WARNING

Do not alter or tamper with throttle/cable adjustment or routing.

Fuel and Oil Filters

These filters should be replaced by an authorized SEA-DOO sport boat dealer annually.

Refer to *M² Jet Drive Operator's Guide*.

Steering/Jet Pump Nozzle Adjustment

When the steering is directed in straight ahead position, the jet pump nozzle should be in the same direction to allow the craft to run in a straight line.

Refer to an authorized SEA-DOO sport boat dealer if an adjustment is necessary.

WARNING

Ensure the steering/jet pump nozzle operate freely from side to side and is not stressing the steering cable.

Reverse Gate

WARNING

Ensure the throttle/shift lever and reverse gate operate freely and are not stressing the reverse cable.

Refer to an authorized SEA-DOO sport boat dealer if an adjustment is necessary.

Deck Drain(s)

Remove any obstruction from deck drain.

Fuses

Accessories, Craft Electrical System and Gauges

If a fuse is defective, replace by one of the same rating.

WARNING

Do not use a higher rated fuse as this can cause severe damage. If a fuse has burnt out. Source of malfunction should be determined and connected before restarting. See an authorized SEA-DOO sport boat dealer for servicing.

Engine

Refer to *M² Jet Drive Operator's Guide*.

Bilge Air Blower

Verify bilge air blower for proper operation. It is located inside engine compartment beneath ventilation duct.

Clean both openings. Ensure that both openings are not obstructed. See next illustration.

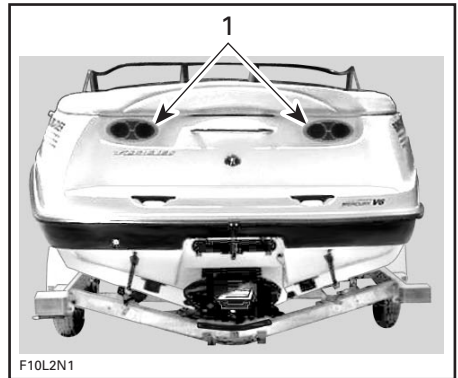

1. Bilge ventilation ducts

WARNING

If bilge blower does not operate refer to an authorized SEA-DOO sport boat dealer before starting the craft.

Navigation Light Bulb Replacement

Bow Light

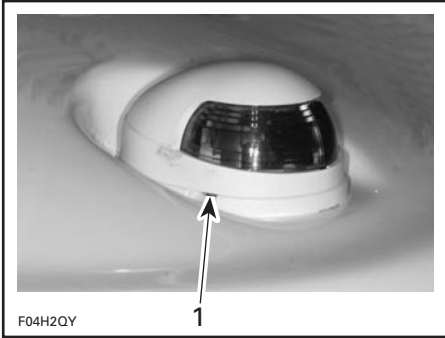

TYPICAL

1. Gently pry here with a screwdriver

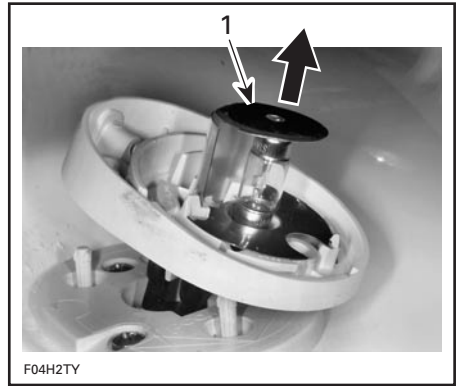

TYPICAL

1. Lift and remove bulb

The assembly is essentially the reverse of removal procedures. However, pay particular attention to the following:

Apply dielectric grease on bulb contact surface.

When installing the bulb under the upper terminal plate, it is possible that the bulb remains loose. The cover will compress the terminal plate against the bulb at reinstallation.

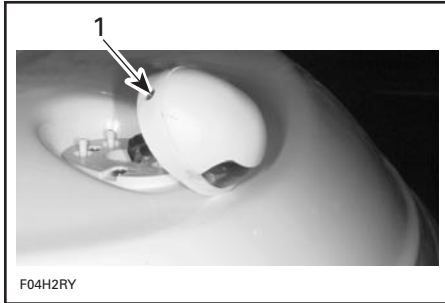

TYPICAL

1. Remove this screw

Stern Light

Unscrew lens counterclockwise and pull it out.

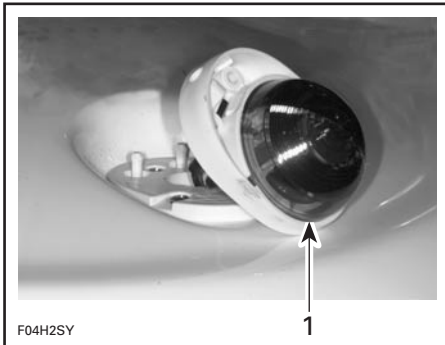

TYPICAL

1. Pull lens out

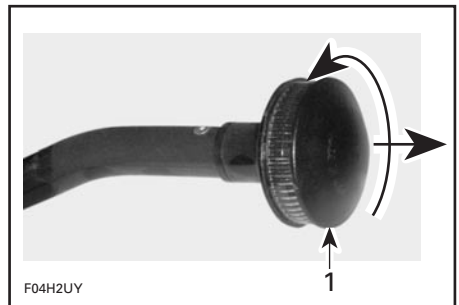

1. Unscrew then pull

Pull bulb to remove it.

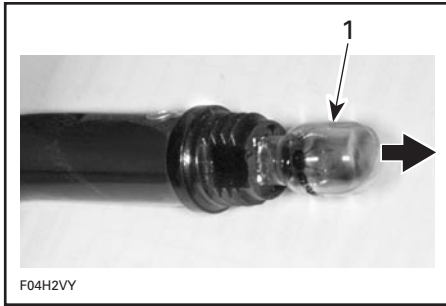

1. Pull bulb out

Apply dielectric grease on new bulb contact surface.

The assembly is the reverse of removal procedure.

General Inspection and Cleaning

Inspection

Check engine compartment for any damage. Ensure all hose clamps are properly secured and no hose is cracked, kinked or presenting any other damage.

WARNING

If any gasoline leak and/or odors are present, do not start the engine. Have the craft serviced by an authorized SEA-DOO sport boat dealer.

Inspect muffler, battery, fuel tank and oil reservoir fastening devices. Visually check electrical connections for corrosion and tightness.

Inspect hull and jet pump water intake grate for damage. Replace or have damaged parts repaired.

Cleaning

The bilge should be cleaned by the dealer to remove any possible fuel/oil/electrolyte deposits and mildew.

Occasionally, wash the body with hot water and soap (only use mild detergent). Remove any marine organisms from engine and/or hull. Apply non-abrasive wax.

CAUTION: Never clean fiberglass and plastic parts with strong detergent, degreasing agent, paint thinner, acetone, etc.

Wash windscreen with Bombardier cleaner or equivalent (P/N 293 110 001 — 400 g) and water. For fine scratches and scuff marks removal, use a windshield polisher for acrylic, lucite, polycarbonate and similar materials.

Stains may be removed from seats and fiberglass with Knight's Spray-Nine* from Korkay System Ltd or the equivalent.

Respect the environment by ensuring fuel, oil or cleaning solutions do not drain into the waterways.

STORAGE AND PRE-SEASON PREPARATION

WARNING

Because fuel and oil are flammable, have an authorized SEA-DOO sport boat dealer inspect the fuel and oil systems integrity as specified in the periodic inspection chart.

Storage

It is recommended that the craft be taken to an authorized SEA-DOO sport boat dealer for proper storage but the following operations can be performed by you with a minimum of tools.

CAUTION: Do not run the engine during the storage period.

Fuel System

Refer to *M² Jet Drive Operator's Guide*.

Cooling System Flushing and Engine Internal Lubrication

Refer to *M² Jet Drive Operator's Guide*.

Propulsion System

Refer to *M² Jet Drive Operator's Guide*.

Craft Cleaning/Repair

Wash the body and the trailer with soap and water solution (only use mild detergent). Rinse thoroughly with fresh water. Remove any marine organisms from the hull.

CAUTION: Never clean apparent fiberglass and plastic parts with strong detergent, degreasing agent, paint thinner, acetone, etc.

Stains may be removed from seats and fiberglass with Knight's Spray-Nine* from Korkay System Ltd or the equivalent.

If repairs are needed to the body or to the hull contact your dealer. For paint touch up to mechanical parts use Bombardier spray paint. For minor gelcoat repairs, a Bombardier repair kit is available. Replace damaged labels/decals.

Clean the bilge with hot water and detergent or with bilge cleaner. Rinse thoroughly. Unscrew drain plug(s) and lift front end of craft to completely drain bilge.

Battery

Contact your authorized SEA-DOO sport boat dealer.

Anticorrosion Treatment

Wipe off any residual water in the engine compartment.

Lubricate the throttle cable with BOMBARDIER LUBE lubricant or equivalent.

Finalizing Storage Preparation

Apply a non-abrasive wax to body.

The engine cover should be left partially opened during storage (detach the gas shocks from the cover to prevent full opening). Remove storage tray. Place it on deck. This will avoid engine compartment condensation and possible corrosion.

If the craft is to be stored outside, cover it with a vented opaque tarpaulin to prevent sun rays and grime from affecting the plastic components, craft finish as well as preventing dust accumulation.

CAUTION: Never leave the craft stored in direct sunlight. UV radiation will dull finishes. The craft must never be left in water for storage. Make sure to turn off main battery cut-off switch.

During storage, it is necessary to lift the bow up and safely block in this position so drainage can take place. Ensure the drain plug is unscrewed.

Pre-Season Preparation

Use the following chart.

Since technical skills and special tools are required, some operations should be performed by an authorized SEA-DOO sport boat dealer.

WARNING

Only perform procedure as detailed in this guide. It is recommended that the assistance of an authorized SEA-DOO sport boat dealer be periodically obtained on other components/systems not covered in this guide and/or *M² Jet Drive Operator's Guide*. Unless otherwise specified, engine must not be running and the main battery cut-off switch must be turned OFF for all maintenance procedures.

Pre-Season Preparation Chart

NOTE: It is highly recommended that the dealer perform at the same time the annual safety inspection in addition to the pre-season preparation.

OPERATIONS	TO BE PERFORMED BY
Lubrication/corrosion protection	OPERATOR
Safety lanyard cap condition	DEALER
Battery condition/charging and reinstallation	DEALER
Starter connections and routing ①	DEALER
Oil reservoir filling	OPERATOR
Fuel filter replacement	DEALER
Fuel line condition ①	DEALER
Filler neck, fuel tank and fuel cap condition ①	DEALER
Check fuel system fasteners	DEALER
Steering system and low-speed steering control system inspection ①	DEALER
Throttle/shifter system inspection ①	DEALER
Inspection of deck drains/bilge pump/drain plugs	DEALER
Fire extinguisher condition/mounting ①	OPERATOR

① Safety item covered in the annual safety inspection.

CAUTION: Only perform this operation in a well ventilated area. Garden hose must be installed or craft must be in water to cool engine. Running the engine without cooling water will damage exhaust hose interior and may damage engine.

SPECIFICATIONS

MODELS		UTOPIA 185	UTOPIA 205
ENGINE			
Number of engines		1	
Engine options		200 Opti, 240 EFI Plus	200 Opti, 240 EFI Plus, 250 Optimax
Engine type		Mercury Marine V-6, 2 stroke	
Maximum engine power capacity rating		150 kW (200 HP) @ 5650 RPM 1179 kW (240 HP) @ 6250 RPM 186 kW (250 HP) @ 5850 RPM	
Induction type		Reed valve	
Exhaust system	Type	Mercury Marine, 2 mufflers	
Starting system		Electric start	
Low-speed RPM adjustment		1800 RPM	
Lubrication	Fuel/oil mixture	Refer to M² Jet Drive specifications	
	Oil injection pump		
	Oil type		
Number of cylinders		6	
ADDITIONAL INFORMATION: Refer to M² Jet Drive specifications for more detailed information.			
ELECTRICAL			
Ignition system type		Digital-CDI (Capacitor Discharge Ignition) Digital Inductive (200 Opti)	
Spark plug	Make and type	Refer to M² Jet Drive specifications	
	Gap		
Starting system		Electric starter	
Battery		Not supplied ①	
Fuse	Deck (courtesy) lights	1 A (2)	
	Bilge air blower	7.5 A	
	Bilge pump	7.5 A	
	Navigation lights	3 A	
	Gauges/low fuel	3 A	
	Radio	5 A	
	Horn system	5 A	
12-volt jack system		10 A	
ADDITIONAL INFORMATION: ① Recommended: See Mercury Marine recommendations . Battery posts: On top. Round taper type. Battery maximum allowed size: 267 mm (10-1/2 in) long x 172 mm (6-3/4 in) wide x 238 mm (9-3/8 in) high.			

MODELS	UTOPIA 185	UTOPIA 205
CARBURETION		
Refer to M² Jet Drive specifications for more detailed information.		
COOLING		
Type	Open circuit — Direct water flow	
PROPULSION		
Propulsion system	Mercury Marine Sport Jet	
Number of pumps	1	
Jet pump type	Mixed flow, single stage	
Steering nozzle pivoting angle	26°	
Minimum required water level	90 cm (36 in)	
Refer to M² Jet Drive specifications for more detailed information.		
DIMENSION		
Dead rise	20°	
Draft	30.5 cm (12 in)	
Overall length	5.56 m (18 ft 3 in)	5.91 m (19 ft 5 in)
Overall width (beam)	2.44 m (8 ft)	
Dry weight	930 kg (2050 lb) with 200 Optimax 957 kg (2110 lb) with 240 EFI Plus/ 250 Optimax	1056 kg (2330 lb) with 240 EFI Plus/ 250 Optimax
Load limit (passengers + luggage)	8 passengers or 600 kg (1320 lb) (based on calm water operation)	
CAPACITIES		
Fuel tank (including reserve)	151 L (40 U.S. gal)	
Main injection oil reservoir	11 L (3 U.S. gal)	
MATERIALS		
Hull	Composite (fiberglass and balsa)	
Fuel tank	Polyethylene	
Injection oil reservoir	Polyethylene	
Seat	Base: Polyethylene Foam: Polyurethane	
Windshield	Tinted, tempered glass	

SI* METRIC INFORMATION

BASE UNITS			
DESCRIPTION		UNIT	SYMBOL
length		meter	m
mass		kilogram	kg
force		newton	N
liquid		liter	L
temperature		Celsius	°C
pressure		kilopascal	kPa
torque		newton-meter	N•m
land velocity		kilometer per hour	km/h
navigation velocity		knot	kn
PREFIXES			
PREFIX	SYMBOL	MEANING	VALUE
kilo	k	one thousand	1000
centi	c	one hundredth of	0.01
milli	m	one thousandth of	0.001
micro	μ	one millionth of	0.000001
CONVERSION FACTORS			
TO CONVERT		TO ①	MULTIPLY BY
in		mm	25.4
in		cm	2.54
in ²		cm ²	6.45
in ³		cm ³	16.39
ft		m	0.3
oz		g	28.35
lb		kg	0.45
lbf		N	4.4
lbf•in		N•m	0.11
lbf•ft		N•m	1.36
lbf•ft		lbf•in	12
PSI		kPa	6.89
imp. oz		U.S. oz	0.96
imp. oz		mL	28.41
imp. gal		U.S. gal	1.2
imp. gal		L	4.55
U.S. oz		mL	29.57
U.S. gal		L	3.79
knot		MPH	1.15
MPH		km/h	1.61
Fahrenheit		Celsius	(°F - 32) ÷ 1.8
Celsius		Fahrenheit	(°C × 1.8) + 32
hp		kW	.75

* The international system of units abbreviates SI in all languages.

① To obtain the reverse sequence, divide by the given factor. Example: to convert millimeters to inches, divide by 25.4.

NOTE: Conversion factors are rounded off to 2 decimals for easier use.

WARRANTY

BOMBARDIER LIMITED WARRANTY FOR MODEL YEAR 2004 SEA-DOO® SPORT BOATS SOLD IN THE UNITED STATES AND CANADA

1. SCOPE

Bombardier Motor Corporation of America* ("Bombardier") warrants its new and unused Model Year 2004 Sea-Doo sport boats ("Sport Boat") sold by authorized Sea-Doo sport boat Dealers in the fifty United States and Canada ("Dealer") will be free from defects in material and workmanship for the period and under the conditions below. If your Sport Boat comes equipped with a Rotax® engine, the Rotax engine is also covered by this Limited Warranty under the terms hereof. If your Sport boat came equipped with another engine, that engine is covered by the Limited Warranty issued by the manufacturer of that engine and is not covered by this Limited Warranty.

2. WARRANTY COVERAGE DURATION

This limited warranty will be in effect from the date of delivery to the first retail consumer or the date the Sport Boat is first put to use, whichever occurs first, for a period of:

- TWELVE (12) CONSECUTIVE MONTHS for private, recreational use, except that: the deck and hull fiberglass structure are covered for SIXTY (60) CONSECUTIVE MONTHS; and the emission related components providing input to emission controls (e.g. sensors) are covered for TWENTY-FOUR (24) CONSECUTIVE MONTHS OR 200 HOURS OF ENGINE USE, whichever occurs first.
- FOUR (4) CONSECUTIVE MONTHS for commercial use, except that: the deck and hull fiberglass structure is covered for TWELVE (12) CONSECUTIVE MONTHS; and the emission related components providing input to emission controls (e.g. sensors) are covered for TWENTY-FOUR (24) CONSECUTIVE MONTHS OR 200 HOURS OF ENGINE USE whichever occurs first. A Sport Boat is used commercially when it is used in connection with generating income or any work or employment during any part of the warranty period. A Sport Boat is also used commercially when, at any point during the warranty period, it has commercial tags or is licensed for commercial use.

For Sport Boats with Rotax engine(s) produced by Bombardier for sale in California that are originally sold in California to a California resident or subsequently warranty registered to a California resident, please also refer to Bombardier's California Emission Control Warranty Statement.

All genuine Bombardier accessories installed by an authorized Dealer at the time of delivery carry the same warranty as the Sport Boat. The repair or replacement of parts or the performance of service to a Sport Boat under this warranty does not extend the life of this limited warranty beyond its original expiration date.

3. CONDITIONS TO HAVE WARRANTY COVERAGE

This warranty coverage is available only after the purchaser and Dealer have: (i) completed and documented the Bombardier specified pre-delivery inspection process; and properly registered the Sport Boat. Only the original purchaser and any subsequent owners who reside in the United States or Canada and have purchased the Sport Boat from a U.S. or Canadian Dealer are eligible for warranty coverage hereunder. Such limitations are necessary in order to allow Bombardier to protect the safety of its products, consumers, and the general public. As outlined in the *Operator's Guide*, timely required maintenance must be performed to maintain warranty coverage. Bombardier may require proof of proper maintenance prior to authorizing warranty coverage.

4. WHAT TO DO TO OBTAIN WARRANTY COVERAGE

The owner must notify an authorized Dealer within two (2) days of the appearance of the defect and must promptly bring the Sport Boat, including any defective part, to Dealer (in any event, within the warranty period) and must provide Dealer with reasonable opportunity to repair the defect. If the Sport Boat has not previously been registered, the owner may also be required to present proof of purchase to Dealer for warranty repairs. Owner is required to sign the repair/work order prior to the start of the repair in order to validate the warranty repair. All parts replaced under this warranty become the property of Bombardier.

5. WHAT BOMBARDIER WILL DO

Bombardier's obligations under this warranty are limited to, at its sole discretion, repairing or replacing parts of the Sport Boat found to be defective in material or workmanship, in the reasonable judgment of Bombardier. Such repair or replacement of parts will be done without charge for parts and labor, at any authorized Dealer. Bombardier's responsibility is limited to making the required repairs or replacements of parts with genuine Bombardier parts. The expenses of transporting the Sport Boat to and from Dealer for warranty service are to be borne by the owner. No claim of breach of warranty shall be cause for cancellation or rescission of the sale of the Sport Boat to owner. In the event that warranty service is required outside of the fifty United States or Canada, owner will bear responsibility for any additional charges due to local practices and conditions, such as, but not limited to, freight, insurance, taxes, license fees, import duties, and any and all other financial charges, including those levied by governments, states, territories and their respective agencies. Bombardier reserves the right to improve, modify or change its Sport Boats from time to time without assuming any obligation to modify Sport Boats previously manufactured.

6. EXCLUSIONS —

The following are not warranted under any circumstances:

- Replacement of parts due to normal wear and tear;
- Routine maintenance parts and services, including but not limited to adjustments, oil, lubricant and coolant changes, spark plug replacement, water pumps and the like;
- Damage caused by improper or lack of maintenance or storage, or failure to follow the procedures and recommendations in the *Operator's Guide*;

- Damage resulting from removal of parts, improper repairs, service, maintenance, or modification, or use of parts or accessories not manufactured or approved by Bombardier, which in its reasonable judgment, are either incompatible with Sport Boats or adversely affect its operation, performance, or durability, or resulting from repairs done by a person that is not an authorized Dealer;
- Damage caused by abuse, misuse, abnormal use, neglect, racing, improper operation or operation of the Sport Boat in a manner inconsistent with the recommended operation described in the *Operator's Guide*;
- Damages resulting from external damage, submersion, water or foreign object ingestion, accident, fire, theft, vandalism or any act of God;
- Operation with fuel, oils or lubricants that are not suitable for the Sport Boat (see *Operator's Guide*);
- Damage from rust, corrosion or exposure to the elements;
- Damage from cooling system or jet pump blockage by foreign material;
- Damage to gel coat finish including but not limited to cosmetic gel coat finish defects, blisters, starring, crazing; and fiberglass delamination caused by blisters, crazing, spyder or hairline cracks or exposure to the elements.

This warranty will be voided in its entirety and rendered null and void where:

- The Sport Boat has been altered or modified in such a way so as to adversely affect its operation, performance or durability, or has been altered or modified to change its intended use; or
- The Sport Boat is or has been used for racing at any point, even by a prior owner.

7. LIMITATIONS OF LIABILITY

ALL WARRANTIES, EXPRESSED OR IMPLIED, INCLUDING WITHOUT LIMITATION ANY WARRANTY OF MERCHANTABILITY OR FITNESS FOR A PARTICULAR PURPOSE ARE LIMITED IN DURATION TO THE LIFE OF THE EXPRESS LIMITED WARRANTY. ALL INCIDENTAL, CONSEQUENTIAL, DIRECT, INDIRECT OR OTHER DAMAGES OF ANY KIND ARE EXCLUDED FROM COVERAGE UNDER THIS WARRANTY INCLUDING, BUT NOT LIMITED TO: expense for gasoline, expense for transporting Sport Boat to and from Dealer, mechanic's travel time, in-and-out of water charges, slip or dock fees, trailering or towing, storage, telephone, cell phone, fax or telegram charges, rental of a like or replacement boat during warranty services or down time, taxi, travel, lodging, loss of or damage to personal property, inconvenience, cost of insurance coverage, loan payments, loss of time, loss of income, revenue or profits, or loss of enjoyment or use of Sport Boat. **SOME STATES, PROVINCES, OR JURISDICTIONS DO NOT ALLOW FOR THE DISCLAIMERS, LIMITATIONS OF INCIDENTAL OR CONSEQUENTIAL DAMAGES, OR OTHER EXCLUSIONS IDENTIFIED ABOVE. AS A RESULT, THEY MAY NOT APPLY TO YOU. THIS WARRANTY GIVES YOU SPECIFIC RIGHTS, AND YOU MAY ALSO HAVE OTHER LEGAL RIGHTS WHICH MAY VARY FROM STATE TO STATE, OR PROVINCE TO PROVINCE.**

No distributor, Dealer or any other person is authorized to make any affirmation, representation or warranty regarding a Sport Boats other than those contained in this limited warranty and, if made, shall not be enforceable against Bombardier. Bombardier reserves the right to modify this warranty at any time, although such modification will not alter the warranty conditions applicable to the Sport Boats sold while this warranty was in effect.

8. TRANSFER

If the ownership of a product is transferred during the warranty coverage period, this warranty shall also be transferred and be valid for the remaining coverage period provided that BOMBARDIER is notified of such transfer of ownership in the following way:

- a) The former owner contacts BOMBARDIER (at the phone number provided below) or an authorized BOMBARDIER dealer and gives the coordinates of the new owner; or
- b) BOMBARDIER or an authorized BOMBARDIER Dealer receives a proof that the former owner agreed to the transfer of ownership, in addition to the coordinates of the new owner.

9. CONSUMER ASSISTANCE

In the event of a controversy or a dispute in connection with this BOMBARDIER LIMITED WARRANTY, BOMBARDIER suggests that you try to resolve the issue at the Dealership level. We recommend discussing the issue with the authorized Dealer's service manager or owner.

If further assistance is required, please contact Bombardier's Customer Assistance Center:

IN CANADA

BOMBARDIER INC.
RECREATIONAL PRODUCTS
CUSTOMER ASSISTANCE CENTER
VALCOURT QC J0E 2L0
Tel: (819) 566-3366

IN USA

BOMBARDIER MOTOR
CORPORATION OF AMERICA
CUSTOMER ASSISTANCE CENTER
7575 BOMBARDIER COURT
WAUSAU WI 54401
Tel: (715) 848-4957

* Sport Boats sold in Canada are distributed and serviced by Bombardier Inc.

March 2003

® registered trademarks of Bombardier Inc. or its subsidiaries.
© 2003 Bombardier Inc. All rights reserved.

CALIFORNIA EMISSION CONTROL WARRANTY STATEMENT FOR MODEL YEAR 2004 SEA-DOO® SPORT BOATS EQUIPPED WITH A ROTAX® ENGINE(S)

If your Sea-Doo sport boat has an engine other than a Rotax engine, the warranty issued by that engine manufacturer will apply.

Your Model Year 2004 Sea-Doo sport boat ("Sport Boat") equipped with a Rotax engine(s) has a special environmental label required by the California Air Resources Board. The label has 1, 2, 3 or 4 stars. A hangtag, provided with your Sport Boat, describes the meaning of the star rating system.

The Star Label Means Cleaner Marine Engines

The Symbol for Cleaner Marine Engines:



F18L3CQ

Cleaner Air and Water

For a healthier lifestyle and environment.

Better Fuel Economy

Burns up to 30 - 40 percent less gas and oil than conventional carbureted two-stroke engines, saving money and resources.

Longer Emission Warranty

Protects consumer for worry free operation.

One Star - Low-Emission

The one-star label identifies personal watercraft, outboard, sterndrive and inboard engines that meet the Air Resources Board's Personal Watercraft and Outboard marine engine 2001 exhaust emission standards. Engines meeting these standards have 75% lower emissions than conventional carbureted two-stroke engines. These engines are equivalent to the U.S. EPA's 2006 standards for marine engines.

Two Stars - Very Low Emission

The two-star label identifies personal watercraft, outboard, sterndrive and inboard engines that meet the Air Resources Board's Personal Watercraft and Outboard marine engine 2004 exhaust emission standards. Engines meeting these standards have 20% lower emissions than One Star - Low-Emission engines.

Three Stars - Ultra Low Emission

The three-star label identifies engines that meet the Air Resources Board's Personal Watercraft and Outboard marine engine 2008 exhaust emission standards or the Sterndrive and Inboard marine engine 2003 exhaust emission standards. Engines meeting these standards have 65% lower emissions than One Star - Low Emission engines.

Four Stars - Super Ultra Low Emission

The four-star label identifies engines that meet the Air Resources Board's Sterndrive and Inboard marine engine 2009 exhaust emission standards. Personal Watercraft and Outboard marine engines may also comply with these standards. Engines meeting these standards have 90% lower emissions than One Star - Low Emission engines.

For more information: Cleaner Watercraft – Get the Facts

1 800 END-SMOG

www.arb.ca.gov

Your Emission Control Warranty Rights and Obligations

The California Air Resources Board and Bombardier Motor Corporation of America ("Bombardier") are pleased to explain the emission control system warranty on your Model Year 2004 Sea-Doo sport boat equipped with a Rotax engine(s). In California, new Sport Boat engines must be designed, built and equipped to meet the State's stringent anti-smog standards. Bombardier must warrant the emission control system on your Sport Boat engine for the periods of time listed below provided there has been no abuse, neglect or improper maintenance of your Sport Boat engine.

Your emission control system may include parts such as the fuel injection system, the ignition system and catalytic converter. Also included may be hoses, belts, connectors and other emission-related assemblies.

Where a warrantable condition exists, Bombardier will repair your Sport Boat's Rotax engine at no cost to you, including diagnosis, parts and labor, provided that such work is performed by an authorized Sea-Doo sport boat Dealer.

Manufacturer's Limited Warranty Coverage

This emission limited warranty covers Model Year 2004 Sea-Doo sport boats equipped with a Rotax engine(s) certified and produced by Bombardier for sale in California, that are originally sold in California to a California resident or subsequently warranty registered to a California resident. The Bombardier limited warranty conditions for Sea-Doo Sport Boats are still applicable to these models with the necessary modifications.

Select emission control parts of your 2004 Sea-Doo Sport Boat equipped with Rotax engine(s) are warranted from the date of delivery to the first retail consumer for a period of 4 years, or for 250 hours of use, whichever occurs first. However, warranty coverage based on the hourly period is only permitted for sport boat equipped with the appropriate hour meters or their equivalent. If any emission-related part on your engine is defective under warranty, the part will be repaired or replaced by Bombardier.

Parts covered for a Model Year 2004 Sea-Doo Sport Boat Sportster LE DI equipped with a Rotax engine(s):

Air Lines	Coolant Temp. Sensor
Fuel Rail	Throttle Position Sensors
Rave Valve	Ignition Coil
Reed Valve	Manifold Temp. Sensor
Tuned Pipe	Manifold Air Press. Sensor
High-tension Ignition Wires	Crankshaft Posit. Sensor
Electrical Harness	Air Pressure Regulator
Throttle Bodies	Fuel Pressure Regulator
Exhaust Hoses	Fuel Injectors
Fuel Lines	Electronic Control Module
Water Regulator	Exhaust Manifold
Air Compressor	Intake Manifold
Cylinder Head	Fuel Pump
Detonation/Knock Sensor	Air Injector
Spark plugs	All emission component related gaskets; head, base, exhaust

Parts covered for a Model Year 2004 Sea-Doo Sport Boat Sportster 4-TEC and Speedster 200 equipped with a Rotax engine(s):

Digital Linear Actuator (low idle control)	All Fuel System Components
Throttle Position Sensor	Spark Plugs
Intake Manifold Air Pressure Sensor	Ignition Coils
Intake Manifold Air Temperature Sensor	Piston and Rings
Engine Temperature Sensor	Intake and Exhaust Valve Gear/Train
Knock Sensor	Valves, Valve Guides and Valve Guide Sealing
Emission Control Unit	Crankcase Ventilation Valve
Injectors	Wire Harness and Connectors
Fuel Pressure Regulator	Emission Related Seals, Gaskets and Hoses
Intake manifold	Exhaust manifold

The emission warranty covers damage to other engine components that is caused by the failure of a warranted part.

The Bombardier *Operator's Guide* provided contains written instructions for the proper maintenance and use of your Sport Boat. All emission warranty parts are warranted by Bombardier for the entire warranty period of the Sport Boat, unless the part is scheduled for replacement as required maintenance in the *Operator's Guide*.

Emission warranty parts that are scheduled for replacement, as required maintenance, are warranted by Bombardier for the period of time before the first scheduled replacement date for that part. Emission warranty parts that are scheduled for regular inspection, but not regular replacement, are warranted by Bombardier for the entire warranty period of the Sport Boat. Any emission warranty part repaired or replaced under the terms of this warranty statement is warranted by Bombardier for the remainder of the warranty period of the original part. All parts replaced under this limited warranty become the property of Bombardier.

Maintenance receipts and records should be transferred to each subsequent owner of the Sport Boat.

Owner's Warranty Responsibilities

As the owner of a Sea-Doo Sport Boat equipped with a Rotax engine(s), you are responsible for the performance of the required maintenance listed in your *Operator's Guide*. Bombardier recommends that you retain all receipts covering maintenance on your Rotax engine, but Bombardier cannot deny warranty solely for the lack of receipts or your failure to ensure the performance of all scheduled maintenance.

As the owner of a Sea-Doo Sport Boat equipped with a Rotax engine(s), you should however be aware that Bombardier may deny you warranty coverage if your Rotax engine(s) or a part has failed due to abuse, neglect, improper maintenance or unapproved modifications.

You are responsible for presenting your Rotax engine to an authorized Bombardier Dealer as soon as a problem exists. The warranty repairs will be completed in a reasonable amount of time, not to exceed 30 days.

If you have any questions regarding your warranty rights and responsibilities or for the name and location of the nearest authorized Bombardier Dealer you should contact the Customer Assistance Center at 1-715-848-4957.

BOMBARDIER INTERNATIONAL LIMITED WARRANTY FOR MODEL YEAR 2004 SEA-DOO® SPORT BOATS

1. SCOPE

Bombardier Inc. ("Bombardier") warrants its new and unused Model Year 2004 Sea-Doo sport boats ("Sport Boat") that are sold by authorized Sea-Doo sport boat Distributors/Dealers outside of the fifty United States and Canada ("Distributor/Dealer") from defects in material and workmanship for the period and under the conditions below. If your Sport Boat comes equipped with a Rotax® engine, the Rotax engine is also covered by this Limited Warranty under the terms hereof. If your Sport Boat came equipped with another engine, that engine is covered by the Limited Warranty issued by the manufacturer of that engine and is not covered by this Limited Warranty.

2. WARRANTY COVERAGE DURATION

This limited warranty will be in effect from the date of delivery to the first retail consumer or the date the Sport Boat is first put to use, whichever occurs first, for a period of:

- TWELVE (12) CONSECUTIVE MONTHS for private, recreational use, except that: the deck and hull fiberglass structure are covered for SIXTY (60) CONSECUTIVE MONTHS;
- FOUR (4) CONSECUTIVE MONTHS for commercial use, except that: the deck and hull fiberglass structure is covered for TWELVE (12) CONSECUTIVE MONTHS. A Sport Boat is used commercially when it is used in connection with generating income or any work or employment during any part of the warranty period. A Sport Boat is also used commercially when, at any point during the warranty period, it has commercial tags or is licensed for commercial use.

All genuine Bombardier accessories installed by an authorized Distributor/Dealer at the time of delivery carry the same warranty as the Sport Boat. The repair or replacement of parts or the performance of service to a Sport Boat under this warranty does not extend the life of this limited warranty beyond its original expiration date.

3. CONDITIONS TO HAVE WARRANTY COVERAGE

This warranty coverage is available only in the country in which the sale occurred and only after the purchaser and Distributor/Dealer have: completed and documented the Bombardier specified pre-delivery inspection process; and properly registered the Sport Boat. Only the original purchaser and any subsequent owners who reside in the country where the sale occurred are eligible for warranty coverage hereunder. Such limitations are necessary in order to allow Bombardier to protect the safety of its products, consumers, and the general public. As outlined in the *Operator's Guide*, timely required maintenance must be performed to maintain warranty coverage. Bombardier may require proof of proper maintenance prior to authorizing warranty coverage.

4. WHAT TO DO TO OBTAIN WARRANTY COVERAGE

The owner must notify an authorized Distributor/Dealer within two (2) days of the appearance of the defect and must promptly bring the Sport Boat, including any defective part, to Distributor/Dealer (in any event, within the warranty period) and must provide Distributor/Dealer with reasonable opportunity to repair the defect. If the Sport Boat has not previously been registered, the owner may also be required to present proof of purchase for warranty repairs. Owner is required to sign the repair/work order prior to the start of the repair in order to validate the warranty repair. All parts replaced under this warranty become the property of Bombardier.

5. WHAT BOMBARDIER WILL DO

Bombardier's obligations under this warranty are limited to, at Bombardier's sole discretion, repairing or replacing parts of the Sport Boat found to be defective in material or workmanship, in the reasonable judgment of Bombardier. Such repair or replacement of parts will be done without charge for parts and labor, at any authorized Sea-Doo Distributor/Dealer in the country where the Sport Boat was sold. Bombardier's responsibility is limited to making the required repairs or replacements of parts with genuine Bombardier parts. The expenses of transporting the Sport Boat to and from Distributor/Dealer for warranty service are to be borne by the owner. No claim of breach of warranty shall be cause for cancellation or rescission of the sale of the Sport Boat to owner. In the event that warranty service is required outside of the country where the Sport Boat was purchased, owner will bear responsibility for any additional charges due to local practices and conditions, such as, but not limited to, freight, insurance, taxes, license fees, import duties, and any and all other financial charges, including those levied by governments, states, territories and their respective agencies. Bombardier reserves the right to improve, modify or change its Sport Boats from time to time without assuming any obligation to modify Sport Boats previously manufactured.

6. EXCLUSIONS —

The following are not warranted under any circumstances:

- Replacement of parts due to normal wear and tear;
- Routine maintenance parts and services, including but not limited to adjustments, oil, lubricant and coolant changes, spark plug replacement, water pumps and the like;
- Damage caused by improper or lack of maintenance or storage, or failure to follow the procedures and recommendations in the *Operator's Guide*;
- Damage resulting from removal of parts, improper repairs, service, maintenance, or modification, or use of parts or accessories not manufactured or approved by Bombardier, which in its reasonable judgment, are either incompatible with Sport Boats or adversely affect its operation, performance, or durability, or resulting from repairs done by a person that is not an authorized Distributor/Dealer;
- Damage caused by abuse, misuse, abnormal use, neglect, racing, improper operation or operation of the Sport Boat in a manner inconsistent with the recommended operation described in the *Operator's Guide*;
- Damages resulting from external damage, submersion, water or foreign object ingestion, accident, fire, theft, vandalism or any act of God;

- Operation with fuel, oils or lubricants that are not suitable for the Sport Boat (see *Operator's Guide*);
- Damage from rust, corrosion or exposure to the elements;
- Damage from cooling system or jet pump blockage by foreign material;
- Damage to gel coat finish including but not limited to cosmetic gel coat finish defects, blisters, starring, crazing; and fiberglass delamination caused by blisters, crazing, spyder or hairline cracks or exposure to the elements.

This warranty will be voided in its entirety and rendered null and void where:

- The Sport Boat has been altered or modified in such a way so as to adversely affect its operation, performance or durability, or has been altered or modified to change its intended use; or
- The Sport Boat is or has been used for racing at any point, even by a prior owner.

7. LIMITATIONS OF LIABILITY

ALL WARRANTIES, EXPRESSED OR IMPLIED, INCLUDING WITHOUT LIMITATION ANY WARRANTY OF MERCHANTABILITY OR FITNESS FOR A PARTICULAR PURPOSE ARE LIMITED IN DURATION TO THE LIFE OF THE EXPRESS LIMITED WARRANTY. ALL INCIDENTAL, CONSEQUENTIAL, DIRECT, INDIRECT OR OTHER DAMAGES OF ANY KIND ARE EXCLUDED FROM COVERAGE UNDER THIS WARRANTY INCLUDING, BUT NOT LIMITED TO: expense for gasoline, expense for transporting Sport Boat to and from Distributor/Dealer, mechanic's travel time, in-and-out of water charges, slip or dock fees, trailering or towing, storage, telephone, cell phone, fax or telegram charges, rental of a like or replacement boat during warranty services or down time, taxi, travel, lodging, loss of or damage to personal property, inconvenience, cost of insurance coverage, loan payments, loss of time, loss of income, revenue or profits, or loss of enjoyment or use of Sport Boat. **SOME JURISDICTIONS DO NOT ALLOW FOR THE DISCLAIMERS, LIMITATIONS OF INCIDENTAL OR CONSEQUENTIAL DAMAGES, OR OTHER EXCLUSIONS IDENTIFIED ABOVE. AS A RESULT, THEY MAY NOT APPLY TO YOU. THIS WARRANTY GIVES YOU SPECIFIC RIGHTS, AND YOU MAY ALSO HAVE OTHER LEGAL RIGHTS WHICH MAY VARY WITH THE JURISDICTION.**

No Distributor, Dealer or any other person is authorized to make any affirmation, representation or warranty regarding a Sport Boat other than those contained in this limited warranty and, if made, shall not be enforceable against Bombardier. Bombardier reserves the right to modify this warranty at any time, although such modification will not alter the warranty conditions applicable to Sport Boats sold while this warranty was in effect.

8. TRANSFER

If the ownership of a product is transferred during the warranty coverage period, this warranty shall also be transferred and be valid for the remaining coverage period provided that BOMBARDIER is notified of such transfer of ownership in the following way:

BOMBARDIER or an authorized BOMBARDIER Distributor/Dealer receives a proof that the former owner agreed to the transfer of ownership, in addition to the co-ordinates of the new owner. The distributor will then forward this information directly to Bombardier.

9. CONSUMER ASSISTANCE

- a) In the event of a controversy or a dispute in connection with this BOMBARDIER LIMITED WARRANTY, BOMBARDIER suggests that you try to resolve the issue at the dealership level. We recommend discussing the issue with the authorized dealer's service manager or owner.
- b) If further assistance is required, the distributor's service department should be contacted in order to resolve the matter.
- c) If the matter still remains unresolved then contact Bombardier by writing to us at the address listed below.

BOMBARDIER INC.
RECREATIONAL PRODUCTS
BOMBARDIER SEA-DOO
CUSTOMER ASSISTANCE CENTER
VALCOURT QC J0E 2L0
Tel: (819) 566-3366

March 2003

® registered trademarks of Bombardier Inc. or its subsidiaries.
© 2003 Bombardier Inc. All rights reserved.

WEB SITES

Bombardier Sea-Doo Website: www.sea-doo.com

Canadian Coast Guard	www.ccg-gcc.gc.ca/obs-bsn/sbg-gsn/main_e.htm
United States Coast Guard	www.uscgboating.org/regulations/boating_laws.htm
Alabama	www.dcnr.state.al.us/mp/menu.htm
Alaska	www.dnr.state.ak.us/parks/boating
Arizona	www.azgfd.com
Arkansas	www.agfc.state.ar.us/
California	www.dbw.ca.gov
Colorado	http://parks.state.co.us/boating/
Connecticut	http://dep.state.ct.us/rec/prgactiv.htm
Delaware	www.dnrec.state.de.us/fw/fwwel.htm
Florida (freshwater)	http://floridaconservation.org/law
Florida (saltwater)	www.dep.state.fl.us/law
Georgia	www.boat-ed.com
Hawaii	www.hawaii.gov/dlnr/dbor/dbor
Idaho	www.idahoparks.org/rec/boating.html
Illinois	http://131.230.57.1/stat_rul/ILLREG.htm
Indiana	www.state.in.us/dnr/regulations
Iowa	www.iowadnr.com/
Kansas	www.kdwp.state.ks.us/boating/boating.html
Kentucky	www.state.ky.us/agencies/fw/boating.htm
Louisiana	www.w/f.state.la.us
Maine	www.state.me.us/ifw/rv/boatinglaws2002.htm
Maryland	www.dnr.state.md.us/boating
Massachusetts	www.state.ma.us/dfwele/dle/boatrvsafe.htm
Michigan	www.boat-ed.com/mi/handbook
Minnesota	www.dnr.state.mn.us/safety/boatwater
Mississippi	www.dmr.state.ms.us
Missouri	www.mswp.state.mo.us
Montana	www.fwp.state.mt.us/education/outdoorskills.asp

Nebraska	www.ngpc.state.ne.us/boating
Nevada	http://www.boatnevada.org/
New Hampshire	www.state.nh.us/safety/ss/links.html
New Jersey	www.state.nj.us/mvs/boats.htm
New Mexico	www.emnrd.state.nm.us/nmparks/pages/question/regulate/rules/nmac172.pdf
New York	www.nysparks.com
North Carolina	www.ncwildlife.org/fs_index_02_regulations.htm
North Dakota	http://www.state.nd.us/gnf/boating/
Ohio	www.dnr.state.oh.us/odnr/watercraft
Oklahoma	www.boat-ed.com
Oregon	www.osmb.state.or.us
Pennsylvania	www.fish.state.pa.us
Rhode Island	www.state.ri.us/dem/topics/boating.htm
South Carolina	www.dnr.state.sc.us/etc/boating.htm
South Dakota	www.state.sd.us/gfp/divisionwildlife/boating/index.htm
Tennessee	www.state.tn.us/twra/boatmain.html
Texas	www.tpwd.state.tx.us/boat/boat.htm
Utah	www.nr.state.ut.us/parks/boating.htm
Vermont	www.boatsafe.com/vermont
Virginia	www.dgif.state.va.us/boating
Washington	www.parks.wa.gov/boating.asp
West Virginia	www.dnr.state.wv.us/law/boating.htm
Wisconsin	http://www.dnr.state.wi.us/org/caer/cs/Registrations/Boats.htm
Wyoming	http://gf.state.wy.us

NOTE: These web sites are for the information and education of the owner of this Sport Boat and are current as of March 2003. Bombardier makes no endorsement of or representation regarding these sites.

LIST OF DISTRIBUTORS

NORTH AMERICA

USA (Except Puerto Rico)	BOMBARDIER MOTOR CORPORATION OF AMERICA 7575, Bombardier Court P.O. Box 8035 WAUSAU, WI. 54401 Phone: (715) 848-4957 Fax: (715) 847-6879 http://www.bombardier.com
CANADA Alberta British Columbia Manitoba North West Territories Ontario Quebec Saskatchewan Yukon New-Brunswick Nova Scotia Prince Edward Island Nunavut Newfoundland	BOMBARDIER INC. RECREATIONAL PRODUCT 75, J.A. BOMBARDIER ST. SHERBROOKE, QC J1L 1W3 Phone: (819) 566-3366 Fax: (819) 566-3062 http://www.bombardier.com

If your Sea-Doo sport boat requires warranty service, you must take it to any authorized Sea-Doo sport boat dealer. Be sure to bring your warranty registration card or other valid proof of the original date of purchase. If a question or problem arises regarding warranty, first contact the service manager or owner of the Sea-Doo sport boat dealership.

To find the nearest authorized Sea-Doo sport boat dealer, dial: 1 800 882-2900.

NOTE: If outside Canada and USA, consult the local distributor.



DECLARATION OF CONFORMITY

Application of Council Directives: 94/25/CE — Recreational craft
89/336/CEE — Electromagnetic compatibility

Standards to which conformity is declared: ISO 7840, ISO 8469, ISO 8665, ISO 8846,
ISO 8848, ISO 8849, ISO 9094, ISO 9097,
ISO 10087, ISO 10088, ISO 10133, ISO 10240,
ISO 11105, ISO 11591, ISO 11592, ISO 12215,
ISO 12216, ISO 13592, COLREGS, ABYC H-5,
ABYC H-8

Manufacturer's name: Bombardier Motor Corporation of America.

Manufacturer's address: 451 E. Illinois Ave
Benton, Illinois
62812-0394

Importer's name: Société ANF — Industrie S.A.

Importer's address: 2, rue du Nouveau Bercy
94220 Charenton
Paris, France

Notified body for Directive 94/25/CE: International Marine Certification Institute
Trèves centre, rue de Trèves 45
1040 Brussels, Belgium

Competent body for Directive 89/336/CEE: UTAC
Autodrome de Linas-Monthéry, B.P. 212
91311 Monthéry cedex, France

Type of equipment: Sport boats, inshore category C

Model names and numbers: _____
Model name

Model number(s)

I, the undersigned, hereby declare that the equipment specified above conforms to the above Directives and Standards.

Name of signatory: Fernando Garcia

Title of signatory on behalf of Bombardier Motor Corporation of America: Director - Public and Regulatory Affairs —
Sea-Doo sport boats

Homologation and Certification

These boats comply with the following standards:

STANDARD	TYPE OF CERTIFICATION
United States Coast Guard	Self certification
Canadian Coast Guard	Self certification
Russian Maritime Register of Shipping	Certify by Russian Maritime Register of Shipping 8, Dvortsovaya Nab., 191186 St. Petersburg, Russia
Directive 89/336/CEE of the council relating to electromagnetic compatibility	Internal production control plus control carried out on the responsibility of a competent body. Competent body: UTAC Autodrome de Linas-Montlhéry, B.P. 212 91311 Montlhéry cedex, France
Directive 94/25/EC of the European Parliament and of the council relating to recreational craft	Internal production control plus control carried out on the responsibility of a notified body. Notified body: International Marine Certification Institute Trèves centre, rue de Trèves 45 1040 Brussels, Belgium

Operator's Guide Confirmation of Receipt

Your dealer

Name:	_____
Address:	_____

Will assist you and help you to resolve any problems you may have.

Upon delivery of your sport boat, complete and sign the form hereunder and forward it to your dealer in order to be covered by our warranty.

Warranty conditions are as detailed in the Warranty Section of this guide.

----- Cut here

Receipt	
Name:	_____
Address:	_____
Owner of _____	Sport Boat model No. _____
HIN (to be completed by customer or selling dealer) _____	
This warranty begins _____ (date).	
The dealer named on this document has instructed me on the operation, maintenance, safety features and warranty policy, all of which I understand and agree to be bound with. I am also satisfied with the predelivery set-up and inspection of my Sea-Doo sport boat. I have also received a copy of the <i>Operator's Guide and Safety Videocassette</i> for my Sea-Doo sport boat.	
Signature: _____	
Date: _____	

PRIVACY INFORMATION

We wish to inform you that your coordinates will be used for safety and warranty purposes. Sometimes, we also use the coordinates of our clients to inform them about our products and to present them offers. Should you prefer not to receive information on our products, services and offers, please let us know by writing to the address below.

Also note that, from time to time, carefully selected and trustworthy organizations may be permitted to use the coordinates of our clients to promote quality products and services. If you prefer not to have your name and address released, please let us know by writing to the address below:

Bombardier Inc.
Recreational Products
Warranty Department
75 J.A. Bombardier Street
Sherbrooke, Québec J1L 1W3
Canada
Fax Number (819) 566-3590



AFFIX
PROPER
POSTAGE

BOMBARDIER
RECREATIONAL PRODUCTS
WARRANTY DEPARTMENT
75, J.A. BOMBARDIER ST.
SHERBROOKE (QUEBEC)
CANADA J1L 1W3

SPORT BOAT MODEL No. _____

HULL

IDENTIFICATION NUMBER (H.I.N.) _____

MERCURY OR ROTAX ENGINE

IDENTIFICATION NUMBER (E.I.N.) _____

Owner: _____

NAME

No.

STREET

APT

CITY

STATE/PROVINCE

ZIP/POSTAL CODE

Purchase Date _____

YEAR

MONTH

DAY

Warranty Expiry Date _____

YEAR

MONTH

DAY

To be completed by the dealer at the time of the sale.

DEALER IMPRINT AREA

Please verify with your selling dealer to ensure your SEA-DOO craft has been registered with Bombardier.

SEA

SEABOARD

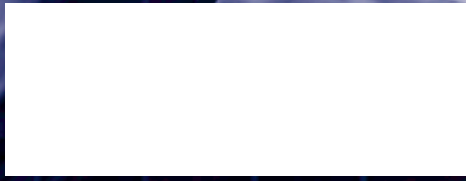
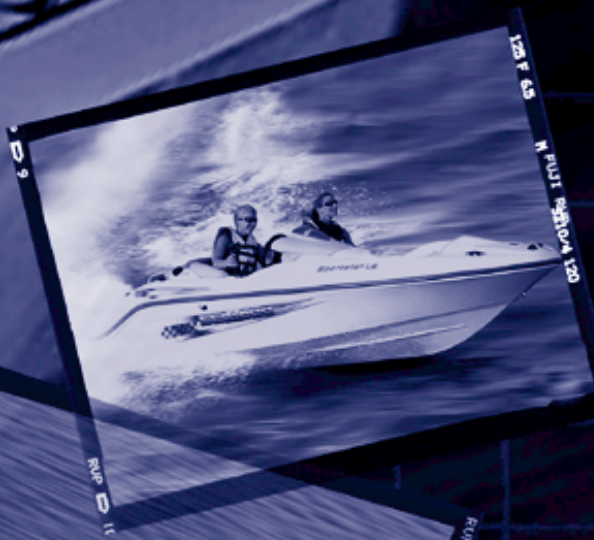

®™TRADEMARKS OF BOMBARDIER INC. OR ITS SUBSIDIARIES.
©2003 BOMBARDIER INC. ALL RIGHTS RESERVED
PRINTED IN CANADA