

SEA-DOO®

Sport Boats



OPERATOR'S GUIDE

2000

219 000 100

**CHALLENGER 1800
SPORTSTER 1800
SPEEDSTER/SK**

SAFETY WARNING

Disregarding any of the safety precautions and instructions contained in this *Operator's Guide*, the *Safety Handbook* and on *Product Warning Labels* could cause injury, including the possibility of death. The operator has the responsibility to inform passenger(s) of safety precautions.

This *Operator's Guide*, the *Safety Handbook* and *Videocassette* should remain with the craft at the time of resale.

BOMBARDIER

Recreational Products
After-Sales Service
Valcourt (Quebec)
Canada J0E 2L0



**The following trademarks are property of
Bombardier Inc. and/or its subsidiaries:**

SEA-DOO®
BOMBARDIER-ROTAX®
Bombardier Lube®
BOMBARDIER-ROTAX Formula XP-S Synthetic
Injection Oil
BOMBARDIER-ROTAX Injection Oil
Sea-Doo Synthetic Grease

Gelcote[†] is a trademark of Gelcote International
Knight's Spray-Nine[†] is a trademark of Korkay
System Ltd

Doin'it on your new Sea-Doo Sport Boat

Congratulations, you are now the proud owner of a Sea-Doo sport boat. Whether you are an experienced boater or are new to the sport of boating, we ask you to take the time to view the *Videocassette* provided with the craft, to read this *Operator's Guide*, the *Safety Handbook* and familiarize yourself with the contents. These manuals contain pertinent information which, if followed, will provide you with the necessary knowledge to help you fully enjoy the pleasures of this craft.

We strongly recommend that any craft operator complete a safety boating course. Check with your local Coast Guard or Power and Sail Squadron in your area for course availability. More serious boaters may want to obtain *Chapman Piloting* by Elbert S. Maloney, available at most book stores.

When introducing your family or friends to the sport, be sure they fully understand the controls and operation of the craft and the importance of courteous, responsible riding.

Each operator has a responsibility to ensure the passenger safety and the safety of other water users. Please follow all safety instructions and drive with care.

We encourage you to have an Annual Safety Inspection of your craft. Please contact your authorized Sea-Doo dealer for further details.

Finally, we urge you to visit your authorized Sea-Doo dealer regularly for regular and safety maintenance as well as any craft accessories you may require.

Have fun and... Bon Voyage.

Please keep this *guide* and *Safety Handbook* on board. These manuals should remain with the craft at time of resale.

TABLE OF CONTENTS

FOREWORD	5
▲ SAFETY WARNING	6
General	6
Operation	6
Maintenance	8
LIST OF DISTRIBUTORS	10
BOMBARDIER LIMITED WARRANTY NORTH AMERICA: 2000 SEA-DOO® SPORT BOAT	11
BOMBARDIER INTERNATIONAL LIMITED WARRANTY: 2000 SEA-DOO® SPORT BOAT	13
REGISTRATION NUMBER LOCATION	15
LOCATION OF THE IMPORTANT LABELS	16
IDENTIFICATION NUMBERS	19
Hull.....	19
Engine.....	19
CONTROLS AND COMPONENTS LOCATION	20
Cockpit.....	20
Overview	22
1) Safety Lanyard	24
2) Steering Wheel	25
3) Throttle Lever.....	25
4) Shift Lever.....	26
5) Ignition Switch	26
6) 12-Volts Accessory Jack	27
7) Navigation Light Switch.....	27
8) Bilge Pump Switch.....	27
9) Bilge Air Blower Switch.....	28
10) Horn Switch	28
11) Deck Light Switch.....	28
12) Low-Fuel Warning System Switch.....	29
13) Fuel Gauge/Low Oil Level Pilot Lamp and Beeper	29
14) Tachometer.....	29
15) Speedometer	30
16) Wind Deflector.....	30
17) Bilge Drain Plugs.....	31
18) Grab Handles	31
19) Rear Grab Handle(s)	31
20) Swim Platform	31
21) Sun Deck (if so equipped)	31
22) Seats	32
23) Bow Seat (if so equipped)	32
24) Cup Holders	34
25) Right/Left Front Storage Compartment(s)	35

26) Deck Storage Compartment.....	37
27) Rear Storage Compartment.....	38
28) Bow Cover.....	39
29) Jet Pump Water Intake.....	39
30) Bow and Stern Eyelets.....	39
31) Bow Light.....	40
32) Removable Stern Light.....	40
33) Mooring Cleats.....	41
34) Deck.....	41
35) Fuel Tank Cap.....	41
36) Deck Drain(s).....	41
37) Main Oil Reservoir Cap.....	41
38) Flushing Connector.....	41
39) Ventilation Ducts.....	41
40) Jet Pump Nozzle.....	42
41) Reverse Gate.....	42
42) Retractable Ladder (if so equipped).....	42
43) Scupper Valve.....	42
44) Hydro-Surge Grate System.....	42
45) Fuel Tank Vent.....	43
46) Ski Post.....	43
47) Fuses.....	44
48) Radio (if so equipped).....	44
49) Glove Box (if so equipped).....	45
50) Water Bypass System.....	45
51) Main Battery Cut-Off Switch.....	45

FUEL AND LUBRICATION 47

Fueling Procedure.....	47
Recommended Fuel.....	47
Recommended Oil.....	47
Main Oil Reservoir Level.....	47
Engine Mounted Oil Reservoir Level.....	48

BREAK-IN PERIOD 49

Engine.....	49
10-Hour Inspection.....	49

DAILY PRE-OPERATION CHECKS 50

Hull.....	51
Jet Pump Water Intake.....	51
Bilge.....	51
Battery.....	51
Fuel Tank/Oil Reservoirs.....	51
Engine Compartment.....	51
Fire Extinguisher.....	51
Steering System.....	51
Throttle System.....	51
Shifter System.....	51
Inlet Grate.....	51

Safety Lanyard and Ignition Switch	52
Storage Compartment Covers	52
OPERATING INSTRUCTIONS	53
Launching/Loading	53
Trailing	53
Principle of Operation	53
Boarding from a Dock	55
Boarding from the Water	56
Starting the Engine	57
Rough Water or Poor Visibility Operation	57
Crossing Waves	57
Stopping/Docking	57
Beaching	58
Shutting Off the Engine	58
POST-OPERATION CARE	59
General Care	59
Additional Care for Foul Water or Salt Water	59
SPECIAL PROCEDURE	60
Engine Overheating	60
Jet Pump Water Intake and Impeller Cleaning	60
Capsized Boat	60
Submerged Boat	60
Low-Charge Battery Condition	60
MAINTENANCE	61
Lubrication	61
Periodic Inspection	62
Periodic Inspection Chart	63
Throttle Cable	64
Fuel and Oil Filters	64
Steering/Jet Pump Nozzle Adjustment	64
Reverse Gate	64
Deck Drain(s)	64
Fuses	64
Bilge Air Blower	64
Navigation Light Bulb Replacement	65
General Inspection and Cleaning	66
STORAGE AND PRE-SEASON PREPARATION	67
Storage	67
Pre-Season Preparation	68
SPECIFICATIONS	69
SI METRIC INFORMATION GUIDE	73
CHANGE OF ADDRESS	75

FOREWORD

The *Operator's Guide* and *Safety Handbook* have been prepared to acquaint the owner/operator or passenger with this personal craft and its various controls, maintenance and safe riding instructions. Each is indispensable for the proper use of the product, and should be kept in a waterproof bag with the craft at all times.

For any questions pertaining to the warranty and its application, consult the WARRANTY section in this guide, and/or an authorized SEA-DOO dealer.

The information contained in this guide should always be used in conjunction with the information included in *Mercury Marine (M²) Jet Drive Operator's Guide*.

This guide uses the following symbols to emphasize particular information.

WARNING

Identifies an instruction which, if not followed, may cause serious personal injuries including the possibility of death.

CAUTION: Denotes an instruction which, if not followed, may damage the craft and/or components.

NOTE: Indicates supplementary information needed to fully complete an instruction.

Although the mere reading of such information does not eliminate the hazard, the understanding and application of the information will promote its correct use.

The information and components/system descriptions contained in this guide are correct at the time of publication. Bombardier Motor Corporation of America (B.M.C.A.) however, maintains a policy of continuous improvement of its products without imposing upon itself any obligation to install them on products previously manufactured.

Because of our ongoing commitment to product quality and innovation, Bombardier reserves the right at any time to discontinue or change specifications, designs, features, models or equipment without incurring obligation.

The illustrations in this document show the typical construction of the different assemblies and may not represent the full detail or exact shape of the parts. However, they represent parts that have the same or similar function.

It is understood that this guide may be translated into another language. In the event of any discrepancy, the English version shall prevail.

Specifications are given in the SI metric system with the SAE U.S. equivalent in parenthesis. Where precise accuracy is not required, some conversions are rounded off for easier use.

A *Shop Manual* can be obtained for complete service, maintenance and more repair information.

⚠ SAFETY WARNING

General

- ⚠ To fully appreciate the pleasures, enjoyment and excitement of boating there are some basic rules that should be observed and followed by any boater. Some rules may be new to you or covered in the PWC/Sport boat *Safety Handbook* or *Safety Video*, others may be common sense or obvious... irrespective, we ask that you please take a few minutes of your time to completely read these safety instructions before you operate your craft. **Failure to follow this safety information and safe boating rules could result in injury, including the possibility of death to you, your passenger(s), or other water users.**
- ⚠ Information in this guide is limited. It is strongly recommended that you obtain further boating information from the local Coast Guard or Power Squadron. We also recommend all operators to take a boating safety course. Please check local and federal boating laws applicable to the waterways where you intend to use the craft. Learn the local rules of the road. Always carry the regulatory required safety items on board.
- ⚠ The performance of this craft may significantly exceed that of other boats you have operated. Therefore, use of this craft by a novice or inexperienced operator, or an underage or disabled person, is not recommended.
- ⚠ Observe and follow all on-product warning labels.

- ⚠ Become completely familiar with the controls and operation of the craft before embarking on your first trip or taking on a passenger(s). If you have not had the opportunity to do so with your dealer, practice driving solo in a suitable area and feel the response of each control. Be fully familiar with all controls before applying the throttle above idle speed. As its operator, you control and are responsible for the craft's safe operation.
- ⚠ Always carry the regulatory required safety items on board. Check with local regulations or your dealer.
- ⚠ Make sure that all users of the craft read and are aware of all warnings.

Operation

- ⚠ An operator and passenger(s) should wear suitable eye and body protection as well as deck shoes or booties.
- ⚠ Store or tie-down any loose articles or necessary boating equipment before operating the craft.
- ⚠ Always perform the pre-operation checks as specified in this guide.
- ⚠ Always keep in mind that as the throttle lever is released to idle position, less directional control is available. **To turn the craft, both steering and throttle are necessary.** This craft has the capability of turning more sharply than other boats, however, unless in an emergency, do not negotiate sharp, high speed turns. You and your passenger(s) could be thrown from the craft. It should also be remembered that sun, wind, alcohol or drugs, may impair your judgment and reaction time.

- ⚠ While your craft has the capacity of operating at high speeds, it is strongly recommended that high speed operation only be applied when ideal conditions exist and are permitted. Higher speed operation requires a higher degree of skill and increases the risk of severe injuries.
- ⚠ The forces generated on the body of riders while turning, negotiating waves or wakes, operating in choppy waters, or falling off the watercraft, especially at higher speeds, may cause injury including the possibility of broken legs and other bones. Remain flexible and avoid sharp turns. Never place your feet and legs in the water to aid turning.
- ⚠ **Ensure operator all-round visibility is unrestricted. Always keep a constant lookout for other water users or other potential hazards especially when turning. Make sure to keep a safe distance from all other craft, other water users or other objects.**
- ⚠ Like any other boats, this craft has no brake. Stopping distance will vary depending on initial speed, load, wind, and water conditions. Practice stopping and docking in a safe, traffic free area to have an idea of how long it will take to stop the craft under varying conditions. Do not release throttle when trying to steer away from objects. You need throttle to steer. **Do not** use the craft's reverse, if so equipped, to stop.
- ⚠ Ensure that all passengers know how to swim and how to reboard the craft from the water. The operator and passenger(s) should be properly seated and wearing an approved PFD before starting or moving the craft and at all times when craft is in motion. **Do not** start or operate the craft if a person(s) is seated on the sun deck or swim platform, or are nearby in the water. The craft's jet thrust can cause injury. Always accelerate slowly. To prevent accidental starting or unauthorized use, always detach the safety lanyard from the craft especially when swimmers are boarding or nearby, or during removal of any weeds or debris from the intake grate.
- ⚠ Riding with a passenger(s) or pulling other boats, tubes, skier or wakeboarder makes the craft handle differently and requires greater skill. Do not overload the craft or take on more passengers than designated for the particular craft. Overloading can affect maneuverability, stability and performance. Avoid adding on accessories, or equipment which may alter your control of the craft. The craft may be fitted with tow eyelets which can be used to attach a ski rope. However, do not use these eyelets or the craft's cleats to tow a parasail. Severe craft damage may occur.
- ⚠ Always respect the safety and comfort of your passenger(s) and person being towed on skis, wakeboards or other water products. Always have an observer while towing a skier, proceed with only as much speed as required, and follow the observers instructions. Unless absolutely necessary, do not make tight, sharp turns.

- ⚠ Know the waters in which the craft is to be operated. Current, tides, rapids, hidden obstacles, wakes and waves etc., can affect safe operation. It is not advisable to operate the craft in rough or inclement weather.
- ⚠ Wake or wave jumping or riding the surf line can cause severe personal injury and damage the craft. Never attempt to splash others with your craft. You may misjudge the ability of the craft or your own riding skills and strike a boat or person.
- ⚠ In shallow water, proceed with caution and at very low speeds. Grounding or abrupt stops may result in injury. Debris may also be picked up and be thrown rearward by the jet pump onto people or property.
- ⚠ Respect no wake zones, the rights of other water users and the environment. As the "skipper" and owner of a boat you are responsible for damage to other boats caused by the wake of your craft. Allow no one to throw refuse overboard.
- ⚠ This craft is equipped with navigation lights which should be used between sunset and sunrise. Reduce speed and do not operate the craft in reduced visibility. Avoid adding on accessories or equipment which may alter the craft's configuration or balance.
- ⚠ Remember, gasoline fumes are inflammable and explosive. Always adhere to the fueling procedure contained in this guide and those given to you by the marina. Always verify fuel level before use and during the ride. Apply the principle of 1/3 fuel to destination, 1/3 back and 1/3 reserve fuel supply. Do not carry spare fuel or inflammable liquids in any of the storage or engine compartments.
- ⚠ Combustion engine needs air to operate; consequently this craft can not be totally watertight. Any man-ouvers such as figure eights etc., that cause the upper deck to be under water may cause severe engine problems due to water ingestion. Refer to "Special Procedures" and Limited Warranty contained in this guide.
- ⚠ Due to the close proximity of other racers, It is recommended that an approved personal watercraft helmet be used during racing events. Read and follow all instructions and warnings provided with the helmet.
- ⚠ Operation of this craft by a minor or disabled person is NOT recommended.

Maintenance

- ⚠ Only perform servicing procedures which are detailed in this guide. Further assistance or information can be obtained from your authorized Sea-Doo dealer. In many instances proper tools and training is required for certain servicing or repair procedures.
- ⚠ Maintain the craft and equipment in top condition at all times. Adhere to the prescribed maintenance schedules. An annual inspection of the craft is always a good recommendation that should be followed.
- ⚠ The bilge must be kept clean of oil, water or other foreign materials.
- ⚠ Do not attempt to lift the craft without special equipment and training.

- ⚠ The engine and the corresponding components identified in this guide should not be utilized on product(s) other than for those they were designed. Maintenance procedures and specified tightening torque must be strictly adhered to. Never attempt repairs unless the appropriate tools are available. These craft are designed with parts dimensioned in both the metric and the imperial systems. When replacing fasteners, make sure to use only those recommended by Bombardier. If required, contact your authorized Sea-Doo dealer for further servicing information.
- ⚠ Operate your craft prudently and have fun. Don't forget that all persons must assist other boaters in an emergency.

LIST OF DISTRIBUTORS

NORTH AMERICA

U.S.A. (Except Puerto Rico)	BOMBARDIER MOTOR CORPORATION OF AMERICA 5000 STEWART WAUSAU, WI 54401 Phone: (715) 842-8886 Fax: (715) 848-3455 http://www.bombardier.com
CANADA Alberta British Columbia Manitoba North West Territories Ontario Quebec Saskatchewan Yukon New-Brunswick Nova Scotia Prince Edward Island Nunavut	BOMBARDIER RECREATIONAL PRODUCT 75, J.A. BOMBARDIER ST. SHERBROOKE, QC J1L 1W3 Phone: (450) 532-2211 FAX: (450) 532-5077 http://www.bombardier.com
Newfoundland	CHARLES R. BELL P.O. BOX 1050 RIVERSIDE DRIVE CORNER BROOKE, NFLD A2H 6J3 Phone: (709) 634-3533 FAX: (709) 634-2444

If your SEA-DOO Sport Boat requires warranty service, you should take it to any authorized SEA-DOO Sport Boat dealer. Be sure to bring your warranty registration card or other valid proof of the original date of purchase. If a question or problem arises regarding warranty, first contact the service manager or owner of the SEA-DOO Sport Boat dealership.

To find the nearest authorized Sea-Doo Sport Boat dealer, dial: 1-800-882-2900.

NOTE: If outside Canada and U.S.A., consult the local distributor.

BOMBARDIER LIMITED WARRANTY NORTH AMERICA: 2000 SEA-DOO® SPORT BOAT

1. WARRANTY COVERAGE PERIOD

In Canada and in the USA, BOMBARDIER INC. ("Bombardier") on behalf of Bombardier Motor Corporation of America, warrants FROM THE DATE OF DELIVERY TO THE FIRST CONSUMER that each 2000 SEA-DOO SPORT BOAT sold, as NEW and UNUSED and PREDELIVERED by an authorized North American SEA-DOO SPORT BOAT dealer, will be free from any defects in material and/or workmanship for a PERIOD of:

a) For private use:

TWELVE (12) CONSECUTIVE MONTHS, with the exception of the deck and hull fiberglass structure; and

SIXTY (60) CONSECUTIVE MONTHS for the deck and hull fiberglass structure.

b) For commercial use:

FOUR (4) CONSECUTIVE MONTHS, with the exception of the deck and hull fiberglass structure; and

TWELVE (12) CONSECUTIVE MONTHS for the deck and hull fiberglass structure.

All genuine Bombardier accessories, installed by an authorized SEA-DOO SPORT BOAT dealer at the time of delivery of the new and unused SEA-DOO SPORT BOAT, carry the same Warranty Coverage Period as for the SEA-DOO SPORT BOAT.

2. WHAT BOMBARDIER WILL DO

BOMBARDIER will repair or replace, at its option, all genuine BOMBARDIER part found defective in material and/or workmanship, under normal use, maintenance and service, with a genuine BOMBARDIER part without charge for parts and labor, at any authorized SEA-DOO SPORT BOAT dealer during the Warranty Coverage Period.

3. CONDITION TO HAVE WARRANTY WORK VALIDATED

The customer must notify an authorized SEA-DOO SPORT BOAT dealer within two (2) days of the appearance of the defect in material and/or workmanship and present to the servicing authorized SEA-DOO SPORT BOAT dealer the SEA-DOO Warranty Registration Card or a proof of purchase of the NEW and UNUSED 2000 SEA-DOO SPORT BOAT and must sign the repair/work order prior to the start of the repair in order to validate a warranty repair. All parts replaced under this limited warranty become the property of BOMBARDIER.

4. EXCLUSIONS — ARE NOT WARRANTED

- The engine and corresponding components which are warranted by Mercury Marine. Refer to *Mercury Marine (M²) Jet Drive Operator's Guide*.
- Normal wear and tear items;
- Labor, parts and lubricant costs of all maintenance services;
- Damage caused by failure to provide proper maintenance and/or storage, as described in the "2000 SEA-DOO SPORT BOAT *Operator's Guide*";
- Damage resulting from improper repairs, modifications or use of non-approved parts or, repairs done by a non-authorized SEA-DOO SPORT BOAT dealer;
- Damage resulting from abuse, misuse, neglect, racing;
- Damage resulting from accident, fire, theft, vandalism or any act of God;
- Incidental or consequential damages, or damages of any kind such as but not limited to towing charges, telephone calls or taxi;
- Water damages caused by water ingestion;
- Damage related to gel coat finish including but not limited to cosmetic gel coat finish, blisters or fiberglass delamination caused by blisters, crazing, spider or hairline cracks; and
- Damages resulting from improper service or maintenance.

5. LIMITATIONS OF LIABILITY

This warranty gives you specific rights, and you may also have other legal rights which may vary from state to state, or province to province. **WHERE APPLICABLE, THIS WARRANTY IS EXPRESSLY GIVEN AND ACCEPTED IN LIEU OF ANY AND ALL OTHER WARRANTIES, EXPRESSED OR IMPLIED, INCLUDING WITHOUT LIMITATION ANY WARRANTY OF MERCHANTABILITY OR FITNESS FOR ANY PARTICULAR PURPOSE.**

Neither the distributor, any authorized SEA-DOO SPORT BOAT dealer nor any other person has been authorized to make any affirmation, representation or warranty other than those contained in this warranty, and if made, such affirmation, representation or warranty shall not be enforceable against BOMBARDIER or any other person.

In no event shall BOMBARDIER be liable for special, consequential or incidental damages, including but not limited to loss of use and transportation costs. Some states or provinces do not allow the exclusion or limitation of incidental or consequential damages, or limitations on how long an implied warranty lasts, so the above limitation or exclusion may not apply.

BOMBARDIER reserves the right to modify this warranty at any time, being understood that such modification will not alter the warranty conditions applicable to the SEA-DOO SPORT BOAT sold while this warranty is in effect.

6. TRANSFER

If the customer sells the sport boat guaranteed under the present, he shall assign and transfer this warranty, which shall be valid for the rest of the relevant PERIOD as defined in section 1 hereinabove, to the new customer.

7. CONSUMER ASSISTANCE

- a) In the event of a controversy or a dispute arising in connection with this BOMBARDIER LIMITED WARRANTY, BOMBARDIER suggests that you try to resolve the issue at the dealership level. We recommend discussing the issue with the authorized dealer's service manager or owner.
- b) If further assistance is required, the DISTRIBUTOR's service department should be contacted in order to resolve the matter. In the USA, SEA-DOO products are distributed by B.M.C.A.
- c) If the issue has still not been resolved, please submit in writing your complaint to:

IN CANADA:

BOMBARDIER INC.
RECREATIONAL PRODUCTS
SPORT BOATS
CUSTOMER ASSISTANCE CENTER
VALCOURT QC J0E 2L0
Tel: (450) 532-5000

IN USA:

BOMBARDIER MOTOR
CORPORATION OF AMERICA
RECREATIONAL PRODUCTS
SPORT BOATS
CUSTOMER ASSISTANCE CENTER
P.O. BOX 8035
7575 BOMBARDIER COURT
WAUSAU WI 54402-8035
Tel: (715) 848-4957

MARCH 1999

® Registered trademark of Bombardier Inc. and/or subsidiaries.

BOMBARDIER INTERNATIONAL LIMITED WARRANTY: 2000 SEA-DOO® SPORT BOAT

1. WARRANTY COVERAGE PERIOD

BOMBARDIER INC. ("Bombardier") on behalf of Bombardier Motor Corporation of America, warrants FROM THE DATE OF DELIVERY TO THE FIRST CONSUMER that each 2000 SEA-DOO SPORT BOAT sold anywhere in the world except the United States and Canada, as NEW and UNUSED and PREDELIVERED by an authorized SEA-DOO SPORT BOAT dealer, duly appointed by an authorized SEA-DOO International Distributor, will be free from any defects in material and/or workmanship for a PERIOD of:

a) For private use:

TWELVE (12) CONSECUTIVE MONTHS, with the exception of the deck and hull fiberglass structure; and

SIXTY (60) CONSECUTIVE MONTHS for the deck and hull fiberglass structure.

b) For commercial use:

FOUR (4) CONSECUTIVE MONTHS, with the exception of the deck and hull fiberglass structure; and

TWELVE (12) CONSECUTIVE MONTHS for the deck and hull fiberglass structure.

All genuine Bombardier accessories, installed by an authorized SEA-DOO SPORT BOAT dealer at the time of delivery of the new and unused SEA-DOO SPORT BOAT, carry the same Warranty Coverage Period as for the SEA-DOO SPORT BOAT.

2. WHAT BOMBARDIER WILL DO

BOMBARDIER through the local SEA-DOO International Distributor will, during the Warranty Coverage Period, repair or replace, at its option, all genuine BOMBARDIER part found defective in material and/or workmanship, under normal use, maintenance and service, with a genuine BOMBARDIER part without charge for parts and labor, at any local authorized SEA-DOO SPORT BOAT dealer.

3. CONDITION TO HAVE WARRANTY WORK VALIDATED

The customer must notify a local authorized SEA-DOO SPORT BOAT dealer within two (2) days of the appearance of the defect in material and/or workmanship and present to the servicing authorized SEA-DOO SPORT BOAT dealer the SEA-DOO Warranty Registration Card or a proof of purchase of the NEW and UNUSED 2000 SEA-DOO SPORT BOAT and must sign the repair/work order prior to the start of the repair in order to validate a warranty repair. All parts replaced under this limited warranty become the property of the international distributor of the specific territory and/or BOMBARDIER.

4. EXCLUSIONS — ARE NOT WARRANTED

- The engine and corresponding components which are warranted by Mercury Marine. Refer to *Mercury Marine (M²) Jet Drive Operator's Guide*.
- Normal wear and tear items;
- Labor, parts and lubricant costs of all maintenance services;
- Damage caused by failure to provide proper maintenance and/or storage, as described in the "2000 SEA-DOO SPORT BOAT *Operator's Guide*";
- Damage resulting from improper repairs, modifications or use of non-approved parts or repairs done by a non-authorized SEA-DOO SPORT BOAT dealer;
- Damage resulting from abuse, misuse, neglect, racing;
- Damage resulting from accident, fire, theft, vandalism or any act of God;
- Incidental or consequential damages, or damages of any kind such as but not limited to towing charges, telephone calls or taxi;

- Water damages caused by water ingestion;
- Damage related to gel coat finish including but not limited to cosmetic gel coat finish, blisters or fiberglass delamination caused by blisters, crazing, spider or hairline cracks; and
- Damages resulting from improper service or maintenance.

5. LIMITATIONS OF LIABILITY

This warranty gives you specific rights, and you may also have other legal rights resulting from the application of mandatory national laws which may vary from country to country. **WHERE APPLICABLE, THIS WARRANTY IS EXPRESSLY GIVEN AND ACCEPTED IN LIEU OF ANY AND ALL OTHER WARRANTIES, EXPRESSED OR IMPLIED, INCLUDING WITHOUT LIMITATION ANY WARRANTY OF MERCHANTABILITY OR FITNESS FOR ANY PARTICULAR PURPOSE.**

In no event shall BOMBARDIER be liable for special, consequential or incidental damages, including but not limited to loss of use and transportation costs. Some countries do not allow the exclusion or limitation of incidental or consequential damages, or limitations on how long an implied warranty lasts, so the above limitation or exclusion may not apply.

Neither the SEA-DOO International Distributor, the authorized SEA-DOO SPORT BOAT dealer nor any other person has been authorized to make any affirmation, representation or warranty other than those contained in this warranty, and if made, such affirmation, representation or warranty shall not be enforceable against BOMBARDIER or any other person.

Every SEA-DOO SPORT BOAT is sold with the English version of this warranty. A specific SEA-DOO International Distributor may elect to translate this warranty into local language, it is then understood and agreed that in the event of any discrepancies or inconsistencies between the two versions, the English version shall prevail.

It is the customer's responsibility to ensure that the SEA-DOO SPORT BOAT complies with all boating regulations and standards of any country, other than the original country of sale, where the SEA-DOO SPORT BOAT is intended to be used.

BOMBARDIER reserves the right to modify this warranty at any time, being understood that such modification will not alter the warranty conditions applicable to the SEA-DOO SPORT BOAT sold while this warranty is in effect.

6. TRANSFER

If the customer sells the sport boat guaranteed under the present, he shall assign and transfer this warranty, which shall be valid for the rest of the relevant PERIOD as defined in section 1 hereinabove, to the new customer.

7. CONSUMER ASSISTANCE

- In the event of a controversy or a dispute arising in connection with this BOMBARDIER INTERNATIONAL LIMITED WARRANTY, BOMBARDIER suggests that you try to resolve the issue at the dealership level. We recommend discussing the issue with the authorized dealer's service manager or owner.
- If further assistance is required, the authorized local SEA-DOO INTERNATIONAL DISTRIBUTOR's Service Department should be contacted in order to resolve the matter.
- If the issue has still not been resolved, please submit in writing your complaint to:

BOMBARDIER RECREATIONAL PRODUCTS
SPORT BOATS
INTERNATIONAL SERVICE DEPARTMENT
VALCOURT QUEBEC J0E 2L0
CANADA

MARCH 1999

® Registered trademark of Bombardier Inc. and/or subsidiaries

REGISTRATION NUMBER LOCATION

All craft are required by federal law to be registered and legally numbered. Due to space availability for proper display of registration number, refer to the following illustration for location. The registration number should appear on each side of the craft.

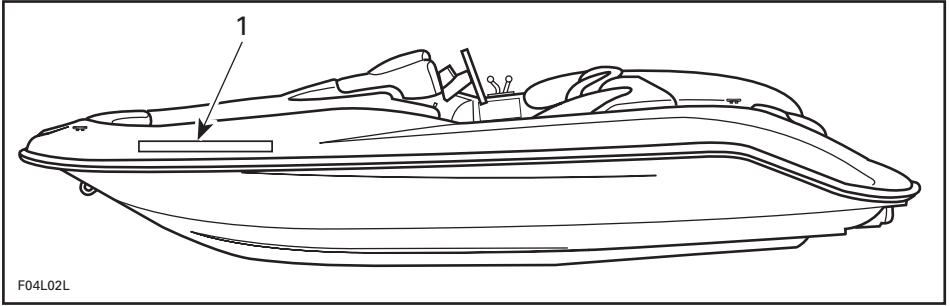

TYPICAL

1. *Registration number location*

LOCATION OF THE IMPORTANT LABELS

Please read the following labels carefully before operating this craft.

Sportster* 1800 and Challenger* 1800 Models

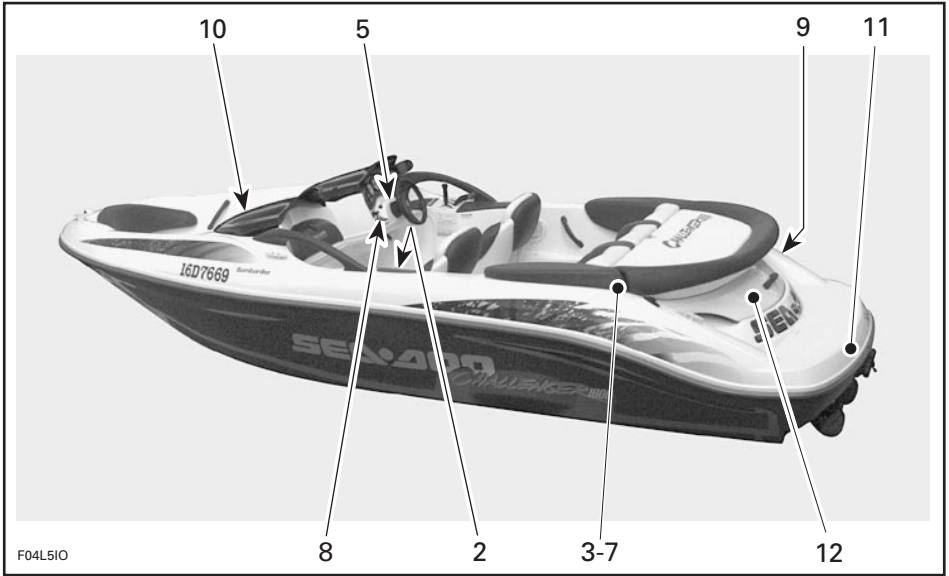

Speedster* and Speedster SK Models

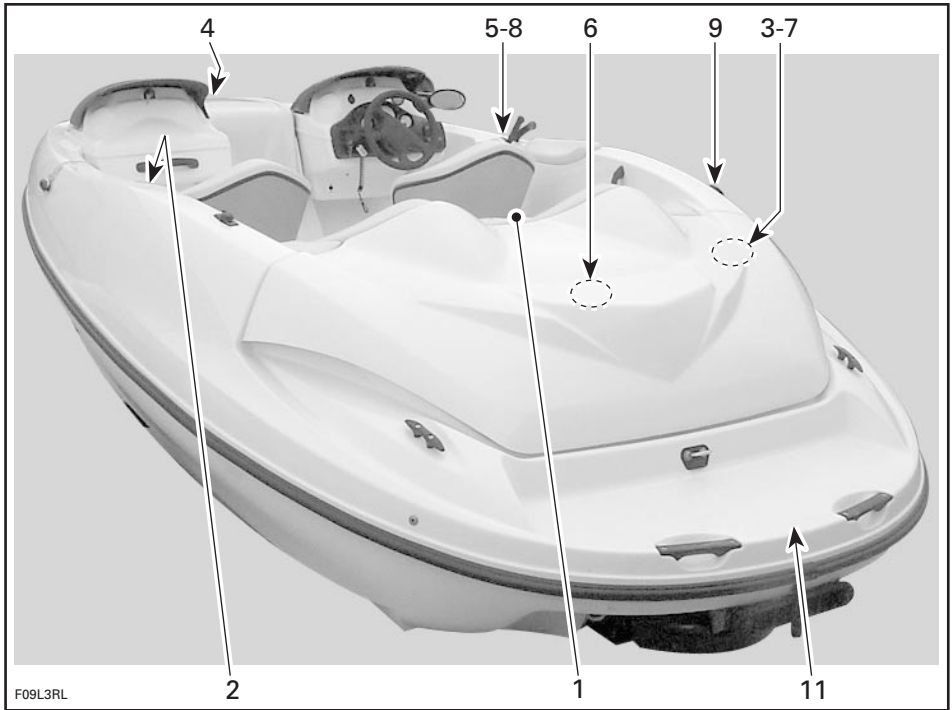

F09L3RL

TYPICAL — SPEEDSTER SHOWN

Label 1

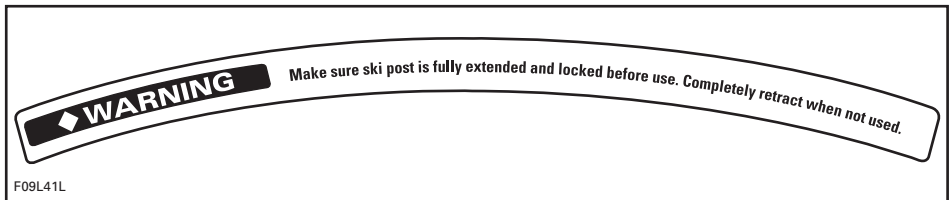

F09L41L

Label 2



F09L2KZ

TYPICAL — REFER TO ACTUAL LABEL ON CRAFT

Label 3

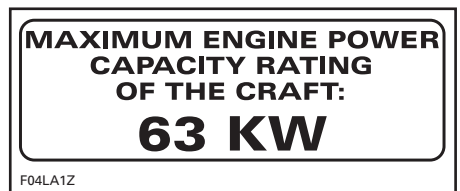

F04LA1Z

TYPICAL — REFER TO ACTUAL LABEL ON CRAFT

Label 4

◆ WARNING

Do not allow children in or near bow storage compartment.

F09L40Y

Label 5

◆ WARNING

Read and follow warning labels and operator guide/safety handbook before operating. Severe injury or death can result from ignoring warnings or through improper use of this sport boat.

- Check throttle/shifter controls and steering position before starting engine.
- Directional control is reduced when throttle is released and lost when engine is off.
- Do not splash others or jump waves or wakes with this sport boat.
- Operator and passengers should always wear approved life vests and recommended clothing.
- Do not operate if passengers are not properly seated and using handgrips, or if visibility is obstructed. Do not allow passenger(s) on bow seat above idle speed or rough/choppy water.
- Properly attach safety lanyard to your life vest.
- Keep a safe distance from all other water users. Be aware of all boating regulations.

F09L3ZY

Label 6

◆ WARNING

Make sure the hand spring plunger is engaged in the ski post and the ski post is fully retracted and locked under the wakeboard extension before use. Remove and store when not in use.

F09L4ZY

Label 7

◆ WARNING

Do not boost battery. Servicing of electrical components should be done by dealer only.

F04L8M0

Label 8

◆ WARNING

Gasoline vapors can explode. Before starting engine, operate blower for **5** minutes and check engine compartment bilge for gasoline vapors.

F04L8N0

Label 9

◆ WARNING

While fueling, stop engine(s). Fuel tank may be pressurized. Slowly turn cap when opening. Keep watercraft level. Do not overfill. Use regular unleaded gasoline. Check oil level. Periodically, verify fuel system.

F04L800

Label 10

◆ WARNING

Do not sit in bow seats above idle speed or rough/choppy water.

F04L8P0

Label 11

◆ WARNING

Engine(s) must be off when using platform. Keep away from jet(s) or intake grate(s).

F04L8Q0

Label 12

Emission Control Information BOMBARDIER RECREATIONAL PRODUCTS

THIS ENGINE IS CERTIFIED TO OPERATE ON UNLEADED GASOLINE AND CONFORMS TO 1999 U.S. EPA REGULATIONS FOR MARINE SI ENGINES.

ENGINE FAMILY: XXX
 FEL: XXX GM/KW-HR HC + NO_x
 ENGINE DISPLACEMENT: XXX CC
 EXHAUST EMISSION CONTROL SYSTEM: XXX

TUNE-UP SPECIFICATIONS

IDLE SPEED: XXX RPM ± 200
 SPARK PLUG TYPE: XXX
 SPARK PLUG GAP: XXX IN.

F00L0J1

TYPICAL — REFER TO ACTUAL LABEL ON ENGINE

IDENTIFICATION NUMBERS

The main components of the craft (engine and hull) are identified by different serial numbers. It may sometimes become necessary to locate these numbers for warranty purposes or to trace the craft in the event of theft.

Hull

The Hull Identification Number (H.I.N.) is located on the right side of the transom.

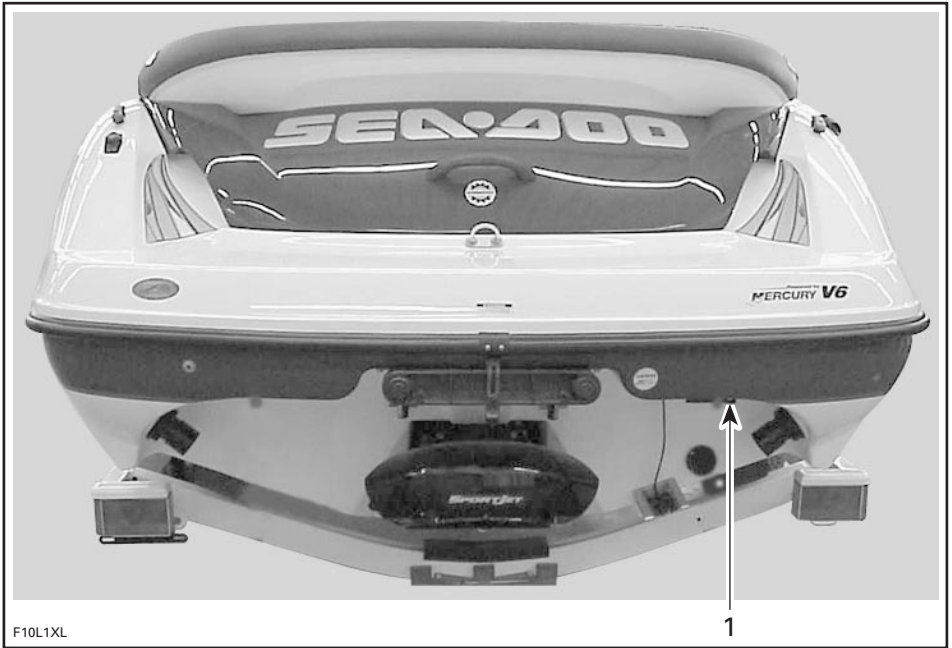

TYPICAL

1. Hull Identification Number (H.I.N.)

Engine

Refer to *Mercury Marine (M²) Jet Drive Operator's Guide*.

CONTROLS AND COMPONENTS LOCATION

Cockpit

Speedster and Speedster SK Models

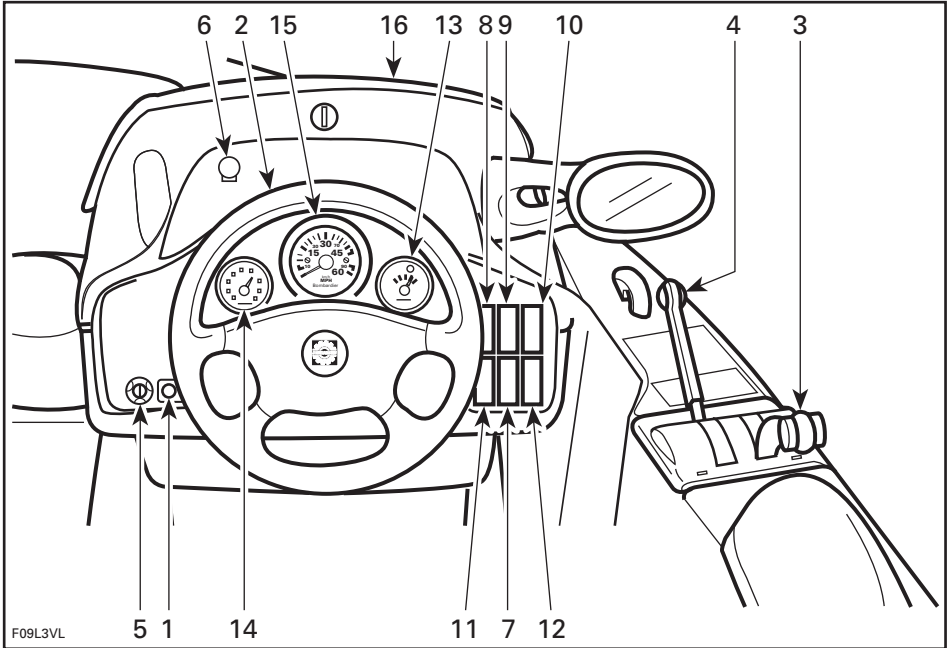

TYPICAL — COCKPIT VIEW

Sportster 1800 and Challenger 1800 Models

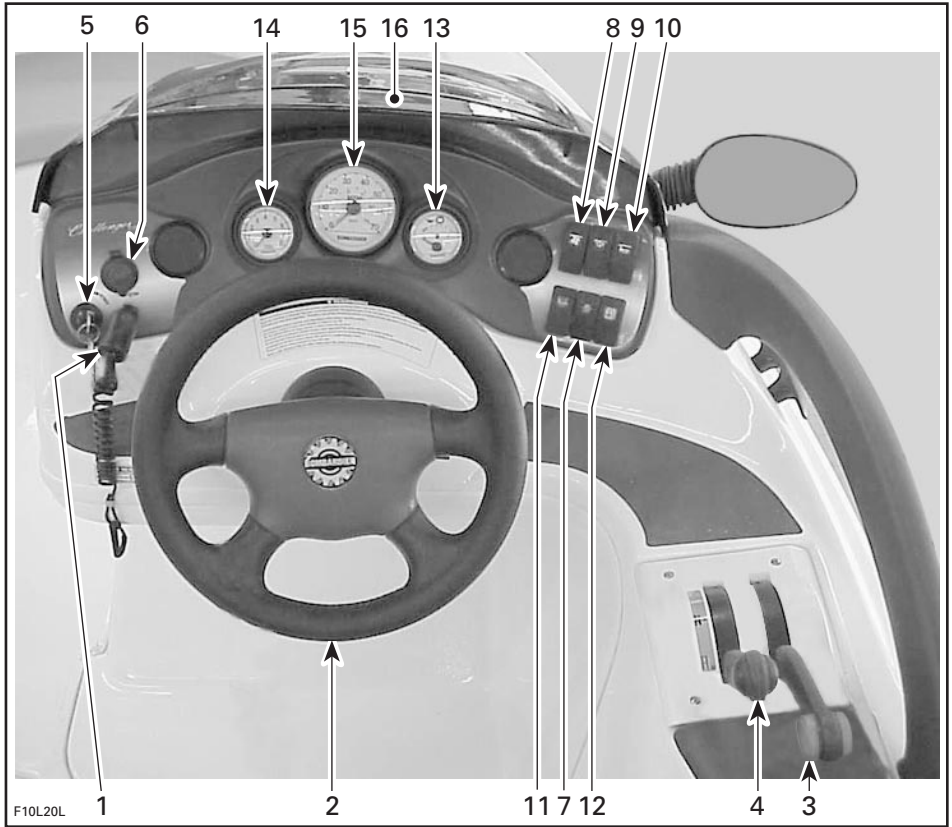

TYPICAL — COCKPIT VIEW

Overview

Speedster and Speedster SK Models

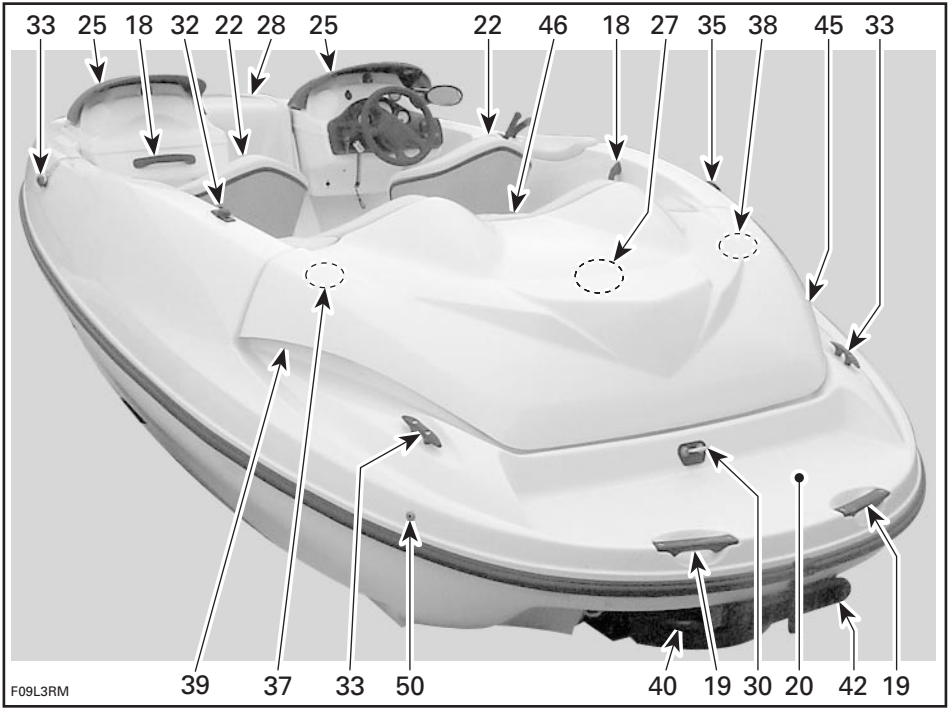

TYPICAL — SPEEDSTER SK TOP/SIDE VIEW

Sportster 1800 and Challenger 1800 Models

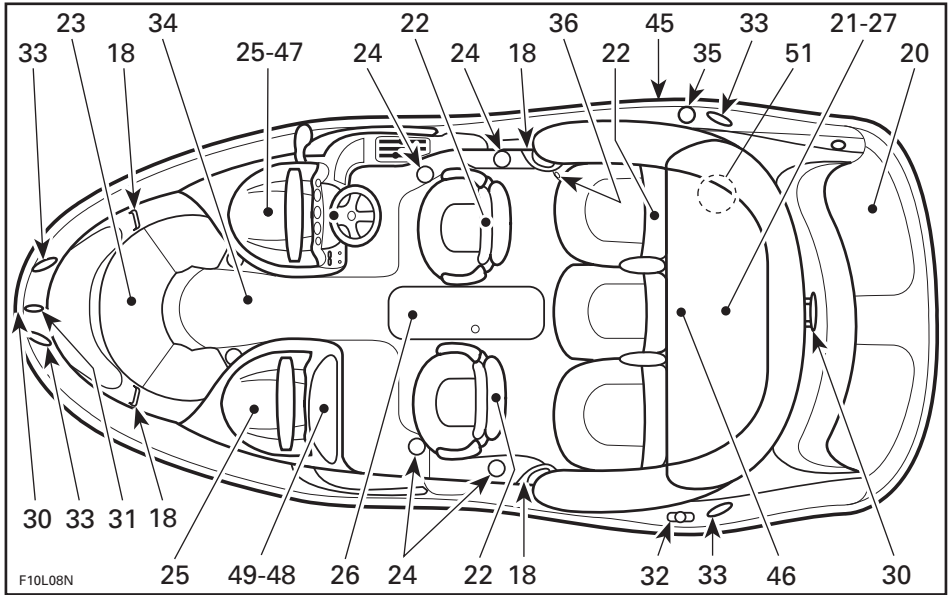

TYPICAL — CHALLENGER 1800 TOP VIEW

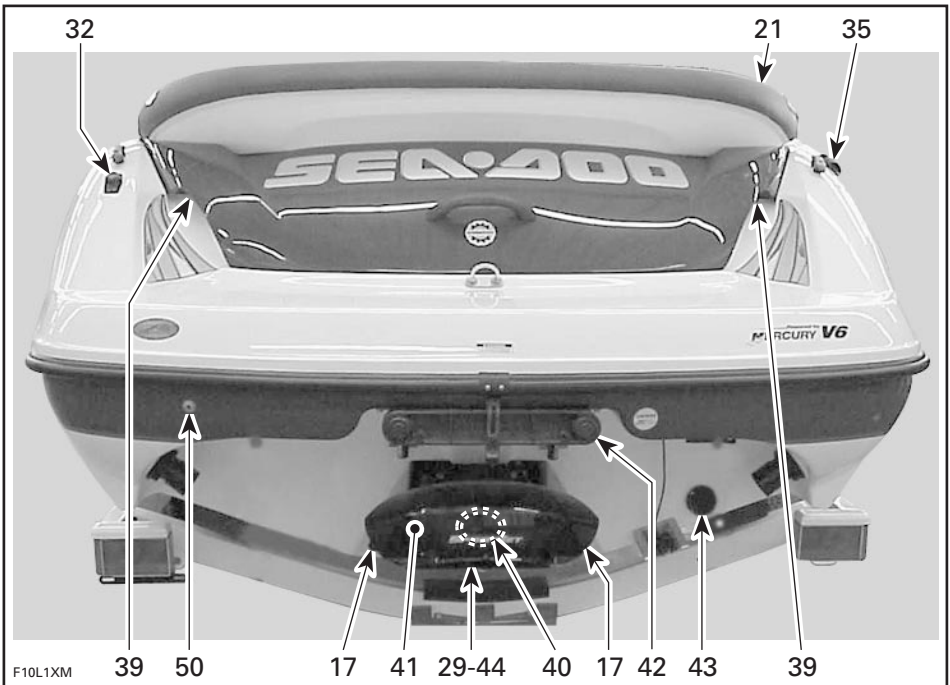

TYPICAL — SPORTSTER 1800 REAR VIEW

1. Safety Lanyard
2. Steering Wheel
3. Throttle Lever
4. Shift Lever
5. Ignition Switch
6. 12-Volts Accessory Jack
7. Navigation Light Switch
8. Bilge Pump Switch
9. Bilge Air Blower Switch
10. Horn Switch
11. Deck Light Switch
12. Low-Fuel Warning System Switch
13. Fuel Gauge/Low Oil Level Pilot Lamp and Beeper
14. Tachometer
15. Speedometer
16. Wind Deflector
17. Bilge Drain Plug
18. Grab Handles
19. Rear Grab Handle(s)
20. Swim Platform
21. Sun Deck (if so equipped)
22. Seats
23. Bow Seat (if so equipped)
24. Cup Holders
25. Right/Left Front Storage Compartment(s)
26. Deck Storage Compartment
27. Rear Storage Compartment
28. Bow Cover (if so equipped)
29. Jet Pump Water Intake
30. Bow and Stern Eyelets
31. Bow Light
32. Removable Stern Light
33. Mooring Cleats
34. Deck
35. Fuel Tank Cap
36. Deck Drain(s)
37. Main Oil Reservoir Cap
38. Flushing Connector
39. Ventilation Ducts
40. Jet Pump Nozzle
41. Reverse Gate
42. Retractable Ladder (if so equipped)
43. Scupper Valve
44. Hydro-Surge Grate System
45. Fuel Tank Vent
46. Ski Post
47. Fuses
48. Radio (if so equipped)
49. Glove Box (if so equipped)
50. Water Bypass System
51. Main Battery Cut-Off Switch

1) Safety Lanyard

The safety lanyard cap should be securely snapped onto its switch to be fully operational.

Pulling the safety lanyard cap from the switch stops the engine operation. Attach the safety lanyard to the operator's Personal Flotation Device (PFD) and snap the cap to the switch to be able to start the engine.

WARNING

Should the safety lanyard cap become loose or fails to remain on its switch, replace it immediately.

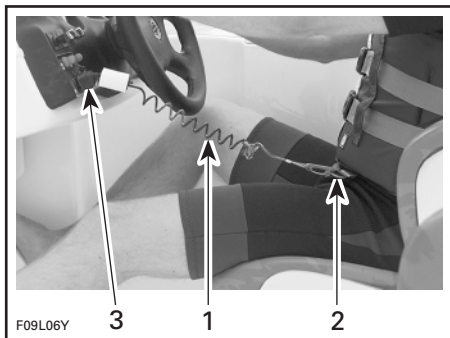

TYPICAL

1. Safety lanyard
2. Secure to PFD
3. Snap to safety lanyard switch

⚠ WARNING

Directional control is reduced when throttle is released and lost when engine is off. Always disconnect safety lanyard when leaving craft.

⚠ WARNING

Do not lubricate the safety lanyard switch.

⚠ WARNING

While engine can be stopped using the ignition switch, good driving habits recommend that the safety lanyard also be disconnected when stopping.

2) Steering Wheel

The steering wheel controls the direction of the craft. Turning the steering wheel clockwise steers the craft to the right and inversely.

⚠ WARNING

Check steering and corresponding steering nozzle operation before starting.

Low-Speed Steering Control System

Whenever the throttle lever is in **idle position** and the steering wheel is approaching the end of its rotation, the engine speed will be slightly accelerated to increase the jet pump thrust and thus improving the steering control for low speed operation and when approaching/leaving a dock. Refer to OPERATING INSTRUCTIONS for more details.

3) Throttle Lever

When pushed forward craft accelerates. When fully pulled back, engine return to idle speed and the craft is gradually stopped by water drag.

NOTE: To activate throttle lever, shift lever must be in forward or reverse position.

⚠ WARNING

Check throttle lever operation before starting the engine.

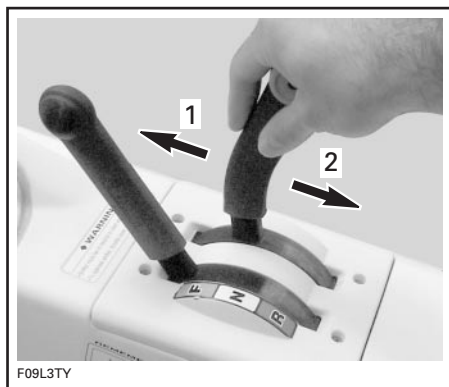

TYPICAL

1. Increase speed
2. Decrease speed

4) Shift Lever

A 3-position lever:

- forward
- neutral
- reverse

In order to shift, throttle lever must be fully pulled back to idle speed.

Shift lever must be in neutral position to allow engine starting.

NOTE: With throttle lever at idle and shift lever in neutral position throttle lever should be locked.

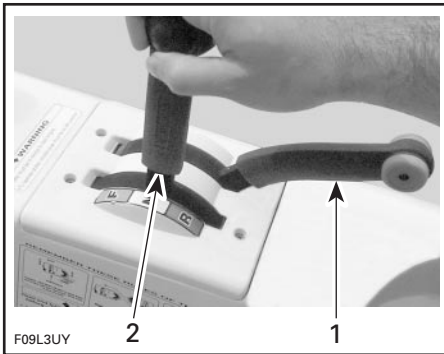

TYPICAL

1. Throttle lever back to idle position
2. Shift lever in neutral position

NOTE: To ease shifter use, line up the shifter arrow with the appropriate dot (Forward/Neutral/Reverse).

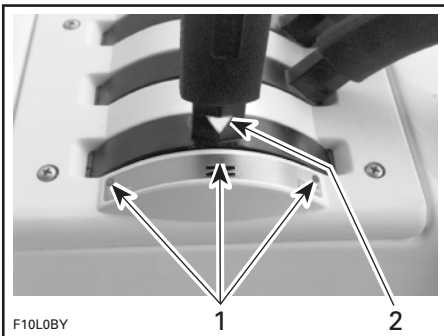

TYPICAL

1. Dots besides shifting position
2. Arrow on shifter

WARNING

Shift lever should only be used when the engine is idling and craft is completely stopped.

WARNING

Only use reverse at slow speed and for the shortest time possible. Always ensure the path behind is clear of obstacles, swimmers and children playing in shallow water.

CAUTION: Never rev the engine at high RPM in reverse.

5) Ignition Switch



TYPICAL

1. Ignition switch

Starting and Stopping

Refer to *M² Jet Drive Operator's Guide* for complete detailed procedure.

WARNING

Directional control is not available when engine is off.

6) 12-Volts Accessory Jack

Located in dashboard. A 12-volts jack to plug temporary accessories.



TYPICAL — SPEEDSTER SHOWN

Lift protection cap to expose jack.

Using the accessory jack for a prolonged time without engine running may discharge the battery.

Close protection cap when jack is not in use to protect against weather inclemency.

Challenger 1800 Only

A supplemental 12-volts jack is located in glove box.

7) Navigation Light Switch

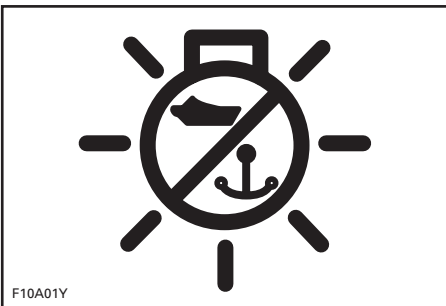

A 3-position NAV/OFF/ANC push type switch.

Press switch to first position to turn on the stern light (anchorage position).

Press switch to second position to turn on the bow and stern lights.

Press to OFF position to turn off navigation lights.

NOTE: Switches and gauges are lit when navigation lights are turn on.

Navigation lights should always be used between sunset and sunrise. Ensure the stern light is installed. See **Removable Stern Light** in this section for location and installation.

NOTE: The navigation lights may be operated without the safety lanyard on its switch.

8) Bilge Pump Switch

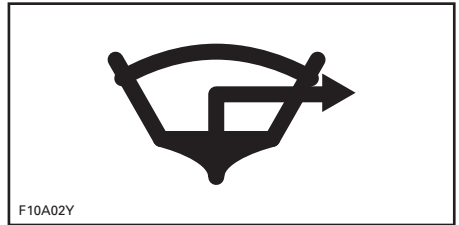

A 2-position push type switch.

Press switch to ON position when a manual operation is required (after cleaning, storage, etc.).

Press to OFF position when bilge is dry.

CAUTION: Do not operate for prolonged time if the bilge is dry, battery drainage will occur.

NOTE: The bilge pump may be operated without the safety lanyard on its switch.

CAUTION: Ensure to always turn pump OFF when bilge is dry or before operating the engine above idle. Bilge pump will then switch to automatic mode.

Automatic Bilge Pump

An automatic bilge pump will evacuate water from the bilge. A water sensor detects the water which activates the bilge pump. After the water is pumped out, the pump shuts-off automatically. This automatic mode is working at all times: with/without safety lanyard on its switch and with/without engine running.

CAUTION: Bear in mind that when the main battery cut-off switch is turned OFF while craft is moored, the bilge pump will not start if water comes up in the bilge.

9) Bilge Air Blower Switch

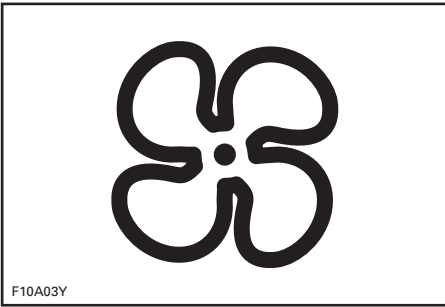

A 2-position push type switch. When ON, it ventilates the engine compartment.

Press switch to ON position to turn on the blower.

Press the switch to OFF to turn off the bilge blower.

WARNING

Always use blower for a minimum of 5 minutes prior to engine starting then, turn it OFF above idle speed. Use of the bilge blower should never replace "smelling" for gasoline vapors.

Using the bilge blower for a prolonged time when the engine is not running will discharge the battery.

Blower should be turned off during boat operation.

10) Horn Switch

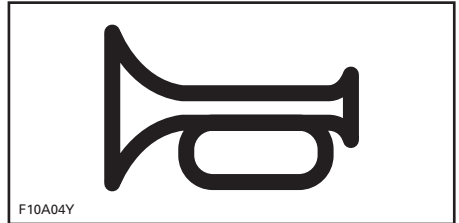

A 2-position push type switch.

Press and hold the switch to activate horn.

Release the switch to stop horn.

11) Deck Light Switch

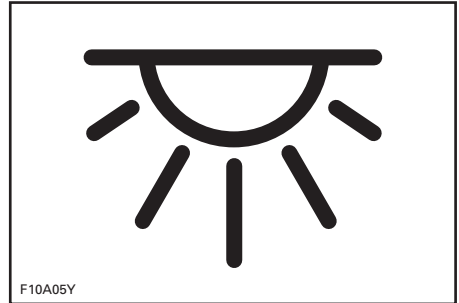

A 2-position push type switch.

Press switch to ON position to turn on the deck lights.

Press switch to OFF position to turn off the deck lights.

Using the deck lights for a prolonged time when the engine is not running will discharge the battery.

12) Low-Fuel Warning System Switch

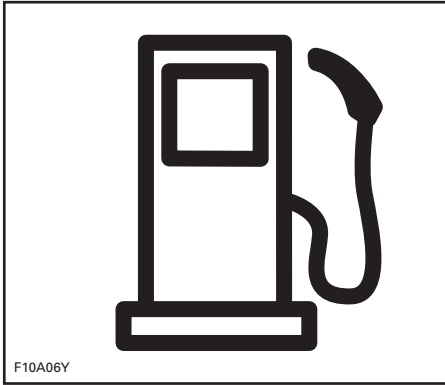

A 2-position push type switch.

When the fuel tank level is low, a beeper will sound and the pilot lamp on the switch will flash to advise the operator.

Press the switch to stop the beeper and turn off the pilot lamp.

From that point, approximately 10% of the fuel tank capacity is left.

WARNING

Always refill the fuel tank when low-fuel light comes on or before.

13) Fuel Gauge/Low Oil Level Pilot Lamp and Beeper

Fuel Gauge

Located in dashboard, the analog gauge continuously indicates the amount of fuel in fuel tank when engine is running.

The gauge is illuminated whenever the navigation lights are used.

NOTE: The fuel level can also be verified without having engine running. With the safety lanyard removed from its switch, turn ignition switch to ON position; the gauge will be activated.

CAUTION: Always turn ignition switch to OFF position once fuel level has been checked.

Low Oil Level Pilot Lamp and Beeper

The pilot lamp and the beeper turn on when the oil level is low in engine mounted oil reservoir or if a wire/connector of this electrical circuit is not properly connected. Fill reservoir as soon as possible or contact an authorized dealer if light or beeper remain on.

CAUTION: Never run engine out of oil. Serious engine damage will occur.

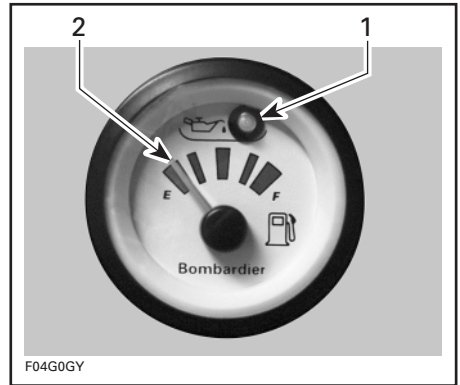

TYPICAL

1. Low injection oil level pilot lamp
2. Fuel level

14) Tachometer

Analog tachometer indicates the revolutions per minute (RPM) of the engine. Multiply reading by 1000 to obtain actual RPM.

The gauge is illuminated whenever the navigation lights are used.

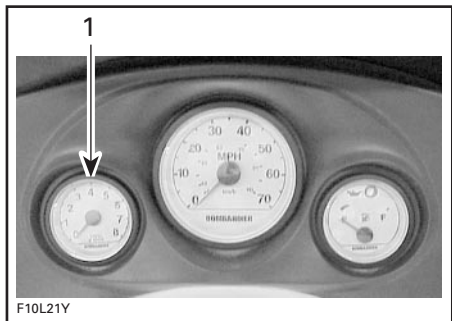

F10L21Y

TYPICAL

1. Tachometer

15) Speedometer

Analog speedometer indicates the speed of the craft in miles per hour (MPH) and kilometers per hour (km/h).

The gauge is illuminated whenever the navigation lights are used.

A speed sensor mounted on the hull near Mercury M² Jet Drive sends the signal to the speedometer.

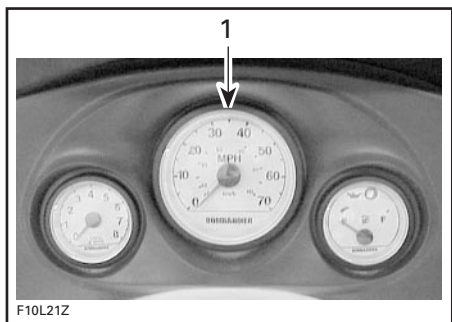

F10L21Z

TYPICAL

1. Speedometer

Speedster SK Model

This craft is equipped with a water ski performance oriented speedometer. Two performance zones to help driver in speed control when towing a water skier.

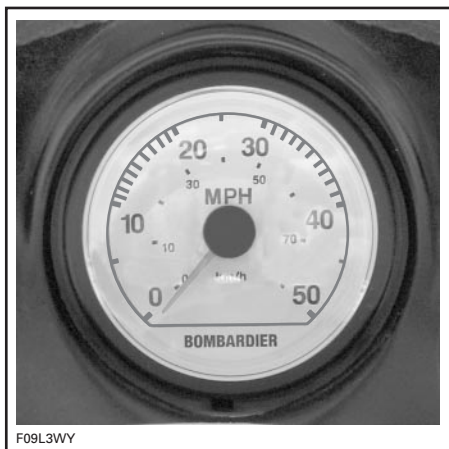

F09L3WY

16) Wind Deflector

For your convenience, a movable deflector may be used to divert the air flow. Pull latch then lift the deflector until locked by the retaining device. When finished, lower deflector then push down to relatch.



F10L0EY

TYPICAL

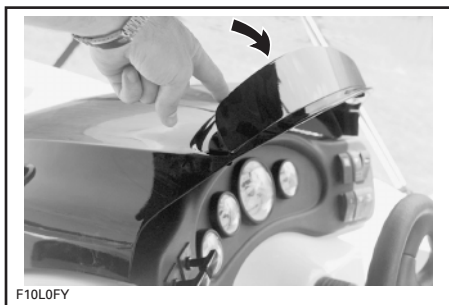

F10L0FY

TYPICAL

17) Bilge Drain Plugs

Should water be found in the bilge, it can be easily drained by unscrewing the drain plugs.

WARNING

Make sure drain plugs are properly secured prior launching the craft in water.

Tilt the craft slightly to the rear so that the water can completely flow out of the bilge.

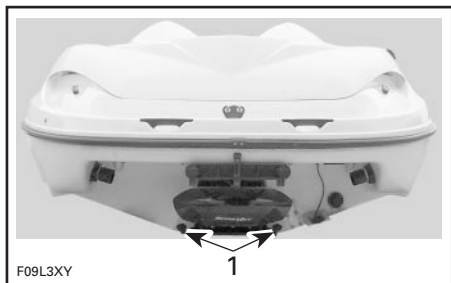

TYPICAL

1. Drain plug

18) Grab Handles

Provide a handhold for the passengers.

CAUTION: Never use the grab handles to pull anything or to lift the craft.

Refer to components location illustrations at the beginning of this section for grab handles location.

19) Rear Grab Handle(s)

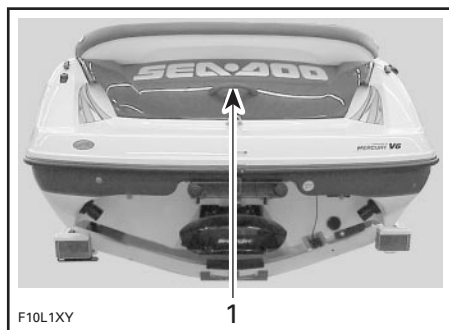

TYPICAL — SPORTSTER 1800 SHOWN

1. Grab handle

Provides a handhold for boarding when needed.

CAUTION: Never use the grab handle to tow anything or to lift the craft.

20) Swim Platform

Provides an anti-skid surface for easy boarding from rear of craft.

WARNING

Engine must be off when using platform. Keep away from jet or intake grate.

21) Sun Deck (if so equipped)

A convenient space to rest or take some sun while anchored.

WARNING

Do not start or operate the craft if a person or more is seated on the sun deck or swim platform.

22) Seats

Each passenger should be seated while underway.

WARNING

Allow no one to sit on edge of craft or stand up while in operation. Seat/grab handles should be used in rough waters.

Speedster, Speedster SK and Challenger 1800 Models

For your convenience, front seats are provided with grab handles molded in the seat base.

Both front seats are swivels.

To unlock swivel, pull lever toward front in a rotating movement. Turn seat at the desired position. The seat can be locked in steps of 45°. To lock swivel, release lever.

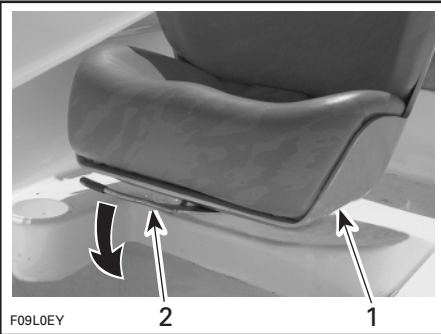

TYPICAL — SPEEDSTER AND SPEEDSTER SK SHOWN

1. Grab handles molded in seat base
2. Swivel control lever

With this feature, the front passenger seat can be rotated backward to be used as a spotter seat.

WARNING

Always ensure swivel is locked before riding. Seat must also face steering wheel.

Challenger 1800 Only

Both front seats are adjustable fore and aft.

For the fore and aft adjustment, lift lever to unlock seat. Move seat at the desired position. Release lever after adjustment is completed.

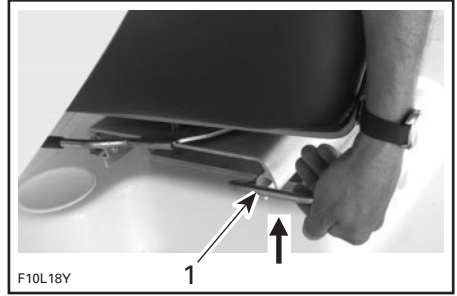

1. Fore and aft control lever

NOTE: It is necessary to move the seat completely forward to allow a rotation of 180° (half a turn).

23) Bow Seat (if so equipped)

Located at front of craft, it is provided as a sun seat.

WARNING

No passenger should use this seat except when the craft is stopped or under idle speed.

Use grab handles as necessary.

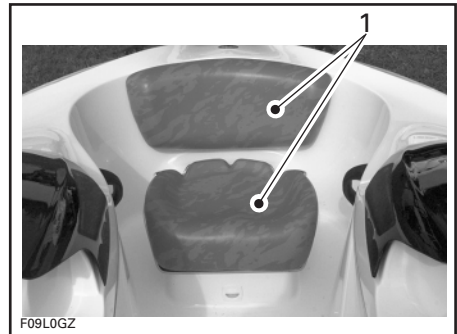

TYPICAL — SPEEDSTER SHOWN

1. Bow seat

Storage Compartments

Speedster Only

Bow Seat

Lift backrest of bow seat to expose storage compartment.

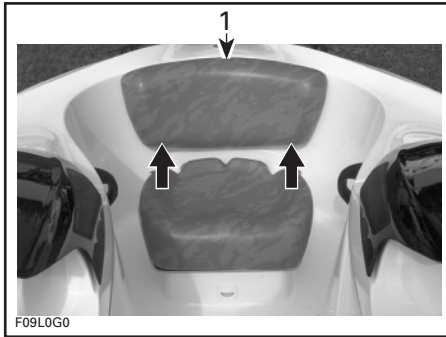

1. Lift backrest

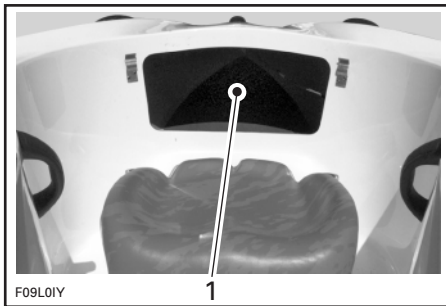

1. Storage compartment behind backrest

When reinstalling backrest, firmly slide its slots over the retaining brackets. Ensure backrest is properly locked.

Sportster 1800 Only

Bow Seat

Lift bow seat to expose storage compartment. Pay attention to the retaining strap when laying down seat.

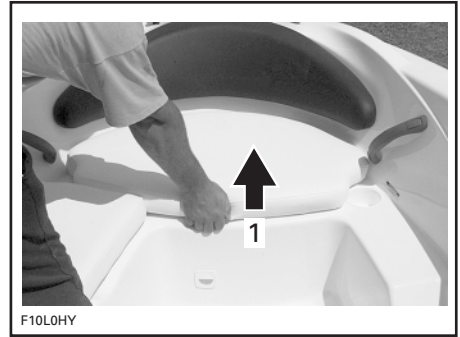

1. Lift seat



When reinstalling seat, slide it so that its base goes under the two stoppers then push down to properly latch.

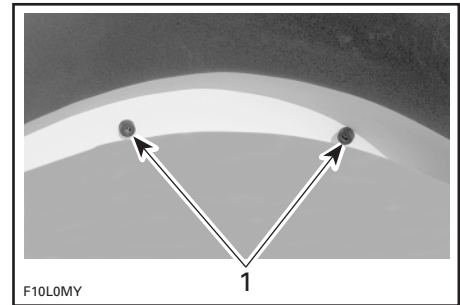

1. Slide seat under stoppers

Side Seat

Lift side seat to expose storage compartment. Pay attention to the retaining strap when laying down seat.



A holder is provided to store an approved fire extinguisher.

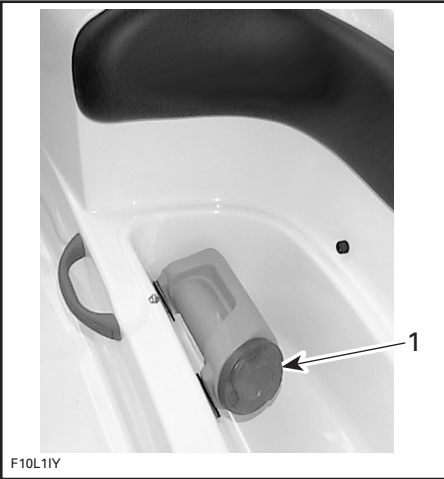

1. Extinguisher holder

The fire extinguisher (sold separately) should not be loose in the storage compartment.

When finished, reinstall seat as described for bow seat above.

Side Seat Backrest

Pull backrest a small amount to unlatch then gently rotate clockwise.

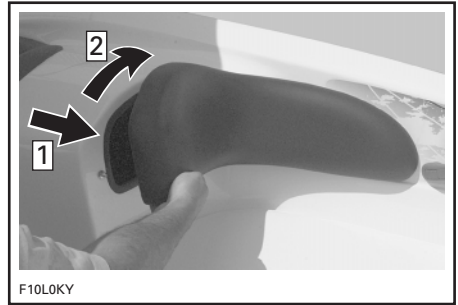

Step 1: Pull a small amount to unlatch

Step 2: Gently rotate clockwise

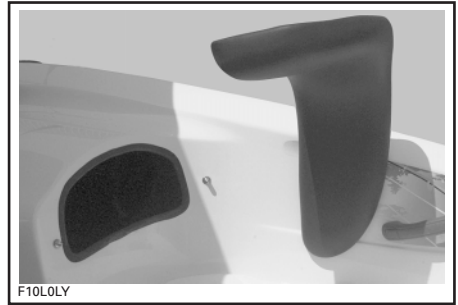

When finished, rotate backrest to cover storage compartment opening then push backrest to properly latch.

24) Cup Holders

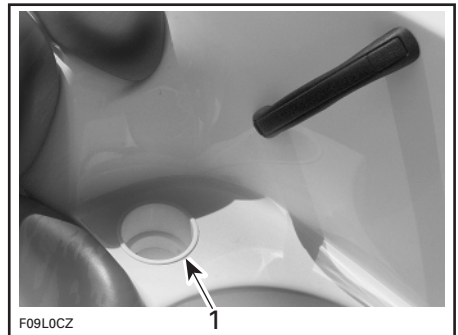

1. Cup holder

Convenient locations for non-alcoholic beverages.

⚠ WARNING

Do not drink alcoholic beverages while aboard. Do not keep bottles, cans etc. in cup holders while riding at speed and/or on rough waters.

25) Right/Left Front Storage Compartment(s)

A convenient watertight, lockable storage compartment with a removable basket to carry personal articles. The basket is the ideal location for spare spark plugs, first aid kit, etc.

⚠ WARNING

Never leave any heavy or loose breakable objects in the storage basket.

To access the compartment, open the cover using the provided key to unlock the release button.

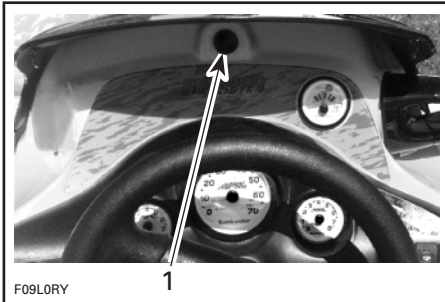

TYPICAL
1. Release button

Press the release button to open cover.

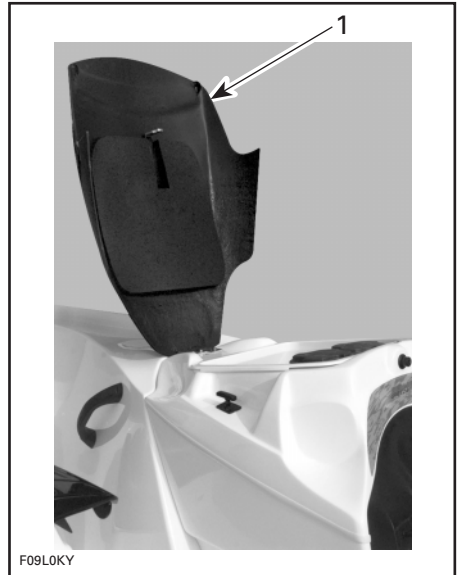

SPEEDSTER AND SPEEDSTER SK
1. Storage cover open

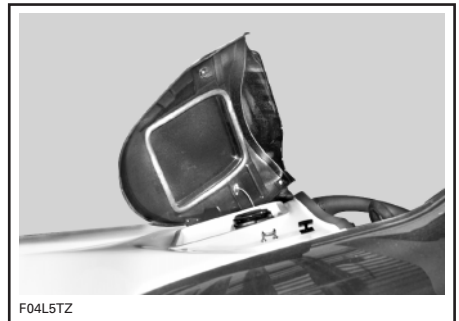

SPORTSTER 1800 AND CHALLENGER 1800

The right side basket is provided with a holder to store an approved fire extinguisher.

The fire extinguisher (sold separately) should not be loose in the storage compartment.

A second holder contains the *Operator's Guides* and can be used to carry personal articles.

The *Operator's Guides* should be kept in a waterproof bag and remains with the craft at all times.

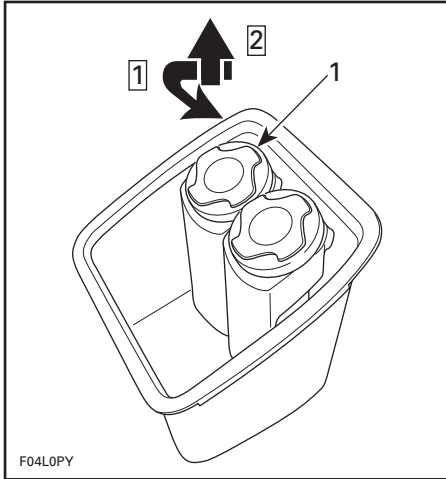

TYPICAL

Step 1: Turn covers counterclockwise to unlock

Step 2: Lift

1. Extinguisher holder

WARNING

Do not remove the basket to have access to increased storage area.

Reinstall basket as shown.



TYPICAL — BASKET INSTALLATION

1. Holders toward rear

Push cover down to release mechanism then move down slowly. When bottomed on latch, firmly push cover to lock.

Periodically verify the lock pin tightness of storage cover. tighten if needed and make sure storage cover latches properly.

WARNING

Never operate the craft with the storage compartment cover open.

Sportster 1800

A convenient watertight, lockable storage compartment with a removable cooler.

The cooler is the ideal location to keep a lunch or beverages.

The opening cover is the same as per the **Challenger 1800** model above.

The cooler contains the *Operator's Guide* which should be kept in a waterproof bag and remain with the craft at all times. It is suggested to place the guide in the storage area underneath the cooler.

Remove the cooler.

The storage area below the cooler can be used to carry large personal articles. Ideal location for sleeping bags, blanket, duffle bags, etc.

Reinstall cooler as shown.

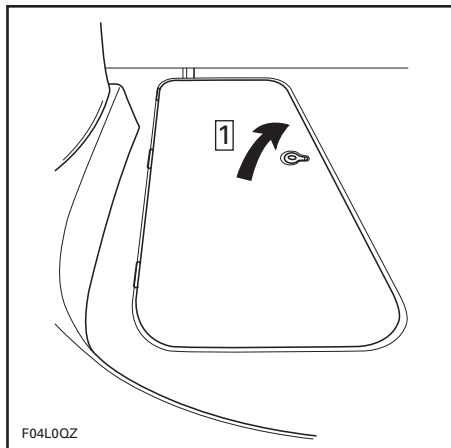

TYPICAL

Step 1: Pull latch and lift cover

Lift the latch ring and open cover gently until stopped by retaining spring.

When completely opened, the cover remains in that position on calm water.

To close, gently push on the side of the spring to release it and lower the cover.



TYPICAL — COOLER INSTALLATION

26) Deck Storage Compartment

The deck storage compartment is a convenient location for water-skis, paddles, anchor and rope, etc.

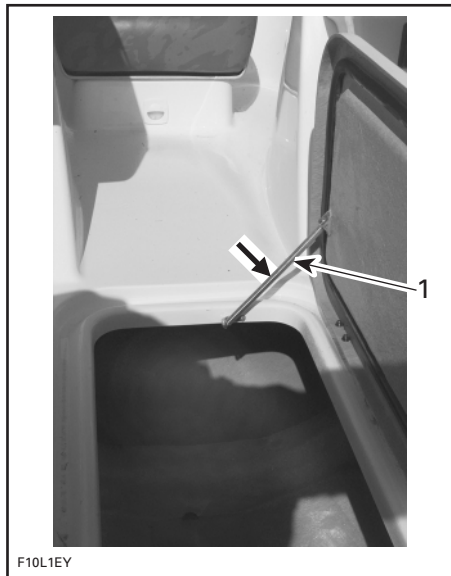

1. Gently push here to release the spring

WARNING

Never operate the craft with the storage compartment cover open.

27) Rear Storage Compartment

Convenient rear storage location to be used to carry large personal articles. Ideal location for spare Personal Flotation Device (PFD), towels, lunch etc.

All Models

To open engine cover, open the right front storage compartment cover and pull lever.

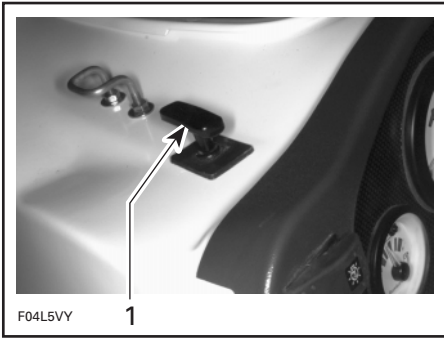

TYPICAL — CHALLENGER 1800 SHOWN
1. Lever

The gas assist cylinders will complete the opening and hold engine cover open.

NOTE: Access to the rear storage compartment is protected only when the right front storage compartment cover is locked.

Storage Tray

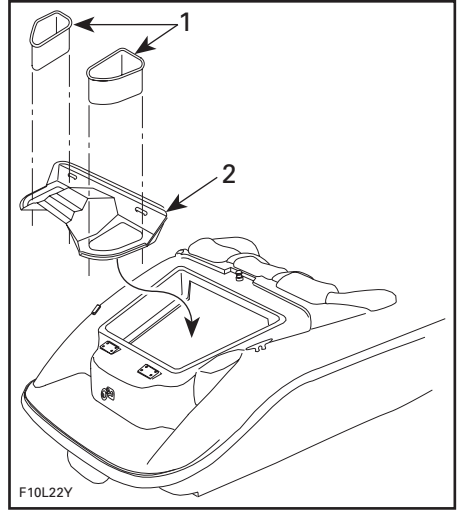

1. Basket
2. Storage tray

CAUTION: In order to avoid damage, **MAXIMUM LOAD** on storage tray must not exceed 22.5 kg (50 lbs).

Two removable baskets are mounted on storage tray. To remove basket, pull it out.

The storage tray is removable to give access to the engine compartment. Grab the handle and lift in a rearward movement.

WARNING

When storage tray is lifted or removed, never touch any electrical part when starting engine or while in operation. Never leave any object, rag or tool in the engine compartment or in the bilge.

Reinstall storage tray then insert both baskets in place.

Firmly close engine cover to relatch.

⚠ WARNING

Never operate the craft with the engine cover open.

28) Bow Cover

Speedster SK Models

To open bow cover pull lever, as shown in the next photo.



F09L2RY

1. Pull lever to lift bow cover

Firmly close bow cover to relatch.

⚠ WARNING

Never operate the craft with the bow cover open.

29) Jet Pump Water Intake

The water is drawn up by the impeller through this opening. It minimizes entry of foreign objects into the propulsion system.

Refer to *M² Jet Drive Operator's Guide* for more detailed information.

30) Bow and Stern Eyelets

Bow Eyelet

Eyelets can be used for mooring, towing and as a tie-down point during transportation.

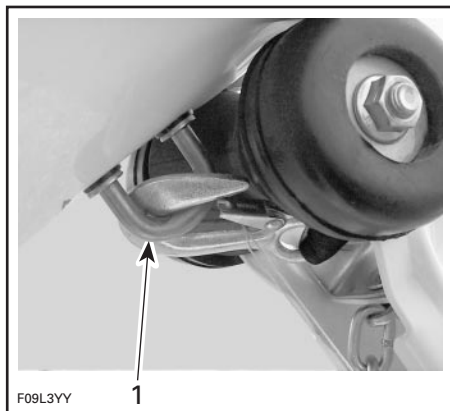

F09L3YY

TYPICAL

1. Bow eyelet

Stern Eyelets

This eyelet allows a rope with a hook, a closes end or an open end to be attached.

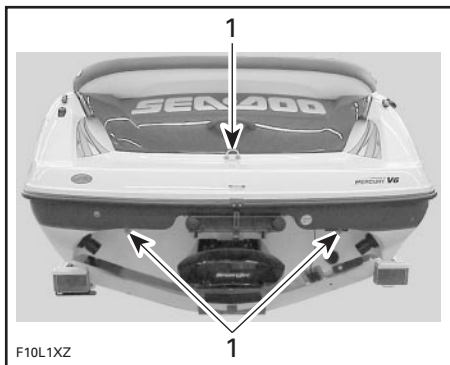

F10L1XZ

TYPICAL

1. Stern eyelets

31) Bow Light

Mandatory red/green light. See **Light Switch** as mentioned earlier in this section.

32) Removable Stern Light

Mandatory stern white light.

It is recommended to keep it in rear storage compartment at all times except when needed.

To remove from engine cover, pull it out. Snap in place to store again.

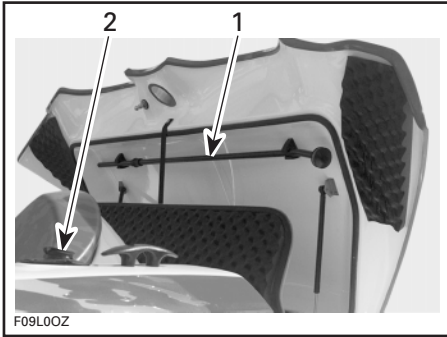

TYPICAL

1. Stern light storage location
2. Stern light operation position

Installation

- Lift connector cap.
- Insert post in connector hole. Ensure to align hole keyway with post screw head.
- Firmly push downward to engage terminals.
- Push lock ring downward. Turn until locked. It may be necessary to slightly turn it to allow its insertion in the hole.
- Check light operation. See Navigation **Light Switch** as mentioned earlier in this section.

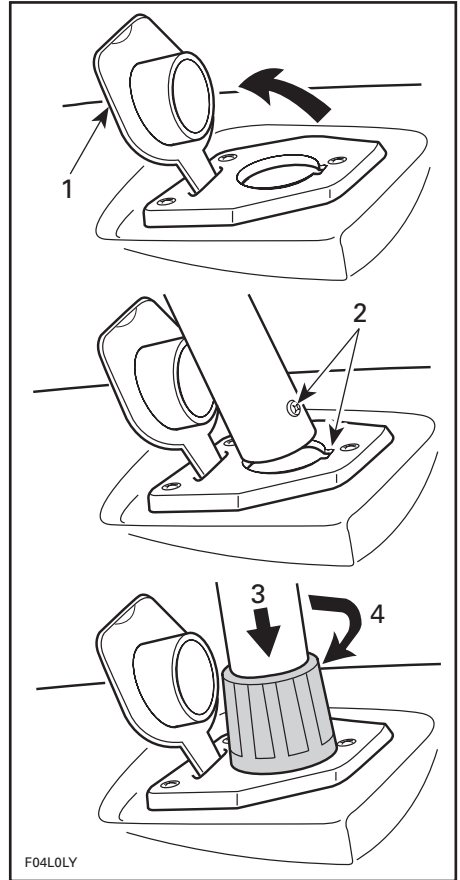

TYPICAL

1. Lift
2. Align screw in groove
3. Push downward
4. Turn to lock

CAUTION: Ensure dielectric grease is present in connector area of light to prevent corrosion.

33) Mooring Cleats

When mooring to a dock, it is recommended to secure with both front and rear cleats. The use of dock lines with sealed air fenders is recommended to protect your craft.

CAUTION: Never use mooring cleats to pull or lift the craft.

34) Deck

Flat surface of craft, should be kept clean and clear.

35) Fuel Tank Cap

Unscrew the cap counterclockwise. Reinstall cap and fully tighten after fueling.

WARNING

Never use a lit match or open flame to check fuel level.

36) Deck Drain(s)

It provides drainage of water from rain, deck washing, water splashing, etc. Keep clean to avoid clogging.

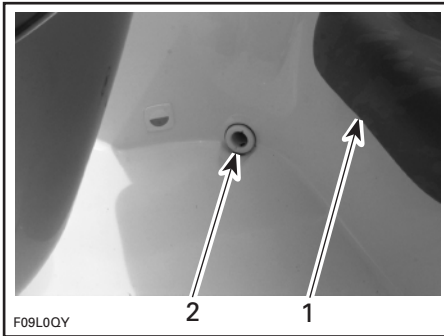

TYPICAL

1. Rear seat
2. Deck drain

37) Main Oil Reservoir Cap

Open the engine cover to expose the oil cap. The cap is located under the engine cover.



To add injection oil in the reservoir, unscrew the cap counterclockwise. Add oil to level mark. Do not overfill. Reinstall cap and fully tighten.

CAUTION: Oil system must be pressurized. Always ensure that reservoir caps are firmly tighten. Refer to *M² Jet Drive Operator's Guide* for recommended oil and complete reservoirs filling procedure.

38) Flushing Connector

Refer to *M² Jet Drive Operator's Guide* for proper use.

For your convenience, flushing connector is located under engine cover. Lift cover, the flushing connector is on starboard side of the storage compartment.

39) Ventilation Ducts

This is where air flows to supply engine and ventilate engine compartment. They should never be obstructed.

40) Jet Pump Nozzle

Turns side to side via input from the steering wheel. This provides directional control when engine is running.

WARNING

Never use nozzle as a supporting point to board the craft or to lift it.

41) Reverse Gate

When selecting the neutral or reverse position with the shift lever, the reverse gate moves up or down to obtain the desired position.

WARNING

Never use gate as a supporting point to board the craft. Do not reverse while at speed.

42) Retractable Ladder (if so equipped)

Located under swim platform.

A convenient ladder to help reboarding the craft.

WARNING

Engine should be OFF when using ladder. Keep limbs away from jet or intake grate. Stay on center of the ladder. Only one person at the time on the ladder. Never use the ladder for pulling, towing, diving or jumping, boarding a craft that is out of water or any other purpose other than a ladder.

Pull latch to unlock the ladder.

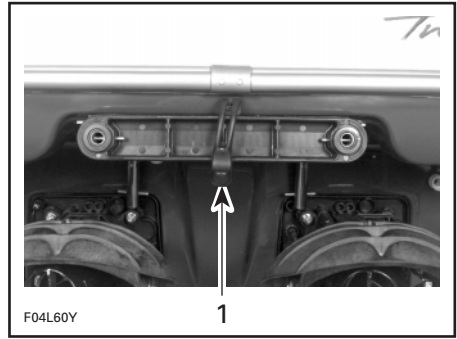

TYPICAL

1. Latch

Slide ladder toward rear, then push down.

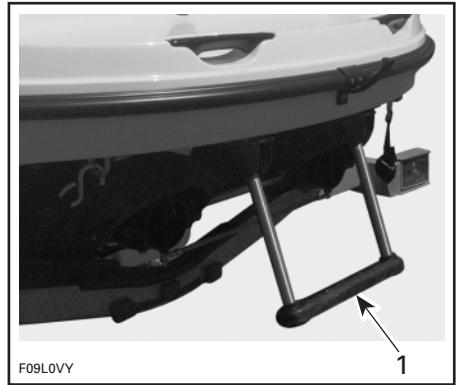

TYPICAL

1. Ladder lowered

To store ladder, lift horizontally completely then slide toward front.

43) Scupper Valve

This is where water from deck drains out. Keep clean to avoid clogging.

44) Hydro-Surge Grate System

Refer to *M² Jet Drive Operator's Guide*.

45) Fuel Tank Vent

It allows fuel vapors and pressure to escape from fuel tank.

WARNING

Never use a lit match or open flame close to vent. Follow the **Fueling Procedure** instructions in the FUEL AND LUBRICATION section.



TYPICAL

1. Fuel tank vent

46) Ski Post

All Models Except Speedster and Speedster SK Models

Pull up the post to allow hooking a ski rope.

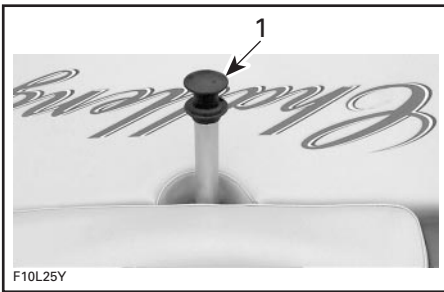

TYPICAL — CHALLENGER 1800 SHOWN

1. Lift ski post to use

Push down when finished.

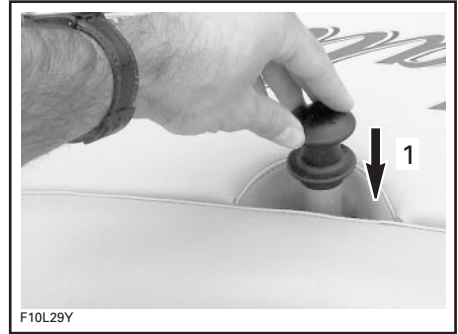

TYPICAL — CHALLENGER 1800 SHOWN

1. Push down when not used

Speedster and Speedster SK Models

Pull ski post upward until it stops then turn ski post end clockwise (CW) to lock post in place. See next photo.

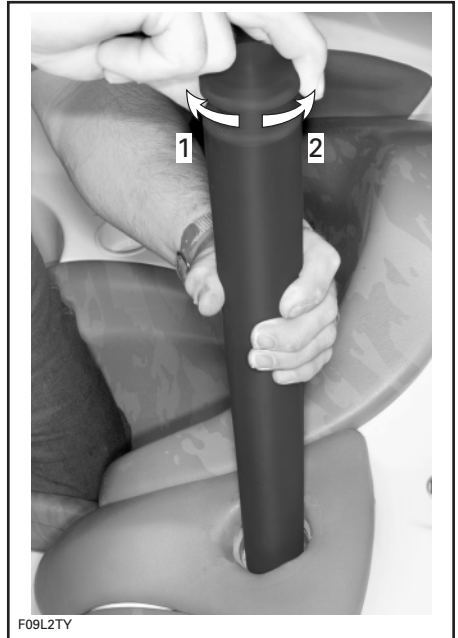

1. Turn clockwise to LOCK

2. Turn counterclockwise to UNLOCK

Speedster SK

Slide wakeboard extension (located in rear storage compartment) over ski post until hand spring plunger is engaged in the ski post.

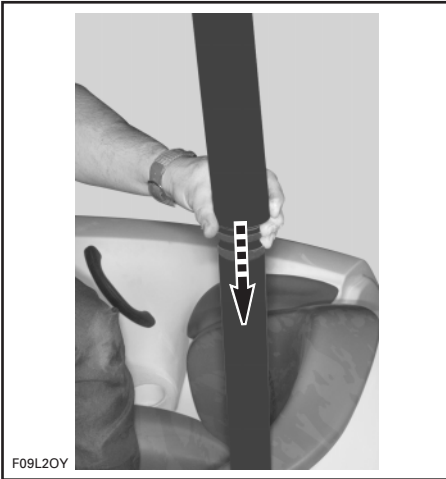

TYPICAL

1. Wakeboard extension
2. Ski post

Pull hand spring plunger then remove wakeboard extension, as shown in the next photo.

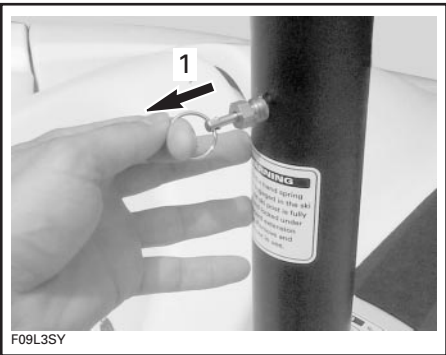

1. Pull hand spring plunger

Speedster and Speedster SK Models

Turn ski post end counterclockwise (CCW) then push post down when finished.

All Models

Always have one person other than the operator as an observer.

CAUTION: Never use the ski post or wakeboard extension to tow other boats.

WARNING

Use caution with skier in tow as tow rope may backlash into deck when released. Never perform a sharp turn when towing a skier or any water toy.

47) Fuses

Craft electrical system fuses are located inside starboard front storage compartment.

Refer to *M² Jet Drive Operator's Guide* for ENGINE ELECTRICAL SYSTEM.

48) Radio (if so equipped)

Refer to its guide for a complete explanation of the features and controls.

Using the radio for a prolonged time without engine running may discharge the battery.

Sportster 1800



TYPICAL

Lift protection flap and push in when completely lifted.

Close protection flap when radio is not in use to protect against weather inclemency.

Challenger 1800

Located in glove box of LH side console.

Open the glove box to access the radio.

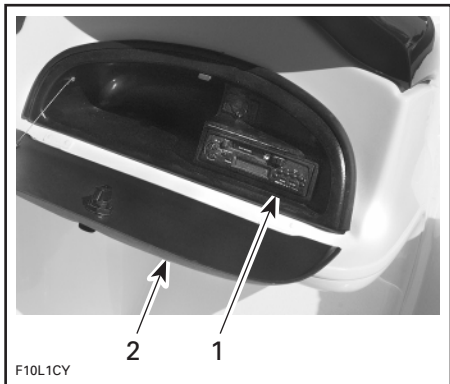

TYPICAL

1. Radio
2. Glove box cover opened

NOTE: The radio is better protected from theft when the glove box and left front storage compartment cover are locked.

49) Glove Box (if so equipped)



TYPICAL

1. Glove box

Located on LH side console.

A small, convenient lockable storage compartment for keys, wallet, etc.

To access the glove box, unlock the release button using the provided key and press button.

NOTE: Always relatch and lock glove box.

WARNING

Never operate the craft with the glove box cover open.

50) Water Bypass System

At idle speed, there will not be a water flow through this outlet.

When engine is running above idle speed, water must flow through this hole. This allows air in engine water jacket to escape.

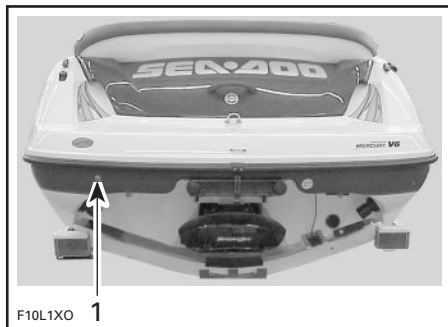

TYPICAL

1. Water bypass outlet

CAUTION: Should water not flow from the outlet a few seconds after engine starts and runs above idle, immediately stop engine and refer to POST-OPERATION CARE and look for cooling system flushing or refer to an authorized dealer for servicing.

51) Main Battery Cut-Off Switch

The switch is located in the engine compartment, close to battery. It is provided to allow a complete cut-out of the electrical system.

When in OFF position, ALL electrical equipments and electronics will not be powered and not working.

It must be in the ON position to allow the use of electrical components and to start the engine.

CAUTION: Stop engine before switching OFF.

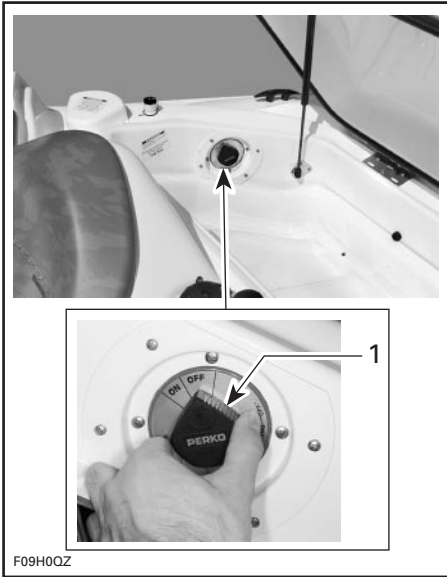

1. Main battery cut-off switch

It is recommended to set in the OFF position whenever performing maintenance in the engine compartment, on the electrical system, for transportation and for short term storage on the trailer.

CAUTION: Bear in mind that when the switch is turned OFF while craft is moored, the bilge pump will not start if water comes up in the bilge.

FUEL AND LUBRICATION

Fueling Procedure

WARNING

Follow these safe boating fueling instructions explicitly.

Do not allow anyone to remain on the craft.

Tie craft securely to the fueling pier.

Use bilge blower for a minimum of 5 minutes.

Turn off bilge air blower, bilge pump and any other devices that could produce a spark.

Ensure engine cover is closed to prevent fumes from entering the engine compartment.

Have a fire extinguisher close at hand.

Do not insert the spout too far in filler neck.

Pour fuel slowly so that air can escape from the tank and prevent fuel flow-back.

Fill fuel tank to bottom of filler neck. **Do not overfill.** Fully tighten fuel tank cap.

WARNING

The tank design makes provision for fuel expansion of about 5%. If this area is filled, fuel will expand and may come out through fuel vent. Always stop the engine before refueling. Fuel is inflammable and explosive under certain conditions. Always work in a well ventilated area. Do not smoke or allow open flames or sparks in the vicinity. Never top off the fuel tank and leave craft in the sun. As temperature increases, fuel expands and might overflow. Always wipe off any fuel spillage from the craft.

Recommended Fuel

Use regular unleaded gasoline with 87 octane (Ron + Mon/2) specification.

NOTE: This craft features an oil injection system which does not require manual fuel/oil mixing. Do not mix oil with fuel except at engine break-in. Refer to *M² Jet Drive Operator's Guide* BREAK-IN PERIOD. Always check oil reservoir level when refueling.

Refer to *M² Jet Drive Operator's Guide* for more detailed information.

CAUTION: The use of a fuel other than regular unleaded fuel can result in craft performance deterioration and damage to fuel system and engine components. Never experiment with other fuels or fuel ratios. Never use fuel containing alcohol, methanol or similar products including naphtha.

Recommended Oil

Use Quicksilver or Mercury Precision Premium-Plus lubricants NMMA/BIA certified TC-W3 2-cycle outboard oil or equivalent.

Refer to *M² Jet Drive Operator's Guide* specifications for more detailed information.

Main Oil Reservoir Level

A sufficient amount of oil should be maintained in the reservoir.

NOTE: Always carry a spare 1 liter of oil.

The use of a funnel is recommended to pour the oil into the reservoir. Stop filling as soon as oil appears at approximately 13 mm (1/2 in) from top of reservoir. Do not overfill. Wipe off any oil spillage.

CAUTION: Always maintain a sufficient amount of oil in the oil reservoir. Check and refill every time you refuel. Do not overfill. If the engine runs out of oil, severe engine damage will occur. If the oil reservoir is found almost empty, refer to an authorized dealer to have the oil injection system inspected.

CAUTION: Oil system must be pressurized. Always ensure that reservoir caps are firmly tighten. Refer to *M2 Jet Drive Operator's Guide* for complete reservoirs filling procedure.

Engine Mounted Oil Reservoir Level

Refer to *M² Jet Drive Operator's Guide*.

BREAK-IN PERIOD

Engine

Refer to *M² Jet Drive Operator's Guide*.

10-Hour Inspection

It is highly recommended that after the first 10 hours of operation, the craft be checked by an authorized Sea-Doo dealer. This inspection will also provide the opportunity to discuss any unanswered questions you may have encountered during the first hours of operation.

The following chart should be used in conjunction with Mercury chart. Refer to *M² Jet Drive Operator's Guide*.

The 10-hour inspection is at the expense of the craft owner.

10-HOUR INSPECTION CHECK LIST	✓
Fuel system lines and fasteners	
Throttle cable adjustment if required	
Oil lines	
Muffler, battery and reservoir fastening devices	
Exhaust system hose clamps torque	
Steering system and low-speed steering control system	
Steering cable adjustment if required	
Shifter cable adjustment if required	
Ensure that throttle levers keep the selected position. Adjust levers friction as necessary	
Hose condition and fasteners	
Bilge pump and bilge blower	
Safety lanyard switch	
Monitoring beeper	
Electrical connections (starter, battery, etc.)	
Lighting system inspection	
Hull condition	
Inspection of fasteners for tightness	

We recommend that this inspection chart be signed by an authorized dealer.

Date of 10-hour inspection

Authorized dealer signature

Dealer code

DAILY PRE-OPERATION CHECKS

Some of the following items may not have been previously covered in this guide, however they will be described in the MAINTENANCE or SPECIAL PROCEDURES section. Please refer to these portions to have more detailed information.

Prior to operating the craft, verify the following:

WARNING

Safety lanyard must always be removed from its switch prior to verifying any of the following.

SUMMARY

ITEM	OPERATION	✓
Safety Lanyard ignition switch	Check operation.	
Hull	Inspect.	
Jet pump water intakes	Inspect/clean.	
Bilge	Drain. Ensure plug is secured.	
Battery	Inspect tightness of cables and retaining straps.	
Main battery cut-off switch	Ensure it is in the ON position.	
Navigation lights	Check operation.	
Fuel tank and oil reservoirs	Refill.	
Engine compartment	Verify fuel/oil system components.	
Fire extinguisher	Inspect condition/mounting.	
Steering	Check operation.	
Throttle/shifter system	Check operation.	
Bilge blower and bilge pump	Check operation.	
Mandatory safety boating equipment	Check operation.	
Storage compartment covers and engine cover	Ensure they are closed and latched.	

Hull

Inspect hull for cracks or damage.

Jet Pump Water Intake

Remove weeds, shells, debris or anything else that could restrict the flow of water and damage the cooling system or propulsion units. Clean as necessary. If any obstruction can not be removed, refer to an authorized Sea-Doo dealer for servicing.

Inspect leading edges of the impellers, if they have nicks or bends, performance will be greatly reduced.

Bilge

Should water be present in the bilge, use bilge pump or tilt the craft to the rear and unscrew drain plugs if craft is out of the water, as the case may be, to completely empty the bilge.

Secure bilge drain plugs.

Battery

WARNING

Verify tightness of battery cables to their posts and condition of retaining straps/fasteners.

Fuel Tank/Oil Reservoirs

With the craft horizontal, fill the fuel tank to specified level.

Check the oil level and refill reservoir as necessary.

CAUTION: Oil system must be pressurized. Always ensure that reservoir caps are firmly tighten. Refer to *M² Jet Drive Operator's Guide* for complete reservoirs filling procedure.

Check fuel tank/oil reservoirs retaining straps/fasteners.

Engine Compartment

WARNING

Should any leak or gasoline odor be present, do not start the engine. Consult an authorized Sea-Doo dealer before use.

Fire Extinguisher

Make sure it is full, in good condition and well secured.

Steering System

Assisted by another person, check steering operation for free movement. When the steering is centered, the jet pump nozzle should be in the straight ahead position. Ensure the jet pump nozzle pivots easily when steering is turned.

Throttle System

Check throttle lever once for free and smooth operation.

NOTE: To activate throttle lever, shift lever must be in forward or reverse position.

Shifter System

Check reverse gate operation for free movement. With shift lever in forward position, the gate should be in upward position. With the shift lever in neutral position, gate should be in middle position. With shift lever in reverse position, gate should be in downward position.

Inlet Grate

Ensure inlet grate is not blocked or obstructed by any weeds or debris. Refer to *M² Jet Drive Operator's Guide*.

Safety Lanyard and Ignition Switch

Ensure that ignition switch operates properly.

Start engine and stop it using switch. See STARTING PROCEDURE on page 57.



WARNING

Only start craft once all items have been checked and operate properly.

Storage Compartment Covers

Ensure they are closed and latched.

OPERATING INSTRUCTIONS

WARNING

Always perform **DAILY PRE-OPERATION CHECKS** before operating the craft. Become thoroughly familiar with all controls and the function of each. Should any control or instruction be not fully understood, refer to an authorized Sea-Doo dealer.

Launching/Loading

Before launching the craft, ensure the main battery cut-off switch is turned ON and the bilge plugs are fully screwed.

After loading the craft, ensure the main battery cut-off switch is turned OFF and the bilge plugs are removed to drain bilge.

Trailing

Refer to the trailer instructions for proper capacity, operation, maintenance, accessories and warranty.

Check the regulations in your area concerning towing a trailer, especially the following rules:

- brake system
- tow vehicle weight
- mirrors

NOTE: An optional brake system is available for your trailer, see an authorized Sea-Doo dealer

Take the following precautions when trailing the craft:

Tie the craft to both bow and stern (front/rear) eyelets so that it is firmly retained on the trailer. Use additional tie-downs if necessary.

- Remove stern light (if installed).
- Ensure that ski post is pushed down.
- Ensure all storage compartment covers are properly latched.
- A SEA-DOO cover can protect the craft, particularly before driving on dirt roads, to prevent dirt entry through the air intake opening(s).

Observe trailering safety precautions.

Principle of Operation

Propulsion

Engine is directly coupled to a drive shaft which, in turn, rotates an impeller. This impeller is accurately adjusted in a housing where the water is drawn up from underneath the craft. Then, the water flows through the impeller to a venturi. The venturi accelerates the water and produces thrust to move the craft. Pushing the throttle lever forward increase engine speed and therefore craft speed.

WARNING

Whenever an engine is to be started, the operator and passengers should always be sitting in the craft with the shift lever in neutral position and throttle lever in idle position.

Shift Lever

FORWARD

The shift lever should be in the forward position in order for the craft to advance.

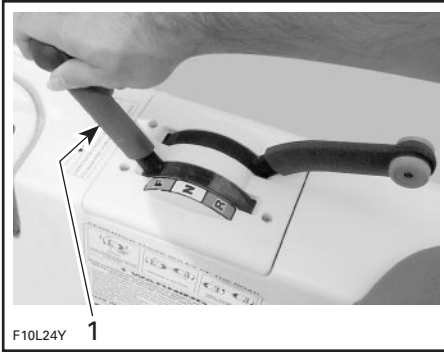

TYPICAL

1. Shift lever in forward position

NEUTRAL

To obtain neutral, pull shift lever halfway. The reverse gate will be in the middle position, directing half of the thrust toward the front of the craft to minimize craft movement.

WARNING

When the craft is in neutral position, the impeller is turning.

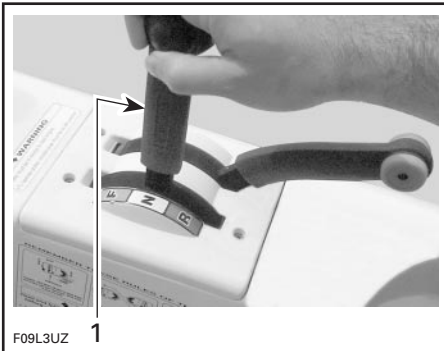

TYPICAL

1. Shift lever in neutral position

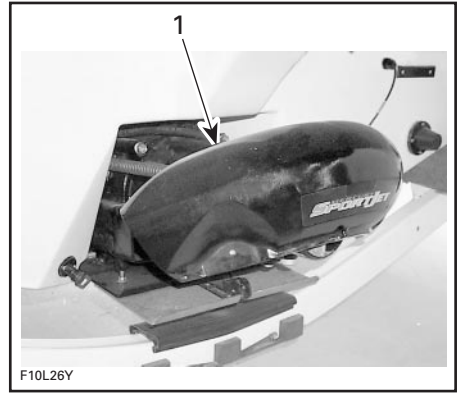

TYPICAL

1. Reverse gate in middle position

REVERSE

To obtain reverse, pull shift lever completely. The reverse gate will be in downward position, directing all the thrust toward the front of the craft.



TYPICAL — SHIFT LEVER IN REVERSE POSITION

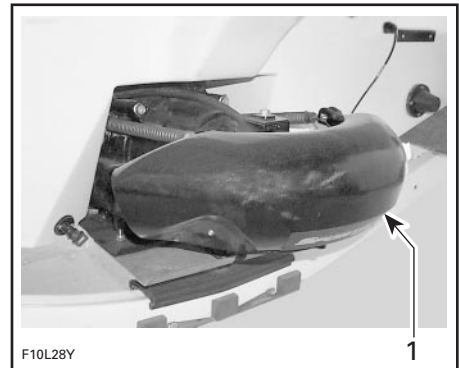

TYPICAL

1. Reverse gate in downward position

NOTE: To obtain maximum efficiency and control from the reverse, increase engine speed to slightly above idle. Too much RPM will create water turbulence and reduce reverse efficiency.

In reverse position, turn the steering wheel in the opposite direction that you want to move the rear of the craft.

For example, to steer the rear of the craft to the left side, turn the steering wheel to the right side.

⚠ WARNING
Shift lever should only be used when the engine is idling.

Steering

Turning the steering pivots the jet pump nozzle which control the craft direction. Turning the steering clockwise will turn the craft to the right and inversely.

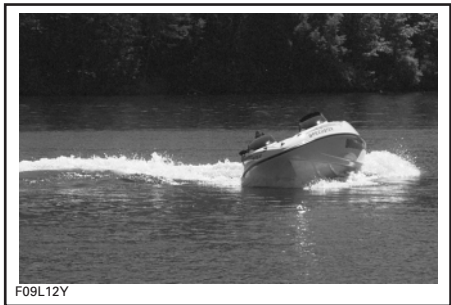

F09L12Y

TYPICAL

Above idle speed, the throttle must be applied to turn the craft.

⚠ WARNING
Throttle must be applied and steering turned to change the direction of the craft at speed. Steering efficiency will differ depending on the number of passengers, load and water conditions.

A craft needs some throttle to turn. Practice in a safe area applying the throttle and turning away from an imaginary object. This is a good collision avoidance practice.

Low-Speed Steering Control System

Whenever the throttle lever is in **IDLE position AND** the steering wheel is approaching the end of its rotation, the engine speed will be slightly accelerated to increase the jet pump thrust. This helps steering control for low-speed navigation or when approaching/leaving a dock. For docking tips, refer to **Stopping/Docking** section below.

⚠ WARNING
Become fully familiar with this feature during your first ride and before carrying passengers.

Boarding from a Dock

As with any craft, boarding should be done carefully and engine should not be running.

When boarding from a dock, slowly place one foot on the craft deck nearest to the dock and then move the other foot inside the craft. Push the craft away from the dock.



F09L11Y

TYPICAL

CAUTION: Engine should be started with at least 90 cm (3 ft) of water below the hull.

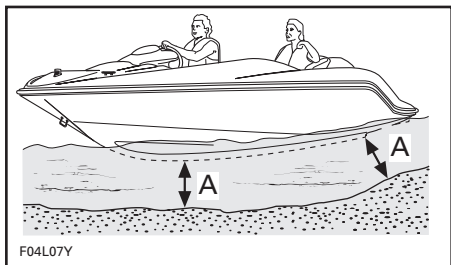

TYPICAL
A. 90 cm (3 ft)

Boarding from the Water

⚠ WARNING

Inexperienced riders should practice how to get aboard close to shore first before venturing into deep water.

⚠ WARNING

Engine should not be running while boarding. Never use propulsion components as a supporting point to board the craft.

Swim to the rear of the craft.

Come close to rear of craft then unlatch and slide ladder toward rear. Grip swim platform grab handles.



TYPICAL

Climb the ladder and pull yourself upward using the swim platform grab handles.



TYPICAL

When you can reach the engine cover grab handle, grip it and continue to pull yourself upward to place one of your foot on the swim platform.



TYPICAL

Continue to climb on engine cover and go down on the deck.



TYPICAL

To store ladder, lift horizontally completely then slide toward front.

CAUTION: Do not leave ladder hanging when operating the boat. Before operating the craft, always lock the ladder using the latch.

 **WARNING**

Do not start engines until all passengers are properly seated.

Starting the Engine

Always activate bilge blower 5 minutes minimum before starting the engine. The bilge blower will ventilate the bilge.

 **WARNING**

Bilge blower must be turned off above idle speed.

Before unloading the craft from the trailer, it can be started for about 10 seconds to verify proper operation.

 **WARNING**

Do not touch electrical parts or jet pump area when engine is running.

Attach the safety lanyard to your PFD and snap the cap to its switch before starting the engine.

 **WARNING**

Before moving, the operator and passengers should always be properly seated.

Grip steering wheel with your right hand and place both feet on the floorboard. Turn off bilge blower.

Starting Procedure

Refer to *M² Jet Drive Operator's Guide* for complete detailed procedure.

Rough Water or Poor Visibility Operation

Avoid operation in these conditions. If you must do so, proceed with caution and prudence using minimum speed. Turn on navigation lights if necessary.

Crossing Waves

Reduce speed. Always be prepared to steer and balance as necessary.

When crossing wakes, always keep a safe distance from boat ahead.

 **WARNING**

When crossing wakes, slow down. Operator and passenger(s) can brace themselves by posting. Do not jump waves or wakes.

Stopping/Docking

The craft is slowed by water drag. The stopping distance will vary depending on the craft size, weight, speed, water surface condition, presence and direction of wind and current.

The operator should become familiarized with the stopping distance under different conditions.

Reduce speed to idle. Shift to neutral, reverse or forward as required.

 **WARNING**

Directional control is reduced when throttle is released and lost when engine is off.

Low-Speed Steering Control System

Reducing RPM to IDLE activates the low-speed steering control feature as described previously. For more details, refer to **Low-Speed Steering Control System** in Turning section above.

 **WARNING**

Become familiar with this feature during your first ride.

Beaching

CAUTION: It is not recommended to run the craft to the beach.

Come slowly to the beach and shut off the engine using the safety lanyard when water depth is 90 cm (3 ft) under the hull, then pull the craft to the beach. Ensure that all accessories are OFF.



A. 90 cm (3 ft) of water under the hull

WARNING

In shallow water, shells, sand, pebbles or other objects could be drawn up by the jet pump and be thrown rearward.

As necessary, the cooling system of the engine should be flushed before restarting, to remove sand or shell accumulation which may clog the water passages. Refer to POST-OPERATION CARE and look for **Cooling System Flushing**.

Shutting Off the Engine

Refer to *M² Jet Drive Operator's Guide*.

POST-OPERATION CARE

⚠ WARNING

Allow engine to cool before performing any maintenance.

General Care

Should water be present in the bilge after use of bilge pump, unscrew the drain plug and tilt the craft to the rear in order to allow water to drain.

Wipe up any remaining fluid in the engine compartment (bilge, engine, etc.) with clean dry rags. This is particularly important in salt water use.

Remove the craft from the water every day to prevent marine organisms growth.

Additional Care for Foul Water or Salt Water

When the craft is operated in foul water and particularly in salt water, additional care must be taken to protect the craft and its components. Rinse trailer and craft's hull/bilge area with fresh water.

CAUTION: Failure to perform proper care such as: craft rinsing, cooling system flushing and anticorrosion treatment, when used in salt water, will result in damage to the craft and its components. Never leave the craft stored in direct sunlight.

Cooling System Flushing

General

Flushing the cooling system with fresh water is essential to neutralize corroding effects of salt or other chemical products present in water. It will help to remove sand, salt, shells or other particles in water jackets (engine, exhaust manifold, tuned pipe) and/or hoses.

Flushing should be performed when the craft is not expected to be used further the same day or when the craft is stored for any extended time.

⚠ WARNING

Perform this operation in a well ventilated area.

Flushing

1. Clean jet pump by spraying water in its inlet and outlet and then apply a coating of Bombardier lube lubricant or equivalent.
2. Open engine cover.
3. Connect a garden hose directly to the flushing connector, as shown in the next photo. Do not open the water tap yet.

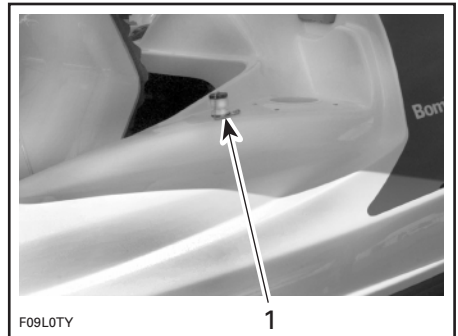

TYPICAL — SPEEDSTER SHOWN

1. Flushing connector with its cap

Refer to *M² Jet Drive Operator's Guide* for complete engine flushing procedure.

SPECIAL PROCEDURE

Engine Overheating

If the monitoring beeper continuously sounds, **stop engine immediately**.

Refer to *M² Jet Drive Operator's Guide*.

If engine still overheats, refer to an authorized Sea-Doo dealer for servicing.

Jet Pump Water Intake and Impeller Cleaning

Weeds, shells or debris can get caught on the intake grate, drive shaft and/or impeller. A clogged water intake may cause troubles such as:

1. **Cavitation:** Engine speed is high but craft moves slowly due to reduced jet thrust; jet pump components may be damaged.
2. **Overheating:** Since the jet pump operation controls the flow of water to cool the engine, a clogged intake will cause the engine to overheat and damage engine internal components.

The clogged area can be cleaned as described in *M² Jet Drive Operator's Guide*.

CAUTION: Avoid craft operation in weeded areas. If unavoidable, vary craft speed. Weeds tend to entangle more at steady and slow speeds. Inspect water intake grate for damage. Refer to an authorized Sea-Doo dealer for repair as necessary.

Capsized Boat

The boat is designed so that it should not turn over easily due to its long and wide dimensions. If the boat ever capsizes, remember that it will continue to float, and it is usually best to remain with it, you will be more easily located by others.

WARNING

Operator and passengers should always wear approved personal flotation devices.

Submerged Boat

WARNING

DO NOT attempt to restart engine. See an authorized dealer as soon as possible to service the engine.

Low-Charge Battery Condition

See your authorized Sea-Doo dealer to have it charged or replaced.

WARNING

Do not charge or boost the battery while installed on the craft.

MAINTENANCE

WARNING

It is recommended that the assistance of an authorized dealer be periodically obtained on other components/systems not covered in this guide and/or *M² Jet Drive Operator's Guide*. Unless otherwise specified, engine must not be running and the main battery cut-off switch must be turned OFF for all maintenance procedures.

Lubrication

Anticorrosion Protection

Throttle Cable

Lubricate the throttle cable with BOMBARDIER LUBE lubricant or equivalent, every 25 hours of use (every 10 hours in salt water use).

Electrical Connections

As necessary, apply dielectric grease on battery posts and all exposed cable connectors including stern light connectors on mat and craft.

Additional Lubrication

BOMBARDIER LUBE lubricant or equivalent will help to prevent corrosion and maintain proper operation of moving mechanisms.

Lubrication of the following items should be performed every 50 hours in fresh water use but every 10 hours in salt water use.

Engine Cover Mechanism and Hinges

Use BOMBARDIER LUBE lubricant or equivalent on metal parts.

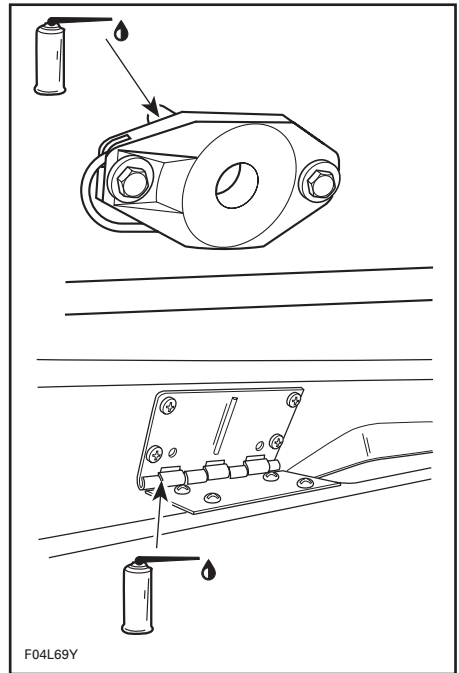

TYPICAL

Bow Seat Lock Pin

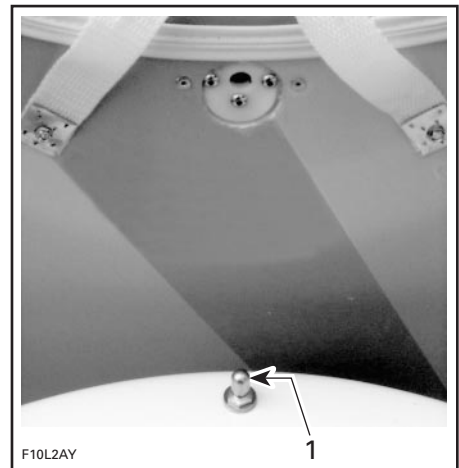

1. Bow seat lock pin

Lubricate lock pin. Install and remove seat a few times to distribute lubricant.

Ski Post

Lubricate ski post through all its length. Pull out then push in several times to distribute the lubricant.

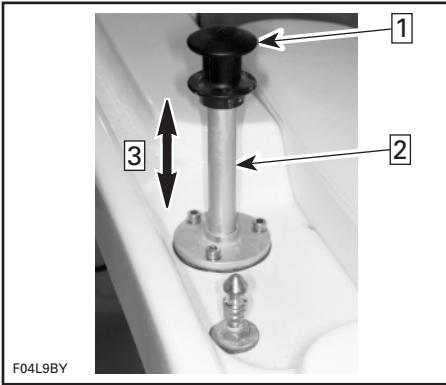

SPEEDSTER, SPORTSTER 1800 AND CHALLENGER 1800

Step **1**: Lift ski post to lubricate

Step **2**: Lubricate here

Step **3**: Move post up and down several times to distribute lubricant

Locks

Lubricate locks of glove box, front storage compartment covers and deck storage compartment.

Engine Cover Cylinders

Lubricate rod of cylinders.

Periodic Inspection

Routine maintenance is necessary for all mechanized products. A periodic inspection contributes to the products life span.

The following maintenance chart gives guidelines for regular craft servicing schedule to be performed by you and/or by an authorized Sea-Doo dealer. The schedule should be adjusted according to operating conditions and use.

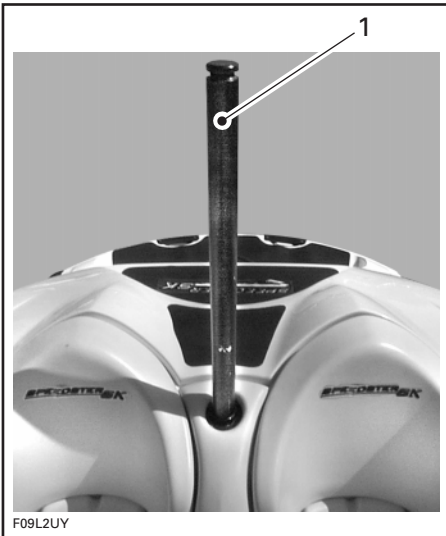

SPEEDSTER AND SPEEDSTER SK

1. Ski post, on this model, does not need to be lubricated

Periodic Inspection Chart

DESCRIPTION	FREQUENCY				TO BE PERFORMED BY
	FIRST 10 HOURS	EVERY 25 HOURS	EVERY 50 HOURS	EVERY 100 HOURS OR SEASONALLY	
Lubrication/corrosion protection			✓		OPERATOR
Lubrication of storage compartment cover locks	①		✓		OPERATOR
Safety lanyard cap				✓	DEALER
Throttle/choke cables operation/lubrication	①	✓			OPERATOR
Throttle cable adjustments				✓	DEALER
Fuel filter inspection		✓			DEALER
Fuel filter replacement				✓	DEALER
Steering system and low-speed steering control system			✓		DEALER
Throttle and shifter systems				✓	DEALER
Muffler, battery and reservoir fastening devices			✓		DEALER
Fuel/oil line, hose inspection	✓	✓	✓	✓	DEALER
Bilge pump/deck drain/scupper valve inspection			✓		OPERATOR
Battery condition			✓		DEALER
Starter cables		✓			DEALER
Monitoring beeper/electrical connections			✓		DEALER
Hull condition and ride shoes				✓	DEALER
Cooling system flushing ③		✓			OPERATOR
Navigation lights condition		✓			DEALER
Sacrificial aluminum anode(s)			✓		OPERATOR
Bilge blower inspection			✓		DEALER

NOTE: Some items are included in the PRE-OPERATION CHECKS and are not necessarily mentioned in this chart but must also be done. Refer to *M² Jet Drive Operator's Guide* for engine and jet pump checks.

- ① Every 10 hours in salt water use.
- ② These items have to be initially checked after 25 hours. Thereafter, servicing to be made as specified in this chart.
- ③ Daily flushing in salt water or foul water use.
- ④ Have your dealer inspect anti-rattle pusher.

Throttle Cable

Activate the throttle lever throughout its full range of motion. It must operate smoothly. Refer to an authorized Sea-Doo dealer if adjustment is necessary.

⚠ WARNING

Do not alter or tamper with throttle cable adjustment or routing.

Fuel and Oil Filters

These filters should be replaced by an authorized dealer annually.

Refer to *M² Jet Drive Operator's Guide*.

Steering/Jet Pump Nozzle Adjustment

When the steering is directed in straight ahead position, the jet pump nozzle should be in the same direction to allow the craft to run in a straight line.

Refer to an authorized Sea-Doo dealer if an adjustment is necessary.

⚠ WARNING

Ensure the steering/jet pump nozzle operate freely from side to side and is not stressing the steering cable.

Reverse Gate

⚠ WARNING

Ensure the shifter and reverse gate operate freely and are not stressing the reverse cable.

Refer to an authorized Sea-Doo dealer if an adjustment is necessary.

Deck Drain(s)

Remove any obstruction from deck drain and scupper valve.

Fuses

Accessories, Craft Electrical System and Gauges

If a fuse is defective, replace by one of the same rating.

CAUTION: Do not use a higher rated fuse as this can cause severe damage. If a fuse is regularly burnt, refer to an authorized Sea-Doo dealer.

Engine

Refer to *M² Jet Drive Operator's Guide*.

Bilge Air Blower

Verify bilge air blower for proper operation. It is located inside engine compartment beneath ventilation duct.

Clean both clam shells opening. Ensure that both openings are not obstructed. Air is sucked in by clam shell attached to the blower and drawn out by the other side. See next illustration.

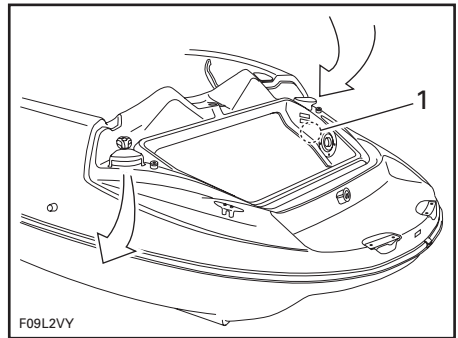

TYPICAL — AIR FLOW

1. Bilge air blower inside engine compartment

⚠ WARNING

If bilge blower does not operate refer to an authorized Sea-Doo dealer before starting the craft.

Navigation Light Bulb Replacement

Bow Light

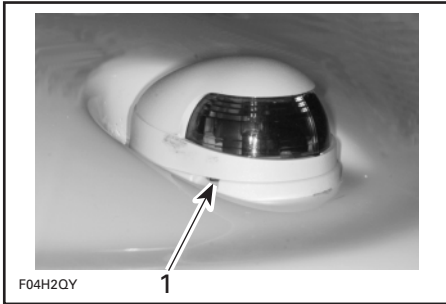

TYPICAL

1. Gently pry here with a screwdriver

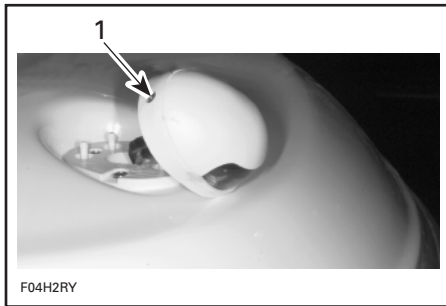

TYPICAL

1. Remove this screw

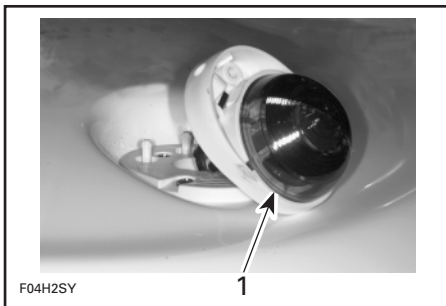

TYPICAL

1. Pull lens out

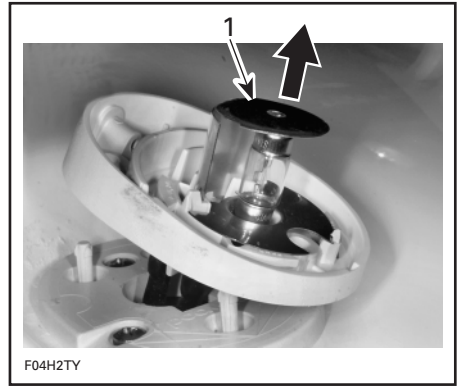

TYPICAL

1. Lift and remove bulb

The assembly is essentially the reverse of removal procedures. However, pay particular attention to the following:

Apply dielectric grease on bulb contact surface.

When installing the bulb under the upper terminal plate, it is possible that the bulb remains loose. The cover will compress the terminal plate against the bulb at reinstallation.

Stern Light

Unscrew lens counterclockwise and pull it out.

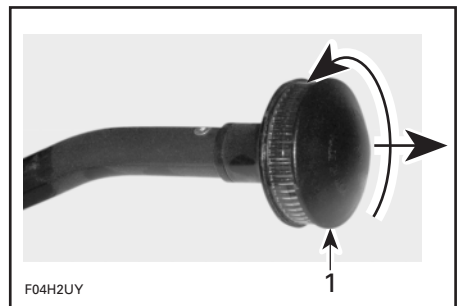

1. Unscrew then pull

Pull bulb to remove it.

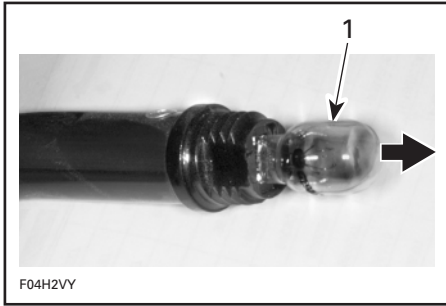

1. Pull bulb out

Apply dielectric grease on new bulb contact surface.

The assembly is the reverse of removal procedure.

General Inspection and Cleaning

Inspection

Check engine compartment for any damage. Ensure all hose clamps are properly secured and no hose is cracked, kinked or presenting any other damage.

WARNING

If any gasoline leak and/or odors are present, do not start the engine. Have the craft serviced by an authorized Sea-Doo dealer.

Inspect muffler, battery, fuel tank and oil reservoir fastening devices. Visually check electrical connections for corrosion and tightness.

Inspect hull and jet pump water intake grate for damage. Replace or have damaged parts repaired.

Cleaning

The bilge should be cleaned by the dealer to remove any possible fuel/oil/electrolyte deposits and mildew.

Occasionally, wash the body with hot water and soap (only use mild detergent). Remove any marine organisms from engine and/or hull. Apply non-abrasive wax.

CAUTION: Never clean fiberglass and plastic parts with strong detergent, degreasing agent, paint thinner, acetone, etc.

Wash windscreen with Bombardier cleaner or equivalent (P/N 293 110 001 — 400 g) and water. For fine scratches and scuff marks removal, use a windshield polisher for acrylic, lucite, polycarbonate and similar materials.

Stains may be removed from seats and fiberglass with Knight's Spray-Nine* from Korkay System Ltd or the equivalent.

Respect the environment by ensuring fuel, oil or cleaning solutions do not drain into the waterways.

STORAGE AND PRE-SEASON PREPARATION

Storage

It is recommended that the craft be taken to an authorized Sea-Doo dealer for proper storage but the following operations can be performed by you with a minimum of tools.

CAUTION: Do not run the engine during the storage period.

Fuel System

Refer to *M² Jet Drive Operator's Guide*.

Cooling System Flushing and Engine Internal Lubrication

Refer to *M² Jet Drive Operator's Guide*.

Propulsion System

Refer to *M² Jet Drive Operator's Guide*.

Craft Cleaning/Repair

Wash the body and the trailer with soap and water solution (only use mild detergent). Rinse thoroughly with fresh water. Remove any marine organisms from the hull.

CAUTION: Never clean apparent fiberglass and plastic parts with strong detergent, degreasing agent, paint thinner, acetone, etc.

Stains may be removed from seats and fiberglass with Knight's Spray-Nine* from Korkay System Ltd or the equivalent.

If repairs are needed to the body or to the hull contact your dealer. For paint touch up to mechanical parts use Bombardier spray paint. For minor gelcoat repairs, a Bombardier repair kit is available. Replace damaged labels/decals.

Clean the bilge with hot water and detergent or with bilge cleaner. Rinse thoroughly. Unscrew drain plug(s) and lift front end of craft to completely drain bilge.

Battery

Contact your authorized Sea-Doo dealer.

Anticorrosion Treatment

Wipe off any residual water in the engine compartment.

Lubricate the throttle cable with BOMBARDIER LUBE lubricant or equivalent.

Finalizing Storage Preparation

Apply a non abrasive wax to body.

The engine cover should be left partially opened during storage (detach the gas shocks from the cover to prevent full opening). Remove storage tray. Place it on deck. This will avoid engine compartment condensation and possible corrosion.

If the craft is to be stored outside, cover it with a vented opaque tarpaulin to prevent sun rays and grime from affecting the plastic components, craft finish as well as preventing dust accumulation.

CAUTION: Never leave the craft stored in direct sunlight. UV radiation will dull finishes. The craft must never be left in water for storage. Make sure to turn off main battery cut-off switch.

For the storage period, it is necessary to lift the bow up and safely block in this position so drainage can take place. Ensure the drain plug is unscrewed.

Pre-Season Preparation

Use the following chart.

Since technical skills and special tools are required, some operations should be performed by an authorized dealer.

WARNING

Observe WARNINGS and CAUTIONS mentioned throughout this guide which are pertinent to the item being checked. When component conditions seem less than satisfactory, replace with genuine BOMBARDIER parts or approved equivalents.

Pre-Season Preparation Chart

NOTE: It is highly recommended that the dealer perform at the same time the annual safety inspection in addition to the pre-season preparation.

OPERATIONS	TO BE PERFORMED BY
Lubrication/corrosion protection	OPERATOR
Safety lanyard cap condition	DEALER
Battery condition/charging and reinstallation	DEALER
Starter connections and routing ①	DEALER
Oil reservoir filling	OPERATOR
Fuel filter replacement	DEALER
Fuel line condition ①	DEALER
Filler neck, fuel tank and fuel cap condition ①	DEALER
Check fuel system fasteners	DEALER
Steering system and low-speed steering control system inspection ①	DEALER
Throttle/shifter system inspection ①	DEALER
Inspection of deck drains/bilge pump/drain plugs	DEALER
Fire extinguisher condition/mounting ①	OPERATOR

① Safety item covered in the annual safety inspection.

CAUTION: Only perform this operation in a well ventilated area. Garden hose must be installed or craft must be in water to cool engine. Running the engine without cooling water will damage exhaust hose interior and may damage engine.

SPECIFICATIONS

ENGINE		SPEEDSTER	SPEEDSTER SK
Number of engines		1	
Engine type		V-6 Mercury engine, 2 stroke	V-6 Mercury engine, 2 stroke
Induction type		Reed valve	
Exhaust system		Mercury type	
Lubrication	Type	See Mercury specifications	
	Oil type	See Mercury specifications	
Number of cylinders		6	
Displacement		2500 cm ³ (152.53 in ³)	
COOLING			
Type		Water cooled	
ELECTRICAL			
Ignition system type		Digital-CDI (Capacitor Discharge Ignition)	
Spark plug	Make and type	See Mercury specifications	
	Gap	See Mercury specifications	
Starting system		Electric starter	
Battery		Not supplied ①	
Fuses	Courtesy lights	1 A (2)	
	Bilge air blower	7.5 A	
	Bilge pump	7.5 A	
	Navigation lights	3 A	
	Gauges/Low fuel	3 A	
	Radio	5 A	
	Horn system	5 A	
Jack system	10 A		
CARBURETION			
Fuel type		See Mercury specifications	
Fuel system type		See Mercury specifications	

PROPULSION	SPEEDSTER	SPEEDSTER SK
Propulsion system	Mercury Sport Jet	
Number of jet pumps	1	
Jet pump type	Mixed flow, single stage	
Pivoting angle of direction (nozzle)	~26°	
Minimum required water level for jet pumps	See Mercury specifications	
DIMENSIONS		
Overall length	503 cm (16 ft 6 in)	
Beam	231 cm (7 ft 7 in)	
Draft	30 cm (12 in)	
Dead rise	20°	
Weight (dry)	953 kg (2100 lb)	964 kg (2125 lb)
Load limit (passengers + luggage)	5 passengers	4 passengers
	410 kg (905 lb) (based on calm water operation)	
Maximum engine power capacity rating of the craft	180 kW (240 HP) @ 6500 RPM	157 kW (209 HP) @ 5650 RPM
Hull material	Composite (fiberglass)	
CAPACITIES		
Fuel tank (reserve included)	151 L (40 U.S. gal)	
Main oil reservoir	11 L (3 U.S. gal)	

① Recommended: Exide R-24-130, 12 V, 25 A•h (130 minutes reserve) or R-24-160 (160 minutes) or equivalent.

Battery posts: On top. Round taper type.

Battery maximum allowed size: 285 mm (11-1/4 in) long x 190 mm (7-1/2 in) wide x 238 mm (9-3/8 in) high.

BOMBARDIER reserves the right to make changes in design and specifications and/or to make additions to, or improvements in its products without imposing any obligation upon itself to install them on its products previously manufactured.

ENGINE		SPORTSTER 1800	CHALLENGER 1800
Number of engines		1	
Engine type		V-6 Mercury engine, 2 stroke	V-6 Mercury engine, 2 stroke
Induction type		Reed valve	
Exhaust system		Mercury type	
Lubrication	Type	See Mercury specifications	
	Oil type	See Mercury specifications	
Number of cylinders		6	
Displacement		2500 cm ³ (152.53 in ³)	
COOLING			
Type		Water cooled	
ELECTRICAL			
Ignition system type		Digital-CDI (Capacitor Discharge Ignition)	
Spark plug	Make and type	See Mercury specifications	
	Gap	See Mercury specifications	
Starting system		Electric starter	
Battery		Not supplied ①	
Fuses	Courtesy lights	1 A (2)	
	Bilge air blower	7.5 A	
	Bilge pump	7.5 A	
	Navigation lights	3 A	
	Gauges/Low fuel	3 A	
	Radio	5 A	
	Horn system	5 A	
Jack system	10 A		
CARBURETION			
Fuel type		See Mercury specifications	
Carburetor		See Mercury specifications	

PROPULSION	SPORTSTER 1800	CHALLENGER 1800
Propulsion system	Mercury Sport Jet	
Number of jet pumps	1	
Jet pump type	Mixed flow, single stage	
Pivoting angle of direction (nozzle)	~26°	
Minimum required water level for jet pumps	See Mercury specifications	
DIMENSIONS		
Overall length	5.46 m (17 ft 11 in)	
Beam	2.29 m (7 ft 6 in)	
Draft	27 cm (10.5 in)	
Dead rise	19.5°	
Weight (dry)	1003 kg (2210 lb)	1062 kg (2340 lb)
Load limit (passengers + luggage)	7 passengers OR 565 kg (1245 lb) (based on calm water operation)	
Maximum engine power capacity rating of the craft	157 kW (209 HP) @ 5650 RPM	180 kW (240 HP) @ 6500 RPM
Hull material	Composite (fiberglass)	
CAPACITIES		
Fuel tank (reserve included)	151 L (40 U.S. gal)	
Main oil reservoir	11 L (3 U.S. gal)	

① Recommended: Exide R-24-130, 12 V, 25 A•h (130 minutes reserve) or R-24-160 (160 minutes) or equivalent.

Battery posts: On top. Round taper type.

Battery maximum allowed size: 285 mm (11-1/4 in) long x 190 mm (7-1/2 in) wide x 238 mm (9-3/8 in) high.

BOMBARDIER reserves the right to make changes in design and specifications and/or to make additions to, or improvements in its products without imposing any obligation upon itself to install them on its products previously manufactured.

SI* METRIC INFORMATION GUIDE

BASE UNITS			
DESCRIPTION	UNIT	SYMBOL	
length	meter	m	
mass	kilogram	kg	
force	newton	N	
liquid	liter	L	
temperature	Celsius	°C	
pressure	kilo pascal.....	kPa	
torque	newton-meter	N•m	
land velocity	kilometer per hour.....	km/h	
navigation velocity.....	knot.....	kn	
PREFIXES			
PREFIX	SYMBOL	MEANING	VALUE
kilo	K.....	one thousand	1000
centi	c	one hundredth of	0.01
milli.....	M.....	one thousandth of.....	0.001
micro.....	μ.....	one millionth of.....	0.000001
CONVERSION FACTORS			
TO CONVERT	TO ①	MULTIPLY BY	
in	mm.....	25.4	
in	cm.....	2.54	
in ²	cm ²	6.45	
in ³	cm ³	16.39	
ft	m	0.3	
oz	g	28.35	
lb	kg	0.45	
lbf.....	N	4.4	
lbf•in.....	N•m	0.11	
lbf•ft.....	N•m	1.36	
lbf•ft.....	lbf•in.....	12	
PSI	kPa	6.89	
imp. oz	U.S. oz.....	0.96	
imp. oz	mL.....	28.41	
imp. gal	U.S. gal.....	1.2	
imp. gal	L	4.55	
U.S. oz.....	mL.....	29.57	
U.S. gal.....	L	3.79	
knot.....	MPH	1.15	
MPH.....	km/h.....	1.61	
Fahrenheit.....	Celsius	(°F - 32) ÷ 1.8	
Celsius	Fahrenheit.....	(°C x 1.8) + 32	
hp.....	kW.....	.75	

* The international system of units abbreviates SI in all languages.

① To obtain the reverse sequence, divide by the given factor. To convert “milli-meters” to “inches”, divide by 25.4.

NOTE: Conversion factors are rounded off to 2 decimals for easier use.

SPORT BOAT MODEL No. _____

HULL

IDENTIFICATION NUMBER (H.I.N.) _____

MERCURY ENGINE

IDENTIFICATION NUMBER (E.I.N.) _____

Purchase Date _____
year month day

Warranty Expiry Date _____
year month day

To be completed by the dealer at the time of the sale

DEALER IMPRINT AREA

Please verify with your selling dealer to ensure your SEA-DOO craft has been registered with Bombardier.



AFFIX
PROPER
POSTAGE

BOMBARDIER
Recreational Products
Sea-Doo Warranty
Valcourt (Quebec)
Canada J0E 2L0



DECLARATION **CE** OF CONFORMITY

Application of Council Directives: 94/25/CE — Recreational craft
89/336/CEE — Electromagnetic compatibility

Standards to which conformity is declared: ISO 7840, ISO 8469, ISO 8665, ISO 8846,
ISO 8848, ISO 8849, ISO 9094, ISO 9097,
ISO 10087, ISO 10088, ISO 10133, ISO 10240,
ISO 11105, ISO 11591, ISO 11592, ISO 12215,
ISO 12216, ISO 13592, COLREGS, ABYC H-5,
ABYC H-8

Manufacturer's name: Bombardier Motor Corporation of America.

Manufacturer's address: 451 E. Illinois Ave
Benton, Illinois
62812-0394

Importer's name: Société ANF — Industrie S.A.

Importer's address: 2, rue du Nouveau Bercy
94220 Charenton
Paris, France

Notified body for Directive 94/25/CE: International Marine Certification Institute
Trèves centre, rue de Trèves 45
1040 Brussels, Belgium

Competent body for Directive 89/336/CEE: UTAC
Autodrome de Linas-Monthéry, B.P. 212
91311 Monthéry cedex, France

Type of equipment: Sport boats, inshore category C

Model names and numbers: Challenger 1800 (5691),
Sportster 1800 (5686), Speedster (5690),
Speedster SK (5687)

I, the undersigned, hereby declare that the equipment specified above conforms to the above Directives and Standards.

Name of signatory: Ghislain Ghiot

Title of signatory on behalf of
Bombardier Motor Corporation of America: Zone Manager — Sea-Doo sport boats

Homologation and Certification

These boats comply with the following standards:

STANDARD	TYPE OF CERTIFICATION
United States Coast Guard	Self certification
Canadian Coast Guard	Self certification
Russian Maritime Register of Shipping	Certify by Russian Maritime Register of Shipping 8, Dvortsovaya Nab., 191186 St. Petersburg, Russia
Directive 89/336/CEE of the council relating to electromagnetic compatibility	Internal production control plus control carried out on the responsibility of a competent body. Competent body: UTAC Autodrome de Linas-Montlhéry, B.P. 212 91311 Montlhéry cedex, France
Directive 94/25/EC of the European Parliament and of the council relating to recreational craft	Internal production control plus control carried out on the responsibility of a notified body. Notified body: International Marine Certification Institute Trèves centre, rue de Trèves 45 1040 Brussels, Belgium

Operator's Guide Confirmation of Receipt

Your dealer

Name:	_____
Address:	_____

Is the representative of our company and will afford you the necessary help to resolve any problems you may have.

As soon as you are the owner, date and sign the receipt here and give it (or send it) to the dealer to be covered by our warranty.

Warranty condition as detailed in the Warranty Section of this Guide.

----- Cut here

Receipt	
Name:	_____
Address:	_____
Owner of _____	No. _____
HIN (to be completed by customer or selling dealer) _____	
This warranty begins _____ (date).	
The dealer named on this document has instructed me on the operation, maintenance, safety features and warranty policy, all of which I understand. I am also satisfied with the predelivery set-up and inspection of my sport boat. I have also received a copy of the <i>Operator's Guide</i> for my sport boat.	
Signature: _____	



BOMBARDIER
RECREATIONAL PRODUCTS

SEAN

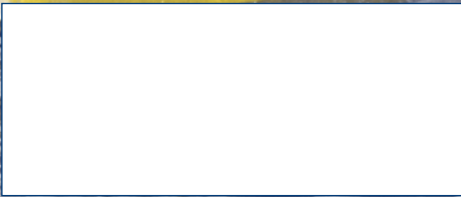

© *Trademarks of Bombardier Inc.
© 1999 Bombardier Inc. - All rights Reserved
Printed in Canada

BOMBARDIER
RECREATIONAL PRODUCTS



VERSION FRANÇAISE ÉGALEMENT DISPONIBLE