

ski-doo®



2013

OPERATOR'S GUIDE

Includes
Safety, Vehicle
and Maintenance Information

MX Z™ X™ 600RS

WARNING

Read this guide thoroughly.
It contains important safety information.
Minimum recommended operator's age: 16 years old.
Keep this Operator's Guide in the vehicle.

5 2 0 0 0 1 2 1 9

⚠ WARNING

Disregarding any of the safety precautions and instructions contained in this Operator's Guide, *SAFETY DVD* video and on-product safety labels could cause injury including the possibility of death!

⚠ WARNING

This vehicle may exceed the performance of other vehicles you may have ridden in the past. Take time to familiarize yourself with your new vehicle.



In USA, products are distributed by BRP US Inc.

In Canada, products are distributed by Bombardier Recreational Products Inc.

The following are trademarks of Bombardier Recreational Products Inc. or its subsidiaries.

HPG™

RAVE™

ROTAX®

TRA™

MX Z®

PCX™

Ski-Doo®

XPS™

The KYB Pro series is a registered mark of KYB America LLC.

FOREWORD

Deutsch	Dieses Handbuch ist möglicherweise in Ihrer Landessprache verfügbar. Bitte wenden Sie sich an Ihren Händler oder besuchen Sie: www.operatorsguide.brp.com.
English	This guide may be available in your language. Check with your dealer or go to: www.operatorsguide.brp.com.
Français	Ce guide peut être disponible dans votre langue. Vérifier avec votre concessionnaire ou aller à: www.operatorsguide.brp.com.
Italiano	Questa guida potrebbe essere disponibile nella propria lingua. Contattare il concessionario o consultare www.operatorsguide.brp.com.
Norsk	Denne boken kan finnes tilgjengelig på ditt eget språk. Kontakt din forhandler eller gå til: www.operatorsguide.brp.com.
Русский	Воспользуйтесь руководством на вашем языке. Узнайте о его наличии у дилера или на странице по адресу www.operatorsguide.brp.com.
Suomi	Käyttöohjekirja voi olla saatavissa omalla kielelläsi. Tarkista jälleenmyyjältä tai käy osoitteessa: www.operatorsguide.brp.com.
Svenska	Denna bok kan finnas tillgänglig på ditt språk. Kontakta din återförsäljare eller gå till: www.operatorsguide.brp.com.

Congratulations on your purchase of a new Ski-Doo® snowmobile. Whatever model you have chosen, it is backed by the Bombardier Recreational Products Inc. (BRP) warranty and a network of authorized Ski-Doo snowmobile dealers ready to provide the parts, service or accessories you may require.

At delivery, you were informed of the warranty coverage and signed the *PREDELIVERY CHECK LIST* to ensure your new vehicle was prepared to your entire satisfaction.

Your dealer is committed to your satisfaction. If you need more information, please ask your dealer.

Know Before you Go

To learn how to reduce the risk for you or bystanders being hurt or killed, read the following sections before you operate the vehicle:

- SAFETY INFORMATION
- VEHICLE INFORMATION.

Also read all safety labels on your snowmobile and watch your *SAFETY DVD* video.

This vehicle is designed for special purposes and may exceed provincial/state width limitations for trail riding. Riders must get all relevant information on local width limitations.

We highly recommend that you take a safety riding course. Please check with your dealer or local authorities for availability in your area.

Failure to follow the warnings contained in this Operator's Guide can result in SERIOUS INJURY or DEATH.

Safety Messages

The types of safety messages, what they look like and how they are used in this guide are explained as follows:

The safety alert symbol  indicates a potential injury hazard.

WARNING

Indicates a potential hazard, if not avoided, could result in serious injury or death.

 **CAUTION** Indicates a hazard situation which, if not avoided, could result in minor or moderate injury.

NOTICE Indicates an instruction which, if not followed, could severely damage vehicle components or other property.

About this Operator's Guide

This Operator's Guide has been prepared to acquaint the owner and the operator with this snowmobile and its various controls, safe riding and maintenance instructions.

The following terminology in regards to operator, passenger and vehicle configuration is used as follows throughout this guide:

- **Operator:** refers to the person being behind the controls and driving the snowmobile.
- **Passenger:** refers to a person sitting behind the operator.
- **1-UP:** refers to a model designed for an operator only.
- **2-UP:** refers to a model designed to accommodate **one** passenger.

Keep this Operator's Guide in the vehicle as you can refer to it for things such as maintenance, troubleshooting and instructing others.

Note that this guide is available in several languages. In the event of any discrepancy, the English version shall prevail.

If you want to view and/or print an extra copy of your Operator's Guide, simply visit the following website
www.operatorsguide.brp.com.

The informations contained in this document are correct at the time of publication. BRP, however, maintains a policy of continuous improvement of its products without imposing upon itself any obligation to install them on products previously manufactured. Due to late changes, some differences between the manufactured product and the descriptions and/or specifications in this guide may occur. BRP reserves the right at any time to discontinue or change specifications, designs, features, models or equipment without incurring any obligation upon itself.

This Operator's Guide and the *SAFETY DVD* video should remain with the vehicle when it's sold.

TABLE OF CONTENTS

FOREWORD	1
Know Before you Go	1
Safety Messages.....	1
About this Operator's Guide	2

SAFETY INFORMATION

GENERAL PRECAUTIONS	8
Avoid Carbon Monoxide Poisoning	8
Avoid Gasoline Fires and Other Hazards	8
Avoid Burns from Hot Parts	8
Accessories and Modifications	8
SPECIAL SAFETY MESSAGES	9

RIDING THE VEHICLE	12
Pre-Ride Inspection	12
How to Ride	14
Rider Position (Reverse Operation)	15
Carrying a Passenger	15
Terrain/Riding Variations	15
Environment.....	19

TRACTION ENHANCING PRODUCTS	21
Manoeuvrability	21
Acceleration	22
Braking	22
Important Safety Rules	23
Effects of Having a Studded Track on the Life of the Snowmobile.....	23
Installation of Studs on BRP Approved Tracks	23
Inspection of a Studded Track.....	24

IMPORTANT ON-PRODUCT LABELS	25
Hang Tag	25
Vehicle Safety Labels	25
Compliance Labels.....	29

VEHICLE INFORMATION

CONTROLS, INSTRUMENTS AND EQUIPMENT	32
1) Handlebar	33
2) Throttle Lever.....	33
3) Brake Lever	33
4) Parking Brake Lever	33
5) Engine Cut-off Switch.....	34
6) Emergency Engine Stop Switch	34
7) Primer Button.....	34
8) Rewind Starter Handle	35
9) Pre-Heat Switch	35

CONTROLS, INSTRUMENTS AND EQUIPMENT (cont'd)	
10) High Beam/Low Beam Switch.....	35
11) Heated Grips/Heated Throttle Lever Switch.....	35
12) Multifunction Analog/Digital Gauge.....	35
13) Seat Latch.....	49
14) Front and Rear Bumpers.....	50
15) Drive Belt Guard.....	50
16) Spare Drive Belt Holder.....	51
17) Hood.....	52
18) Side Panels.....	52
FUEL AND OIL.....	53
Recommended Fuel.....	53
Recommended Oil.....	54
Premix Fuel/Oil Ratio.....	54
BREAK-IN PERIOD.....	55
Operation During Break-In.....	55
BASIC PROCEDURES.....	56
Engine Starting Procedure.....	56
Vehicle Warm-Up.....	56
Shutting Off the Engine.....	56
RIDING CONDITIONS AND YOUR SNOWMOBILE.....	57
Altitude.....	57
Temperature.....	57
Hard Packed Snow.....	57
SPECIAL PROCEDURES.....	58
Towing Another Snowmobile.....	58
Emergency Starting Procedure.....	58
TUNE YOUR RIDE.....	60
Rear Suspension Adjustments.....	60
Front Suspension Adjustments.....	64
Adjustment Tips According to Vehicle Behavior.....	67
VEHICLE TRANSPORTATION.....	68

MAINTENANCE INFORMATION

BREAK-IN INSPECTION.....	70
MAINTENANCE SCHEDULE.....	71
MAINTENANCE PROCEDURES.....	73
Throttle Position Sensor (TPS).....	73
Air Filter.....	73
Engine Coolant.....	74
Exhaust System.....	74
Spark Plugs.....	74
Engine Stopper.....	75
Brake Fluid.....	75

MAINTENANCE PROCEDURES (cont'd)

Chaincase Oil 76

Drive Belt 77

Drive Pulley 79

Track 81

Suspension 84

Skis 85

Fuse 85

Lights 85

VEHICLE CARE 88

Post-Operation Care 88

Vehicle Cleaning and Protection 88

TECHNICAL INFORMATION

VEHICLE IDENTIFICATION 90

Vehicle Description Decal 90

Identification Numbers 90

EC DECLARATION OF CONFORMITY 91

EPA CERTIFIED ENGINES 92

Engine Emissions Information 92

SPECIFICATIONS 93

TROUBLESHOOTING

TECHNICAL GUIDELINES 98

MONITORING SYSTEM 100

Pilot Lamps, Messages and Beeper Codes 100

Fault Codes 101

WARRANTY

LIMITED WARRANTY VALIDATION 104

**BRP LIMITED WARRANTY USA AND CANADA: 2013 SKI-DOO®
SNOWMOBILES 105**

**BRP INTERNATIONAL LIMITED WARRANTY: 2013 SKI-DOO®
SNOWMOBILES 109**

**BRP LIMITED WARRANTY FOR THE EUROPEAN AND THE RUSSIAN
ECONOMIC AREAS AND TURKEY ECONOMIC AREA: 2013 SKI-DOO®
SNOWMOBILES 114**

CUSTOMER INFORMATION

PRIVACY INFORMATION 120
CHANGE OF ADDRESS/OWNERSHIP 121

SAFETY INFORMATION

GENERAL PRECAUTIONS

Avoid Carbon Monoxide Poisoning

All engine exhaust contains carbon monoxide, a deadly gas. Breathing carbon monoxide can cause headaches, dizziness, drowsiness, nausea, confusion and eventually death.

Carbon monoxide is a colorless, odorless, tasteless gas that may be present even if you do not see or smell any engine exhaust. Deadly levels of carbon monoxide can collect rapidly, and you can quickly be overcome and unable to save yourself. Also, deadly levels of carbon monoxide can linger for hours or days in enclosed or poorly ventilated areas. If you experience any symptoms of carbon monoxide poisoning, leave the area immediately, get fresh air and seek medical treatment.

To prevent serious injury or death from carbon monoxide:

- Never run the vehicle in poorly ventilated or partially enclosed areas such as garages, carports or barns. Even if you try to ventilate engine exhaust with fans or open windows and doors, carbon monoxide can rapidly reach dangerous levels.
- Never run the vehicle outdoors where engine exhaust can be drawn into a building through openings such as windows and doors.

Avoid Gasoline Fires and Other Hazards

Gasoline is extremely flammable and highly explosive. Fuel vapors can spread and be ignited by a spark or flame many feet away from the engine. To reduce the risk of fire or explosion, follow these instructions:

- Use only an approved gasoline container to store fuel.
- Strictly adhere to instructions in *FUELING PROCEDURE*.
- Never start or operate the engine if the fuel cap is not properly installed.

Gasoline is poisonous and can cause injury or death.

- Never siphon gasoline by mouth.
- If you swallow gasoline, get any in your eye or inhale gasoline vapor, see your doctor immediately.

If gasoline spills on you, wash with soap and water and change your clothes.

Avoid Burns from Hot Parts

The exhaust system and engine become hot during operation. Avoid contact during and shortly after operation to avoid burns.

Accessories and Modifications

Do not make unauthorized modifications, or use attachments or accessories that are not approved by BRP. Since these changes have not been tested by BRP, they may increase the risk of crashes or injuries, and they can make the vehicle illegal.

Accessory passenger seats approved by BRP and conforming to SSCC standards may be available for certain models. If such a seat is used, you must follow the guidelines and recommendations in regards to a passenger in this guide.

WARNING

Passenger seat must have a strap or handholds and must meet SSCC standards.

See your authorized Ski-Doo dealer for available accessories for your vehicle.

SPECIAL SAFETY MESSAGES

SEVERE INJURY OR DEATH can result if you do not follow these instructions:

- Always make a pre-ride inspection BEFORE you start the engine.
- Throttle mechanism should be checked for free movement and return to idle position before starting engine.
- Always attach tether cord eyelet to clothing before starting the engine.
- Never operate the engine without drive belt guard and brake disk guard securely installed or, with hood or side panels opened or removed. Never run the engine without drive belt installed. Running an unloaded engine such as without drive belt or with track raised, can be dangerous.
- Always engage parking brake before starting the engine.
- Everyone is a beginner the first time he sits behind the controls of a snowmobile regardless of previous experience in driving any other type of vehicle. The safe use of your snowmobile depends on many conditions such as visibility, speed, weather, environment, traffic, vehicle condition and the condition of the operator.
- Basic training is required for the safe operation of any snowmobile. Study your Operator's Guide paying particular attention to cautions and warnings. Join your local snowmobile club: its social activities and trail systems are planned for both fun and safety. Obtain basic instructions from your snowmobile dealer, friend, fellow club member or enroll in your state or provincial safety training program.
- Any new operator must read and understand all safety labels on the snowmobile, the Operator's Guide and watch the *SAFETY DVD* video before operating the snowmobile. Only allow a new operator to operate the snowmobile in a restricted flat area, at least until he is completely familiar with its operation. If snowmobile operator's training course is offered in your area, have him enroll.
- The performance of some snowmobiles may significantly exceed that of other snowmobiles you have operated. Therefore, use by novice or inexperienced operators is not recommended.
- Snowmobiles are used in many areas and in many snow conditions. Not all models perform the same in similar conditions. Always consult your snowmobile dealer when selecting the snowmobile model for your particular needs and uses.
- Injury or death may result to the snowmobile operator or bystander if the snowmobile is used in risky conditions which are beyond the operators's or snowmobile's capabilities or intended use.
- BRP recommends the operator has at least 16 years old of age.
- It is very important to inform any operator, regardless of his experience, of the handling characteristics of this snowmobile. The snowmobile configuration, such as ski stance, ski type, suspension type, track length, width and type vary from a model to another. The snowmobile handling is greatly influenced by these characteristics.
- The novice operator should become familiar with the snowmobile through practice on a level area at slow speeds before venturing far afield.

- Know your local laws. Federal, state, provincial and local government agencies have enacted laws and regulations pertaining to the safe use and operation of snowmobiles. It is your responsibility as a snowmobiler to learn and obey these laws and regulations. Respect and observance will result in safer snowmobiling for all. Be aware of the liability property damages and insurance laws regarding your equipment.
- Speeding can be fatal. In many cases, you cannot react or respond quickly enough to the unexpected. Always ride at a speed which is suitable to the trail, weather conditions and your own ability. Know your local rules. Speed limit may be in effect and meant to be observed.
- Always keep right hand side of the trail.
- Always keep a safe distance from other snowmobiles and bystanders.
- Remember, promotional material may show risky maneuvers performed by professional riders under ideal and/or controlled conditions. You should never attempt any such risky maneuvers if they are beyond your level of riding ability.
- Never ride this vehicle under influence of alcohol or drugs. They slow reaction time and impair judgement.
- Your snowmobile is not designed to be operated on public streets, roads or highways.
- Avoid road traveling. If you must do so, and it is permitted, reduce speed. The snowmobile is not designed to operate or turn on paving. When crossing a road, make a full stop, then look carefully in both directions before crossing at a 90° angle. Be wary of parked vehicles.
- Snowmobiling at night can be a delightful experience but because of reduced visibility, be extra cautious. Avoid unfamiliar terrain and be sure your lights are working. Always carry a flashlight and spare light bulbs.
- Never remove any original equipment from your snowmobile. Each vehicle has many built in safety features. Such features include various guards and consoles, plus reflective materials and safety labels.
- Nature is wonderful but don't let it distract your attention from driving. If you want to truly appreciate winter's scenery, stop your snowmobile on the side of the trail so that you don't become a hazard to others.
- Fences represent a very serious threat for both you and your snowmobile. Give a wide berth to telephone poles or posts.
- Hidden wires unseen from a distance can cause serious accidents.
- Always wear an approved safety helmet, eye protection and a face shield.
- Be aware of inherent risks associated with riding off trails, such as avalanche and other natural or man made hazards or obstacles.
- Tailgating another snowmobile should be avoided. If the snowmobile in front of you slows for any reason, its operator and passenger could be harmed through your neglect. Maintain a safe stopping distance between you and the snowmobile in front of you. Depending on the terrain condition, stopping may require a little more space than you think. Play it safe. Be prepared to use evasive driving.
- Venturing out alone with your snowmobile could also be hazardous. You could run out of fuel, have an accident, or damage your snowmobile. Remember, your snowmobile is capable of traveling further in half an hour than you may be able to walk in a day. Use the "buddy system". Always ride with a friend or member of your snowmobile club. Even then, tell someone where you are going and the approximate time you plan to return.

- Meadows sometimes have low areas where water accumulate and freezes over in winter. This ice is usually glare ice. Attempting to turn or brake on this surface could cause your vehicle to spin out of control. Never brake or attempt speeding or turning on glare ice. If you do happen to travel over such a condition, reduce speed by carefully releasing the throttle.
- Never “jump” with your snowmobile.
- When riding in group, do not “gun” the throttle. Snow and ice can be thrown back into the path of a following snowmobile. In addition, when “gunning” the throttle, the vehicle digs into and leaves an irregular snow surface for others.
- Riding in group is fun and enjoyable but don't show off or overtake others in the group. A less experienced operator might try to do the same as you and fail. When riding with others, limit your abilities to the experience of others.
- In case of an emergency, press down on the engine emergency stop switch, then apply brake.
- Always engage parking brake when vehicle is not in use.
- Never run the engine in a non-ventilated area and/or if vehicle is left unattended.
- Ensure the path behind is clear of obstacles or bystanders before proceeding in reverse.
- Always remove the tether cord cap from engine cut-off switch when vehicle is not in operation in order to prevent accidental engine starting, to avoid unauthorized use by children or others or theft.
- NEVER stand behind or near a rotating track. Debris could be projected causing severe injuries. To remove packed snow or ice, stop engine, tilt and hold vehicle on its side and use screwdriver.
- Do not stud the track unless it has been approved for studs. At speed, a studded track that has not been approved for studs could tear and separate from vehicle. See an authorized Ski-Doo dealer for current specific studding availability and applications.
- You may stud the track on this vehicle model. However, you MUST only use the BRP approved type stud for use on Ski-Doo snowmobiles. DO NOT EVER use conventional studs because the track thickness is thinner than our standard tracks. The stud could tear off of track and separate from vehicle.
- Always wear an approved helmet and follow the same dressing guidelines as those recommended for the operator and described in this guide.
- Make sure that you are able to achieve a stable stance, both feet resting positively on the footboards of footrests with good grip, and that you are able to hold on firmly to the handholds.
- Do not forget, with 2-UP models, the operator is responsible for the safety of the passenger. Always remember that the snowmobile handling, stability and braking distance may be affected when riding with a passenger.
- Before riding the vehicle, ask your passenger to inform you to slowdown or stop immediately if he feels uncomfortable or insecure during the ride. Keep a watchful eye on your passenger while riding.

RIDING THE VEHICLE

Each operator has a responsibility to ensure the safety of other recreationists or bystanders.

You are responsible for proper operation of your vehicle as well as training those whom you allow to ride or drive. There may be noticeable handling and performance differences from one snowmobile to the other.

A snowmobile is relatively simple to operate but like any other vehicle or mechanical equipment, it can be hazardous if you are reckless, thoughtless or inattentive. We encourage you to have an Annual Safety Inspection of your snowmobile. Please contact an authorized Ski-Doo dealer for further details. Finally, we urge you to visit an authorized Ski-Doo dealer periodically for regular and safety maintenance, as well as snowmobile accessories you may require.

Before venturing on the trails, operate the snowmobile in a restricted flat area until you are completely familiar with its operation and feel comfortable that you can safely tackle a more demanding task. Have an enjoyable and safe ride.

Pre-Ride Inspection

WARNING

The pre-operation check is very important prior to operating the vehicle. Always check the proper operation of critical controls, safety features and mechanical components before starting.

Before Starting the Engine

1. Remove snow and ice from body including lights, seat, footrests, controls and instruments.
2. Verify that air silencer prefilter is free of snow.
3. Verify that skis and steering operate freely. Check corresponding action of skis versus handlebar.
4. Check fuel level. Replenish if necessary.
5. Check coolant and brake fluid levels. In case of a low level, contact an authorized Ski-Doo dealer.
6. All storage compartments must be properly latched and they must not contain any heavy or breakable objects. Hood and side panels must be also properly latched.
7. Check track condition. Remove snow or ice if necessary.
8. Check rear suspension slider shoes condition.
9. Activate the throttle control lever several times to check that it operates easily and smoothly. It must return to idle position when released.
10. Activate the brake lever and make sure the brake fully applies before the brake control lever touches the handlebar grip. It must return to the rest position when released.
11. Apply parking brake and check if it operates properly. Leave parking brake applied.

After Engine is Started

For proper engine starting procedure, refer to the *ENGINE STARTING PROCEDURE* section.

1. Check headlights high beam and low beam, taillight, stop light and pilot lamps operation.

NOTE: You may need to detach tether cord from your clothes to check lights. In such a case, attach cord as soon as you get back at the controls of the snowmobile.

2. Check the engine cut-off switch (by pulling tether cord cap) and emergency engine stop switch operation.
3. Release parking brake.
4. Refer to the *VEHICLE WARM UP* section and follow instructions.

Pre-Ride Check List

ITEM	OPERATION	✓
Body including seat, footrests, lights, controls and instruments	Check condition and remove snow or ice.	
Air silencer prefilter	Check condition and remove snow or ice.	
Steering system	Check for free movement and proper action.	
Skis and runners	Check condition.	
Fuel	Check level and replenish if necessary.	
Coolant	Check level. If low, contact an authorized Ski-Doo dealer.	
Brake fluid	Check level. A low fluid level indicates a leak or worn brake pads. Contact an authorized Ski-Doo dealer.	
Storage compartment	Check for proper latching and no heavy or breakable objects.	
Throttle lever	Check for proper action.	
Track	Check condition and remove snow or ice. For studded tracks, see <i>INSPECTION</i> in the <i>TRACTION ENHANCING PRODUCTS</i> subsection.	
Rear suspension slider shoes	Check condition.	
Brake lever	Check for proper operation.	
Parking device	Check for proper operation.	
Emergency engine stop switch and engine cut-off switch	Check for proper action. Tether cord must be attached to operator clothing eyelet.	
Lights	Check for proper operation.	

How to Ride

Riding Gear

Proper snowmobile clothing should be worn. It should be comfortable and not too tight. Always check the weather forecast before going on a ride. Dress for the coldest weather expected. Thermal underwear next to the skin also provides a good insulation.

Wear an approved helmet at all times for safety and comfort. They provide both warmth and reduce injury. A stocking type cap, balaclava and face mask should always be carried or worn. Goggles or a face shield that attach to the helmet are indispensable. Carry colored lens if your helmet is not equipped so.

Hands should be protected by a pair of snowmobile gloves or mitts which have sufficient insulation and allow use of thumbs and fingers for operation of controls.

Rubber bottom boots with either a nylon or a leather top, with removable felt liners are best suited for snowmobiling.

You should keep yourself as dry as possible when snowmobiling. When you come indoors, take your snowmobile suit and boots off and make certain they dry properly.

Do not wear long scarfs and loose apparels that could get caught in moving parts.

What to Bring

First aid kit	Mobile phone
Knife	Spare spark plugs
Flashlight	Friction tape
Trail map	Spare drive belt
Snack	Toolkit

Rider Position (Forward Operation)

Your riding position and balance are the two basic principles of making your snowmobile go where you want it to. When turning on the side of a hill, you must be ready to shift body weight to help it turn in the desired direction. You must never attempt this maneuvering by placing feet outside of the vehicle. Experience will teach you how much lean to put into turns at different speeds and how much you will have to lean into a slope to maintain proper balance.

Generally, the riding position for best balance and control is sitting. However, the posting, kneeling or standing positions are also used under certain conditions.

WARNING

Do not attempt any maneuvers if they are beyond your abilities.

Sitting

Feet on the running boards, body mid-way back on seat is an ideal position when operating the snowmobile over familiar, smooth terrain. Knees and hips should remain flexible to absorb shocks.



Posting

A semi-sitting position with the body off the seat and the feet under the body in a sort of squatting posture, thus allowing the legs to absorb the shocks when traveling over uneven terrain. Avoid abrupt stops.



Kneling

This position is achieved by placing one foot firmly on the running board and the opposite knee on the seat. Avoid abrupt stops.



Standing

Place both feet on the running boards. Knees should be flexed to absorb the shock from surface bumps. This is an effective position to see better and to shift weight as conditions dictate. Avoid abrupt stop.



Rider Position (Reverse Operation)

We recommend sitting on your snowmobile when operating in reverse.

Avoid standing up. Your weight could shift forward against throttle lever while operating in reverse, causing an unexpected acceleration.

⚠ WARNING

Unexpected acceleration when snowmobile operates in reverse can cause a loss of control.

Carrying a Passenger

Certain snowmobiles are designed for an operator only (1-UP), and others can allow one passenger only (2-UP). Make sure to identify and respect the warnings according to your specific models.

Even when a passenger is allowed, this person must be physically fit for snowmobiling.

Terrain/Riding Variations

Groomed Trail

On a maintained trail, sitting is the most preferred riding position. Do not race and, above all, keep to the right hand side of the trail. Be prepared for the unexpected. Observe all trail signs. Do not zigzag from one side of the trail to the other.

Ungroomed Trail

Unless there has been a fresh snowfall you can expect "washboard" and snowdrift conditions. Taken at excessive speeds, such conditions can be physically harmful. Slow down. Hold on the handlebar and assume a posting position. Feet should be under the body assuming a crouched position to absorb any jarring effect. On longer stretches of "washboard" trails, the kneeling position of one knee on the seat can be adopted. This provides a

certain amount of comfort, while at the same time keeps the body loose and capable of vehicle control. Beware of hidden rocks or tree stumps partially hidden by a recent snowfall.

Deep Snow

In deep “powder” snow, your vehicle could begin to “bog” down. If this occurs, turn in as wide an arc as possible and look for a firmer base. If you do get “bogged”, and it happens to everyone, do not spin your track as this makes the vehicle sink deeper. Instead, turn the engine off, get off and move the back of the vehicle onto new snow. Then tramp a clear path ahead of the vehicle. A few feet will generally suffice. Restart the engine. Assume the standing position and rock the vehicle gently as you steadily and slowly apply the throttle. Depending on whether the front or rear end of the vehicle is sinking, your feet should be placed on the opposing end of the running boards. Never place foreign material beneath the track for support. Do not allow anyone to stand in front of, or to the rear of, the snowmobile with the engine running. Stay away from the track. Personal injury will result if contact is made with the revolving track.

Frozen Water

Traveling frozen lakes and rivers can be fatal. Avoid waterways. If you are in an unfamiliar area, ask the local authorities or residents about the ice condition, inlets, outlets, springs, fast moving currents or other hazards. Never attempt to operate your snowmobile on ice that may be too weak to support you and the vehicle. Operating a snowmobile on ice or icy surfaces can be very dangerous if you do not observe certain precautions. The very nature of ice is foreign to good control of a snowmobile or any vehicle. Traction for starting, turning or stopping is much less than that on snow. Thus, these distances can be multi-

plied manifold. Steering is minimal, and uncontrolled spins are an ever present danger. When operating on ice, drive slowly with caution. Allow yourself plenty of room for stopping and turning. This is especially true at night.

Hard Packed Snow

Don't underestimate hard packed snow. It can be difficult to negotiate as both skis and track do not have as much traction. Best advice is to slow down and avoid rapid acceleration, turning or braking.

Uphill

There are two types of hills you can encounter — the open hill on which there are few trees, cliffs or other obstacles, and a hill that can only be climbed directly. On an open hill, the approach is to climb it by side hilling or slalomming. Approach at an angle. Adopt a kneeling position. Keep your weight on the uphill side at all times. Maintain a steady, safe speed. Continue as far as you can in this direction, then switch to an opposite hill angle and riding position.

A direct climb could present problems. Choose the standing position, accelerate before you start the climb and then reduce throttle pressure to prevent track slippage.

In either case, vehicle speed should be as fast as the incline demands. Always slow down as you reach the crest. If you cannot proceed further, don't spin your track. Turn the engine off, free the skis by pulling them out and downhill, place the rear of the snowmobile uphill restart the engine and ease it out with slow even throttle pressure. Position yourself to avoid tipping over, then descend.

Downhill

Downhill driving requires that you have full control of your vehicle at all times. On steeper hills, keep your center of

gravity low and both hands on the handlebar. Maintain slight throttle pressure and allow the machine to run downhill with the engine operating. If a higher than safe speed is reached, slow down by braking but apply the brake with frequent light pressure. Never jam the brake and lock the track.

Side Hill

When crossing a side hill or traversing up or downhill, certain procedures must be followed. All riders should lean towards the slope as required for stability. The preferred operating positions are the kneeling position, with the knee of the down hill leg on the seat and the foot of the uphill leg on the running board, or the posting position. Be prepared to shift your weight quickly as needed. Side hills and steep slopes are not recommended for a beginner or a novice snowmobiler.

Slush

Slush should be avoided at all times. Always check for slush before starting across any lake or river. If dark spots appear in your tracks, get off the ice immediately. Ice and water can be thrown rearward into the path of a following snowmobile. Getting a vehicle out of a slush area is strenuous and in some cases, impossible.

Fog or Whiteout Conditions

On land or water, fog or visibility-limiting snow can form. If you have to proceed into the fog or heavy snow, do so slowly with your lights on and watch intently for hazards. If you are not sure of your way, do not proceed. Keep a safe distance behind other snowmobilers to improve visibility and reaction time.

Unfamiliar Territory

Whenever you enter an area that is new to you, drive with extreme caution. Go slow enough to recognize potential hazards such as fences or

fence posts, brooks crossing your path, rocks, sudden dips, guy wires and countless other obstacles which could result in a termination of your snowmobile ride. Even when following existing tracks, be cautious. Travel at a speed so you can see what is around the next bend or over the top of the hill.

Bright Sunshine

Bright sunny days can considerably reduce your vision. The glare from sun and snow may blind you to the extent that you cannot easily distinguish ravines, ditches or other obstacles. Goggles with colored lenses should always be worn under these conditions.

Unseen Obstruction

There may be obstructions hidden beneath the snow. Driving off established trails and in the woods requires reduced speed and increased vigilance. Driving too fast in an area can make even minor obstacles very hazardous. Even hitting a small rock or stump could throw your snowmobile out of control and cause injury to its riders. Stay on established trails to reduce your exposure to hazards. Be safe, slow down and enjoy the scenery.

Hidden Wires

Always be on the lookout for hidden wires, especially in areas that may have been farmed at one time or another. Too many accidents have been caused by running into wires in the fields, guy wires next to poles and roads, and into chains and wires used as road closures. Slow speeds are a must.

Obstacles and Jumping

Unplanned jumps of snowdrifts, snowplow ridges, culverts or indistinguishable objects can be dangerous. You

can avoid them by wearing the proper color lenses or face shields and by operating at a lower speed.

Jumping a snowmobile is an unsafe and dangerous practice. However, if the trail does suddenly drop away from you, crouch (stand) towards the rear of the vehicle and keep the skis up and straight ahead. Apply partial throttle and brace yourself for the impact. Knees must be flexed to act as shock absorbers.

Turning

Depending on terrain conditions, there are two preferred ways to turn or corner a snowmobile. For most snow surfaces, "body english" is the key to turning. Leaning towards the inside of the turn and positioning body weight on the inside foot will create a "banking" condition beneath the track. By adopting this position and positioning yourself as far forward as possible, weight will be transferred to the inside ski.

On occasion, you will find that the only way to turn the vehicle about in deep snow is to pull the snowmobile around. Do not over-exert yourself. Get assistance. Remember to always lift using your legs as opposed to your back.



Road Crossing

In some cases, you will be approaching the road from a ditch or snowbank. Choose a place where you know you

can climb without difficulty. Use the standing position and proceed with only as much speed needed to crest the bank. Stop completely at the top of the bank and wait for all traffic to clear. Judge the drop to the roadway. Cross the road at a 90° angle. If you encounter another snowbank on the opposite side, position your feet near the rear of the vehicle. Remember, your snowmobile is not designed to operate on bare pavement and steering on this type of surface is more difficult.

Railroad Crossing

Never ride on railroad tracks. It is illegal. Railroad tracks and railroad rights-of-way are private property. A snowmobile is no match for a train. Before crossing a railroad track, stop, look and listen.

Night Rides

The amount of natural and artificial light at a given time can affect your ability to see or to be seen. Nighttime snowmobiling is delightful. It can be a unique experience if you acknowledge your reduced visibility. Before you start, make certain your lights are clean and work properly. Drive at speeds that will allow you to stop in time when you see an unknown or dangerous object ahead. Stay on established trails and never operate in unfamiliar territory. Avoid rivers and lakes. Guy wires, barbed wire fences, cabled road entrances and other objects such as tree limbs are difficult to see at night. Never drive alone. Always carry a flashlight. Keep away from residential areas and respect the right of others to sleep.

Group Riding

Before starting out, designate a "trail boss" to lead the party and another person to follow-up at the end of the party. Ensure that all members of the party are aware of the proposed route and destination. Make certain that you are

carrying all necessary tools and equipment and that you have sufficient fuel to complete the trip. Never overtake the trail boss or, for that matter, any other snowmobile. Use down-the-line hand signals to indicate hazards or intent of direction change. Assist others whenever necessary.

It is always IMPORTANT to keep a safe distance between each snowmobile. Always maintain a safe interval and allow sufficient stopping distance. Don't be a tailgater. Know the position of the machine ahead.

Signals

If you intend to stop, raise either hand straight above your head. A left turn is indicated by extending your left hand straight out in the proper direction. For right turns, extend the left arm and raise the hand to a vertical position so it forms a right angle at the elbow. Every snowmobiler should relay any signal to the ones behind.

Trail Stops

Whenever possible, pull off the trail when you stop. This will reduce the hazard to other snowmobilers using the trail.

Trails and Signs

Trail signs are used to control, direct or regulate the use of snowmobiles on trails. Become familiar with all signs used in the area where you are snowmobiling.

Environment

Wildlife compliments your snowmobiling day. Snowmobile tracks provide firm ground over which animals can travel from area to area. Do not violate this privilege by chasing or harassing wildlife. Fatigue and exhaustion can lead to animal's death. Avoid areas posted for the protection or feeding of wildlife.

If you happen to be fortunate enough to see an animal, stop your snowmobile and observe quietly.

The guidelines that we support are not designed to limit your snowmobiling fun, but to preserve the beautiful freedom that you can experience only on a snowmobile! These guidelines will keep snowmobilers healthy, happy and able to introduce others to what they know and enjoy about their favorite winter pastime. So, the next time you hit the trails on a cool, crisp and clear winter day, we ask you to remember that you are paving the way for the future of our sport. Help us lead it down the right path! From all of us at BRP, thank you for doing your share.

There is nothing more exhilarating than snowmobiling. Venturing onto snowmobile trails that criss-cross wild areas is an exciting and healthy winter sport. However, as the number of people using these recreational parks increases, so does the potential for damage to the environment. Abuse of land, facilities and resources inevitably leads to restrictions and closures of both private and public land.

In essence, the greatest threat to our sport, is all around us. Which leaves us with one logical choice. When we snowmobile, we must always ride responsibly.

The vast majority respect the law and the environment. Each of us must set an example for those who are new to the sport, young and old alike.

It is in every one's best interest to tread lightly into our recreational areas. Because, in the long run, to protect the sport we must preserve the environment.

Recognizing the importance of this issue and the need for snowmobilers to do their share in preserving areas that make it possible to enjoy our sport, BRP has developed the "Light Treading Is Smart Sledding" campaign for snowmobilers.

Light Treading refers to more than the thread of our tracks. It's a statement of concern, respect and willingness to take the lead and take action. It applies to the environment in general, its proper care and maintenance, its natural inhabitants and all enthusiasts and the public at large who enjoy the great outdoors. With this theme, we invite all snowmobilers to remember that respecting the environment is not only critical to the future of our industry but to future generations.

Light Treading in no way suggests you should curb your appetite for snowmobiling fun! It simply means tread with respect!

The fundamental objective of Light Treading is one of respect for where and how you ride a snowmobile. You're a light treader when you follow the principles below.

Become informed. Obtain maps, regulations and other information from the Forest Service or from other public land agencies. Learn the rules and follow them and that goes for speed limits, too!

Avoid running over young trees, shrubs, and grasses and don't cut wood. On flatlands or areas where trail riding is popular, it's important to ride only where authorized. Remember, there is a link between protecting your environment and your own safety.

Respect wildlife and be particularly sensitive of animals that are rearing young or suffering from food shortage. Stress can sap scarce energy reserves. Refrain from riding in areas where only animals are intended to tread!

Obey gate closures and regulatory signs and remember, light treaders don't litter!

Stay out of wilderness areas. They're closed to all vehicles. Know where the boundaries are.

Obtain permission to travel across private land. Respect the rights of landowners and other people's privacy. Remember, snowmobile technology has lowered the noise factor considerably, but you still shouldn't rev your engines where quiet "is the order of the day".

Snowmobilers know all too well the efforts that have been made throughout the sport's history to enjoy access to areas where people can snowmobile safely and responsibly. This effort continues today, as strong as ever.

Respecting the areas where we ride... wherever they may be... is the only way to ensure their future enjoyment. That's one major reason why we know you'll agree that Light Treading is smart sledding! And there are more.

Enjoying the opportunity to see winter and all its natural majestic wonders, is an experience cherished by snowmobilers. Light Treading will preserve this opportunity and will make it possible for us to expose others to the beauty of winter and the unique thrill of our sport! Light Treading will help our sport to grow!

Finally, Light Treading is the sign of a smart snowmobiler. You don't have to leave big tracks or careen through a virgin forest to show you can ride. So whether you're driving a high performance Ski-Doo, a sporty MX Z® snowmobile or any other make or model, show you know what you're doing. Show you know how to send snow flying and make tracks with a light touch!

TRACTION ENHANCING PRODUCTS

NOTE: This section is applicable to snowmobiles equipped with a factory installed track that has been approved by BRP for special studs installation.

NOTE: The factory installed track on model MX Z x 600 RS is studdable in accordance with ISR competition standards

WARNING

Never stud a track that has not been approved for studs. Approved tracks can be identified by a stud symbol (see illustration below) molded into the track surface. Installing studs on an unapproved track could increase the risk of the track tearing or severing.

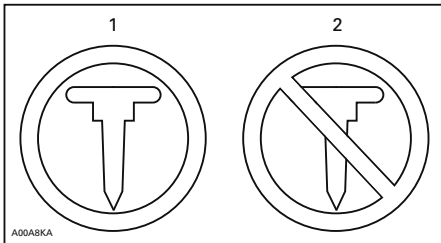

TRACK SYMBOLS

1. *Approved*
2. *NOT Approved*

WARNING

Use only the BRP approved type stud for these Ski-Doo snowmobiles. DO NOT EVER use conventional studs as the track thickness is thinner than other standard tracks. The stud could tear off of track and separate from vehicle. See an authorized Ski-Doo dealer for current specific studding availability and applications.

Using traction enhancing products such as, more aggressive ski carbide runners and/or studs on your snow-

mobile will change its behavior, particularly in terms of manoeuvrability, acceleration, and braking.

Using traction enhancing products gives a better grip on packed snow and ice, but has no noticeable effect on soft snow. For this reason, driving a snowmobile equipped with traction enhancing products requires a certain adaptation period. If your snowmobile is equipped with traction enhancing products, be sure to take plenty of time to get used to the way it handles when turning, accelerating, and braking.

Also, always check local regulations concerning the use of traction enhancing products on snowmobiles. Always drive your snowmobile in a responsible manner, respecting the environment and other people's property.

Manoeuvrability

Using traction enhancing products such as, more aggressive ski carbide runners and/or studs makes the snowmobile grip the ground better at both the front and at the rear. The use of carbide runners is therefore required to give the skis a better grip, so that the front and rear of the snowmobile are in balance. While off-the-shelf carbide ski runners are adequate, they don't necessarily give you optimal control, since that depends on your personal preferences, your riding style, and how your suspension is adjusted.

WARNING

If the front and rear of the snowmobile are out of balance due to an incorrect combination of traction enhancing products, the snowmobile may tend to oversteer or understeer, which could lead to a loss of control.

Oversteering

In certain conditions, using more aggressive ski carbide runners without studs on the rear track could make the snowmobile prone to oversteering, see illustration.

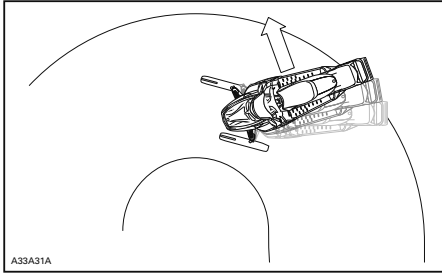

OVERSTEERING

Understeering

In certain conditions, the use of studs on the track could make the snowmobile prone to understeering if the skis are not equipped with more aggressive ski carbide runners, see illustration.

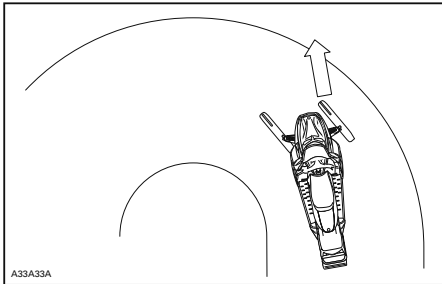

UNDERSTEERING

Controlled Driving

A balanced combination of carbide ski runners and studs on the track ensures adequate control and better handling, see illustration.

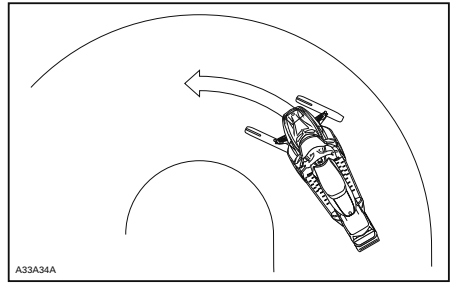

CONTROLLED DRIVING

Acceleration

Using studs on the track will allow your sled to accelerate better on packed snow and ice but will have no noticeable effect on soft snow. This can cause sudden variations in traction under certain conditions.

⚠ WARNING

To prevent surprises that could lead to a loss of control of the snowmobile:

- Always go easy on the throttle.
- NEVER try to spin the track to make the rear of the snowmobile skid.

This could cause debris or ice to be thrown violently backwards, possibly injuring others nearby or on snowmobiles behind you.

Braking

As in the case of acceleration, using studs on the track will give you better braking capacity on packed snow or ice but will have no noticeable effect on soft snow. Braking may thus vary suddenly under certain conditions. Be sure to use restraint in braking to keep from blocking the track in order to avoid surprises that could lead to a loss of control.

Important Safety Rules

⚠ WARNING

To prevent serious injury to individuals near the snowmobile:

- NEVER stand behind or near a moving track.
- Always use a wide-base snowmobile stand with a rear deflector panel if it is necessary to rotate track.
- When the track is raised off the ground, only run it at the lowest possible speed.

Centrifugal force could cause debris, damaged or loose studs, pieces of torn track, or an entire severed track to be violently thrown backwards out of the tunnel with tremendous force.

Effects of Having a Studded Track on the Life of the Snowmobile

The use of traction enhancing products can increase the load and the stress on certain snowmobile components, as well as the vibration level. This can cause premature wear on parts such as drive belts, brake linings, bearings, chain, chaincase sprocket, and on approved studded tracks, shorten track life. Always proceed with a visual inspection of your track before each use. For more information, refer to the *TRACK* section in *MAINTENANCE INFORMATION*.

Studs on the track can also cause serious damage to your snowmobile if it is not equipped with the tunnel protectors designed for your particular model. Damage to the electrical wiring or perforation of the heat exchangers are potential hazards, that could cause the engine to overheat and be severely damaged.

⚠ WARNING

If tunnel protectors are excessively worn or not installed, the gas tank could be punctured, causing a fire.

NOTICE Ask your dealer for the appropriate tunnel protectors model and kit number required for your snowmobile.

NOTE: Consult the BRP limited warranty to find out what warranty limitations are related to the use of studs.

Installation of Studs on BRP Approved Tracks

⚠ WARNING

Never stud a track that has not been approved for studs. Installing studs on an unapproved track could increase the risk of the track tearing or severing.

To ensure safe and proper installation, BRP recommends to have the studs installed by your dealer.

- Use only the BRP approved special studs.
- Never use studs that exceed the height of your snowmobile's track profile by more than 9.5 mm (3/8 in).

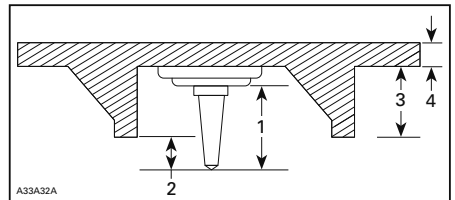

INSTALLATION OF STUDS

1. Stud size
2. Penetration range 6.4 mm to 9.5 mm (1/4 ft to 3/8 ft)
3. Track lug height
4. Track belt thickness

⚠ WARNING

- See an authorized Ski-Doo dealer for current specific stud-
ding availability and applica-
tions.
- DO NOT EVER use conventional
stud because, the track thick-
ness is thinner than our stan-
dard tracks and the stud could
tear off of track and separate
from vehicle.
- Studs should only be installed
in the locations indicated by
molded bulges in the track sur-
face.
- Never stud a track with a profile
of 35 mm (1.375 in) or more.
- The number of studs installed
must always perfectly match
the pattern of molded bulges in
the track.
- Always consult the traction
product manufacturer's instal-
lation instructions and recom-
mendations before having your
dealer install studs and runners.
It is very important to follow
the torque specifications for the
stud bolts.

**INSTALLING AN INCORRECT
NUMBER OF STUDS OR AN IM-
PROPER INSTALLATION CAN IN-
CREASE THE RISK OF THE TRACK
TEARING OR SEVERING.**

- Broken rods
- Broken studs (studded tracks)
- Bent studs (studded tracks)
- Missing studs
- Studs that are torn off the track
- Missing track guide(s)
- Loose studs.

On approved studded tracks, replace broken or damaged studs immediately. If your track shows signs of deteriora-
tion, it must be replaced immediately.
When in doubt, ask your dealer. Al-
ways proceed with a visual inspection
of your track before each use.

⚠ WARNING

**Riding with a damaged track or
studs could lead to loss of control.**

**Inspection of a Studded
Track**

PROCEED WITH A VISUAL INSPEC-
TION OF YOUR TRACK BEFORE
EACH RIDE.

Look for any defects, such as:

- Perforations in the track
- Tears in the track (particularly
around traction holes on studded
tracks)
- Lugs that are broken or torn off, ex-
posing portions of rods
- Delamination of the rubber

IMPORTANT ON-PRODUCT LABELS

Hang Tag

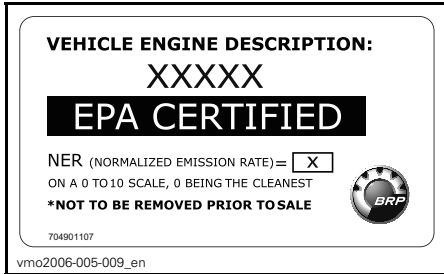

TYPICAL

Vehicle Safety Labels

These labels are affixed to the vehicle for the safety of the operator, passenger or bystanders.

The following labels are on your vehicle and they should be considered permanent parts of the vehicle. If missing or damaged, the decals can be replaced free of charge. See an authorized Ski-Doo dealer.

NOTE: In the event of any discrepancy between this guide and the vehicle, the safety labels on the vehicle have precedence over the labels in this guide.

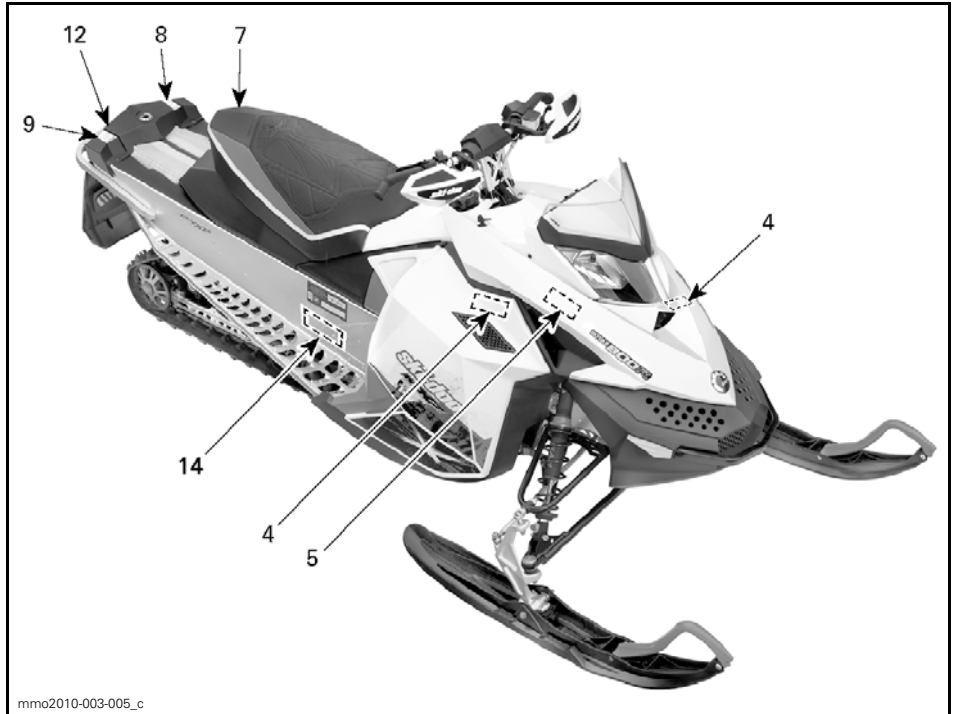

mmo2010-003-005_c

TYPICAL

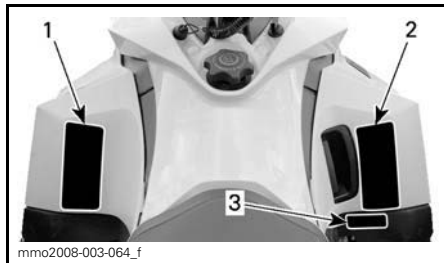

mmo2008-003-064_f

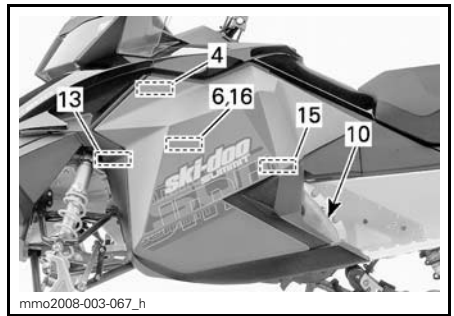

mmo2008-003-067_h

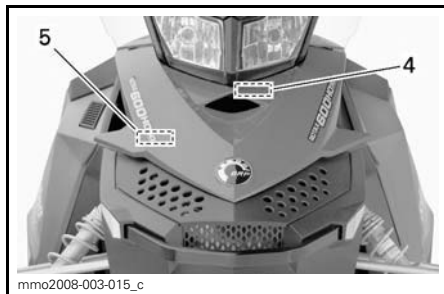

mmo2008-003-015_c

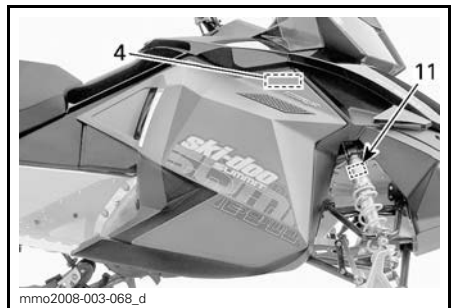

mmo2008-003-068_d

⚠ WARNING

- Read and understand all safety labels, operator's guide and watch your safety DVD before operation. Operator's guide is located either in the passenger seat or under the driver's seat. To access guide under driver's seat, pull front of seat cushion then pull tab to unlock seat (if applicable, passenger's seat needs to be removed first).
- Get familiar with your vehicle. Inexperienced riders may overlook risks and be surprised by vehicle's specific behavior and terrain conditions. Ride slowly.
- Excessive speed and reckless driving can kill!
ALWAYS adjust your speed according to snow conditions and circumstances.
- Steering control and braking ability may be reduced on hard-pack snow, ice or roads. Reduce speed & allow more space to stop or turn.
- Respect laws on minimum operator age. Manufacturer recommends a minimum operating age of 16 years old.
- Never open side panels or hood while engine is running or if vehicle is in motion. Ensure to remove DESS key before opening those.

BEFORE STARTING :

1. Attach tether cord to your clothing.
2. Check proper operation of the throttle and brake levers each time before starting. They must return to their initial position when released.
3. Apply parking brake.
4. Turn handlebars all the way in both directions to check for interference and insure free operation.

AFTER STARTING :

1. Pull-out tether cord to check if engine shuts off.
2. Re-start and push in the emergency engine stop switch to check if engine shuts off.
3. Disengage parking brake before riding to avoid brake fading.

516005227

LABEL 1

⚠ WARNING

This vehicle is designed for one (1) operator and as many passengers as there are seats with straps or handgrips installed on the vehicle conforming to SSSC standards.

Ce véhicule a été conçu pour un (1) conducteur et autant de passagers qu'il y a de sièges avec courroies ou poignées installés sur le véhicule et rencontrant la norme SSSC.

When riding with a passenger :

- Braking ability and steering control are reduced. Decrease speed and allow extra space to maneuver.
- Adjust suspensions according to weight.

REMEMBER : YOU ARE RESPONSIBLE FOR THE SAFETY OF YOUR PASSENGER!

ALL DRIVERS AND PASSENGERS MUST READ THE FOLLOWING:
Avoid surprises!
BE ON THE LOOK-OUT for the unexpected.



Operate defensively.

- Scan constantly for people, objects, conditions and upcoming vehicles.
- Avoid thin ice / open water.
- Use extra caution whenever off-trail.

ALWAYS wear a DOT approved HELMET and clothing appropriate for snowmobiling.



NEVER ride under the influence of alcohol or drugs even as a passenger.



516005228

LABEL 2

⚠ WARNING ⚠ AVERTISSEMENT





516005226

LABEL 3 – EUROPEAN MODELS



LABEL 4



LABEL 5

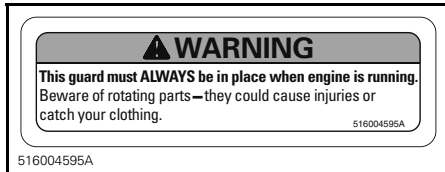

LABEL 6



LABEL 7

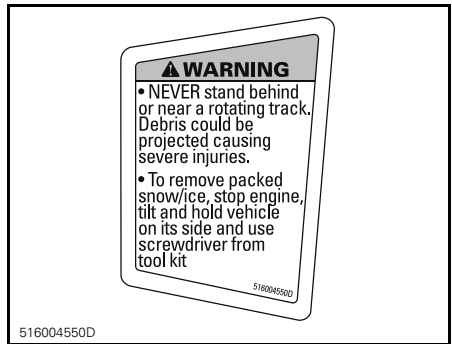

LABEL 8

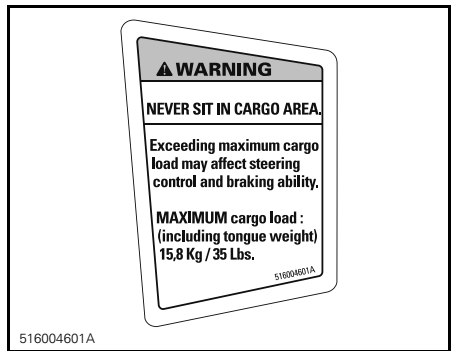

LABEL 9



LABEL 10 – ON BRAKE DISC GUARD

WARNING

- This shock absorber is pressurized.
- An explosion may occur if heated or punctured.
- Do not disassemble.

mmo2010-003-101_en

LABEL 11 – ON SHOCK GAS CHARGED ABSORBERS

WARNING

If you stud the track on this vehicle use special BRP approved studs ONLY.

Studding this track with conventional studs may cause studs to tear off track and separate from vehicle posing a potential risk of severe injury or death. See the Operator's Guide that came with this vehicle for all details pertaining to track studding.

mmo2008-003-052_en

LABEL 12 – MODELS WITH TRACK APPROVED FOR STUDS

Compliance Labels

EPA Compliance Label

EMISSION CONTROL INFORMATION

THIS VEHICLE IS CERTIFIED TO OPERATE ON UNLEADED GASOLINE AND MEETS (XXXX) U.S. EPA REGULATIONS FOR SNOWMOBILE SI ENGINES. 121

ENGINE FAMILY	XXXXX XXXXXXXX	FAMILLE DE MOTEUR	
PERMEATION FAMILY	XXXXXXXXXXXXXX	FAMILLE DE PERMÉATION	
FEL	XX g/kW-hr HC XXX g/kW-hr CO	LIMITE DES ÉMISSIONS DE LA FAMILLE	
ENGINE DISPLACEMENT	XXX.X cm ³	CYLINDRÉE	
EXHAUST EMISSION CONTROL SYSTEM	XXX	SYSTÈME DE CONTRÔLE DES ÉMISSIONS	

RENSEIGNEMENTS SUR LE DISPOSITIF ANTIPOLLUTION
 CE VÉHICULE EST CERTIFIÉ POUR FONCTIONNER À L'ESSENCE SANS PLOMB ET IL RÉPOND AUX NORMES (XXXX) DE L'EPA DES E.-U. POUR LES MOTONEIGES À MOTEUR SI.
 SEE OPERATOR'S GUIDE FOR MAINTENANCE SPECIFICATIONS VOIR GUIDE DU CONDUCTEUR POUR LES SPÉCIFICATIONS D'ENTRETIENS
BOMBARDIER RECREATIONAL PRODUCTS INC.

516 005 052

COMPLIANCE LABEL 13 - IN ENGINE COMPARTMENT

SSCC Label

Safety standards for snowmobiles have been adopted by the Snowmobile Safety and Certification Committee (SSCC) of which BRP is a proud participating member. Assurance that your snowmobile meets these standards is easily checked by locating the Certification Label on a right vertical portion of the vehicle.

The following label shows that an independent testing laboratory has verified compliance with the SSCC safety standards.

CE MODÈLE A ÉTÉ ÉVALUÉ PAR UN LABORATOIRE D'ESSAIS INDÉPENDANT ET S'ATTAQUE À TOUTES LES NORMES DE SÉCURITÉ DU SSCC EN VIGUEUR À LA DATE DE FABRICATION. PARRAÎNÉ PAR LE COMITÉ DE SÉCURITÉ ET CERTIFICATION DE LA MOTONEIGE, INC.	CERTIFIED CERTIFIÉ	THIS MODEL HAS BEEN EVALUATED BY AN INDEPENDENT TESTING LABORATORY AND IT MEETS ALL SSCC SAFETY STANDARDS IN EFFECT ON THE DATE OF ITS MANUFACTURE. SPONSORED BY THE SNOWMOBILE SAFETY AND CERTIFICATION COMMITTEE, INC.
---	---	---

A00A1MA

LABEL 14 – ON TUNNEL

Technical Information Labels

CAUTION	ATTENTION
<ul style="list-style-type: none"> To comply with noise regulations, this engine is designed to operate with an air intake silencer. Operation without air intake silencer or with one not properly installed may cause engine damage. 	<ul style="list-style-type: none"> Le moteur a été conçu pour fonctionner avec ce silencieux d'admission afin de se conformer aux lois et règlements relatifs au bruit. Son absence ou une mauvaise installation peut endommager le moteur.

mmo2007-009-051

LABEL 15

NOTICE

Drive pulley bolt recommended torque
85-92 lbf-ft / 115-125 N-m

Not applying the recommended torque may result in a major failure of the drive pulley and the engine. Refer to the shop manual for the complete assembly procedure.

Couple de serrage recommandé pour le boulon de la poulie motrice
115-125 N-m / 85-92 lbf-pi

Ne pas appliquer le couple de serrage recommandé pourrait entraîner un bris majeur à la poulie motrice et au moteur. Rétérez au manuel de réparation pour avoir la procédure complète d'assemblage.

516023708

mmo2010-003-001

LABEL 16 – LOCATED ON DRIVE BELT GUARD

NOTICE

- To comply with noise regulations, this engine is designed to operate with an air intake silencer.
- Operation without air intake silencer or with one not properly installed may cause engine damage.

516004572

516004572

LOCATED ON AIR INTAKE SILENCER



mmo2013-002-002

LOCATED ON FUEL CAP - (INSIDE NORTH AMERICA)

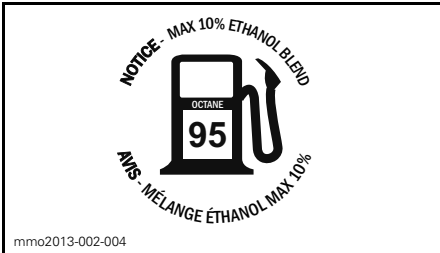

mmo2013-002-004

LOCATED ON FUEL CAP - (OUTSIDE NORTH AMERICA)

VEHICLE INFORMATION

CONTROLS, INSTRUMENTS AND EQUIPMENT

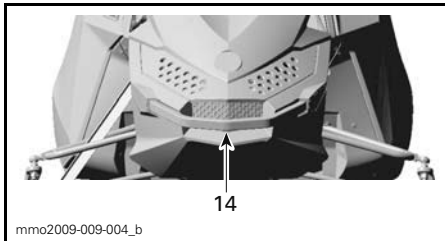
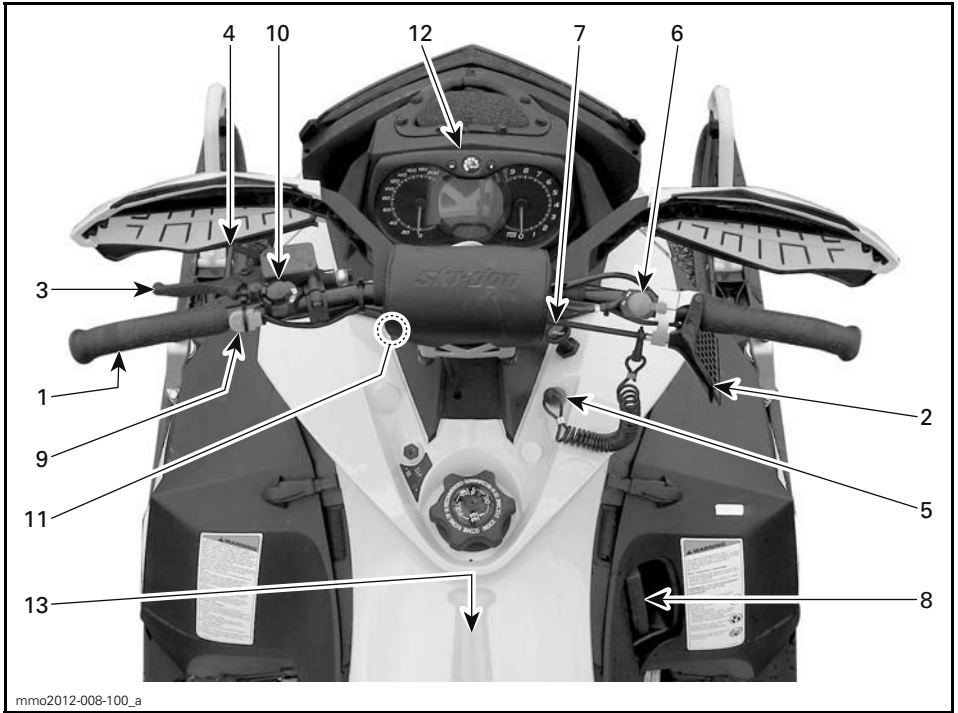

1) Handlebar

The handlebar controls the steering of the snowmobile. As the handlebar is rotated to right or left, the skis are turned right or left to steer the snowmobile.

2) Throttle Lever

Throttle lever is located on the RH side of handlebar.

Designed to be thumb activated. When squeezed, it increases the engine speed and engages the transmission. When released, engine speed returns automatically to idle.

⚠ WARNING

Test the throttle lever operation each time before starting the engine. The lever must return to its original position once released. Otherwise, do not start engine.

3) Brake Lever

Brake lever is located on the LH side of handlebar.

When squeezed, brake is applied. When released, it automatically returns to its original position. Braking effect is proportional to the pressure applied on the lever and to the type of terrain and its snow coverage.

4) Parking Brake Lever

Parking brake is located on the LH side of handlebar.

Parking brake should be used whenever snowmobile is parked.

⚠ WARNING

Make sure parking brake is fully disengaged before operating the snowmobile. When you ride the vehicle, brake pads that are caused to drag by a continuous pressure on the lever may cause damage to the brake system and cause loss of braking capacity and/or fire.

To Engage Parking Brake

Apply and hold brake, then lock brake lever using the parking brake lever as shown.

NOTICE Parking brake position can vary depending on brake pads wear. Ensure when the parking brake is applied that the vehicle stays securely in place.

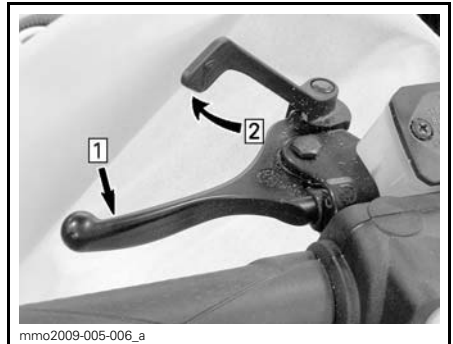

TYPICAL — ENGAGE MECHANISM

Step 1: Apply and hold brake

Step 2: Lock brake lever using parking brake lever

To Release Parking Brake

Squeeze brake lever. Locking lever will automatically return to its original position. Always release parking brake before riding.

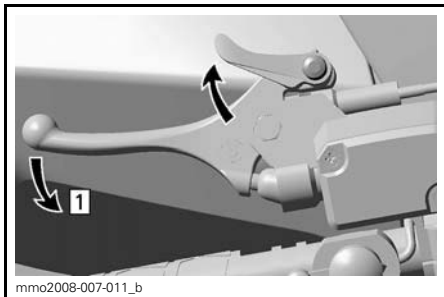

TYPICAL — RELEASE MECHANISM
 Step 1: Squeeze brake lever

5) Engine Cut-off Switch

General

When the tether cord cap is removed, it shuts the engine off preventing snowmobile to runaway if the operator falls off the vehicle accidentally.

⚠ WARNING

Always remove the tether cord cap when vehicle is not in operation in order to prevent accidental engine starting, to avoid unauthorized use by children or others or theft.

Operation

Attach tether cord eyelet to clothing, then snap cap over post before starting engine.

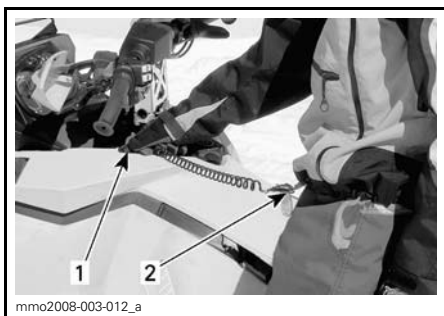

TYPICAL
 1. Snap over post
 2. Attach to clothing

If emergency engine shut off is required, pull tether cord cap from post completely.

6) Emergency Engine Stop Switch

The emergency engine stop switch is located on the RH side of handlebar.

To stop the engine in an emergency, select OFF position (down or up) and simultaneously apply the brake.

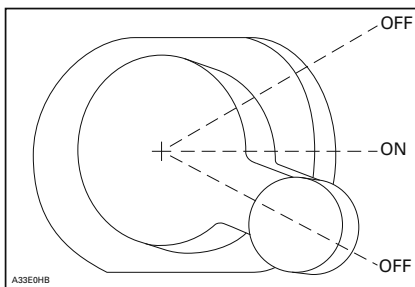

To allow engine starting, the switch must be in the ON position (middle position).

All operators of the snowmobile should familiarize themselves with the function of this device by using it several times on first outing and whenever stopping the engine thereafter. This engine shut off procedure will become a reflex and will prepare operators for emergency situations requiring its use.

⚠ WARNING

If the switch has been used in an emergency caused by a suspected malfunction, the source of the malfunction should be determined and corrected before restarting engine. See an authorized Ski-Doo dealer for servicing.

7) Primer Button

Pull and push button. It is not necessary when engine is warm.

To prime, activate button until a pumping resistance is felt. From this point, pump 2 or 3 times to inject fuel in intake manifold. After priming, ensure that primer button is pushed back.

NOTE: In very cold temperature, it is recommended to rotate primer button 3 - 4 turns prior to pulling it. This will eliminate the possibility of sticking.

8) Rewind Starter Handle

Auto-rewind type located on right hand side of snowmobile. To engage mechanism, pull handle slowly until a resistance is felt then pull vigorously. Slowly release handle.

9) Pre-Heat Switch

Racing Application Only

NOTE: This switch must be removed on vehicles modified for warranty validation.

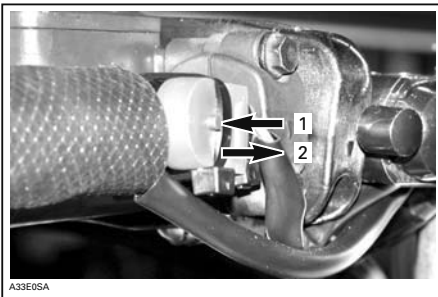

1. Button depressed: Pre-heat timing curve
2. Button released: Normal timing curve

After starting the engine, push and hold the pre-heat switch button in order to pre-heat the tuned pipe.

Release pre-heat switch button once the tuned is pre-heated.

10) High Beam/Low Beam Switch

Allows selection of headlamp high beam or low beam.

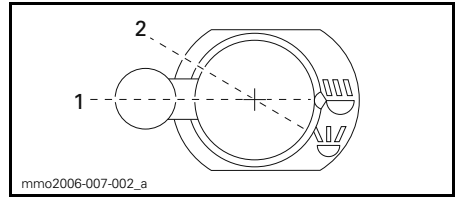

1. Low beam
2. High beam

11) Heated Grips/Heated Throttle Lever Switch

Select the desired position to keep your hands and thumb at a comfortable temperature.

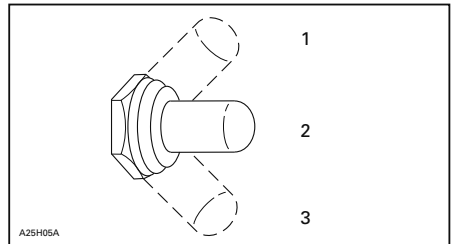

1. Hot
2. Warm
3. Off

12) Multifunction Analog/Digital Gauge

⚠ WARNING

Reading the gauge digital display can distract from the operation of the vehicle, particularly from constantly scanning the environment.

Gauge Description

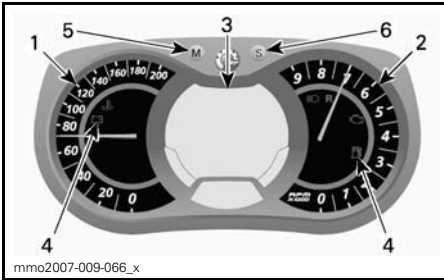

MULTIFUNCTION ANALOG/DIGITAL GAUGE

1. Speedometer
2. Tachometer
3. Multifunction digital display
4. Pilot lamps
5. Mode button
6. Set button

NOTE: The gauge is factory preset in Imperial units but it is possible to change it to metric units, contact an authorized Ski-Doo dealer for unit settings.

1) Speedometer

Measures vehicle speed.



RH PORTION OF GAUGE

3) Multifunction Digital Display

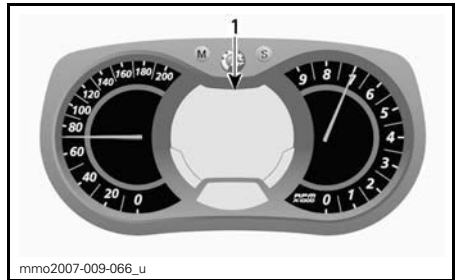

MULTIFUNCTION ANALOG/DIGITAL GAUGE

1. Multifunction display



LH PORTION OF GAUGE

2) Tachometer (RPM)

Measures engine revolution per minute (RPM). Multiply by 1000 to obtain the actual revolutions.

The multifunction display is used to:

- Display the WELCOME message on power up
- Display the KEY recognition message
- Provide various indications as selected by the operator
- Activating or changing various functions or modes of operation
- Display scrolling messages of function activation or system faults
- Display fault codes.

When the information center is first powered up, the numerical display defaults to the last selected indication.

⚠ WARNING





Never adjust or set functions on the multifunction gauge while riding the vehicle.

4) Pilot Lamps and Messages



TYPICAL — PILOT LAMPS

See table below for usual pilot lamps information. Refer to *MONITORING SYSTEM* for details on malfunction pilot lamps.

PILOT LAMP(S) ON	BEEPER	MESSAGE DISPLAY	DESCRIPTION
	4 short beeps every 5 minutes	LOW OIL	Two stroke engine: Injection oil level is low. Stop vehicle in a safe place then, replenish injection oil reservoir.
			Four stroke engines: Low engine oil pressure. Stop vehicle in a safe place then, check oil level. Fill to proper level. If oil level was correct, discontinue use and contact an authorized Ski-Doo dealer.
	—	—	Low fuel level. One (1) bar left in fuel level display. Replenish fuel tank as soon as possible.
	Long beeps repeating slowly	REVERSE	Reverse is selected.
	3 short beeps	REV. FAIL	Reverse did not engage, try again.
	—	—	High beam headlights are selected.
—	—	WARM UP	Engine and/or injection oil need to warm-up before normal operation. The engine's RPM is limited until desired temperature is reached (up to 10 minutes when driving). Warm-up period may occur after a restart in very cold weather.

5) MODE (M) Button

Button use to navigate in gauge multi-function display.

NOTE: MODE (M) button on the multi-switch housing has the same functions and can also be used.

6) SET (S) Button

Button used to navigate, adjust or re-set gauge multifunction display.

In order to memorize settings, engine must be running.

NOTE: SET (S) button on the multi-function switch has the same functions and can also be used.

Gauge Features

GAUGE FEATURES	
FUNCTIONS	600 RS
A) Speedometer	Indication by default
B) Tachometer RPM	X
C) Odometer	X
D) Trip meter "A" or "B"	X
E) Trip hour meter	X
F) Top speed	X
G) Average speed	X
H) Instant fuel consumption	X
I) Total fuel consumption	X
J) Message display	X
K) Top RPM	X
L) Lap record mode	X
M) Exhaust gas temperature	X
N) Throttle position display	X
X = An X indicates a standard feature	

A) Speedometer

In addition of the analog type speedometer, vehicle speed can also be displayed via the multifunction display.

Vehicle speed can be displayed on display 1 or display 2.

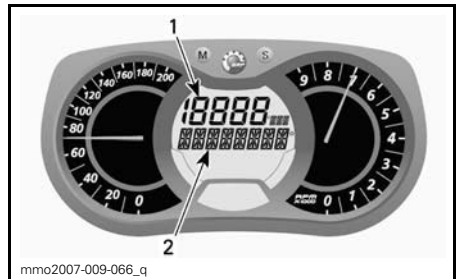

MULTIFUNCTION DISPLAY

- 1. Display 1
- 2. Display 2

Use MODE (M) button to select the desired display, then proceed as follows:

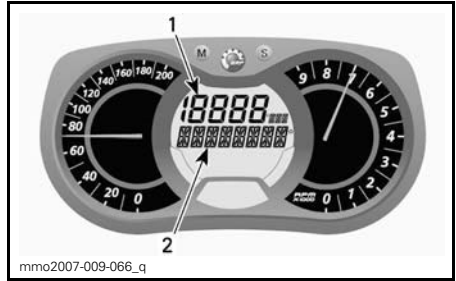

MULTIFUNCTION DISPLAY

1. Display 1
2. Display 2

While display is flashing, press the SET (S) button to select speedometer mode.

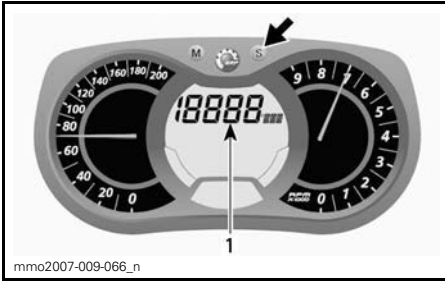

1. Speedometer mode

Press the MODE (M) button to confirm selection or wait 5 seconds.

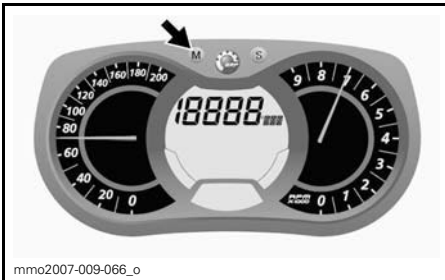

B) Tachometer (RPM)

In addition of the analog type tachometer, RPMs can also be displayed via the multifunction display.

Engine RPM can be displayed on display 1 or display 2.



While display is flashing, press SET (S) button to select RPM mode.

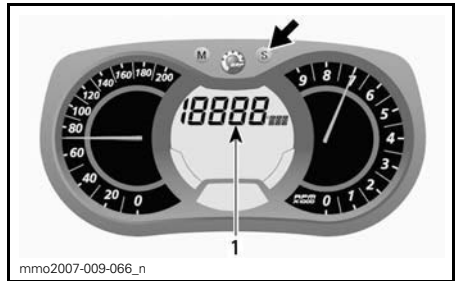

1. RPM mode

Press the MODE (M) button to confirm selection or wait 5 seconds.



C) Odometer

Records the total distance travelled.
Press the SET (S) button to select odometer mode.

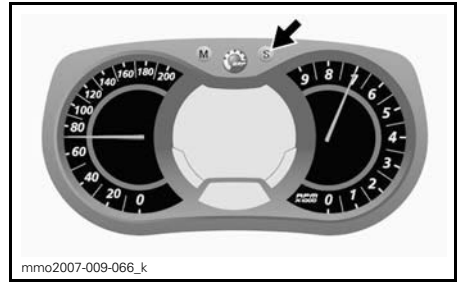

E) Trip Hour Meter

Records vehicle running time when the electrical system is activated since it has been reset.
Press the SET (S) button to select trip hour meter (HrTRIP) mode.

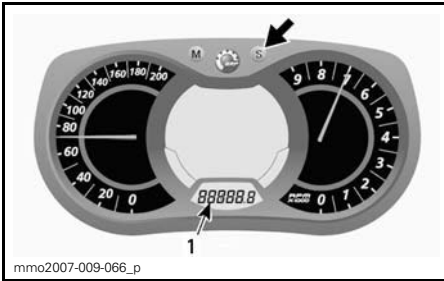

1. Odometer (km/mi) mode

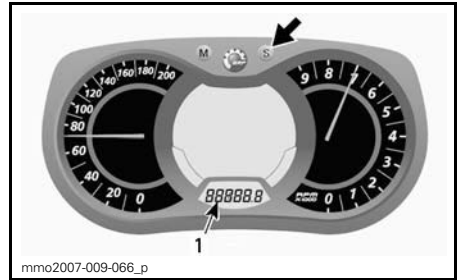

1. Trip hour meter (HrTRIP) mode

D) Trip Meter "A" or "B"

Trip meters records distance travelled since it has been reset.
Press the SET (S) button to select trip meter (TRIP A/TRIP B) mode.

Press and hold the SET (S) button to re-set.

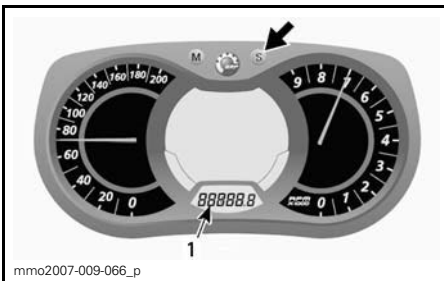

1. Trip meter (TRIP A/TRIP B) mode

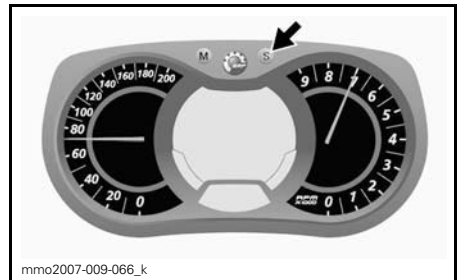

F) Top Speed

Press and hold the SET (S) button to re-set.

Records vehicle top speed since it has been reset.
To display vehicle top speed, proceed as follows.

Press the MODE (M) button to select display 1.



While display flashes, press and hold the SET (S) button within 5 seconds to reset.

While display flashes, press the SET (S) button to select top speed (TOP_SPD) mode.

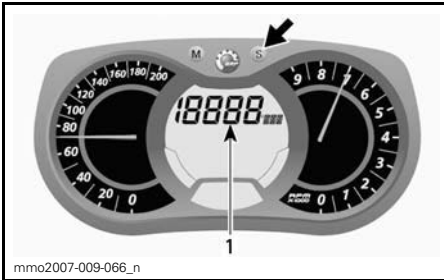

1. Top speed (TOP_SPD) mode

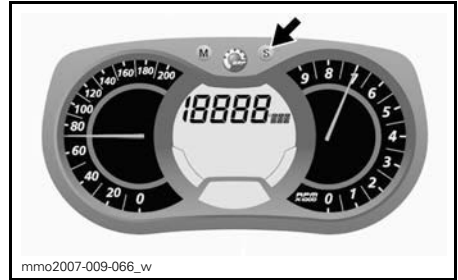

G) Average Speed

Records vehicle average speed since it has been reset.

To display vehicle average speed, proceed as follows.

Press the MODE (M) button to select display 1.

Press the MODE (M) button to confirm selection or wait 5 seconds.

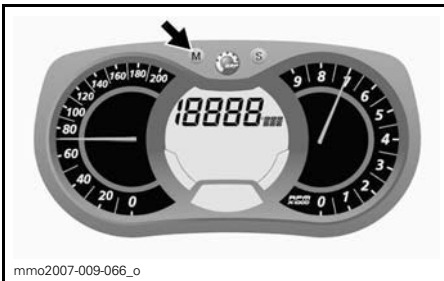

To reset, press the MODE (M) to select mode.

While display flashes, press SET (S) button to select vehicle average speed (AVR_SPD) mode.

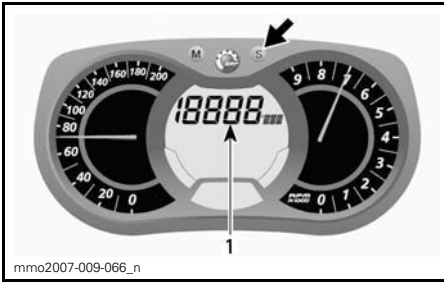

1. Vehicle average speed (AVR_SPD) mode

Press the MODE (M) button to confirm selection or wait 5 seconds.

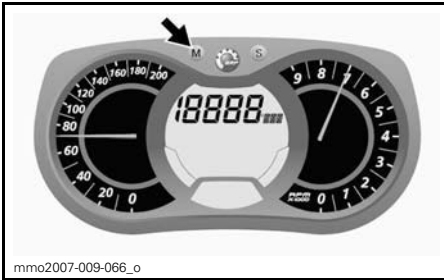

To reset, press the MODE (M) to select mode.

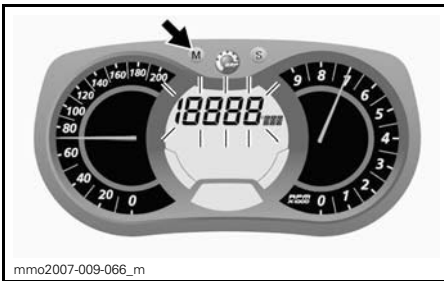

While display flashes, press and hold the SET (S) button within 5 seconds to reset.

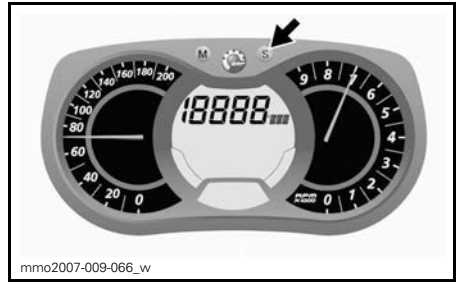

H) Instant Fuel Consumption

Calculates vehicle average fuel consumption while riding.

To display vehicle average fuel consumption, proceed as follows.

Press the MODE (M) button to select display 1.

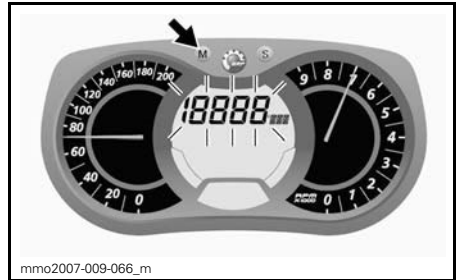

While display flashes, press SET (S) button to select instant fuel consumption mode.

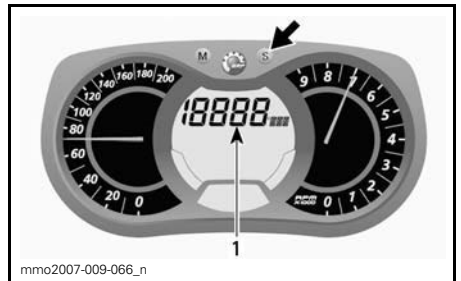

1. Instant fuel consumption mode

Press the MODE (M) button to confirm selection or wait 5 seconds.

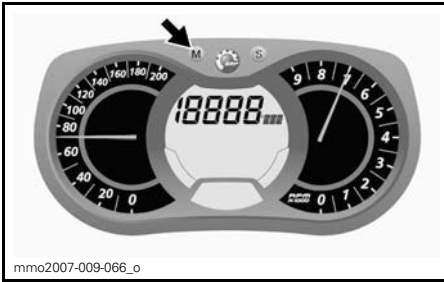

I) Total Fuel Consumption

Records vehicle average fuel consumption since it has been reset.

To display vehicle total fuel consumption, proceed as follows.

Press the MODE (M) button to select the display.

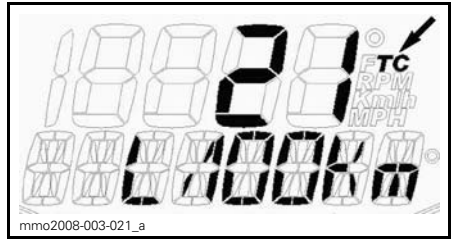

TYPICAL

Press the MODE (M) button to confirm selection or wait 5 seconds.

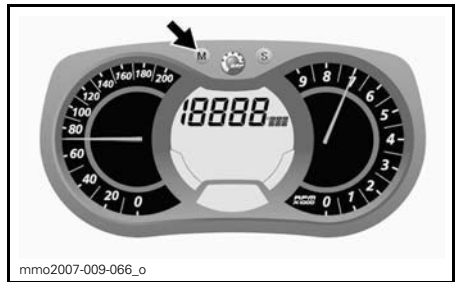

While display flashes, press the SET (S) button to select total fuel consumption (TC) mode.

To reset, set the trip meter to TRIP B. Refer to *TRIP METER "A" OR "B"* for more details.

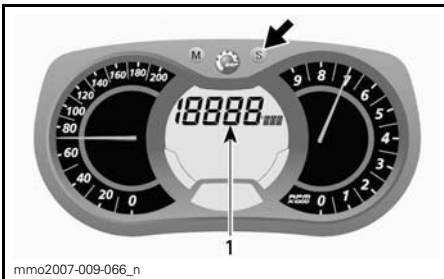

1. Total fuel consumption (TC) mode

TC appears when the mode is selected.

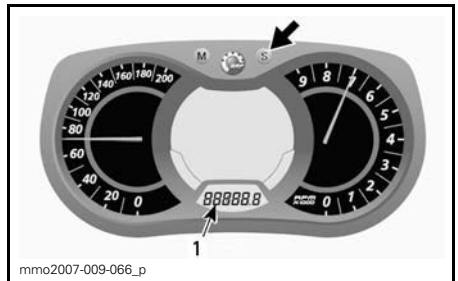

1. Trip meter (TRIP B) mode

Press and hold the SET (S) button to reset.

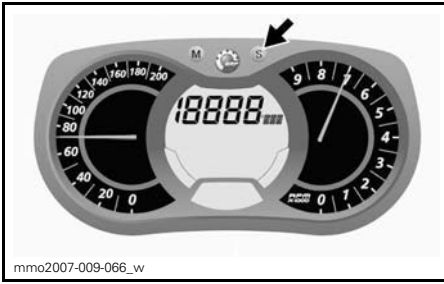

J) Message Display

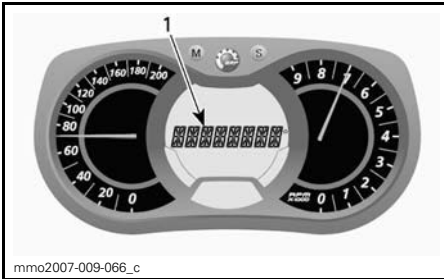

1. Message display

Refer to *PILOT LAMPS AND MESSAGES* in this section for details on usual messages.

Refer to *MONITORING SYSTEM* for details on malfunction.

K) Top RPM

Records engine top revolution per minute (RPM) since it has been reset.

To display engine top revolution per minute, proceed as follows:

1. Press the MODE (M) button to select display.



NOTE: Display will flash for approximately 5 seconds, then will return to the previously selected mode if display is not changed.

2. While display flashes, press the SET (S) button to scroll and select top RPM (TOP_RPM) mode.

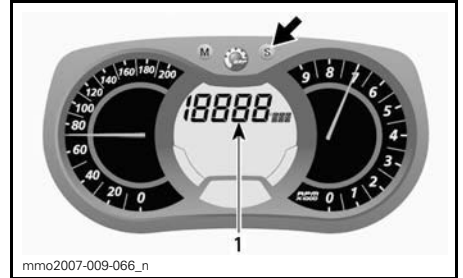

1. Top RPM (TOP_RPM) mode

3. Press the MODE (M) button to confirm selection or wait 5 seconds.

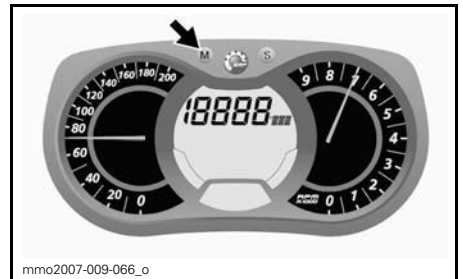

To reset, press the MODE (M) to select mode.



Press and hold the SET (S) button within 5 seconds to reset.

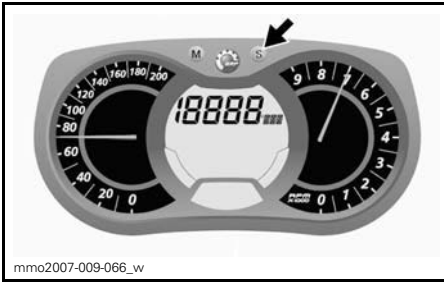

L) Lap Record Mode

With this mode, vehicle speed, engine revolutions per minute (RPM) and a preselected function in display 1 can be recorded at the same time during a period of time defined by the operator.

Also, a possibility of nine (9) different sessions (laps) can be recorded for a maximum total of 2-1/2 minutes.

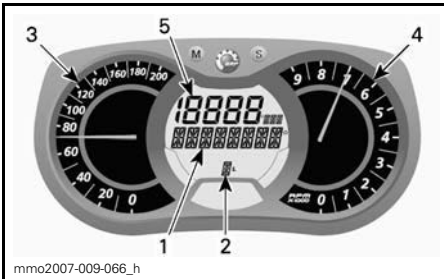

LAP RECORD MODE

1. Lap record mode display
2. Sessions (laps)
3. Vehicle speed
4. Engine revolution per minute (RPM)
5. Preselected function

To Activate Lap Record Mode:

1. Press the SET (S) button to select the odometer mode in display 3.
2. Press and hold SET (S) button for 2 seconds to activate mode, REC will be displayed to indicate that record mode has been selected.



1. Record mode
2. Odometer

3. Press the SET (S) button to scroll between modes.

Available modes are: STOP, REC (record) or PLAY.

To Record:

1. Select REC (record) mode.

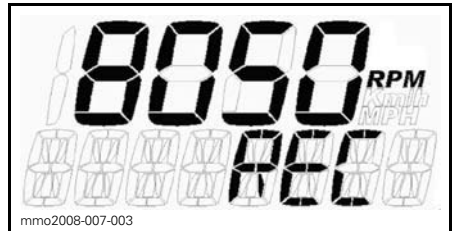

RECORD MODE

2. Press the MODE (M) button to start recording.
3. While recording, press the MODE (M) button again each time you want to record a new lap time (from 1 to 9 laps).

Press the SET (S) button to stop recording.

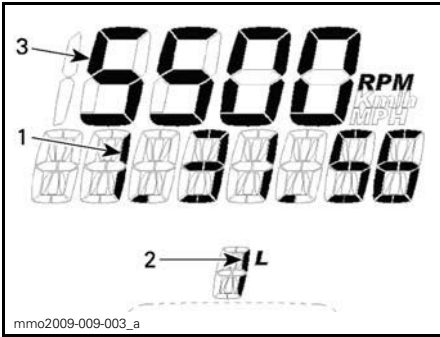
**RECORD MODE**

1. Recording time
2. Lap/session
3. Selected mode

To record another session, press the SET (S) button until REC (record) mode appears in display. Repeat same procedure previously described to record.

To Review Recorded Data:
Select PLAY mode.

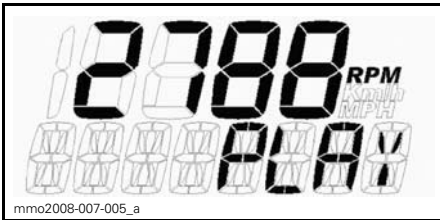
**PLAY MODE**

1. Press the MODE (M) button to play recorded data.

All recorded data (speedometer, tachometer and the preselected mode in display 1) will be displayed at the same time.

2. Press the SET (S) button to stop recorded lap OR press the MODE (M) button to switch to another recorded lap.

NOTE: Pressing the SET (S) button will stop time of the lap in progress, then the display will show the recorded time length of that lap and will switch automatically to the following recorded lap after 5 seconds.

At the end of all recorded laps, STOP will appear in display.

To review recorded data again, press the SET (S) button to return to PLAY mode. Repeat same procedure previously described to review.

To record other laps, press the SET (S) button to switch to REC (record) mode. Repeat same procedure previously described to record.

Press and hold SET (S) button for 5 seconds to exit the lap record mode, the previously selected mode will be displayed.

M) Exhaust Gas Temperature

Displays real time exhaust gas temperature and records the maximum reading.

To display exhaust gas temperature, proceed as follows:

1. Press the MODE (M) button to select display.

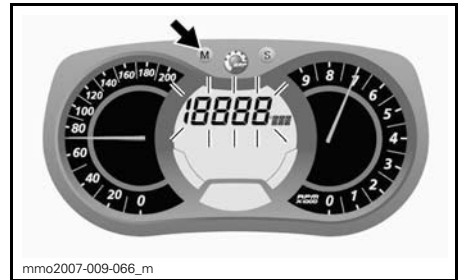

NOTE: Display will flash for approximately 5 seconds, then will return to the previously selected mode if display is not changed.

2. While display flashes, press the SET (S) button to scroll and select exhaust gas temperature (EGTM) mode.

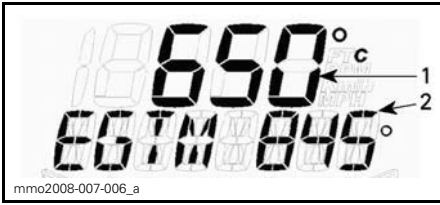

EXHAUST GAS TEMPERATURE (EGTM) MODE

1. Current temperature
 2. Maximum temperature recorded
3. Press the MODE (M) button to confirm selection or wait 5 seconds.

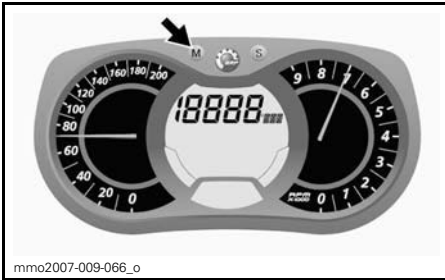

To reset maximum temperature recorded, press the MODE (M) to select mode.



Press and hold the SET (S) button within 5 seconds to reset.

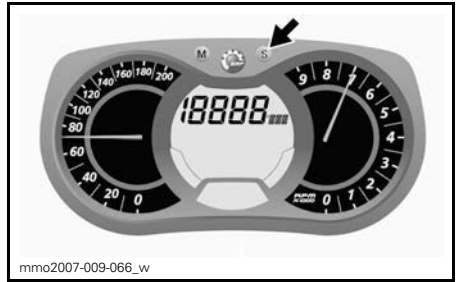

N) Throttle Position Display

Displays real time throttle opening in percentage from approximately 0 to 100%.

To display throttle position, proceed as follows:

1. Press the MODE (M) button to select display.

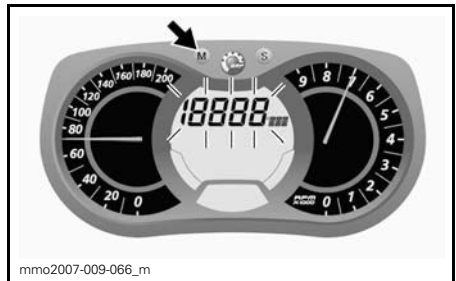

NOTE: Display will flash for approximately 5 seconds, then will return to the previously selected mode if display is not changed.

2. While display flashes, press the SET (S) button to scroll and select throttle position (TPS) mode.

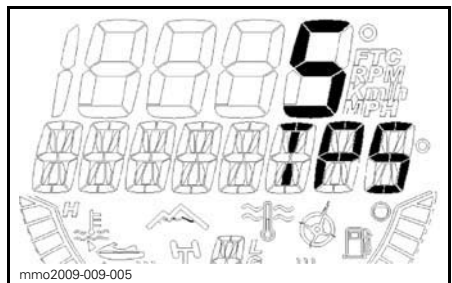

THROTTLE POSITION MODE

- Press the MODE (M) button to confirm selection or wait 5 seconds.

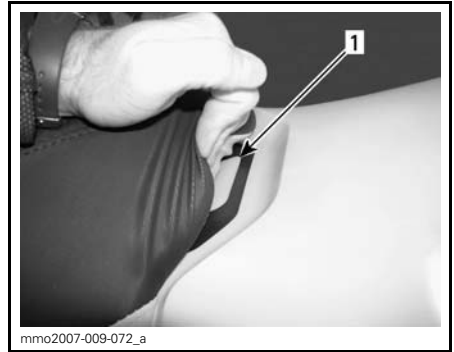

TYPICAL
1. Seat latch

Pull and hold seat latch, then, pull seat with a rearward movement to remove.

13) Seat Latch

Seat can be removed to access to the Operator's Guide (located in seat base) or for maintenance purposes.

The seat latch is located at the front of the seat.

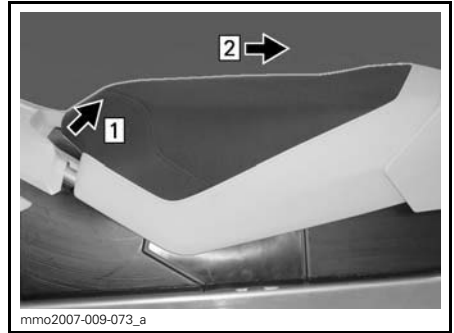

TYPICAL
Step 1: Pull and hold seat latch
Step 2: Pull seat with a rearward movement

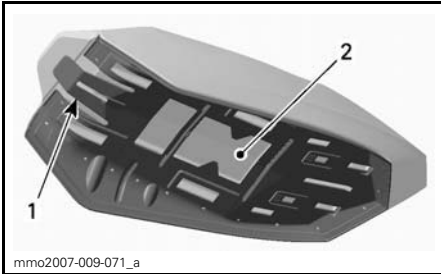

TYPICAL - SEAT BASE

- Seat latch
- Operator's Guide location

Seat Removal

To access the seat latch, gently pull the front of seat.

Seat Installation

NOTICE Riding the vehicle with any objects between the seat and the fuel tank could damage the fuel tank. NEVER place any objects between seat and fuel tank.

Position seat in place.

Push seat forward until it latch in its position.

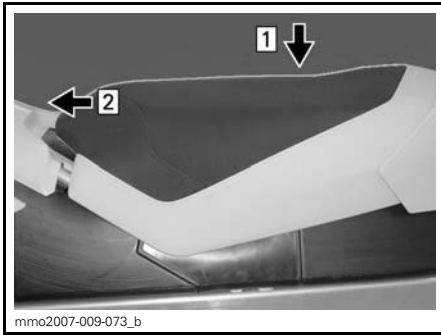

TYPICAL

Step 1: Position seat in place
Step 2: Push seat forward until it latch

NOTE: A distinctive snap will be felt. Double check that the seat is secure by giving it a tug to confirm proper latching.



SEAT INSTALLED - TYPICAL

⚠ WARNING

Make sure seat is securely latched before riding.

14) Front and Rear Bumpers

To be used whenever snowmobile requires manual lifting.

⚠ CAUTION Use proper lifting techniques, notably using your legs force. Do not attempt to lift either end of the vehicle if it is above your limits. Use appropriate lifting device or have assistance to share lifting stress if possible.

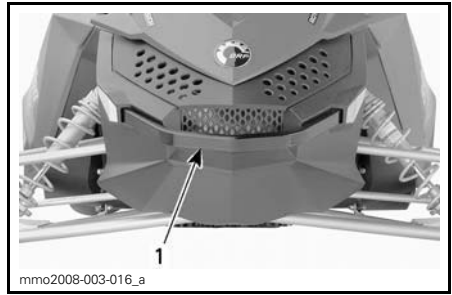

FRONT

1. Front bumper

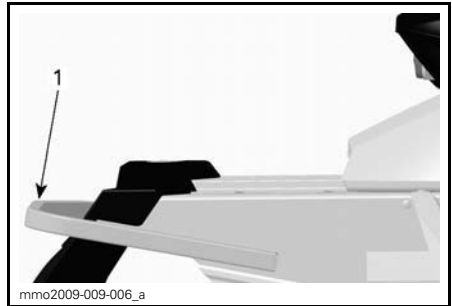

REAR

1. Rear bumper

NOTICE Do not use skis to pull or lift snowmobile.

15) Drive Belt Guard

Drive Belt Guard Removal

⚠ WARNING

NEVER operate engine:

- Without shields and belt guard securely installed.
- With hood and/or side panels opened or removed.

NEVER attempt to make adjustments to moving parts while engine is running.

NOTE: Belt guard is purposely made slightly oversize to maintain tension on its pins and retainers preventing undue noise and vibration. It is important that this tension be maintained when reinstalling.

Remove the tether cord cap.

Open engine compartment LH side panel, refer to *CONTROLS, INSTRUMENTS AND EQUIPMENT*.

Remove retaining pin.



1. Retaining pin

Lift rear portion of guard then release from upper retaining pin.

Release guard from the front tabs by pivoting the guard outwards.

Drive Belt Guard Installation

When reinstalling belt guard, position its cutaway toward front of snowmobile.

Place the front LH slot of the guard over the longest tab.

Pivot the guard inward to engage the shortest tab in the RH slot.



1. Tabs

Position the grommet over the retaining rod. It may be necessary to slightly lift the console to make room.

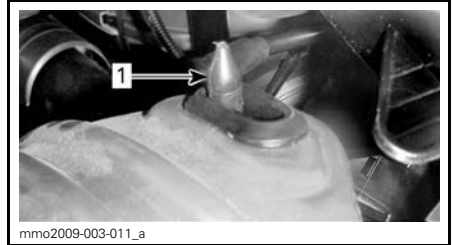

1. Retaining rod

Position rear portion of belt guard over retainer and secure it using retaining pin.



1. Retaining pin

16) Spare Drive Belt Holder

A spare drive belt can be stored in holder.

NOTE: Spare drive belt is not supplied with the snowmobile.

Properly install spare belt and secure with Velcro strap as shown.

NOTICE To avoid damages to the drive belt, ensure that belt does not come in contact with tuned pipe when installed in its support.

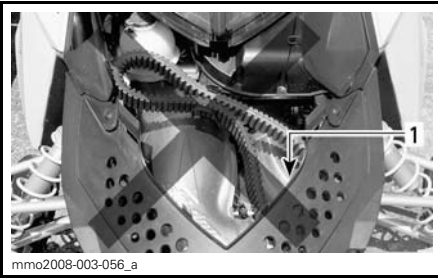

WRONG INSTALLATION

1. Drive belt in contact with tuned pipe

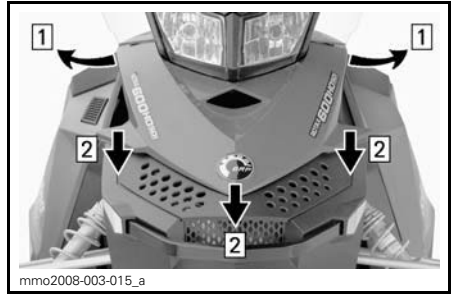

- Step 1: Release retaining pins
Step 2: Slide hood towards the front

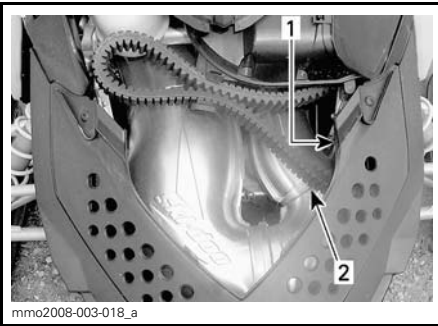

INSTALLED CORRECTLY

1. Drive belt over bumper
2. Ensure there is no contact with tuned pipe

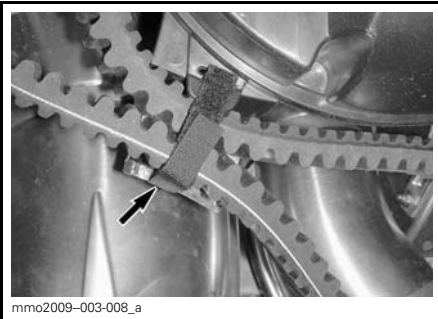

SECURE WITH VELCRO STRAP

17) Hood

⚠ WARNING
Never operate engine with hood removed from vehicle.

To open hood, release hood retaining pins then slide hood towards the front of the vehicle.

18) Side Panels

⚠ WARNING
Never operate engine with side panels opened or removed from vehicle.

To open a side panel, stretch and unhook the latches.

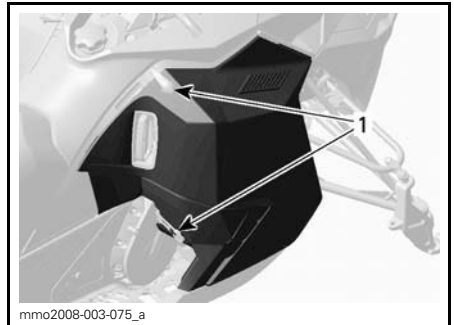

- TYPICAL**
1. Latches

To remove a side panel, open it then lift it up. Free the lower hinge from its slot, then free the upper hinge by lowering the panel.

FUEL AND OIL

Recommended Fuel

NOTICE This vehicle has no oil pump, oil must be mixed with fuel. Refer to *RECOMMENDED OIL* for proper fuel/oil ratio.

Use premium unleaded gasoline containing MAXIMUM 10% ethanol. The gasoline must have the following recommended minimum octane requirements.

NOTE: When the vehicle is used in racing condition, the use of oxygenated fuel is prohibited. Contact racing authority for more details.

Inside North America

OCTANE REQUIREMENT	
600 RS	91

Outside North America

OCTANE REQUIREMENT	
600 RS	95

NOTICE Never experiment with other fuels. Engine or fuel system damages may occur with the use of an inadequate fuel.

Fuel System Antifreeze

When using oxygenated fuel, additional gas line antifreeze or water absorbing additives are not required and should be not used.

When using non-oxygenated fuel, we highly recommend the use of isopropyl base gas line antifreeze in a proportion of 150 ml (5 U.S. oz) of gas line antifreeze added to 40 L (10 U.S. gal.) of gas.

This precaution is in order to reduce the risk of frost buildup in carburetors or other fuel system components which may lead, in certain cases, to high fuel consumption or severe damage to engine.

NOTE: Use only methyl hydrate free gas line antifreeze. When the vehicle is used in racing condition, verify with the racing authority to know which quantity of gas line antifreeze is allowed to avoid disqualification.

Vehicle Fueling Procedure

⚠ WARNING

- Fuel is flammable and explosive under certain conditions.
- Never use an open flame to check fuel level.
- Never smoke or allow flame or spark in vicinity.
- Always work in a well-ventilated area.

1. Stop engine.

⚠ WARNING

Always stop engine before refueling.

2. Ensure no one sits on vehicle while refueling.

⚠ WARNING

Do not allow anyone seated on the vehicle while fueling.

3. Unscrew slowly the fuel reservoir cap counterclockwise to remove it.

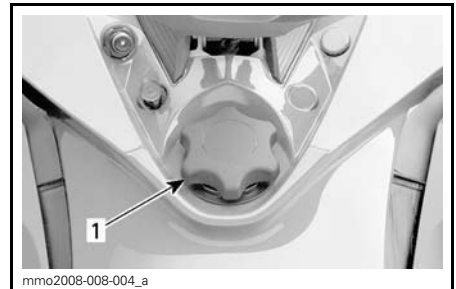

TYPICAL
1. Fuel tank cap

⚠ WARNING

If a differential pressure condition is noticed (whistling sound heard when loosening fuel reservoir cap) have vehicle inspected and/or repaired before further operation.

4. Insert the spout into the filler neck.
5. Pour fuel slowly so that air can escape from the tank and prevent fuel flow back. Be careful not to spill fuel.
6. Stop filling when the fuel reaches the bottom of filler neck. Do not overfill.

⚠ WARNING

Never top up the fuel tank before placing the vehicle in a warm area. As temperature increases, fuel expands and may overflow.

7. Fully tighten fuel reservoir cap clockwise.

⚠ WARNING

Always wipe off any fuel spillage from the vehicle.

NOTE: Do not sit or lean on seat when fuel tank cap is not properly installed.

Recommended Oil

This vehicle has no oil pump, oil must be mixed with fuel at the ratio of **33:1** in a jerry can then, be poured in the fuel tank.

Refer to *PREMIX FUEL/OIL RATIO* table below as a guideline to properly premix oil with fuel.

NOTICE Never experiment with other fuel/oil ratios. Use only oil that can flow at -40°C (-40°F).

Use only two-stroke engine injection oil, sold by authorized Ski-Doo dealers.

2-STROKE ENGINE INJECTION OIL

600 RS	XPS SYNTHETIC 2-STROKE OIL (P/N 293 600 132)
	XPS SYNTHETIC BLEND 2-STROKE OIL (P/N 293 600 100)

NOTICE (1) The engine of this snowmobile has been developed and validated using the XPS™ Synthetic Blend 2-stroke oil and XPS synthetic 2-stroke oil. BRP strongly recommends the use of either lubricant at all times. Damages caused by oil which is not suitable for the engine will not be covered by the BRP limited warranty.

Premix Fuel/Oil Ratio

NOTE: The recommended fuel/oil ratio is 33:1.

Following are examples with this fuel/oil ratio.

FUEL/OIL RATIO
946 ml (1 qt (U.S. liq.)) oil bottle : 31.2 L (8.3 U.S. gal.) of fuel
1 L (1.1 qt (U.S. liq.)) oil bottle : 33 L (8.7 U.S. gal.) of fuel

BREAK-IN PERIOD

Operation During Break-In

A break-in period of 10 operating hours or 500 km (300 mi) is required for the vehicle.

After the break-in period, the vehicle should be inspected by an authorized Ski-Doo dealer. Refer to *MAINTENANCE* section.

Engine

During the break-in period:

- Add 500 ml of oil for the first fuel tank.
- Avoid prolonged full throttle operation.
- Avoid sustained accelerations.
- Avoid prolonged cruising speeds.
- Avoid engine overheating.

However, brief accelerations and speed variations contribute to a good break-in.

During the first few hours of break-in, the engine management system controls some engine parameters which will slightly reduce the engine performance.

Drive Belt

A new drive belt requires a break in period of 50 km (30 mi).

During the break-in period:

- Avoid strong acceleration and deceleration.
- Avoid pulling a load.
- Avoid high speed cruising.

BASIC PROCEDURES

Engine Starting Procedure

Procedure

1. Apply parking brake.
2. Recheck throttle control lever operation.
3. Put your helmet on.
4. Ensure that the tether cord cap is in position and that the cord attached to your clothing eyelet.
5. Ensure that the emergency engine stop switch is in the ON position.
6. To prime, activate button until a pumping resistance is felt. From this point, pump 2 or 3 times to inject fuel in intake manifold. After priming, ensure that primer button is pushed back.

NOTE: In very cold temperature, it is recommended to rotate primer button 3-4 turns prior to pull it. This will eliminate the possibility of sticking.

NOTE: Priming is not necessary when engine is warm.

7. Grab manual starter handle, pull handle slowly until a resistance is felt, then hold handle firmly and pull vigorously to start engine.
8. Release parking brake.

NOTE: For an initial cold start, do not release parking brake. Perform the *VEHICLE WARM-UP* procedure as explained below.

Vehicle Warm-Up

Before every ride, vehicle has to be warmed up as follows.

1. Start engine as explained in *ENGINE STARTING PROCEDURE* above.
2. Allow engine to warm up one or two minutes at idle speed.

NOTE: It is not recommended to let engine running at idle speed for more than 10 minutes.

3. Disengage parking brake.

4. Apply throttle until drive pulley engages. Drive at low speed the first two or three minutes.

NOTICE If vehicle does not move when throttle is applied, remove tether cord cap, then do the following.

- Check if skis are stuck on the ground. Lift one ski at a time by the handle, then put it down.
- Check if track is stuck on the ground. Lift rear of snowmobile enough to clear track from the ground, then drop.
- Check rear suspension for hard snow or ice accumulation that could interfere with track rotation. Clean the area.

CAUTION Beware of injuries by using proper lifting techniques, notably using your legs force. Do not attempt to lift the rear of vehicle if it is above your limits.

WARNING

Make sure tether cord cap is away from post before standing in front the vehicle, getting close to the track or rear suspension components.

Shutting Off the Engine

Release throttle lever and wait until engine has returned to idle speed.

Shut off the engine using either emergency engine stop switch or pulling off the tether cord cap.

WARNING

Always remove the tether cord cap when vehicle is not in operation in order to prevent accidental engine starting or to avoid unauthorized use by children or others or theft.

RIDING CONDITIONS AND YOUR SNOWMOBILE

Altitude

NOTICE This vehicle is factory calibrated for a sea level usage ONLY, below 600 m (2000 ft).

Temperature

All vehicles have been calibrated for -20°C (-4°F). They can be operated at warmer winter temperatures without risk of problems.

NOTICE For colder temperatures than -20°C (-4°F), carburetor(s) must be recalibrated to avoid engine damage. Refer to an authorized Ski-Doo dealer.

Hard Packed Snow

This snowmobile's track has a lug profile of 44.5 mm (1.75 in) and BRP **does not recommend** to ride it at **high speed** on a trail, hard packed snow or ice.

In the event that you have to ride on such surfaces, **reduce your speed** and minimize the travel distance.

NOTICE Running that type of track at high speeds on a trail, on hard packed surfaces or ice puts more stress on the lugs, causing heat. To avoid potential premature degradation or damage to the track, reduce your speed, and minimize the distance you ride on those surfaces.

SPECIAL PROCEDURES

Towing Another Snowmobile

If a snowmobile is disabled and must be towed use a rigid tow bar. Remove the drive belt from the disabled snowmobile, refer to *DRIVE BELT* in the *MAINTENANCE PROCEDURE* section and tow at moderate speed.

NOTICE Always remove the drive belt of the snowmobile that is to be towed to prevent damage to its belt and drive system.

In an emergency situation only, if a rigid tow bar is not available, a rope can be used provided you proceed with extra caution. In some areas, it may be illegal to do so. Check with state or local authorities.

Remove the drive belt, attach the rope to the ski legs (spindles), have someone sit on the towed snowmobile to activate the brake, and tow at low speed.

NOTICE In order to prevent damage to the steering system, never attach the tow rope to the ski loops (handles).

⚠ WARNING

Never ride at high speed when towing a disabled snowmobile. Proceed slowly with extra caution.

Emergency Starting Procedure

The engine can be started with an emergency starter rope.

Remove drive belt guard.

⚠ WARNING

Do not wind starting rope around your hand. Hold rope by the handle only. Do not start the snowmobile by the drive pulley unless it is a true emergency situation. Have the snowmobile repaired as soon as possible.

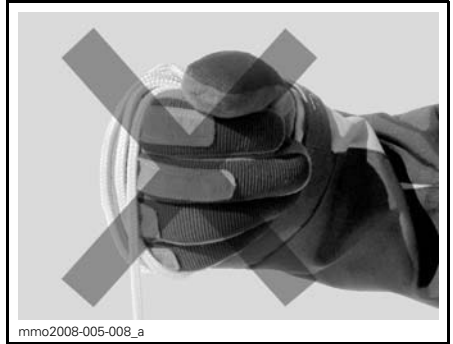

Attach one end of emergency rope to rewind handle.

NOTE: The spark plug socket can be used as an emergency handle.

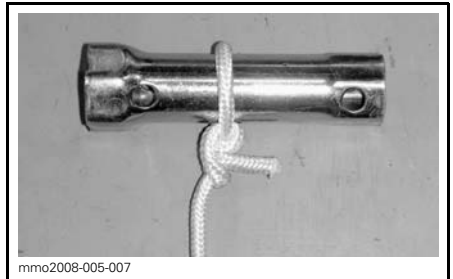

Attach the other end of emergency rope to a starter clip.

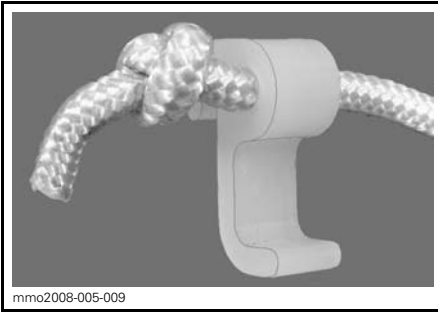

Hook up clip on drive pulley.

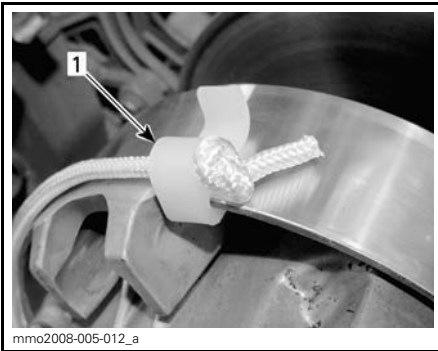

1. *Clip installation location*

Wind the rope tightly around drive pulley. When pulled, pulley must rotate counterclockwise.

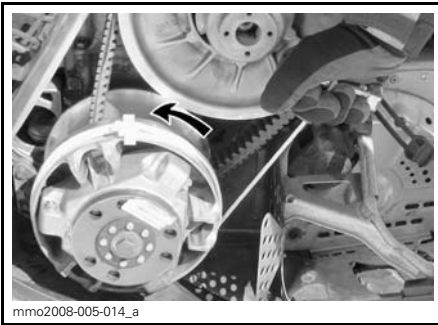

Pull the rope using a sharp, crisp pull so the rope comes free of the drive pulley. Start engine as per usual manual starting.

⚠ WARNING

When starting the snowmobile in an emergency situation, using drive pulley, do not reinstall the drive belt guard and return slowly to have snowmobile repaired.

TUNE YOUR RIDE

Snowmobile handling and comfort depends on suspension adjustments.

⚠ WARNING

Suspension adjustment could affect vehicle handling. Always take time to familiarize yourself with the vehicle's behavior after any suspension adjustment have been made. Always adjust LH and RH suspension components to the same setting.

Choice of suspension adjustments vary with carrying load, operator's weight, personal preference, riding speed and field condition.

NOTE: Some adjustments may not apply to your snowmobile.

⚠ WARNING

Before proceeding with any suspension adjustment, remember:

- Park in a safe place.
- Remove the tether cord cap.
- Use appropriate lifting device or have assistance to share lifting stress. If a lifting device is not used, use proper lifting techniques, notably using your legs force.
- Do not attempt to lift the front or rear of vehicle if it is above your limits.
- Support front of vehicle off the ground with a suitable device before adjusting suspension.
- Support rear of vehicle off the ground with a wide-base snowmobile stand with a rear deflector panel.
- Make sure support device is stable and secure.

The best way to set up the suspension is to customize each adjustment one at a time. Various adjustments are interrelated. It may be necessary

to readjust center spring after adjusting front springs for instance. Test run the snowmobile under the same conditions; trail, speed, snow, operator riding position, etc. Proceed methodically until you are satisfied.

Following are guidelines to fine-tune suspension.

Rear Suspension Adjustments

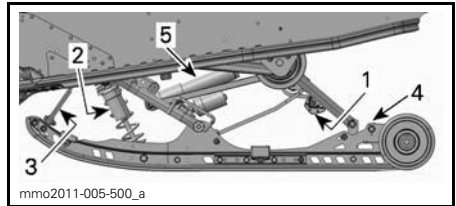

rMOTION RACING - ADJUSTABLE COMPONENTS

1. Rear spring preload
2. Center spring preload and shock absorber damping
3. Stopper strap
4. Anti-transfer cam adjustment
5. Rear shock absorber damping

NOTICE Whenever adjusting rear suspension, check track tension and adjust if necessary.

Rear Spring

Rear spring preload has an effect on comfort, ride height and load compensation.

Also, adjusting rear spring preload shifts more or less weight to the snowmobile front end. As a result, more or less weight is applied to the skis. This has an effect on performance in deep snow, steering effort and handling.

Slight suspension bottoming occurring under the worst riding conditions indicates a good choice of spring preload.

ACTION	RESULT
Increasing preload	Firmer rear suspension
	Higher rear end
	More bump absorption capability
	Heavier steering
Decreasing preload	Softer rear suspension
	Lower rear end
	Less bump absorption capability
	Lighter steering
	Better performance and handling in deep snow

Refer to the following to determine if preload is correct.

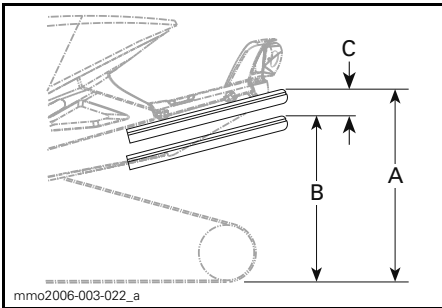

TYPICAL — PROPER ADJUSTMENT

- A. Suspension fully extended
- B. Suspension has collapsed with operator and load added
- C. Distance between dimension "A" and "B", see table below

"C"	WHAT TO DO
50 mm to 75 mm (2 in to 3 in)	No adjustment required
More than 75 mm (3 in)	Adjusted too soft, increase preload
Less than 50 mm (2 in)	Adjusted too firm, decrease preload

NOTE: If the specification is unattainable with the original springs, see an authorized Ski-Doo dealer for other available springs.

NOTICE To increase spring preload, always turn the left side adjustment cam in a clockwise direction, and the right side cam in a counterclockwise direction.

CAUTION Never set preload cams directly from position 5 to 1 or directly from position 1 to 5.

The adjustment cams have 5 different settings, 1 being the softest.

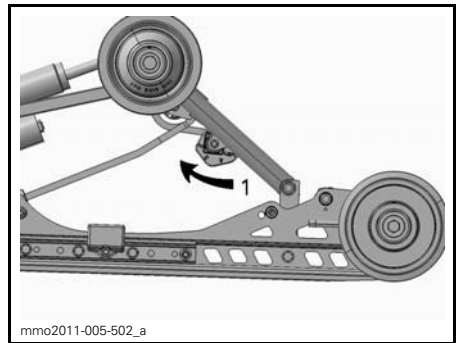

TYPICAL - rMOTION RACING - LH SIDE
1. Adjust spring preload

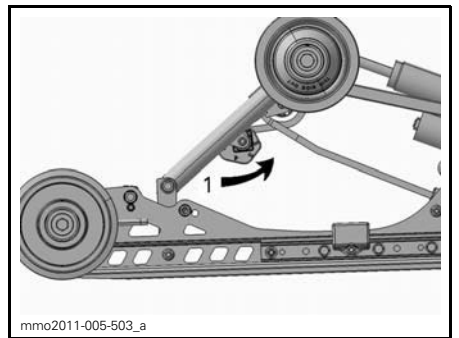

TYPICAL - rMOTION RACING - RH SIDE
1. Adjust spring preload

Center Spring

Center spring preload has an effect on steering effort, handling and bump absorption.

Also, since center spring preload adjustment puts more or less pressure on the front of the track, it has an effect on the performance in deep snow.

ACTION	RESULT
Increasing preload	Lighter steering
	More bump absorption capability
	Better deep snow starts
	Better deep snow performance and handling
Decreasing preload	Heavier steering
	Less bump absorption capability
	Better trail handling

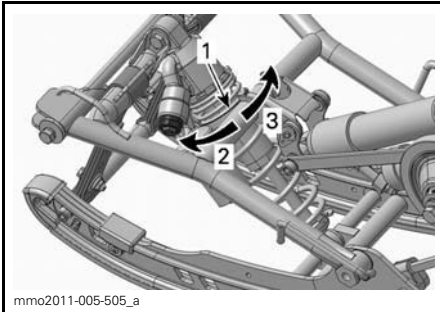

TYPICAL - RING TYPE

1. Spring preload adjustment ring
2. Increase preload
3. Decrease preload

NOTICE Whenever stopper strap length is changed, track tension must be checked.

ACTION	RESULT
Increasing stopper strap length	Lighter ski pressure under acceleration
	More center spring travel
	More bump absorption capability
Decreasing stopper strap length	Heavier ski pressure under acceleration
	Less center spring travel
	Less bump absorption capability

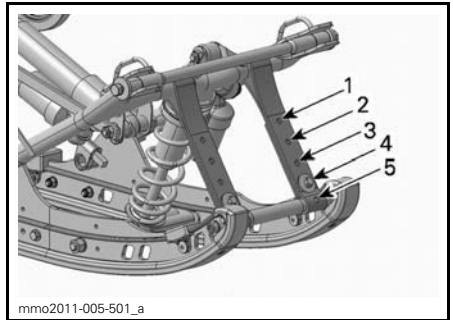

TYPICAL

1. Position 1 (not used)
2. Position 2 (factory setting)
3. Position 3
4. Position 4
5. Position 5

NOTE: Decreasing the stopper strap length may reduce comfort. Always install stopper strap bolt as close as possible to the lower shaft.

When operating the snowmobile in deep snow, it may be necessary to vary stopper strap length and/or riding position, to change the angle at which the track rides on the snow. Operator's familiarity with the various adjustments as well as snow conditions will dictate the most efficient combination.

Generally, a longer stopper strap setting gives better performance in deep snow on a flat landscape.

Rear Shock

Low Speed Compression Damping

Low speed compression damping controls how the shock absorber reacts to a low suspension velocity (slow compression strokes, in most cases when riding at lower speeds).

ACTION	RESULT ON BIG BUMPS
Increasing low speed compression damping force	Firmer compression damping (slow compression)
Decreasing low speed compression damping force	Softer compression damping (slow compression)

To adjust, turn clockwise to increase damping force and counterclockwise to decrease damping force.

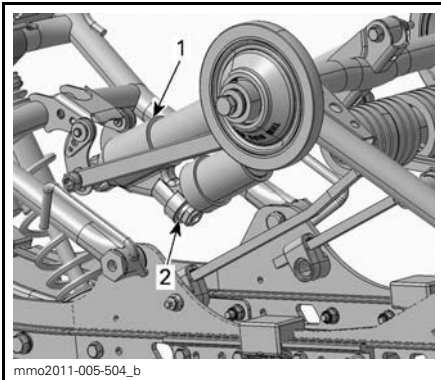

1. Rear shock absorber
2. Low speed compression damping adjuster (knob or slot)

High Speed Compression Damping

High speed compression damping controls how the shock absorber reacts to a high suspension velocity (quick compression strokes, in most cases when riding at higher speeds).

ACTION	RESULT ON SMALL BUMPS
Increasing high speed compression damping force	Firmer compression damping (fast compression)
Decreasing high speed compression damping force	Softer compression damping (fast compression)

To adjust, turn clockwise to increase damping force and counterclockwise to decrease damping force.

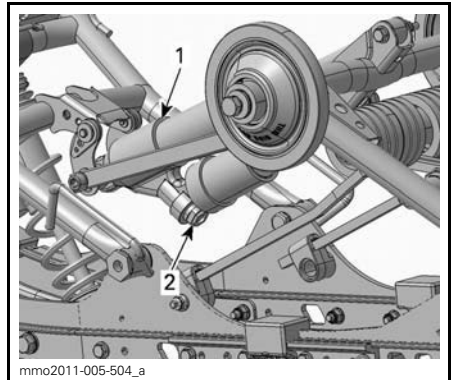

1. Rear shock absorber
2. High speed compression damping adjuster (hexagonal)

Center Shock

Low Speed Compression Damping

Low speed compression damping controls how the shock absorber reacts to a low suspension velocity (slow compression strokes, in most cases when riding at lower speeds).

ACTION	RESULT ON BIG BUMPS
Increasing low speed compression damping force	Firmer compression damping (slow compression)
Decreasing low speed compression damping force	Softer compression damping (slow compression)

To adjust, turn clockwise to increase damping force and counterclockwise to decrease damping force.

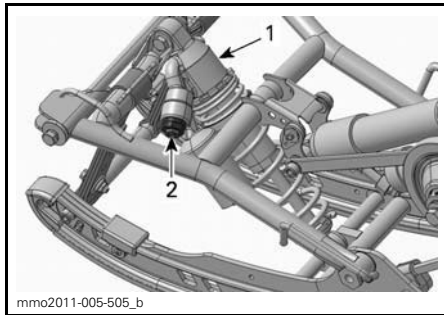

1. Center shock absorber
2. Low speed compression damping adjuster (knob or slot)

High Speed Compression Damping

High speed compression damping controls how the shock absorber reacts to a high suspension velocity (quick compression strokes, in most cases when riding at higher speeds).

ACTION	RESULT ON SMALL BUMPS
Increasing high speed compression damping force	Firmer compression damping (fast compression)
Decreasing high speed compression damping force	Softer compression damping (fast compression)

To adjust, turn clockwise to increase damping force and counterclockwise to decrease damping force.

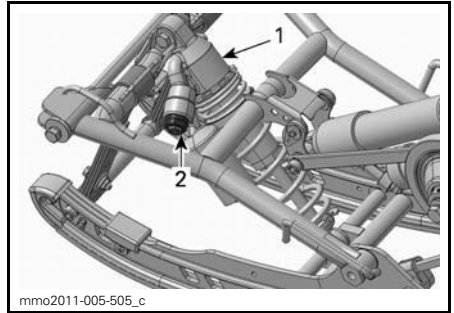

1. Center shock absorber
2. High speed compression damping adjuster (hexagonal)

Front Suspension Adjustments

Front Springs

Front spring preload has an effect on front suspension firmness.

Front spring preload also has an effect on the steering behavior.

ACTION	RESULT
Increasing preload	Firmer front suspension
	Higher front end
	More precise steering
	More bump absorption capability
Decreasing preload	Softer front suspension
	Lower front end
	Lighter steering
	Less bump absorption capability

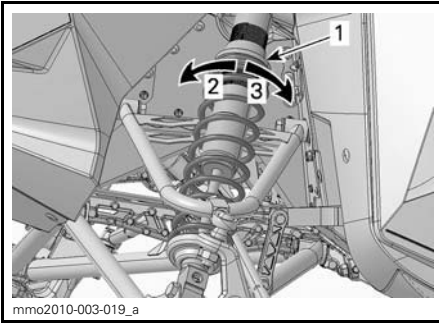

TYPICAL- RING TYPE

1. Spring preload adjustment ring
2. Increase preload
3. Decrease preload

NOTICE Make sure that both front springs are still pre-loaded when front of vehicle is off the ground.

Front Shock Absorbers

Low Speed Compression Damping

Low speed compression damping controls how the shock absorber reacts to a low suspension velocity (slow compression strokes, in most cases when riding at lower speeds).

ACTION	RESULT
Increasing low speed compression damping force	Firmer compression damping (slow compression)
Decreasing low speed compression damping force	Softer compression damping (slow compression)

To adjust, turn clockwise to increase damping force and counterclockwise to decrease damping force.

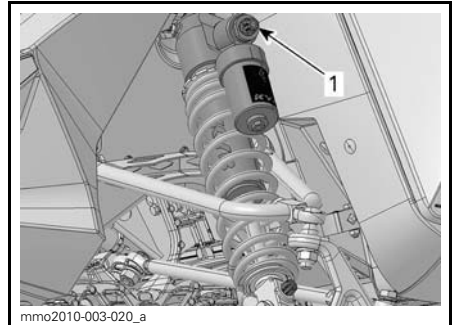

1. Low speed compression damping adjuster (slot or knob)

High Speed Compression Damping

High speed compression damping controls how the shock absorber reacts to a high suspension velocity (quick compression strokes, in most cases when riding at higher speeds).

ACTION	RESULT
Increasing high speed compression damping force	Firmer compression damping (fast compression)
Decreasing high speed compression damping force	Softer compression damping (fast compression)

To adjust, turn clockwise to increase damping force and counterclockwise to decrease damping force.

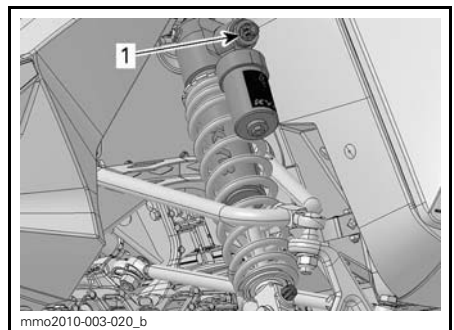

1. High speed compression damping adjuster (hexagonal)

Rebound Damping

Rebound damping controls how the shock absorber restrains the extension stroke.

ACTION	RESULT
Increasing rebound damping force	Firmer rebound damping (extension stroke)
Decreasing rebound damping force	Softer rebound damping (extension stroke)

NOTE: In repetitive short small bumps (ripple), it is recommended to use a lower rebound damping setting.

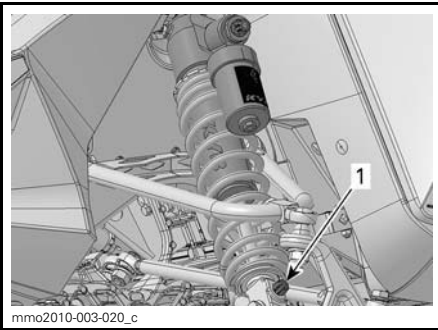

1. Rebound adjuster (knob or slot)

Adjustment Tips According to Vehicle Behavior

PROBLEM	CORRECTIVE MEASURES
Front suspension darting	Check ski alignment. – Reduce front suspension spring preload. – Increase center spring preload. – Reduce rear spring preload.
Steering feels too heavy at steady speeds	– Reduce front suspension spring preload. – Increase center spring preload.
Steering feels too heavy during acceleration	– Reduce rear spring preload – Lengthen limiter strap.
Too much ski lift during cornering or acceleration	– Shorten limiter strap. – Increase rear spring preload.
Rear of snowmobile seems too stiff	– Reduce rear spring preload. – Reduce compression damping adjustment (if applicable)
Rear of snowmobile seems too soft	Increase rear spring preload.
Rear suspension is frequently bottoming	– Increase rear spring preload. – Increase center spring preload. – Lengthen limiter strap. – Increase compression damping adjustment (if applicable)
Snowmobile seems to pivot around its center	– Reduce center spring preload. – Increase rear spring preload. – Increase front suspension spring preload. – Shorten limiter strap.
Track spins too much at start	– Lengthen limiter strap.

VEHICLE TRANSPORTATION

Make sure that fuel tank cap is properly installed.

Tilt bed trailers can easily be equipped with a winch mechanism to afford maximum safety in loading.

WARNING

NEVER drive your snowmobile onto a tilt bed trailer or any other kind of trailer or vehicle. As easy to do as it may seem, many serious accidents have resulted from driving up and over a trailer.

Anchor your vehicle securely, front and rear, even on short hauls. Be certain all equipment is securely fastened. Cover your snowmobile when trailering to prevent road grime from causing damage.

Be certain your trailer meets state or provincial requirements. Ensure the hitch and safety chains are secure and the brake, turn indicators and clearance lights all function.

MAINTENANCE INFORMATION

BREAK-IN INSPECTION

We suggest that after the first 10 hours or 500 km (300 mi) of operation, whichever comes first, your vehicle be inspected by an authorized Ski-Doo dealer. The break-in inspection is very important and must not be neglected.

NOTE: The break-in inspection is at the expense of the vehicle owner.

We recommend that this inspection be signed by an authorized Ski-Doo dealer.

Date of inspection

Authorized dealer signature

Dealer name

BREAK-IN INSPECTION
Inspect spark plugs
Inspect exhaust system and check for leaks
Check coolant level
Inspect fuel lines and connections
Inspect throttle cable
Inspect drive belt
Visually inspect drive pulley
Tighten drive pulley retaining screw to specified torque
Inspect driven pulley
Adjust and align track
Change chaincase oil
Adjust drive chain
Check brake fluid level
Inspect brake hose, pads and disk
Inspect steering mechanism
Inspect skis and runners
Inspect front suspension
Inspect rear suspension (including stopper straps and slider shoes)

MAINTENANCE SCHEDULE

Maintenance is very important for keeping your vehicle in safe operating condition. Proper maintenance is the owner's responsibility. This vehicle should be serviced as per maintenance schedule.

The maintenance schedule does not exempt the pre-ride inspection.

WARNING

Failure to properly maintain the vehicle according to the maintenance schedule and procedures can make it unsafe to operate.

EVERY 1 500 KM (1,000 MI)

Adjust drive chain

EVERY 3 000 KM (2,000 MI) OR 1 YEAR (WHICHEVER COMES FIRST)

Inspect engine rubber mounts

Inspect exhaust system and check for leaks

Adjust engine stopper

Visually inspect and clean drive pulley

Tighten drive pulley retaining screw to specified torque

Clean driven pulley

Adjust and align track

Inspect brake hose, pads and disk

Inspect steering mechanism

Inspect front suspension

Inspect rear suspension (including stopper straps and slider shoes)

Lubricate rear suspension (lubricate whenever the vehicle is used in wet conditions (rain, puddles))

MAINTENANCE SCHEDULE

**EVERY 6 000 KM (4,000 MI) OR 2 YEARS
(WHICHEVER COMES FIRST)**

Inspect fuel pump strainer and replace if necessary

Replace brake fluid

Inspect throttle cable

Clean and lubricate rewind starter

EVERY 5 YEARS

Replace engine coolant

MAINTENANCE PROCEDURES

This section includes instructions for basic maintenance procedures. If you have the necessary mechanical skills and the required tools, you can perform these procedures. If not, see your authorized Ski-Doo dealer.

Other important items in the maintenance schedule that are more difficult and require special tools are best performed by your authorized Ski-Doo dealer.

⚠ WARNING

Turn off the engine, remove tether cord cap and follow these maintenance procedures when performing maintenance. If you do not follow proper maintenance procedures you can be injured by hot parts, moving parts, electricity, chemicals or other hazards.

⚠ WARNING

Should removal of a locking device (e.g. lock tabs, self-locking fasteners, etc.) be required when undergoing disassembly/assembly, always replace with a new one.

Throttle Position Sensor (TPS)

Throttle Position Sensor Reset

To reset TPS, proceed as follows:

1. Refer to *CONTROLS, INSTRUMENTS AND EQUIPMENT* and open the RH side panel.
2. Remove the 6-pin vehicle connector from its protective cap on the RH side.
3. Connect the T-HARNESS (P/N 529 035 869) on the 6-pin connector.
4. Connect the T-harness to a 12 V battery using the 12 V BATTERY SUPPLY CABLE (P/N 529 035 997).

NOTICE Respect battery polarity. Install the RED probe on the positive battery post, then the BLACK probe on the negative battery post.

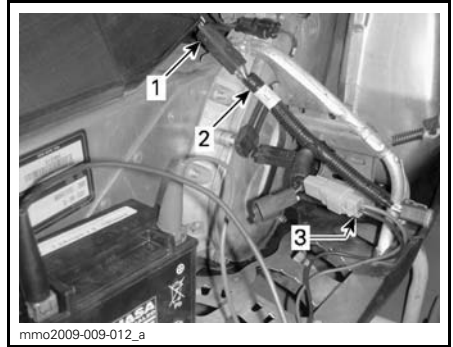

1. 6-pin connector
2. T-harness
3. 12 V battery supply cable

5. Fully depress throttle lever (wide open position) and hold.
6. Depress the pre-heat switch for 5 seconds until beeper sounds.
7. Release throttle and pre-heat switch.
8. Unplug battery and cables, close side panel.

Air Filter

Air Filter Verification

Ensure that air intake filter is properly installed, clean and in good condition.

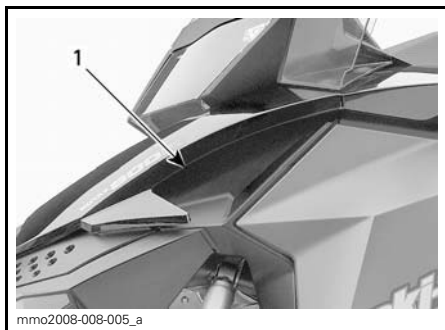

TYPICAL
1. Air filter

If the filter has to be cleaned or replaced, see an authorized Ski-Doo dealer.

Engine Coolant

⚠ WARNING

Never open radiator cap when engine is hot.

Engine Coolant level

Check coolant level at room temperature. Liquid should be at cold level line (engine cold) of coolant tank.

NOTE: When checking level at low temperature it may be slightly lower than the mark.

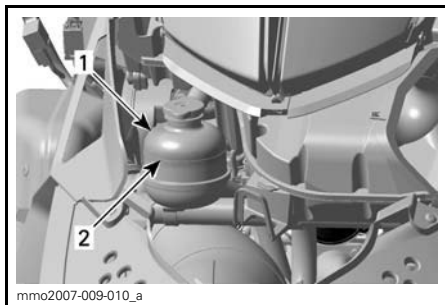

TYPICAL
1. Coolant tank
2. COLD LEVEL line

If coolant is low, remove the coolant tank cap and add the recommended engine coolant.

⚠ WARNING

Do not open coolant tank cap when engine is hot.

Recommended Engine Coolant

Always use ethylene-glycol antifreeze containing corrosion inhibitors specifically for internal combustion aluminum engines.

Cooling system must be filled with BRP PREMIXED COOLANT (P/N 219 700 362) or with distilled water and antifreeze solution (50% distilled water, 50% antifreeze).

Exhaust System

Exhaust System Verification

The muffler tail pipe should be centered with the exit hole in the bottom pan. Exhaust system must be free of rust or leaks. Make sure that all parts are securely in place.

Check retaining springs condition and replace if necessary.

The exhaust system is designed to reduce noise and to improve the total performance of the engine. Modification may be in violation of local laws.

NOTICE If any exhaust system component is removed, modified or damaged, severe engine damage may result.

Spark Plugs

Spark Plug Removal

1. Open LH side panel, refer to *CONTROLS, INSTRUMENTS AND EQUIPMENT*.
2. Remove belt guard, refer to *DRIVE BELT GUARD REMOVAL*.
3. Carefully remove spark plug wire cap with a twisting and pulling motion.

- Using a 19 mm spark plug socket, unscrew spark plug a few turns without removing it.
- Clean vicinity of spark plugs.

NOTICE Engine damage can occur if grime particles enter into the combustion chamber.

- Remove spark plug.

Spark Plug Installation

- Measure the spark plug gap.

NOTE: The gap is not adjustable. If gap is incorrect, replace spark plugs.

NOTICE Do not attempt to adjust gap on these spark plugs.

SPARK PLUG GAP	
0.45 mm ± 0.05 mm (.018 in ± .002 in)	

- Apply LOCTITE 767 (ANTISEIZE LUBRICANT) (P/N 293 800 070) on spark plug threads.
- Screw each spark plug into cylinder head by hand until it bottoms.
- Perform the final tightening using a torque wrench and a proper socket. Torque to specification

TORQUE	
Spark plug	27 N•m ± 2 N•m (20 lbf•ft ± 1 lbf•ft)

- Connect spark plug wires.

Engine Stopper

Engine Stopper Adjustment

The engine stopper is located on the LH front engine support, in front of the drive pulley.

- Remove the tether cord cap.
- Remove the LH side panel, refer to *CONTROLS, INSTRUMENTS AND EQUIPMENT*.

- Remove drive belt guard, refer to *DRIVE BELT GUARD REMOVAL in CONTROLS, INSTRUMENTS AND EQUIPMENT*.
- Loosen the three bolts retaining the engine stopper to the engine support without removing them.

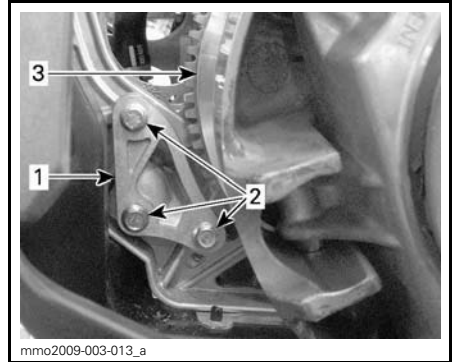

- Engine stopper
- Engine stopper screws
- Drive pulley

- Apply a downward pressure on the engine stopper with your fingers while tightening the screws just enough to obtain contact between the screw heads and the surface of the stopper.
- Torque screws to specification.

TORQUE	
Engine stopper screw	10 N•m ± 2 N•m (89 lbf•in ± 18 lbf•in)

NOTICE Serious pulley damage can occur if the engine stopper and its screws are not properly installed.

Brake Fluid

Recommended Fluid

Use only DOT 4 brake fluid from a sealed container. An opened container may be contaminated or may have absorbed moisture from the air.

⚠ WARNING

To avoid serious damage to the braking system, do not use fluids other than the recommended one, nor mix different fluids for topping up.

NOTICE Brake fluid can damage painted and plastic parts. Handle with care. Rinse thoroughly in case of spillage.

Brake Fluid Level

NOTICE Vehicle must be on a level surface before checking any fluid levels.

Check brake fluid (DOT 4) in reservoir for proper level. Add fluid (DOT 4) as required.

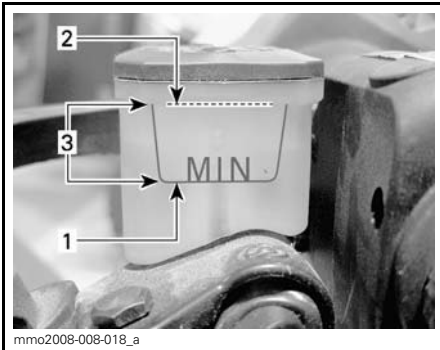

1. Minimum mark
2. Maximum mark
3. Operating range

⚠ WARNING

Avoid getting brake fluid on skin or eyes - it may cause severe burns. In case of contact with skin, wash thoroughly. In case of contact with the eyes, immediately rinse with plenty of water for at least 10 minutes and then consult a doctor immediately.

Chaincase Oil

Recommended Chaincase Oil

Use XPS SYNTHETIC CHAINCASE OIL (P/N 413 803 300).

NOTICE Use only the recommended type oil when servicing. Do not mix synthetic oil with other types of oil.

Chaincase Oil Level

With the vehicle on a level surface, check the oil level by removing the magnetic check plug on the left side of chaincase.

Oil level must reach the threaded hole's lower edge.

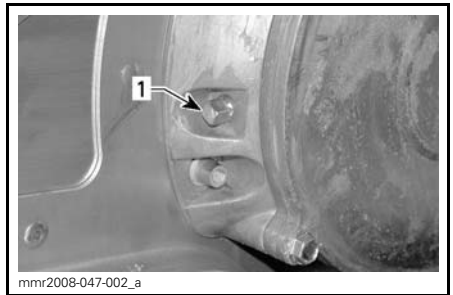

1. Magnetic check plug

NOTE: It is normal to find metallic particles stuck to magnetic check plug. If bigger pieces of metal are found, remove the chaincase cover and inspect the chaincase parts.

Remove metal particles from magnetic check plug.

To add oil, remove the filler cap on chaincase cover.



1. Filler cap

Pour recommended oil in chaincase by the filler hole until oil comes out by the magnetic check plug hole. Reinstall magnetic check plug and torque to specification.

TORQUE	
Magnetic check plug	6 N•m ± 1 N•m (53 lbf•in ± 9 lbf•in)

Drive Belt

Drive Belt Inspection

Inspect belt for cracks, fraying or abnormal wear (uneven wear, wear on one side, missing cogs, cracked fabric). If abnormal wear is noted, probable cause could be excessive RPM with frozen track, fast starts without warm-up period, burred or rusty sheave, oil on belt or distorted spare belt. Contact an authorized Ski-Doo dealer.

Drive Belt Replacement

Drive Belt Removal

1. Remove tether cord cap.

Open LH side panel, refer to *CONTROLS, INSTRUMENTS AND EQUIPMENT*.

2. Remove belt guard, refer to *BELT GUARD REMOVAL*.

3. Insert the drive belt installer/remover provided in the tool box in the threaded hole on the adjuster hub.



DRIVE BELT INSTALLER/REMOVER TOOL



4. Open the driven pulley by screwing the tool in.
5. Remove the belt by slipping it over the top of the driven pulley, then over the drive pulley.

Drive Belt Installation

The drive belt deflection must be checked every time a new drive belt is installed and should be rechecked after 50 km (30 mi). Refer to *DRIVE BELT ADJUSTMENT* below.

NOTE: The maximum drive belt life span is obtained when the arrow on the drive belt is directed toward the front of the vehicle. This will ensure that correct direction of rotation is respected.

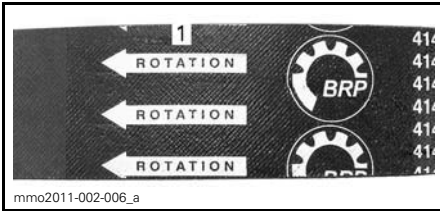

1. To be pointed in the direction of rotation

1. If necessary, open the driven pulley, refer to *DRIVE BELT REMOVAL* above.
2. Set drive belt in the drive pulley then in the driven pulley starting from the bottom.

NOTICE Do not force or use tools to pry the belt into place, as this could cut or break the cords in the belt.



3. Unscrew and remove the drive belt installer/remover tool.
4. Rotate the driven pulley several times to properly set the belt between the sheaves.
5. Install belt guard, refer to *DRIVE BELT GUARD INSTALLATION*.
6. Close side panel, refer to *CONTROLS, INSTRUMENTS AND EQUIPMENT*.

Drive Belt Adjustment

Drive belt adjustment must be performed every time a new belt is installed.

To adjust the drive belt, proceed as follows:

1. Remove the tether cord cap.
2. Open LH side panel, refer to *CONTROLS, INSTRUMENTS AND EQUIPMENT*.
3. Remove belt guard, refer to *DRIVE BELT GUARD REMOVAL*.
4. Keep the set screw from turning using a 1/8 inch Allen wrench and loosen the lock nut using a 7/16 in open wrench.
5. Turn the set screw 1/4 turn at a time then rotate the driven pulley to properly set the belt between the pulley sheaves. Measure belt deflection using a straight edge and the TENSIO-METER (P/N 414 348 200) as explained below.



6. Repeat until the right belt deflection is reached.

NOTE: Turn the set screw clockwise to increase the distance between the sheaves and counterclockwise to decrease the distance.

7. Tighten the lock nut after the belt adjustment has been made.

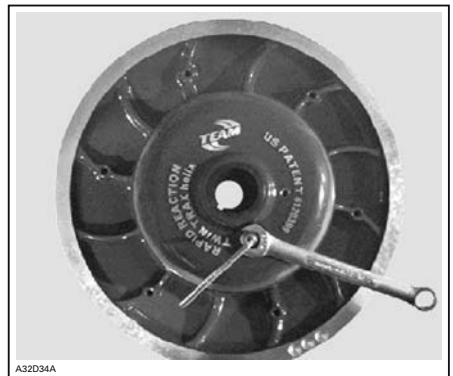

Belt Deflection Measurement

1. Set deflection between 27 mm (1.06 in) and 37 mm (1.46 in) using bottom O-ring.



DEFLECTION SETTING

1. Bottom O-ring set to specification
2. Place upper O-ring to 0 kgf (0 lbf).
3. Position a straight edge ruler on the drive belt.
4. Position the tensiometer on drive belt, halfway between pulleys.
5. Push the tensiometer downwards until bottom O-ring (deflection) be aligned with the inner edge of the straight ruler.
6. Read load recorded by the upper O-ring on the tensiometer.



LOAD READING

1. Upper O-ring
7. Load reading must be as per the following table.

DRIVE BELT ADJUSTMENT SPECIFICATION	
Belt deflection setting	27 mm to 37 mm (1.06 in to 1.46 in)
Belt load reading	11.3 kg (25 lb)

8. Adjust as required.

Drive Pulley

Drive Pulley Adjustment

⚠ WARNING

Remove the tether cord cap before performing any maintenance or adjustment, unless otherwise specified. Vehicle must be parked in a safe place, away from the trail.

General

The drive pulley is factory calibrated to transmit maximum engine power at a predefined RPM. Factors such as ambient temperature, altitude or surface condition may vary this critical engine RPM thus affecting snowmobile efficiency.

This adjustable drive pulley allows setting maximum engine RPM to maintain maximum power.

Calibration screws should be adjusted so that actual maximum engine RPM matches the maximum horsepower RPM.

ENGINE	MAXIMUM HORSEPOWER RPM
600 RS	8400 RPM (± 100)

NOTE: Use precision digital tachometer for engine RPM adjustment.

NOTE: The adjustment has an effect on high RPM only.

Calibration screw has a notch on top of its head.

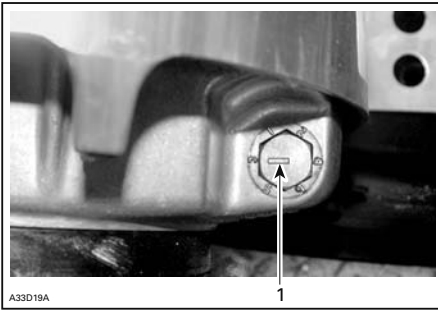

TYPICAL
1. Notch

There are 6 positions numbered 1 to 6. Each position modifies maximum engine RPM by about 200 RPM.

Lower position numbers decrease engine RPM in steps of 200 RPM and higher position numbers increase it in steps of 200 RPM.

Example:

Calibration screw is set at position 4 and is changed to position 6. So maximum engine RPM is increased by 400 RPM.

Adjustment

Loosen the lock nut just enough to pull calibration screw partially out and adjust to desired position. Do not completely remove the locking nut. Torque locking nut to specification.

TORQUE	
Locking nut	10 N•m ± 2 N•m (89 lbf•in ± 18 lbf•in)

NOTICE Do not completely remove calibration screw otherwise internal washers will fall off. Always adjust all 3 calibration screws and make sure they are all set to the same position.

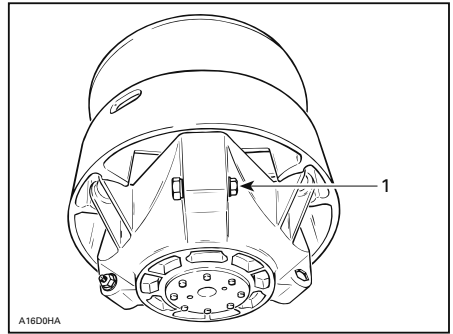

TYPICAL
1. Loosen just enough to permit rotating of calibrate screw

⚠ WARNING

NEVER disassemble or modify the drive pulley. Improper assembly or modifications could cause the pulley to explode violently under the stress generated by the high rotational speed. This could lead to serious injury including the possibility of death.

See your Ski-Doo dealer to maintain or service the drive pulley. Improper servicing or maintenance may affect performance and reduce belt life. Always respect maintenance schedules.

⚠ WARNING

NEVER operate engine:

- Without shields and belt guard securely installed.
- With hood and/or side panels opened or removed.

NEVER attempt to make adjustments to moving parts while engine is running.

Track

Track Condition

WARNING

Remove the tether cord cap before performing any maintenance or adjustment, unless otherwise specified. Vehicle must be parked in a safe place, away from the trail.

Remove the tether cord cap.

Lift the rear of the snowmobile and support it with a wide-base snowmobile mechanical stand with a rear deflector panel. With the engine off, rotate the track by hand, and inspect condition. If worn or cut, or if track fibers are exposed, or if missing or defective inserts or guides are noted; contact an authorized Ski-Doo dealer.

Snowmobiles Equipped with Traction Enhancing Products

If your snowmobile is equipped with a BRP approved studded track, PROCEED WITH A VISUAL INSPECTION OF YOUR TRACK BEFORE EACH USE.

Look for any defects, such as:

- Perforations in the track
- Tears in the track (particularly around traction holes on studded tracks)
- Lugs that are broken or torn off, exposing portions of rods
- Delamination of the rubber
- Broken rods
- Broken studs (studded tracks)
- Bent studs (studded tracks)
- Missing studs
- Studs that are torn off the track
- Missing track guide(s)
- Also, ensure that studs nut are tighten to the recommended torque.

On approved studded tracks, replace broken or damaged studs immediately. If your track shows signs of deterioration, it must be replaced immediately. When in doubt, ask your dealer.

WARNING

Riding with a damaged track or studs could lead to a loss of control, resulting in a risk of serious injury or death.

For complete information on traction enhancing products, refer to the section entitled *TRACTION ENHANCING PRODUCTS* in the *SAFETY INFORMATION* section at the beginning of this Operator's Guide.

Track Tension and Alignment

NOTE: Track tension and alignment are interrelated. Do not adjust one without the other.

WARNING

To prevent serious injury to individuals near the snowmobile:

- NEVER stand behind or near a moving track
- Always use a wide-base snowmobile stand with a rear deflector panel
- When the track is raised off the ground, only run it at the lowest possible speed.

Centrifugal force could cause debris, damaged or loose studs, pieces of torn track, or an entire severed track to be violently thrown backwards out of the tunnel with tremendous force.

Track Tension Verification

1. Lift rear of vehicle and support it off the ground.
2. Allow rear suspension to fully extend.

- Use the TENSIO METER (P/N 414 348 200).



- Set deflection to 3.2 cm (1.26 in) using bottom O-ring.



DEFLECTION SETTING

- Bottom O-ring

- Place upper O-ring to 0 kgf (0 lbf).
- Position the tensiometer on track, halfway between front and rear idler wheels.
- Push the tensiometer downwards until bottom O-ring (deflection) be aligned with the bottom of slider shoe.

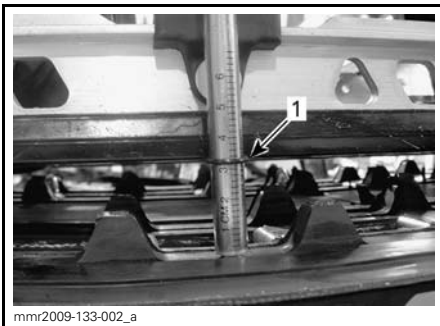
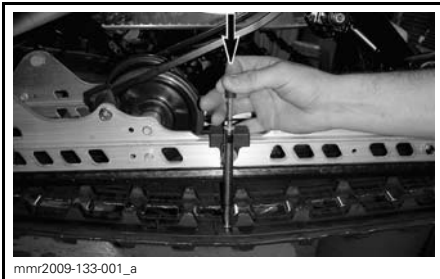

- Deflection O-ring aligned with slider shoe

- Read load recorded by the upper O-ring on the tensiometer.



LOAD READING

- Upper O-ring

Load reading must be as per the following table.

TRACK ADJUSTMENT SPECIFICATION	
Track deflection setting	3.2 cm (1.26 in)
Track load reading	6.0 kgf to 8.5 kgf (13 lbf to 19 lbf)

- If load reading is not in accordance with the specification, adjust track tension. Refer to *TRACK TENSION ADJUSTMENT*.

NOTICE Too much tension will result in power loss and excessive stresses on suspension components.

Track Tension Adjustment

- Remove the tether cord cap.
- Remove rear wheel caps (if so equipped).

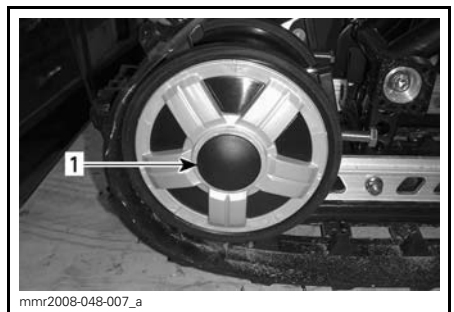

- RH rear idler wheel cap

- Loosen the rear idler wheel retaining bolts.

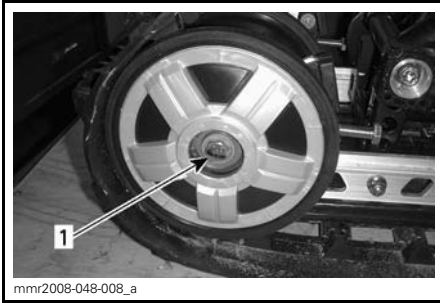

1. RH rear idler wheel bolt

- Tighten or loosen both adjustment screws to increase or decrease track tension.

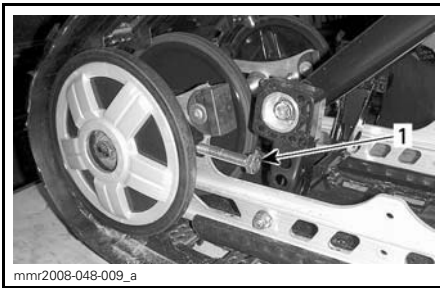

1. RH adjustment screw

- If correct tension is unattainable, contact an authorized Ski-Doo dealer.
- Retighten retaining bolts to specifications.

TORQUE	
Retaining bolts	48 N•m ± 6 N•m (35 lbf•ft ± 4 lbf•ft)

- Check track alignment as described below.

Track Alignment

⚠ WARNING

Before checking track alignment, ensure that the track is free of all particles which could be thrown out while track is rotating. Keep hands, tools, feet and clothing clear of track. Always lift the snowmobile on a wide-base stand with a rear deflector panel. Ensure no one is standing in close proximity to the snowmobile, especially at the rear of the track. Never rotate track at high speed. Centrifugal force could cause debris, damaged or loose studs, pieces of torn track, or an entire severed track to be violently thrown backwards out of the tunnel with tremendous force.

- Start the engine and accelerate slightly so that track slowly turns. This must be done in a short period of time (15 to 20 seconds).
- Check that the track is well centered; equal distance on both sides between edges of track guides and slider shoes.

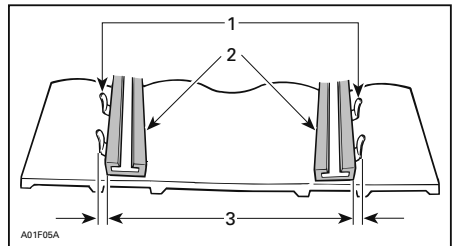

- Guides
- Slider shoes
- Equal distance

- To correct track alignment:

- Stop engine.
- Remove tether cord cap.

⚠ WARNING
 Remove the tether cord cap before performing any maintenance or adjustment, unless otherwise specified. Vehicle must be parked in a safe place, away from the trail.

- 3.3 Loosen rear wheel screws.
- 3.4 Tighten adjustment screw on side where the slider shoe is the farthest from the track insert guides.

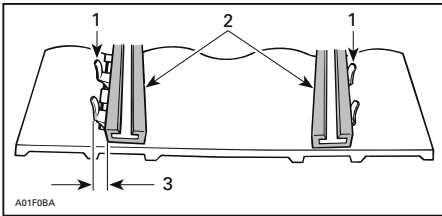

1. Guides
2. Slider shoes
3. Tighten on this side

4. Tighten retaining bolts.

⚠ WARNING
 Properly tighten wheel retaining bolts, otherwise wheel may come off and cause track to "lock".

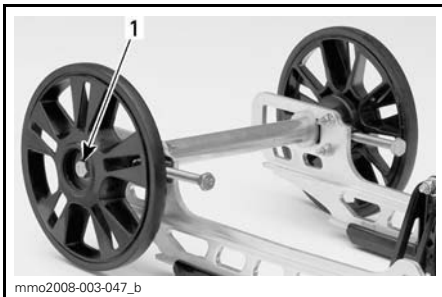

- TYPICAL**
1. Retighten to $48\text{ N}\cdot\text{m} \pm 6\text{ N}\cdot\text{m}$
 ($35\text{ lbf}\cdot\text{ft} \pm 4\text{ lbf}\cdot\text{ft}$)

5. Restart engine and rotate track slowly to recheck alignment.
6. Reposition snowmobile on ground.
7. Install rear wheel caps if so equipped.

Suspension

Rear Suspension Condition

Visually inspect all suspension components including slider shoes, springs, wheels, etc.

NOTE: During normal driving, snow will act as a lubricant and coolant for the slider shoes. Extensive riding on ice or sanded snow, will create excessive heat build-up and cause premature slider shoe wear.

Suspension Stopper Straps Condition

Inspect stopper straps for wear and cracks, bolt and nut for tightness. If loose inspect holes for deformation. Replace as required. Torque nuts to $10\text{ N}\cdot\text{m} \pm 1\text{ N}\cdot\text{m}$ ($89\text{ lbf}\cdot\text{in} \pm 9\text{ lbf}\cdot\text{in}$).

Rear Arm Lubrication

Lubricate rear arm at grease fittings using suspension SUSPENSION GREASE (P/N 293 550 033). Refer to MAINTENANCE SCHEDULE for maintenance frequency.

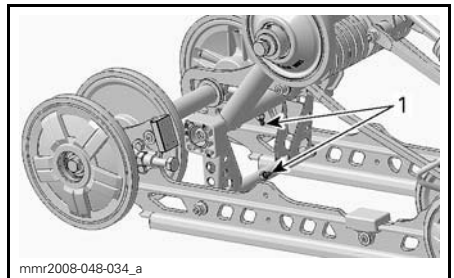

- TYPICAL**
1. Grease fittings

Steering and Front Suspension Condition

Visually inspect steering and front suspension for tightness of components (steering arms, control arms and links, tie rods, ball joints, ski bolts, ski legs, etc.). If necessary, contact an authorized Ski-Doo dealer.

Skis

Wear and Condition of Skis and Runners

Check the condition of the skis and ski runner carbides. If worn, contact an authorized Ski-Doo dealer.

⚠ WARNING

Excessively worn skis and/or ski runners will adversely affect snowmobile control.

Fuse

Fuse Inspection

The accessories circuits are protected with a fuse.

Check fuse condition and replace it if necessary.

To remove fuse from holder, pull fuse out. Check if filament is melted.

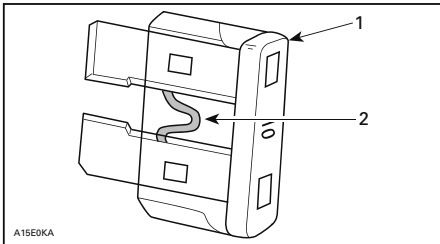

1. Fuse
2. Check if melted

NOTICE Do not use a higher rated fuse as this can cause severe damage to electrical components and/or be a potential fire.

⚠ WARNING

If fuse has burnt out, source of malfunction should be determined and corrected before restarting. See an authorized Ski-Doo dealer for servicing.

Fuse Location

The fuse holder is located on the RH side of the engine compartment near the chaincase.

To access the fuse holder, refer to *CONTROLS, INSTRUMENTS AND EQUIPMENT* and open the RH side panel.

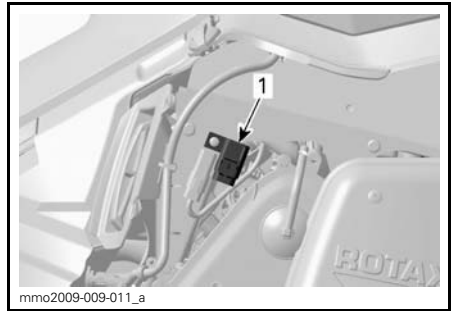

1. Fuse holder location

Lights

Always check light operation after bulb replacement.

Headlights Bulb Replacement

NOTICE Never touch glass portion of an halogen bulb with bare fingers, it shortens its operating life. If glass is touched, clean it with isopropyl alcohol which will not leave a film on the bulb.

By using a small screwdriver, release multifunction gauge locking tabs.

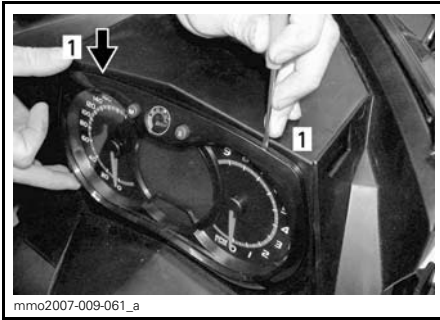

1. Locking tab

Gently pull on multifunction gauge and set aside.



Disconnect burnt bulb connector. Remove the rubber boot.

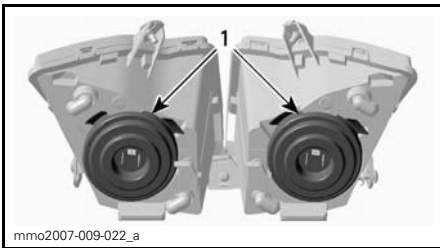

1. Rubber boot

Press and pull both sides of the retaining clip at the same time to release it from bulb support.

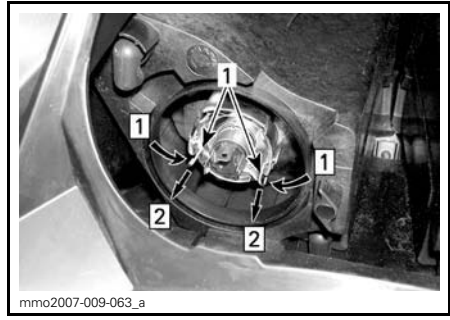

Step 1: Push both sides in
Step 2: Pull to release

1. Retaining clip

Pull bulb and replace. Properly reinstall parts.

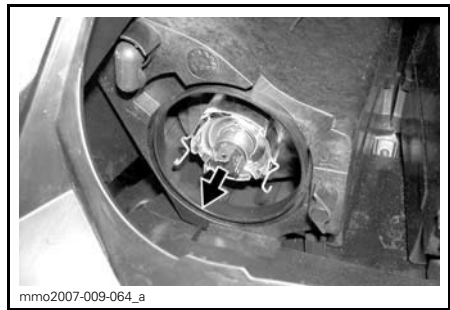

PULL BULB AND REPLACE

Headlights Beam Aiming

Remove multifunction gauge, refer to *HEADLIGHTS BULB REPLACEMENT*. Turn knob to adjust beam height.

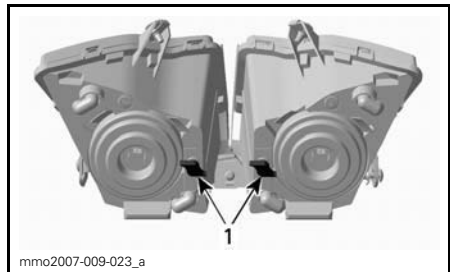

TYPICAL
1. Knob

Taillight Bulb Replacement

1. Remove taillight housing by carefully pulling on lens at both ends.

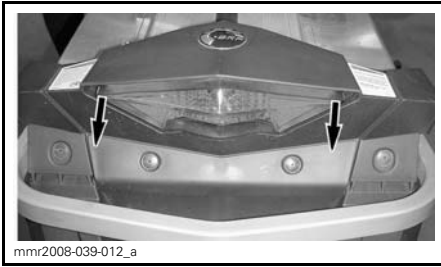

TYPICAL - CAREFULLY PULL OUT AT CORNERS

NOTICE Taillight housing is held in place by two plastic pins inserted in rubber grommets. If taillight housing is forced too far sideways when removing, mounting pins may break and housing will have to be replaced. Do not pull taillight housing out too far to avoid damaging wiring.

NOTE: Note position of bulb locking pins on its base, and socket alignment key.

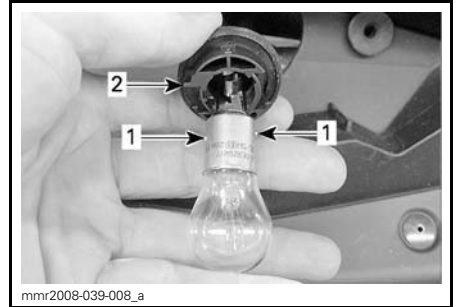

1. Bulb locking pins
2. Bulb holder alignment key

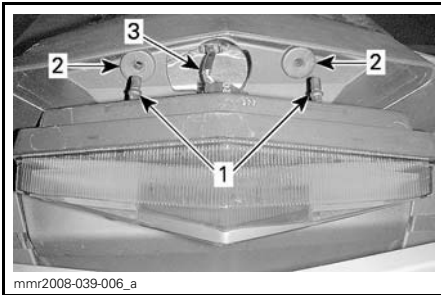

1. Taillight housing retaining pins
2. Retaining grommets
3. Light wire harness

2. Rotate bulb socket counterclockwise to remove it from taillight housing.
3. Push in and rotate bulb counterclockwise to remove it from its socket.
4. Install the new bulb by pushing it in the socket and turning it clockwise.

VEHICLE CARE

Post-Operation Care

Remove snow and ice from rear suspension, track, front suspension, steering mechanism and skis.

WARNING

Make sure tether cord cap is away from engine cut-off switch before standing in front the vehicle, getting close to the track or rear suspension components.

Always cover your snowmobile when leaving it outside overnight or during extended periods of inactivity. This will protect it from frost and snow as well as help retain its appearance.

Vehicle Cleaning and Protection

Remove any dirt or rust.

To clean the entire vehicle, use only flannel cloths or equivalent.

NOTICE It is necessary to use flannel cloths or equivalent on windshield and hood to avoid scratching the surfaces.

To remove grease, oil and grime, use BRP HEAVY DUTY CLEANER (P/N 293 110 001).

NOTICE Do not use Heavy duty cleaner on decals or vinyl.

To remove stubborn dirt from all plastic and vinyl surfaces, use XPS MULTI-PURPOSE CLEANER (P/N 219 701 709).

To remove scratches on windshield or hood use the SCRATCH REMOVER KIT (P/N 861 774 800).

NOTICE Never clean plastic parts or hood with strong detergent, degreasing agent, paint thinner, acetone, products containing chlorine, etc.

Wax painted portion of the vehicle for better protection.

NOTE: Apply wax on glossy finish only.

TECHNICAL INFORMATION

VEHICLE IDENTIFICATION

Vehicle Description Decal

Vehicle description decal is located on right hand side of tunnel.

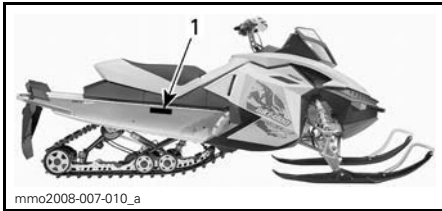

TYPICAL

1. Vehicle description decal

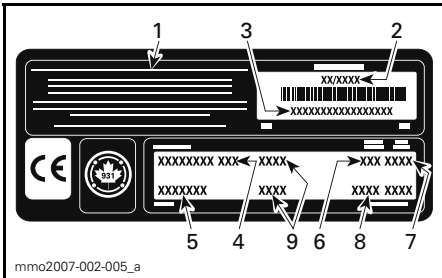

VEHICLE DESCRIPTION DECAL

1. Manufacturer name
2. Manufacturing date
3. Vehicle identification number (VIN)
4. Model name
5. Option package
6. Engine type
7. Model year
8. Color codes
9. Vehicle weight/engine power (European models)

Identification Numbers

The main components of your snowmobile (engine and frame) are identified by different identification numbers. It may sometimes become necessary to locate these numbers for warranty purposes or to trace your snowmobile in the event of loss. These numbers are required by the authorized Ski-Doo dealer to complete warranty claims properly. No warranty will be allowed by BRP if the engine identification number or vehicle identification number (VIN) is removed or mutilated in any way. We strongly recommend that you take note of all the

identification numbers on your snowmobile and supply them to your insurance company.

Vehicle Identification Number (VIN)

VIN is scribed on vehicle description decal. See above. It is also engraved on tunnel near vehicle description decal.

Model number and model year are part of the information found in the VIN. See illustration.

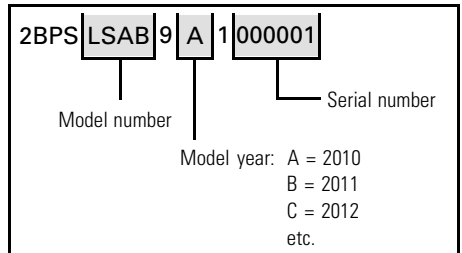

Engine Identification Number



TYPICAL – 600 RS ENGINE

1. Engine serial number

The EC-Declaration of Conformity does not appear in this version of the Operator's Guide.

Please refer to the printed version that was delivered with your vehicle.

EPA CERTIFIED ENGINES

Maintenance, replacement, or repair of the emission control devices and systems may be performed by any snowmobile SI (spark ignition) engine repair establishments or individual.

Engine Emissions Information

Manufacturer's Responsibility

Beginning with 2007 model year engines, snowmobile manufacturers of snowmobile engines need to determine the exhaust emission levels for each engine horsepower family and certify these engines with the United States of America Environmental Protection Agency (EPA). An emissions control information label, showing emission levels and engine specifications, must be placed on each vehicle at the time of manufacture.

Dealer's Responsibility

When performing service on a certified Ski-Doo snowmobiles that carry an emissions control information label, adjustments must be kept within published factory specifications.

Replacement or repair of any emission related component must be executed in a manner that maintains emission levels within the prescribed certification standards.

Dealers are not to modify the engine in any manner that would alter the horsepower or allow emission levels to exceed their predetermined factory specifications.

Exceptions include manufacturer's prescribed changes, such as altitude adjustments for example.

Owner Responsibility

The owner/operator is required to have engine maintenance performed to maintain emission levels within prescribed certification standards.

The owner/operator is not to, and should not allow anyone to modify the engine in any manner that would alter the horsepower or allow emissions levels to exceed their predetermined factory specifications.

EPA Emission Regulations

All Ski-Doo snowmobiles manufactured by BRP are certified to the EPA as conforming to the requirements of the regulations for the control of air pollution from new snowmobile engines. This certification is contingent on certain adjustments being set to factory standards. For this reason, the factory procedure for servicing the product must be strictly followed and, whenever practicable, returned to the original intent of the design.

The responsibilities listed above are general and in no way a complete listing of the rules and regulations pertaining to the EPA requirements on exhaust emissions for snowmobile products. For more detailed information on this subject, you may contact the following locations:

Mail:

U.S. Environmental Protection Agency
Office of Transportation and Air Quality
1200 Pennsylvania Ave. NW
Mail Code 6403J
Washington D.C. 20460

Internet WEB Site:

www.epa.gov/otaq/

SPECIFICATIONS

MODEL		MX Z x 600 RS
ENGINE SYSTEM		
Engine type	ROTAX® 593 RS	
Cylinders	2	
Displacement	594.4 cm ³ (36.3 in ³)	
Bore	72 mm (2.8 in)	
Stroke	73 mm (2.9 in)	
Maximum horsepower RPM	8400 ± 100 RPM	
Carburetion	2 x TMX38	
Exhaust system	Single tuned pipe, baffle muffler	
Oil type	Refer to <i>RECOMMENDED OIL</i> in <i>FUEL AND OIL</i> section	
Fuel/oil ratio	33:1	
Coolant	Ethylene glycol/water mix (50% coolant, 50% distilled water). Use BRP premix coolant or coolant specifically designed for aluminum engines	
Cooling system capacity	4.5 L (4.8 qt (U.S. liq.))	
Recommended fuel type	Premium unleaded	
Minimum octane rating	Inside North America	91 (RON+MON/2)
	Outside North America	95 RON
Fuel tank capacity	20 L (5.3 U.S. gal.)	
Water pump shaft oil	XPS INJECTION OIL (P/N 293 600 117)	
DRIVE SYSTEM		
Drive pulley type	TRA™ III light	
Driven pulley type	Team rapid reaction	
Engagement	5250 RPM	
Small sprocket number of teeth	19	
Large sprocket number of teeth	49	
Drive sprocket number of teeth	8	

SPECIFICATIONS

MODEL		MX Z x 600 RS
DRIVE SYSTEM (cont'd)		
Chaincase oil		XPS SYNTHETIC CHAINCASE OIL (P/N 413 803 300)
Chaincase oil capacity		250 ml (8.5 U.S. oz)
Brake system		Hydraulic, REV-XP brake type
Brake Fluid		SRF (DOT 4) or GTLMA (DOT 4)
Track nominal width		381 mm (15 in)
Track nominal length		3 051 mm (120 in)
Track profile height		44.5 mm (1.75 in)
Track tension	Deflection	30 mm - 35 mm (1-3/16 in - 1-3/8 in)
	Force ⁽¹⁾	7.3 kg (16 lb)
Track alignment		Equal distance between edges of track guides and slider shoes
Drive belt part number		417 300 425 ⁽³⁾
SUSPENSION		
Front suspension		REV-XP
Front shock		HPG™ C-40 racing clicker
Front suspension max. travel		242 mm (9.5 in)
Rear suspension		PCX
Front arm shock		HPG C-40 racing clicker
Rear arm shock		HPG C-40 racing clicker
Rear suspension max. travel		381 mm (15 in)
ELECTRICAL SYSTEM		
Lightning system output		360 Watts @ 6000 RPM
Headlamp bulb HI/LOW beam		2 x 60/55 Watts (H-4)
Taillight bulb		5/21
Spark plug	Type	NGK BR9ECS ⁽²⁾
	Gap	0.45 mm ± 0.05 mm (.018 in ± .002 in) (not adjustable)
Fuse (accessories)		20 A

MODEL	MX Z x 600 RS
WEIGHT AND DIMENSIONS	
Weight (dry)	195 kg (430 lb)
Vehicle overall length	2 890 mm (114 in)
Vehicle overall width ⁽⁴⁾	1 217 mm to 1 249 mm (47.9 in to 49.2 in)
Vehicle overall height	1 000 mm (39 in)
Ski stance	1 065 mm to 1 108 mm (41.93 in to 43.62 in)

- ⁽¹⁾ Measure gap between slider shoe and bottom inside of track when exerting a downward pull to the track.
- ⁽²⁾ **NOTICE** Do not attempt to adjust gap on this type of spark plug.
- ⁽³⁾ Drive belt height must be adjusted every time a new drive belt is installed. Confirm drive belt part number application with an authorized Ski-Doo dealer.
- ⁽⁴⁾ Trail riding: check your local regulations and set skis at the narrowest position if needed.

***This page is
intentionally blank***

TROUBLESHOOTING

TECHNICAL GUIDELINES

ENGINE IS CRANKED BUT FAILS TO START

1. **Emergency engine stop switch is in OFF position or tether cord cap away from post.**
 - *Place emergency engine stop switch in the ON position and install tether cord cap on post.*
2. **Mixture not rich enough to start cold engine.**
 - *Check fuel tank level and check starting procedure, particularly use of the primer.*
3. **Flooded engine (spark plug wet when removed).**
 - *Do not use primer. Remove wet spark plug, place emergency engine stop switch in OFF position and crank engine several times. Install clean dry spark plug.*
 - *Start engine following usual starting procedure. If engine continues to flood, see an authorized Ski-Doo dealer.*
4. **No fuel to the engine (spark plug dry when removed).**
 - *Check fuel tank level; check condition of fuel and impulse lines and their connections. Possible failure of the fuel pump or carburetor. Contact an authorized Ski-Doo dealer.*
5. **Spark plug/ignition (no spark).**
 - *Install new spark plugs, crank engine. If engine fails to start, contact an authorized Ski-Doo dealer.*
6. **Engine compression.**
 - *As the engine is pulled over with the rewind starter, “cycles” of resistance should be felt as piston goes past top dead center (each piston on multi-cylinder engines).*
 - *If no pulsating resistance is felt, it suggests a major loss of compression. Contact an authorized Ski-Doo dealer.*

ENGINE LACKS POWER

1. **Fouled or defective spark plug.**
 - *Check item 5 of ENGINE IS CRANKED BUT FAILS TO START.*
2. **Lack of fuel to engine.**
 - *Check item 4 of ENGINE IS CRANKED BUT FAILS TO START.*
3. **Carburetor adjustments.**
 - *Contact an authorized Ski-Doo dealer.*
4. **Drive belt worn too thin.**
 - *If the drive belt has lost more than 3 mm (1/8 in) of its original width, it will affect vehicle performance.*
 - *Replace drive belt.*
5. **Pulleys misaligned or defective.**
 - *Contact an authorized Ski-Doo dealer.*

ENGINE LACKS POWER (cont'd)

6. Incorrect track adjustment.

- *See MAINTENANCE and/or an authorized Ski-Doo dealer for proper alignment and tension adjustments.*

ENGINE BACKFIRES

1. Faulty spark plug (carbon accumulation).

- *See item 5 of ENGINE IS CRANKED BUT FAILS TO START.*

2. Engine is running too hot.

- *Check coolant level, see MAINTENANCE PROCEDURES.*
- *Check heat exchangers cleanliness. Clean if necessary.*
- *If coolant level is correct and heat exchangers are clean, contact an authorized Ski-Doo dealer.*

3. Ignition timing is incorrect or there is an ignition system failure.

- *Contact an authorized Ski-Doo dealer.*

ENGINE MISFIRES

1. Fouled/defective/worn spark plugs.

- *Clean/verify spark plug gap and identification number. Replace as required.*

2. Water in fuel.

- *Drain fuel system and refill with fresh fuel.*

MONITORING SYSTEM

Pilot Lamps, Messages and Beeper Codes

Gauge pilot lamps will inform you if an anomaly occurs or to inform you of a particular condition.

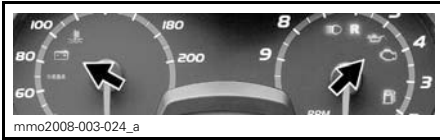

TYPICAL — PILOT LAMPS

This display is used as a complement of the pilot lamps to give you a brief description if an anomaly occurs or to inform you of a particular condition.

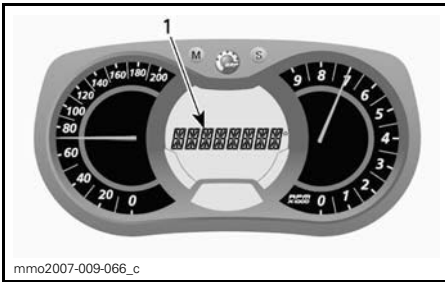



1. Message display

The message is displayed along with a beeper code and a pilot lamp.

Beeper codes will be heard and messages (depending on gauge model) will be displayed to catch your attention.

See table below for details.

PILOT LAMP(S) ON	BEEPER	MESSAGE DISPLAY	DESCRIPTION
	Fast short beeps	ENGINE OVERHEAT	Engine is overheating, reduce snowmobile speed and run in loose snow or stop engine immediately and allow engine to cool. Check cooling system.
	4 short beeps	CHECK ENGINE	Engine fault, see an authorized Ski-Doo dealer as soon as possible.
	Continuously beeps	SHUTDOWN	Shutdown procedure in force due to engine overheating problem, remove tether cord cap and contact an authorized Ski-Doo dealer.

Fault Codes

Multifunction Analog/Digital Display Only

To read any active fault code, press and hold MODE (M) Button and simultaneously depress the HI/LOW beam switch repeatedly several times.

If two or more codes are registered, use SET (S) or MODE (M) to scroll.

To exit the fault codes mode, press and hold MODE (M) button.

Contact an authorized Ski-Doo dealer for code signification.

***This page is
intentionally blank***

WARRANTY

LIMITED WARRANTY VALIDATION

Because of its racing application, the 2012 MX Z X 600 RS is shipped from the factory with no limited warranty. If your intention is to use the unit in a trail application and not to use it in racing or any other competitive activity, please refer to your authorized BRP dealer at the time of delivery for the complete procedure on how to activate the Limited Warranty. No requests to activate the Limited Warranty will be accepted after first delivery to the consumer.

BRP LIMITED WARRANTY USA AND CANADA: 2013 SKI-DOO® SNOWMOBILES

1) SCOPE OF THE LIMITED WARRANTY

Bombardier Recreational Products Inc. ("BRP")* warrants its 2013 Ski-Doo snowmobiles sold by authorized BRP dealers (as defined below) in the fifty United States and Canada from defects in material or workmanship for the period and under the conditions described below. This limited warranty will become null and void if: (1) the snowmobile was used for racing or any other competitive activity, at any point, even by a previous owner; or (2) the snowmobile has been altered or modified in such a way so as to adversely affect its operation, performance or durability, or has been altered or modified to change its intended use.

Except if otherwise specified, all genuine Ski-Doo parts and accessories, installed by an authorized BRP dealer (as hereinafter defined) at the time of delivery of the 2013 Ski-Doo snowmobile, carry the same warranty as that of the snowmobile.

2) LIMITATIONS OF LIABILITY

THIS WARRANTY IS EXPRESSLY GIVEN AND ACCEPTED IN LIEU OF ANY AND ALL OTHER WARRANTIES, EXPRESSED OR IMPLIED, INCLUDING WITHOUT LIMITATION ANY WARRANTY OF MERCHANTABILITY OR FITNESS FOR A PARTICULAR PURPOSE. TO THE EXTENT THAT THEY CANNOT BE DISCLAIMED, THE IMPLIED WARRANTIES ARE LIMITED IN DURATION TO THE LIFE OF THE EXPRESS WARRANTY. INCIDENTAL AND CONSEQUENTIAL DAMAGES ARE EXCLUDED FROM COVERAGE UNDER THIS WARRANTY. SOME STATES/PROVINCES DO NOT ALLOW FOR THE DISCLAIMERS, LIMITATIONS AND EXCLUSIONS IDENTIFIED ABOVE, AS A RESULT, THEY MAY NOT APPLY TO YOU. THIS WARRANTY GIVES YOU SPECIFIC RIGHTS, AND YOU MAY ALSO HAVE OTHER LEGAL RIGHTS WHICH MAY VARY FROM STATE TO STATE, OR PROVINCE TO PROVINCE.

3) EXCLUSIONS – ARE NOT WARRANTED

The following are not warranted under any circumstances:

- Normal wear and tear;
- Routine maintenance items, tune ups, adjustments;
- Damage caused by failure to provide proper maintenance and/or storage, as described in the Operator's Guide;
- Damage resulting from removal of parts, improper repairs, service, maintenance, modifications or use of parts or accessories not manufactured or approved by BRP which in its reasonable judgement are either incompatible with the product or adversely affect its operation, performance and durability, or resulting from repairs done by a person that is not an authorized servicing BRP distributor/dealer;
- Damage caused by abuse, abnormal use, neglect, racing or operation of the product on surfaces other than snow, or operation of the product in a manner inconsistent with the recommended operation described in the Operator's Guide;
- Damage resulting from accident, submersion, fire, snow or water ingestion, theft, vandalism or any act of God;
- Operation with fuels, oils or lubricants which are not suitable for use with the product (see the Operator's Guide);

- Snow or water ingestion;
- Incidental or consequential damages, or damages of any kind including without limitation towing, storage, telephone, rental, taxi, inconvenience, insurance coverage, loan payments, loss of time, loss of income; and
- Damage resulting from studs installed on tracks if the installation does not conform to BRP’s instructions.

4) WARRANTY COVERAGE PERIOD

This warranty will be in effect from the date of delivery to the first retail consumer or the date the product is first put into use, whichever occurs first and for the following period:

TWELVE (12) CONSECUTIVE MONTHS, for private or commercial use owners. However, the warranty coverage period on a snowmobile delivered between June 1st and December 1st of a given year will expire November 30th of the following year.

Exhaust emission-related components that are installed on EPA certified snowmobiles registered in the USA are covered for thirty (30) consecutive months or 200 hours or 2500 miles (4000 km) of engine use whichever occurs first. If the 2500 miles (4000 km) are reached during the regular warranty coverage period, the emission-related components are still covered by BRP’s standard warranty until the end of regular coverage period. Evaporative emission related components that are installed on EPA certified snowmobiles registered in the USA are warranted for twenty-four (24) consecutive months.

To obtain a list of the current warranted emission-related components, please see an authorized Can-Am dealer.

The repair or replacement of parts or the performance of service under this warranty does not extend the life of this warranty beyond its original expiration date.

5) CONDITIONS REQUIRED FOR WARRANTY COVERAGE

This warranty coverage is available **only** if each of the following conditions has been fulfilled:

- The 2013 Ski-Doo snowmobile must be purchased as new and unused by its first owner from a BRP dealer authorized to distribute Ski-Doo snowmobiles in the country in which the sale occurred (“BRP dealer”);
- The BRP specified pre-delivery inspection process must be completed and documented and signed by the purchaser;
- The 2013 Ski-Doo snowmobile must have undergone proper registration by an authorized BRP dealer;
- The 2013 Ski-Doo snowmobile must be purchased in the country in which the purchaser resides; and
- Routine maintenance outlined in the Operator’s Guide must be timely performed in order to maintain warranty coverage. BRP reserves the right to make warranty coverage contingent upon proof of proper maintenance.

BRP will not honor this limited warranty to any private use owner or commercial use owner if one of the preceding conditions has not been met. Such limitations are necessary in order to allow BRP to preserve both the safety of its products, and also that of its consumers and the general public.

6) WHAT TO DO TO OBTAIN WARRANTY COVERAGE

The customer must cease using the snowmobile upon the appearance of an anomaly. The customer must notify a servicing BRP dealer within three (3) days of the appearance of a defect, and provide it with reasonable access to the product and reasonable opportunity to repair it. The customer must also present to the authorized BRP dealer, proof of purchase of the product and must sign the repair/work order prior to starting the repair in order to validate the warranty repair. All parts replaced under this limited warranty become the property of BRP.

7) WHAT BRP WILL DO

BRP's obligations under this warranty are limited to, at its sole discretion, repairing parts found defective under normal use, maintenance and service, or replacing such parts with new genuine Ski-Doo parts without charge for parts and, at any authorized BRP dealer during the warranty coverage period under the conditions described herein. No claim of breach of warranty shall be cause for cancellation or rescission of the sale of the snowmobile to the owner.

In the event that service is required outside of the country of original sale, the owner will bear responsibility for any additional charges due to local practices and conditions, such as, but not limited to, freight, insurance, taxes, license fees, import duties, and any and all other financial charges, including those levied by governments, states, territories and their respective agencies.

BRP reserves the right to improve or modify products from time to time without assuming any obligation to modify products previously manufactured.

8) TRANSFER

If the ownership of a product is transferred during the warranty coverage period, this warranty shall also be transferred and be valid for the remaining coverage period provided that BRP is notified of such transfer of ownership in the following way:

1. The former owner contacts BRP (at the phone number provided below) or an authorized BRP dealer and gives the coordinates of the new owner; or
2. BRP or an authorized BRP dealer receives a proof that the former owner agreed to the transfer of ownership, in addition to the coordinates of the new owner.

9) CONSUMER ASSISTANCE

In the event of a controversy or a dispute in connection with this limited warranty, BRP suggests that you try to resolve the issue at the dealership level. We recommend discussing the issue with the authorized dealer's service manager or owner.

If the issue has not yet been resolved, please submit your complaint in writing or call the appropriate number below:

In Canada

BOMBARDIER RECREATIONAL PRODUCTS INC.

Customer Assistance Center
75 J.-A. Bombardier Street
Sherbrooke QC J1L 1W3
Tel.: 819 566-3366

In USA

BRP US INC.

Customer Assistance Center
7575 Bombardier Court
Wausau WI 54401
Tel.: 715 848-4957

* In the USA, products are distributed and serviced by BRP US Inc.
© 2011 Bombardier Recreational Products Inc. All rights reserved.
® Registered trademark of Bombardier Recreational Products Inc.

BRP INTERNATIONAL LIMITED WARRANTY: 2013 SKI-DOO® SNOWMOBILES

1) SCOPE OF THE LIMITED WARRANTY

Bombardier Recreational Products Inc. ("BRP")* warrants its 2013 Ski-Doo snowmobiles sold by distributors or dealers authorized by BRP to distribute SKI-Doo snowmobiles ("Ski-Doo Distributor/Dealer") outside of the fifty United States, Canada and states that are members of the European Economic Area ("EEA") (which is comprised of the states members of the European Union plus Norway, Iceland and Liechtenstein), Turkey, and states members of the Commonwealth of the Independent States ("CIS") (which is comprised of the Russian Federation and ex-members states of the USSR), from defects in material or workmanship for the period and under the conditions described below.

All genuine Ski-Doo parts and accessories, installed by an authorized Ski-Doo Distributor/Dealer at the time of delivery of the 2013 Ski-Doo snowmobile, carry the same warranty as that of the snowmobile.

This limited warranty will become null and void if: (1) the snowmobile was used for racing or any other competitive activity, at any point, even by a previous owner; or (2) the snowmobile has been altered or modified in such a way so as to adversely affect its operation, performance or durability, or has been altered or modified to change its intended use.

2) LIMITATIONS OF LIABILITY

TO THE EXTENT PERMITTED BY LAW, THIS WARRANTY IS EXPRESSLY GIVEN AND ACCEPTED IN LIEU OF ANY AND ALL OTHER WARRANTIES, EXPRESSED OR IMPLIED, INCLUDING WITHOUT LIMITATION ANY WARRANTY OF MERCHANTABILITY OR FITNESS FOR A PARTICULAR PURPOSE. TO THE EXTENT THAT THEY CANNOT BE DISCLAIMED, THE IMPLIED WARRANTIES ARE LIMITED IN DURATION TO THE LIFE OF THE EXPRESS WARRANTY. INCIDENTAL AND CONSEQUENTIAL DAMAGES ARE EXCLUDED FROM COVERAGE UNDER THIS WARRANTY. SOME JURISDICTIONS DO NOT ALLOW FOR THE DISCLAIMERS, LIMITATIONS AND EXCLUSIONS IDENTIFIED ABOVE, AS A RESULT, THEY MAY NOT APPLY TO YOU. THIS WARRANTY GIVES YOU SPECIFIC RIGHTS, AND YOU MAY ALSO HAVE OTHER LEGAL RIGHTS WHICH MAY VARY FROM COUNTRY TO COUNTRY. (FOR PRODUCTS PURCHASED IN AUSTRALIA SEE CLAUSE 4 BELOW).

Neither the Ski-Doo Distributor/Dealer nor any other person has been authorized to make any affirmation, representation or warranty regarding the product, other than those contained in this limited warranty, and if made, shall not be enforceable against BRP.

BRP reserves the right to modify this warranty at any time, being understood that such modification will not alter the warranty conditions applicable to the products sold while this warranty is in effect.

3) EXCLUSIONS – ARE NOT WARRANTED

The following are not warranted under this limited warranty under any circumstances:

- Normal wear and tear;
- Routine maintenance items, tune ups, adjustments;

- Damage caused by negligence or failure to provide proper maintenance and/or storage, as described in the Operator's Guide;
- Damage resulting from removal of parts, improper repairs, service, maintenance, modifications or use of parts or accessories not manufactured or approved by BRP which in its reasonable judgement are either incompatible with the product or adversely affect its operation, performance and durability, or resulting from repairs done by a person that is not an authorized servicing Ski-Doo Distributor/Dealer;
- Damage caused by abuse, abnormal use, neglect, racing or operation of the product on surfaces other than snow, or operation of the product in a manner inconsistent with the recommended operation described in the Operator's Guide;
- Damage resulting from accident, submersion, fire, snow or water ingestion, theft, vandalism or any act of God;
- Operation with fuels, oils or lubricants which are not suitable for use with the product (see the Operator's Guide);
- Damage resulting from rust, corrosion or exposure to the elements;
- Incidental or consequential damages, or damages of any kind including without limitation towing, storage, transportation expenses, telephone, rental, taxi, inconvenience, insurance coverage, loan payments, loss of time, loss of income; or time missed for downtime experience due to service work.
- And damage resulting from studs installed on tracks if the installation does not conform to BRP's instructions.

4) WARRANTY COVERAGE PERIOD

This warranty will be in effect from (1) the date of delivery to the first retail consumer or (2) the date the product is first put into use, whichever occurs first and for a period of:

TWELVE (12) CONSECUTIVE MONTHS, for private or commercial use owners. However, the warranty coverage period on a snowmobile delivered between June 1st and December 1st of a given year will expire November 30th of the following year.

The repair or replacement of parts or the performance of service under this warranty does not extend the life of this warranty beyond its original expiration date.

Note that the duration and any other modalities of the warranty coverage are subject to the applicable national or local legislation in the customer's country.

FOR PRODUCTS SOLD IN AUSTRALIA ONLY

Nothing in these Warranty terms and conditions should be taken to exclude, restrict or modify the application of any condition, warranty, guarantee, right or remedy conferred or implied under the Competition and Consumer Act 2010 (Cth), including the Australian Consumer Law or any other law, where to do so would contravene that law, or cause any part of these terms and conditions to be void. The benefits given to you under this limited warranty are in addition to other rights and remedies that you have under Australian law.

Our goods come with guarantees that cannot be excluded under the Australian Consumer Law. You are entitled to a replacement or refund for a major failure and for compensation for any other reasonably foreseeable loss or damage. You are also entitled to have the goods repaired or replaced if the goods fail to be of acceptable quality and the failure does not amount to a major failure.

5) CONDITIONS TO HAVE WARRANTY COVERAGE

This warranty coverage is available **only** if each of the following conditions has been fulfilled:

- The 2013 Ski-Doo snowmobile must be purchased as new and unused by its first owner from a Ski-Doo Distributor/Dealer authorized to distribute Ski-Doo snowmobiles in the country in which the sale occurred;
- The BRP specified pre-delivery inspection process must be completed and documented;
- The product must have undergone proper registration by an authorized Ski-Doo Distributor/Dealer;
- The 2013 Ski-Doo snowmobile must be purchased in the country or union of countries in which the purchaser resides.
- Routine maintenance outlined in the Operator’s Guide must be timely performed in order to maintain warranty coverage. BRP reserves the right to make warranty coverage contingent upon proof of proper maintenance.

BRP will not honour this limited warranty to any private use owner or commercial use owner if one of the preceding conditions has not been met. Such limitations are necessary in order to allow BRP to preserve both the safety of its products, and also that of its consumers and the general public.

6) WHAT TO DO TO OBTAIN WARRANTY COVERAGE UNDER THIS WARRANTY

The customer must cease using the snowmobile upon the appearance of an anomaly. The customer must notify a servicing Ski-Doo Distributor/Dealer within two (2) days of the appearance of a defect, and provide it with reasonable access to the product and reasonable opportunity to repair it. The customer must also present to the authorized Ski-Doo Distributor/Dealer, proof of purchase of the product and must sign the repair/work order prior to starting the repair in order to validate the warranty repair. All parts replaced under this limited warranty become the property of BRP.

Note that the notification period is subject to the applicable national or local legislation in customer's country.

7) WHAT BRP WILL DO

To the extent permitted by law, BRP’s obligations under this warranty are limited to, at its sole discretion, repairing parts found defective under normal use, maintenance and service, or replacing such parts with new genuine Ski-Doo parts without charge for parts and labour, at any authorized Ski-Doo Distributor/Dealer during the warranty coverage period under the conditions described herein. BRP’s responsibility is limited to making the required repairs or replacements of parts. No claim

of breach of warranty shall be cause for cancellation or rescission of the sale of the snowmobile to the owner. You may have other legal rights which may vary from country to country.

In the event that service is required outside of the country of original sale, the owner will bear responsibility for any additional charges due to local practices and conditions, such as, but not limited to, freight, insurance, taxes, license fees, import duties, and any and all other financial charges, including those levied by governments, states, territories and their respective agencies.

BRP reserves the right to improve or modify products from time to time without assuming any obligation to modify products previously manufactured.

8) TRANSFER

If the ownership of a product is transferred during the warranty coverage period, this warranty shall also be transferred and be valid for the remaining coverage period provided BRP or an authorized Ski-Doo Distributor/Dealer receives a proof that the former owner agreed to the transfer of ownership, in addition to the co-ordinates of the new owner.

9) CONSUMER ASSISTANCE

1. In the event of a controversy or a dispute in connection with this limited warranty, BRP suggests that you try to resolve the issue at the Ski-Doo Distributor/Dealer level. We recommend discussing the issue with the authorized Ski-Doo Distributor/Dealer's service manager or owner.
2. If further assistance is required, the Ski-Doo Distributor/Dealer service department should be contacted in order to resolve the matter.
3. If the matter still remains unresolved then contact BRP by writing at the address listed below.

For countries within Middle East and Africa please contact our European office:

BRP EUROPE N.V.

Customer Assistance Center

Skaldenstraat 125

9042 Gent

Belgium

Tel.: +32 9 218 26 00

For all other countries, please contact your local Ski-Doo Distributor/Dealer (visit our website at www.brp.com for contact information), or contact our North American office at:

BOMBARDIER RECREATIONAL PRODUCTS INC.

Customer Assistance Center
75, J.-A Bombardier Street
Sherbrooke QC J1L 1W3
Canada
Tel.: +1 819 566-3366

* For the territory covered by this limited warranty, products are distributed and serviced by Bombardier Recreational Products Inc. or its affiliates.

© 2012 Bombardier Recreational Products Inc. All rights reserved.

® Registered trademark of Bombardier Recreational Products Inc.

BRP LIMITED WARRANTY FOR THE EUROPEAN AND THE RUSSIAN ECONOMIC AREAS AND TURKEY ECONOMIC AREA: 2013 SKI-DOO® SNOWMOBILES

1) SCOPE OF THE LIMITED WARRANTY

Bombardier Recreational Products Inc. ("BRP")* warrants its 2013 Ski-Doo snowmobiles sold by distributors or dealers authorized by BRP to distribute Ski-Doo snowmobiles ("Ski-Doo Distributor/Dealer") in states members of the European Economic Area, ("EEA") (which is comprised of the states member of the European Union plus Norway, Iceland and Liechtenstein) in member states of the Commonwealth of the Independent States ("CIS") (which is comprised of the Russian Federation and ex-members states of the USSR) and Turkey from defects in material or workmanship for the period and under the conditions described below.

All genuine Ski-Doo parts and accessories, installed by an authorized Ski-Doo Distributor/Dealer (at the time of delivery of the 2013 Ski-Doo snowmobile, carry the same warranty as that of the snowmobile.

This limited warranty will become null and void if: (1) the snowmobile was used for racing or any other competitive activity, at any point, even by a previous owner; or (2) the snowmobile has been altered or modified in such a way so as to adversely affect its operation, performance or durability, or has been altered or modified to change its intended use.

2) LIMITATIONS OF LIABILITY

TO THE EXTENT PERMITTED BY LAW, THIS WARRANTY IS EXPRESSLY GIVEN AND ACCEPTED IN LIEU OF ANY AND ALL OTHER WARRANTIES, EXPRESSED OR IMPLIED, INCLUDING WITHOUT LIMITATION ANY WARRANTY OF MERCHANTABILITY OR FITNESS FOR A PARTICULAR PURPOSE. TO THE EXTENT THAT THEY CANNOT BE DISCLAIMED, THE IMPLIED WARRANTIES ARE LIMITED IN DURATION TO THE LIFE OF THE EXPRESS WARRANTIES. INCIDENTAL AND CONSEQUENTIAL DAMAGES ARE EXCLUDED FROM COVERAGE UNDER THIS WARRANTY. SOME JURISDICTIONS DO NOT ALLOW FOR THE DISCLAIMERS, LIMITATIONS AND EXCLUSIONS IDENTIFIED ABOVE, AS A RESULT, THEY MAY NOT APPLY TO YOU. THIS WARRANTY GIVES YOU SPECIFIC RIGHTS, AND YOU MAY ALSO HAVE OTHER LEGAL RIGHTS WHICH MAY VARY FROM COUNTRY TO COUNTRY.

Neither the Ski-Doo Distributor/Dealer nor any other person has been authorized to make any affirmation, representation or warranty regarding the product, other than those contained in this limited warranty, and if made, shall not be enforceable against BRP.

BRP reserves the right to modify this warranty at any time, being understood that such modification will not alter the warranty conditions applicable to the products sold while this warranty is in effect.

3) EXCLUSIONS – ARE NOT WARRANTED

The following are not warranted under this limited warranty under any circumstances:

- Normal wear and tear;

- Routine maintenance items, tune ups, adjustments;
- Damage caused by negligence or failure to provide proper maintenance and/or storage, as described in the Operator's Guide;
- Damage resulting from removal of parts, improper repairs, service, maintenance, modifications or use of parts or accessories not manufactured or approved by BRP which in its reasonable judgement are either incompatible with the product or adversely affect its operation, performance and durability, or resulting from repairs done by a person that is not an authorized servicing Ski-Doo Distributor/Dealer;
- Damage caused by abuse, abnormal use, neglect, racing or operation of the product on surfaces other than snow, or operation of the product in a manner inconsistent with the recommended operation described in the Operator's Guide;
- Damage resulting from accident, submersion, fire, snow or water ingestion, theft, vandalism or any act of God;
- Operation with fuels, oils or lubricants which are not suitable for use with the product (see the Operator's Guide);
- Damage resulting from rust, corrosion or exposure to the elements;
- Incidental or consequential damages, or damages of any kind including without limitation towing, transportation expenses, storage, telephone, rental, taxi, inconvenience, insurance coverage, loan payments, loss of time, loss of income or time missed for downtime experience due to service work;
- and damage resulting from studs installed on tracks if the installation does not conform to BRP's instructions.

4) WARRANTY COVERAGE PERIOD

This warranty will be in effect from (1) the date of delivery to the first retail consumer or (2) the date the product is first put into use, whichever occurs first and for a period of:

TWENTY-FOUR (24) CONSECUTIVE MONTHS, for private use owners and TWELVE (12) CONSECUTIVE MONTHS for commercial use owners. However, the warranty coverage period on a snowmobile delivered between June 1st and December 1st of a given year will expire November 30th of the applicable year. A snowmobile is used commercially when it is used in connection with generating income or any work or employment during any part of the warranty period. A snowmobile is also used commercially when, at any point during the warranty period, it has commercial tags or is licensed for commercial use.

The repair or replacement of parts or the performance of service under this warranty does not extend the life of this warranty beyond its original expiration date.

Note that the duration and any other modalities of the warranty coverage are subject to the applicable national or local legislation in the customer's country.

5) CONDITIONS TO HAVE WARRANTY COVERAGE

This warranty coverage is available **only** if each of the following conditions has been fulfilled:

- The 2013 Ski-Doo snowmobile must be purchased as new and unused by its first owner from a Ski-Doo Distributor/Dealer authorized to distribute Ski-Doo products in the country in which the sale occurred;

- The BRP specified pre-delivery inspection process must be completed and documented;
- The product must have undergone proper registration by an authorized Ski-Doo Distributor/Dealer;
- The 2013 Ski-Doo snowmobile must be purchased within the EEA by an EEA resident, in the CIS for residents of the countries comprised in such area and in Turkey for residents of Turkey; and
- Routine maintenance outlined in the Operator's Guide must be timely performed in order to maintain warranty coverage. BRP reserves the right to make warranty coverage contingent upon proof of proper maintenance.

BRP will not honour this limited warranty to any private use owner or commercial use owner if one of the preceding conditions has not been met. Such limitations are necessary in order to allow BRP to preserve both the safety of its products, and also that of its consumers and the general public.

6) WHAT TO DO TO OBTAIN WARRANTY COVERAGE UNDER THIS WARRANTY

The customer must cease using the snowmobile upon the appearance of an anomaly. The customer must notify a servicing Ski-Doo Distributor/Dealer within two (2) months of the appearance of a defect, and provide it with reasonable access to the product and reasonable opportunity to repair it. The customer must also present to the authorized Ski-Doo Distributor/Dealer, proof of purchase of the product and must sign the repair/work order prior to starting the repair in order to validate the warranty repair. All parts replaced under this limited warranty become the property of BRP.

Note that the notification period is subject to the applicable national or local legislation in customer's country.

7) WHAT BRP WILL DO

To the extent permitted by law, BRP's obligations under this warranty are limited to, at its sole discretion, repairing parts found defective under normal use, maintenance and service, or replacing such parts with new genuine Ski-Doo parts without charge for parts and labour, at any authorized Ski-Doo Distributor/Dealer during the warranty coverage period under the conditions described herein. BRP's responsibility is limited to making the required repairs or replacements of parts. No claim of breach of warranty shall be cause for cancellation or rescission of the sale of the snowmobile to the owner. You may have other legal rights which may vary from country to country.

In the event that service is required outside of the EEA, CIS or Turkey, the owner will bear responsibility for any additional charges due to local practices and conditions, such as, but not limited to, freight, insurance, taxes, license fees, import duties, and any and all other financial charges, including those levied by governments, states, territories and their respective agencies.

BRP reserves the right to improve or modify products from time to time without assuming any obligation to modify products previously manufactured.

8) TRANSFER

If the ownership of a product is transferred during the warranty coverage period, this warranty shall also be transferred and be valid for the remaining coverage period provided BRP or an authorized Ski-Doo Distributor/Dealer receives a proof that the former owner agreed to the transfer of ownership, in addition to the co-ordinates of the new owner.

9) CONSUMER ASSISTANCE

1. In the event of a controversy or a dispute in connection with this limited warranty, BRP suggests that you try to resolve the issue at the Ski-Doo Distributor/Dealer level. We recommend discussing the issue with the authorized Ski-Doo Distributor/Dealer's service manager or owner.
2. If further assistance is required, the Ski-Doo Distributor/Dealer service department should be contacted in order to resolve the matter.
3. If the matter still remains unresolved then contact BRP at the address listed below:

For countries within Europe, Turkey, the CIS and Russia please contact our European office:

BRP EUROPE N.V.

Customer Assistance Center
Skaldenstraat 125
9042 Gent
Belgium
Tel.: +32 9 218 26 00

For Scandinavian countries, please contact our Finland office:

BRP FINLAND OY

Service Department
Isoaavantie 7
FIN-96320 Rovaniemi
Finland
Tel.: +358 163 208 111

You can find your Ski-Doo Distributor/Dealer's coordinates on www.brp.com.

* In the EEA, products are distributed and serviced by BRP European Distribution S.A. and other affiliates or subsidiaries of BRP.

© 2012 Bombardier Recreational Products Inc. All rights reserved.

® Registered trademark of Bombardier Recreational Products Inc.

ADDITIONAL TERMS AND CONDITIONS FOR FRANCE ONLY

The following terms and conditions are applicable to products sold in France only:

The seller shall deliver goods that are complying with the contract and shall be responsible for defects existing upon delivery. The seller shall also be responsible for defects resulting from packaging, assembling instructions or the installation when it is its responsibility per the contract or if accomplished under its responsibility. To be compliant with the contract, the good shall:

1. Be fit for normal use for goods similar thereto and, if applicable:
 - Correspond to the description provided by the seller and have the qualities presented to the buyer through sample or model;
 - Have the qualities that a buyer may legitimately expect considering the public declarations of the seller, the manufacturer of its representative, including in advertising or labeling; or
2. Have the characteristics mutually agreed upon as between the parties or be fit for the specific use intended by the buyer and brought to the attention of the seller and which accepted

The action for failure to comply is prescribed after two years after delivery of the goods. The seller is responsible for the warranty for hidden defects of the good sold if such hidden defects are rendering the good unfit for the intended use, or if they diminish its use in such a way that the buyer would not have acquired the good or would have given a lesser price, had he known. The action for such hidden defects shall be taken by the buyer within 2 years of the discovery of the defect.

CUSTOMER INFORMATION

PRIVACY INFORMATION

BRP wishes to inform you that your coordinates will be used for safety and warranty related purposes. Furthermore, BRP and its affiliates may use its customer list to distribute marketing and promotional information about BRP and related products.

To exercise your right to consult or correct your data, or to be removed from the addressee-list for direct marketing, please contact BRP.

By E-mail: privacyofficer@brp.com

By mail: BRP
 Senior Legal Counsel-Privacy Officer
 726 St-Joseph
 Valcourt QC
 Canada
 J0E 2L0

CHANGE OF ADDRESS/OWNERSHIP

If your address has changed or if you are the new owner of the Snowmobile, be sure to notify BRP by either:

- Mailing one of the change of address cards on the following pages
- North America only: Calling at 715 848-4957 (USA) or 819 566-3366 (Canada)
- Notifying an authorized Ski-Doo dealer.

In case of change of ownership, please join a proof that the former owner agreed to the transfer.

Notifying BRP, even after the expiration of the limited warranty, is very important as it enables BRP to reach the Snowmobile owner if necessary, like when safety recalls are initiated. It is the owner's responsibility to notify BRP.

STOLEN UNITS: If your personal Snowmobile is stolen, you should notify BRP or an authorized Ski-Doo dealer. We will ask you to provide your name, address, phone number, the vehicle identification number and the date it was stolen.

North America

BOMBARDIER RECREATIONAL PRODUCTS INC.

Warranty Department
75 J.-A. Bombardier Street
Sherbrooke QC J1L 1W3
Canada

Scandinavian countries

BRP FINLAND OY

Service Department
Isoaavantie 7
FIN-96320 Rovaniemi

Other countries in the world

BRP EUROPEAN DISTRIBUTION

Warranty Department
Chemin de Messidor 5-7
1006 Lausanne
Switzerland

***This page is
intentionally blank***

CHANGE OF ADDRESS CHANGE OF OWNERSHIP 

VEHICLE IDENTIFICATION NUMBER

Model Number

Vehicle Identification Number (V.I.N.)

OLD ADDRESS
OR PREVIOUS OWNER:

NAME

NO.

STREET

APT

CITY

STATE/PROVINCE

ZIP/POSTAL CODE

COUNTRY

TELEPHONE

NEW ADDRESS
OR NEW OWNER:

NAME

NO.

STREET

APT

CITY

STATE/PROVINCE

ZIP/POSTAL CODE

COUNTRY

TELEPHONE

E-MAIL ADDRESS

V00A2F

CHANGE OF ADDRESS CHANGE OF OWNERSHIP 

VEHICLE IDENTIFICATION NUMBER

Model Number

Vehicle Identification Number (V.I.N.)

OLD ADDRESS
OR PREVIOUS OWNER:

NAME

NO.

STREET

APT

CITY

STATE/PROVINCE

ZIP/POSTAL CODE

COUNTRY

TELEPHONE

NEW ADDRESS
OR NEW OWNER:

NAME

NO.

STREET

APT

CITY

STATE/PROVINCE

ZIP/POSTAL CODE

COUNTRY

TELEPHONE

E-MAIL ADDRESS

V00A2F



520 001 219

CA

OPERATOR'S GUIDE, MX Z X 600RS ENGLISH
GUIDE DU CONDUCTEUR, MX Z X 600RS ANGLAIS

FAIT AU / MADE IN CANADA

U/M:P.C.