

Operator's manual

formula^{*} sp

formula plus/mx

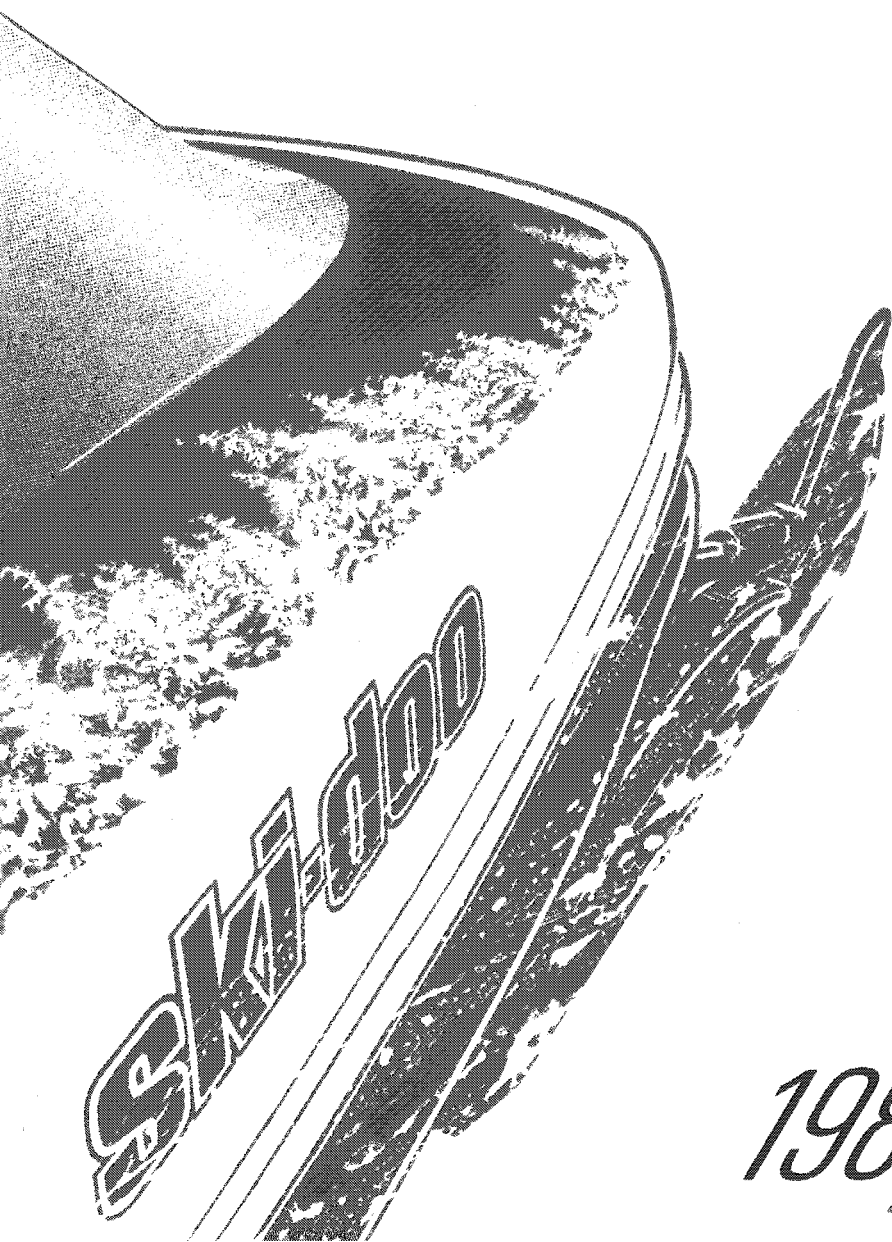

1986

414 5724 00

model _____

V.I.N. _____

purchase date _____

warranty expiry date _____

To be completed by dealer at time of sale

DEALER IMPRINT AREA

AFTER SALES SERVICE
BOMBARDIER INC.
VALCOURT, QUEBEC
CANADA, JOE 2LO



The following are trademarks of Bombardier Inc.

ALPINE®	FUTURA®	SAFARI*
BLIZZARD®	GRAND PRIX SPECIAL*	SKANDIC*
BOMBARDIER®	MIRAGE*	SKI-DOO®
CARRY-BOOSE®	MOTO-SKI®	SONIC*
CITATION®	NORDIK*	SPIRIT*
ELAN®	NUVIK*	SUPER SONIC*
ELITE®	OLYMPIQUE*	T'NT®
EVEREST®	ROTAX*	TUNDRA*
FORMULA*	RV*	ULTRA SONIC*

FOREWORD

The operator manual and the Snowmobile Safety Handbook have been prepared to acquaint the owner / operator of a new snowmobile with the various vehicle controls, maintenance and safe operating instructions. Each is indispensable for the proper use of the product, and should be kept with the vehicle at all times.

Should you have any questions pertaining to the warranty and its application, please consult the "Often Asked Question" section of this manual, or your authorized dealer.

This manual uses the following symbols.

 **WARNING:** Identifies an instruction which, if not followed, could cause personal injury.

 **CAUTION:** Denotes an instruction which, if not followed, could severely damage vehicle components.

 **NOTE:** Indicates supplementary information needed to fully complete an instruction.

Although the mere reading of such information does not eliminate the hazard, your understanding of the information will promote its correct use.

The information, illustrations and components/system descriptions contained in this manual are correct at time of publication. Bombardier Inc. however, maintains a policy of continuous improvement of its products without imposing upon itself any obligation to install them on products previously manufactured.

Bombardier Inc. reserves the right at any time to discontinue or change specifications, designs, features, models or equipment without incurring obligation.

Most specifications are given in both metric and customary units. Where precise accuracy is not required, some conversions are rounded to even numbers for easier use.

A shop manual can be obtained for complete service, maintenance and repair information.

 **WARNING:** The engines and the corresponding components identified in this manual should not be utilized on product(s) other than those mentioned on the cover page of this manual.

 **WARNING:** This vehicle is built with parts dimensioned in the metric system. All fasteners are metric and must not be replaced by customary fasteners. Mismatched or incorrect fasteners could cause damage to the vehicle or possible personal injury.

SAFETY MEASURES

Observe the following precautions:

- Throttle mechanism should be checked for free movement before starting engine.
- The snowmobile engine can be stopped by activating the emergency cut-out or tether switches or turning off the key.
- Clean and check operation of the headlight, tail light and brake light.
- Engine should be running only when belt guard and/or pulley guard is secured in place.
- Never run the engine without drive belt installed. Running an unloaded engine can prove to be dangerous.
- Never run the engine when the track is raised off the ground.
- It can be dangerous to run engine with the hood removed.
- Gasoline is flammable and explosive under certain conditions. Always manipulate in a well ventilated area. Do not smoke or allow open flames or sparks in the vicinity. If gasoline fumes are noticed while driving, the cause should be determined and corrected without delay.
- Maintain your vehicle in top mechanical condition at all times.
- Your snowmobile is not designed to be driven or operated on black top, bare earth, or other abrasive surfaces. On such surfaces abnormal and excessive wear of critical parts is inevitable.
- Your snowmobile is not designed to be operated on public streets, road or highways. In most States and Provinces, it is considered an illegal operation.
- Installation of other than standard equipment, including ski-spreaders, bumpers, pack racks, etc., could severely affect the stability and safety of your vehicle. Avoid adding on accessories that alter the basic vehicle configuration.
- Whenever the vehicle is parked outdoors, overnight or for a long period, it is suggested to protect it against the inclemency of the weather with a snowmobile cover.
- Do not lubricate throttle and/or brake cables and housings.
- Only perform procedures as detailed in this manual. Unless otherwise specified, engine should be turned OFF for all lubrication and maintenance procedures.
- Since engine cooling is fully in effect only when the vehicle is in motion and driven on snow, it is not recommended that you allow the engine to idle for more than brief periods and/or you drive the vehicle on icy surface. Prolonged idling and/or continuous driving on ice may cause engine damage.
- When removing coolant tank cap, first place a cloth over cap then turn cap to its first step to release pressure. Never drain or refill the cooling system when engine is hot.
- These vehicles are designed for the driver only. No provisions have been made for a passenger.
- The performance of the Formula MX, Plus may significantly exceed that of other snowmobiles you have operated. Therefore, use of this vehicle by novice or inexperienced operators is not recommended.
- Should removal of a nylon lock nut be required when undergoing repairs/disassembly, always replace by new ones. Tighten as specified in the applicable Shop Manual.

PLEASE READ AND UNDERSTAND ALL WARNINGS AND CAUTIONS IN THIS MANUAL AND ON THE VEHICLE.

THIS MANUAL SHOULD REMAIN WITH THE VEHICLE AT THE TIME OF RESALE.

INDEX

THE 1986 "LIMITED WARRANTY"	4
OFTEN ASKED QUESTIONS	6
LISTING OF AREA DISTRIBUTORS	8
HOW TO IDENTIFY YOUR SNOWMOBILE	9
CONTROLS/INSTRUMENTS	
Throttle lever, brake lever, ignition/light switch, headlamp dimmer switch, emergency cut-out switch, tether cut-out switch, rewind starter handle, primer, adjustable steering handle, speedometer, tachometer, temperature gauge, injection oil level pilot lamp, high beam pilot lamp, electric fuel level gauge, tank cap, hood opening, tool box, tool bag, fuse holder, spare drive belt holder.	10
BREAK-IN PERIOD	
Engine and belt break-in, 10 hour-inspection, inspection check list	14
FUEL	
Recommended gasoline, recommended oil, oil injection system.	16
PRE-START CHECK	
Check points	17
STARTING PROCEDURE	
Manual starting, before riding, emergency starting	17
LUBRICATION	
Frequency, steering mechanism, steering and front suspension mechanism, drive axle, countershaft (disk brake and driven pulley), slide suspension, chain-case oil level, oil injection system, rotary valve system	19
MAINTENANCE	
Chart, belt guard removal, drive belt removal and installation, drive belt condition, new drive belt, brake condition, brake adjustment, spark plugs, suspension condition, stopper strap condition, suspension adjustment, track condition, track tension and alignment, drive pulley, drive chain tensionner, steering mechanism, steering and front suspension mechanism, steering adjustment, steering and ski legs camber adjustment, muffler attachment, engine head nuts, engine mount nuts, carburetors adjustment, oil injection system, cooling system, headlamp beam aiming, bulb replacement, general inspection	26
STORAGE	
Track, suspension, skis, controls, chaincase, drive pulley, countershaft (disk brake and driven pulley), cooling system, engine and primer lubrication, fuel tank & carburetors, chassis, general inspection, suspension stopper strap	39
PRE-SEASON PREPARATION	
Pre-season preparation chart	44
TROUBLE SHOOTING	45
TOOLS	47
SPECIFICATIONS	48
WIRING DIAGRAM	50
SI METRIC INFORMATION GUIDE	51

THE 1986 SNOWMOBILE LIMITED WARRANTY

1 - PERIOD

BOMBARDIER® INC. as manufacturer, warrants FROM THE DATE OF FIRST CONSUMER SALES, every 1986 BOMBARDIER snowmobile, sold as NEW AND UNUSED, and predelivered by an authorized BOMBARDIER dealer for a period of:

- 12 consecutive months.

2 - WHAT BOMBARDIER WILL DO

BOMBARDIER will repair and/or replace, at its option, components defective in material and/or workmanship (under normal use and service,) with a genuine BOMBARDIER component without charge for parts or labour, at any authorized BOMBARDIER dealer during said warranty period.

3 - CONDITION TO HAVE WARRANTY WORK PERFORMED

Present to the servicing dealer, the hard copy of the BOMBARDIER Warranty Registration card received by the customer from the selling dealer at time of purchase.

4 - WARRANTY TRANSFER

This warranty is transferable to subsequent owner(s) for remainder of warranty period from original date of sale.

5 - EXCLUSIONS - ARE NOT WARRANTED

- Normal wear on all items such as, but not limited to:
 - drive belts
 - slider shoes
 - spark plugs
 - bulbs
 - runners on skis
- Replacement parts and/or accessories which are not genuine BOMBARDIER parts and/or accessories.
- Damage resulting from installation of parts other than genuine BOMBARDIER parts.
- Damage caused by failure to provide proper maintenance as detailed in the Operator Manual. The labour, parts and lubricants costs of all maintenance services, including tune-ups and adjustments will be charged to the owner.
- Wet cells battery.
- Vehicles designed and/or used for racing purposes.
- All optional accessories installed on the vehicle.
(The normal warranty policy for parts and accessories, if any, applies).
- Damage resulting from accident, fire or other casualty, misuse, abuse or neglect.
- Damage resulting from operation of the snowmobile on surfaces other than snow.

-
- Damage resulting from modification to the snowmobile not approved in writing by BOMBARDIER.
 - Losses incurred by the snowmobile owner other than parts and labour, such as, but not limited to, transportation, towing, telephone calls, taxis, or any other incidental or consequential damages.

6 - BATTERY WARRANTY:

- 12 consecutive months. (Pro-rated.)

100% warranty coverage will start on the date the snowmobile was purchased and run to the following April 30th. The remainder of the 12 months period will be pro-rated as follows:

- 50% from April 30th to December 1st.
- 40% from December 1st to December 31st.
- 30% from January 1st to end of warranty.

7 - EXPRESSED OR IMPLIED WARRANTIES

This warranty gives you specific rights, and you may also have other legal rights which may vary from state to state, or province to province. Where applicable this warranty is expressly in lieu of all other expressed or implied warranties of BOMBARDIER, its distributors and the selling dealer, including any warranty of merchantability of fitness for any particular purpose; otherwise the implied warranty is limited to the duration of this warranty. However, some states or provinces do not allow limitations on how long an implied warranty lasts, so the above limitation may not apply.

Neither the distributor, the selling dealer, nor any other person has been authorized to make any affirmation, representation or warranty other than those contained in this warranty, and if made, such affirmation, representation or warranty shall not be enforceable against BOMBARDIER or any other person.

Some states or provinces do not allow the exclusion or limitation of incidental or consequential damages, so the above limitation or exclusion may not apply.

BOMBARDIER INC. reserves the right to modify its warranty policy at any time, being understood that such modification will not alter the warranty conditions applicable to vehicles sold while the above warranty is in effect.

8 - CONSUMER ASSISTANCE

If a servicing problem or other difficulty occurs, we suggest the following:

1. Try to resolve the problem at the dealership with the Service Manager or Owner.
2. If this fails, contact your area distributor listed in the Operator Manual.
3. Then if your grievance still remains unsolved, you may write to us:

Bombardier Inc.
Service Department
Recreational Products Division
Valcourt, Quebec, Canada, JOE 2L0

February 1985
Bombardier Inc.
Valcourt, Quebec, Canada, JOE 2L0

®*Trademarks of Bombardier Inc.

OFTEN ASKED QUESTIONS

Q: Why must my snowmobile be registered? After all I do have my original invoice as proof of when I purchased my snowmobile.

A: Your warranty is valid at any authorized dealer of the product. Your registration is the key element in providing the servicing dealer with the necessary data to complete warranty claim forms. This information is also used to notify owners in the event of a safety recall.

Q: Who should send the registration card to Bombardier Inc.?

A: The dealer. However, the customer must make sure that it has been sent. The company might contact you should your vehicle be recalled or in case of a particular warranty campaign.

Q: I bought my snowmobile in O'King County but I snowmobile in Washington County. Can the dealer in Washington County accept to perform warranty work on my snowmobile?

A: Yes, any authorized dealer in North America can perform warranty repairs, providing the customer warranty registration card is presented.

Q: Where can I find information on the lubrication and maintenance of my snowmobile?

A: In this Operator Manual provided with the vehicle at the time of first sale.

Q: Will the entire warranty be void or cancelled, if I do not operate or maintain my new snowmobile exactly as specified in the Operator's Manual?

A: The warranty of the new snowmobile cannot be "Voided" or "Cancelled". However, if a particular failure is caused by operation or maintenance other than is shown in the Operator Manual, THAT failure may not be covered under warranty. This includes service work performed by the customer, especially the critical adjustments to ignition, timing, carburation and oil injection/or oil mixture.

Q: Would you give some examples of abnormal use or strain, neglect or abuse?

A: These terms are general and overlap each other in areas. Some specific examples may include: running the machine out of oil, chain failure caused by a lack of lubrication, operating the machine with a broken or damaged part which causes another part to fail, and so on. If you have any specific questions on operation or maintenance, please contact your dealer for advice.

Q: What costs are my responsibility during the warranty period?

A: The customer's responsibility includes all costs of normal maintenance services, non-warranty repairs, accidents and collision damage, as well as oils, and spark plugs, and incidental or consequential damages costs as explained in the warranty.

Q: Are "Genuine" Bombardier replacement parts used in warranty repairs covered by warranty?

A: Yes. When installed by an authorized dealer, any "genuine" Bombardier part used in warranty repairs assumes the remaining warranty that exists on the machine.

Q: If I sell my snowmobile within the warranty period, will the new owner qualify for the balance of the warranty?

A: Yes, provided the unit has already been registered with the manufacturer. Note that the change of ownership card in this manual should be completed and sent to Bombardier Inc.

Q: How can I receive the best owner assistance?

A: The satisfaction and goodwill of the owners of Bombardier products are of primary concern to your dealer and Bombardier Inc. Normally, any problems that arise in connection with the sales transaction or the operation of your snowmobile will be handled by your Dealers Sales or Service Departments. It is recognized, however, that despite the best intentions of everyone concerned, misunderstandings will sometimes occur. If you have a problem that has not been handled to your satisfaction through normal channels, we suggest that you discuss your problem with a member of dealership management. Frequently, complaints are the result of a breakdown in communications and can quickly be resolved by a member of the dealership management. If the problem already has been reviewed with the Sales Manager or Service Manager, contact the Dealer himself or the General Manager.

LISTING OF AREA DISTRIBUTORS

CANADIAN DISTRIBUTORS

BOMBARDIER INC.
EASTERN CANADA DISTRIBUTION DIVISION
Atlantic Branch
P.O. Box 670
Shediac, New Brunswick, E0A 3G0
(506) 386-6117
Magdalen Island, Nova Scotia, New Brunswick, Prince Edward Island

Quebec Branch
1350 Nobel Boulevard
Boucherville, Quebec, J4B 1A1
(514) 655-6121
Province of Quebec

Ontario Branch
230 Bayview Drive
Barrie, Ontario, L4N 4Y8
(705) 728-8600
Province of Ontario

BROOKS EQUIPMENT LIMITED
1616 King, Edward Street
P.O. Box 985
Winnipeg, Manitoba, R3C 2V8
(204) 633-7247
British Columbia, Manitoba, Saskatchewan, Alberta, Yukon

CHARLES R. BELL LIMITED
Newfoundland, Labrador
Offices
- Riverside Drive
P.O. Box 1050
Corner Brook, Newfoundland, A2H 6J3
(709) 634-3533
- 81 Kenmount Road
P.O. Box 8127
St-John's, Newfoundland, A1B 3N1
(709) 722-6700

HUDSON'S BAY CO. LTD.
165 Hymus Blvd
Pointe-Claire, Quebec, H9R 1G2
(514) 697-8500
North-West Territories, Franklin District & Keewatin

AMERICAN DISTRIBUTORS

BOMBARDIER CORPORATION
All States (excluding Alaska)

SERVICE OFFICES
- East Main Street Road
Malone, New York 12953
(518) 483-4411

- 4505 West Superior Street
P.O. Box 6106
Duluth, Minnesota 55806
(218) 628-2881

- P.O. Box 1569
Idaho Falls, Idaho, 83401
(208) 529-9510

NATIONAL SALES OFFICE
- O'Hare Lake Plaza
2350 Devon Avenue
Suite 150
Des Plaines, Illinois 60018
(312) 298-9540

MILLER EQUIPMENT AND RECREATIONAL CENTER
1049 Whitney Road
Anchorage, Alaska 99501
(907) 274-9513
Alaska

HOW TO IDENTIFY YOUR SNOWMOBILE

The main components of your snowmobile (engine, track and frame) are identified by different serial numbers. It may sometimes become necessary to locate these numbers for warranty purposes or to trace your snowmobile in the event of theft.

462 ENGINE TYPE

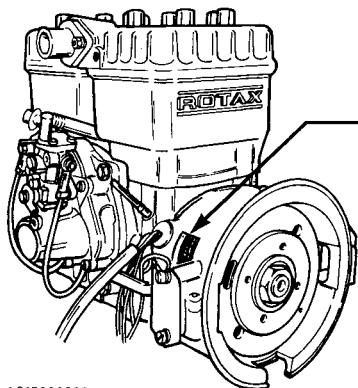

ENGINE SERIAL NUMBER

A015002008

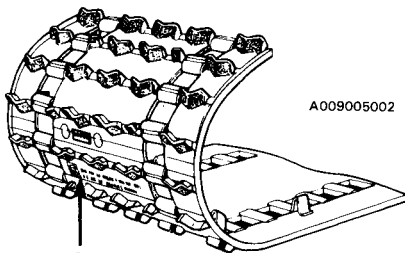

A009005002

TRACK SERIAL NUMBER

467 AND 537 ENGINE TYPE

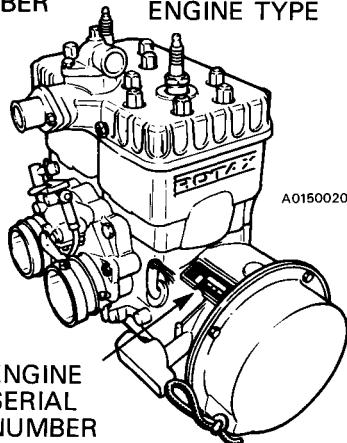

ENGINE SERIAL NUMBER

A015002019

VEHICLE SERIAL NUMBER

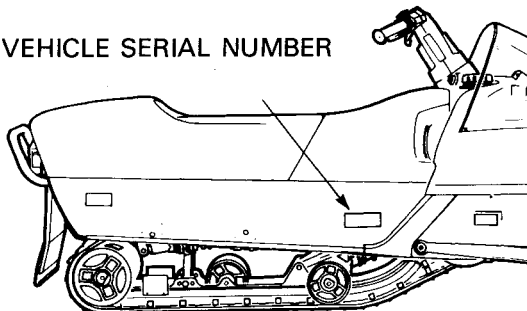

A015007001

0000000000

Vehicle no.

Model no.

NOTE: We strongly recommend that you take note of all the serial numbers on your vehicle and supply them to your insurance company. It will surely help in the event a snowmobile is stolen.

CONTROLS/ INSTRUMENTS

Formula SP

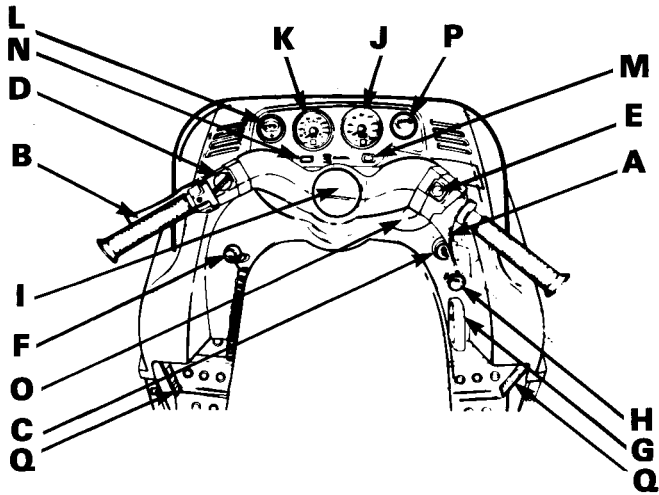

A014007001

Formula MX, Plus

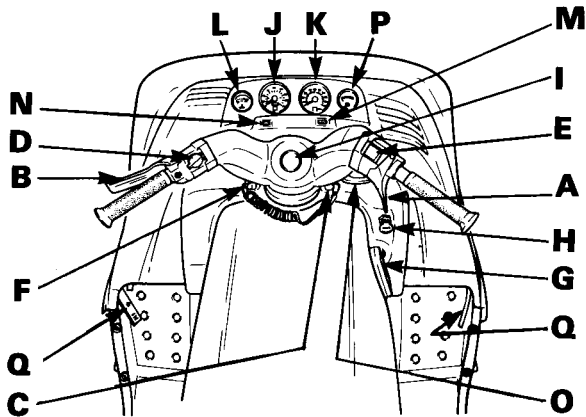

A015007002

A) Throttle lever

B) Brake lever

C) Ignition/light switch

D) Headlamp dimmer switch

E) Emergency cut-out switch

F) Tether cut-out switch

G) Rewind starter handle

H) Primer

I) Adjustable steering handle

J) Speedometer

K) Tachometer (optional on some models)

L) Temperature gauge

M) Injection oil level pilot lamp (red)

N) High beam pilot lamp (blue)

O) Tank cap (fuel gauge on some models)

P) Electric fuel level gauge (optional on some models)

Q) Hood opening

A) Throttle Lever

Located on right side of handlebar. When compressed, it controls the engine speed and the engagement of the transmission. When released, engine speed returns automatically to idle.

B) Brake Lever

Located on the left side of handlebar. When compressed, the brake is applied. When released, it automatically returns to its original position. Braking effect is proportionate to the pressure applied on the lever and to the type of terrain and its snow coverage.

C) Ignition/Light Switch

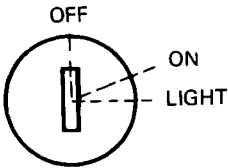

A002007002

Key operated, 3 position switch. To start engine, first turn key clockwise to ON position. To stop engine, turn key counter-clockwise to OFF position.

To put lights on while engine is running, turn key to LIGHT position.

CAUTION: Never start a vehicle equipped with halogen headlamp with the key placed on the "Light" position. Otherwise headlamp bulb may burn as a voltage peak may be produced when the engine starts running.

D) Headlamp Dimmer Switch

The dimmer switch, located on left side of handlebar, allows correct selection of headlamp beam. To obtain high or low beam simply flick the switch.

E) Emergency Cut-Out Switch

A push pull type switch located on the right side of the handlebar. To stop the engine in an emergency, push the button to the lower off position and simultaneously apply the brakes. To start engine, button must be at the upper on position.

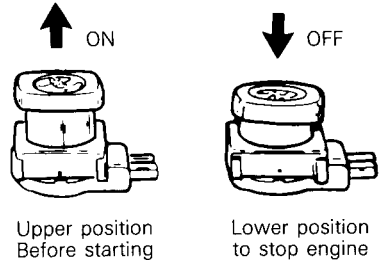

A017006004

The driver of this vehicle should familiarize himself with the function of this device by using it several times on first outing. Thereby being mentally prepared for emergency situations requiring its use.

WARNING: If the switch has been used in an emergency situation the source of malfunction should be determined and corrected before re-starting engine.

WARNING: For safety reasons, the emergency cut-out switch is easily accessible; be careful not to operate it inadvertently.

F) Tether Cut-Out Switch

A pull switch located below the handlebar. Attach tether cord to wrist or other convenient location then snap tether cut-out cap over receptacle before starting engine.

If emergency engine "shut off" is required completely pull cap from safety switch and engine power will be automatically shut "off".

NOTE: The cap must be installed on the safety switch at all times in order to operate the vehicle.

◆ WARNING: If the switch is used in an emergency situation the source of malfunction should be determined and corrected before restarting engine.

G) Rewind Starter Handle

Auto rewind type located on right hand side of vehicle. To engage mechanism, pull handle.

H) Primer

A push-pull button located below handlebar. Pull and push button (2-3 times) to activate primer. The primer should always be used for cold engine starts. After engine is warm however, it is not necessary to use primer when starting.

I) Adjustable steering handle

- Remove steering pad.
- Loosen the four (4) retaining screws.
- Adjust the handle to the desired position.

◆ WARNING: Do not adjust too high as the brake lever may contact the windshield when turning.

- Lock the steering handle in place by tightening the four (4) retaining screws to 26 N•m (19 lbf•ft).
- Reinstall steering pad.

J) Speedometer

The speedometer is linked directly to the drive axle. Direct-reading dial indicates the speed of the vehicle. Odometer records the total distance travelled in kilometers.

K) Tachometer (Optional on some models)

The tachometer registers the impulses of magneto. Direct-reading dial indicates the number of revolutions per minute (RPM) of the engine.

▼ CAUTION: The tachometer is protected by a fuse, if tachometer stops operating check fuse condition and if necessary replace. The fuse is 0.1 amp. Do not use a higher rated fuse as this can cause severe damage to the tachometer.

L) Temperature Gauge

The gauge indicates engine coolant temperature. Normal operating temperature is 50°C (120°F) on the Formula SP and 60°C (140°F) on the Formula MX, Plus. However, coolant temperature can vary depending on driving condition. If coolant temperature exceeds 95°C (200°F) on the Formula SP and 100°C (212°F) on the Formula MX, Plus, reduce speed and run vehicle in loose snow or stop engine immediately.

◆ WARNING: To remove coolant tank cap, place a cloth over the cap and unscrew it to the first step to release the pressure. If this notice is disregarded loss of fluid and possible severe burns could occur.

M) Injection Oil Level Pilot Lamp (Red)

Will light up when injection oil level is low. Check level and replenish as soon as possible.

▼ CAUTION: Do not run engine out of oil. Serious engine damage will occur.

○ NOTE: Whenever brake lever is compressed, oil injection level pilot lamp should light up. If not replace lamp.

N) High Beam Pilot Lamp (Blue)

Lights up when headlamp is on high beam.

O) Tank cap (Fuel gauge on some models)

Unscrew fuel tank cap and withdraw dipstick to check fuel level on models without electric fuel gauge.

◆ **WARNING:** Never use a lite match or open flame to check fuel level.

P) Electric fuel level gauge

The electric fuel gauge is located in the dashboard and allows driver to observe the fuel level while riding the snowmobile.

Q) Hood Opening

Pull down the latches to unhook the hood from its anchors.

○ **NOTE:** Always lift hood gently up until stopped by restraining device.

◆ **WARNING:** It is dangerous to run an engine with the hood open unfastened or removed.

Tool Box (Formula SP Only)

Located under the hood. To gain access, tilt hood. Ideal location for spare plugs, rope, first aid kit, flashlight, etc..

Tool Bag (Formula MX, Plus, Only)

To gain access, tilt hood. Ideal location for spare plugs, rope, first aid kit, flashlight, etc..

Fuse Holder (models equipped with a tachometer only)

Tachometer

The tachometer is protected with 0.1 ampere rated fuse. Fuse holder is located under the hood behind the tachometer. If it stops operating, check fuse condition and replace if necessary.

Spare drive belt holder (Formula MX, Plus Only)

A spare drive belt can be installed in clips on belt guard.

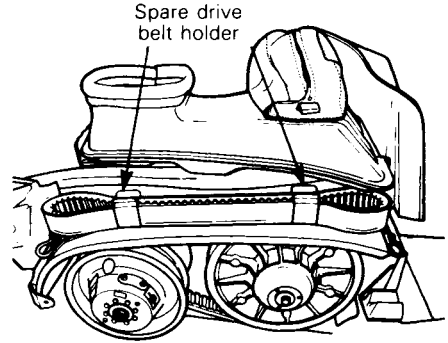



A015003008

BREAK-IN PERIOD

Engine

With Bombardier-Rotax snowmobile engines, a break-in period is required before running the vehicle at full throttle. Engine's manufacturer recommendation is 10 to 15 operating hours. During this period, maximum throttle should not exceed $\frac{3}{4}$, however, brief full acceleration and speed variations contribute to a good break-in. Continued wide open throttle accelerations, prolonged cruising speeds, and lugging are detrimental during the break-in period.

 **NOTE:** To assure additional protection during the initial engine break-in, 500 ml (18 imp. oz.) of BLIZZARD OIL should be added to the first full fuel tank filling.

 **CAUTION:** Remove and clean spark plugs after engine break-in.

Belt

A new drive belt requires a break-in period of 25 km (15 miles).

10-Hour Inspection

As with any precision piece of mechanical equipment, we suggest that after the first 10 hours of operation or 30 days after the purchase, whichever comes first, your vehicle be checked by your dealer. This inspection will give you the opportunity to discuss the unanswered questions you may have encountered during the first hours of operation. Remember that it is easier to remedy at this time than to allow the snowmobile to operate until a possible failure occurs.

The 10 hour inspection is at the expense of the vehicle owner.

10-HOUR INSPECTION CHECK LIST	✓
Engine timing	
Spark plugs condition: (Remove and clean)	
Carburetor adjustment	
Oil injection pump adjustment	
Engine head nuts	
Engine mount nuts	
Muffler attachment	
Chaincase oil level	
Drive chain tension	
Injection system oil level	
Rotary valve oil level	
Engine coolant level	
Brake operation and lining condition	
Ski alignment (runners condition), ski leg camber adjustment (Formula MX, Plus only)	
Steering arm, retighten	
Handlebar bolts, retorque to 26 N•m (19 lbf•ft)	
Pulley alignment and drive belt condition	
Track condition, tension and alignment	
Suspension, torque rear axle screw to 48 N•m (35 lbf•ft) (Formula MX, Plus only)	
Lubrication (steering, suspension, drive axle)	
Electrical wiring (loose connections, stripped wires, damaged insulation), tighten all loose bolts, nuts and linkage	
Operation of lighting system (HI / LO beam, brake light, etc.), test operation of emergency cut-out switch and tether cut-out switch	

We recommend that you have your dealer sign this inspection .

Date of 10 hour inspection

Dealer signature

FUEL

Recommended Gasoline

Formula SP

Use **regular** leaded or unleaded gasoline available from all service stations.

Formula MX, Plus

Use **premium** leaded or unleaded gasoline (92 octane) available from all service stations.

Recommended Oil

Use "Bombardier Snowmobile Injection Oil" (P/N 496 0133 00 - 1 liter) available from your dealer. This type of oil will flow at temperatures as low as minus 40°C (-40°F).

It is a blend of specially selected base oils and additives which provides outstanding lubrication, engine cleanliness and minimum spark plug fouling.

If "Bombardier Snowmobile Injection Oil" is unavailable, substitute with BLIZZARD OIL P/N 496 0135 00.

▼ **CAUTION:** Never use outboard or straight mineral oils.

Oil Injection System

Always maintain a sufficient amount of Bombardier Snowmobile injection oil in the injection oil tank.

Formula SP

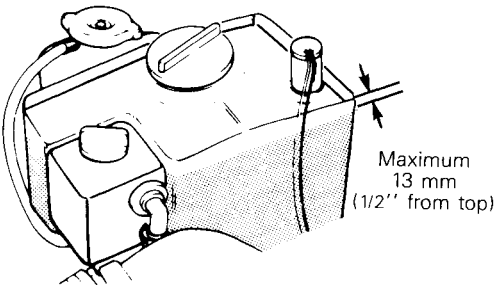

A009002018

Formula MX, Plus

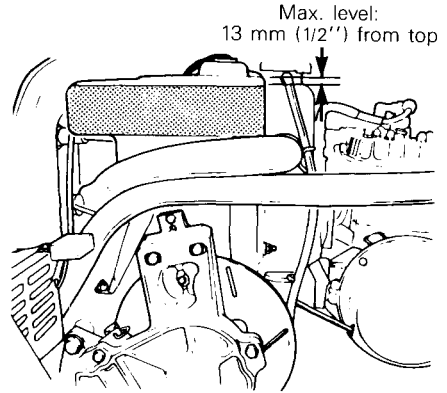

A015002020

▼ **CAUTION:** Check level and refill every time you refuel.

○ **NOTE:** To assure additional protection during the initial engine break-in, 500 ml (18 imp. oz.) of BLIZZARD oil should be added to the first full fuel tank filling only.

PRE-START CHECK

Check Points

- **ACTIVATE THE THROTTLE CONTROL LEVER SEVERAL TIMES** to check that it operates easily and smoothly. The throttle control lever must return to idle position when released.
- Check that the skis and the track are not frozen to the ground or snow surface and that steering operates freely.
- Activate the brake control lever and make sure the brake fully applies before the brake control lever touches the handlebar grip.
- Check coolant level. Liquid should be 25 mm (1 in.) below filler neck. If additional coolant is necessary or if entire system has to be refilled, use a solution of 3 parts of antifreeze for 2 parts of water (60% antifreeze, 40% water). See cooling system in storage.

○ **NOTE:** Always use ethylene-glycol antifreeze containing corrosion inhibitors specifically recommended for aluminium engines.

◆ **WARNING:** Before removing the radiator pressure cap place a cloth over the cap and unscrew it to the first step to release the pressure. Never drain or refill the cooling system when engine is hot. Loss of fluid and possibility of severe burns could occur, if this notice is disregarded.

- Check injection oil level.
- Check fuel level.
- Verify that the path ahead of the vehicle is clear of bystanders and obstacles.

◆ **WARNING:** Only start your snowmobile once all components are checked and functioning properly.

STARTING PROCEDURE

Test throttle control lever.

Check that the emergency cut-out switch is in the ON position.

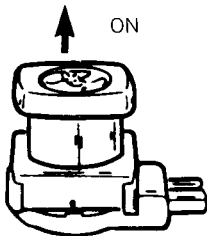

Upper position
before starting engine

A017006007

Ensure the tether cut-out cap is in position and that the cord is attached to your clothing.

Activate the primer (2 or 3 times).

○ **NOTE:** Primer is not necessary when the engine is warm.

Manual Starting

Insert the key in the ignition and turn to ON position.

Grasp manual starter handle firmly and pull slowly until a resistance is felt then pull vigorously. Slowly release the re-wind starter handle.

◆ **WARNING:** Do not apply throttle while starting.

▼ **CAUTION:** Never start a vehicle equipped with halogen headlamp with the key placed on the "Light" position. Otherwise headlamp bulb may burn as a voltage peak may be produced when the engine starts running.

Before riding

Check operation of the emergency cut-out switch, and tether switch. Restart engine.

◆ **WARNING:** If engine does not shut-off when applying the emergency cut-out switch and or when pulling the tether cut-out cap, stop the engine by turning off the ignition key. Do not operate the vehicle further, see your dealer.

Allow the engine to warm before operating at full throttle.

Emergency Starting

Should the rewind starter rope fray and break, the engine can be started with an emergency starter rope.

○ **NOTE:** The spark plug socket can be used as an emergency starter grip.

◆ **WARNING:** Do not wind starting rope around your hand. Hold rope by the handle only.

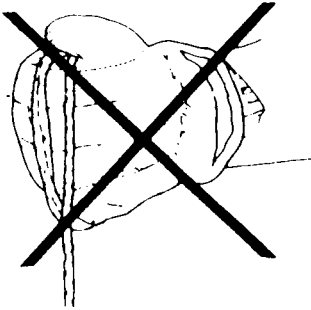

A007003030

◆ **WARNING:** Do not start the vehicle by the drive pulley unless it is a true emergency situation. Have the vehicle repaired as soon as possible.

Attach emergency rope to starter grip. Remove the belt guard from the vehicle and wind the emergency rope tight around the drive pulley between the sliding half and the roller guard. Start the engine as per usual manual starting.

◆ **WARNING:** When starting the vehicle in an emergency situation by the drive pulley, do not make a knot at the end of the emergency rope and do not reinstall the belt guard.

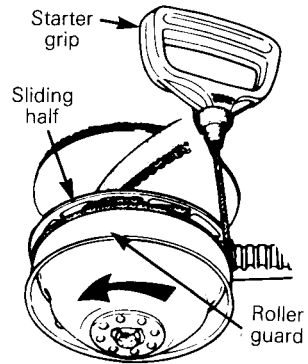

A017003018

LUBRICATION

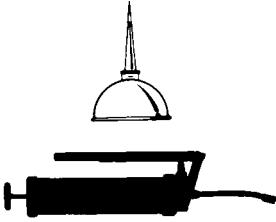

A000000007

Frequency

Routine maintenance is necessary for all mechanized products, and the snowmobile is no exception. A weekly vehicle inspection contributes to the life span of the snowmobile as well as retains safe and dependable operation. It is recommended that the steering system and suspension be lubricated monthly or every 40 hours of operation. If the vehicle is operated in wet snow or in severe conditions these items should be lubricated more frequently.

For the Formula MX, Plus, penetrating lubricant is recommended on ball joints and moving parts. May be used either:

- chain lube from Bardahl (BCS 362 dry)
- WD-40

Other grease fittings require low temperature grease (P/N 413 7044 00) using usual grease gun.

The following symbols will be used to show what type of lubricant should be used at the suitable locations.

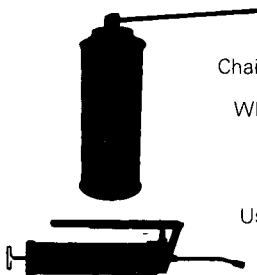



Chain lube
or
WD-40

Usual grease
gun

A000006001

 **NOTE:** When lubricating grease fittings, grease until grease appears at joints. Always use low temperature grease (P/N 413 7044 00).

 **WARNING:** Only perform such procedures as detailed in this manual. It is recommended that dealer assistance be periodically obtained on other components/systems not covered in this manual. Unless otherwise specified, engine should be turned OFF for all lubrication and maintenance procedures.

 **WARNING:** Do not lubricate throttle and/or brake cables and housings.

Steering Mechanism

Formula SP

Lubricate the ski legs and spring coupler bolts at grease fittings until new grease appears at joints.

Coat spring slider cushion with grease.

Oil ball joints and steering column bushings.

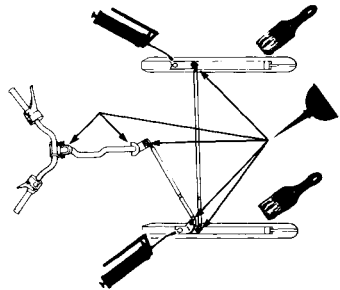

A009006001

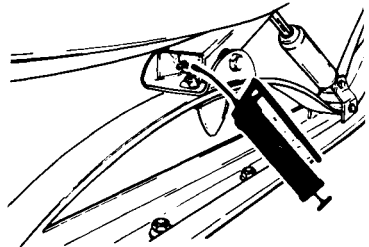

A009006002

Steering and Front Suspension Mechanism

◆ **WARNING:** Do not lubricate throttle and/or brake cables and housings.

— Lubricate upper and lower control arms and tie rod ends.

- Grease ski legs, ski pivots and idler arm.
- Coat stabilizer sliders with grease and oil their ball joints.

○ **NOTE:** There are 33 places to lubricate.

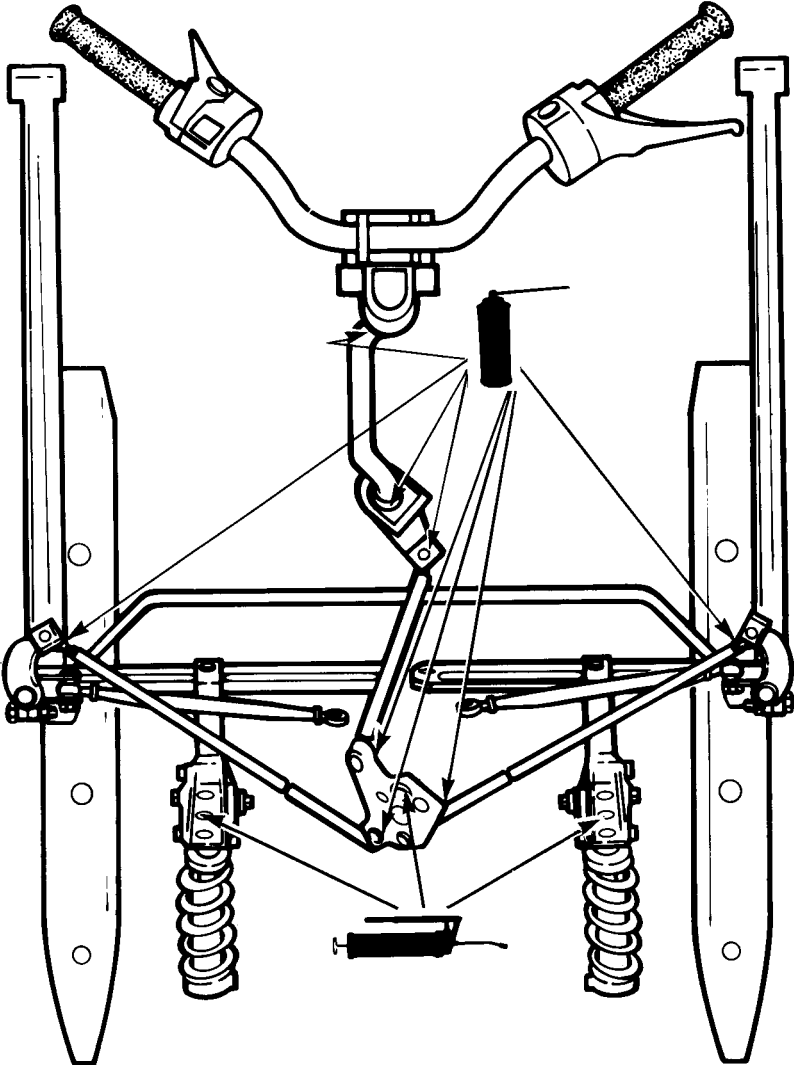

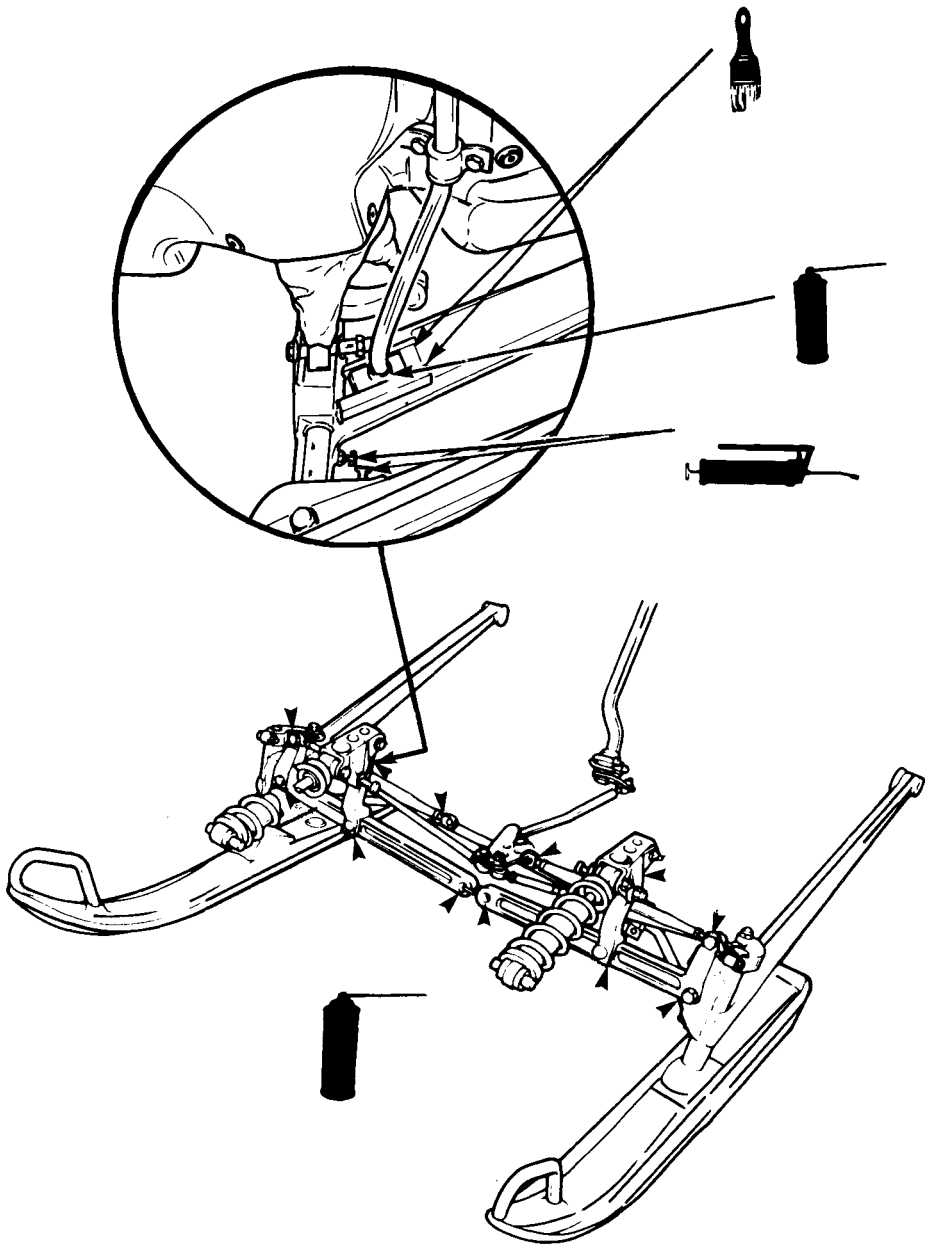

A015006003

Drive Axle

Lubricate at grease fitting using low temperature grease.

Formula SP

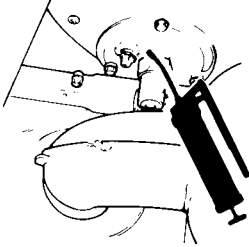

A009003010

▼ **CAUTION:** When lubricating the drive axle bearing, do not apply excessive grease as the seal will be pushed out of its housing. Check seal position with finger.

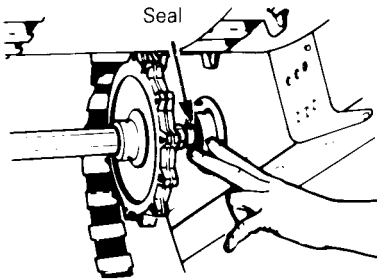

A007003031

Formula MX, Plus

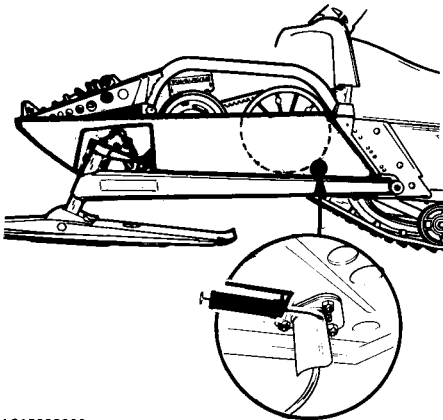

A015003009

Countershaft (disk brake & driven pulley)

Formula MX, Plus

For proper operation, disk and driven pulley must slide freely on countershaft. So lubricate slightly and evenly.

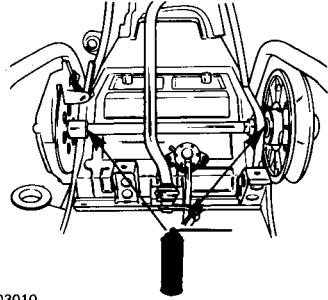

A015003010

▼ **CAUTION:** Do not lubricate excessively as the lubricant could contact and soil brake pads and/or drive belt.

Slide Suspension

Formula SP

Lubricate front and rear arms at grease fittings.

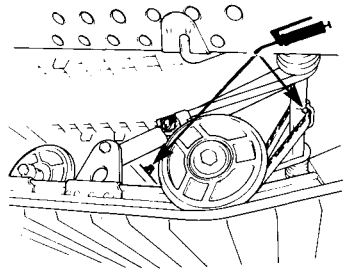

A014005007

Front section

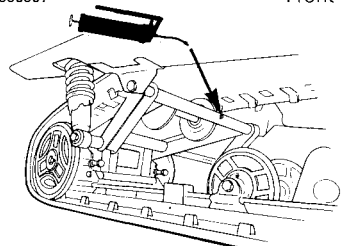

A014005008

Rear section

Formula MX, Plus

Lubricate rear suspension at grease fittings:

- Front arm: upper and lower axle.
- Front swing arm: upper and lower axle.
- Front shackles.
- Rear arm: upper and lower axle.
- Rear shackle.

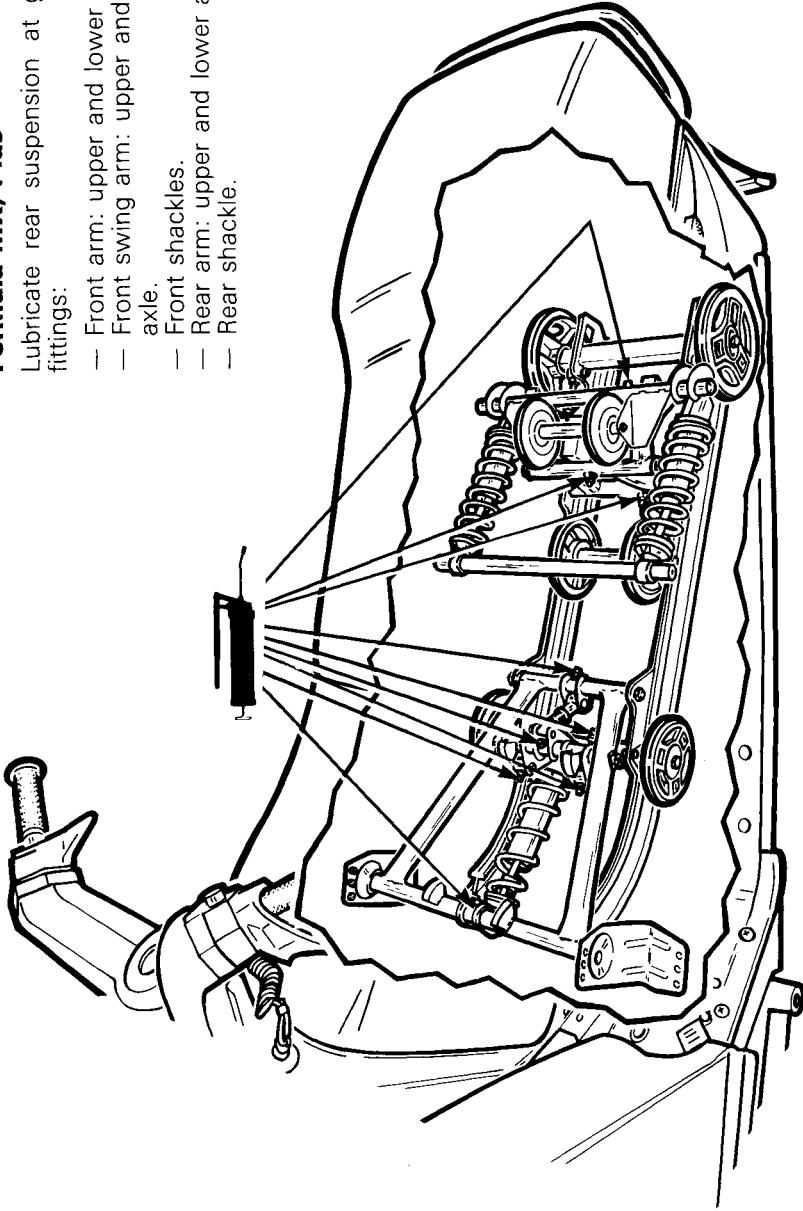

A015005022

NOTE: There are 9 grease fittings.



Chaincase Oil Level Formula SP

Using the spark plug socket, remove the filler cap then using a rigid wire as a "dipstick" check oil level. The oil level on the "dipstick" should be 50-65 mm (2" to 2 1/2"). Replenish as necessary using Bombardier chaincase oil (P/N 413 8019 00 - 200 mL).



A009003011

NOTE: The chaincase oil capacity is approximately 200 mL (7 oz).

Formula MX, Plus

Check the oil level by removing the oil filler cap. Oil level must be within lower and upper mark on dipstick. Refill as required using Bombardier chaincase oil (P/N 413 8019 00 - 200 mL).

Dipstick

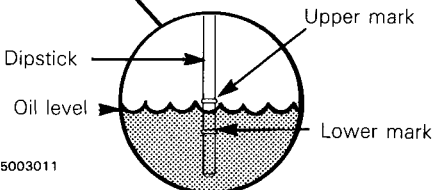
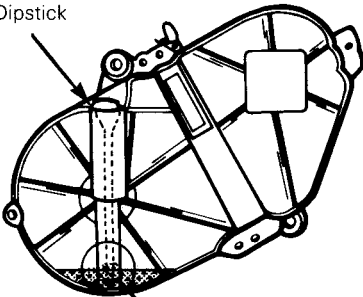

A015003011

NOTE: The chaincase oil capacity is approximately 256 mL (9 imp. oz.).

Oil Injection System

Always maintain a sufficient amount of Bombardier Snowmobile Injection Oil in the Injection oil tank.

CAUTION: Check level and refill every time you refuel.

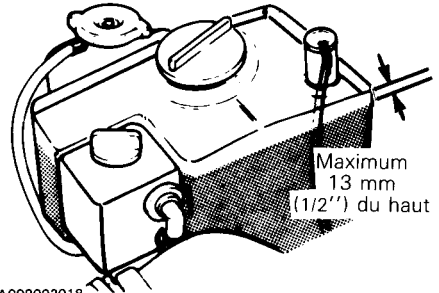

A009002018

Formula MX, Plus

Max. level:
13 mm (1/2") from top

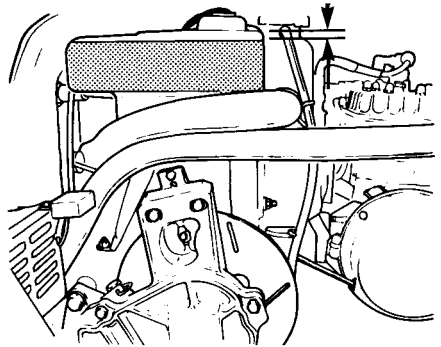

A015002020

Rotary Valve System

Check reservoir oil level frequently. Level should be between level lines of plastic reservoir. If necessary replenish to maximum oil level line using Bombardier Snowmobile Injection oil available from your authorized dealer.

Formula SP

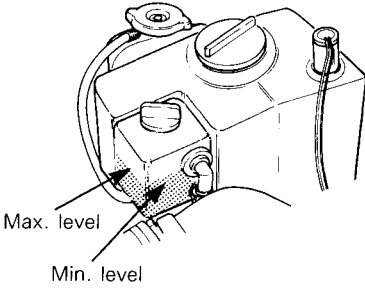

A009002018

Formula MX, Plus

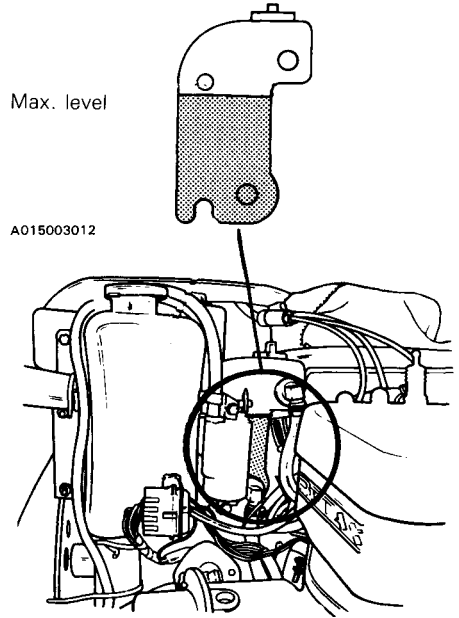

A015003012

A015003013

MAINTENANCE

The following Maintenance Chart indicates regular servicing schedules to be performed by you or your authorized dealer. If these services are performed as suggested, your snowmobile will give you many years of low-cost use.

WARNING: Only perform such procedures as detailed in this manual. It is recommended that an authorized assistance be periodically obtained on other components/systems not covered in this manual. Unless otherwise specified, engine should be turned OFF for all lubrication and maintenance procedures.

SERVICE AND MAINTENANCE CHART	Weekly or every 240 km (150 mi)	Monthly or every 800 km (500 mi)	Once a year or every 3200 km (2000 mi)	Refer to page
Drive belt condition	•			28
Brake condition	•			28
Brake adjustment		•		29
Spark plugs		•		29
Suspension condition		•		30
Suspension adjustment		(as required)		30
Track condition		•		32
Track tension and alignment		•		32
Drive pulley		•		33
Drive chain tension (Formula MX, Plus only)		•		33
Steering and front suspension mechanism		•		34
Steering and ski legs camber adjustment (Formula MX, Plus only)		•		35
Muffler attachment		•		35
Engine head nuts			•	35
Engine mount nuts			•	36
Carburetors adjustment/cable inspection			•	36
Injection oil filter condition		•		36
Oil injection pump adjustment			•	36
Cooling system			•	37
Headlamp beam aiming			•	37
General inspection		•		38

 **NOTE:** The ten hour inspection is a very important part of proper service and maintenance.

Belt Guard Removal

◆ **WARNING:** Engine should be running only when belt guard is secured in place.

1. Tilt the hood.
2. Pull out both retaining pins.
3. Lift and remove the belt guard.

Formula SP

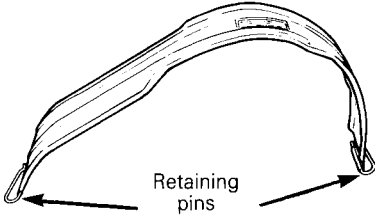

A009003012

Formula MX, Plus

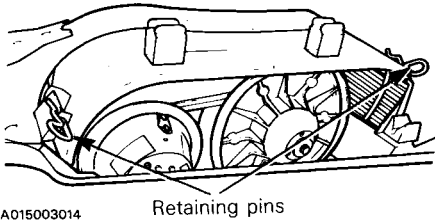

A015003014

Drive Belt Removal and Installation

◆ **WARNING:** Never start or run engine without the drive belt installed. Running an unloaded engine is dangerous.

Formula SP

1. Tilt the hood and remove the belt guard.
2. Unlock and raise driven pulley support.

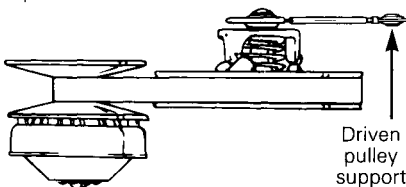

A004003006

3. Open the driven pulley by twisting and pushing the sliding half. Hold in fully open position.



A007003020

4. Slip slackened belt over the top edge of the sliding half.



A004003008

5. Slip the belt out from the drive pulley and remove completely from vehicle.

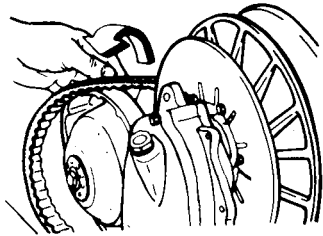

A004003009

To install the drive belt, reverse the procedure.

Formula MX, Plus

1. Tilt the hood and remove the belt guard.
2. Open the driven pulley by twisting and pushing the sliding half. Hold in fully open position.

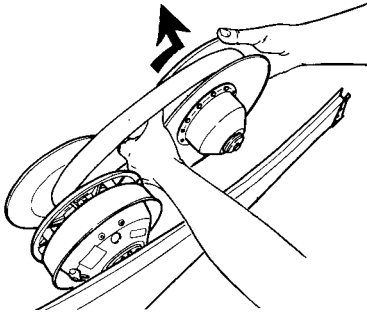

A002003015

3. Slip the belt over the top edge of the fixed half.

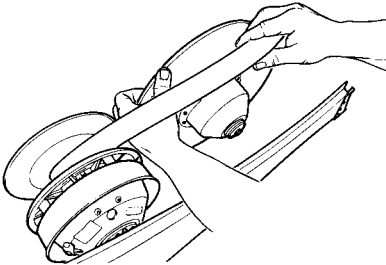

A002003016

4. Slip the belt out from the drive pulley and remove completely from the vehicle. To install the drive belt, reverse the procedure.

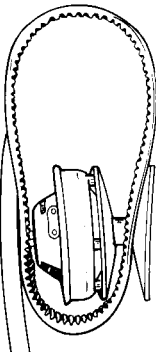

A015003015

Drive Belt Condition

Inspect belt for cracks, fraying or abnormal wear (uneven wear, wear on one side, missing cogs, cracked fabric). If abnormal wear is noted, probable cause could be pulley misalignment, excessive R.P.M. with frozen track, fast starts without warm-up period, burred sheave, oil on belt or distorted spare belt. Contact your dealer.

Check the drive belt width. Replace it if less than 32 mm (1 1/4").

New Drive Belt

When installing a new drive belt, break-in period of 25 km (15 miles) is strongly recommended.

○ **NOTE:** Always store a spare belt in a manner to allow its natural shape to be maintained.

Brake Condition

The brake mechanism on your snowmobile is an essential safety device. Keep this mechanism in proper working condition. Above all, do not operate your snowmobile without an effective brake system.

Formula SP

◆ **WARNING:** Brake pads less than 3 mm (1/8") thick must be replaced. Replacement must be performed by an authorized dealer.

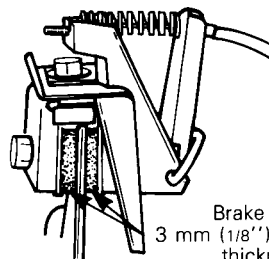

A009003013

Formula MX, Plus

WARNING: If less than 1 mm (1/32") of the fixed pad is projected out of caliper **or** there is less than 13 mm (1/2") between lever and handlebar grip, brake pads must be replaced. Replacement must be performed by an authorized dealer.

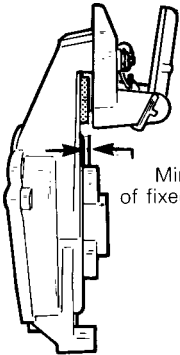

Minimum projection
of fixed pad: 1 mm (1/32")

A015003016

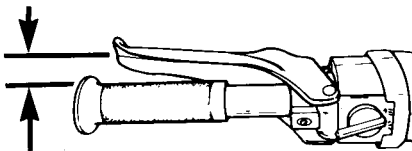

13 mm (1/2")
approx.

A008006002

Brake Adjustment

The brake mechanism is a self-adjusting type. If a quicker brake response is desired, strongly pull the brake lever several times, this will actuate the self adjusting mechanism.

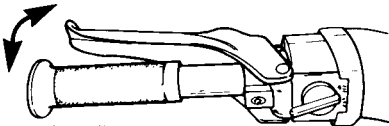

Strongly pull

A008006002

After the adjustment, brake should apply fully when lever is approximately 13 mm (1/2") from handlebar grip. If not, do not tamper with the brake, contact your servicing dealer.

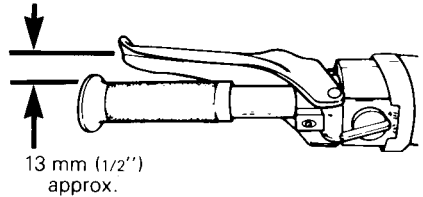

A008006002

Spark Plugs

Disconnect the spark plug wires and remove the spark plugs.

Check the condition of the plugs.

- A brownish tip reflects ideal conditions. (Carburetor adjustments, spark plug heat range, etc.; are correct).
- A black insulator tip indicates fouling caused by: carburetor idle speed mixture and/or high speed mixture too rich, incorrect fuel mixture ratio, wrong type of spark plug (heat range), or excessive idling.
- A light grey insulator tip indicates a lean mixture caused by; carburetor high speed mixture adjusted too lean, wrong spark plug heat range, incorrect fuel mixture ratio, or a leaking seal or gasket.

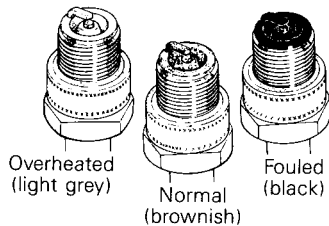

A000004010

CAUTION: If spark plug condition is not ideal, contact your authorized dealer.

Check spark plug gap using a wire feeler gauge.

Reinstall plugs and connect wires.

Suspension Condition

Check all front suspension components for excessive play or wear including ball joints, control arms and links etc.

Visually inspect all rear suspension components including slider shoes, springs, wheels, etc.

○ **NOTE:** During normal driving, snow will act as a lubricant and coolant for the slider shoes. Extensive riding on ice or sanded snow will create excessive heat build-up and cause premature slider shoe wear.

Stopper Strap Condition

Formula SP only

Inspect strap for wear and cracks, bolt and nut for tightness. If loose inspect holes for deformation, replace as required. Torque nut to 10 N•m (89 lbf•in).

Suspension Adjustment

Formula SP

The suspension is adjustable. The front adjustment for surface condition, the rear for driver's weight. Use the special keys located in tool box.

When the front adjuster blocks are at the lowest elevation more weight is distributed on the skis. At the highest position the weight is transferred from the skis to the track.

○ **NOTE:** For deep snow condition or hill climbing, it is recommended to place the front adjuster blocks on the highest position.

▼ **CAUTION:** Always turn the left side adjuster blocks in a clockwise direction, the right side blocks in a counterclockwise direction. Left and right adjuster blocks of each adjustment must always be set at the same elevation.

The rear spring preload can be adjusted as follows:

lowest position: 68 kg (150 lbs) or less
middle position: 68 kg-82 kg (150-180 lbs)

highest position: 82 kg (180 lbs) and higher.

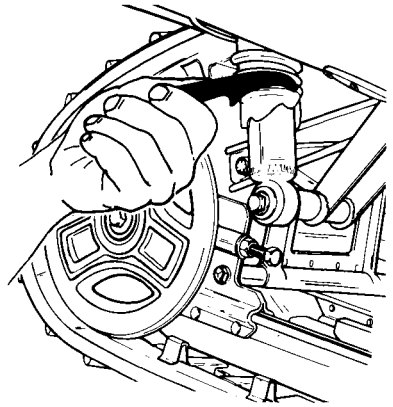
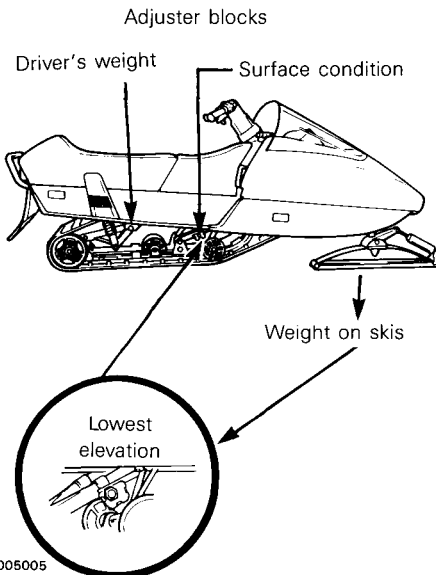

A014005013

To adjust, use the adjustment key supplied and turn the spring collar accordingly.

Formula MX, Plus

The rear suspension has 2 preload adjustments:

- The front shock spring for surface condition.
- The rear shock spring (twin shocks) for driver's weight.

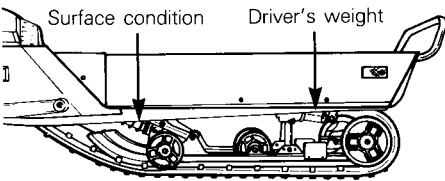

A015005021

Each shock absorber has a 5 position cam located at the bottom of the shock. If a stiffer or softer action is desired, the spring preload may be increased or decreased by adjusting the cam.

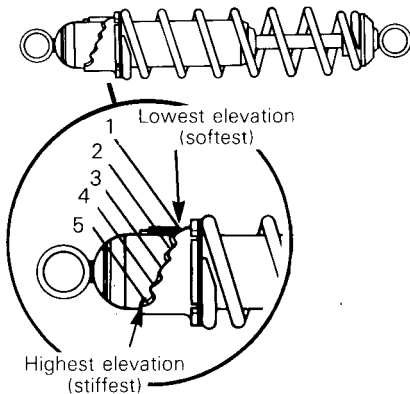

A015005015

Front spring

When the front spring cam is at the lowest elevation more weight is distributed on the skis.

At the highest position the weight is transferred from the skis to the track.

NOTE: For deep snow condition or hill climbing it is recommended to place the front spring cam at position 4 or 5. For hard surface riding place it at position 1 - 2 or 3.

Rear Spring

Driver's Weight kg (lb)		Cam position
From	Up to	
—	64 (140)	1
64 (140)	73 (160)	2
73 (160)	82 (180)	3
82 (180)	—	4-5

To adjust, use the adjustment key supplied. Spray some WD 40 between spring and spring collar.

CAUTION: There must be two thrust washers between spring and spring collar. If any is missing, replace it (P/N 503 0887 00) before attempting to adjust spring collar.

The central shock of the rear suspension should be removed to adjust spring collar.

Fit the key on the shock spring collar and turn clockwise for stiffest or counterclockwise for softest.

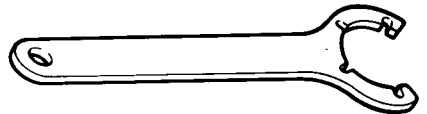

A014001001

Track Condition

Lift the rear of the vehicle and support it off the ground. With the engine off, rotate the track by hand, and inspect condition. If worn or cut, or if track fibers are exposed, or if missing or defective inserts or guides are noted; contact your dealer.

WARNING: Do not operate a snowmobile with a cut, torn or damaged track.

Track Tension and Alignment

Tension:

Lift the rear of vehicle and support with a mechanical stand. Allow the slide to extend normally. The gap should be 13 mm (1/2") between the slider shoe and the bottom inside of the track. If the track tension is too loose, the track will have a tendency to thump.

TYPICAL

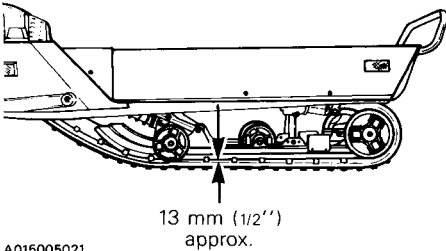

A015005021

CAUTION: Too much tension will result in power loss and excessive stresses on suspension components.

If necessary to adjust; loosen the rear idler wheel retaining screws and the adjuster bolt lock nuts, then loosen or tighten the adjuster screws located on the inner side of the rear idler wheels. If correct tension is unattainable, contact your dealer.

NOTE: On the Formula MX, Plus only torque retaining screw to 48 N•m (35 lbf•ft) after adjustment.

TYPICAL

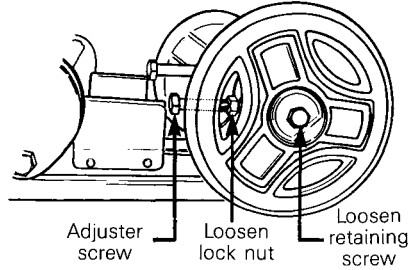

A014005021

NOTE: Track tension and alignment are inter-related. Do not adjust one without the other.

Alignment:

Start the engine and accelerate slightly so that track turns **slowly**. Check that the track is well centered; equal distance on both sides between edges of track guides and slider shoes.

TYPICAL

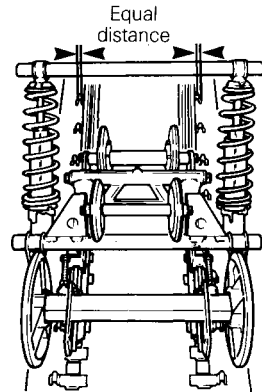

A014005022

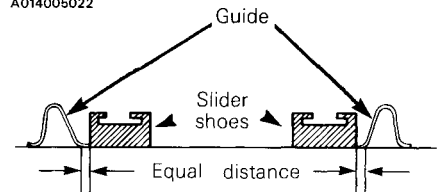

A001005011

WARNING: Before checking track alignment, ensure that the track is free of particles which could be thrown out while it is rotating. Keep hands, tools, feet and clothing clear of track. Ensure no-one is standing in close proximity to the vehicle.

To correct, **stop the engine**, loosen the rear idler wheels retaining screws then loosen the lock nuts and tighten the adjuster screw on side where the slider shoe is the farthest to the track insert guides.

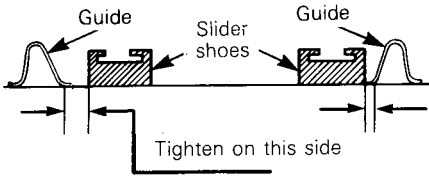

A001005011

Tighten lock nuts and the idler wheel retaining screws.

NOTE: On the Formula MX, Plus torque retaining screw to 48 N•m (35 lbf•ft) after adjustment.

TYPICAL

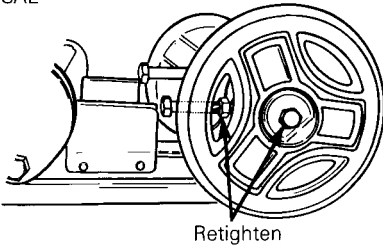

A014005021

Restart engine, rotate track **slowly** and recheck alignment.

Drive Pulley

Inspect the Duralon bushing condition by checking the free-play of the sliding half pulley. This is achieved by restraining the inner half and checking if the sliding half moves in the direction of the arrows more than 3 mm (1/8"). If so, contact your authorized dealer.

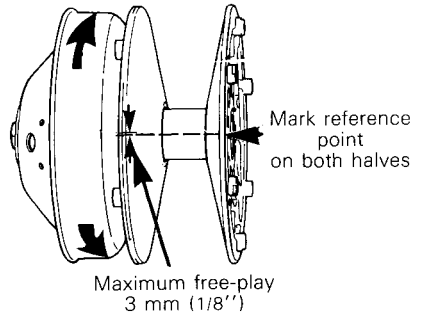

A007003004

WARNING: The drive pulley should be inspected by an authorized dealer at least annually.

Drive Chain Tensioner

Formula MX, Plus only

Run vehicle forward so that true free-play can be taken. Check free-play then turn driven pulley 1/2 turn forward and recheck. The movement should be within 3-6 mm (1/8 - 1/4).

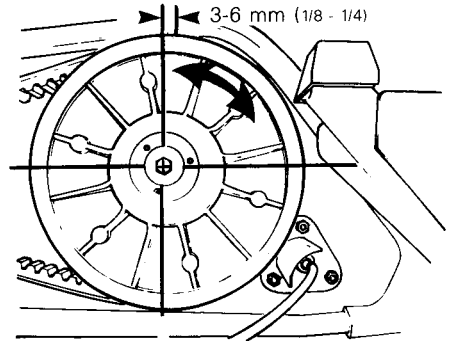

A015003017

To adjust remove the hair pin in adjusting screw. Turn the screw clockwise to tighten the chain. Secure hair pin then recheck free-play.

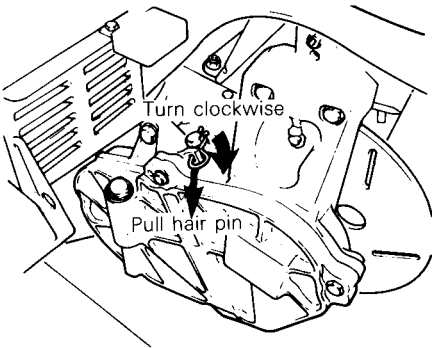

A015003018

Steering Mechanism

Formula SP

Inspect the steering mechanism for tightness of components (steering arms, tie rods, ball joints, spring coupler bolts, etc.). If necessary, replace or retighten.

Torque steering arm bolts as illustrated below:

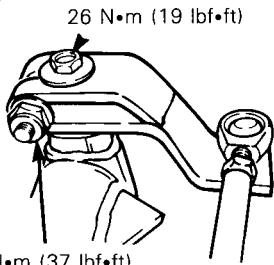

A009006003

Check the condition of the skis and the ski runners. Replace if more than half worn.

Steering and Front Suspension Mechanism

Formula MX, Plus

Inspect steering and front suspension mechanism tightness of components (steering arms, control arms and links, tie rods, ball joints, ski coupler bolts etc.). If necessary replace or retighten.

Check the condition of the skis and the ski runners. Replace if worn.

◆ **WARNING: Excessively worn skis and/or ski runners will hinder proper vehicle control.**

Steering Adjustment

Formula SP

Skis should have a toe out of 3 mm (1/8"). To check, measure the distance between each ski at the front and rear of the leaf springs. The front distance should be 3 mm (1/8") more than the rear when the handlebar is horizontal.

IMPORTANT: Close the front of the skis manually to eliminate all slack from the steering mechanism.

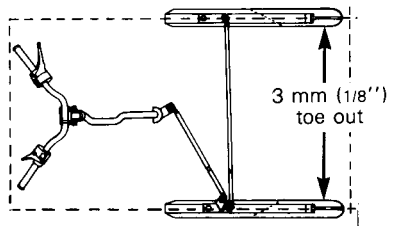

A009006004

If adjustment is required:

Loosen the lock nuts of the longest tie rod. Turn the tie rod manually until the skis are properly aligned. Firmly retighten the lock nuts.

The handlebar should also be horizontal when the skis are pointed toward the front.

To adjust:

Loosen the lock nuts of the shortest tie rod. Turn the tie rod manually until the handlebar is horizontal. Retighten the lock nuts firmly.

◆ **WARNING:** The ball joint socket must run parallel with the steering arm. The socket must be restrained when tightening the tie rod end lock nuts.

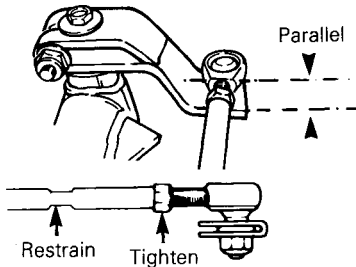

A007008004

Steering and Ski Legs Camber Adjustment

Formula MX, Plus

There are many adjustments to perform on this vehicle and they should be done only by an authorized dealer.

Muffler attachment

The engine/exhaust system parts are vital toward efficient muffler function. Check all attachments. Replace the springs and/or tighten if necessary.

▼ **CAUTION:** Do not operate vehicle with muffler disconnected otherwise serious engine damage will occur.

Engine Head Nuts

With the engine cold, check that the engine head nuts are tight and equally torqued to these values:

MODEL	ENGINE TYPE	TORQUE N•m (lbf•ft)
Formula SP	462	23 (17)
Formula MX, Formula Plus	467, 537	20 (15)

Follow the illustrated sequence:

462 engine type

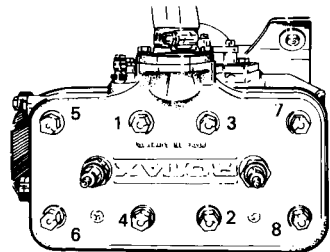

Front

A013002010

467 engine type

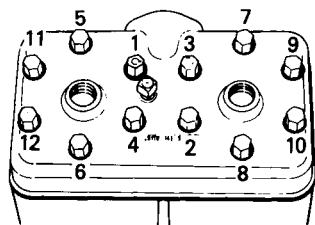

Front

A015002011

537 engine type

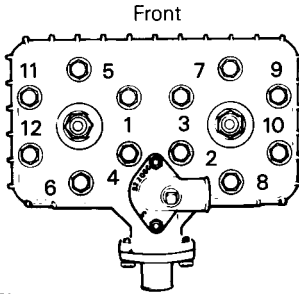

A016002001

IMPORTANT: The engine head nut torque should be checked after the first 5 hours of operation.

Engine Mount Nuts

Check the engine mount nuts for tightness. Retighten if necessary.

Carburetors Adjustment

▼ **CAUTION:** Never operate your snowmobile with the air intake silencer disconnected. Serious engine damage will occur if this notice is disregarded.

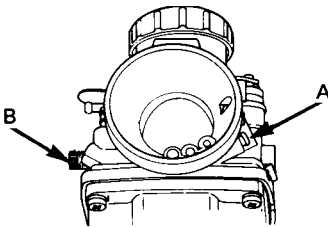

A002002009

A) Air Screw Adjustment

Completely close the air screw (until a slight reseating resistance is felt) then back off screw:

462-467 engine type: 1 1/2 turn.
537 engine type: 1 turn.

B) Idle Speed Adjustment

Turn idle speed screw clockwise until it contacts the throttle slide then continue turning two (2) additional turns. This will provide a preliminary idle speed setting. Start engine and allow it to warm then adjust idle speed to 1800-2000 R.P.M. by turning idle speed screw clockwise or counterclockwise.

▼ **CAUTION:** Do not attempt to set the idle speed by using the air screw. Severe engine damage can occur. If idle speed is unattainable contact your authorized dealer.

Oil Injection System

Injection Oil Filter Condition

Inspect oil filter at least once a month. Insure that filter is not obstructed by foreign particles; if so, see your dealer.

▼ **CAUTION:** An obstructed injection oil filter will cause oil starvation resulting in serious engine damage.

○ **NOTE:** After a storage period, it is important that your dealer replaces the injection oil filter and that he verifies the oil flow of the injection pump.

Injection Pump Adjustment

Proper oil injection pump adjustment is very important. Any delay in the opening of the pump can result in serious engine damage.

▼ **CAUTION:** The carburetor must be adjusted before adjusting the oil injection pump. Make sure the idle speed is 1800-2000 R.P.M..

To check adjustment: eliminate the throttle cable free-play by pressing the throttle lever until a light resistance is felt then hold in place. The aligning marks on the pump casting and lever must align perfectly. If not, contact your dealer.

NOTE: Injection pump should be adjusted by your authorized dealer.

TYPICAL

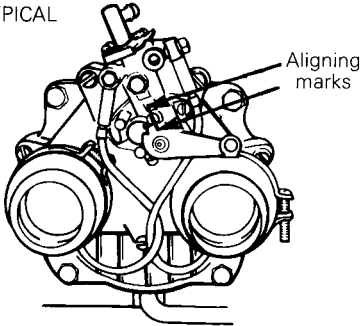

A015002017

Cooling System

Check condition of hoses and clamps tightness. Using a hydrometer check that the antifreeze solution is strong enough for the temperature in which the vehicle is operated.

NOTE: Should the coolant temperature raise above recommended range 50° - 95°C (120° - 200°F), for the Formula SP and 60° - 100°C (140°F - 210°F), for the Formula MX, Plus, hose off grime from the heat exchanger (underneath the frame above the track).

Headlamp Beam Aiming

The angle of the headlamp beam has been pre-adjusted prior to delivery. Should you wish re-adjustment, place the vehicle on a flat surface 7.6 m (25') from a wall or screen.

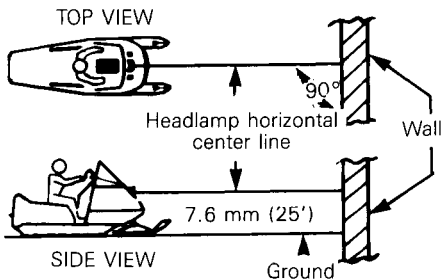

A002004006

With the suspension correctly adjusted, the rider seated on the vehicle and the high beam ON check that the center of high intensity zone of high beam is 50 mm (2") below horizontal line of headlamp height.

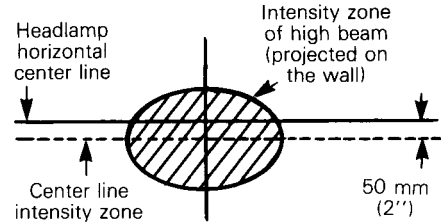

A002004007

To adjust, remove the four caps, turn upper or lower adjusting screws to obtain desired beam position.

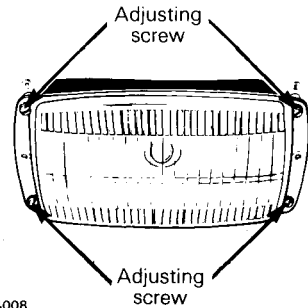

A002004008

Bulb Replacement

If the headlamp bulb is burnt, tilt hood, unplug the connector from the headlamp. Remove the rubber boot and unfasten bulb retainer clips. Detach the bulb and replace.

▼ **CAUTION:** Never touch glass portion of new halogen bulb with fingers, otherwise bulb may burn as soon as electric current flows.

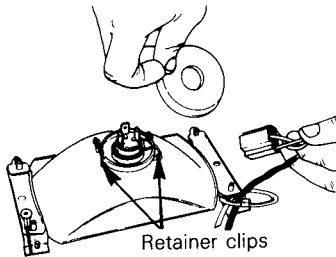

A002004009

If taillight bulb is burnt, expose the bulb by removing the red plastic lens. To remove, unfasten the two (2) screws.

◆ **WARNING:** Always check light operation after bulb replacement.

General Inspection

Check the electrical wiring and components, retighten loose connections. Check for stripped wires or damaged insulation. Thoroughly inspect the vehicle and tighten loose bolts, nuts and linkage. Inspect skis and ski runners for wear.

STORAGE

It is during summer, or when a vehicle is not in use for any length of time that proper storage is a necessity. Storage of the snowmobile during long period of inactivity consists of checking and replacing missing, broken or worn parts: Proper lubrication and treatment to insure that parts do not become rusted; cleaning items such as carburetor of oil mixtures, to prevent gum varnish formation within the carburetor; and in general, preparing the vehicle so that when the time comes to use the snowmobile again it will be in top condition.

◆ **WARNING:** Only perform such procedures as detailed in this manual. It is recommended that dealer assistance be periodically obtained on other components/systems not covered in this manual. Unless otherwise specified, engine should be turned OFF for all lubrication and maintenance procedures.

Track

Inspect the track for wear, cuts, missing track guides and broken rods. Make any necessary replacement.

◆ **WARNING:** Do not operate a snowmobile with a cut, torn or damage track.

Lift the rear of vehicle until track is clear of the ground then support with a brace or trestle. The snowmobile should be stored in such a way that the track does not stay in contact with the cement floor or bare ground.

○ **NOTE:** The track should be rotated periodically, (every 40 days). Do not release track tension.

▼ **CAUTION:** To prevent track damage, temperature in the storage area must not exceed 38° C (100° F).

Suspension

Remove any dirt or rust. Grease at all grease fittings. Wipe off surplus. Replace worn slider shoes.

Skis

Wash or brush all dirt or rust accumulation from the skis and springs. Grease at all grease fittings. Check the condition of the skis, and ski runners. Replace if worn more than half.

Controls

Lubricate the steering mechanism. Inspect all components for tightness, (spring coupler bolts, steering arm locking bolts, tie rods, ball joints, etc.). Tighten if necessary. Oil moving joints of the brake mechanism.

◆ **WARNING:** Do not lubricate the throttle and/or brake cables and housings. Avoid getting oil on the brake pads.

Coat all electrical connections and switches with a greaseless metal protector. If unavailable, use petroleum jelly.

Chaincase

Drain the chaincase and refill to proper level, using fresh chaincase oil. (P/N 413 8019 00 - 200 mL). To drain, remove the chaincase cover.

Drive Pulley

Inspection and cleaning must be performed by an authorized dealer at the end of each season.

Countershaft (disk brake & driven pulley)

Formula MX, Plus only

For proper operation, disk and driven pulley must slide freely on countershaft. So lubricate slightly and evenly.

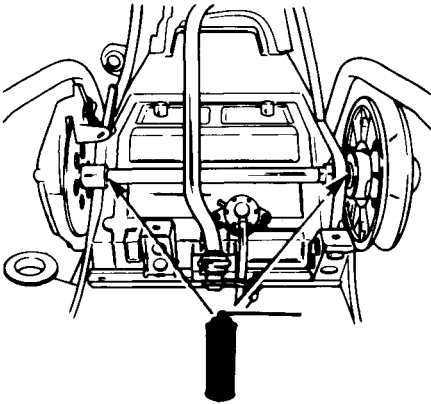

A015003019

CAUTION: Do not lubricate excessively as the lubricant could contact and soil brake pads and/or drive belt.

Cooling System

The engine cooling system should be drained and refilled with a new coolant mixture before each storage period.

WARNING: Never drain or refill the cooling system when engine is hot.

Formula SP

To drain cooling system:

- Use a length of hose long enough to drain coolant into a container lower than engine.
- Remove the engine coolant hose from water pump.
- Connect "drain hose" onto water pump.

- Put both hose ends into the container.
- Then, remove coolant tank cap and lift the rear of the vehicle to drain the heat exchangers.
- When the coolant level is low enough, remove the hose from thermostat housing.

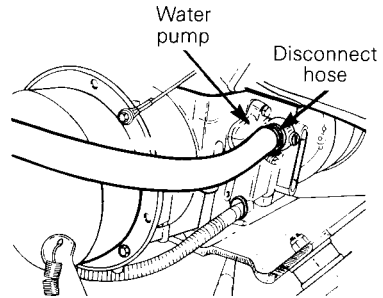

A013002009

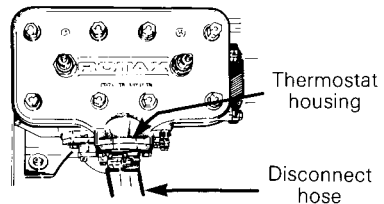

A013002010

CAUTION: To prevent rust formation or freezing condition, always replenish the system with 60% antifreeze and 40% water.

Pure antifreeze without water produces premature freezing. Always use ethylene-glycol antifreeze containing corrosion inhibitors specifically recommended for aluminum engines.

To refill cooling system:

- Remove "drain hose" and reinstall initial one.
- Place rear of vehicle on the ground.
- Refill coolant tank slowly until coolant overfills at thermostat housing.

- Reinstall hose at thermostat housing.
- Continue to pour coolant in the tank until level reaches 25 mm (1 in) below filler neck.
- With the coolant tank cap still removed, start engine and let it warm to reach its normal operating temperature and thermostat open. Allow it to run a few minutes more.
- Stop engine and check coolant level. Refill as required then put back the cap.

Formula MX, Plus

To drain the cooling system, siphon the coolant mixture from the coolant tank, using a primer pump and a length of plastic hose and steel tubing inserted as deep as possible into the lower hose of the tank.

WARNING: Use **PRIMER PUMP** to siphon the coolant mixture. Do not siphon with your mouth. The coolant mixture is poison and can be fatal is swallowed.

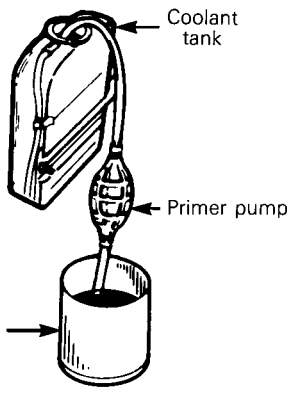

A015002010

When the coolant level is low enough, remove the engine bleed screw and lift the rear of vehicle to drain the heat exchangers.

CAUTION: To prevent rust formation in the cooling system, always replenish the system with the recommended solution (60% antifreeze 40% water). Pure antifreeze without water produces premature freezing. Always use ethylene-glycol antifreeze containing corrosion inhibitors specifically recommended for aluminum engines.

To refill the cooling system:

- Put back the rear of vehicle on the ground.

467 engine type

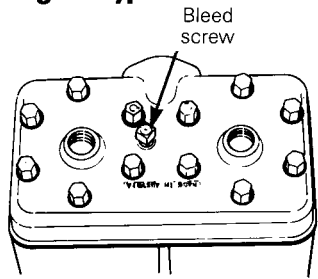

A015002011

- Refill tank slowly until coolant overfills at bleed hole.
- Reinstall bleed screw.

537 engine type

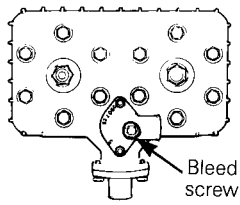

A016002001

Continue to pour the coolant in the tank until level reaches 25 mm (1") below filler neck. With the coolant tank cap still removed start the engine and let it warm up to reach its operating temperature and thermostat open. Allow it running a few minutes more. Stop engine and check coolant level, refill as required then put back the cap.

◆ **WARNING:** Before removing the cap place a cloth over the coolant tank and release the cap to the first step to release the pressure. Loss of fluid and possibility of severe burns could occur, if this notice is disregarded.

Engine and Primer Lubrication

Engine internal parts must be lubricated to protect them from possible rust formation during the storage period.

To perform the storage procedures (engine and primer valve) proceed as follows:

1. Lift the rear of the vehicle and support it off the ground.

◆ **WARNING:** Ensure the track is free of all particles which could be thrown out while it is rotating. Keep hands, tools, feet and clothing clear of track. Ensure no-one is standing in close proximity to the vehicle.

2. Start the engine and allow it to run at idle speed until the engine reaches its operational temperature.

3. Stop the engine.

4. Disconnect the inlet primer hose from the primer valve.

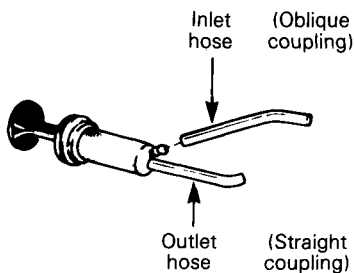

A002002009

5. Plug inlet primer hose to prevent gasoline from draining.

6. Using an appropriate hose, connect one end of the hose to the inlet of the primer valve and place the other end in a Bombardier Snowmobile Injection Oil container.

7. Activate the primer in order to fill it with oil.

8. Restart engine and run at idle.

9. Using the primer valve, inject oil until the engine dies or until a sufficient quantity of oil has entered the engine (approximately 25 complete strokes of the primer). Do not run engine during storage period.

10. The engine stopped, remove the sparks plugs and pour approximately 85 ml (3 fl. oz. Imp.) of oil into the cylinders.

11. Crank the engine to allow the crankshaft to turn 2 or 3 revolutions.

12. Reinstall the spark plugs and the inlet primer hose.

Do not run engine during storage period.

Fuel Tank and Carburetors

Remove the cap then using a syphon, remove the gasoline from tank.

◆ **WARNING:** Gasoline is flammable and explosive under certain conditions. Always manipulate in a well ventilated area. Do not smoke or allow open flames or sparks in the vicinity.

Carburetors must be dried out completely to prevent gum formation during the storage period.

Once the fuel tank is emptied, remove the float chamber drain plug on each carburetor. Drain carburetor.

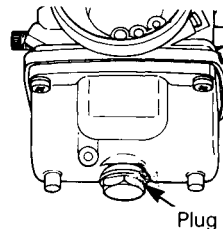

A002002010

Reinstall plug.

Check all fuel lines, replace if necessary.

Chassis

Clean the vehicle thoroughly, removing all dirt and grease accumulation.

▼ **CAUTION:** Plastic alloy components such as fuel tank, windshield, controls, etc., can be cleaned using mild detergents or isopropyl alcohol. Do not use strong soaps, degreasing solvents, abrasive cleaners, paint thinners, etc.

Inspect the hood and repair any damage. Clean the frame. For the unpainted aluminum portion use only "Aluminum cleaner" and follow instructions on the container.

Touch up all metal spots where paint has been scratched off. Spray all bare metal parts with metal protector. Wax the hood and the painted portion of the frame for better protection.

○ **NOTE:** Apply wax on glossy finish only. Protect the vehicle with a cover to prevent dust accumulation during storage.

▼ **CAUTION:** If for some reason the snowmobile has to be stored outside it is necessary to cover it with an opaque tarpaulin. This caution will prevent the sun rays and the grime from affecting the plastic components and the vehicle finish.

General Inspection

Check the electrical wiring and components, retighten loose connections. Check for stripped wires or damaged insulation.

Thoroughly inspect the vehicle and tighten loose bolts, nuts and linkage.

○ **NOTE:** Leave the drive belt off the pulleys for the entire storage period.

Suspension Stopper Strap

Formula SP only

Replace annually and/or as condition dictates. Torque nut to 10 N•m (89 lbf•in).

PRE-SEASON PREPARATION

To simplify the pre-season preparation we have drawn up a small chart. The chart indicates servicing points to be performed by you and your authorized dealer. If these services are performed as suggested, your vehicle will give you many hours of fun and low cost use.

IMPORTANT: Observe all Warnings and Cautions mentioned throughout this manual which are pertinent to the item being checked. When component conditions seem less than satisfactory, replace with genuine Bombardier parts or suitable equivalents.

PRE-SEASON PREPARATION CHART	TO BE PERFORMED BY DEALER	●
	TO BE PERFORMED BY OWNER	○
Change spark plugs*		○
Check chaincase oil level		○
Check drive chain tension (Formula MX, Plus only)		○
Check rotary valve oil level		○
Replace fuel filter (filter is located inside fuel tank)		○
Refill gas tank		○
Check track condition, tension and alignment		○
Check and lubricate suspension		○
Inspect drive belt and install		○
Check throttle cable for damage and free operation		○
Check steering, steering alignment and ski runners condition (Formula SP)		○
Check steering, ski legs camber adjustments and ski runners condition (Formula MX, Plus)		●
Check electrical wiring (broken wire, damaged insulation)		○
Inspect condition of starting rope		○
Check tightness of all bolts, nuts and links		○
Check coolant condition and level		●
Inspect seals for possible cuts or leaks		●
Inspect brake condition and operation		●
Replace injection oil filter		●
Refill injection oil tank		●
Adjust oil injection pump		●
Set engine timing		●
Check pulleys, verify components and clean. Lubricate.		●
Adjust carburetors		●

○ ***NOTE:** Before installing new spark plugs, it is suggested to burn excess storage oil by starting the engine, using the old spark plugs. Only perform this operation in a well ventilated area.

TROUBLE SHOOTING

NOTE: The possible causes have been listed in an order of frequency. Therefore items should be checked out in the same order as mentioned in the trouble shooting guide.

SYMPTOMS	POSSIBLE CAUSES	SOLUTIONS
Engine turns over but fails to start or starts with difficulty	1. No fuel to the engine	Check the tank level and fill up with correct gas oil mixture. Check for possible clogging of fuel line, item 4.
	2. Flooded engine	Remove wet spark plugs, turn ignition to OFF and crank engine several times. Install clean dry spark plugs. Start engine following usual starting procedure. If engine continues to flood, see your dealer.
	3. Spark plug/faulty ignition	Check that emergency cut-out switch is at the upper position (ON) and the tether cut-out switch cap is snapped over the receptacle.
		Check for fouled or defective spark plug. Disconnect spark plug wire, unscrew plug and remove from cylinder head. Reconnect wire and ground exposed plug on engine cowl, being careful to hold away from spark plug hole . Follow engine starting procedure and check for spark. If no sparks appear, replace spark plug. If trouble persists, contact your dealer.
	4. Clogged fuel line (water or dirt)	Check condition and connections of fuel lines. Check the cleanliness of fuel tank.
	5. Incorrect carburetor adjustment	Contact your dealer.
	6. Too much oil in fuel	See the dealer for oil injection pump adjustment.
	7. Engine timing	Engine timing may be defective or out of adjustment. Contact your dealer.
8. Poor engine compression	Running with a lean fuel mixture may produce excessive engine wear resulting in poor engine compression. If this occurs, contact your dealer at once.	
Engine will not turn manually	1. Seized engine	In the case of a seized engine contact your dealer.

SYMPTOMS	POSSIBLE CAUSES	SOLUTIONS
Engine lacks acceleration or power	1. Fouled or defective spark plug	Check item 3 of "Engine turns over but fails to start or starts with difficulty"
	2. Clogged fuel line (water or dirt)	Check fuel line condition. (See item 4 of "Engine turns over but fails to start or starts with difficulty").
	3. Carburetor	Contact your dealer.
	4. Ignition	First check item 2 and 3 of "Engine turns over but fails to start or starts with difficulty". If the ignition system still seems faulty, contact your dealer.
	5. Engine	If unable to locate specific symptoms, contact your dealer.
Engine continually backfires	1. Spark plug	Check item 3 of "Engine turns over but fails to start or starts with difficulty".
	2. Overheated	Carburetor too lean, see your dealer.
	3. Engine timing incorrectly set	Contact your dealer.
Snowmobile cannot reach full speed	1. Drive Belt	Check for damaged or worn drive belt. Replace if necessary.
	2. Incorrect track adjustment	Check track tension and alignment. Readjust to specifications. (See Maintenance Section).
	3. Engine	Check item 1 to 5 of "Engine lacks acceleration or power."
	4. Pulley misaligned	Contact your dealer.

TOOLS

As standard equipment each new snowmobile is supplied with basic tools such as screwdriver, wrenches, emergency starter rope, etc.

Standard Tools

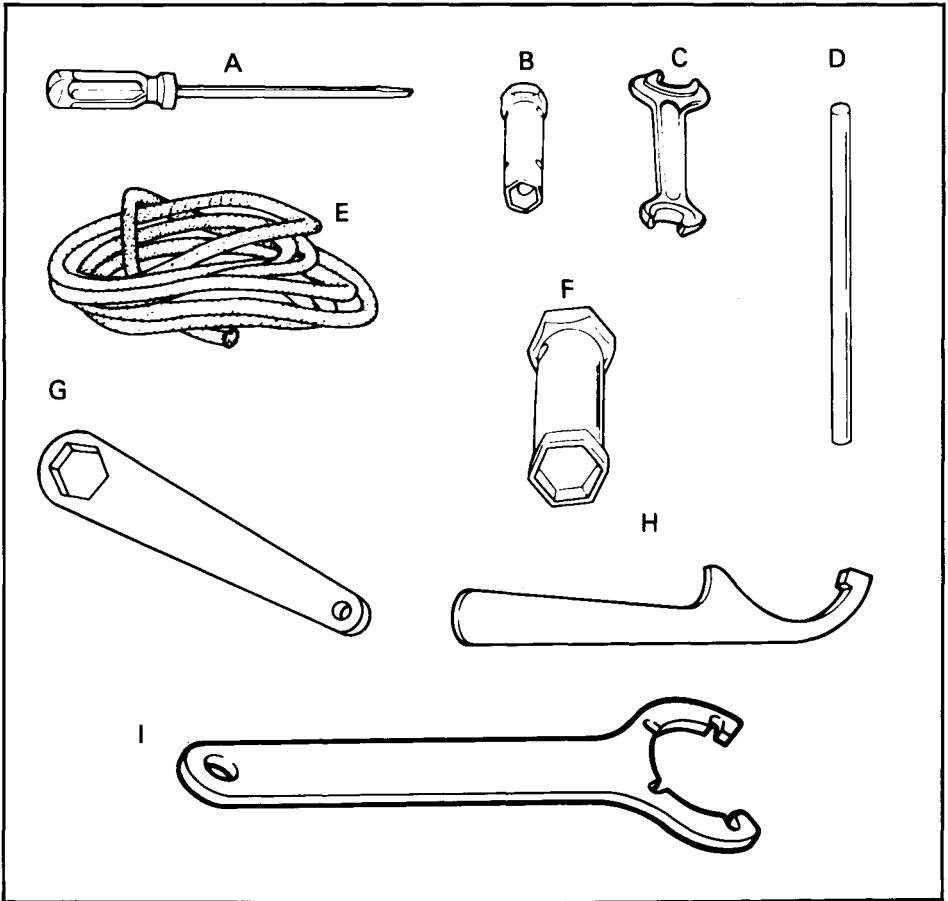

- A. Screwdriver
- B. Socket 10 / 13 mm
- C. Open end wrench 10 / 13 mm
- D. Socket wrench handle
- E. Starter rope
- F. Socket 21 / 26 mm
- G. Hexagonal wrench (Formula SP only)
- H. Spring collar adjustment key (Formula SP only)
- I. Spring collar adjustment key (Formula MX, Plus only)

SPECIFICATIONS

	FORMULA SP	FORMULA MX	FORMULA PLUS
ENGINE			
Type	462	467	537
No. of cylinders		2	
Bore	69.5 mm (2.736")	69.5 mm (2.736")	72.0 mm (2.835")
Stroke	61.0 mm (2.402")	61.0 mm (2.402")	64.0 mm (2.520")
Displacement	462.8 cm ³ (28.24 in ³)	462.8 cm ³ (28.24 in ³)	521.2 cm ³ (31.81 in ³)
Compression ratio (effective)	6.7:1	6.5:1	7.5:1
Maximum R.P.M. (red line)	7200	8500	9000
Carburetor type	Mikuni VM 34-334	PTO Mikuni VM 34-320 PTO Mikuni VM 34-321	N.A.
Carburetor adjustment:			
- air screw	1 1/2 turn	1 1/2 turn	1 turn
- idle speed		1800-2000 R.P.M.	
Rotary valve oil — SI	568 ml	455 ml	455 ml
reservoir — Imp.	20 oz	16 oz	16 oz
Cooling system — SI	4.7 L	4.2 L	4.2 L
capacity — Imp.	164 oz	148 oz	148 oz
— U.S.	158 oz	142 oz	142 oz
Antifreeze/water mixture (% by volume)		60/40	
Thermostat	43°C (110°F)	37°C (98°F)	42°C (108°F)
Radiator pressure cap		90 kPa (13 lb/in ²)	
Torque:			
- engine head nuts	M8: 23 N•m (17 lbf•ft)	M8: 20 N•m (15 lbf•ft)	
- crankcase nuts	M8: 21 N•m (15 lbf•ft) M6: 9 N•m (80 lbf•in)	M8: 20 N•m (15 lbf•ft) M6: 9 N•m (80 lbf•in)	
magnéto ring nut	M22: 95 N•m (70 lbf•ft)	M22: 100 N•m (74 lbf•ft)	
- crankcase/engine support nuts	M10: 38 N•m (28 lbf•ft)		
- exhaust manifold bolts	M8: 24 N•m (18 lbf•ft)		
CHASSIS			
Overall length	266.7 cm (105")	271.8 cm (107")	
Overall width	96.5 cm (38")	104.1 cm (41")	
Overall height	99 cm (39")	91.4 cm (36")	
Ski stance (center to center)	81.9 cm (32.25")	92.1 cm (36.25")	
Ski alignment (toe out)	3 mm (1/8")	N.A.	
Torque:			
- steering arm/ski leg bolt	50 N•m (37 lbf•ft)	N.A.	
- steering column/handlebar	26 N•m (19 lbf•ft)	N.A.	
Weight	197 kg (434 lb)	198.7 kg (438 lb)	N.A.
Bearing area	7065 cm ² (1095 in ²)	5968 cm ² (925 in ²)	6348 cm ² (984 in ²)
Ground pressure	2.79 kPa (.396 lb/in ²)	3.33 kPa (.474 lb/in ²)	N.A.

	FORMULA SP	FORMULA MX	FORMULA PLUS
POWER TRAIN			
Track:			
- width	41.9 cm (16.5")	38.1 cm (15")	41.9 cm (16.5")
- length	289.5 cm (114")	289.5 cm (114")	289.5 cm (114")
- tension	13 mm (1/2") gap between slide and bottom inside of track.		
- alignment	Equal distance between edges of track guides and slider shoes.		
Standard gear ratio	21/37	26/40	20/38
Drive belt			
- number	414 5233 00		414 5283 00
- Max. width	34.9 mm (1 3/8")		34.5 mm (1 23/64")
- Min. width	31.7 mm (1 ")		31.75 (1 1/4")
Chaincase oil	200 mL (7 oz)	256 mL (9 oz)	256 mL (9 oz)
ELECTRICAL			
Lighting system (output)		12 V. 160 W	
Bulb:			
- headlamp	60/55 W (halogen)	60/60 W	60/55 W (halogen)
- tail/stop	5/21 W	5/21 W	5/21 W
- speedometer	5 W	5 W	5 W
- tachometer	5 W	OPT.	5 W
- temperature gauge	5 W	5 W	5 W
- fuel gauge	5 W	OPT.	5 W
Fuse:			
- tachometer	0.1 A	N.A.	0.1 A
Spark plug:			
- type	NGK BR8ES	NGK BR10ES	NGK BR9ES
- gap	0.4 mm (.016")	0.4 mm (.016")	0.4 mm (.016")
Ignition timing:			
- timing mark (B.T.D.C.)	1.75 mm (.069") (17.5°)	2.5 mm (.098") (21°)	1.75 mm (.069") (17°)
- stroboscopic timing	6000 R.P.M.	6000 R.P.M.	6000 R.P.M.
FUEL			
Gas type	Regular leaded or unleaded	Premium leaded or unleaded (92 octane)	
Fuel tank capacity — SI	28.6 L	40.9 L	40.9 L
— Imp.	6.3 gal.	9.0 gal.	9.0 gal.
— U.S.	7.6 gal.	10.8 gal.	10.8 gal.
Injection oil		Bombardier snowmobile injection oil	
- type			
- tank capacity — SI	2.6 L	2.9 L	2.9 L
— Imp.	92 oz	102 oz	102 oz
— U.S.	88 oz	98 oz	98 oz
BRAKE			
Type	Disc, self adjusting	Disc, self adjusting	Disc, self adjusting
Lining minimum thickness	3 mm (1/8")	See "Maintenance" section	See "Maintenance" section
Control lever adjustment	13 mm (1/2") minimum distance from handlebar grip when fully applied.		

Bombardier Inc. reserves the right to make changes in design and specifications and/or make addition to, or improvements in its product without imposing any obligation upon itself to install them on its products previously manufactured.

N.A.: Not available

OPT.: Optional

WIRING DIAGRAM

FORMULA SP, MX, PLUS

- ① LIGHTING COIL
- ② GENERATOR COIL
- ③ IGNITION COIL
- ④ AMPLIFIER
- ⑤ BULB (5-21W)
- ⑥ BULB (60-55 W)
FORMULA SP & PLUS
BULB (60-60W)
FORMULA MX
- ⑦ BULB (5W)
- ⑧ BULB (2W)
- ⑨ LAMP (10W)
- ⑩ FUSE (0.1 A)
- ⑪ RESISTOR 30 Ω
- ⑫ TEMPERATURE SENSOR

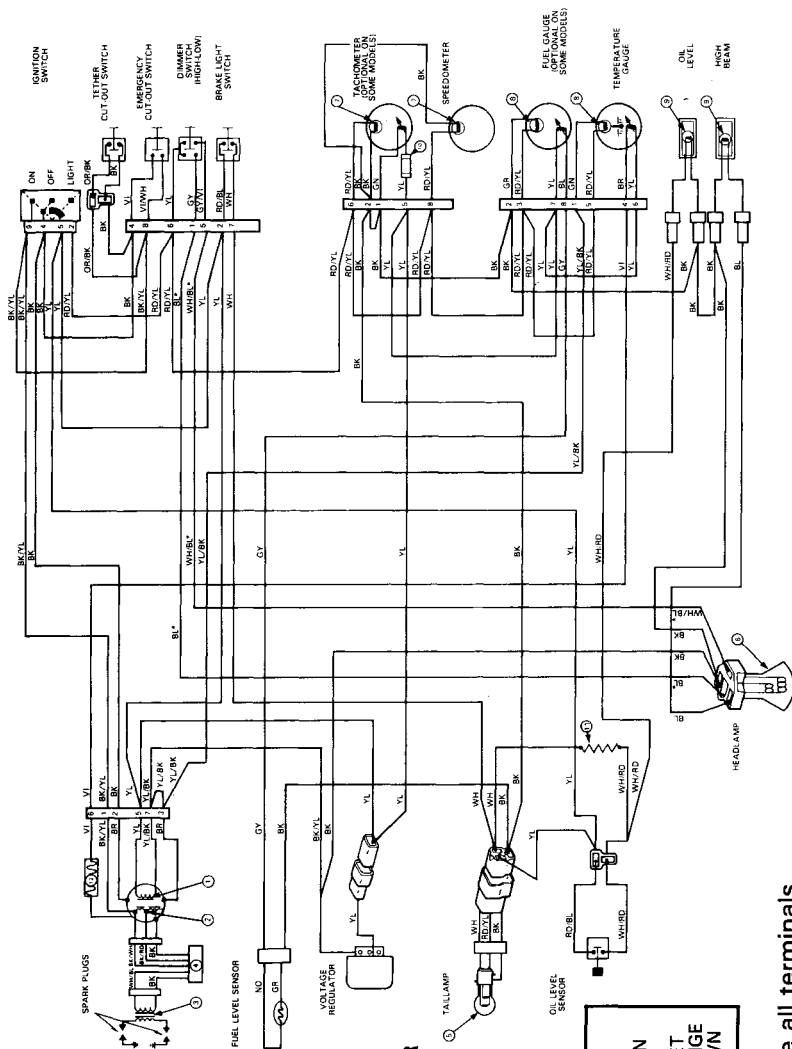

COLOUR CODES

BK	—	BLACK	GN	—	GREEN
WH	—	WHITE	GY	—	GREY
RD	—	RED	VI	—	VIOLET
BL	—	BLUE	OR	—	ORANGE
YL	—	YELLOW	BR	—	BROWN

WARNING: Ensure all terminals are properly crimped on the wires and all connector housings are properly fastened.

SI* INFORMATION GUIDE

BASE UNITS

DESCRIPTION	UNIT	SYMBOL
length	meter	m
mass	kilogram	kg
force	Newton	N
liquid	liter	L
temperature	Celsius	°C
pressure	kilopascal	kPa
torque	Newton meter	N•m
speed	kilometer per hour	km/h

PREFIXES

PREFIX	SYMBOL	MEANING	VALUE
kilo	k	one thousand	1,000
centi	c	one hundredth of a	0.01
milli	m	one thousandth of a	0.001

CONVERSION FACTORS

TO CONVERT	TO †	MULTIPLY BY
lbf•ft	lbf•in	12.00
imp. oz	U.S. oz	0.96
imp. gal.	U.S. gal.	1.20
in	mm	25.40
in	cm	2.54
ft	m	0.30
mille/h	km/h	1.61
in ²	cm ²	6.45
in ³	cm ³	16.39
imp. oz	ml	28.41
U.S. oz	ml	29.57
imp. gal.	L	4.55
U.S. gal.	L	3.79
oz	g	28.35
lb	kg	0.45
lbf	N	4.40
lbf•in	N•m	0.11
lbf•ft	N•m	1.36
lbf•in ²	kPa	6.89
Fahrenheit	Celsius	(°F - 32) x 5/9
Celsius	Fahrenheit	(°C x 1.8) + 32

*The international system of units (SYSTEME INTERNATIONAL) abbreviates "SI" in all languages.

†To obtain the inverse sequence, divide by the given factor. Eg: To convert mm to in divide by 25.4.

NOTES

CHANGE OF ADDRESS AND OWNERSHIP

Any change in address or ownership should be brought to the attention of the manufacturer by completing and sending out the card supplied below.

NOTICE TO ALL NEW OWNERS: Make sure to receive the warranty registration card from the previous owner, at the time the ownership is transferred. Also enclose a photocopy of this registration card when informing of a change of ownership.



CHANGE OF ADDRESS

VEHICLE IDENTIFICATION NUMBER

--	--	--	--	--	--	--	--	--	--	--	--	--	--	--	--	--	--	--	--

OLD ADDRESS:

NAME _____

NO _____ STREET _____ APT. _____

CITY _____ STATE/PROVINCE _____ ZIP/POSTAL CODE _____

NEW ADDRESS:

NAME _____

NO _____ STREET _____ APT. _____

CITY _____ STATE/PROVINCE _____ ZIP/POSTAL CODE _____



CHANGE OF OWNERSHIP

VEHICLE IDENTIFICATION NUMBER

--	--	--	--	--	--	--	--	--	--	--	--	--	--	--	--	--	--	--	--

The ownership of this vehicle is transferred

FROM:

NAME _____

NO _____ STREET _____ APT. _____

CITY _____ STATE/PROVINCE _____ ZIP/POSTAL CODE _____

TO:

NAME _____

NO _____ STREET _____ APT. _____

CITY _____ STATE/PROVINCE _____ ZIP/POSTAL CODE _____



STAMP

BOMBARDIER INC.
ATT.: WARRANTY DEPARTMENT
VALCOURT, QUEBEC
CANADA, JOE 2LO

STAMP

BOMBARDIER INC.
ATT.: WARRANTY DEPARTMENT
VALCOURT, QUEBEC
CANADA, JOE 2LO