

Operator's manual

SKANDIC

SKANDIC R

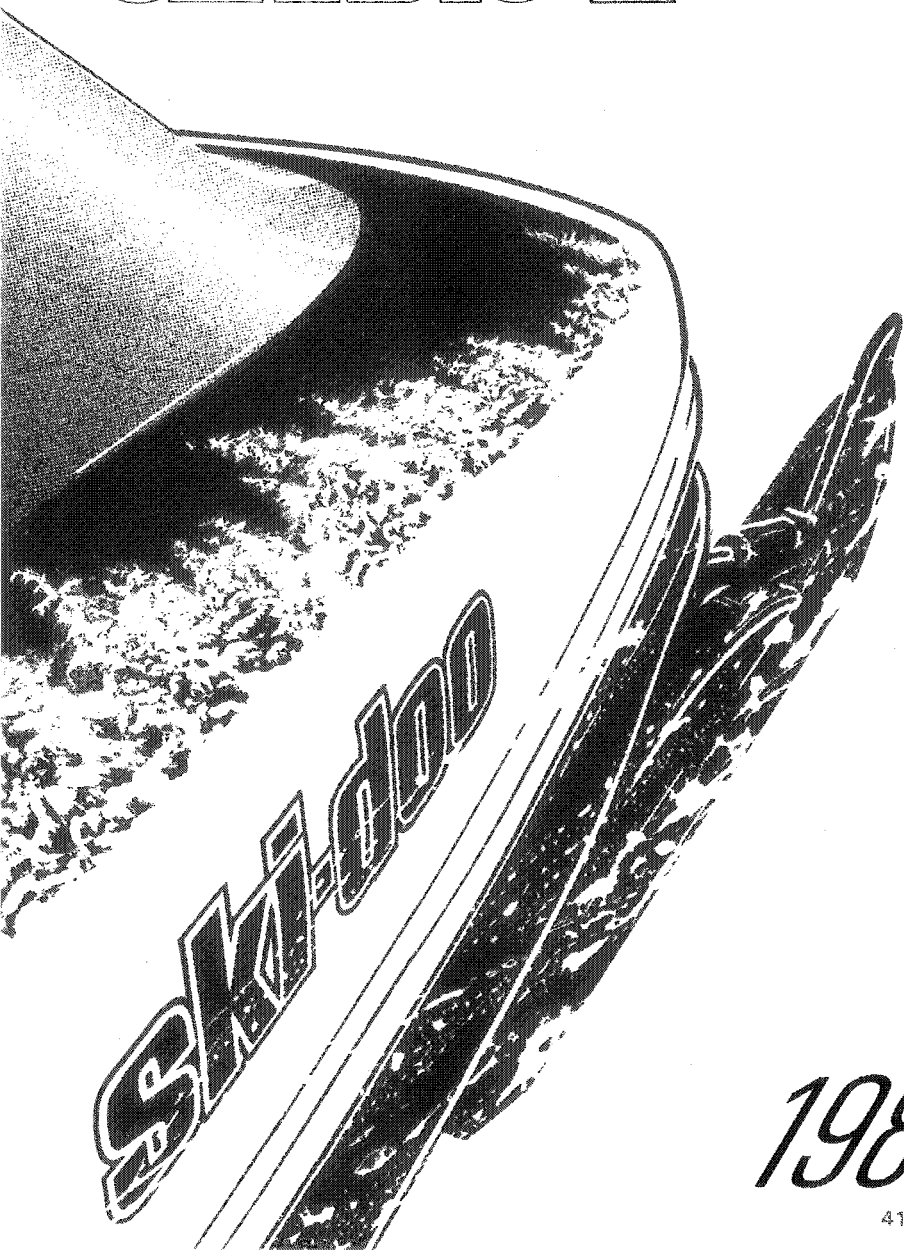

1986

414 5722 00

model _____

V.I.N. _____

purchase date _____

warranty expiry date _____

To be completed by dealer at time of sale

DEALER IMPRINT AREA

AFTER SALES SERVICE
BOMBARDIER INC.
VALCOURT, QUEBEC
CANADA, JOE 2LO



The following are trademarks of Bombardier Inc.

ALPINE®	FUTURA®	SAFARI*
BLIZZARD®	GRAND PRIX SPÉCIAL*	SKANDIC*
BOMBARDIER®	MIRAGE*	SKI-DOO®
CARRY-BOOSE*	MOTO-SKI®	SONIC*
CITATION®	NORDIK*	SPIRIT*
ÉLAN®	NUVIK*	SUPER SONIC*
ÉLITE®	OLYMPIQUE*	T'NT®
EVEREST®	ROTAX*	TUNDRA*
FORMULA*	RV*	ULTRA SONIC*

FOREWORD

The operator manual and the Snowmobile Safety Handbook have been prepared to acquaint the owner / operator of a new snowmobile with the various vehicle controls, maintenance and safe operating instructions. Each is indispensable for the proper use of the product, and should be kept with the vehicle at all times.

Should you have any questions pertaining to the warranty and its application, please consult the "Often Asked Question" section of this manual, or your authorized dealer.

This manual uses the following symbols.

 **WARNING:** Identifies an instruction which, if not followed, could cause personal injury.

 **CAUTION:** Denotes an instruction which, if not followed, could severely damage vehicle components.

 **NOTE:** Indicates supplementary information needed to fully complete an instruction.

Although the mere reading of such information does not eliminate the hazard, your understanding of the information will promote its correct use.

The information, illustrations and components/system descriptions contained in this manual are correct at time of publication. Bombardier Inc. however, maintains a policy of continuous improvement of its products without imposing upon itself any obligation to install them on products previously manufactured.

Bombardier Inc. reserves the right at any time to discontinue or change specifications, designs, features, models or equipment without incurring obligation.

Most specifications are given in both metric and customary units. Where precise accuracy is not required, some conversions are rounded to even numbers for easier use.

A shop manual can be obtained for complete service, maintenance and repair information.

 **WARNING:** The engines and the corresponding components identified in this manual should not be utilized on product(s) other than those mentioned on the cover page of this manual.

 **CAUTION:** This vehicle is built with parts dimensioned in the metric system. All fasteners are metric and must not be replaced by customary fasteners. Mismatched or incorrect fasteners could cause damage to the vehicle or possible personal injury.

SAFETY MEASURES

Observe the following precautions:

- Throttle mechanism should be checked for free movement before starting engine.
- Engine should be running only when belt guard and/or pulley guard is secured in place.
- Never run the engine without drive belt installed. Running an unloaded engine can prove to be dangerous.
- Never run the engine when the track is raised off the ground.
- It can be dangerous to run engine with the hood removed.
- Gasoline is flammable and explosive under certain conditions. Always manipulate in a well ventilated area. Do not smoke or allow open flames or sparks in the vicinity. If gasoline fumes are noticed while driving, the cause should be determined and corrected without delay.
- Maintain your vehicle in top mechanical condition at all times.
- Your snowmobile is not designed to be driven or operated on black top, bare earth, or other abrasive surfaces. On such surfaces abnormal and excessive wear of critical parts is inevitable.
- Your snowmobile is not designed to be operated on public streets, road or highways. In most States and Provinces, it is considered an illegal operation.
- Installation of other than standard equipment, including ski-spreaders, bumpers, pack racks, etc., could severely affect the stability and safety of your vehicle. Avoid adding on accessories that alter the basic vehicle configuration.
- The snowmobile engine can be stopped by activating the emergency cut-out switch, tether switch or by turning off the key.
- Whenever the vehicle is parked outdoors, overnight or for a long period, it is suggested to protect it against the inclemency of the weather with a snowmobile cover.
- Do not lubricate throttle and/or brake cables and housings.
- Only perform procedures as detailed in this manual. Unless otherwise specified, engine should be turned OFF for all lubrication and maintenance procedures.
- Clean and check operation of the headlight, taillight and brake light.
- These vehicles are designed for the driver only. No provisions have been made for a passenger.
- Should removal of a nylon lock nut be required when undergoing repairs/disassembly, always replace by new ones. Tighten as specified in the applicable Shop Manual.

PLEASE READ AND UNDERSTAND ALL WARNINGS AND CAUTIONS IN THIS MANUAL AND ON THE VEHICLE.

THIS MANUAL SHOULD REMAIN WITH THE VEHICLE AT THE TIME OF RESALE.

INDEX

THE 1986 "LIMITED WARRANTY"	4
OFTEN ASKED QUESTIONS	6
LISTING OF AREA DISTRIBUTORS	8
HOW TO IDENTIFY YOUR SNOWMOBILE	9
CONTROLS/INSTRUMENTS	
Throttle lever, brake lever, parking brake lever, restraining device, gear shift lever, ignition/light switch, headlamp dimmer switch, emergency cut-out switch, tether cut-out switch, horn, rewind starter handle, primer, adjustable steering handle, speedometer, fuel gauge/tank cap, hood opening, tool box, spark plug holder, spare drive belt holder, hitch	10
BREAK-IN PERIOD	
Engine and belt break-in, 10 hour-inspection, inspection check list	15
FUEL	
Recommended gasoline, recommended oil, fuel mixture ratio and mixing procedure, fuel/oil mixing chart	17
PRE-START CHECK	
Check points	19
STARTING PROCEDURE	
Manual starting, before riding, emergency starting	19
LUBRICATION	
Frequency, steering mechanism, drive axle, countershaft support bearing, transfer shaft, slide suspension, chaincase/transmission oil level, drive pulley	21
MAINTENANCE	
Chart, belt guard removal, drive belt removal and installation, drive belt condition, new drive belt, brake condition, brake adjustment, brake light switch adjustment, drive chain tension, spark plugs, suspension condition, stopper strap condition, suspension adjustment, track condition, track tension and alignment, drive pulley, steering mechanism, steering adjustment, muffler attachment, engine head nuts, engine mount nuts, carburetor adjustment, fan belt, headlamp beam aiming, bulb replacement, general inspection	24
STORAGE	
Track, suspension, skis, controls, chaincase/transmission, drive pulley, engine and primer lubrication, fuel tank and carburetor, chassis, general inspection, suspension stopper strap	35
PRE-SEASON PREPARATION	
Pre-season preparation chart	38
TROUBLE SHOOTING	39
TOOLS	41
SPECIFICATIONS	42
WIRING DIAGRAMS	44
SI METRIC INFORMATION GUIDE	45

THE 1986 SNOWMOBILE LIMITED WARRANTY

1 - PERIOD

BOMBARDIER® INC. as manufacturer, warrants FROM THE DATE OF FIRST CONSUMER SALES, every 1986 BOMBARDIER snowmobile, sold as NEW AND UNUSED, and predelivered by an authorized BOMBARDIER dealer for a period of:

- 12 consecutive months.

2 - WHAT BOMBARDIER WILL DO

BOMBARDIER will repair and/or replace, at its option, components defective in material and/or workmanship (under normal use and service,) with a genuine BOMBARDIER component without charge for parts or labour, at any authorized BOMBARDIER dealer during said warranty period.

3 - CONDITION TO HAVE WARRANTY WORK PERFORMED

Present to the servicing dealer, the hard copy of the BOMBARDIER Warranty Registration card received by the customer from the selling dealer at time of purchase.

4 - WARRANTY TRANSFER

This warranty is transferable to subsequent owner(s) for remainder of warranty period from original date of sale.

5 - EXCLUSIONS - ARE NOT WARRANTED

- Normal wear on all items such as, but not limited to:
 - drive belts
 - slider shoes
 - spark plugs
 - bulbs
 - runners on skis
- Replacement parts and/or accessories which are not genuine BOMBARDIER parts and/or accessories.
- Damage resulting from installation of parts other than genuine BOMBARDIER parts.
- Damage caused by failure to provide proper maintenance as detailed in the Operator Manual. The labour, parts and lubricants costs of all maintenance services, including tune-ups and adjustments will be charged to the owner.
- Wet cells battery.
- Vehicles designed and/or used for racing purposes.
- All optional accessories installed on the vehicle.
(The normal warranty policy for parts and accessories, if any, applies).
- Damage resulting from accident, fire or other casualty, misuse, abuse or neglect.
- Damage resulting from operation of the snowmobile on surfaces other than snow.

-
- Damage resulting from modification to the snowmobile not approved in writing by BOMBARDIER.
 - Losses incurred by the snowmobile owner other than parts and labour, such as, but not limited to, transportation, towing, telephone calls, taxis, or any other incidental or consequential damages.

6 - BATTERY WARRANTY:

- 12 consecutive months. (Pro-rated.)
100% warranty coverage will start on the date the snowmobile was purchased and run to the following April 30th. The remainder of the 12 months period will be pro-rated as follows:
 - 50% from April 30th to December 1st.
 - 40% from December 1st to December 31st.
 - 30% from January 1st to end of warranty.

7 - EXPRESSED OR IMPLIED WARRANTIES

This warranty gives you specific rights, and you may also have other legal rights which may vary from state to state, or province to province. Where applicable this warranty is expressly in lieu of all other expressed or implied warranties of BOMBARDIER, its distributors and the selling dealer, including any warranty of merchantability of fitness for any particular purpose; otherwise the implied warranty is limited to the duration of this warranty. However, some states or provinces do not allow limitations on how long an implied warranty lasts, so the above limitation may not apply.

Neither the distributor, the selling dealer, nor any other person has been authorized to make any affirmation, representation or warranty other than those contained in this warranty, and if made, such affirmation, representation or warranty shall not be enforceable against BOMBARDIER or any other person.

Some states or provinces do not allow the exclusion or limitation of incidental or consequential damages, so the above limitation or exclusion may not apply.

BOMBARDIER INC. reserves the right to modify its warranty policy at any time, being understood that such modification will not alter the warranty conditions applicable to vehicles sold while the above warranty is in effect.

8 - CONSUMER ASSISTANCE

If a servicing problem or other difficulty occurs, we suggest the following:

1. Try to resolve the problem at the dealership with the Service Manager or Owner.
2. If this fails, contact your area distributor listed in the Operator Manual.
3. Then if your grievance still remains unsolved, you may write to us:

Bombardier Inc.
Service Department
Recreational Products Division
Valcourt, Quebec, Canada, JOE 2LO

February 1985
Bombardier Inc.
Valcourt, Quebec, Canada, JOE 2LO

®* Trademarks of Bombardier Inc.

OFTEN ASKED QUESTIONS

Q: Why must my snowmobile be registered? After all I do have my original invoice as proof of when I purchased my snowmobile.

A: Your warranty is valid at any authorized dealer of the product. Your registration is the key element in providing the servicing dealer with the necessary data to complete warranty claim forms. This information is also used to notify owners in the event of a safety recall.

Q: Who should send the registration card to Bombardier Inc..?

A: The dealer. However, the customer must make sure that it has been sent. The company might contact you should your vehicle be recalled or in case of a particular warranty campaign.

Q: I bought my snowmobile in O'King County but I snowmobile in Washington County. Can the dealer in Washington County accept to perform warranty work on my snowmobile?

A: Yes, any authorized dealer in North America can perform warranty repairs, providing the customer warranty registration card is presented.

Q: Where can I find information on the lubrication and maintenance of my snowmobile?

A: In this Operator Manual provided with the vehicle at the time of first sale.

Q: Will the entire warranty be void or cancelled, if I do not operate or maintain my new snowmobile exactly as specified in the Operator's Manual?

A: The warranty of the new snowmobile cannot be "Voided" or "Cancelled". However, if a particular failure is caused by operation or maintenance other than is shown in the Operator Manual, THAT failure may not be covered under warranty. This includes service work performed by the customer, especially the critical adjustments to ignition, timing, carburation and oil injection/or oil mixture.

Q: Would you give some examples of abnormal use or strain, neglect or abuse?

A: These terms are general and overlap each other in areas. Some specific examples may include: running the machine out of oil, chain failure caused by a lack of lubrication, operating the machine with a broken or damaged part which causes another part to fail, and so on. If you have any specific questions on operation or maintenance, please contact your dealer for advice.

Q: What costs are my responsibility during the warranty period?

A: The customer's responsibility includes all costs of normal maintenance services, non-warranty repairs, accidents and collision damage, as well as oils, and spark plugs, and incidental or consequential damages costs as explained in the warranty.

Q: Are "Genuine" Bombardier replacement parts used in warranty repairs covered by warranty?

A: Yes. When installed by an authorized dealer, any "genuine" Bombardier part used in warranty repairs assumes the remaining warranty that exists on the machine.

Q: If I sell my snowmobile within the warranty period, will the new owner qualify for the balance of the warranty?

A: Yes, provided the unit has already been registered with the manufacturer. Note that the change of ownership card in this manual should be completed and sent to Bombardier Inc.

Q: How can I receive the best owner assistance?

A: The satisfaction and goodwill of the owners of Bombardier products are of primary concern to your dealer and Bombardier Inc. Normally, any problems that arise in connection with the sales transaction or the operation of your snowmobile will be handled by your Dealers Sales or Service Departments. It is recognized, however, that despite the best intentions of everyone concerned, misunderstandings will sometimes occur. If you have a problem that has not been handled to your satisfaction through normal channels, we suggest that you discuss your problem with a member of dealership management. Frequently, complaints are the result of a breakdown in communications and can quickly be resolved by a member of the dealership management. If the problem already has been reviewed with the Sales Manager or Service Manager, contact the Dealer himself or the General Manager.

LISTING OF AREA DISTRIBUTORS

CANADIAN DISTRIBUTORS

BOMBARDIER INC.
EASTERN CANADA DISTRIBUTION DIVISION

- Quebec Branch
1350 Nobel Boulevard
Boucherville, Quebec, J4B 1A1
(514) 655-6121
Province of Quebec

- Ontario Branch
230 Bayview Drive
Barrie, Ontario, L4N 4Y8
(705) 728-8600
Province of Ontario

BROOKS EQUIPMENT LIMITED
1616 King, Edward Street
P.O. Box 985
Winnipeg, Manitoba, R3C 2V8
(204) 633-7247
British Columbia, Manitoba, Saskatchewan,
Alberta, Yukon

CHARLES R. BELL LIMITED
Newfoundland, Labrador
Offices
- Riverside Drive
P.O. Box 1050
Corner Brook, Newfoundland, A2H 6J3
(709) 634-3533

- 81 Kenmount Road
P.O. Box 8127
St-John's, Newfoundland, A1B 3N1
(709) 722-6700

HUDSON'S BAY CO. LTD.
165 Hymus Blvd
Pointe-Claire, Quebec, H9R 1G2
(514) 697-8500
North-West Territories, Franklin District &
Keewatin

AMERICAN DISTRIBUTORS

BOMBARDIER CORPORATION
All States (excluding Alaska)

SERVICE OFFICES
- East Main Street Road
Malone, New York 12953
(518) 483-4411

- 4505 West Superior Street
P.O. Box 6106
Duluth, Minnesota 55806
(218) 628-2881

- P.O. Box 1569
Idaho Falls, Idaho, 83401
(208) 529-9510

NATIONAL SALES OFFICE
- O'Hare Lake Plaza
2350 Devon Avenue
Suite 150
Des Plaines, Illinois 60018
(312) 298-9540

**MILLER EQUIPMENT AND RECREATIONAL
CENTER**
1049 Whitney Road
Anchorage, Alaska 99501
(907) 274-9513
Alaska

HOW TO IDENTIFY YOUR SNOWMOBILE

The main components of your snowmobile (engine, track(s) and frame) are identified by different serial numbers. It may sometimes become necessary to locate these numbers for warranty purposes or to trace your snowmobile in the event of theft.

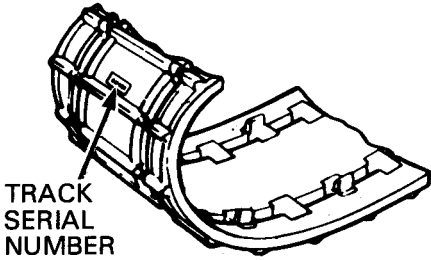

A002005010

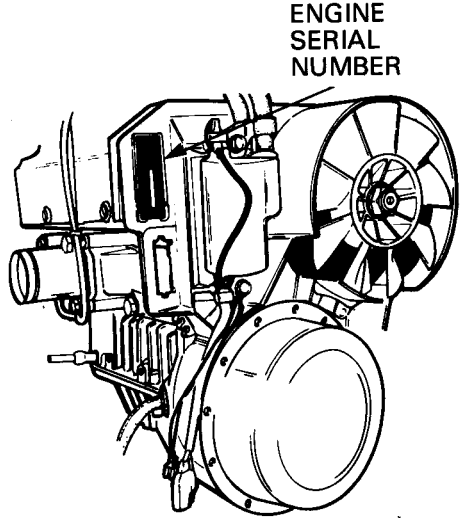

A007002001

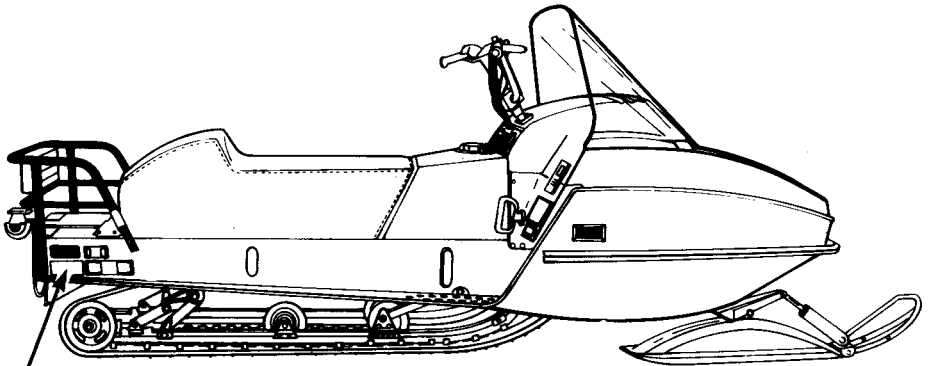

A007007002

Vehicle serial number identification

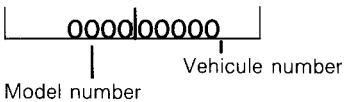

NOTE: We strongly recommend that you take note of all the serial numbers on your vehicle and supply them to your insurance company. It will surely help in the event a snowmobile is stolen.

CONTROLS/INSTRUMENTS

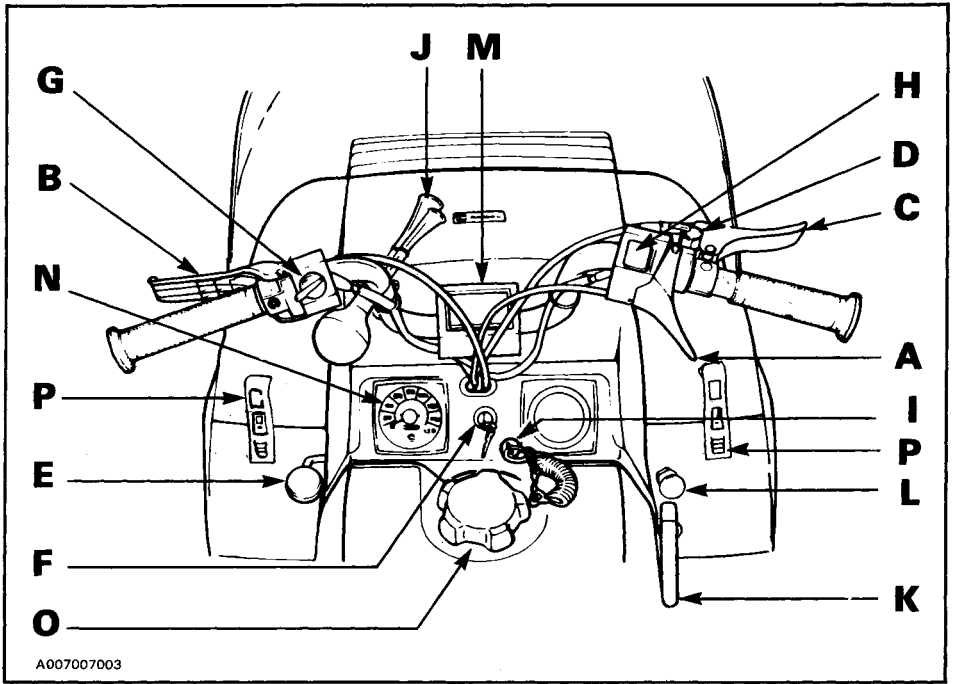

- A) Throttle Control Lever
- B) Brake Control Lever
- C) Parking Brake Lever (Skandic R only)
- D) Parking Brake Lever Restraining Device (Skandic R only)
- E) Gear Shift Lever (Skandic R only)
- F) Ignition/Light Switch
- G) Headlamp Dimmer Switch
- H) Emergency Cut-Out Switch
- I) Tether Cut-Out Switch
- J) Horn (Skandic R only)
- K) Rewind Starter Handle
- L) Primer
- M) Adjustable Steering Handle
- N) Speedometer
- O) Fuel Gauge/Tank Cap
- P) Hood Opening

A) Throttle Lever

Located on right side of handlebar. When compressed, it controls the engine speed and the engagement of the transmission. When released, engine speed returns automatically to idle.

B) Brake Lever

Located on the left side of handlebar. When compressed, the brake is applied. When released, it automatically returns to its original position. Braking effect is proportionate to the pressure applied on the lever and to the type of terrain and its snow coverage.

C) Parking Brake Lever (Skandic R only)

Located on right side of handlebar. Use to park the vehicle.

D) Parking Brake Restraining Device (Skandic R only)

Device used to maintain the parking brake locked.

To lock: Strongly press then turn the device clockwise to maintain the lever in place.

To lock:

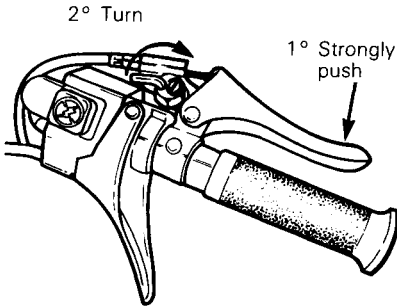

A008006001

To unlock: Press the lever then turn the device counterclockwise.

CAUTION: Always unlock the restraining device prior to activating the throttle lever and moving the vehicle.

E) Gear Shift Lever (Skandic R only)

A 2 position (forward/reverse) gear shift lever. Pull lever out for forward speed or push in for reverse.

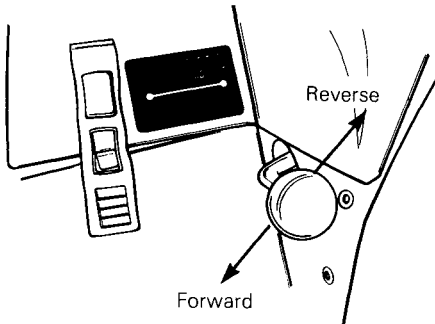

A008003013

WARNING: This snowmobile is capable of a fast reverse. On first outing, operator should become familiar with this operation by practicing on level ground. Always apply the brake before shifting and come to a complete stop then while holding brake on, change gear. This is particularly important while on a slope. Ensure the path behind is clear of obstacles or bystanders. Fast reverse, while turning, could result in loss of stability.

F) Ignition/Light Switch

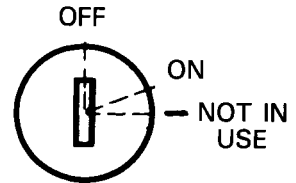

A002007002

Key operated, 3 position switch. To start engine, turn key fully clockwise to ON position. To stop engine, turn key counterclockwise to OFF position.

The 3rd position is not in use.

The lights are automatically ON whenever the engine is running.

G) Headlamp Dimmer Switch

The dimmer switch, located on left side of handlebar, allows correct selection of headlamp beam. To obtain high or low beam simply flick switch.

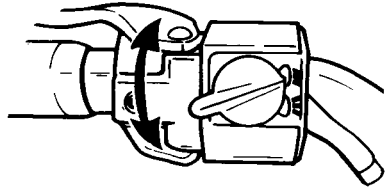

A008006003

H) Emergency Cut-Out Switch

A push pull type switch located on the right side of the handlebar. To stop the engine in an emergency, push the button to the lower off position and simultaneously apply the brakes. To start engine, button must be at the upper ON position.

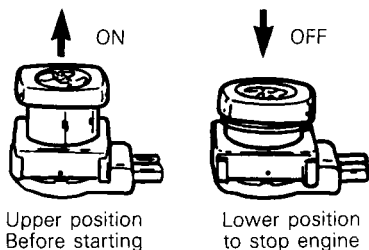

A017006004

The driver of this vehicle should familiarize himself with the function of this device by using it several times on first outing. Thereby being mentally prepared for emergency situations requiring its use.

◆ **WARNING:** For safety reasons, the emergency cut-out switch is easily accessible; be careful not to operate it inadvertently.

◆ **WARNING:** If the switch has been used in an emergency situation the source of malfunction should be determined and corrected before re-starting engine.

I) Tether Cut-Out Switch

Attach tether cord to wrist or other convenient location then snap tether cut-out cap over receptacle before starting engine.

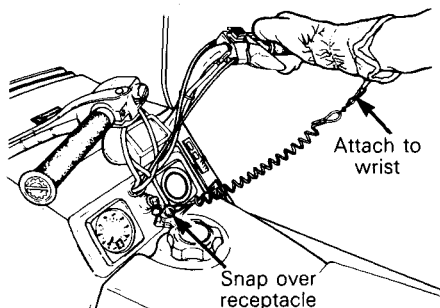

A007007004

If emergency engine "shut off" is required, completely pull cap from safety switch and engine power will be automatically shut "off"

○ **NOTE:** The cap must be installed on the safety switch at all times in order to operate the vehicle.

◆ **WARNING:** If the switch is used in an emergency situation the source of malfunction should be determined and corrected before restarting engine.

J) Horn (Skandic R only)

Located on left side of handlebar. Adjust as the driver's preference. Squeeze to hoot.

◆ **WARNING:** Do not adjust too low as the horn might contact hood and/or dash while turning.

K) Rewind Starter Handle

Auto rewind type located on right hand side of vehicle. To engage mechanism, pull handle.

L) Primer

A push-pull button. Pull and push button (2-3 times) to activate primer. The primer should always be used for cold engine starts. After engine is warm however, it is not necessary to use primer when starting.

M) Adjustable Steering Handle

- Remove steering cover.
- Loosen the four (4) retaining screws.
- Adjust the handle to the desired position.

◆ **WARNING:** Do not adjust too high as the brake lever may contact the windshield when turning.

- Lock the steering handle in place by tightening the four (4) retaining screws to 26 N•m (19 lbf•ft).
- Reinstall steering cover.

N) Speedometer

The speedometer is linked directly to the drive axle. Direct-reading dial indicates the speed of the vehicle. Odometer records the total distance travelled in kilometers.

The trip meter reset button is located on the speedometer housing. To reset, open hood and turn black knob counterclockwise until all numbers read zero.

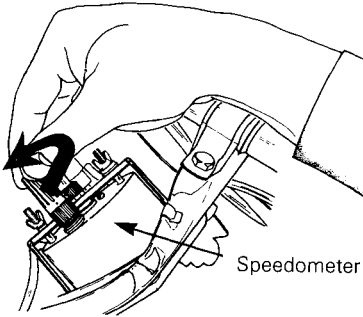

Turn
counterclockwise

O) Fuel Gauge/Tank Cap

Unscrew fuel tank cap and withdraw dipstick to check fuel level.

◆ **WARNING:** Never use a lit match or open flame to check fuel level.

P) Hood Opening

Pull down the latches to unlock the hood from the anchor.

○ **NOTE:** Always lift hood gently up until stopped by restraining device.

◆ **WARNING:** It is dangerous to run an engine with the hood open unfastened or removed.

Tool Box

Located under the hood. To gain access, tilt hood. Ideal location for spare rope, first aid kit, etc..

Spark Plug Holder

Spare spark plugs can be carried in the special holes in the air silencer.

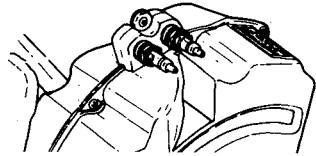

A007004001

A007003028

Spare Drive Belt Holder

A spare drive belt can be installed in belly pan clip.

◆ **WARNING:** Always be careful not to burn yourself on the exhaust system when removing or installing drive belt.

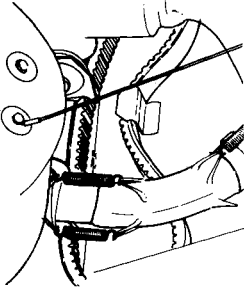

A007003029

Hitch

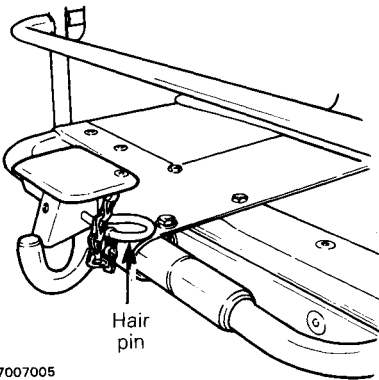

A007007005

Fixed on the rear bumper. A hair pin is supplied to lock the hook attachment.

◆ **WARNING:** When towing a sled or trailer, always ensure to lock the hook attachment with the hair pin.

Trailers or sleds towed behind a snowmobile should always be loaded in a way to obtain the lowest possible center of gravity. Use a rigid tow bar when pulling a tow sled behind your snowmobile. When you are pulling passengers in a trailer or tow sled, use moderate speed and avoid rough terrain for their safety. Also, have all passengers get out of a towed vehicle and walk across all roads.

BREAK-IN PERIOD

Engine

With Bombardier-Rotax snowmobile engines, a break-in period is required before running the vehicle at full throttle. Engine manufacturer recommendation is 10 to 15 operating hours. Maximum throttle should not exceed $\frac{3}{4}$, however, brief full acceleration and speed variations contribute to a good break-in. Continued wide open throttle accelerations, prolonged cruising speeds, and lugging are detrimental during the break-in period.

 **NOTE:** Recommended fuel/oil ratio is 40:1 during engine break-in period.

This will assure additional protection during the initial engine break-in.

 **CAUTION:** Remove and clean spark plugs after engine break-in.

Belt

A new drive belt requires a break-in period of 15-25 km (10-15 miles).

10-Hour inspection

As with any precision piece of mechanical equipment, we suggest that after the first 10 hours of operation or 30 days after the purchase, whichever comes first, that your vehicle be checked by your dealer. This inspection will give you the opportunity to discuss the unanswered questions you may have encountered during the first hours of operation. Remember that it is easier to remedy at this time than to allow the snowmobile to operate until a possible failure occurs.

The 10 hour inspection is at the expense of the vehicle owner.

10-HOUR INSPECTION CHECKLIST	✓
Engine timing	
Fan belt tension	
Spark plugs condition: (Remove and clean)	
Carburetor adjustment	
Engine head nuts	
Engine mount nuts	
Muffler attachment	
Chaincase/transmission oil level	
Drive chain tension (Skandic R only)	
Brake operation and lining condition	
Skis alignment (runners condition)	
Steering arm retorque to: 60 N•m (44 lbf•ft)	
Handlebar bolts, retorque to 26 N•m (19 lbf•ft)	
Pulley alignment and drive belt condition	
Track condition, tension and alignment	
Lubricate (steering, suspension, drive axle, countershaft support bearing, transfer shaft)	
Electrical wiring (loose connections, stripped wires, damaged insulation), tightened all loose bolts, nuts and linkage	
Operation of lighting system (HI / LO beam, brake light, etc.), test operation of emergency cut-out switch and tether switch	

We recommend that you have your dealer sign this inspection list.

Date of 10 hour inspection

Dealer signature

FUEL

Recommended Gasoline

Use regular leaded or unleaded gasoline available from all service stations.

▼ **CAUTION:** Never experiment with different fuel or fuel ratios. Never use naphtha, methanol, gasohol or similar products.

◆ **WARNING:** Never "top up" the gas tank before placing the vehicle in a warm area. At certain temperatures, gasoline will expand and overflow. Always wipe off any gasoline spillage from the snowmobile.

Recommended Oil

Use BLIZZARD oil (P/N 496 0135 00 - 500 ml) available from the dealer. This type of oil will flow at temperatures as low as minus 40°C (-40°F).

It is a blend of specially selected base oils and additives which provides outstanding lubrication, engine cleanliness and minimum spark plug fouling.

If BLIZZARD oil is unavailable, substitute with Bombardier Snowmobile Injection Oil (P/N 496 0133 00 - 1 liter).

▼ **CAUTION:** Never use outboard or straight mineral oils.

Fuel Mixture Ratio & Mixing Procedure

Oil must be added to the gasoline in pre-measured amounts then both oil and gasoline should be thoroughly mixed together before fueling the tank.

The importance of using the correct fuel mixture cannot be overstressed. An incorrect fuel ratio results in serious engine damage. Recommended fuel ratio is 50:1 (40:1 during break-in period).

SI UNITS

500 ml oil to 25 liters = 50:1

IMPERIAL UNITS

16 oz oil to 5 imp. gal. = 50:1
or

500 ml oil to 5 1/2 imp. gal. = 50:1

U.S. UNITS

13 oz oil to 5 U.S. gal. = 50:1

○ **NOTE:** To facilitate fuel mixing, oil should be kept at room temperature.

To mix the gasoline and oil always use a separate clean container. Never mix directly in your snowmobile tank. For best results, acquire two containers, either plastic or metal. Draw from one until empty then use the second one.

◆ **WARNING:** Gasoline is flammable and explosive under certain conditions. Always manipulate in a well ventilated area. Do not smoke or allow open flames or sparks in the vicinity. If gasoline fumes are noticed while driving, the cause should be determined and corrected without delay. Never add fuel while the engine is running. Avoid skin contact with fuel at below freezing temperatures.

FUEL/OIL MIXING CHARTS (50:1 ratio)

1. Pour approximately 4 liters (one gallon) of gasoline into a clean container.

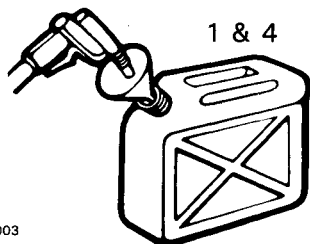

A000000003

2. Add the full amount of oil required for the mixture.

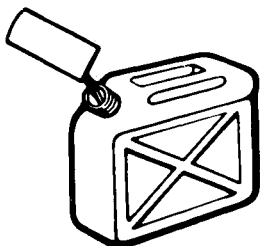

A000000004

3. Replace the container cap and shake the container thoroughly.

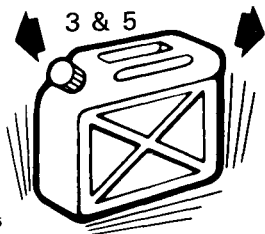

A000000005

4. Add the remainder of the gasoline.
5. Once again thoroughly agitate the container. Then using a funnel with a FINE MESH SCREEN to prevent the entry of foreign particles, pour the mixture into the snowmobile tank.

WARNING: To prevent fuel spillage, a funnel must always be used when filling the gas tank.

NOTE: When using pre-mixed fuel, always shake the container thoroughly as the oil has a tendency to settle.

METRIC (SI)

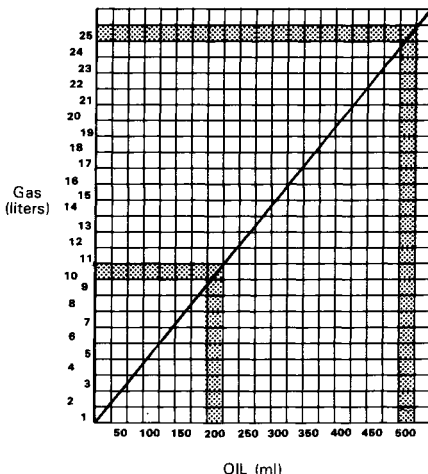

IMPERIAL

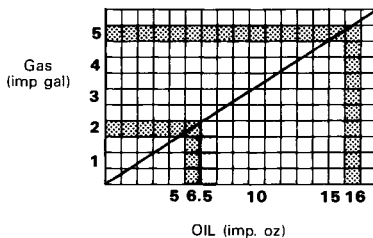

UNITED-STATES

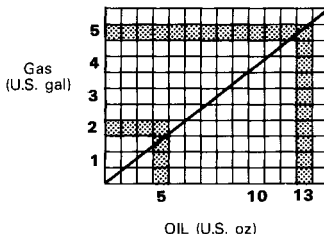

A000000006

USE BLIZZARD OIL

PRE-START CHECK

Check Points

- **ACTIVATE THE THROTTLE CONTROL LEVER SEVERAL TIMES** to check that it operates easily and smoothly. The throttle control lever must return to idle position when released.
- Check fuel level.
- Check that the skis and the track are not frozen to the ground or snow surface and that steering operates freely.

- Activate the brake control lever and make sure the brake fully applies before the brake control lever touches the handlebar grip.
- Verify that the path ahead of the vehicle is clear of bystanders and obstacles.

◆ **WARNING:** Only start your snowmobile once all components are checked and functioning properly.

STARTING PROCEDURE

Test throttle control lever.

Check that the emergency cut-out switch is in the ON position.

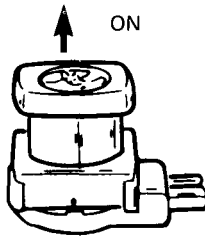

Upper position
before starting engine
A017006004

Ensure the tether cut-out cap is in position and that the cord is attached to your clothing.

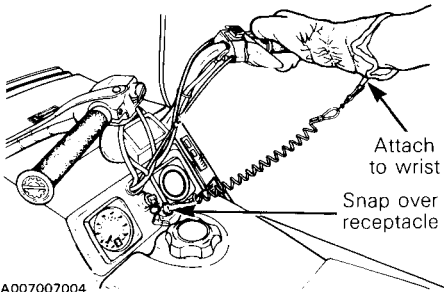

A007007004

Activate the primer (2 or 3 times).

○ **NOTE:** The use of the primer is not necessary when the engine is warm.

Manual Starting

Insert the key in the ignition and turn to ON position.

Grasp manual starter handle firmly and pull slowly until a resistance is felt then pull vigorously. Slowly release the rewind starter handle.

◆ **WARNING:** Do not apply throttle while starting.

Before Riding

Check operation of the emergency cut-out switch, and tether switch. Restart engine.

◆ **WARNING:** If engine does not shut-off when applying the emergency cut-out switch and or when pulling the tether cut-out cap, stop the engine by turning off the ignition key. Do not operate the vehicle further, see your dealer.

Allow the engine to warm before operating at full throttle.

Emergency Starting

Should the rewind starter rope fray and break, the engine can be started with an emergency starter rope.

◆ **WARNING:** Do not start the vehicle by the drive pulley unless it is a true emergency situation, have the vehicle repaired as soon as possible.

◆ **WARNING:** Do not wind starting rope around your hand. Hold rope by the handle only. The spark plug socket can be used as an emergency starter grip.

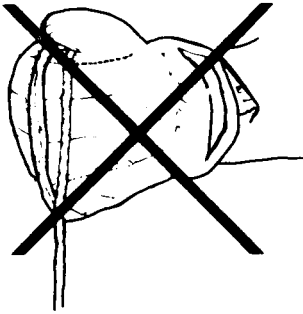

A007003030

Remove the belt guard from the vehicle and wind the emergency rope tight around the drive pulley between the sliding half and the roller guard. Start the engine as per usual manual starting.

◆ **WARNING:** When starting the vehicle in an emergency situation by the drive pulley, do not make a knot at the end of the emergency rope and do not reinstall the belt guard.

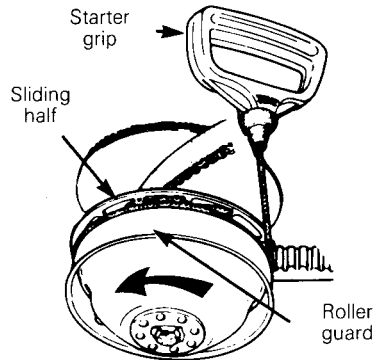

A007003018

LUBRICATION

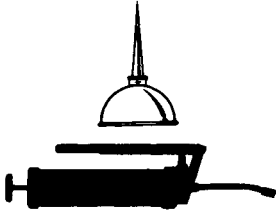

A000000007

Frequency

Routine maintenance is necessary for all mechanized products, and the snowmobile is no exception. A weekly vehicle inspection contributes to the life span of the snowmobile as well as retains safe and dependable operation.

○ **NOTE:** When lubricating grease fittings, grease until grease appears at joints. Always use low temperature grease (P/N 413 7044 00).

◆ **WARNING:** Only perform such procedures as detailed in this manual. It is recommended that dealer assistance be periodically obtained on other components/systems not covered in this manual. Unless otherwise specified, engine should be turned OFF for all lubrication and maintenance procedures.

It is recommended that the steering system and suspension be lubricated monthly or every 40 hours of operation. If the vehicle is operated in wet snow or in severe conditions these items should be lubricated more frequently.

◆ **WARNING:** Do not lubricate throttle and/or brake cables and housings.

Steering Mechanism

Lubricate the ski legs at grease fittings until new grease appears at joints. Coat spring slider cushion with grease.

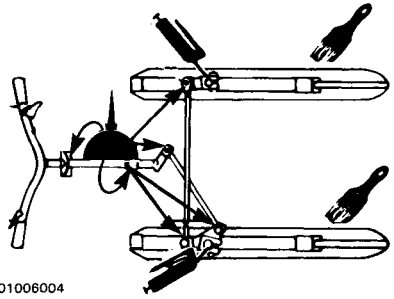

A001006004

Oil spring coupler bolts, ball joints and steering column bushings.

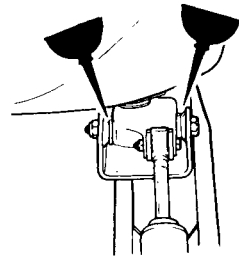

A007006001

Drive Axle (Skandic Only)

Lubricate at grease fitting using low temperature grease.

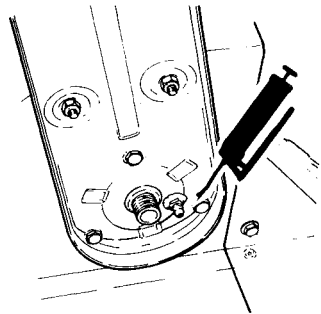

A007003025

CAUTION: When lubricating the drive axle bearing, do not apply excessive grease as the seal will be pushed out of its housing. Check seal position with finger.

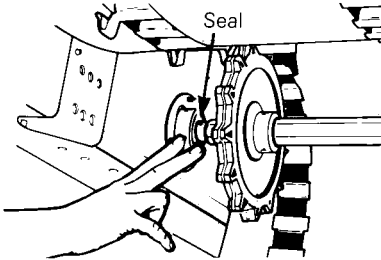

A007003031

Transfer Shaft (Skandic R Only)

Lubricate at grease fitting using low temperature grease.

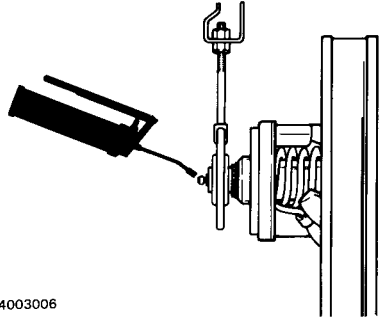

A004003006

Countershaft Support Bearing (Skandic Only)

Lubricate at grease fitting, using low temperature grease.

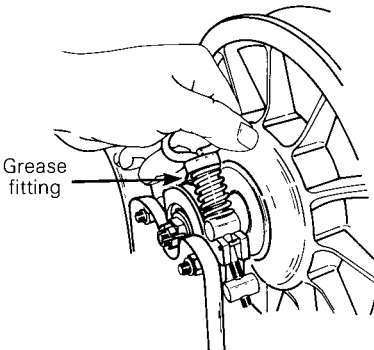

A007003019

Slide Suspension

Lubricate idler wheels at grease fittings until grease appears at joints. Use low temperature grease only.

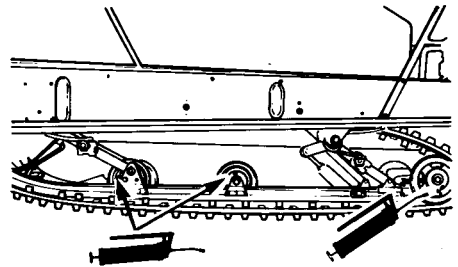

A007005014

Also lubricate front & rear arms at grease fittings.

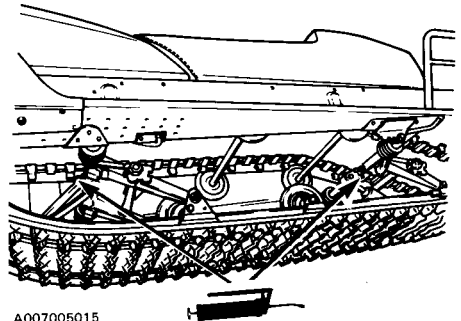

A007005015

Chaincase/Transmission Oil Level

Check the oil level by removing the oil level cap plug.

Skandic

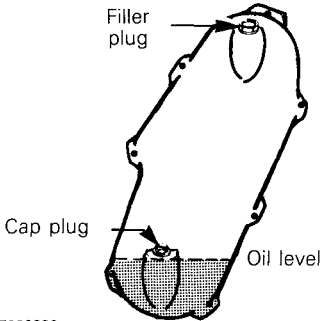

A007003032

The oil should be level with the bottom of the oil level orifice.

○ **NOTE:** The chaincase oil capacity is approximately 200 ml (7 imp. oz.).

Skandic R:

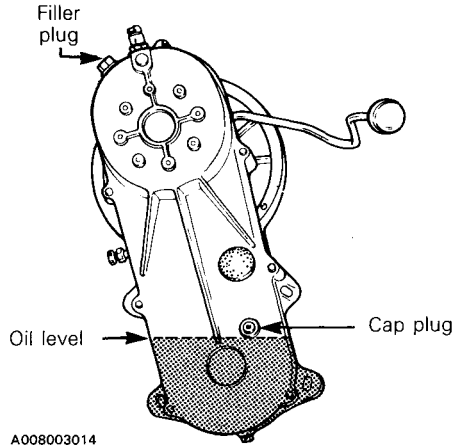

A008003014

○ **NOTE:** The chaincase oil capacity is approximately 455 ml (16 imp. oz.).

To fill, remove filler plug from top of chaincase or transmission. Refill as required using Bombardier chaincase oil (P/N 413 8019 00 - 200 ml).

MAINTENANCE

The following Maintenance Chart indicates regular servicing schedules to be performed by you or your servicing dealer. If these services are performed by yourself or an authorized dealer. If these services are performed as suggested, your snowmobile will give you many years of low-cost use.

◆ WARNING: Only perform such procedures as detailed in this manual. It is recommended that dealer assistance be periodically obtained on other components / systems not covered in this manual. Unless otherwise specified, engine should be turned OFF for all lubrication and maintenance procedures.

MAINTENANCE CHART	Weekly or every 240 km (150 mi)	Monthly or every 800 km (500 mi)	Once a year or every 3200 km (2000 mi)	Refer to page
Drive belt condition	•			27
Brake condition	•			27
Brake adjustment		•		28
Spark plugs		•		29
Suspension condition		•		30
Stopper strap condition			•	30
Suspension adjustment	(as required)			30
Track condition		•		31
Track tension and alignment		•		31
Drive pulley		•		32
Drive chain tension (Skandic R only)		•		29
Steering mechanism		•		32
Steering adjustment		•		32
Muffler attachment		•		33
Engine head nuts			•	33
Engine mount nuts			•	33
Carburetor adjustment			•	33
Fan belt			•	34
Headlamp beam aiming			•	34
General inspection		•		35

○ **NOTE:** The ten hour inspection is a very important part of proper service and maintenance.

Belt Guard Removal

◆ **WARNING:** Engine should be running only when belt guard is secured in place.

- A. Raise the hood and remove the retaining clip of the rear pin and remove the pin.
- B. Pull the guard out of the center retaining bolt.
- C. Remove the guard.

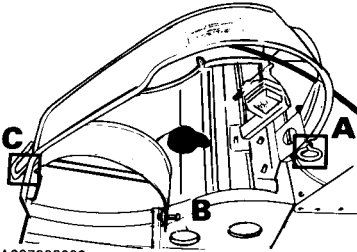

A007003033

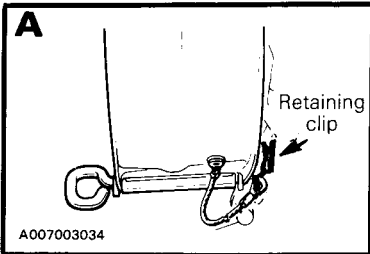

A007003034

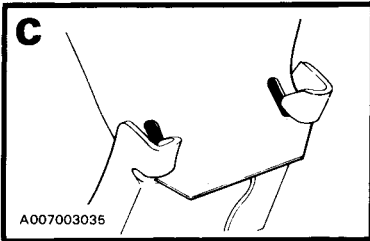

A007003035

Skandic:

- 1. Remove the belt guard.
- 2. Loosen the countershaft bearing retaining screw and open the bearing cage.

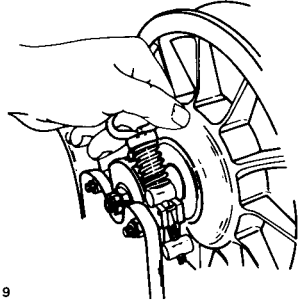

A007003019

- 3. Open the driven pulley by twisting and pushing the sliding half. Hold in fully open position.

Slip slackened belt over the top edge of the fixed half.

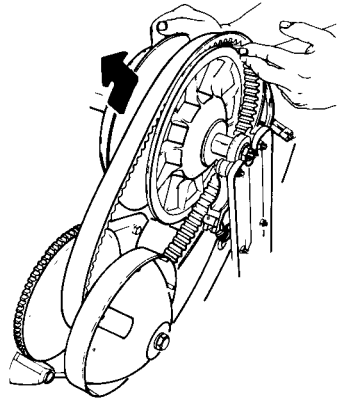

A007003021

Drive Belt Removal and Installation

◆ **WARNING:** At the removal or installation of the drive belt be careful not to burn yourself on the exhaust muffler. Never start or run engine without the drive belt installed. Running an unloaded engine is dangerous.

- Lift the countershaft upward approx. 50 mm (2 in.) and slip the belt between the shaft and the bearing cage to remove completely.

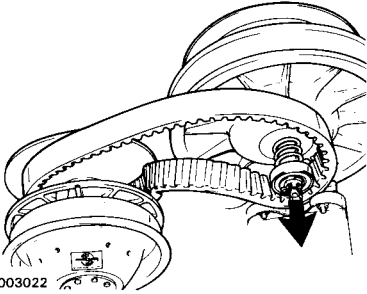

A007003022

NOTE: It may be necessary to loosen the brake adjustment in order to easily lift the countershaft.

- Slip the belt out from the drive pulley.

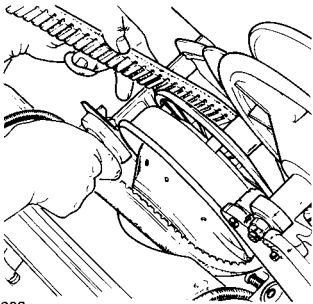

A007003023

To install the drive belt, reverse the procedure.

CAUTION: Once belt is installed, be sure to secure the countershaft bearing by closing the bearing cage and firmly tightening the retaining screw.

WARNING: After drive belt installation, always check that the brake disc is correctly installed between the brake pads and that the brake is well adjusted. Check brake light operation.

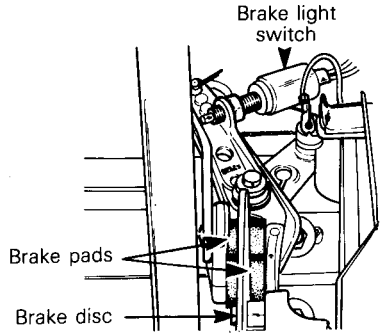

A007003018

Skandic R

- Remove the belt guard.
- Unlock and raise driven pulley support.

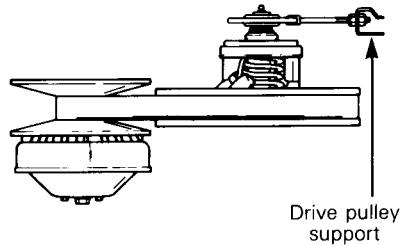

A004003006

- Open the driven pulley by twisting and pushing the sliding half. Hold in fully open position. Slip slackened belt over the top edge of the sliding half.

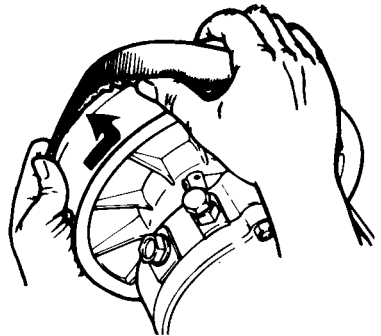

A004003008

- Slip the belt out from the drive pulley and remove completely from vehicle.

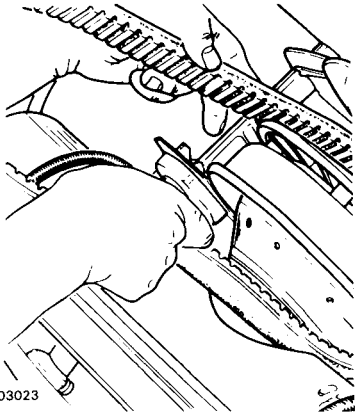

A007003023

To install the drive belt, reverse the procedure.

CAUTION: Once belt is installed be sure to lock driven pulley support.

Drive Belt Condition

Inspect belt for cracks, fraying or abnormal wear (uneven wear, wear on one side, missing cogs, cracked fabric). If abnormal wear is noted, probable cause could be pulley misalignment, excessive R.P.M. with frozen track, fast starts without warm-up period, burred sheave, oil on belt or distorted spare belt. Contact your dealer.

Check the drive belt width. If less than 30 mm (1 3/16 in), replace the drive belt.

New Drive Belt

When installing a new drive belt, break-in period of 25 km (15 miles) is strongly recommended.

NOTE: Always store a spare belt in a manner to allow its natural shape to be maintained.

Brake Condition

The brake mechanism on your snowmobile is an essential safety device. Keep this mechanism in proper working condition. Above all, do not operate your snowmobile without an effective brake system.

Skandic

WARNING: Brake linings less than 3 mm (1/8") thick must be replaced. Replacement must be performed by an authorized dealer.

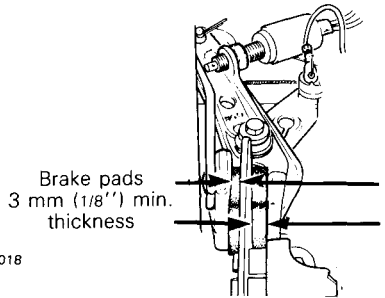

A007003018

Skandic R

WARNING: Brake pads must be replaced as soon as only 1 mm (1/32") of the fixed lining is still projected out of caliper. Replacement must be performed by an authorized dealer.

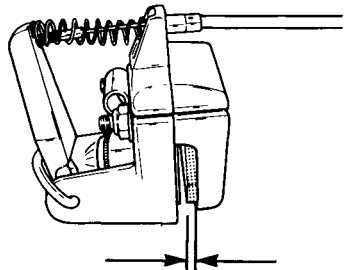

A008003015

Brake Adjustment

Skandic

Brake should apply fully while brake control lever is still 13 mm (1/2'') approx. from the handlebar grip.

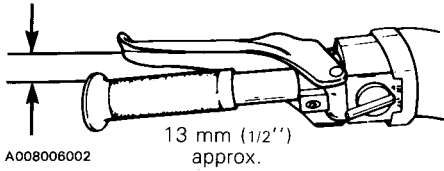

If adjustment is required, turn the brake cable adjuster counterclockwise until the brake disc is hard to turn then back off the adjuster to approximately 1 1/2 turn. Recheck brake operation.

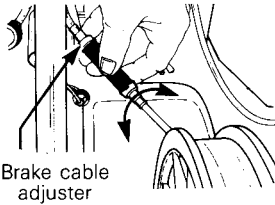

WARNING: Whenever the brake is readjusted, the brake light switch operation must also be checked and adjusted as needed.

Skandic R

The brake mechanism is a self-adjusting type. If a quicker brake response is desired, strongly pull the brake lever several times, this will actuate the self adjusting mechanism.

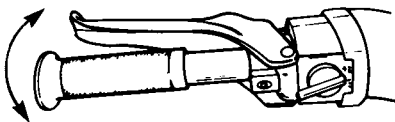

After the adjustment, brake should apply fully when lever is approximately 13 mm (1/2'') from handlebar grip. If not, do not tamper with the brake, contact an authorized dealer.

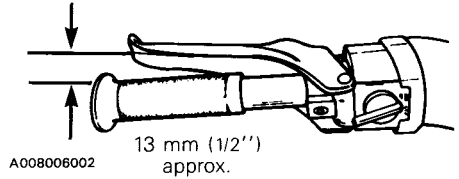

This also apply to parking brake lever.

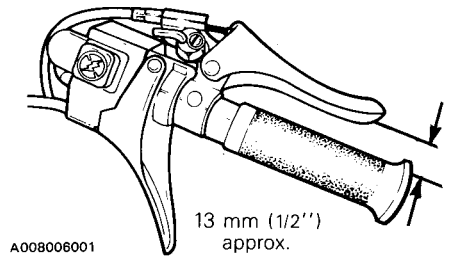

Brake Light Switch Adjustment

To check operation:

Pull the brake lever to hold the pads on the disc. Check that a light resistance is felt while rotating the driven pulley. This is the position where the switch should have lit the brake light.

To adjust:

- Loosen the brake switch lock nut. (Restrain the other one on Skandic R).

Skandic

- Holding the brake lever at the lit position, unscrew the switch to turn the light on or screw it in to turn it off.

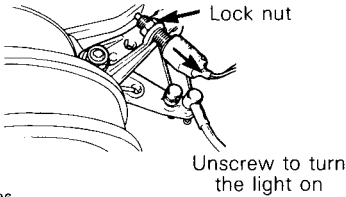

A007003036



To adjust, loosen lock nut and turn adjuster bolt to obtain the specified free-play. Tighten lock nut and recheck chain tension.

Skandic R

- By turning adjusting nut, pull outward the switch to turn the light on or push inward to turn it off.

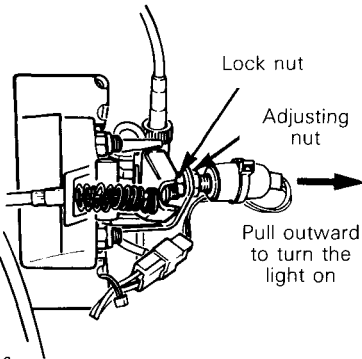

A008003016

- Tighten the brake switch lock nut (restrain the other one on Skandic R).
- Recheck brake light operation.

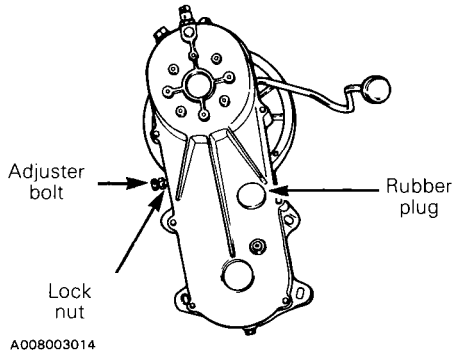

Spark Plugs

Disconnect the spark plug wires and remove the spark plugs.

Check the condition of the plugs.

- A brownish tip reflects ideal conditions. (Carburetor adjustment, spark plug heat range, etc., are correct.)
- A black insulator tip indicates fouling caused by: carburetor idle speed mixture and/or high speed mixture too rich, incorrect fuel mixture ratio, wrong type of spark plug (heat range), or excessive idling.

Drive Chain Tension (Skandic R only)

Remove rubber plug and check chain tension. Free-play must be from 4 to 7 mm (5/32 to 9/32").

- A light grey insulator tip indicates a lean mixture caused by: carburetor high speed mixture adjusted too lean, wrong spark plug heat range, incorrect fuel mixture ratio, or a leaking seal or gasket.

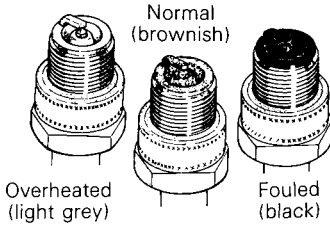

A000004010

CAUTION: If spark plug condition is not ideal, contact your authorized dealer.

Check spark plug gap using a wire feeler gauge.

Reinstall plugs and connect wires.

Suspension Condition

Visually inspect all suspension components including slider shoes, springs, wheels, etc..

NOTE: During normal driving, snow will act as a lubricant and coolant for the slider shoes. Extensive riding on ice or sanded snow, will create excessive heat build-up and cause premature slider shoe wear.

Stopper Strap Condition

Inspect strap for wear and cracks, bolt and nut for tightness. If loose inspect holes for deformation, replace as required. Torque nut to 9 N•m (80 lbf•in).

Suspension Adjustment

The suspension is adjustable, the front adjustment for surface condition, the rear for driver's weight.

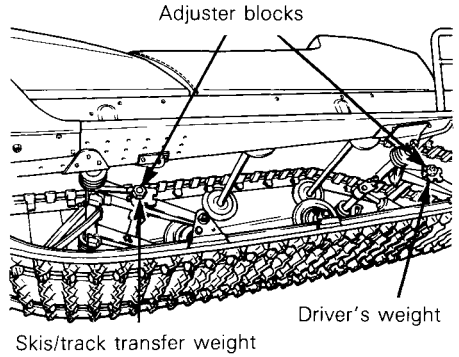

A007005015

When the front adjuster blocks are at the lowest elevation more weight is distributed on the skis.

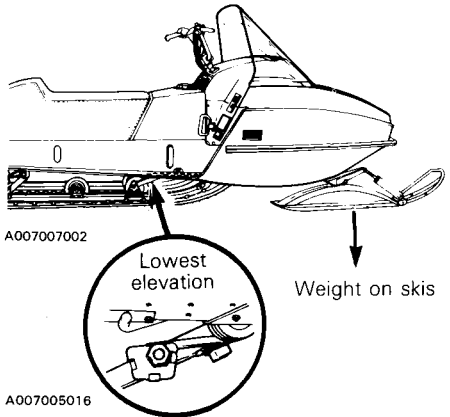

At the highest position the weight is transferred to the track. The rear adjuster blocks should be adjusted to suit the driver's preference.

CAUTION: Always turn the left side adjuster blocks in a clockwise direction, the right side blocks in a counterclockwise direction. Left and right adjuster blocks of each adjustment must always be set at the same elevation.

○ **NOTE:** For deep snow condition or hill climbing, it is recommended to place the front adjuster blocks on the highest position.

Track Condition

Lift the rear of the vehicle and support it off the ground. With the engine **OFF**, rotate the track by hand, and inspect condition. If worn, cut or track fibers are exposed or missing or defective inserts or guides are noted, contact your dealer.

◆ **WARNING:** Do not operate a snowmobile with a cut, torn or damaged track.

Track Tension and Alignment

Tension:

Lift the rear of vehicle and support with a mechanical stand. Allow the slide to extend normally. Check the gap 13 mm ($1/2''$) between the slider shoe and the bottom inside of the track. If the track tension is too loose, the track will have a tendency to thump.

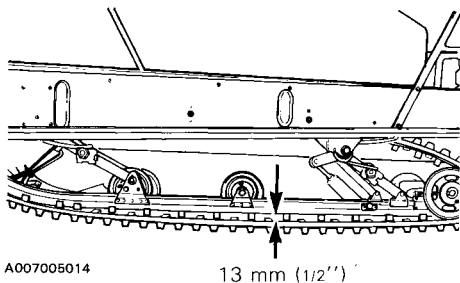

▼ **CAUTION:** Too much tension will result in power loss and excessive stresses on suspension components.

If necessary to adjust; loosen the rear idler wheel retaining screw and the adjuster bolt lock nut; then loosen or tighten the adjuster bolts located on the inner side of the rear idler wheels. If correct tension is unattainable, contact your dealer.

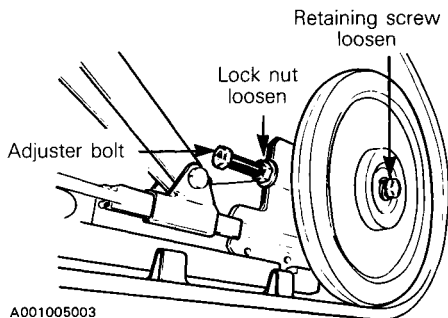

○ **NOTE:** Track tension and alignment are inter-related. Do not adjust one without the other.

Alignment

Start the engine and accelerate slightly so that track turns **slowly**. Check that the track is well centered; equal distance on both sides between edges of track guides and slider shoes.

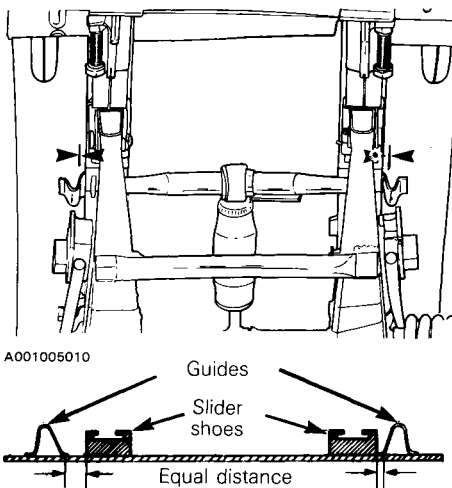

WARNING: Before checking track alignment, ensure that the track is free of all particles which could be thrown out while track is rotating. Keep hands, tools, feet and clothing clear of track. Ensure no-one is standing in close proximity to the vehicle.

To correct, **stop the engine**, loosen the rear idler wheels retaining screws then loosen the lock nuts and tighten the adjuster bolt on side where the slider shoe is the furthest to the track insert guides.

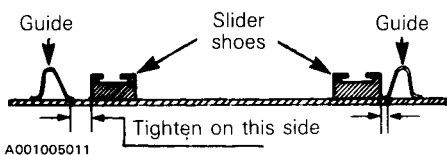

Tighten lock nuts and recheck the alignment. Ensure to retighten the idler wheel retaining screws.

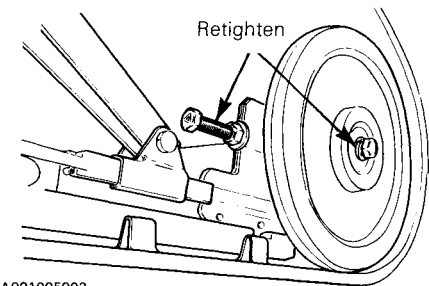

Drive Pulley

Inspect the Duralon bushing condition by checking the free-play of the sliding half pulley. This is achieved by restraining the inner half and checking if the sliding half moves in the direction of the arrows more than 3 mm (1/8''). If so, contact your dealer.

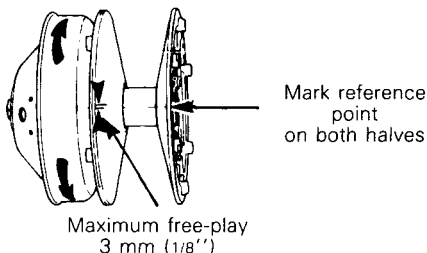

A007003004

Steering Mechanism

Inspect the steering mechanism for tightness of components (steering arms, tie rods, ball joints, spring coupler bolts, etc.). If necessary, replace or retighten.

Torque steering arm bolts to 60 N•m (44 lbf•ft).

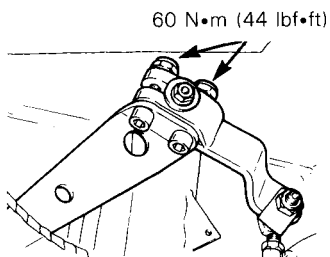

A007006002

Check the condition of the skis and the ski runners. Replace if more than half worn.

Steering Adjustment

Skis should have a toe out of 3 mm (1/8''). To check, measure the distance between each ski at the front and rear of the leaf springs. The front distance should be 3 mm (1/8'') more than the rear when the handlebar is horizontal.

IMPORTANT: Close the front of the skis manually to eliminate all slack from the steering mechanism.

If adjustment is required:

Loosen the lock nuts of the longest tie rod. Turn the tie rod manually until the skis are properly aligned. Firmly retighten the lock nuts.

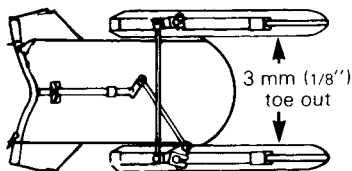

A001006004

The handlebar should also be horizontal when the skis are pointed toward the front.

To adjust:

Loosen the lock nuts of the shortest tie rod. Turn the tie rod manually until the handlebar is horizontal. Retighten the lock nuts firmly.

WARNING: The ball joint socket must run parallel with the steering arm. The steering arm must be restrained when tightening the tie rod end lock nuts.

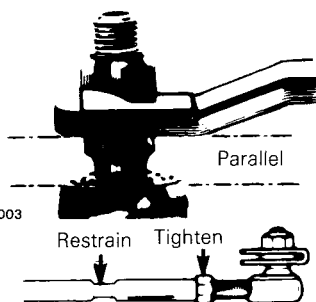

A007006003

A007006004

Muffler Attachment

The engine/muffler attaching parts are vital toward efficient muffler function. Check all attachments. Replace the springs and/or tighten if necessary.

CAUTION: Do not operate vehicle with muffler disconnected otherwise serious engine damage will occur.

Engine Head Nuts

With the ENGINE COLD, check that the engine head nuts are tight and equally torqued to 21 N•m (15 lbf•ft).

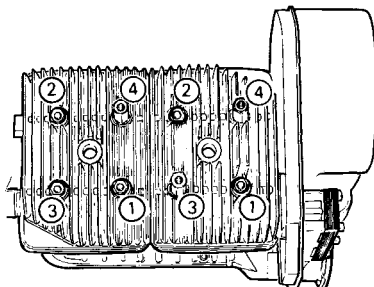

A007002002

Following sequence above shown, torque engine head nuts twice.

IMPORTANT: The engine head nut torque should be checked after the first 5 hours of operation.

Engine Mount Nuts

Check the engine mount nuts for tightness. Retighten if necessary.

Carburetor Adjustment

CAUTION: Never operate your snowmobile with the air intake silencer disconnected. Serious engine damage will occur if this notice is disregarded.

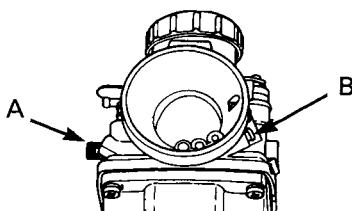

A002002009

A) Air Screw Adjustment

Completely close the air screw (until a slight reseating resistance is felt) then back off screw: 1 1/2 turn.

B) Idle Speed Adjustment

Turn the idle speed screw clockwise until it contacts the throttle slide then continue turning two (2) additional turns. This will provide a preliminary idle speed setting. Start the engine and allow it to warm then adjust the idle speed by turning the idle speed screw clockwise or counter-clockwise. Idle speed: 1800-2000 R.P.M.

CAUTION: Do not attempt to set the idle speed by using the air screw. Severe engine damage can occur. If idle speed is unattainable contact your authorized dealer.

Fan Belt

Inspect belt for cracks, uneven wear, etc.. Check fan belt tension, 10 mm (3/8") deflection should exist when deflection is correct.

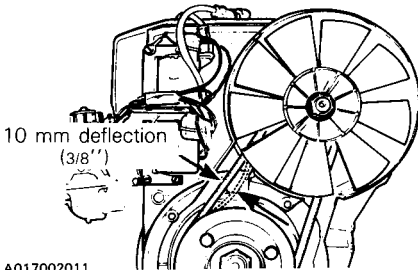

If belt seems damaged or if tension is incorrect, contact your dealer immediately.

WARNING: If fan protector is removed, always reinstall after servicing.

Headlamp Beam Aiming

The angle of the headlamp beam has been pre-adjusted prior to delivery. Should you wish re-adjustment, place the vehicle on a flat surface 7.6 m (25') from a wall or screen.

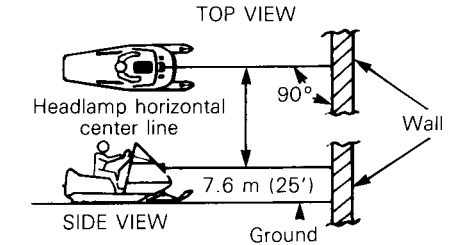

With the suspension correctly adjusted, the rider seated on the vehicle and the high beam ON check that the center of high intensity zone of high beam is 50 mm (2") below horizontal line of headlamp height.

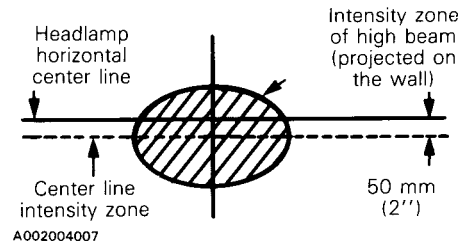

To adjust, remove the four caps, turn upper or lower adjusting screws to obtain desired beam position.

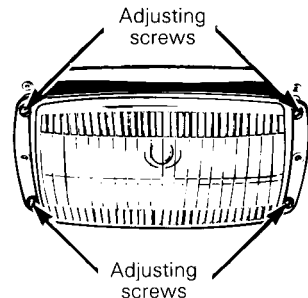

Bulb Replacement

If the headlamp bulb is burnt, tilt hood, unplug the connector from the headlamp. Remove the rubber boot and unfasten bulb retainer clips. Detach the bulb and replace.

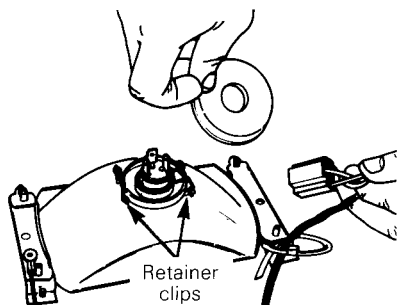

A002004009

If taillight bulb is burnt, expose the bulb by removing the red plastic lens. To remove, unfasten the two (2) screws.

◆ **WARNING:** Always check light operation after bulb replacement.

General Inspection

Check the electrical wiring and components, retighten loose connections. Check for stripped wires or damaged insulation. Thoroughly inspect the vehicle and tighten loose bolts, nuts and linkage. Inspect skis and ski runners for wear.

STORAGE

It is during summer, or when a vehicle is not in use for any length of time that proper storage is a necessity. Storage of the snowmobile during long period of inactivity consists of checking and replacing missing, broken or worn parts, proper lubrication and treatment to insure that parts do not become rusted; cleaning items such as carburetor of oil mixtures, to prevent gum varnish formation within the carburetor; and in general, preparing the vehicle so that when the time comes to use the snowmobile again it will be in top condition.

◆ **WARNING:** Only perform such procedures as detailed in this manual. It is recommended that dealer assistance be periodically obtained on other components/systems not covered in this manual. Unless otherwise specified, engine should be turned OFF for all lubrication and maintenance procedures.

Track

Inspect the track for wear, cuts, missing track guides and broken rods. Make any necessary replacement.

◆ **WARNING:** Do not operate a snowmobile with a cut, torn or damage track.

Lift the rear of vehicle until track is clear of the ground then support with a brace or trestle. The snowmobile should be stored in such a way that the track does not stay in contact with the cement floor or bare ground.

○ **NOTE:** The track should be rotated periodically, (every 40 days). Do not release track tension.

▼ **CAUTION:** To prevent track damage, temperature in the storage area must not exceed 38°C (100°F).

Suspension

Remove any dirt or rust. Grease idler wheels at grease fittings. Wipe off surplus. Replace worn slider shoes.

Skis

Wash or brush all dirt or rust accumulation from the skis and springs. Grease the ski legs at the grease fittings. Check the condition of the skis, ski runners and leaf springs. Replace if worn more than half.

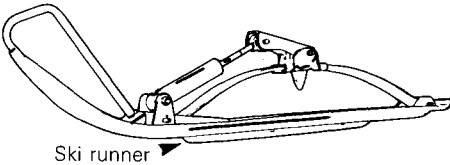

A007008006

Controls

Lubricate the steering mechanism. Inspect all components for tightness, (spring coupler bolts, steering arm locking bolts, tie rods, ball joints, etc.). Tighten if necessary. Oil metal moving joints of the brake mechanism.

WARNING: Do not lubricate the throttle and/or brake cables and housings. Avoid getting oil on the brake pads.

Coat all electrical connections and switches with a greaseless metal protector. If unavailable, use petroleum jelly.

Chaincase/Transmission

Skandic

Drain the chaincase and refill to proper level, using fresh chaincase oil (P/N 413 8019 00- 200 ml). To drain, remove the chaincase cover.

Skandic R

Drain the chaincase and refill to proper level, using fresh chaincase oil (P/N 413 8019 00 - 200 ml). To drain, remove the chaincase drain plug.

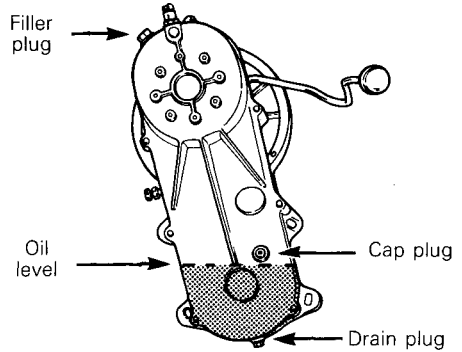

A008003014

NOTE: Drain plug is accessible through a hole located underneath vehicle.

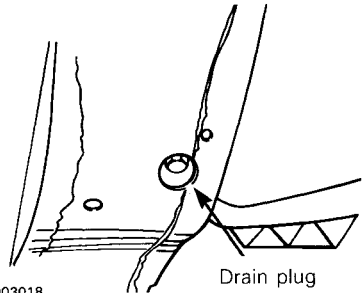

A008003018

Drive Pulley

Inspection and cleaning must be performed by an authorized dealer at the end of each season.

Engine and Primer Lubrication

Engine internal parts must be lubricated to protect cylinder walls from possible rust formation during the storage period.

To perform the storage procedures (engine and primer valve) proceed as follows:

1. Lift the rear of the vehicle and support it off the ground.

◆ **WARNING:** Ensure the track is free of all particles which could be thrown out while it is rotating. Keep hands, tools, feet and clothing clear of track. Ensure no one is standing in close proximity to the vehicle.

2. Start the engine and allow it to run at idle speed until the engine reaches its operational temperature.
3. Stop the engine.
4. Disconnect the inlet primer hose from the primer valve.

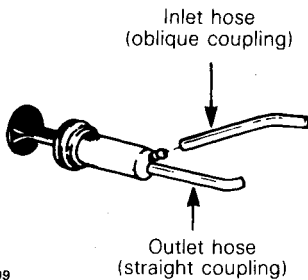

A002002009

5. Plug inlet primer hose to prevent gasoline from draining.
6. Using an appropriate hose, connect one end of the hose to the inlet of the primer valve and place the other end in a Bombardier Snowmobile Injection Oil container.
7. Activate the primer in order to fill it with oil.
8. Restart engine and run at idle.
9. Using the primer valve, inject oil until the engine dies or until a sufficient quantity of oil has entered the engine (approximately 25 complete strokes of the primer).
10. The engine stopped, remove the sparks plugs and pour approximately 85 ml (3 Imp. oz.) of oil into the cylinders.

11. Crank the engine to allow the crankshaft to turn 2 or 3 revolutions.
12. Reinstall the spark plugs and the inlet primer hose.

Do not run engine during storage period.

Fuel Tank and Carburetor

Remove the cap then using a syphon, remove the gasoline from tank.

◆ **WARNING:** Gasoline is flammable and explosive under certain conditions. Always manipulate in a well ventilated area. Do not smoke or allow open flames or sparks in the vicinity.

Carburetor must be dried out completely to prevent gum formation during the storage period.

Once the fuel tank is emptied, remove the float chamber drain plug from carburetor. Drain carburetor and reinstall plug.

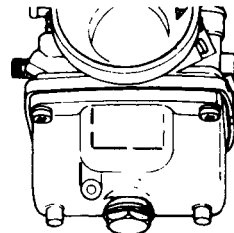

A002002010

Check all fuel lines. Replace if necessary.

Chassis

Clean the vehicle thoroughly, removing all dirt and grease accumulation.

▼ **CAUTION:** Plastic alloy components such as fuel tank, controls, windshield, etc., can be cleaned using mild detergents or isopropyl alcohol. Do not use strong soaps, degreasing solvents, abrasive cleaners, paint thinners, etc..

Clean the frame. For the aluminum portion use only "Aluminum cleaner" and follow instructions on the container.

Touch up all metal spots where paint has been scratched off. Spray all bare metal parts with metal protector. Wax the cab for better protection.

▼ **CAUTION:** If for some reason the snowmobile has to be stored outside it is necessary to cover it with an opaque tarpaulin. This caution will prevent the sun rays and the grime from affecting the plastic components and the vehicle finish.

General Inspection

Check the electrical wiring and components, retighten loose connections. Check for stripped wires or damaged insulation.

Thoroughly inspect the vehicle and tighten loose bolts, nuts and linkage.

○ **NOTE:** Leave the drive belt off the pulleys for the entire storage period.

Suspension Stopper Strap

Replace annually and/or as condition dictates. Torque nut to 9 N•m (80 lbf•in).

PRE-SEASON PREPARATION

To simplify the pre-season preparation we have drawn up a small chart. The chart indicates servicing points to be performed by yourself and your authorized dealer. If these services are performed as suggested, your vehicle will give you many hours of fun and low cost use.

IMPORTANT: Observe all Warnings and Cautions mentioned throughout this manual which are pertinent to the item being checked. When component conditions seem less than satisfactory, replace with genuine Bombardier parts or suitable equivalents.

PRE-SEASON PREPARATION CHART	TO BE PERFORMED BY DEALER	●
	TO BE PERFORMED BY OWNER	○
Change spark plugs*		○
Check chaincase oil level		○
Check drive chain tension (Skandic R only)		○
Replace fuel filter (located inside fuel tank)		○
Check track condition, tension and alignment		○
Check and lubricate suspension		○
Inspect drive belt and install		○
Check throttle cable for damage and free operation		○
Check steering alignment and ski runner condition		○
Inspect seals for possible cuts or leaks		○
Check electrical wiring (broken wire, damaged insulation)		○
Inspect condition of starting rope		○
Check tightness of all bolts, nuts and linkage		○
Refill gas tank		○
Inspect brake condition and operation		●
Set engine timing		●
Check pulleys, verify components and clean. Lubricate.		●
Adjust carburetor		●
Check fan belt condition and adjust tension		●

○ ***NOTE:** Before installing new spark plugs, it is suggested to burn the excess storage oil by starting the engine, using the old spark plugs.

▼ **CAUTION:** Only perform this procedure in a well ventilated area.

TROUBLE SHOOTING GUIDE

NOTE: The possible causes have been listed in an order of frequency. Therefore, items should be checked out in the same order as mentioned in the trouble shooting guide.

SYMPTOMS	POSSIBLE CAUSES	WHAT TO DO
Engine turns over but fails to start or starts with difficulty	1. No fuel to the engine	Check the tank level. Check for possible clogging of fuel line, item 4.
	2. Flooded engine	Remove wet spark plugs, turn ignition to OFF and crank engine several times. Install clean dry spark plugs. Start engine following usual starting procedure. If engine continues to flood, see your dealer.
	3. Spark plug/ignition	Check that emergency cut out switch is at the upper position (ON) and the tether cut-out switch cap is snapped over the receptacle.
		Check for fouled or defective spark plug. Disconnect spark plug wire, unscrew plug and remove from cylinder head. Reconnect wire and ground exposed plug on engine cowl, being careful to hold away from spark plug hole. Follow engine starting procedure and check for spark. If no sparks appear, replace spark plug. If trouble persists, contact your dealer.
	4. Clogged fuel line (water or dirt)	Remove and clean the fuel filter. Change filter cartridge if necessary. Check condition and connections of fuel lines. Check the cleanliness of fuel tank.
	5. Carburetor	Contact your dealer for repair.
	6. Too much oil in fuel	Contact your dealer.
	7. Engine timing	Engine timing may be incorrect or out of adjustment. Contact your dealer.
8. Engine compression	Running with a lean fuel mixture may produce excessive engine wear resulting in poor engine compression. If this occurs, contact your dealer at once.	
Engine will not turn manually	1. Seized engine	In the case of a seized engine contact your dealer.

SYMPTOMS	POSSIBLE CAUSES	WHAT TO DO
Engine lacks acceleration or power	1. Fouled or defective spark plug	Check item 3 of "Engine turns over but fails to start or starts with difficulty"
	2. Clogged fuel line (water or dirt)	Check fuel line condition. (See item 4 of "Engine turns over but fails to start or starts with difficulty").
	3. Carburetors	Contact your dealer.
	4. Ignition	First check item 3 of "Engine turns over but fails to start or starts with difficulty". If the ignition system still seems faulty, contact your dealer.
	5. Engine	If unable to locate specific symptoms, contact your dealer.
Engine continually backfires	1. Faulty spark plug	Check item 3 of "Engine turns over but fails to start or starts with difficulty".
	2. Overheating	Carburetor set too lean. Contact your dealer.
	3. Engine timing incorrectly set	Contact your dealer.
Snowmobile cannot reach full speed	1. Drive Belt	Check for damaged or worn drive belt. Replace if necessary.
	2. Incorrect track adjustment	Check track tension and alignment. Readjust to specifications. (See Maintenance Section).
	3. Engine	Check item 1 to 5 of "Engine lacks acceleration or power."
	4. Pulley misaligned	Contact your dealer.

TOOLS

As standard equipment each new snowmobile is supplied with a basic tool kit such as screwdriver, wrenches, emergency starter rope, etc..

Standard Tools

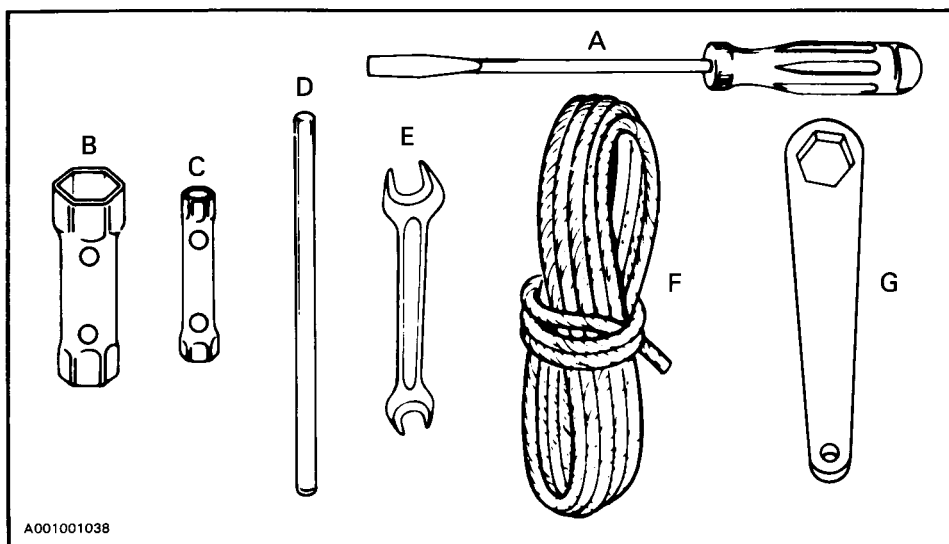

- A. Screwdriver
- B. Socket 21/26 mm
- C. Socket 10/13 mm
- D. Socket handle
- E. Fork wrench 10/13 mm
- F. Starter rope
- G. Suspension adjustment key

SPECIFICATIONS

	SKANDIC 377	SKANDIC 377R
ENGINE		
Type		377
No. of cylinders		2
Bore		62 mm (2.441")
Stroke		61 mm (2.401")
Displacement		368.3 cm ³ (22.48 in ³)
Compression ratio (corrected)		6.9:1
Maximum R.P.M.		7500
Carburetor type		VM 34-276
Carburetor adjustment:		
— air screw		1 1/2 turn
— idle speed		1800-2000 R.P.M.
Torque:		
— engine head nuts		21 N•m (15 lbf•ft)
— crankcase nuts		M6: 9 N•m (7 lbf•ft) M8: 21 N•m (15 lbf•ft)
— magneto ring nut		85 N•m (63 lbf•ft)
— fan nut		65 N•m (48 lbf•ft)
— crankcase engine support nuts		38 N•m (28 lbf•ft)
— exhaust manifold bolts		21 N•m (15 lbf•ft)
CHASSIS		
Overall length		289.5 cm (114")
Overall width		96.5 cm (38")
Overall height		108 cm (42 1/2")
Ski stance (center to center)		81.9 cm (32 1/4")
Ski alignment (toe out)		3.0 mm (1/8")
Torque:		
— steering arm/ski leg bolt		60 N•m (45 lbf•ft)
— steering column/handlebar		26 N•m (19 lbf•ft)
Dry weight	186 kg (410 lb)	192 kg (422 lb)
Bearing area		7579 cm ² (1175 in ²)
Ground pressure	2.45 kPa (.349 PSI)	2.53 kPa (.359 PSI)
POWER TRAIN		
Track:		
— width		38.1 cm (15")
— length		353 cm (139")
— tension		13 mm (1/2") gap between slider shoe and the bottom inside of track.
— alignment		Equal distance between edges of track guides and slider shoes.
Chaincase gear ratio	14/35	17/40
Drive belt:		
— number		414 3758 00
— Max. width		33.3 mm (1 5/16")
— Min. width		30.1 mm (1 3/16")
Chaincase oil capacity		
— SI	200 ml	455 ml
— Imp.	7 oz	16 oz

SKANDIC 377**SKANDIC 377R****ELECTRICAL**

Lighting system (output)	160 W
Bulb:	
— headlamp	60/60 W
— tail/stop	5/21 W
— speedometer	5 W
Spark plug:	
— type	NGK BR8-ES
— gap	0.4 mm (.016")
Ignition timing:	
— timing mark (B.T.D.C.)	2.31 (.091") (20°)
— stroboscopic timing	6000 RPM

FUEL

Gas type	Regular leaded or unleaded
Fuel tank capacity	
— SI	28.4 liters
— Imp.	6.25 gal
— U.S.	7.5 gal
Premixed fuel/oil	
— type	Blizzard oil
— ratio	50:1

BRAKE

Type	Disk	Disk self-adjusting
Lining minimum thickness	3 mm (1/8")	When only 1 mm (1/32") of fixed pad is projected out of caliper.
Control lever adjustment	13 mm (1/2") minimum distance from handlebar grip when fully applied.	

Bombardier Inc. reserves the right to make changes in design and specifications and/or to make additions to, or improvements in its product without imposing any obligation upon itself to install them on its products previously manufactured.

WIRING DIAGRAM

Skandic 377R

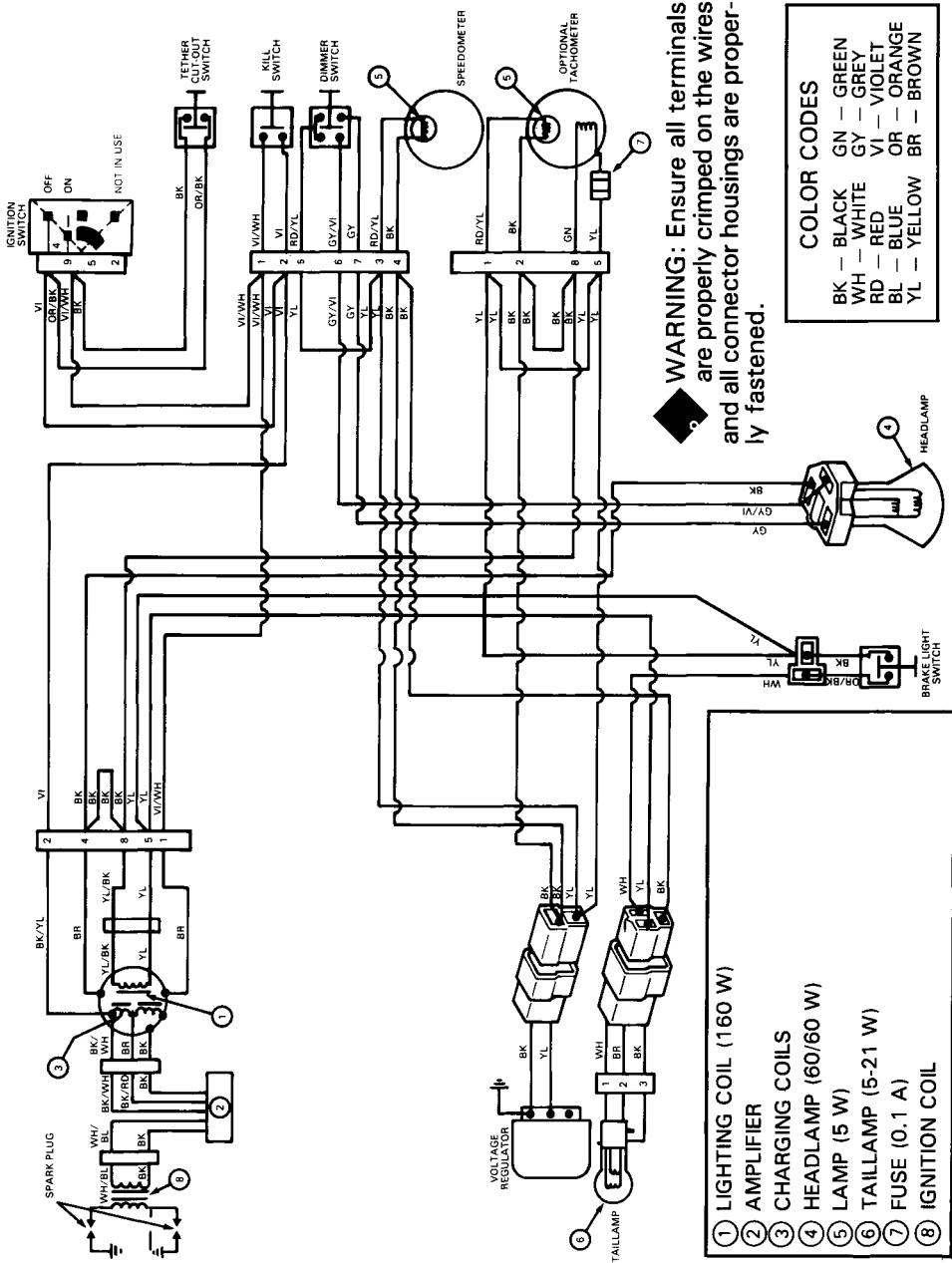

SI * INFORMATION GUIDE

BASE UNITS

DESCRIPTION	UNIT	SYMBOL
length	meter	m
mass	kilogram	kg
force	Newton	N
liquid	liter	l
temperature	celsius	°C
pressure	kilopascal	kPa
torque	Newton meter	N•m
speed	kilometer per hour	km/h

PREFIXES

PREFIX	SYMBOL	MEANING	VALUE
kilo	k	one thousand	1,000
centi	c	one hundredth of a	0.01
milli	m	one thousandth of a	0.001

CONVERSION FACTORS

TO CONVERT	TO †	MULTIPLY BY
lbf•ft	lbf•in	12
imp. oz	U.S. oz	0.96
imp. gal.	U.S. gal.	1.2
in	mm	25.4
in	cm	2.54
ft	m	0.3
mile/h	km/h	1.61
in ²	cm ²	6.45
in ³	cm ³	16.39
imp. oz	ml	28.41
U.S. oz	ml	29.57
imp. gal.	l	4.55
U.S. gal.	l	3.79
oz	g	28.35
lb	kg	0.45
lbf	N	4.4
lbf•in	N•m	0.11
lbf•ft	N•m	1.36
lbf/in ²	kPa	6.89
Fahrenheit	Celsius	(°F - 32) x 5/9
Celsius	Fahrenheit	(°C x 1.8) + 32

* THE INTERNATIONAL SYSTEM OF UNITS (SYSTÈME INTERNATIONAL) ABBREVIATES "SI" IN ALL LANGUAGES.

† TO OBTAIN THE INVERSE SEQUENCE, DIVIDE BY THE GIVEN FACTOR EG: TO CONVERT MM TO IN DIVIDE BY 25.4.

NOTES

CHANGE OF ADDRESS AND OWNERSHIP

Any change in address or ownership should be brought to the attention of the manufacturer by completing and sending out the card supplied below.

NOTICE TO ALL NEW OWNERS: Make sure to receive the warranty registration card from the previous owner, at the time the ownership is transferred. Also enclose a photocopy of this registration card when informing of a change of ownership.



CHANGE OF ADDRESS

VEHICLE IDENTIFICATION NUMBER

--	--	--	--	--	--	--	--	--	--	--	--	--	--	--	--	--	--	--	--

OLD ADDRESS:

NAME _____

NO _____ STREET _____ APT _____

CITY _____ STATE/PROVINCE _____ ZIP/POSTAL CODE _____

NEW ADDRESS:

NAME _____

NO _____ STREET _____ APT _____

CITY _____ STATE/PROVINCE _____ ZIP/POSTAL CODE _____



CHANGE OF OWNERSHIP

VEHICLE IDENTIFICATION NUMBER

--	--	--	--	--	--	--	--	--	--	--	--	--	--	--	--	--	--	--	--

The ownership of this vehicle is transferred

FROM:

NAME _____

NO _____ STREET _____ APT _____

CITY _____ STATE/PROVINCE _____ ZIP/POSTAL CODE _____

TO:

NAME _____

NO _____ STREET _____ APT _____

CITY _____ STATE/PROVINCE _____ ZIP/POSTAL CODE _____



STAMP

BOMBARDIER INC.
ATT.: WARRANTY DEPARTMENT
VALCOURT, QUEBEC
CANADA, J0E 2L0

STAMP

BOMBARDIER INC.
ATT.: WARRANTY DEPARTMENT
VALCOURT, QUEBEC
CANADA, J0E 2L0