

SUNBELT

377

377E

447

Grand Luxe

**OPERATOR'S
MANUAL**

1984

model _____

V.I.N. _____

purchase date _____

warranty expiry date _____

To be completed by dealer at time of sale

DEALER IMPRINT AREA

AFTER SALES SERVICE
BOMBARDIER INC.
VALCOURT, QUEBEC
CANADA, JOE 2L0



The following are trademarks of Bombardier Inc.

BOMBARDIER	EVEREST	MOTO-SKI
SKI-DOO	CITATION	FUTURA
ALPINE	OLYMPIQUE	SPIRIT
BLIZZARD	T'NT	NUVIK
CARRY-BOOSE	SKANDIC	MIRAGE
ELAN	NORDIK	SUPER SONIC
ELITE	SAFARI*	ULTRA SONIC
GRAND PRIX SPECIAL		SONIC

FOREWORD

The operator manual and the Snowmobile Safety Handbook have been prepared to acquaint the owner / operator of a new snowmobile with the various vehicle controls, maintenance and safe operating instructions. Each is indispensable for the proper use of the product, and should be kept with the vehicle at all times.

Should you have any questions pertaining to the warranty and its application, please consult the "Often Asked Questions" section of this manual, or your selling dealer.

This manual uses the following symbols.

 **WARNING:** Identifies an instruction which, if not followed, could cause personal injury.

 **CAUTION:** Denotes an instruction which, if not followed, could severely damage vehicle components.

 **NOTE:** Indicates supplementary information needed to fully complete an instruction.

Although the mere reading of such information does not eliminate the hazard, your understanding of the information will promote its correct use.

 **WARNING:** The engines and the corresponding components identified in this manual should not be utilized on product(s) other than those mentioned on the cover page of this manual.

Most specifications are given in both metric and customary units. Where precise accuracy is not required, some conversions are rounded to even numbers for easier use.

A shop manual can be obtained for complete service, maintenance and repair information.

SAFETY IN MAINTENANCE

Observe the following precautions:

- Throttle mechanism should be checked for free movement before starting engine.
- The snowmobile engine can be stopped by activating the emergency cut-out or tether switches or turning off the key.
- Clean and check operation of the headlight and tail light and brake light.
- Engine should be running only when belt guard and/or pulley guard is secured in place.
- Never run the engine without drive belt installed. Running an unloaded engine can prove to be dangerous.
- Never run the engine when the track is raised off the ground.
- It can be dangerous to run engine with the hood removed.
- Gasoline is flammable and explosive under certain conditions. Always manipulate in a well ventilated area. Do not smoke or allow open flames or sparks in the vicinity. If gasoline fumes are noticed while driving, the cause should be determined and corrected without delay.
- Maintain your vehicle in top mechanical condition at all times.
- Your snowmobile is not designed to be driven or operated on black top, bare earth, or other abrasive surfaces. On such surfaces abnormal and excessive wear of critical parts is inevitable.

- Your snowmobile is not designed to be operated on public streets, road or highways. In most States and Provinces, it is considered an illegal operation.
- Installation of other than standard equipment, including ski-spreaders, bumpers, pack racks, etc., could severely affect the stability and safety of your vehicle. Avoid adding on accessories that alter the basic vehicle configuration.
- Whenever the vehicle is parked outdoors, overnight or for a long period, it is suggested to protect it against the inclemency of the weather with a snowmobile cover.
- Do not lubricate throttle and/or brake cables and housings.
- Only perform procedures as detailed in this manual. Unless otherwise specified, engine should be turned OFF for all lubrication and maintenance procedures.

◆ WARNING: Should removal of a nylon lock nut be required when undergoing repairs/disassembly, always replace by new ones. Tighten as specified in the applicable Shop Manual.

PLEASE READ AND UNDERSTAND ALL WARNINGS AND CAUTIONS IN THIS MANUAL AND ON THE VEHICLE.

THIS MANUAL SHOULD REMAIN WITH THE VEHICLE AT THE TIME OF RESALE.

INDEX

THE 1984 "LIMITED WARRANTY"	4
OFTEN ASKED QUESTIONS	6
LISTING OF AREA DISTRIBUTORS	8
HOW TO IDENTIFY YOUR SNOWMOBILE	9
CONTROLS/INSTRUMENTS	
Throttle lever, brake lever, ignition switch, light switch, headlamp dimmer switch, emergency cut-out switch, tether cut-out switch, rewind starter handle, primer, adjustable steering handle, speedometer, tachometer, high beam pilot lamp, oil level pilot lamp, fuel gauge/tank cap, hood opening, retractable headlamp lever, tool box, fuse holders	10
BREAK-IN PERIOD	
Break-in, 10 hour-inspection, inspection check list	13
FUEL	
Recommended gasoline, recommended oil, oil injection system	15
PRE-START CHECK	
Check points	15
STARTING PROCEDURE	
Manual starting, electric starting, before riding, emergency starting	16
LUBRICATION	
Frequency, steering mechanism, drive axle, slide suspension, chaincase oil level, oil injection system	17
MAINTENANCE	
Chart, belt guard removal, drive belt removal, drive belt condition, new drive belt, brake condition, brake adjustment, spark plugs, battery, suspension condition, suspension adjustment, track condition, track tension and alignment, drive pulley, steering mechanism, steering adjustment, muffler attachments, engine head nuts, engine mount nuts, carburetor adjustment, oil injection system, fan belt, headlamp beam aiming, bulb replacement, general inspection	20
STORAGE	
Track, suspension, skis, controls, chaincase, drive pulley, engine and primer lubrication, fuel tank and carburetor, battery, chassis, general inspection	29
PRE-SEASON PREPARATION	
Pre-season preparation chart	32
TROUBLE SHOOTING	33
TOOLS	35
SPECIFICATIONS	36
WIRING DIAGRAMS	38
SI INFORMATION GUIDE	40
CHANGE OF ADDRESS OR OWNERSHIP	43

THE 1984 LIMITED WARRANTY _____

1 - PERIOD

BOMBARDIER® INC. as manufacturer, warrants FROM THE DATE OF FIRST CONSUMER SALES, every 1984 SKI-DOO® snowmobile, sold as NEW AND UNUSED, by an authorized SKI-DOO dealer for a period of:

- 12 consecutive months.

2 - WHAT BOMBARDIER WILL DO

BOMBARDIER will repair and/or replace, at its option, components defective in material and/or workmanship (under normal use and service,) with a genuine BOMBARDIER component without charge for parts or labour, at any authorized SKI-DOO dealer during said warranty period.

3 - CONDITION TO HAVE WARRANTY WORK PERFORMED

Present to the servicing dealer, the hard copy of the BOMBARDIER Warranty Registration card received by the customer from the selling dealer at time of purchase.

4 - WARRANTY TRANSFER

This warranty is transferable to subsequent owner(s) for remainder of warranty period from original date of sale.

5 - EXCLUSIONS - ARE NOT WARRANTED

- Normal wear on all items such as, but not limited to:
 - drive belts
 - slider shoes
 - spark plugs
 - bulbs
 - runners on skis
- Replacement parts and/or accessories which are not genuine BOMBARDIER parts and/or accessories.
- Damage resulting from installation of parts other than genuine BOMBARDIER parts.
- Damage caused by failure to provide proper maintenance as detailed in the Operator Manual. The labour, parts and lubricants costs of all maintenance services, including tune-ups and adjustments will be charged to the owner.
- Wet cells battery.
- Vehicles designed and/or used for racing purposes.
- All optional accessories installed on the vehicle.
(The normal warranty policy for parts and accessories, if any, applies).
- Damage resulting from accident, fire or other casualty, misuse, abuse or neglect.
- Damage resulting from operation of the snowmobile on surfaces other than snow.

-
- Damage resulting from modification to the snowmobile not approved in writing by BOMBARDIER.
 - Losses incurred by the snowmobile owner other than parts and labour, such as, but not limited to, transportation, towing, telephone calls, taxis, or any other incidental or consequential damages.

6 - BATTERY WARRANTY:

- 12 consecutive months. (Pro-rated.)

100% warranty coverage will start on the date the snowmobile was purchased and run to the following April 30th. The remainder of the 12 months period will be pro-rated as follows:

- 50% from April 30th to December 1st.
- 40% from December 1st to December 31st.
- 30% from January 1st to end of warranty.

Some states or provinces do not allow the exclusion or limitation of incidental or consequential damages, so the above limitation or exclusion may not apply.

7 - EXPRESSED OR IMPLIED WARRANTIES

This warranty gives you specific rights, and you may also have other legal rights which may vary from state to state, or province to province. Where applicable this warranty is expressly in lieu of all other expressed or implied warranties of BOMBARDIER, its distributors and the selling dealer, including any warranty of merchantability of fitness for any particular purpose; otherwise the implied warranty is limited to the duration of this warranty. However, some states or provinces do not allow limitations on how long an implied warranty lasts, so the above limitation may not apply.

Neither the distributor, the selling dealer, nor any other person has been authorized to make any affirmation, representation or warranty other than those contained in this warranty, and if made, such affirmation, representation or warranty shall not be enforceable against BOMBARDIER or any other person.

BOMBARDIER INC. reserves the right to modify its warranty policy at any time, being understood that such modification will not alter the warranty conditions applicable to vehicles sold while the above warranty is in effect.

8 - CONSUMER ASSISTANCE

If a servicing problem or other difficulty occurs, we suggest the following:

1. Try to resolve the problem at the dealership with the Service Manager or Owner.
2. If this fails, contact your area distributor listed in the Operator Manual.
3. Then if your grievance still remains unsolved, you may write to us:

Bombardier Inc.
Service Department
Recreational Products Division
Valcourt, Quebec, Canada, JOE 2LO

February 1983
Bombardier Inc.
Valcourt, Quebec, Canada, JOE 2LO

®*Trademarks of Bombardier Inc.

OFTEN ASKED QUESTIONS

Q: Why must my snowmobile be registered? After all I do have my original invoice as proof of when I purchased my snowmobile.

A: Your warranty is valid at any authorized dealer of the product. Your registration is the key element in providing the servicing dealer with the necessary data to complete warranty claim forms. This information is also used to notify owners in the event of a safety recall.

Q: I bought my snowmobile in O'King County but I snowmobile in Washington County. Can the dealer in Washington County accept to perform warranty work on my snowmobile?

A: Yes, any authorized dealer in North America can perform warranty repairs, providing the customer warranty registration card is presented.

Q: Where can I find information on the lubrication and maintenance of my snowmobile?

A: In this Operator Manual provided with the vehicle at the time of first sale.

Q: Will the entire warranty be void or cancelled, if I do not operate or maintain my new snowmobile exactly as specified in the Operator's Manual?

A: The warranty of the new snowmobile cannot be "Voided" or "Cancelled". However, if a particular failure is caused by operation or maintenance other than is shown in the Operator Manual, THAT failure may not be covered under warranty. This includes service work performed by the customer, especially the critical adjustments to ignition, timing, carburation and oil injection/or oil mixture.

Q: Would you give some examples of abnormal use or strain, neglect or abuse?

A: These terms are general and overlap each other in areas. Some specific examples may include: running the machine out of oil, chain failure caused by a lack of lubrication, operating the machine with a broken or damaged part which causes another part to fail, and so on. If you have any specific questions on operation or maintenance, please contact your dealer for advice.

Q: What costs are my responsibility during the warranty period?

A: The customer's responsibility includes all costs of normal maintenance services, non-warranty repairs, accidents and collision damage, as well as oils, and spark plugs, and incidental or consequential damages costs as explained in the warranty.

Q: Are "Genuine" Bombardier replacement parts used in warranty repairs covered by warranty?

A: Yes. When installed by an authorized dealer, any "genuine" Bombardier part used in warranty repairs assumes the remaining warranty that exists on the machine.

Q: If I sell my snowmobile within the warranty period, will the new owner qualify for the balance of the warranty?

A: Yes, provided the unit has already been registered with the manufacturer. Note that the change of ownership card in this manual should be completed and sent to Bombardier Inc.

Q: How can I receive the best owner assistance?

A: The satisfaction and goodwill of the owners of Bombardier products are of primary concern to your dealer and Bombardier Inc. Normally, any problems that arise in connection with the sales transaction or the operation of your snowmobile will be handled by your Dealers Sales or Service Departments. It is recognized, however, that despite the best intentions of everyone concerned, misunderstandings will sometimes occur. If you have a problem that has not been handled to your satisfaction through normal channels, we suggest that you discuss your problem with a member of dealership management. Frequently, complaints are the result of a breakdown in communications and can quickly be resolved by a member of the dealership management. If the problem already has been reviewed with the Sales Manager or Service Manager, contact the Dealer himself or the General Manager.

LISTING OF AREA DISTRIBUTORS

CANADIAN DISTRIBUTORS

BOMBARDIER INC.
EASTERN CANADA DISTRIBUTION DIVISION
Atlantic Branch
P.O. Box 670
Shediac, New Brunswick, E0A 3G0
(506) 386-6117
Magdalen Island, Nova Scotia, New Brunswick, Prince Edward Island

Quebec Branch
1350 Nobel Boulevard
Boucherville, Quebec, J4B 1A1
(514) 655-6121
Province of Quebec

Ontario Branch
230 Bayview Drive
Barrie, Ontario, L4N 4Y8
(705) 728-8600
Province of Ontario

BROOKS EQUIPMENT LIMITED
1616 King, Edward Street
P.O. Box 985
Winnipeg, Manitoba, R3C 2V8
(204) 633-7247
British Columbia, Manitoba, Saskatchewan, Alberta, Yukon

CHARLES R. BELL LIMITED
Newfoundland, Labrador
Offices
- Riverside Drive
P.O. Box 1050
Corner Brook, Newfoundland, A2H 6J3
(709) 634-3533
- 81 Kenmount Road
P.O. Box 8127
St-John's, Newfoundland, A1B 3N1
(709) 722-6700

HUDSON'S BAY CO. LTD.
165 Hymus Blvd
Pointe-Claire, Quebec, H9R 1G2
(514) 697-8500
North-West Territories, Franklin District & Keewatin

AMERICAN DISTRIBUTORS

BOMBARDIER CORPORATION
All States (excluding Alaska)

SERVICE OFFICES
- P.O. Box 6106
Shediac, New Brunswick, E0A 3G0
(506) 386-6117

- 4505 West Superior Street
P.O. Box 6106
Duluth, Minnesota 55806
(218) 628-2881

- P.O. Box 1569
Idaho Falls, Idaho, 83401
(208) 529-9510

NATIONAL SALES OFFICE
- O'Hare Lake Plaza
2350 Devon Avenue
Suite 150
Des Plaines, Illinois 60018
(312) 298-9540

MILLER EQUIPMENT AND RECREATIONAL CENTER
1049 Whitney Road
Anchorage, Alaska 99501
(907) 274-9513
Alaska

HOW TO IDENTIFY YOUR SNOWMOBILE

The main components of your snowmobile (engine, track and frame) are identified by different serial numbers. It may sometimes become necessary to locate these numbers for warranty purposes or to trace your snowmobile in the event of theft.

ENGINE
SERIAL
NUMBER

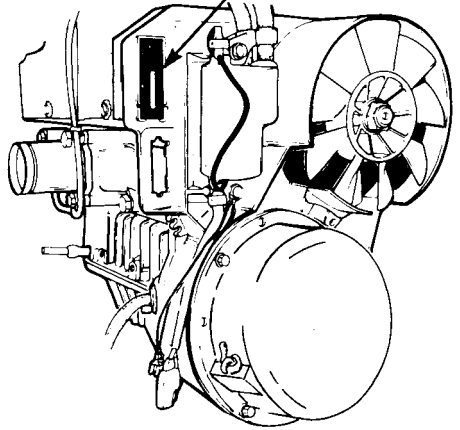

TRACK
SERIAL
NUMBER

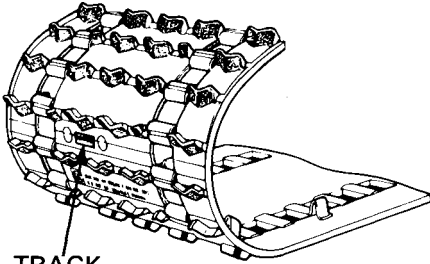

VEHICLE SERIAL NUMBER

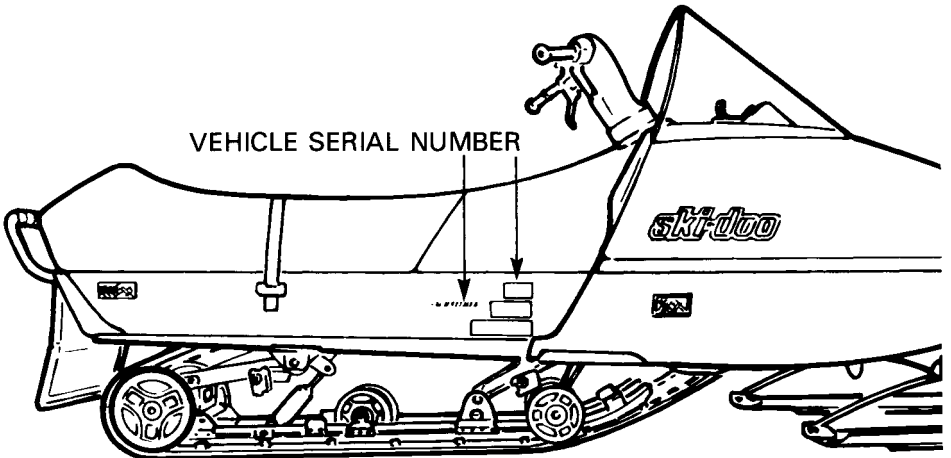

○ NOTE: We strongly recommend that you take note of all the serial numbers on your vehicle and supply them to your insurance company. It will surely help in the event a snowmobile is stolen.

CONTROLS/INSTRUMENTS

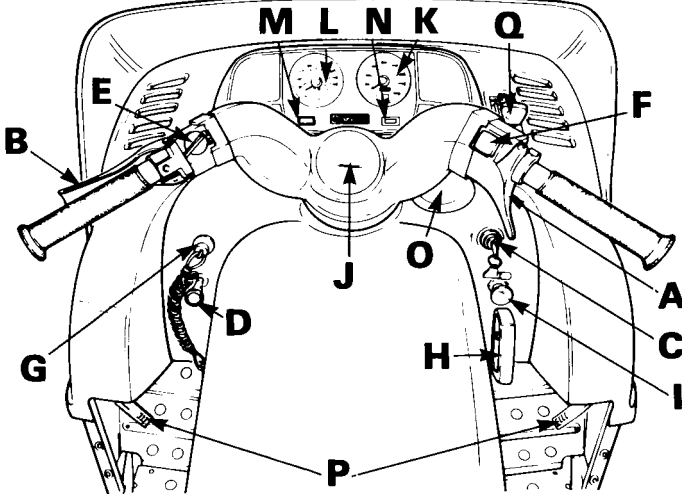

- A) Throttle lever
- B) Brake lever
- C) Ignition switch
- D) Light switch (Safari 377E & Grand Luxe)
- E) Headlamp dimmer switch
- F) Emergency cut-out switch
- G) Tether cut-out switch
- H) Rewind starter handle
- I) Primer
- J) Adjustable steering handle

- K) Speedometer (Safari 447 & Grand Luxe)
- L) Tachometer (Safari Grand Luxe)
- M) High beam pilot lamp (Safari 447 & Grand Luxe)
- N) Oil level pilot lamp (Safari 447 & Grand Luxe)
- O) Fuel Gauge/Tank Cap
- P) Hood opening
- Q) Retractable headlamp lever

A) Throttle Lever

Located on the right side of handlebar. When compressed, it controls the engine speed and the engagement of the transmission. When released, engine speed returns automatically to idle.

B) Brake Lever

Located on the left side of handlebar. When compressed, the brake is applied. When released, it automatically returns to its original position. Braking effect is proportionate to the pressure applied on the lever and to the type of terrain and its snow coverage.

C) Ignition Switch

Safari 377 & 447

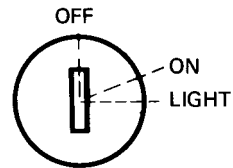

Key operated 3 position switch. To start engine, first turn key clockwise to ON position. To stop engine, turn key counter-clockwise to OFF position.

To put lights on while engine is running, turn key to LIGHT position.

Safari 377E & Grand Luxe

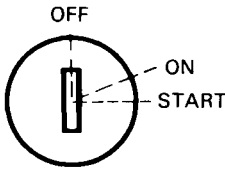

Key operated, 3 position switch. To start engine, turn key fully clockwise to START position and hold. Return key to ON position immediately when engine has started. To stop engine, turn key counter-clockwise to OFF position.

CAUTION: Holding key in START position when engine has started could damage starter mechanism.

D) Light Switch

(Safari 377E & Grand Luxe)

To illuminate headlamp and taillight, pull switch knob. (Ignition switch must be turned to ON position).

E) Headlamp Dimmer Switch

The dimmer switch allows correct selection of headlamp beam. To obtain high or low beam simply flick switch.

F) Emergency Cut-Out Switch

To stop the engine in an emergency, push the button to the lower off position and simultaneously apply the brakes. To start engine, button must be at the upper on position.

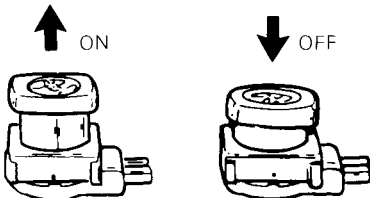

Upper position
Before starting

Lower position
to stop engine

The driver of this vehicle should familiarize himself with the function of this device by using it several times on first outing. Thereby being mentally prepared for emergency situations requiring its use.

WARNING: If the switch has been used in an emergency situation the source of malfunction should be determined and corrected before re-starting engine.

G) Tether Cut-Out Switch

Attach tether cord to wrist or other convenient location of the driver's clothing. Snap tether cut-out cap over receptacle before starting engine.

If emergency engine "shut off" is required, completely pull cap from safety switch and engine power will be automatically shut "off".

NOTE: The cap must be installed on the safety switch at all times in order to operate the vehicle.

WARNING: If the switch is used in an emergency situation the source of malfunction should be determined and corrected before re-starting engine.

H) Rewind Starter Handle

Auto rewind type located on right hand side of vehicle. To engage mechanism, pull handle.

I) Primer

Pull and push button (2-3 times) to activate primer. The primer should always be used for cold engine starts. After engine is warm however, it is not necessary to use primer when starting.

J) Adjustable Steering Handle

- Remove steering pad.
- Loosen the four (4) retaining screws.
- Adjust the handle to the desired position.

◆ **WARNING:** Do not adjust too high as the brake lever may contact the windshield when turning.

- Lock the steering handle in place by tightening the four (4) retaining screws to 26 N•m (19 ft-lbs).
- Reinstall steering pad.

K) Speedometer

(Safari 447 & Grand Luxe)

The speedometer is linked directly to the drive axle. Direct-reading dial indicates the speed of the vehicle. Odometer records the total distance travelled in kilometers.

L) Tachometer

(Safari Grand Luxe)

The tachometer registers the impulses of magneto. Direct-reading dial indicates the number of revolutions per minute (RPM) of the engine.

▼ **CAUTION:** The tachometer is protected by a fuse, if tachometer stops operating check fuse condition and if necessary replace. The fuse is 0.1 amp. Do not use a higher rated fuse as this can cause severe damage to the tachometer.

M) High Beam Pilot Lamp

(Safari 447 & Grand Luxe)

Lights up when headlamp is on high beam.

N) Oil Level Pilot Lamp

(Safari 447 & Grand Luxe)

Will light up when injection oil level is low. Check level and replenish as soon as possible.

▼ **CAUTION:** Do not run engine until it is out of oil. Serious engine damage will occur.

Whenever brake lever is compressed, oil level pilot lamp should light up. If not, replace lamp.

O) Fuel Gauge/Tank Cap

Unscrew fuel tank cap and withdraw dipstick to check fuel level.

◆ **WARNING:** Never use a lit match or open flame to check fuel level.

P) Hood Opening

Pull down the latches to unlock the hood from the anchor.

○ **NOTE:** Always lift hood gently up until stopped by restraining device.

◆ **WARNING:** It is dangerous to run an engine with the hood open, unfastened or removed. Personal injury could result.

Q) Retractable Headlamp Lever

Push lever forward to expose headlamp. To retract, pull lever backward.

Tool Box

Located under the hood. To gain access, tilt hood. Ideal location for spare plugs, rope, first aid kit, flashlight, etc...

Fuse Holders

Safari 377E & Grand Luxe

Starting system is protected with a 30 amperes rated fuse. Fuse holder is located near the starter. If starter does not operate, check fuse condition and if necessary replace.

Ignition switch and instruments are protected with a 15 amperes rated fuse. Fuse holder is located near the injection oil tank. If instruments stop operating, check fuse condition and if necessary replace.

Safari Grand Luxe only

The tachometer is protected with 0.1 ampere rated fuse. Fuse holder is located under the hood behind the tachometer. If it stops operating, check fuse condition and replace if necessary.

BREAK-IN PERIOD

With Bombardier-Rotax snowmobile engines, a break-in period is required before running the vehicle at full throttle. Engine's manufacturer recommendation is 10 to 15 operating hours. During this period, maximum throttle should not exceed $3/4$, however, brief full acceleration and speed variations contribute to a good break-in. Continued wide open throttle accelerations, prolonged cruising speeds, and lugging are detrimental during the break-in period.

 **CAUTION:** Remove and clean spark plugs after engine break-in.

 **NOTE:** A new drive belt requires a break-in period of 15-25 km (10-15 miles).

10-Hour Inspection

As with any precision piece of mechanical equipment, we suggest that after the first 10 hours of operation or 30 days after the purchase, whichever comes first, your vehicle be checked by your dealer. This inspection will give you the opportunity to discuss the unanswered questions you may have encountered during the first hours of operation. Remember that it is easier to remedy at this time than to allow the snowmobile to operate until a possible failure occurs.

The 10 hours inspection is at the expense of the vehicle owner.

10-HOUR INSPECTION CHECKLIST	
Engine timing	
Fan belt tension	
Spark plugs condition: (Remove and clean)	
Carburetor adjustment	
Oil injection pump adjustment	
Engine head nuts	
Engine mount nuts	
Muffler attachment	
Chaincase oil level	
Injection system oil level	
Brake operation and lining condition	
Ski alignment (runners condition)	
Steering arm, retorque to 60 N•m (45 ft-lbs)	
Handlebar bolts, retorque to 26 N•m (19 ft-lbs)	
Pulley alignment and drive belt condition	
Track condition, tension and alignment	
Lubrication (steering, suspension, drive axle)	
Electrical wiring (loose connections, stripped wires, damaged insulation), tighten all loose bolts, nuts and linkage	
Operation of lighting system (HI / LO beam, brake light, etc.), test operation of emergency cut-out switch and tether switch	
Battery electrolyte level (Safari 377E & Grand Luxe)	

We recommend that you have your dealer sign this inspection list.

Date of 10 hour inspection

Dealer signature

FUEL

Recommended Gasoline

Use regular leaded gasoline available from all service stations.

▼ **CAUTION:** Never experiment with different fuel or fuel ratios. Never use naphtha, methanol, gasohol or similar products.

◆ **WARNING:** Never "top up" the gas tank before placing the vehicle in a warm area. At certain temperatures, gasoline will expand and overflow. Always wipe off any gasoline spillage from the snowmobile.

Recommended Oil

Use "Bombardier Snowmobile Injection Oil" (P/N 496 0133 00 - 1 liter) available from your dealer. This type of oil will flow at temperatures as low as minus 40°C (-40°F).

If "Bombardier Snowmobile Injection Oil" is unavailable, substitute with "Bombardier 50:1 Snowmobile Oil".

▼ **CAUTION:** Never use outboard or straight mineral oils.

Oil Injection System

Always maintain a sufficient amount of Bombardier Snowmobile injection oil in the injection oil tank.

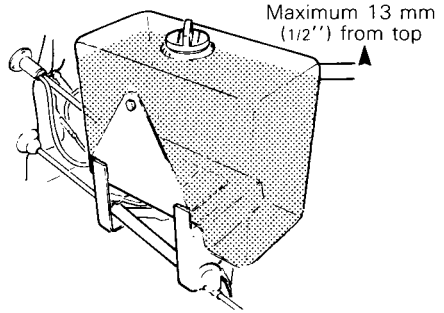

▼ **CAUTION:** Check level and refill every time you refuel.

○ **NOTE:** To assure additional protection during the initial engine break-in, 450 ml (16 oz.) of Bombardier Snowmobile Injection oil should be added to the first full fuel tank filling.

PRE-START CHECK

Check Points

- ACTIVATE THE THROTTLE CONTROL LEVER SEVERAL TIMES to check that it operates easily and smoothly. The throttle control lever must return to idle position when released.
- Check that the skis and the track are not frozen to the ground or snow surface and that steering operates freely.

- Activate the brake control lever and make sure the brake fully applies before the brake control lever touches the handlebar grip.
- Check injection oil level.
- Check fuel level.
- Verify that the path ahead of the vehicle is clear of bystanders and obstacles.

◆ **WARNING:** Only start your snowmobile once all components are checked and functioning properly.

STARTING PROCEDURE

Test throttle control lever.

Check that the emergency cut-out switch is in the ON position.

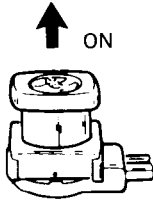

Upper position
before starting engine

Ensure the tether cut-out cap is in position and that the cord is attached to your clothing.

Activate the primer (2 or 3 times).

○ **NOTE:** The use of the primer is not necessary when the engine is warm.

Manual Starting

(All Models)

Insert the key in the ignition and turn to ON position.

Grasp manual starter handle firmly and pull slowly until a resistance is felt then pull vigorously. Slowly release the rewind starter handle.

◆ **WARNING:** Do not apply throttle while starting.

Electric Starting

(Safari 377E & Grand Luxe)

▼ **CAUTION:** Never operate your snowmobile with the battery removed or disconnected.

Insert key in ignition switch.

Turn ignition key clockwise until starter engages.

▼ **CAUTION:** To avoid starter overheating, the cranking period should never exceed 30 seconds and a rest period should be observed between the cranking cycles to let starter cool down.

Release key immediately when engine has started. If engine does not start on first try, key must be turned fully back to OFF each time.

◆ **WARNING:** Do not apply throttle while starting.

○ **NOTE:** If for some reason the vehicle cannot be started electrically, place ignition key to ON position and start engine manually.

Before Riding

Check operation of the emergency cut-out switch, and tether switch. Restart engine.

◆ **WARNING:** If engine does not shut-off when applying the emergency cut-out switch and or when pulling the tether cut-out cap, stop the engine by turning off the ignition key. Do not operate the vehicle further, see your dealer.

Allow the engine to warm before operating at full throttle.

Emergency Starting

Should the rewind starter rope fray and break, the engine can be started with an emergency starter rope.

◆ **WARNING:** Do not start the vehicle by the drive pulley unless it is a true emergency situation, have the vehicle repaired as soon as possible.

Attach emergency rope to starter grip. Remove the belt guard from the vehicle and wind the emergency rope tight around the drive pulley between the sliding half and the roller guard. Start the engine as per usual manual starting.

◆ **WARNING:** When starting the vehicle in an emergency situation by the drive pulley, do not make a knot at the end of the emergency rope and do not reinstall the belt guard.

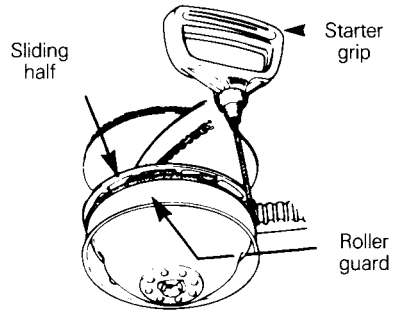

LUBRICATION

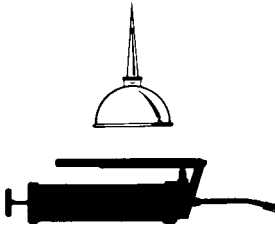

Frequency

Routine maintenance is necessary for all mechanized products, and the snowmobile is no exception. A weekly vehicle inspection contributes to the life span of the snowmobile as well as retains safe and dependable operation. It is recommended that the steering system and suspension be lubricated monthly or every 40 hours of operation. If the vehicle is operated in wet snow or in severe conditions these items should be lubricated more frequently.

◆ **WARNING:** Only perform such procedures as detailed in this manual. It is recommended that dealer assistance be periodically obtained on

other components/systems not covered in this manual. Unless otherwise specified, engine should be turned OFF for all lubrication and maintenance procedures.

Steering Mechanism

◆ **WARNING:** Do not lubricate throttle and/or brake cables and housings.

Lubricate the ski legs and spring coupler bolts at grease fittings until new grease appears at joints.

Coat spring slider cushion with grease.

Oil ball joints and steering column bushings.

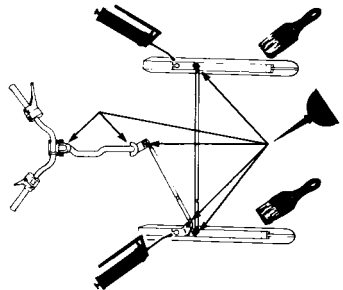

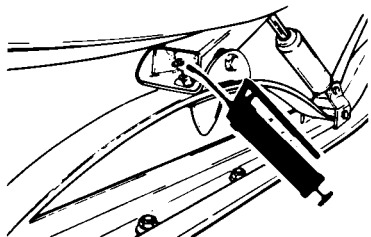

Drive Axle

Lubricate at grease fitting using low temperature grease.

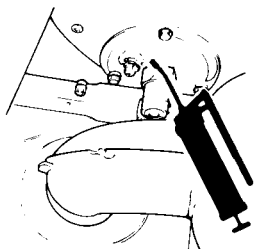

CAUTION: When lubricating the drive axle bearing, do not apply excessive grease as the seal will be pushed out of its housing. Check seal position with finger.

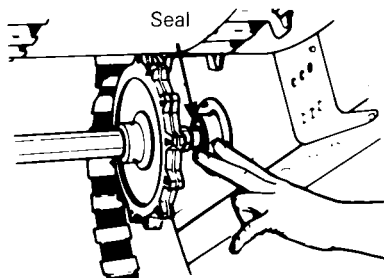

Slide Suspension

Lubricate idler wheels at grease fittings until grease appears at joints. Use low temperature grease only.

Also lubricate front & rear arms at grease fittings.

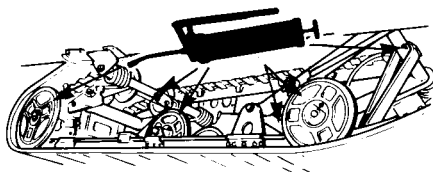

○ **NOTE:** A needle fitted unto grease gun must be used to lubricate idler wheels.



Chaincase Oil Level

Using the spark plug socket, remove the filler cap then using a rigid wire as a "dipstick" check oil level. The oil level on the "dipstick" should be 50-65 mm (2" to 2 1/2"). Replenish as necessary.

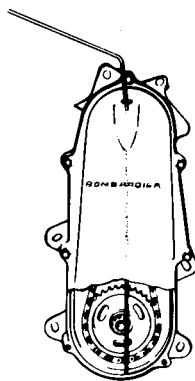

○ **NOTE:** The chaincase oil capacity is approximately 200 ml (7 oz.).

Oil Injection System

Always maintain a sufficient amount of Bombardier Snowmobile Injection Oil in the injection oil tank.

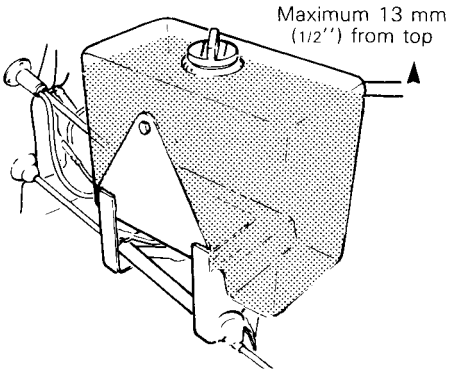

▼ **CAUTION:** Check level and refill every time you refuel.

MAINTENANCE

The following Maintenance Chart indicates regular servicing schedules to be performed by you or your servicing dealer. If these services are performed as suggested, your snowmobile will give you many years of low-cost use.

WARNING: Only perform such procedures as detailed in this manual. It is recommended that dealer assistance be periodically obtained on other components/systems not covered in this manual. Unless otherwise specified, engine should be turned OFF for all lubrication and maintenance procedures.

MAINTENANCE CHART	Weekly or every 240 km (150 mi)	Monthly or every 800 km (500 mi)	Once year or every 3200 km (2000 mi)	Refer to page
Drive belt condition	•			21
Brake condition	•			22
Brake adjustment		•		22
Spark plugs		•		22
Battery (Safari 377E & Grand Luxe)	•			23
Suspension condition		•		23
Suspension adjustment	(as required)			23
Track condition		•		24
Track tension and alignment		•		24
Drive pulley		•		25
Steering mechanism		•		25
Steering adjustment		•		25
Muffler attachment		•		26
Engine head nuts			•	26
Engine mount nuts			•	26
Carburetor adjustment			•	26
Injection oil filter condition		•		27
Oil injection pump adjustment			•	27
Fan belt			•	27
Headlamp beam aiming			•	28
General inspection		•		28

NOTE: The ten hour inspection is a very important part of proper service and maintenance.

Belt Guard Removal

◆ **WARNING:** Engine should be running only when belt guard is secured in place.

1. Tilt the hood.
2. Pull out both retaining pins.

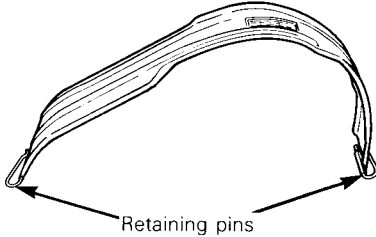

3. Lift and remove the belt guard assembly.

Drive Belt Removal

◆ **WARNING:** Never start or run engine without the drive belt installed. Running an unloaded engine is dangerous.

1. Remove the belt guard.
2. Unlock and raise driven pulley support.

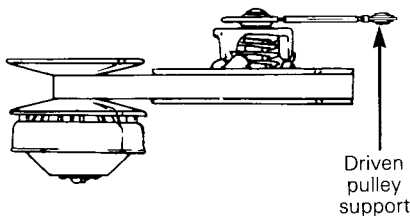

3. Open the driven pulley by twisting and pushing the sliding half. Hold in fully open position.



4. Slip slackened belt over the top edge of the sliding half.

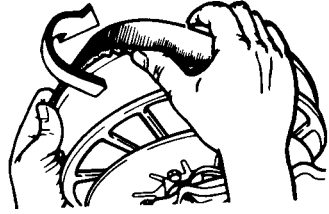

5. Slip the belt out from the drive pulley and remove completely from vehicle.

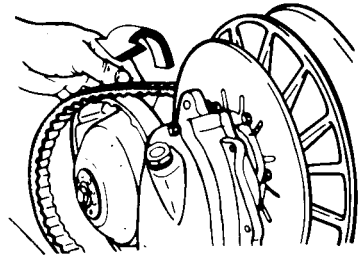

To install the drive belt, reverse the procedure.

Drive Belt Condition

Inspect belt for cracks, fraying or abnormal wear (uneven wear, wear on one side, missing cogs, cracked fabric). If abnormal wear is noted, probable cause could be pulley misalignment, excessive R.P.M. with frozen track, fast starts without warm-up period, burred sheave, oil on belt or distorted spare belt. Contact your dealer.

Check the drive belt width. If less than 32 mm (1 1/4 in), replace the drive belt.

New Drive Belt

When installing a new drive belt, break-in period of 25 km (15 miles) is strongly recommended.

○ **NOTE:** Always store a spare belt in a manner to allow its natural shape to be maintained.

Brake Condition

The brake mechanism on your snowmobile is an essential safety device. Keep this mechanism in proper working condition. Above all, do not operate your snowmobile without an effective brake system.

◆ **WARNING:** Brake pads less than 3 mm (1/8") thick must be replaced. Replacement must be performed by an authorized dealer.

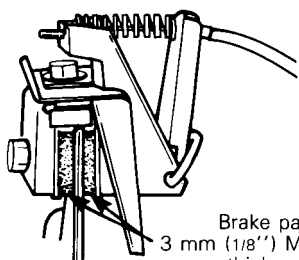

Brake pads
3 mm (1/8") MINIMUM
thickness

Brake Adjustment

The brake mechanism is a self-adjusting type. If a quicker brake response is desired, strongly pull the brake lever several times, this will actuate the self adjusting mechanism.

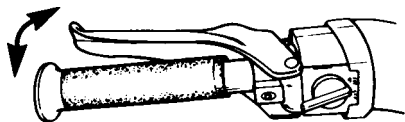

Strongly pull

After the adjustment, brake should apply fully when lever is approximately 13 mm (1/2") from handlebar grip. If not, do not tamper with the brake, contact your servicing dealer.

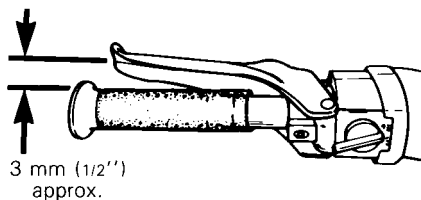

Spark Plugs

Disconnect the spark plug wires and remove the spark plugs.

Check the condition of the plugs.

- A brownish tip reflects ideal conditions. (Carburetor adjustments, spark plug heat range, etc., are correct.)
- A black insulator tip indicates fouling caused by: carburetor idle speed mixture and/or high speed mixture too rich, incorrect fuel mixture ratio, wrong type of spark plug (heat range), or excessive idling.
- A light grey insulator tip indicates a lean mixture caused by: carburetor high speed mixture adjusted too lean, wrong spark plug heat range, incorrect fuel mixture ratio, or a leaking seal or gasket.

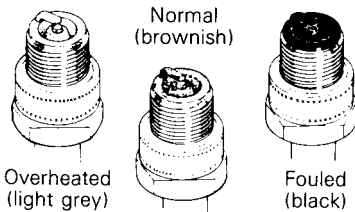

▼ **CAUTION:** If spark plug condition is not ideal, contact your authorized dealer.

Check spark plug gap using a wire feeler gauge.

Reinstall plugs and connect wires.

Battery

(Safari 377E & Grand Luxe)

Check electrolyte level weekly. Electrolyte level must be at upper level line on battery casing.

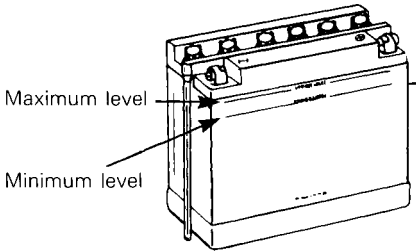

If necessary add distilled water. Battery connections must also be free of corrosion. If cleaning is necessary remove corrosion using a stiff brush then clean with a solution of baking soda and water. Rinse and dry well.

CAUTION: Do not allow cleaning solution to enter battery. It will destroy the chemical properties of the electrolyte.

After reconnecting battery, coat battery terminals and connectors with petroleum jelly to prevent corrosion. Check that battery is well secured and that battery vent tube is not kinked or blocked.

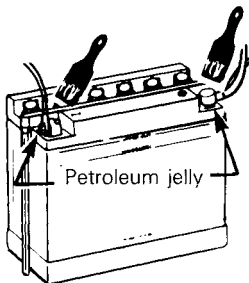

WARNING: Vent tube must be free and open. If not, it will restrict ventilation and create a gas accumulation that could result in an explosion. Avoid skin contact with electrolyte.

CAUTION: Prior to charging the battery, always remove it from the vehicle to prevent electrolyte spillage.

NOTE: Always keep battery fully charged. (To charge, refer to "Battery" in "Storage" section).

Suspension Condition

Visually inspect all suspension components including slider shoes, springs, wheels, etc...

NOTE: During normal driving, snow will act as a lubricant and coolant for the slider shoes. Extensive riding on ice or sanded snow, will create excessive heat build-up and cause premature slider shoe wear.

Suspension Adjustment

The suspension is adjustable. The front adjustment for surface condition, the rear for driver's weight. Use the special key located in tool box.

Adjuster blocks

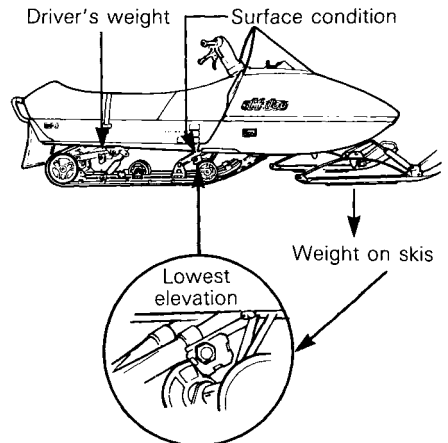

When the front adjuster blocks are at the lowest elevation more weight is distributed on the skis.

At the highest position the weight is transferred from the skis to the track. The rear adjuster blocks should be adjusted to suit the driver's preference.

○ **NOTE:** For deep snow condition or hill climbing, it is recommended to place the front adjuster blocks on the highest position.

▼ **CAUTION:** Always turn the left side adjuster blocks in a clockwise direction, the right side blocks in a counter-clockwise direction. Left and right adjuster blocks of each adjustment must always be set at the same elevation.

Track Condition

Lift the rear of the vehicle and support it off the ground. With the engine off, rotate the track by hand, and inspect condition. If worn, or cut, or if track fibers are exposed, or if missing or defective inserts or guides are noted; contact your dealer.

◆ **WARNING:** Do not operate a snowmobile with a cut, torn or damaged track.

Track Tension and Alignment

Tension:

Lift the rear of vehicle and support with a mechanical stand. Allow the slide to extend normally. The gap should be between 9.5 mm ($3/8''$) and 13 mm ($1/2''$) between the slider shoe and the bottom inside of the track when a weight of 2.95 kg (6.5 lbs) is applied on track. If the track tension is too loose, the track will have a tendency to thump.

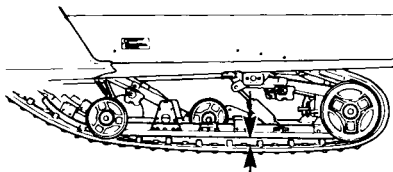

9.5 mm to 13 mm ($3/8$ to $1/2''$)

▼ **CAUTION:** Too much tension will result in power loss and excessive stresses on suspension components.

If necessary to adjust; loosen the rear idler wheel retaining screw and the adjuster bolt lock nut; then loosen or tighten the adjuster bolts located on the inner side of the rear idler wheels. If correct tension is unattainable, contact your dealer.

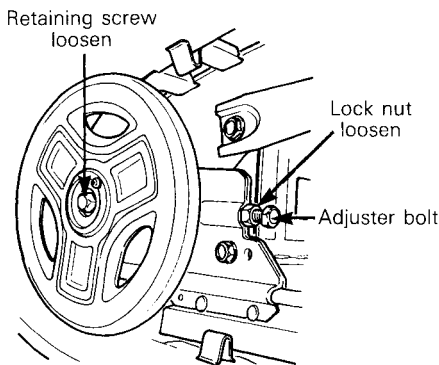

○ **NOTE:** Track tension and alignment are inter-related. Do not adjust one without the other.

Alignment

Start the engine and accelerate slightly so that track turns **slowly**. Check that the track is well centered; equal distance on both sides between edges of track guides and slider shoes.

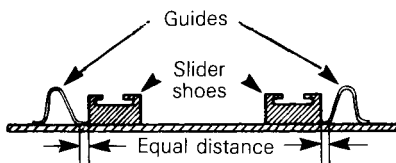

WARNING: Before checking track alignment, ensure that the track is free of all particles which could be thrown out while track is rotating. Keep hands, tools, feet and clothing clear of track. Ensure no-one is standing in close proximity to the vehicle.

To correct, stop the engine, loosen the rear idler wheels retaining screws then loosen the lock nuts and tighten the adjuster bolt on side where the slider shoe is the furthest to the track insert guides.

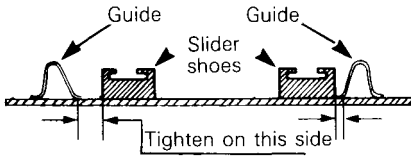

Tighten lock nuts and recheck the alignment. Ensure to retighten the idler wheel retaining screws.

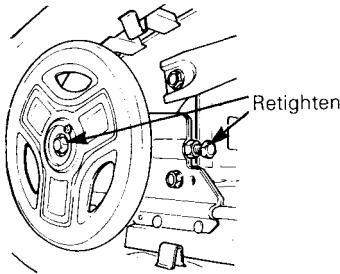

Drive Pulley

Inspect the Duralon bushing condition by checking the free-play of the sliding half pulley. This is achieved by restraining the inner half and checking if the sliding half moves in the direction of the arrows more than 3 mm (1/8"). If so, contact your dealer.

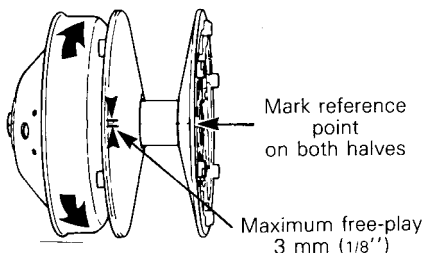

Steering Mechanism

Inspect the steering mechanism for tightness of components (steering arms, tie rods, ball joints, spring coupler bolts, etc.). If necessary, replace or retighten.

Torque steering arm bolts as illustrated below:

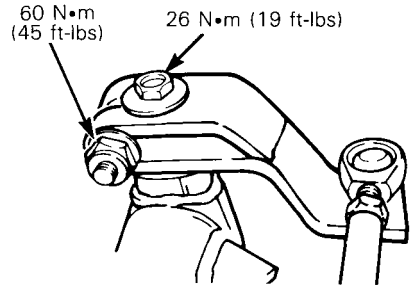

Check the condition of the skis and the ski runners. Replace if more than half worn.

Steering Adjustment

Skis should have a toe out of 3 mm (1/8"). To check, measure the distance between each ski at the front and rear of the leaf springs. The front distance should be 3 mm (1/8") more than the rear when the handlebar is horizontal.

IMPORTANT: Close the front of the skis manually to eliminate all slack from the steering mechanism.

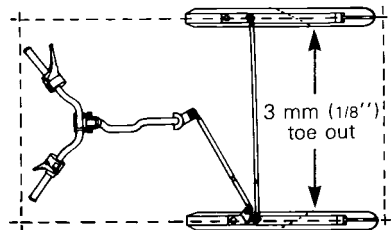

If adjustment is required:

Loosen the lock nuts of the longest tie rod. Turn the tie rod manually until the skis are properly aligned. Firmly retighten the lock nuts.

The handlebar should also be horizontal when the skis are pointed toward the front.

To adjust:

Loosen the lock nuts of the shortest tie rod. Turn the tie rod manually until the handlebar is horizontal. Retighten the lock nuts firmly.

◆ **WARNING:** The ball joint socket must run parallel with the steering arm. The socket must be restrained when tightening the tie rod end lock nuts.

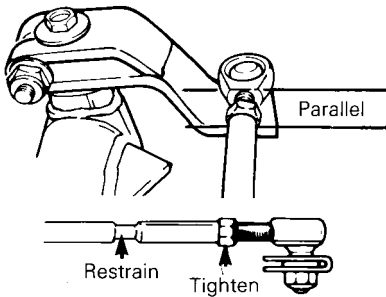

Muffler Attachment

The engine/exhaust system parts are vital toward efficient muffler function. Check all attachments. Replace the springs and/or tighten if necessary.

▼ **CAUTION:** Do not operate vehicle with muffler disconnected otherwise serious engine damage will occur.

Engine Head Nuts

With the engine cold, check that the engine head nuts are tight and equally torqued to 22 N•m (16 ft-lbs). Follow the illustrated sequence.

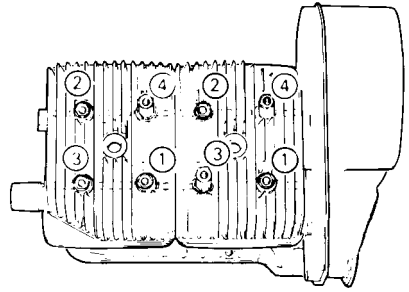

IMPORTANT: The engine head nut torque should be checked after the first 5 hours of operation.

Engine Mount Nuts

Check the engine mount nuts for tightness. Retighten if necessary.

Carburetor Adjustment

▼ **CAUTION:** Never operate your snowmobile with the air intake silencer disconnected. Serious engine damage will occur if this notice is disregarded.

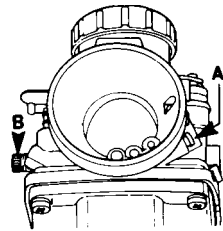

A) Air Screw Adjustment

Completely close the air screw (until a slight reseating resistance is felt) then back off screw: 1 1/2 turn.

B) Idle Speed Adjustment

Turn the idle speed screw clockwise until it contacts the throttle slide then continue turning two (2) additional turns. This will provide a preliminary idle speed setting. Start engine and allow it to warm then adjust idle speed to 1800-2000 R.P.M. by turning idle speed screw clockwise or counter-clockwise.

▼ **CAUTION:** Do not attempt to set the idle speed by using the air screw. Severe engine damage can occur. If idle speed is unattainable contact your authorized dealer.

Oil Injection System

Injection Oil Filter Condition

Inspect oil filter at least once a month. Insure that filter is not obstructed by foreign particles; if so, see your dealer.

▼ **CAUTION:** An obstructed injection oil filter will cause oil starvation resulting in serious engine damage.

○ **NOTE:** After a storage period, it is important that your dealer replaces the injection oil filter and that he verifies the oil flow of the injection pump.

Injection Pump Adjustment

Proper oil injection pump adjustment is very important. Any delay in the opening of the pump can result in serious engine damage.

▼ **CAUTION:** The carburetor must be adjusted before adjusting the oil injection pump.

To check adjustment: eliminate the throttle cable free-play by pressing the throttle lever until a light resistance is felt then hold in place. The aligning marks on the pump casting and lever must align perfectly. If not, contact your dealer.

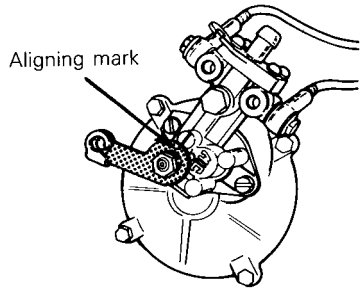

○ **NOTE:** Injection pump should be adjusted by your dealer.

Fan Belt

Inspect belt for cracks, uneven wear, etc. Check fan belt tension, 9-10 mm (3/8'') free-play should exist when deflection is correct.

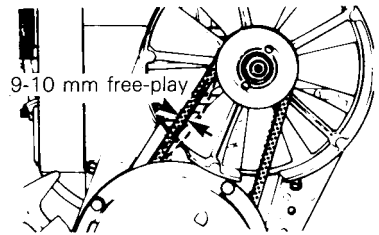

If belt seems damaged or if tension is incorrect, contact your dealer immediately.

◆ **WARNING:** If fan protector is removed, always reinstall after servicing.

Headlamp Beam Aiming

The angle of the headlamp beam has been pre-adjusted prior to delivery. Should you wish re-adjustment, place the vehicle on a flat surface 7.6 m (25') from a wall or screen.

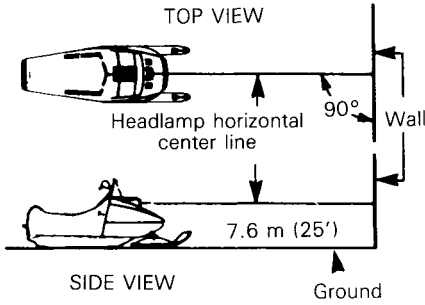

With the suspension correctly adjusted, the rider seated on the vehicle and the high beam ON check that the center of high intensity zone of high beam is 50 mm (2'') below horizontal line of headlamp height.

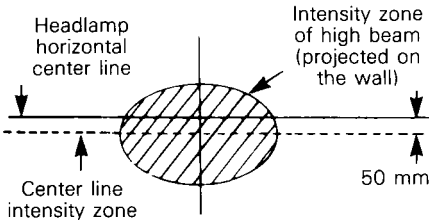

To adjust, remove the four caps, turn upper or lower adjusting screws to obtain desired beam position.

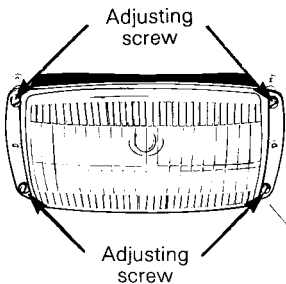

Bulb Replacement

If the headlamp bulb is burnt, tilt hood, unplug the connector from the headlamp. Remove the rubber boot and unfasten bulb retainer clips. Detach the bulb and replace.

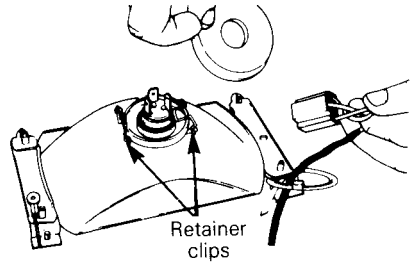

If taillight bulb is burnt, expose the bulb by removing the red plastic lens. To remove, unfasten the two (2) screws.

WARNING: Always check light operation after bulb replacement.

General Inspection

Check the electrical wiring and components, retighten loose connections. Check for stripped wires or damaged insulation. Thoroughly inspect the vehicle and tighten loose bolts, nuts and linkage. Inspect skis and ski runners for wear.

STORAGE

It is during summer, or when a vehicle is not in use for any length of time that proper storage is a necessity. Storage of the snowmobile during long period of inactivity consists of checking and replacing missing, broken or worn parts, proper lubrication and treatment to insure that parts do not become rusted; cleaning items such as carburetor of oil mixtures, to prevent gum varnish formation within the carburetor; and in general, preparing the vehicle so that when the time comes to use the snowmobile again it will be in top condition.

◆ **WARNING:** Only perform such procedures as detailed in this manual. It is recommended that dealer assistance be periodically obtained on other components/systems not covered in this manual. Unless otherwise specified, engine should be turned OFF.

Track

Inspect the track for wear, cuts, missing track guides and broken rods. Make any necessary replacement.

◆ **WARNING:** Do not operate a snowmobile with a cut, torn or damage track.

Lift the rear of vehicle until track is clear of the ground then support with a brace or trestle. The snowmobile should be stored in such a way that the track does not stay in contact with the cement floor or bare ground.

○ **NOTE:** The track should be rotated periodically, (every 40 days). Do not release track tension.

▼ **CAUTION:** To prevent track damage, temperature in the storage area must not exceed 38°C (100°F).

Suspension

Remove any dirt or rust. Grease all components equipped with grease fittings. Wipe off surplus. Replace worn slider shoes.

Skis

Wash or brush all dirt or rust accumulation from the skis and springs. Grease the ski legs at the grease fittings. Check the condition of the skis, ski runners and leaf springs. Replace if weak or worn more than half.

Controls

Lubricate the steering mechanism. Inspect all components for tightness, (spring coupler bolts, steering arm locking bolts, tie rods, ball joints etc.). Tighten if necessary. Oil moving joints of the brake mechanism.

◆ **WARNING:** Do not lubricate the throttle and/or brake cables and housings. Avoid getting oil on the brake pads.

Coat all electrical connections and switches with a greaseless metal protector. If unavailable, use petroleum jelly.

Chaincase

Drain the chaincase and refill to proper level, using fresh chaincase oil. To drain, remove the chaincase cover.

Drive Pulley

Inspection and cleaning must be performed by the dealer at the end of each season.

Engine and Primer Lubrication

Engine internal parts must be lubricated to protect them from possible rust formation during the storage period.

To perform the storage procedures (engine and primer valve) proceed as follows:

1. Lift the rear of the vehicle and support it off the ground.

◆ **WARNING:** Ensure the track is free of all particles which could be thrown out while it is rotating. Keep hands, tools, feet and clothing clear of track. Ensure no-one is standing in close proximity to the vehicle.

2. Start the engine and allow it to run at idle speed until the engine reaches its operational temperature.
3. Stop the engine.
4. Disconnect the inlet primer hose from the primer valve.

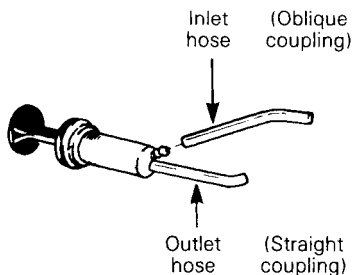

5. Plug inlet primer hose to prevent gasoline from draining.
6. Using an appropriate hose, connect one end of the hose to the inlet of the primer valve and place the other end in a Bombardier Snowmobile Injection Oil container.
7. Activate the primer in order to fill it with oil.
8. Restart engine and run at idle.
9. Using the primer valve, inject oil until the engine dies or until a sufficient quantity of oil has entered the engine (approximately 25 complete strokes of the primer).

10. The engine stopped, remove the spark plugs and pour approximately 85 ml (3 fl. oz. U.S.) of oil into the cylinders.
11. Crank the engine to allow the crankshaft to turn 2 or 3 revolutions.
12. Reinstall the spark plugs and the inlet primer hose.

Do not run engine during storage period.

Fuel Tank and Carburetor

Remove the cap then using a syphon, remove the gasoline from tank.

◆ **WARNING:** Gasoline is flammable and explosive under certain conditions. Always manipulate in a well ventilated area. Do not smoke or allow open flames or sparks in the vicinity.

Carburetor must be dried out completely to prevent gum formation during the storage period.

Once the fuel tank is emptied, remove the float chamber drain plug from carburetor. Drain carburetor.

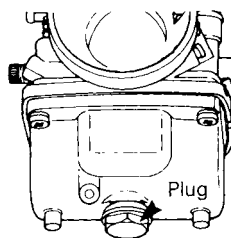

Reinstall plug.

Check all fuel lines, replace if necessary.

Battery

(Safari 377E & Grand Luxe)

1. Disconnect the battery cables and remove the battery retainer cover.

▼ **CAUTION:** Be careful not to ground positive terminal with the chassis. Always disconnect black negative cable first.

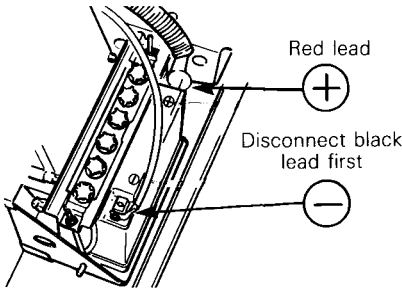

2. Remove the battery vent tube from the vent hole.
3. Lift out the battery.
4. Clean outside surface of battery with solution of baking soda and water. Remove all deposits from posts then rinse with clear tap water.

▼ **CAUTION:** Do not allow cleaning solution to enter battery interior since it will destroy the electrolyte.

5. Check electrolyte level. Refill if necessary with distilled water. Fully charge battery at a maximum rate of 2.0 amps.

▼ **CAUTION:** Prior to charging the battery, always remove it from the vehicle to prevent electrolyte spillage.

◆ **WARNING:** Gases given off by a battery being charged are highly explosive. Always charge in a well ventilated area. Keep battery away from cigarettes or open flames. Avoid skin contact with electrolyte.

6. Coat electrical connections and switches with a greaseless metal protector, if unavailable, use petroleum jelly.
7. Store unit in a cool, dry place.

○ **NOTE:** To prevent battery from discharging, store it on a wooden shelf away from moisture. A stored battery must be recharged at least every 40 days.

Chassis

Clean the vehicle thoroughly, removing all dirt and grease accumulation.

▼ **CAUTION:** Plastic alloy components such as fuel tank, windshield, controls, etc., can be cleaned using mild detergents or isopropyl alcohol. Do not use strong soaps, degreasing solvents, abrasive cleaners, paint thinners, etc.

Inspect the hood and repair any damage. Clean the frame. For the unpainted aluminum portion use only "Aluminum cleaner" and follow instructions on the container.

Touch up all metal spots where paint has been scratched off. Spray all bare metal parts with metal protector. Wax the hood and the painted portion of the frame for better protection.

○ **NOTE:** Apply wax on glossy finish only. Protect the vehicle with a cover to prevent dust accumulation during storage.

▼ **CAUTION:** If for some reason the snowmobile has to be stored outside it is necessary to cover it with an opaque tarpaulin. This caution will prevent the sun rays and the grime from affecting the plastic components and the vehicle finish.

General Inspection

Check the electrical wiring and components, retighten loose connections. Check for stripped wires or damaged insulation.

Thoroughly inspect the vehicle and tighten loose bolts, nuts and linkage.

○ **NOTE:** Leave the drive belt off the pulleys for the entire storage period.

PRE-SEASON PREPARATION

To simplify the pre-season preparation we have drawn up a small chart. The chart indicates servicing points to be performed by you and your servicing dealer. If these services are performed as suggested, your vehicle will give you many hours of fun and low cost use.

IMPORTANT: Observe all Warnings and Cautions mentioned throughout this manual which are pertinent to the item being checked. When component conditions seem less than satisfactory, replace with genuine Bombardier parts or suitable equivalents.

PRE-SEASON PREPARATION CHART	TO BE PERFORMED BY DEALER	•
	TO BE PERFORMED BY OWNER	○
Change spark plugs*		○
Check chaincase oil level		○
Replace fuel filter (located inside fuel tank)		○
Check track tension and alignment		○
Lubricate suspension		○
Inspect drive belt and install		○
Check steering alignment and ski runner condition		○
Inspect condition of starting rope		○
Check tightness of all bolts, nuts and linkage		○
Refill gas tank		○
Check throttle cable for damage and free operation		•
Check electrical wiring (broken wire, damaged insulation)		○
Inspect seals for possible cuts or leaks		•
Replace injection oil filter		•
Refill injection oil tank		•
Inspect brake condition and operation		•
Set engine timing		•
Check pulleys, verify components and clean. Lubricate.		•
Adjust carburetor		•
Adjust oil injection pump		•

○ ***NOTE:** Before installing new spark plugs, it is suggested to burn the excess storage oil by starting the engine, using the old spark plugs..

▼ **CAUTION:** Only perform this procedure in a well ventilated area.

TROUBLE SHOOTING GUIDE

○ NOTE: The possible causes have been listed in an order of frequency. Therefore, items should be checked out in the same order as mentioned in the trouble shooting guide.

SYMPTOMS	POSSIBLE CAUSES	SOLUTIONS
Engine turns over but fails to start or starts with difficulty	1. No fuel to the engine	Check the tank level and fill it up. Check for possible clogging of fuel line, item 4.
	2. Flooded engine	Remove wet spark plugs, turn ignition to OFF and crank engine several times. Install clean dry spark plugs. Start engine following usual starting procedure. If engine continues to flood, see your dealer.
	3. Spark plug/ignition	Check for fouled or defective spark plug. Disconnect spark plug wire, unscrew plug and remove from cylinder head. Reconnect wire and ground exposed plug on engine cowl, being careful to hold away from spark plug hole. Follow engine starting procedure and check for spark. If no sparks appear, replace spark plug. If trouble persists, contact your dealer.
	4. Clogged fuel line (water or dirt)	Remove and clean the fuel filter. Change filter cartridge if necessary. Check condition and connections of fuel lines. Check the cleanliness of fuel tank.
	5. Incorrect carburetor adjustment	Contact your dealer.
	6. Incorrect injection pump adjustment	Contact your dealer.
	7. Engine timing	Engine timing may be incorrect or out of adjustment. Contact your dealer.
	8. Poor engine compression	Running with a lean fuel mixture may produce excessive engine wear resulting in poor engine compression. If this occurs, contact your dealer at once.
Engine will not turn manually	1. Seized engine	In the case of a seized engine contact your dealer.

SYMPTOMS	POSSIBLE CAUSES	SOLUTIONS
Engine lacks acceleration or power	1. Fouled or defective spark plug	Check item 3 of "Engine turns over but fails to start or starts with difficulty"
	2. Clogged fuel line (water or dirt)	Check fuel line condition. (See item 4 of "Engine turns over but fails to start or starts with difficulty").
	3. Carburetor	Contact your dealer.
	4. Ignition	First check item 2 and 3 of "Engine turns over but fails to start or starts with difficulty". If the ignition system still seems faulty, contact your dealer.
	5. Engine	If unable to locate specific symptoms, contact your dealer.
Engine continually backfires	1. Spark plug	Check item 3 of "Engine turns over but fails to start or starts with difficulty".
	2. Overheated	Carburetor too lean, see your dealer.
	3. Engine timing incorrectly set	Contact your dealer.
Snowmobile cannot reach full speed	1. Drive Belt	Check for damaged or worn drive belt. Replace if necessary.
	2. Incorrect track adjustment	Check track tension and alignment. Readjust to specifications. (See Maintenance Section).
	3. Engine	Check item 1 to 5 of "Engine lacks acceleration or power."
	4. Pulley misaligned	Contact your dealer.

TOOLS

As standard equipment each new snowmobile is supplied with basic tools such as screwdriver, wrenches, emergency starter rope, etc...

Standard Tools

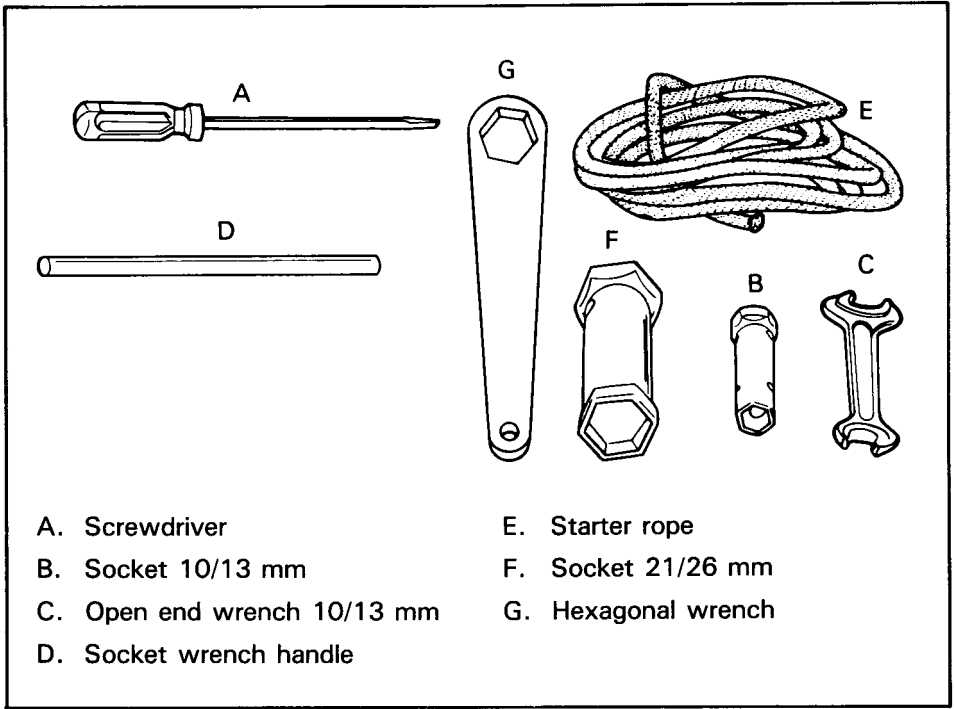

A. Screwdriver

B. Socket 10/13 mm

C. Open end wrench 10/13 mm

D. Socket wrench handle

E. Starter rope

F. Socket 21/26 mm

G. Hexagonal wrench

SPECIFICATIONS

	377 & 377E	447	Grand Luxe
ENGINE			
Type	377	447	447
No. of cylinders	2	2	2
Bore	62 mm (2.440")	67.5 mm (2.657")	67.5 (2.657")
Stroke	61 mm (2.401")	61 mm (2.401")	61 mm (2.401")
Displacement	368.3 cm ³ (22.47 in ³)	436.6 cm ³ (26.64 in ³)	436.6 cm ³ (26.64 in ³)
Compression ratio (corrected)	6.9:1	6.3:1	6.3:1
Maximum R.P.M.	7500	7500	7500
Carburetor type	Mikuni VM 34	Mikuni VM 34	Mikuni VM 34
Carburetor adjustment:			
– air screw	1 1/2 turn out	1 1/2 turn out	1 1/2 turn out
– idle speed	1800-2000 R.P.M.	1800-2000 R.P.M.	1800-2000 R.P.M.
Fan belt free-play	9-10 mm (3/8")	9-10 mm (3/8")	9-10 mm (3/8")
Torque:			
– engine head nuts	M8: 22 N•m (16 ft-lbs)	M8: 22 N•m (16 ft-lbs)	M8: 22 N•m (16 ft-lbs)
– crankcase nuts	M6: 9 N•m (6 ft-lbs)	M6: 9 N•m (6 ft-lbs)	M6: 9 N•m (6 ft-lbs)
	M8: 22 N•m (16 ft-lbs)	M8: 22 N•m (16 ft-lbs)	M8: 22 N•m (16 ft-lbs)
– magneto ring nut	M22: 85 N•m (63 ft-lbs)	M22: 85 N•m (63 ft-lbs)	M22: 85 N•m (63 ft-lbs)
– fan nut	M16: 65 N•m (48 ft-lbs)	M16: 65 N•m (48 ft-lbs)	M16: 65 N•m (48 ft-lbs)
– crankcase engine support nuts	M10: 38 N•m (28 ft-lbs)	M10: 38 N•m (28 ft-lbs)	M10: 38 N•m (28 ft-lbs)
– exhaust manifold bolts	M8: 22 N•m (16 ft-lbs)	M8: 22 N•m (16 ft-lbs)	M8: 22 N•m (16 ft-lbs)
– electrical starter bolts	M8: 22 N•m (16 ft-lbs)	N.A.	M8: 22 N•m (16 ft-lbs)
	M5: 4 N•m (3 ft-lbs)	N.A.	M5: 4 N•m (3 ft-lbs)
CHASSIS			
Overall length	266.7 cm (105")	279.4 cm (110")	279.4 cm (110")
Overall width	96.5 cm (38")	96.5 cm (38")	96.5 cm (38")
Overall height	96.5 cm (38")	96.5 cm (38")	96.5 cm (38")
Ski stance (center to center)	81.9 cm (32.25")	81.9 cm (32.25")	81.9 cm (32.25")
Ski alignment (toe out)	3 mm (1/8")	3 mm (1/8")	3 mm (1/8")
Torque:			
– steering arm/ski leg bolt	43 N•m (32 ft-lbs)	43 N•m (32 ft-lbs)	43 N•m (32 ft-lbs)
– steering column/handlebar	26 N•m (19 ft-lbs)	26 N•m (19 ft-lbs)	26 N•m (19 ft-lbs)
Weight	177 kg (390 lbs) manual 194 kg (428 lbs) electric	183 kg (402 lbs)	195 kg (429 lbs)
Bearing area	6645 cm ² (1030 in ²) manual 7064 cm ² (1095 in ²) electric	7593 cm ² (1177 in ²)	7593 cm ² (1177 in ²)
Ground pressure	2.61 kPa (.379 lbs/in ²) manual 2.69 kPa (.391 lbs-in ²) electric	2.35 kPa (.342 lbs/in ²)	2.51 kPa (.364 lbs-in ²)

	377 & 377E	447	Grand Luxe
POWER TRAIN			
Track:			
— width	38.1 cm (15") manual 41.9 cm (16 1/2") electric	41.9 cm (16 1/2")	41.9 cm (16 1/2")
— length	289.5 cm (114")	314.9 cm (124")	314.9 cm (124")
— tension	13 mm (1/2") gap between slider shoe and bottom inside of track.		
— alignment	Equal distance between edges of track guides and slider shoes.		
Standard gear ratio	16/34	19/39	19/39
Drive belt:			
— number	414 5233 00	414 5233 00	414 5233 00
— Max. width	34.92 mm (1 3/8")	34.92 mm (1 3/8")	34.92 mm (1 3/8")
— Min. width	31.74 mm (1 1/4")	31.74 mm (1 1/4")	31.74 mm (1 1/4")
Chaincase oil	200 ml (7 oz)	200 ml (7 oz)	200 ml (7 oz)
ELECTRICAL			
Lighting system (output)	12 V. 160 watts	12 V. 160 watts	12 V. 160 watts
Bulb:			
— headlamp	60/60 W	60/60 W	60/55 W (H4-Halogen)
— tail/stop	5/21 W	5/21 W	5/21 W
— speedometer	N.A.	5W	5W
— tachometer	N.A.	N.A.	5W
Fuse:			
— ignition switch	15A (electric model)	N.A.	15 A
— starter solenoid	30A (electric model)	N.A.	30 A
— tachometer	N.A.	N.A.	0.1 A
Spark plug			
— type	Nippondenso W24ERSU	Nippondenso W24ERSU	Nippondenso W24ERSU
— gap	0.4 mm (0.016")	0.4 mm (0.016")	0.4 mm (0.016")
Ignition timing:			
— timing mark (B.T.D.C.)	2.31mm (.090") (20°)	1.88 mm (.074") (18°)	1.88 mm (.074") (18°)
— stroboscopic timing	6000 R.P.M.	6000 R.P.M.	6000 R.P.M.
FUEL			
Gas type	Regular leaded or unleaded		
Fuel tank capacity			
— SI	28.64 liters	28.64 liters	28.64 liters
— Imp.	6.3 gals	6.3 gals	6.3 gals
— U.S.	7.56 gals	7.56 gals	7.56 gals
Injection oil			
Type	Bombardier snowmobile injection oil		
Tank capacity			
— SI	2.55 liters	2.55 liters	2.55 liters
— Imp.	2.25 quarts	2.25 quarts	2.25 quarts
— U.S.	2.70 quarts	2.70 quarts	2.70 quarts
BRAKE			
Type	Disc, self-adjusting	Disc, self-adjusting	Disc self-adjusting
Lining minimum thickness	3 mm (1/8")	3 mm (1/8")	3 mm (1/8")
Control lever adjustment	13 mm (1/2") minimum distance from handlebar grip when fully applied.		

N.A.: Not applicable

Bombardier Inc. reserves the right to make changes in design and specifications and/or to make additions to, or improvements in its product without imposing any obligation upon itself to install them on its products previously manufactured.

WIRING DIAGRAM

Safari 377 & 447

WARNING: Ensure all terminals are properly crimped on the wires and all connector housings are properly fastened.

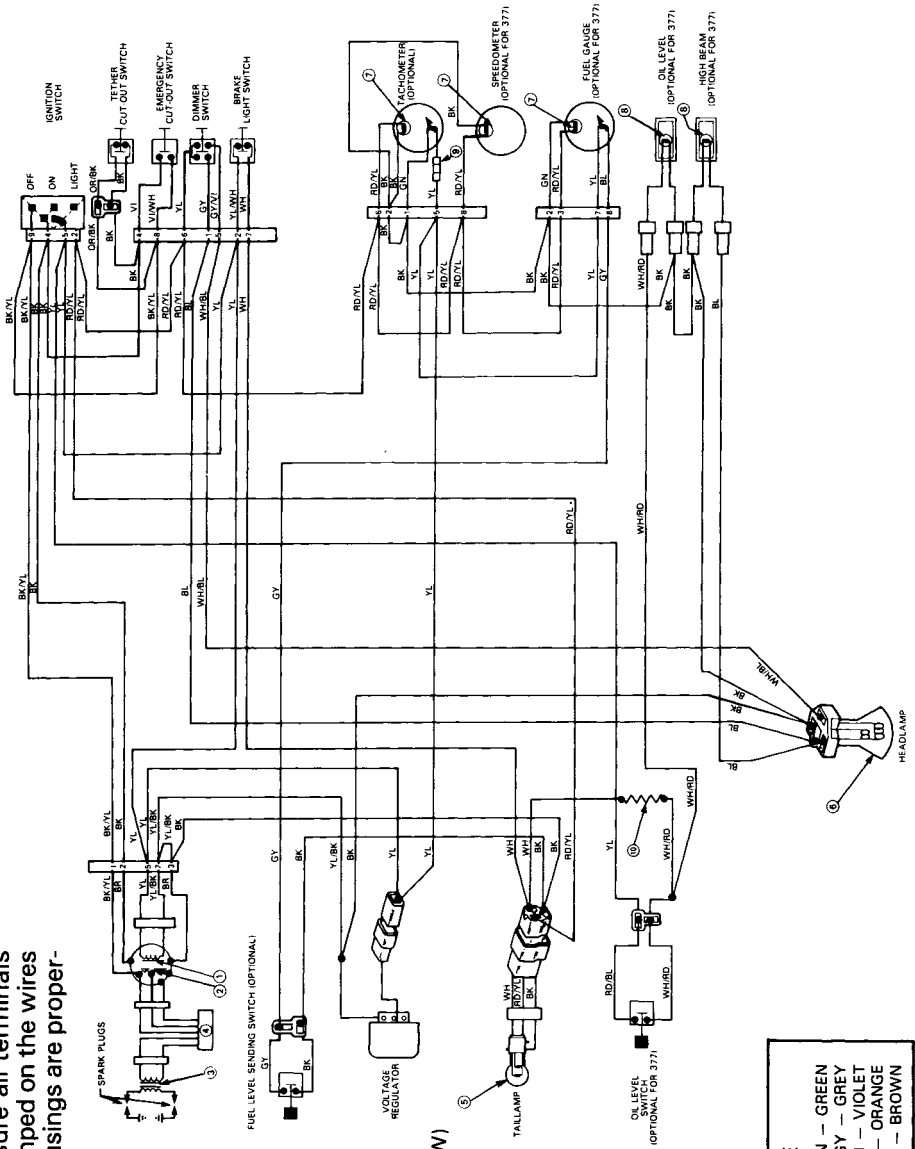

- ① LIGHTING COIL (160W)
- ② GENERATOR COIL
- ③ IGNITION COIL
- ④ AMPLIFIER
- ⑤ BULB 5-21W
- ⑥ BULB 60-60W
- ⑦ BULB 5W
- ⑧ LAMP
- ⑨ FUSE 0.1 A
- ⑩ RESISTOR 30Ω

COLOUR CODE

BK	—	BLACK
WH	—	WHITE
RD	—	RED
BL	—	BLUE
YL	—	YELLOW
GN	—	GREEN
GY	—	GREY
VI	—	VIOLET
OR	—	ORANGE
BR	—	BROWN

WIRING DIAGRAM

Safari 377E & Grand Luxe

- ① LIGHTING COIL (160 W)
- ② GENERATOR COIL
- ③ IGNITION COIL
- ④ AMPLIFIER
- ⑤ BULB 5-21W
- ⑥ BULB 60-60W
- ⑦ BULB 5W
- ⑧ LAMP
- ⑨ BULB 2W
- ⑩ STARTER
- ⑪ SOLENOID SWITCH
- ⑫ FUSE
- ⑬ BATTERY
- ⑭ REGULATOR - RECTIFIER
- ⑮ FUSE 0.1 A
- ⑯ DIODE I-N-4585

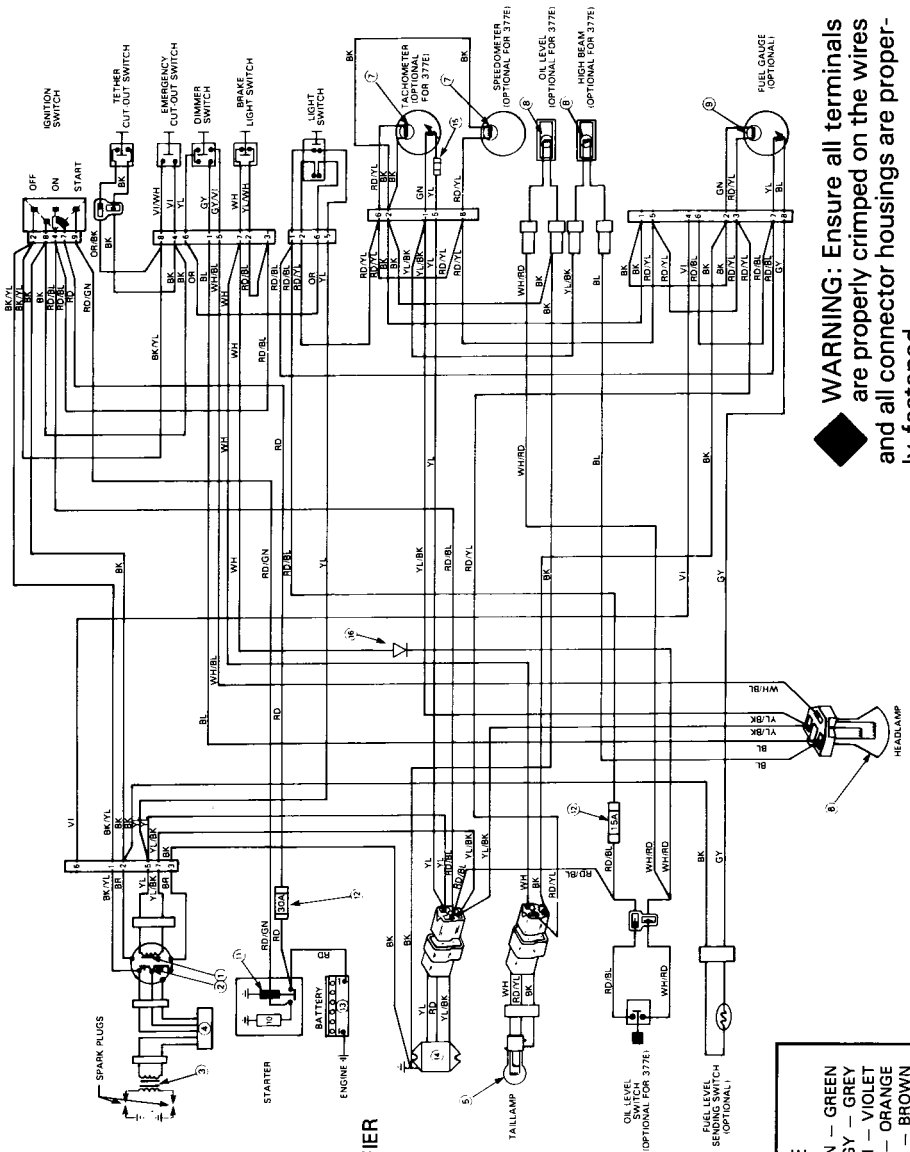

COLOUR CODE

BK	—	BLACK
WH	—	WHITE
RD	—	RED
BU	—	BLUE
YL	—	YELLOW
GN	—	GREEN
GY	—	GREY
VI	—	VIOLET
OR	—	ORANGE
BR	—	BROWN

WARNING: Ensure all terminals are properly crimped on the wires and all connector housings are properly fastened.

SI* INFORMATION GUIDE

BASE UNITS

DESCRIPTION	UNIT	SYMBOL
length	meter	m
mass	kilogram	kg
liquid	liter	L
temperature	celsius	°C
pressure	kilopascal	kPa
torque	Newton meter	N•m
speed	kilometer per hour	km/h

PREFIXES

PREFIX	SYMBOL	MEANING	VALUE
kilo	k	one thousand	1,000
centi	c	one hundredth of a	0.01
milli	m	one thousandth of a	0.001

*THE INTERNATIONAL SYSTEM OF UNITS (SYSTEME INTERNATIONAL) ABBREVIATES "SI" IN ALL LANGUAGES.

NOTES

NOTES

CHANGE OF ADDRESS AND OWNERSHIP

Any change in address or ownership should be brought to the attention of the manufacturer by completing and sending out the card supplied below.

NOTICE TO ALL NEW OWNERS: Make sure to receive the warranty registration card from the previous owner, at the time the ownership is transferred. Also enclose a photocopy of this registration card when informing of a change of ownership.

CHANGE OF ADDRESS

VEHICLE IDENTIFICATION NUMBER

--	--	--	--	--	--	--	--	--	--	--	--	--	--	--	--	--	--	--	--

OLD ADDRESS:

NAME		
NO	STREET	APT.
CITY	STATE/PROVINCE	ZIP / POSTAL CODE

NEW ADDRESS:

NAME		
NO	STREET	APT.
CITY	STATE/PROVINCE	ZIP / POSTAL CODE

CHANGE OF OWNERSHIP

VEHICLE IDENTIFICATION NUMBER

--	--	--	--	--	--	--	--	--	--	--	--	--	--	--	--	--	--	--	--

The ownership of this vehicle is transferred

FROM:

NAME		
NO	STREET	APT.
CITY	STATE/PROVINCE	ZIP / POSTAL CODE

TO:

NAME		
NO	STREET	APT.
CITY	STATE/PROVINCE	ZIP / POSTAL CODE

BOMBARDIER INC.
ATT.: WARRANTY DEPARTMENT
VALCOURT, QUEBEC
CANADA, J0E 2L0

BOMBARDIER INC.
ATT.: WARRANTY DEPARTMENT
VALCOURT, QUEBEC
CANADA, J0E 2L0