

---

---

---

---

---

# Alpine®

1983  
OPERATOR'S  
MANUAL



414-8025-90

---

---

---

---

---

model \_\_\_\_\_

V.I.N. \_\_\_\_\_

purchase date \_\_\_\_\_

warranty expiry date \_\_\_\_\_

To be completed by dealer at time of sale

DEALER IMPRINT AREA

Technical Publication  
After Sales Service  
Bombardier Inc.  
Valcourt, Quebec  
Canada, J0E 2L0

The following are trademarks of Bombardier Inc.

BOMBARDIER	EVEREST	MOTO-SKI
SKI-DOO	CITATION	FUTURA
ALPINE	OLYMPIQUE	SPIRIT
BLIZZARD	T'NT	NUVIK
CARRY-BOOSE	SKANDIC	MIRAGE
ELAN	NORDIK	SUPER SONIC
ELITE		ULTRA SONIC
GRAND PRIX SPECIAL		SONIC

# FOREWORD

The operator's Manual and the Snowmobile Safety Handbook have been prepared to acquaint the owner / operator of a new snowmobile with the various vehicle controls, maintenance and safe operating instructions. Each is indispensable for the proper use of the product, and should be kept with the vehicle at all times.

Should you have any questions pertaining to the warranty and its application, please consult the "Often Asked Question" section of this manual, or your selling dealer.

This manual uses the following symbols.

 **WARNING:** Identifies an instruction which, if not followed, could cause personal injury.

 **CAUTION:** Denotes an instruction which, if not followed, could severely damage vehicle components.

 **NOTE:** Indicates supplementary information needed to fully complete an instruction.

Although the mere reading of such information does not eliminate the hazard, your understanding of the information will promote its correct use.

Most specifications are given in both metric and customary units. Where precise accuracy is not required, some conversions are rounded to even numbers for easier use.

A shop manual can be obtained for complete service, maintenance and repair information.

# SAFETY IN MAINTENANCE

## Observe the following precautions:

- Throttle mechanism should be checked for free movement before starting engine.
  - The snowmobile engine can be stopped by activating the emergency cut-out or tether switches or turning off the key.
  - Clean and check operation of the headlight, tail light and brake light.
  - Engine should be running only when belt guard and/or pulley guard is secured in place.
  - Never run the engine without drive belt installed. Running an unloaded engine can prove to be dangerous.
  - Never run the engine when the track is raised off the ground.
  - It can be dangerous to run engine with the hood removed.
  - Gasoline is flammable and explosive under certain conditions. Always manipulate in a well ventilated area. Do not smoke or allow open flames or sparks in the vicinity. If gasoline fumes are noticed while driving, the cause should be determined and corrected without delay.
  - Maintain your vehicle in top mechanical condition at all times.
  - Your snowmobile is not designed to be driven or operated on black top, bare earth, or other abrasive surfaces. On such surfaces abnormal and excessive wear of critical parts is inevitable.
  - Your snowmobile is not designed to be operated on public streets, road or highways. In most States and Provinces, it is considered an illegal operation.
  - Installation of other than standard equipment, including ski-spreaders, bumpers, pack racks, etc., could severely affect the stability and safety of your vehicle. Avoid adding on accessories that alter the basic vehicle configuration.
  - Whenever the vehicle is parked outdoors, overnight or for a long period, it is suggested to protect it against the inclemency of the weather with a snowmobile cover.
  - Do not lubricate throttle and/or brake cables and housings.
  - Only perform procedures as detailed in this manual. Unless otherwise specified, engine should be turned OFF for all lubrication and maintenance procedures.
  - This vehicle is designed for the driver only. No provisions have been made for a passenger.
- 
- PLEASE READ AND UNDERSTAND ALL WARNINGS AND CAUTIONS IN THIS MANUAL AND ON THE VEHICLE.
- 

 **WARNING:** Should removal of a nylon lock nut be required when undergoing repairs/disassembly always replace by new ones. Tighten as specified in the applicable Shop Manual.

**THIS MANUAL SHOULD REMAIN WITH THE VEHICLE AT THE TIME OF RESALE.**

<b>THE 1983 "LIMITED WARRANTY"</b> .....	<b>4</b>
<b>OFTEN ASKED QUESTIONS</b> .....	<b>6</b>
<b>LISTING OF AREA DISTRIBUTORS</b> .....	<b>8</b>
<b>HOW TO IDENTIFY YOUR SNOWMOBILE</b> .....	<b>9</b>
<b>CONTROLS/INSTRUMENTS</b>	
Throttle lever, brake lever, ignition switch, light switch, headlamp dimmer switch, emergency cut-out switch, tether cut-out switch, rewind starter handle, primer, gear shift lever, speedometer, trip meter reset button, access door latch, fuel gauge/tank cap, seat compartment, hood removal, fuse holders, hitch .....	<b>10</b>
<b>BREAK-IN PERIOD</b>	
Break-in, 10 hour-inspection, inspection check list .....	<b>13</b>
<b>FUEL</b>	
Recommended gasoline, recommended oil, fuel mixture ratio, fuel mixing procedure, fuel/oil mixing charts .....	<b>15</b>
<b>PRE-START CHECK</b>	
Check points .....	<b>17</b>
<b>STARTING PROCEDURE</b>	
Manual starting, electric starting, before riding, emergency starting .....	<b>17</b>
<b>LUBRICATION</b>	
Frequency, steering mechanism, bogie wheels, rear axles, gearbox oil level, driven pulley .....	<b>18</b>
<b>MAINTENANCE</b>	
Chart, belt guard and pulley guard removal, drive belt removal, drive belt condition, new drive belt, brake condition, brake adjustment, brake light switch adjustment, spark plugs, battery, suspension condition, suspension adjustment, tracks condition, tracks tension and alignment, drive pulley, steering mechanism, steering adjustment, muffler attachments, engine head nuts, engine mount nuts, carburetor adjustment, front hood louvers, air silencer box, fan belt, drive chain tension, headlamp beam aiming, bulb replacement, general inspection .....	<b>20</b>
<b>STORAGE</b>	
Tracks, suspension, ski assembly, controls, gearbox, drive pulley, driven pulley, engine and primer lubrication, fuel tank and carburetor, battery, chassis, general inspection .....	<b>28</b>
<b>PRE-SEASON PREPARATION</b>	
Pre-season preparation chart .....	<b>32</b>
<b>TROUBLE SHOOTING</b> .....	<b>33</b>
<b>TOOLS</b> .....	<b>35</b>
<b>SPECIFICATIONS</b> .....	<b>36</b>
<b>WIRING DIAGRAMS</b> .....	<b>39</b>
<b>SI METRIC INFORMATION GUIDE</b> .....	<b>40</b>
<b>CHANGE OF ADDRESS OR OWNERSHIP</b> .....	<b>41</b>

# THE 1983 "LIMITED WARRANTY"

## 1 - PERIOD

BOMBARDIER® INC. as manufacturer, warrants FROM THE DATE OF FIRST CONSUMER SALES, every 1983 SKI-DOO® / MOTO-SKI® snowmobile, sold as NEW AND UNUSED, by an authorized SKI-DOO or MOTO-SKI dealer respectively, for a period of:

- 12 consecutive months.

## 2 - WHAT BOMBARDIER WILL DO

BOMBARDIER will repair and/or replace, at its option, components defective in material and/or workmanship (under normal use and service,) with a genuine BOMBARDIER component without charge for parts or labour, at any authorized SKI-DOO or MOTO-SKI dealer during said warranty period.

## 3 - CONDITION TO HAVE WARRANTY WORK PERFORMED

Present to the servicing dealer, the hard copy of the BOMBARDIER Customer Registration card received by the customer from the selling dealer at time of purchase.

## 4 - WARRANTY TRANSFER

This warranty is transferable to subsequent owner(s) for remainder of warranty period from original date of sale.

## 5 - EXCLUSIONS - ARE NOT WARRANTED

- Normal wear on all items such as, but not limited to:
  - drive belts
  - slider shoes
  - spark plugs
  - bulbs
  - runners on skis
- Replacement parts and/or accessories which are not genuine BOMBARDIER parts and/or accessories.
- Damage resulting from installation of parts other than genuine BOMBARDIER parts.
- Damage caused by failure to provide proper maintenance as detailed in the Operator Manual. The labour, parts and lubricants costs of all maintenance services, including tune-ups and adjustments will be charged to the owner.
- Wet cells battery.
- Vehicles designed and/or used for racing purposes.
- All optional accessories installed on the vehicle.  
(The normal warranty policy for parts and accessories, if any, applies).
- Damage resulting from accident, fire or other casualty, misuse, abuse or neglect.
- Damage resulting from operation of the snowmobile on surfaces other than snow.

- Damage resulting from modification to the snowmobile not approved in writing by BOMBARDIER.
- Losses incurred by the snowmobile owner other than parts and labour, such as, but not limited to, transportation, towing, telephone calls, taxis, or any other incidental or consequential damages.

## **6 - BATTERY WARRANTY:**

- 12 consecutive months. (Pro-rated.)

100% warranty coverage will start on the date the snowmobile was purchased and run to the following April 30th. The remainder of the 12 months period will be pro-rated as follows:

- 50% from April 30th to December 1st.
- 40% from December 1st to December 31st.
- 30% from January 1st to end of warranty.

**Some states or provinces do not allow the exclusion or limitation of incidental or consequential damages, so the above limitation or exclusion may not apply.**

## **7 - EXPRESSED OR IMPLIED WARRANTIES**

**This warranty gives you specific rights, and you may also have other legal rights which may vary from state to state, or province to province. Where applicable this warranty is expressly in lieu of all other expressed or implied warranties of BOMBARDIER, its distributors and the selling dealer, including any warranty of merchantability of fitness for any particular purpose; otherwise the implied warranty is limited to the duration of this warranty. However, some states or provinces do not allow limitations on how long an implied warranty lasts, so the above limitation may not apply.**

**Neither the distributor, the selling dealer, nor any other person has been authorized to make any affirmation, representation or warranty other than those contained in this warranty, and if made, such affirmation, representation or warranty shall not be enforceable against BOMBARDIER or any other person.**

**BOMBARDIER INC. reserves the right to modify its warranty policy at any time, being understood that such modification will not alter the warranty conditions applicable to vehicles sold while the above warranty is in effect.**

## **8 - CONSUMER ASSISTANCE**

If a servicing problem or other difficulty occurs, we suggest the following:

1. Try to resolve the problem at the dealership with the Service Manager or Owner.
2. If this fails, contact your area distributor listed in the Operator Manual.
3. Then if your grievance still remains unsolved, you may write to us:

Bombardier Inc.  
Service Department  
Recreational Products Division  
Valcourt, Quebec, Canada, JOE 2LO

April 1982  
Bombardier Inc.  
Valcourt, Quebec, Canada, JOE 2LO

® \*Trademarks of Bombardier Inc.

## OFTEN ASKED QUESTIONS

Q: Why must my snowmobile be registered? After all I do have my original invoice as proof of when I purchased my snowmobile.

*A: Your warranty is valid at any authorized dealer of the product. Your registration is the key element in providing the servicing dealer with the necessary data to complete warranty claim forms. This information is also used to notify owners in the event of a safety recall.*

Q: I bought my snowmobile in O'King County but I snowmobile in Washington County. Can the dealer in Washington County accept to perform warranty work on my snowmobile?

*A: Yes, any authorized dealer in North America can perform warranty repairs, providing the customer warranty registration card is presented.*

Q: Where can I find information on the lubrication and maintenance of my snowmobile?

*A: In this Operator Manual provided with the vehicle at the time of first sale.*

Q: Will the entire warranty be void or cancelled, if I do not operate or maintain my new snowmobile exactly as specified in the Operator's Manual?

*A: The warranty of the new snowmobile cannot be "Voided" or "Cancelled". However, if a particular failure is caused by operation or maintenance other than is shown in the Operator Manual, THAT failure may not be covered under warranty. This includes service work performed by the customer, especially the critical adjustments to ignition, timing, carburation and oil injection/or oil mixture.*

Q: Would you give some examples of abnormal use or strain, neglect or abuse?

*A: These terms are general and overlap each other in areas. Some specific examples may include: running the machine out of oil, chain failure caused by a lack of lubrication, operating the machine with a broken or damaged part which causes another part to fail, and so on. If you have any specific questions on operation or maintenance, please contact your dealer for advice.*

Q: What costs are my responsibility during the warranty period?

*A: The customer's responsibility includes all costs of normal maintenance services, non-warranty repairs, accidents and collision damage, as well as oils, and spark plugs, and incidental or consequential damages costs as explained in the warranty.*





Q: Are "Genuine" Bombardier replacement parts used in warranty repairs covered by warranty?

*A: Yes. When installed by an authorized dealer, any "genuine" Bombardier part used in warranty repairs assumes the remaining warranty that exists on the machine.*

Q: If I sell my snowmobile within the warranty period, will the new owner qualify for the balance of the warranty?

*A: Yes, provided the unit has already been registered with the manufacturer. Note that the change of ownership card in this manual should be completed and sent to Bombardier Inc.*

Q: How can I receive the best owner assistance?

*A: The satisfaction and goodwill of the owners of Bombardier products are of primary concern to your dealer and Bombardier Inc. Normally, any problems that arise in connection with the sales transaction or the operation of your snowmobile will be handled by your Dealers Sales or Service Departments. It is recognized, however, that despite the best intentions of everyone concerned, misunderstandings will sometimes occur. If you have a problem that has not been handled to your satisfaction through normal channels, we suggest that you discuss your problem with a member of dealership management. Frequently, complaints are the result of a breakdown in communications and can quickly be resolved by a member of the dealership management. If the problem already has been reviewed with the Sales Manager or Service Manager, contact the Dealer himself or the General Manager.*

# LISTING OF AREA DISTRIBUTORS

## CANADIAN DISTRIBUTORS

### Ski-Doo & Moto-Ski

BROOKS EQUIPMENT LIMITED  
1616 King, Edward Street  
P.O. Box 985  
Winnipeg, Manitoba, R3C 2V8  
(204) 633-7247  
British Columbia

BOMBARDIER INC.  
EASTERN CANADA DISTRIBUTION DIVISION  
Atlantic Branch  
P.O. Box 670  
Shediac, New Brunswick, E0A 3G0  
(506) 386-6117  
Magdalen Island, Nova Scotia, New  
Brunswick, Prince Edward Island

BOMBARDIER INC.  
EASTERN CANADA DISTRIBUTION DIVISION  
(Quebec Branch)  
1350 Nobel Boulevard  
Boucherville, Quebec, J4B 1A1  
(514) 527-2469 or 655-6121  
Province of Quebec

BOMBARDIER INC.  
EASTERN CANADA DISTRIBUTION DIVISION  
Ontario Branch  
230 Bayview Drive  
Barrie, Ontario, L4N 4Y8  
(705) 728-8600  
Province of Ontario

TRACT EQUIPMENT  
14325 - 114th Avenue  
Edmonton, Alberta, T5M 2Y8  
(403) 452-9910  
Alberta, District of Mackenzie N.W.T., Yukon

### Ski-Doo only

BROOKS EQUIPMENT LIMITED  
1616 King, Edward Street  
P.O. Box 985  
Winnipeg, Manitoba, R3C 2V8  
(204) 633-7247  
Manitoba, Saskatchewan

HUDSON'S BAY CO. LTD.  
165 Hymus Blvd  
Pointe-Claire, Québec, H9R 1G2  
(514) 697-8500  
North-West Territories, Franklin District &  
Keewatin

J.W. Randall Limited  
Weat Street  
P.O. Box 1050  
Corner Brook, Newfoundland, A2H 6G7  
(709) 634-3533  
Newfoundland, Labrador

### Moto-Ski only

CONSOLIDATED TURF (1965) EQUIP. LTD  
972 Powell Avenue  
Winnipeg, Manitoba, R3H 0H6  
(204) 633-7276  
Manitoba, Saskatchewan and a few countries in  
Ontario

EQUIPEMENTS ARNAUD LIMITÉE  
469 Arnaud Avenue  
Sept-Îles, Quebec, G4R 3B3  
(418) 962-5545  
Labrador City, Wabush, Sept-Îles

CHARLES R. BELL LIMITED  
P.O. Box 8127  
81 Kenmount Road  
St-John's, Newfoundland, A1B 3N1  
(709) 722-6700  
Newfoundland and territory of Labrador  
(excluding Labrador City and  
Wabush)

## AMERICAN DISTRIBUTORS

### Ski-Doo & Moto-Ski

BOMBARDIER CORPORATION  
All States (excluding Alaska)

FIELD OFFICES  
- East Main Street Road  
Malone, New York 12953  
(518) 483-4411

- 4505 West Superior Street  
P.O. Box 6106  
Duluth, Minnesota 55806  
(218) 628-2881

- P.O. Box 1569  
Idaho Falls, Idaho, 83401  
(208) 529-9510

MILLER EQUIPMENT AND RECREATIONAL  
CENTER  
1049 Whitney Road  
Anchorage, Alaska 99501  
(907) 274-9513  
Alaska

# HOW TO IDENTIFY YOUR SNOWMOBILE

The main components of your snowmobile (engine, tracks and frame) are identified by different serial numbers. It may sometimes become necessary to locate these numbers for warranty purposes or to trace your snowmobile in the event of theft.

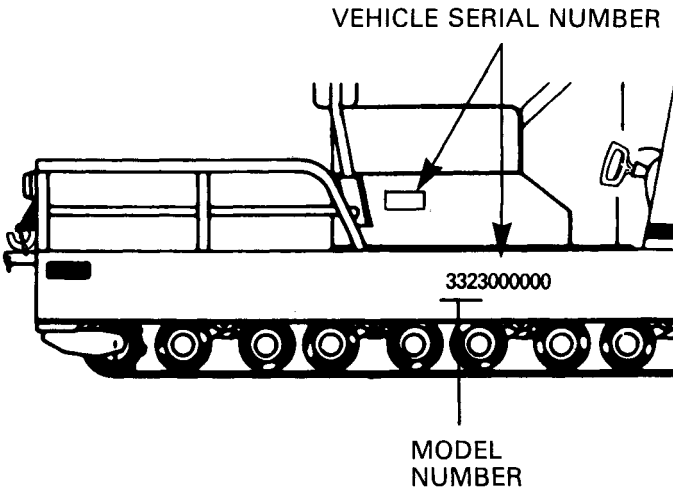
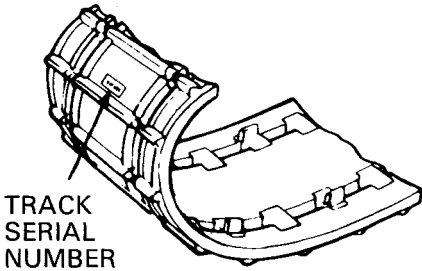
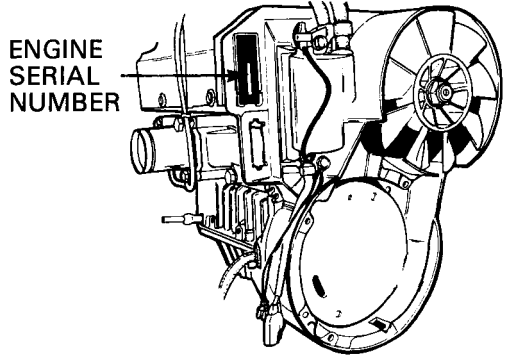

○ NOTE: We strongly recommend that you take note of all the serial numbers on your vehicle and supply them to your insurance company. It will surely help in the event a snowmobile is stolen.

# CONTROLS INSTRUMENTS

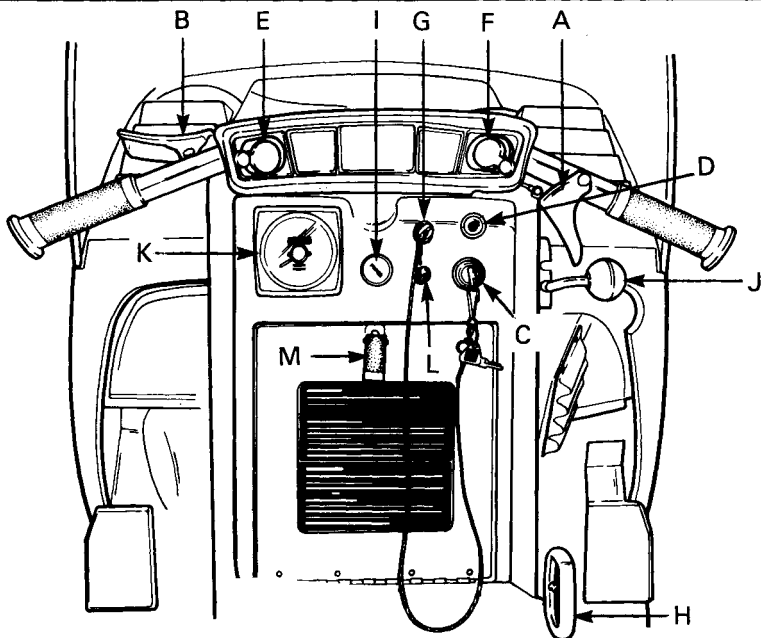

- |                             |                            |
|-----------------------------|----------------------------|
| A) Throttle lever           | H) Rewind starter handle   |
| B) Brake lever              | I) Primer                  |
| C) Ignition switch          | J) Gear shift lever        |
| D) Light switch             | K) Speedometer             |
| E) Headlamp dimmer switch   | L) Trip meter reset button |
| F) Emergency cut-out switch | M) Access door latch       |
| G) Tether cut-out switch    |                            |

## A) Throttle lever

Located on the right side of handlebar. When compressed, it controls the engine speed and the engagement of the transmission. When released, engine speed returns automatically to idle.

## B) Brake Lever

Located on the left side of handlebar. When compressed, the brake is applied. When released, it automatically returns to its original position. Braking effect is proportionate to the pressure applied on the lever and to the type of terrain and it's snow coverage.

## C) Ignition switch

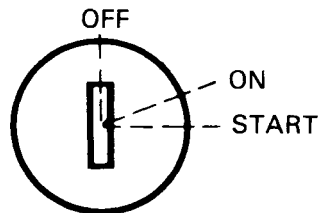

Key operated, 3 position switch. To start engine, turn key fully clockwise to START position and hold. Return key to ON position immediately when engine has started. To stop engine, turn key counter-clockwise to OFF position.

**CAUTION:** Holding key in START position when engine has started could damage starter mechanism.

## D) Light switch

A push pull switch type, to illuminate headlamp and taillight, pull switch knob. (Ignition switch must be turned to ON position.)

## E) Headlamp dimmer switch

The dimmer switch, located on left side of handlebar, allows correct selection of headlamp beam. To obtain high or low beam simply flick switch.

## F) Emergency cut-out switch

A 3 position switch located on the right side of the handlebar. To stop the engine in an emergency, flick the lever to either upper or lower "OFF" position and simultaneously apply the brakes. To start engine, lever must be in middle "ON" position.

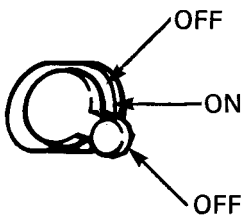

**WARNING:** For safety reasons, the emergency cut-off switch is easily accessible; be careful not to operate it inadvertently.

The driver of this vehicle should familiarized himself with the function of this device by using it several times on first outing. Thereby being mentally prepared for emergency situations requiring its use.

**WARNING:** If the switch has been used in an emergency situation, the source of malfunction should be determined and corrected before restarting the engine.

## G) Tether cut-out switch

Attach tether cord to wrist or other convenient location then snap tether cut-out cap over receptacle before starting engine.

If emergency engine "shut-off" is required completely pull cap from safety switch and engine power will automatically shut "off".

**NOTE:** The cap must be installed on the safety switch at all times in order to operate the vehicle.

**WARNING:** If the switch is used in an emergency situation the source of malfunction should be determined and corrected before restarting engine.

## H) Rewind starter handle

Auto rewind type located on right hand side of vehicle. To engage mechanism, pull handle.

## I) Primer

A push-pull button. Pull and push button (2-3 times) to activate primer. The primer should always be used for cold engine starts. After engine is warm however, it is not necessary to use primer when starting.

## J) Gear shift lever: 4 positions

(2 Forward/neutral/reverse)

**CAUTION:** The vehicle must be completely stopped before shifting.

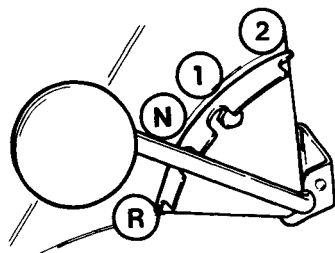

## K) Speedometer

The speedometer is linked directly to the drive axle. Direct-reading dial indicates the speed of the vehicle in kilometers per hour. Odometer records the total number of kilometers travelled. A trip meter is also combined with speedometer.

## L) Trip meter reset button

To reset trip meter, turn black knob (located under tether cut-out switch) until all numbers read zero.

## M) Access door latch

To gain access to the carburetor or spark plugs, lift pressure lock tab and pull open access door.

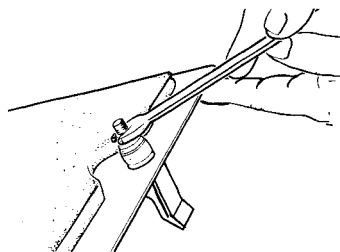

To adjust locking device turn nut in required direction.

## Fuel gauge/tank cap

Unscrew fuel tank cap and withdraw dipstick to check fuel level.

◆ **WARNING:** Never use a lit match or open flame to check fuel level.

## Seat compartment

Remove backrest and tilt seat. Ideal location for spare plugs, belt, rope, etc.

○ **NOTE:** Emergency materials should be wrapped in foam or similar material. This will prevent possible damage to breakable items when travelling over rough or bumpy terrain.

## Hood removal

Unlatch cap by turning both handles toward front of vehicle, remove fuel tank cap, gently lift hood then disconnect junction block. Remove hood from vehicle.

◆ **WARNING:** It is dangerous to run the engine with hood removed. personal injury could result.

## Fuse holders

Starting system is protected with a 30 amperes rated fuse. Fuse holder is located near the starter. If engine does not start, check fuse condition and if necessary replace.

Instruments are protected with a 15 amperes rated fuse. Fuse holder is located inside the console near the ignition switch. If instruments stop operating, check fuse condition and if necessary replace.

## Hitch

Fixed on the rear bumper, the hitch has two attachment points. A hook type and a plate type. A hair pin is supplied to lock the hook type attachment.

◆ **WARNING:** When towing a sled or trailer, always ensure to lock the hook or plate type attachment with a hair pin.

Trailers or sleds towed behind a snowmobile should always be loaded with the lowest possible center of gravity. Use a rigid tow bar when pulling a tow sled behind your snowmobile. When you are pulling passengers in a trailer or tow sled, use moderate speed and avoid rough terrain for their safety. Also, have all passengers get out of a towed vehicle and walk across all roads. Each towed vehicle should have reflectorized material on each side and on the rear.

## BREAK-IN PERIOD

With Bombardier-Rotax snowmobile engines, a break-in period is required before running the vehicle at full throttle. Engine manufacturer recommendation is 10 to 15 operating hours. During this period, a richer mixture is needed (i.e. 40 parts of gas for 1 part of Bombardier snowmobile injection oil). Maximum throttle should not exceed  $\frac{3}{4}$ , however, brief full acceleration and speed variations contribute to a good break-in. Continued wide open throttle accelerations, prolonged cruising speeds, and lugging are detrimental during the break-in period.

○ **NOTE:** A new drive belt requires a break-in period of 15-25 km (10-15 miles).

▼ **CAUTION:** Remove and clean spark plugs after engine break-in.

## 10-HOUR INSPECTION

As with any precision piece of mechanical equipment, we suggest that after the first 10 hours of operation or 30 days after the purchase, whichever comes first, that your vehicle be checked by your dealer. This inspection will give you the opportunity to discuss the unanswered questions you may have encountered during the first hours of operation. Remember that it is easier to remedy at this time than to allow the snowmobile to operate until a possible failure occurs.

The 10 hours inspection is at the expense of the vehicle owner.

<b>10-HOUR INSPECTION CHECK LIST</b>	✓
Engine timing	
Fan belt tension	
Spark plugs condition	
Carburetor adjustment	
Engine head nuts	
Engine mount nuts	
Muffler attachment	
Gearbox oil level	
Chain tension	
Battery electrolyte level	
Brake operation and pad condition	
Ski alignment (runner condition)	
Steering arm retorque to 42 N•m (31 ft-lbs)	
Handlebar bolt retorque to 42 N•m (31 ft-lbs)	
Pulley alignment and drive belt condition	
Track condition, tension and alignment	
Lubricate (steering, suspension, driven pulley)	
Electrical wiring (loose connections, stripped wires, damaged insulation), tightened all loose bolts, nuts and linkage	
Operation of lighting system (HI / LO beam, brake light, etc.), test operation of emergency cut-out switch and tether switch	

**We recommend that you have your dealer sign this inspection list.**

\_\_\_\_\_

Date of 10 hour inspection

\_\_\_\_\_

Dealer signature



# FUEL

Oil must be added to the gasoline in pre-measured amounts then both oil and gasoline should be thoroughly mixed together before fueling the tank.

## Recommended gasoline

Use regular leaded or unleaded gasoline available from all service stations.

**CAUTION:** Never experiment with different fuel or fuel ratios. Never use naphtha, methanol or similar products.

**WARNING:** Never 'top up' the gas tank before placing the vehicle in a warm area. At certain temperatures, gasoline will expand and overflow. Always wipe off any gasoline spillage from the snowmobile.

## Recommended oil

Use "Bombardier Snowmobile Injection Oil" (P/N 496 0133 00-1 liter) available from your dealer. This type of oil will flow at temperatures as low as minus 40°C (-40°F).

It is a blend of specially selected base oils and additives which provides outstanding lubrication, engine cleanliness and minimum spark plug fouling.

If "Bombardier Snowmobile Injection Oil" is unavailable, substitute with "Bombardier 50:1 Snowmobile Oil".

**CAUTION:** Never use outboard or straight mineral oils.

## Fuel mixture ratio

The importance of using the correct fuel mixture cannot be overstressed. An incorrect fuel ratio results in serious engine damage. Recommended fuel ratio is 50/1. (40/1 during break-in period.)

### SI UNITS

500 mL oil to 25 liters = 50/1

### IMPERIAL UNITS

16 oz oil to 5 imp. gals = 50/1

or

500 mL oil to 5 1/2 imp. gals = 50/1

### U.S. UNITS

12 oz oil to 5 U.S. gals = 50/1

**NOTE:** To facilitate fuel mixing, oil should be kept at room temperature.

## Fuel mixing procedure

To mix the gasoline and oil always use a separate clean container. Never mix directly in your snowmobile tank. For best results, acquire two containers, either plastic or metal. Draw from one until empty then use the second one.

**WARNING:** Gasoline is flammable and explosive under certain conditions. Always manipulate in a well ventilated area. Do not smoke or allow open flames or sparks in the vicinity. If gasoline fumes are noticed while driving, the cause should be determined and corrected without delay. Never add fuel while the engine is running. Avoid skin contact with fuel at below freezing temperatures.

1. Pour approximately 4 liters (one gallon) of gasoline into a clean container.

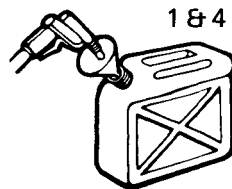

2. Add the full amount of oil required.

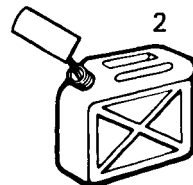

- Replace the container cap and shake the container thoroughly.

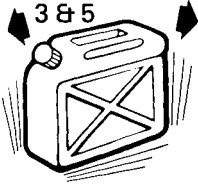

- Add the remainder of the gasoline.
- Once again thoroughly agitate the container. Then using a funnel with a fine mesh screen to prevent the entry of foreign particles, pour the mixture into the snowmobile tank.

**WARNING:** To prevent fuel spillage in the engine compartment, a funnel must always be used when filling the gas tank.

**NOTE:** When using pre-mixed fuel, always shake the container thoroughly as the oil has a tendency to settle.

## FUEL/OIL MIXING CHARTS (50 to 1 ratio)

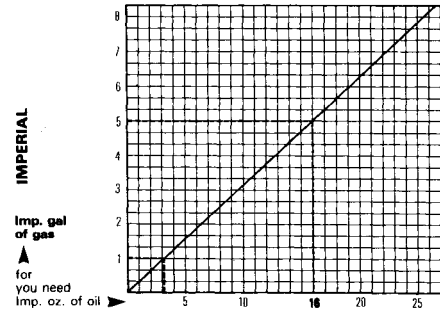
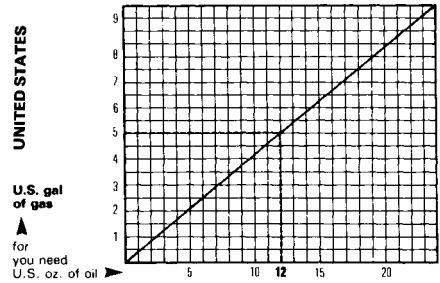
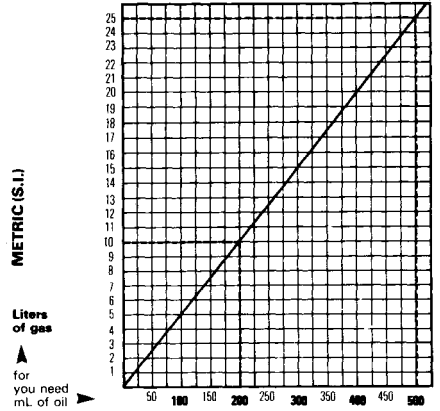

USE BOMBARDIER INJECTION OIL

# PRE-START CHECK

## Check points

- Activate the throttle control lever several times to check that it operates easily and smoothly. The throttle control lever must return to idle position when released.
- Check fuel level.
- Check that the ski and tracks are not frozen to the ground or snow surface and that the steering operates freely.

- Activate the brake control lever and make sure the brake fully applies before the brake control lever touches the handlebar grip.
- Verify that the path ahead of the vehicle is clear of bystanders and obstacles.

Clean and check operation of the headlight, taillight and brake light.

◆ **WARNING:** Only start your snowmobile once all components are checked and functioning properly.

# STARTING PROCEDURE

## Test throttle control lever.

Check that the emergency cut-out switch is in the middle ON position.

Ensure the tether cut-out cap is in position and that the cord is attached to your clothing.

Activate primer (2 to 3 times).

○ **NOTE:** Primer is not necessary when the engine is warm.

## Manual starting

Insert the key in the ignition and turn to ON position.

Grasp manual starter handle firmly and pull slowly until a resistance is felt then pull vigorously. Slowly release the rewind starter handle.

◆ **WARNING:** Do not apply throttle while starting.

## Electric starting

Insert key in ignition switch.

▼ **CAUTION:** Never operate your snowmobile with the battery removed or disconnected.

Turn ignition key clockwise until starter engages. Release key immediately when engine has started. If engine does not start on first try, key must be turned fully back to OFF each time.

▼ **CAUTION:** To avoid starter overheating, the cranking period should never exceed 30 seconds and a rest period should be observed, between cranking cycles, to let starter cool down.

◆ **WARNING:** Do not apply throttle while starting.

○ **NOTE:** If for some reason, the vehicle cannot be started electrically, place ignition key to ON position and start engine manually.

## Before riding

Check operation of the emergency cut-out switch, and tether switch. Restart engine.

◆ **WARNING:** If engine does not shut-off when flicking the emergency cut-out switch and/or by pulling the tether cut-out cap, stop the engine by turning OFF the ignition key. Do not operate the vehicle, see your dealer.

Allow the engine to warm before operating at full throttle.

## Emergency starting

Should the rewind starter rope fray and break, the engine can be started with an emergency starter rope.

◆ **WARNING:** Do not start the vehicle by the drive pulley unless it is a true emergency situation, have the vehicle repaired as soon as possible.

Attach emergency rope to starter grip. Remove the belt guard and pulley guard from the vehicle and wind the emergency rope tight around the drive pulley between the sliding half and the roller guard. Start the engine as per usual manual starting.

◆ **WARNING:** When starting the vehicle in an emergency situation by the drive pulley, do not make a knot at the end of the emergency rope and do not reinstall the belt guard and pulley guard.

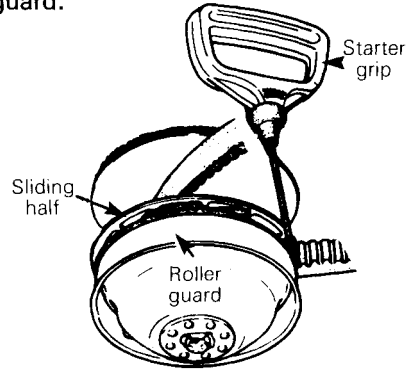

## LUBRICATION

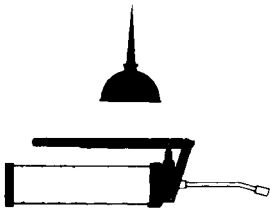

◆ **WARNING:** Only perform such procedures as detailed in this manual. It is recommended that dealer assistance be periodically obtained on other components/systems not covered in this manual. Unless otherwise specified, engine should be turned OFF for all lubrication and maintenance procedures.

### Frequency

Routine maintenance is necessary for all mechanized products, and the snowmobile is no exception. A weekly vehicle inspection contributes to the life span of the snowmobile as well as retains safe and dependable operation. It is recommended that the steering system and suspension be lubricated monthly or every 40 hours of operation. If the vehicle is operated in wet snow or in severe conditions these items should be lubricated more frequently.

### Steering mechanism

◆ **WARNING:** Do not lubricate throttle and/or brake cable and housings.

Lubricate the ski leg at grease fitting until new grease appears at the joint.

Using a small brush, dipped in low temp grease, coat the steering arm ball joint and spring slider cushion.

Using light machine oil, lubricate the spring located on top of steering column housing. Allow oil to run in. Oil the mobile contact point at bottom end of steering arm. Lubricate spring coupler bolt with oil.

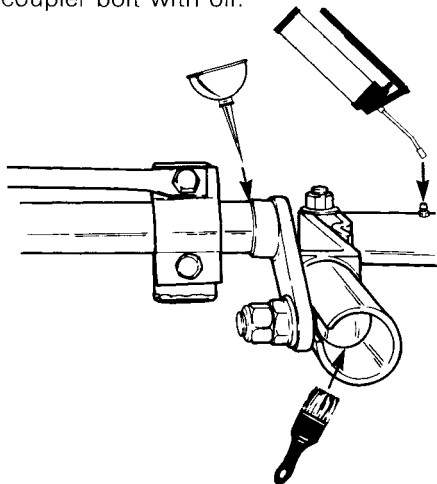

## Rear axles

Lubricate the rear axles with low-temperature grease. Pump grease through the rear axle fittings using a low-pressure grease gun.

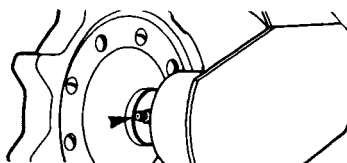

## Gearbox oil level

The gearbox oil capacity is 450 mL (16 oz). To check level:

Remove rubber inspection cover located on bottom right side of gearbox. Using a rigid piece of wire as dipstick, check oil level. Oil level must reach 82 mm (3 1/4") on dipstick.

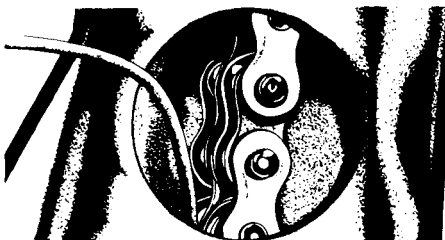

To fill, remove filler cap from top of gearbox. Refill as required using Bombardier chaincase oil.

## Bogie wheels

Using low-temperature grease, lubricate the suspension bogie wheels through the grease fittings until new grease appears at the inner side joints.

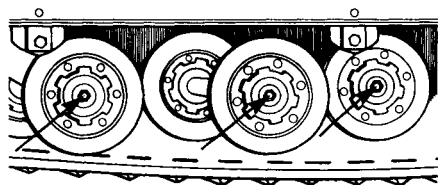

To grease the inner side bogie wheels, tilt vehicle on its side and apply pressure on track to expose grease fittings.

## Driven pulley

Remove pulley guard and slip off drive belt. Open the driven pulley, (push and twist sliding half.)

Thoroughly clean the driven pulley shaft.

Apply a light film of low-temp grease on the shaft. Always wipe off surplus.

○ **NOTE:** Activate the sliding half several times to distribute lubricant over full length of shaft. Be careful that lubricant does not get on inner halves of pulley.

# MAINTENANCE

The following Maintenance Chart indicates regular servicing schedules to be performed by you or your servicing dealer. If these services are performed as suggested, your snowmobile will give you many years of low-cost use.

**WARNING:** Only perform such procedures as detailed in this manual. It is recommended that dealer assistance be periodically obtained on other components / systems not covered in this manual. Unless otherwise specified, engine should be turned OFF for all lubrication and maintenance procedures.

<b>SERVICE AND MAINTENANCE CHART</b>	Weekly or every 240 km (150 m)	Monthly or every 800 km (500 m)	Once a year or every 3200 km (2000 m)	Refer to page
Drive belt	●			21
Brake condition	●			22
Brake adjustment		●		22
Spark plugs		●		23
Battery	●			23
Suspension condition		●		23
Suspension adjustment	(as required)			24
Tracks		●		24
Track tension and alignment		●		24
Drive pulley		●		25
Steering mechanism		●		25
Steering adjustment		●		25
Muffler attachment		●		25
Engine head nuts			●	25
Engine mount nuts			●	25
Carburetor adjustment			●	26
Fan belt			●	26
Drive chain tension			●	27
Headlamp beam aiming			●	27
General inspection		●		28

**NOTE:** The ten hour inspection is a very important part of proper service and maintenance.

## Belt guard & pulley guard removal

◆ **WARNING:** Engine should be running only when belt guard and pulley guard are secured in place.

1. Remove hood. Pull out retaining clip (A) and tilt belt guard towards front of vehicle. If necessary to remove, lift out.

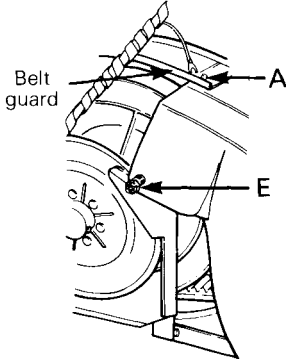

2. Pull out retaining clip (B).
3. Push button (C) towards engine.
4. Lift and pull guard to disengage completely from rear bracket (D).

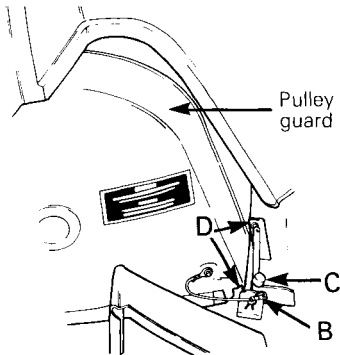

5. Move pulley guard towards front of vehicle to disengage from front attaching device (E).

## Drive belt removal

◆ **WARNING:** Never start or run engine without the drive belt installed. Running an unloaded engine is dangerous.

1. Remove hood, belt guard and pulley guard.
2. Remove the two bolts (A) holding bearing support to the frame.
3. Loosen nut (B) to separate brake caliper and bracket from bearing support.
4. Pivot the bearing support assembly half a turn.
5. Open the driven pulley by twisting and pushing the sliding half.
6. Hold in open position.
7. Slip the belt over the top edge of the fixed half.
8. Slip the belt out from the drive pulley.
9. Remove from vehicle by passing it under the driven pulley, bearing support and brake disc.

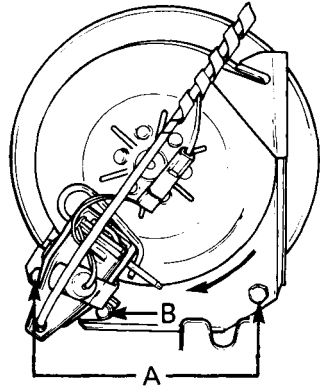

To install drive belt reverse the procedure.

## Drive belt condition

Inspect belt for cracks, fraying or abnormal wear (uneven wear, wear on one side, missing cogs, cracked fabric). If abnormal wear is noted, probable cause could be pulley misalignment, excessive R.P.M. with frozen tracks, fast starts without warm-up period, burred or rusty sheave, oil on belt or distorted spare belt. Contact your dealer.

Check the drive belt width. If less than 30 mm (1 3/16 in), replace the drive belt.

## New drive belt

When installing a new drive belt, break-in period of 25 km (15 miles) is strongly recommended.

○ **NOTE:** Always store a spare belt in a manner to allow its natural shape to be maintained.

## Brake condition

The brake mechanism on your snowmobile is an essential safety device. Keep this mechanism in proper working condition. Above all, do not operate your snowmobile without an effective brake system.

◆ **WARNING:** Brake pads less than 3 mm (1/8") thick must be replaced. Replacement must be performed by an authorized dealer.

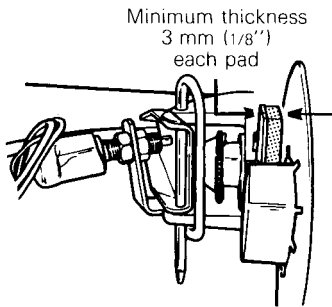

## Brake adjustment

The brake mechanism is a self-adjusting type. If a quicker brake response is desired, strongly pull the brake lever several times, this will actuate the self adjusting mechanism.

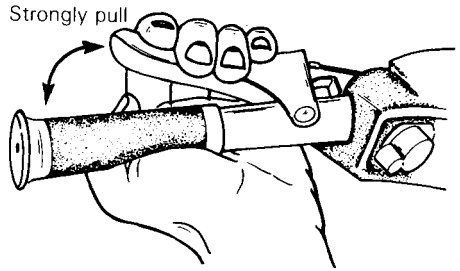

After the adjustment, brake should apply fully when lever is approximately 13 mm (1/2") from handlebar grip. If not, do not tamper with the brake, contact your servicing dealer.

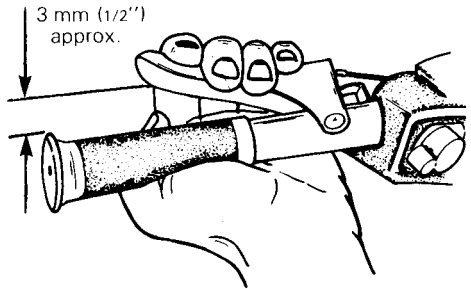

## Brake light switch adjustment

To check operation:

Pull the brake lever to hold the pads on the disc. Check that a light resistance is felt while rotating the driven pulley. This is the position where the switch should have lit the brake light.

To adjust:

- Loosen the brake switch lock nuts.
- Holding brake lever at the lit position, unscrew the switch to put on the light or screw it in to put it out.



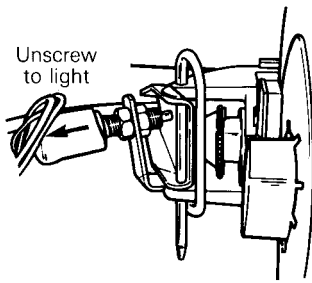

- Tighten the brake switch lock nuts and recheck brake light operation.

## Spark Plugs

Open access door and remove hood. Disconnect spark plug wires and remove plugs. Check condition of plugs.

- A brownish tip reflects ideal conditions. (Carburetor adjustment, spark plug heat range, etc.; are correct.)
- A black insulator tip indicates fouling caused by; carburetor idle speed mixture and / or high speed mixture too rich, incorrect fuel mixture ratio, wrong type of spark plug (heat range), or excessive idling.
- A light grey insulator tip indicates a lean mixture caused by; carburetor high speed mixture adjusted too lean, wrong spark plug heat range, incorrect fuel mixture ratio, or a leaking seal or gasket.

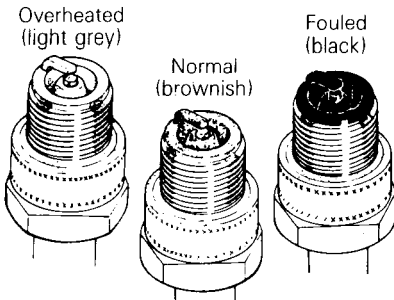

**CAUTION:** If spark plug condition is not ideal, contact your authorized dealer.

Check spark plug gap using a wire feeler gauge. Gap must be 0.4 mm (.016").

Reinstall plugs and connect wires.

## Battery

Check electrolyte level weekly. Electrolyte level must be at upper level line on battery casing.

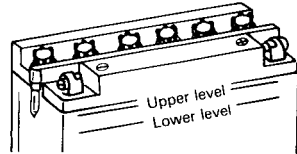

If necessary add distilled water. Battery connections must also be free of corrosion. If cleaning is necessary, remove corrosion using a stiff brush then clean with a solution of baking soda and water. Rinse and dry well.

**CAUTION:** Do not allow cleaning solution to enter battery. It will destroy the chemical properties of the electrolyte.

After reconnecting battery, coat battery terminals and connectors with petroleum jelly to prevent corrosion. Check that battery overflow tube is not blocked or kinked.

**WARNING:** Overflow tube must be free and open. A kinked or bent tube will restrict ventilation and create gas accumulation that could result in an explosion. Avoid skin contact with electrolyte.

**CAUTION:** Prior to charging the battery, always remove it from the vehicle to prevent electrolyte spillage.

## Suspension condition

Visually inspect suspension springs. Replace any weak or broken spring. Check for wear or looseness. Correct as required.

## Suspension adjustment

By raising the outer attachment of the bogie wheel sets, vehicle maneuverability in deep snow will increase. You will note that some partially drilled holes are located approx. 3.5 cm (1 3/8") above the original cross shaft holes of the frame. To reposition bogie wheel sets, drill holes fully through using a 8 mm (5/16") dia. drill. Remove cap-screws securing bogie wheel cross shafts to frame and reinstall in new position.

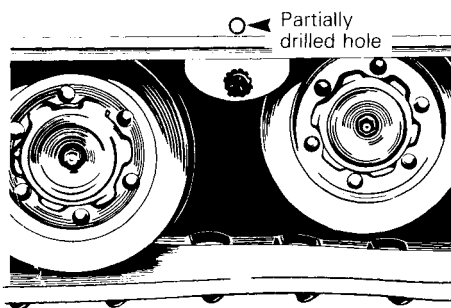

## Tracks condition

Lift rear of vehicle and support it off the ground. With the engine OFF, place gear shift lever in forward position, rotate tracks manually and inspect condition. If worn or cut, or if track fibers are exposed, or if missing or defective inserts are noted; contact your dealer.

**WARNING:** Do not operate a snowmobile with a cut, torn or damaged track.

## Track tension and alignment

Lift the rear of vehicle and support it off the ground. Using a ruler, check track tension, at the second set of bogie wheels from rear.

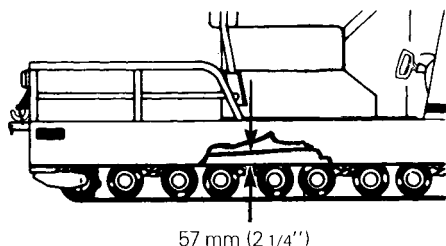

The deflection of each track should be 57 mm (2 1/4") between top inside edge of track and center of bogie wheel set retaining bolt.

To adjust track use the following procedure:

Loosen link plate spring lock nuts (4) located on inner side of link plate springs.

Turn adjuster bolts clockwise to tighten tracks, counterclockwise to slacken.

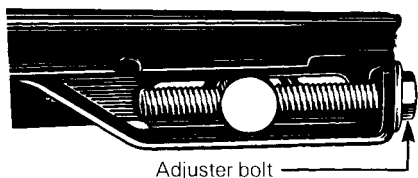

Start engine and allow tracks to rotate **slowly**. Check if tracks are well centered and turn evenly on the rear sprockets. The distance between track edges and link plates should be equal.

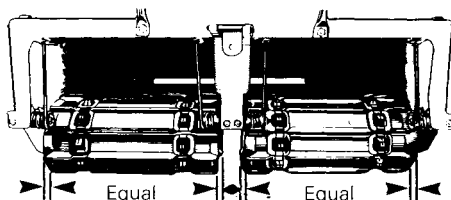

To correct:

On appropriate side, turn inner side adjuster bolt(s) counterclockwise to bring track closer to center link plate(s), turn clockwise to withdraw track(s) from link plate(s).

Tighten link plate spring lock nuts.  
 Rotate tracks **slowly** and recheck alignment.

**WARNING:** Before checking tracks alignment, ensure that the tracks are free of particles which could be thrown out while tracks are rotating. Keep hands, tools, feet and clothing clear of track. Ensure nobody is standing near the vehicle.

### Drive pulley

Inspect the Duralon bushing condition by checking the free-play of the sliding half pulley. This is achieved by restraining the inner half and checking if the sliding half moves in the direction of the arrows more than 3 mm (1/8"). If so, contact your dealer.

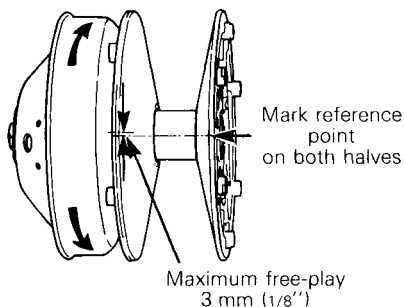

### Steering mechanism

Inspect steering mechanism for tightness of components (steering arm, ball joint, etc.). If necessary, replace or retighten. Check condition of ski and ski runner. Replace if more than half worn.

### Steering adjustment

Ski should be perpendicular to handlebar. To align:

Remove steering padding.

Remove bolt securing handlebar to steering column.

Remove handlebar to expose splined end of steering column.

Reposition handlebar on splines so that it is perpendicular with ski. Install and tighten bolt to 38-47 N•m (28-35 ft-lbs).

**NOTE:** If correct spline alignment is unobtainable at handlebar, move lower steering bracket (located on top of gearbox) to obtain proper location. Lower steering bracket holes are slotted.

### Muffler attachment

The engine/muffler system parts are vital toward efficient muffler function. Check all attachments. Replace springs and/or tighten if necessary.

Ensure that the forced flow system is well aligned and tightened.

**CAUTION:** Do not operate vehicle with muffler disconnected otherwise serious engine damage will occur.

### Engine head nuts

With the engine cold, check that engine head nuts are tight and equally torqued to 22 N•m (16 ft-lbs). Follow the illustrated sequence.

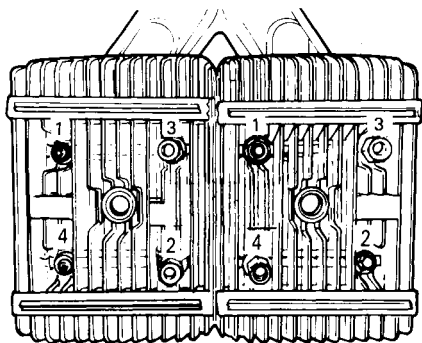

**IMPORTANT:** The engine head nut torque should be checked after the first 5 hours of operation.

### Engine mount nuts

Check engine mount nuts for tightness. Retighten if necessary.

## Carburetor adjustment

▼ **CAUTION:** Never operate your snowmobile with the air intake silencer disconnected. Serious engine damage will occur if this notice is disregarded.

### A) Air screw adjustment

Completely close the air screw (until a slight reseating resistance is felt) then back off screw: 1 1/2 turn.

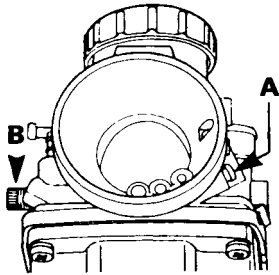

### B) Idle speed adjustment

Turn the idle speed screw clockwise until it contacts the throttle slide then continue turning two (2) additional turns. This will provide a preliminary idle speed setting. Start the engine and allow it to warm then adjust the idle speed to 1800-2000 R.P.M. by turning the idle speed screw clockwise or counterclockwise.

▼ **CAUTION:** Do not attempt to set the idle speed by using the air screw. Severe engine damage can occur. If idle speed is unattainable contact your authorized dealer.

## Front hood louvers

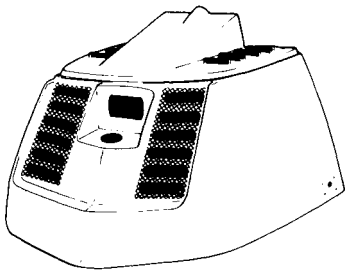

When operating the vehicle in powder snow it is advisable to block the front hood louvers as per illustration using snow deflectors supplied with vehicle. Unblock the louvers as soon as snow condition becomes firmer or as soon as engine becomes too hot.

## Air silencer box

▼ **CAUTION:** Never operate your snowmobile with the air silencer tube disconnected. Serious engine damage will occur if this notice is disregarded.

When operating the vehicle in temperature exceeding  $-10^{\circ}\text{C}$  ( $14^{\circ}\text{F}$ ), the rubber plug must block the engine side orifice and the rubber vent must be positioned on the side of the silencer box to allow cold air circulation.

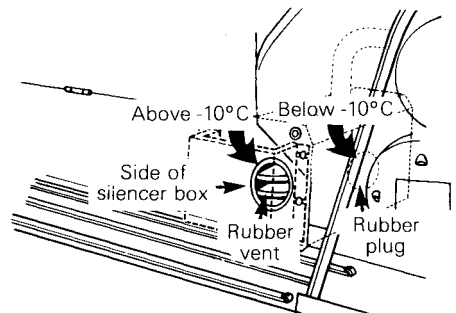

In temperatures below  $-10^{\circ}\text{C}$  ( $14^{\circ}\text{F}$ ) and/or powder snow, the rubber plug must block the entry of fresh air on the side of the silencer box and the rubber vent must allow the warm air being emitted from the engine to be directed over the carburetor.

▼ **CAUTION:** Observe temperature changes and locate plugs accordingly. Incorrect location of plugs may cause carburetor ice-up or engine overheating.

## Fan belt

Inspect belt for cracks, uneven wear, etc. Check fan belt tension, 8 mm ( $5/16''$ ) free-play should exist when deflection is correct.

Belt deflection  
8 mm (5/16")

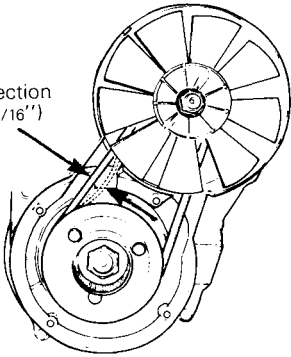

If belt seems damaged or if tension is incorrect, contact your dealer immediately.

**WARNING:** If fan protector is removed, always reinstall after servicing.

## Drive chain tension

Run vehicle forward so that true free-play can be taken. Check tension then turn driven pulley 1/2 turn counter-clockwise and recheck. Starting from maximum reading, adjust chain tension to obtain from 3 mm to 6 mm (1/8" to 1/4") free-play. Remove capscrew locking chain tensioner in place. (Tensioner is located at bottom left of gear-box.)

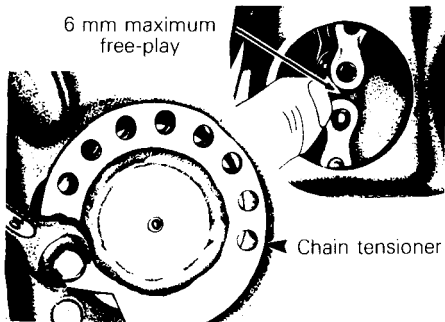

Rotate the tensioner as required to obtain correct chain tension.

Replace capscrew to lock chain tensioner in place.

## Headlamp beam aiming

The angle of the headlamp beam has been pre-adjusted prior to delivery. Should you wish re-adjustment, place the vehicle on a flat surface 7.6 m (25') from a wall or screen.

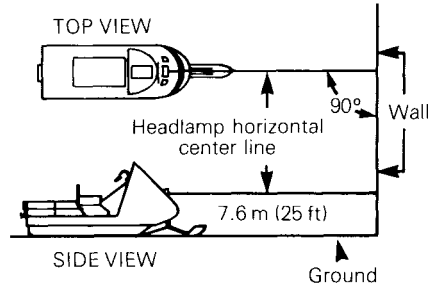

With the suspension correctly adjusted, the rider seated on the vehicle and the high beam ON check that the center of high intensity zone of high beam is 50 mm (2") below horizontal line of headlamp height.

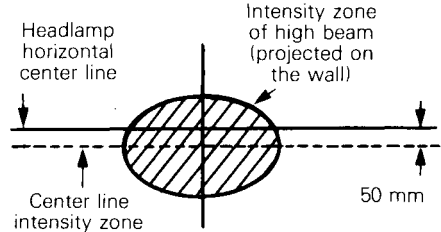

To adjust, remove headlamp ring, turn upper or lower adjusting screws to obtain desired beam position.

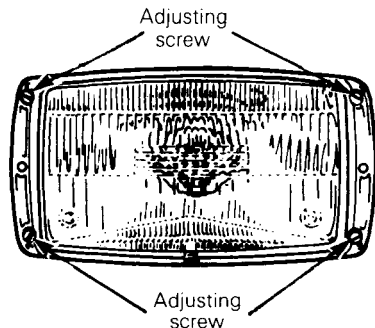

## Bulb replacement

If headlamp is burnt, remove hood. Unplug connector from headlamp. Remove rubber boot and unfasten bulb retainer clips. Detach bulb and replace.

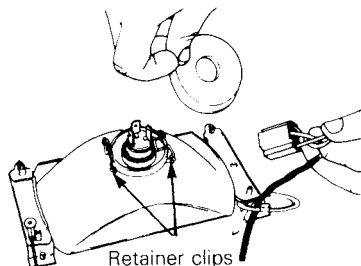

If taillight bulb is burnt, expose bulb by removing the taillight protector and the red plastic lens. To remove, unfasten the screws.

◆ **WARNING:** Always check light operation after bulb replacement.

## General inspection

Check electrical wiring and components, retighten loose connections. Check for stripped wires or damaged insulation. Thoroughly inspect the vehicle and tighten loose bolts, nuts and linkage. Inspect ski and ski runner for wear.

## STORAGE

It is during summer, or when a vehicle is not in use for any length of time, that proper storage is a necessity. Storage of the snowmobile during long period of inactivity consists of checking and replacing missing, broken or worn parts; proper lubrication and treatment to insure that parts do not become rusted, cleaning items such as carburetor of oil mixtures, to prevent gum varnish formation within the carburetor, and in general, preparing the vehicle so that when the time comes to use the snowmobile again it will be in top condition.

◆ **WARNING:** Only perform such procedures as detailed in this manual. It is recommended that dealer assistance be periodically obtained on other components / systems not covered in this manual. Unless otherwise specified, engine should be turned OFF for all lubrication and maintenance procedures.

## Tracks

Inspect tracks for wear, cuts, missing tracks inserts or broken rods.

Make any necessary replacement.

◆ **WARNING:** Do not operate a snowmobile with a cut, torn or damage track.

Lift rear of vehicle until tracks are clear of ground, then support it with a brace or trestle. The snowmobile should be stored in such a way that the tracks do not stay in contact with cement floor or bare ground.

○ **NOTE:** The tracks should be rotated periodically, (every 40 days). Do not release track tension.

▼ **CAUTION:** To prevent track damage, temperature in the storage area must not exceed 38° C (100°F).

## Suspension

Remove the bogie wheel sets from the vehicle. Remove cross shaft from bogie wheel set. Clean bogie wheel assembly and cross shaft of dirt or rust.

Check condition of shaft and replace if bent or worn. Apply a coat of low temp. grease on cross shaft.

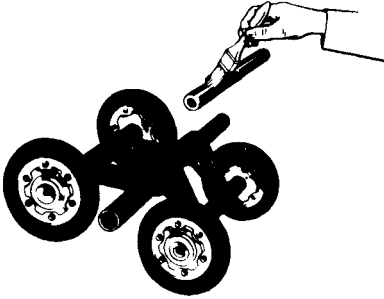

Grease each bogie wheel until the old grease is flushed out. Spray bogie wheel springs with metal protector. If unavailable, wipe with a cloth or rag soaked in oil.

Reassemble entire bogie wheel set, making sure assembly moves freely. Reinstall bogie wheel set in the proper position.

Torque cross shaft bolts to 30 N•m (23 ft-lbs). Repeat above steps on remaining bogie wheel sets. Lubricate rear hubs through grease fittings.

## Ski assembly

Wash or brush all dirt or rust accumulation from ski and spring. Grease ski leg at grease fitting. Check condition of ski and ski runner. Replace if worn or weak. Apply metal protector on ski assembly. If unavailable, wipe the entire ski with a cloth soaked in oil to prevent rust formation.

## Controls

Lubricate steering mechanism. Inspect components for tightness (spring coupler bolt, steering arm locking bolt, ball joint, etc.). Tighten if necessary. Oil moving joints of brake mechanism.

◆ **WARNING:** Do not lubricate throttle and/or brake cable or housing. Avoid getting oil on brake linings.

Coat electrical connections and switches with a greaseless metal protector. If unavailable, use petroleum jelly.

## Gearbox

Drain gearbox and refill with 450 mL (16 oz) of fresh Bombardier chaincase oil. (Drain plug is located beneath frame).

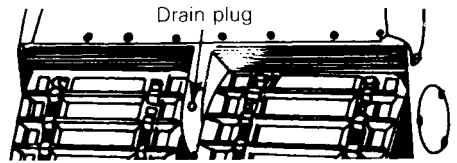

## Drive pulley

The drive pulley should be cleaned and inspected. It also requires lubrication.

◆ **WARNING:** The lubrication of the drive pulley should be performed only by an authorized dealer.

## Driven Pulley

Remove hood and drive belt. Thoroughly clean the driven pulley shaft. Apply a light film of low-temperature grease on shaft. Activate the sliding half several times to distribute grease on shaft. Spray internal pulley surfaces with metal protector.

○ **NOTE:** Leave drive belt off during entire storage period.

## Engine and primer lubrication

Engine internal parts must be lubricated to protect cylinder walls from possible rust formation during the storage period.

To perform the storage procedures (engine and primer valve) proceed as follows:

### Engine

1. Start the engine and allow it to run at idle speed until the engine reaches its operational temperature.
2. Stop the engine, remove the air silencer box, start the engine.
3. Using the concentrated Bombardier Snowmobile Oil, squirt oil into the carburetor throat until the engine dies.
4. Remove the spark plugs and pour approximately 85 mL (3 fl. oz. imp., 3 fl. oz. U.S.) of oil into the cylinders.
5. Crank the engine to allow the crankshaft to turn 2 or 3 revolutions.
6. Reinstall the spark plugs and the air intake silencer.

Do not run engine during storage period.

### Primer valve

1. Disconnect the inlet primer hose from the primer valve.

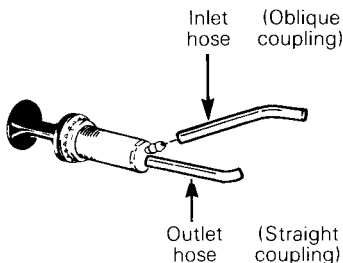

2. Hold the hose higher than the gas tank to prevent gasoline from draining.

3. Using an appropriate hose, connect one end of the hose to the inlet of the primer valve and place the other end in a concentrated Bombardier Snowmobile Oil can.
4. Activate the primer in order to fill it with oil.
5. Reinstall the inlet primer hose to the primer valve.

## Fuel tank and carburetor

Remove the cap then, using a syphon, remove gasoline from tank.

**◆ WARNING: Gasoline is flammable and explosive under certain conditions. Always manipulate in a well ventilated area. Do not smoke or allow open flames or sparks in the vicinity.**

The carburetor must be dried out completely to prevent gum formation during the storage period.

Once the fuel tank is emptied, remove the float chamber drain plug from carburetor. Drain carburetor and reinstall plug.

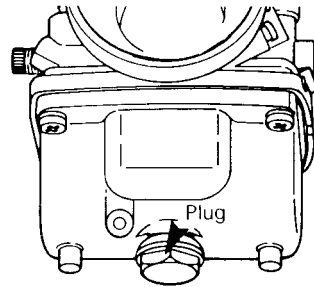

Check all fuel lines, replace if necessary.



## Battery

The battery should be removed from vehicle for the entire length of the storage period.

To remove, proceed as follows:

1. Disconnect the battery cables and remove the battery retainer cover.

**▼ CAUTION:** To avoid possibility of grounding the positive terminal with the chassis, always disconnect black negative lead first.

2. Remove the battery vent tube from the vent hole.
3. Lift out the battery.

Before storing the battery, clean outside surface with a solution of baking soda and water. Remove all deposits from posts then rinse with clear tap water.

**▼ CAUTION:** Do not allow cleaning solution to enter battery interior since it will destroy the electrolyte.

Check electrolyte level. Refill as necessary with distilled water. Fully charge battery.

**▼ CAUTION:** Prior to charging the battery, always remove it from the vehicle to prevent electrolyte spillage.

**◆ WARNING:** Gases given off by a battery being charged are highly explosive. Always charge in a well ventilated area. Keep battery away from cigarettes or open flames. Avoid skin contact with electrolyte.

**○ NOTE:** To prevent battery from discharging, store it on a wooden shelf in a cool, dry place. (A stored battery should be recharged at least every 40 days.)

Coat electrical connections and switches with a greaseless metal protector, if unavailable, use petroleum jelly.

## Chassis

Clean the vehicle thoroughly, removing all dirt and grease accumulation.

**▼ CAUTION:** Plastic alloy components such as windshield, console, etc., can be cleaned using mild detergents or isopropyl alcohol. Do not use strong soaps, degreasing solvents, abrasive cleaners, paint thinners, etc.

Inspect hood and repair damage. Repair kits are available at your authorized Bombardier dealer.

Touch up all metal spots where paint has been scratched off. Spray all bare metal parts of vehicle with metal protector. Wax the hood for better protection.

**○ NOTE:** Apply wax on glossy finish of hood only. Protect the vehicle with a cover to prevent dust accumulation during storage.

**▼ CAUTION:** Cover the snowmobile with an opaque tarpaulin. This caution will prevent the sun rays or grime from affecting the plastic components and the vehicle finish.

## General Inspection

Check electrical wiring and components, retighten loose connections. Check for stripped wires or damaged insulation. Thoroughly inspect the vehicle and tighten loose bolts, nuts and linkage.

# PRE-SEASON PREPARATION

To simplify the pre-season preparation we have drawn up a small chart. The chart indicates servicing points to be performed by you and your servicing dealer. If these services are performed as suggested, your vehicle will give you many hours of fun and low cost use.

**IMPORTANT:** Observe all Warnings and Cautions mentioned throughout this manual which are pertinent to the item being checked. When component conditions seem less than satisfactory, replace with genuine Bombardier parts.

<b>PRE-SEASON PREPARATION CHART</b>	
	To be performed by dealer ●
	To be performed by owner ○
Change spark plugs	○
Check gear box oil level	○
Check steering adjustment / ski runner	○
Replace fuel filter	○
Check fuel lines and attaching points	○
Check track tension and alignment	○
Lubricate suspension	○
Inspect drive belt and install	○
Check throttle cable for damage and free operation.	○
Inspect brake condition and operation	○
Check electrical wiring (broken wire, damaged insulation)	○
Inspect condition of starting rope	○
Check tightness of all bolts, nuts and linkage	○
Refill gas tank	○
Check pulleys, clean and check condition of drive pulley	●
Inspect oil seals for possible cuts or leaks	●
Test battery, clean and install	●
Set engine timing	●
Adjust carburetor	●
Check fan belt condition and tension	●

# TROUBLE SHOOTING

○ **NOTE:** The possible causes have been listed in an order of frequency. Therefore, items should be checked out in the same order as mentioned in the trouble shooting guide.

SYMPTOMS	POSSIBLE CAUSES	WHAT TO DO
Engine turns over but fails to start or starts with difficulty	1. No fuel to the engine	Check the tank level and fill up with correct gas-oil mixture. Check for possible clogging of fuel line, item 4.
	2. Flooded engine	Remove wet spark plugs, turn ignition to OFF and crank engine several times. Install clean dry spark plugs. Start engine following usual starting procedure. If engine continues to flood, see your dealer.
	3. Spark plug/faulty ignition	Check for fouled or defective spark plug. Disconnect spark plug wire, unscrew plug and remove from cylinder head. Reconnect wire and ground exposed plug on engine cowl, <b>being careful to hold away from spark plug hole.</b> Follow engine starting procedure and check for spark. If no sparks appear, replace spark plug. If trouble persists, contact your dealer.
	4. Clogged fuel line (water or dirt)	Check condition and connections of fuel lines Check the cleanliness of fuel tank.
	5. Incorrect carburetor adjustment	Contact your dealer.
	6. Too much oil in fuel	Drain the fuel tank and refill with the correct gas/oil mixture.
	7. Engine timing	Engine timing may be defective or out of adjustment. Contact your dealer.
	8. Poor engine compression	Running with a lean fuel mixture may produce excessive engine wear resulting in poor engine compression. If this occurs, contact your dealer at once.
Engine will not turn manually	1. Seized engine	In the case of a seized engine contact your dealer.

<b>SYMPTOMS</b>	<b>POSSIBLE CAUSES</b>	<b>WHAT TO DO</b>
Engine lacks acceleration or power	1. Fouled or defective spark plug	Check item 3 of "Engine turns over but fails to start or starts with difficulty"
	2. Clogged fuel line (water or dirt)	Check fuel line condition. (See item 4 of "Engine turns over but fails to start or starts with difficulty").
	3. Carburetor	Contact your dealer.
	4. Ignition	First check item 3 of "Engine turns over but fails to start or starts with difficulty". If the ignition system still seems faulty, contact your dealer.
	5. Engine	If unable to locate specific symptoms, contact your dealer.
Engine continually backfires	1. Spark plug	Check item 3 of "Engine turns over but fails to start or starts with difficulty".
	2. Overheated	Carburetor set too lean. Contact your dealer.
	3. Engine timing incorrectly set	Contact your dealer.
Snowmobile cannot reach full speed	1. Drive Belt	Check for damaged or worn drive belt. Replace if necessary.
	2. Incorrect track adjustment	Check track tension and alignment. Readjust to specifications. (See Maintenance Section).
	3. Engine	Check item 1 to 5 of "Engine lacks acceleration or power."
	4. Pulley misaligned	Contact your dealer.

# TOOLS

As standard equipment, each new snowmobile is supplied with a basic tool kit such as screwdriver, wrenches, emergency starter rope, etc...

## Standard Tools

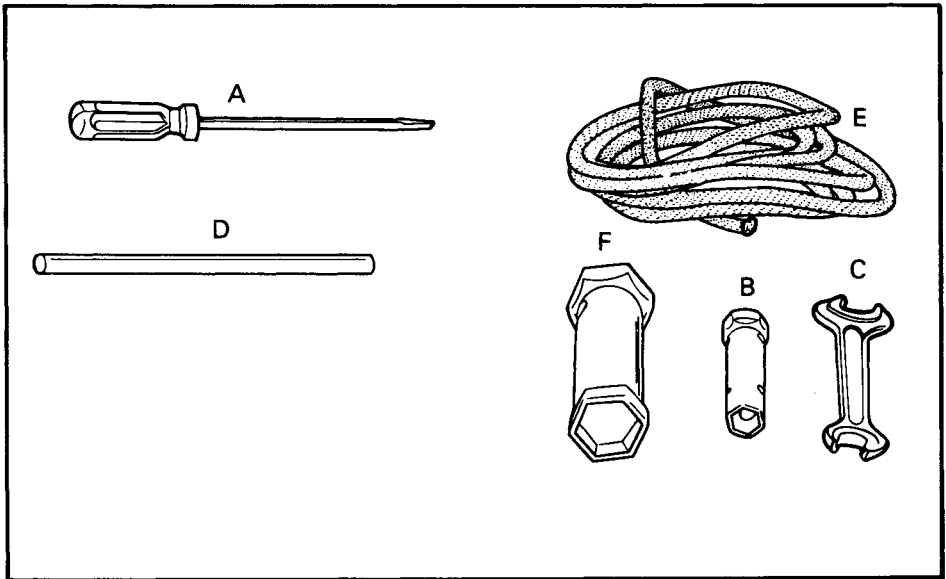

- A. Screwdriver
- B. Socket 10 / 13 mm
- C. Open end wrench 10 / 13 mm
- D. Socket wrench handle
- E. Starter rope
- F. Socket 21 / 26 mm

# SPECIFICATIONS

<b>ENGINE</b>	
Type	503
No. of cylinders	2
Bore	72 mm (2.834")
Stroke	61 mm (2.401")
Displacement	496.7 cm <sup>3</sup> (30.31 in. <sup>3</sup> )
Compression ratio (corrected)	6.3:1
Maximum R.P.M.	6500
Carburetor type	VM 34-297
Carburetor adjustment	
– air screw	1 1/2 turn
– main jet	250
– idle speed	1800-2000 R.P.M.
Fan belt free-play	8-9 mm (5/16")
Torque:	
– engine head nuts	M8: 22 N•m (16 ft-lbs)
– crankcase nuts	M8: 22 N•m (16 ft-lbs)
– magneto ring nut	M22: 85 N•m (63 ft-lbs)
– fan nut	M16: 65 N•m (48 ft-lbs)
– crankcase engine support nuts	M10: 38 N•m (28 ft-lbs)
– exhaust manifold bolts	M8: 22 N•m (16 ft-lbs)
– electrical starter bolts	M8: 22 N•m (16 ft-lbs) M5: 4 N•m (3 ft-lbs)
<b>CHASSIS</b>	
Overall length	288.3 cm (113.5 in.)
Overall width	90.1 cm (35.5 in.)
Overall height	123.5 cm (48.5 in.)
Ski alignment	Ski perpendicular to handlebar
Torque:	
– steering arm/ski leg bolt	38-47 N•m (28-35 ft-lbs)
– steering column/handlebar	38-47 N•m (28-35 ft-lbs)
Weight	291.4 kg (642.5 lbs)
Bearing area	13936.3 cm <sup>2</sup> (2160 in. <sup>2</sup> )
Ground pressure	2.05 kPa (.298 lbs/in. <sup>2</sup> )

## POWER TRAIN

Track dimensions	2 x 38.1 cm (15 in.) x 353 (139 in.)
Track tension	A deflection of 57 mm ( $2\frac{1}{4} \pm \frac{1}{8}$ in.) should exist between the top inside edge of the track and the retaining bolt of the second bogie wheel set from the rear of the vehicle.
Track alignment	Equal distance between edges of track and link plates.
Std. gearbox ratio	19/42
Gearbox oil capacity	450 mL (16 oz.)
Gearbox chain tension	6 mm ( $\frac{1}{4}$ in.)
Drive belt:	
– number	414 3758 00
– max. width	33.3 mm ( $1\frac{5}{16}$ "
– min. width	30.1 mm ( $1\frac{3}{16}$ "

## ELECTRICAL

Lighting system (output):	12 V, 160 watts
Bulb:	
– headlamp	60/60 W
– tail/stop	5/21 W
– speedometer	5W
Fuse:	
– ignition switch	15 A
– main wiring	30 A
Spark plug:	
– type	NGK BR-7ES
– gap	0.4 mm (0.016")
Ignition timing:	
– timing mark (B.T.D.C.)	2.29 mm (.090") (20°)
– stroboscopic timing	6000 R.P.M.

**FUEL**

Tank capacity	— SI*	22.7 liters
	— Imp.	5 gallons
	— U.S.	6 gallons

Gasoline	Regular (leaded or unleaded)
----------	------------------------------

Gas/oil ratio	50/1
---------------	------

**BRAKE**

Brake type	Disc, self-adjusting
------------	----------------------

Brake adjustment (control lever)	13 mm (1/2 in.) minimum distance from handlebar grip when fully applied
----------------------------------	---

Brake linings (minimum thickness)	3 mm (1/8 in.)
-----------------------------------	----------------

\*International Standard

*Bombardier Inc. reserves the right to make changes in design and specifications and/or to make additions to, or improvements in its product without imposing any obligation upon itself to install on its product previously manufactured.*



# WIRING DIAGRAM

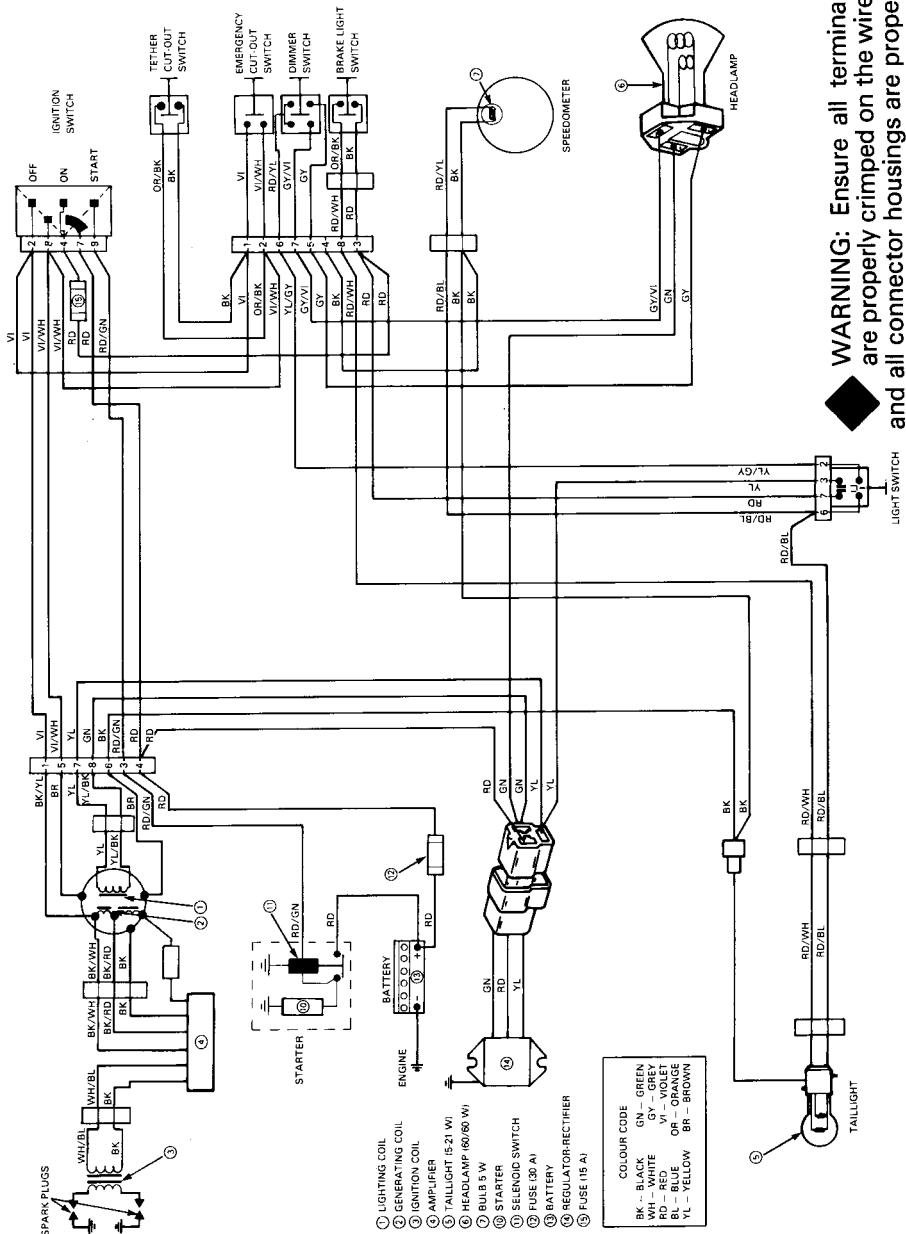

**WARNING:** Ensure all terminals are properly crimped on the wires and all connector housings are properly fastened.

# SI\* METRIC INFORMATION GUIDE

## BASE UNITS

DESCRIPTION	UNIT	SYMBOL
length	meter	m
mass	kilogram	kg
liquid	liter	L
temperature	celsius	°C
pressure	kilopascal	kPa
torque	Newton meter	N•m
speed	kilometer per hour	km/h

---

## PREFIXES

PREFIX	SYMBOL	MEANING	VALUE
kilo	k	one thousand	1,000
centi	c	one hundredth of a	0.01
milli	m	one thousandth of a	0.001

\*THE INTERNATIONAL SYSTEM OF UNITS (SYSTEME INTERNATIONAL) ABBREVIATES "SI" IN ALL LANGUAGES.

# CHANGE OF ADDRESS AND OWNERSHIP

Any change in address or ownership should be brought to the attention of the manufacturer by completing and sending out the card supplied below.

## CHANGE OF ADDRESS



VEHICLE IDENTIFICATION NUMBER

--	--	--	--	--	--	--	--	--	--	--	--	--	--	--	--	--	--	--	--

OLD ADDRESS:

\_\_\_\_\_

NAME

\_\_\_\_\_

NO STREET APT.

\_\_\_\_\_

CITY STATE/PROVINCE ZIP / POSTAL CODE

NEW ADDRESS:

\_\_\_\_\_

NAME

\_\_\_\_\_

NO STREET APT.

\_\_\_\_\_

CITY STATE/PROVINCE ZIP / POSTAL CODE



## CHANGE OF OWNERSHIP

VEHICLE IDENTIFICATION NUMBER

--	--	--	--	--	--	--	--	--	--	--	--	--	--	--	--	--	--	--	--

The ownership of this vehicle is transferred

FROM:

\_\_\_\_\_

NAME

\_\_\_\_\_

NO STREET APT.

\_\_\_\_\_

CITY STATE/PROVINCE ZIP / POSTAL CODE

TO:

\_\_\_\_\_

NAME

\_\_\_\_\_

NO STREET APT.

\_\_\_\_\_

CITY STATE/PROVINCE ZIP / POSTAL CODE





**BOMBARDIER INC.**  
ATT.: WARRANTY DEPARTMENT  
VALCOURT, QUEBEC  
CANADA, JOE 2L0

**BOMBARDIER INC.**  
ATT.: WARRANTY DEPARTMENT  
VALCOURT, QUEBEC  
CANADA, JOE 2L0