

elan®

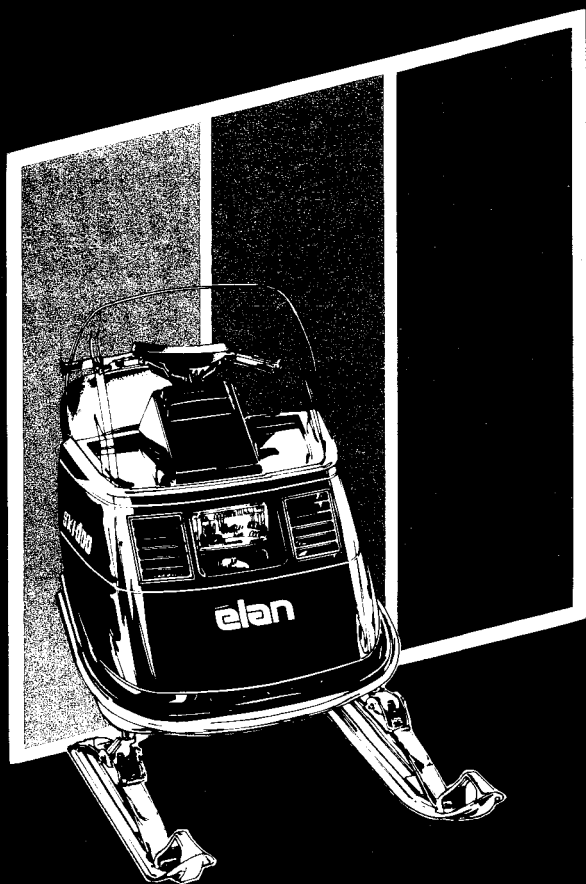

1981 OPERATOR'S MANUAL



© Trademark of Bombardier Limited

model _____

V.I.N. _____

purchase date _____

warranty expiry date _____

To be completed by dealer at time of sale

DEALER IMPRINT AREA

Text by:

Technical Publication
After Sales Service Department
Bombardier Limitée
Valcourt, Quebec
Canada, J0E 2L0

The following are trademarks of Bombardier Limitée.

BOMBARDIER	EVEREST	MOTO-SKI
SKI-DOO	CITATION	FUTURA
ALPINE	OLYMPIQUE	SPIRIT
BLIZZARD	T'NT	NUVIK
CARRY-BOOSE		MIRAGE
ELAN		SUPER SONIC
ELITE		ULTRA SONIC
GRAND PRIX SPECIAL		

INDEX

THE 1981 "LIMITED WARRANTY"	2
FOREWORD	4
SAFETY IN MAINTENANCE	5
CONTROLS/INSTRUMENTS	
Throttle lever, brake lever, ignition/light switch, headlamp dimmer switch, emergency cut-out switch, decompressor, manual starter handle, primer, tether cut-out switch	6
BREAK-IN PERIOD	
Break-in, inspection, inspection checklist	8
FUEL MIXING	
Recommended gasoline, recommended oil, fuel mixture ratio, fuel mixing procedure	10
PRE-START CHECK	
Check points	11
STARTING PROCEDURE	
Starting procedure, emergency starting	12
LUBRICATION	
Frequency, console removal, pulley guard removal, drive belt removal, boggie wheel suspension, steering mechanism, chaincase oil, drive pulley	13
MAINTENANCE	
Maintenance chart, spark plug, suspension, track, track tension and alignment, carburetor, drive belt, steering mechanism, brake, steering adjustment, engine head nuts, engine mount nuts, muffler attachment, general inspection, bulb replacement	16
STORAGE	
Track, suspension, ski assembly, controls, chaincase, drive pulley, fuel tank, carburetor, cylinder lubrication, chassis, general inspection	20
PRE-SEASON PREPARATION	
Pre-season preparation, chart,	23
TROUBLE SHOOTING	24
TOOLS	26
SPECIFICATIONS	27
WIRING DIAGRAM	28
SI METRIC INFORMATION GUIDE	29
OFTEN ASKED QUESTIONS	30
LISTING OF AREA DISTRIBUTORS	32
HOW TO IDENTIFY YOUR SNOWMOBILE	33
CHANGE OF ADDRESS OR OWNERSHIP	35

LIMITED WARRANTY 1981 SKI-DOO® SNOWMOBILES

1 - PERIOD

BOMBARDIER Limitée as manufacturer, warrants FROM THE DATE OF FIRST CONSUMER SALES, every 1981 Ski-Doo® snowmobile, sold as NEW AND UNUSED, by an authorized Ski-Doo dealer, for periods of:

- 12 months for ELAN® , CITATION* , EVEREST® , ELITE® , ALPINE® models.
- 90 consecutive days for BLIZZARD® 5500, 7500, 9500 models subject to the following:
 1. If delivery is made after the 31st day of March of a given year and before the 1st day of December of the same year, the above 90 day warranty will start on December 1st.
 2. If delivery is made on/or after the 2nd day of January of a given year but before the 31st day of March of the same year, all the unused portion of the 90 day period will be carried over to the next winter and start again on the 1st day of December of the same year.

2 - WHAT BOMBARDIER WILL DO

BOMBARDIER will repair and/or replace, at its option, components defective in material and/or workmanship (under normal use and service,) with a genuine BOMBARDIER component without charge for parts or labour, at any authorized Ski-Doo dealer during said warranty period.

3 - CONDITION TO HAVE WARRANTY WORK PERFORMED

Present to the servicing dealer, the hard copy of the BOMBARDIER Customer Registration card received by the customer from the selling dealer at time of purchase.

4 - WARRANTY TRANSFER

This warranty is transferable to subsequent owner(s) for remainder of warranty period from original date of sale.

5 - EXCLUSIONS - ARE NOT WARRANTED

- Normal wear on all items such as, but not limited to:
 - drive belts
 - slider shoes
 - spark plugs
 - breaker points
 - runners on skis
- A sulphated battery.
- Replacement parts and/or accessories which are not genuine Bombardier parts and/or accessories.
- Damage resulting from installation of parts other than genuine BOMBARDIER parts.
- Damage caused by failure to provide proper maintenance as detailed in the Operator Manual. The labour, parts and lubricants costs of all maintenance services, including tune-ups and adjustments will be charged to the owner.

- Vehicles used for racing purposes.
- All optional accessories installed on the vehicle.
(The normal warranty policy for parts and accessories, if any, applies).
- Damage resulting from accident, fire or other casualty, misuse, abuse or neglect.
- Damage resulting from modification to the snowmobile not approved in writing by BOMBARDIER.
- **Losses incurred by the snowmobile owner other than parts and labour, such as, but not limited to, transportation, towing, telephone calls, taxis, or any other incidental or consequential damages.**

Some states or provinces do not allow the exclusion or limitation of incidental or consequential damages, so the above limitation or exclusion may not apply.

6 - EXPRESSED OR IMPLIED WARRANTIES

This warranty gives you specific rights, and you may also have other legal rights which may vary from state to state, or province to province. Where applicable this warranty is expressly in lieu of all other expressed or implied warranties of BOMBARDIER, its distributors and the selling dealer, including any warranty of merchantability of fitness for any particular purpose; otherwise the implied warranty is limited to the duration of this warranty. However, some states or provinces do not allow limitations on how long an implied warranty lasts, so the above limitation may not apply.

Neither the distributor, the selling dealer, nor any other person has been authorized to make any affirmation, representation or warranty other than those contained in this warranty, and if made, such affirmation, representation or warranty shall not be enforceable against BOMBARDIER or any other person.

7 - CONSUMER ASSISTANCE

If a servicing problem or other difficulty occurs, we suggest the following:

1. Try to resolve the problem at the dealership with the Service Manager or Owner.
2. If this fails, contact your area distributor listed in the Operator Manual.
3. Then if your grievance still remains unsolved, you may write to us:

BOMBARDIER LIMITÉE
Customer Relations
Recreational Product Division
Valcourt, Quebec, Canada, JOE 2LO

BOMBARDIER LIMITÉE RESERVES THE RIGHT TO MODIFY ITS WARRANTY POLICY AT ANY TIME, BEING UNDERSTOOD THAT SUCH MODIFICATION WILL NOT ALTER THE WARRANTY CONDITIONS APPLICABLE TO VEHICLES SOLD WHILE THE ABOVE WARRANTY IS IN EFFECT.

October 1979
Bombardier Limitée
Valcourt, Quebec, Canada, JOE 2LO

© *Trademarks of Bombardier Limitée

FOREWORD

The operator manual and the Snowmobile Safety handbook have been prepared to acquaint the owner / operator of a new snowmobile with the various vehicle controls, maintenance and safe operating instructions. Each is indispensable for the proper use of the product, and should be kept with the vehicle at all times.

Should you have any questions pertaining to the warranty and its application, please consult the "Often Asked Question" section of this manual, or your selling dealer.

This manual uses the following symbols.

 **WARNING:** Identifies and instruction which, if not followed, could cause personal injury.

 **CAUTION:** Denotes an instruction which, if not followed, could severely damage vehicle components.

 **NOTE:** Indicates supplementary information needed to fully complete an instruction.

Although the mere reading of such information does not eliminate the hazard, your understanding of the information will promote its correct use.

SAFETY IN MAINTENANCE

Observe the following precautions:

- Throttle mechanism should be checked for free movement before starting engine.
- Engine should be running only when pulley guard is secured in place.
- Never run engine without drive belt installed. Running an unloaded engine can prove to be dangerous.
- Never run the engine when the track is raised off the ground.
- It can be dangerous to run engine with the cab removed.
- Gasoline is flammable and explosive under certain conditions. Always manipulate in a well ventilated area. Do not smoke or allow open flames or sparks in the vicinity. If gasoline fumes are noticed while driving, the cause should be determined and corrected without delay.
- Maintain your vehicle in top mechanical condition at all times.
- Your snowmobile is not designed to be driven or operated on black top, bare earth, or other abrasive surfaces. On such surfaces abnormal and excessive wear of critical parts is inevitable.
- Installation of other than standard equipment, including ski-spreaders, bumpers, pack racks, etc., could severely affect the stability and safety of your vehicle. Avoid adding on accessories that alter the basic vehicle configuration.
- The snowmobile engine can be stopped by activating the emergency cut-out switch, tether switch or by turning off the key.
- Whenever the vehicle is parked outdoors, overnight or for a long period, it is suggested to protect it against the inclemency of the weather with a snowmobile cover.
- Do not lubricate throttle and/or brake cables and housings.
- **Please read and understand all warnings and cautions in this manual and on the vehicle.**

THIS MANUAL SHOULD REMAIN WITH THE VEHICLE AT THE TIME OF RESALE.

CONTROLS / INSTRUMENTS

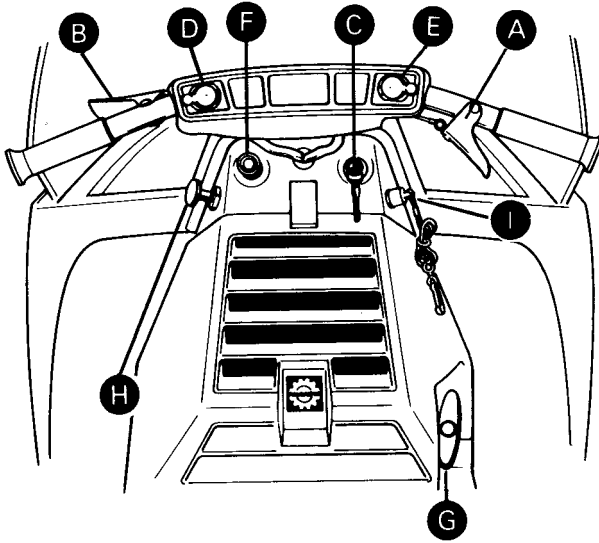

- A) *Throttle Control Lever*
- B) *Brake Control Lever*
- C) *Ignition / Light Switch*
- D) *Headlamp Dimmer Switch*
- E) *Emergency Cut-Out Switch*
- F) *Decompressor*
- G) *Manual Starter Handle*
- H) *Primer*
- I) *Tether Cut-Out Switch*

A) Throttle Control Lever

Located on the right side of the handlebar. When compressed, it controls the **engine speed** and the **engagement of the transmission**. When released, engine speed returns automatically to idle.

B) Brake Control Lever

Located on the left side of the handlebar. When compressed, the brake is applied. When released, it automatically returns to its original position. Braking effect is proportionate to the pressure applied on the lever.

C) Ignition / Light Switch

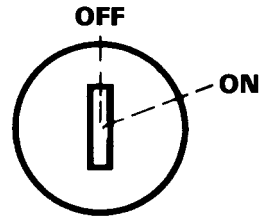

Key operated, 2 position switch. To start the engine, first turn the key clockwise to ON position. **To stop the engine**, turn the key counter-clockwise to OFF position.

The lights are automatically ON whenever the engine is running.

D) Headlamp Dimmer Switch

Located on left side of handlebar, flick switch to high or low beam.

E) Emergency Cut-Out Switch

A 3 position switch located on the right side of the handlebar. To stop the engine in an emergency, flick the lever to either upper or lower "OFF" position. To start engine, lever must be in middle "ON" position.

The driver of this vehicle should familiarize himself with the function of this device by using it several times on the first outing, thereby being mentally prepared for emergency situations requiring its use.

◆ **WARNING:** If the switch has been used in an emergency situation the source of malfunction should be determined and corrected before re-starting the engine.

F) Decompressor

Two position (OFF / ON), push-pull knob. To engage, pull the decompressor knob fully out.

▼ **CAUTION:** The decompressor provides easier starting by reducing engine compression. However, leaving the decompressor engaged while running will damage your engine. Always disengage after the engine has started.

G) Manual Starter Handle

Auto rewind type located on the right hand side of vehicle. To engage mechanism, pull handle.

H) Primer

A push-pull button. Pull and push button (2-3 times) to activate primer. The primer should always be used for cold engine starts. After engine is warm however, it is not necessary to use primer when starting.

I) Tether Cut-Out Switch

Attach tether cord to wrist or other convenient location then snap tether cut-out cap over receptacle before starting engine.

If emergency engine "shut-off" is required completely pull cap from safety switch and engine power will automatically shut "off".

○ **NOTE:** The cap must be installed on the safety switch at all times in order to operate the vehicle.

◆ **WARNING:** If the switch is used in an emergency situation the source of malfunction should be determined and corrected before re-starting engine.

Hood Opening

Unlock latches on both sides where the hood meets the frame.

○ **NOTE:** Always lift the hood gently up until stopped by the restraining rope.

◆ **WARNING:** It is dangerous to run engine with hood opened, off or unfastened. Personal injury could result.

Tool Box

Located under the hood. To gain access, tilt the hood. Ideal location for spare plugs, belt, rope, etc.

Fuel Gauge

The tank is translucent and fuel level can be checked by opening hood and glancing at tank.

◆ **WARNING:** Never use a lit match or open flame to check fuel level.

BREAK-IN PERIOD

With Bombardier-Rotax snowmobile engines, a break-in period is required before running the vehicle at full throttle. Engine manufacturer recommendation is 10 to 15 operating hours. During this period, a richer mixture is needed (i.e. 40 parts of gas for 1 part of 50/1 Bombardier oil). Maximum throttle should not exceed $\frac{3}{4}$, however, brief full acceleration and speed variations contribute to a good break-in. Continued wide open throttle accelerations, prolonged cruising speeds, and lugging are detrimental during the break-in period.

 **NOTE:** A new drive belt requires a break-in period of 15-25 km (10-15 miles)

10 Hour Inspection

As with any precision piece of mechanical equipment, we suggest that after the first 10 hours of operation or 30 days after the purchase, whichever comes first, that your vehicle be checked by your dealer. This inspection will give you the opportunity to discuss the unanswered questions you may have encountered during the first hours of operation. Remember that it is easier to remedy at this time than to allow the snowmobile to operate until a possible failure occurs.

The 10 hour inspection is at the expense of the vehicle owner.



10-HOUR INSPECTION CHECKLIST	✓
Engine timing	
Spark plug(s) condition	
Carburetor adjustment	
Engine head nuts	
Engine mount nuts	
Muffler attachment	
Chaincase oil level	
Suspension components	
Brake operation and lining condition	
Ski alignment (runners condition)	
Pulley alignment and drive belt condition	
Track condition, tension and alignment	
Lubricate (steering suspension)	
Electrical wiring (loose connections, stripped wires, damaged insulation), tightend all loose bolts, nuts and linkage	
Operation of lighting system (HI / LO beam, brake light, etc.), test operation of emergency cut-out switch and tether switch	

We recommend that you have your dealer sign this inspection list.

 Date of 10 hour inspection

 Dealer signature

FUEL MIXING

Oil must be added to the gasoline in pre-measured amounts then both oil and gasoline should be thoroughly mixed together before fueling the tank.

Recommended Gasoline

Use regular leaded gasoline available from all service stations.

▼ **CAUTION:** Never experiment with different fuel or fuel ratios. Never use naphtha, methanol or similar products.

Recommended Oil

Use concentrated Bombardier snowmobile oil available from your dealer. This type of oil has specially formulated oil bases to meet the lubrication requirements of the Bombardier-Rotax engine.

If Bombardier snowmobile oil is unavailable, substitute with a high-quality 2 cycle snowmobile oil. The oil / gas mix must meet the vehicle requirements. See oil manufacturer recommendations on the container.

▼ **CAUTION:** Never use outboard or straight mineral oils.

Fuel Mixture Ratio

The importance of using the correct fuel mixture cannot be overstressed. An incorrect fuel ratio results in serious engine damage. Recommended fuel ratio is 50/1 (40/1 during break-in period).

SI UNITS

500 mL oil to 25 liters = 50/1

IMPERIAL UNITS

1 can 16 oz oil to 5 imp. gals = 50/1

or

1 can 500 mL oil to 5 1/2 imp. gals = 50/1

U.S. UNITS

1 can 12 oz oil to 5 U.S. gals = 50/1

○ **NOTE:** To facilitate fuel mixing oil should be kept at room temperature.

Fuel Mixing Procedure

To mix the gasoline and oil always use a separate clean container. Never mix directly in your snowmobile tank. For best results, acquire two containers, either plastic or metal. Draw from one until empty then use the second one.

◆ **WARNING:** Gasoline is flammable and explosive under certain conditions. Always manipulate in a well ventilated area. Do not smoke or allow open flames or sparks in the vicinity. If gasoline fumes are noticed while driving, the cause should be determined and corrected without delay. Never add fuel while the engine is running. Avoid skin contact with fuel at below freezing temperatures.

1. Pour approximately one gallon of gasoline into a clean container.

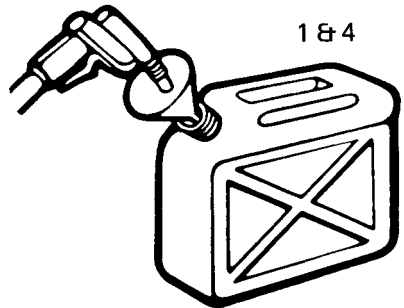

2. Add the full amount of oil.

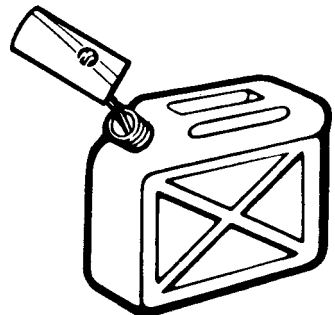

3. Replace the container cap and shake the container thoroughly.

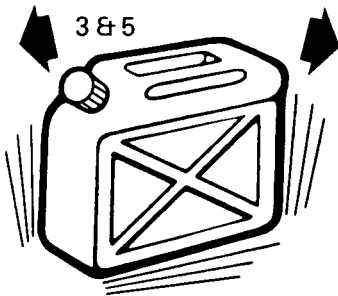

4. Add the remainder of the gasoline.
5. Once again thoroughly agitate the container. Then **using a funnel** with a fine mesh screen to prevent the entry of water and foreign particles, pour the mixture into the snowmobile tank.

○ **NOTE:** When using pre-mixed fuel, always shake the container thoroughly as the oil has a tendency to settle.

◆ **WARNING:** Never 'top up' the gas tank before placing the vehicle in a warm area. At certain temperatures, gasoline will expand and overflow. Always wipe off any gasoline spillage from the snowmobile.

Check Points

- Activate the throttle control lever several times to check that it operates easily and smoothly. The throttle control lever must return to idle position when released.
- Check fuel level.
- Check that the ski and the tracks are not frozen to the ground or snow surface and that the steering operates freely.
- Activate the brake control lever and make sure the brake fully applies before the brake control lever touches the handlebar grip.
- Verify that the path ahead of the vehicle is clear of bystanders and obstacles.

◆ **WARNING:** Only start your snowmobile once all components are checked and functioning properly.

STARTING PROCEDURE

Emergency Cut-Out Switch

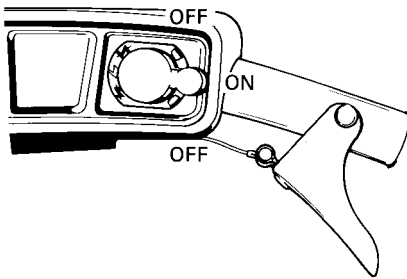

Manual Starting

1. Insert the key in the ignition switch and turn to ON position.
2. Test the throttle control lever.
3. Activate the primer (2 to 3 times). (Also pull the decompressor knob fully out.)

○ **NOTE:** The use of the primer is not necessary when the engine is warm.

4. Make sure that the tether cut-out cap is in position and that the cord is attached to your clothing. Check that the emergency cut-out switch is in the ON position.
5. Grasp manual starter handle firmly and pull slowly until a resistance is felt then pull vigorously. Slowly release the rewind starter handle.

◆ **WARNING:** Do not apply throttle while starting.

6. Push in the decompressor
7. Check the operation of the emergency cut-out switch and the tether switch. Restart the engine.

◆ **WARNING:** If engine does not shut-off when flicking the emergency cut-out switch to OFF position and pulling the tether cut-out cap, stop the engine by turning off the ignition key. Do not operate the vehicle further, see your dealer.

8. Allow the engine to warm before operating at full throttle.

Emergency Starting

Should the rewind starter rope fray and break, the engine can be started with an emergency starter rope.

Remove the rewind starter assembly from the engine and transfer the rope handle to your emergency rope.

Wind the rope around the starting pulley.

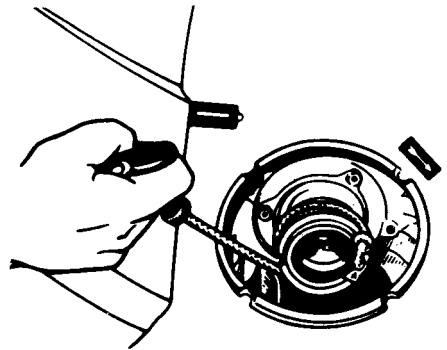

◆ **WARNING:** When starting the vehicle in an emergency situation by the starting pulley do not reinstall the rewind starter assembly.

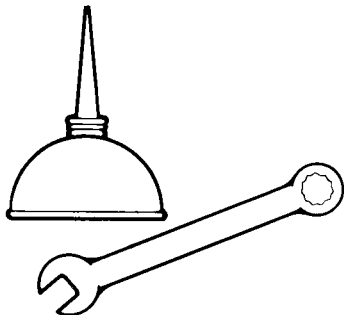

Routine maintenance is necessary for all mechanized products, and the snowmobile is no exception. A weekly vehicle inspection contributes to the life span of the snowmobile as well as retains safe and dependable operation. It is recommended that the steering system and suspension be lubricated monthly or every 40 hours of operation. If the vehicle is operated in wet snow or in severe conditions these items should be lubricated more frequently.

◆ **WARNING:** Only perform such procedures as detailed in this manual. It is recommended that dealer assistance be periodically obtained on other components / systems not covered in this manual. Unless otherwise specified, engine should be turned OFF for all lubrication and maintenance procedures.

Console Removal

For any procedure that may require removal of the console, proceed as follows:

1. Unlock the latch where the console and dashpanel meet.
2. Push the console downward then tilt away from the engine. To re-install, reverse the procedure.

Pulley Guard Removal

◆ **WARNING:** Engine should be running only when pulley guard is secured in place.

1. Tilt the hood and remove the console.
2. Remove the driven pulley guard (front) by unlocking it from its attaching points.
3. To remove the drive pulley guard, pull out the retaining clip (A) and pull on the spring (B) to disengage the pin from the bracket.

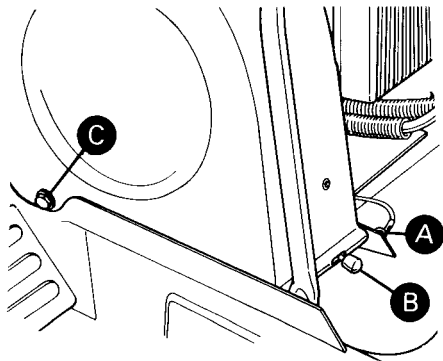

4. Push the pulley guard forward to disengage the front attachment (C) from the frame. Lift the guard from the vehicle.

Drive Belt Removal

◆ **WARNING:** Never start or run the engine without the drive belt installed. Running an unloaded engine is dangerous.

1. Tilt the hood and remove the pulley guard.
2. Open the driven pulley by twisting and pushing the sliding half. Hold in fully open position.

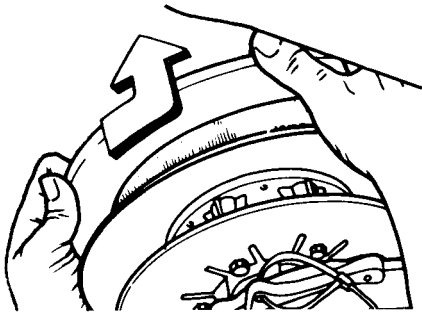

3. Slip the belt over the top edge of the sliding half.

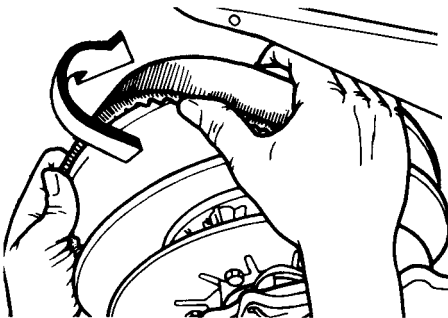

4. Slip the belt out from the drive pulley and remove completely from the vehicle. To install the drive belt, reverse the procedure.

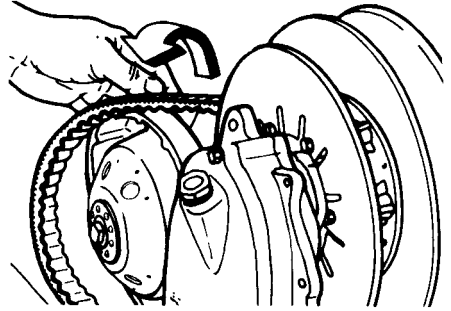

Bogie Wheel Suspension

Lubricate the suspension bogie wheels using low temperature grease. Pump through the grease fitting at the center of each wheel until new grease appears at the joint of the inner side of the shaft.

Lubricate the rear axle with low temperature grease. Pump through the rear axle fittings.

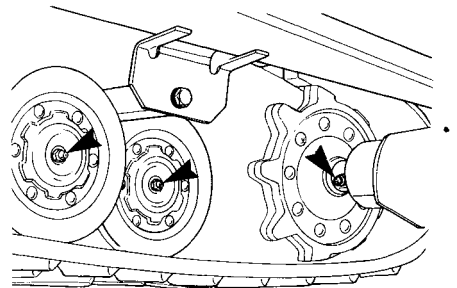

▼ **CAUTION:** Always use a low pressure grease gun when lubricating rear axle.

Steering Mechanism

◆ **WARNING:** Do not lubricate throttle and / or brake cable and housings.

Lubricate the ski legs at the grease fittings until new grease appears at the joints. Oil the spring coupler bolts.

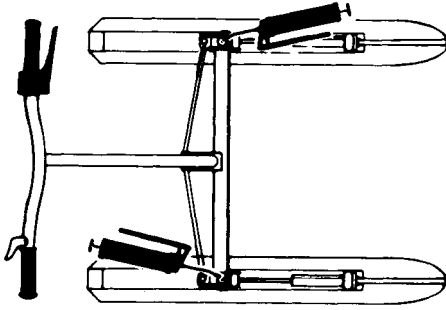

Drive pulley

The drive pulley requires lubrication bi-monthly or every 20 hours of operation.

◆ **WARNING:** The lubrication of the drive pulley should be performed only by an authorized dealer. A disassembly, cleaning, inspection and lubrication where applicable should also be performed by the dealer every 50 operating hours or at the end of each season, whichever occurs first.

Chaincase oil level

Remove the tool box then check the oil level by removing the oil level inspection plug. Oil should be at the bottom lip of the hole. Replenish as necessary by removing the filler cap using a spark plug socket.

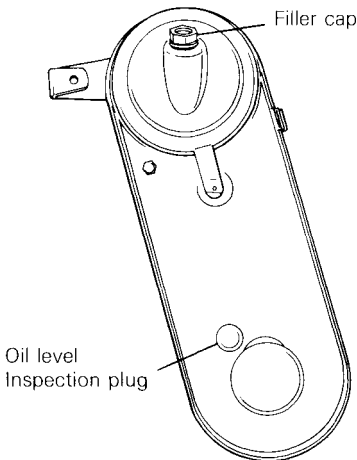

MAINTENANCE

The following Maintenance Chart indicates regular servicing schedules to be performed by you or your servicing dealer. If these services are performed as suggested, your snowmobile will give you many years of low-cost use.

◆ WARNING: Only perform such procedures as detailed in this manual. It is recommended that dealer assistance be periodically obtained on other components / systems not covered in this manual. Unless otherwise specified, engine should be turned OFF for all lubrication and maintenance procedures.

SERVICE AND MAINTENANCE CHART	Weekly or every 240 km (150 m)	Monthly or every 800 km (500 m)	Once a year or every 3200 km (2000 m)	Refer to page
Spark plug		●		17
Suspension condition		●		17
Track condition		●		17
Track tension and alignment		●		17
Carburetor adjustment			●	18
Drive belt condition	●			18
Steering mechanism		●		18
Brake condition	●			18
Steering adjustment		●		19
Engine head nuts			●	19
Engine mount nuts			●	19
Muffler attachment		●		19
General inspection		●		20

○ **NOTE:** The ten hour inspection is a very important part of proper service and maintenance.

Spark Plug

Disconnect the spark plug wire and remove the spark plug.

Check condition of plug.

- A brownish tip reflects ideal conditions. (Correct carburetor, spark plug heat range; etc.).
- A black insulator tip indicates fouling caused by; carburetor idle speed mixture and / or high speed mixture too rich, incorrect fuel mixture ratio, wrong type of spark plug (heat range), or excessive idling.
- A light grey insulator tip indicates a lean mixture caused by; carburetor high speed mixture adjusted too lean, wrong spark plug heat range, incorrect fuel mixture ratio, or a leaking seal or gasket.

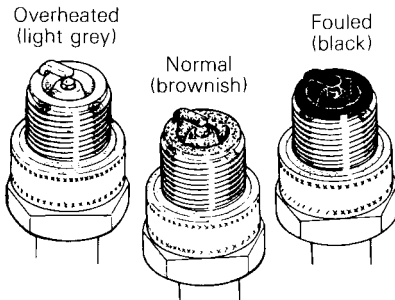

CAUTION: If spark plug condition is not ideal, contact your authorized dealer.

Check the spark plug gap using a wire feeler gauge.

Reinstall the plug and connect the wire.

Suspension Condition

Visually inspect suspension springs. Replace any weak or broken spring. Check for wear or looseness. Correct as required.

Track Condition

Lift the rear of vehicle and support it off the ground. With the engine off, rotate the track by hand, and inspect. If worn, cut or the track fiber is exposed or missing or defective inserts or guides are noted, contact your dealer.

WARNING: Do not operate a snowmobile with a cut, torn or damaged track.

Track Tension and Alignment

Lift the rear of the vehicle and support it off the ground. Using a rule, check the track tension from the middle set of bogie wheels.

The distance between the top inside edge of the track and the bottom of the footboard should be 35 mm (1 3/8").

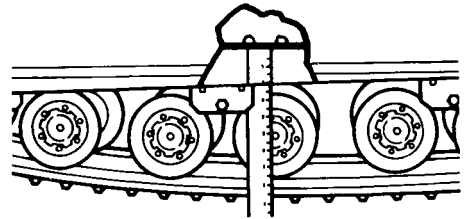

If the track tension is too loose, the track will have a tendency to thump. If too tight, performance will be affected.

If necessary to adjust.

1. Using a wrench, loosen both track adjusters by unscrewing the lock nuts situated on the inner side of the suspension springs.
2. Adjust to proper tension by turning adjuster bolts clockwise to tighten counter-clockwise to slacken. Adjust both side equally.

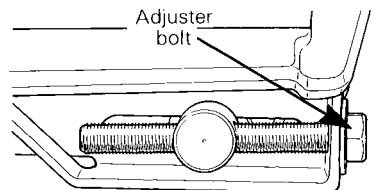

3. Proceed with track alignment.

○ **NOTE:** Track tension and alignment are inter-related. Do not adjust one without checking the other.

Support the rear of vehicle with a mechanical stand. Start the engine and accelerate slightly so that the track turns **slowly**. Check that the track is well centered and turns evenly on the rear sprockets. The distance between the edges of the track and the link plates should be the same on both sides. Misalignment can cause excessive wear of track edges and sprocket teeth.

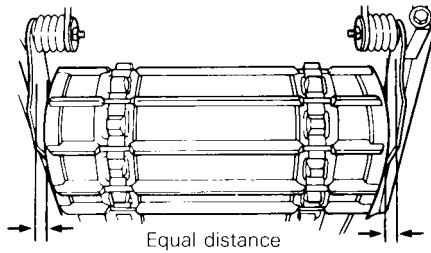

To adjust:

1. **Stop the engine.** Using a wrench, turn the track adjuster bolt clockwise on the side where the track is closest to the link plate until track aligns.
2. Firmly retighten the adjuster lock nuts.
3. Restart the engine and rotate the track **slowly** and recheck alignment.

◆ **WARNING:** Before checking the track alignment, ensure that the track is free of all particles which could be thrown out while it is rotating. Keep hands, feet, tools and clothing clear of track. Ensure no-one is standing in close proximity to the vehicle.

Carburetor Adjustment

▼ **CAUTION:** Never operate your snowmobile with the air intake silencer disconnected. Serious engine damage will occur.

Carburetor adjustment should be performed by your dealer.

Drive Belt

Inspect belt for cracks, fraying or abnormal wear (uneven wear, wear on one side, etc.) If abnormal wear is noted, probable cause is pulley misalignment. Contact your dealer.

Check the drive belt width, if less than 2.7 cm (1 1/16"). Replace the drive belt.

○ **NOTE:** When installing a new drive belt, break-in period of 15-25 km (10-15 miles) is strongly recommended.

Steering Mechanism

Inspect the steering mechanism for tightness of components (steering arms, tie rods, ball joints, spring coupler bolts, etc.). If necessary, replace or retighten.

Check the condition of skis and ski runners. Replace if worn more than half.

Brake

The brake mechanism on your snowmobile is an essential safety device. Keep this mechanism in proper working condition. Above all, do not operate your snowmobile without an effective brake system.

◆ **WARNING:** Brake pad or pucks less than 5 mm (3/16 in.) thick must be replaced. Replacement must be performed by an authorized dealer.

Brake should apply fully while brake control lever is still 2.5 cm (1 inch) minimum from the handlebar grip.

If a minor adjustment is indicated, slack off the cable housing nut (A) and tighten the nut (B) to increase the lever clearance.

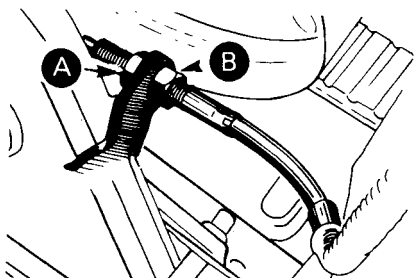

Once minor adjustment is completed, firmly tighten the nuts (A and B) against the bracket. If correct brake control lever clearance is unobtainable, proceed with major adjustment as follows:

Slacken off the nut retaining the brake cable to the lower brake lever. Adjust the cable to required length by lengthening or shortening the brake cable. Retighten the nut. Ensure that minor adjustment nuts are located approximately half way on the adjuster threads.

WARNING: Always check the stop light to see if it functions after performing brake adjustment.

Steering Adjustment

Skis should have a toe out of 3 mm (1/8 in.). To check, measure distance between skis at front and rear of leaf springs.

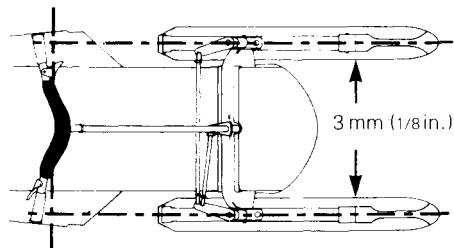

If necessary to adjust:

Loosen the lock nuts of the longer tie rod. Turn the tie rod manually until the skis are properly aligned. Firmly retighten the lock nuts.

Handlebar should also be horizontal when the skis are pointed toward the front. To adjust; loosen the lock nuts of the shorter tie rod. Turn the tie rod manually until the handlebar is horizontal. Retighten the lock nuts firmly. Check tightness of the steering arm locking bolts and the wear of the ball joints.

WARNING: The cut off section of the ball joint must run parallel with the steering arm. When tightening lock nuts, restrain ball joint with appropriate size wrench. Ensure at least half of the ball joint threads are inserted into the tie rod.

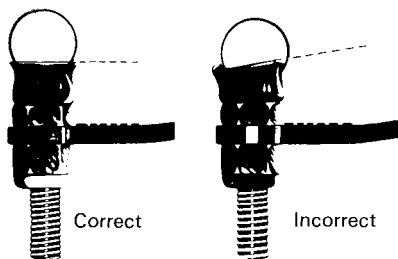

Engine Head Nuts

With the engine cold, check that the engine head nuts are tight and equally torqued to 22 N•m (16 ft-lbs).

IMPORTANT: The engine head nut torque should be checked after the first 5 hours of operation.

Engine Mount Nuts

Check the engine mount nuts for tightness. Retighten if necessary.

Muffler Attachment

The engine / muffler attaching parts are vital toward efficient muffler function. Check all attachments. Replace springs and / or tighten if necessary.

General Inspection

Check electrical wiring and components, retighten loose connections. Check for stripped wires or damaged insulation. Thoroughly inspect the vehicle and tighten loose bolts, nuts and linkage.

Bulb Replacement

If the headlamp is burnt, tilt hood and unplug the connector from the headlamp. Remove the rubber boot and unfasten the bulb retainer clips. Detach the bulb and replace. If the taillight bulb is burnt, expose the bulb by removing the red plastic lens. (Two (2) Phillips head screws). Verify all lights after replacement.

 **WARNING:** Only perform such procedures as detailed in this manual. It is recommended that dealer assistance be periodically obtained on other components / systems not covered in this manual. Unless otherwise specified, engine should be turned OFF for all lubrication and maintenance procedures.

Track

Inspect the track for wear, cuts, missing track guides and broken rods. Make any necessary replacement.

 **WARNING:** Do not operate a snowmobile with a cut, torn or damage track.

Lift the rear of the vehicle until the track is clear of the ground, then support it with a brace or trestle. The snowmobile should be stored in such a way that the track does not stay in contact with the ground.

 **NOTE:** The track should be rotated periodically, (every 40 days). Do not release track tension.

 **CAUTION:** To prevent track damage, temperature in the storage area must not exceed 38°C (100°F).

Suspension

Bogie Wheels

Remove the bogie wheel sets. Remove the cross shaft from each bogie wheel set. Clean the bogie wheel assembly and shaft of dirt and rust. Check the condition of the cross shaft, replace if worn. Apply a coat of low temperature grease over the shaft.

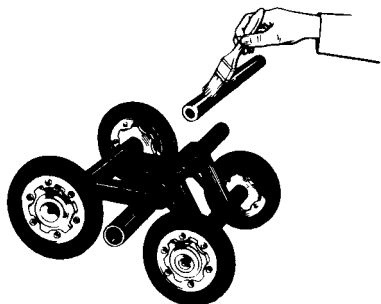

Grease each set then spray the springs with metal protector, or wipe with an oil soaked cloth. Assemble and install each set in the proper position.

Ski

Wash or brush all dirt or rust accumulation on the skis and springs. Grease the ski leg grease fittings. Check the condition of skis, ski runners and leaf springs. Replace if worn or weak.

Controls

Lubricate the steering mechanism. Inspect all components for tightness, (spring coupler bolts, steering arm locking bolts, tie rods, ball joints, etc.). Tighten if necessary. Oil moving joints of the brake mechanism.

◆ **WARNING:** Do not lubricate throttle and / or brake cable housing. Avoid getting oil on brake pads.

Coat electrical connections and switches with a greaseless metal protector. If unavailable, use petroleum jelly.

▼ **CAUTION:** Plastic alloy components such as fuel tank, windshield, etc., can be cleaned using mild detergents or isopropyl alcohol. Do not use strong soaps, degreasing solvents, abrasive cleaners, paint thinners, etc.

Chaincase

Drain the chaincase and refill to proper level. To drain the chaincase remove the access plug (lower plug) and tilt vehicle hard left.

Drive Pulley

The drive pulley should be cleaned and inspected. It also requires lubrication.

◆ **WARNING:** The lubrication of the drive pulley should be performed only by an authorized dealer.

Fuel Tank and Carburetor

Remove the cap then using a syphon, remove gasoline from tank.

◆ **WARNING:** Gasoline is flammable and explosive under certain conditions. Always manipulate in a well ventilated area. Do not smoke or allow open flames or sparks in the vicinity.

The carburetor must be dried out completely to prevent gum formation during the storage period.

Assure that the carburetor inlet fuel line is disconnected. Remove the plug of the float chamber. Drain carburetor into a container.

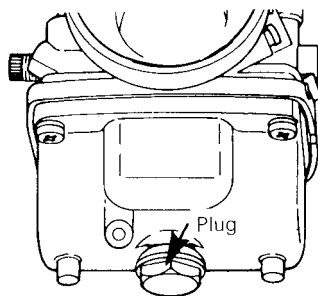

Reinstall the plug and connect the fuel line.

Check all fuel lines, replace if necessary.

Cylinder Lubrication

Engine internal parts must be lubricated to protect the cylinder walls from possible rust formation during the storage period.

○ **NOTE:** This operation should be repeated every 40 days during storage.

Remove the spark plug. Operate the rewind starter to bring the piston at top position. Pour the equivalent of one spoonful of oil into spark plug hole.

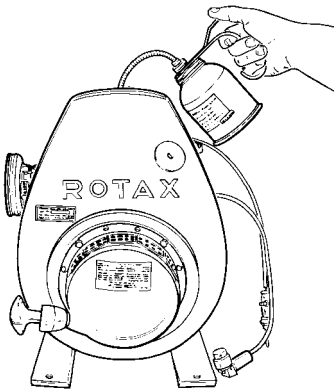

Slowly crank the engine several times using the manual starter.

Install the spark plug.

▼ **CAUTION:** To prevent ignition system damage, make sure that the cut-out switch is in the OFF position.

Chassis

Clean the vehicle thoroughly, removing all dirt and grease accumulation.

▼ **CAUTION:** Plastic alloy components such as fuel tank, windshield, etc., can be cleaned using mild detergents or isopropyl alcohol. Do not use strong soaps, degreasing solvents, abrasive cleaners, paint thinners, etc.

Inspect the hood and repair if needed. Repair kits are available at your authorized dealer. Clean the frame.

Touch up all metal spots where the paint has been scratched off. Spray all bare metal parts with metal protector. Wax the cab for better protection.

○ **NOTE:** Apply wax on glossy finish of the hood only. Protect the vehicle with a cover to prevent dust accumulation during storage.

▼ **CAUTION:** Cover the snowmobile with an opaque tarpaulin. This will prevent the sun rays or grime from affecting the plastic components and the vehicle finish.

General Inspection

Check the electrical wiring and components, retighten loose connections. Check for stripped wires or damaged insulation.

Thoroughly inspect the vehicle and tighten loose bolts, nuts and linkage.

○ **NOTE:** Leave the drive belt off the pulleys for the entire storage period.

PRE-SEASON PREPARATION

To simplify the pre-season preparation we have drawn up a small chart. The chart indicates servicing points to be performed by you and your servicing dealer. If these services are performed as suggested, your vehicle will give you many hours of fun and low cost use.

IMPORTANT: Observe all Warnings and Cautions mentioned throughout this manual which are pertinent to the item being checked. When component conditions seem less than satisfactory, replace with genuine Bombardier parts or suitable equivalents.

PRE-SEASON PREPARATION CHART

To be performed by dealer.	●
To be performed by owner.	○
Change spark plug.	○
Check chaincase oil level.	○
Check pulleys, verify components and clean. Lubricate.	●
Check steering alignment and ski runner condition.	●
Check track tension and alignment.	○
Lubricate suspension.	○
Inspect drive belt and install.	○
Check throttle cable for damage and free operation.	○
Inspect brake condition and operation.	●
Inspect oil seals for possible cuts or leaks.	○
Set engine timing, if necessary replace breaker points.	●
Check electrical wiring (broken wire, damaged insulation).	○
Inspect condition of starting rope.	○
Check tightness of all bolts, nuts and linkage.	○
Refill gas tank.	○
Adjust carburetor.	●

TROUBLE SHOOTING

SYMPTOMS	POSSIBLE CAUSES	WHAT TO DO
<p>Engine turns over but fails to start or starts with difficulty</p>	<p>1. No fuel to the engine</p>	<p>Check the tank level and fill up with correct gas-oil mixture. Check for possible clogging of fuel line, item 5.</p>
	<p>2. Flooded engine</p>	<p>Remove wet spark plug, turn ignition to OFF and crank engine several times. Install clean dry spark plug. Start engine following usual starting procedure. If engine continues to flood, see your dealer.</p>
	<p>3. Spark plug/faulty ignition</p>	<p>Check for fouled or defective spark plug. Disconnect spark plug wire, unscrew plug and remove from cylinder head. Reconnect wire and ground exposed plug on engine cowl, being careful to hold away from spark plug hole. Follow engine starting procedure and check for spark. If no sparks appear, replace spark plug. If trouble persists, contact your dealer.</p>
	<p>4. Clogged fuel line (water or dirt)</p>	<p>Check condition and connections of fuel lines. Check the cleanliness of fuel tank.</p>
	<p>5. Incorrect carburetor adjustment</p>	<p>Contact your dealer for repair.</p>
	<p>6. Too much oil in fuel</p>	<p>Drain the fuel tank and refill with the correct gas/oil mixture.</p>
	<p>7. Engine timing</p>	<p>Engine timing may be defective or out of adjustment. Contact your dealer.</p>
	<p>8. Poor engine compression</p>	<p>Running with a lean fuel mixture may produce excessive engine wear resulting in poor engine compression. If this occurs, contact your dealer at once.</p>
<p>Engine will not turn manually</p>	<p>1. Seized engine</p>	<p>In the case of a seized engine contact your dealer.</p>

SYMPTOMS	POSSIBLE CAUSES	WHAT TO DO
Engine lacks acceleration or power	1. Fouled or defective spark plug	Check item 3 of "Engine turns over but fails to start or starts with difficulty"
	2. Clogged fuel line (water or dirt)	Check fuel line condition. (See item 5 of "Engine turns over but fails to start or starts with difficulty").
	3. Carburetor	Contact your dealer.
	4. Ignition	First check item 2 and 3 of "Engine turns over but fails to start or starts with difficulty". If the ignition system still seems faulty, contact your dealer.
	5. Engine	If unable to locate specific symptoms, contact your dealer.
Engine continually backfires	1. Spark plug	Check item 3 of "Engine turns over but fails to start or starts with difficulty".
	2. Overheated	Carburetor set too lean. Contact your dealer.
	3. Engine timing incorrectly set	Contact your dealer.
Snowmobile cannot reach full speed	1. Drive Belt	Check for damaged or worn drive belt. Replace if necessary.
	2. Incorrect track adjustment	Check track tension and alignment. Readjust to specifications. (See Maintenance Section).
	3. Engine	Check item 1 to 5 of "Engine lacks acceleration or power."
	4. Pulley misaligned	Contact your dealer.

TOOLS

As standard equipment, each new snowmobile is supplied with a basic tool kit such as screwdriver, wrenches, emergency starter rope, etc...

Standard Tools

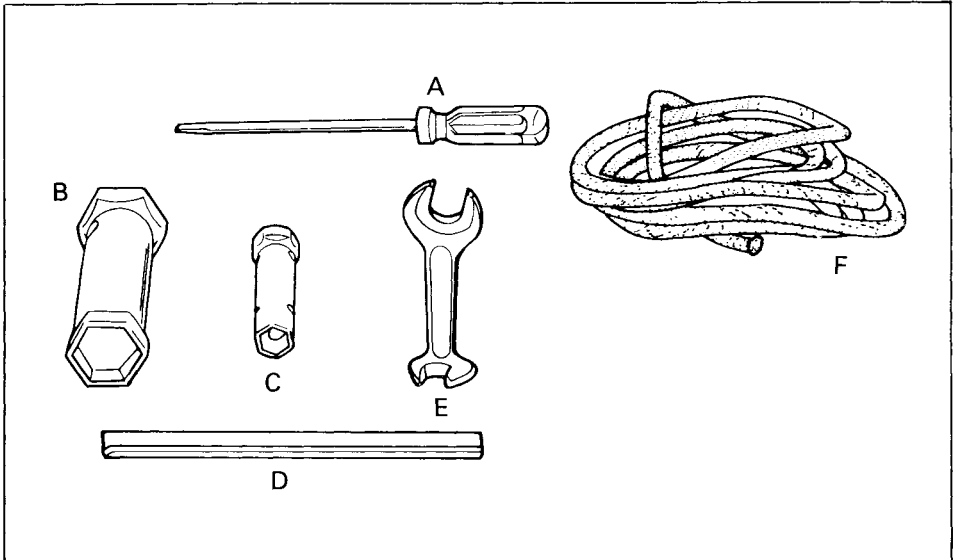

- A. Screwdriver
- B. Socket 21 / 26 mm
- C. Socket 10 / 13 mm
- D. Socket handle
- E. Angular wrench 10 / 13 mm
- F. Starter rope

SPECIFICATIONS

1981 ELAN	250 (single)
ENGINE No. of cylinders Bore Stroke Displacement Compression ratio (corrected) Carburetor type Carburetor adjustment — air screw — idle speed Engine head nuts (torque)	1 69.5 mm (2.73") 66 mm (2.598") 250.4 cm ³ (15.28 in. ³) 5:6 Mikuni VM 28-242 1 1/2 turn ± 1/8 1100-1300 R.P.M. 22 N•m (16 ft-lbs)
CHASSIS Overall length Overall width Overall height Ski stance (center to center) Ski alignment (toe out) Weight Bearing area Ground pressure	2.25 m (88 1/2") 77.5 cm (30 1/2") 116.7 cm (42") 64.8 cm (25 1/2") 3 mm (1/8") 129.2 kg (285 lbs) 6904 cm ² (1070 in. ²) 1.813 kPa (.263 lbs/in ²)
POWER TRAIN Track dimensions Track tension Track alignment Std. gear ratio Chaincase oil capacity Drive belt (minimum width)	38.1 cm (15") x 289.6 cm (114") 35 mm ± 3 (1 3/8" ± 1/8") distance between top inside edge of track and the bottom of the footboard Equal distance between edges of tracks and link plates. 10/25 200 mL (7 oz.) 2.7 cm (1 1/16 in.)
ELECTRICAL Lighting system (output) Headlamp bulb Tail/stop light Spark plug (Bosch) Breaker point gap Spark plug (gap) Advanced ignition timing	12 volts, 75/23 W 60/60 W 5/21 W M-175 T-1 (M7A) 0.35 - 0.40 mm (.014" - .016") 0.50 mm (.020") 3.73-4.24 mm (.147"- .167") B.T.D.C. (direct)
FUEL Tank capacity — S.I.* — Imp. — U.S. Gasoline Gas/oil ratio	13.6 liters 3 gallons 3.6 gallons Regular 50/1
BRAKE Brake type Brake adjustment (control level) Brake shoe (minimum thickness)	Drum 2.5 cm (1") minimum distance from handlebar grip when fully applied 5 mm (3/16 in.)

*International Standard

Bombardier Limitée reserves the right to make changes in design and specifications and/or to make additions to, or improvements in its product without imposing any obligation upon itself to install them on its product previously manufactured.

WIRING DIAGRAM

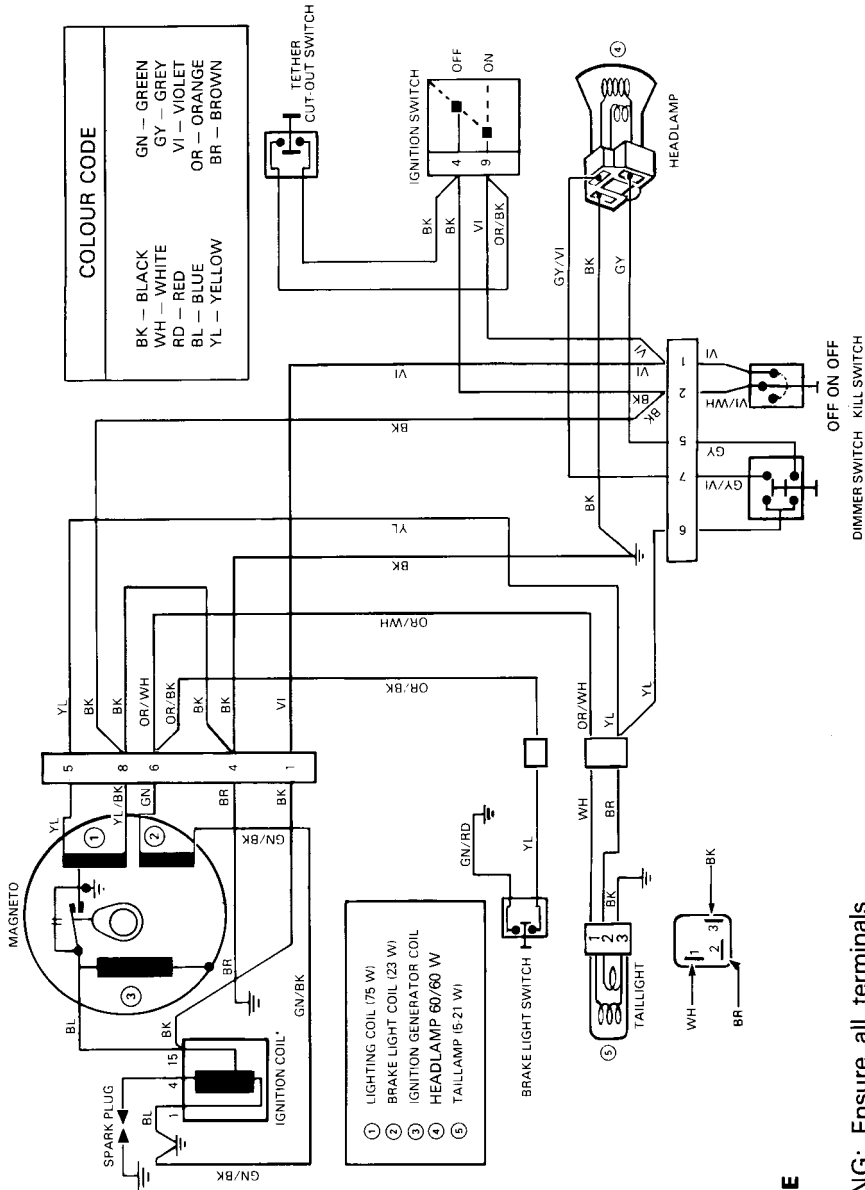

247 cc SINGLE

WARNING: Ensure all terminals are properly crimped on the wires and all connector housings are properly fastened.

SI* METRIC INFORMATION GUIDE

BASE UNITS

DESCRIPTION	UNIT	SYMBOL
length	meter	m
mass	kilogram	kg
liquid	liter	L
temperature	celsius	°C
pressure	kilopascal	kPa
torque	Newton meter	N•m
speed	kilometer per hour	km/h

PREFIXES

PREFIX	SYMBOL	MEANING	VALUE
kilo	k	one thousand	1,000
centi	c	one hundredth of a	0.01
milli	m	one thousandth of a	0.001

*THE INTERNATIONAL SYSTEM OF UNITS (SYSTEME INTERNATIONAL) ABBREVIATES "SI" IN ALL LANGUAGES.

OFTEN ASKED QUESTIONS

Q: Why must my snowmobile be registered? After all I do have my original invoice as proof of when I purchased my snowmobile.

A: Your warranty is valid at any authorized dealer of the product. Your registration is the key element in providing the servicing dealer with the necessary data to complete warranty claim forms. This information is also used to notify owners in the event of a safety recall.

Q: How do I know my vehicle has been registered at the factory?

*A: When you bought your snowmobile the dealer should have completed, and forwarded us the manufacturer's copy of the Customer Warranty Registration. The **hard copy** of the card is your proof that the snowmobile is registered.*

Q: I bought my snowmobile in O'King County but I snowmobile in Washington County. Can the dealer in Washington County accept to perform warranty work on my snowmobile?

A: Yes, any authorized dealer in North America can perform warranty repairs, providing the customer warranty registration card is presented.

Q: Where can I find information on the lubrication and maintenance of my snowmobile?

A: In this Operator Manual provided with the vehicle at the time of first sale.

Q: Will the entire warranty be void or cancelled, if I do not operate or maintain my new snowmobile exactly as specified in the Operator's Manual?

*A: The warranty of the snowmobile cannot be "Voided" or "Cancelled". However, if a particular failure is caused by operation or maintenance other than is shown in the Operator Manual, **that** failure may not be covered under warranty. This includes service work performed by the customer, especially the critical adjustments to ignition, timing, carburetion and oil injection/or oil mixture.*

Q: Would you give some examples of abnormal use or strain, neglect or abuse?

A: These terms are general and overlap each other in areas. Some specific examples may include: running the machine out of oil, chain failure caused by a lack of lubrication, operating the machine with a broken or damaged part which causes another part to fail, and so on. If you have any specific questions on operation or maintenance, please contact your dealer for advice.

Q: What costs are my responsibility during the warranty period?

A: The customer's responsibility includes all costs of normal maintenance services, non-warranty repairs, accidents and collision damage, as well as oils, and spark plugs.

Q: Are "Genuine" Bombardier replacement parts used in warranty repairs covered by warranty?

A: Yes. When installed by an authorized dealer, any "genuine" Bombardier part used in warranty repairs assumes the remaining warranty that exists on the machine.

Q: What is Bombardier's policy on extending a warranty?

A: It is not Bombardier's policy to extend warranty. Bombardier has selected a warranty period sufficiently long to permit adequate use of the machine to allow for concealed manufacturing defects to occur.

Q: Manufacturer does not accept warranty work on seized, scored or melted pistons, why?

A: From testing and experience, we know that such piston failures can only be caused by detonation or pre-ignition, which are directly related to the following factors and therefore, are beyond the manufacturer's control.

- Incorrect oil/gas mixture (too little or too much oil).
- Poor quality, outboard or straight mineral oils.
- Removal of intake silencer.
- Hot spark plug(s) (improper heat range).

Q: If I sell my snowmobile within the warranty period, will the new owner qualify for the balance of the warranty?

A: Yes, provided the unit has already been registered with the manufacturer. Note that the change of ownership card in this manual should be completed and sent to Bombardier Limitée.

LISTING OF AREA DISTRIBUTORS



CANADIAN DISTRIBUTORS

ALPINE DISTRIBUTORS LIMITED
Kalamalka Lake Road
P.O. Box 159
Vernon, British Columbia, V1J 6M2
(604) 545-1314
British Columbia

BOMBARDIER LIMITEE
EASTERN CANADA DISTRIBUTION DIVISION
Atlantic Branch
P.O. Box 670
Shediac, New Brunswick, E0A 3G0
(506) 532-4454
Magdalen Island, Nova Scotia, New Brunswick,
Prince Edward Island

BOMBARDIER LIMITEE
EASTERN CANADA DISTRIBUTION DIVISION
(Quebec Branch)
1350 Nobel Boulevard
Boucherville, Quebec, J4B 1A1
(514) 527-2469 or 655-6121
Province of Quebec

BOMBARDIER LIMITEE
EASTERN CANADA DISTRIBUTION DIVISION
Ontario Branch
230 Bayview Drive
Barrie, Ontario, L4M 2Y8
(705) 728-8600
Province of Ontario

BROOKS EQUIPMENT LIMITED
1616 King Edward Street
P.O. Box 985
Winnipeg, Manitoba, R3C 2V8
(204) 633-7247
Manitoba, Saskatchewan

HUDSON'S BAY CO. LTD.
165 Hymus Blvd.
Pointe-Claire, Québec, M4W 1A8
(514) 697-8500
North-West Territories, Franklin District & Keewatin

J.W. RANDALL LIMITED
West Street
P.O. Box 1050
Corner Brook, Newfoundland, A2H 6G7
(709) 634-3533
Newfoundland, Labrador

TRACT EQUIPMENT
14325, 114th Avenue
Edmonton, Alberta, T5M 2Y8
(403) 452-9910
Alberta, Dist. Mackenzie, Yukon, N.W.T.

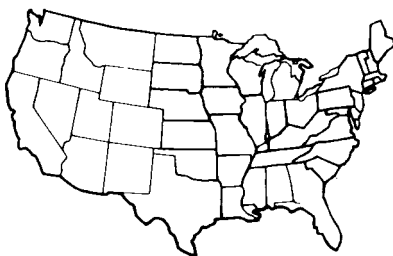

AMERICAN DISTRIBUTORS

BOMBARDIER CORPORATION
4505 West Superior Street
P.O. Box 6106
Duluth, Minnesota 55806
(218) 628-2881
North Dakota, Minnesota, Wisconsin, Illinois, Missouri,
Michigan, Indiana, Ohio (less eastern half), Tennessee,
Kentucky, West Virginia, Virginia, Northern Idaho,
Northern Wyoming, Montana, Iowa, Washington

ELLIOTT & HUTCHINS INC.
East Main Street Road
Malone, New York 12953
(518) 483-4411
New York, Massachusetts, Connecticut, Rhode Island,
Pennsylvania, New Jersey, Maryland, Delaware, District of
Columbia, Northern half of Ohio.

MILLER EQUIPMENT AND RECREATIONAL CENTER
1049 Whitney Road
Anchorage, Alaska 99501
(907) 274-9513
Alaska

TIMBERLAND MACHINES INC.
10 North Main Street
Lancaster, New Hampshire 03584
(603) 788-4738
Maine, New Hampshire, Vermont

HOW TO IDENTIFY YOUR SNOWMOBILE

The main components of your snowmobile (engine, track and frame) are identified by different serial numbers. It may sometimes become necessary to locate these numbers for warranty purposes or to trace your snowmobile in the event of theft.

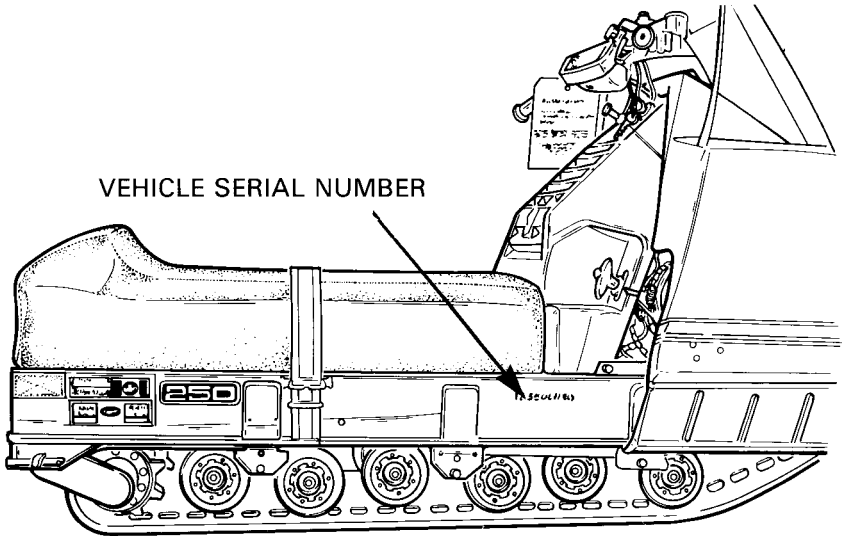
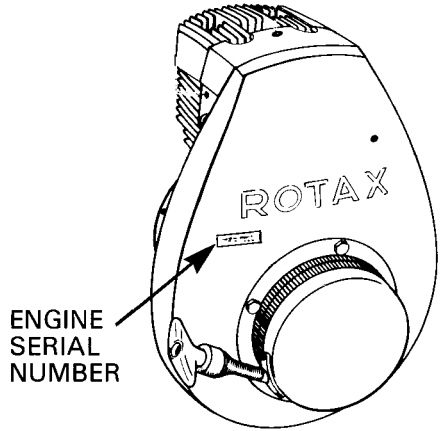
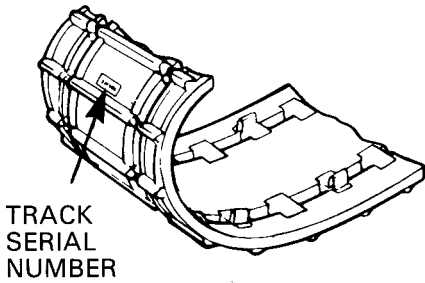

NOTE: We strongly recommend that you take note of all the serial numbers on your vehicle and supply them to your insurance company. It will surely help in the event a snowmobile is stolen.

CHANGE OF ADDRESS AND OWNERSHIP

Any change in address or ownership should be brought to the attention of the manufacturer by completing and sending out the card supplied below. This will help us to maintain our files up-to-date.

CHANGE OF ADDRESS



VEHICLE IDENTIFICATION NUMBER

--	--	--	--	--	--	--	--	--	--	--	--	--	--	--	--	--	--	--	--

OLD ADDRESS:

NAME

NO STREET APT.

CITY STATE ZIP / POSTAL CODE

NEW ADDRESS:

NAME

NO STREET APT.

CITY STATE ZIP / POSTAL CODE

CHANGE OF OWNERSHIP



VEHICLE IDENTIFICATION NUMBER

--	--	--	--	--	--	--	--	--	--	--	--	--	--	--	--	--	--	--	--

The ownership of this vehicle is transferred

FROM:

NAME

NO STREET APT.

CITY STATE ZIP / POSTAL CODE

TO:

NAME

NO STREET APT.

CITY STATE ZIP / POSTAL CODE





BOMBARDIER LIMITÉE
ATT.: WARRANTY DEPARTMENT
VALCOURT, QUEBEC
CANADA, J0E 2L0

BOMBARDIER LIMITÉE
ATT.: WARRANTY DEPARTMENT
VALCOURT, QUEBEC
CANADA, J0E 2L0

