

# Citation\*

3500  
4500  
& SS



## 1980 OPERATOR'S MANUAL



® Trademark of Bombardier Limited

model \_\_\_\_\_

V.I.N. \_\_\_\_\_

purchase date \_\_\_\_\_

warranty expiry date \_\_\_\_\_

DEALER IMPRINT AREA

TECHNICAL INFORMATION CENTRE  
AFTER SALES SERVICE DEPARTMENT  
BOMBARDIER LIMITED  
VALCOURT, QUEBEC  
CANADA, J0E 2L0

The following are trademarks of Bombardier Limited.

BOMBARDIER	EVEREST	MOTO-SKI
SKI-DOO	CITATION	FUTURA
ALPINE	OLYMPIQUE	SPIRIT
BLIZZARD	T'NT	NUVIK
CARRY-BOOSE		MIRAGE
ELAN		SUPER SONIC
ELITE		ULTRA SONIC
GRAND PRIX SPECIAL		

# INDEX

<b>FOREWORD</b> .....	<b>2</b>
<b>SAFETY IN MAINTENANCE</b> .....	<b>3</b>
<b>CONTROLS/INSTRUMENTS</b>	
Throttle lever, brake lever, ignition light switch, headlamp dimmer switch, emergency cut-out switch, light switch, manual starter handle, primer, tether cut-out switch, adjustable steering, speedometer (optional on some models), hood opening, tool box, fuel gauge .....	<b>4</b>
<b>BREAK-IN PERIOD</b>	
Break-in, inspection, inspection checklist .....	<b>6</b>
<b>FUEL MIXING</b>	
Recommended gasoline, recommended oil, fuel mixture ratio, fuel mixing procedure, injection oil .....	<b>8</b>
<b>PRE-START CHECK</b>	
Check points .....	<b>10</b>
<b>STARTING PROCEDURE</b>	
Starting procedure, emergency starting .....	<b>10</b>
<b>LUBRICATION</b>	
Frequency, drive pulley, pulley guard removal, drive belt removal, steering mechanism, chaincase oil level, slide suspension .....	<b>12</b>
<b>MAINTENANCE</b>	
Maintenance chart, spark plugs, battery, suspension, track, track tension and alignment, carburetor adjustment, drive belt, steering mechanism, drive pulley, brake, steering adjustment, engine head nuts, engine mount nuts, muffler attachment, fan belt, general inspection, headlamp beam aiming, oil injection pump, bulb replacement .....	<b>15</b>
<b>STORAGE</b>	
Track, suspension, ski assembly, controls, chaincase, drive pulley, fuel tank, carburetor, cylinder lubrication, battery, chassis, general inspection .....	<b>22</b>
<b>PRE-SEASON PREPARATION</b>	
Pre-season preparation chart .....	<b>26</b>
<b>TROUBLE SHOOTING</b> .....	<b>27</b>
<b>TOOLING</b> .....	<b>29</b>
<b>SPECIFICATIONS</b> .....	<b>30</b>
<b>WIRING DIAGRAMS</b> .....	<b>32</b>
<b>S.I. METRIC INFORMATION GUIDE</b> .....	<b>35</b>
<b>THE 1980 "LIMITED WARRANTY"</b> .....	<b>36</b>
<b>OFTEN ASKED QUESTIONS</b> .....	<b>40</b>
<b>HOW TO IDENTIFY YOUR SNOWMOBILE</b> .....	<b>42</b>
<b>CHANGE OF ADDRESS OR OWNERSHIP</b> .....	<b>43</b>
<b>LISTING OF AREA DISTRIBUTORS</b> .....	<b>45</b>

# FOREWORD

CONGRATULATIONS... You are now the proud owner of a new 1980 Bombardier snowmobile. This vehicle is the result of incomparable teamwork between Bombardier designers, engineers and technicians. Consequently, this vehicle is designed and engineered with safety, handling, comfort and quietness in mind.

The Operator Manual and the Snowmobile Safety handbook have been prepared to acquaint the owner / operator of a new snowmobile with the various vehicle controls maintenance and safe operating instructions.

Each is indispensable for the proper use of the product, and should be kept with the vehicle at all times.

Should you have any questions pertaining to the warranty and its application, please consult the "Often Asked Question" section of this manual, or your selling dealer.

This manual emphasizes particular information denoted by the following symbols and wording.

 **WARNING:** Identifies an instruction which, if not followed, could cause personal injury.

 **CAUTION:** Denotes an instruction which, if not followed, could severely damage vehicle components.

 **NOTE:** Indicates supplementary information needed to fully complete an instruction.

Although the mere reading of such information does not eliminate the hazard, your understanding of the information will promote its correct use.

**Ride safe and have fun.**

Recreational Products Group  
Bombardier Limited,  
Valcourt, Quebec, Canada, JOE 2L0

Most specifications are given in both metric and customary units. Where precise accuracy is not required, some conversions are rounded to even numbers for easier use.

**PLEASE ENSURE YOUR WARRANTY BY REGISTERING YOUR SNOWMOBILE THROUGH YOUR DEALER, AT THE COMPANY.**

# SAFETY IN MAINTENANCE

## Observe the following precautions:

- Throttle mechanism should be checked for free movement before starting engine.
- Engine should be running only when pulley guard is secured in place.
- Never run the engine without drive belt installed. Running an unloaded engine can prove to be dangerous.
- Never run the engine when the track is raised off the ground.
- It can be dangerous to run engine with the cab removed.
- Gasoline is flammable and explosive under certain conditions. Always perform procedures in a well ventilated area. Do not smoke or allow open flames or sparks in the vicinity. If gasoline fumes are noticed while driving, the cause should be determined and corrected without delay.
- Your snowmobile is not designed to be operated on public streets, road or highways. In most States and Provinces, it is considered an illegal operation.
- Maintain your vehicle in top mechanical condition at all times.
- Your snowmobile is not designed to be driven or operated on black top, bare earth, or other abrasive surfaces. On such surfaces abnormal and excessive wear of critical parts is inevitable.
- Only perform procedures as detailed in this manual. Unless otherwise specified, engine should be turned OFF for all lubrication and maintenance procedures.
- Installation of other than standard equipment, including ski-spreaders, bumpers, pack racks, etc., could severely affect the stability and safety of your vehicle. Avoid adding on accessories that alter the basic vehicle configuration.
- **The snowmobile engine can be stopped by activating the emergency cut-out or tether switches or turning off the key.**
- Whenever the vehicle is parked outdoors, overnight or for a long period, it is suggested to protect it against the inclemency of the weather with a snowmobile cover.

---

**Please read and understand all other warnings contained elsewhere.**

---

This vehicle is built with parts dimensioned in the metric system. All fasteners are metric and must not be replaced by customary fasteners. Mismatched or incorrect fasteners can cause damage to the vehicle or possible personal injury.

**THIS MANUAL SHOULD REMAIN WITH THE VEHICLE AT THE TIME OF RESALE.**

# CONTROLS/INSTRUMENTS

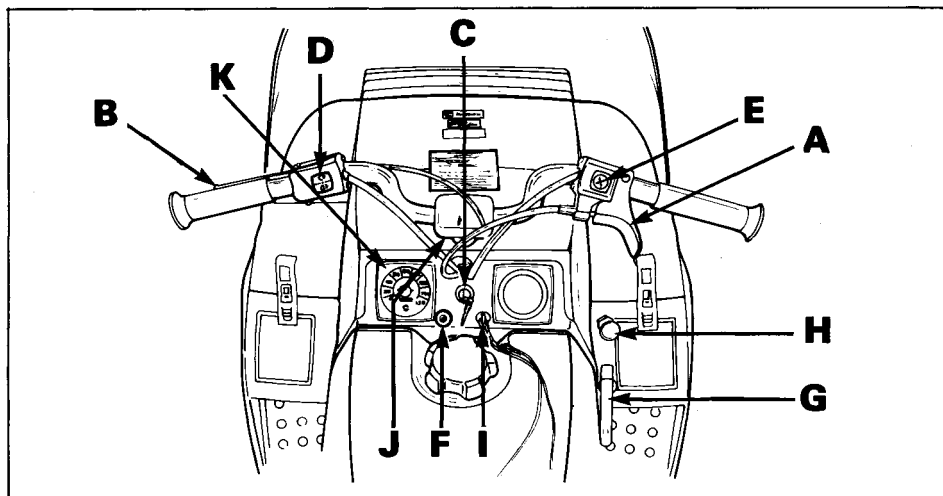

- A) Throttle Control Lever
- B) Brake Control Lever
- C) Ignition/Light Switch
- D) Headlamp Dimmer Switch
- E) Emergency Cut-Out Switch
- F) Light Switch (Electric Model)
- G) Manual Starter Handle
- H) Primer
- I) Tether Cut-Out Switch
- J) Adjustable Steering Handle
- K) Speedometer (Optional on Some Models)

## A) Throttle Control Lever

Located on right side of handlebar. When compressed, it controls the **engine speed** and the **engagement of the transmission**. When released, engine speed returns automatically to idle.

## B) Brake Control Lever

Located on the left side of handlebar. When compressed, the brake is applied. When released, it automatically returns to its original position. Braking effect is proportionate to the pressure applied on the lever.

## C) Ignition/Light Switch

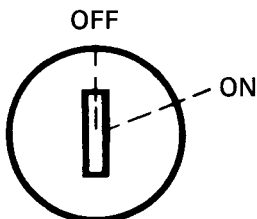

Key operated, 2 position switch. To start engine, first turn key clockwise to ON position. **To stop engine**, turn key counter-clockwise to OFF position.

The lights are automatically ON whenever the engine is running.

## (Electric Start Models)

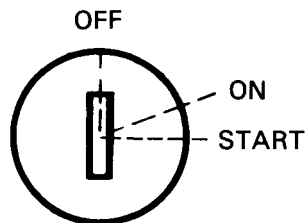

Key operated, 3 position switch. To start engine, turn key fully clockwise to **START** position and hold. **Return key to ON position immediately** when engine has started. **To stop engine**, turn key counter-clockwise to OFF position.

## D) Headlamp Dimmer Switch

The dimmer switch, located on left side of handlebar, allows correct selection of headlamp beam. To obtain high or low beam simply depress switch.

## E) Emergency Cut-Out Switch

A push button switch located on right side of handlebar. To stop the engine in an emergency, press button down into **lower** position.

Before re-starting engine always depress button into released **upper** position. The driver of this vehicle should familiarize himself with the function of this device by using it several times on first outing, thereby being mentally prepared for emergency situations requiring its use.

◆ **WARNING:** If the button has been used in an emergency situation the source of malfunction should be determined and corrected before re-starting engine.

## F) Light Switch (Electric Start Models)

A push pull switch type, to illuminate headlamp and taillight, pull switch knob. (Ignition switch must be turned to ON position).

## G) Manual Starter Handle

Auto rewind type located on right hand side of vehicle. To engage mechanism, pull handle.

## H) Primer

A push-pull button. Pull and push button (2-3 times) to activate primer. The primer should always be used for cold engine starts. After engine is warm however, it is not necessary to use primer when starting.

## I) Tether Cut-Out Switch

Attach tether cord to wrist or other convenient location then snap tether cut-out cap over receptacle before starting engine.

If emergency engine "shut off" is required, completely pull cap from safety switch and engine power will be automatically shut "off".

○ **NOTE:** The cap must be installed on the safety switch at all times in order to operate the vehicle.

◆ **WARNING:** If the switch is used in an emergency situation the source of malfunction should be determined and corrected before restarting engine.

## J) Adjustable steering handle

- Remove handle cap and loosen the 4 bolts.
- Adjust the steering handle to the desired position.
- Lock the steering handle in place by tightening the four (4) screws to 26 N•m (19 ft-lbs).

◆ **WARNING:** Do not adjust the handlebar to high to avoid interference when turning, between the brake lever and windshield.

## K) Speedometer

The speedometer is linked directly to the drive axle. Direct-reading dial indicates the speed of the vehicle. Odometer records the total distance travelled.

## Hood Opening

Pull down the latches to unlock the hood from the anchor.

○ **NOTE:** Always lift hood gently up until stopped by restraining device.

◆ **WARNING:** It is dangerous to run an engine with the hood open or removed. Personal injury could result.

# BREAK-IN PERIOD

## Tool Box

Located under the cab. To gain access, tilt cab. Ideal location for spare plugs, belt, rope, etc.

## Fuel Gauge

Unscrew fuel tank cap and withdraw dipstick to check fuel level.

◆ **WARNING: Never use a lit match or open flame to check fuel level.**

With Bombardier-Rotax snowmobile engines, a break-in period is required before running the vehicle at full throttle. Engine manufacturer recommendation is 10 to 15 operating hours. During this period, a richer mixture is needed (i.e. 40 parts of gas for 1 part of 50/1 Bombardier oil). Maximum throttle should not exceed 3/4, however, brief full acceleration and speed variations contribute to a good break-in. Continued wide open throttle accelerations, prolonged cruising speeds, and lugging are detrimental during the break-in period.

## Oil Injection Models

Oil injection models do not require mixing oil with gas. However, proper break-in period applies.

## 10-Hour Inspection

As with any precision piece of mechanical equipment, we suggest that after the first 10 hours of operation or 30 days after the purchase, whichever comes first, that your vehicle be checked by your dealer. This inspection will give you the opportunity to discuss the unanswered questions you may have encountered during the first hours of operation. Remember that it is easier to remedy at this time than to allow the snowmobile to operate until a possible failure occurs.

---

**The 10 hours inspection is at the expense of the vehicle owner.**

---



## 10-HOUR INSPECTION CHECK LIST



Engine timing	
Fan belt tension	
Spark plug(s) condition: (Remove and clean)	
Carburetor adjustment	
Oil injection pump adjustment	
Engine head nuts	
Engine mount nuts	
Muffler attachment	
Chaincase and injection system oil levels	
Brake operation and lining condition	
Ski alignment (runner condition)	
Pulley alignment and drive belt condition	
Track condition, tension and alignment	
Lubrication (steering)	
Electrical wiring (loose connections, stripped wires, damaged insulation), tighten all loose bolts, nuts and linkage	
Operation of lighting system (HI / LO beam, brake light, etc.), test operation of emergency cut-out switch and tether cut-out switch	

**We recommend that you have your dealer sign this inspection .**

\_\_\_\_\_  
Date of 10 hour inspection

\_\_\_\_\_  
Dealer signature

# FUEL MIXING

On models not equipped with oil injection, oil must be added to the gasoline in pre-measured amounts then both oil and gasoline should be thoroughly mixed together before fueling the tank.

## Recommended Gasoline

Use regular leaded gasoline available from all service stations.

▼ **CAUTION:** Never experiment with different fuel or fuel ratios. Never use naphtha, methanol or similar products.

## Recommended Oil

Use concentrated Bombardier snowmobile oil available from your dealer. This type of oil has specially formulated oil bases to meet the lubrication requirements of the Bombardier-Rotax engine.

If Bombardier snowmobile oil is unavailable, substitute with a high-quality 2 cycle snowmobile oil. The oil/gas mix must meet the vehicle requirements. See oil manufacturer recommendations on container.

▼ **CAUTION:** Never use outboard or straight mineral oils.

## Fuel Mixture Ratio

The importance of using the correct fuel mixture cannot be overstressed. An incorrect fuel ratio results in serious engine damage. Recommended fuel ratio is 50/1.

### S.I. MEASURE

500 mL oil to 25 liters = 50/1

### IMPERIAL MEASURE

1 can 16 oz oil to 5 imp. gals = 50/1  
or

1 can 500 mL to 5 1/2 imp. gals = 50/1

### U.S. MEASURE

1 can 12 oz oil to 5 U.S. gals = 50/1

○ **NOTE:** To facilitate fuel mixing, oil should be kept at room temperature.

## Fuel Mixing Procedure

To mix the gasoline and oil always use a separate clean container. Never mix directly in your snowmobile tank. For best results, acquire two containers, either plastic or metal. Draw from one until empty then use the second one.

◆ **WARNING:** Gasoline is flammable and explosive under certain conditions. Always perform procedures in a well ventilated area. Do not smoke or allow open flames or sparks in the vicinity. If gasoline fumes are noticed while driving, the cause should be determined and corrected without delay. Never add fuel while engine is running. Avoid skin contact with fuel at below freezing temperatures.

1. Pour approximately one gallon of gasoline into a clean container.

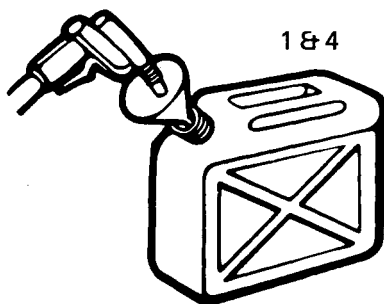

2. Add the full amount of oil.

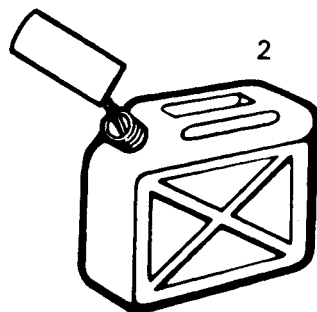

3. Replace container cap and shake the container thoroughly.

Check level and refill every time you re-fuel.

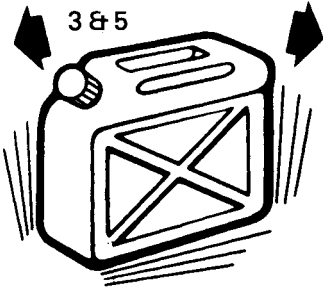

- 4. Add the remainder of the gasoline.
- 5. Once again thoroughly agitate the container. Then **using a funnel** with a fine mesh screen to prevent the entry of water and foreign particles, transfer mixture from container into the snowmobile tank.

○ **NOTE:** When using pre-mixed fuel, always shake the container thoroughly as the oil has a tendency to settle.

◆ **WARNING:** Never 'top up' gas tank before placing the vehicle in a warm area. At certain temperatures, gasoline will expand and overflow.

### **Oil Injection Models**

Always maintain a sufficient amount of Bombardier 50 to 1 snowmobile oil in the injection system oil tank.

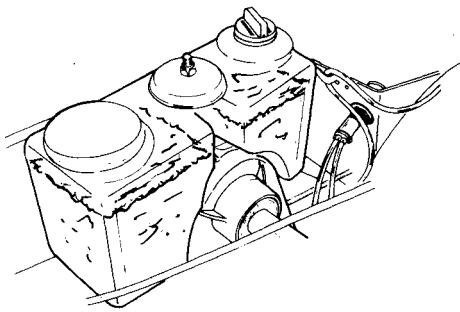

## Check Points

- Activate the throttle control lever several times to check that it operates easily and smoothly. The throttle control lever must return to idle position when released.
- Check fuel level.
- Check injection oil level (if applicable).
- Check that the skis and the track are not frozen to the ground or snow surface and that steering operates freely.
- Activate the brake control lever and make sure the brake fully applies before the brake control lever touches the handlebar grip.
- Verify that the path ahead of the vehicle is clear of bystanders and obstacles.

◆ **WARNING:** Only start your snowmobile once all components are checked and functioning properly.

## Emergency Cut-Out Button

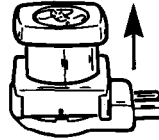

**Upper position**  
before starting engine

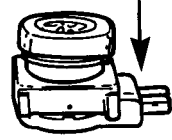

**Lower position**  
to stop engine

## Manual Starting

1. Insert the key in the ignition switch and turn to ON position.
2. **Test throttle control lever.**
3. Activate the primer (2 or 3 times).

○ **NOTE:** The use of the primer is not necessary when the engine is warm.

4. Make sure that the tether cut-out cap is in position and that the cord is attached to your clothing. Check that the emergency cut-out button is in the released **upper** position.
5. Grasp manual starter handle firmly and pull slowly until a resistance is felt then pull vigorously. Slowly release the rewind starter handle.

◆ **WARNING:** Do not apply throttle while starting.

6. Check the operation of the emergency cut-out switch and the tether switch. Restart the engine.

◆ **WARNING:** If engine does not shut-off when applying the emergency cut-out switch and pulling the tether cut-out cap, stop the engine by turning off the ignition key. Do not operate the vehicle further, see your dealer.

7. Allow the engine to warm before operating at full throttle.

## Electric Starting

**CAUTION:** Never operate your snowmobile with the battery removed or disconnected.

1. Insert key in ignition switch.
2. **Test throttle control lever.** Activate primer (2 or 3 times).

**NOTE:** Primer is not necessary when engine is warm.

3. **Make sure that the tether cut-out cap is in position and that the cord is attached to your clothing. Check that the emergency cut-out button is in the released upper position.**
4. Turn ignition key clockwise until starter engages. If engine does not start on first try, key must be turned fully back to OFF each time.

**WARNING:** Do not apply throttle while starting.

5. Released key immediately after engine has started.
6. Check operation of the emergency cut-out switch and tether switch. Restart engine.

**WARNING:** If engine does not shut-off when applying the emergency cut-out switch and pulling the tether cut-out cap, stop the engine by turning off the ignition key. Do not operate the vehicle further, see your dealer.

7. Allow the engine to warm before operating at full throttle.

## Emergency Starting

### Single Carburetor Models (with roller round shaft pulley)

Should the rewind starter rope fray and break, the engine can be started with an emergency starter rope and clip.

**WARNING:** Do not start the vehicle by the drive pulley unless it is a true emergency situation, have the vehicle repaired as soon as possible.

Remove the pulley guard from vehicle.

Assemble the emergency starting clip to the emergency starting rope and wind the rope tightly around the drive pulley.

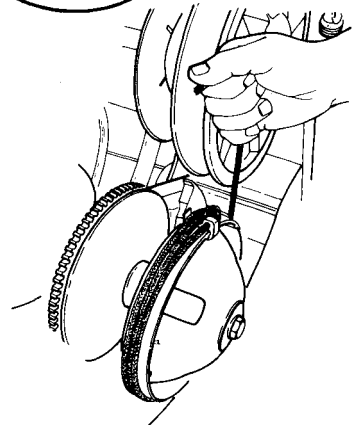
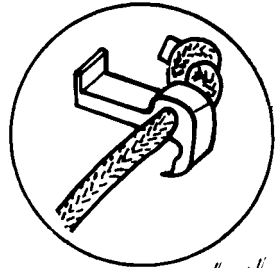

Start as per manual starting procedure.

**WARNING:** When starting the vehicle in an emergency situation by the drive pulley do not reinstall the pulley guard.

## Dual Carburetor Models (with roller square shaft pulley)

Remove the pulley guard from the vehicle and wind the emergency rope tight around the drive pulley between the sliding half and the roller guard. Start the engine as per usual manual starting.

◆ **WARNING:** When starting the vehicle in an emergency situation by the drive pulley, do not make a knot at the end of the emergency rope and do not reinstall the pulley guard.

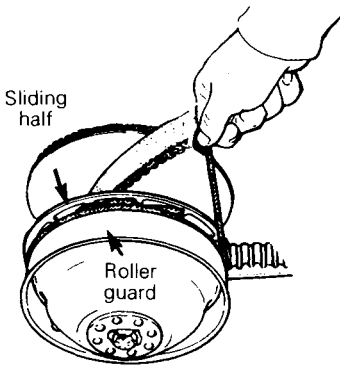

## Frequency

Routine maintenance is necessary for all mechanized products, and the snowmobile is no exception. A weekly vehicle inspection contributes to the life span of the snowmobile as well as retains safe and dependable operation. It is recommended that the steering system and suspension be lubricated monthly or every 40 hours of operation. If the vehicle is operated in wet snow or in severe conditions these items should be lubricated more frequently.

◆ **WARNING:** Only perform such procedures as detailed in this manual. It is recommended that dealer assistance be periodically obtained on other components/systems not covered in this manual. Unless otherwise specified, engine should be turned OFF for all lubrication and maintenance procedures.

## Drive Pulley (roller round shaft type single carburetor models)

This drive pulley requires lubrication bi-monthly or every 20 hours of operation.

◆ **WARNING:** The lubrication of the drive pulley should be performed only by an authorized dealer. A disassembly, cleaning, inspection and lubrication where applicable should also be performed by the dealer every 50 operating hours or at the end of each season, whichever occurs first.

**IMPORTANT:** The drive pulley assembly will be excluded from warranty, if the factory seal is broken by other than a duly authorized representative of Bombardier.

## Pulley Guard Removal

◆ **WARNING:** Pulley guard should always be in place when engine is running.

- A. Raise the hood and pull up the front retaining pin; pry the guard removal rearward and raise the guard.
- B. Pull the guard out of the center retaining bolt.
- C. Remove the retaining clip of the rear pin and remove the pin.
- D. Remove the guard.

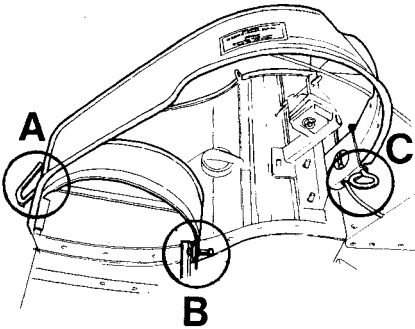

### Drive belt removal and installation.

◆ **WARNING:** At the removal or installation of the drive belt be careful not to burn yourself on the exhaust muffler.

1. Remove the pulley guard.
2. Loosen the countershaft bearing retaining screw and open the bearing cage.

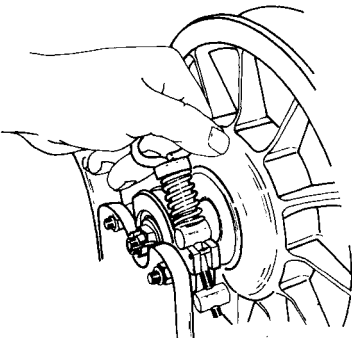

3. Open the driven pulley by twisting and pushing the sliding half. Hold in fully open position.

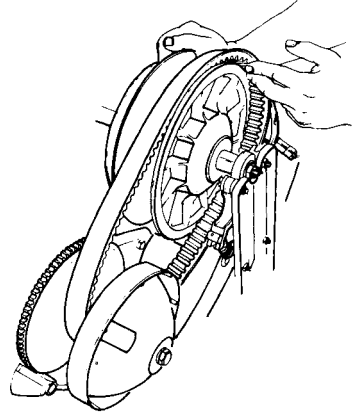

4. Slip the belt over the top edge of the sliding half.
5. Lift the countershaft upward approx. 50 mm (2 in.) and slip the belt between the shaft and the bearing cage to remove completely.

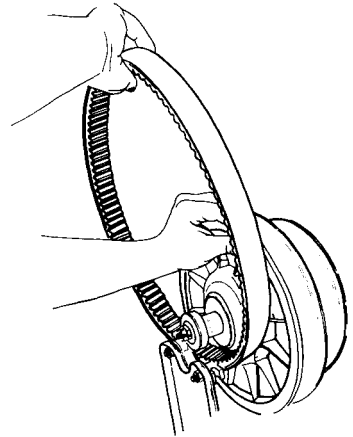

Slip the belt out from the drive pulley.

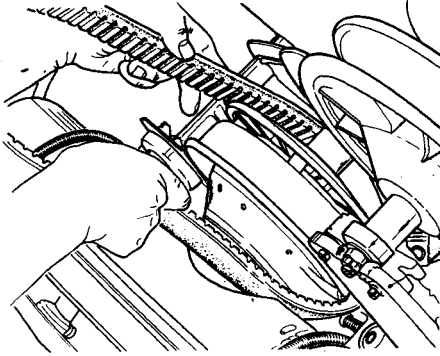

◆ **WARNING:** It may necessary to loosen the brake adjustment in order to easily lift the countershaft. Always check that the brake disc is correctly installed between the brake pads and that the brake is well adjusted. Check brake light operation.

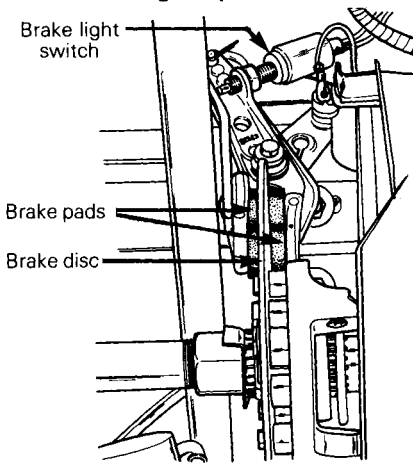

To install the drive belt, reverse the procedure.

▼ **CAUTION:** Once belt is installed, be sure to secure the countershaft bearing by closing the bearing cage and firmly tightening the retaining screw.

## Steering Mechanism

◆ **WARNING:** Do not lubricate throttle and/or brake cables and housings.

Lubricate the ski legs at grease fittings until new grease appears at joints. Oil spring coupler bolts.

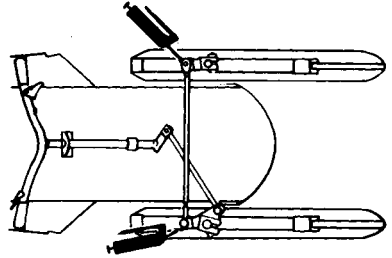

## Chaincase Oil Level

Check the oil level by removing the oil level cap plug.

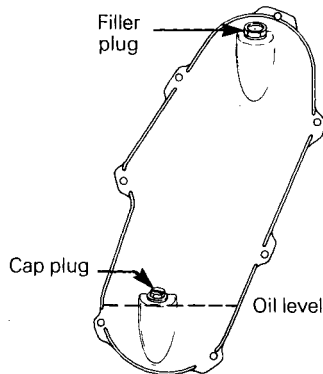

The oil should be level with the bottom of the oil level orifice.

○ **NOTE:** The chaincase oil capacity is approximately 170 mL (6 oz.).



# MAINTENANCE

The following Maintenance Chart indicates regular servicing schedules to be performed by you or your servicing dealer. If these services are performed as suggested, your snowmobile will give you many years of low-cost use.

◆ **WARNING:** Only perform such procedures as detailed in this manual. It is recommended that dealer assistance be periodically obtained on other components/systems not covered in this manual. Unless otherwise specified, engine should be turned OFF for all lubrication and maintenance procedures.

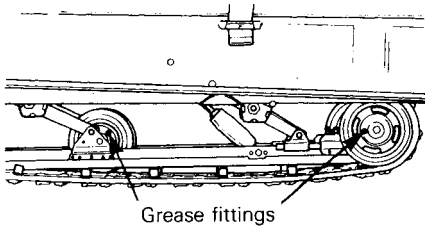

Code	(Weekly)	Page
W1	Spark plug	15
W2	Battery (electric start models)	16
W3	Suspension condition	16
W4	Track condition	16
W5	Track tension and alignment	17
W6	Carburetor adjustment	18
W7	Drive belt	19
W8	Steering mechanism	19
W9	Drive pulley	19

Code	(Monthly)	Page
M1	Brake	19
M2	Steering adjustment	20
M3	Engine head nuts	20
M4	Engine mount nuts	20
M5	Muffler attachment	20
M6	Fan belt	20
M7	General inspection Headlamp adjustment	21
M8	Oil injection pump	21

## (W1) Spark Plugs

Disconnect the spark plug wires and remove the spark plugs.

Check the condition of the plugs.

- A brownish tip reflects ideal conditions. (Correct carburetor, spark plug heat range; etc.).
- A black insulator tip indicates fouling caused by: carburetor idle speed mixture too rich, incorrect fuel mixture ratio, wrong type of spark plug (heat range), or excessive idling.

- A light grey insulator tip indicates a lean mixture caused by; carburetor high speed mixture adjusted too lean, wrong spark plug heat range, incorrect fuel mixture ratio, or a leaking seal or gasket.

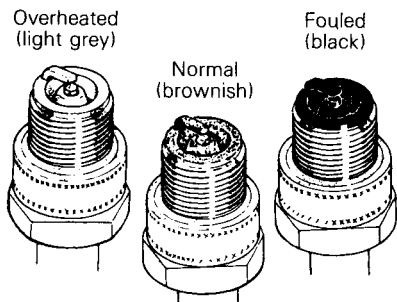

**CAUTION:** If spark plug condition is not ideal, contact your authorized dealer.

Check spark plug gap using a wire feeler gauge.

Reinstall plugs and connect wires.

## (W2) Battery (Electric Start Models)

Check electrolyte level. Electrolyte level must be at upper level line on battery casing.

If necessary add distilled water. Battery connections must also be free of corrosion. If cleaning is necessary remove corrosion using a stiff brush then clean with a solution of baking soda and water. Rinse and dry well.

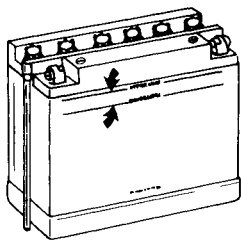

**CAUTION:** Do not allow cleaning solution to enter battery. It will destroy the chemical properties of the electrolyte.

After reconnecting battery coat battery terminals and connectors with petroleum jelly to prevent corrosion. Check that battery is well secured and that battery overflow tube is not blocked or kinked.

**WARNING:** Overflow tube must be free and open. A kinked or bend tube will restrict ventilation and create gas accumulation that could result in an explosion. Avoid skin contact with electrolyte.

**CAUTION:** Prior to charging the battery, always remove it from the vehicle to prevent electrolyte spillage.

## (W3) Suspension Condition

Visually inspect all suspension components including slider shoes, springs, wheels, etc...

**NOTE:** During normal driving, snow will act as a lubricant and coolant for the slider shoes. Extensive riding on ice or sanded snow, (not to mention dirt, asphalt, etc. never recommended) will create excessive heat build-up and cause premature slider shoe wear.

## (W4) Track Condition

Lift the rear of the vehicle and support it off the ground. With the engine off, rotate the track by hand, and inspect condition. If worn, cut or track fibers are exposed or missing or defective inserts or guides are noted, contact your dealer.

**WARNING:** Do not operate a snowmobile with a cut, torn or damaged track.

## (W5) Track Tension and Alignment

The suspension is adjustable, the front adjustment for surface condition, the rear for driver's weight.

When the front adjuster blocks are at the lowest elevation more weight is distributed on the skis. At the highest position the weight is transferred to the track. The rear adjuster blocks should be adjusted to suit the driver's preference.

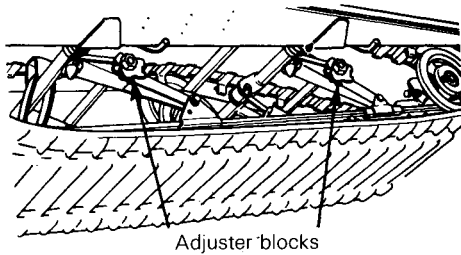

**CAUTION:** Always turn the left side adjuster blocks in a clockwise direction, the right side blocks in a counter-clockwise direction. Left and right adjuster blocks of each adjustment must always be set at the same elevation.

Lift the rear of vehicle and support with a mechanical stand. Allow the slide to extend normally. Check the gap 13 mm (1/2") between the slider shoe and the bottom inside of the track. If the track tension is too loose, the track will have a tendency to thump.

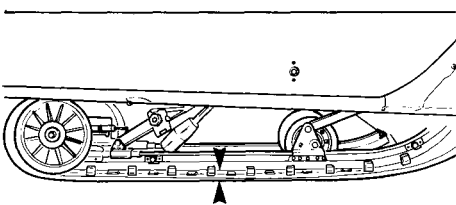

13 mm (1/2")

**CAUTION:** Too much tension will result in power loss and excessive stresses on suspension components.

If necessary to adjust. Loosen the rear idler wheel retaining screw and then loosen or tighten the adjuster bolts located on the inner side of the rear idler wheels. If correct tension is unattainable. Contact your dealer.

**NOTE:** Track tension and alignment are inter-related. Do not adjust one without the other.

Start the engine and accelerate slightly so that track turns slowly. Check that the track is well centered; equal distance on both sides between edges of track guides and slider shoes.

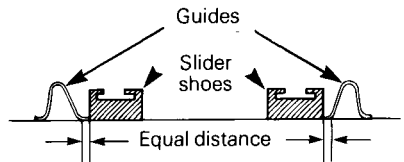
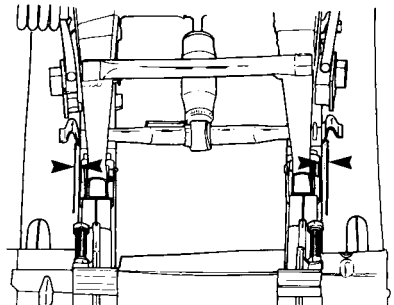

**WARNING:** Before checking track alignment, ensure that the track is free of all particles which could be thrown out while track is rotating. Keep hands, tools, feet and clothing clear of track. Ensure no-one is standing in close proximity to the vehicle.

To correct, stop the engine, loosen the rear idler wheels retaining screws then loosen the lock nuts and tighten the adjuster bolt on side where the slider shoe is the furthest to the track insert guides.

Tighten lock nuts and recheck the alignment. Ensure to retighten the idler wheel retaining screws.

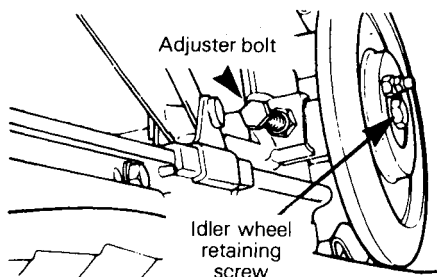

## (W6) Carburetor Adjustment

**CAUTION:** Never operate your snowmobile with the air intake silencer disconnected. Serious engine damage will occur if this notice is disregarded.

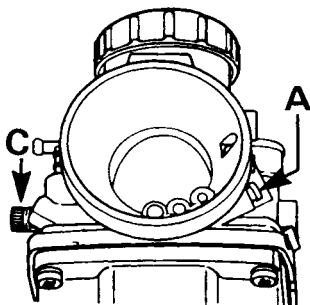

### A) Air Screw Adjustment

Completely close the air screw (until a slight reseating resistance is felt) then back off screw as specified.

## B) Throttle Slide Adjustment

**WARNING:** Ensure the engine is turned **OFF**, prior to the throttle slide adjustment.

With the throttle cable adjuster jam nut unlocked, press the throttle lever against the handle grip.

By turning the cable adjuster, adjust the carburetor slide cut away so that it is flush with the top of the carburetor bore.

Tighten the cable adjuster jam nut.

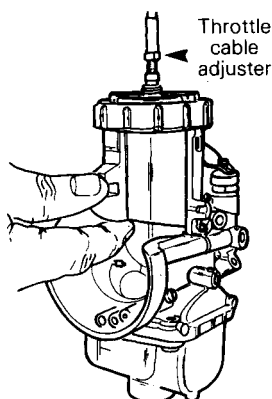

**WARNING:** It is important that the throttle slide adjustment be performed to ensure proper functioning of throttle mechanism.

## C) Idle Speed Adjustment

Turn the idle speed screw clockwise until it contacts the throttle slide then continue turning two (2) additional turns. This will provide a preliminary idle speed setting. Start the engine and allow it to warm then adjust the idle speed to 2000 R.P.M. by turning the idle speed screw clockwise or counter-clockwise.

**CAUTION:** Do not attempt to set the idle speed by using the air screw. Severe engine damage can occur. If idle speed is unattainable contact your authorized dealer.

## (W7) Drive Belt

Inspect the belt for cracks, fraying or abnormal wear (uneven wear, wear on one side, etc.) If abnormal wear is noted, probable cause is pulley misalignment. Contact your dealer.

Check the drive belt width, if less than 3 cm (1 3/16") replace.

○ **NOTE:** When installing a new drive belt, a break-in period of 15-25 km (10-15 miles) is strongly recommended.

## (W8) Steering Mechanism

Inspect the steering mechanism for tightness of components (steering arms, tie rods, ball joints, spring coupler bolts, etc.). If necessary, replace or retighten.

Check the condition of the skis and the ski runners. Replace if worn.

## (W9) Drive Pulley (roller square shaft type, dual carburetor models only)

Inspect the Duralon bushing condition by checking the free-play of the sliding half pulley. This is achieved by restraining the inner half and checking if the sliding half moves in the direction of the arrows more than 3 mm (1/8"). If so contact your dealer.

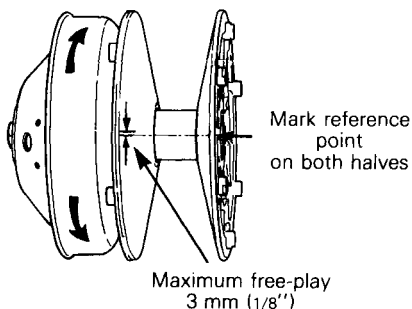

## Drive Pulley (roller round shaft type, single carburetor models)

This drive pulley requires lubrication bi-monthly or every 20 hours of operation.

◆ **WARNING:** The lubrication of the drive pulley should be performed only by an authorized dealer. A disassembly, cleaning, inspection and lubrication where applicable should also be performed by the dealer every 50 operating hours or at the end of each season, whichever occurs first.

**IMPORTANT:** The drive pulley assembly will be excluded from warranty, if the factory seal is broken by other than a duly authorized representative of Bombardier.

## (M1) Brake

The brake mechanism on your snowmobile is an essential safety device. Keep this mechanism in proper working condition. Above all, do not operate your snowmobile without an effective brake system.

◆ **WARNING:** Brake pucks less than 3 mm (1/8") thick must be replaced. Replacement must be performed by an authorized dealer.

Brake should apply fully while brake control lever is still 13 mm (1/2") approximated from the handlebar grip.

If adjustment is required, turn the brake cable adjuster counter-clockwise until the brake disc is hard to turn then back off the adjuster to approximately 1 1/2 turn. Recheck brake operation.

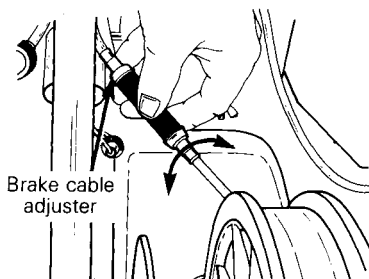

◆ **WARNING:** Whenever the brake is readjusted, the brake light switch operation must also be checked and adjusted as needed.

### (M2) Steering Adjustment

Skis should have a toe out of 3 mm (1/8"). To check, measure the distance between each ski at the front and rear of the leaf springs. The front distance should be 3 mm (1/8") more than the rear when the handlebar is horizontal.

**IMPORTANT:** Close the front of the skis manually to eliminate all slack from the steering mechanism.

If adjustment is required:

Loosen the lock nuts of the longer tie rod. Turn the tie rod manually until the skis are properly aligned. Firmly retighten the lock nuts.

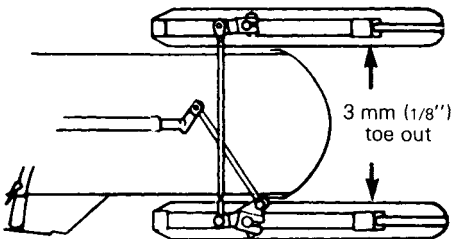

The handlebar should also be horizontal when the skis are pointed toward the front.

To adjust:

Loosen the lock nuts of the shorter tie rod. Turn the tie rod manually until the handlebar is horizontal. Retighten the lock nuts firmly.

◆ **WARNING:** The ball joint socket must run parallel with the steering arm. The socket must be restrained when tightening the tie rod end lock nuts.

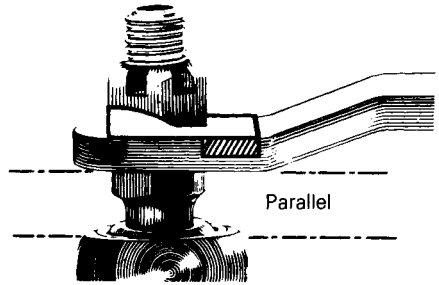

### (M3) Engine Head Nuts

With the engine cold, check that the engine head nuts are tight and equally torqued to 22 N•m (16 ft-lbs).

**IMPORTANT:** The engine head nut torque should be checked after the first 5 hours of operation.

### (M4) Engine Mount Nuts

Check the engine mount nuts for tightness. Retighten if necessary.

### (M5) Muffler Attachment

The engine/muffler attaching parts are vital toward efficient muffler function. Check all attachments. Replace the springs and/or tighten if necessary.

### (M6) Fan Belt

Inspect belt for cracks, uneven wear, etc. Check fan belt tension, 6 mm (1/4") free-play should exist when deflection is correct.

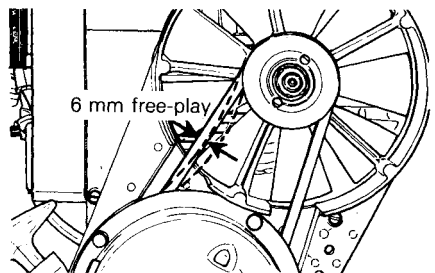

If belt seems damaged or if tension is incorrect, contact your dealer immediately.

**WARNING:** If fan protector is removed, always reinstall after servicing.

### (M7) General Inspection

Check the electrical wiring and components, retighten loose connections. Check for stripped wires or damaged insulation. Thoroughly inspect the vehicle and tighten loose bolts, nuts and linkage. Inspect skis and ski runners for wear.

### Headlamp Beam Aiming

The angle of the headlamp beam has been pre-adjusted prior to delivery. Should you wish re-adjustment, place the vehicle on a flat surface 7.6 m (25') from a wall or screen.

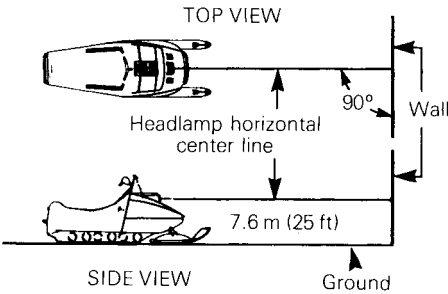

With the suspension correctly adjusted, the rider seated on the vehicle and the high beam ON check that the center of high intensity zone of high beam is 50 mm (2") below horizontal line of headlamp height.

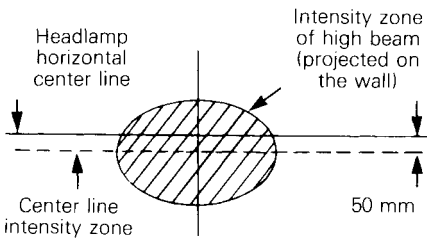

To adjust, remove headlamp chrome ring, turn upper or lower adjusting screws to obtain desired beam position.

### (M8) Oil Injection Pump Adjustment

**CAUTION:** The carburetor must be adjusted before adjusting the oil injection pump. Make sure the idle speed is 2000 RPM.

To adjust: With engine stopped, eliminate the throttle cable free-play by pressing the throttle lever until a light resistance is felt then hold in place. The aligning marks on the pump casting and lever must align perfectly. If not, loosen the adjuster nut and adjust accordingly.

Tighten the adjuster nut.

**NOTE:** The oil injection pump synchronizing marks can be seen by placing a mirror between the side lpan and the pump.

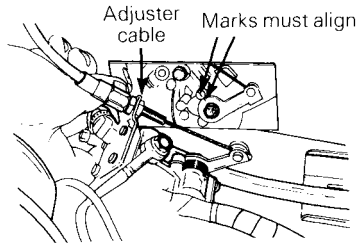

**CAUTION:** Proper oil injection pump adjustment is very important. Any delay in the opening of the pump can result in serious engine damage.

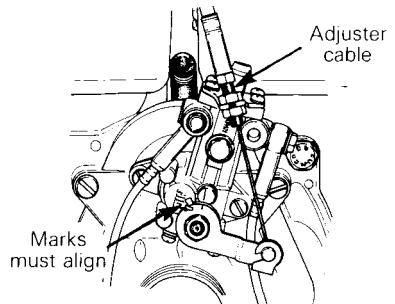

## Bulb Replacement

If the headlamp bulb is burnt, tilt cab, unplug the connector from the headlamp. Remove the rubber boot and unfasten bulb retainer clips. Detach the bulb and replace. If taillight bulb is burnt, expose the bulb by removing the red plastic lens. To remove, unscrew the two (2) Phillips head screws. Verify all lights after replacement.

It is during summer, or when a vehicle is not in use for any length of time that proper storage is a necessity. Storage of the snowmobile during long period of inactivity consists of checking and replacing missing, broken or worn parts, proper lubrication and treatment to insure that parts do not become rusted; cleaning items such as carburetor of oil mixtures, to prevent gum varnish formation within the carburetor; and in general, preparing the vehicle so that when the time comes to use the snowmobile again it will start and be in top condition.

 **WARNING:** Only perform such procedures as detailed in this manual. It is recommended that dealer assistance be periodically obtained on other components/systems not covered in this manual. Unless otherwise specified, engine should be turned OFF for all lubrication and maintenance procedures.

## Track

Inspect the track for wear, cuts, missing track guides and broken rods. Make any necessary replacement.

 **WARNING:** Do not operate a snowmobile with a cut, torn or damaged track.

Lift the rear of vehicle until track is clear of the ground then support with brace or trestle. The snowmobile should be stored in such a way that the track does not stay in contact with the cement floor or bare ground.

 **NOTE:** The track should be rotated periodically, (every 40 days). Do not release track tension.

 **CAUTION:** To prevent track damage, temperature in the storage area must not exceed 38°C (100°F).

## Slide Suspension

Remove any dirt or rust. Grease idler wheels at grease fittings. Wipe off surplus. Replace worn slider shoes.



## Ski

Wash or brush all dirt or rust accumulation from the skis and springs. Grease the ski legs at the grease fittings. **Check the condition of the skis, ski runners and leaf springs. Replace if worn or weak.**

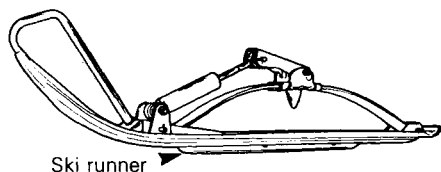

## Controls

Lubricate the steering mechanism. Inspect all components for tightness, (spring coupler bolts, steering arm locking bolts, tie rods, ball joints, etc.). Tighten if necessary. Oil moving joints of the brake mechanism.

◆ **WARNING:** Do not lubricate the throttle and/or brake cables and housings. Avoid getting oil on the brake pads.

Coat all electrical connections and switches with a greaseless metal protector. If unavailable, use petroleum jelly.

## Chaincase

Drain the chaincase and refill to proper level, using fresh chaincase oil. To drain, remove the chaincase cover.

## Drive Pulley

The drive pulley should be cleaned and inspected. The roller round shaft type drive pulley requires lubrication.

◆ **WARNING:** The lubrication of the drive pulley should be performed only by an authorized dealer. A disassembly, cleaning, inspection and lubrication where applicable should also be performed by the dealer every 50 operating hours or at the end of each season, which ever occurs first.

**IMPORTANT:** The drive pulley assembly will be excluded from warranty, if the factory seal is broken by other than a duly authorized representative of Bombardier.

## Fuel Tank

Remove the cap then using a siphon, remove the gasoline from tank.

◆ **WARNING:** Gasoline is flammable and explosive under certain conditions. Always perform procedures in a well ventilated area. Do not smoke or allow open flames or sparks in the vicinity.

## Carburetor

Carburetor must be dried out completely to prevent gum formation during the storage period.

Once the fuel tank is emptied, remove the float chamber drain plug on each carburetor. Drain carburetor.

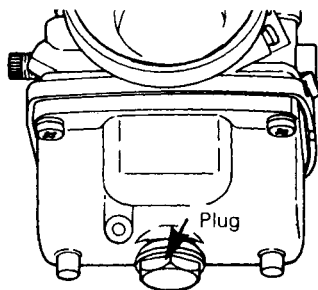

Re-install plug and connect fuel line.

## Cylinder Lubrication

Engine internal parts must be lubricated to protect cylinder walls from possible rust formation during the storage period.

○ **NOTE:** This operation should be repeated every 40 days during storage.

Remove the spark plugs. Operate the rewind starter to bring the piston at top position. Pour the equivalent of one spoonful of oil into spark plug hole.

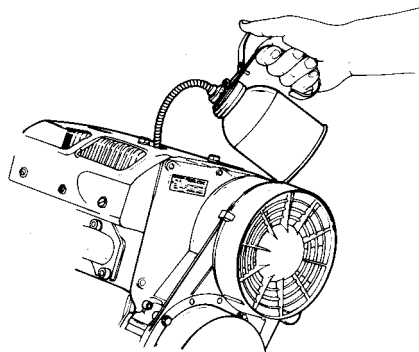

Slowly crank the engine several times using the manual starter. Repeat above steps for other cylinder. Install the spark plugs.

▼ **CAUTION:** To prevent ignition system damage, make sure that the cut-out button is in the lower position.

## Battery Removal & Installation

1. Remove and push aside the injection oil reservoir. **Do not disconnect the hose.**
2. Disconnect the battery cables and remove the battery cover.
3. Remove the battery vent tube from the vent hole.
4. Lift out the battery.

▼ **CAUTION:** Be careful not to damage the oil injection pump lever when lifting out the battery.

5. Reinstall by reversing the procedure.

## Battery

Remove battery from vehicle and clean outside surface of battery with solution of baking soda and water. Remove all deposits from posts then rinse with clear tap water.

▼ **CAUTION:** Do not allow cleaning solution to enter battery interior since it will destroy the electrolyte.

Check electrolyte level. Refill if necessary with distilled water. Fully charge battery. (A stored battery should be recharged at least every 40 days).

▼ **CAUTION:** Prior to charging the battery, always remove it from the vehicle to prevent electrolyte spillage.

◆ **WARNING:** Gases given off by a battery being charged are highly explosive. Always charge in a well ventilated area. Keep battery away from cigarettes or open flames. Avoid skin contact with electrolyte.

Coat electrical connections and switches with a greaseless metal protector, if unavailable, use petroleum jelly. Store unit in a cool, dry place.

## Chassis

Clean the vehicle thoroughly, removing all dirt and grease accumulation.

▼ **CAUTION:** Plastic alloy components such as fuel tank, windshield, etc., can be cleaned using mild detergents or isopropyl alcohol. Do not use strong soaps, degreasing solvents, abrasive cleaners, paint thinners, etc.

Inspect the cab and repair any damage. Repair kits are available at your authorized dealer. Clean the frame. For the aluminum portion use only "Aluminum cleaner" and follow instructions on the container.

Touch up all metal spots where paint has been scratched off. Spray all bare metal parts with metal protector. Wax the cab for better protection.

○ **NOTE:** Apply wax on glossy finish of cab only. Protect the vehicle with a cover to prevent dust accumulation during storage.



**▼ CAUTION:** If for some reason the snowmobile has to be stored outside it is necessary to cover it with an opaque tarpaulin. This caution will prevent the sun rays affecting the plastic components and the vehicle finish.

### **General Inspection**

Check the electrical wiring and components, retighten loose connections. Check for stripped wires or damaged insulation.

Thoroughly inspect the vehicle and tighten loose bolts, nuts and linkage.

**○ NOTE:** Leave the drive belt **off** the pulleys for the entire storage period.

# PRE-SEASON PREPARATION

Snow is falling and you are now anticipating the next snowmobile safari. If you have observed and adhered to the storage procedures outlined in this manual, your vehicle preparation becomes a relatively easy task.

To simplify the pre-season preparation we have drawn up a small chart. **The chart indicates servicing points to be performed by you and your servicing dealer.** If these services are performed as suggested, your vehicle will give you many hours of fun and low cost use.

**IMPORTANT:** Observe all Warnings and Cautions mentioned throughout this manual which are pertinent to the item being checked. When component conditions seem less than satisfactory, replace with genuine Bombardier parts or suitable equivalents.

## PRE-SEASON PREPARATION CHART

To be performed by dealer	●
To be performed by owner	○
Change spark plugs	○
Check chaincase oil level	○
Check pulleys, verify components and clean. Lubricate.	○
Check steering alignment and ski runner condition	●
On vehicle equipped with fuel filter cartridge, replace cartridge.	○
Check track tension and alignment	○
Lubricate suspension	○
Inspect drive belt and install	○
Check throttle cable for damage and free operation	○
Inspect brake condition and operation	●
Inspect oil seals for possible cuts or leaks	○
Set engine timing, if necessary replace breaker points	●
Check electrical wiring (broken wire, damaged insulation)	○
Inspect condition of starting rope	○
Check tightness of all bolts, nuts and linkage	○
Refill injection oil tank	○
Refill gas tank	○
Adjust carburetor	●
Adjust oil injection pump	●

# TROUBLE SHOOTING

SYMPTOMS	POSSIBLE CAUSES	WHAT TO DO
Engine turns over but fails to start or starts with difficulty	1. No fuel to the engine	Check the tank level and fill up with correct gas-oil mixture. Check for possible clogging of fuel line, item 5.
	2. Flooded engine	Remove wet spark plugs, turn ignition to OFF and crank engine several times. Install clean dry spark plugs. Start engine following usual starting procedure. If engine continues to flood, see your dealer.
	3. Spark plug/faulty ignition	Check for fouled or defective spark plug. Disconnect spark plug wire, unscrew plug and remove from cylinder head. Reconnect wire and ground exposed plug on engine cowl, <b>being careful to hold away from spark plug hole.</b> Follow engine starting procedure and check for spark. If no sparks appear, replace spark plug. If trouble persists, contact your dealer.
	4. Clogged fuel line (water or dirt)	Remove and clean the fuel filter. Change filter cartridge if necessary. Check condition and connections of fuel lines. Check the cleanliness of fuel tank.
	5. Faulty carburetor	First make primary adjustments on carburetor (See Maintenance Section). If carburetor is still faulty, contact your dealer for repair.
	6. Too much oil in fuel	Drain the fuel tank and refill with the correct gas/oil mixture.
	7. Engine timing	Engine timing may be defective or out of adjustment. Contact your dealer.
	8. Poor engine compression	Running with a lean fuel mixture may produce excessive engine wear resulting in poor engine compression. If this occurs, contact your dealer at once.
Engine will not turn manually	1. Seized engine	In the case of a seized engine contact your dealer.

<b>SYMPTOMS</b>	<b>POSSIBLE CAUSES</b>	<b>WHAT TO DO</b>
Engine lacks acceleration or power	1. Fouled or defective spark plug	Check item 3 of "Engine turns over but fails to start or starts with difficulty"
	2. Clogged fuel line (water or dirt)	Check fuel line condition. (See item 4 of "Engine turns over but fails to start or starts with difficulty").
	3. Carburetors	Readjust the carburetor. (See Maintenance section). If trouble persists, contact your dealer.
	4. Faulty ignition	First check item 3 of "Engine turns over but fails to start or starts with difficulty". If the ignition system still seems faulty, contact your dealer.
	5. Engine	If unable to locate specific symptoms, contact your dealer.
Engine continually backfires	1. Faulty spark plug	Check item 3 of "Engine turns over but fails to start or starts with difficulty".
	2. Overheated	Carburetor set too lean. Contact your dealer.
	3. Engine timing incorrectly set	Contact your dealer.
Snowmobile cannot reach full speed	1. Drive Belt	Check for damaged or worn drive belt. Replace if necessary.
	2. Incorrect track adjustment	Check track tension and alignment. Readjust to specifications. (See Maintenance Section).
	3. Faulty engine	Check item 1 to 5 of "Engine lacks acceleration or power."
	4. Pulley misaligned	Contact your dealer.

# TOOLS

As standard equipment each new snowmobile is supplied with a basic tool kit such as screwdriver, wrenches, emergency starter rope, etc...

## Standard Tools

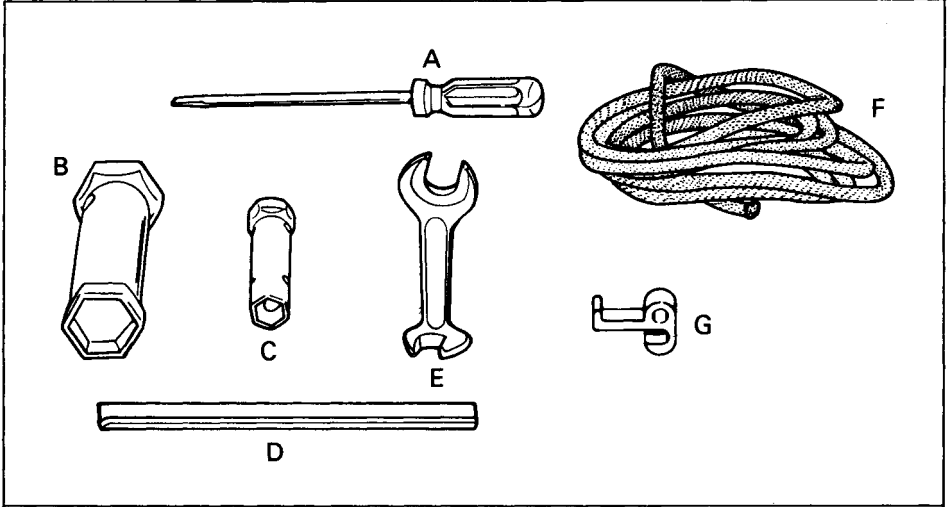

- A. Screwdriver
- B. Socket 21/26 mm
- C. Socket 10/13 mm
- D. Socket handle
- E. Angular wrench 10/13 mm
- F. Starter rope
- G. Emergency starting clip

# SPECIFICATIONS

	CITATION 3500	CITATION 4500	CITATION SS
<b>ENGINE</b>			
No. of cylinders	1	2	2
Bore	72 mm (2.83")	62 mm (2.44")	62 mm (2.44")
Stroke	66 mm (2.60")	61 mm (2.40")	61 mm (2.40")
Displacement	268.7 cm <sup>3</sup> (16.4 in <sup>3</sup> )	368.3 cm <sup>3</sup> (22.47 in <sup>3</sup> )	368.3 cm <sup>3</sup> (22.47 in <sup>3</sup> )
Compression ratio (corrected)	6.7:1	6.9:1	6.55:1
Carburetor type	VM 34-228	VM 34-229	2 x VM 30-111
Carburetor adjustment:			
— air screw	1 1/2 turn	1 turn	
— idle speed	1500-2000 RPM	2000 RPM	1500-2000
Engine head nuts (torque)	22 N•m (16 ft-lbs)	22 N•m (16 ft-lbs)	22 N•m (16 ft-lbs)
<b>CHASSIS</b>			
Overall length	249 cm (98")	263 cm (103 1/2")	249 cm (98")
Overall width	92.7 cm (36 1/2")	92.7 cm (36 1/2")	92.7 cm (36 1/2")
Overall height	98.4 cm (38 3/4")	98.4 cm (38 3/4")	98.4 cm (38 3/4")
Ski stance (center to center)	82 cm (32 1/4")	82 cm (32 1/4")	82 cm (32 1/4")
Ski alignment (toe out)	3.2 mm (1/8")	3.2 mm (1/8")	3.2 mm (1/8")
Weight	148.3 kg (327 lbs)	man: 160 kg (353 lbs) elec: 172.4 kg (380 lbs)	159.7 kg (352 lbs)
Bearing area	5838 cm <sup>2</sup> (905 in <sup>2</sup> )	6225 cm <sup>2</sup> (965 in <sup>2</sup> )	5838 cm <sup>2</sup> (905 in <sup>2</sup> )
Ground pressure	2.49 kPa (.361 PSI)	man: 2.52 kPa (.366 PSI) elec: 2.72 kPa (.394 PSI)	2.68 kPa (.389 PSI)
<b>POWER TRAIN</b>			
Track dimensions	38.1 cm (15") x 269.3 cm (106")	38.1 cm (15") x 289.6 cm (114")	38.1 cm (15") x 269.2 cm (106")
Track tension	13 mm (1/2") gap should exist between slide shoe and bottom inside of track.		
Track alignment	Equal distance between edges of track guides and slider shoes.		
Std. gear ratio	15/34	16/33	18/34
Chaincase oil capacity	170 mL (6 oz)	170 mL (6 oz)	170 mL (6 oz)
Drive belt (minimum width)	30.15 mm (1 3/16")	30.15 mm (1 3/16")	30.15 mm (1 3/16")
<b>ELECTRICAL</b>			
Lighting system (output)	140 watts	140 watts	140 watts
Headlamp bulb	45/45 W	45/45 W	45/45 W
Tail stop/ light	5/21 W	5/21 W	5/21 W
Spark plug (Bosch)			
— normal use	W275 T2 (W3C)	W275 T2 (W3C)	W275 T2 (W3C)
— severe use			
Spark plug (gap)	.4 mm (.016")	.4 mm (.016")	.4 mm (.016")
Breaker points (gap)	.35 mm (.014")	.35 mm (.014")	.35 mm (.014")
Advance ignition timing (B.T.D.C.)	2.35 mm (.092")	2.07 mm (.081")	2.07 mm (.081")
<b>FUEL</b>			
Tank capacity — S.I.*	28.4 liters	28.4 liters	28.4 liters
— Imp.	6.25 gals	6.25 gals	6.25 gals
— U.S.	7.8 gals	7.8 gals	7.8 gals
Gasoline	Regular	Regular	Regular
Injection oil — S.I.*	NA	1.36 L	NA
— Imp.	NA	48 oz	NA
— U.S.	NA	46 oz	NA

N.A.: Not applicable





	CITATION 3500	CITATION 4500	CITATION SS
<b>BRAKE</b>			
Brake type	Disc, adjust as required.		
Brake adjustment (control lever)	13 mm (1/2'') minimum distance from handlebar grip when fully applied.		
Brake lining (minimum thickness)	3 mm (1/8'')	3 mm (1/8'')	3 mm (1/8'')

\*International System

*Bombardier Limited reserves the right to make changes in design and specifications and/or to make additions to, or improvements in its product without imposing any obligation upon itself to install them on its products previously manufactured.*

# WIRING DIAGRAM

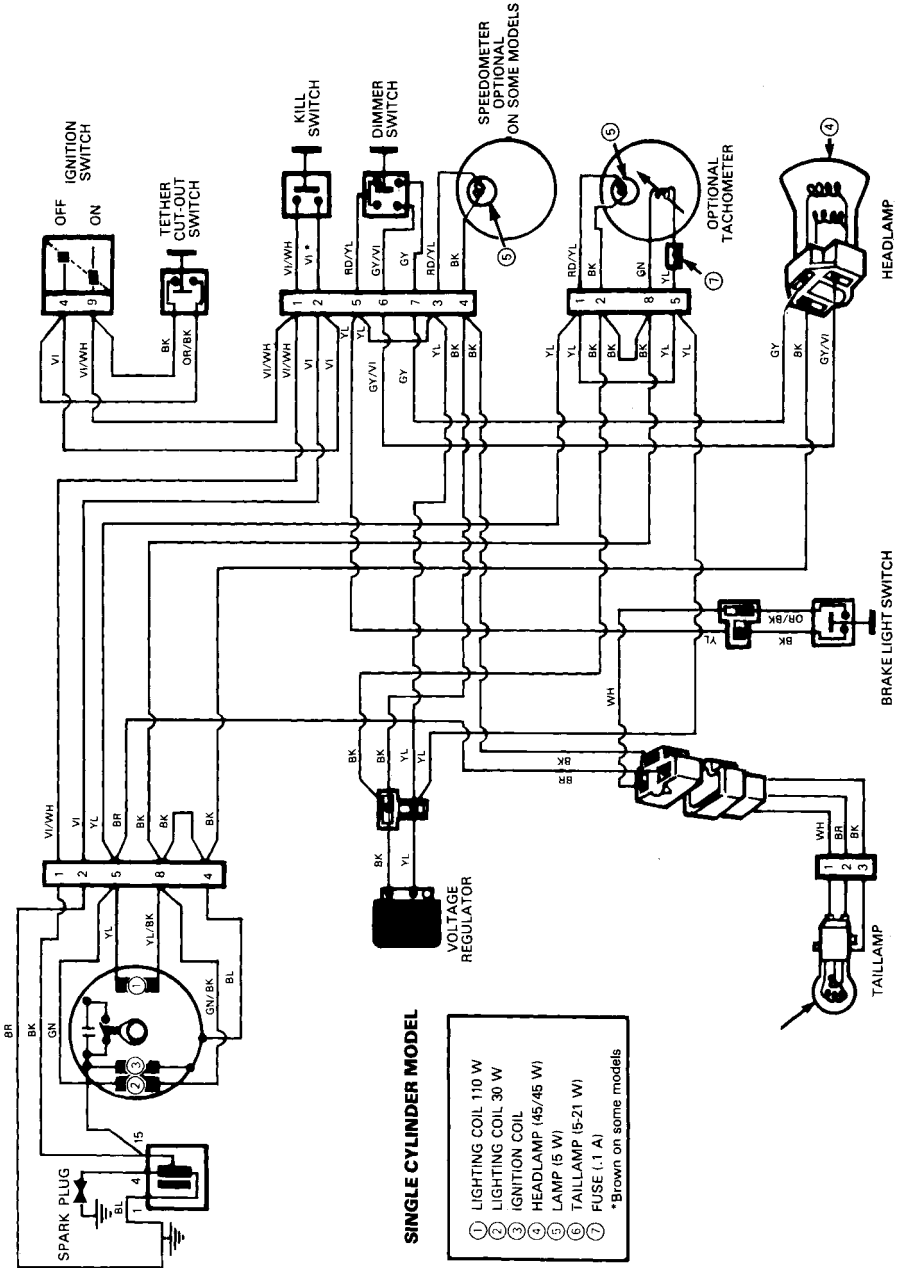

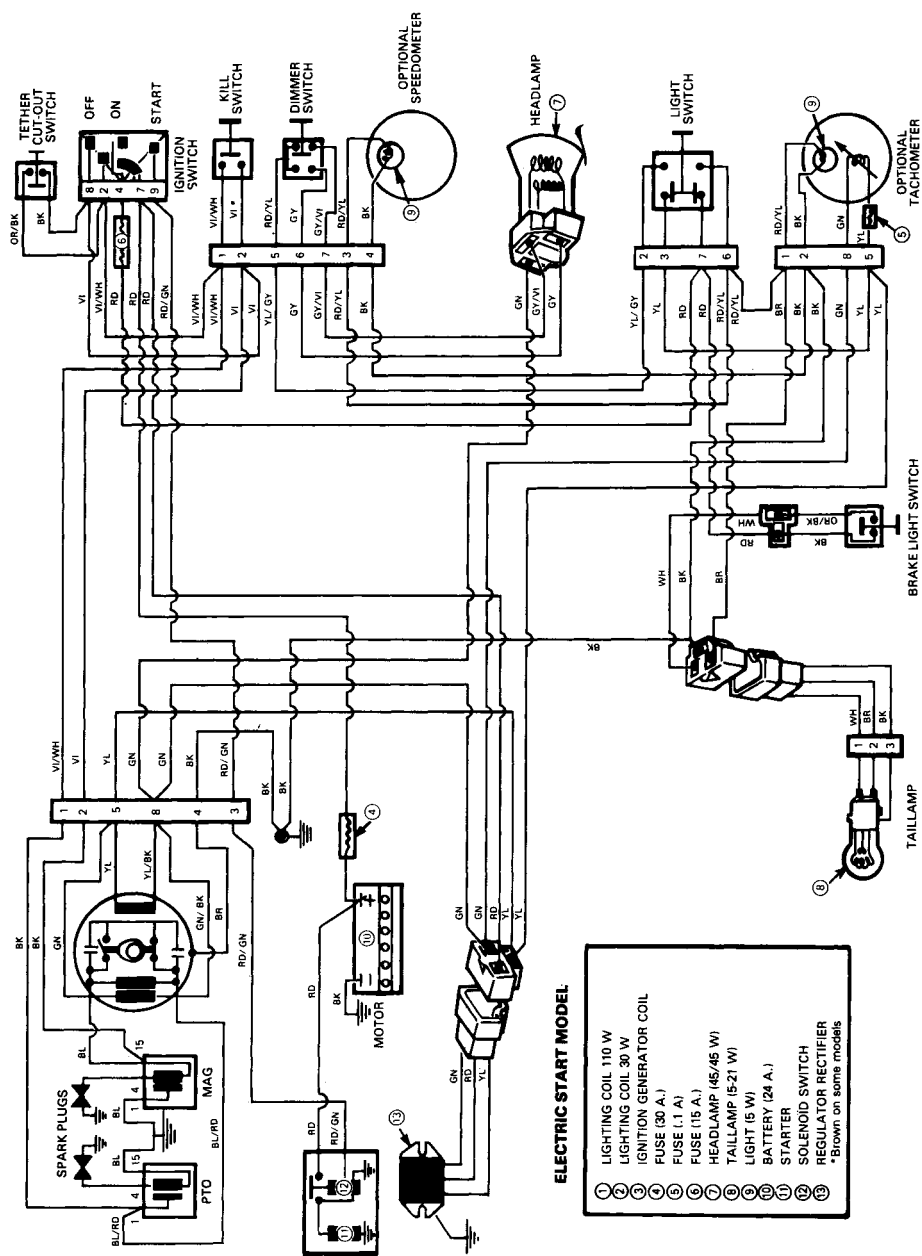

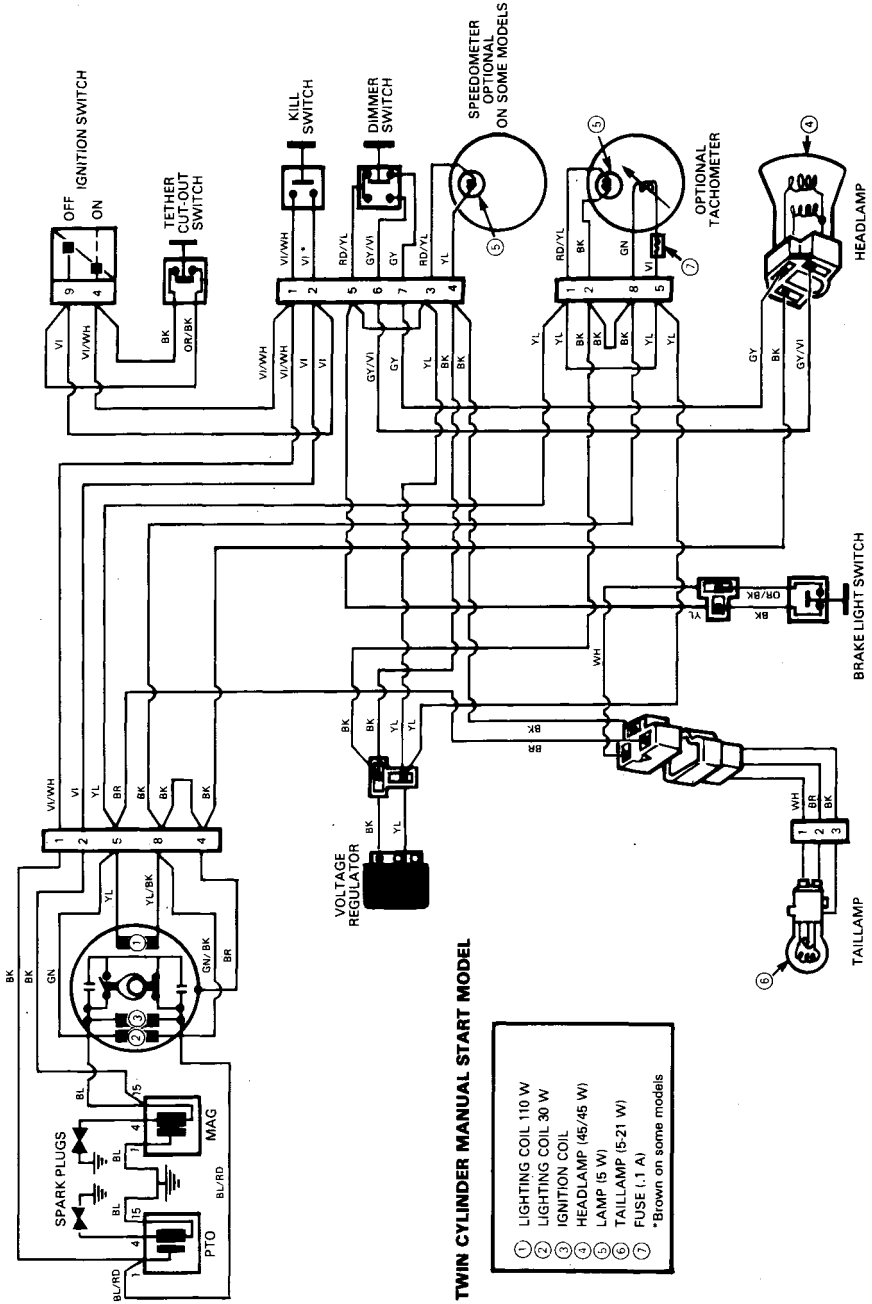

**TWIN CYLINDER MANUAL START MODEL**

- ① LIGHTING COIL 110 W
  - ② LIGHTING COIL 30 W
  - ③ IGNITION COIL
  - ④ HEADLAMP (45/45 W)
  - ⑤ LAMP (5 W)
  - ⑥ TAILLAMP (5/21 W)
  - ⑦ FUSE (1 A)
- \*Brown on some models

# S.I.\* METRIC INFORMATION GUIDE

## BASE UNITS

DESCRIPTION	UNIT	SYMBOL
length	meter	m
mass	kilogram	kg
liquid	liter	L
temperature	celsius	°C
pressure	kilopascal	kPa
torque	Newton meter	N•m
speed	kilometer per hour	km/h

---

## PREFIXES

PREFIX	SYMBOL	MEANING	VALUE
kilo	k	one thousand	1,000
centi	c	one hundredth of a	0.01
milli	m	one thousandth of a	0.001

\*THE INTERNATIONAL SYSTEM OF UNITS (SYSTEME INTERNATIONAL) ABBREVIATES "SI" IN ALL LANGUAGES.

## LIMITED WARRANTY SKI-DOO® SNOWMOBILES 1980

BOMBARDIER Limited as manufacturer, warrants FROM THE DATE OF FIRST CONSUMER SALE, every 1980 Ski-Doo® snowmobile, sold as NEW AND UNUSED, by an authorized SKI-DOO dealer, subject to the following limitations and conditions, for a period of:

- 
- **two (2) seasons maximum** for models:

Elan® , Citation\* , Everest® , Elite® ,

Warranty STARTS on the date of sale to the first consumer and ENDS the SECOND APRIL 30TH following the date warranty coverage started.

---

or

- 
- **Ninety (90) consecutive** days for the following models: BLIZZARD® 5500-7500-9500 and ALPINE® subject to the following:
    1. When a sale is made after MARCH 31ST of a given year but before THE 1ST DAY OF DECEMBER of the same year, the warranty will start on DECEMBER 1ST following the date of sale and terminate 90 days later.
    2. When a sale is made on/or after JANUARY 2ND of a given year, the unused portion of the 90 days warranty as of MARCH 31ST, of that year will be carried over to the next season, beginning the 1ST DAY OF DECEMBER.
- 

**Any 1980 model not listed is not warranted.**

### WHAT WE WILL DO

BOMBARDIER will repair and/or replace, at its option, components defective in **material and/or workmanship (under normal use and service,)** with a genuine BOMBARDIER component without charge for parts or labour at any authorized SKI-DOO dealer during said warranty period.

## EXCLUSIONS

### Items and components:

Any of the following expendable items and/or components that are damaged or worn due to normal use: variable speed drive belt, windshield, filters, ignition breaker points, condensers, spark plugs, light bulbs, protective lenses, brake linings, ski runner shoes, slider shoes on suspension and variable speed pulleys, labels, soft trim, appearance items, lubricants and paints and all tune-ups, seized, melted or holed piston and adjustments required.

### Also excluded are:

- Damage resulting from installation of parts other than genuine BOMBARDIER parts.
- Damage caused by failure to provide **proper maintenance** as detailed in the **Operator Manual** supplied with each SKI-DOO snowmobile. The labour, parts and lubricants cost of all maintenance services, including tune-ups and adjustments will be charged to the owner.
- Damage resulting from improper servicing or adjustment of the drive pulley assembly. **The drive pulley assembly is factory sealed, and can only be serviced by an authorized SKI-DOO dealer.**
- Vehicles used for racing purposes.
- Vehicle used for rental purpose or other business purposes.
- All optional accessories installed on the vehicle. **(The normal warranty policy for parts and accessories, if any, applies).**
- Damage resulting from operation of the snowmobile on surfaces other than snow.
- Damage resulting from accident, fire or other casualty, misuse, abuse or neglect.
- Damage resulting from modification to the snowmobile not approved in writing by BOMBARDIER.
- Losses incurred by the snowmobile owner other than parts and labour, such as, but not limited to, transportation, towing, telephone calls, taxis, or any other incidental or consequential damages.



Some states or provinces do not allow the exclusion or limitation of incidental or consequential damages, so the above limitation or exclusion may not apply.

### **CONDITION TO HAVE WARRANTY WORK PERFORMED**

Present, to the servicing dealer, the hard copy of the BOMBARDIER Customer Registration card given by the selling dealer at time of purchase.

### **EXPRESSED OR IMPLIED WARRANTIES**

This warranty gives you specific rights, and you may also have other legal rights which may vary from state to state, or province to province.

Where applicable this warranty is expressly in lieu of all other expressed or implied warranties of BOMBARDIER, its distributors and the selling dealer, including any warranty of merchantability of fitness for any particular purpose; otherwise the implied warranty is limited to the duration of this warranty. However, some states or provinces do not allow limitations on how long an implied warranty lasts, so the above limitation may not apply.

Neither the distributor, the selling dealer, nor any other person has been authorized to make any affirmation, representation or warranty other than those contained in this warranty, and if made, such affirmation, representation or warranty shall not be enforceable against BOMBARDIER or any other person.

### **CONSUMER ASSISTANCE**

If a servicing problem or other difficulty occurs, we suggest the following:

1. Try to resolve the problem at the dealership with the Service Manager or Owner.
2. If this fails, contact your area distributor listed in the Operator Manual.
3. Then if your grievance still remains unsolved, you may write to us:

Bombardier Limited  
Customer Relations Department  
Recreational Product Group  
Valcourt, Quebec, Canada, JOE 2LO





**Bombardier Limited reserves the right to modify its warranty policy at any time, being understood that such modification will not alter the warranty conditions applicable to vehicles sold while the above warranty is in effect.**

November 1978

Bombardier Limited  
Valcourt, Quebec, Canada, JOE 2LO

\*Trademark of Bombardier Limited

® Registered Trademark Bombardier Limited

## OFTEN ASKED QUESTIONS

Q: Why must my snowmobile be registered? After all I do have my original invoice as proof of when I purchased my snowmobile.

*A: The information provided by the Customer Warranty Registration card is computerized, and all warranty claims thereafter, are processed by the computer. Without this valuable information on the Warranty Registration Card, we cannot acknowledge warranty or notify owners of a possible safety recall.*

Q: How do I know my vehicle has been registered at the factory?

*A: When you bought your snowmobile the dealer should have completed, and forwarded us the manufacturer's copy of the Customer Warranty Registration. The **hard copy** of the card is your proof that the snowmobile is registered.*

Q: I bought my snowmobile in O'King County but I snowmobile in Washington County. Can the dealer in Washington County accept warranty work on my snowmobile?

*A: Yes, any authorized dealer in North America can perform warranty repairs, providing the customer warranty registration card is presented.*

Q: Where can I find information on the lubrication and maintenance of my snowmobile?

*A: In this Operator Manual provided with the vehicle at the time of first sale.*

Q: Will the entire warranty be void or cancelled, if I do not operate or maintain my new snowmobile exactly as specified in the Operator's Manual?

*A: The warranty of the new snowmobile cannot be "Voided" or "Cancelled". However, if a particular failure is caused by operation or maintenance other than is shown in the Operator Manual, **that** failure may not be covered under warranty. This includes service work performed by the customer, especially the critical adjustments to ignition, timing, carburetion and oil injection/or oil mixture.*

Q: Would you give some examples of abnormal use or strain, neglect or abuse?

*A: These terms are general and overlap each other in areas. Some specific examples may include: running the machine out of oil, sustained high r.p.m. full throttle use, chain failure caused by a lack of lubrication and/or adjustments, operating the machine with a broken or damaged part which causes another part to fail, and so on. If you have any specific questions on operation or maintenance, please contact your dealer for advice.*

Q: What costs are my responsibility during the warranty period?

*A: The customer's responsibility includes all costs of normal maintenance services, non-warranty repairs, accidents and collision damage, as well as oils, and spark plugs, and incidental or consequential damages costs as explained in the warranty.*

Q: Are "Genuine" Bombardier replacement parts used in warranty repairs covered by warranty?

*A: Yes. When installed by an authorized dealer, any "genuine" Bombardier part used in warranty repairs assumes the remaining warranty that exists on the machine.*

Q: What is Bombardier's policy on extending a warranty?

*A: It is not Bombardier's policy to extend warranty. Bombardier has selected a warranty period sufficiently long to permit adequate use of the machine to allow for possible concealed manufacturing defects to occur.*

Q: If I sell my snowmobile within the warranty period, will the new owner qualify for the balance of the warranty?

*A: Yes, provided the unit has already been registered with the manufacturer. Note that the change of ownership card in this manual should be completed and sent to Valcourt.*

# HOW TO IDENTIFY YOUR SNOWMOBILE

The main components of your snowmobile (engine, track and frame) are identified by different serial numbers. It may sometimes become necessary to locate these numbers for warranty purposes or to trace your snowmobile in the event of theft.

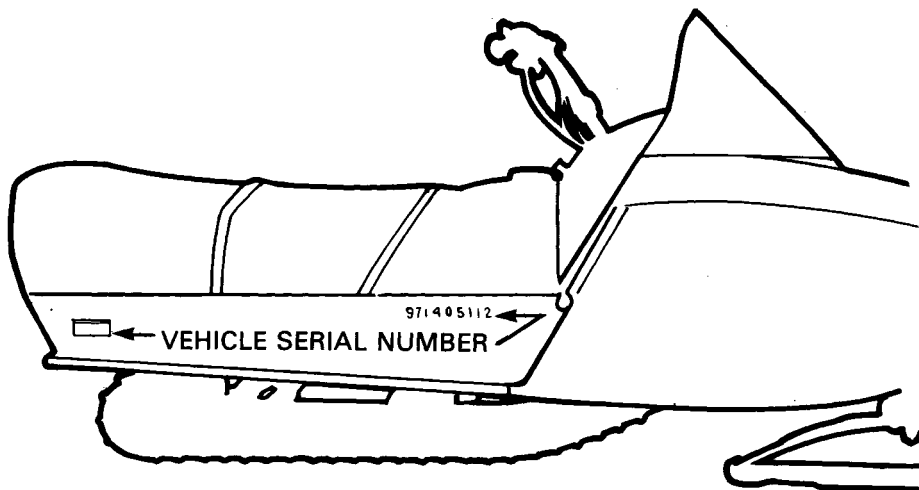
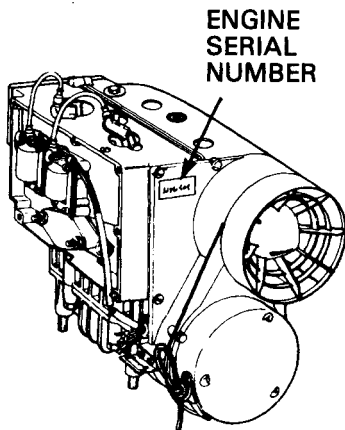
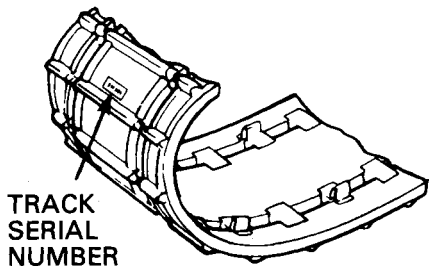

NOTE: We strongly recommend that you take note of all the serial numbers on your vehicle and supply them to your insurance company. It will surely help in the event a snowmobile is stolen.

# CHANGE OF ADDRESS AND OWNERSHIP

Any change in address or ownership should be brought to the attention of the manufacturer by completing and sending out the card supplied below. This will help us to maintain our files up-to-date.

## CHANGE OF ADDRESS



VEHICLE IDENTIFICATION NUMBER

--	--	--	--	--	--	--	--	--	--	--	--	--	--	--	--	--	--	--	--

OLD ADDRESS:

NAME

---

NO STREET APT.

---

CITY STATE ZIP / POSTAL CODE

NEW ADDRESS:

NAME

---

NO STREET APT.

---

CITY STATE ZIP / POSTAL CODE

## CHANGE OF OWNERSHIP



VEHICLE IDENTIFICATION NUMBER

--	--	--	--	--	--	--	--	--	--	--	--	--	--	--	--	--	--	--	--

The ownership of this vehicle is transferred

FROM:

NAME

---

NO STREET APT.

---

CITY STATE ZIP / POSTAL CODE

TO:

NAME

---

NO STREET APT.

---

CITY STATE ZIP / POSTAL CODE





**BOMBARDIER LIMITED**  
ATT.: WARRANTY DEPARTMENT  
VALCOURT, QUEBEC  
CANADA, J0E 2L0

**BOMBARDIER LIMITED**  
ATT.: WARRANTY DEPARTMENT  
VALCOURT, QUEBEC  
CANADA, J0E 2L0

# LISTING OF AREA DISTRIBUTORS



## CANADIAN DISTRIBUTORS

**ALPINE DISTRIBUTORS LIMITED**  
Kalamalka Lake Road  
P.O. Box 159  
Vernon, British Columbia, V1T 6M2  
(604) 545-1314  
British Columbia

**BOMBARDIER LIMITED**  
EASTERN CANADA DISTRIBUTION DIVISION  
Atlantic Branch  
P.O. Box 670  
Shediac, New Brunswick, E0A 3G0  
(506) 532-4454  
Magdalen Island, Nova Scotia, New Brunswick,  
Prince Edward Island

**BOMBARDIER LIMITED**  
EASTERN CANADA DISTRIBUTION DIVISION  
(Quebec Branch)  
1350 Nobel Boulevard  
Boucherville, Quebec, J4B 1A1  
(514) 527-2469 or 655-6121  
Province of Quebec

**BOMBARDIER LIMITED**  
EASTERN CANADA DISTRIBUTION DIVISION  
Ontario Branch  
230 Bayview Drive  
Barrie, Ontario, L4M 2Y8  
(705) 728-8600  
Province of Ontario

**BROOKS EQUIPMENT LIMITED**  
1616 King Edward Street  
P.O. Box 985  
Winnipeg, Manitoba, R3C 2V8  
(204) 633-7247  
Manitoba, Saskatchewan

**HUDSON'S BAY CO. LTD.**  
165 Hymus Boulevard  
Pointe-Claire, Québec, M4W 1A8  
(514) 697-8500  
North-West Territories, Franklin District & Keewatin

**J.W. RANDALL LIMITED**  
West Street  
P.O. Box 1050  
Corner Brook, Newfoundland, A2H 6G7  
(709) 634-3533  
Newfoundland, Labrador

**TRACT EQUIPMENT**  
14325, 114th Avenue  
Edmonton, Alberta, T5M 2Y8  
(403) 452-9910  
Alberta, Dist. Mackenzie, Yukon, N.W.T.

## AMERICAN DISTRIBUTORS

**BOMBARDIER CORPORATION**  
4505 West Superior Street  
P.O. Box 6106  
Duluth, Minnesota 55806  
(218) 628-2881  
North Dakota, Minnesota, Wisconsin, Illinois, Missouri,  
Michigan, Indiana, Ohio (less eastern half), Tennessee,  
Kentucky, West Virginia, Virginia, Northern Idaho,  
Northern Wyoming, Montana, Iowa, Washington

**ELLIOTT & HUTCHINS INC.**  
East Main Street Road  
Malone, New York 12953  
(518) 463-4411  
New York, Massachusetts, Connecticut, Rhode Island,  
Pennsylvania, New Jersey, Maryland, Delaware, District of  
Columbia, Northern half of Ohio.

**MILLER EQUIPMENT AND RECREATIONAL CENTER**  
1049 Whitney Road  
Anchororage, Alaska 99501  
(907) 274-9513  
Alaska

**TIMBERLAND MACHINES INC.**  
10 North Main Street  
Lancaster, New Hampshire 03584  
(603) 788-4738  
Maine, New Hampshire, Vermont







A series of 25 horizontal lines for writing, evenly spaced across the page.



Lined writing area consisting of 25 horizontal lines.