

# RV\* 340

# 1977 OPERATOR MANUAL

*\*Trademark of Bombardier Limited*

Litho'd in Canada 484 0197 00



**ski-doo.**  
snowmobiles



## Recreational Products

\*The following are trademarks of  
Bombardier Limited.

BOMBARDIER  
SKI-DOO  
ALPINE  
BLIZZARD  
CARRY BOOSE  
ELAN  
RV

ELITE  
EVEREST  
MIRAGE  
NORDIC  
OLYMPIQUE  
SKI BOOSE  
T'NT

This manual has been published by the:

TECHNICAL INFORMATION CENTRE  
AFTER SALES SERVICE DEPARTMENT  
BOMBARDIER LIMITED  
VALCOURT, QUEBEC, CANADA

Suggested Retail Price \$1.00  
(First copy free with unit purchased)

All rights reserved © Bombardier Limited 1976

## FOREWORD

Within the North American Continent, there exists a very special breed of people... people who enjoy ice and snow, and the unexcelled trails that lead to virtually every corner of the snowbelt. They enjoy too, the comfort of warm clothing, the friendliness of companions, and the recreational vehicle that made it all possible... the Ski-Doo snowmobile.

We, like millions of North American families, have never forgotten our pioneer heritage, or our love of nature and the great outdoors, consequently, we have designed and engineered all our models with safety, comfort and quietness foremost in our minds. We do respect your desires, and that of others.

Information has been prepared to acquaint the owner / operator of a new 1977 snowmobile with the various vehicle controls, owner-related maintenance, and safe operating instructions.

This is accomplished via three manuals; 'The Snowmobile Safety Handbook' the 'Warranty and Consumer Guide Booklet' and the 'Operator Manual'. Each is inseparable toward proper use of the product, and should be kept with the vehicle at all times.

This manual emphasizes particular information denoted by the wording and symbols;

◆ **WARNING:** Identifying an instruction which, if not followed, could cause personal injury.

▼ **CAUTION:** Denotes an instructions which, if not followed, could severely damage vehicle components.

○ **NOTE:** Indicates supplementary information needed to fully complete an instruction.

Ride safe and have fun.

MICHEL CLOUTIER,



General Manager  
Recreational Product Group

# SAFETY IN MAINTENANCE

## Observe the following precautions:

- Throttle mechanism should be checked for free movement before starting engine.
- Engine should be running only when pulley guard is secured in place.
- Never run engine without drive belt installed. Running an unloaded engine can prove to be dangerous.
- Never run the engine at high R.P.M. when the track of the vehicle is raised off the ground.
- It can be dangerous to run engine with the cab open.
- Since engine cooling is in effect only when the vehicle is in motion, it is recommended that you do not allow the engine to idle for more than brief periods. Prolonged idling and low speed operation may cause engine damage.
- Gasoline is flammable and explosive under certain conditions. Always perform procedures in a well ventilated area. Do not smoke or allow open flames or sparks in the vicinity. If gasoline fumes are noticed while driving, the cause should be determined and corrected without delay.
- Your snowmobile is not designed to be operated on public streets, road or highways. In most States and Provinces, it is considered an illegal operation.
- Maintain your vehicle in top mechanical condition at all times.
- Your snowmobile is not designed to be driven or operated on black top, bare earth, or other abrasive surfaces. On such surfaces abnormal and excessive wear of critical parts is inevitable.
- Only perform procedures as detailed in this manual. Unless otherwise specified, engine should be turned OFF for all lubrication and maintenance procedures.
- Installation of other than "stock" equipment, including ski-spreaders, bumpers, pack racks, etc., could severely affect the stability and safety of your vehicle. Avoid adding on" accessories that alter the basic vehicle configuration.
- The snowmobile engine can be stopped by activating the emergency cut-out or tether switches, or turning off the key.
- The R.V. is designed for the driver only. No provisions have been made for a passenger.

---

**Please read and understand all other warnings contained elsewhere.**

---

**THIS MANUAL SHOULD REMAIN WITH THE VEHICLE AT THE TIME OF RESALE.**

# INDEX

## **CONTROLS / INSTRUMENTS**

Throttle control lever, brake control lever, ignition switch, light switch, headlamp dimmer switch, emergency cut-out switch, tether cut-out switch, rewind starter, primer, tachometer, cab opening, tool box, fuel gauge . . . . . **4,5**

## **BREAK-IN PERIOD**

Inspection . . . . . **6**

## **FUEL MIXING**

Recommended gasoline, recommended oil, fuel mixture ratio, fuel mixing procedure . . . . . **6,7**

## **PRE-START CHECK**

Check points . . . . . **8**

## **STARTING PROCEDURE**

Manual starting, emergency starting . . . . . **8,9**

## **DRIVING TIPS**

Air intake silencer, slide suspension . . . . . **9**

## **LUBRICATION**

Frequency, pulley guard removal, drive belt removal, steering mechanism, chain-case oil level, slide suspension, rotary valve system . . . . . **10,11**

## **MAINTENANCE**

Spark plug, suspension, track, suspension adjustment, track tension and alignment, carburetor adjustment, drive belt, steering mechanism, brake, steering adjustment, engine head nuts, engine mount nuts, exhaust system, general inspection, headlamp beam aiming, bulb replacement . . . . . **12,13,14,15**

**TROUBLE SHOOTING GUIDE** . . . . . **16,17**

## **STORAGE**

Track, slide suspension, ski, fuel tank, carburetor, cylinder lubrication, drive pulley, chaincase, controls, chassis, general inspection . . . . . **18,19,20**

## **PRE-SEASON PREPARATION**

Pre-season preparation chart . . . . . **21**

**SPECIFICATIONS** . . . . . **22**

# CONTROLS / INSTRUMENTS

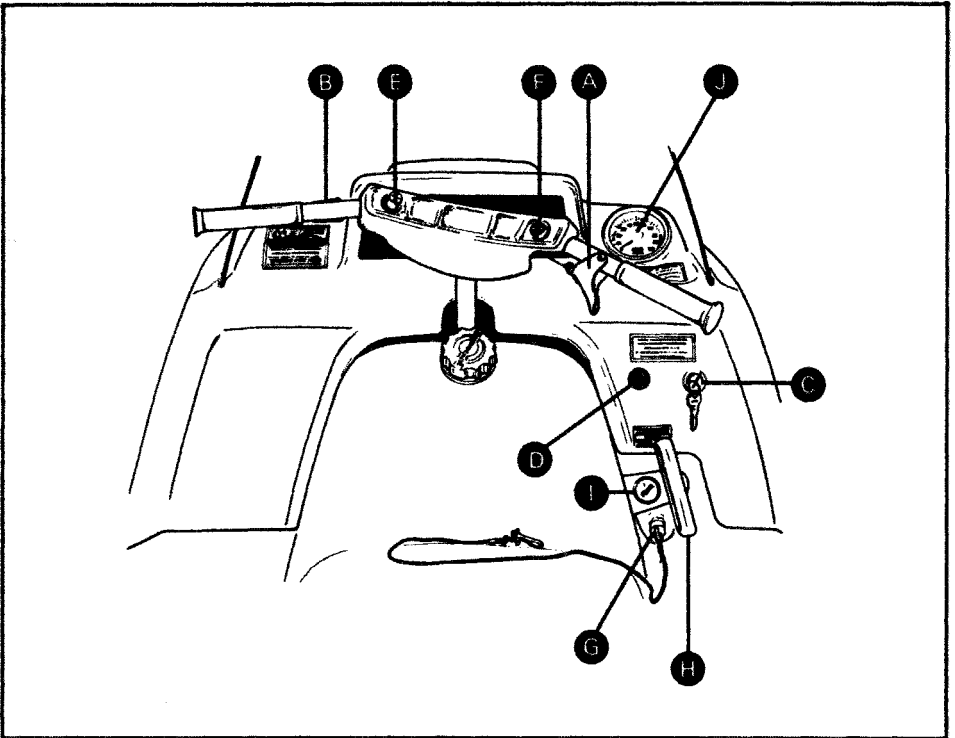

- A) Throttle Control Lever
- B) Brake Control Lever
- C) Ignition Switch
- D) Light Switch
- E) Headlamp Dimmer Switch

- F) Emergency Cut-Out Switch
- G) Tether Cut-Out Switch
- H) Manual Starter Handle
- I) Primer
- J) Tachometer

## A) Throttle Control Lever

Located on right side of handlebar. When compressed, it controls the **engine speed** and the **engagement of the transmission**. When released, engine speed returns automatically to idle.

## B) Brake Control Lever

Located on the left side of handlebar. When compressed, the brake is applied. When released, it automatically returns to its original position. Braking effect is proportionate to the pressure applied on the lever.

## C) Ignition Switch

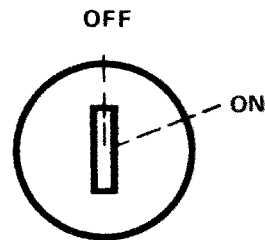

Key operated, 2 position switch (OFF / ON). To start engine, first turn key clockwise to ON position. To stop engine, turn key counter-clockwise to OFF position.

## D) Light Switch

A push-pull switch located on right side of cab. With engine running, illuminates both headlamp taillight. Pull fully out to illuminate.

## E) Headlamp Dimmer Switch

The dimmer switch, located on left side of handlebar, allows correct selection of headlamp beam. To obtain high or low beam simply depress switch.

## F) Emergency Cut-Out Switch

A push button switch located on right side of handlebar. To stop the engine in an emergency, press button down into **lower** position. Before re-starting engine always depress button into released **upper** position. The driver of this vehicle should familiarize himself with the function of this device by using it several times on first outing. Thereby being mentally prepared for emergency situations requiring its use.

◆ **WARNING:** If the button has been used in an emergency situation the source of malfunction should be determined and corrected before restarting engine.

## G) Tether Cut-Out Switch

A pull switch located on the right side of cab. Attach tether cord to wrist or other convenient location before starting engine then fully insert tether cut-out cap on receptacle.

○ **NOTE:** The cap must be used at all time in order to operate the vehicle.

If emergency engine "shut OFF" is required, "pull" out completely the cap from switch and engine power will automatically be shut "off".

◆ **WARNING:** If the switch is used in an emergency situation the source of malfunction should be determined and corrected before re-starting engine.

## H) Rewind Starter Handle

Auto rewind type located on right hand side of vehicle. To start engine, pull handle.

## I) Primer

A push-pull button located alongside manual starter handle. Pull and push button (2-3 times) to activate primer. The primer should always be used for cold engine starts. After engine is warm however, it is not necessary to use primer when starting.

## J) Tachometer

The tachometer registers the impulses of magneto. Direct-reading dial indicates the number of revolutions per minute (RPM) of the engine.

▼ **CAUTION:** The tachometer is protected by a fuse, if tachometer stops operating check fuse condition and if necessary replace. The fuse is 0.2 amp. Do not use a higher rated fuse as this can cause severe damage to the tachometer.

## Cab Opening

To open cab, unfasten latches on both sides near footrest where cab meets frame. Always lift cab gently up until stopped by restraining device.

◆ **WARNING:** It is dangerous to run engine with cab open. Personal injury could result.

## Tool Box

Located beside the chaincase under the cab, to gain access, tilt cab. Ideal location for spare plugs, belt, rope, etc.

## Fuel Gauge

To check fuel level, simply unscrew fuel tank cap and withdraw dipstick.

◆ **WARNING:** Never use a lite match or open flame to check fuel level.

With Bombardier-Rotax snowmobile engines, a break-in period is required before running the vehicle at full throttle. Manufacturer's, recommendation for the Bombardier-Rotax engine is 10 to 15 operating hours. During this period, a richer mixture is needed (i.e. 40 parts of gas for 1 part of 50 / 1 Bombardier snowmobile oil). Maximum throttle should not exceed  $\frac{3}{4}$ , however, brief full acceleration and speed variations contribute to a good break-in. Continued wide open throttle accelerations, prolonged cruising speeds, and lugging are detrimental during the break-in period.

### Inspection

After the break-in period, each snowmobile must have an inspection check. This inspection is at the expense of the vehicle owner.

Oil must be added to the gasoline in pre-measured amounts then both oil and gasoline should be thoroughly mixed together before fueling the tank.

### Recommended Gasoline

The correct gasoline is **premium** gasoline, available from all service stations.

 **CAUTION:** Never experiment with different fuel or fuel ratios. Never use low lead or non leaded gasoline, naphta, methanol or simular products.

### Recommended Oil

Use concentrated Bombardier snowmobile oil available from your dealer. This type of oil has specially formulated oil bases to meet the lubrication requirements of the Bombardier-Rotax engine.

If Bombardier snowmobile oil is unavailable, substitute with a high quality 2-cycle snowmobile oil. The oil / gas mix must meet the vehicle requirements. See oil manufacturer recommendations on container.

 **CAUTION:** Never use ouboard or straight mineral oils.

### Fuel mixture Ratio

The importance of using the correct fuel mixture cannot be overstressed. An incorrect fuel ratio results in serious engine damage. Recommended fuel ratio is 50 / 1.

5 gallons recommended gasoline plus 1 can of 50 / 1 concentrated Bombardier snowmobile oil = correct fuel mixture.

 **NOTE:** To facilitate fuel mixing, oil should be kept at room temperature.



## Fuel Mixing Procedure

To mix the gasoline and oil always use a separate clean container. Never mix directly in your snowmobile tank. For best results, acquire two containers, either plastic or metal. Draw from one until empty then use the second one.

◆ **WARNING:** Gasoline is flammable and explosive under certain conditions. Always perform procedures in a well ventilated area. Do not smoke or allow open flames or sparks in the vicinity. If gasoline fumes are noticed while driving, the cause should be determined and corrected without delay. Never add fuel while engine is running. Avoid skin contact with fuel at below freezing temperatures.

1. Pour approximately one gallon of gasoline into a clean container.

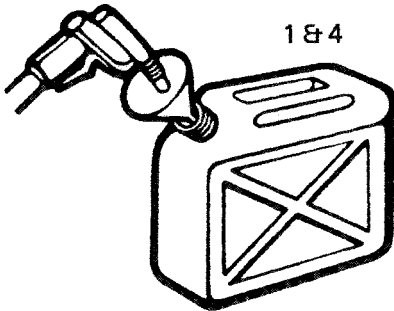

2. Add full amount of oil.

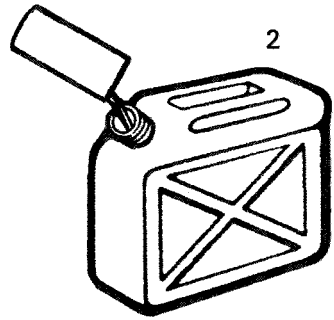

3. Replace container cap and shake the container thoroughly.

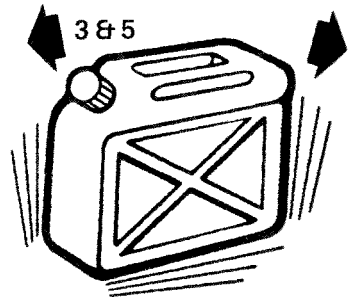

4. Add the remainder of the gasoline.
5. Once again thoroughly agitate the container. Then using a funnel with a fine mesh screen to prevent the entry of water and foreign particles, transfer mixture from container into the snowmobile tank.

○ **NOTE:** When using pre-mixed fuel, always shake the container thoroughly as the oil has a tendency to settle.

◆ **WARNING:** Never 'top up' gas tank before placing the vehicle in a warm area. At certain temperatures, gasoline will expand and overflow.

## Check Points

- Activate the throttle control lever several times to check that it operates easily and smoothly. The throttle control lever must return to idle position when released.
- Check that the skis and the track are not frozen to the ground or snow surface and that the steering operates freely.
- Activate the brake control lever and make sure the brake fully applies before the brake control lever touches the handlebar grip.
- Check fuel level.
- Verify that the path ahead of the vehicle is clear of bystanders and obstacles.

◆ **WARNING:** Only start your snowmobile once all components are checked and functioning properly.

Upper position  
before starting  
engine

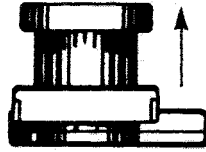

Lower position  
to stop engine

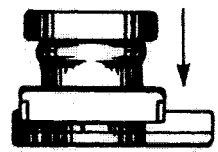

1. Insert key in ignition and turn to ON position.
2. **Test throttle control lever.**
3. Activate primer (2 to 3 times). Primer is not necessary when engine is warm.
4. Make sure the tether cut-out cap is in position and that the cord is attached to your body. Check that the emergency cut-out button is in the released upper position.
5. Grasp manual starter handle firmly and pull slowly until a resistance is felt then pull vigorously. Slowly release rewind starter handle.

◆ **WARNING:** Do not apply throttle while starting.

6. Check operation of the emergency cut-out switch, and tether switch. Restart engine.

◆ **WARNING:** If engine does not shut-off when applying the emergency cut-out switch and / or, pulling the tether cut-out cap, stop the engine by turning off the ignition key. Do not operate the vehicle further, see your dealer.

7. Allow the engine to warm before operating at full throttle.

Should the rewind starter rope fray and break, the engine can be started with an emergency starter rope.

Remove the tuned exhausts.

◆ **WARNING:** Make sure that the tuned exhausts are cold before attempting to remove them from vehicle.

Remove the rewind starter assembly from the engine and transfer the rope handle to your emergency rope.

Wind rope around starting pulley, the knot of the emergency rope should be positioned behind one stud of the pulley.

Reinstall tune exhausts **before** attempting to start engine.

Pull vigorously as per usual manual starting to start engine.

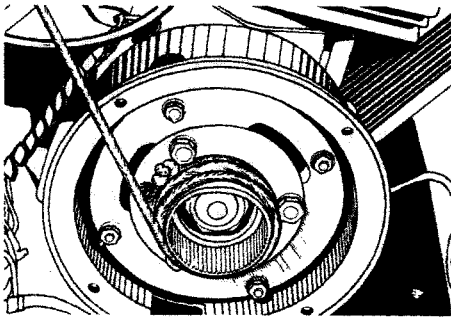

### Air Intake Silencer

The neck of the air intake silencer must always be turned down and facing the rear (see illustration) otherwise the pressure created by the vehicle speed will lean the mixture and cause engine damage.

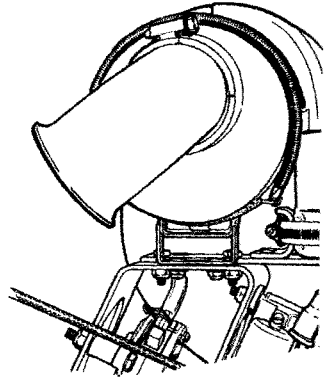

▼ **CAUTION:** Never operate your snowmobile with the air intake silencer disconnected. Serious engine damage will occur if this notice is disregarded.

### Slide Suspension

During normal driving, snow will act as a lubricant and coolant for the slider shoes. Extensive riding on ice or sanded snow, (not to mention dirt, asphalt, etc. never recommended) will create excessive heat build-up and cause premature slider shoe wear.

# LUBRICATION

## Frequency

Routine maintenance is necessary for all mechanized products, and the snowmobile is no exception. A weekly vehicle inspection contributes to the life span of the snowmobile as well as retain safe and trouble-free operation. It is recommended that the steering system and suspension, be lubricated monthly or every 40 hours of operation. If the vehicle is operated in wet snow or in severe conditions these items should be lubricated more frequently.

◆ **WARNING:** Only perform such procedures as detailed in this manual. It is recommended that dealer assistance be periodically obtained on other components / systems not covered in this manual. Unless otherwise specified, engine should be turned OFF for all lubrication and maintenance procedures.

## Pulley Guard Removal

◆ **WARNING:** Engine should be running only when pulley guards are secured in place.

Tilt cab. To tilt drive pulley guard remove clip and unscrew wing nut (A).

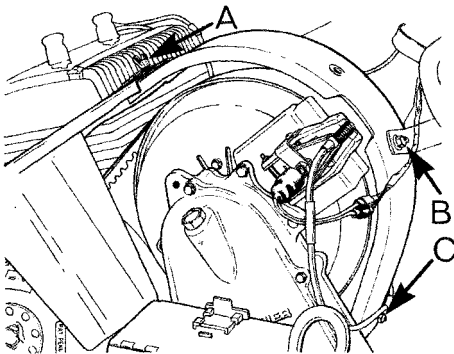

If necessary to remove driven pulley guard remove nuts (B) and (C).

## Drive Belt Removal

◆ **WARNING:** Never start or run engine without drive belt installed. Running an unloaded engine is dangerous.

1. Tilt cab and pulley guard, unlock and raise driven pulley support.

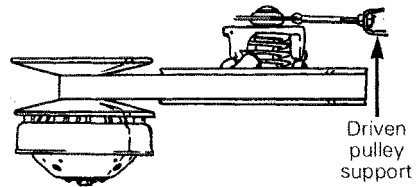

2. Open the driven pulley by twisting and pushing the sliding half. Hold in fully open position.

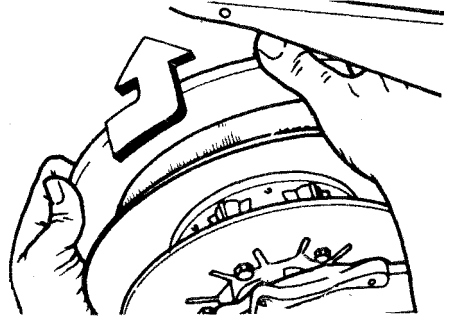

3. Slip slackened belt over the top edge of the sliding half.

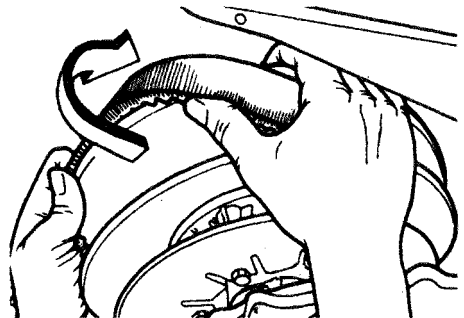

4. Slip the belt out from the drive pulley and remove completely from vehicle. To install drive belt, reverse procedure.

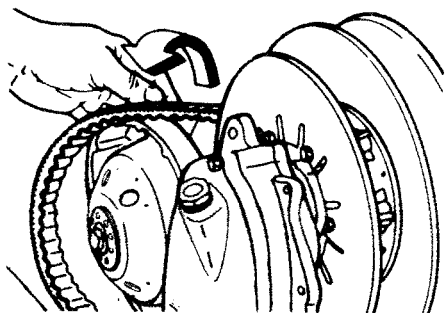

### Steering Mechanism

Lubricate ski legs at grease fittings until new grease appears at joints. Oil ski leg / coupler bolts.

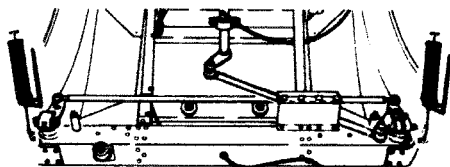

**CAUTION:** Do not lubricate throttle and/or brake cable housings.

### Chaincase Oil Level

Using the spark plug socket, remove the filler cap then using a rigid wire as a "dipstick" check oil level. The oil level on the "dipstick" should be 75-90 mm (3" to 3½"). Replenish as necessary.

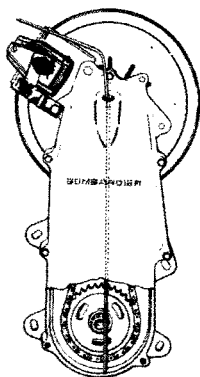

○ **NOTE:** The chaincase oil capacity is approximately 250 ml (9 oz.).

### Slide Suspension

Using a low pressure grease gun, lubricate the idler wheels with low temperature grease. Pump 3 to 4 times through the grease fitting located on each cap of idler wheel. Wipe off excess.

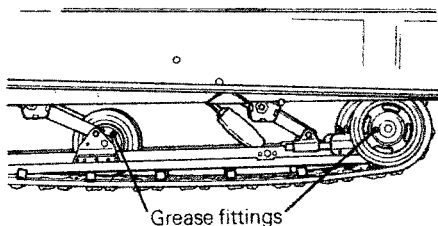

### Rotary Valve System

Check reservoir oil level frequently. Level should not be below level line of plastic reservoir. If necessary replenish to oil level line using "Castrol Injector Oil" or equivalent available from your dealer.

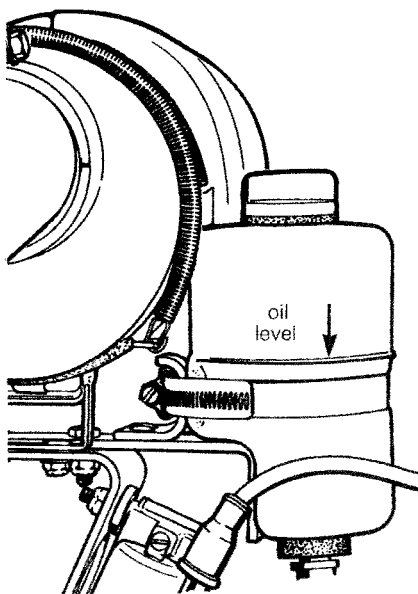

# MAINTENANCE

The following Maintenance Chart indicates regular servicing schedules to be performed by you or your servicing dealer. If these services are performed as suggested, your snowmobile will give you many years of low-cost use.

◆ **WARNING:** Only perform such procedures as detailed in this manual. It is recommended that dealer assistance be periodically obtained on other components / systems not covered in this manual. Unless otherwise specified, engine should be turned OFF for all lubrication and maintenance procedures.

Code	Weekly	Page
W1	Spark plugs	12
W2	Suspension (condition)	12
W3	Track	12
W4	Suspension (adjustment)	13
W5	Carburetor adjustment	14
W6	Drive belt	14
W7	Steering mechanism	14

  

Code	Monthly	Page
M1	Brake	14
M2	Steering adjustment	14
M3	Engine head nuts	15
M4	Engine mount nuts	15
M5	Exhaust system	15
M6	Vehicle general inspection Headlamp adjustment	15

## (W1) Spark Plugs

Disconnect spark plug wires and remove spark plugs. Check condition of plugs.

- A brownish tip reflects ideal conditions (correct carburetor adjustment, spark plug heat range, etc.).
- A black insulator tip indicates fouling caused by: carburetor idle speed mixture and / or high speed mixture too rich, incorrect fuel mixing ratio, wrong type of spark plug (heat range), or excessive idling.
- A light grey insulator tip indicates a lean mixture caused by: carburetor high speed mixture adjusted too lean, wrong spark plug heat range, incorrect fuel mixture ratio, or a leaking seal or gasket.

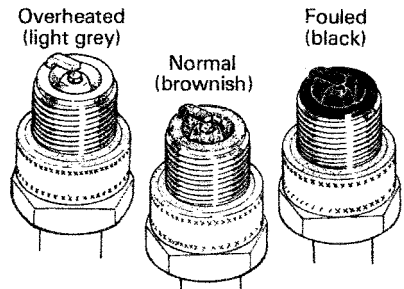

▼ **CAUTION:** If spark plug condition is not ideal, contact your dealer.

Check spark plug gap using a wire feeler gauge. Gap must be 0.50 mm (.020"). Reinstall plugs and connect wires.

## (W2) Suspension (condition)

Visually inspect suspension springs. Replace any weak or broken spring. Inspect shoe condition of slide suspension and replace as necessary.

## (W3) Track

With rear of vehicle off the ground, rotate track and inspect condition. Check for bad cuts, missing inserts or track guides. If bad cuts, missing or defective inserts or guides are noted, contact your dealer.

**WARNING:** Do not operate a snowmobile with a cut, torn, or damage track.

#### (W4) Suspension (adjustment)

The suspension is adjustable, the front adjustment for surface condition, the rear for driver's weight.

When the front adjuster blocks are at the lowest elevation more weight is distributed on skis. At the highest position the weight is transferred from the skis to the track. The rear adjuster blocks should be adjusted to suit the driver's preference. (The spark plug socket is an ideal tool to turn adjuster blocks).

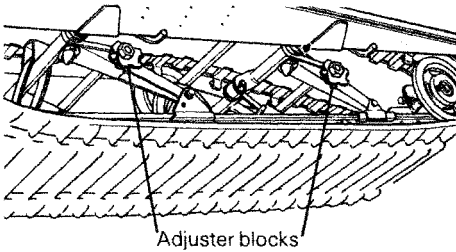

**CAUTION:** Always turn left side adjuster blocks in a clockwise direction, the right side blocks in a counter-clockwise direction. Left and right adjuster blocks of each adjustment must always be set at the same elevation.

#### Tension

Lift rear of vehicle and support with a mechanical stand. Allow slide to extend normally. A gap of 19 mm ( $\frac{3}{4}$ "') should exist between slider shoe and bottom inside of track. If track tension is too loose, the track will have a tendency to thump.

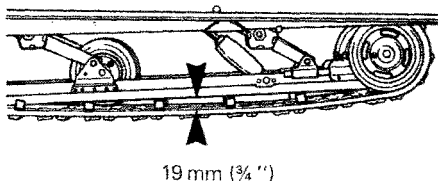

**CAUTION:** Too much tension will result in power loss and excessive stresses on suspension components.

If necessary to adjust, loosen or tighten adjuster bolts located on inner side of rear idler wheels. If correct tension is unobtainable, contact your dealer.

**NOTE:** Track tension and alignment are inter-related. Do not adjust one without the other.

#### Alignment

Start the engine and accelerate slightly so that track turns **slowly**. Check that track is well centered and turns evenly.

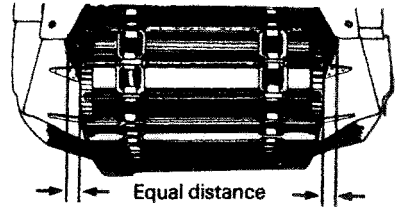

To correct, stop engine then loosen the lock nuts and tighten the adjuster bolt on side where track is closest to the frame. Tighten lock nuts and recheck alignment.

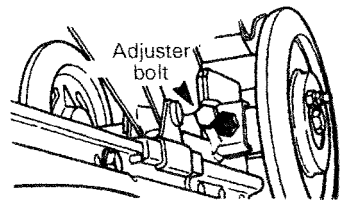

**WARNING:** Before checking track alignment, ensure that the track is free of all particles which could be thrown out while track is rotating. Keep hands, tools, feet and clothing clear of track.

## (W5) Carburetor Adjustment

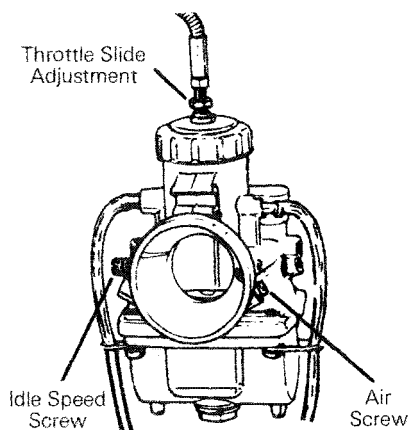

### Air Screw Adjustment

Completely close the air screw (of each carburetor) until a slight seating resistance is felt then back off 1 turn.

### Throttle Slide Adjustment

Completely open (counter-clockwise) the idle speed screw (of each carburetor). Unlock cables adjuster lock nuts then adjust the throttle cables to remove all slack and to synchronize the two throttle slides when operating throttle control lever. Lock cables adjusters in position by tightening the adjusters lock nuts.

### Idle Speed Adjustment

Turn idle speed screw (of each carburetor) clockwise until it contacts the throttle slide then continue turning two (2) additional turns. This will provide a preliminary idle speed setting. Start engine and allow it to warm then adjust idle speed to 3000-3200 RPM by turning idle speed screws clockwise or counter-clockwise.

**CAUTION:** Do not attempt to set the idle speed by using the air screws. Severe engine damage can occur.

## (W6) Drive Belt

If belt is less than 30 mm (1 1/4") wide, replace. Check condition of belt. Inspect for cracks, fraying or abnormal wear, (uneven wear, wear on one side, etc.). If abnormal wear is noted, probable cause is pulley misalignment.

**NOTE:** When installing a new drive belt, a break-in period of 15-25 km (10-15 miles) is strongly recommended.

## (W7) Steering Mechanism

Inspect steering mechanism for tightness of components (steering arms, tie rods, ball joints, spring coupler bolts, etc.). If necessary, replace or retighten.

Check condition of skis and ski runners. Replace if worn.

## (M1) Brake

The brake mechanism is self-adjusting, therefore, periodic adjustment is not required. However, the brake mechanism can be checked by depressing brake control lever. Brake should apply fully when lever is 13 mm (1/2") approx. from handlebar grip. If it does not, do not tamper with the brake, contact your servicing dealer. Check the stop light to see if it functions. If necessary, readjust switch position.

**WARNING:** Brake pucks less than 5 mm (3/16") must be replaced. Replacement must be performed by an authorized dealer. Always check the stop light to see if it functions.

## (M2) Steering Adjustment

Skis should have a toe out of 3 mm (1/8"). To check, measure distance between skis at front and rear of leaf springs. If necessary to adjust:

Using a wrench, loosen the lock nuts of the longer tie rod.

Turn tie rod manually until skis are properly aligned.

Firmly retighten lock nuts.



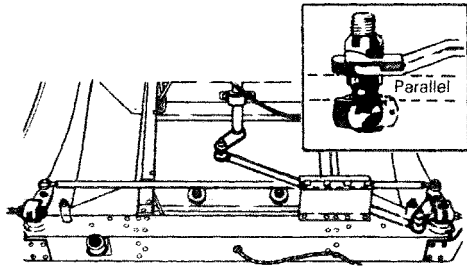

Handlebar should also be horizontal when the skis are pointed toward front.

To adjust:

Using a wrench, loosen the lock nuts of the shorter tie rod.

Turn tie rod manually until handlebar is horizontal.

Retighten lock nuts firmly.

**WARNING:** The ball joint socket must run parallel with the steering arm. The socket must be restrained when tightening the tie rod end lock nuts.

### (M3) Engine Head Nuts

After the first 5 hours of operation, check that engine head nuts are tight and equally torqued to 1.5-1.8 kg-m (11-13 ft-lbs) when cold.

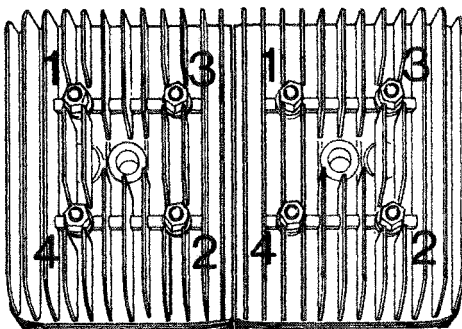

### (M4) Engine Mount Nuts

Check engine mount nuts for tightness. Retighten if necessary.

### (M5) Exhaust System

The engine / exhaust system parts are vital toward efficient muffler function. Check all attachments. Replace springs and / or tighten if necessary.

**CAUTION:** Do not operate vehicle with muffler disconnected (at the end of the two tuned exhaust) otherwise serious engine damage will occur.

### (M6) Vehicle General Inspection

Check electrical wiring and components, retighten loose connections. Check for stripped wires or damaged insulation. Thoroughly inspect the vehicle and tighten loose bolts, nuts and linkage. Inspect skis and ski runners for wear.

### Headlamp

The angle of the headlamp beam has been pre-adjusted prior to delivery. Should you wish re-adjustment, place vehicle on a flat surface, 7.6 meter (25 feet) from a wall or screen. Turn HI beam on (engine must be running). Beam aiming is correct when beam center is equal with a horizontal beam line, within a maximum horizontal deviation of 50 mm (2") and a maximum vertical deviation of 25 mm (1").

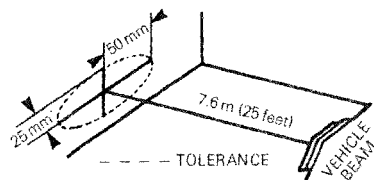

Remove chrome ring then turn upper or lower adjustment screws to obtain specified beam position.

### Bulb Replacement

If headlamp is burnt, tilt cab. Unplug connector from headlamp. Remove rubber boot and unfasten bulb retainer clips. Detach bulb and replace. If taillight bulb is burnt, expose bulb by removing red plastic lens. To remove, unscrew the two (2) Phillips head screws. Verify all lights after replacement.

# TROUBLE SHOOTING

SYMPTOMS	POSSIBLE CAUSES	WHAT TO DO
<p>Engine turns over but fails to start or starts with difficulty</p>	<p>1. No fuel to the engine</p>	<p>Check the tank level and fill up with correct gas-oil mixture. Check for possible clogging of fuel, item 5.</p>
	<p>2. Spark plug</p>	<p>Check for fouled or defective spark plug. Disconnect spark plug wire, unscrew plug and remove from cylinder head. Reconnect wire and ground exposed plug on engine, being careful to hold away from spark plug hole. Follow engine starting procedure and check for spark. If no sparks appear, replace spark plug. If trouble persists, check item 3.</p>
	<p>3. Faulty ignition</p>	<p>Disconnect spark plug wire from plug, unscrew the spark plug cap then hold wire about 3 mm ( 1/8") from the cylinder head. Follow engine starting procedure and if no sparks appear, it means a faulty ignition system. Do not attempt to repair. Contact your dealer.</p>
	<p>4. Flooded engine</p>	<p>Remove wet spark plugs, turn ignition to OFF and crank engine several times. Install clean dry spark plugs. Start engine following usual starting procedure. If engine continues to flood, see your dealer.</p>
	<p>5. Clogged fuel line (water or dirt)</p>	<p>Remove and clean the fuel filter. Change filter cartridge if necessary. Check condition and connections of fuel lines. Check the cleanliness of fuel tank.</p>
	<p>6. Faulty carburetor</p>	<p>First make primary adjustments on carburetor (See Maintenance Section). If carburetor is still faulty, contact your dealer for repair.</p>
	<p>7. Too much oil in fuel</p>	<p>Drain the fuel tank and refill with the correct gas / oil mixture.</p>
	<p>8. Engine timing</p>	<p>Engine timing may be defective or out of adjustment. Contact your dealer.</p>
	<p>9. Poor engine compression</p>	<p>Running with a lean fuel mixture may produce excessive engine wear resulting in poor engine compression. If this occurs, contact your dealer at once.</p>
<p>Engine will not turn manually</p>	<p>1. Seized engine</p>	<p>In the case of a seized engine contact your dealer. Seizure is a direct result of poor lubrication.</p>

<b>SYMPTOMS</b>	<b>POSSIBLE CAUSES</b>	<b>WHAT TO DO</b>
Engine lacks acceleration or power	1. Fouled or defective spark plug	Check item 2 of "Engine turns over but fails to start or starts with difficulty".
	2. Clogged fuel line (water or dirt)	Check fuel line condition. (See item 5 of "Engine turns over but fails to start or starts with difficulty".)
	3. Carburetor	Readjust the carburetors. (See Maintenance section). If trouble persists, contact your dealer.
	4. Faulty ignition	First check item 2 and 3 of "Engine turns over but fails to start or starts with difficulty". If the ignition system still seems faulty, contact your dealer.
	5. Engine	If unable to locate specific symptoms, contact your dealer.
Engine continually backfires	1. Faulty spark plug	Check item 2 of "Engine turns over but fails to start or starts with difficulty".
	2. Overheated	Carburetors set too lean. Contact your dealer.
	3. Engine timing incorrectly set	Contact your dealer.
Snowmobile cannot reach full speed	1. Drive belt	Check for damaged or worn drive belt. Replace if necessary.
	2. Incorrect track adjustment	Check track tension and alignment. Readjust to specifications. (See Maintenance section).
	3. Faulty engine	Check item 1 to 5 of "Engine lacks acceleration or power".
	4. Pulley misaligned	Contact your dealer.

## STORAGE

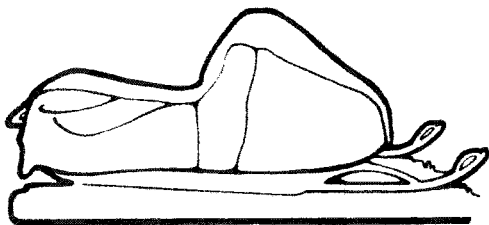

**IMPORTANT:** It is during summer, or when a vehicle is not in use for any length of time that proper storage is a necessity. **Storage of the snowmobile during long periods of inactivity consists of checking and replacing missing broken or worn parts; proper lubrication and treatments to insure that parts do not become rusted;** cleaning items such as carburetor of oil mixtures, to prevent gum varnish formation within the carburetor; and in general, preparing the vehicle so that when the time comes to use the snowmobile again it will start and be in top condition.

◆ **WARNING:** Only perform such procedures as detailed in this manual. It is recommended that dealer assistance be periodically obtained on other components / systems not covered in this manual. Unless otherwise specified, engine should be turned OFF for all lubrication and maintenance procedures.

### Track

Inspect track for cuts, missing track guides and broken rods. Make any necessary replacement. Lift rear of vehicle until track is clear of ground then support with brace or trestle. The snowmobile should be stored in such a way that track does not stay in contact with cement floor or bare ground.

○ **NOTE:** The track should be rotated periodically, (every 40 days). Do not release track tension.

### Slide Suspension

Remove any dirt or rust. Grease idler wheels at grease fittings. Wipe off surplus. Replace worn slider shoes.

### Ski Assembly

Wash or brush all dirt or rust accumulation from skis and springs. Grease ski legs at grease fittings. Check condition of skis, ski runners and leaf springs. Replace if worn or weak.

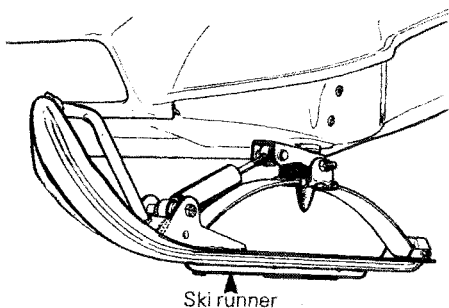

Apply metal protector on ski assembly. If unavailable, wipe the entire ski with cloth soaked in oil to prevent rust formation.

## Fuel Tank

Remove cap then using a syphon, remove gasoline from tank.

◆ **WARNING:** Gasoline is flammable and explosive under certain conditions. Always perform procedures in a well ventilated area. Do not smoke or allow open flames or sparks in the vicinity.

## Carburetor

The carburetors must be dried out completely to prevent gum formation during the storage period.

Assure that inlet fuel line is disconnected.

Remove plug of the float chamber of each carburetor. Drain carburetors.

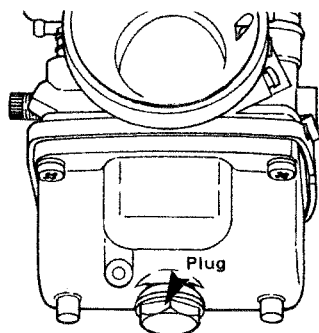

Reinstall plug and connect fuel line.

## Cylinder Lubrication

Engine internal parts must be lubricated to protect cylinder walls from possible rust formation during the storage period.

○ **NOTE:** This operation should be repeated every 40 days during storage.

Remove spark plugs. Operate rewind starter to bring piston at top position. Pour the equivalent of one spoonful of oil into spark plug hole.

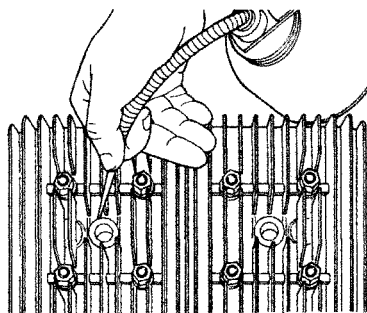

Slowly crank engine several times using manual starter. Repeat above steps for other cylinder. Install spark plugs.

▼ **CAUTION:** To prevent ignition system damage, make sure that the cut-out button is in the lower position.

## Drive Pulley

Inspection and cleaning should be performed by the dealer every 100 operating hours or at the end of each season, whichever occurs first.

**IMPORTANT:** The drive pulley assembly will be excluded from warranty, if the factory seal is broken by other than a duly authorized representative of Bombardier.

## Chaincase

Drain the chaincase completely and re-fill to proper level using fresh chaincase oil. To drain, remove chaincase cover.

## Controls

Lubricate steering mechanism. Inspect components for tightness, (spring coupler bolts, steering arm locking bolts, tie rods, ball joints, etc.). Tighten if necessary. Oil moving joints of brake mechanism.

◆ **WARNING:** Do not lubricate throttle and / or brake cable housing. Avoid getting oil on brake pads.

Coat electrical connections and switches with a greaseless metal protector. If unavailable, use petroleum jelly.

## Chassis

Clean the vehicle thoroughly, removing all dirt and grease accumulation.

▼ **CAUTION:** Plastic alloy components such as fuel tank, windshield, etc., can be cleaned using mild detergents or isopropyl alcohol. Do not use strong soaps, degreasing solvents, abrasive cleaners, paint thinners, etc.

Inspect cab and repair damage. Repair kits are available at your authorized dealer. Clean frame. (Use only "Aluminum cleaner" and follow instructions on container).

Touch up all metal spots where paint has been scratched off. Spray all bare metal parts of vehicle with metal protector. Wax the cab for better protection.

○ **NOTE:** Apply wax on glossy finish of cab only. Protect the vehicle with a cover to prevent dust accumulation during storage.

▼ **CAUTION:** If for some reason the snowmobile has to be stored outside it is necessary to cover it with an opaque tarpaulin. This caution will prevent the sun rays affecting the plastic components and the vehicle finish.

## General Inspection

Check electrical wiring and components, retighten loose connections. Check for stripped wires or damaged insulation.

Thoroughly inspect the vehicle and tighten loose bolts, nuts and linkage.

○ **NOTE:** Leave drive belt off pulleys for the entire storage period.

# PRE-SEASON PREPARATION

Snow is falling and you are now anticipating the next snowmobile safari. If you have observed and adhered to the storage procedures outlined in this manual, your vehicle preparation becomes a relatively easy task.

To simplify the pre-season preparation we have drawn up a small chart. **The chart indicates servicing points to be performed by you and your servicing dealer.** If these services are performed as suggested, your vehicle will give you many hours of fun and low cost use.

**IMPORTANT:** Observe all Warnings and Cautions mentioned throughout this manual which are pertinent to the item being checked. When component conditions seem less than satisfactory, replace with genuine Bombardier parts.

## PRE-SEASON PREPARATION CHART

To be performed by dealer ●	
To be performed by owner ○	
Change spark plugs	○
Check chaincase oil level	○
Check drive pulley and clean	●
Check ski alignment	○
Replace fuel filter	○
Connect fuel lines and check attaching points	○
Check track tension and alignment	○
Lubricate suspension	○
Inspect drive belt and install	○
Check throttle cable for damage and free operation	○
Inspect brake condition and operation	○
Inspect oil seals for possible cuts or leaks	●
Check engine timing	●
Check electrical wiring (broken wire, damaged insulation)	○
Inspect condition of starting rope	○
Check tightness of all bolts, nuts and linkage	○
Refill gas tank	○
Adjust carburetors	●
Check oil level of rotary valve reservoir	○

# SPECIFICATIONS

<b>RV 340</b>	
<b>Engine</b>	Numbers of cylinders 2 Bore 63 mm (2.480") Stroke 54 mm (2.126") Displacement 336.7 cc (20.5 in <sup>3</sup> ) Compression ratio 12.5 Carb. (Mikuni) 2 x VM 34 Starting Manual Overall length 271.8 cm (107") Overall width 106 cm (41 3/4") Overall height 83.8 cm (33") Dry weight 156.5 kg (345 lbs) Bearing area 7032 cm <sup>2</sup> (1090 in <sup>2</sup> ) Ground pressure 22.25 g / cm <sup>2</sup> (316 lb / in <sup>2</sup> ) Track width 38 cm (15") Std gear ratio 18 / 38 Lighting system (output) 140 W Headlamp 60 / 60 W Tail / brake light 5 / 21 W Spark plug (Bosch) W 280 MZ 2 Spark plug gap 0.50 mm (.020") Ignition timing 1 mm (.039") Between marks at 6000 RPM Tank capacity — S.I.* 20 liters — Imp. gals. 4.5 — U.S. gals. 5.5 Gasoline Premium Gas / oil ratio 50 / 1 Type Disc self-adjusting
<b>Chassis</b>	
<b>Power Train</b>	
<b>Electrical System</b>	
<b>Fuel</b>	
<b>Brake</b>	

\* International System

*All information, illustration and component / system description contained in this manual are correct at the time of publication. However, Bombardier Limited reserves the right to make changes in design and specifications and / or to make additions to, or improvements in its product without imposing any obligation upon itself them on its products previously manufactured.*