

ski-doo.

TNT

F/A



'73 Owner's Manual

*Trademark Bombardier Limited

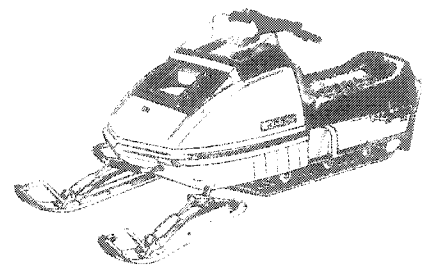
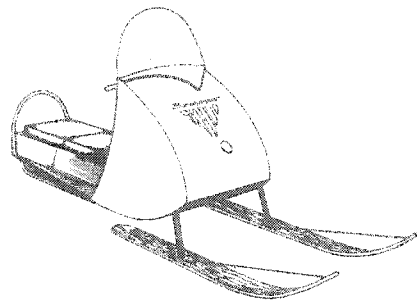

THE COMPANY THAT CHANGED WINTER HAS CHANGED

In 1957 and 1958, tests began on what is considered the forerunner of the Ski-Doo®. We experimented with many different frames and engines—in search of a light machine for one or two passengers. By the fall of '58, the first prototype was ready. Initial tests made it obvious the machine could hold its own in the recreation market. Production began one year later and 225 machines were sold at about \$1,000 each.

Like its predecessors the '73 Ski-Doo snowmobile is a combination of lightness, economy, strength and dependability. And yet, with all this, it has one other additional feature . . . personality.

Each model in each series has a complexity of characteristics that distinguishes itself as part of a bold breed . . . **the Ski-Doo snowmobiles.**

At Bombardier, we fully realize that the purchase of a snowmobile is a very important decision. For this reason, we have ensured that each Ski-Doo snowmobile is backed up by an international Ski-Doo Distributor and Dealer Network whose factory trained personnel are equipped to give you prompt and efficient service wherever you are in Snow Country.

Furthermore, each dealer is prepared to serve you with information, parts and accessories. Feel free to contact him.

At this time we would like to thank you for your patronage and welcome you to Winter. Enjoy yourself but remember: Safety depends on you, the driver, the condition of your vehicle and nature of the terrain.

All of the information, illustrations and component/system descriptions contained in this manual are correct at the time of publication. However, Bombardier Limited reserves the right to make changes in design and specifications, and/or to make additions to or improvements in its products without imposing any obligations upon itself to install them on its products previously manufactured.

This manual has been published by the Technical Information Centre, Bombardier Limited, 8600 Decarie Blvd., Montreal 307, Quebec, Canada.

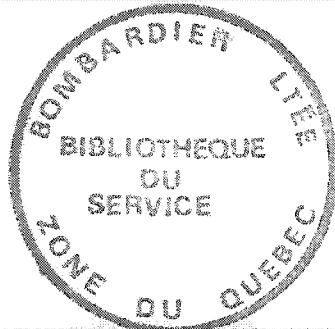

INDEX

*The following are trade marks of Bombardier Limited.

Ski-Doo	Valmont	Skandic
Ski-Boose	T'NT	Carry-Boose
Nordic	Élan	Bombardier
Alpine	Blizzard	

PATENTS and DESIGNS

This vehicle is covered by one or more of the following patents and design registrations.

Canadian Patents: 605,317 - 710,592 - 724,395 - 853,605.

United States Patents: 2,899,242 - 3,066,546 - 3,536,153

Canadian Designs: DI/217 F/28172 - DI/249 F/31317 and '316 - D32,479 - D32,535 - D32,655 to '657 - D32,661 to '669 - 33,982 - 33,933 - 34,006 and '007.

United States Design Patents:

Des. 221,332 to '334 -

Des. 221,637 and '638 -

Des. 222,244 to '247.

Others: Swedish Design No. 6038 -

Swiss Design No. 104,756 -

Norwegian Design No. 51,444.

WHAT YOU SHOULD KNOW

BEFORE FIRST RIDE..... 2

SERVICE AREAS 3

DO'S 4

DONT'S 5

GOOD DRIVING TECHNIQUE... 6, 7

CONTROLS / INSTRUMENTS 8, 9

FUEL MIXING 10, 11

**BREAK-IN PERIOD,
PRE-START CHECK 12, 13**

IN CASE OF EMERGENCY 13

STARTING PROCEDURE 14

LUBRICATION 15, 16, 17

MAINTENANCE 18, 19, 20, 21, 22

EMERGENCY GUIDE 23

TROUBLE SHOOTING 24, 25

OFF SEASON STORAGE... 26, 27, 28

PRE SEASON PREPARATION 29

SPECIFICATIONS 30, 31

WARRANTY 32



WHAT YOU SHOULD KNOW . . . before first ride.

To many of us, Winter is a revealing experience. Weather, atmospheric conditions, snow surfaces, individual driving habits and vehicle usage have considerable affects. We ask that you familiarize yourself with them . . . **read** the owner's manual; it has been prepared to acquaint you with the operation of your vehicle, its safety aspects and systems as well as preventative maintenance procedures that must be periodically upheld . . . all aimed toward a more enjoyable Winter season.

Observe the following precautions:

- Throttle mechanism should be checked for free movement **before** starting engine.
- Engine should be running **only when** pulley guard is secured in place.
- **Never** run engine without drive belt installed. Running an unloaded engine

can prove to be dangerous.

- **Never** run the engine at high R.P.M. when the track of the vehicle is raised off the ground.
- It can be dangerous to run engine with the **cab open**.
- Prolonged sitting while riding over rough terrain may cause kidney and/or spinal discomfort, specially for the driver or passenger having an existing back weakness.
- Gasoline is flammable and explosive under certain conditions. Always perform procedures in a well ventilated area. Do not smoke or allow open flames or sparks in the vicinity. If gasoline fumes are noticed while driving, the cause should be determined and corrected without delay.
- **Under no circumstances** should you wear loose clothing or scarves that

could become entangled with moving parts of your snowmobile.

- Your snowmobile **is not** designed to be operated on public streets, roads or highways. In most States and Provincoes, it is considered an **illegal** operation.
 - Hidden telephone guy wires or roadside ditches can cause serious **accidents**.
 - Your snowmobile **is not** designed to be driven or operated on black top, bare earth, or other abrasive surfaces. Abnormal and excessive wear of critical parts is inevitable.
 - **Always** wear an approved snowmobile safety helmet. Be informed on local laws legislating the sport.
 - Maintain your vehicle in top mechanical condition at all times.
- Please read and understand all other warnings contained elsewhere in this manual.**

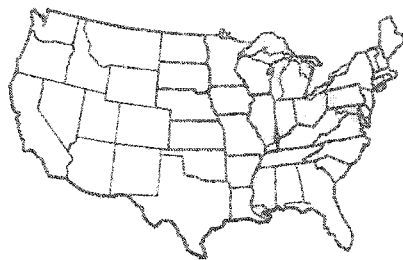

We recommend you contact your local Authorized Ski-Doo dealer when your Ski-Doo snowmobile requires service. However, for further inquiries, you may contact your Regional Distributor listed below.

SERVICE AREAS

CANADIAN DISTRIBUTORS

Name of Distributors	Coverage Area
ALPINE DISTRIBUTORS 3206 - 28th Ave., Vernon, B.C.	British Columbia
ATLANTIC SKI-DOO LTD. P.O. Box 670, Shediac, N.B.	Prince Edward Island Magdalen Island Nova Scotia New Brunswick
BOMBARDIER ONTARIO LTD. 28 Currie St., Barrie, Ont.	Ontario
BOMBARDIER QUE. LTD. 1350 Nobel St. Boucherville, Que.	Quebec
BROOKS EQUIPMENT LTD. Box 985, Winnipeg 21, Man.	Manitoba Saskatchewan
HUDSON'S BAY CO 121 Richmond W. Toronto, Ont.	North-West Territories
J. W. RANDALL LTD. P.O. Box 757, Corner Brook, Newfoundland	Newfoundland
TRACT EQUIPMENT LTD. 14325 - 114th Ave., Edmonton, Alta.	Yukon Alberta

AMERICAN DISTRIBUTORS

Name of Distributors	Coverage Area
BOMBARDIER EAST INC. Railroad St., Lee, Massachusetts 01238	Massachusetts Connecticut Rhoda Island
BOMBARDIER WEST INC. 609 West Broadway, Idaho Falls, Idaho 83401	California New Mexico Nevada Arizona Montana Kansas Idaho Nebraska Wyoming Washington Utah Oregon Colorado
CRAIG TAYLOR EQUIPMENT CO P.O. Box 3338, Anchorage, Alaska 99501	Alaska
ELLIOTT & HUTCHINS INC. East Main Street Road, Melrose, New York 12953	New York Pennsylvania New Jersey Maryland Delaware District of Columbia Virginia

HALVORSON INCORPORATED 325 South Lake Avenue, Duluth 2, Minn. 55802	North Dakota South Dakota Minnesota Wisconsin Iowa Illinois Missouri Upper Michigan
HEATH INTERNATIONAL INC. 33737 - 32 Mile Road, Richmond, Mich. 48062	Lower Michigan Indiana Ohio Tennessee Kentucky W. Virginia
TIMBERLAND MACHINES INC 10 Main St. North, Lancaster, New Hampshire 03584	Maine New Hampshire Vermont

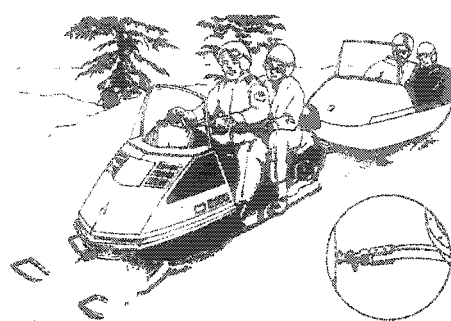
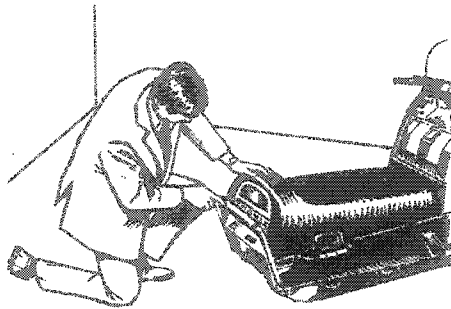

DO'S

- Register your Ski-Doo snowmobile at your nearest Licensing Bureau, where State or Provincial Laws require it, and affix Registration Plate to the vehicle. Carry your registration certificate with you. It provides proof of ownership in the event that the vehicle becomes lost or stolen.
- Obtain your State or Provincial booklet on snowmobiling. It gives valuable information on the neighbouring snowmobile trails and the laws governing snowmobiling in your particular area.
- Observe all posted snowmobile signs. Not all private landowners allow snowmobiling on their property. You can have just as much fun, even more so, by traveling elsewhere.
- When with others, limit your actions to the experience of the main body. Show the inexperienced driver how to properly handle a snowmobile.
- Always travel with at least one other snowmobile, especially in unfamiliar terrain or on trail rides. Even in snowmobiling, a pair beats one of a kind.
- If you are planning to explore new areas, leave word of your approximate whereabouts and estimated time of return with someone.
- Always make a full stop then look carefully in both directions before crossing roads. When traveling in pairs or in a group, have one member direct the others across singly.
- When trailering your Ski-Doo snowmobile, secure it solidly at both ends, protect it with a bright cover (Ski-Doo® cover) then check that trailer hitch and safety chain are secure and that brake, flashers, position and parking lights are all in working order.

*Trademark Bombardier Limited

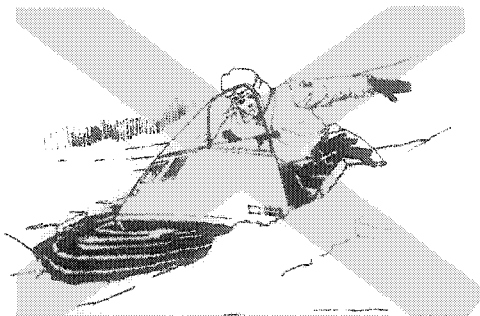
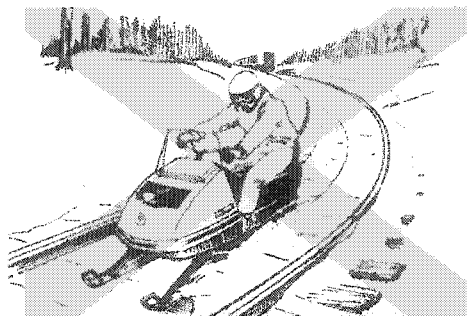

DON'TS

- Don't cut across in front of the line of travel of another snowmobile. Don't tailgate; collision, or the threat of it, is serious with any moving vehicle.
- Don't risk injury or damage to your machine with needless and foolish stunting. Don't "jump" your snowmobile. This part of snowmobiling should be left to the professional "stunt" men.
- **Never** ride on railway tracks. The sound of your moving vehicle drown out noise of approaching trains. Your vehicle may also become caught in track junctions. In many States and Provinces snowmobiling on railway tracks constitutes an infraction of the law.
- Never cut through fences or attempt to run over them.

- Don't cross a river or lake without first being positive that the thickness of the ice is sufficient to support both you and your vehicle. **Your life may depend on it.** If at all in doubt, take an alternate route.
- Unless you are certain of a fueling stop, never travel further than $\frac{1}{2}$ of the fuel remaining in your tank. Even then, leave yourself a safety margin. Remember that a snowmobile does not necessarily travel the same distance each time on the same amount of fuel. A lot depends on speed, snow conditions of the trail and adjustment of the carburetor.
- Don't drive your snowmobile in the vicinity of skiers and keep off ski trails. Always respect the rights of those who enjoy winter in another way.

- **"If you drink don't snowmobile! If you snowmobile, don't drink!"** Remember alcohol and gasoline don't mix.
- Don't lend your snowmobile to inexperienced or under-age drivers. In many cases it is the vehicle owner and not the rider that is responsible for mishaps. Check State or Provincial minimum age limits for drivers.
- Don't get hands or feet in track or moving parts. If your vehicle gets "bogged" down, stand to one side, squeeze the throttle lightly, lift the rear grab handle, and walk out the machine.

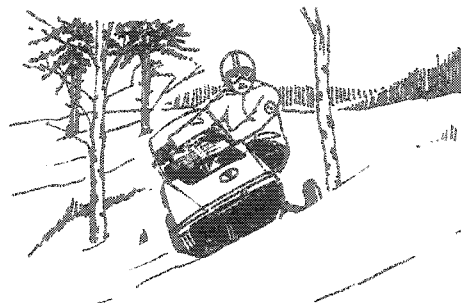
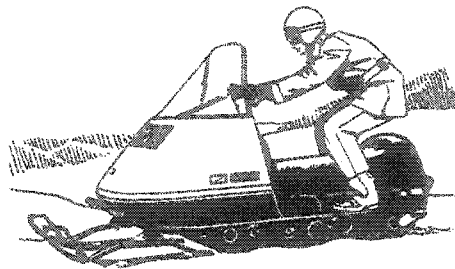

GOOD DRIVING TECHNIQUE

Everyone knows, or should know, the difference between a good snowmobiler and a poor one. Most beginners think that snowmobiling is just a matter of starting the engine and riding away. It's not so. There are right and wrong ways to go about it. Here are some of the preferred methods.

Tips

Where possible, enter a snowmobile training program. Thoroughly know your vehicle and how to drive it before attempting difficult or rapid manoeuvres.

Driving Positions.

There are three driving positions on a snowmobile—Standing, Kneeling or Sitting. Each presents certain advantages depending on the nature of the terrain, snow conditions, the turns you desire or the personal preference of the driver.

Standing—This position is undoubtedly the best for climbing steep hills, traveling a short stretch of bumpy trail or when manoeuvring in deep snow. In this position, however, always keep your knees slightly flexed to absorb surface shocks.

Kneeling—crossing a steep slope, for example, from side to side, you will find the kneeling position a definite advantage. Place one foot on the footboard (on the high side of the hill), the opposite knee on the seat then lean into the hill.

Warning: Side hills and steep slopes are not recommended for a beginner.

An alternate recommended kneeling position and one that is frequently used, is to place both knees on the seat, with one foot on each side, loosely pressing against the seat.

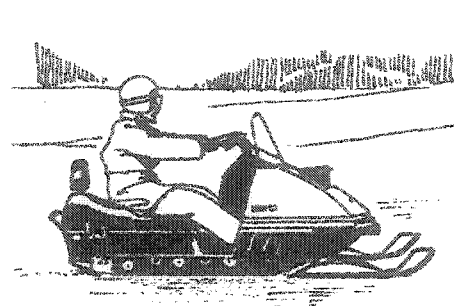
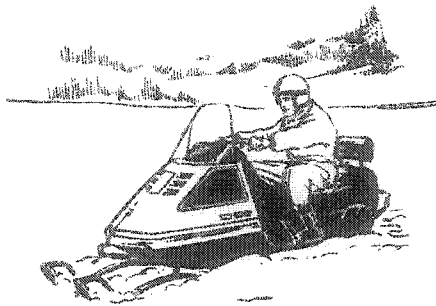

Sitting—for all normal driving. Feet should be on the footboards, body mid-way back on the seat. **Avoid** placing your foot inside the support braces of the footboard.

Warning: Prolonged sitting while riding over rough terrain may cause kidney and/or spinal discomfort, specially for the driver or passenger having an existing back weakness.

Turning.

To snowmobile properly you must learn to "body english", (using the weight or position of your body). Shifting to left or right as the turn demands and keeping your center of gravity as low as possible will give you the mark of an experienced snowmobiler.

Moving your body weight toward the front of the vehicle, particularly in hard-packed snow, adds pressure to the skis and ski runners so that they bite more deeply into the snow surface.

Icy Surface.

Ice or extremely hard-packed snow can be difficult to negotiate as both skis and track do not have much traction. Best advice is to slow down and avoid rapid acceleration or braking.

Deep Snow.

Use the standing position recommended earlier and if your vehicle continues to make reasonable headway, responding to light changes in acceleration, you are safe enough to explore new areas. If not, turn in as wide an arc as possible and look for firmer trails.

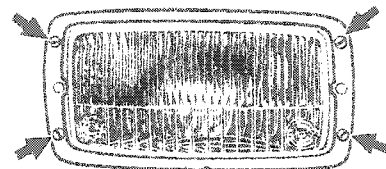
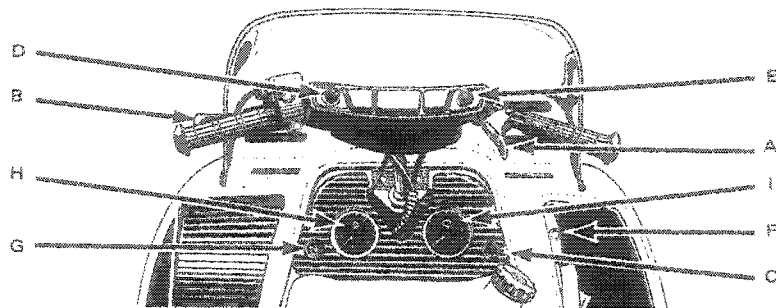

CONTROLS/INSTRUMENTS

Steering

Rotation of the handlebar causes a push-pull action on the steering linkage and forces the skis to turn in the required direction. Incorporated in the crash padded handlebar are the dimmer switch, kill button, brake and throttle levers.

Throttle Lever (A)

Located on right side of handlebar. When depressed, the lever controls the **engine speed** and the **engagement of the transmission**. When lever is released the engine speed returns automatically to **idle**.

Brake Lever (B)

Mounted on left side of handlebar, when applied activates the hydraulic disc system bringing the vehicle to a fast smooth stop.

Warning: It is strongly recommended that you familiarize yourself with the positive braking action of this system.

Light Switch (C)

A push-pull switch located on right of dash panel. With engine running, illuminates both headlamp and taillight. Pull fully out to illuminate.

Headlamp Dimmer Switch (D)

The dimmer switch, located on left side of handlebar, allows correct selection of headlamp beam. To obtain high or low beam simply depress switch.

Note: The angle of the headlamp beam had been pre-adjusted prior to delivery. Should you wish re-adjustment, remove headlamp chrome ring and turn upper or lower adjusting screws to obtain desired beam position.

Kill Button (E)

A push button switch located on right side of handlebar. To stop the engine, press button down into **lower** position. Before re-starting engine always depress button into released **upper** position. The driver of this vehicle should familiarize himself with the function of this device by using it several times on first outing, thereby being mentally prepared for emergency situations requiring its use.

Warning: If the button has been used in an emergency situation the source of malfunction should be determined and corrected before restarting engine.

Upper position
before starting
engine.

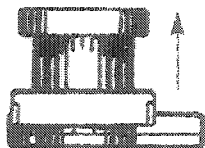

Lower position
to stop engine.

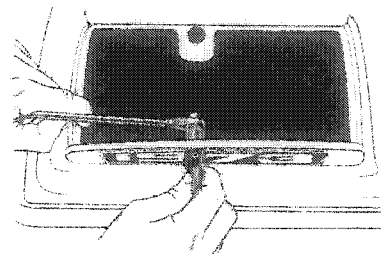
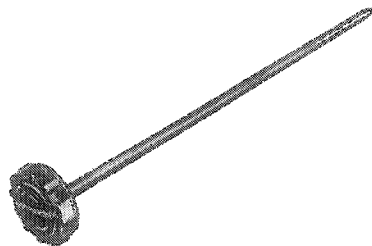
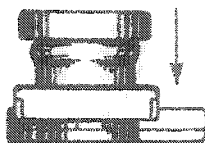

Manual Starter (F)

Auto-rewind type located at right side of console in cab recess. To start engine, pull handle. (See Starting Procedure).

Choke (G)

A push-pull button located on left of dashpanel. Pull button to engage choke, push to disengage. The choke should always be used for easier cold engine starts. After engine is warmed up, however, it is not necessary to use choke when starting.

Note: The purpose of the choke is to reduce the amount of air flowing through the carburetor, in effect enriching the air/fuel mixture. **Always** push choke knob to off, once engine has started. **Never** operate your vehicle with choke on.

Tachometer (H)

The tachometer registers the impulses of the magneto. Direct-reading dial indicates, in thousands, the number of revolutions per minute (R.P.M.) of the engine.

Speedometer (I) (Optional)

The speedometer is linked directly to the drive axle. Direct-reading dial indicates the speed of the vehicle in miles per hour (M.P.H.) 6 digit odometer records the number of miles travelled.

Fuel Gauge

To check fuel level, unscrew fuel tank cap and withdraw dipstick.

Cab Latches

For those procedures that require cab open, unlock latches on both sides where cab meets frame then lift cab gently up until stopped by restraining device.

Warning: It can be dangerous to run engine with cab open.

Rear Compartment

Recessed underseat compartment. Ideal location for spare plugs, belt, rope, etc. Pressure lock fastened. To adjust lock simply tighten or slacken adjusting nut.

Tips

Emergency items should be wrapped in foam or similar material. This will prevent possible breakage while traveling over rough or bumpy terrain.

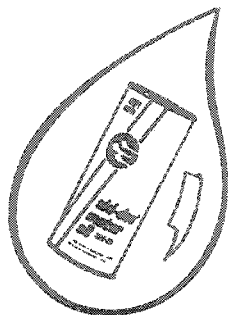
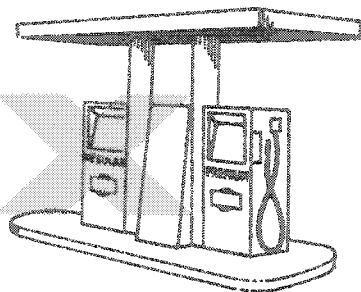

40:1

FUEL MIXING

With Ski-Doo snowmobiles, the **oil** must be added to the **gasoline** in pre-measured amounts then both oil and gasoline should be thoroughly mixed together **before** fueling the tank.

Which Gasoline to Use

On all models the correct gasoline is **Premium** gasoline (not less than 98 octane) available from all service stations.

Caution: Never experiment with different fuel or fuel ratios. Never use regular or no lead gasoline,† naphta, methanol or similar products.

†Tests are not conclusive enough therefore we do not recommend the use of no-lead gasolines.

Which Oil to Use

Use **concentrated** Ski-Doo* oil available from your Ski-Doo dealer. This type of oil has specially formulated oil bases to meet the lubrication requirements of the Bombardier-Rotax engine.

Caution: The carburetors of the 1973 Ski-Doo snowmobile have been calibrated for a mixture of gasoline and concentrated Ski-Doo oil.

Unless absolutely necessary, do not use regular snowmobile oil. If such oil is used, observe mixing instructions on the container. Never use outboard or straight mineral oils.

Fuel Mixing Ratio

The importance of using the correct fuel mixture cannot be overstressed. Prior experience has shown that an incorrect fuel ratio results in serious engine damage. The correct fuel/oil ratio is 40/1. **5 gallons, premium gasoline plus 1 pint Ski-Doo oil = correct fuel mixture.**

Note: To facilitate fuel mixing, oil should be kept at room temperature.

*Trademark Bombardier Limited

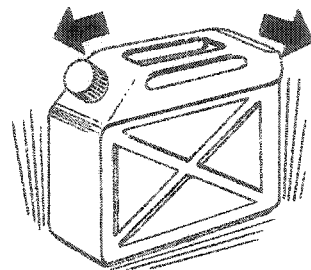
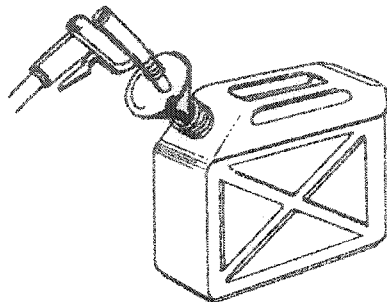
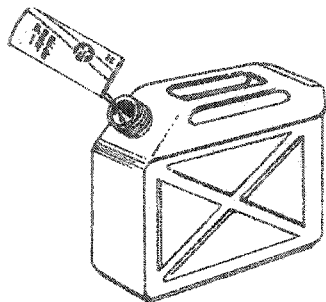

FUEL MIXING

Fuel Mixing Procedure

To mix the gasoline and oil always use a separate clean container. Never mix directly in your snowmobile tank. For best results, acquire two containers, either plastic or metal. Draw from one until empty then use the second one.

Warning: Gasoline is flammable and explosive under certain conditions. Always perform procedures in a well ventilated area. Do not smoke or allow open flames or sparks in the vicinity. If gasoline fumes are noticed while driving, the cause should be determined and corrected without delay. Never add fuel while engine is running.

- Pour the full amount of Ski-Doo oil required for the total mixture into the container.
- Add approximately half the amount of gasoline to be mixed.
- Shake the container thoroughly.
- Add the remainder of the gasoline.
- Once again thoroughly agitate the container.
- Using a funnel with a fine mesh screen to prevent the entry of water and foreign particles, transfer mixture from container into the snowmobile tank.

Note: When using pre-mixed fuel, always shake the container thoroughly as the oil has a tendency to settle.

Warning: Never 'top up' gas tank before placing vehicle in a warm area. At certain

temperatures, gasoline will expand and overflow.

Fuel consumption

A good idea is for you to rate the fuel consumption of your snowmobile at the first opportunity. Starting with a full fuel tank, mark the time of your departure then note time elapsed until tank is half-full. Repeat on different occasions to get a mean average of your snowmobiles' consumption and length of running time under varying conditions.

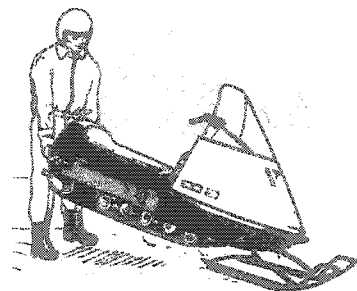
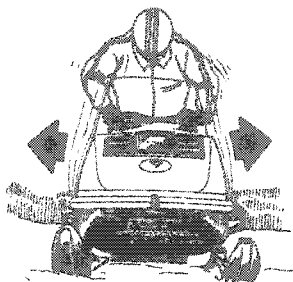
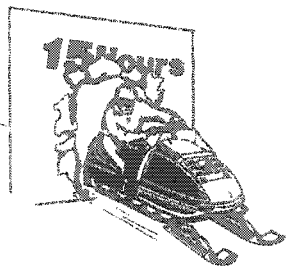

BREAK-IN PERIOD

PRE-START CHECK

With Ski-Doo snowmobile engines, a break-in period is required **before** running the vehicle at full throttle. Manufacturer's recommendation for the Bombardier-Rotax engine is 10 to 15 operating hours. During this period, maximum throttle should not exceed $\frac{3}{4}$. However, brief full accelerations and speed variations contribute to a good break-in. Continued wide open throttle accelerations, prolonged 'cruising' speeds and lugging are detrimental during the break-in period.

Inspection

After the break-in period, we suggest that each Ski-Doo snowmobile has an inspection check. This inspection is at the discretion and expense of the vehicle owner.

Fuel Tank Quantity

Check that there is sufficient fuel in the tank for your trip. A good habit to acquire is to refill the tank before starting out each day.

Since mixed fuel has a tendency to settle overnight, agitate the fuel in the tank by standing on the footboards and rocking the vehicle from side to side.

Track (Daily, before first run)

Under certain climatic conditions, the track of a snowmobile left outdoors overnight may freeze to the ground or snow surface. Always make sure that the track is free before attempting to start the vehicle. (This procedure will eliminate unnecessary drive belt wear).

Steering Operation

Check operation of steering mechanism by rotating the handlebar several times from side to side. If roughness or binding is felt, check for ice or snow that may be blocking the mechanism.

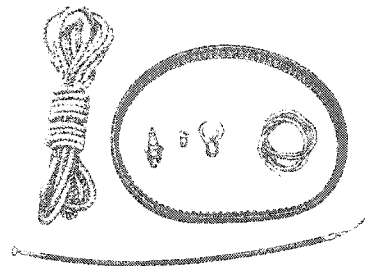
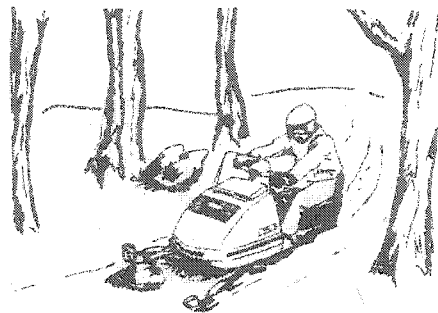
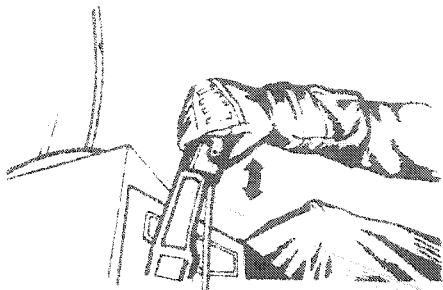

IN CASE OF EMERGENCY

Throttle and Brake

Depress throttle lever several times to check that it operates easily and smoothly. The throttle lever should return to the idle position when released. If the lever does not return swiftly, remove cable and/or housing and replace. Re-check lever operation. Brake leverage is correct when the lever has 1" min. clearance from handlebar grip when fully applied.

Warning: Throttle mechanism should be checked for free movement before starting engine. Once all components are checked and functioning properly, you can start your Ski-Doo snowmobile.

Emergency situations are accepted hazards with any moving vehicle. A hidden rock or stump on the trail, a burnt light bulb while driving at night, an empty fuel tank while miles from anywhere, can all cause varying degrees of inconvenience. Unlike an automobile, which has a distinct advantage in that service stations are usually within walking distance, **snowmobiles are specifically designed to travel off the highways.** When the unexpected happens, the driver often has only his own ingenuity and that of his companions to return home safely. Fortunately, 9 out of 10 difficulties encountered on the trail can be fixed on the spot. However, you must carry at least a minimum assortment of Tools and Spare Parts to enable you to effect minor repairs.

Emergency Materials

In addition to those tools which the manufacturer provides, you should carry the following:

Tools: General Purpose Pliers—Adjustable Wrench (3/4" opening)—Flashlight.

Spare Parts: Spark Plugs—Drive belt—Headlamp and Taillight bulbs—Throttle Cable and Housing—Starting and towing rope.

Important: Always carry spare plugs and drive belt. Check condition of spark plug frequently and look for signs of a fouled or defective plug.

Upper position
before starting
engine.

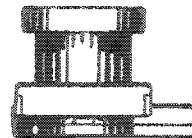

Lower position
to stop engine.

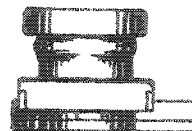

STARTING PROCEDURE

Warning: Never run the engine at high RPM when the track of the vehicle is raised off the ground.

To start the engine:

Before starting the engine make sure the kill button is in the **released** upper position.

1. Engage choke. (Choke is not necessary if engine is warmed up).
2. Test throttle operation then apply throttle lever slightly.
3. Grasp manual starter handle firmly and pull slowly until a resistance is felt then pull vigorously and engine will start. Allow handle to return **slowly** to its original position. If engine does not start, repeat the procedure.

Note: Do not pull starting rope to its fullest extent or allow starting handle to "fly back" to its original position.

4. Release throttle and disengage choke immediately engine has started.
5. Allow the engine to warm up before operating at full throttle.

Flooding

If cold engine is difficult to start, continued choking will only lead to a "flooded" condition.

If engine has not started after the first few tries but appears ready to start, return choke to OFF position. Depress throttle lever fully and try to start the engine.

Warning: Release throttle lever immediately after engine starts.

If engine will not start, check for possible cause.

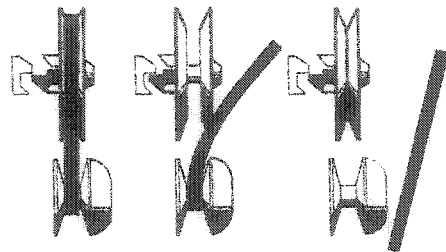
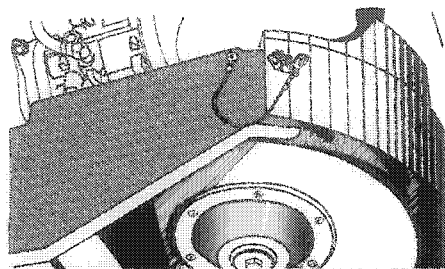
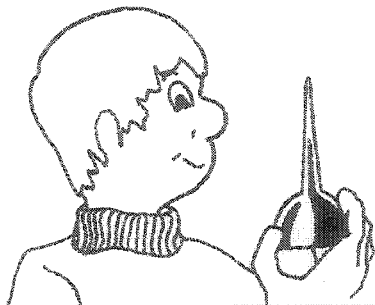

LUBRICATION

Code	Weekly	Page
L1	Steering Mechanism	16
L2	Chaincase Oil Level	16

Code	Weekly	Page
L3	Drive Pulley	16
L4	Hydraulic Disc Brake	17

Pulley Guard Removal

Tilt cab, pull out upper retaining clip and remove wing nut. Tilt pulley guard forward. To remove completely, remove front locking clip and disengage pin from bracket.

Warning: Never start the engine or operate the vehicle without the pulley guard installed.

Drive Belt Removal

1. Tilt cab and pulley guard. Open the driven pulley. (Twist and push the sliding half and hold in place.)
2. Pull the bottom of belt in toward the driven pulley then slip slackened belt over the top edge of driven pulley.
3. Slip the belt from the drive pulley. (To install, follow reverse procedure.)

Warning: Never start or run the engine without drive belt installed.

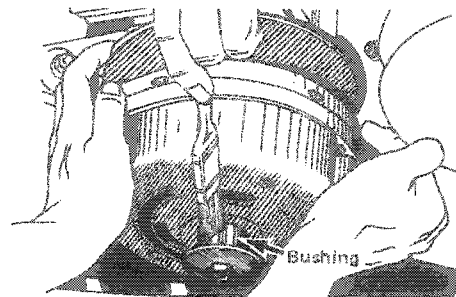
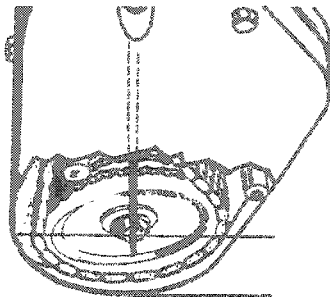
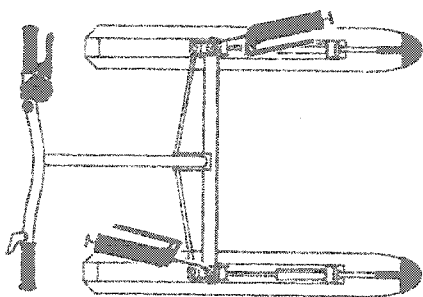

(L1) Steering Mechanism

Oil spring coupler bolts. Lubricate ski legs at grease fittings until new grease appears at joints.

(L2) Chaincase Oil Level

Remove filler cap then using a rigid wire, check oil level. The oil level on the "dipstick" should be 1/2" - 3/4" max. When necessary, replenish using Ski-Doo® chaincase oil. The oil capacity is approximately 6 ozs.

(L3) Drive Pulley

1. Tilt cab, remove pulley guard and drive belt.
2. Push governor assembly in toward engine to expose bushing.
3. Apply low temp. grease to the bushing and release governor. Reinstall belt and pulley guard.

Warning: Do not disassemble drive pulley. If repair or replacement is necessary, contact your dealer.

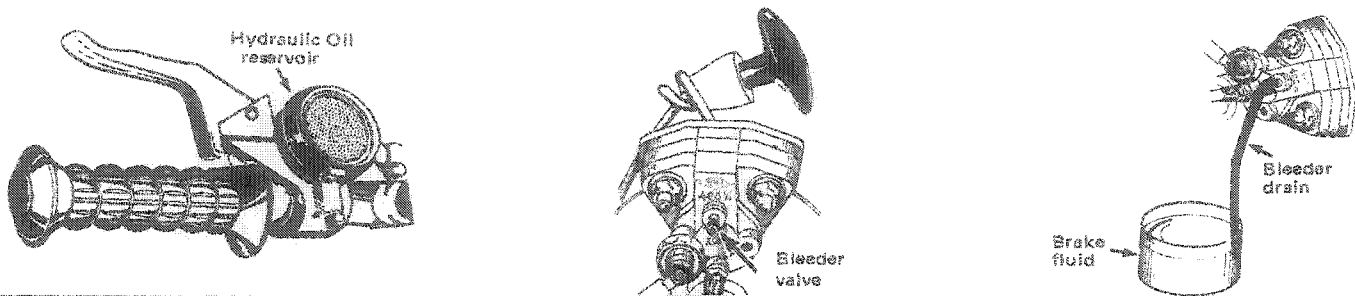

(L4) Hydraulic Disc Brake (Oil Level)

The brake mechanism on your snowmobile is an essential safety device. Keep this mechanism in proper working condition. Above all, do not operate your snowmobile without an effective brake system.

Brake hoses should be checked for abrasion and signs of leakage. The fluid level in the master cylinder should also be checked.

Caution: Use only hydraulic brake fluid, available from your Ski-Doo* dealer. Never re-use brake fluid obtained by bleeding.

To check fluid level, turn handlebar to right and remove reservoir cover located on handlebar. Fluid must reach top lip of reservoir.

*Trademark Bombardier Limited

Warning: The entry of dirt or foreign particles into the brake fluid may constitute system flushing.

Filling and Bleeding

If the reservoir is low and/or air has entered the system creating a soft, spongy braking action, the following should be done:

1. Remove reservoir cover and 'top up' fluid level.

Note: Retain this reservoir level throughout the following procedure.

2. Connect a bleeder drain to the valve and insert end of bleeder hose into a container of brake fluid.

3. Repeatedly depress the brake lever in quick succession, (pumping), to obtain pressure. Once obtained, hold lever, open bleeder valve then quickly depress brake

lever. Close bleeder valve and allow brake lever to return slowly.

4. Continue pressing and releasing brake lever until the fluid injected into the container is air free.

5. Disconnect bleeder hose, recheck brake fluid level and install reservoir cover.

Note: Change brake fluid at least once during the snowmobiling season.



Fouled
(black)



Normal (Brownish)



Overheated
(light grey)

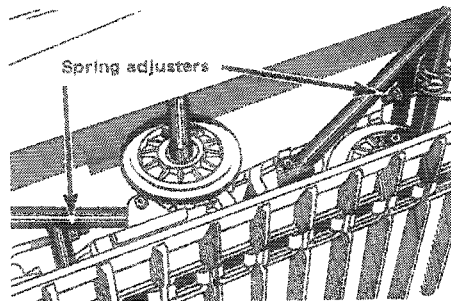

MAINTENANCE

Code	Weekly	Page
W1	Spark Plugs	18
W2	Suspension Springs	18
W3	Track	19
W4	Track Tension	19
W5	Track Alignment	19
W6	Chain Tension	19
W7	Carburetor Adjustment	20
W8	Drive Belt Condition	21

Code	Monthly	Page
M1	Carburetor Flange Nuts	21
M2	Brake Puck Wear	21
M3	Steering Adjustment	21
M4	Engine Head Nuts	21
M5	Engine Mount Nuts	21
M6	Pulley Alignment	22
M7	Slider Shoe Wear	22
M8	Vehicle General Inspection	22

(W1) Spark Plugs

1. Disconnect spark plug wires and remove spark plugs.

2. Check condition of plugs.

- A brownish tip reflects ideal conditions. (Correct carburetor adjustment, spark plug heat range; etc.).
- A black insulator tip indicates fouling caused by: carburetor idle speed mixture and/or high speed mixture-too rich, incorrect fuel mixing ratio, wrong type of spark plug (heat range), or excessive idling.
- A light grey insulator tip indicates a lean mixture caused by: carburetor high speed mixture adjusted too lean, wrong spark plug heat range, incorrect fuel mixing ratio, or a leaking seal or gasket.

Caution: If, when checking spark plug color, you find that the engine is not running under ideal conditions, contact your authorized Ski-Doo* dealer.

3. Reinstall plugs and connect wires.

(W2) Suspension (Adjustment)

With engine off, visually inspect suspension springs. Replace any broken spring. The suspension is adjustable, the front adjustment for surface condition, the rear for driver's weight. In either case, both sides of the adjustment should be equal.

*Trademark Bombardier Limited

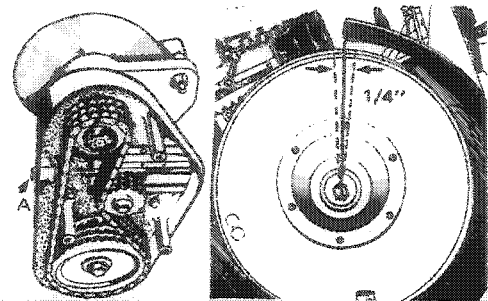
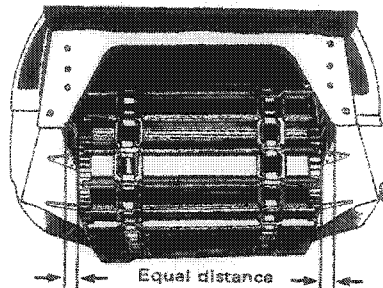
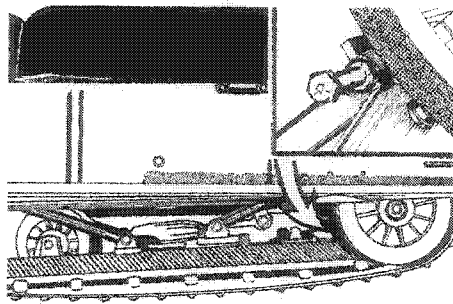

(W3) Track

Lift the rear of the vehicle and support it off the ground so that the track is free to turn. With engine **off**, rotate track by hand and visually inspect track condition.

(W4) Track Tension

Lift rear of vehicle and support it off the ground. Allow slide to extend normally. A gap of 1" should exist between slider shoe and bottom inside of track.

If track tension is too loose, the track will have a tendency to thump. If too tight, performance will be affected. Adjust to correct tension by loosening or tightening adjuster bolts located on inner side of rear idler wheels.

Note: Track tension and alignment are inter-related. Do not adjust one without the other.

(W5) Track Alignment

After track tension has been corrected start the engine and accelerate slightly so that track turns **slowly**. Check that track is well centered and turns evenly. To correct, loosen the lock nut and tighten the adjuster bolt on side where track is closest to the frame. Tighten lock nut and re-check alignment.

Warning: Before checking track alignment, ensure that the track is free of all particles which could be thrown out while track is rotating. Keep hands, feet and clothing clear of track.

(W6) Chain Tension

The correct chain tension is 1/4" at driven pulley level. To check, with engine **off**, move driven pulley from side to side. To correct, unlock tensioner bolt (A) then turn bolt clockwise or counter-clockwise.

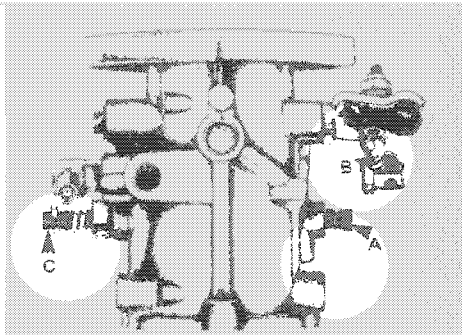
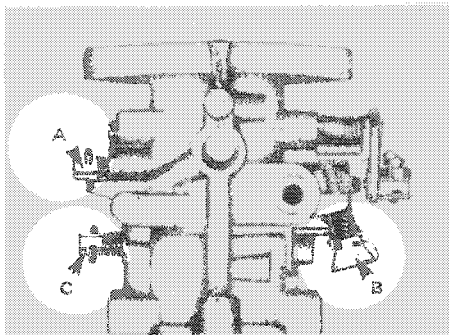

(W7) Carburetor Adjustment

The carburetor adjustments for the Ski-Doo snowmobile are: Maximum Throttle Opening, Idle Speed Mixture, Idle Speed and High Speed Mixture.

Note: A relationship exists between each adjustment. Do not correct one without checking the other.

Maximum Throttle Opening

With engine **off** adjust throttle cable and rod so that the throttle butterflies are fully open when throttle lever gently touches handlebar.

Warning: Before starting engine, carburetor throttle levers must return to idle position by contacting with the tip of Idle Speed Adjusting Screws. Never start engine unless this situation is verified.

Idle Mixture Adjustment (A)

A primary adjustment, with engine **off**, should be made by first turning Idle Mixture Screws fully clockwise until closed. Back off screws one (1) turn counter-clockwise.

Note: Do not close screws too tightly as needle and/or needle seat can be damaged.

For final adjustment, start engine and allow it to warm up. Turn Idle Mixture Screws until engine reaches maximum R.P.M. and obtain a steady idle and a fast response of engine to the throttle.

(Turning Idle Mixture Screw clockwise produces a leaner mixture, more air/less fuel; counter-clockwise, a richer mixture, less air/more fuel.)

Idle Speed Adjustment (B)

Turn the Idle Speed Adjusting Screws clockwise to increase idling speed, counter-

clockwise to decrease.

High Speed Mixture Adjustment (C)

Warning: High Speed Mixture Adjustment must be carried out only by an authorized Ski-Doo* dealer.

For primary adjustment however, with engine **off**, turn High Speed Mixture Adjusting Screws fully clockwise until closed. (Do not close screws too tightly as screws and/or screw seats can be damaged.) Back off screws one (1) turn counter-clockwise.

Caution: Never operate your snowmobile with the air silencer tubes disconnected. Serious engine damage will occur if this notice is disregarded.

*Trademark Bombardier Limited

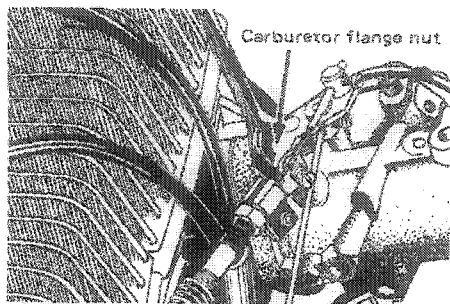

Carburetor flange nut

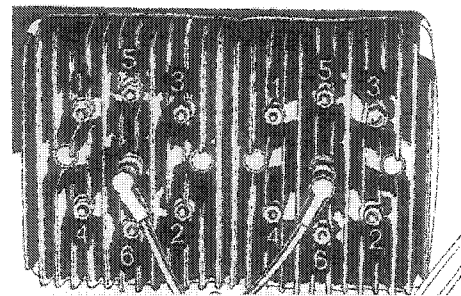
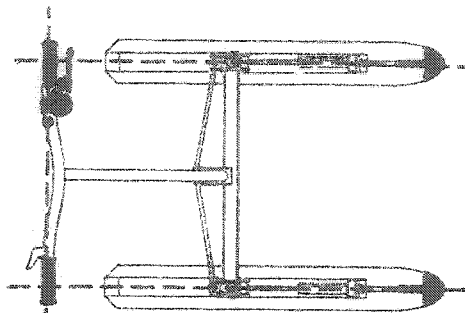

(M8) Drive Belt Condition

If belt is less than 1" wide, replace. Check condition of belt. Inspect for cracks, fraying or abnormal wear (uneven wear, wear on one side, etc.). If abnormal wear is noted, probable cause is pulley misalignment.

(M1) Carburetor Flange Nuts

After the first two (2) hours of operation, check carburetor flange nuts. Tighten, if necessary.

(M2) Brake

The brake mechanism on your snowmobile is an essential safety device. Keep this mechanism in proper working condition. Above all do not operate your snowmobile without an effective brake system. Brake pucks less than 3/8" thick **must** be replaced.

(M3) Steering Adjustment

Skis should be parallel to each other. To check, measure distance between each ski at front and rear of leaf springs. The skis should also be parallel to the vehicle when the handlebar is horizontal.

If adjustment is required:

1. Unscrew the nuts locking the tie rods in place.
2. Turn one or both tie rods until ski alignment is correct.
3. Tighten the nuts **firmly** against the tie rod. Firmly tighten the steering arm bolts. (In case of serious misalignment, contact your dealer.)

Warning: The ball joint socket must run parallel with the steering arm. The socket must be restrained when tightening the tie rod end lock nuts.

(M4) Engine Head Nuts

Tilt cab and check head nut torque. (16 ft/lbs when **cold**). Always torque using a cross sequence.

(M5) Engine Mount Nuts

With cab tilted, check engine mount nuts for tightness. Torque to 300-350 inch/lbs.

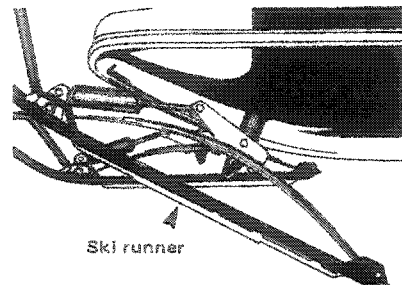
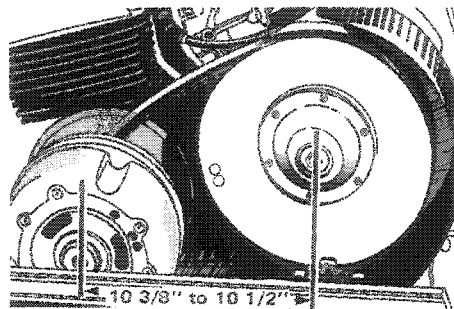
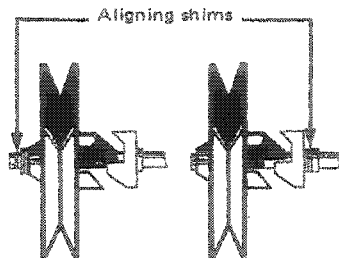

(M6) Pulley Alignment

Due to the installation position and method of attachment, the distance between the center of the drive and driven pulley shafts is non adjustable. Should this distance vary from $10 \frac{3}{8}''$ to $10 \frac{1}{2}''$, inspect engine mounts for security, distortion, etc.

Pulley offset is $\frac{1}{2}'' \pm \frac{1}{16}''$. When **greater**, transfer aligning shims from cam side to fixed pulley half side of the driven pulley. When **less** than $\frac{7}{16}''$, transfer shims from fixed pulley half to cam side of driven pulley.

(M7) Slider Shoe Wear

During normal driving, snow will act as a lubricant and coolant for the slider shoes. Extensive riding on ice or sanded snow, not to mention dirt, asphalt, etc. **never** recommended, may create excessive heat built up and cause premature slider shoe wear. Always inspect shoe condition and replace as necessary.

(M8) Vehicle General Inspection

Check electrical wiring and components, retighten loose connections. Check for stripped wires or damaged insulations. Thoroughly inspect the vehicle and tighten loose bolts, nuts and linkage. Inspect ski runners for wear.

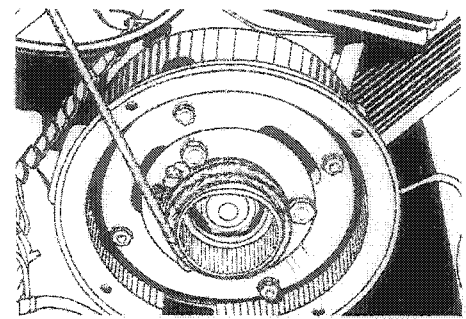
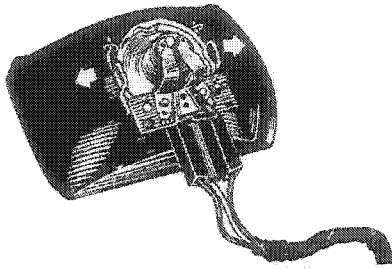

EMERGENCY GUIDE

Burnt Light Bulb

If headlamp is burnt, stop engine, unlock cab latches (2) and tilt cab. Unfasten bulb retainer clips. Remove rubber boot. Detach bulb and replace. If taillight bulb is burnt, expose bulb by removing red plastic lens. To remove, unscrew the two (2) Phillips head screws.

Broken Throttle Cable

Remove throttle cable and replace. Check lever operation. If necessary replace housing. **Do not** start the engine until lever returns swiftly.

Broken Rewind Starter Rope

Abuse of the rewind starter may cause the rope to fray and break. Should this situation arise, remove starter unit using 10 mm wrench supplied in tool kit. Transfer rope grip to your emergency rope. Place starter unit in rear compartment. Make a knot at the end of emergency starter rope and wind rope around starter pulley. Pull vigorously as per usual manual start. See your dealer for immediate repair or replacement of starter unit.

TROUBLE SHOOTING GUIDE

Symptoms	Possible Causes	What To Do
Engine turns over but fails to start or starts with difficulty	1. No fuel to the engine	Check the tank level and fill up with correct gas-oil mixture. Check for possible clogging of fuel line, item 5.
	2. Spark Plug	Check for fouled or defective spark plug. Disconnect spark plug wire, unscrew plug and remove from cylinder head. Reconnect wire and ground exposed plug on engine head, being careful to hold away from spark plug hole. Follow engine starting procedure and check for spark. If no sparks appear, replace spark plug. If trouble persists, check item 3.
	3. Faulty ignition	Disconnect spark plug wire from plug, unscrew the spark plug cap then hold wire about 1/8" from the cylinder head. Follow engine starting procedure and if no sparks appear, it means a faulty ignition system. Do not attempt to repair. Contact your dealer.
	4. Flooded engine	Disengage choke, wait 60 seconds or more then depress throttle lever fully and try to start engine. Release throttle lever immediately after engine starts.
	5. Clogged fuel line (water or dirt)	Remove and clean the fuel filter. Change filter cartridge if necessary. Check condition and connections of fuel lines. Check the cleanliness of the fuel tank.
	6. Faulty Carburetor	First make primary adjustments on carburetors (See Maintenance Section). If carburetor(s) is still faulty, contact your dealer for repair.
	7. Too much oil in fuel	Drain the fuel tank and refill with the correct gas/oil mixture.
	8. Engine Timing	Engine timing may be defective or out of adjustment. Contact your dealer.
	9. Poor engine compression	Running with a lean fuel mixture may produce excessive engine wear resulting in poor engine compression. If this occurs, contact your dealer at once.
Engine will not turn manually	1. Seized engine	In the case of a seized engine, contact your dealer. Seizure is a direct result of poor lubrication.

Symptoms	Possible Causes	What to Do
Engine lacks acceleration or power	1. Fouled or defective spark plug	Check item 2 of "Engine turns over but fails to start or starts with difficulty".
	2. Clogged fuel line (water or dirt)	Check fuel line condition. (See item 5 of "Engine turns over but fails to start or starts with difficulty").
	3. Carburetor	Readjust the carburetor. (See Maintenance Section). If trouble persists, contact your dealer.
	4. Defective ignition	First check item 2 and 3 of "Engine turns over but fails to start or starts with difficulty". If the ignition system still seems defective, contact your dealer.
	5. Engine	If unable to locate specific symptoms, contact your dealer.
Engine continually backfires	1. Faulty spark plug	Check item 2 of "Engine turns over but fails to start or starts with difficulty".
	2. Overheated	Carburetor set too lean. Contact your dealer.
	3. Engine timing incorrectly set	Contact your dealer.
Snowmobile cannot reach full speed	1. Drive belt	Check for defective or worn drive belt. Replace if necessary.
	2. Incorrect track adjustment	Check track tension and alignment. Readjust to specifications. (See Maintenance Section).
	3. Faulty engine	Check items 1 to 5 of "Engine lacks acceleration or power".
	4. Pulley misaligned	Readjust the pulleys. (See Maintenance Section).

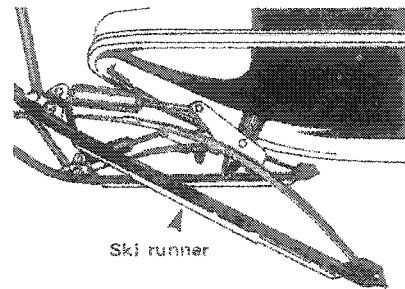
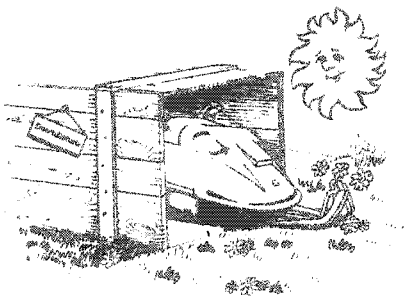

OFF SEASON STORAGE

It is during Summer, or when a vehicle is not in use for any length of time that proper storage is a necessity.

Storage of the Ski-Doo snowmobile during long periods of inactivity consists of checking and replacing missing or worn parts; Proper lubrication and treatments to insure that parts do not become rusted; Cleaning items such as carburetor of oil gas mixtures; to prevent gum varnish formation within the carburetor; and in general, preparing the vehicle so that when the time comes to use the snowmobile again it will start and be in top condition.

Important: The necessity of proper storage cannot be overstressed. If you lack the time or proper tools, see your authorized Ski-Doo Dealer.

(S1) Track

1. Inspect track for cuts, missing track inserts or broken rods and make any necessary replacement.
2. Lift rear of vehicle until track is clear of ground then support with brace or trestle. The Ski-Doo snowmobile should be stored in such a way that track does not stay in contact with cement floor or bare ground.

Note: The track should be rotated periodically, (every 40 days).

(S2) Suspension

Remove slide suspension and lubricate cross shafts.

(S3) Ski Assembly

1. Wash or brush all dirt or rust accumulation from skis and springs.
2. Grease ski legs at grease fittings.
3. Check condition of ski runners. Replace if worn.
4. Apply metal protector on ski assembly. If unavailable, wipe the entire ski with cloth soaked in oil to prevent rust formation.

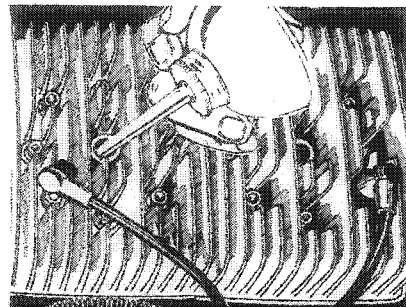
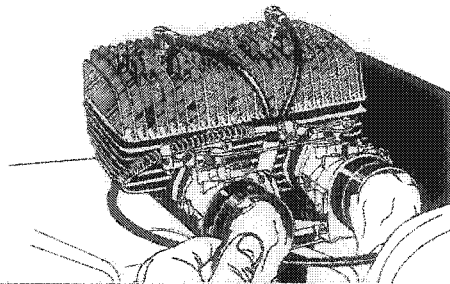

(S4) Fuel Tank

Remove cap then using a syphon, remove gasoline from tank.

Warning: Gasoline is flammable and explosive under certain conditions. Always perform procedures in a well ventilated area. Do not smoke or allow open flames or sparks in the vicinity.

(S5) Carburetors

The carburetors must be dried out completely to prevent gum formation during the storage period.

1. Assure that inlet fuel lines are disconnected then start the engine and run it out of gas.
2. Remove air silencer.
3. Engage choke then pack carburetor throats with clean pieces of cloth and turn the engine a few more times. The suction should eliminate the remaining fuel.
4. Install air silencer and connect fuel lines.

(S6) Cylinder Lubrication

Engine internal parts must be lubricated to protect cylinder walls from possible rust formation during the storage period.

Caution: To prevent magneto damage, make sure that the kill button is in the lower position.

1. Remove spark plugs.
2. Operate rewind starter to bring piston at **top** position.
3. Pour about one spoonful of oil into spark plug hole.
4. Slowly crank engine 10 to 12 times using manual starter.
5. Repeat above steps for other cylinder.
6. Install spark plugs.

Note: This operation should be repeated every 40 days during storage.

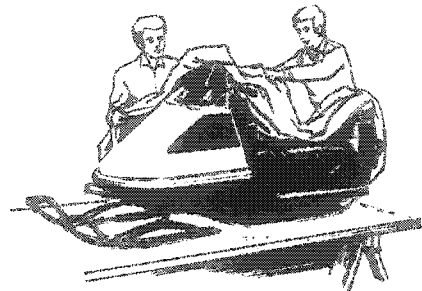
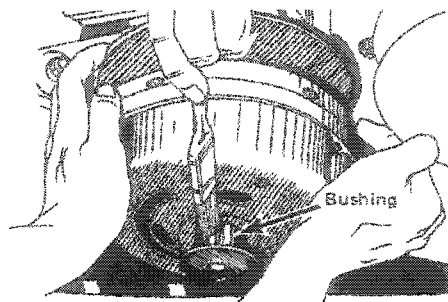
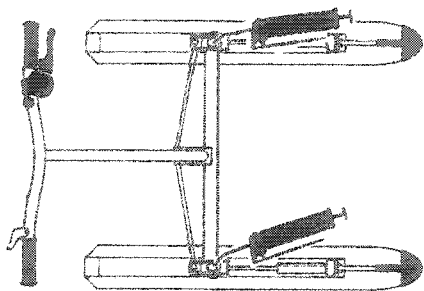

(S7) Chaincase

Drain the chaincase completely and refill with 6 ozs of fresh Ski-Doo* chaincase oil. To drain, remove chaincase cover.

(S8) Controls

1. Oil steering mechanism. Inspect components for tightness, (spring coupler bolts, tie rods, spherical ball joints, etc.) Tighten if necessary.
2. Oil moving joints of brake mechanism. **Avoid getting oil on brake pucks.**
3. Coat all electrical connections and switches with a greaseless metal protector. If unavailable, use petroleum jelly.
4. Drain brake system. Refill and bleed as described in Lubrication Section.

(S9) Drive Pulley

1. Tilt cab, remove pulley guard and drive belt.
2. Push governor assembly in toward engine to expose bushing.
3. Apply low temp. grease to the bushing and release governor. Reinstall belt and pulley guard.
4. Spray internal pulley surfaces with metal protector.

Note: Leave drive belt off during entire storage period.

(S10) Chassis

1. Clean the vehicle thoroughly, removing all dirt and grease accumulation. **Caution:** Do not use solvent to clean cab or plastic components. To clean the frame, use only an 'aluminum cleaner'.
2. Inspect cab and repair damage. Repair kits are available at your authorized Ski-Doo dealer.
3. Wax the complete cab for better protection.
4. Protect the vehicle with a Ski-Doo* cover to prevent dust accumulation during storage.

*Trademark Bombardier Limited

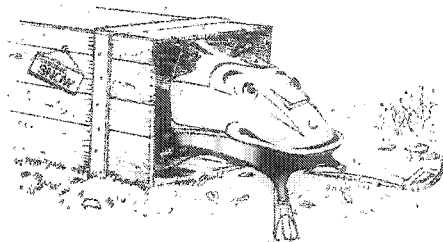

PRE-SEASON PREPARATION

Snow is falling and you are now anticipating the next snowmobile safari. If you have observed and adhered to the storage procedures outlined in this manual, your vehicle preparation becomes a relatively easy task.

To simplify the pre-season preparation we have drawn up a small check list.

Many items have been forementioned in the Lubrication or Maintenance sections of this manual therefore quick and easy reference is possible.

Again we mention, should you lack the time or tools to complete the task, to contact the Ski-Doo dealer of your choice and obtain his professional assistance.

- Spark plugs; Change.
- Chaincase; Check oil level.
- Pulleys; Clean, lubricate drive pulley and align drive and driven pulleys.
- Skis; Align.
- Fuel Filters; Change.
- Fuel lines; Connect then check attaching points at tank and carburetors.
- Track; Check tension and alignment.
- Suspension; Lubricate cross shafts, wipe off excess grease.
- Drive belt; Inspect and install.
- Throttle Cable; Check for damage. Check operation.
- Brake; Inspect puck, check oil level.
- Oil seals; Inspect for possible cuts or leaks.
- Engine Timing; Check ignition and set timing.

- Wiring; Check electrical wiring for broken or damaged insulation. Inspect connections.
- Manual Starter; Inspect condition of starting rope.
- Fasteners; Check tightness of all nuts, bolts and linkage. Pay particular attention to engine head nuts— 16 ft/lbs torque. Governor bolt 35-40 ft/lbs torque.
- Gas Tank; Refill.
- Carburetors; Adjust.

IMPORTANT: Observe all Warnings and Cautions mentioned throughout this manual which are pertinent to the item being checked. When component conditions seem less than satisfactory, replace with genuine Bombardier parts.

SPECIFICATIONS

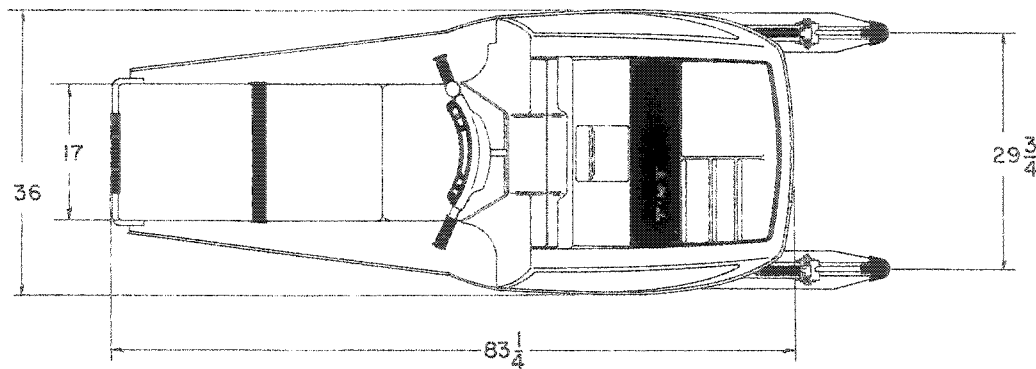
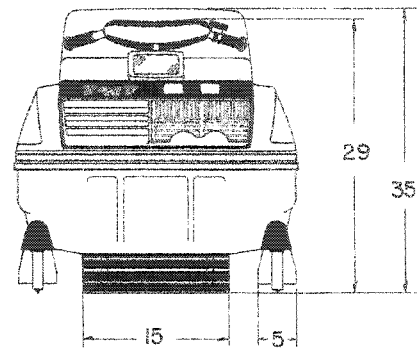
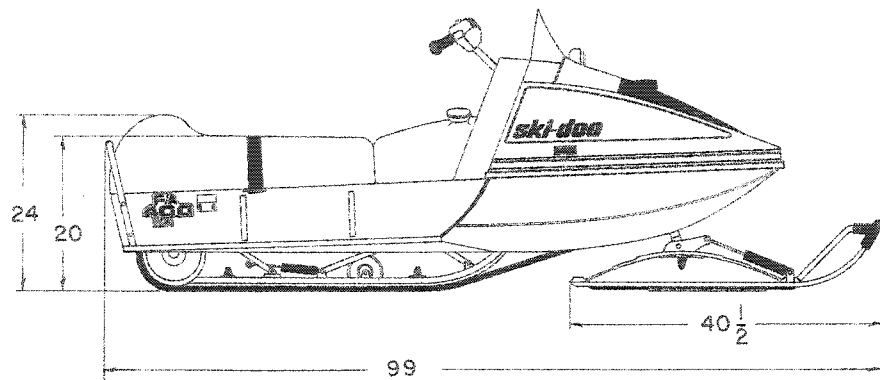

SPECIFICATIONS

MODEL	T'NT (Free Air)	340	400
Engine	Number of cylinders	2	2
	Bore	59.5mm	64.5mm
	Stroke	61mm	61mm
	Displacement	339.2	398.6
	Compression Ratio	11:1	11:1
	Carburetor (Tillotson)	2 X HR	2 X HD
	Starting	Manual	Manual
Chassis	Overall length	99"	99"
	Overall width	36"	36"
	Height	35"	35"
	Height w/o windshield	29"	29"
	Weight (lbs)	385 (approx.)	385 (approx.)
	Bearing area	1092	1092
Power Train	Ground Pressure (P.S.I.)	.353	.353
	Track width	15"	15"
	Driving Chain	3/8" pitch, triple	3/8" pitch, triple
Electrical System	Brake light coil output	23W	23W
	Lighting coil output	75W	75W
	Headlamp (watt)	60/60W	60/60W
	Tail/stop light	8/23W	8/23W
	Spark plug (Bosch)	W-280-M2	W-280-M2
	Spark plug gap	.020"	.020"
	Breaker points gap	.014" - .018"	Capacitor Discharge System
Fuel	Voltage regulator	Yes	Yes
	Tank capacity - Imp.	6	6
	- U.S.	7.2	7.2
	Gasoline	Premium	Premium
Brake	Gas/Oil ratio	40/1	40/1
	Type	Hydraulic disc	Hydraulic disc

1973 SKI-DOO WARRANTY

Bombardier Limited (Bombardier) as manufacturer, warrants every 1973 Ski-Doo snowmobile, Ski-Boose or Carry-Boose tow sled, SOLD AS A NEW VEHICLE, BY AN AUTHORIZED SKI-DOO DEALER, to be free from defects in material, and workmanship under normal use and service, for a period of ninety (90) days subject to the following coverage period:

1. Beginning no sooner than from the date of delivery to the first retail buyer, for a period of ninety (90) consecutive days.
2. Since snow is required for snowmobiling; all deliveries **prior to December 15th, 1972**, shall be covered under this warranty from **December 15th, 1972 to March 15th, 1973**.
3. All units delivered on or after **January 2nd, 1973**, but prior to **March 31st, 1973**, shall have a warranty carry-over into the next season, starting on **December 15th, 1973**, for the unused portion of the ninety (90) day warranty.

CONDITIONS

1. That maintenance be performed, at the owner's expense, as set down in the applicable owner's manual. Any failure which occurs as a result of inadequate maintenance † or improper use shall not be assumed by this warranty.
2. Any damages to any part of the above-mentioned vehicles and their components caused through improper use or maintenance or by any part installed which is not a genuine Ski-Doo replacement part, or not installed by an authorized Ski-Doo dealer, voids any future warranty

coverage to the affected parts.

3. This warranty does not apply to any defect which results from:
 - i) misuse or accident;
 - ii) Installation of repair parts other than genuine Bombardier replacement parts or;
 - iii) Repairs by any person other than an authorized Ski-Doo snowmobile dealer;
 - iv) Lack of preventative maintenance;
 - v) Alterations or modifications other than those approved in writing by Bombardier.
 4. Proof of ownership and warranty registration must be submitted to the service dealer by means of the Ski-Doo Service Card.
- † **Guidelines for proper use and maintenance are detailed in each owner's manual.**

EXCLUSIONS

- **Maintenance Items and Services** are considered non-warrantable and necessary to proper functioning of the vehicle, and without limiting the foregoing the following parts and services are excluded.
- Variable speed drive belt, fan belt, windshield, filters, ignition breaker points and condensers, spark plugs, light bulbs and protective lenses, brake linings, ski runner shoes, slider shoes on variable speed pulleys, all fasteners, labels, soft trim and appearance items, lubricants and paints, and all tune-ups or adjustments required.

SKI-DOO * SHOP MANUALS

1970-1971 Completely illustrated, with over three hundred full size pages, the content includes entire sections on Engine—Carburetor—Chassis—Suspension—Electrics—etc. Lists step by step procedures for Repairs—Servicing and much much more. Covers both 1970 and 1971 vehicles. \$8.95.

1972 Over two hundred pages of up-to-date information on Repairs and Servicing. Completely illustrated. Everything you'll ever need to know about servicing your 1972 Ski-Doo snowmobile. \$7.95.

1973 Supplement edition of the '72 Shop Manual. Includes the latest design changes and servicing techniques for '73 vehicles. \$5.00.

Reserve your copy now! Send certified cheque or money order to:

Canada

Bombardier Limited,
Technical Information Centre,
8600 Decarie Blvd.,
Montreal 307, P.Q.

U.S.A.

Bombardier East Inc.,
Railroad Street,
Lee, Massachusetts, 01238

To be completed and returned with
a money order or a certified cheque
(Postage included)

NAME _____

(BLOCK LETTERS)

STREET _____

CITY _____

STATE / PROV. _____

ZIP CODE _____

SEND ME _____

1970-71 SHOP MANUAL \$8.95

1972 SHOP MANUAL \$7.95

1973 SUPPLEMENT \$5.00
(Available December '72)

*Trademark Bombardier Limited

- Any part damaged through lack of lubrication unless it is proven to be attributable to a manufacturing defect
- Blizzard models or any of the vehicles referred to in this text which may have been used for racing or professional competition.
- Any damages resulting from an accident unless such damages are proven to result from a manufacturing defect.
- Any losses incurred to the vehicle owner other than the parts and labour required to repair the warrantable defect.

This warranty is expressly in lieu of all other expressed or implied warranties of Bombardier, its distributors and the selling dealer, including any implied warranty of merchantability or fitness for any particular purpose. Neither Bombardier, its distributors nor the selling dealer shall be responsible, under any circumstances, for any loss or damage as a result of hidden defects, accidents, misuses or other faults.

Neither the distributor, the selling dealer nor any other person has been authorized to make any affirmation, representation or warranty other than those contained in this warranty and if made, such affirmation, representation or warranty shall not be enforceable against Bombardier or any other person.

BOMBARDIER LIMITED
FEBRUARY 2, 1972

NOTE: In the event of change of ownership, complete the notice of transfer form below in order to qualify the new owner for balance of warranty. All such transfers should be reported to an authorized Ski-Doo dealer for modification of the Ski-Doo Service Card. In the event of a lost Service Card, contact the original selling dealer for completion of the "Request for New Service Card" form. For a \$2.00 handling charge, Bombardier will mail your new personalized Service Card to you.

Bombardier Limited,
Valcourt, Québec, Canada. February 1972.

NOTICE OF TRANSFER

Model Vehicle Serial No.

The ownership of this vehicle is transferred
 From

 Signature of registered owner

To
 Full name of purchaser *Block letters*

Address _____
 No Street or Village

 City County
 Date

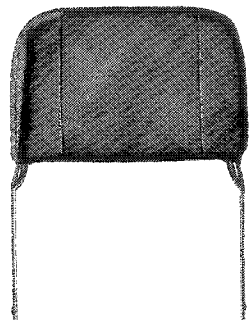

Backrest

- Easily installed on Ski-Doo® snowmobiles.
- Can be attached at two locations—center for driver only rear for passenger.
- Attractive sturdy leatherette and metal construction also available chrome coated.
- Highly recommendable for all snowmobiles carrying more than one passenger.

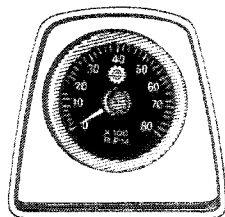

Speedometer

Linked directly to the drive axle. Direct-reading dial indicates the speed of the vehicle in miles per hour (M.P.H.). 6 digit Odometer records the number of miles travelled.

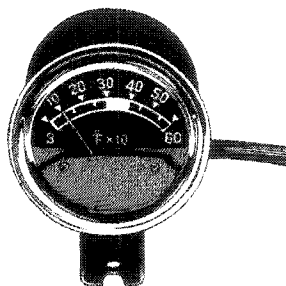

Tachometer

The tachometer registers the impulses of the magneto. Direct-reading dial indicates (in thousands) the number of revolutions per minute (R.P.M.) of the engine. Vital towards maximum performance and engine diagnosis.

Temperature Gauge

Developed for observing changes in cylinder head temperatures. Features: high sensitivity . . . quick response . . . special heat compensating bi-metal . . . internal illumination and quick connect pick-up unit. Applicable to all models.



Snow Guard

- Prevents snow from binding trailing snowmobilers
- Strong, thick rubber ensures long lasting durability.
- Perfectly flexible even under extreme cold
- A must for all racing snowmobiles and an added precaution for snowmobilers on safari.
- Applicable to all models.

All genuine Ski-Doo parts and accessories are specifically designed to provide you with peak performance. Whether it's for comfort or safety, you know that you can depend on genuine Ski-Doo parts and accessories available only at Ski-Doo dealers across the country.

. . . and the **Bombardier** corporation is behind them all.

*Trademark Bombardier Limited