

*ski-doo*  
**Elite.**

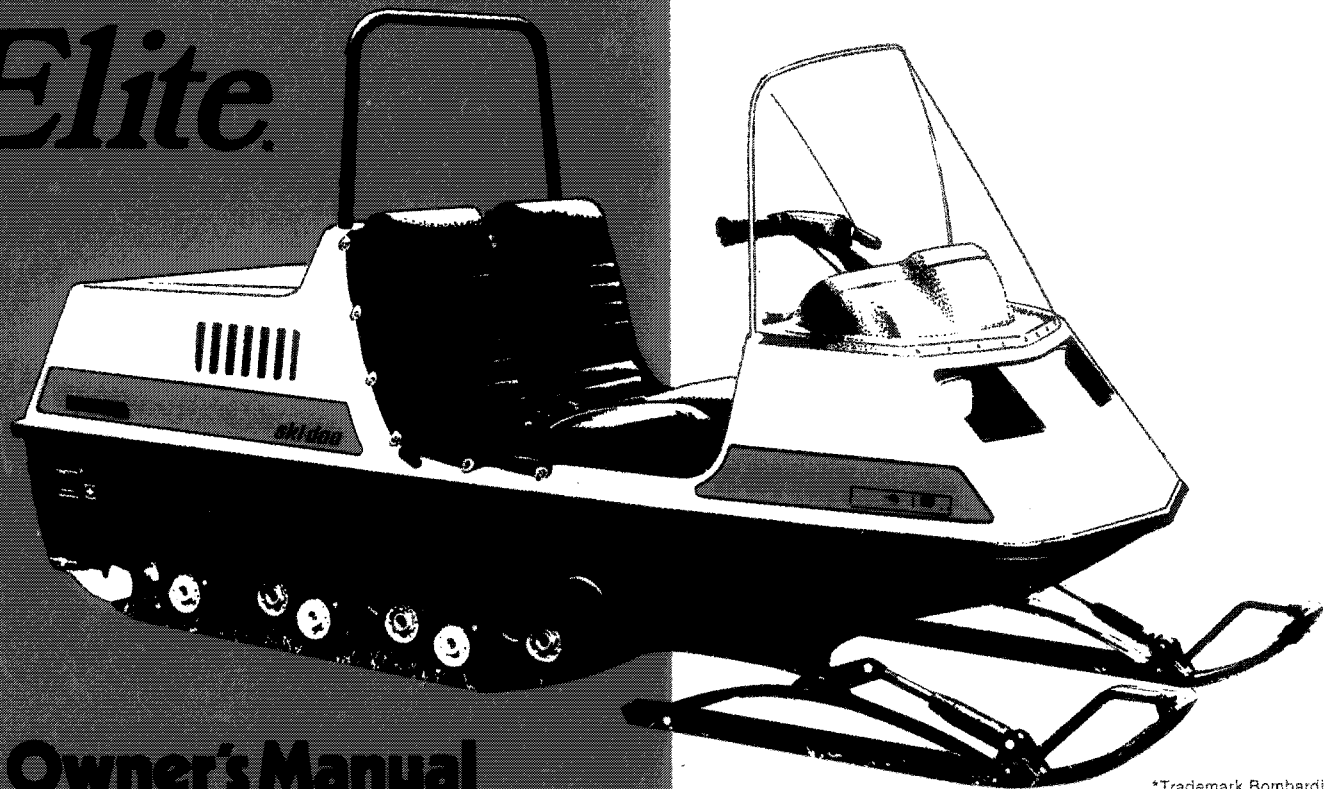

**'73** Owner's Manual

\*Trademark Bombardier Limited  
480-0054 Lith'd in Canada



## INDEX

\*The following are trade marks of Bombardier Limited.

<b>Ski-Doo</b>	<b>Valmont</b>	<b>Skandic</b>
<b>Ski-Boose</b>	<b>T'NT</b>	<b>Carry-Boose</b>
<b>Nordic</b>	<b>Élan</b>	<b>Bombardier</b>
<b>Alpine</b>	<b>Blizzard</b>	

### PATENTS and DESIGNS

This vehicle is covered by one or more of the following patents and design registrations.

Canadian Patents: 605,317 - 710,592 - 724,395 - 853,505.

United States Patents: 2,899,242 - 3,068,546 - 3,536,153.

Canadian Designs: DI/217 F/28172 -DI/249 F/31317 and '316 -D32,479 - D32,535 - D32,655 to '657 - D32,661 to '669 - 33,982 -33,933 - 34,006 and '007.

United States Design Patents  
Des. 221,332 to '334 -  
Des. 221,637 and '638 -  
Des. 222,244 to '247.

Others: Swedish Design No. 6038 -  
Swiss Design No. 104,756 -  
Norwegian Design No. 51,444.

<b>WHAT YOU SHOULD KNOW BEFORE FIRST RIDE .....</b>	<b>2</b>
<b>SERVICE AREAS .....</b>	<b>3</b>
<b>DO'S .....</b>	<b>4</b>
<b>DONT'S .....</b>	<b>5</b>
<b>CONTROLS/INSTRUMENTS ....</b>	<b>6,7</b>
<b>FUEL MIXING .....</b>	<b>8</b>
<b>BREAK-IN PERIOD .....</b>	<b>9</b>
<b>IN CASE OF EMERGENCY.....</b>	<b>9</b>

<b>STARTING PROCEDURE .....</b>	<b>10</b>
<b>LUBRICATION .....</b>	<b>11,12,13</b>
<b>MAINTENANCE..</b>	<b>14,15,16,17,18,19</b>
<b>OFF SEASON CARE .....</b>	<b>19</b>
<b>PRE-SEASON PREPARATION....</b>	<b>19</b>
<b>TROUBLE SHOOTING .....</b>	<b>20,21</b>
<b>WARRANTY .....</b>	<b>22,23</b>
<b>SPECIFICATIONS .....</b>	<b>24</b>

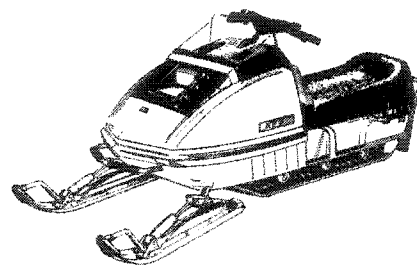
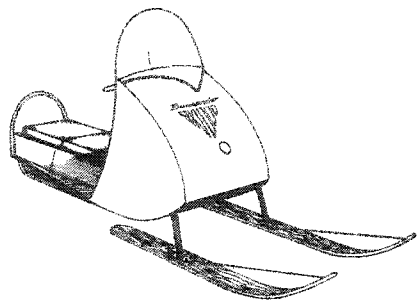

## THE COMPANY THAT CHANGED WINTER HAS CHANGED

In 1957 and 1958, tests began on what is considered the forerunner of the Ski-Doo®. We experimented with many different frames and engines—in search of a light machine for one or two passengers. By the fall of '58, the first prototype was ready. Initial tests made it obvious the machine could hold its own in the recreation market. Production began one year later and 225 machines were sold at about \$1,000 each.

Like its predecessors the '73 Ski-Doo snowmobile is a combination of lightness, economy, strength and dependability. And yet, with all this, it has one other additional feature . . . personality.

Each model in each series has a complexity of characteristics that distinguishes itself as part of a bold breed . . . **the Ski-Doo snowmobiles.**

At Bombardier, we fully realize that the purchase of a snowmobile is a very important decision. For this reason, we have ensured that each Ski-Doo snowmobile is backed up by an international Ski-Doo Distributor and Dealer Network whose factory trained personnel are equipped to give you prompt and efficient service wherever you are in Snow Country.

Furthermore, each dealer is prepared to serve you with information, parts and accessories. Feel free to contact him.

At this time we would like to thank you for your patronage and welcome you to Winter. Enjoy yourself but remember: Safety depends on you, the driver, the condition of your vehicle and nature of the terrain.

All of the information, illustrations and component/system descriptions contained in this manual are correct at the time of publication. However, Bombardier Limited reserves the right to make changes in design and specifications, and/or to make additions to or improvements in its products without imposing any obligations upon itself to install them on its products previously manufactured.

This manual has been published by the Technical Information Centre, Bombardier Limited, 8600 Decarie Blvd., Montreal 307, Quebec, Canada.



## WHAT YOU SHOULD KNOW . . . before first ride.

To many of us, Winter is a revealing experience. Weather, atmospheric conditions, snow surfaces, individual driving habits and vehicle usage have considerable affects. We ask that you familiarize yourself with them . . . **read** the owner's manual; it has been prepared to acquaint you with the operation of your vehicle, its safety aspects and systems as well as preventative maintenance procedures that must be periodically upheld . . . all aimed toward a more enjoyable Winter season.

### **Observe the following precautions:**

- Throttle mechanism should be checked for free movement **before** starting engine.
- Engine should be running **only when** pulley guard is secured in place.
- **Never** run engine without drive belt installed. Running an unloaded engine

can prove to be dangerous.

- **Never** run the engine at high R.P.M. when the tracks of the vehicle are raised off the ground.
- It can be dangerous to run engine with the **engine cover open**.
- The Elite is designed to carry two persons only; the operator and one passenger.

Make sure the passenger seat belt is fastened while driving the vehicle.

- Gasoline is flammable and explosive under certain conditions. Always perform procedures in a well ventilated area. Do not smoke or allow open flames or sparks in the vicinity. If gasoline fumes are noticed while driving, the cause should be determined and corrected without delay.
- **Under no circumstances** should you wear loose clothing or scarves that could become entangled with moving

parts of your snowmobile.

- Your snowmobile **is not** designed to be operated on public streets, road or highways. Moreover, in most States and Provinces, it is considered an **illegal** operation.
  - Hidden telephone guy wires or roadside ditches can cause serious **accidents**.
  - Your snowmobile **is not** designed to be driven or operated on black top, bare earth, or other abrasive surfaces. Abnormal and excessive wear of critical parts is inevitable.
  - **Always** wear an approved snowmobile safety helmet. Be informed on local laws legislating the sport.
  - Maintain your vehicle in top mechanical condition at all times.
- Please read and understand all other warnings contained elsewhere in this manual.**

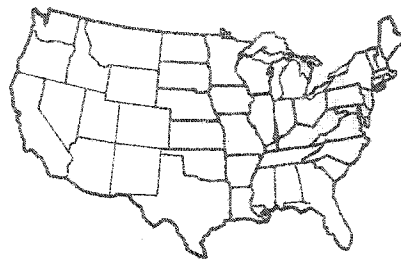

We recommend you contact your local Authorized Ski-Doo dealer when your Ski-Doo snowmobile requires service. However, for further inquiries, you may contact your Regional Distributor listed below.

## SERVICE AREAS

### CANADIAN DISTRIBUTORS

Name of Distributors	Coverage Area
ALPINE DISTRIBUTORS 3206 - 28th Ave., Vernon, B.C.	British Columbia
ATLANTIC SKI-DOO LTD. P.O. Box 670, Shediac, N.B.	Prince Edward Island Magdalen Island Nova Scotia New Brunswick
BOMBARDIER ONTARIO LTD. 28 Currie St., Barrie, Ont.	Ontario
BOMBARDIER QUE. LTD. 1350 Nobel St. Boucherville, Que.	Quebec
BROOKS EQUIPMENT LTD. Box 985, Winnipeg 21, Man.	Manitoba Saskatchewan
HUDSON'S BAY CO. 121 Richmond W. Toronto, Ont.	North-West Territories
J. W. RANDALL LTD. P.O. Box 757, Corner Brook, Newfoundland	Newfoundland
TRACT EQUIPMENT LTD. 14325 - 114th Ave., Edmonton, Alta.	Yukon Alberta

### AMERICAN DISTRIBUTORS

Name of Distributors	Coverage Area
BOMBARDIER EAST INC. Railroad St., Lee, Massachusetts 01238	Massachusetts Connecticut Rhode Island
BOMBARDIER WEST INC. 609 West Broadway, Idaho Falls, Idaho 83401	California New Mexico Nevada Arizona Montana Kansas Idaho Nebraska Wyoming Washington Utah Oregon Colorado
CRAIG TAYLOR EQUIPMENT CO. P.O. Box 3338, Anchorage, Alaska 99501	Alaska
ELLIOTT & HUTCHINS INC. East Main Street Road, Malone, New York 12953	New York Pennsylvania New Jersey Maryland Delaware District of Columbia Virginia

HALVORSON INCORPORATED  
325 South Lake Avenue,  
Duluth 2, Minn. 55802

HEATH INTERNATIONAL INC.  
33737 - 32 Mile Road,  
Richmond, Mich. 48062

TIMBERLAND MACHINES INC  
10 Main St. North, Lancaster,  
New Hampshire 03584

North Dakota  
South Dakota  
Minnesota  
Wisconsin  
Iowa  
Illinois  
Missouri  
Upper Michigan  
  
Lower Michigan  
Indiana  
Ohio  
Tennessee  
Kentucky  
W Virginia  
  
Maine  
New Hampshire  
Vermont

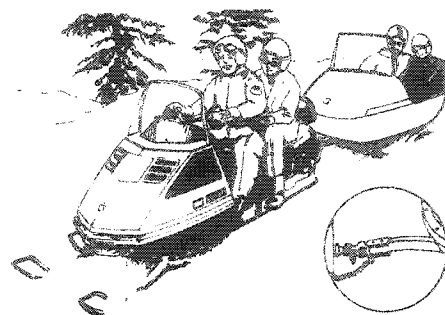
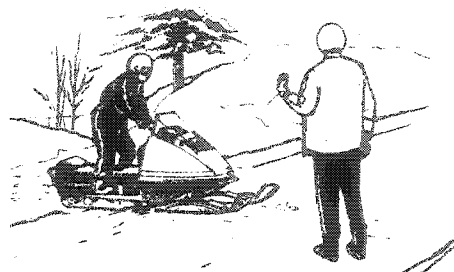
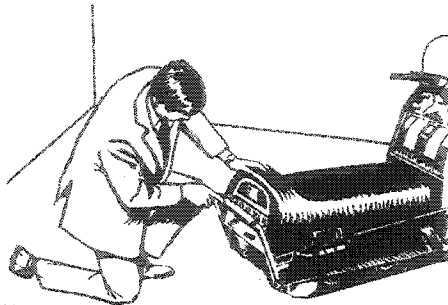

## DO'S

- Register your Ski-Doo snowmobile at your nearest Licensing Bureau, where State or Provincial Laws require it, and affix Registration Plate to the vehicle. Carry your registration certificate with you. It provides proof of ownership in the event that the vehicle becomes lost or stolen.
- Obtain your State or Provincial booklet on snowmobiling. It gives valuable information on the neighbouring snowmobile trails and the laws governing snowmobiling in your particular area.
- Observe all posted snowmobile signs. Not all private landowners allow snowmobiling on their property. You can have just as much fun, even more so, by traveling elsewhere.

- When with others, limit your actions to the experience of the main body. Show the inexperienced driver how to properly handle a snowmobile.
- Always travel with at least one other snowmobile, especially in unfamiliar terrain or on trail rides. Even in snowmobiling, a pair beats one of a kind.
- If you are planning to explore new areas, leave word of your approximate whereabouts and estimated time of return with someone.
- Always make a full stop then look carefully in both directions before crossing roads. When traveling in pairs or in a group, have one member direct the others across singly.

- Use a rigid hitch or tow-bar when pulling any sled or trailer behind your Ski-Doo snowmobile. Rigid hitches prevent tailgate collision when going downhill or on sudden stops. Always secure safety chain when pulling a sled or trailer.
- Reduce speed and verify attachment frequently when pulling a sled or a Ski-Boose\* trailer behind your vehicle, especially when giving children a ride. Go more slowly and check frequently.
- When trailering your Ski-Doo snowmobile, secure it solidly at both ends, protect it with a bright cover then check that trailer hitch and safety chain are secure and that brake, flashers, position and parking lights are all in working order.

\*Trademark Bombardier Limited

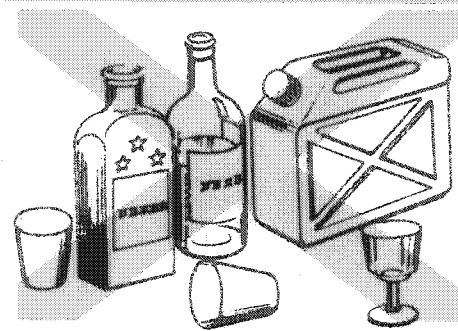
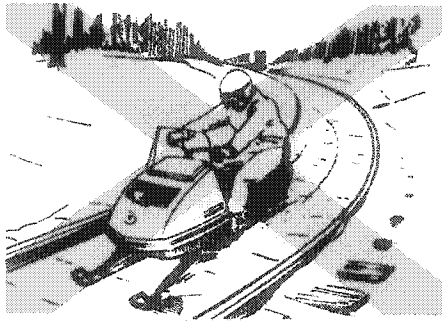

## DON'TS

- Don't cut across in front of the line of travel of another snowmobile. Don't tail-gate; collision, or the threat of it, is serious with any moving vehicle.
- Don't risk injury or damage to your machine with needless and foolish stunting. Don't "jump" your snowmobile. This part of snowmobiling should be left to the professional "stunt" men.
- **Never** ride on railway tracks. The sound of your moving vehicle drown out noise of approaching trains. Your vehicle may also become caught in track junctions. In many States and Provinces snowmobiling on railway tracks constitutes an infraction of the law.
- Never cut through fences or attempt to run over them.
- Don't cross a river or lake without first being positive that the thickness of the ice is sufficient to support both you and your vehicle. **Your life may depend on it.** If at all in doubt, take an alternate route.
- Unless you are certain of a fueling stop, never travel further than  $\frac{1}{2}$  of the fuel remaining in your tank. Even then, leave yourself a safety margin. Remember that a snowmobile does not necessarily travel the same distance each time on the same amount of fuel. A lot depends on speed, snow conditions of the trail and adjustment of the carburetor.
- Don't drive your snowmobile in the vicinity of skiers and keep off ski trails. Always respect the rights of those who enjoy winter in another way.
- **"If you drink don't snowmobile! If you snowmobile, don't drink!"** Remember alcohol and gasoline don't mix.
- Don't lend your snowmobile to inexperienced or under-age drivers. In many cases it is the vehicle owner and not the rider that is responsible for mishaps. Check State or Provincial minimum age limits for drivers.
- Don't leave your keys in the ignition switch. It presents an invitation to thieves and a danger to children.

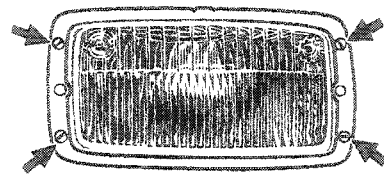
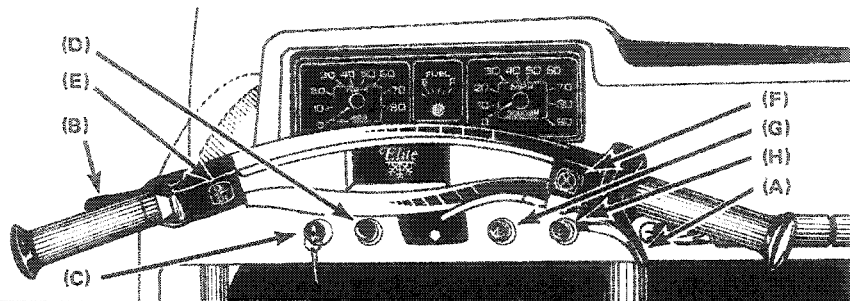

## CONTROLS/INSTRUMENTS

### Steering

Rotation of the handlebar causes a push-pull action on the steering linkage and forces the skis to turn in the required direction. Incorporated in the padded handlebar are the dimmer switch, kill button, brake and throttle levers.

### Throttle Lever (A)

Located on right side of handlebar. When depressed, the lever controls the **engine speed** and thereby the **engagement of the transmission**. When lever is released the engine speed returns automatically to idle and disengages the transmission.

### Brake Lever (B)

Located on left side of handlebar. When lever is depressed, the brake is applied. When released, it automatically releases the brake mechanism. Braking effect is proportionate to the applied pressure on the lever.

### Ignition Switch (C)

Key operated, 3 position switch (OFF/ON/START). To start engine, turn key fully clockwise to START position and hold. Return key to ON position **immediately** engine has started.

### Light Switch (D)

With engine running, pull switch knob to illuminate headlamps and taillights.

### Headlamp Dimmer Switch (E)

The dimmer switch allows you to alternate between high or low headlamp beams. To obtain Hi or Low beams, simply depress switch. A Hi beam indicator light is mounted in the tachometer dial. High beam should not be used when approaching on coming vehicles.

**Note:** The angles of your headlamp beams have been pre-adjusted prior to delivery. Should you wish readjustment, remove headlamp chrome ring and turn upper or lower adjusting screws to obtain desired beam position.



Upper position before starting engine.

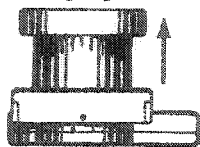

Lower position to stop engine.

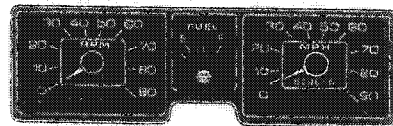
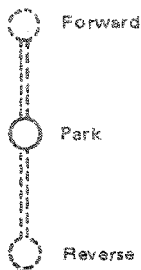
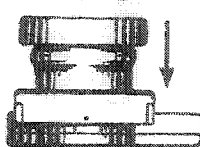

### Kill Button (F)

A push button switch located on right side of handlebar. For emergency stops, press button down into **lower** position. Before re-starting engine always depress button into released **upper** position.

The driver of this vehicle should familiarize himself with the function of this device by using it several times on first outing, thereby being mentally prepared for emergency situations requiring its use. After such a situation, the source of malfunction should be determined and corrected before restarting engine.

### Choke (G)

Pull button to engage choke, push to disengage. The choke should always be used for easier cold engine starts. After engine is warmed up, however, it is not necessary to use choke when starting.

### Lighter (H)

Push in to activate, lighter pops up automatically when lit.

### Gear Shift Lever

Three position lever, (FORWARD/PARK/REVERSE). Push **up** for forward, **center** for park and **down** for reverse.

**Warning: Do not re-position gear shift lever while snowmobile is in motion. When towing the vehicle, the drive belt must be removed from pulleys and the gear shift lever positioned into forward gear.**

### Tachometer

Direct-reading dial indicates (in thousands), the number of revolutions per minute (R.P.M.), of the engine.

### Fuel Gauge

Direct-reading dial indicates the amount of fuel in the tank.

### Speedometer

Direct-reading dial indicates the speed of the vehicle in miles per hour (M.P.H.). 6 digit odometer records the number of miles travelled.

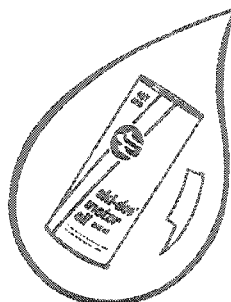
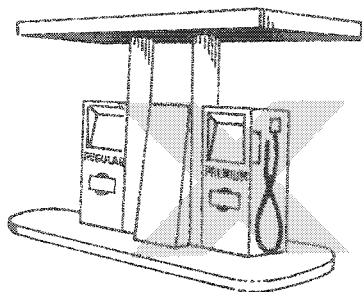

# 40:1

## FUEL MIXING

### Which Gasoline to Use

The correct gasoline is **Regular** gasoline, (not less than 88 octane), available from all service stations.

**Caution:** Never experiment with other than recommended fuels or fuel ratios. Never use no lead gasoline†, naphta, methanol or similar products.

### Which Oil to Use

Use **concentrated** Ski-Doo\* oil available from your Ski-Doo dealer. This type of oil has specially formulated oil bases to meet the lubrication requirements of the Bombardier-Rotax engine.

**Caution:** The carburetors of the 1973 Ski-Doo snowmobile have been calibrated for a mixture of gasoline and concentrated Ski-Doo oil. Unless absolutely necessary, do not use regular snowmobile oil. If such

†Tests are not conclusive enough therefore we do not recommend the use of no-lead gasolines.

oil is used, observe mixing instructions on the container. Never use outboard or straight mineral oils.

### Fuel Mixing Ratio

The correct fuel/oil ratio is 40/1. **Five gallons, regular gasoline plus 1 pint Ski-Doo oil = correct fuel mixture.**

**Note:** To facilitate fuel mixing, oil should be kept at room temperature.

### Fuel Mixing Procedure

To mix the gasoline and oil always use a separate clean container. Never mix directly in your snowmobile tank.

**Warning: Gasoline is flammable and explosive under certain conditions. Always perform procedures in a well ventilated area. Do not smoke or allow open flames or sparks in the vicinity. If gasoline fumes are noticed while driving, the cause should**

**be determined and corrected without delay. Never add fuel while engine is running.**

1. Pour the full amount of Ski-Doo oil required for the total mixture into the container.
2. Add approximately half the amount of gasoline to be mixed.
3. Shake the container thoroughly.
4. Add the remainder of the gasoline.
5. Once again thoroughly agitate the container.
6. Using a funnel with a fine mesh screen to prevent the entry of water and foreign particles, transfer the mixture from the container into the snowmobile tank.

**Warning: Never 'top up' gas tank before placing vehicle in a warm area. At certain temperatures, gasoline will expand and overflow.**

\*Trademark Bombardier Limited

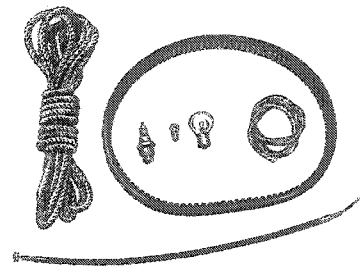
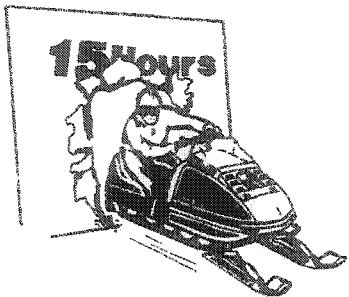

## BREAK-IN PERIOD

With Ski-Doo snowmobile engines, a break-in period is required **before** running the vehicle at full throttle. Manufacturer's recommendation for the Bombardier-Rotax engine is 10 to 15 operating hours. During this period, maximum throttle should not exceed  $\frac{3}{4}$ . However, brief full accelerations and speed variations contribute to a good break-in. Continued wide open throttle accelerations, prolonged "cruising" speeds and lugging are detrimental during the break-in period.

### Inspection

After the break-in period, we suggest that each Ski-Doo snowmobile has an inspection check. This inspection is at the discretion and expense of the vehicle owner.

## IN CASE OF EMERGENCY

Emergency situations are accepted hazards with any moving vehicle. A hidden rock or stump on the trail or an empty fuel tank while miles from anywhere can cause varying degrees of inconvenience. Unlike an automobile, which has a distinct advantage in that service stations are usually within walking distance, **snowmobiles are specifically designed to travel off the highways.** When the unexpected happens, the driver often has only his own ingenuity and that of his companions to return home safely. Fortunately, 9 out of 10 difficulties encountered on the trail can be fixed on the spot. However, you must carry at least a minimum assortment of tools and spare parts to enable you to effect minor repairs.

### Emergency Material

In addition to those tools which the manufacturer provides, you should also carry the following:

**Note:** A tool box is located to the right of the passenger side floor.

**Tools:** General purpose pliers — adjustable wrench (3/4" opening) — flashlight.

**Spare Parts:** Spark plugs — drive belt — headlamp and taillight bulbs — throttle cable and housing — towing rope — fuse.

**Important:** Always carry spare plugs and drive belt. Check condition of spark plugs frequently and look for signs of a fouled or defective plug.

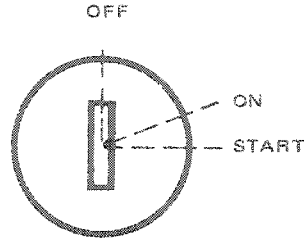

## STARTING PROCEDURE

**Warning:** Ensure the gear shift lever is in **PARK** position before starting engine. Never run the engine at high R.P.M. when the shift lever is in **PARK** or when the tracks of the vehicle are raised off the ground.

**Note:** Before starting the engine make sure the kill button is in the released upper position.

1. Insert key in ignition switch.
2. Engage choke. (Choke is not necessary if engine is warmed up).
3. Test throttle operation then apply throttle lever slightly.
4. Turn ignition key clockwise until starter engages.

**Caution:** Do not engage starter longer than 30 seconds. If engine does not start on first try, key must be turned fully back to OFF each time. Allow starter to

cool for 2 minutes before repeating procedure.

5. **Release** throttle and key **immediately** after engine has started. Disengage choke.
6. Allow the engine to warm up before operating at full throttle.

**Caution:** Never operate the Ski-Doo snowmobile with the battery removed or disconnected.

A manual starter is standard equipment on all Ski-Doo snowmobile engines. If for some reason the vehicle cannot be started electrically, place ignition in ON position, open engine cover and start engine manually.

### Flooding

If cold engine is difficult to start, continued choking will only lead to a 'flooded' condition. If engine has not started after the first few tries but appears ready to start, return choke to OFF position. Depress throttle lever fully and try to start the engine.

**Warning: Release throttle lever immediately after engine starts.**

If engine will not start, check for possible cause.

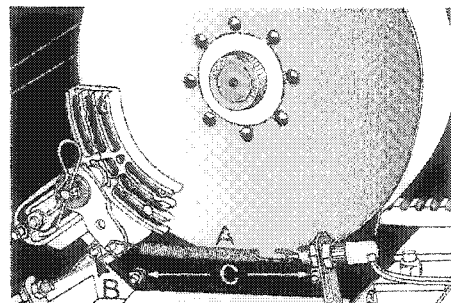
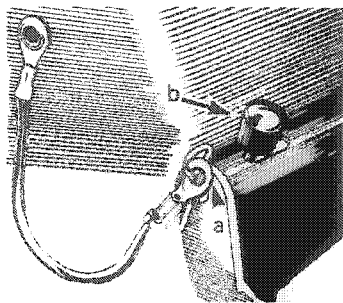
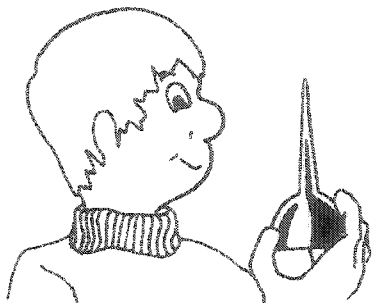

## LUBRICATION

### Frequency of Lubrication

It is recommended that the steering mechanism, the suspension and the driven pulley be lubricated monthly or after every 40 hours of operation. However, if the vehicle is operated in wet snow, the suspension and steering system should be lubricated more frequently.

### Pulley Guard Removal

1. Open engine cover.
2. Pull out retaining clip and pull on spring bolt to disengage pin from bracket.
3. Push pulley guard forward to disengage from bracket. Remove from vehicle.

**Warning: Engine should be running only when pulley guard is secured in place.**

### Drive Belt Removal

1. Open engine cover and remove pulley guard.
2. Disconnect the stop light spring (**A**) and the brake cable (**B**) from brake lever cam.
3. Remove the two bolts (**C**) holding the lower disc brake bracket to the frame then pivot the brake bracket assembly half a turn.
4. Open the driven pulley, (larger pulley most forward). Twist and push the sliding half then **hold** in open position.
5. Pull the bottom of belt in toward the front of the driven pulley then slip slackened belt over the top edge of the sliding half.
6. Slip the belt out from the drive pulley (centrifugal governor) and remove completely from vehicle by passing in between muffler and end of driven pulley.

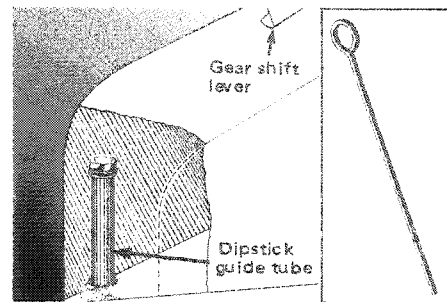
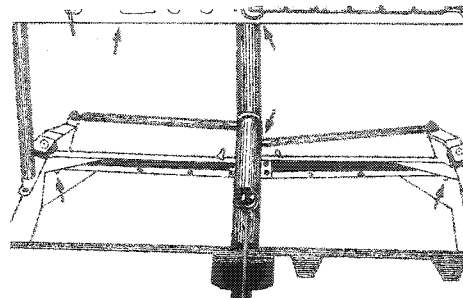
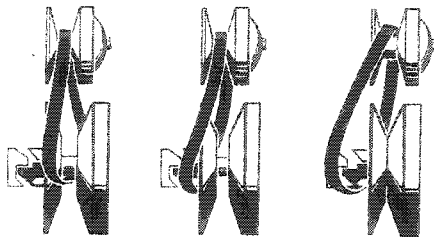

To install drive belt, reverse procedure.

**Warning:** Never run the engine without drive belt installed. Running an unloaded engine can prove to be dangerous.

**Tip**

A spare drive belt can be positioned and secured around the gear box for fast installation in the field. Make sure the spare belt doesn't rub against moving parts.

**Steering Mechanism**

Remove the floor paneling to access to the ski-leg grease fittings. Using low temperature grease, pump through the grease fitting of each leg until new grease appears at the joints. Inspect steering mechanism for tightness of components (steering arms, tie rods, etc.). Tighten if necessary. Reinstall floor paneling.

**Gear Box**

The gear box oil level should be checked weekly. A dipstick is provided with your tool bag. To check oil level, lift edge of seat leatherette and remove the bolt from the dipstick guide tube. (The tube is in front of the gear shift lever). Insert dipstick into tube then withdraw. Oil should reach the FULL mark on the dipstick. If not, remove filler cap (red cap) from top of gear box and replenish gear box with Ski-Doo\* chaincase oil. Reinstall bolt.

\*Trademark Bombardier Limited

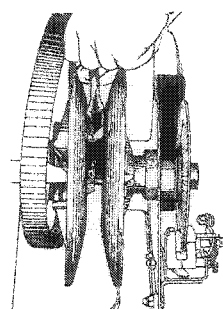
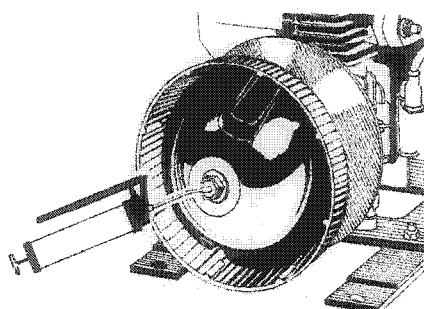
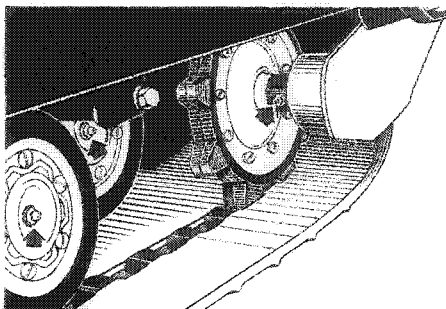

### Suspension

Grease the suspension bogie wheels with low-temp. grease. Pump through the grease fitting at the center of each wheel until new grease appears at the joint of inner side of shaft. Also grease rear axles at grease fittings using a low pressure grease gun.

### Drive Pulley

The drive pulley needs to be lubricated bi-monthly or every 20 hrs. of operation. To lubricate the pulley, open the engine cover and remove the pulley guard. Using a grease gun filled with low-temp. grease, pump **once** or **twice** through the grease fitting of the pulley.

**Caution:** Too much lubricant in the drive pulley will affect the drive belt. If necessary, lubricate the drive pulley more frequently. **Do not over-pack the pulley with lubricant.**

### Driven Pulley

With engine cover open, grease the driven pulley shaft as follows:

1. Remove pulley guard and slip drive belt from driven pulley.
2. Thoroughly clean the driven pulley shaft.
3. Apply a light coat of low-temp. grease on the shaft. Always lubricate lightly and wipe off surplus.

**Note:** Activate the sliding half several times to distribute lubricant over full length of shaft. Be careful that lubricant does not get on inner halves of pulley.

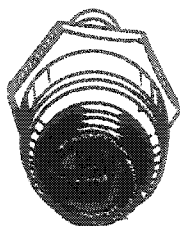

Carbonized

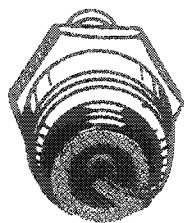

Normal

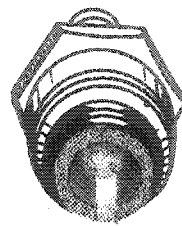

Burnt

## MAINTENANCE

Code	Weekly	Page
W1	Spark Plugs	14
W2	Battery (electrolyte level)	15
W3	Suspension Springs	15
W4	Track	15
W5	Track Tension and Alignment	15
W6	Carburetor Adjustment	16
W7	Drive Belt Condition	17
Code	Monthly	Page
M1	Battery (connections)	17
M2	Carburetor Flange Nuts	17
M3	Drive Chain Tension	17
M4	Brake	18
M5	Steering Adjustment	18
M6	Engine Head Nuts	19
M7	Engine Mount Nuts	19
M8	Vehicle General Inspection	19

### (W1) Spark Plugs

1. Open engine cover. Disconnect spark plug wires and remove plugs.
2. Check condition of plugs.
  - A brownish tip reflects ideal conditions (proper carburetor adjustment, spark plug heat range, etc.).
  - A black insulator tip indicates fouling caused by: carburetor idle speed mixture too rich. Incorrect fuel mixing ratio, wrong type of spark plug (heat range), or excessive idling.
  - A light grey insulator tip indicates a lean mixture caused by: carburetor idle speed mixture adjusted too lean, wrong spark plug heat range, incorrect fuel mixing ratio, or a leaking seal or gasket.

**Caution:** Having a spark plug with too hot a heat range will cause serious engine damage if the severity of engine operating conditions are greater than the plugs' intended range.

3. Check spark plug gap using a wire feeler gauge. Gap must be .020".
4. Reinstall plugs and connect wires.



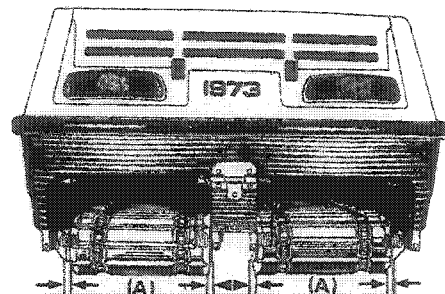
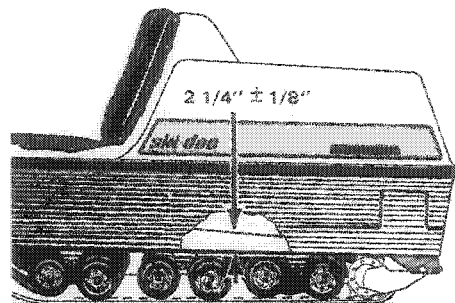

#### (W2) Battery

Remove battery caps then check electrolyte level at each cell. Electrolyte level must touch bottom of filler hole. If necessary, add distilled water.

#### (W3) Suspension Springs

With engine **off**, visually inspect suspension springs. Replace any weak or broken spring.

#### (W4) Tracks

Lift rear of vehicle and support it off the ground. Place gear shift lever in forward position. With engine **off**, rotate tracks by hand and inspect condition. If bad cuts or missing track inserts are noted, see your dealer.

**Note:** Without these inserts continual abrasion would wear and cut the track therefore, always replace a missing or damaged insert as soon as possible.

#### (W5) Track Tension and Alignment

Lift the rear of vehicle and support it off the ground. Using a rule, check track tension. (Take measurement from the middle set of bogie wheels.)

The tension of each track should be  $2\frac{1}{4}'' \pm \frac{1}{8}''$  between top inside edge of track and bottom of side member.

To adjust:

1. Loosen link plate spring lock nuts (4) located on inner side of link plate springs.
2. Turn outer side adjuster bolt(s) clockwise to tighten track(s), counter-clockwise to slacken.
3. Start engine and allow tracks to rotate **slowly**. Check if tracks are well centered and turn evenly on the rear sprockets. The distance (A) between track edges and link plates should be equal.

To correct:

1. Turn inner side adjuster bolt counter-clockwise to bring track closer to center link plate, turn clockwise to withdraw track from link plate.
2. Tighten link plate spring lock nuts.
3. Rotate tracks slowly and recheck alignment.

**Warning:** Before checking track alignment, ensure that the tracks are free of all particles which could be thrown out during rotation. Keep hands, feet and clothing clear of tracks.

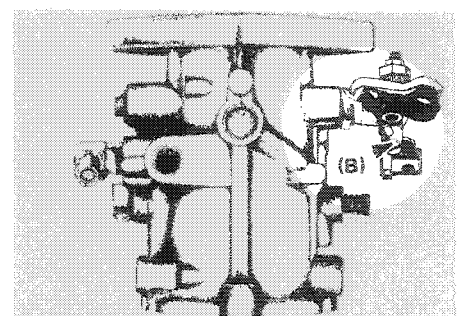
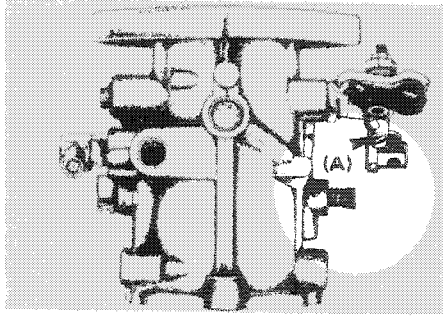

### (W6) Carburetor Adjustment

The carburetor adjustments for the Ski-Doo snowmobile are: Maximum Throttle Opening, Idle Speed Mixture and Idle Speed.

**Note:** A relationship exists between each adjustment. Do not correct one without checking the other.

#### Maximum Throttle Opening

With engine **off**, unscrew the Idle Speed Adjusting Screw until a gap exists between screw end and carburetor shaft lever. Depress the throttle lever at handlebar and hold. Butterfly should be horizontal when the lever gently touches the handlebar grip.

To adjust for maximum opening, loosen screw at point where cable joins carburetor lever. Hold throttle lever to handle-

bar. With finger, hold carburetor lever in fully open position (UP), pull cable downward until taut. Retighten screw.

**Warning:** Before starting engine, carburetor throttle lever must return to idle position by contacting with the tip of Idle Speed Adjusting Screw. Never start engine unless this situation is verified.

#### Idle Mixture Adjustment (A)

A primary adjustment (with engine **off**), should be made by first turning Idle Mixture Screw fully clockwise until closed. Back off screw  $3/4$  of a turn counter-clockwise.

Turning screw clockwise produces a leaner mixture, (more air/less fuel), counter-clockwise, a richer mixture (less air/more fuel).

**Note:** Do not close too tightly as needle and/or needle seat can be damaged.

For final adjustment, start engine and allow it to warm up. Turn Idle Mixture Screw until engine reaches maximum R.P.M. and obtain a steady idle and a fast response of the engine to the throttle.

#### Idle Speed Adjustment (B)

Turn the Idle Speed Adjusting Screw clockwise to increase idling speed, counter-clockwise to decrease.

**Caution:** Never operate vehicle with air intake tube removed as serious engine damage may occur.

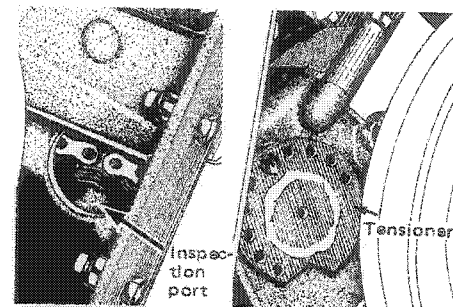
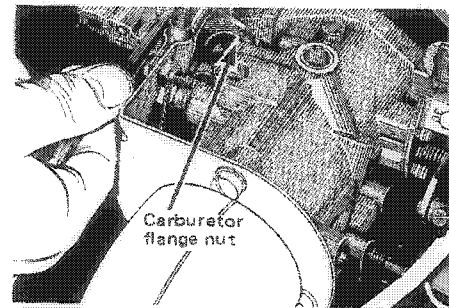

### (W7) Drive Belt Condition

Check condition of drive belt. Inspect for cracks, fraying or abnormal wear. (Uneven wear, wear on one side, etc.). If abnormal wear is noted, probable cause is misalignment of drive and driven pulleys. Contact your dealer. If belt is less than 7/8" wide it should be replaced.

### (M1) Battery Connections

Check that battery connections are tight and free of corrosion. If not, remove corrosion using a stiff brush then clean with a solution of baking soda and water. Rinse and dry well. After reconnecting, coat battery terminals and connectors with petroleum jelly to retard corrosion. Check that battery is well secured.

**Caution:** Do not allow cleaning solution

to enter battery. It will destroy the chemical properties of the electrolyte.

### (M2) Carburetor Flange Nuts

After the first 2 hours of operation, check tightness of carburetor flange nuts. Open tab locks, tighten nuts and close tab locks.

**Caution:** The tab locks should be changed after being opened three times.

### (M3) Drive Chain Tension

**Note:** Chain tension should also be checked after the first 5 hours of operation.

To check:

1. Run vehicle forward so that true free-play can be obtained.
2. Unfasten passenger seat belt, unscrew gear shift lever knob. Remove seats and access panels. Pull off inspection plug and check chain free-play. The free-play should be 1/4 inch.

If necessary to adjust:

1. Remove capscrew locking chain tensioner in place. Chain tensioner is located on driven pulley side.
2. Rotate tensioner to obtain correct free-play.
3. Re-install tensioner capscrew. Re-position access panels and seat. Install lever knob.

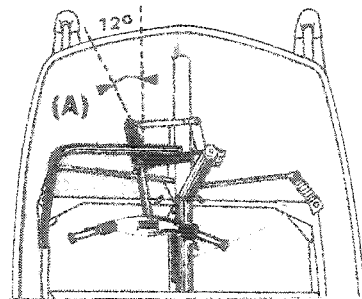
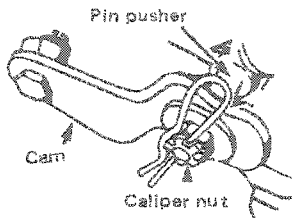
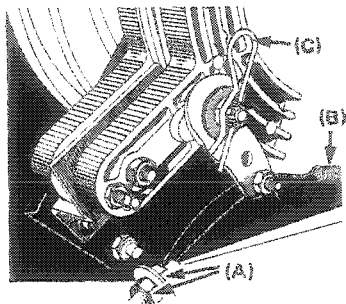

#### (M4) Brake

The brake mechanism on your snowmobile is an essential safety device. Keep this mechanism in proper working condition. Above all, do not operate your snowmobile without an effective brake system.

Check operation of brake mechanism by depressing brake lever. Brake should apply fully while lever is still 1 inch minimum from handlebar grip.

If adjustment is necessary:

1. With seats and access panel removed, position brake cable housing nuts (A) approximately half way on housing threads.
2. Disconnect stop light switch spring (B) and pull out the hair pin (C) locking the caliper nut.
3. Slacken off the cable retaining bolt and manoeuvre the lower brake lever and brake cable until the pin pushers are seated di-

rectly in the deepest section of the cam of the brake lever. Lock cable in position.

4. Tighten the caliper nut until a disc/puck friction is felt. Back off nut slightly and install hair pin.

5. Connect brake light spring. Reinstall access panel and seats. Check brake operation.

**Note:** Always check the stop light to see if it functions after performing brake adjustment. If necessary, loosen stop light switch lock nuts and adjust to proper length. Check fuse condition.

#### (M5) Steering Adjustment

Skis should be parallel to each other and to vehicle when the handlebar is horizontal. To check, measure distance between skis at front and back.

If out of alignment:

1. Remove foot panels and loosen the tie rod lock nuts.
2. Turn one or both tie rods until skis are aligned. Tighten the lock nuts firmly against the tie rods. Re-install foot panels.

**Note:** Make sure that the handlebar forms an angle of approximately 12° with the steering arm (A). To obtain, unlock upper tie rod and turn it until the steering arm angle is correct. If necessary, reposition handlebar on steering column spline.

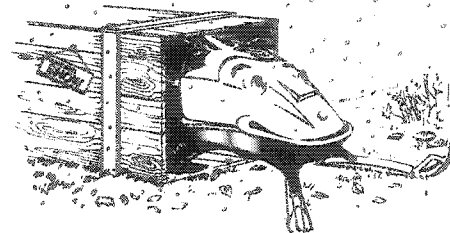
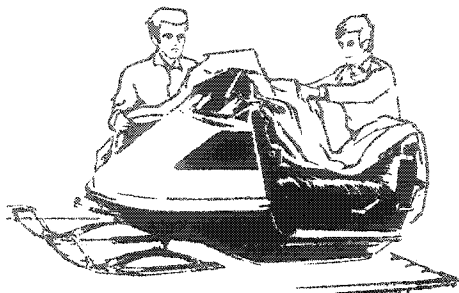

## OFF SEASON CARE

## PRE-SEASON PREPARATION

### (M6) Engine Head Nuts

Check that engine head nuts are tight and equally torqued, (16-18 ft/lbs with engine cold).

### (M7) Engine Mount Nuts

Check engine mount nuts for tightness. Retighten if necessary.

### (M8) Vehicle General Inspection

Check electrical wiring and components, retighten loose connections. Check for stripped wires or damaged insulation. Repair or replace as necessary. Thoroughly inspect the vehicle and tighten loose bolts, nuts or linkage. Check condition of ski runners.

To protect your vehicle during the inactive period, we recommend to perform all lubrication and maintenance procedures previously mentioned, plus the following:

- Suspension: Store the vehicle in such a way that the tracks do not stay in contact with cement floor or bare ground. Do not unhook link plate springs. Rotate tracks every 40 days.
- Fuel System: Syphon gas tank. Disconnect carburetor inlet fuel line. Dry out carburetor by running engine out of gas.
- Pulleys: Remove drive belt. Spray internal faces of pulleys with metal protector.
- Engine: Lubricate cylinder by pouring a spoonful of Ski-Doo oil through spark plug hole then manually crank engine slowly 10 or 12 times.
- Electrical System: Remove battery. Clean. Charge every 40 days.

If you have performed the off season care procedures your vehicle preparation becomes a relatively easy task.

- Connect fuel line and fill up gas tank.
- Clean pulley faces and install drive belt.
- Install new spark plugs.
- Install battery.
- Check gear box oil level.

**Note:** If you lack the time or tools to complete the off season and/or pre-season procedures, we suggest that you contact the Ski-Doo dealer of your choice and obtain his professional assistance.

## TROUBLE SHOOTING GUIDE

Symptoms	Possible Causes	What To Do
Engine turns over but fails to start or starts with difficulty	1. No fuel to the engine	Check the tank level and fill up with correct gas-oil mixture. Check for possible clogging of fuel line, item 5.
	2. Spark plug	Check for fouled or defective spark plug. Disconnect spark plug wire, unscrew plug and remove from cylinder head. Reconnect wire and ground exposed plug on engine head, being careful to hold away from spark plug hole. Turn key to ON position, crank engine manually and check for sparks. If no sparks appear, replace spark plug. If trouble persists, check item 3.
	3. Faulty ignition	Disconnect spark plug wire from plug, unscrew the spark plug cap then hold wire about 1/8" from the cylinder head. Turn key to ON position, crank engine manually and check if sparks appear. If no sparks appear it means a faulty ignition system. Do not attempt to repair. Contact your dealer.
	4. Flooded engine	Pull choke knob to OFF, wait 60 seconds or more then depress throttle lever fully and try to start engine. <b>Release throttle lever immediately after engine starts.</b>
	5. Clogged fuel line (water or dirt)	Remove and clean the carburetor filter. Change filter cartridge if necessary. Check condition and connections of fuel lines. Check the cleanliness of the fuel tank.
	6. Faulty Carburetor	First make primary adjustments on carburetor (See Maintenance Section). If carburetor is still faulty, contact your dealer for repair.
	7. Too much oil in fuel	Syphon the fuel tank and refill with the correct gas/oil mixture.
	8. Breaker points	Breaker points may be worn or out of adjustment. Contact your dealer.
	9. Poor engine compression	Running with a lean fuel mixture may produce excessive engine wear resulting in poor engine compression. If this occurs, contact your dealer at once.
Engine will not turn manually	1. Seized engine	In the case of a seized engine, contact your dealer. Seizure is a direct result of poor lubrication.

Symptoms	Possible Causes	What To Do
<b>Engine will not start.</b> <b>Note: If failure is in starting system, engine will start manually.</b>	1. Poor connections or burnt fuse	Check for loose or corroded battery and starter connections. Clean and tighten. Try to restart engine electrically. If engine still does not start, check item 2.
	2. Battery	Check condition of battery, it may be discharged or defective. Contact your dealer to charge or replace.
	3. Starter	If wire connections are tight and battery is in working order, most probable cause of trouble is defective starter. Contact your dealer for repair.
<b>Engine lacks acceleration or power</b>	1. Fouled or defective spark plug	Check item 2 of "Engine turns over but fails to start or starts with difficulty".
	2. Clogged fuel line (water or dirt)	Check fuel line condition. (See item 5 of "Engine turns over but fails to start or starts with difficulty").
	3. Carburetor	Readjust the carburetor. (See Maintenance Section). If trouble persists, contact your dealer.
	4. Defective ignition	First check item 2 and 3 "Engine turns over but fails to start or starts with difficulty". If the ignition system still seems defective, contact your dealer.
	5. Engine	If unable to locate specific symptoms, contact your dealer.
<b>Engine continually backfires</b>	1. Faulty spark plug	Check item 2 of "Engine turns over but fails to start or starts with difficulty".
	2. Overheating	Contact your dealer.
	3. Engine timing incorrectly set.	Contact your dealer.
<b>Vehicle cannot reach full speed</b>	1. Drive belt	Check for defective or worn drive belt. Replace if necessary.
	2. Incorrect track adjustment	Check tension and alignment of tracks. Readjust to specifications. (See Maintenance Section).
	3. Faulty engine	Check items 1 to 5 of "Engine lacks acceleration or power".
	4. Pulley misaligned	Contact your dealer.

## 1973 SKI-DOO WARRANTY

Bombardier Limited (Bombardier) as manufacturer, warrants every 1973 Ski-Doo snowmobile, Ski-Boose or Carry-Boose tow sled, SOLD AS A NEW VEHICLE, BY AN AUTHORIZED SKI-DOO DEALER, to be free from defects in material, and workmanship under normal use and service, for a period of ninety (90) days subject to the following coverage period:

1. Beginning no sooner than from the date of delivery to the first retail buyer, for a period of ninety (90) consecutive days.
2. Since snow is required for snowmobiling; all deliveries **prior to December 15th, 1972**, shall be covered under this warranty from **December 15th, 1972 to March 15th, 1973**.
3. All units delivered on or after **January 2nd, 1973**, but prior to **March 31st, 1973**, shall have a warranty carry-over into the next season, starting on **December 15th, 1973**, for the unused portion of the ninety (90) day warranty.

### CONDITIONS

1. That maintenance be performed, at the owner's expense, as set down in the applicable owner's manual. Any failure which occurs as a result of inadequate maintenance † or improper use shall not be assumed by this warranty.
2. Any damages to any part of the above-mentioned vehicles and their components caused through improper use or maintenance or by any part installed which is not a genuine Ski-Doo replacement part, or not installed by an authorized Ski-Doo dealer, voids any future warranty

coverage to the affected parts.

3. This warranty does not apply to any defect which results from:
  - i) misuse or accident;
  - ii) Installation of repair parts other than genuine Bombardier replacement parts or;
  - iii) Repairs by any person other than an authorized Ski-Doo snowmobile dealer;
  - iv) Lack of preventative maintenance;
  - v) Alterations or modifications other than those approved in writing by Bombardier.
4. Proof of ownership and warranty registration must be submitted to the service dealer by means of the Ski-Doo Service Card.

† **Guidelines for proper use and maintenance are detailed in each owner's manual.**

### EXCLUSIONS

- **Maintenance Items and Services** are considered non-warrantable and necessary to proper functioning of the vehicle, and without limiting the foregoing the following parts and services are excluded:
- Variable speed drive belt, fan belt, windshield, filters, ignition breaker points and condensers, spark plugs, light bulbs and protective lenses, brake linings, ski runner shoes, slider shoes on variable speed pulleys, all fasteners, labels, soft trim and appearance items, lubricants and paints, and all tune-ups or adjustments required.



- Any part damaged through lack of lubrication unless it is proven to be attributable to a manufacturing defect
- Blizzard models or any of the vehicles referred to in this text which may have been used for racing or professional competition
- Any damages resulting from an accident unless such damages are proven to result from a manufacturing defect
- Any losses incurred to the vehicle owner other than the parts and labour required to repair the warrantable defect

This warranty is expressly in lieu of all other expressed or implied warranties of Bombardier, its distributors and the selling dealer, including any implied warranty of merchantability or fitness for any particular purpose. Neither Bombardier, its distributors nor the selling dealer shall be responsible, under any circumstances, for any loss or damage as a result of hidden defects, accidents, misuses or other faults.

Neither the distributor, the selling dealer nor any other person has been authorized to make any affirmation, representation or warranty other than those contained in this warranty and if made, such affirmation, representation or warranty shall not be enforceable against Bombardier or any other person.

**BOMBARDIER LIMITED**  
**FEBRUARY 2, 1972**

**NOTE:** *In the event of change of ownership, complete the notice of transfer form below in order to qualify the new owner for balance of warranty. All such transfers should be reported to an authorized Ski-Doo dealer for modification of the Ski-Doo Service Card. In the event of a lost Service Card, contact the original selling dealer for completion of the "Request for New Service Card" form. For a \$2.00 handling charge, Bombardier will mail your new personalized Service Card to you.*

**Bombardier Limited,**  
**Valcourt, Québec, Canada. February 1972.**

**NOTICE OF TRANSFER**

Model  Vehicle Serial No.

The ownership of this vehicle is transferred  
 From \_\_\_\_\_

\_\_\_\_\_  
 Signature of registered owner

To \_\_\_\_\_  
 Full name of purchaser *Block letters*

Address \_\_\_\_\_  
 No Street or Village

\_\_\_\_\_  
 City County Date



## SPECIFICATIONS

ITEM	ELITE	440
Engine	No. of Cylinders	Two
	Bore	67.5mm
	Stroke	61mm
	Displacement	436.6cc
	Compression Ratio	10:1
	Carburetor (Tillotson)	HD
	Starting	Electric
	Horse Power	30
Chassis	Overall length	103"
	Overall width	44"
	Height	52"
	Height w/o windshield	35"
	Weight (lbs)	682
	Bearing area	1812 sq.in.
	Ground pressure (p.s.i.)	.376
Power train	Track width	2 X 15"
	Std. gear ratio	17/46
Electrical System	Lighting coil output	120 watt
	Headlamp (watt)	35/35
	Tail/Stop light	8/23
	Spark plug (Bosch)	M-280-T-31
	Spark plug gap	.020"
Breaker points gap	.014" - .018"	
Fuel	Tank capacity – Imp.	5.5
	– U.S.	6.42
	Gasoline	Regular
	Gas/oil ratio	40/1
Brake	Type	Disc