

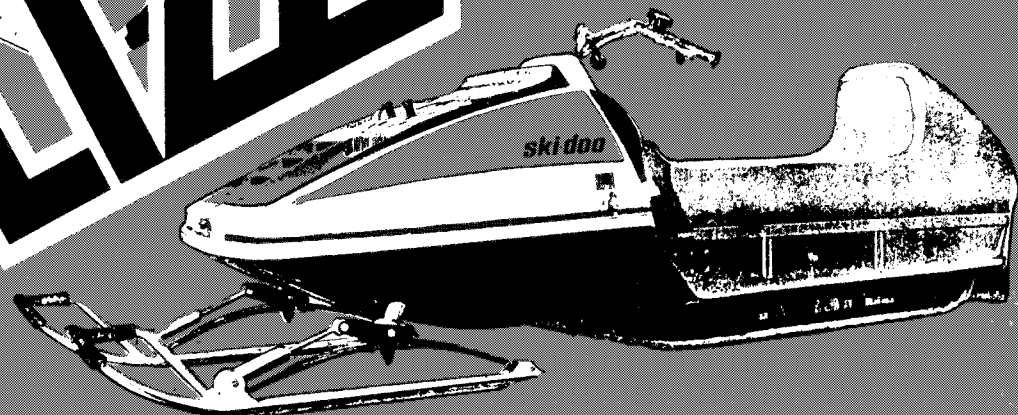

ski-doo.

# BLIZZARD

Owner's Manual  
'73



# \$250,000 available in prize money for '73

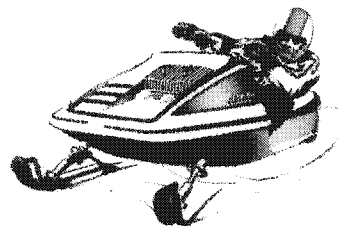

\$100,000, more prize money for racers who ride Ski-Doo machines . . . a total of up to a quarter of a million dollars to be won this season . . . more sponsored meetings . . . This is part of the new racing program announced by the Ski-Doo division of Bombardier Limited.

Last year the company came up with a \$150,000. incentive program for 29 major races in Canada and the U.S. This year the program offers more money, and includes 38 major races.

The incentives are as follows: in the modified classes \$500., \$300. and \$100. for first, second and third places; in the stock classes \$300., \$150. and \$75.; and in endurance races the 1st gets \$2,000., 2nd \$1,500., 3rd \$800., 4th \$400., 5th \$200., and 6th \$100.

The cheques will be presented by the Ski-Doo distributor, in whose territory the sponsored races are held.

At a sponsored meeting, the program entry form will state clearly which classes are eligible for Ski-Doo prize money. The entry forms are available from the race-organizers' registration offices.

The prize money does not go to the Ski-Doo Factory Racing Team. When any one of our track stars come in first, second or third, the prize money goes to the Ski-Doo snowmobile rider who comes in first, second or third after them. In other words, if the factory team wins an endurance race, and an individual Ski-Doo snowmobile owner finishes second, the \$2,000. goes to the individual and not to the team.

In order to protect the winning eligibility of independent racers, this offer is not valid for the Bombardier Limited Racing Team Personnel and families of Bombardier Limited.

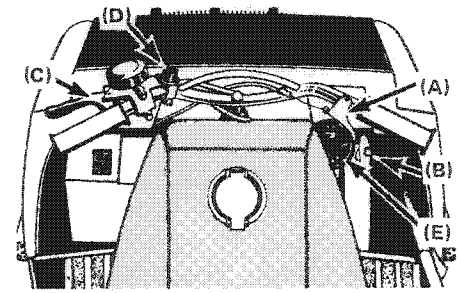
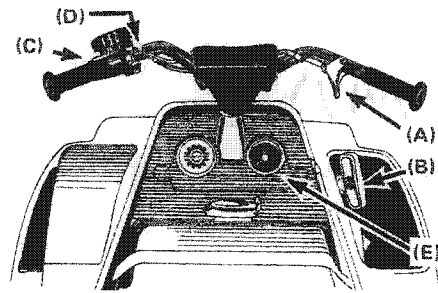

## INDEX

CONTROLS/INSTRUMENTS .....	1
FUEL MIXING .....	2
BREAK-IN PERIOD .....	3
STARTING PROCEDURE .....	3
LUBRICATION .....	4,5,6
MAINTENANCE .....	7,8,9,10,11
SPECIFICATIONS .....	12

## CONTROLS/INSTRUMENTS

### Throttle Lever (A)

### Manual Starter (B)

### Brake Lever (C)

When applied activates the hydraulic disc system bringing the vehicle to a fast smooth stop.

**Warning:** It is strongly recommended that you familiarize yourself with the positive braking action of this system.

### Kill Button (D)

To stop engine for any given reason, merely depress button. Wearing the emergency bracelet with its pin inserted into the kill button at the ON (depressed) position ensures engine cut-out should you unvoluntarily leave the vehicle.

Reinserting the pin will complete the electric circuit and allow the engine to restart.

**Warning:** If the button has been used in an emergency situation, the source of malfunction should be determined and corrected before restarting engine.

### Tachometer (E)

Standard equipment on all models. Registers magneto impulse. Direct-reading dial indicates, in thousands, the number of revolutions per minute, R.P.M., of the engine.

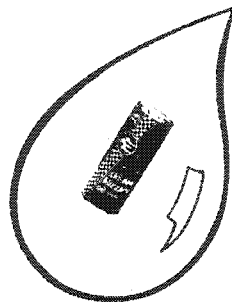
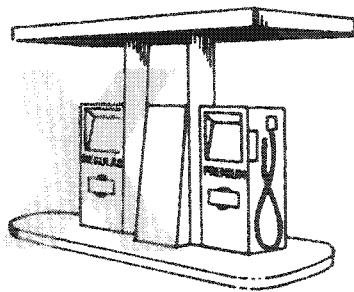

# 30:1

## FUEL MIXING

### Gasoline.

The correct gasoline for your Blizzard snowmobile is **premium** gasoline, (not less than 98 octane).

### Oil.

Use only Blizzard oil available at your Ski-Doo dealer. This oil type has an especially formulated oil base to meet the lubrication requirements of the Bombardier-Rotax engine. (If Blizzard oil is unavailable, concentrated Ski-Doo oil can be used.)

**Caution:** The carburetors of the 1973 Ski-Doo snowmobile have been calibrated for a mixture of gasoline and concentrated Blizzard oil. Unless absolutely necessary, do not use regular snowmobile oil. If such oil is used, observe mixing instructions on the container. Never use outboard or straight mineral oils.

### Fuel Mixing Ratio.

The correct fuel mixture ratio is 30/1. 3 3/4 U.S. gallons or 3 Imperial gallons **premium** gasoline plus 1 pint concentrated Blizzard oil, 16 ounces = correct fuel mixture.

**Caution:** To facilitate fuel mixing oil should be kept at room temperature.

### Fuel Mixing Procedure.

To mix the gasoline and oil always use a separate clean container. Never mix directly in your snowmobile tank.

**Warning: Gasoline is flammable and explosive under certain conditions. Store in a well ventilated area. Always stop the engine and do not smoke or allow open flames or sparks near the vehicle when refuelling. If gasoline fumes are noticed while driving, the cause should be determined and corrected without delay.**

Pour approximately one gallon of gasoline into a separate, clean container. Add the full amount of concentrated Blizzard oil. Shake the container thoroughly then add the remainder of the gasoline. Once again, thoroughly agitate the container.

Using a funnel with a fine mesh screen to prevent the entry of water and foreign particles, transfer the mixture from the container into the snowmobile tank.

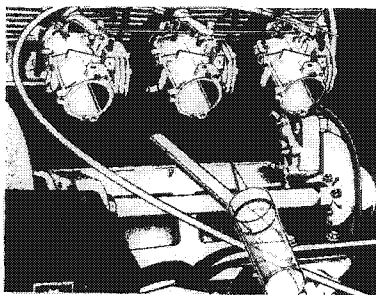
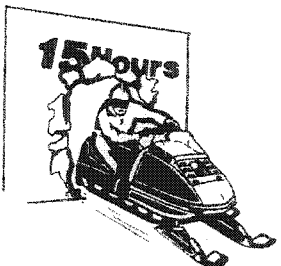

## BREAK-IN PERIOD

With Blizzard snowmobile engines, a break-in period is required before running the vehicle at full throttle.

Manufacturer's recommendation for the Bombardier-Rotax engine is 2 to 5 operating hours. During this period, maximum throttle should not exceed  $\frac{3}{4}$ . However, while cruising, brief full throttle accelerations contribute to a good break-in. Continued wide open throttle accelerations can be detrimental. Never let your engine overheat.

**Note:** Horsepower loss can be attributed to incorrect or lack of a break-in period.

After first three hours of vehicle operation, the engine head nuts should be torqued to 16-18 ft/lbs with engine **cold**.

## STARTING PROCEDURE

**Warning:** Never run engine at high R.P.M. when the track of the vehicle is raised off the ground.

1. Using a squish bottle containing pre-mixed gas and oil, inject two or three squirts into carburetor throats. (The choke butterfly has been removed to increase air breathing).
2. Test throttle lever operation. If the lever does not return swiftly, remove cable and/or housing and replace.

**Warning:** Do not start the engine until throttle lever returns swiftly.

3. Apply throttle lever slightly.
4. Grasp manual starter handle firmly and pull slowly until a resistance is felt then pull vigorously and engine will start. Do not pull starting rope to its fullest extent. Allow handle to return slowly to its original position. If engine does not start, repeat procedure.

5. Allow the engine to warm up before operating at full throttle.

### Flooding

Feeding an excessive amount of fuel mixture into the engine will make it difficult to start. Flooding characteristics are easily detectable by fuel moisture dripping from the carburetors, or wet spark plug faces. If engine has flooded, depress throttle lever fully and continue starting procedure. **Release throttle lever immediately after engine starts.**

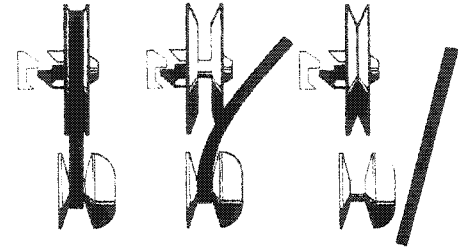
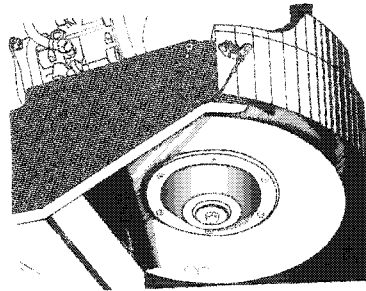
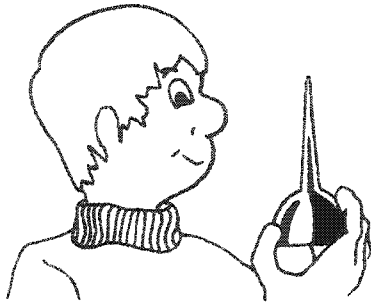

## LUBRICATION

Code	Weekly	Page
L1	Rotary Valve System	5
L2	Steering Mechanism	5
L3	Chaincase Oil Level	5
L4	Driven Pulley	6

Code	Monthly	Page
L5	Hydraulic Disc Brake	6

### Pulley Guard Removal

Tilt or remove cab, pull out upper retaining clip and remove wing nut. Tilt pulley guard forward. To remove completely, remove front locking clip and disengage pin from bracket.

**Warning: Never start the engine or operate the vehicle without the pulley guard installed.**

### Drive Belt Removal

1. Tilt or remove cab. Remove pulley guard. Open the driven pulley, twist and push the sliding half, and hold in place.
2. Pull the bottom of belt in toward the driven pulley then slip slackened belt over the top edge of driven pulley.
3. Slip the belt from the drive pulley. To install, follow reverse procedure.

**Warning: Never start or run the engine without drive belt installed.**

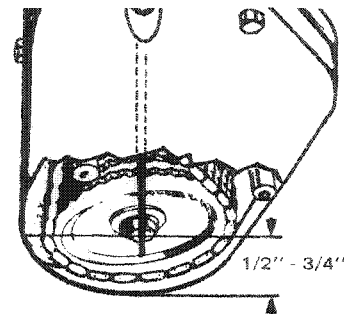
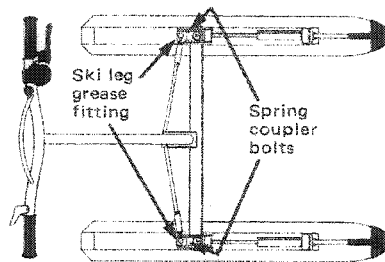

### (L1) Rotary Valve System

#### 298-345 Models

Check reservoir oil level frequently. Level should be 1/2 inch from top of plastic reservoir located on upper column. Replenish, using Ski-Doo chaincase oil.

**Caution:** Never operate engine without adequate inlet/outlet oil circulation. If circulation is poor or non-existent, fill reservoir, remove spark plugs and crank engine until oil circulates.

#### 441 model

Remove white plug located on exhaust side of engine and check if oil level is flush with bottom lip of hole. Replenish using chaincase oil. To facilitate drainage, a drain plug is located on the lower crankcase half.

### (L2) Steering Mechanism

Oil spring coupler bolts. Lubricate ski legs at grease fittings until new grease appears at joints.

### (L3) Chaincase Oil Level

Remove filler cap and using a rigid wire, check oil level. The oil level on the "dipstick" should be 1/2" - 3/4" max. When necessary, replenish using Ski-Doo\* chaincase oil. The oil capacity is approximately 6 ozs.

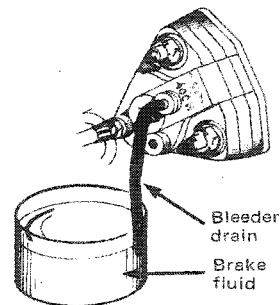
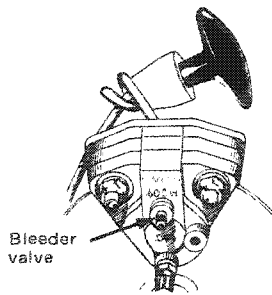
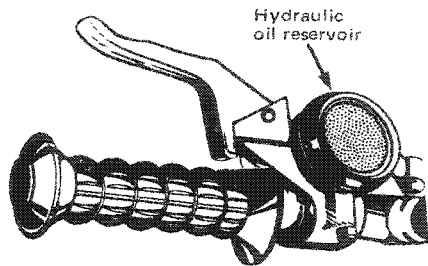

#### (L4) Driven Pulley

1. Remove or tilt cab, remove pulley guard and drive belt. Open driven pulley and thoroughly clean pulley shaft. Keep pulley shaft free of drive belt grime. (The driven pulley bushing does not require lubrication.)

#### (L5) Hydraulic Disc Brake (Oil level)

Brake hoses should be checked for abrasion and signs of leakage. The fluid level in the master cylinder should also be checked.

**Caution:** Use only hydraulic brake fluid available from your Ski-Doo\* dealer. Never re-use brake fluid obtained by bleeding.

To check fluid level, turn handlebar to right and remove reservoir cover located on handlebar. Fluid must reach top lip of reservoir. The diaphragm must contact the brake fluid.

**Warning:** The entry of dirt or foreign particles into the brake fluid may constitute system flushing.

#### Filling and Bleeding

If the reservoir is low and/or air has entered the system creating a soft, spongy braking action, the following should be done:

1. Remove reservoir cover and diaphragm, then "top up" fluid level. (Retain this reservoir level throughout the following procedure.)
2. Connect a bleeder drain to the valve and insert end of bleeder hose into a container of brake fluid.
3. Repeatedly depress the brake lever in quick succession, (pumping), to obtain pressure. Once obtained, hold lever, open bleeder valve then quickly depress brake lever. Close bleeder valve and allow brake lever to return slowly.
4. Continue pressing and releasing brake lever until the fluid injected into the container is air free.
5. Disconnect bleeder hose, recheck brake fluid level and install reservoir cover.

**Note:** Change brake fluid at least once during the snowmobiling season.

\*Trademark Bombardier Limited



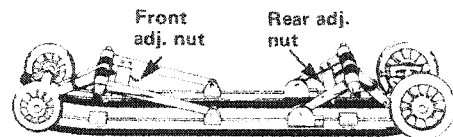
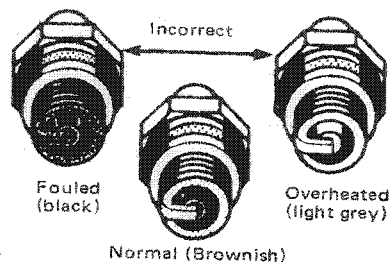

## MAINTENANCE

Code	Weekly	Page
W1	Spark Plugs	7
W2	Suspension Springs	7
W3	Track Condition	8
W4	Track Tension	8
W5	Track Alignment	8
W6	Chain Tension	8
W7	Carburetor Adjustment	9
W8	Drive Belt Condition	10
Code	Monthly	Page
M1	Carburetor Flange Nuts	10
M2	Steering Adjustment	10
M3	Engine Head Nuts	10
M4	Engine Mount Nuts	10
M5	Pulley Alignment	11
M6	Slider Shoe Wear	11
M7	Vehicle General Inspection	11

### (W1) Spark Plugs

1. Disconnect spark plug wires and remove spark plugs.
2. Check condition of plugs:
  - A brownish tip reflects ideal conditions, (correct carburetor adjustment, spark plug heat range, etc.)
  - A black insulator tip indicates fouling caused by; carburetor idle speed mixture and/or high speed mixture too rich incorrect fuel mixing ratio, wrong type of spark plug (heat range), or excessive idling.
  - A light grey insulator tip indicates a lean mixture caused by: carburetor high speed mixture adjusted too lean, wrong spark plug heat range, incorrect fuel mixing ratio, or a leaking seal or gasket.

- Caution:** If, when checking spark plug color, you find that the engine is not running under ideal conditions, contact your authorized Ski-Doo dealer.
3. Reinstall plugs and connect wires.

### (W2) Suspension Spring Adjustment

With engine **off**, visually inspect suspension springs. Replace any broken spring. The suspension is adjustable, the front adjustment for the surface condition, the rear for driver's weight. In either case, both sides of the adjustment should be equal.

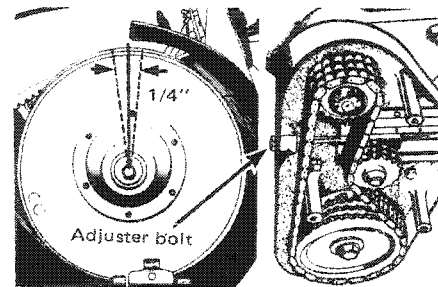
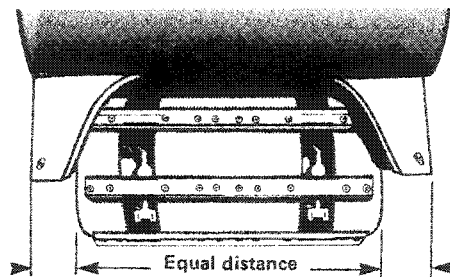
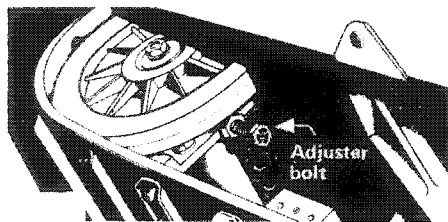

### (W3) Track Condition

Lift the rear of the vehicle and support it off the ground so that the track is free to turn. With engine **off**, rotate track by hand and visually inspect track condition. Pay particular notice to cross links and rivets.

### (W4) Track Tension

Lift rear of vehicle and support it off the ground. Allow pressure of slide to extend track normally. The slider shoes should be just touching the cross links or track inserts.

If track tension is too loose, the track will have a tendency to thump. If too tight, performance will be affected. Adjust to correct tension by loosening or tightening adjuster bolts.

**Note:** Track tension and alignment are inter-related. Do not adjust one without the other.

### (W5) Track Alignment

After track tension has been corrected start the engine and accelerate slightly so that track turns **slowly**. Check that track is well centered and turns evenly. To correct, loosen the lock nut and tighten the adjuster bolt on side where track is closest to the frame. Tighten lock nut and recheck alignment.

### (W6) Chain Tension

The correct chain tension is 1/4" at driven pulley level. To check, with engine **off**, move driven pulley from side to side. To correct, unlock tensioner bolt then turn clockwise to increase free-play, counter-clockwise to decrease.

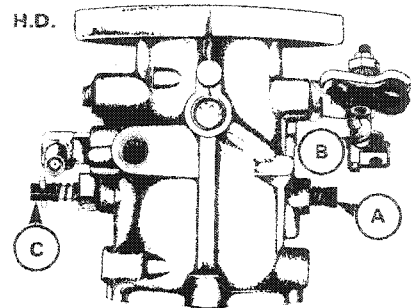
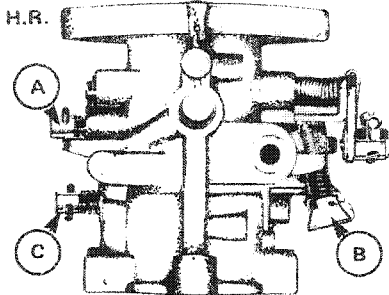

### (W7) Carburetor Adjustment

There are four different adjustments for the carburetor.

(1) Maximum Throttle Opening, (2) Idle Speed Mixture, (3) Idle Speed, and (4) High Speed Mixture.

#### Maximum Throttle Opening

With engine **off**, adjust throttle cable and rod so that the throttle butterflies are horizontal when throttle lever gently touches handlebar.

**Warning:** Before starting engine make sure carburetor throttle levers return to idle position when handlebar throttle is released.

#### Idle Mixture (A)

A primary adjustment (with engine **off**) should be made by first turning Idle Mixture Screws fully clockwise until closed. Do not close too tightly as needle and/or needle seat can be damaged. Back off screws counter-clockwise as follows:

298	1 1/8 turn
345	1 turn
441	1 1/2 turn
645	1 1/2 turn
797	1 1/2 turn

For final adjustment, start engine and allow it to warm up. Turn Idle Mixture Screws until engine reaches maximum R.P.M. and obtain a steady idle and a fast response of engine to the throttle.

Turning Idle Mixture Screw clockwise produces a leaner mixture; (more air/less fuel); counter-clockwise, a richer mixture (less air/more fuel).

#### Idle Speed (B)

Turn the Idle Speed Adjusting Screws clockwise to increase idling speed, counter-clockwise to decrease.

#### High Speed Mixture (C)

**Warning:** High speed mixture adjustment must be carried out only by an authorized Ski-Doo dealer.

For primary adjustment however, with engine **off**, turn High Speed Mixture Adjusting Screws fully clockwise until closed. (Do not close too tightly as screws and/or screw seats can be damaged). Back off screws counter-clockwise as follows:

298	1 turn
345	1 turn
441	1 1/2 turn
645	1 1/2 turn
797	1 1/2 turn

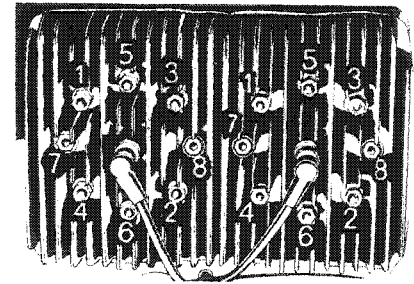
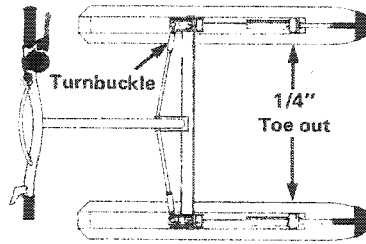

#### **(W8) Drive Belt Condition**

Remove cab and inspect drive belt for wear. If belt is less than 1" wide, replace. Check condition of belt. Inspect for cracks, fraying or abnormal wear (uneven wear, wear on one side, etc.). If abnormal wear is noted, probable cause is pulley misalignment.

#### **(M1) Carburetor Flange Nuts**

After the first two (2) hours of operation, check tightness of carburetor flange nuts. Tighten, if necessary.

#### **(M2) Steering Adjustment**

Skis should have a toe out of 1/8" to 1/4" max. To check, measure distance between skis at front and rear of leaf springs. If adjustment is required, position handlebar so that it is horizontal to vehicle. Release turnbuckle locknuts and rotate one or both turnbuckles to obtain correct toe out. Firmly retighten locknuts.

#### **(M3) Engine Head Nuts**

Remove cab and check head nut torque. (16 to 18 ft/lbs when **cold**). (Always torque in a cross sequence.)

#### **(M4) Engine Mount Nuts**

With cab removed check engine mount nuts. Torque to 25-35 ft/lbs.

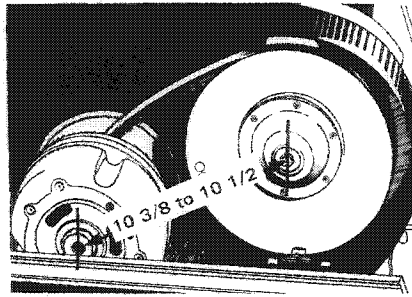
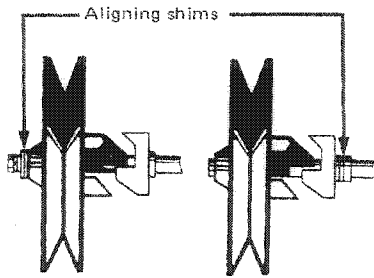

#### (M5) Pulley Alignment

Due to the installation position and method of attachment, the distance between the center of the drive and driven pulley shafts is non adjustable. Should this distance vary, inspect engine mounts for security, distortion, etc. Distance should be: 10 3/8" to 10 1/2".

Pulley offset is  $1/2" \pm 1/16"$ . When greater, transfer aligning shims from cam side to fixed pulley half side of the driven pulley. When less than  $7/16"$ , transfer shims from fixed pulley half to cam side of driven pulley.

Verify tension of driven pulley spring, it should be as follows;

298-345 9 lbs

441-645-797 13 lbs

If correction is required, relocate spring end.

#### (M6) Slider Shoe Wear

During normal driving, snow will act as a lubricant and coolant for the slider shoes. Extensive riding on ice or sanded snow, (not to mention dirt, asphalt, etc. never recommended) may create excessive heat build up and cause premature slider shoe wear. Always inspect shoe condition and replace as necessary prior to all races.

#### (M7) Vehicle General Inspection

Check electrical wiring and components, retighten loose connections. Check for stripped wires or damaged insulations. Thoroughly inspect the vehicle and tighten loose bolts, nuts and linkage.

### 298 - 345 and 441 models

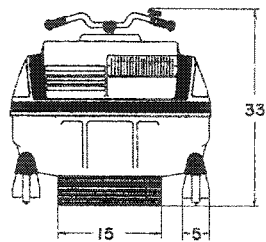
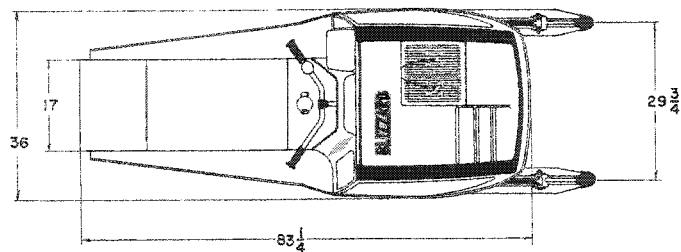
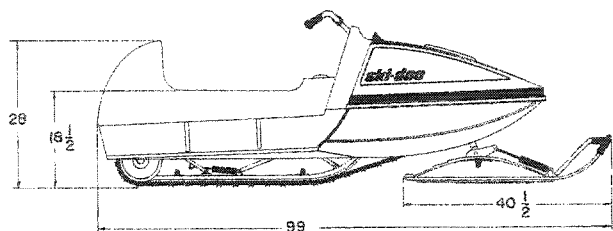

### 645 - 797 models

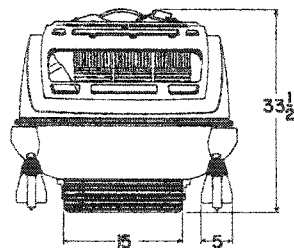
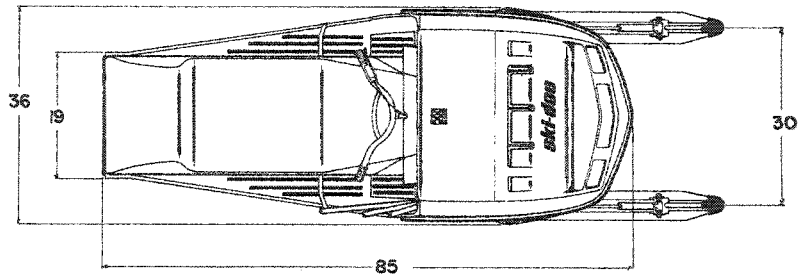
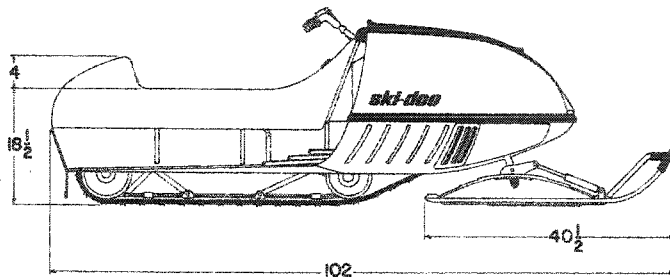

# SPECIFICATIONS

BLIZZARD	ITEM	298	345	441	645	797
Engine	No. of cylinders	2	2	2	3	3
	Bore	58.5mm	63mm	67.5mm	67mm	74.5mm
	Stroke	54mm	54mm	61mm	61mm	61mm
	Displacement	290.3cc	336.7cc	436.6cc	645.2cc	797.7cc
	Compression Ratio	11.8:1	11.8:1	11.0:1	12.0:1	12.3:1
	Carburetor (Tillotson)	2 X HR	2 X HR	2 X HD	3 X HD	3 X HD
Chassis	Overall Length	99"	99"	99"	102"	102"
	Overall Width	36"	36"	36"	36"	36"
	Height	29"	29"	29"	33 1/2"	33 1/2"
	Bearing Area	1092 sq.in.	1092 sq.in.	1092 sq.in.	1117 sq.in.	1117 sq.in.
	Suspension	Slide	Slide	Slide	Slide	Slide
Power train	Track Width	15"	15"	15"	15"	15"
	Track Material	cleated or rubber				
	Standard Gear Ratio	13/40	14/40	16/40	18/40	19/40
Ignition	Lighting Coil	No	No	75W	No	No
	Spark Plugs (Bosch)	W300-M-2	W300-M-2	W300-M-2	W300-M-2	W300-M-2
	Breaker Points (gap)	Polar fire CD system			.014" - .018"	.014" - .018"
Fuel	Tank Capacity (Imp)	1.92	1.92	1.92	5.2	5.2
	(US)	2.30	2.30	2.30	6.5	6.5
	Mixing Ratio Premium gas/Blizzard oil	30/1	30/1	30/1	30/1	30/1
Brake	Type	hydraulic disc				

**Arts**Graphiques

Bombardier Limited, Valcourt, Quebec, Canada.  
Litho'd in Canada. 480-0052

**BOMBARDIER LIMITED**

*All rights reserved ©Bombardier Limited 1972*

