

BOMBARDIER



OPERATOR'S GUIDE

DS 7404



 **WARNING**

Read this guide thoroughly.
It contains important safety information.
Minimum recommended operator age:
16 years old.

704 000 008

Particularly important information in this Operator's Guide is designated by the following:



The Safety Alert Symbol means ATTENTION!



WARNING

Identifies an instruction which if not followed, may cause injuries including the possibility of death.

CAUTION: Denotes an instruction which if not followed, may damage the ATV and/or components.

WARNING

YOUR ATV CAN BE HAZARDOUS TO OPERATE. A collision or rollover can occur quickly, even during routine maneuvers such as turning and driving on hills or over obstacles, if you fail to take proper precautions.

For your safety, understand and follow all the warnings contained in the *Operator's Guide*, the *Safety Handbook* and the labels on your vehicle. **Failure to follow these warnings can result in SEVERE INJURY OR DEATH.**

Keep this *Operator's Guide* and the *Safety Handbook* with the vehicle at all times.

WARNING

This ATV may exceed the performance of other ATV's you may have ridden in the past.

This category S (sport) is a high performance ATV for off road use only. It is for sport type recreational and competitive use by operators with advanced skills and substantial experience.

AFTER SALES SERVICE
BOMBARDIER
RECREATIONAL PRODUCTS
VALCOURT, QUEBEC
CANADA J0E 2L0



FOREWORD

Congratulations on your purchase of a new Bombardier all-terrain vehicle (ATV). It is backed by the Bombardier warranty and a network of authorized Bombardier ATV dealers ready to provide the parts, service or accessories you may require.

Your dealer is committed to your satisfaction. He has taken training to perform the initial set-up and inspection of your vehicle as well as completed the final adjustment before you took possession. At delivery, your dealer would have explained the vehicle for the operation, maintenance and safety features. We trust you have taken full advantage of this! If you need more complete servicing information, please ask your dealer about the proper model-year ATV *Shop Manual*.

At delivery, you were also informed of the warranty coverage and completed the Warranty Registration Form which is to be sent to us for processing. In the near future you should be receiving a warranty card which will confirm our receipt of the registration as well as be used for warranty or recall purposes.

You are invited to contact our customer assistance center should you experience problems which cannot be resolved by an authorized Bombardier ATV dealer.

It is understood that this guide may be translated into another language. In the event of any discrepancy, the English version shall prevail.

The information and components/system descriptions contained in this document are correct at the time of publication. Bombardier however, maintains a policy of continuous improvement of its products without imposing upon itself any obligation to install them on products previously manufactured. Due to late changes, it may have some differences between the manufactured product and the descriptions and/or specifications in this guide. Bombardier reserves the right at any time to discontinue or change specifications, designs, features, models or equipment without incurring any obligation upon itself.

The illustrations in this document show the typical construction of the different assemblies and may not reproduce the full detail or exact shape of the parts. However, they represent parts that have the same or similar function.

Specifications are given in the SI metric system with the SAE U.S. equivalent in parenthesis. Where precise accuracy is not required, some conversions are rounded off for easier use.

We recommend genuine Bombardier products for replacement parts and accessories. They've been specially designed for your vehicle and manufactured to meet of Bombardier demanding standards.

A *Shop Manual* can be obtained for complete service, maintenance and more repair information.

TABLE OF CONTENTS

WARNING

Indicates a potential hazard that could result in serious injury or death.

NOTICE	4
SPECIAL SAFETY MESSAGES	5
OPERATION WARNINGS	7
BOMBARDIER LIMITED WARRANTY 2000 BOMBARDIER ATV ALL-TERRAIN VEHICLE	32
FREQUENTLY ASKED QUESTIONS	34
EMISSION REQUIREMENTS	36
HANG TAG	36
LOCATION OF THE IMPORTANT LABELS	37
HOW TO IDENTIFY YOUR ATV	39
Engine and Vehicle Identification Number Location	39
CONTROLS/INSTRUMENTS/EQUIPMENTS	40
1) Throttle Lever.....	42
2) Front Brake Lever	42
3) Clutch Lever.....	43
4) Parking Lever Lock.....	43
5) Headlight Switch.....	44
6) Engine Stop Switch.....	44
7) Start Button.....	44
8) Fuel Tank Cap	44
9) Ignition Switch	45
10) Indicator Lamp	45
11) Front Brake Fluid Reservoir.....	45
12) Fuel Valve.....	45
13) Gearshift Pedal.....	46
14) Storage Compartment	46
15) Seat Latch	47
16) Footpeg	47
17) Foot Brake Pedal.....	47
18) Rear Brake Fluid Reservoir.....	48
19) Engine/Transmission Oil Tank Cap	48

LIQUIDS	49
Fuel.....	49
Engine/Transmission Oil.....	49
Engine Coolant	51
Brake Fluid.....	51
Battery.....	52
BREAK-IN PERIOD	53
Engine	53
10-Hour Inspection	53
PRE-OPERATION CHECK	54
OPERATING INSTRUCTIONS	55
General.....	55
Initial Cold Starting	55
Warm Engine Starting	56
Stopping the Engine	56
Shifting the Transmission.....	56
SPECIAL PROCEDURES	57
Flooded Engine.....	57
Engine Overheat.....	57
Post-Operation Care	57
Storage and Preseason Preparation	57
MAINTENANCE CHART	58
Noise Emission Control System Regulation.....	58
Emission Requirements	58
MAINTENANCE	61
Lubrication.....	61
Maintenance.....	63
Fuel System	65
Electrical.....	66
Drive Train	69
Suspension.....	70
Tires/Wheels	71
Brake	72
Body/Frame	72
CARGO AND TRANSPORTATION	73
Cargo	73
Transportation	73
TROUBLESHOOTING	74
SPECIFICATIONS	76
SI METRIC INFORMATION GUIDE	79
CHANGE OF ADDRESS	81

NOTICE

The *Operator's Guide* and *Safety book* have been prepared to acquaint the owner/operator of a new vehicle with the various vehicle controls, maintenance and safe operating instructions. They are indispensable for the proper use of the product.

This guide uses the following symbols.

WARNING

Identifies an instruction which, if not followed, could cause serious personal injuries including the possibility of death.

CAUTION: Denotes an instruction which, if not followed, could severely damage vehicle components.

NOTE: Indicates supplementary information needed to fully complete an instruction.

Although the mere reading of such information does not eliminate the hazard, the understanding and application of the information will promote its correct use.

To fully appreciate the pleasures, enjoyment and excitement of using an all-terrain vehicle (ATV), there are some basic rules that **MUST** be observed and followed by any four-wheeler.

SPECIAL SAFETY MESSAGES

AN ATV IS NOT A TOY AND CAN BE HAZARDOUS TO OPERATE.

An ATV handles differently from other vehicles including motorcycles and cars. A collision or rollover can occur quickly, even during routine maneuvers such as turning and driving on hills or over obstacles, if you fail to take proper precautions.

SEVERE INJURY OR DEATH can result if you do not follow these instructions:

- Read the *Operator's Guide*, the *Safety Handbook* and all labels carefully and follow the operating procedures described.
- Never operate an ATV without proper instruction. **Take a training course.** Beginners should receive training from a certified instructor. Contact an authorized ATV dealer to find out about the training courses nearest you or call the Specialty Vehicle Institute of America (SVIA) at 1-800-887-2887 or in Canada, the Canada Safety Council (CSC) at 1-613-739-1535 ext. 227.
- Always follow this age recommendation: A child under 16 years old should never operate this ATV.
- Never carry a passenger on an ATV.
- Never operate an ATV on any paved surfaces, including sidewalks, driveways, parking lots and streets.
- Never operate an ATV on any public street, road or highway, even a dirt or gravel one.
- Never operate an ATV without wearing an approved helmet that fits properly. You should also wear eye protection (goggles or face shield), gloves, boots, long sleeved shirt or jacket, and long pants.
- Never consume alcohol or drugs before or while operating this ATV.
- Never operate at excessive speeds. Always go at a speed that is proper for the terrain, visibility, and operating conditions, and your experience.
- Never attempt wheelies, jumps, or other stunts.
- Always inspect your ATV each time you use it to make sure it is in safe operating condition. Always follow the inspection and maintenance procedures and schedules described in the *Operator's Guide* and the *Safety Handbook*.
- Always keep both hands on the handlebars and both feet on the footpegs of the ATV during operation.
- Always go slowly and be extra careful when operating on unfamiliar terrain. Always be alert to changing terrain conditions when operating the ATV.
- Never operate on excessively rough, slippery or loose terrain until you have learned and practiced the skills necessary to control the ATV on such terrain. Always be especially cautious on these kinds of terrain.
- Always follow proper procedures for turning as described in the *Operator's Guide* and the *Safety Handbook*. Practice turning at low speeds before attempting to turn at faster speeds. Do not turn at excessive speed.
- Never operate the ATV on hills too steep for the ATV or for your abilities. Practice on smaller hills before attempting larger hills.

- Always follow proper procedures for climbing hills as described in the *Operator's Guide* and the *Safety Handbook*. Check the terrain carefully before you start up any hill. Never climb hills with excessively slippery or loose surfaces. Shift your weight forward. Never open the throttle suddenly or make sudden gear changes. Never go over the top of any hill at high speed.
- Always follow proper procedures for going down hills and for braking on hills as described in the *Operator's Guide* and the *Safety Handbook*. Check the terrain carefully before you start down any hill. Shift your weight backward. Never go down a hill at high speed. Avoid going down a hill at an angle that would cause the vehicle to lean sharply to one side. Go straight down the hill where possible.
- Always follow proper procedures for crossing the side of a hill as described in the *Operator's Guide* and the *Safety Handbook*. Avoid hills with excessively slippery or loose surfaces. Shift your weight to the uphill side of the ATV. Never attempt to turn the ATV around on any hill until you have mastered the turning technique described in the *Operator's Guide* and the *Safety Handbook* on level ground. Avoid crossing the side of a steep hill if possible.
- Always use proper procedures if you stall or roll backwards when climbing a hill. To avoid stalling, use proper gear and maintain a steady speed when climbing a hill. If you stall or roll backwards, follow the special procedure for braking described in the *Operator's Guide* and the *Safety Handbook*. Dismount on the uphill side or to a side if pointed straight uphill. Turn the ATV around and remount, following the procedure described in the *Operator's Guide* and the *Safety Handbook*.
- Always check for obstacles before operating in a new area. Never attempt to operate over large obstacles, such as large rocks or fallen trees. Always follow proper procedures when operating over obstacles as described in the *Operator's Guide* and the *Safety Handbook*.
- Always be careful when skidding or sliding. Learn to safely control skidding or sliding by practicing at low speeds and on level, smooth terrain. On extremely slippery surfaces, such as ice, go slowly and be very cautious in order to reduce the chance of skidding out of control.
- Never operate an ATV in fast flowing water or in water deeper than that specified in the *Operator's Guide* and the *Safety Handbook*. Remember that wet brakes may have reduced stopping ability. Test your brakes after leaving water. If necessary, apply them several times to let friction dry out the pads.
- Always be sure there are no obstacles or people behind you when you operate in reverse. When it is safe to proceed in reverse, go slowly.
- Always use the size and type tires specified in the *Operator's Guide*. Always maintain proper tire pressure as described in this guide.
- Never modify an ATV through improper installation or use of accessories.
- Never exceed the stated load limits for an ATV. Cargo should be properly distributed and securely attached. Reduce speed and follow instructions in the *Operator's Guide* and the *Safety Handbook* for carrying cargo or pulling a trailer. Allow greater distance for braking.
- **FOR MORE INFORMATION ABOUT ATV SAFETY**, call the Specialty Vehicle Institute of America (SVIA) at 1-800-887-2887 or in Canada, the Canada Safety Council (CSC) at 1-613-739-1535 ext. 227.

OPERATION WARNINGS

While reading this guide, remember that:

WARNING

Indicates a potential hazard that could result in serious injury or death.

The following warnings and their format have been requested by the United States Consumer Product Safety Commission and are required to be in the *Operator's Guide* and *Safety Handbook* for all ATV's.

NOTE: The following illustrations are a general representation only. Your model may differ.

WARNING



V00A0AR

POTENTIAL HAZARD

Operating this ATV without proper instruction.

WHAT CAN HAPPEN

The risk of an accident is greatly increased if the operator does not know how to operate the ATV properly in different situations and on different types of terrain.

HOW TO AVOID THE HAZARD

Beginning and inexperienced operators should complete the certified training course offered by Bombardier. They should then regularly practice the skills learned in the course and the operating techniques described in the *Operator's Guide* and the *Safety Handbook*.

For more information about the training course, contact an authorized ATV dealer or call Bombardier at 1-450-532-5000.



V00A01Q

POTENTIAL HAZARD

Failure to follow the age recommendations for this ATV.

WHAT CAN HAPPEN

Use by children of ATVs that are not recommended for their age can lead to severe injury or death of the child.

Even though a child may be within the age group for which an ATV is recommended, he or she may not have the skills, abilities, or judgment needed to operate the ATV safely and may be involved in a serious accident.

HOW TO AVOID THE HAZARD

No one under 16 should operate a Bombardier ATV.

 **WARNING**



V00A02Q

POTENTIAL HAZARD

Carrying a passenger on this ATV.

WHAT CAN HAPPEN

Greatly reduces your ability to balance and control this ATV.

Could cause an accident, resulting in harm to you and/or your passenger.

HOW TO AVOID THE HAZARD

Never carry a passenger. The long seat is to allow the operator to shift position as needed during operation. It is not for carrying passengers.

WARNING

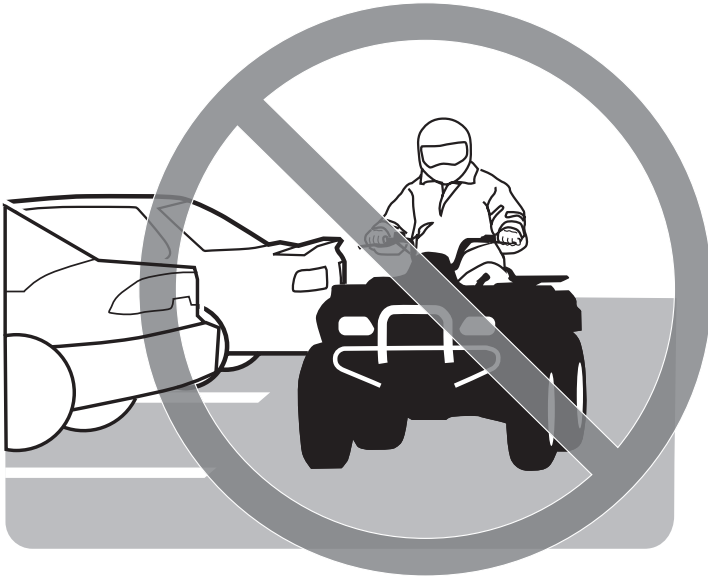

V00A03Q

POTENTIAL HAZARD

Operating this ATV on paved surfaces.

WHAT CAN HAPPEN

The ATV's tires are designed for off-road use only, not for use on pavement. Paved surfaces may seriously affect handling and control of the ATV, and may cause the vehicle to go out of control.

HOW TO AVOID THE HAZARD

Never operate the ATV on any paved surfaces, including sidewalks, driveways, parking lots and streets.

⚠ WARNING



V00A04Q

POTENTIAL HAZARD

Operating this ATV on public streets, roads or highways.

WHAT CAN HAPPEN

You can collide with another vehicle.

HOW TO AVOID THE HAZARD

Never operate this ATV on any public street, road or highway, even a dirt or gravel one. In many states it is illegal to operate ATV's on public streets, roads and highways.

WARNING



V00A06Q

POTENTIAL HAZARD

Operating this ATV without wearing an approved motorcycle helmet, eye protection and protective clothing.

WHAT CAN HAPPEN

Operating without an approved motorcycle helmet increases your chances of a severe head injury or death in the event of an accident.

Operating without eye protection can result in an accident and increases your chances of a severe injury in the event of an accident.

Operating without protective clothing increases your chances of severe injury in the event of an accident.

HOW TO AVOID THE HAZARD

Always wear an approved motorcycle helmet that fits properly. You should also wear:

- eye protection (goggles or face shield)
- gloves
- boots
- long sleeved shirt or jacket
- long pants

 **WARNING**



V00A07Q

POTENTIAL HAZARD

Operating this ATV after consuming alcohol or drugs.

WHAT CAN HAPPEN

- Could seriously affect your judgment.
- Could cause you to react more slowly.
- Could affect your balance and perception.
- Could result in an accident.

HOW TO AVOID THE HAZARD

Never consume alcohol or drugs before or while driving this ATV.

⚠ WARNING

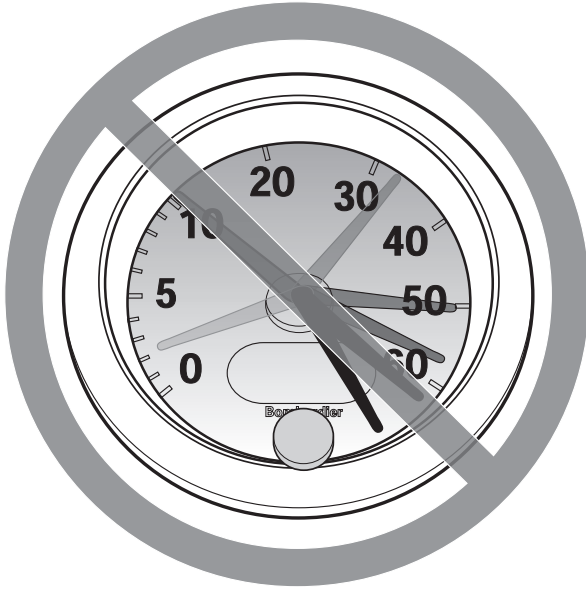

V00A08Q

POTENTIAL HAZARD

Operating this ATV at excessive speeds.

WHAT CAN HAPPEN

Increases your chances of losing control of the ATV, which can result in an accident.

HOW TO AVOID THE HAZARD

Always travel at a speed which is proper for the terrain, visibility and operating conditions, and your experience.

⚠ WARNING

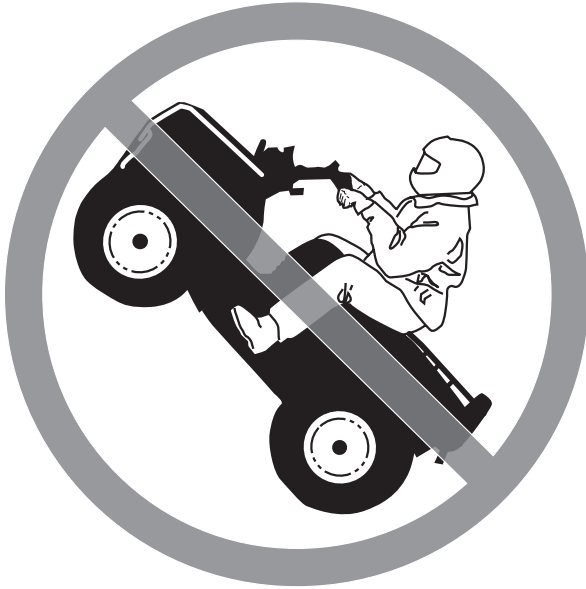

V00A09Q

POTENTIAL HAZARD

Attempting wheelies, jumps and other stunts.

WHAT CAN HAPPEN

Increases the chance of an accident, including an overturn.

HOW TO AVOID THE HAZARD

Never attempt stunts, such as wheelies or jumps. Don't try to show off.

⚠ WARNING

POTENTIAL HAZARD

Failure to inspect the ATV before operating. Failure to properly maintain the ATV.

WHAT CAN HAPPEN

Increases the possibility of an accident or equipment damage.

HOW TO AVOID THE HAZARD

Always inspect your ATV each time you use it to make sure the ATV is in safe operating condition.

Always follow the inspection and maintenance procedures and schedules described in the *Operator's Guide* and the *Safety Handbook*.

WARNING



V00A0BQ

POTENTIAL HAZARD

Removing hands from handlebars or feet from footpegs during operation.

WHAT CAN HAPPEN

Removing even one hand or foot can reduce your ability to control the ATV or could cause you to lose your balance and fall off the ATV. If you remove a foot from the footpegs, your foot or leg may come into contact with the rear wheels, which could injure you or cause an accident.

HOW TO AVOID THE HAZARD

Always keep both hands on the handlebars and both feet on the footpegs of your ATV during operation.

⚠ WARNING

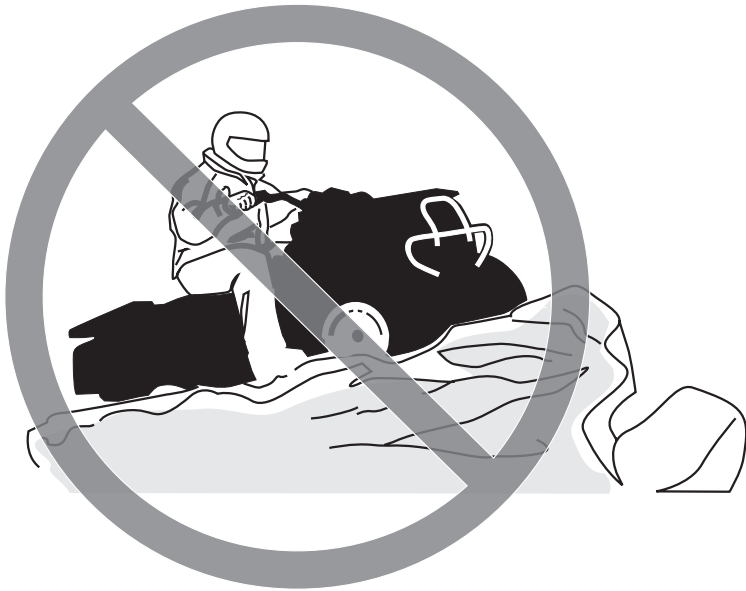

V00A0CQ

POTENTIAL HAZARD

Failure to use extra care when operating this ATV on unfamiliar terrain.

WHAT CAN HAPPEN

You can come upon hidden rocks, bumps, or holes, without enough time to react.

Could result in the ATV overturning or going out of control.

HOW TO AVOID THE HAZARD

Go slowly and be extra careful when operating on unfamiliar terrain.

Always be alert to changing terrain conditions when operating the ATV.

WARNING



V00A0DQ

POTENTIAL HAZARD

Failure to use extra care when operating on excessively rough, slippery or loose terrain.

WHAT CAN HAPPEN

Could cause loss of traction or vehicle control, which could result in an accident, including an overturn.

HOW TO AVOID THE HAZARD

Do not operate on excessively rough, slippery or loose terrain until you have learned and practiced the skills necessary to control the ATV on such terrain.

Always be especially cautious on these kinds of terrain.

 **WARNING**



V00A0EQ

POTENTIAL HAZARD

Turning improperly.

WHAT CAN HAPPEN

ATV could go out of control, causing a collision or overturn.

HOW TO AVOID THE HAZARD

Always follow proper procedures for turning as described in the *Operator's Guide* and the *Safety Handbook*. Practice turning at low speeds before attempting to turn at faster speeds.

Do not turn at excessive speed.

WARNING



V00A0QQ

POTENTIAL HAZARD

Operating on excessively steep hills.

WHAT CAN HAPPEN

The vehicle can overturn more easily on extremely steep hills than on level surfaces or small hills.

HOW TO AVOID THE HAZARD

Never operate the ATV on hills too steep for the ATV or for your abilities. Practice on smaller hills before attempting larger hills.

 **WARNING**



V00A0FQ

POTENTIAL HAZARD

Climbing hills improperly.

WHAT CAN HAPPEN

Could cause loss of control or cause ATV to overturn.

HOW TO AVOID THE HAZARD

Always follow proper procedures for climbing hills as described in the *Operator's Guide* and the *Safety Handbook*.

Always check the terrain carefully before you start up any hill.

Never climb hills with excessively slippery or loose surfaces.

Shift your weight forward.

Never open the throttle suddenly or make sudden gear changes. The ATV could flip over backwards.

Never go over the top of any hill at high speed. An obstacle, a sharp drop, or another vehicle or person could be on the other side of the hill.

⚠ WARNING



V00A0GQ

POTENTIAL HAZARD

Going down a hill improperly.

WHAT CAN HAPPEN

Could cause loss of control or cause ATV to overturn.

HOW TO AVOID THE HAZARD

Always follow proper procedures for going down hills as described in the *Operator's Guide* and the *Safety Handbook*.

NOTE: A special technique is required when braking as you go down a hill.

Always check the terrain carefully before you start down any hill.

Shift your weight backward.

Never go down a hill at high speed.

Avoid going down a hill at an angle which would cause the vehicle to lean sharply to one side. Go straight down the hill where possible.

⚠ WARNING



V00A0HQ

POTENTIAL HAZARD

Improperly crossing hills or turning on hills.

WHAT CAN HAPPEN

Could cause loss of control or cause ATV to overturn.

HOW TO AVOID THE HAZARD

Never attempt to turn the ATV around on any hill until you have mastered the turning technique as described in the *Operator's Guide* and the *Safety Handbook* on level ground. Be very careful when turning on any hill.

Avoid crossing the side of a steep hill if possible.

When crossing the side of a hill:

Always follow proper procedures as described in the *Operator's Guide* and the *Safety Handbook*.

Avoid hills with excessively slippery or loose surfaces.

Shift your weight to the uphill side of the ATV.

WARNING



V00A01Q

POTENTIAL HAZARD

Stalling, rolling backwards or improperly dismounting while climbing a hill.

WHAT CAN HAPPEN

Could result in ATV overturning.

HOW TO AVOID THE HAZARD

Use proper gear and maintain steady speed when climbing a hill.

If you lose all forward speed:

Keep weight uphill.

Apply the brakes.

Lock parking device after you are stopped.

If you begin rolling backwards:

Keep weight uphill.

Never apply the rear brake while rolling backwards.

Apply the front brake gradually.

When fully stopped, apply rear brake as well, and then lock parking device.

Dismount on uphill side, or to a side if pointed straight uphill.

Turn the ATV around and remount, following the procedure described in the *Operator's Guide* and the *Safety Handbook*.

⚠ WARNING



V00A0JQ

POTENTIAL HAZARD

Improperly operating over obstacles.

WHAT CAN HAPPEN

Could cause loss of control or a collision. Could cause the ATV to overturn.

HOW TO AVOID THE HAZARD

Before operating in a new area, check for obstacles.

Never attempt to ride over large obstacles, such as large rocks or fallen trees.

When you go over obstacles, always follow proper procedures as described in the *Operator's Guide* and the *Safety Handbook*.

WARNING



V00A0KQ

POTENTIAL HAZARD

Skidding or sliding improperly.

WHAT CAN HAPPEN

You may lose control of this ATV.

You may also regain traction unexpectedly, which may cause the ATV to overturn.

HOW TO AVOID THE HAZARD

Learn to safely control skidding or sliding by practicing at low speeds and on level, smooth terrain.

On extremely slippery surfaces, such as ice, go slowly and be very cautious in order to reduce the chance of skidding or sliding out of control.

⚠ WARNING



V00A0LQ

POTENTIAL HAZARD

Operating this ATV through deep or fast flowing water.

WHAT CAN HAPPEN

Tires may float, causing loss of traction and loss of control, which could lead to an accident.

HOW TO AVOID THE HAZARD

Never operate this ATV in fast flowing water or in water deeper than that specified in the *Operator's Guide* and the *Safety Handbook*.

Remember that wet brakes may have reduced stopping ability. Test your brakes after leaving water. If necessary, apply them several times to let friction dry out the pads.

⚠ WARNING



V00A0MQ

POTENTIAL HAZARD

Improperly operating in reverse.

WHAT CAN HAPPEN

You could hit an obstacle or person behind you, resulting in serious injury.

HOW TO AVOID THE HAZARD

When you select reverse gear, make sure there are no obstacles or people behind you. When it is safe to proceed, go slowly.

 **WARNING**



V00A00Q

POTENTIAL HAZARD

Operating this ATV with improper tires, or with improper or uneven tire pressure.

WHAT CAN HAPPEN

Use of improper tires on this ATV, or operation of this ATV with improper or uneven tire pressure, may cause loss of control, and increases the risk of an accident.

HOW TO AVOID THE HAZARD

Always use the size and type, tires specified in the *Operator's Guide* for this vehicle.

Always maintain proper tire pressure as described in the *Operator's Guide* and the *Safety Handbook*.

WARNING



V02A01Q

POTENTIAL HAZARD

Operating this ATV with improper modifications.

WHAT CAN HAPPEN

Improper installation of accessories or modification of this vehicle may cause changes in handling which in some situations could lead to an accident.

HOW TO AVOID THE HAZARD

Never modify this ATV through improper installation or use of accessories. All parts and accessories added to this vehicle should be genuine Bombardier or equivalent components designed for use on this ATV and should be installed and used according to instructions. If you have questions, consult an authorized Bombardier ATV dealer.

⚠ WARNING



V02A02Q

POTENTIAL HAZARD

Overloading this ATV or carrying or towing cargo improperly.

WHAT CAN HAPPEN

Could cause changes in vehicle handling which could lead to an accident.

HOW TO AVOID THE HAZARD

Never exceed the stated load capacity for this ATV.

Cargo should be properly distributed and securely attached.

Reduce speed when carrying cargo or pulling a trailer. Allow greater distance for braking.

Always follow the instructions in the *Operator's Guide* and the *Safety Handbook* for carrying cargo or pulling a trailer.

While reading this guide, remember that:

⚠ WARNING

Indicates a potential hazard that could result in serious injury or death.

BOMBARDIER LIMITED WARRANTY 2000 BOMBARDIER ATV ALL-TERRAIN VEHICLE

1. WARRANTY COVERAGE PERIOD

In Canada, BOMBARDIER INC. or in the USA, BOMBARDIER MOTOR CORPORATION OF AMERICA ("Bombardier"), warrants FROM THE DATE OF DELIVERY TO THE FIRST CONSUMER that each 2000 BOMBARDIER ATV sold, as NEW and UNUSED and PREDELIVERED by an authorized North American BOMBARDIER ATV dealer, will be free from any defects in material and/or workmanship for a period of:

SIX (6) CONSECUTIVE MONTHS, for private use owners, or

THREE (3) CONSECUTIVE MONTHS, for commercial use owners.

Tires supplied as original equipment on your ATV are warranted separately by the individual tire manufacturers as identified below. If an original tire on your Bombardier ATV has a defect in material or workmanship, please contact the corresponding tire manufacturer or ask your authorized Bombardier ATV dealer for assistance.

Carlisle Tire & Wheel Company

23 Windham Boulevard

Aiken, SC 29805

Warranty Information: 1-800-260-7959

Kenda U.S.A.

7095 Americana Parkway

Reynoldsburg, OH 43068

Warranty Information: (614) 866-9803, Ext. 210

All genuine Bombardier accessories, installed by an authorized BOMBARDIER ATV dealer at the time of delivery of the new and unused BOMBARDIER ATV, carry the same Warranty Coverage Period as for the BOMBARDIER ATV.

2. WHAT BOMBARDIER WILL DO

BOMBARDIER will repair or replace, at its option, all genuine BOMBARDIER part found defective in material and/or workmanship, under normal use, maintenance and service, with a genuine BOMBARDIER part without charge for parts and labor, at any authorized BOMBARDIER ATV dealer during the Warranty Coverage Period.

3. CONDITION TO HAVE WARRANTY WORK VALIDATED

The customer must notify an authorized BOMBARDIER ATV dealer within two (2) days of the appearance of a defect in material and/or workmanship and present to the servicing authorized BOMBARDIER ATV dealer the BOMBARDIER ATV Warranty Registration Card or a proof of purchase of the NEW and UNUSED 2000 BOMBARDIER ATV and must sign the repair/work order prior to the start of the repair in order to validate a warranty repair. All parts replaced under this limited warranty become the property of BOMBARDIER.

4. EXCLUSIONS - ARE NOT WARRANTED

- Normal wear and tear items;
- Labor, parts and lubricant costs of all maintenance services;
- Damage caused by failure to provide proper maintenance and/or storage, as described in the "2000 BOMBARDIER ATV Operator's Guide";
- Damage resulting from improper repairs, modifications or use of non-approved parts or, repairs done by a non-authorized BOMBARDIER ATV dealer;
- Damage resulting from abuse, misuse, neglect or racing.
- Damage resulting from accident, fire, theft, vandalism or any act of God;
- Incidental or consequential damages, or damages of any kind as but not limited to towing charges, telephone calls or taxi; and
- Damages resulting from improper service or maintenance.

5. LIMITATIONS OF LIABILITY

This warranty gives you specific rights, and you may also have other legal rights which may vary from state to state, or province to province. **WHERE APPLICABLE, THIS WARRANTY IS EXPRESSLY GIVEN AND ACCEPTED IN LIEU OF ANY AND ALL OTHER WARRANTIES, EXPRESSED OR IMPLIED, INCLUDING WITHOUT LIMITATION ANY WARRANTY OF MERCHANTABILITY OR FITNESS FOR ANY PARTICULAR PURPOSE.**

Neither the distributor, any authorized BOMBARDIER ATV dealer nor any other person has been authorized to make any affirmation, representation or warranty other than those contained in this warranty, and if made, such affirmation, representation or warranty shall not be enforceable against BOMBARDIER or any other person.

In no event shall BOMBARDIER be liable for special, consequential or incidental damages, including but not limited to loss of use and transportation costs. Some states or provinces do not allow the exclusion or limitation of incidental or consequential damages, or limitations on how long an implied warranty lasts, so the above limitation or exclusion may not apply.

BOMBARDIER reserves the right to modify this warranty at any time, being understood that such modification will not alter the warranty conditions applicable to the BOMBARDIER ATV sold while this warranty is in effect.

6. TRANSFER

If the customer sells the ATV guaranteed under the present, he shall assign and transfer this warranty, which shall be valid for the rest of the relevant PERIOD as defined in section 1 hereinabove, to the new customer.

7. CONSUMER ASSISTANCE

- a) In the event of a controversy or a dispute arising in connection with this BOMBARDIER LIMITED WARRANTY, BOMBARDIER suggests that you try to resolve the issue at the dealership level. We recommend discussing the issue with the authorized dealer's service manager or owner.
- b) If further assistance is required, the DISTRIBUTOR's Service Department should be contacted in order to resolve the matter.
- c) If the issue has still not been resolved, please submit in writing your complaint to:

IN CANADA:



BOMBARDIER INC.
RECREATIONAL PRODUCTS
ATV
CUSTOMER ASSISTANCE CENTER
VALCOURT QC J0E 2L0
Tel: (450) 532-5000

IN USA:



**BOMBARDIER MOTOR
CORPORATION OF AMERICA**
RECREATIONAL PRODUCTS
ATV
CUSTOMER ASSISTANCE CENTER
P.O. BOX 8035
7575 BOMBARDIER COURT
WAUSAU WI 54402-8035
Tel: (715) 848-4957

BOMBARDIER
RECREATIONAL PRODUCTS

JUNE 1999

® Registered trademark of Bombardier Inc. and/or subsidiaries.

FREQUENTLY ASKED QUESTIONS

Q: Why must my vehicle be registered with the factory? After all, I do have my original invoice as proof of when I purchased my vehicle.

A: *Registration is very important and an authorized Bombardier ATV dealer must register your vehicle with Bombardier. Make sure the card has been sent. All of this will allow you to:*

a) Have warranty work performed at any authorized Bombardier ATV dealer in North America. Your registration card will provide the dealer with all the necessary data to complete warranty claim forms.

b) Be advised by Bombardier should there be a safety recall or a particular warranty campaign.

c) Be contacted much faster by the police, in the event that they find your vehicle subsequent to a theft.

Q: Why must my vehicle be registered with the governing body having jurisdiction over vehicle use?

A: *Vehicle registration has two purposes: In many provinces or States, it is mandatory to register a vehicle in the same way as for a car. It allows the State or province to maintain records of existing vehicles. In some jurisdictions, governmental agencies use part of the registration fees for establishing and maintaining trails.*

Q: Where can I find information on the lubrication and maintenance of my vehicle?

A: *In the Operator's Guide provided with the vehicle at the time of delivery.*

Q: Will the entire warranty be voided or cancelled, if I do not operate or maintain my new vehicle exactly as specified in the *Operator's Guide*?

A: *The warranty of the new vehicle cannot be VOIDED or CANCELLED if pre-delivered by an authorized Bombardier ATV dealer. However, if a particular failure is caused by operation or maintenance other than is shown in the Operator's Guide, THAT failure may not be covered under warranty. This includes service work performed by the customer, oil and filter change and especially the critical adjustments such as the carburetor.*

Q: Would you give some examples of abnormal use or strain, neglect or abuse which may affect the limited warranty coverage?

A: *These terms are general and overlap each other in some cases. Some specific examples may include: running the engine out of oil, operating the vehicle with a broken or damaged part which causes another part to fail, and so on. If you have any specific questions on operation or maintenance, please contact an authorized Bombardier ATV dealer for advice.*

Q: What costs are my responsibility during the warranty period?

A: *The customer's responsibility includes all costs of normal maintenance services, non-warranty repairs, accidents and collision damage, as well as oils, and spark plugs, and incidental or consequential damages costs as explained in the warranty.*

Q: Are "Genuine" Bombardier replacement parts used in warranty repairs also covered by the limited warranty coverage?

A: *Yes. When installed by an authorized Bombardier ATV dealer, any "Genuine" Bombardier part used in warranty repairs assumes the remaining warranty that exists on the vehicle.*

Q: If I sell my vehicle within the warranty period, will the new owner qualify for the balance of the limited warranty coverage?

A: *Yes, provided the re-sale has been registered with the manufacturer.*

Q: How can I receive the best owner assistance?

A: *The satisfaction and goodwill of the owners of Bombardier products are of primary concern to your ATV dealer and Bombardier. Normally, any problems that arise in connection with the sales transaction or the operation of your vehicle will be handled by your Dealer's Sales or Service Departments. It is recognized, however, that despite the best intentions of everyone concerned, misunderstandings will sometimes occur. Frequently, complaints are the result of a breakdown in communications and can quickly be resolved by a member of the dealership management. If the problem already has been reviewed with the Sales Manager or Service Manager, contact the Dealer Principal himself or the General Manager.*

We are always pleased to receive your comments on the Bombardier ATV.

EMISSION REQUIREMENTS

The California Air Resources Board (CARB) requires that your ATV observe with applicable exhaust emissions standards during its useful life, when operated and maintained according to the instructions supplied.

A non-compliance Red Label (as well as a Green Label) is obtained annually during California Vehicle registration. The appropriate label is denoted by the vehicle identification number (in the 8th character detailed herein).

VEHICLE CATEGORY	VIN 8 TH CHARACTER
Non-complying Red Label	Must denote a C or 3
Complying Green Label	Any alphanumeric designation other than a C or 3

HANG TAG

This ATV comes with a hang tag and labels containing important safety information.

The labels should be considered as permanent parts of the vehicle. If a label comes off or becomes hard to read, please contact an authorized Bombardier ATV dealer for replacements.

Any person who rides this vehicle should read and understand this information before riding.

⚠ WARNING

Improper ATV use can result in SEVERE INJURY or DEATH.



ALWAYS USE AN APPROVED HELMET AND PROTECTIVE GEAR.



NEVER USE ON PUBLIC ROADS.



NEVER CARRY PASSENGERS.



NEVER USE WITH DRUGS OR ALCOHOL.

NEVER operate:

- without proper training or instructions.
- at speeds too fast for your skills or the conditions.
- on public roads - a collision can occur with another vehicle.
- with a passenger - passengers affect balance and steering and increase risk of losing control.

ALWAYS:

- use proper riding techniques to avoid vehicle overturns on hills and rough terrain and in turns.
- avoid paved surfaces - pavement may seriously affect handling and control.

LOCATE AND READ OPERATOR'S GUIDE.
FOLLOW ALL INSTRUCTIONS & WARNINGS.

704 900 001

S

SPORT MODEL

THIS ATV IS FOR
RECREATIONAL USE
BY EXPERIENCED OPERATORS ONLY.

OPERATOR ONLY-NO PASSENGERS

NO OPERATOR UNDER AGE 16

THIS CATEGORY (SPORT) ATV IS A HIGH PERFORMANCE ATV FOR OFF ROAD USE ONLY. IT IS FOR SPORT TYPE RECREATIONAL AND COMPETITIVE USE BY OPERATORS WITH ADVANCED SKILLS AND SUBSTANTIAL EXPERIENCE.

TRAINING COURSES TO TEACH ATV RIDING SKILLS ARE AVAILABLE. FOR INFORMATION CONTACT YOUR DEALER.

CHECK WITH YOUR DEALER TO FIND OUT ABOUT STATE OR LOCAL LAWS REGARDING ATV OPERATION.

THIS HANGTAG IS NOT TO BE REMOVED BEFORE SALE.

V02M01L

LOCATION OF THE IMPORTANT LABELS

The following labels are on your ATV. If missing or damaged, they can be replaced free of charge. See an authorized Bombardier ATV dealer.

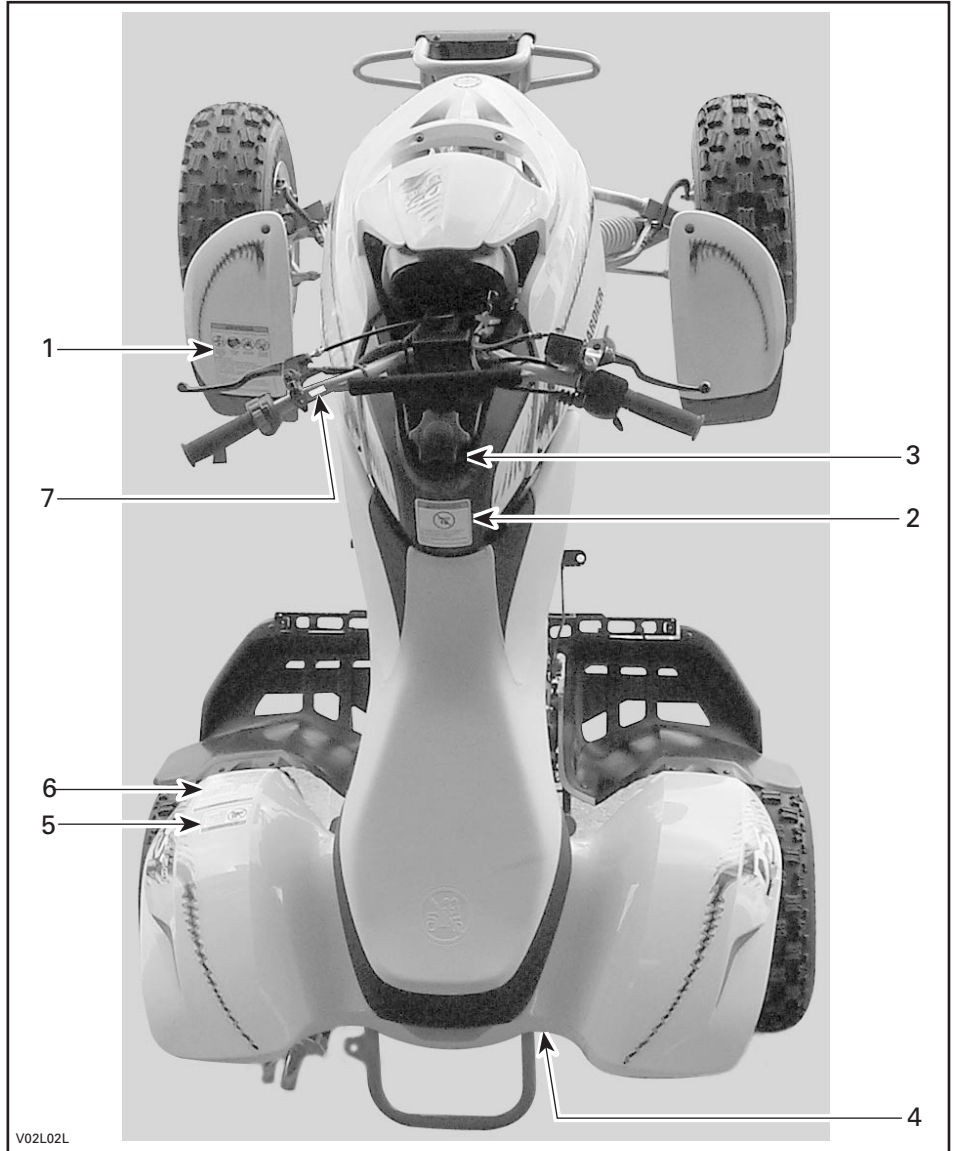

V02L02L

LABEL 1

WARNING

Improper ATV use can result in SEVERE INJURY or DEATH.

ALWAYS USE AN APPROVED HELMET AND PROTECTIVE GEAR.

NEVER USE ON PUBLIC ROADS.

NEVER CARRY PASSENGERS.

NEVER USE WITH DRUGS OR ALCOHOL.

NEVER operate:

- without proper training or instructions.
- at speeds too fast for your skills or the conditions.
- on public roads - a collision can occur with another vehicle.
- with a passenger - passengers affect balance and steering and increase risk of losing control.

ALWAYS:

- use proper riding techniques to avoid vehicle overturns on hills and rough terrain and in turns.
- avoid paved surfaces - pavement may seriously affect handling and control.

LOCATE AND READ OPERATOR'S GUIDE.
FOLLOW ALL INSTRUCTIONS & WARNINGS.

704 900 001

V01M01Z

LABEL 4

DRIVE CHAIN

DRIVE CHAIN MUST BE WELL ADJUSTED AND LUBRICATED. FREE PLAY IS 22mm (7/8") WITH DRIVER ON VEHICLE. SEE OWNERS MANUAL FOR COMPLETE INSTRUCTIONS.

V02M06Y

LABEL 5

WARNING

NEVER ride as a passenger. Passengers can cause a loss of control, resulting in SEVERE INJURY or DEATH.

704 900 005

V01M07Z

LABEL 2

WARNING

UNDER 16

Operating this ATV if you are under the age of 16 increases your chance of SEVERE INJURY or DEATH.

NEVER operate this ATV if you are under age 16.

704 900 011

V01M02Z

LABEL 6

WARNING

Improper tire pressure or overloading can cause loss of control.

Loss of control can result in SEVERE INJURY or DEATH.

TIRE PRESSURE

- Set with tires cold:

- Recommended:	FRONT:	34,0 KPa, (0,34 kgf / cm ²), 5,0 psi.
	REAR:	34,0 KPa, (0,34 kgf / cm ²), 5,0 psi.
- Recommended:	FRONT:	21,0 KPa, (0,21 kgf / cm ²), 3,0 psi.
	REAR:	21,0 KPa, (0,21 kgf / cm ²), 3,0 psi.
- Never set tire pressure below minimum. It could cause the tire to dislodge from the rim.
- Maximum Vehicle Load: 275 lbs. (125 kg). Includes weight of operator and accessories.

704 900 001

V02M03Y

LABEL 3

WARNING

This ATV may exceed the performance of other ATVs you may have ridden in the past.

This category S (sport) is a high performance ATV for off road use only. It is for sport type recreational and competitive use by operators with advanced skills and substantial experience.

704 900 003

V02M05Y

LABEL 7

**HOLD START BUTTON
4 SECONDS MAX.**

V02M07Y

HOW TO IDENTIFY YOUR ATV

The main components of your vehicle (engine and frame) are identified by different serial numbers. It may sometimes become necessary to locate these numbers for warranty purposes or to trace your vehicle in the event of loss. These numbers are required by the authorized Bombardier ATV dealer to complete warranty claims properly. No warranty will be honored by Bombardier if the engine identification number (EIN) or vehicle identification number (VIN) is removed or mutilated in any way. We strongly recommend that you take note of all the serial numbers on your vehicle and supply them to your insurance company.

Engine and Vehicle Identification Number Location

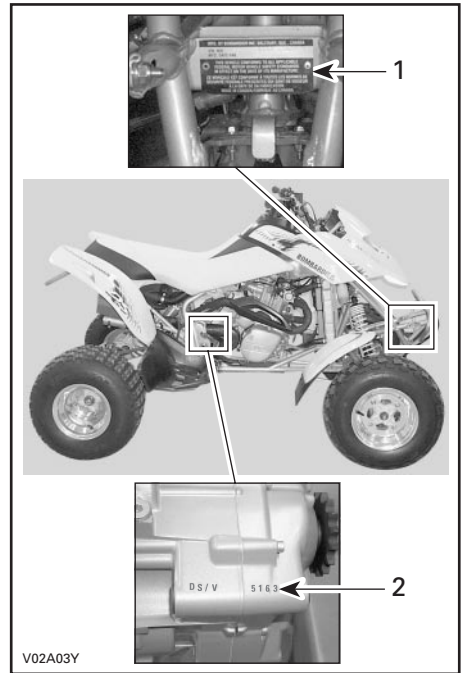

1. *EIN (Engine Identification Number)*
2. *VIN (Vehicle Identification Number)*

CONTROLS/INSTRUMENTS/EQUIPMENTS

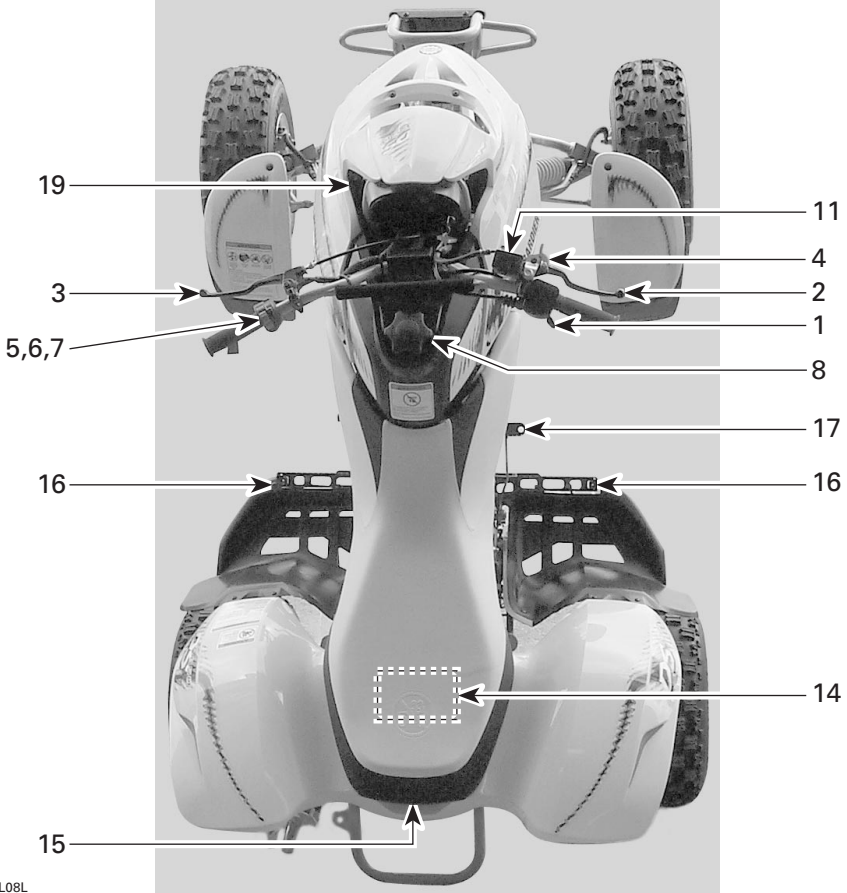

V02L08L

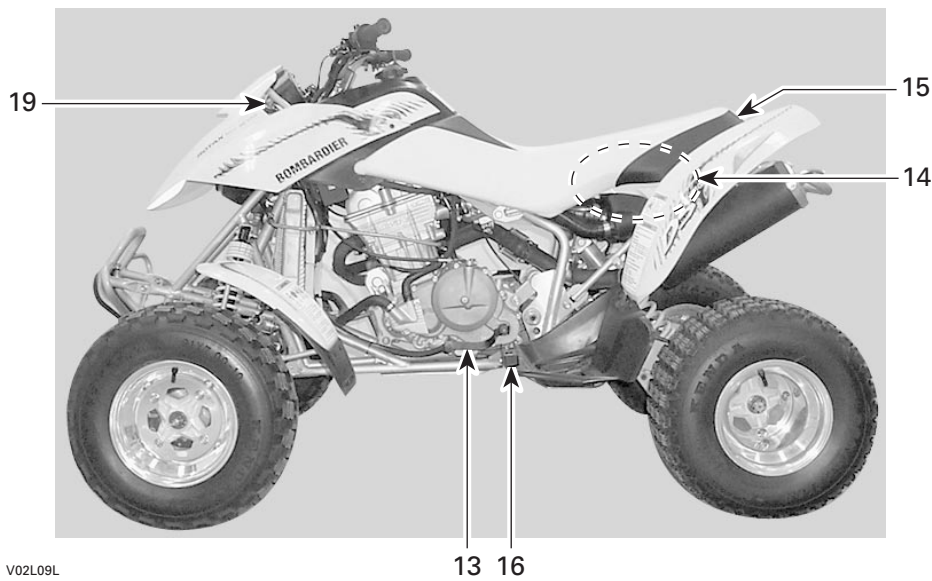
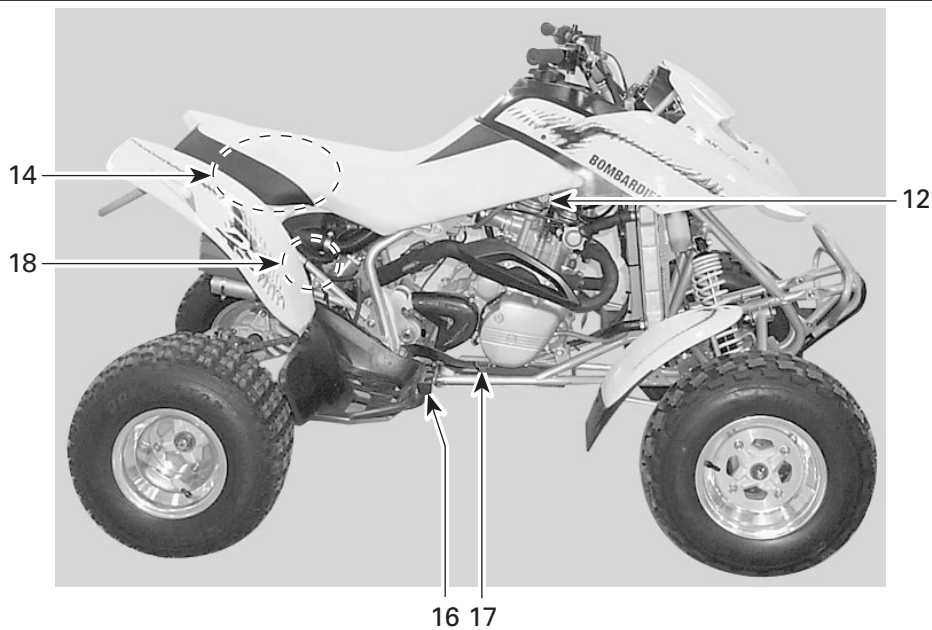

V02L09L

While reading this guide, remember that:

WARNING

Indicates a potential hazard that could result in serious injury or death.

WARNING

This ATV may exceed the performance of other ATV's you may have rider in the past.

This category S (sport) is a high performance ATV for off road use only. It is for sport type recreational and competitive use by operators with advanced skills and substantial experience.

NOTE: This section gives basic functions of the various controls of your ATV. For more details of how to operate one control in conjunction with some others, refer to OPERATING INSTRUCTIONS in this *Operator's Guide* and *Safety Handbook*.

1) Throttle Lever

Located on the right side of handlebar. When pushed, it increases the engine speed that allows the engagement of the transmission on the selected gear.

When released, the engine speed should return automatically to idle and the vehicle will gradually slow down.

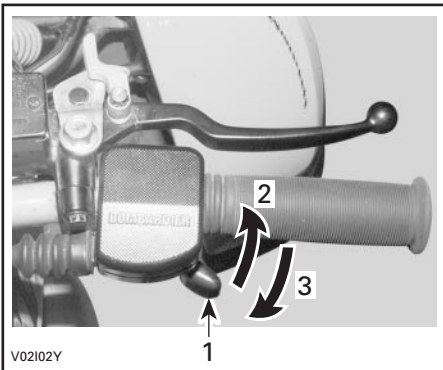

1. Throttle lever
2. To accelerate
3. To decelerate

WARNING

Always release the throttle when shifting gears. Shifting gears without releasing the throttle, could cause loss of control including the ATV to overturn and mechanical damages.

2) Front Brake Lever

Located on the right side of handlebar. When compressed, the brake is applied. When released, it should automatically return to its original position. Braking effect is proportional to the force applied on the lever and to the type and condition of the terrain.

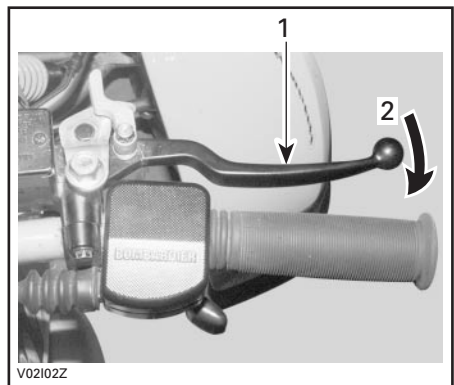

1. Brake lever
2. To apply brake

3) Clutch Lever

Located on the left side of handlebar. When compressed, the clutch is disengaged. When released, the clutch is engaged.

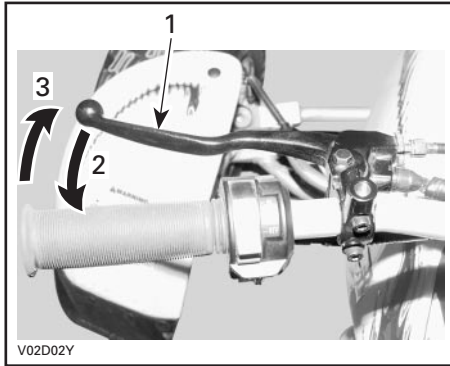

1. Clutch lever
2. To disengage
3. To engage

WARNING

Always release the throttle when shifting gears. Shifting gears without releasing the throttle, could cause loss of control including the ATV to overturn and mechanical damages.

4) Parking Lever Lock

Located on right side of handlebar on brake lever. When applied, it temporarily prevents the vehicle from moving. Useful when the brake needs to be locked for example such as doing a K-turn.

WARNING

Make sure parking device is fully disengaged before operating the ATV.

When you ride the vehicle, the prolonged use of brakes may cause damage to the brake system and cause loss of efficiency which could lead to a loss of control.

To engage mechanism: Squeeze front brake lever and maintain while moving lever lock with a finger. Front brake lever is now compressed and applying front brake.

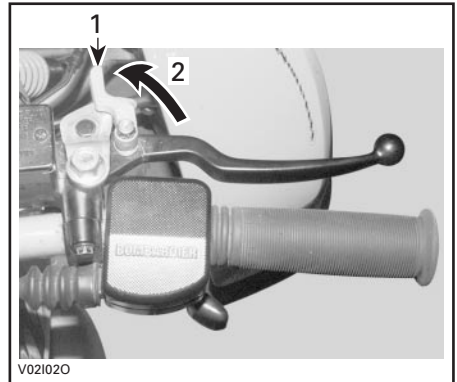

1. Parking lever lock
2. To apply parking device

To release mechanism: Squeeze front brake lever. Lever lock should automatically return to its original position. Front brake lever should return to rest position.

5) Headlight Switch

Located on left side of handlebar. Place switch to LO for the low beam and taillight. Place switch to HI for the high beam and taillight. Place switch to OFF position for closed the headlight.

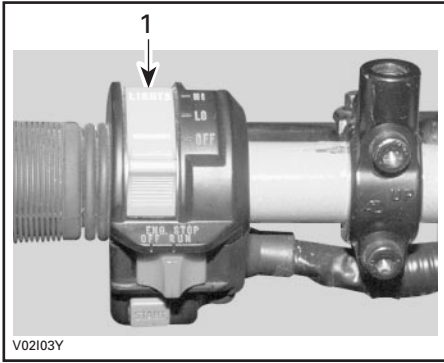

1. Headlight switch

6) Engine Stop Switch

Located on left side of handlebar. The engine will not run or start if the engine stop switch is turned to OFF position.

This switch is used to stop engine and as an emergency control.

NOTE: While engine can be stopped by turning ignition key OFF, we recommend the engine be stopped by the engine stop button.

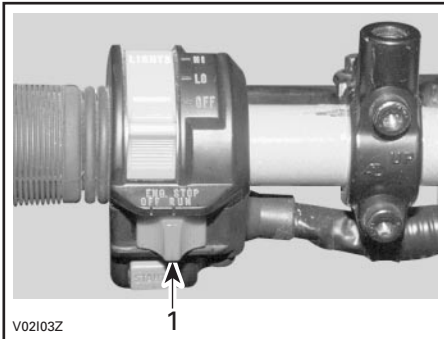

1. Engine stop switch

7) Start Button

Located on left side of handlebar. To start engine:

- Place the engine stop switch to RUN.
- Select transmission to the NEUTRAL position or squeeze the clutch lever.
- Turn ignition key to ON.
- Press and hold the start button.

CAUTION: Do not hold start button more than 4 seconds. A rest period should be observed between the cranking cycles to let starter cool down. Pay attention not to discharge battery.

Release immediately after engine is started.

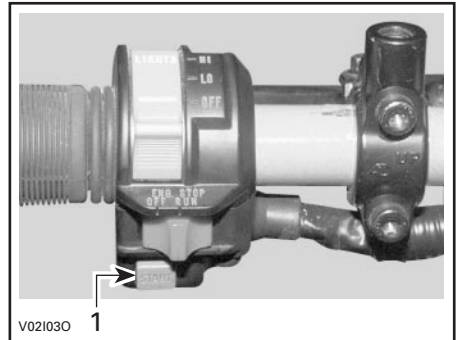

1. Start button

8) Fuel Tank Cap

Unscrew counterclockwise and remove cap to allow fuel tank filling then fully tighten clockwise.

WARNING

Never use an open flame to check fuel level.

9) Ignition Switch

Located on the right side of the control panel.

Key-operated, 2 position switch: OFF, and ON without lights.

Insert key in switch and turn to the desired position. To remove key, turn key to OFF then pull it out.

NOTE: While engine can be stopped by turning ignition key OFF, we recommend the engine be stopped by pushing the engine stop switch.

10) Indicator Lamp

The indicator lamps are located above ignition switch.

Neutral Indicator Lamp (green)

When the transmission is in neutral, the neutral indicator lamp light comes ON.

Engine Indicator Lamp (red)

When the engine oil pressure is too low or the engine temperature is too high, the engine indicator lamp comes ON.

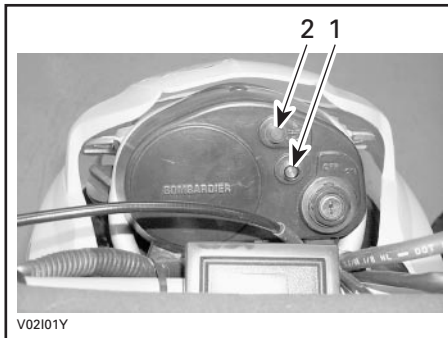

1. Neutral indicator lamp (green)
2. Engine indicator lamp (red)

In the event that the vehicle is flipped over or stays tilted on the side, be sure to check RED engine indicator lamp after restarting engine. If lamp stays ON, stop engine and see an authorized Bombardier ATV dealer.

CAUTION: Failure to stop the engine immediately after RED engine indicator lamp comes ON will adversely affect the service life of the engine.

11) Front Brake Fluid Reservoir

Located above front brake lever.

12) Fuel Valve

Located on right side under fuel tank. 3-position rotary valve: OFF, ON, RES. Rotate the knob to align its pointer with ON, OFF or RES.

OFF

Stops fuel supply to carburetor.

CAUTION: Turn valve to OFF position when ATV is not being operated or when transporting.

ON

Allows fuel to flow to carburetor. This is the normal position for operation of the vehicle.

RES (RESERVE)

When fuel is exhausted in the fuel tank when in the ON position, an emergency supply of fuel is available by turning the knob to RES. The reserve contains approximately 30% of the fuel tank capacity. Use only this position when the ON supply is empty.

When down to the reserve, refuel as soon as possible. Ensure to turn the valve back to the ON position after refuelling.

14) Storage Compartment

Located on back of air box, under seat.

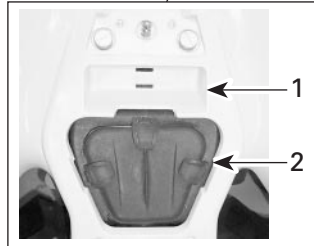
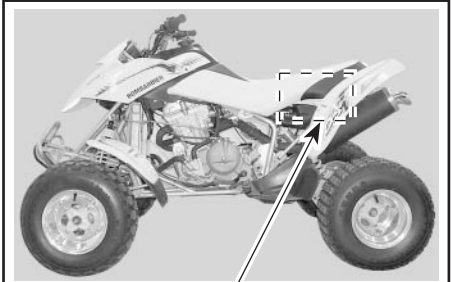

V02A0MY

1. Storage compartment
2. Air box

Tool Box

Located in storage compartment. The tool box contains tools for basic maintenance, the *Operator's Guide* and the *Safety Handbook*.

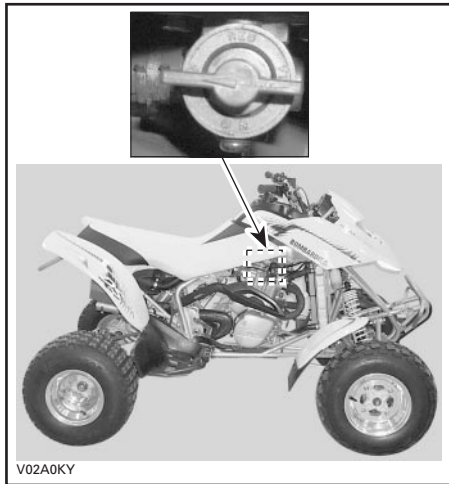

CAUTION: Improper opening of fuel valve will restrict the flow of fuel. Make sure valve is fully opened while running.

13) Gearshift Pedal

Located in front of left footpeg.

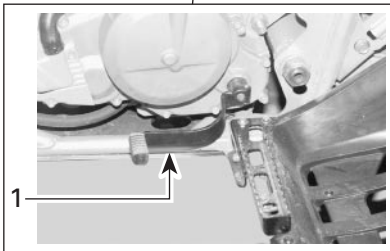
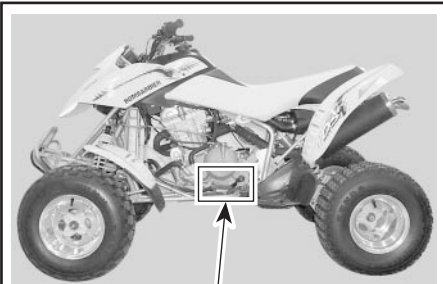

V02A0LY

1. Gearshift pedal

15) Seat Latch

Located underneath rear end of seat. It allows the removal of seat to give access to air box and storage compartment.

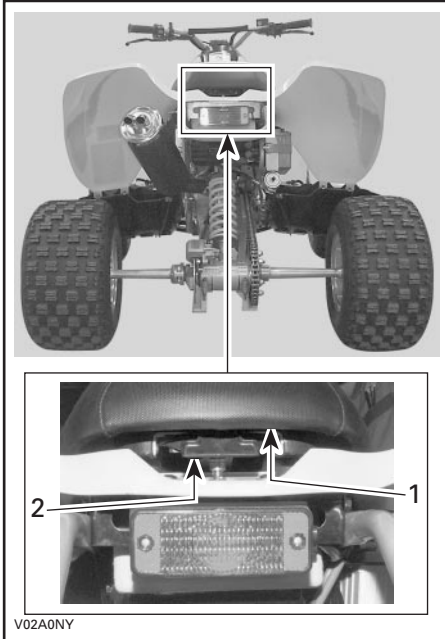

1. Seat
2. Seat latch

Seat Removal

Pull latch upward while gently lifting rear of seat. Continue lifting movement until you can release the front retaining devices then completely remove seat.

Seat Installation

Insert seat front tab into body hook. Pull latch lever to insert it over the rear lock pin. Release latch lever then firmly push on rear of the seat to relatch.

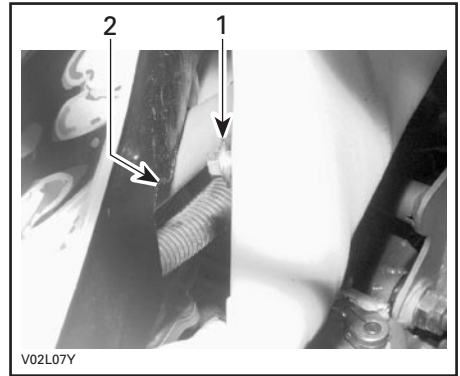

1. Seat tab
2. Body hook

WARNING

Periodically verify the seat lock pin and tighten if needed. Make sure seat is securely latched before riding.

16) Footpeg

Located on both side of the vehicle.

17) Foot Brake Pedal

Located in front of right footpeg. When pressed down, the rear brake is applied. When released, it should return to its original position.

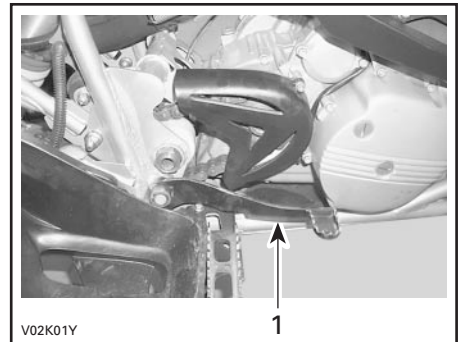

1. Foot brake pedal

NOTE: Braking effect is proportional to the force applied on the lever and to the type and condition of the terrain.

18) Rear Brake Fluid Reservoir

Located near the right rear fender.



1. Rear brake fluid reservoir

19) Engine/Transmission Oil Tank Cap

Located on LH of control panel.

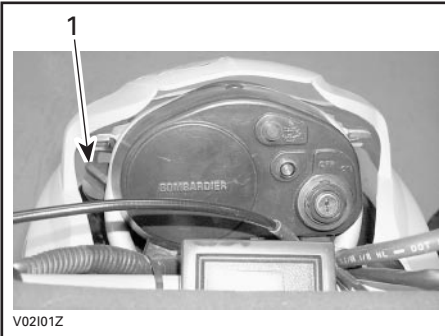

1. Engine/transmission oil tank cap

WARNING

The oil tank can be hot. Do not touch with your hands.

LIQUIDS

While reading this guide, remember that:

WARNING

Indicates a potential hazard that could result in serious injury or death.

This section specifies the recommended liquids and procedures to check their levels. Refer to MAINTENANCE for procedures to replace the liquids.

Fuel

Recommended Fuel

Use super unleaded gasoline or gasohol containing less than 10% of ethanol or methanol, available from most service stations. Use The gasoline used must have an octane number of 91 ((R + M)/2) or higher.

NOTE: In most service station, pump octane number corresponds to (R + M)/2 octane number. Usually a sticker can be found on the pump.

CAUTION: Never experiment with other fuels. The use of unrecommended fuel can result in vehicle performance deterioration and damage to critical parts in the fuel system and engine components.

CAUTION: Never mix oil with fuel. This ATV has a 4-stroke engine. Oil must be added to oil tank only.

Fuel Level

WARNING

Never top up the fuel tank before placing the vehicle in a warm area. As temperature increases, fuel expands and may overflow. Fuel is flammable and explosive under certain conditions. Always wipe off any fuel or oil spillage from the vehicle.

Engine/Transmission Oil

Recommended Oil

Always use 4-stroke mineral-based engine oil that meets or exceeds the requirements for API service classification SH or SJ. Always check the API service label on the oil container to be sure it includes the letters SH or SJ. Only use high-quality high-detergent oil.

CAUTION: The same oil lubricates both engine and transmission. Do not use synthetic, synthetic blend oil or special oil additive. They affect the clutching calibration.

Oil Viscosity

SAE 10W40 is recommended for general use.

Other viscosity should be used if the average temperature is outside the range of the recommended oil. See chart below.

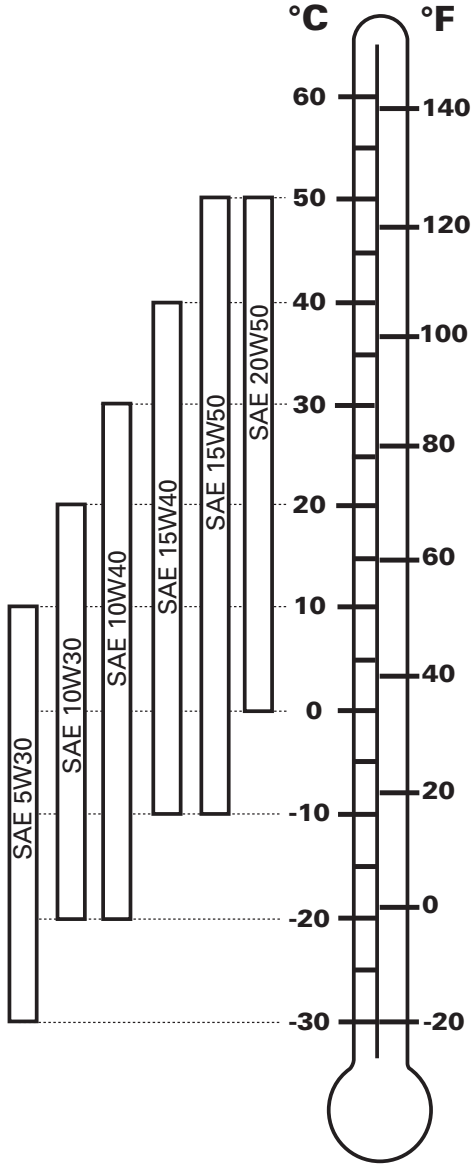

V01A0VL

Oil Level

CAUTION: Check level frequently and refill if necessary. Do not overfill. Operating the engine/transmission with an improper level may severely damage engine/transmission. Wipe off any spillage.

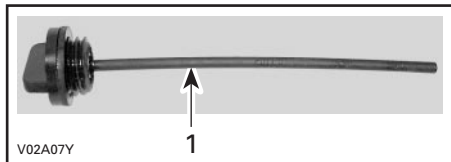

LH SIDE OF DASH

1. Dipstick

With vehicle on a level surface and engine not running, check oil level as follows:

1. Unscrew dipstick out and wipe clean.
2. Screw dipstick until it bottoms.
3. Remove dipstick and check oil level. It should be between lower and upper marks.
4. Add oil up to upper mark if required.
5. To add oil, use a funnel to avoid spillage. Do not overfill.
6. Properly tighten dipstick.

Engine Coolant

Recommended Coolant

Always use ethylene-glycol antifreeze containing corrosion inhibitors specifically for internal combustion aluminum engines.

Cooling system must be filled with water and antifreeze solution (40% water, 60% antifreeze).

Coolant Level

WARNING

Check coolant level with engine cold. Never add coolant in cooling system when engine is hot.

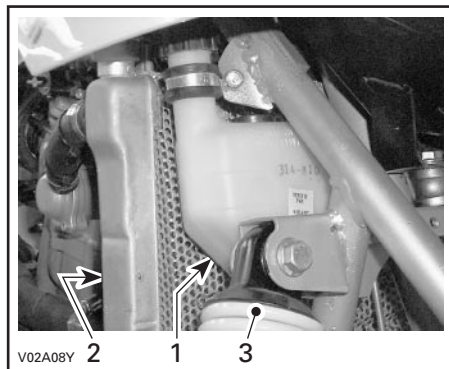

1. Coolant reservoir
2. Radiator
3. RH front shock

With vehicle on a level surface, liquid should be between MIN. and MAX. level marks of coolant reservoir.

NOTE: When checking level at temperature lower than 20°C (69°F), it may be slightly lower than MIN. mark.

Remove filler cap then add coolant up to MAX. mark if required. Use a funnel to avoid spillage. **Do not overfill.**

Properly reinstall and tighten filler cap.

NOTE: A cooling system that frequently requires coolant is the indication of leaks or engine problems. See an authorized Bombardier ATV dealer.

Brake Fluid

Recommended Fluid

Always use brake fluid meeting the specification DOT 4 only.

CAUTION: Never use other type of oil such as mineral-based or synthetic oil.

Fluid Level

With vehicle on a level surface, check brake fluid in reservoir for proper level. It should be above MIN. mark.

Add fluid as required. **Do not overfill.**

Clean filler cap before removing.

CAUTION: Use only DOT 4 brake fluid from a sealed container.

NOTE: A low level may indicate leaks or worn brake pads. See an authorized Bombardier ATV dealer.

Front Brake Fluid Reservoir

Turn steering in the straight-ahead position to ensure reservoir is level.

Visually inspect lever boot condition. Check for cracks, tears etc. Replace if damaged.



Rear Brake Fluid Reservoir



RH SIDE OF VEHICLE

Battery

This vehicle is equipped with a dry battery that requires no maintenance.

Cleaning

Clean battery post with a wire brush. Apply dielectric grease on post to protect against oxidation.

Removal

Disconnect negative BLACK cable first then positive cable.

⚠ WARNING

Always respect this order for disassembly; disconnect BLACK negative cable first. Oil or fuel vapors can be present in engine compartment and a spark may ignite them and possibly cause personal injuries.

Remove bolts retaining battery holder from rack.

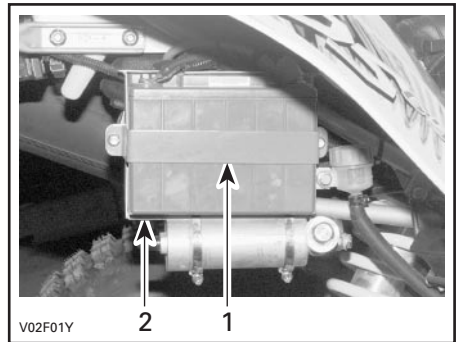

1. Battery holder
2. Rack

Installation

Reinstall battery in vehicle. Fasten battery holder.

⚠ WARNING

Connect positive RED cable first then negative cable. Always connect RED positive cable first.

BREAK-IN PERIOD

Engine

A break-in period of 10 operating hours is required before running the vehicle at sustained full throttle.

CAUTION: Never mix oil with fuel. This vehicle has a 4-stroke engine. Oil must be added to engine base only.

During this period, maximum throttle should not exceed $\frac{3}{4}$. **However, brief full acceleration and speed variations contribute to a good break-in.** Continued wide open throttle accelerations, prolonged cruising speeds and engine overheating are detrimental during the break-in period.

10-Hour Inspection

As with any precision piece of mechanical equipment, we suggest that after the first 10 hours or 30 days after the purchase, whichever comes first, your vehicle be inspected by an authorized Bombardier ATV dealer. This inspection will give you the opportunity to discuss the unanswered questions you may have encountered during the first hours of operation.

The 10-hour inspection is at the expense of the vehicle owner.

PRE-OPERATION CHECK

WARNING

The pre-operation check is very important prior to operating the vehicle. Always check the proper operation of critical controls, safety features and mechanical components before starting. If not done as specified here, severe injury or death might occur.

- Check the parking device. Apply parking device and check if it operates properly.
 - Check tire pressure and condition.
 - Check wheels and bearings for wear and damage.
 - Check location of controls and ensure they work properly.
 - Verify steering operates freely.
 - Activate throttle control lever several times to ensure it operates freely. It must return to idle position when released.
 - Activate the brake lever and foot pedal to make sure the brakes fully apply. Lever and pedal must fully return when released.
 - Check all brake line fitting for tightness and against leaks.
 - With the parking device correctly applied. Activate the clutch lever. Lever must fully return when released.
 - Check operation of ignition switch, start button, headlight switch (HI-LO), taillight, brake light, indicator lights and engine stop switch.
 - Check drive chain for lubrication and adjustment.
 - Check sprockets for wear and damages.
 - Check fuel, oil and coolant levels.
 - Check for oil leaks on the engine/transmission and oil tank.
 - Ensure fuel valve is in fully open position (ON).
 - Clean headlight and taillight.
 - Ensure seat is properly latched.
 - If you transport cargo, respect load capacity. Ensure cargo is properly secured to the vehicle.
 - If you are pulling a trailer or other equipment, ensure it respects the tongue capacity and towing capacity. Ensure trailer is properly secured to hitch.
 - Look and feel for loose parts while engine is off. Check fasteners.
 - Ensure the path of travel is free of persons and obstacles.
 - Drive forward slowly a few feet and apply all brakes individually to test them.
- Correct any problem you may have found. See an authorized Bombar-dier ATV dealer as necessary.**

OPERATING INSTRUCTIONS

General

This vehicle has five-forward gears. Engine can be started in any gear (from 1 to 5).

Transmission must be on NEUTRAL or pull in the clutch lever to allow engine starting.

Initial Cold Starting

Insert key in ignition switch and turn to ON.

Place the engine stop switch to run position.

In severe cold weather, colder than -20°C (-4°F), move the choke lever to full position.

Press start button and hold until engine starts.

CAUTION: Do not hold start button more than 4 seconds. A rest period should be observed between the cranking cycles to let starter cool down. Pay attention not to discharge battery.

Release start button immediately when engine has started.

WARNING

Do not apply throttle while starting.

After a few minutes, move the lever to half position.

NOTE: Overusing choke may flood engine and make it hard to start. Refer to SPECIAL PROCEDURES if it occurs.

When the engine is warm, move the choke lever to OFF and release brakes.

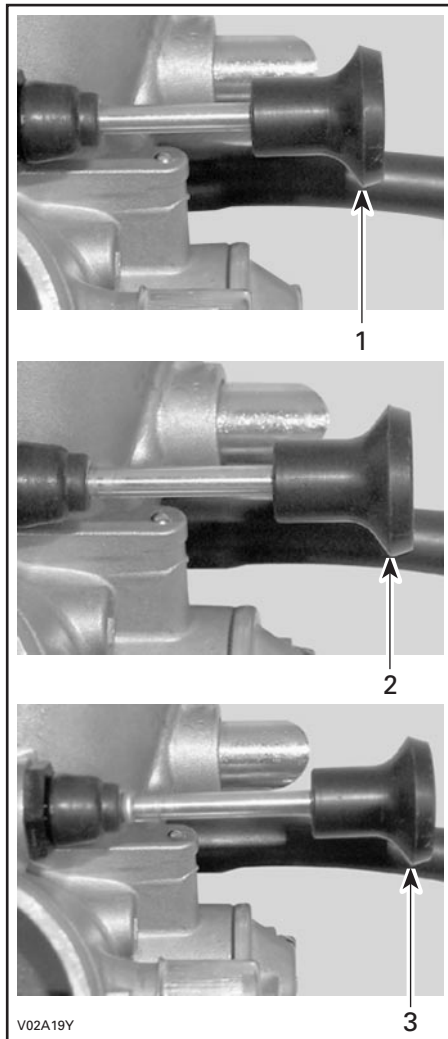

UNDER SEAT, ON THE LH SIDE

1. Off position
2. Half position
3. Full position

Warm Engine Starting

Start the engine as explained above but without any choke. If the engine will not start after two 4-second attempts with the electric starter, move choke lever to position 1. Start the engine without activating the throttle lever. After few times, move the choke lever to OFF.

Stopping the Engine

Release throttle and completely stop the vehicle.

Apply the parking device.

Press the clutch lever and shift to 1st gear.

Push the engine stop switch.

Turn key in ignition switch to OFF.

Remove key from ignition switch.

Shifting the Transmission

Gearshift Control

To shift the transmission, pull in the clutch lever, then operate gearshift pedal as follow.

WARNING

Always use the clutch lever to up-shift or downshift

One full stroke of the pedal shifts the transmission to the next higher or lower gear in the shifting sequence. The pedal should automatically return to its original position.

To upshift to a higher gear, put the end of your boot under gearshift lever and lift up the pedal one full stroke. To downshift, step on the gearshift pedal and depress pedal one full stroke.

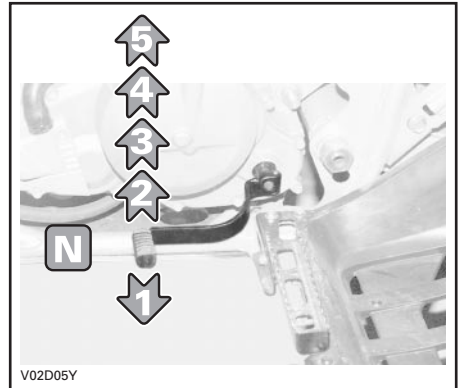

WARNING

Always release the throttle when shifting gears. Shifting gears without releasing the throttle, could cause loss of control or cause the ATV to overturn.

CAUTION: Make sure parking device is fully disengaged before operating the ATV.

SPECIAL PROCEDURES

Flooded Engine

When the engine does not start after several attempts, the engine may be fuel flooded. Proceed as follows.

Turn ignition switch to ON and ensure choke is not applied.

Ensure the transmission is in NEUTRAL or pull in the clutch lever.

Fully press throttle lever and hold while starting the engine. Try several times.

As soon as the engine starts, release throttle lever. Do not race engine.

If it does not work:

Disconnect spark plug cables.

Clean the spark plug area then remove spark plugs (tools are supplied in tool box).

Crank engine several times. Install clean dry spark plugs if possible.

Start engine as explained above. If engine continues to flood, see an authorized Bombardier ATV dealer.

Engine Overheat

If engine overheats and engine indicator lamp (red) comes ON, try the following:

Check oil level in oil tank and refill if necessary.

Ensure radiator is not obstructed.

Check radiator fins. See MAINTENANCE section.

Reduce vehicle speed but try to keep vehicle moving to supply air to radiator. If engine is still overheating after approximately one minute, stop vehicle and set transmission to NEUTRAL. Apply parking device and stop engine.

Inspect radiator area and clean as necessary. Check coolant level and refill if possible.

WARNING

Never refill cooling system when engine is hot. Let engine cool down.

See an authorized Bombardier ATV dealer as soon as possible.

Post-Operation Care

When vehicle is used in salt-water environment (beach area, launching/loading boats etc.), rinsing the vehicle with fresh water is necessary to preserve vehicle and its components. Metallic parts lubrication is highly recommended. Use BOMBARDIER LUBE. This must be performed at the end of each operating day.

When vehicle is operated in muddy conditions, rinsing the vehicle is recommended to preserve vehicle and its components and to keep lights clean.

Storage and Preseason Preparation

When a vehicle is not in use for more than one month, proper storage is a necessity.

See an authorized Bombardier ATV dealer for proper procedures.

When using your ATV after storage, a preparation is required. See an authorized Bombardier ATV dealer for proper procedures.

MAINTENANCE CHART

Noise Emission Control System Regulation

Tampering with Noise Control System Prohibited!

U.S Federal law and Canadian provincial laws may prohibit the following acts or the causing thereof:

1. The removal or rendering inoperative by any person other than for purposes of maintenance, repair or replacement of any device or element of design incorporated into any new vehicle for the purpose of noise control prior to its sale or delivery to the ultimate purchaser or while it is in use or
2. The use of the vehicle after such device or element of design has been removed or rendered inoperative by any person.

Among those Acts Presumed to Constitute Tampering are the Acts Listed Below:

1. Removal or alteration or the puncturing of the muffler or any engine component which conducts removal of engine exhaust gases.
2. Removal or alteration or the puncturing of any part of the intake system.
3. Replacing any moving parts of the vehicle or parts of the exhaust or intake system, with parts other than those specified by the manufacturer.
4. Lack of proper maintenance.

Emission Requirements

The California Air Resources Board (CARB) requires that your ATV observe with applicable exhaust emissions standards during its useful life, when operated and maintained according to the instructions supplied.

A non-compliance Red Label (as well as a green label) is obtained annually during California Vehicle registration. The appropriate label is denoted by the vehicle identification number (in the 8th character detailed herein).

VEHICLE CATEGORY	VIN 8 TH CHARACTER
Non-complying red label	Must denote a C or 3
Complying green label	Any alphanumeric designation other than a C or 3

Refer to MAINTENANCE section of Shop Manual for more details.

LUBRICATION AND MAINTENANCE CHART		INITIAL 10-HOUR INSPECTION ①	EVERY 25 HOURS	EVERY 50 HOURS	EVERY 100 HOURS OR ONCE A YEAR	EVERY 200 HOURS OR 2 YEARS	TO BE PERFORMED BY
ENGINE/ TRANSMISSION	Engine/transmission oil level	EVERY RIDE					CUSTOMER
	Engine/transmission oil and filter replacement	✓		✓			CUSTOMER
	Valve clearance	✓			✓		DEALER
	Engine mount fasteners	✓			✓		DEALER
	Exhaust system/spark arrester	✓			✓		DEALER
	Condition of seals	✓			✓		DEALER
	Coolant level	EVERY RIDE					CUSTOMER
	Coolant replacement					✓	DEALER
	Cooling system condition	✓			✓		DEALER
	Radiator cap pressure test	✓				✓	DEALER
	Radiator condition/cleanliness (radiator fins)	✓		✓			CUSTOMER
	Clutch and transmission operation				✓		DEALER
	Clutch lever adjustment	✓		✓			DEALER
FUEL SYSTEM	Air filter cleaning/drainage	✓	✓				CUSTOMER
	Air filter and foam replacement			✓			CUSTOMER
	Fuel lines and connections	✓			✓		DEALER
	Fuel tank strainer replacement					✓	DEALER
	Carburetor adjustment	✓			✓		DEALER
ELECTRICAL	Spark plugs inspection/replacement ②	✓			✓		DEALER
	Battery connections				✓		DEALER
	Wiring harnesses, cables and lines	✓			✓		DEALER
	Condition of ignition switch and start button	EVERY RIDE					CUSTOMER
	Condition of lighting system (HI/LO intensity, brake light, etc.)	EVERY RIDE					CUSTOMER
DRIVE TRAIN	Headlight beam aiming	✓			✓		CUSTOMER
	Drive chain lubrication	EVERY RIDE					CUSTOMER
	Drive chain adjustment	EVERY RIDE					CUSTOMER
	Drive chain slider condition			✓			CUSTOMER
	Sprockets inspection	✓			✓		CUSTOMER
	Wheel bearing condition				✓		DEALER
	Rear hub wheel lubrication					✓	DEALER
Axle adjustment nut lubrication					✓	DEALER	

LUBRICATION AND MAINTENANCE CHART		INITIAL 10-HOUR INSPECTION ①	EVERY 25 HOURS	EVERY 50 HOURS	EVERY 100 HOURS OR ONCE A YEAR	EVERY 200 HOURS OR 2 YEARS	TO BE PERFORMED BY
STEERING/ CONTROL SYSTEMS	Handlebar fastener tightness				✓		DEALER
	Throttle condition	EVERY RIDE					CUSTOMER
	Choke condition	EVERY RIDE					CUSTOMER
	Steering system mechanism	✓			✓		DEALER
	Tie rod ends			✓			DEALER
	Tire pressure	EVERY RIDE					CUSTOMER
	Wheel mount tightness and stud lubrication	✓			✓		CUSTOMER
	Wear and condition of tires	EVERY RIDE					CUSTOMER
	Front wheel alignment and steering adjustment	✓			✓		DEALER
SUSPENSION	Swing arm condition			✓			DEALER
	Swing arm lubrication		✓				CUSTOMER
	A-arm lubrication		✓				CUSTOMER
	A-arm condition			✓			DEALER
	Ball joint boot inspection	✓	✓				CUSTOMER
	Ball joint condition		✓				DEALER
	Shock absorber condition			✓			DEALER
BRAKE	Brake fluid level front/rear	EVERY RIDE					CUSTOMER
	Brake fluid replacement front/rear				✓		DEALER
	Brake pad condition		✓				DEALER
	Brake system condition (discs, hoses etc.)				✓		DEALER
	Brake line fittings	EVERY RIDE					CUSTOMER
BODY/FRAME	Engine area cleaning			✓			CUSTOMER
	Skid plate condition	✓		✓			CUSTOMER
	Frame condition	EVERY RIDE					CUSTOMER
	Fastener condition/tightness			✓			CUSTOMER
	Seat latch				✓		CUSTOMER
	Vehicle cleaning and protection			✓			CUSTOMER

① To be performed by an authorized Bombardier ATV dealer.

② Before installing new spark plugs at pre-season preparation, it is suggested to burn excess storage oil by starting the engine with the old spark plugs. Only perform this operation in a well ventilated area.

NOTE: Some riding conditions may result in requiring more frequent maintenance. See a Bombardier ATV dealer. Some items are part of the pre-operation checks and must always be performed prior to operating the vehicle.

MAINTENANCE

While reading this guide, remember that:

WARNING

Indicates a potential hazard that could result in serious injury or death.

WARNING

Unless otherwise specified, engine should not be running for all maintenance procedures.

WARNING

Should removal of a locking device (e.g. lock tabs, self-locking fasteners, etc.) be required when undergoing disassembly/assembly, always replace with a new one.

The following covers the maintenance items that can be made by the customer if desired. Other items found in maintenance chart must be performed by an authorized Bombardier ATV dealer.

Lubrication

Among other things, this section gives the procedures to replace the liquids. Refer to LIQUIDS for procedures to check levels and refill.

Oil Change and Oil Filter Replacement

Oil and filter are to be replaced at the same time. Oil change should be done with a warm engine.

WARNING

The engine oil can be very hot. Wait until engine oil is warm.

Ensure vehicle is on a level surface.

Remove dipstick.

Clean the drain plug area.

Drain all oil from oil tank by removing the rubber hose on the engine. Wipe out any oil spillage on engine.

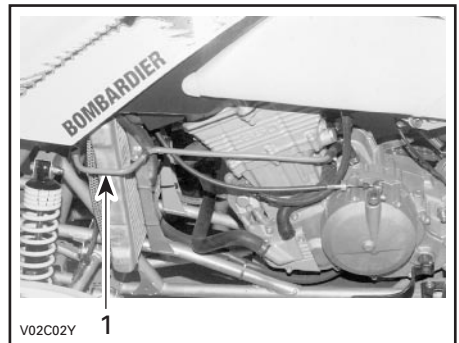

LEFT SIDE OF VEHICLE

1. Remove this hose to drain oil tank

Place a drain pan under the engine drain plug area.

Unscrew drain plug.

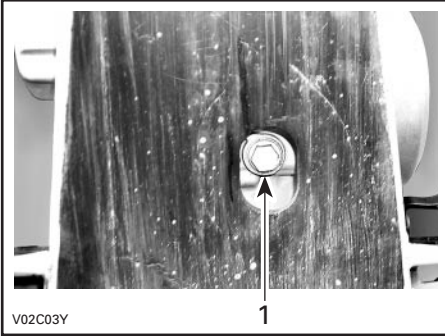

UNDER VEHICLE

1. Oil drain plug

Wait a while to allow oil to flow out of oil filter.

Reinstall the rubber hose on engine.

Unscrew oil filter cover.

Remove the oil filter and replace by a new.

NOTE: Check and change the O-ring, if necessary.

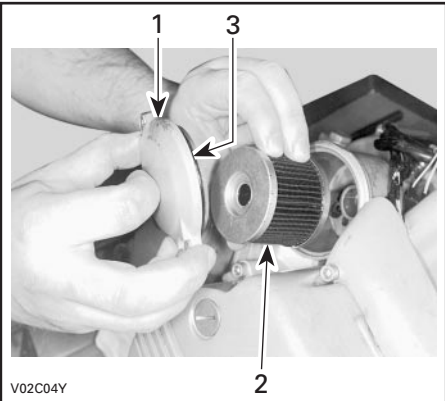

RH SIDE OF ENGINE

1. Oil filter cover
2. Oil filter
3. O-ring

Wipe out any oil spillage on engine.

Change gasket on drain plug. Clean gasket area on engine and drain plug then reinstall plug. Refill oil tank at the proper level with the recommended oil. Refer to SPECIFICATIONS for capacity.

Start engine and let idle for a few minutes.

Check if the RED indicator lamp stay ON, if yes, stop engine and bleed system by removing oil filter and bleeding screw.

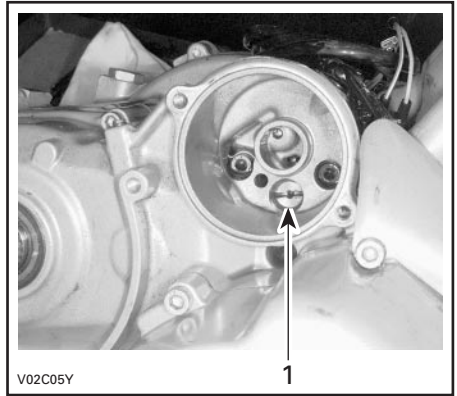

BEHIND OIL FILTER

1. Bleeding screw

Ensure oil filter area, hose and drain plug areas are not leaking.

Stop engine and check oil level. Refill as necessary.

Dispose oil as per your local environmental regulations.

Other Components

CAUTION: Do not lubricate throttle and clutch cables.

Suspension

Front A-arm

Lubricate front A-arms with a grease gun. Use synthetic grease (P/N 293 550 010).

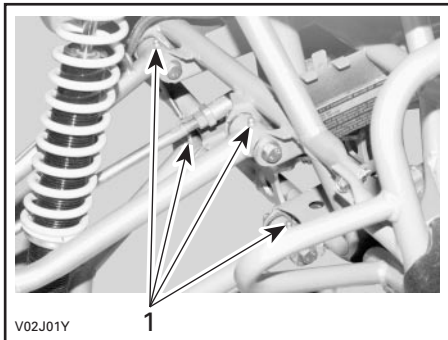

1. Grease fittings

Swing Arm

Lubricate swing arm with a grease gun. Use synthetic grease (P/N 293 550 010).

Occasionally, wheel nuts should be removed to apply anti-seize lubricant on studs to ease further removal. This is particularly important when vehicle is used in salt-water environment or in mud. Remove one nut at a time, lubricate then retorque.

Maintenance

Periodically check the engine and the radiator area for cleanliness.

Valves Adjustment

See an authorized Bombardier ATV dealer for valves adjustment.

Insufficient clearance will cause loss of power and possibly damage the valves. Excessive clearance will cause noise.

Throttle Lever Adjustment

Slide rubber protector back to expose throttle cable adjuster.

Loosen lock nut then turn the adjuster to obtain correct throttle lever free play.

NOTE: Measure throttle free play at the tip of throttle lever.

Tighten lock nut and reinstall protector.

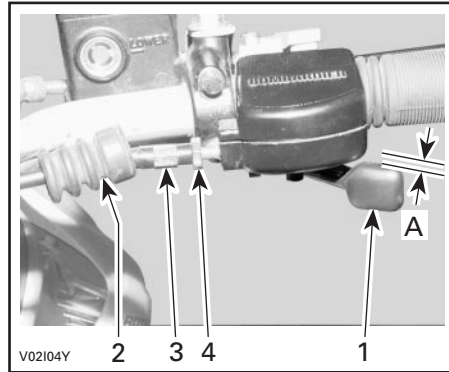

1. Throttle lever
2. Protector
3. Cable adjuster
4. Lock nut
- A. 3 to 8 mm (1/8 to 5/16 in)

Gearshift Pedal Adjustment

Unfasten socket screw near selector shaft end then remove gearshift pedal.

Install gearshift pedal at your convenience then torque socket screw.

Clutch Adjustment

Loosen cable tension.

Adjust clutch release mechanism.

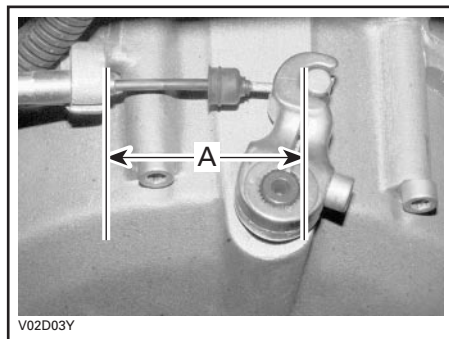

- A. 68 to 75 mm (2-11/16 to 2-31/32 in)

Adjust cable free play.

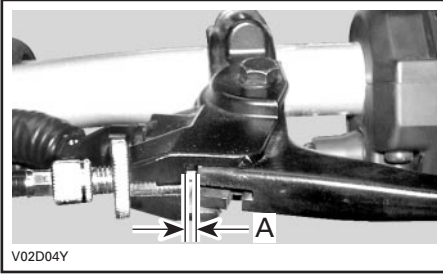

A. $2 \pm 0.5 \text{ mm}$ ($5/64 \pm 1/64 \text{ in}$)

Radiator

Inspect radiator fins. They must be clean, free of mud, dirt, leaves and any other deposit that would prevent the radiator to cool properly.

Remove the deposits as much as you can with your hands. If water is available in proximity, try rinsing the radiator fins.

If available, use a garden hose to rinse the radiator fins.

WARNING

Never clean radiator with your hands when it is hot. Let the radiator cool down before cleaning.

CAUTION: Be careful not to damage the radiator fins when cleaning. Do not use any object/tool that could damage the fins. The fins are purposely thin parts to allow efficient cooling. When hosing, use low pressure only.

Spark Arrester

The muffler must be periodically purged of accumulated carbon. See the maintenance chart.

Removal

WARNING

Never perform this operation immediately after the engine has been run because exhaust system is very hot. Wear eye protection and gloves. Respect all applicable laws and regulations.

Remove:

- the screws retaining the spark arrester to the muffler

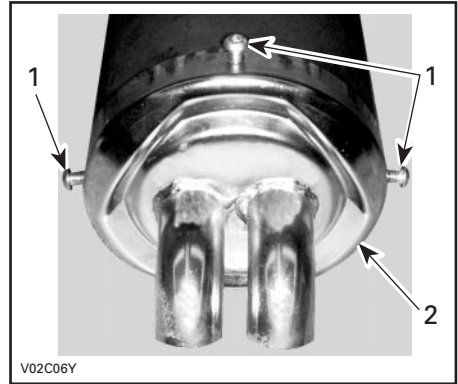

1. Screws
2. Spark arrester

- spark arrester and sealant joint

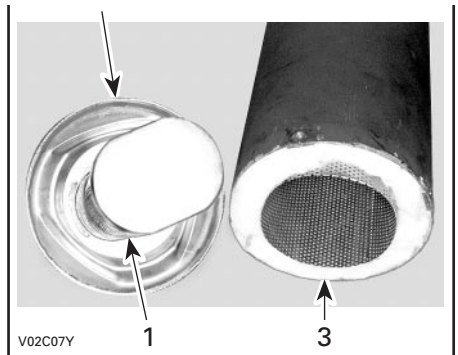

1. Spark arrester
2. Sealant joint
3. Muffler

- inner grill with wool

Remove all carbon deposit in the muffler.

Remove carbon deposits from the spark arrester using a brush.

NOTE: Use a soft brush and be careful to avoid damaging spark arrester.

Installation

For installation, reverse the removal procedure, paying attention to the following details:

Check:

- wool and change if it deteriorate
- the spark arrester condition, it must be free of breaks and holes. Replace if necessary

Remove the old sealant joint and replace by a new one. Use ULTRA COOPER sealant (P/N 413 710 300).



Be sure that wool is in place when inserting grill.

Align grill properly in bottom of muffler shell.

Fuel System

Air Filter Cleaning/Draining

Periodically inspect air filter box drain plug for water or deposits.

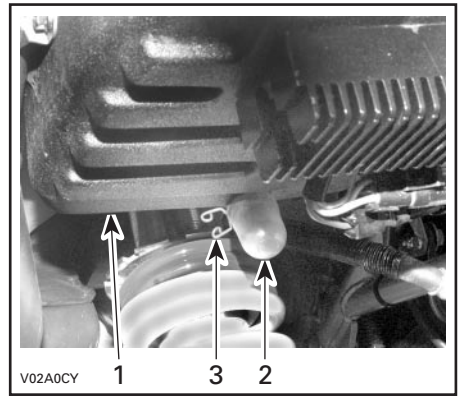

1. Air filter box
2. Drain plug
3. Clamp

NOTE: If vehicle is used in dusty area, inspect more frequently than specified in maintenance chart.

If water/deposits are found, squeeze and remove the clamps. Pull drain tubes out.

CAUTION: Do not start engine when water is found in the drain tubes.

When water/deposits are found, the air filter must be inspected/dried/replaced depending on its condition.

Remove air filter as explained below.

Air Filter Removal

CAUTION: Never remove or modify any component in the air box. Always use genuine parts or suitable equivalent when replacing air filter and foam. The engine carburetion is calibrated to operate specifically with these components. Otherwise, engine performance degradation or damage can occur.

Remove seat.

Release latches and remove air filter box cover.

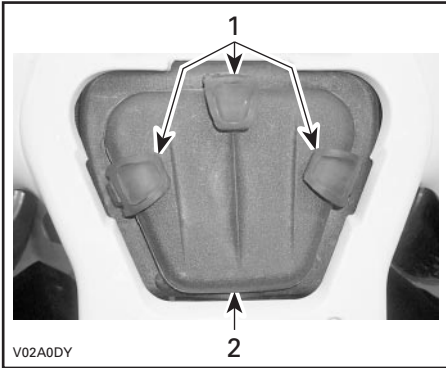

1. Latches
2. Air filter box cover

Remove screw driver cap, push inside of air box.

Loosen screw on clamp and remove filter.

Remove foam.

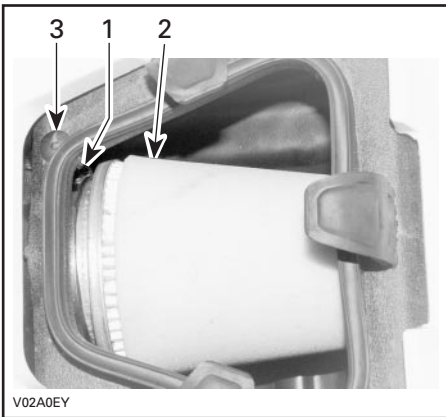

1. Clamp
2. Air filter and foam
3. Screw driver cap

Clean inside of air box.

Wash air filter and foam with warm water and mild detergent as necessary.

Squeeze foam to remove excess water. Let dry air filter and foam thoroughly.

NOTE: Slight dust may be cleaned using a low-pressure airgun. Blow compressed air backward of operating air flow.

If air filter element or foam is dirty, replace with a new one.

Air Filter Installation

Properly reinstall removed parts in the reverse order of their removal.

Electrical

Battery

Cleaning

Clean battery post with a wire brush. Apply dielectric grease on post to protect against oxidation.

Removal

Disconnect negative BLACK cable first then positive cable.

WARNING

Always respect this order for disassembly; disconnect BLACK negative cable first. Oil or fuel vapors can be present in engine compartment and a spark may ignite them and possibly cause personal injuries.

Remove bolts retaining battery holder and rack.

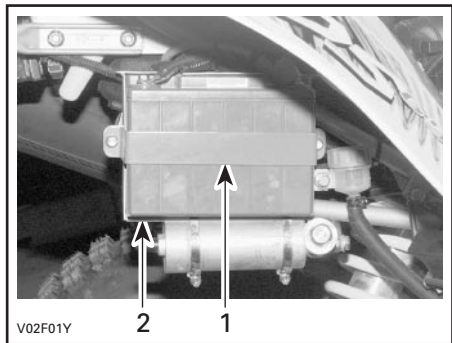

1. Battery holder
2. Rack

Installation

Reinstall battery in vehicle. Fasten battery holder.

WARNING

Connect positive RED cable first then negative cable. Always connect RED positive cable first.

Fuses

If a fuse is damaged, replace it by one of the same rating.

CAUTION: Do not use a higher rated fuse as this can cause severe damage.

Fuses are located under seat, between engine and air box.

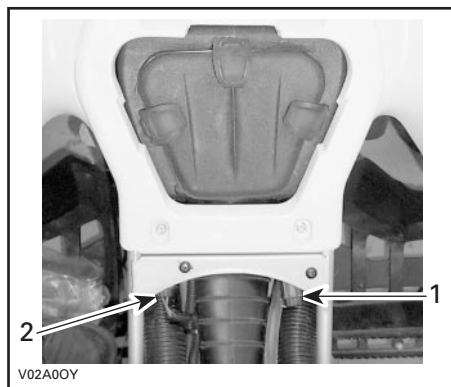

1. Fan (15 A)
2. Charging system (25 A)

Bulb Replacement

Always check light operation after replacement.

Headlight

If the headlight bulb is burnt:

- Remove front fascia and control panel.
- Remove rubber boot and turn counterclockwise bulb retaining ring.

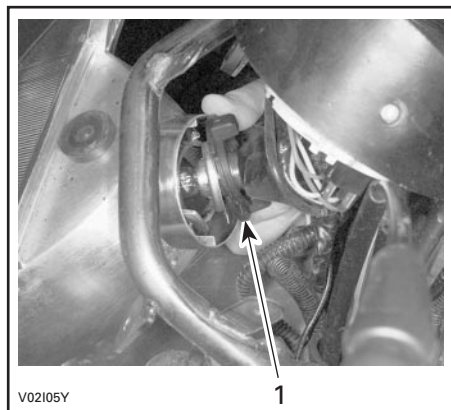

1. Retaining ring

– Detach bulb and replace.

Properly reinstall removed parts in the reverse order of their removal.

CAUTION: On applicable models, never touch glass portion of an halogen bulb with bare fingers, it shortens its operating life. If glass is touched, clean it with isopropyl alcohol which will not leave a film on the bulb.

Adjust beam aiming as follows:

Turn knobs to adjust beam height orientation to your convenience.

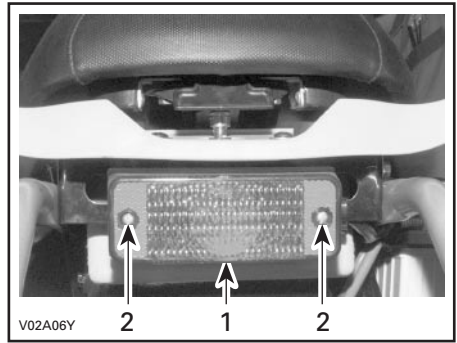

1. Lens
2. Screws

Indicator Lamp Replacement

Removal

Remove the control panel.

Unplug wires on indicator lamp.

Press both taps then push indicator lamp out of hole.

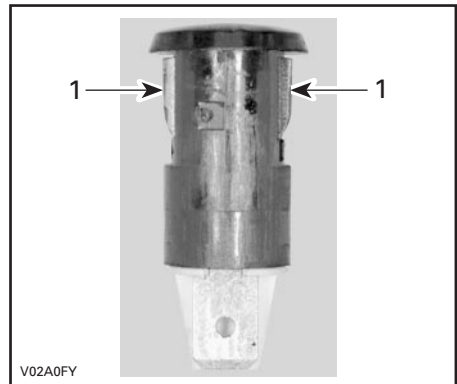

1. Tabs

Installation

For installation, reverse the removal procedure.

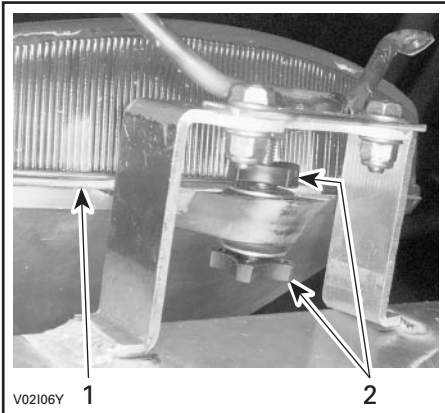

1. Headlight
2. Beam height adjustment

Taillight

Unscrew lens screws to expose bulb.

Push bulb in and hold while turning counterclockwise to release.

Install the new bulb by first pushing in while turning clockwise.

Drive Train

Drive Chain

Adjust the drive chain frequently, see the maintenance chart.

WARNING

Place ignition switch to OFF before check, adjust or lubricate drive chain.

Inspection

This ATV is equipped with O-ring sealed permanently greased pins and rollers. Before operating the vehicle, always inspect the drive chain.

Check for damage or missing O-ring, rollers and correct slack adjustment.

Lubrication and Cleaning

CAUTION: Never wash the chain with a high pressure washer or gasoline. Damage to the O-ring will result, causing premature wear and drive chain failure.

Clean the side surfaces of the chain with a dry cloth.

NOTE: Do not brush chain.

Lubricate only with the approved O-ring chain lubricant. Other commercial chain lubricants may contain solvent which could damage the O-rings.

Adjustment

NOTE: Always adjust drive chain with the driver seated on the vehicle.

Select a level surface and set transmission to NEUTRAL.

Loosen rear axle lock bolts.

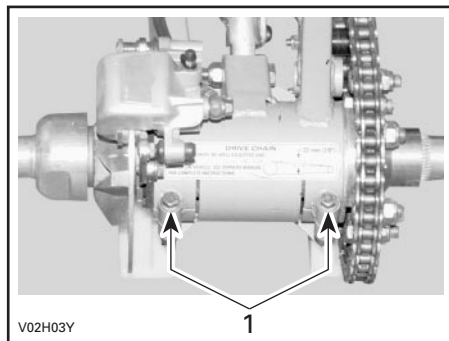

1. Rear axle lock bolts

Insert adjuster lock through sprocket hub and into eccentric axle housing.

Turn the axle ahead to increase or back to decrease chain slack.

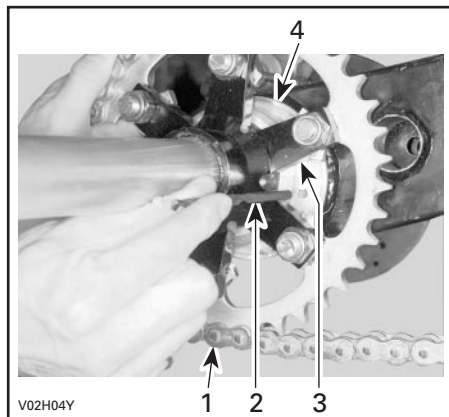

1. Drive chain
2. Adjuster lock
3. Sprocket hub
4. Eccentric axle housing

NOTE: Correct chain slack adjustment is 19 to 25.4 mm (3/4 to 1 in) at the midway between sprockets.

Tighten the rear axle lock bolts to 28 N•m (21 lbf•ft).

Lift rear of vehicle (without driver) and recheck the chain slack. The chain slack should be 44.5 to 51 mm (1-3/4 to 2 in). If not, start again the drive chain adjustment.

Replacement

With the chain installed on vehicle, measure the distance between a span of 13 links from pin center to pin center. Change drive chain if the distance exceeds the service limits, see an authorized Bombardier ATV dealer.

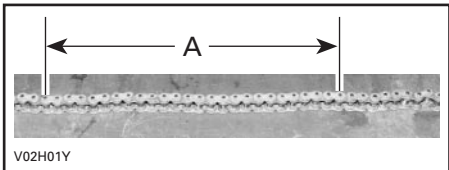

A. 403 mm (15-7/8 in)

Drive Chain Slider

Check the drive chain slider frequently, see the maintenance chart.

Replace the drive chain slider when it is worn.

See an authorized Bombardier ATV dealer for replacement.

Sprocket and Pinion

Check the sprocket axle and pinion for distortion.

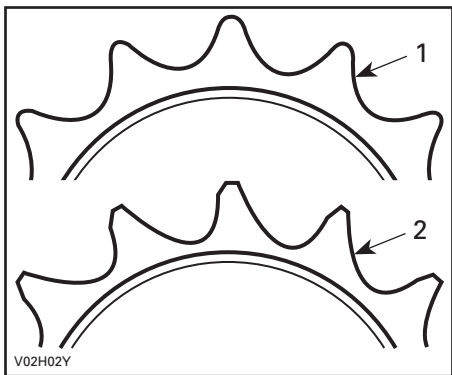

1. Good
2. Replace

CAUTION: Replace chain, sprocket axle and pinion together to prevent rapid chain and sprocket wear. Install a new retaining ring each time the pinion is removed.

Suspension

Inspection

Inspect shock absorber for oil leaks and fasteners for tightness. See an authorized Bombardier ATV dealer as necessary.

Adjustment

Front Shocks

WARNING

Adjust the both springs at the same load. Ensure even adjustment. Uneven adjustment can cause poor handling and loss of stability, and/or control, and increase the risk of an accident.

Preload Adjustment

Turn the spring clockwise for a firmer ride and rough road condition.

Turn the spring counterclockwise for a light load and a smooth road condition.

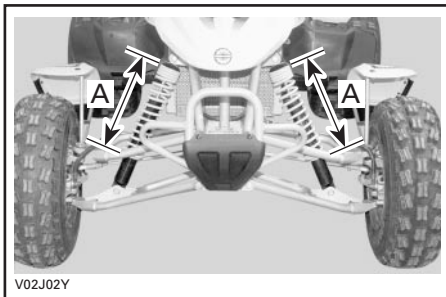

A. Same length

Rear Shock

WARNING

The rear shock includes a damper unit that contains high pressure nitrogen gas. **Do not attempt to disassemble or dispose of the damper**, see an authorized Bombardier ATV dealer.

Preload Adjustment:

- To reduce:
 - Turn the shock spring adjuster counterclockwise for a light load and smooth road condition.
- To increase:
 - Turn the shock spring adjuster clockwise for a firmer ride and rough road condition.

Rebound Damping:

- To reduce:
 - Turn the shock adjuster counterclockwise for a light load and smooth road condition.
- To increase:
 - Turn the shock adjuster clockwise for a firmer ride and rough road condition.

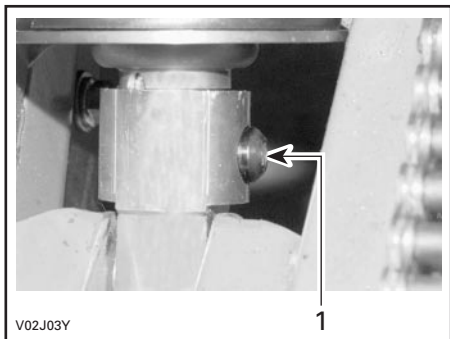

1. Adjuster

NOTE: The adjuster tool is included in the tool kit.

Compression Damping:

- To reduce:
 - Turn the damper adjuster counterclockwise for a light load and smooth road condition.
- To increase:
 - Turn the damper adjuster clockwise for a firmer ride and rough road condition.

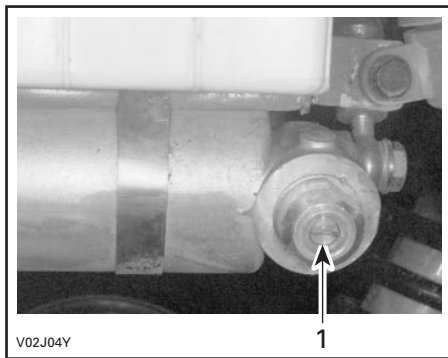

1. Adjuster

Tires/Wheels

Tire Pressure

WARNING

Tire pressure greatly affects vehicle handling and stability. Underpressure may cause tire to deflate and rotate on wheel. Overpressure may burst the tire. Always follow recommended pressure. Since tires are low-pressure types, a manual pump should be used.

Check pressure when tires are COLD before using the vehicle. Tire pressure changes with temperature and altitude. Recheck pressure if one of these conditions has changed.

For your convenience, a pressure gauge is supplied in tool box.

TIRE PRESSURE		
	FRONT	REAR
RECOMMENDED	35 kPa (5 PSI)	35 kPa (5 PSI)
MINIMUM	21 kPa (3 PSI)	21 kPa (3 PSI)

Although the tires are specifically designed for off-road use, a flat may still occur. Therefore, it is recommended to carry a tire pump and a repair kit.

Tire/Wheel Condition

Check tire for damage and wear. Replace if necessary. Do not make a tire rotation. The front and rear tires have a different size. The tires are directional and their rotation must be kept in a specific direction for proper operation.

Wheel Removal

Loosen nuts then lift vehicle. Place a support under vehicle, as shown. Remove nuts then remove wheel. At installation, it is recommended to apply anti-seize lubricant on threads. Gently tighten nuts in a criss-cross sequence then apply a final torque of 52.5 N•m (39 lbf•ft).

Wheel Bearing Condition

Push and pull the wheels from the upper edge to feel the play. See an authorized Bombardier ATV dealer if there is any play.

Brake

Front and Rear Brakes

The front and rear brakes are hydraulic disc types. These brakes are self-adjusting and require no adjustment. Check brake line fittings tightness before every ride.

Body/Frame

Engine Area

Check engine area for any damage and leaks. Ensure all hose clamps are properly secured and no hose is cracked, kinked or otherwise damaged. Inspect muffler, battery and reservoir fastening devices. Check electrical connections for corrosion and tightness. Replace or have damaged parts repaired.

Skid Plate

Check tightness of fasteners and condition of plate for cracks or other damage. Properly retighten fasteners as necessary and have skid plate replaced if damaged.

Front Fender

Check tightness of fasteners and condition of front fender for cracks or other damage. Properly retighten fasteners as necessary and have front fender replaced if damaged.

WARNING

Never remove the front fenders. The important labels are applied on the front fenders. Operating without front fender, increases your chances of severe injury in the event of an accident.

Fasteners

Check fastener condition and tightness on the vehicle. Retighten as required.

Seat Latch

Remove seat and check latch mechanism and pin for wear. See an authorized Bombardier ATV dealer for parts replacement if damaged.

Frame

Check frame for cracks or other damage. See an authorized Bombardier ATV dealer for replace or repair.

Vehicle Cleaning and Protection

Painted parts which are damaged should be properly repainted to prevent rust.

When required, wash the body with hot water and soap (only use mild detergent). Apply non-abrasive wax.

CAUTION: Never clean plastic parts with strong detergent, degreasing agent, paint thinner, acetone, etc.

CARGO AND TRANSPORTATION

While reading this guide, remember that:

WARNING

Indicates a potential hazard that could result in serious injury or death.

Cargo

WARNING

This vehicle is not designed or manufactured to carry cargo or tow a trailer. If you decide to add accessories to allow you to carry cargo or tow a trailer, use common sense.

When cargoeing vehicle, respect these maximum loads.

Transportation

When transporting a vehicle, secure vehicle to trailer with suitable tie-downs. Using ordinary ropes is not recommended.

WARNING

Never tip this vehicle on end for transporting. We recommend that you carry the vehicle in its normal operating position (on all four wheels).

Follow these procedure:

- Place the fuel valve to OFF position.
- Select the parking device and place the transmission in 1st gear.
- Secure the vehicle, using the appropriate areas. See the following illustration.

CAUTION: Attaching vehicle at other locations may damage the vehicle.

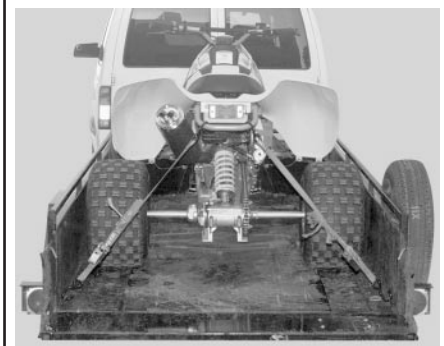
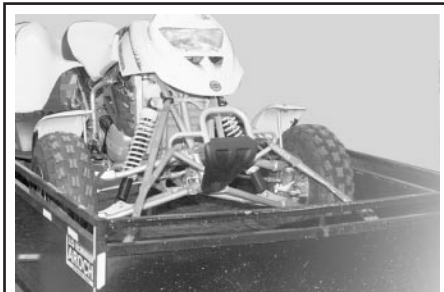

WARNING

Do not tow this vehicle behind a car or other vehicle.

TROUBLESHOOTING

SYMPTOM: <i>Engine does not turn</i>	
Possible causes	What to do
1. Ignition switch is in the OFF position.	Place switch in the ON position.
2. Transmission is not set on the NEUTRAL.	Set transmission either in NEUTRAL or squeeze the clutch lever.
3. Weak battery or loose connections.	Check connections and terminals condition. Have the battery checked. Contact an authorized Bombardier ATV dealer.
4. Engine stop switch is in OFF position.	Place switch in the ON position.

SYMPTOM: <i>Engine turns over but fails to start</i>	
Possible causes	What to do
1. Mixture not rich enough to start cold engine.	Check fuel tank level and check starting procedure, particularly use of the choke.
2. Flooded engine (spark plugs wet when removed).	Refer to SPECIAL PROCEDURES .
3. No fuel to the engine (spark plugs dry when removed).	Check fuel tank level; turn fuel valve to ON (also try on RES). A failure of the fuel pump or carburetor may have occurred. Contact an authorized Bombardier ATV dealer.
4. Spark plug/ignition (no spark).	Check ignition fuse condition. Remove spark plugs then reconnect to spark plug caps. Check that ignition switch is at the ON position. Start engine with spark plugs grounded to engine away from spark plug holes. If no spark appears, replace spark plugs. If trouble persists, contact an authorized Bombardier ATV dealer.
5. Engine compression.	If no pulsating resistance is felt, it suggests a major loss of compression. Contact an authorized Bombardier ATV dealer.

SYMPTOM: <i>Engine lacks acceleration or power</i>	
Possible causes	What to do
1. Fouled or damaged spark plug.	Check item Engine turns over but fails to start .
2. Lack of fuel to engine.	Check item Engine turns over but fails to start .
3. Carburetor adjustments.	Contact an authorized Bombardier ATV dealer.
4. Engine is overheating.	Check Engine Overheat in SPECIAL PROCEDURES . If overheating persists, contact an authorized Bombardier ATV dealer.

SYMPTOM: <i>Engine backfire</i>	
Possible causes	What to do
1. Faulty spark plugs (carbon accumulation).	See Engine turns over but fails to start.
2. Engine is running too hot.	See Engine lacks acceleration or power.
3. Ignition timing is incorrect or there is an ignition system failure.	Contact an authorized Bombardier ATV dealer.
4. Improper carburetor setting.	Contact an authorized Bombardier ATV dealer.

SYMPTOM: <i>Engine misfire</i>	
Possible causes	What to do
1. Fouled/damaged/worn spark plugs.	Clean/verify spark plugs and heat range. Replace as required.
2. Water in fuel.	Drain fuel system and refill with fresh fuel.

SYMPTOM: <i>Vehicle cannot reach full speed</i>	
Possible causes	What to do
1. Engine.	See Engine lacks acceleration or power.
2. Parking device.	Ensure parking lever lock is completely removed.

SYMPTOM: <i>Transmission does not shift smoothly</i>	
Possible causes	What to do
1. Engine/transmission oil level is low.	Refill oil tank with recommended oil at the proper level.
2. Transmission shifting system.	Try depressing the throttle lever more while shifting.
3. Improper oil type.	Drain oil in engine and use recommended oil only.
4. Transmission.	See an authorized Bombardier ATV dealer.

SPECIFICATIONS

BOMBARDIER DS

VEHICLE MODEL NUMBER	7404	
ENGINE		
Type	654 BOMBARDIER-ROTAX, 4 stroke, double overhead camshaft, bush chain drive	
Number of cylinder	Single cylinder	
Number of valve	4 bucket tappet-operated valves	
Displacement	652 cc (39.7 cu. in)	
Compression ratio	9.7:1	
Lubrication	Dry sump lubrication by oil pump with replaceable oil filter (lubrication of engine and transmission simultaneously)	
Decompressor	Automatic	
Exhaust system	Bombardier, stainless header pipe painted steel muffler	
TRANSMISSION		
Clutch	1 multi-disc	
Transmission	Integrated 5 speeds constant mesh transmission.	
COOLING		
Type	Liquid cooled with integrated water pump	
Radiator	Front mounted with thermostatic fan	
CARBURETION		
Carburetor make and type	Mikuni BSR42. Constant depression type with manual choke	
Idle speed	± 100	1300 RPM
ELECTRICAL		
Magneto generator make and type	Denso, 290 W	
Ignition type	Breakerless high voltage condenser ignition system with electronic spark advance	
Ignition timing	Not adjustable	
Engine RPM limiter	7700 RPM (any gear in forward)	
Spark plug make and type	NGK DR8EA	
Number of spark plug	2	
Spark plug gap	0.6 to 0.7 mm (0.024 to 0.027 in)	
Battery	12 V, 13 Ah. Dry type battery.	
Starting system	Electric start. Start in any gear (with clutch applied or on NEUTRAL)	
Headlight	60/55 W, H4V	
Taillight and brake light	8/27 W, 1157	

FUSES		
Fan		15 A
Charging system		25 A
DRIVE TRAIN		
Rear axle		Chain driven/solid axle
SUSPENSION		
Front	Type	Independent suspension — double A-arm
	Travel	305 mm (12 in)
Rear	Type	Rigid swing-arm
	Travel	292 mm (11.5 in)
TIRES		
Pressure	Front	34 kPa (5 PSI) recommended
	Rear	34kPa (5 PSI) recommended
Size	Front	533 OD x 178 W x 254 ID mm (21 x 7 x10 in)
	Rear	508 OD x 279 W x229 ID mm (20 x 11 x 9 in)
Load	Front	290 kg (638 lb) maximum
	Rear	340 kg (748 lb) maximum
WHEELS		
Wheel nut torque		52.5 N•m (39 lbf•ft)
BRAKES		
Front		Nissin hydraulic, 2 discs (Stainless)
Rear		Nissin hydraulic, 1 disc (Stainless)
Parking device		RH brake lever includes a lock on front wheels
DIMENSIONS		
Dry mass		209 kg (460 lbs)
Overall length		1956 mm (77 in)
Overall width	Front	1219.2 mm (48 in)
	Rear	1270 mm (50 in)
Overall height		1181 mm (46.5 in)
Wheel base		1321 mm (52 in)
Wheel track	Front	1048 mm (41 in)
	Rear	994 mm (34 in)
Turning radius		2.4 m (8 ft)
Total toe-out (vehicle on ground)		2.6 mm ± 0.5 mm (0.102 in ± 0.0197 in)
Ground clearance	Front and under engine	121 mm (4-3/4 in)
	Rear axle	105 mm (4-1/8 in)

LIQUIDS		
Oil type (engine and transmission)	SAE 10W40, 4-stroke mineral-based engine oil. API classification SH or SJ. Do not use synthetic or synthetic blend oil	
Coolant	Ethyl glycol/water mix (60% coolant, 40% water). Use coolant specifically designed for aluminum engines	
Fuel	Type	Super unleaded gasoline
	Octane	91 (R + M)/2 or higher
Hydraulic brake	Brake fluid, DOT 4	
CAPACITIES		
Vehicle range	Approximately 3 hours depending on many factors such as temperature and operating conditions	
Fuel tank	12.2 L (3.5 U.S. gal) including approximately 2.4 L (0.8 U.S. gal) reserve	
Engine/transmission oil	3.1 L (3.3 U.S. quarts)	
Coolant	1.75L (1.9 U.S. quarts)	

OD = outside diameter

W = width

ID = inside diameter

LEDS = light-emitting diodes

dia. = diameter

Because of our ongoing commitment to product quality and innovation, Bombardier reserves the right, at any time, to make changes in design and specifications and/or to make additions to, or improvements in its products without imposing any obligation upon itself to install them on its products previously manufactured.

SI* METRIC INFORMATION GUIDE

BASE UNITS			
DESCRIPTION	UNIT	SYMBOL	
length	meter	m	
mass	kilogram	kg	
force	newton	N	
liquid	liter	L	
temperature	Celsius	°C	
pressure	kilo pascal	kPa	
torque	newton-meter	N•m	
land velocity	kilometer per hour	km/h	
PREFIXES			
PREFIX	SYMBOL	MEANING	VALUE
kilo	k	one thousand	1000
centi	c	one hundredth of	0.01
milli	m	one thousandth of	0.001
micro	μ	one millionth of	0.000001
CONVERSION FACTORS			
TO CONVERT	TO ①	MULTIPLY BY	
in	mm	25.4	
in	cm	2.54	
in ²	cm ²	6.45	
in ³	cm ³	16.39	
ft	m	0.3	
oz	g	28.35	
lb	kg	0.45	
lbf	N	4.4	
lbf•in	N•m	0.11	
lbf•ft	N•m	1.36	
lbf•ft	lbf•in	12	
PSI	kPa	6.89	
imp. oz	U.S. oz	0.96	
imp. oz	mL	28.41	
imp. gal	U.S. gal	1.2	
imp. gal	L	4.55	
U.S. oz	mL	29.57	
U.S. gal	L	3.79	
MPH	km/h	1.61	
Fahrenheit	Celsius	$(°F - 32) \div 1.8$	
Celsius	Fahrenheit	$(°C \times 1.8) + 32$	
hp	kW75	

* The international system of units abbreviates SI in all languages.

① To obtain the reverse sequence, divide by the given factor. To convert **milli-meters** to **inches**, divide by 25.4.

NOTE: Conversion factors are rounded off to 2 decimals for easier use.



AFFIX
PROPER
POSTAGE

BOMBARDIER
Recreational Products
ATV Warranty
Valcourt (Quebec)
Canada JOE 2L0



AFFIX
PROPER
POSTAGE

BOMBARDIER
Recreational Products
ATV Warranty
Valcourt (Quebec)
Canada JOE 2L0



AFFIX
PROPER
POSTAGE

BOMBARDIER
Recreational Products
ATV Warranty
Valcourt (Quebec)
Canada JOE 2L0



AFFIX
PROPER
POSTAGE

BOMBARDIER
Recreational Products
ATV Warranty
Valcourt (Quebec)
Canada JOE 2L0

 **WARNING**

Indicates a potential hazard that could result in serious injury or death.



BOMBARDIER RECREATIONAL PRODUCTS

WARNING

THIS VEHICLE CAN BE HAZARDOUS TO OPERATE.

A collision or rollover can occur quickly, even during routine manoeuvres such as turning and driving on hills or over obstacles, if you fail to take proper precautions.

SEVERE INJURY OR DEATH can result if you do not follow these instructions:

- **BEFORE YOU OPERATE THIS ATV, READ THE OPERATOR'S GUIDE, THE SAFETY HANDBOOK AND ALL LABELS.**
- **NEVER OPERATE THIS ATV, WITHOUT PROPER INSTRUCTION.** Beginners should complete a certified training course.
- **NEVER CARRY A PASSENGER.** You increase your risk of losing control if you carry a passenger.
- **NEVER OPERATE THIS ATV ON A PAVED SURFACE.** You increase your risk of losing control if you operate this ATV on pavement.
- **NEVER OPERATE THIS ATV ON PUBLIC ROADS.** You can collide with another vehicle if you operate this ATV on a public road.
- **ALWAYS WEAR AN APPROVED HELMET,** eye protection, and protective clothing.
- **NEVER CONSUME ALCOHOL OR DRUGS** before or while operating this vehicle.
- **NEVER OPERATE THIS ATV AT EXCESSIVE SPEEDS.** You increase your risk of losing control if you operate this ATV at speeds too fast for the terrain, visibility conditions, or your experience.
- **NEVER ATTEMPT WHEELIES, JUMPS, OR OTHER STUNTS.**