

# can-am™



# 2007

**Operator's  
Guide**

*Includes  
Safety, Vehicle  
and Maintenance  
Information*

# RENEGADE™

 **WARNING**

Read this guide thoroughly.  
It contains important safety information.  
Minimum recommended operator age: 16 years.  
Do not remove this Operator's Guide from the  
vehicle.

2 1 9 0 0 0 4 3 3

 **WARNING**

**YOUR VEHICLE CAN BE HAZARDOUS TO OPERATE.** A collision or rollover can occur quickly, even during routine maneuvers such as turning and driving on hills or over obstacles, if you fail to take proper precautions. For your safety, understand and follow all the warnings contained in this Operator's Guide and the labels on your vehicle. **Failure to follow these warnings can result in SEVERE INJURY OR DEATH!** Keep this Operator's Guide with the vehicle at all times.

 **WARNING**

Disregarding any of the safety precautions and instructions contained in this Operator's Guide, *SAFETY VIDEO* and on-product labels could cause injury including the possibility of death!

 **WARNING**

This vehicle may exceed the performance of other vehicles you have ridden in the past. This category S (sport) is a high performance vehicle for off road use only. It is for sport type recreational and competitive use by operators with advanced skills and substantial experience.

---

# IMPORTANT INFORMATION

This Operator's Guide utilizes the following symbols to emphasize particular information:

 The Safety Alert Symbol indicates a potential personal injury hazard.

 **WARNING** Indicates a potential hazard that, if not avoided, could result in serious injury or death.

**CAUTION:** Denotes an instruction which, if not followed, could severely damage vehicle components.

**NOTE:** Indicates supplementary information needed to fully complete an instruction.

All safety documentation should remain with the vehicle at the time of sale.

All content of the *SAFETY INFORMATION* section should be interpreted by the reader as a warning which, if not followed, may result in injury including the possibility of death.

In Canada, products are distributed by Bombardier Recreational Products Inc. (BRP).

In USA, products are distributed by BRP US Inc.

**The following trademarks are the property of Bombardier Recreational Products Inc.:**

Can-Am™

Renegade™

Rotax®

XP-S™

TTI™

DESS™

---

# FOREWORD

Congratulations on your purchase of a new Can-Am™ ATV. It is backed by the BRP warranty and a network of authorized Can-Am dealers ready to provide the parts, service or accessories you may require.

Your dealer is committed to your satisfaction. He has taken training to perform the initial setup and inspection of your vehicle as well as completed the final adjustment before you took possession. At delivery, your dealer would have explained the operation, maintenance and safety features of the vehicle. We trust you have taken full advantage of this! If you need more complete servicing information, please ask your dealer.

At delivery, you were also informed of the warranty coverage and completed the Warranty Registration Form which is to be sent to us for processing. In the near future you should be receiving a warranty card which will confirm our receipt of the registration as well as be used for warranty or recall purposes.

You are invited to contact our customer assistance center should you experience problems which cannot be resolved by an authorized Can-Am dealer.

It is understood that this Operator's Guide may be translated into another language. In the event of any discrepancy, the English version shall prevail. Throughout this document the masculine is used to denote the masculine or feminine.

If you want to view and/or print an extra copy of your Operator's Guide, simply visit the following website [www.operatorsguide.brp.com](http://www.operatorsguide.brp.com). Also note that the guide is available in several languages.

The information and components/system descriptions contained in this document are correct at the time of publication. BRP, however, maintains a policy of continuous improvement of its products without imposing upon itself any obligation to install them on products previously manufactured. Due to late changes, some differences between the manufactured product and the descriptions and/or specifications in this guide may occur. BRP reserves the right at any time to discontinue or change specifications, designs, features, models or equipment without incurring any obligation upon itself.

The illustrations in this document show the typical construction of the different assemblies and may not reproduce the full detail or exact shape of the parts. However, they represent parts that have the same or similar function.

The use of RIGHT and LEFT indications in the text always refers to driving position (when sitting on vehicle).

Specifications are given in the international metric system with the SAE U.S. equivalent in parenthesis. Where precise accuracy is not required, some conversions are rounded off for easier use.

We recommend genuine BRP products for replacement parts and accessories. They've been especially designed for your vehicle and manufactured to meet BRP's demanding standards.

A *SHOP MANUAL* can be obtained for complete service and maintenance information and more repair information.

---

# TABLE OF CONTENTS

While reading this Operator's Guide, remember that:

## **WARNING**

Indicates a potential hazard that, if not avoided, could result in serious injury or death.

<b>NOTICE</b> .....	<b>7</b>
<b>INTRODUCTION</b> .....	<b>8</b>

### ***SAFETY INFORMATION***

<b>SPECIAL SAFETY MESSAGES</b> .....	<b>10</b>
<b>OPERATION WARNINGS</b> .....	<b>13</b>
<b>RIDING THE VEHICLE</b> .....	<b>40</b>
Pre-Operation Check .....	41
Clothing .....	42
Carrying Loads .....	43
Hauling a Trailer (if so equipped) .....	43
Working with your Vehicle .....	43
Recreational Riding .....	44
Environment.....	44
Design Limitation .....	45
Off-Highway Operation.....	45
General Operating and Safety Precautions .....	45
Uphill Driving .....	46
Downhill Driving .....	46
Side Hilling.....	46
Drop-Offs .....	46
Riding Techniques .....	47
Routine Maintenance.....	53
<b>HANG TAG</b> .....	<b>54</b>
<b>ON-PRODUCT LABELS</b> .....	<b>55</b>

### ***VEHICLE INFORMATION***

<b>HOW TO IDENTIFY YOUR VEHICLE</b> .....	<b>60</b>
Engine Identification Number .....	60

<b>NOISE EMISSION CONTROL SYSTEM REGULATION .....</b>	<b>61</b>
<b>EMISSION REQUIREMENTS .....</b>	<b>62</b>
<b>BREAK-IN PERIOD.....</b>	<b>63</b>
<b>CONTROLS/INSTRUMENTS/EQUIPMENT .....</b>	<b>64</b>
1) Throttle Lever .....	65
2) 2WD/4WD Selector.....	65
3) Brake Lever.....	65
4) Parking Brake.....	66
5) Transmission Lever .....	66
6) Multifunction Switch .....	67
7) Multifunction Gauge.....	69
8) 12-Volt Power Outlet .....	73
9) Ignition Switch .....	73
10) Fuel Tank Cap .....	73
11) Brake Pedal .....	74
12) Footpeg.....	74
13) Central Panel.....	74
14) Rear Storage Compartment.....	75
15) Seat Latch.....	75
16) Rear Cargo Area .....	76
17) Recovery Hook .....	76
18) Radiator Cap .....	76
19) Fuses .....	76
20) Tool Kit.....	77
21) Dipstick.....	77
22) Brake Lever Fluid Reservoir .....	77
23) Brake Pedal Fluid Reservoir .....	77
24) Engine Coolant Reservoir.....	78
<b>LIQUIDS.....</b>	<b>79</b>
Fuel.....	79
Engine Oil.....	79
Gearbox Oil .....	81
Engine Coolant .....	81
Brake Fluid.....	82
Battery .....	82
<b>OPERATING INSTRUCTIONS.....</b>	<b>83</b>
General.....	83
Pre-Operation Check .....	83
Starting the Engine .....	84
Shifting the Transmission .....	84
2WD/4WD Selector.....	84
Stopping the Engine .....	85
Post-Operation Care.....	85

<b>SPECIAL PROCEDURES</b> .....	<b>86</b>
Turn Over .....	86
Vehicle Immersion .....	86
<b>CARGO AND TRANSPORTATION</b> .....	<b>87</b>
<b>TROUBLESHOOTING</b> .....	<b>89</b>
<b>SPECIFICATIONS</b> .....	<b>93</b>

## ***MAINTENANCE INFORMATION***

<b>MAINTENANCE CHART</b> .....	<b>98</b>
<b>GENERAL</b> .....	<b>102</b>
<b>ENGINE</b> .....	<b>103</b>
Oil Change and Oil Filter Replacement .....	103
Coolant Replacement .....	103
Air Filter .....	104
Drive Belt .....	105
CVT Cover Drain Screw .....	105
Valve Adjustment .....	105
Spark Arrester .....	105
Radiator .....	106
<b>GEARBOX</b> .....	<b>107</b>
Oil Change .....	107
<b>FUEL SYSTEM</b> .....	<b>108</b>
Throttle Cable Lubrication .....	108
Throttle Lever Adjustment .....	109
<b>ELECTRICAL</b> .....	<b>111</b>
Spark Plug .....	111
Battery .....	111
Fuses .....	112
Bulb Replacement .....	113
<b>DRIVE TRAIN</b> .....	<b>115</b>
Drive Shaft Boot/Protector .....	115
Wheel .....	115
Wheel Bearing Condition .....	115
Tires/Wheels .....	116
<b>SUSPENSION</b> .....	<b>118</b>
Lubrication .....	118
Inspection .....	118
Adjustment .....	118
<b>BRAKE</b> .....	<b>119</b>
Adjustment/Inspection .....	119
Brake Fluid Replacement .....	119

<b>BODY/FRAME.....</b>	<b>120</b>
Engine Area .....	120
Recovery Latching Point Condition .....	120
Chassis Fasteners .....	120
Seat Fasteners .....	120
Vehicle Cleaning and Protection.....	120
<b>STORAGE AND PRESEASON PREPARATION .....</b>	<b>121</b>

***WARRANTY***

<b>BRP LIMITED WARRANTY NORTH AMERICA: 2007 CAN-AM™ ATV ...</b>	<b>124</b>
<b>BRP INTERNATIONAL LIMITED WARRANTY: 2007 CAN-AM™ ATV ....</b>	<b>128</b>
<b>BRP EUROPEAN UNION MEMBER STATES LIMITED WARRANTY: 2007 CAN-AM™ ATVS .....</b>	<b>132</b>
<b>PRIVACY OBLIGATION/DISCLAIMER .....</b>	<b>136</b>
<b>CHANGE OF ADDRESS/OWNERSHIP .....</b>	<b>137</b>



---

# NOTICE

This Operator's Guide has been prepared to acquaint the owner/operator of a new vehicle with the various vehicle controls, maintenance and safe operating instructions. It is indispensable for the proper use of the product.

This Operator's Guide uses the following symbols.

 **WARNING**

Indicates a potential hazard that, if not avoided, could result in serious injury or death.

**CAUTION:** Denotes an instruction which, if not followed, could severely damage vehicle components.

**NOTE:** Indicates supplementary information needed to fully complete an instruction.

Although the mere reading of such information does not eliminate the hazard, the understanding and application of the information will promote the correct use of this vehicle.

To fully appreciate the pleasures, enjoyment and excitement of using this vehicle, there are some basic rules that **MUST** be observed and followed by any user.

---

# INTRODUCTION

Your dealer should have provided you with some basic information on the particular controls and features of your new vehicle. Please take the time to study this Operator's Guide and all on-product warning labels as well as the *SAFETY VIDEO* that came with this vehicle. They more completely describe what you should know about this vehicle before riding it.

Whether you are a new user or an experienced rider, it is important for your personal safety that you know the controls and features of this vehicle. Equally important is knowing how to properly ride.

Irrespective of your age, experience or state regulations, it is always prudent for you or any other person who may ride your vehicle, to take an approved safe riding course. Please check with your dealer or local authorities for availability in your area. If you are a completely new rider, this should be done before your first ride. Your instructor should be able to provide advice on local conditions and safe riding practices particular to the area.

Riding conditions vary from place to place. Each is subject to weather conditions which may radically change from time to time and from season to season.

Riding on sand is different than riding on snow or through forests or marshes. Each location may require a greater degree of awareness and skill. Show good judgement. Always proceed with caution. Please do not take any unnecessary risks that could leave you stranded or possibly injured.

The contents of this Operator's Guide provide riding information which has been proven reliable by other users. They are not intended as a definitive means of avoiding accidents. How you apply this information, coupled with your mental and physical condition, the particular terrain hazard and your risk acceptance level will have an effect on your riding experience. Have fun... and ride responsibly.

This Operator's Guide has been prepared to acquaint the owner/operator of a new vehicle with the various vehicle controls, maintenance and safe operating instructions. They are indispensable for the proper use of the product.

We would be pleased to receive any comments on the content and format of this Operator's Guide, the *SAFETY VIDEO* or on-product warnings labels.

# ***SAFETY INFORMATION***

---

## SPECIAL SAFETY MESSAGES

### THIS VEHICLE IS NOT A TOY AND CAN BE HAZARDOUS TO OPERATE.

This vehicle handles differently from other vehicles including motorcycles and cars. A collision or rollover can occur quickly, even during routine maneuvers such as turning and driving on hills or over obstacles, if you fail to take proper precautions.

**SEVERE INJURY OR DEATH** can result if you do not follow these instructions:

- ⚠ Read this Operator's Guide and all on-product warning labels carefully and follow the operating procedures described. Watch and pay attention to the *SAFETY VIDEO* before operation.
- ⚠ Never operate this vehicle without proper instruction. **Take a training course.** All operators should receive training from a certified instructor. Contact an authorized Can-Am dealer for more information.
- USA and Canada Only:** to find out about available training course nearest you, call the Specialty Vehicle Institute of America (SVIA) at 1 800 877-2887 or in Canada, the Canada safety Council (CSC) at 1 (613) 739-1535 ext. 227.
- ⚠ Always follow this age recommendation: A person under 16 years old should never operate this vehicle.
- ⚠ Never carry a passenger on this vehicle.
- ⚠ Never operate this vehicle on any paved surfaces, including sidewalks, driveways, parking lots and streets.
- ⚠ Never operate this vehicle on any public street, road or highway, even a dirt or gravel one.

- ⚠ Never take place on this vehicle without wearing an approved helmet that fits properly. You should also wear eye protection (goggles or face shield), gloves, boots, long sleeved shirt or jacket, and long pants.
- ⚠ Never consume alcohol or drugs before or while riding this vehicle.
- ⚠ Never operate at excessive speeds. Always go at a speed that is proper for the terrain, visibility, and operating conditions, and your experience.
- ⚠ Never attempt wheelies, jumps, or other stunts.
- ⚠ Always inspect your vehicle each time you use it to make sure it is in safe operating condition. Always follow the inspection and maintenance procedures and schedules described in this Operator's Guide.
- ⚠ Always keep both hands on the handlebars and both feet on the footrests of the vehicle during operation.
- ⚠ Always go slowly and be extra careful when operating on unfamiliar terrain. Always be alert to changing terrain conditions when operating this vehicle.
- ⚠ Never operate on excessively rough, slippery or loose terrain until you have learned and practiced the skills necessary to control this vehicle on such terrain. Always be especially cautious on these kinds of terrain.
- ⚠ Always follow proper procedures for turning as described further in this Operator's Guide. Practice turning at low speeds before attempting to turn at faster speeds. Do not turn at excessive speed.

- ⚠ Never operate this vehicle on hills too steep for the vehicle or for your abilities. Practice on smaller hills before attempting larger hills.
- ⚠ Always follow proper procedures for climbing hills as described further in this Operator's Guide. Check the terrain carefully before you start up any hill. Never climb hills with excessively slippery or loose surfaces. Shift your weight forward. Never open the throttle suddenly or make sudden gear changes. Never go over the top of any hill at high speed.
- ⚠ Always follow proper procedures for going down hills and for braking on hills as described further in this Operator's Guide. Check the terrain carefully before you start down any hill. Shift your weight backward. Never go down a hill at high speed. Avoid going down a hill at an angle that would cause the vehicle to lean sharply to one side. Go straight down the hill where possible.
- ⚠ Always follow proper procedures for crossing the side of a hill as described further in this Operator's Guide. Avoid hills with excessively slippery or loose surfaces. Shift your weight to the uphill side of the vehicle. Never attempt to turn the vehicle around on any hill until you have mastered the turning technique described in this Operator's Guide on level ground. Avoid crossing the side of a steep hill if possible.
- ⚠ Always use proper procedures if you stall or roll backwards when climbing a hill. To avoid stalling, use proper gear and maintain a steady speed when climbing a hill. If you stall or roll backwards, follow the special procedure for braking described in this Operator's Guide. Dismount on the uphill side or to a side if pointed straight uphill. Turn the vehicle around and remount, following the procedure described further in this Operator's Guide.
- ⚠ Always check for obstacles before operating in a new area. Never attempt to operate over large obstacles, such as large rocks or fallen trees. Always follow proper procedures when operating over obstacles as described further in this Operator's Guide.
- ⚠ Always be careful when skidding or sliding. Learn to safely control skidding or sliding by practicing at low speeds and on level smooth terrain. On extremely slippery surfaces, such as ice, go slowly and be very cautious in order to reduce the chance of skidding out of control.
- ⚠ Never operate this vehicle in fast flowing water or in water deeper than that specified in this Operator's Guide. Remember that wet brakes may have reduced stopping ability. Test your brakes after leaving water. If necessary, apply them several times to let friction dry out the pads.
- ⚠ Always be sure there are no obstacles or people behind the vehicle when you operate in reverse. When it is safe to proceed in reverse, go slowly.
- ⚠ Always use the size and type tires specified further in this Operator's Guide. Always maintain proper tire pressure as described further in this Operator's Guide.

⚠ Never modify this vehicle through improper installation or use of accessories. Only use BRP's approved accessories. NEVER install passenger seat or use the cargo area to carry a passenger.

⚠ Never exceed the stated load limits for this vehicle including operator, all other loads and added accessories. Cargo should be properly distributed and securely attached. Reduce speed and follow instructions in this manual for carrying cargo or pulling a trailer. Allow greater distance for braking.

⚠ **FOR MORE INFORMATION ABOUT ATV SAFETY**, contact an authorized Can-Am dealer to find out about available training courses nearest you.

**USA and Canada only:** Call the Specialty Vehicle Institute of America (SVIA) at 1 800 877-2887 or in Canada, the Canada Safety Council (CSC) at 1 (613) 739-1535 ext. 227.

# OPERATION WARNINGS

While reading this Operator's Guide, remember that:

## WARNING

Indicates a potential hazard that, if not avoided, could result in serious injury or death.

The following warning and their format have been requested by the United States Consumer Product Safety Commission and are required to be in the Operator's Guide for all ATVs.

**NOTE:** The following illustrations are general representations only. Your model may differ.

## WARNING



V00A0AQ

### **POTENTIAL HAZARD**

Operating this vehicle without proper instruction.

### **WHAT CAN HAPPEN**

The risk of an accident is greatly increased if the operator does not know how to operate this vehicle properly in different situations and on different types of terrain.

### **HOW TO AVOID THE HAZARD**

Beginning and inexperienced operators should complete a training course. They should then regularly practice the skills learned in the course and the operating techniques described in this Operator's Guide.

For more information about the training course, contact an authorized Can-Am dealer.



V00A01Q

**POTENTIAL HAZARD**

Failure to follow the age recommendations for this vehicle.

**WHAT CAN HAPPEN**

A lack of respect for this age recommendation can lead to severe injury or death of the child.

Even though a child may be within the age group for which this vehicle is recommended, he may not have the skills, abilities, or judgment needed to operate this vehicle safely and may be involved in a serious accident.

**HOW TO AVOID THE HAZARD**

No one under 16 should operate this vehicle.



 **WARNING**



V00A02Q

**POTENTIAL HAZARD**

Carrying a passenger on this vehicle.

**WHAT CAN HAPPEN**

Greatly reduces your ability to balance and control this vehicle.

Could cause an accident, resulting in harm to you and/or your passenger.

**HOW TO AVOID THE HAZARD**

Never carry passenger. Even with a long seat that provides unrestricted operator movement, it is not designed nor intended to carry passenger(s).

 **WARNING**

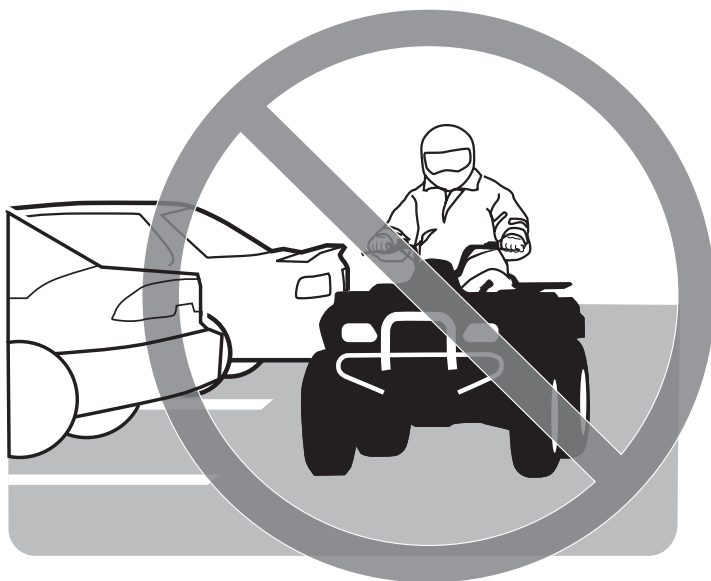

V00A03Q

**POTENTIAL HAZARD**

Operating this vehicle on paved surfaces.

**WHAT CAN HAPPEN**

The tires are designed for off-road use only, not for use on pavement. Paved surfaces may seriously affect handling and control of this vehicle, and may cause the vehicle to go out of control.

**HOW TO AVOID THE HAZARD**

Never operate this vehicle on any paved surfaces, including sidewalks, driveways, parking lots and streets.

 **WARNING**



V00A04Q

**POTENTIAL HAZARD**

Operating this vehicle on public streets, roads or highways.

**WHAT CAN HAPPEN**

You can collide with another vehicle.

**HOW TO AVOID THE HAZARD**

Never operate this vehicle on any public street, road or highway, even a dirt or gravel one. In many states or provinces it is illegal to operate this vehicle on public streets, roads or highways.

## **WARNING**



V00A06Q

### **POTENTIAL HAZARD**

Riding this vehicle without wearing an approved helmet, eye protection and protective clothing.

### **WHAT CAN HAPPEN**

The following items concern all ATV's operator:

- riding without an approved helmet increases the chances of a severe head injury or death in the event of an accident
- riding without eye protection can result in an accident and increases the chances of a severe injury in the event of an accident
- riding without protective clothing increases the chances of severe injury in the event of an accident.

### **HOW TO AVOID THE HAZARD**

Always wear an approved helmet that fits properly. You should also wear:

- eye protection (goggles or face shield)
- gloves and boots
- long sleeved shirt or jacket
- long pants.

**⚠ WARNING**



V00A07Q

**POTENTIAL HAZARD**

Riding this vehicle after consuming alcohol or drugs.

**WHAT CAN HAPPEN**

- Could seriously affect your judgment.
- Could cause you to react more slowly.
- Could affect your balance and perception.
- Could result in an accident or death.

**HOW TO AVOID THE HAZARD**

Never consume alcohol or drugs before or while riding this vehicle.

**⚠ WARNING**

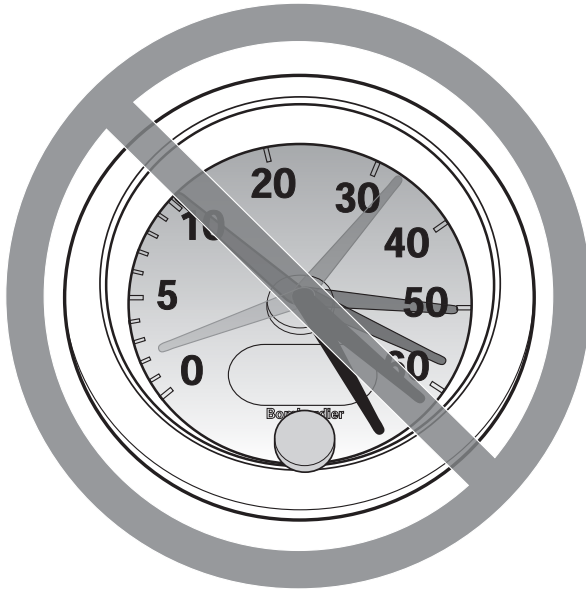

V00A08Q

**POTENTIAL HAZARD**

Operating this vehicle at excessive speeds.

**WHAT CAN HAPPEN**

Increases your chances of losing control of the vehicle, which can result in an accident.

**HOW TO AVOID THE HAZARD**

Always travel at a speed which is proper for the terrain, visibility and operating conditions, and your experience.

 **WARNING**



V00A09Q

**POTENTIAL HAZARD**

Attempting wheelies, jumps and other stunts.

**WHAT CAN HAPPEN**

Increases the chance of an accident, including an overturn.

**HOW TO AVOID THE HAZARD**

Never attempt stunts, such as wheelies or jumps. Do not try to show off.

 **WARNING**

**POTENTIAL HAZARD**

Failure to inspect the vehicle before operating.

Failure to properly maintain the vehicle.

**WHAT CAN HAPPEN**

Increases the possibility of an accident or equipment damage.

**HOW TO AVOID THE HAZARD**

Always inspect your vehicle each time you use it to make sure the vehicle is in safe operating condition.

Always follow the inspection and maintenance procedures and schedules described further in this Operator's Guide.

 **WARNING**

**POTENTIAL HAZARD**

Riding on frozen waterways.

**WHAT CAN HAPPEN**

Severe injury or death can result if the vehicle and/or operator break through the ice.

**HOW TO AVOID THE HAZARD**

Never ride this vehicle on a frozen surface before you are sure the ice is thick enough and sound enough to support the vehicle and its load, as well as the force that is created by a moving vehicle.



**⚠ WARNING**



V00A0BQ

**POTENTIAL HAZARD**

Removing hands from handlebar or feet from the footrests during operation.

**WHAT CAN HAPPEN**

Removing even one hand or foot can reduce your ability to control the vehicle or could cause you to lose your balance and fall off the vehicle. If you remove a foot from the footrests, your foot or leg may come into contact with the rear wheels, which could injure you or cause an accident.

**HOW TO AVOID THE HAZARD**

Always keep both hands on the handlebar and both feet on the footrests during vehicle operation.

**⚠ WARNING**

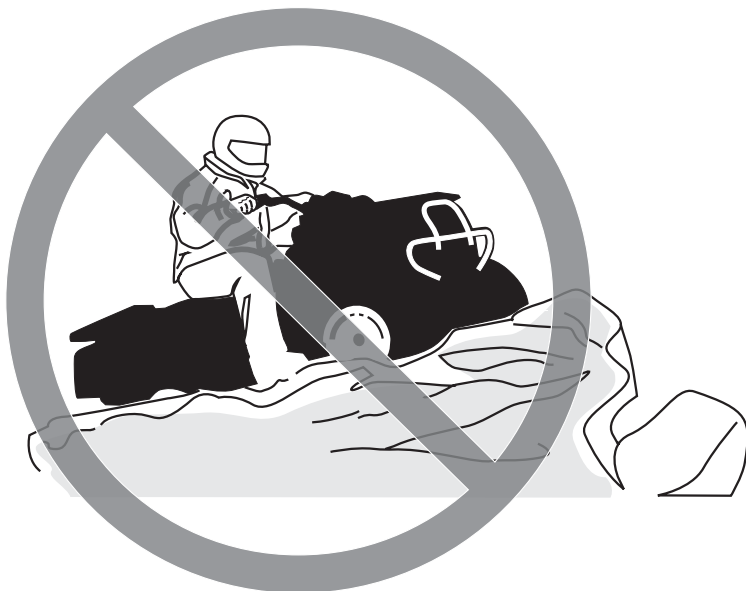

V00A0CQ

**POTENTIAL HAZARD**

Failure to use extra care when operating this vehicle on unfamiliar terrain.

**WHAT CAN HAPPEN**

You can come upon hidden rocks, bumps, or holes, without enough time to react.

Could result in the vehicle overturning or loss of control.

**HOW TO AVOID THE HAZARD**

Go slowly and be extra careful when operating on unfamiliar terrain.

Always be alert to changing terrain conditions when operating the vehicle.

**⚠ WARNING**



V00A0DDQ

**POTENTIAL HAZARD**

Failure to use extra care when operating on excessively rough, slippery or loose terrain.

**WHAT CAN HAPPEN**

Could cause loss of traction or vehicle control, which could result in an accident, including an overturn.

**HOW TO AVOID THE HAZARD**

Do not operate on excessively rough, slippery or loose terrain until you have learned and practiced the skills necessary to control this vehicle on such terrain.

Always be especially cautious on these kinds of terrain.

 **WARNING**



V00A0EQ

**POTENTIAL HAZARD**

Turning improperly.

**WHAT CAN HAPPEN**

Vehicle could go out of control, causing a collision or overturn.

**HOW TO AVOID THE HAZARD**

Always follow proper procedures for turning as described further in this Operator's Guide. Practice turning at low speeds before attempting to turn at faster speeds.

Do not turn at excessive speed.

 **WARNING**



V00A0QQ

**POTENTIAL HAZARD**

Operating on excessively steep hills.

**WHAT CAN HAPPEN**

The vehicle can overturn more easily on extremely steep hills than on level surfaces or small hills.

**HOW TO AVOID THE HAZARD**

Never operate this vehicle on hills too steep for the vehicle or for your abilities.

Practice on smaller hills before attempting larger hills.

 **WARNING**



V00A0FQ

**POTENTIAL HAZARD**

Climbing hills improperly.

**WHAT CAN HAPPEN**

Could cause loss of control or cause vehicle to overturn.

**HOW TO AVOID THE HAZARD**

Always follow proper procedures for climbing hills as described further in this Operator's Guide.

Always check the terrain carefully before you start up any hill.

Never climb hills with excessively slippery or loose surfaces.

Shift your weight forward.

Never open the throttle suddenly or make sudden gear changes. The vehicle could flip over backwards.

Never go over the top of any hill at high speed. An obstacle, a sharp drop, or another vehicle or person could be on the other side of the hill.

 **WARNING**



V00A0GQ

**POTENTIAL HAZARD**

Going down a hill improperly.

**WHAT CAN HAPPEN**

Could cause loss of control or cause vehicle to overturn.

**HOW TO AVOID THE HAZARD**

Always follow proper procedures for going down hills as described further in this Operator's Guide. **NOTE:** A special technique is required when braking as you go down a hill.

Always check the terrain carefully before you start down any hill.

Shift your weight backward.

Never go down a hill at high speed.

Avoid going down a hill at an angle which would cause the vehicle to lean sharply to one side. Go straight down the hill where possible.

## WARNING



V00A0HQ

### **POTENTIAL HAZARD**

Improperly crossing hills or turning on hills.

### **WHAT CAN HAPPEN**

Could cause loss of control or cause vehicle to overturn.

### **HOW TO AVOID THE HAZARD**

Never attempt to turn the vehicle around on any hill until you have mastered the turning technique as described further in this Operator's Guide on level ground. Be very careful when turning on any hill.

Avoid crossing the side of a steep hill if possible.

#### ***When crossing the side of a hill:***

Always follow proper procedures as described further in this Operator's Guide.

Avoid hills with excessively slippery or loose surfaces.

Shift your weight to the uphill side of the vehicle.



**⚠ WARNING**



V00A01Q

**POTENTIAL HAZARD**

Stalling, rolling backwards or improperly dismounting while climbing a hill.

**WHAT CAN HAPPEN**

Could result in vehicle overturning.

**HOW TO AVOID THE HAZARD**

Use proper gear and maintain steady speed when climbing a hill.

***If you lose all forward speed:***

Keep your weight uphill. Never open the throttle suddenly or make sudden gear changes. The vehicle could flip over backwards.

Apply the brakes.

Lock parking brake after you are stopped.

Dismount on uphill side, or to a side if pointed straight uphill.

***If you begin rolling backwards:***

Keep your weight uphill. Never open the throttle suddenly or make sudden gear changes. The vehicle could flip over backwards.

Never apply the rear brake while rolling backwards.

Apply the front brake gradually.

When fully stopped, apply rear brake as well and lock parking brake.

Dismount on uphill side, or to a side if pointed straight uphill.

Turn the vehicle around and remount, following the procedure described further in this Operator's Guide.

**⚠ WARNING**



V00A0.JQ

**POTENTIAL HAZARD**

Improperly operating over obstacles.

**WHAT CAN HAPPEN**

Could cause loss of control or a collision.

Could cause the vehicle to overturn.

**HOW TO AVOID THE HAZARD**

Before operating in a new area, check for obstacles.

Never attempt to ride over large obstacles, such as large rocks or fallen trees.

When you go over obstacles, always follow proper procedures as described further in this Operator's Guide.

 **WARNING**



V00A0KQ

**POTENTIAL HAZARD**

Skidding or sliding improperly.

**WHAT CAN HAPPEN**

You may lose control of this vehicle.

You may also regain traction unexpectedly, which may cause the vehicle to overturn.

**HOW TO AVOID THE HAZARD**

Learn to safely control skidding or sliding by practicing at low speeds and on level smooth terrain.

On extremely slippery surfaces, such as ice, go slowly and be very cautious in order to reduce the chance of skidding or sliding out of control.

## WARNING



V00A0LQ

### **POTENTIAL HAZARD**

Operating this vehicle through deep or fast flowing water.

### **WHAT CAN HAPPEN**

Tires may float, causing loss of traction and loss of control, which could lead to an accident.

### **HOW TO AVOID THE HAZARD**

Never operate this vehicle in fast flowing water or in water deeper than that specified further in this Operator's Guide.

Check water depth and current before you attempt to cross any water. Water should not go above footrests.

Remember that wet brakes may have reduced stopping ability. Test your brakes after leaving water. If necessary, apply them several times to let friction dry out the pads.

 **WARNING**



V00A0MQ

**POTENTIAL HAZARD**

Improperly operating in reverse.

**WHAT CAN HAPPEN**

You could hit an obstacle or person behind the vehicle, resulting in serious injury.

**HOW TO AVOID THE HAZARD**

When you select reverse gear, make sure there are no obstacles or people behind the vehicle. When it is safe to proceed, go slowly.

 **WARNING**



V00A00Q

**POTENTIAL HAZARD**

Operating this vehicle with improper tires, or with improper or uneven tire pressure.

**WHAT CAN HAPPEN**

Use of improper tires on this vehicle, or operation of this vehicle with improper or uneven tire pressure, may cause loss of control, tire blow outs, tire to move around on its rim and increases the risk of an accident.

**HOW TO AVOID THE HAZARD**

Always use the size and type of tires specified further in this Operator's Guide for this vehicle.

Always maintain proper tire pressure as described further in this Operator's Guide.

Always replace wheels or tires that are damaged.

 **WARNING**



V00A0NQ

**POTENTIAL HAZARD**

Operating this vehicle with improper modifications.

**WHAT CAN HAPPEN**

Improper installation of accessories or modification of this vehicle may cause changes in handling which in some situations could lead to an accident.

**HOW TO AVOID THE HAZARD**

Never modify this vehicle through improper installation or use of accessories. All parts and accessories added to this vehicle should be approved by BRP and should be installed and used according to instructions. If you have questions, consult an authorized Can-Am dealer.

NEVER install passenger seat or use the cargo area to carry a passenger.

Modification of the vehicle to increase speed and performance may violate the terms and conditions of your vehicle limited warranty. In addition, certain modifications including the removal of engine or exhaust components are illegal under most laws.

 **WARNING**



V00A0PQ

**POTENTIAL HAZARD**

Overloading this vehicle or carrying or towing cargo improperly.

**WHAT CAN HAPPEN**

Could cause changes in vehicle handling which could lead to an accident.

**HOW TO AVOID THE HAZARD**

Never exceed the stated load capacity for this vehicle including operator, as well as other loads and added accessories.

Cargo should be properly distributed and securely attached.

Reduce speed when carrying cargo or pulling a trailer. Allow greater distance for braking.

Always follow the instructions in this Operator's Guide for carrying cargo or pulling a trailer.



 **WARNING**



V03M01Q

**POTENTIAL HAZARD**

Transporting flammable or dangerous material can lead to explosions.

**WHAT CAN HAPPEN**

This can cause serious injury or death.

**HOW TO AVOID THE HAZARD**

Never transport flammable or dangerous material.

While reading this Operator's Guide, remember that:

 **WARNING**

Indicates a potential hazard that, if not avoided, could result in serious injury or death.

---

## RIDING THE VEHICLE

To fully appreciate the pleasures and excitement of riding this vehicle, there are some basic rules and tips that you **MUST** follow. Some may be new to you while others may be common sense or obvious. Nonetheless, we ask that you take a few minutes to read this Operator's Guide completely before you operate this vehicle.

Information in this Operator's Guide is limited. It is strongly recommended that you obtain further information and training from your local authorities, ATV clubs, a recognized ATV training organization or contact an authorized Can-Am dealer.

**USA and Canada Only:** to find out about available training course nearest you, call the Specialty Vehicle Institute of America (SVIA) at 1 800 877-2887 or in Canada, the Canada safety Council (CSC) at 1 (613) 739-1535 ext. 227.

The U.S. Consumer Product Safety Commission and all ATV manufacturers do not recommended anyone under the age of 16 to ride an ATV having an engine higher than 90 cc. For the child's safety, we strongly recommend you also follow and enforce this recommendation. You are the sole judge of a rider's capability to understand the risks and operate a vehicle safely.

Persons with cognitive or physical impairments or who are high risk takers have an increased exposure to over-turns or collisions which may result in injury including death.

Become completely familiar with the operational controls and the general operation of the vehicle before venturing into off road conditions. Practice driving in a suitable area free of hazards and feel the response of each control. Drive at low speeds. Higher speeds require greater experience, knowledge and suitable riding conditions.

Not all vehicles are the same. Each has its own unique performance characteristics, controls and features. Each will ride and handle differently.

Never assume that the vehicle will go everywhere safely. Sudden changes in terrain caused by holes, depressions, banks, softer or harder "ground" or other irregularities may cause the vehicle to topple or become unstable. To avoid this, slow down and always observe the terrain ahead. If the vehicle does begin to topple or tipover, it is usually the best advice to immediately get off... **AWAY** from the direction of the tipover!

## Pre-Operation Check

### **WARNING**

The pre-operation check is very important prior to operating the vehicle. Always check the proper operation of critical controls, safety features and mechanical components before starting. If not done, severe injury or death might occur.

Before using this vehicle, the operator should always:

- Apply parking brake and check if it operates properly.
- Check tire pressure and condition.
- Check wheels and bearings for wear and damage.
- Check location of controls and ensure they work properly.
- Verify if steering operates freely.
- Activate throttle control lever several times to ensure it operates freely. It must return to idle position when released.
- Activate the brake levers and brake pedal to make sure the brakes fully apply. Levers and pedal must fully return when released.
- Ensure transmission lever is working then reset in PARK position.
- Check fuel, oil and coolant levels.
- Check for oil leaks on the engine/gearbox and drive train components.
- Clean headlamps and taillight.
- Ensure front central panel and rear storage compartment cover are properly latched.
- Ensure seat is properly latched.
- If you transport cargo, respect load capacity. Ensure cargo is properly secured to the cargo area eyelets.
- Look and feel for loose parts while engine is off. Check fasteners.

- Ensure the path of travel is free of persons and obstacles.
- Check operation of ignition switch, engine start button, engine stop switch, headlamps, taillight and indicator lights.
- Start engine, remove parking brake and drive forward slowly a few feet then apply all brakes individually to test them.
- Check operation of 2WD/4WD selector.

**Correct any problem you may have found before riding. See an authorized Can-Am dealer as necessary.**

## Clothing

Actual weather conditions should help you decide how to dress. However, it is important that the operator always wear the appropriate protective clothing and apparel, including an approved helmet, eye protection, boots, gloves, long sleeved shirt and pants. This type of clothing will provide you protection from some of the minor hazards you may encounter en route. Operator must never wear loose clothing such as a scarf that may get entangled in the vehicle or on tree branches and shrubs. Depending on conditions, antifogging goggles or sunglasses may be required. Different colored lenses available for goggles or sunglasses help you distinguish terrain variations. Sunglasses should only be worn during the daytime.

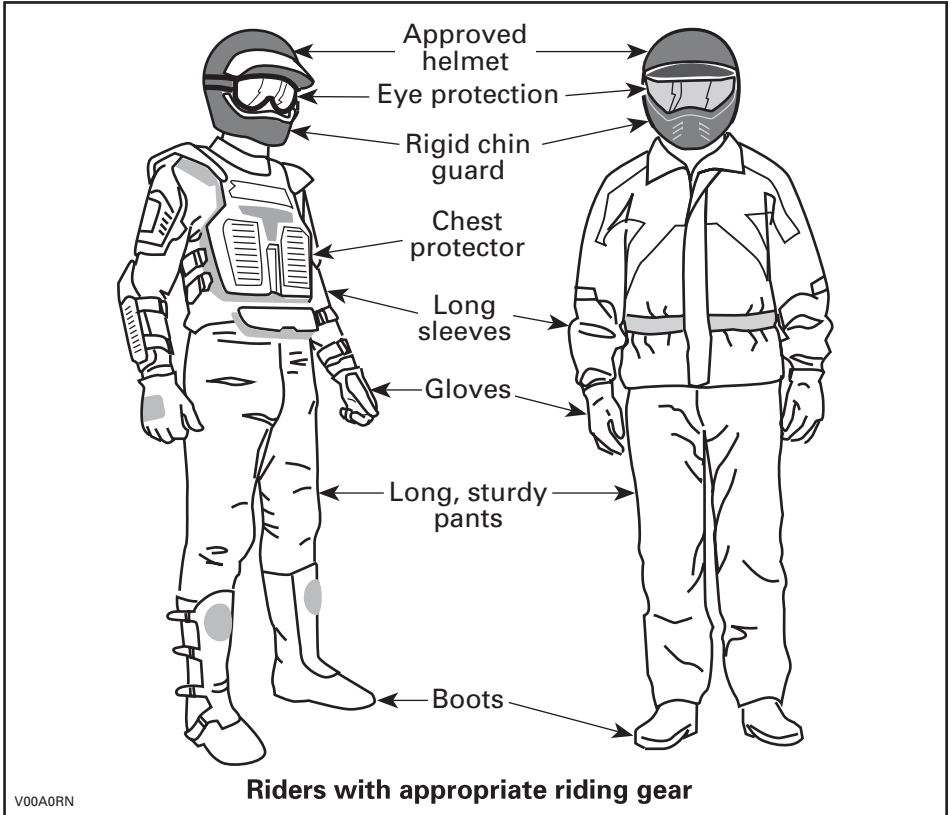

## **Carrying Loads**

Any load carried on the vehicle's carrying rack(s) will affect the stability and control of the vehicle. For this reason, do not exceed the load limits of the vehicle's manufacturer. Always make sure the load is secured and cannot interfere with your proper control. Always be aware that the "load" may slide or fall off and create an accident. Avoid loads that may protrude sideways and get snagged or caught in brush or other obstacles. Avoid covering and obstructing the headlamp or taillight with the cargo.

This vehicle is designed specifically to carry an operator only. Even with a long seat that provide unrestricted operator movements, they are not designed nor intended to carry passenger(s). NEVER install passenger seat or use the cargo area to carry passenger(s). Carrying passenger(s) may affect the stability and your control of the vehicle.

## **Hauling a Trailer (if so equipped)**

Riding this vehicle with a trailer substantially increases the risk of toppling, especially on inclined slopes. If a trailer is used behind the vehicle make sure that its hitch is compatible with the one on the vehicle. Make sure the trailer is horizontal with the vehicle. (In some instances a special extension may have to be installed on the vehicle hitch). Use security chains to secure the trailer with the vehicle. This vehicle may require additional stopping distance if hauling heavy loads, especially on inclined surfaces. Be careful not to skid or slide. When stopped or parked, block the vehicle and trailer wheels from possible movement. Always make sure load is evenly distributed on the trailer. Use caution when disconnecting a loaded trailer; it or its load may topple on you or others. Do not turn at high speeds.

## **Working with your Vehicle**

Your vehicle can help you perform a number of different LIGHT tasks ranging from snow removal to pulling wood or carrying cargo. A variety of accessories are available from your authorized Can-Am dealer. However, always respect the load and capacities of the vehicle. Overloading of the vehicle can overstress the components and cause failure. To prevent possible injury, it is equally important to follow the instructions and warnings that accompany the accessory. Avoid any physical exertion through lifting or pulling of heavy loads or manpowering the vehicle. (Continue to read *RECREATIONAL RIDING* below).

## **Recreational Riding**

Respect the rights and limitations of others. Stay away from areas designated for other types of off road use. This includes snowmobile trails, equestrian trails, cross country ski trails, mountain bike trails, etc. Never assume there are no other users on the trail. Always stay to the complete right of the trail and do not zig zag to one side of the trail then the other. Be prepared to stop or pull off to the side if another trail user appears in front of you.

Join a local ATV club. They will provide you with a map and advice or inform you where you can ride. If a club does not exist in your area, help start one. Group riding and club activities provide a pleasurable, social experience.

Always keep a safe distance from other riders. Your judgment of speed, terrain conditions, weather, mechanical condition of your vehicle and the "trust in judgment" you have in others around you will help you make a better choice of appropriate safe distance. This vehicle, like any other motorized vehicle, cannot stop "on a dime".

Before you ride, tell someone where you are planning to travel and your expected time of return. Never consume alcohol or drugs before or while riding!

Depending on the length of your ride, carry additional tools or emergency equipment. Find out where you can get additional gasoline and oil. Be prepared for the possible conditions you may encounter. An emergency first aid kit should always be a consideration.

## **Environment**

One of the benefits of this vehicle is that it can take you off the beaten path away from most communities. However, you should always respect nature and the rights of others to enjoy it. Do not ride in environmentally sensitive areas. Do not drive over forest crops or shrubs... nor cut down trees or take down fencing... nor spin your wheels and destroy the terrain. "Tread Lightly".

Chasing wildlife is in many areas illegal. Wildlife can die of exhaustion after being chased by a motorized vehicle. If you encounter animals on the trail, stop and observe quietly and with caution. It will be one of the better memories of your life.

Observe the rule... "what you take in, carry out". Do not litter. Do not start campfires unless you have permission to do so... and then only ... away from dry areas. The hazards you may create on the trail may cause injury to others or yourself, even at a later date.

Respect farm lands. Always obtain the permission of the landowner before riding on private land. Respect crops, farm animals and property lines. If you come to a closed a gate, close it again after yourself.

Finally, do not pollute streams, lakes or rivers and do not modify the engine or muffling system, or remove any of its components.

## **Design Limitation**

Although the vehicle is exceptionally rugged for its class, it is still a light vehicle by definition and its operation must be restricted to its proper purpose.

The addition of weight to any part of the vehicle changes its gravitational stability and modifies its performance.

## **Off-Highway Operation**

The very nature of off-highway operation is dangerous. Any terrain, which has not been specially prepared to carry vehicles, presents an inherent danger where angularity, terrain substance and exact steepness are unpredictable. The terrain itself presents a continual element of danger, which must be knowingly accepted by anyone venturing over it.

An operator who takes a vehicle off-road should always exercise the utmost care in selecting the safest path and keeping close watch on the terrain ahead of him. On no account should the vehicle be operated by anyone who is not completely familiar with the driving instructions applicable to the vehicle, nor should it be operated on steep or treacherous terrain.

## **General Operating and Safety Precautions**

Care, caution, experience and driving skill are the best precautions against the hazards of vehicle operation.

Whenever there is the slightest doubt that the vehicle can safely negotiate an obstacle or a particular piece of terrain, always choose an alternate route.

In off-road operation, power and traction, not speed, are important. Never drive faster than visibility and your own ability to select a safe route permit.

Constantly watch the terrain ahead for sudden changes in slopes or obstacles, such as rocks or stumps, that may cause loss of stability, resulting in tipover or rollover.

Never operate the vehicle if the controls do not function normally.

When operating in reverse, check that the path behind the vehicle is free of people or obstacles. Proceed slowly and avoid sharp turns.

When stopped or parked, always apply the parking brake. This is especially important when parking on a slope. On very steep inclines or if the vehicle is carrying cargo, the wheels should be blocked using rocks or bricks. Remember to turn the fuel valve to the closed position.

## **Uphill Driving**

Due to configuration, this vehicle has excellent climbing ability, so much so that tipover is possible before traction is lost. For example, it is common to encounter terrain situations where the top of the hill has eroded to a point that the hill peak rises very sharply. The vehicle can readily negotiate such a condition, however, in doing so, when the front of the vehicle is driven to a point that the vehicle's balance changes rearward tipover can occur.

The same situation may apply if an embedded object causes the front of the vehicle to climb more than desired. If such a situation occurs take an alternate route. Be aware of side hilling dangers when doing so.

It is also wise to know the terrain condition on the other side of the hill or bank. All too often there exists a sharp drop-off that is impossible to negotiate or descend.

## **Downhill Driving**

This vehicle can climb slopes that are steeper than it can safely descend. Therefore, it is essential to assure that a safe route exists to descend a slope before you climb it.

Decelerating while negotiating a slippery downhill slope could "toboggan" the vehicle. Maintain steady speed and/or accelerate slightly to regain control.

## **Side Hilling**

Whenever possible, such operation should be avoided. If necessary, do so with extreme caution. Side hilling on steep inclines could result in rollover. In addition, slippery or unfirm surfaces could result in uncontrollable side sliding. Do not attempt to turn the vehicle downhill with the slide. Avoid all objects or depressions that will intensify the raising of one side of the vehicle higher than the other, thus causing rollover.

## **Drop-Offs**

This vehicle will "bottom-out" and usually stop if either the front or rear wheels are driven over a drop-off. If the drop is sharp or deep, the vehicle will nose dive and tipover.



**Avoid negotiating drop-offs. Reverse and select an alternate route.**



## Riding Techniques

Riding your vehicle too fast for the conditions may result in injury. Apply only enough throttle to proceed safely. Statistics show that high speed turns usually result in mishaps and injury. Always remember that this vehicle is heavy! Its pure weight alone may entrap you should it fall and pin you down.

This vehicle is not designed for jumping nor can it, or you, absorb the energy of high impacts such as jumping. Performing "wheelies" can cause the vehicle to flip over onto you. Both practices have a high risk for you and should be avoided at all times.

To maintain proper control it is strongly advised that you keep your hands on the handlebar and within easy reach of all controls. The same holds true for your feet. To minimize the possibility of any leg or foot injury, keep your feet on the footrests at all times. Do not direct your toes outwards nor place your foot out to assist turning as they can be hit or snagged by passing obstacles or may contact the wheels.

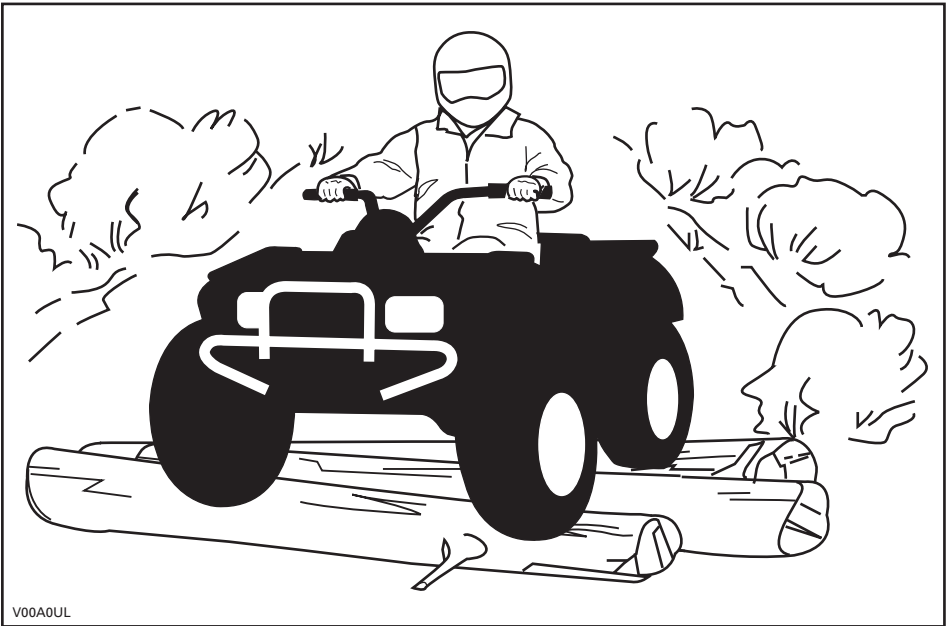

Even though there is an adequate suspensions system on this vehicle there are "washboard" or rough terrain conditions that will make you feel uncomfortable and even cause back injury. "Posting" or riding in a crouched position will often be required. Slow down and allow your flexed legs to absorb impact.

This vehicle is not designed for riding on roads or highways. In most places it is an illegal practice. Riding your vehicle on roads or highways could cause a collision to occur with another vehicle. The tires of this vehicle are not suited for paved road use. Pavement may seriously affect the handling and control of the vehicle. Riding on roads or soft shoulders may confuse other road users, especially if your lights are on. If you have to cross a road, the lead driver should get off his vehicle then observe and give directions to the other riders. The last person after crossing then assists the lead driver to cross. Do not travel sidewalks. They are designated for pedestrian use.

Water can be a unique hazard. If it is too deep the vehicle may "float" and topple. Check the water depth and current before you attempt to cross any water. Water should not go above the footrest. Be wary of slippery surfaces such as rocks, grass, logs, etc., both in the water and on its banks. A loss of traction may occur. Do not attempt to enter the water at high speed. The water will act as a brake and could throw you.

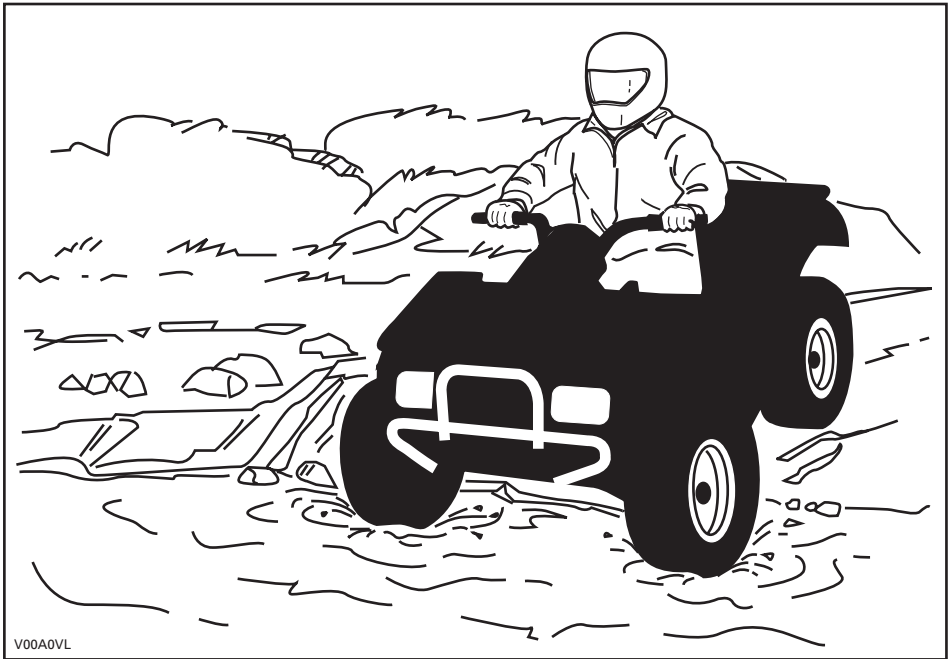

Water will affect the braking ability of your vehicle. Make sure you dry the brakes by applying them several times after the vehicle leaves the water.

Mud or marsh lands may be encountered near water. Be prepared for sudden "holes" or changes in depth. Similarly so, be watchful of hazards such as rocks, logs, etc., partially covered by vegetation.

If your trip crosses frozen waterways, make sure that the ice is thick enough and sound enough to support the total weight of yourself, the vehicle and its load. Be ever watchful of open water... it is a sure indication that the ice thickness will vary. If in doubt, do not attempt to cross.

Ice will also affect the control of vehicle. Slow down and do not "gun" the throttle. This will only result in spinning of the tires and possible tipover of the vehicle. Avoid rapid braking. This again will possibly result in an uncontrolled slide and tipover of the vehicle. Slush should be avoided at all times since it could block the operation or controls of the vehicle.

Sand and riding on sand dunes or on snow is another unique experience but there are some basic precautions that should be observed. Wet, deep or fine sand/snow may create a loss of traction and cause the vehicle to slide, drop off or become "bogged" down. If this occurs look for a firmer base. Again, the best advice is to slow down and be watchful of the conditions.

When riding in sand dunes it is advisable to equip the vehicle with an antenna type safety flag. This will help make your location more visible to others over the next sand dune. Proceed carefully should you see another safety flag ahead. Since the antenna type safety flag can snag and rebound on your body if caught, do not use it in areas where there are low hanging branches or obstacles.

Riding on loose stones or gravel is very similar to riding on ice. They will affect the steering of vehicle... possibly causing it to slide and tipover especially at high speeds. In addition, braking distance may be affected. Remember that "gunning" the throttle or sliding may cause loose stones to be ejected rearwards into the path of another rider's way. Never do it deliberately.

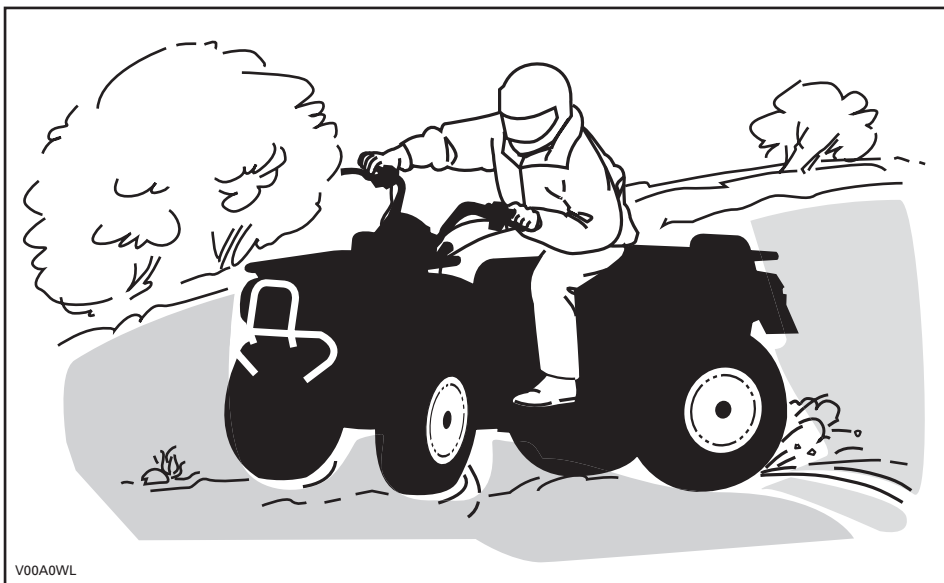

V00A0WL

If you do get into a slide or skid, it may help to turn the handlebar into the direction of the skid until you regain control. Never jam the brakes and lock the wheels.

Respect and follow all posted trail signs. They are there to help you and others.

Obstacles in the "trail" should be traversed with caution. This includes loose rocks, fallen trees, slippery surfaces, fences, posts, and embankments and depressions. You should avoid them whenever possible. Remember that some obstacles are too large or dangerous to cross and should be avoided. Small rocks or fallen trees may be safely crossed... approach at a 90° angle. Stand on the footrests while keeping your knees flexed. Adjust speed without losing momentum and do not "gun" the throttle. Hold handlebar firmly. Place your body weight rearwards and proceed. Do not try to lift the vehicle front wheels off the ground. Be aware that the object may be slippery or may move while crossing.

When driving on hills or slopes two things are highly important... be prepared for slippery surfaces or terrain variations and obstacles and... use proper body positioning.

## Uphill

Keep your body weight forward towards the top of the hill. Keep your feet on the footpegs and shift into low gear then accelerate and when necessary, change gear quickly as you climb. Do not over-speed since this may cause the front of the vehicle to lift from the ground and fall back on you. If the hill is too steep and you cannot proceed or the vehicle begins to roll backwards, apply the brake, being careful not to slide. Dismount then use the "U" turn or "K" turn (while walking back, next to the vehicle on the up hill side and with a hand on the brake lever, slowly back the rear of the vehicle toward the top of the hill then drive downhill). Always walk or dismount on the upside of the slope while keeping clear of the vehicle and its rotating wheels. Do not try to hold on to the vehicle if it begins to topple. Stay clear. Do not ride over the crest of the hill at high speed. Obstacles, including sharp drop-offs, may exist.

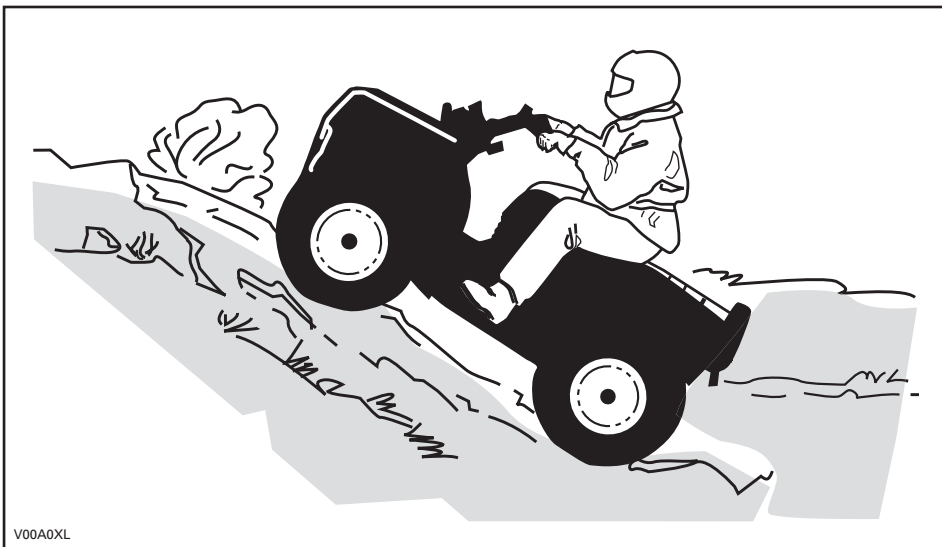

V00A0XL

## Downhill

Keep your body weight rearwards. Apply the brake gradually to prevent skidding. Do not "coast" down the slope using solely engine compression or in neutral gear.

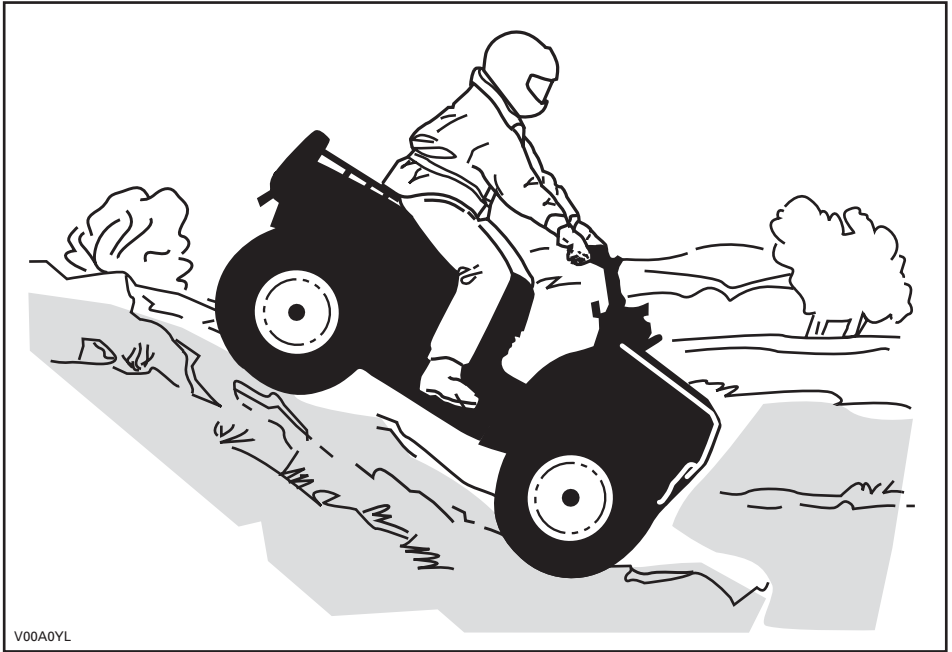

V00A0YL

While reading this Operator's Guide, remember that:

### **WARNING**

Indicates a potential hazard that, if not avoided, could result in serious injury or death.

## Side Hilling

This is one of the **most risky** types of riding since it may drastically change the balance of the vehicle. It should be avoided wherever possible. If it is necessary to do so however, it is important that you **ALWAYS** keep your body weight on the upside of the slope... and be prepared to dismount on that side should the vehicle begin to topple. **Do not try to stop or save the vehicle from damage.**



V00A0ZL

## **Routine Maintenance**

Once your ride completed, it is wise to remove any build up of snow, ice, mud and grime. Not only will this help you keep your vehicle longer and in good condition for resale but will eliminate potential hazards the next time you use the vehicle. Wash your vehicle in warm soapy water then allow it to dry. (A towel may help). Do not wash your vehicle outside during freezing weather. Apply appropriate lubrication as described in the *MAINTENANCE* section.

Part of your responsibility towards safety is to respect the contents of this Operator's Guide. It provides valuable advice on how to properly take care of your vehicle. If further assistance is required your authorized Can-Am dealer is always willing to help.





Modification of the vehicle to increase speed and performance may violate the terms and conditions of your vehicle limited warranty. In addition, certain modifications including the removal of engine or exhaust components are illegal under most laws.

Changing the wheel and/or tire size may affect the stability of the vehicle. Incorrect tire pressure may lead to blow outs or cause a tire to move around on its rim and become lost or damaged. Wheels or tires which are damaged should always be replaced.

# HANG TAG

This vehicle comes with a hang tag and labels containing important safety information.

Any person who rides this vehicle should read and understand this information before riding.

<p style="text-align: center;"><b>S</b> <b>SPORT MODEL</b></p> <p style="text-align: center;">THIS ATV IS FOR <b>RECREATIONAL USE</b> BY EXPERIENCED OPERATORS ONLY.</p> <p style="text-align: center;"><b>OPERATOR ONLY-NO PASSENGERS</b></p> <hr/> <p style="text-align: center;"><b>NO OPERATOR UNDER AGE 16</b></p> <hr/> <p>THIS CATEGORY S (SPORT) ATV IS A HIGH PERFORMANCE ATV FOR OFF ROAD USE ONLY. IT IS FOR SPORT TYPE RECREATIONAL AND COMPETITIVE USE BY OPERATORS WITH ADVANCED SKILLS AND SUBSTANTIAL EXPERIENCE.</p> <hr/> <p>TRAINING COURSES TO TEACH ATV RIDING SKILLS ARE AVAILABLE. FOR INFORMATION CONTACT YOUR DEALER.</p> <hr/> <p>CHECK WITH YOUR DEALER TO FIND OUT ABOUT STATE OR LOCAL LAWS REGARDING ATV OPERATION.</p> <p style="text-align: center;"><b>THIS HANGTAG IS NOT TO BE REMOVED BEFORE SALE.</b></p> <p style="text-align: right;"><small>704590923</small></p>	<p style="text-align: center;"><b>⚠ WARNING</b></p> <p>Improper ATV use can result in SEVERE INJURY or DEATH.</p> <div style="display: flex; justify-content: space-around;"><div style="text-align: center;"><p><small>ALWAYS USE AN APPROVED HELMET AND PROTECTIVE GEAR.</small></p></div><div style="text-align: center;"><p><small>NEVER USE ON PUBLIC ROADS.</small></p></div><div style="text-align: center;"><p><small>NEVER CARRY PASSENGERS.</small></p></div><div style="text-align: center;"><p><small>NEVER USE WITH DRUGS OR ALCOHOL.</small></p></div></div> <p><b>NEVER operate:</b></p> <ul style="list-style-type: none"><li>• without proper training or instructions.</li><li>• at speeds too fast for your skills or the conditions.</li><li>• on public roads - a collision can occur with another vehicle.</li><li>• with a passenger - passengers affect balance and steering and increase risk of losing control.</li></ul> <p><b>ALWAYS:</b></p> <ul style="list-style-type: none"><li>• use proper riding techniques to avoid vehicle overturns on hills and rough terrain and in turns.</li><li>• avoid paved surfaces - pavement may seriously affect handling and control.</li></ul> <p style="text-align: center;">LOCATE AND READ OPERATOR'S GUIDE. FOLLOW ALL INSTRUCTIONS &amp; WARNINGS.</p>
---	--

V02M0FL

## USA and Canada Only

**VEHICLE ENGINE DESCRIPTION:**

XXXXX

EPA CERTIFIED

NER (NORMALIZED EMISSION RATE) =

ON A 0 TO 10 SCALE, 0 BEING THE CLEANEST

**\*NOT TO BE REMOVED PRIOR TO SALE**



704901107

vmo2006-005-009\_en



# ON-PRODUCT LABELS

The following labels are on your vehicle and they should be considered permanent parts of the vehicle. If missing or damaged, they can be replaced free of charge. See an authorized Can-Am dealer.

**NOTE:** The following illustrations used in this Operator's Guide are a general representation only. Your model may differ.

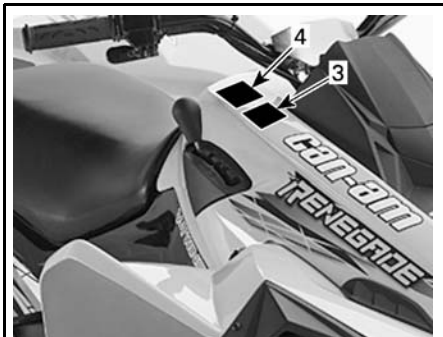

vmo2007-015-001\_a

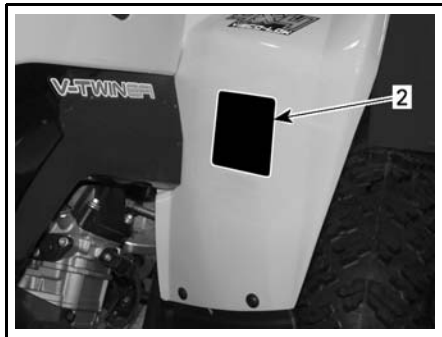

vmo2007-015-004\_a

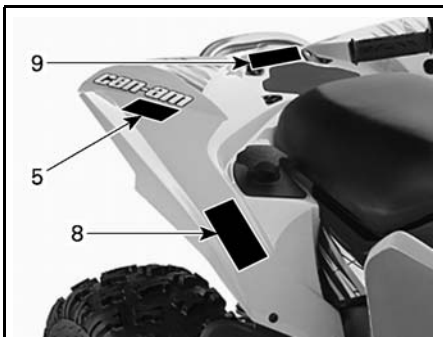

vmo2007-015-002\_a

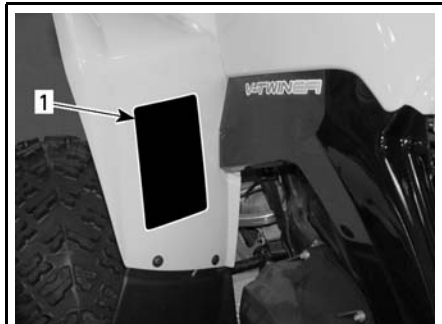

vmo2007-015-006\_a

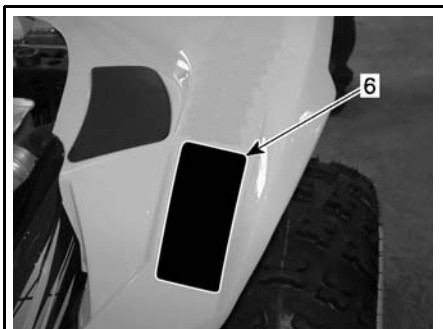

vmo2007-015-003\_a

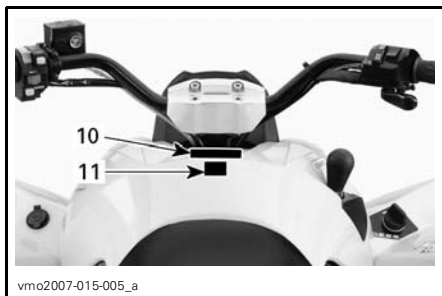

vmo2007-015-005\_a

## Label 1

**⚠ WARNING**

Improper ATV use can result in SEVERE INJURY or DEATH.



**ALWAYS USE AN APPROVED HELMET AND PROTECTIVE GEAR.**

**NEVER USE ON PUBLIC ROADS.**

**NEVER CARRY PASSENGERS.**

**NEVER USE WITH DRUGS OR ALCOHOL.**

**NEVER operate:**

- without proper training or instructions.
- at speeds too fast for your skills or the conditions.
- on public roads - a collision can occur with another vehicle.
- with a passenger - passengers affect balance and steering and increase risk of losing control.

**ALWAYS:**

- use proper riding techniques to avoid vehicle overturns on hills and rough terrain and in turns.
- avoid paved surfaces - pavement may seriously affect handling and control.

LOCATE AND READ OPERATOR'S GUIDE.  
FOLLOW ALL INSTRUCTIONS & WARNINGS.

V01M01Z 704 900 001

## Label 2

**⚠ WARNING**



Operating this ATV if you are under the age of 16 increases your chance of SEVERE INJURY or DEATH.

**NEVER** operate this ATV if you are under age 16.

V01M02Z 704 900 011

## Label 3

**CAUTION**

- **ATV MUST be stopped before shifting lever.**
- **Always apply foot brake to shift from Park(P) and Neutral(N).**

V07M06Y 704 900 470

## Label 4

**CAUTION**

**ATV MUST be stopped to engage or disengage 4WD switch. mechanical damage may occur if switch is engaged or disengaged while driving.**

V07M07Y 704 900 471

## Label 5

**⚠ WARNING**



**NEVER** ride as a passenger. Passengers can cause a loss of control, resulting in SEVERE INJURY or DEATH.

V01M07Z 704 900 005

## Label 6

**⚠ WARNING**

Improper tire pressure or overloading can cause loss of control, resulting in SEVERE INJURY or DEATH.

LOAD	COLD TIRE PRESSURE
FRONT	
UP TO XXX kg (XXX lb)	MAX: XXX kPa (X.X psi) MIN: XX.X kPa (X.X psi)
REAR	
	MAX: XXX kPa (X.X psi) MIN: XX.X kPa (X.X psi)

ALWAYS maintain proper tire pressure as shown.

NEVER set tire pressure below minimum. It could cause the tire to dislodge from the rim.

NEVER exceed the vehicle load capacity of XXX kg(XXX lb) including weight of operator, cargo, accessories and trailer tongue weight.

7049011209

vmo2007-015-019\_en

## Label 7

**EMISSION CONTROL INFORMATION**

THIS VEHICLE IS CERTIFIED TO OPERATE ON UNLEADED GASOLINE AND MEETS TO [xxxx] U.S. EPA AND CALIFORNIA REGULATIONS FOR ATV SI ENGINES.

ENGINE FAMILY	XXXXXX,XXXXXX	FAMILLE DE MOTEUR
CERTIFICATION STANDARD (FEL)	XXXXXXXXXXXXXXXXXX	LIMITE DES ÉMISSIONS DE LA FAMILLE
ENGINE DISPLACEMENT	XXXXXXXXXX	CYLINDRÉE
EXHAUST EMISSION CONTROL SYSTEM	XXXXX	SYSTÈME DE CONTRÔLE DES ÉMISSIONS

**RENSEIGNEMENTS SUR LE DISPOSITIF ANTIPOLLUTION**

CE VÉHICULE EST CERTIFIÉ POUR FONCTIONNER À L'ESSENCE SANS PLOMB ET IL RÉPOND AUX NORMES [xxxx] DE L'EPA ET RÉGLEMENTATIONS CALIFORNIENNES POUR LES VTT À MOTEUR SI.

SEE OPERATOR'S GUIDE FOR MAINTENANCE SPECIFICATIONS  
VOIR GUIDE DU CONDUCTEUR POUR LES SPÉCIFICATIONS D'ENTRETIENS  
**BOMBARDIER RECREATIONAL PRODUCTS INC.**

vmo2007-002-002

LOCATED UNDER SEAT ON THE UPPER BAR OF FRAME

## Label 8

**⚠**

**DA** FIND OG LÆS BRUGERVEJLEDNINGEN. OVERHOLD ALLE INSTRUKTIONER OG ADVARSLER.

**NL** ZOEK DE GEBRUIKERSHANDLEIDING OP EN LEES HEM, HOUD U AAN ALLE AANWIJZINGEN EN WAARSCHUWINGEN.

**FR** LOCALISER ET LIRE LE GUIDE DE L'OPÉRATEUR. SUIVRE TOUS LES CONSIGNES ET AVERTISSEMENTS. PARCOURREZ LA LUE KÄYTTÄJÄN OPAS. NUODATA KÄYTTÖOHJEITA JA VAROITUKSIA.

**FI** BETRIEBSANLEITUNG AUSFINDIG MACHEN UND LESEN. ALLE ANWEISUNGEN UND WARNHINWEISE BEFOLGEN.

**DE** SPICETE KAJ DŽAGAŽITE TON DŽAFID ŽEBESTIH, AKO ŽVREŠTE O ŽE ŽE TIE DŽAFI ŽE Ž KAJ ŽIPELOŽOTIŽIŽEŽEŽ.

**EL** LEGGERE IL MANUALE DELL'OPERATORE. SEGUIRE TUTTE LE ISTRUZIONI E AVVERTENZE.

**IT** LOCALIZAR E LER O GUIA DE OPERAÇÃO. OBSERVAR TODAS AS INSTRUÇÕES E MENSAGENS DE AVISO.

**PT** UBICAR Y LEER LA GUIA DEL OPERADOR. ATENERSE A TODAS LAS INSTRUCCIONES Y MENSAJES DE ADVERTENCIA.

**ES** TA REDA PÅ INSTRUKTIONSBOKEN OCH LÄS DEN. UPPMÄRKSAMMA ALLA ANVISNINGAR OCH VARNINGAR.

**SV**

704 901 177

vmo2006-014-003\_a

INTERNATIONAL MODELS ONLY

## Label 9

**⚠ WARNING**

- NEVER carry a passenger on this cargo area
- MAXIMUM REAR LOAD : XX lb (XX kg) evenly distributed.

704 901 083

vmo2007-015-020\_en

## Label 10

**⚠ WARNING**

This ATV may exceed the performance of other ATVs you may have ridden in the past.

This category S (sport) is a high performance ATV for off road use only. It is for sport type recreational and competitive use by operators with advanced skills and substantial experience.

704 900 085

V02M05Y

## Label 11

THIS VEHICLE IS AN ALL  
TERRAIN VEHICLE AND  
IS NOT INTENDED FOR  
USE ON PUBLIC ROADS.  
CE VÉHICULE EST UN VÉHICULE  
TOUT TERRAIN QUI N'EST PAS  
DESTINÉ À ÊTRE UTILISÉ SUR  
LES VOIES PUBLIQUES.  
V.I.N. IS LOCATED BELOW THE SEAT  
N.I.V. EST SITUÉ EN DESSOUS DU SIÈGE

704901315

vmo2007-015-021

# ***VEHICLE INFORMATION***

# HOW TO IDENTIFY YOUR VEHICLE

The main components of your vehicle (engine and frame) are identified by different serial numbers. It may sometimes become necessary to locate these numbers for warranty purposes or to trace your vehicle in the event of loss. These numbers are required by the authorized Can-Am dealer to complete warranty claims properly. No warranty will be allowed by BRP Inc. if the engine identification number (EIN) or vehicle identification number (VIN) is removed or mutilated in any way. We strongly recommend that you take note of all the serial numbers on your vehicle and supply them to your insurance company.

## Vehicle Identification Number



### TYPICAL — VEHICLE SERIAL NUMBER LABEL

1. VIN (Vehicle Identification Number)
2. Model number



1. Vehicle serial number label location

## Engine Identification Number

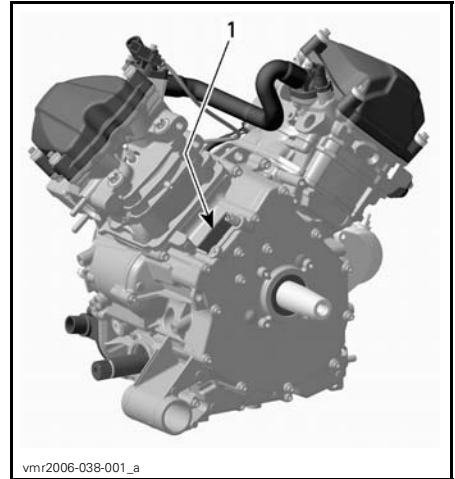

### TYPICAL — ENGINE SERIAL NUMBER LABEL

1. EIN (Engine Identification Number)

## Compliance Label

This label indicates vehicle's compliance in many countries.

LABEL LOCATION	
Renegade	Under seat, on the upper bar of frame



### USA AND CANADA



### OTHER COUNTRIES IN THE WORLD

---

# NOISE EMISSION CONTROL SYSTEM REGULATION

## *USA and Canada Only*

### **Tampering with Noise Control System Is Prohibited!**

U.S. Federal law and Canadian provincial laws may prohibit the following acts or the causing there of:

1. The removal or rendering inoperative by any person other than for purposes of maintenance, repair or replacement of any device or element of design incorporated into any new vehicle for the purpose of noise control prior to its sale or delivery to the ultimate purchaser or while it is in use or
2. The use of the vehicle after such device or element of design has been removed or rendered inoperative by any person.

### **Among those Acts Presumed to Constitute Tampering Are the Acts Listed Below:**

1. Removal or alteration or the puncturing of the muffler or any engine component which conducts removal of engine exhaust gases.
2. Removal or alteration or the puncturing of any part of the intake system.
3. Replacing any moving parts of the vehicle or parts of the exhaust or intake system, with parts other than those specified by the manufacturer.
4. Lack of proper maintenance.

---

# EMISSION REQUIREMENTS

## ***USA Only***

The California Air Resources Board (CARB) requires that your vehicle comply with applicable exhaust emissions standards during its useful life, when operated and maintained according to the instructions supplied.

A non-compliance Red Label (as well as a Green Label) is obtained annually during California Vehicle registration. The appropriate label is denoted by the vehicle identification number (in the 8<sup>th</sup> character detailed herein).

VEHICLE CATEGORY	VIN 8 <sup>TH</sup> CHARACTER
Non-complying Red Label	Must denote a C or 3
Complying Green Label	Any alphanumeric designation other than a C or 3



---

# BREAK-IN PERIOD

## Engine

A break-in period of 10 operating hours is required before running the vehicle at sustained full throttle.

**CAUTION:** Never mix oil with fuel. This vehicle has a 4-stroke engine. Oil must be added to engine base only.

During this period, maximum throttle should not exceed  $3/4$ . However, brief full acceleration and speed variations contribute to a good break-in. Continued wide open throttle accelerations, prolonged cruising speeds and engine overheating are detrimental during the break-in period.

## Belt

A new belt requires a break-in period of 50 km (30 miles). Avoid strong acceleration/deceleration, pulling a load or high speed cruising.

## 10-Hour Inspection

**NOTE:** The 10-hour inspection is at the expense of the vehicle owner.

As with any precision piece of mechanical equipment, we suggest that after the first 10 hours, 300 km (185 mi) or 30 days after the purchase, whichever comes first, your vehicle be inspected by an authorized Can-Am dealer. This inspection will give you the opportunity to discuss the unanswered questions you may have encountered during the first hours of operation.

# CONTROLS/INSTRUMENTS/EQUIPMENT

NOTE: Some controls/instruments/equipment are optional.

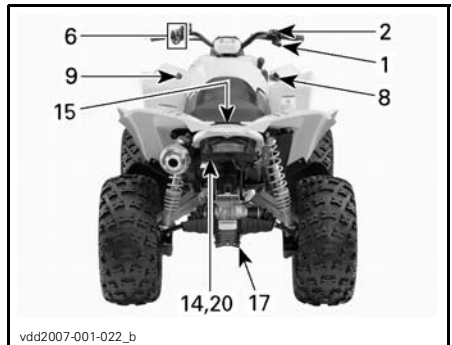
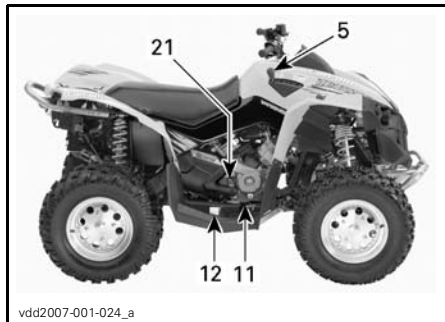
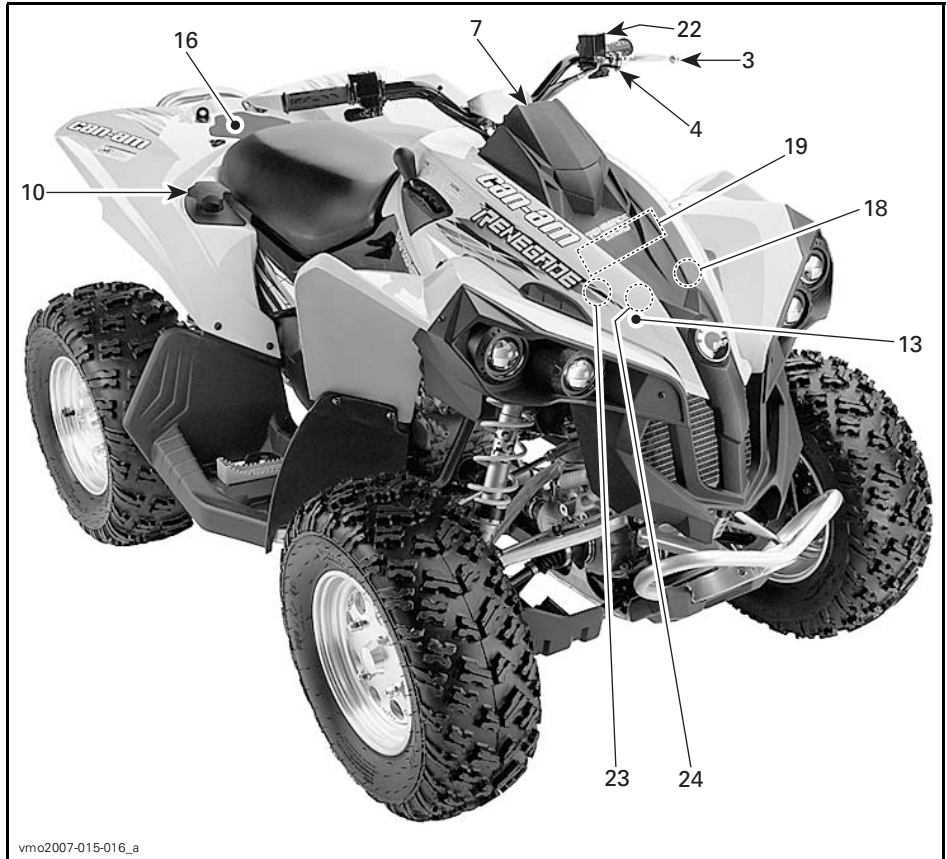

While reading this Operator's Guide, remember that:

## **WARNING**

Indicates a potential hazard that, if not avoided, could result in serious injury or death.

**NOTE:** This section gives basic functions of the various controls of your vehicle. For more details of how to operate one control in conjunction with some others, refer to *OPERATING INSTRUCTIONS* further in this section.

### **1) Throttle Lever**

When pushed, it increases the engine speed that allows the engagement of the transmission on the selected gear.

When released, the engine speed should return automatically to idle and the vehicle will gradually slow down.

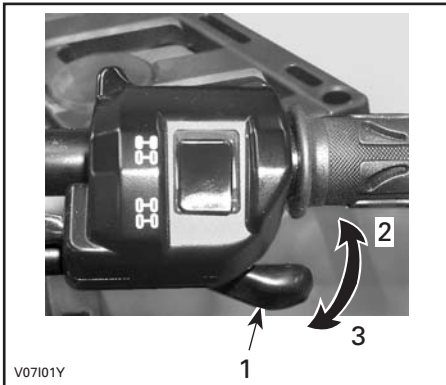

#### **TYPICAL**

1. Throttle lever
2. To accelerate
3. To decelerate

### **2) 2WD/4WD Selector**

This selector allow to choose between 2WD or 4WD.

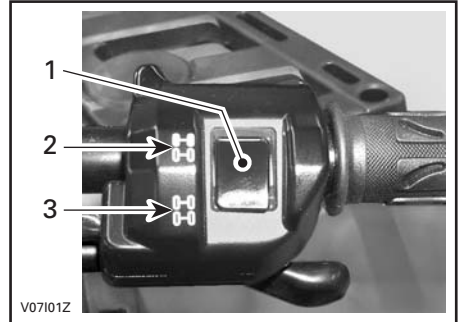

#### **TYPICAL**

1. Selector
2. 2WD position
3. 4WD position

### **3) Brake Lever**

When the brake lever is compressed, the front and rear brakes are applied. When released, the brake lever should automatically return to its original position. Braking effect is proportional to the force applied on the lever and to the type and condition of the terrain.

**NOTE:** As on other wheeled vehicles, the vehicle weight is transferred to the front wheels when braking. To obtain greater stopping efficiency, the brake system distributes more braking force to the front wheels. This will affect vehicle handling and steering control when braking vigorously. Take it into account when braking.

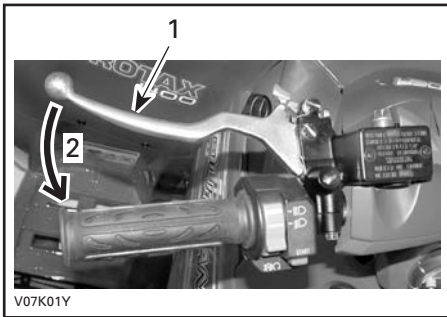

**TYPICAL**

1. Brake lever
2. To apply brakes

### 4) Parking Brake

When applied, it prevents the vehicle from moving. Useful when the brake needs to be locked for example when doing a K-turn, during transportation or when the vehicle is not in operation.

**⚠ WARNING**

Always use the parking brake **and** engage the PARK position on the transmission lever when the vehicle is not in operation.

**⚠ WARNING**

Make sure parking brake is fully disengaged before operating the vehicle.  
When you ride the vehicle, brakes that are caused to drag by a continuous pressure on the lever may cause damage to the brake system and cause loss of braking capacity and/or fire.

**To engage mechanism:** Squeeze brake lever and maintain while moving lever lock. Brake lever is now compressed and applying all brakes.

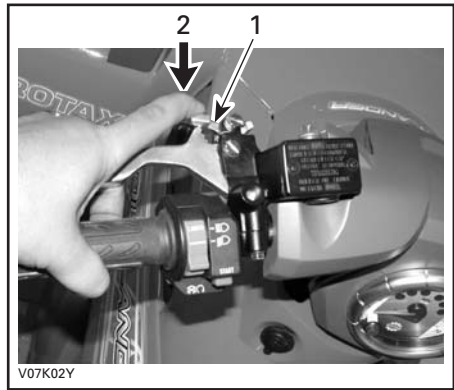

**TYPICAL**

1. Brake lever lock
2. Press to apply parking brakes

**To release mechanism:** Squeeze brake lever. Lever lock should automatically return to its original position. Brake lever should return to rest position. Always release parking brake before riding.

### 5) Transmission Lever

A 5-position lever: P, R, N, H and L.

To change the transmission position, completely stop vehicle then move lever to the desired position. Do not force lever. If unable to shift, rock the vehicle back and forth to move the gears in the transmission and try again.



**SHIFT PATTERN**

**CAUTION:** Always completely stop the vehicle and apply the brake prior to moving the transmission lever.

**P: Park**

This position locks the transmission to help prevent vehicle movement. Always use when the vehicle is not in operation. In some circumstances, it may be necessary to rock the vehicle back and forth to move the gears in the transmission to allow the park to be engaged.

**R: Reverse**

This allows the vehicle to go backward. The vehicle speed is limited.

**⚠ WARNING**

Before moving vehicle in reverse, ensure the path behind is clear of obstacles or bystanders. Remain seated.

**N: Neutral**

This position disengages the transmission to allow manual vehicle movement.

**H: High gear**

This selects the high speed range of the transmission in the gear box. It is the normal driving speed range. It allows the vehicle to reach its maximum speed.

**L: Low gear**

This selects the low speed range of the transmission in the gear box. It is the working position. It allows the vehicle to move slowly with the maximum traction and power.

**NOTE:** Use the low speed range to pull any load or to climb a steep incline.

**6) Multifunction Switch**

The controls located on this multifunction switch are:

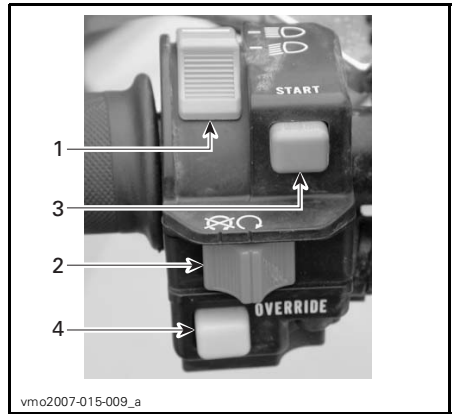

**TYPICAL — MULTIFUNCTION SWITCH**

- 1. Headlamp switch
- 2. Engine stop switch
- 3. Engine start button
- 4. Override button

**Headlamp Switch**

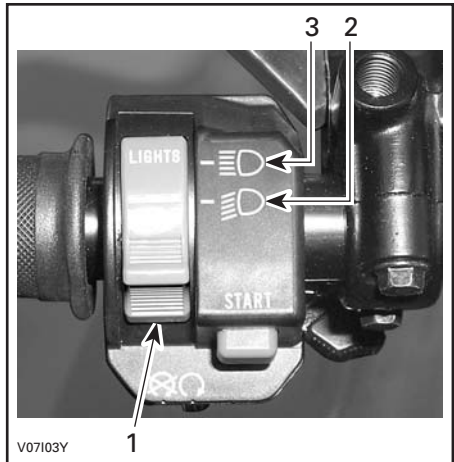

**HEADLAMP SWITCH FUNCTIONS**

- 1. Headlamp switch
- 2. Low beam and taillight
- 3. High beam and taillight

**NOTE:** Place ignition switch to ON "without light" position to close the headlamp.

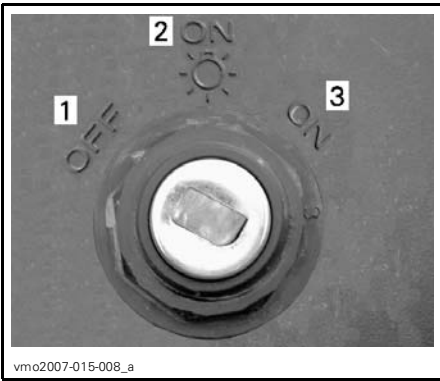

vmo2007-015-008\_a

### IGNITION SWITCH POSITIONS

1. OFF
2. ON "with light"
3. ON "without light"

### Engine Stop Switch

This switch can be used to stop engine and as an emergency control.

To stop engine, fully release throttle lever then use the engine stop switch.

**NOTE:** While engine can be stopped by turning ignition key to OFF position, we recommend the engine be stopped by the engine stop switch.



V07105Y

### TYPICAL

1. Engine stop switch

### Engine Start Button

To start engine, place the engine stop switch to RUN.

Press and hold the engine start button. Release immediately after engine is started.

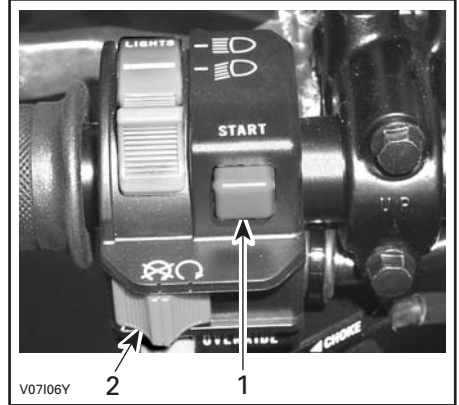

V07106Y

### TYPICAL

1. Engine start button
2. Engine stop switch

**NOTE:** The engine will not turn over if the engine stop switch is turned to the OFF position.

### Override Button

This button is used to override the reverse speed limiter system while power backing up. Press and hold the override button then depress throttle lever gradually.

### WARNING

Never activate the override button if throttle lever is already depressed as a loss of control may result, causing severe personal injury or death.

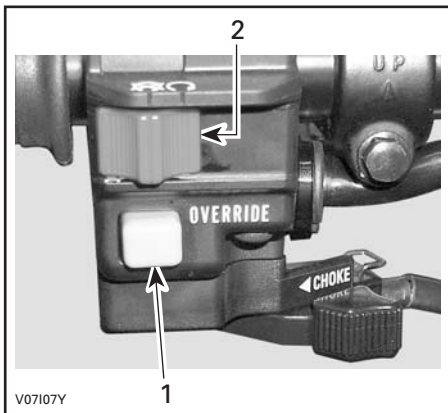

V07107Y

#### TYPICAL

1. Override button
2. Engine stop switch

## 7) Multifunction Gauge

This vehicle is equipped with an electronic multifunction gauge.

The functions on this gauge are:

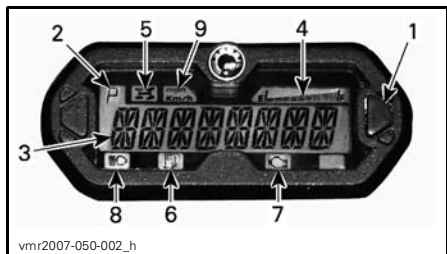

vmr2007-050-002\_h

1. Multifunction display selector button
2. Transmission position display
3. Multifunction display
4. Fuel level display
5. 4WD indicator lamp
6. Low fuel level indicator lamp
7. Check engine indicator lamp
8. High beam indicator lamp
9. MPH, Km/h indicator lamp

### Unit Selection (MPH vs km/h)

The speedometer, odometer and trip meter are factory preset in miles but it is possible to change them to kilometer reading. Contact an authorized Can-Am dealer.

## Multifunction Display (normal display mode)

After vehicle startup, the normal display mode shows either:

- vehicle speed
- engine revolution per minute (RPM)
- both parameters simultaneously.

To change from one to the other, push and HOLD selector button for 2 seconds.



vmr2007-050-002\_c

1. Selector button

### Speed Mode

In this mode, the display shows the speed of the vehicle either in km/h or in MPH.

### RPM Mode

In this mode, the display shows the engine RPM.

### Combined Mode

In this mode, the display shows the speed of the vehicle and the engine RPM.

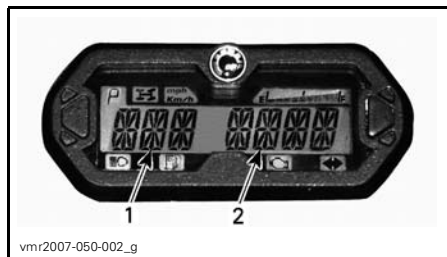

vmr2007-050-002\_g

1. Vehicle speed
2. Engine RPM

## Multifunction Display (temporary display mode)

Press and release selector button to change the normal display mode to the following temporary mode:

- odometer
- trip meter (resettable)
- hour meter (resettable)
- vehicle hour meter.

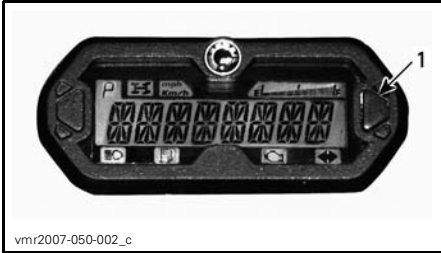

1. Selector button

The gauge will display the selected mode for 10 seconds then will return to the normal display mode.

While in a resettable mode, push and HOLD selector button for 2 seconds to reset it.

## Odometer (ODO)

Odometer records the total distance travelled either in miles or kilometers.

## Trip Meter (trip)

The trip meter records distance travelled since it has been reset. Distance travelled is displayed either in miles or kilometers.

It can be used to establish a fuel tank range or distance between 2 way points for instance.

Push and HOLD display selection button for 2 seconds to reset the trip meter.

## Hour Meter (trip time)

The hour meter records vehicle running time when the electrical system is activated. It can be used to establish traveling time between 2 way points for instance.

Push and HOLD display selection button for 2 seconds to reset the hour meter.

## Hour Meter (engine hours)

The hour meter records engine running time.



## Multifunction Display Messages

MESSAGE	DESCRIPTION
INVALID KEY	Indicates that you have used the wrong ignition key, use the proper key for this vehicle. It is also possible that the ignition key has a bad contact, remove and clean key.
BRAKE	Is displayed when parking brake is applied for more than 15 seconds.
LO BATT	Low battery voltage, check battery voltage and charging system.
HI BATT	High battery voltage, check battery voltage and charging system.
LOW OIL <sup>(1)</sup>	Engine low oil pressure, stop engine immediately and check oil level.
LOW FUEL	Low fuel indicator lamp also turns on. Refer to <i>INDICATOR LAMPS</i> .
HI TEMP <sup>(2)</sup>	Engine is overheating, refer to <i>ENGINE OVERHEAT</i> in <i>TROUBLESHOOTING</i> .
LIMP HOME	Serious fault on the engine that can change the normal operation of the engine, check engine indicator lamp will also blink, refer to <i>TROUBLESHOOTING</i> for more details.
CHECK ENGINE	Engine fault, check engine indicator lamp will also be ON, refer to <i>TROUBLESHOOTING</i> for more details.
MAINTENANCE SOON <sup>(3)</sup>	Periodic maintenance required. See an authorized Can-Am dealer.
NO ECM COMMUNICATION	Communication error between gauge and engine control module (ECM), contact an authorized Can-Am dealer.

**CAUTION:** <sup>(1)</sup> If the light does not turn off right after engine starting, stop engine. Check engine oil level. Refill if necessary. If the oil level is good, see an authorized Can-Am dealer. Do not use the vehicle until repaired.

**CAUTION:** <sup>(2)</sup> If the light does not turn off right after engine starting, stop engine. See an authorized Can-Am dealer. Do not use the vehicle until repaired.

<sup>(3)</sup> Message must be erased by an authorized Can-Am dealer.

## Transmission Position Display

This display will show transmission position.

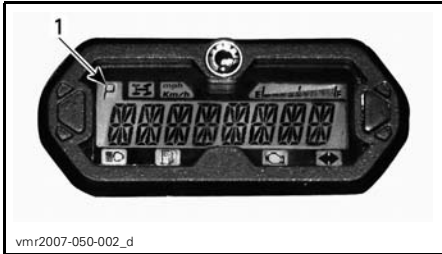

1. Transmission position

DISPLAY	FUNCTION
P	Park
R	Reverse
N	Neutral
H	High Gear
L	Low Gear

**NOTE:** If the letter “E” is displayed in the transmission position display, it means that there is a electrical communication error. Contact an authorized Can-Am dealer.

## Fuel Level Display

Bar gauge continuously indicates the amount of fuel in the fuel tank while riding.

When the low fuel indicator lamp is ON, it indicates that there is only 30% of fuel left in fuel tank, approximately 6 L (1.6 U.S. gal).

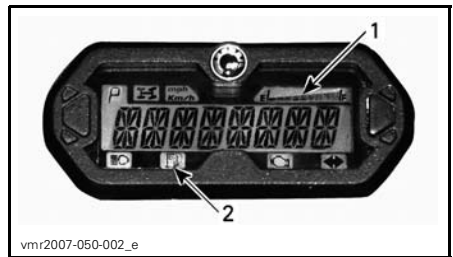

1. Fuel level display  
2. Low fuel indicator lamp

## Indicator Lamps

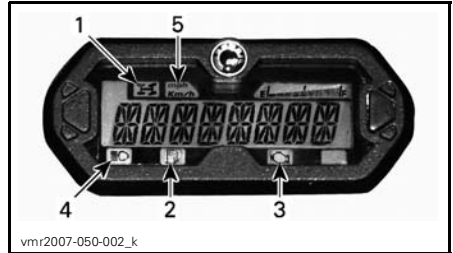

1. 4WD indicator lamp  
2. Low fuel level indicator lamp  
3. Check engine indicator lamp  
4. High beam indicator lamp  
5. MPH or km/h indicator lamp



When this indicator is ON, it indicates the 4WD system is activated.



When this indicator is ON, it indicates that there is only 30% of fuel left in fuel tank, approximately 6 L (1.6 U.S. gal).



When this indicator is ON, it indicates an engine fault code, look for message in multifunction display.

When this indicator blinks, it indicates that the LIMP HOME mode is activated, refer to *TROUBLESHOOTING* for more details.

 When this indicator is ON, it indicates high intensity is selected on the headlamps and ignition key is in LIGHTS position.

**mph** The proper lamp turns on to indicate the unit the speedometer uses.  
**Km/h**

## 8) 12-Volt Power Outlet

Convenient for handheld spotlight or other portable equipment.

Remove protective cap to use. Always reinstall it after use to protect against weather.

Do not exceed the rating capacity. See *SPECIFICATIONS*.

## 9) Ignition Switch

Key-operated 3-position switch.



### IGNITION SWITCH POSITIONS

1. OFF
2. ON "with light"
3. ON "without light"

Insert key in switch and turn to the desired position. To remove key, turn key to OFF position then pull it out.

**NOTE:** When turning the key to OFF position and removing the key, the vehicle electrical system will take a few seconds to shut down.

The ON with lights position, turns on all lights with either the engine running or not. Remember that having the lights on without the engine running discharges the battery. Always turn ignition key to OFF position after engine has been stopped.

**NOTE:** While engine can be stopped by turning ignition key to OFF position, we recommend the engine be stopped by the engine stop switch.

## Digitally Encoded Security System (DESS™)

The ignition key specifically contains an electronic circuit that gives it a unique electronic serial number.

This ignition key cannot be used on another vehicle and conversely, the one from another vehicle cannot be used on your vehicle except if it was programmed this way.

However, the DESS brings a great flexibility. You can buy an additional ignition key and have it programmed for your vehicle.

To have additional ignition key, refer to an authorized Can-Am dealer.

## 10) Fuel Tank Cap

**CAUTION:** Never place anything over fuel tank cap because the vent hole on the top of fuel tank cap can be blocked and the engine could misfire.

Unscrew counterclockwise and remove cap to allow fuel tank filling then fully tighten clockwise.

## **WARNING**

Always stop engine before refueling. Open cap slowly. If a differential pressure condition is noticed (whistling sound heard when loosening fuel tank cap) have vehicle inspected and/or repaired before further operation. Fuel is flammable and explosive under certain conditions. Never use an open flame to check fuel level. Never smoke or allow flame or spark in vicinity. Always work in a well-ventilated area. Never top up the fuel tank before placing the vehicle in a warm area. As temperature increases, fuel expands and may overflow. Always wipe off any fuel spillage from the vehicle.

### **11) Brake Pedal**

When pressed down, the rear brake is applied. When released, the brake pedal should return to its original position. Braking effect is proportional to the force applied on the pedal and to the type and condition of the terrain.

**NOTE:** The brake will have also an effect on front wheels through the drive train.

The brake pedal applies the rear brake only. Should the front brakes system fail, the rear brake can be activated by depressing the brake pedal.

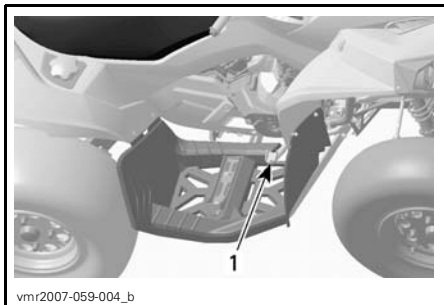

1. Brake pedal

### **12) Footpeg**

Use this area to keep your feet stable.

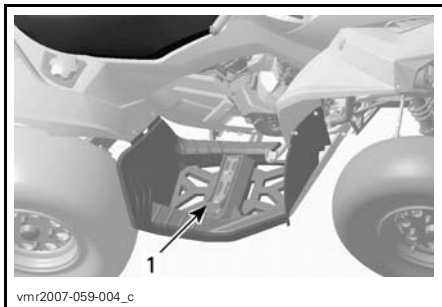

1. Footpeg

### **13) Central Panel**

Remove seat.

Lift the front part of the central panel.

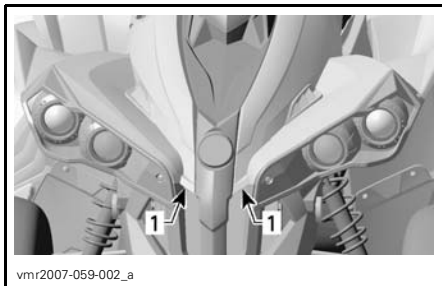

1. Lift here

Come off the plastic studs from the grommets.



Remove central panel.

This panel allows an easier access to the service compartment. The service compartment contains different maintenance items like rear brake fluid reservoir, radiator cap, coolant reservoir and fuse holders.

## 14) Rear Storage Compartment

Convenient location to carry personal articles such as a tool kit, Operator's Guide, spare spark plugs, first aid kit, etc. Stretch and unhook latches to open storage compartment cover.

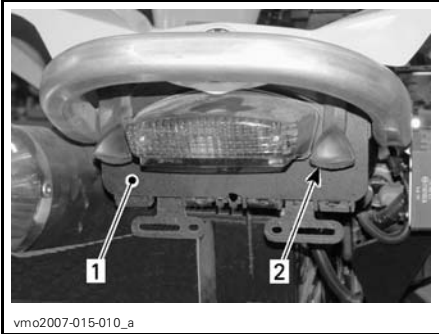

1. Rear storage compartment cover
2. Latch

### **WARNING**

When engine is running, always engage the PARK position on the transmission lever before opening cover. Never leave any heavy or loose breakable objects in the storage compartment. Always latch cover before riding.

## 15) Seat Latch

It allows the removal of seat to give access to engine compartment.

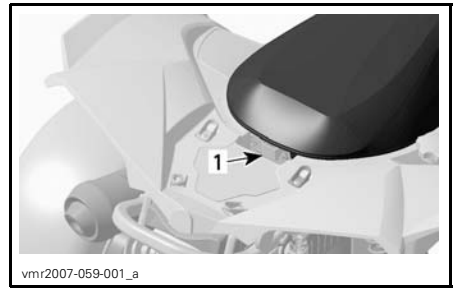

1. Seat latch

### **Seat Removal**

Push latch forward while gently lifting rear of seat. Pull seat rearward. Continue lifting movement until you can release the front retaining device then completely remove seat.

### **Seat Installation**

Insert front tabs of seat into frame hook. When seat rests in its position, firmly push seat down to latch.

**NOTE:** A distinctive snap will be felt. Double check that the seat is secure by giving it a tug to confirm proper latching.

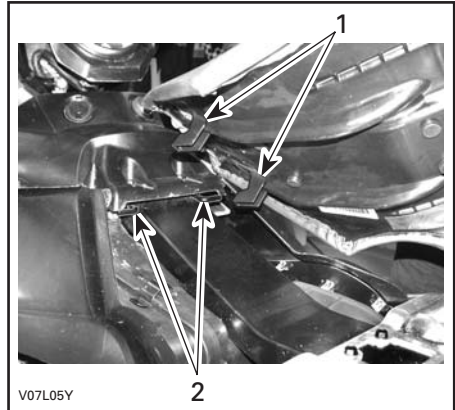

1. Insert these tabs in hooks
2. Hooks

### **WARNING**

Make sure seat is securely latched before riding.

## 16) Rear Cargo Area

Convenient location to carry small articles.

Secure articles to rear fender by using the plastic eyelets provided.

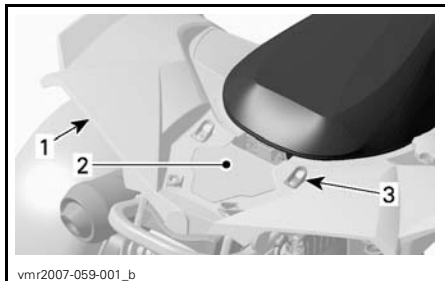

- vmr2007-059-001\_b
1. Rear fender
  2. Cargo area
  3. Plastic eyelets

**CAUTION:** MAXIMUM load for cargo area is 16 kg (35 lb).

### WARNING

Ensure to properly secure articles to rear fender. Do not overload. Ensure load does not interfere with visibility. Do not carry passenger(s).

Refer to *SPECIFICATIONS* for carrying loads and cargo weight distribution recommendations.

## 17) Recovery Hook

Convenient hook that can be use to recover a stuck ATV.

## 18) Radiator Cap

Located in service compartment, under central panel.

### WARNING

In order to avoid getting burned, do not remove the radiator cap when the engine is hot.

To remove the radiator cap, press and turn it counterclockwise. Reverse the removal procedure to install.

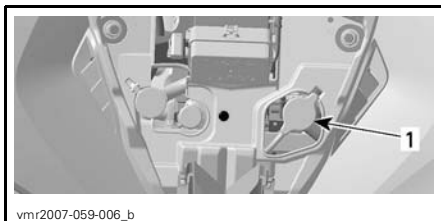

vmr2007-059-006\_b  
**TYPICAL**  
1. Radiator cap

## 19) Fuses

The electrical system is protected with fuses. Refer to *MAINTENANCE* for details.

The fuse holders are located in the front service compartment and at the back near battery.



vmr2006-007-012\_a  
**TYPICAL — FRONT FUSES LOCATION**

1. (F1) Ignition coils (5 A)
2. (F2) Fan (20 A)
3. (F3) Fuel injectors (5 A)
4. (F4) Speedometer/speed sensor/tail lamp (7.5 A)
5. (F5) Fuel pump (7.5 A)
6. (F6) Engine Control Module (ECM) (5 A)
7. (F7) Accessories (20 A)



**TYPICAL — REAR FUSES LOCATION**

1. (F8) Main (30 A)
- (F9) Main accessories (30 A)

## 20) Tool Kit

The tool kit is located in the rear storage compartment. It contains tools for basic maintenance and this Operator's Guide.

The tools included in the tool kit are:

- pliers (1)
- screwdriver (1)
- open wrench 10/13 mm (1)
- open wrench 15/17 mm (1)
- socket wrench 10/13 mm (1)
- socket wrench 16/18 mm (1)
- tire pressure gauge (1)
- shock absorber key (1)
- fuse 30 A (1)
- fuse 20 A (1)
- fuse 15 A (1).

## 21) Dipstick

Allow to check the oil level in the engine.

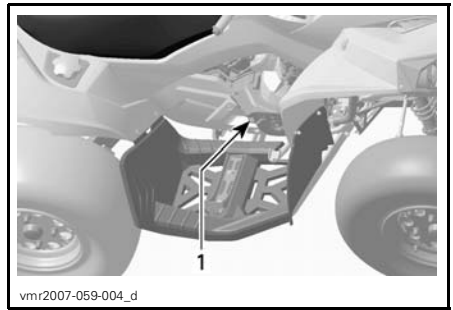

1. Dipstick

Refer to *LIQUID* to check the engine oil level correctly.

## 22) Brake Lever Fluid Reservoir

Located above front brake lever on the handlebar.

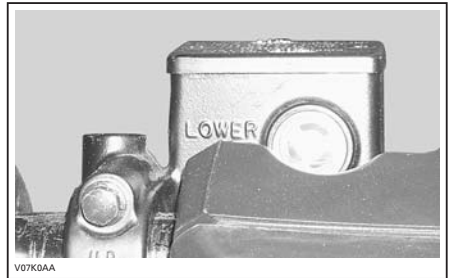

*TYPICAL*

## 23) Brake Pedal Fluid Reservoir

Located in service compartment underneath central panel.

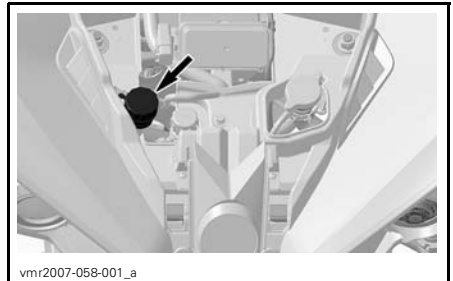

## 24) Engine Coolant Reservoir

Located in service compartment underneath central panel.

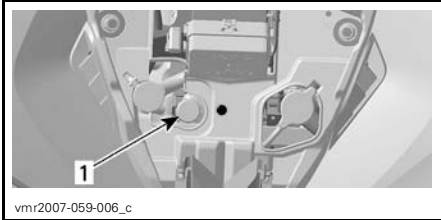

1. Coolant reservoir



# LIQUIDS

While reading this Operator's Guide, remember that:

## WARNING

Indicates a potential hazard that, if not avoided, could result in serious injury or death.

**NOTE:** This section specifies the recommended liquids and procedures to check their levels. Refer to *MAINTENANCE* for procedures to replace the liquids.

## Fuel

### Recommended Fuel

Use regular unleaded gasoline, available from most service stations or oxygenated fuel containing a maximum total of 10% of ethanol or methanol or both. The gasoline used must have the following recommended minimum octane number.

OCTANE NUMBER	
Inside North America	(87 (R + M)/2)
Outside North America	92 RON

**CAUTION:** Never experiment with other fuels. The use of unrecommended fuel can result in vehicle performance deterioration and damage to critical parts in the fuel system and engine components.

## Fuel Level

### WARNING

Always stop engine before refueling. Open cap slowly. If a differential pressure condition is noticed (whistling sound heard when loosening fuel tank cap) have vehicle inspected and/or repaired before further operation. Fuel is flammable and explosive under certain conditions. Never use an open flame to check fuel level. Never smoke or allow flame or spark in vicinity. Always work in a well-ventilated area. Never top up the fuel tank before placing the vehicle in a warm area. As temperature increases, fuel expands and may overflow. Always wipe off any fuel or oil spillage from the vehicle.

## Engine Oil

### Recommended Oil

Use 4-stroke mineral-based engine oil that meets or exceeds the requirements for API service classification SM, SL or SJ. Always check the API service label certification on the oil container, it must contain at least one of the above standards.

## Oil Viscosity

SAE 5W30 mineral-based oil is recommended for all seasons.

However, during the hottest days of the summer the BRP XP-S 10W40 mineral oil (P/N 219 700 346) can be used.

**NOTE:** For improved overall performance and all season applications, use XP-S 5W40 synthetic oil (P/N 293 600 039).

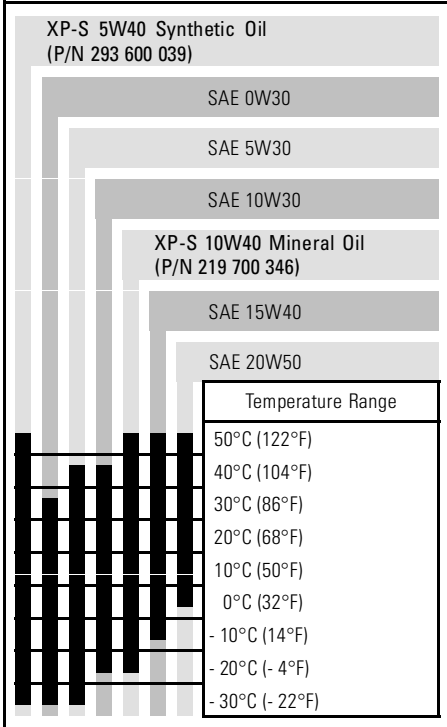

## Oil Level

**CAUTION:** Check level frequently and refill if necessary. **Do not overfill.** Operating the engine with an improper level may severely damage engine. Wipe off any spillage.

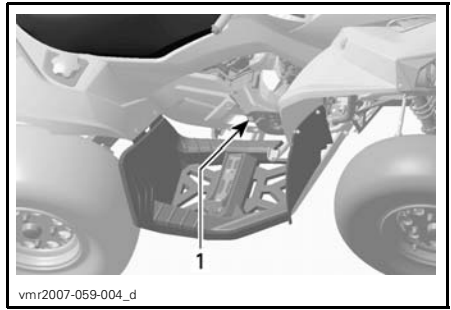

**RH SIDE OF ENGINE**

1. Dipstick

With vehicle on a level surface and engine cold, not running, check the oil level as follows:

1. Unscrew dipstick then remove it and wipe clean.
2. Reinstall dipstick, screw in it completely.
3. Remove and check oil level. It should be near or equal to the upper mark.

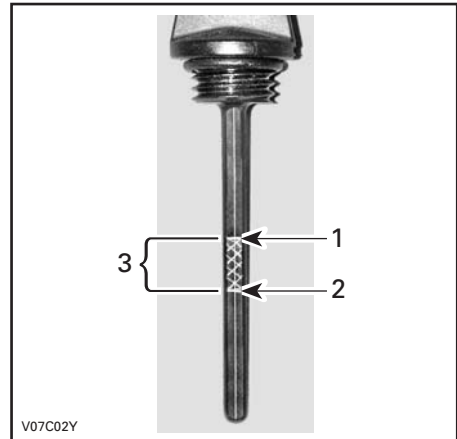

**TYPICAL**

1. Full
2. Add
3. Operating range

To add oil, remove the dipstick. Place a funnel into the dipstick tube to avoid spillage.

Add a small amount of recommended oil and recheck oil level.

Repeat the above procedures until oil level reaches the dipstick's upper mark. **Do not overfill.**

Properly tighten dipstick.

## Gearbox Oil

### Recommended Oil

Use XP-S chaincase oil (P/N 413 801 900) or an equivalent.

**CAUTION:** Do not use unrecommended other types of oil when servicing. Do not mix with other types of oil.

### Gearbox Oil Level

**CAUTION:** Check level and refill if necessary. **Do not overfill.** Operating the gearbox with an improper level may severely damage gearbox. Wipe off any spillage.

Place the vehicle on a level surface. Select NEUTRAL position then apply parking brake.

Check the gearbox oil level by removing the gearbox oil level plug.

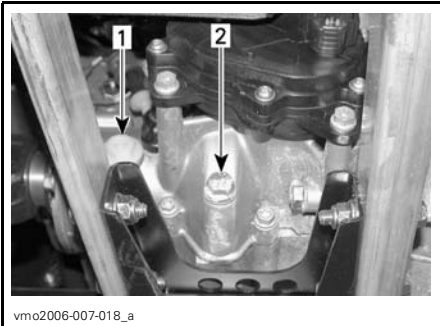

1. Oil level plug
2. Oil drain plug

The oil should be level with the bottom of the oil level hole. Refill as required until gearbox oil level flows through oil level hole.

To change gearbox oil, refer to *MAINTENANCE* section.

## Engine Coolant

### Recommended Coolant

Always use ethylene-glycol antifreeze containing corrosion inhibitors specifically for internal combustion aluminum engines.

Cooling system must be filled with BRP premixed coolant (P/N 219 700 362) or with distilled water and antifreeze solution (50% distilled water, 50% antifreeze).

### Coolant Level

#### **WARNING**

Check coolant level with engine cold. Never add coolant in cooling system when engine is hot.

Remove access panel.

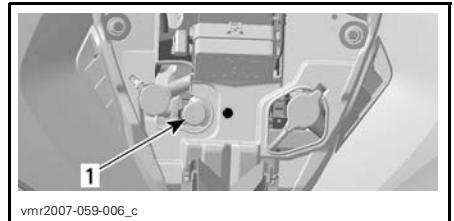

1. Coolant reservoir

With vehicle on a level surface, liquid should be between MIN. and MAX. level marks of coolant reservoir.

**NOTE:** When checking level at temperature lower than 20°C (68°F), it may be slightly lower than MIN. mark.

Add coolant up to MAX. mark if required. Use a funnel to avoid spillage. **Do not overfill.**

Properly reinstall and tighten filler cap and reinstall access panel.

If the coolant is added in the coolant reservoir, check the level in the radiator too. Add coolant if necessary.

## **⚠ WARNING**

In order to avoid getting burned, do not remove the radiator cap if the engine is hot.

**NOTE:** A cooling system that frequently requires coolant is the indication of leaks or engine problems. See an authorized Can-Am dealer.

### **Coolant Replacement**

Refer to *MAINTENANCE* section.

### **Brake Fluid**

#### **Recommended Fluid**

Always use brake fluid meeting the specification DOT 4 only.

**CAUTION:** To avoid serious damage to the braking system, do not use fluids other than the recommended one, nor mix different fluids for topping up.

#### **Fluid Level**

With vehicle on a level surface, check brake fluid in reservoirs for proper level. They should be above MIN. mark.

Add fluid as required. **Do not overfill.**

Clean filler cap before removing.

**CAUTION:** Use only DOT 4 brake fluid from a sealed container. Do not use brake fluid taken from old or already opened containers.

**NOTE:** A low level may indicate leaks or worn brake pads. See an authorized Can-Am dealer.

### **Brake Lever Fluid Reservoir**

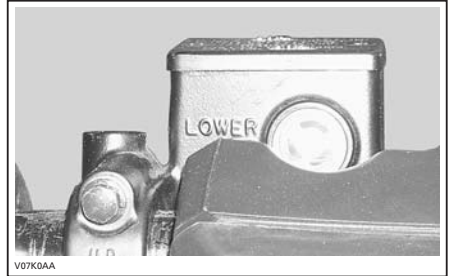

Turn steering in the straight-ahead position to ensure reservoir is level. Check the brake fluid level, the reservoir is full when the fluid reaches of the top of window.

Visually inspect lever boot condition. Check for cracks, tears, etc. Replace if damaged.

### **Brake Pedal Fluid Reservoir**



### **Battery**

This vehicle is equipped with a dry type battery that requires no maintenance.

Refer to *MAINTENANCE* for removal/installation instructions.

---

# OPERATING INSTRUCTIONS

## General

The transmission lever must be on PARK or NEUTRAL to allow engine to start.

**NOTE:** For your convenience, an override mode allows the engine to be started with the transmission lever in any position. Press and hold the brake lever or the brake pedal while pressing the engine start button.

To start the engine, place the engine stop switch to RUN, insert the key in the ignition switch and turn to ON position, then press the engine start button.

## Pre-Operation Check

### **WARNING**

The pre-operation check is very important prior to operating the vehicle. Always check the proper operation of critical controls, safety features and mechanical components before starting. If not done as specified here, severe injury or death might occur.

Before using this vehicle, the operator should always:

- Apply parking brake and check if it operates properly.
- Check tire pressure and condition.
- Check wheels and bearings for wear and damage.
- Check location of controls and ensure they work properly.
- Verify if steering operates freely.
- Activate throttle control lever several times to ensure it operates freely. It must return to idle position when released.

- Activate the brake lever and brake pedal to make sure the brakes fully apply. Lever and pedal must fully return when released.
- Ensure transmission lever is working then reset in PARK position.
- Check fuel, oil and coolant levels.
- Check for oil leaks on the engine/transmission and drive train components.
- Clean headlamps and taillight.
- Ensure front central panel and rear storage compartment cover are properly latched.
- Ensure seat is properly latched.
- If you transport cargo, respect load capacity. Ensure cargo is properly secured to the cargo area eyelets.
- Look and feel for loose parts while engine is off. Check fasteners.
- Ensure the path of travel is free of persons and obstacles.
- Check operation of ignition switch, engine start button, engine stop switch, headlamps, taillight and indicator lights.
- Start engine, remove parking brake and drive forward slowly a few feet and apply all brakes individually to test them.
- Check operation of 2WD/4WD selector.

**Correct any problem you may have found before riding. See an authorized Can-Am dealer as necessary.**

## Starting the Engine

Insert key in ignition switch and turn to ON position.

Place the engine stop switch to RUN.

Press the engine start button and hold until the engine starts.

**CAUTION:** Do not hold the engine start button more than 30 seconds. A rest period should be observed between the cranking cycles to let the starter cool down. Pay attention not to discharge the battery.

Release the engine start button immediately when the engine has started.

**NOTE:** If the battery is dead, engine cannot be started. Have the battery recharged or replaced.

## Shifting the Transmission

Let engine idle to warm up.

Apply brakes and select the desired gear range H or L.

**NOTE:** The brake must be applied when the transmission lever is engaged in the park position.

Release brakes.

**CAUTION:** Make sure parking brake is fully disengaged before operating the vehicle.

Gradually press the throttle lever to increase engine speed and thus engaging the continuously variable transmission (CVT).

At the opposite, when the throttle lever is released, the engine speed decreases.

## Using the Reverse

**CAUTION:** When changing from forward to reverse, or vice-versa, always completely stop the vehicle and apply the brake prior to moving the transmission lever.

The same procedures as *SHIFTING THE TRANSMISSION* above apply except for the following.

Set the transmission lever in REVERSE position.

## 2WD/4WD Selector

The 4WD mode may be selected or deselected when the vehicle is stopped.

**CAUTION:** The vehicle must be stopped to engage or disengage 2WD/4WD selector. Mechanical damage may occur if selector is engaged or disengaged while driving.

**CAUTION:** If the rear wheels are spinning, release the throttle and wait engine return to the idle before selecting the 4WD mode.

While reading this Operator's Guide, remember that:

### **WARNING**

Indicates a potential hazard that, if not avoided, could result in serious injury or death.

The 4WD mode is engaged when the selector is pushed downwards.



*4WD MODE*

To deselect the 4WD mode, press the selector on 2WD.



*2WD MODE*

When the selector is located on the 2WD, the vehicle is in 2 wheel drive at all time.

## Stopping the Engine

### **WARNING**

Avoid parking on slope.

Release throttle and completely stop the vehicle.

Apply the parking brake.

Set transmission lever in PARK position.

Push the engine stop switch in OFF position.

Turn key in ignition switch to OFF position.

Remove key from ignition switch.

## Post-Operation Care

When vehicle is used in salt-water environment (beach area, launching/loading boats etc.), rinsing the vehicle with fresh water is necessary to preserve vehicle and its components. Metallic parts lubrication is highly recommended. Use XP-S Lube (P/N 293 600 016) or an equivalent. This must be performed at the end of each operating day.

When vehicle is operated in muddy conditions, rinsing the vehicle is recommended to preserve vehicle and its components and to keep lights clean.

**NOTE:** Never use a high pressure washer to clean the vehicle. **USE LOW PRESSURE ONLY (like a garden hose).** High pressure can cause electrical or mechanical damages.

---

# SPECIAL PROCEDURES

## Turn Over

When vehicle is turned over or stays tilted on the side, replace the vehicle in its normal operating position (on all four wheels) and wait 3 to 5 minutes before starting engine.

Before starting engine, check engine oil level and refill if necessary. If the oil pressure light stays ON after starting engine, stop engine and see an authorized Can-Am dealer as soon as possible.

## Vehicle Immersion

Should the vehicle become immersed, it will be necessary to take it to an authorized Can-Am dealer as soon as possible. **DO NOT START THE ENGINE!**

**CAUTION:** Immersion of the vehicle can cause serious damage if the correct restart procedure is not followed.



# CARGO AND TRANSPORTATION

While reading this Operator's Guide, remember that:

## WARNING

Indicates a potential hazard that, if not avoided, could result in serious injury or death.

### Cargo

#### WARNING

The vehicle handling, stability and braking distance are affected when loading the rear cargo area and using the vehicle. Correct loading and weight distribution are therefore important. Never overload, tow or carry cargo improperly. Always ensure the cargo is safely secured and properly distributed on the rear cargo area before operating the vehicle. Safely reduce speed according to terrain conditions when carrying cargo or pulling any equipment. Allow greater distance for breaking. Always secure cargo as low as possible on the rear cargo area to reduce the effect of a higher center of gravity. Failure to follow the recommendations here could cause changes in vehicle handling which could lead to an accident resulting in severe injuries including the possibility of death.

When transporting cargo on the vehicle, respect these maximum loads.

MAXIMUM LOADS		
Total load allowed	141 kg (310 lb)	Includes driver, all other loads and added accessories.
Rear cargo area	16 kg (35 lb)	Evenly distributed.

### Transportation

When transporting a vehicle, secure vehicle to trailer or in pickup box with suitable tie-downs. Using ordinary ropes is not recommended.

#### WARNING

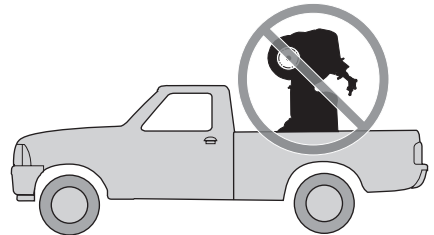

V000A174

Never tip this vehicle on end for transporting. We recommend that you carry the vehicle in its normal operating position (on all four wheels).

Select the PARK position and set the parking brake.

Secure the vehicle by the front bumper and rear bumper.

**CAUTION:** Attaching vehicle at other locations may damage the vehicle.

Unload rear cargo area before transporting the vehicle.

## Front Location

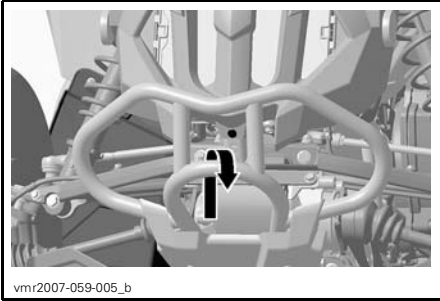

## Rear Location

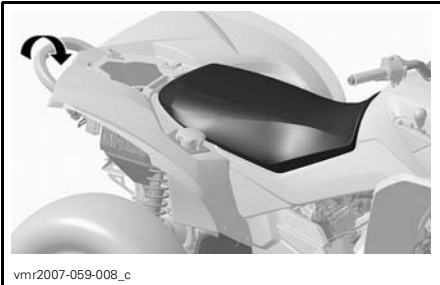

### **WARNING**

Do not tow this vehicle behind a car or other vehicle. Use a trailer.

---

# TROUBLESHOOTING

---

## ENGINE DOES NOT TURN

---

### 1. Ignition switch is in the OFF position.

- Place switch to the ON position.

### 2. Engine stop switch.

- Make sure that engine stop switch is in ON position.

### 3. Transmission is not set on PARK or NEUTRAL.

- Set transmission either in PARK or in NEUTRAL or press the brake lever.

### 4. Burnt fuse.

- Check main fuse condition.

### 5. Weak battery or loose connections.

- Check charging system fuse.
- Check connections and terminals condition.
- Have the battery checked.
- Contact an authorized Can-Am dealer.

### 6. Wrong ignition key, speedometer multifunction display shows INVALID KEY.

- Use the proper key for this vehicle.

---

## ENGINE TURNS OVER BUT FAILS TO START

---

### 1. Flooded engine (spark plug wet when removed).

- (Drowned mode) If the engine does not start and it is fuel-flooded, this special mode can be activated to prevent fuel injection and to cut ignition while cranking. Proceed as follows:

- Insert key in ignition switch and turn to ON position.
- Press completely and HOLD throttle lever.
- Press the engine START button.

The engine should be cranked for 20 seconds. Release engine START button.

Release throttle lever and start/crank engine again to allow starting.

#### **If it does not work:**

- Clean the spark plug caps area then remove them.
- Remove the spark plugs (tools are supplied in tool kit).
- Crank engine several times.
- Install new spark plugs if possible or clean and dry spark plugs.
- Start engine as explained above.

If engine continues to flood, see an authorized Can-Am dealer.

**NOTE:** Make sure to verify that there is no fuel in engine oil, if so, replace engine oil.

### 2. No fuel to the engine (spark plug dry when removed).

- Check fuel tank level.
- A failure of the fuel pump may have occurred.
- Contact an authorized Can-Am dealer.

## **ENGINE TURNS OVER BUT FAILS TO START (cont'd)**

---

### **3. Spark plug/ignition (no spark).**

- Check main fuse condition.
- Remove spark plug then reconnect to ignition coil.
- Check that ignition switch and/or engine stop switch is/are at the ON position.
- Start engine with spark plug grounded to the engine away from spark plug hole. If no spark appears, replace spark plug.
- If trouble persists, contact an authorized Can-Am dealer.

### **4. Speedometer CHECK ENGINE indicator lamp is on and multifunction display shows CHECK ENGINE.**

- Contact an authorized Can-Am dealer.

### **5. Engine is under a protection mode.**

- Speedometer CHECK ENGINE indicator lamp is on and multifunction display shows CHECK ENGINE, contact an authorized Can-Am dealer.

## **ENGINE LACKS ACCELERATION OR POWER**

---

### **1. Fouled or damaged spark plug.**

- Check item ENGINE TURNS OVER BUT FAILS TO START.

### **2. Lack of fuel to engine.**

- Check item ENGINE TURNS OVER BUT FAILS TO START.

### **3. Engine is overheating.**

- CHECK ENGINE indicator light will turn on and HI TEMP will appear in the multifunction display.

Try the following:

- Check and clean radiator fins. See MAINTENANCE section.
- Reduce vehicle speed but try to keep vehicle moving to supply air to radiator. If engine is still overheating after approximately one minute, stop vehicle and set transmission to PARK. Stop engine.
- Place the ignition switch to ON position (**DO NOT RESTART ENGINE YET**). The radiator fan will cool the radiator.
- Let engine cool down. Check coolant level and refill if possible. See ENGINE COOLANT.

See an authorized Can-Am dealer as soon as possible.

- If overheating persists, contact an authorized Can-Am dealer.

### **4. Air filter/housing plugged or dirty.**

- Check air filter and clean if necessary.
- Check deposits in air filter housing drain.
- Check the position of the air intake tube.

### **5. CVT dirty or worn-out.**

- Contact an authorized Can-Am dealer.

## **ENGINE LACKS ACCELERATION OR POWER (cont'd)**

---

### **6. Engine is under a protection mode.**

- *Ckeck speedometer multifunction display for messages.*
- *Speedometer CHECK ENGINE indicator lamp is on and multifunction display shows CHECK ENGINE or LIMP HOME, contact an authorized Can-Am dealer.*

## **ENGINE BACKFIRE**

---

### **1. Exhaust system leakage.**

- *Contact an authorized Can-Am dealer.*

### **2. Engine is running too hot.**

- *See ENGINE LACKS ACCELERATION OR POWER.*

### **3. Ignition timing is incorrect or there is an ignition system failure.**

- *Contact an authorized Can-Am dealer.*

## **ENGINE MISFIRE**

---

### **1. Fouled/damaged/worn spark plug.**

- *Clean/verify spark plug and heat range. Replace as required.*

### **2. Water in fuel.**

- *Drain fuel system and refill with fresh fuel.*

## **VEHICLE CANNOT REACH FULL SPEED**

---

### **1. Engine.**

- *See ENGINE LACKS ACCELERATION OR POWER.*

### **2. Parking brake.**

- *Ensure parking brake is completely removed.*

### **3. Air filter/housing plugged or dirty.**

- *Check air filter and clean if necessary.*
- *Check deposits in air filter housing drain.*
- *Check the position of the air intake tube.*

### **4. CVT dirty or worn-out.**

- *Contact an authorized Can-Am dealer.*

### **5. Engine is under a protection mode.**

- *Ckeck speedometer multifunction display for messages.*
- *Speedometer CHECK ENGINE indicator lamp is on and multifunction display shows CHECK ENGINE or LIMP HOME, contact an authorized Can-Am dealer.*

## **TRANSMISSION LEVER IS HARD TO MOVE**

---

- 1. Transmission gears are in a position that prevents the transmission lever to work.**
  - *Rock the vehicle back and forth to move the gears in the transmission and allow the transmission lever to be set.*
- 2. CVT dirty or worn-out.**
  - *Contact an authorized Can-Am dealer.*

## **THE RPM INCREASES BUT THE VEHICLE DOES NOT MOVE**

---

- 1. The transmission is on PARK or NEUTRAL position.**
  - *Select the R, HI or LO position.*
- 2. CVT dirty or worn-out.**
  - *Contact an authorized Can-Am dealer.*
- 3. Water in the CVT housing.**
  - *Contact an authorized Can-Am dealer.*

# SPECIFICATIONS

VEHICLE MODEL		RENEGADE
<b>ENGINE</b>		
Type	4-stroke, V-twin, liquid cooled, 4-valves SOHC	
Number of cylinder	2	
Number of valves	8 valves with mechanical lifters (adjustable)	
Displacement	800 cc (48.82 cu. in)	
Bore	91 mm (3.58 in)	
Stroke	61.5 mm (2.42 in)	
Compression ratio	10.3:1	
Lubrication	Wet sump with replaceable oil filter	
Exhaust system	Spark arrestor approved by USDA Forest Service	
Air filter	Synthetic paper filter with foam	
<b>TRANSMISSION</b>		
Transmission	Continuously Variable Transmission (CVT), sub-transmission with high, low, park, neutral and reverse	
<b>COOLING</b>		
Type	Liquid cooled	
Radiator	Front mounted with thermostatic fan	
<b>FUEL SYSTEM</b>		
Type	Electronic fuel injection with a single throttle body (46 mm) and 1 injector per cylinder	
Idle speed	± 50	1250 RPM (not adjustable)
Fuel pump	Make	Bosch
	Type	Electrical (in fuel tank)
<b>ELECTRICAL</b>		
Magneto generator	Make	Denso
	Type	400 W @ 6000 RPM
Ignition type	IDI (Inductive Digital Ignition)	
Ignition timing	Not adjustable	
Engine RPM limiter	Forward RPM	8000
	Reverse RPM	3200

VEHICLE MODEL		RENEGADE
<b>ELECTRICAL (cont'd)</b>		
Spark plug	Make	NGK
	Type	DCPR8E
	Gap	0.6 to 0.7 mm (.024 to .027 in)
Number of spark plug		2
Battery	Type	Dry type battery
	Volt	12 volts, 18 A•h
Starting system		Electric start. Start on P, R, N, H or L position (with brake applied)
Headlamp bulb		4 x 60 W
Taillight bulb		8/26 W
Fuse	(F1) Ignition coils	5 A
	(F2) Fan	20 A
	(F3) Fuel injectors	5 A
	(F4) Speedometer/ speed sensor/ tail lamp	7.5 A
	(F5) Fuel pump	7.5 A
	(F6) Engine control module (ECM)	5 A
	(F7) Accessories	20 A
	(F8) Main	30 A
	(F9) Main accessories	30 A
<b>DRIVE TRAIN</b>		
Front differential		Shaft driven/single auto-lock differential (shear pump)
Rear axle		Shaft driven/single differential
Turning radius		2.16 m (7 ft)
<b>SUSPENSION</b>		
Front	Type	Double A-arm
	Travel	229 mm (9 in)
Rear	Type	TTI™ Independent
	Travel	254 mm (10 in)



VEHICLE MODEL			RENEGADE
<b>TIRES</b>			
Make/Type			Carlisle Hole Shot ATR/Radial
Pressure	Up to 141 kg (310 lb)	Front	34.5 kPa (5 PSI) maximum 31 kPa (4.5 PSI) minimum
		Rear	34.5 kPa (5 PSI) maximum 31 kPa (4.5 PSI) minimum
Size	Front		25 x 8 x 12
	Rear		25 x 10 x 12
<b>WHEELS</b>			
Size	Front		12 x 6
	Rear		12 x 7.5
Wheel nuts torque			100 N•m (74 lbf•ft)
<b>BRAKES</b>			
Front			Hydraulic, 2 discs
Rear			Hydraulic, 1 disc
Parking device			Park through transmission. LH brake lever includes a parking brake
<b>LOADING CAPACITY</b>			
Rear cargo area			16 kg (35 lb)
Total vehicle load allowed (includes operator, all other loads and added accessories)			141 kg (310 lb)
GVWR (Gross Vehicle Weight Rating)			476 kg (1050 lb)
Towing capacity			591 kg (1300 lb)
<b>DIMENSIONS</b>			
Dry weight			270 kg (597 lb)
Overall length			2.18 m (86 in)
Overall width			1.17 m (46 in)
Overall height			1.14 m (45 in)
Seat height			877 mm (34.5 in)
Wheel base			1.30 m (51 in)
Wheel track	Front		965 mm (38 in)
	Rear		914 mm (36 in)
Ground clearance			279 mm (11 in)
Weight distribution (front/rear)			51/49%

VEHICLE MODEL		RENEGADE
<b>LIQUIDS AND GREASES</b>		
Engine oil type		SAE 5W30 API classification SM, SL or SJ. Refer to <i>OIL VISCOSITY CHART</i>
Gearbox oil type		XP-S synthetic chaincase oil
Coolant		Ethylene-glycol/water mix (50% coolant, 50% distilled water). Use BRP premixed coolant or a coolant specially designed for aluminum engines
Fuel	Type	Regular unleaded gasoline
	Octane	Inside North America: (87 (R + M)/2) or higher Outside North America: 92 RON
Differential	Front	BRP differential oil (P/N 293 600 043) or Synthetic oil 75W90 (API GL5)
	Rear	
Brake		Brake fluid, DOT 4
Propeller shaft joint grease		Suspension synthetic grease (P/N 293 550 033)
<b>CAPACITIES</b>		
Fuel tank		20 L (5.3 U.S. gal)
Engine		Oil change with filter: 2 L (2.1 U.S. quarts)
Gearbox oil		400 mL (14 U.S. oz)
Coolant		2.2 L (2.32 U.S. quarts)
Differential	Front	500 mL (17 U.S. oz)
	Rear	250 mL (8.5 U.S. oz)
Brake fluid		250 mL (8.5 U.S. oz)

A: Ampere  
RPM: Revolution Per Minute  
USDA: United States Department of Agriculture  
A•h: Ampere hour  
W: Watt

Because of our ongoing commitment to product quality and innovation, BRP reserves the right, at any time, to make changes in design and specifications and/or to make additions to, or improvements in its products without imposing any obligation upon itself to install them on its products previously manufactured.

# ***MAINTENANCE INFORMATION***

# MAINTENANCE CHART

The maintenance is very important, if you are not familiar with safe service practices and adjustment procedures, see your authorized Can-Am dealer.

PERIODIC MAINTENANCE CHART							
<b>A: ADJUST</b> <b>C: CLEAN</b> <b>I: INSPECT</b> <b>L: LUBRICATE</b> <b>R: REPLACE</b>	<b>INITIAL INSPECTION 10 H OR 30 DAYS OR 300 km (185 mi)</b> (To be performed by an authorized Can-Am dealer. The initial maintenance is very important and must not be neglected.)						
	<b>25 H OR 750 km (470 mi)</b>						
	<b>50 H OR 1500 km (930 mi)</b>						
	<b>100 H OR 1 YEAR OR 3000 km (1865 mi)</b>						
	<b>200 H OR 2 YEARS OR 6000 km (3730 mi)</b>						
	<b>TO BE PERFORMED BY</b>						
PART/TASK						LEGEND	
<b>ENGINE</b>							
Engine oil level <sup>(2)</sup>	EVERY RIDE					Customer	(2) Pre-ride inspection item. (3) Every 100 hours, check coolant strength. (4) More often under severe use such dusty area, sand, snow, wet or muddy conditions.
Engine oil and filter	R			R		Customer	
Valve adjustment	I, A			I, A		Dealer	
Engine mounting fasteners	I			I		Dealer	
Air filter <sup>(2)</sup>		C <sup>(4)</sup>	R <sup>(4)</sup>			Customer	
Exhaust system	I			I		Dealer	
Spark arrester				C		Customer	
Condition of engine seals	I			I		Dealer	
Coolant <sup>(2)</sup>	I			I <sup>(3)</sup>	R	Customer	
Cooling system pressure test	I				I	Dealer	
Radiator condition/cleanliness (radiating fins) <sup>(4)</sup>	I		I			Customer	
<b>ENGINE MANAGEMENT SYSTEM</b>							
Sensors <sup>(1)</sup>	I			I		Dealer	(1) Emission-related component.
Fault code reading <sup>(1)</sup>	I			I		Dealer	

## PERIODIC MAINTENANCE CHART

A: ADJUST  
C: CLEAN  
I: INSPECT  
L: LUBRICATE  
R: REPLACE

INITIAL INSPECTION 10 H OR 30 DAYS OR 300 km (185 mi)  
(To be performed by an authorized Can-Am dealer. The initial maintenance is very important and must not be neglected.)

25 H OR 750 km (470 mi)

50 H OR 1500 km (930 mi)

100 H OR 1 YEAR OR 3000 km (1865 mi)

200 H OR 2 YEARS OR 6000 km (3730 mi)

TO BE PERFORMED BY

**PART/TASK**

**LEGEND**

### FUEL SYSTEM

Throttle body	I			I,L		Dealer	(1) Emission-related component. (2) Pre-ride inspection item.
Throttle/housing/cable condition <sup>(2)</sup>	I, A		I,A,L			Dealer/ Customer	
Fuel lines, fuel rail, connections, check valves and fuel tank pressure test <sup>(1)</sup>	I				I	Dealer	
In-line fuel filter				R		Dealer	
Fuel pump pressure test					I	Dealer	

### ELECTRICAL

Spark plug <sup>(1) (5)</sup>	I				R	Customer	(1) Emission-related component. (2) Pre-ride inspection item. (5) Make sure the spark plug is correctly gapped.
Battery connections	I		I			Customer	
ECM connectors				I		Dealer	
Electrical connections and fastening (ignition system, starting system, fuel injectors etc.)	I			I		Dealer	
Digitally Encoded Security System (DESS)	I			I		Dealer	
Condition of ignition switch, engine start button and engine stop switch <sup>(2)</sup>	I			I		Customer	
Condition of lighting system (HI/LO intensity, brake lamp, headlamp aiming, etc.) <sup>(2)</sup>	I			I		Customer	

## PERIODIC MAINTENANCE CHART

**INITIAL INSPECTION 10 H OR 30 DAYS OR 300 km (185 mi)**

(To be performed by an authorized Can-Am dealer. The initial maintenance is very important and must not be neglected.)

**25 H OR 750 km (470 mi)**

**50 H OR 1500 km (930 mi)**

**100 H OR 1 YEAR OR 3000 km (1865 mi)**

**200 H OR 2 YEARS OR 6000 km (3730 mi)**

TO BE PERFORMED BY

A: ADJUST  
C: CLEAN  
I: INSPECT  
L: LUBRICATE  
R: REPLACE

**PART/TASK**

**LEGEND**

### TRANSMISSION

Drive belt				I		Dealer	(4) More often under severe use such dusty area, sand, snow, wet or muddy conditions.
Drive and driven pulleys				I,C		Dealer	
One-way bearing inside CVT				I,L		Dealer	
CVT air inlet	I			I,C		Dealer	
Gearbox oil <sup>(4)</sup>	R			I	R	Dealer	
Speed sensor				C		Dealer	
4 x 4 coupling unit	I			I		Dealer	

### DRIVE TRAIN

Drive shaft boots and protectors <sup>(2)</sup>	I	I				Customer	(2) Pre-ride inspection item. (4) More often under severe use such dusty area, sand, snow, wet or muddy conditions.
Drive shaft joints				I		Dealer	
Rear propeller shaft joint <sup>(4)</sup>	I			I, L		Dealer	
Wheel bearing condition				I		Customer	
Wheel nuts/studs	I			I		Customer	
Tires pressure and wear <sup>(2)</sup>	EVERY RIDE					Customer	
Front/rear differentials (oil level, seals and vents)	I			I	R	Dealer	

### STEERING SYSTEM

Handlebar fasteners				I		Dealer	(4) More often under severe use such dusty area, sand, snow, wet or muddy conditions.
Steering system (column, bearing, etc.) <sup>(4)</sup>	I			I		Dealer	
Tie rod ends				I		Dealer	
Front wheels alignment	I			I, A		Dealer	

## PERIODIC MAINTENANCE CHART

A: ADJUST  
C: CLEAN  
I: INSPECT  
L: LUBRICATE  
R: REPLACE

INITIAL INSPECTION 10 H OR 30 DAYS OR 300 km (185 mi)

(To be performed by an authorized Can-Am dealer. The initial maintenance is very important and must not be neglected.)

25 H OR 750 km (470 mi)

50 H OR 1500 km (930 mi)

100 H OR 1 YEAR OR 3000 km (1865 mi)

200 H OR 2 YEARS OR 6000 km (3730 mi)

TO BE PERFORMED BY

**PART/TASK**

**LEGEND**

### SUSPENSION

Trailing arms				I		Dealer
Trailing arm bearings					I	Dealer
Shock absorbers			I			Dealer
A-arms			I,L			Customer
Ball joints		I				Dealer

### BRAKES

Brake fluid (front and rear) <sup>(2)</sup>	I	I			R <sup>(6)</sup>	Customer/ Dealer	(2) Pre-ride inspection item. (4) More often under severe use such dusty area, sand, snow, wet or muddy conditions. (6) Brake fluid replacement or any brake system repairs must be performed by an authorized Can-Am dealer.
Brake pads		I <sup>(4)</sup>				Customer	
Brake system (discs, hoses, etc.)				I		Customer	

### BODY/FRAME

Engine compartment	I,C		I,C			Customer	(4) More often under severe use such dusty area, sand, snow, wet or muddy conditions.
Frame				I		Dealer	
Chassis fasteners			I			Customer	
Seat fasteners	EVERY RIDE					Customer	
Vehicle cleaning and protection			C <sup>(4)</sup>			Customer	

## GENERAL

While reading this Operator's Guide, remember that:

### **WARNING**

Indicates a potential hazard that, if not avoided, could result in serious injury or death.

### **WARNING**

Unless otherwise specified, engine should not be running for all maintenance procedures.

Before performing any service or inspection operation on the vehicle, wait until the engine and exhaust have cooled down to avoid potential burns.

### **WARNING**

Should removal of a locking device (e.g. lock tabs, self-locking fasteners, etc.) be required when undergoing disassembly/assembly, always replace with a new one.

The following covers the maintenance items that can be performed by the customer if desired. Other items found in *MAINTENANCE CHART* must be performed by an authorized Can-Am dealer.

**NOTE:** Among other things, this section gives the procedures to replace the liquids. Refer to *LIQUIDS* for procedures to check levels and refill.



# ENGINE

## Oil Change and Oil Filter Replacement

Oil and filter are to be replaced at the same time. Oil change should be done with a warm engine.

### WARNING

The engine oil can be very hot. In order to avoid potential burns, do not remove the engine drain plug or the filter cover if the engine is hot. Wait until engine oil is warm.

- Ensure vehicle is on a level surface.
- Remove dipstick.
- Clean the oil drain plug area.
- Place a drain pan under the oil drain plug area.
- Unscrew oil drain plug.

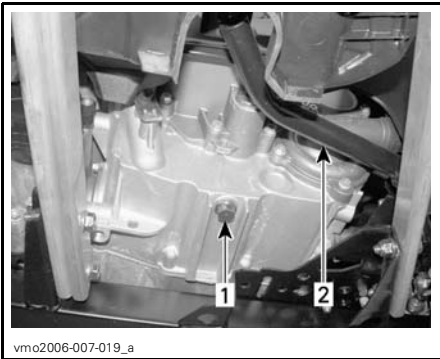

#### TYPICAL

1. Oil drain plug
2. Brake pedal

- Allow enough time for oil to flow out of oil filter.
- Remove the right side panel.
- Unscrew the oil filter cover.



1. Oil filter cover

- Remove the oil filter and replace with a new filter.
- Check the cover O-ring and change it if necessary.
- Screw oil filter cover in place.
- Wipe out any oil spillage on engine.
- Change gasket on oil drain plug. Clean gasket area on engine and oil drain plug then reinstall plug. Refill engine at the proper level with the recommended oil. Refer to *SPECIFICATIONS* for capacity.
- Start engine and let idle for a few minutes. Ensure oil filter area and oil drain plug areas are not leaking.
- Stop engine. Wait a while to allow oil to flow down to crankcase then check oil level. Refill as necessary.
- Dispose of oil as per your local environmental regulations.

## Coolant Replacement

### WARNING

In order to avoid potential burns, do not remove the radiator cap or loosen the coolant drain plug if the engine is hot.

- Open the front access panel and remove the radiator cap.

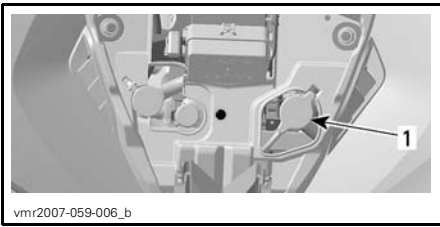

vmr2007-059-006\_b

1. Radiator cap

Unscrew the coolant drain plug and drain the coolant into a suitable container.

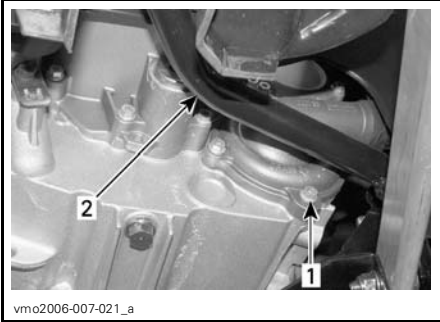

vmo2006-007-021\_a

1. Coolant drain plug  
2. Brake pedal

**NOTE:** Do not unscrew the coolant drain plug completely.

Remove the RH side panel.

Unscrew the bleeding screw on the top of thermostat housing.



vmo2006-007-022\_a

1. Bleeding screw

Drain the system completely and reinstall the coolant drain plug.

Pinch hose between radiator and thermostat housing with a large hose pincher (P/N 529 032 500) or an equivalent.

**CAUTION:** Do not use vise-grip pliers to pinch hose.

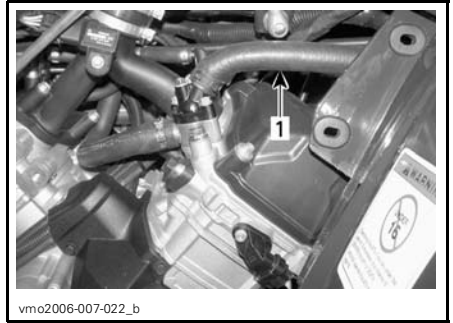

vmo2006-007-022\_b

1. Hose pincher

Fill the radiator until the coolant comes out by the thermostat housing hole. Install the bleeding screw then remove the hose pincher.

Complete the radiator filling.

Check the level in the coolant reservoir and refill if necessary.

Run engine at idle with the radiator cap off. Slowly add coolant if necessary.

At this point, wait until engine reaches normal operating temperature. Depress the throttle lever two or three times; then add coolant if required.

Install radiator cap. Inspect all connections for leaks and check coolant level in the reservoir.

## Air Filter

### Removal

**CAUTION:** Never remove or modify any component in the air filter housing. Otherwise, engine performance degradation or damage can occur. The engine is calibrated to operate specifically with these components.

Remove seat and central panel.

Release clamps and remove air filter box cover.

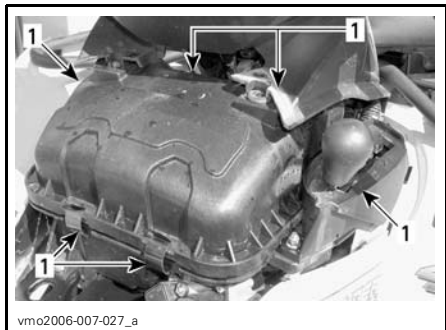

1. Release clamps

Loosen clamp and remove air filter.



1. Clamp  
2. Air filter

## Cleaning

Pour cleaning solution (P/N 219 700 341) or an equivalent into a bucket. Put the filter in to soak.

While filter soaks, clean inside the air filter housing.

Rinse the filter with warm water until all cleaning solution disappears.

Then, let the filter dry completely.

## Installation

Properly reinstall removed parts in the reverse order of their removal.

## Drive Belt

See an authorized Can-Am dealer to check the width and the condition of drive belt.

## CVT Cover Drain Screw

Any time you suspect that water has entered the CVT cover, drain the CVT housing by removing the drain screw.



BEHIND LH FOOTREST

1. Drain screw

## Valve Adjustment

See an authorized Can-Am dealer for valves adjustment.

Insufficient clearance will cause loss of power and possibly damage the valves. Excessive clearance will cause noise.

## Spark Arrester

The muffler must be periodically purged of accumulated carbon.

## **WARNING**

Never run engine in an enclosed area. Never perform this operation immediately after the engine has been run because exhaust system is very hot. Make sure that there are no combustible materials in the area. Wear eye protection and gloves. Never stand behind the vehicle while purging exhaust system. Respect all applicable laws and regulations.

Select a well-ventilated area and make sure the muffler is cool.

Place transmission on PARK position.

Remove the cleanout plug of the muffler.



1. Cleanout plug
2. Muffler

Block the end of the muffler with a shop rag and start engine.

Momentarily increase engine RPM several times to purge accumulated carbon out of the muffler.

Stop engine and allow muffler to cool.

Reinstall the cleanout plug.

## **Radiator**

Periodically check the radiator area for cleanliness.



1. Radiator

Inspect radiating fins. They must be clean, free of mud, dirt, leaves and any other deposit that would prevent the radiator to cool properly.

Remove as much deposits as you can with your hands. If water is available in proximity, try rinsing the radiating fins.

If available, use a garden hose to rinse the radiating fins.

## **WARNING**

Never clean radiator with your hands when it is hot. Let the radiator cool down before cleaning.

**CAUTION:** Be careful not to damage the radiating fins when cleaning. Do not use any object/tool that could damage the fins. The fins are purposely thin parts to allow efficient cooling. **WHEN HOSING, USE LOW PRESSURE ONLY, NEVER USE A HIGH PRESSURE WASHER.**

See an authorized Can-Am dealer to check the performance of the cooling system.

# GEARBOX

## Oil Change

Place the vehicle on a level surface.

Clean drain plug area and oil level plug then remove the gearbox drain plug.

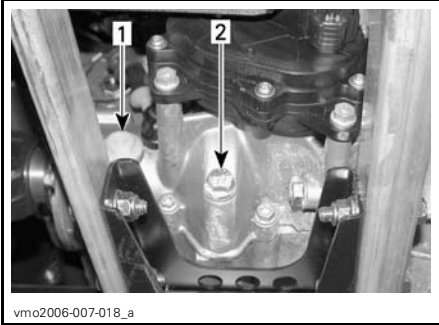

1. Oil level plug
2. Oil drain plug

**NOTE:** To completely drain the gearbox, place a jack under the left footrest and tilt the vehicle toward the right side. When the gearbox is empty, install the drain plug and replace the vehicle on the ground.

Refill gearbox, using XP-S chaincase oil (P/N 413 801 900) or an equivalent.

**CAUTION:** Do not use other unrecommended types of oil when servicing. Do not mix with other types of oil.

The oil should be level with the bottom of the oil level hole. Refill as required until gearbox oil level flows through oil level hole.

Reinstall oil level plug.

# FUEL SYSTEM

## Throttle Cable Lubrication

### Lubrication

The throttle cable must be lubricated with silicone lubricant (P/N 293 600 041) or an equivalent.

### WARNING

Always use a silicone-based lubricant. Using another lubricant (like a water-based lubricant) could cause the throttle lever/cable sticking or stiffness.

Open the throttle lever housing.

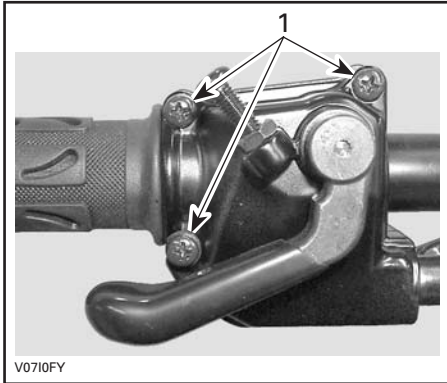

1. Remove these screws

Separate the housing. Slide rubber protector back to expose throttle cable adjuster.

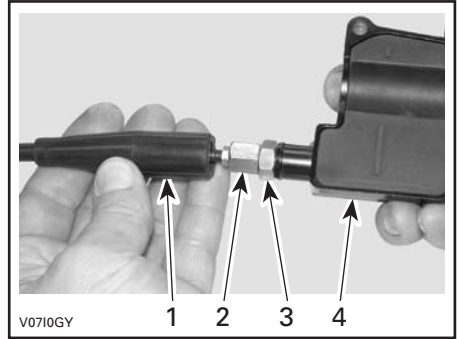

1. Cable protector
2. Throttle cable adjuster
3. Lock nut
4. Throttle lever housing

Screw in the throttle cable adjuster.

Remove:

- inner housing protector

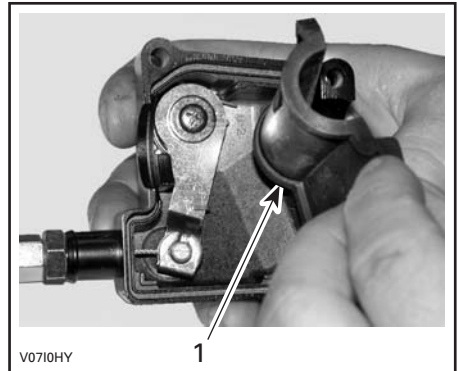

1. Inner housing protector

- the cable from the throttle lever housing.

**NOTE:** Slide cable in clip slot and remove the end of cable from clip.



V0710IY

Remove the throttle body side cover.



vmo2006-007-032\_a

1. Throttle body
2. Side cover screws

Insert the needle of lubricant can in the end of throttle cable adjuster.

## **WARNING**

Always wear eye protection and gloves when you lubricate a cable.



V0710JY

*TYPICAL*

**NOTE:** Place a rag around the throttle cable adjuster to prevent the lubricant from splashing.

Add lubricant until it runs out at throttle body end of the throttle cable.

Reinstall and adjust the cable.

## **Throttle Lever Adjustment**

Slide rubber protector back to expose throttle cable adjuster.

Loosen lock nut then turn the adjuster to obtain correct throttle lever free play.

**NOTE:** Measure throttle free play at the tip of throttle lever.

Tighten lock nut and reinstall protector.

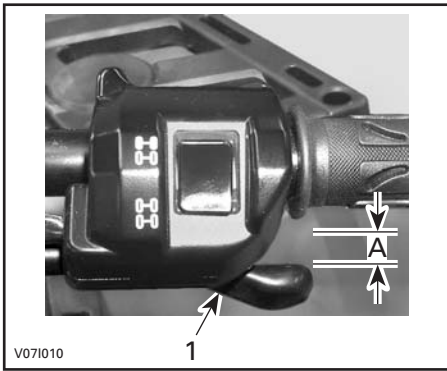

V071010

1

**TYPICAL**

1. Throttle lever

A. 3 to 6 mm (1/8 to 7/32 in)

With the transmission lever on PARK position, start the engine. Check if the throttle cable is adjusted correctly by turning handlebar fully right then fully left. If the engine RPM increases, readjust the throttle lever free play.



# ELECTRICAL

## WARNING

Unless otherwise indicated, always turn ignition switch to the OFF position before performing any maintenance or repair on electrical system.

## Spark Plug

### Removal

Remove side panels.

Unplug spark plug cables.

Unscrew spark plugs one turn.

Clean spark plugs and cylinder heads with pressurized air if possible.

## WARNING

Always wear safety goggles when using pressurized air.

Unscrew spark plugs completely then remove them.

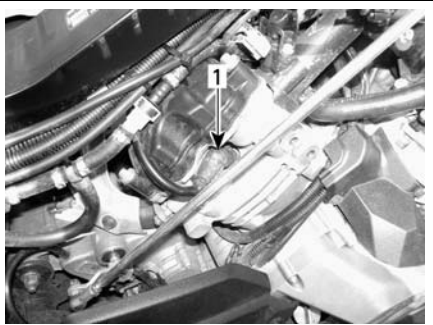

vm02006-007-029\_a

*RH SIDE — REAR CYLINDER*

1. Spark plug



vm02006-007-030\_a

*LH SIDE — FRONT CYLINDER*

1. Spark plug

### Installation

Prior to installation make sure that contact surfaces of cylinder heads and spark plugs are free of grime.

Using a feeler gauge, set the spark plug gap between 0.6 to 0.7 mm (0.024 to 0.027 in).

Apply anti-seize lubricant over spark plug threads to prevent a possible seizure.

Screw spark plugs into cylinder heads by hand and tighten with a torque wrench and a proper socket.

Torque spark plugs to 20 N•m (15 lbf•ft).

## Battery

## WARNING

Never charge a battery while installed in vehicle.

### Removal

Remove storage box.

Disconnect BLACK (-) cable first then RED (+) cable.

## **WARNING**

Always respect this order for disassembly; disconnect BLACK (-) cable first.

Unfasten retaining rod.



Pull out top bracket.  
Remove battery.

## **Cleaning**

Clean battery, battery casing and battery posts using a solution of baking soda and water.

Remove corrosion from battery cable terminals and battery posts using a firm wire brush. Battery casing should be cleaned by soft brush and baking soda solution.

## **Installation**

Reinstall battery in vehicle.

## **WARNING**

Connect RED (+) cable first then BLACK (-) cable. Always connect RED (+) cable first.

## **Fuses**

## **WARNING**

Always turn the ignition switch to OFF position before replacing a defective fuse.

If a fuse is damaged, replace it by one of the same rating.

**CAUTION:** Do not use a higher rated fuse as this can cause severe damage.

Fuses are located in the front service compartment and at the rear near battery.

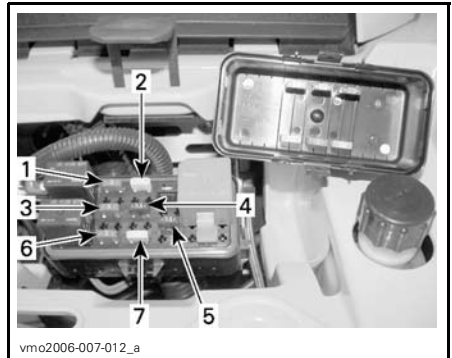

### **TYPICAL — FRONT FUSES LOCATION**

1. (F1) Ignition coils (5 A)
2. (F2) Fan (20 A)
3. (F3) Fuel injectors (5 A)
4. (F4) Speedometer/speed sensor/tail lamp (7.5 A)
5. (F5) Fuel pump (7.5 A)
6. (F6) Engine Control Module (ECM) (5 A)
7. (F7) Accessories (20 A)



**TYPICAL — REAR FUSES LOCATION**

1. (F8) Main (30 A)
- (F9) Main accessories (30 A)

To remove fuse from holder, remove the fuse holder cover then pull fuse out. Check if filament is melted.

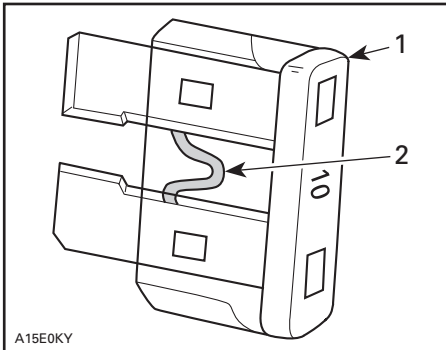

**TYPICAL**

1. Fuse
2. Check if melted

**Bulb Replacement**



Always turn the ignition switch to OFF position before replacing a defective bulb.

Always check light operation after replacement.

**Headlamps**

**CAUTION:** Never touch glass portion of an halogen bulb with bare fingers, it shortens its operating life. If glass is touched, clean it with isopropyl alcohol which will not leave a film on the bulb.

To replace the headlamp bulb, proceed as follows.

**NOTE:** The same headlamp is used on both sides of vehicle and for LO and HI beams.

Unplug connector from bulb.

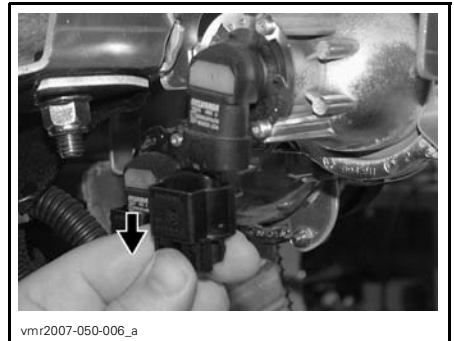

Rotate bulb.



Pull out bulb.

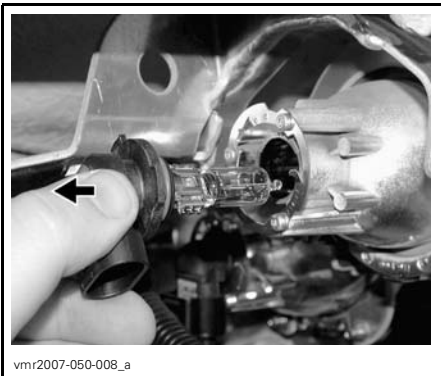

Properly reinstall removed parts in the reverse order of their removal.  
 Validate headlamp operation.

### Beam Aiming Adjustment

Adjust beam aiming as follows:  
 Turn adjustment screws to adjust beam height to your convenience.  
 Adjust headlamps evenly.

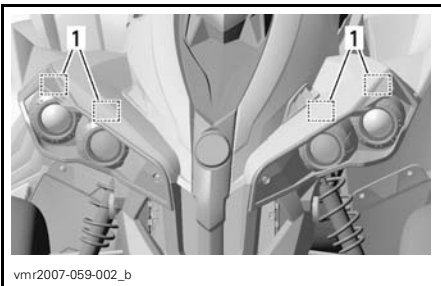

**TYPICAL**  
 1. Adjustment screws

### Taillight

Unscrew lens screws to expose bulbs.

While reading this Operator's Guide, remember that:

## **WARNING**

Indicates a potential hazard that, if not avoided, could result in serious injury or death.

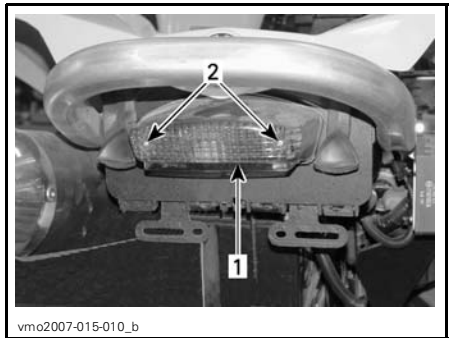

1. Lens  
 2. Screws

Push the bulb in and hold while turning counterclockwise to release.

Install the new bulb by first pushing in while turning clockwise.

### Speedometer

The speedometer is lighted with LEDs. If one LED burnt, replace the speedometer. The LEDs are not available separately.

# DRIVE TRAIN

## Drive Shaft Boot/Protector

### Inspection

Visually inspect drive shaft protectors and boots conditions. Check protectors for damage or rubbing against shafts. Check boots for cracks, tears, leaking grease etc. Repair or replace damaged parts as necessary.

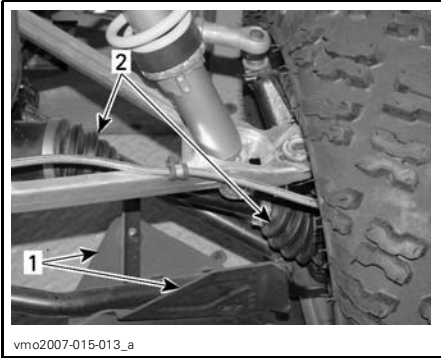

vmo2007-015-013\_a

### FRONT OF VEHICLE

- 1. Drive shaft protector
- 2. Drive shaft boots

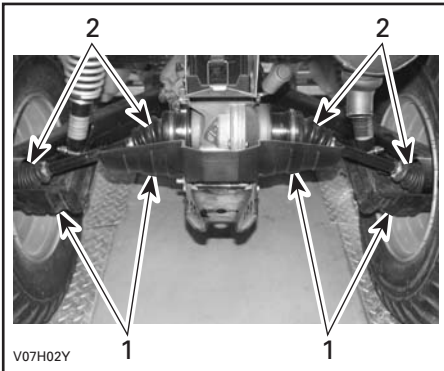

V07H02Y

### TYPICAL — REAR OF VEHICLE

- 1. Drive shaft protector
- 2. Drive shaft boots

## Wheel

Occasionally, wheel nuts should be removed to apply anti-seize lubricant on studs to ease future removal. This is particularly important when vehicle is used in salt-water environment or in mud. Remove one nut at a time, lubricate then retorque.

## Wheel Bearing Condition

Push and pull the wheels from the upper edge to feel the play. See an authorized Can-Am dealer if there is any play.

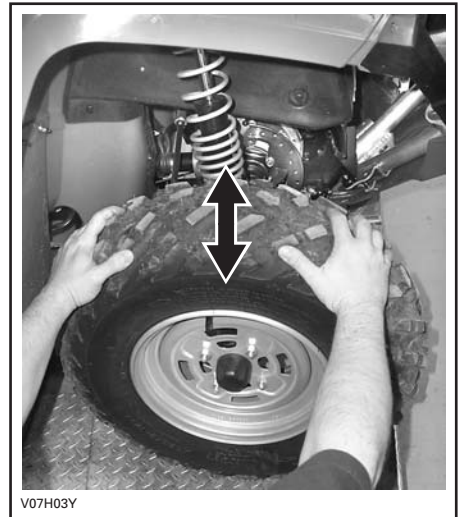

V07H03Y

### TYPICAL

## Tires/Wheels

### WARNING

When the tires are replaced, never install a bias tire with a radial tire. Such a combination could create handling and/or stability problems.

Do not mix tires of different size and/or design on the same axle.

Front and rear tire pairs must be the identical model and manufacturer.

For unidirectional tread pattern, ensure that the tires are installed in the correct direction of rotation. The radial tires must be installed as a complete set.

Severe injury or death can result if you do not follow these instructions.

## Tire Pressure

### WARNING

Tire pressure greatly affects vehicle handling and stability. Underpressure may cause tire to deflate and rotate on wheel. Overpressure may burst the tire. Always follow recommended pressure. Since tires are low-pressure types, a manual pump should be used.

Check pressure when tires are "cold" before using the vehicle. Tire pressure changes with temperature and altitude. Recheck pressure if one of these conditions has changed.

For your convenience, a pressure gauge is supplied in tool kit.

## TIRE PRESSURE

		FRONT	REAR
UP to 141 kg (310 lb)	MAX.	34.5 kPa (5 PSI)	34.5 kPa (5 PSI)
	MIN.	31 kPa (4.5 PSI)	31 kPa (4.5 PSI)

Although the tires are specifically designed for off-road use, a flat may still occur. Therefore, it is recommended to carry a tire pump and a repair kit.

## Tire/Wheel Condition

Check tire for damage and wear. Replace if necessary.

Do not rotate tires. The front and rear tires have a different size. The tires are directional and their rotation must be kept in a specific direction for proper operation.

## Wheel Removal

Loosen nuts then lift vehicle. Place a support under vehicle. Remove nuts then remove wheel.

At installation, it is recommended to apply anti-seize lubricant on threads.

The tires are directional and their rotation must be kept in a specific direction for proper operation.

Torque wheel nuts in accordance with the following illustration.

Torque to 100 N•m (74 lbf•ft).



*TIGHTENING SEQUENCE*

**CAUTION:** Always use the recommended wheel nuts (P/N 250 100 082). Using a different nut could cause damages to the rim.

# SUSPENSION

## Lubrication

Lubricate front A-arms. Use suspension synthetic grease (P/N 293 550 033) or an equivalent. There is two grease fittings on each A-arm.

## Inspection

### Front Suspension

Inspect shock absorber for oil leaks or other damages. Check tightness of fasteners. See an authorized Can-Am dealer as necessary.

### Rear Suspension

Inspect shock absorber for oil leaks or other damages. Check tightness of fasteners. See an authorized Can-Am dealer as necessary.

### Trailing Arms

Check trailing arms for distortion, cracks or bending. See an authorized Can-Am dealer if any problem is detected.

### A-Arms

Check A-arms for cracks, bending or other damages. See an authorized Can-Am dealer as necessary.

## Adjustment

### WARNING

The left and right shock adjustment cams on front or rear suspension must always be set to the same position. Never adjust one adjusting cam only. Uneven adjustment can cause poor handling and loss of stability, which could lead to an accident.

## Preload Adjustment

Adjust spring preload by turning adjusting cam accordingly, with the adjusting wrench in vehicle tool kit.

Turn the adjusting cams clockwise for a firmer ride and rough road condition or when carrying cargo or pulling a trailer.

Turn the adjusting cams counterclockwise for a light load and a smooth road condition.

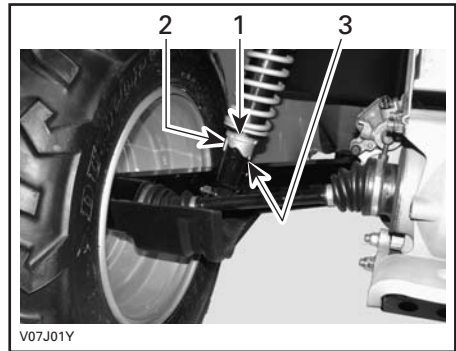

### TYPICAL — REAR SHOCKS

1. Adjusting cams
2. Smooth adjustment
3. Hard adjustment



# BRAKE

## Adjustment/Inspection

The front and rear brakes are hydraulic disc types. These brakes are self-adjusting and require no adjustment.

The brake lever and the brake pedal require no adjustment.

Check the following to keep the brakes in a good operating condition:

- brake system for fluid leaks
- brake for spongy feel
- brake discs for excessive wear and surface condition
- brake pads for wear, damage or looseness.

SERVICE LIMITS	
Brake pads thickness	1 mm (.040 in)
Front discs thickness	3.5 mm (.138 in)
Rear disc thickness	4.3 mm (.170 in)
Maximum discs warpage	0.3 mm (.010 in)

See your authorized Can-Am dealer if a problem is detected concerning the brake system.

## Brake Fluid Replacement

### **WARNING**

The brake fluid replacement or any brake system repairs should be performed by an authorized Can-Am dealer.

---

# BODY/FRAME

## Engine Area

Check engine area for any damage and leaks. Ensure all hose clamps are properly secured and no hose is cracked, kinked or otherwise damaged.

Inspect muffler, battery and reservoir fastening devices.

Check electrical connections for corrosion and tightness.

Replace or have damaged parts repaired.

## Recovery Latching Point Condition

Check tightness of fasteners. Properly retighten as necessary.

## Chassis Fasteners

Check fastener condition and tightness on the vehicle. Retighten as required.

## Seat Fasteners

Remove seat and check latch mechanism and pin for wear. See an authorized Can-Am dealer for parts replacement if damaged.

## Vehicle Cleaning and Protection

Never use a high pressure washer to clean the vehicle. **USE LOW PRESSURE ONLY (like a garden hose).** High pressure can cause electrical or mechanical damages.

Painted parts which are damaged should be properly repainted to prevent rust.

When required, wash the body with hot water and soap (only use mild detergent). Apply non-abrasive wax.

**CAUTION:** Never clean plastic parts with strong detergent, degreasing agent, paint thinner, acetone, etc.

While reading this Operator's Guide, remember that:

### **WARNING**

Indicates a potential hazard that, if not avoided, could result in serious injury or death.

---

## STORAGE AND PRESEASON PREPARATION

### **WARNING**

Have an authorized Can-Am dealer inspect fuel system integrity as specified in *MAINTENANCE CHART*.

When a vehicle is not in use for more than one month, proper storage is a necessity.

See an authorized Can-Am dealer for proper procedures.

When using your vehicle after storage, a preparation is required. See an authorized Can-Am dealer for proper procedures.



# ***WARRANTY***

---

# **BRP LIMITED WARRANTY NORTH AMERICA: 2007 CAN-AM™ ATV**

## **1) SCOPE OF THE LIMITED WARRANTY**

Bombardier Recreational Products Inc. ("BRP")\* warrants its 2007 Can-Am ATV from defects in material or workmanship for the period and under the conditions described below.

All genuine Can-Am ATV parts and accessories, installed by an authorized BRP dealer (as hereinafter defined) at the time of delivery of the 2007 Can-Am ATV, carry the same warranty as that of the Can-Am ATV.

Your 2007 Can-Am Renegade™ 800 ATV is originally equipped with Carlisle<sup>†</sup> tires. The tires are warranted separately by the tire manufacturer. Please contact the manufacturer or ask your authorized BRP dealer for warranty coverage and assistance.

Carlisle Tire & Wheel Company (All 2007 Can-Am Renegade 800 ATVs)  
23 Windham Boulevard,  
Aiken, SC 29805.

Warranty Information:  
in USA 1-800-260-7959  
in Canada 1-800-265-6155  
in Quebec 1-877-997-4999

Use of the product for racing or any other competitive activity, at any point, even by a previous owner, will render this warranty null and void.

## **2) EXCLUSIONS – ARE NOT WARRANTED**

The following are not warranted under any circumstances:

- Normal wear and tear;
- Routine maintenance items, tune ups, adjustments;
- Damage caused by failure to provide proper maintenance and/or storage, as described in the Operator's Guide;
- Damage resulting from removal of parts, improper repairs, service, maintenance, modifications or use of parts not manufactured or approved by BRP or resulting from repairs done by a person that is not an authorized servicing BRP dealer;
- Damage caused by abuse, abnormal use, neglect or operation of the product in a manner inconsistent with the recommended operation described in the Can-Am ATV Operator's Guide;
- Damage resulting from accident, submersion, fire, theft, vandalism or any act of God;
- Operation with fuels, oils or lubricants which are not suitable for use with the product (see the Operator's Guide);
- Water or snow ingestion;
- Incidental or consequential damages, or damages of any kind including without limitation towing, storage, telephone, rental, taxi, inconvenience, insurance coverage, loan payments, loss of time, loss of income.

### 3) LIMITATIONS OF LIABILITY

THIS WARRANTY IS EXPRESSLY GIVEN AND ACCEPTED IN LIEU OF ANY AND ALL OTHER WARRANTIES, EXPRESSED OR IMPLIED, INCLUDING WITHOUT LIMITATION ANY WARRANTY OF MERCHANTABILITY OR FITNESS FOR A PARTICULAR PURPOSE. TO THE EXTENT THAT THEY CANNOT BE DISCLAIMED, THE IMPLIED WARRANTIES ARE LIMITED IN DURATION TO THE LIFE OF THE EXPRESS WARRANTY. INCIDENTAL AND CONSEQUENTIAL DAMAGES ARE EXCLUDED FROM COVERAGE UNDER THIS WARRANTY. SOME STATES/PROVINCES DO NOT ALLOW FOR THE DISCLAIMERS, LIMITATIONS AND EXCLUSIONS IDENTIFIED ABOVE, AS A RESULT, THEY MAY NOT APPLY TO YOU. THIS WARRANTY GIVES YOU SPECIFIC RIGHTS, AND YOU MAY ALSO HAVE OTHER LEGAL RIGHTS WHICH MAY VARY FROM STATE TO STATE, OR PROVINCE TO PROVINCE.

Neither the distributor, any BRP dealer nor any other person has been authorized to make any affirmation, representation or warranty regarding the product, other than those contained in this limited warranty, and if made, shall not be enforceable against BRP.

BRP reserves the right to modify this warranty at any time, being understood that such modification will not alter the warranty conditions applicable to the products sold while this warranty is in effect.

### 4) WARRANTY COVERAGE PERIOD

This warranty will be in effect from the date of delivery to the first retail consumer or the date the product is first put into use, whichever occurs first and for a period of:

SIX (6) CONSECUTIVE MONTHS, for private use or commercial use owners.

The emission-related components included in the chart below, that are installed on EPA certified Can-Am ATVs (see list below) registered in the USA are covered for thirty (30) consecutive months.

The EPA certified Can-Am ATVs are those equipped with 800 engines.

EMISSION-RELATED COMPONENTS	800
TPS (Throttle Position Sensor)	X
TMAPS (Temperature and Manifold Air Pressure Sensor)	X
Fuel pressure regulator	X
Fuel injectors	X
ECM (Engine Control Module)	X
Crankcase ventilation system	X
Cylinder head gasket	X
Intake runner seal	X

The repair or replacement of parts or the performance of service under this warranty does not extend the life of this warranty beyond its original expiration date.

## **5) CONDITIONS TO HAVE WARRANTY COVERAGE**

This warranty coverage is available **only** if **each** of the following conditions has been fulfilled:

- The 2007 Can-Am ATV must be purchased as new and unused by its first owner from a BRP dealer authorized to distribute Can-Am ATVs in the country in which the sale occurred ("BRP dealer");
- The BRP specified pre-delivery inspection process must be completed and documented;
- The 2007 Can-Am ATV must have undergone proper registration by an authorized BRP dealer;
- The 2007 Can-Am ATV must be purchased in the country in which the purchaser resides;
- Routine maintenance outlined in the Operator's Guide must be timely performed in order to maintain warranty coverage. BRP reserves the right to make warranty coverage contingent upon proof of proper maintenance.

BRP will not honour this limited warranty to any private use owner or commercial use owner if the preceding conditions have not been met. Such limitations are necessary in order to allow BRP to preserve both the safety of its products, and also that of its consumers and the general public.

## **6) WHAT TO DO TO OBTAIN WARRANTY COVERAGE**

The customer must notify a servicing BRP dealer within two (2) days of the appearance of a defect, and provide it with reasonable access to the product and reasonable opportunity to repair it. The customer must also present to the authorized BRP dealer, proof of purchase of the product and must sign the repair/work order prior to starting the repair in order to validate the warranty repair. All parts replaced under this limited warranty become the property of BRP.

## **7) WHAT BRP WILL DO**

BRP's obligations under this warranty are limited to, at its sole discretion, repairing parts found defective under normal use, maintenance and service, or replacing such parts with new genuine Can-Am ATV parts without charge for parts and labor, at any authorized BRP dealer during the warranty coverage period.

BRP reserves the right to improve or modify products from time to time without assuming any obligation to modify products previously manufactured.



## 8) TRANSFER

If the ownership of a product is transferred during the warranty coverage period, this warranty shall also be transferred and be valid for the remaining coverage period provided that BRP is notified of such transfer of ownership in the following way:

- a) The former owner contacts BRP (at the phone number provided below) or an authorized BRP dealer and gives the coordinates of the new owner; or
- b) BRP or an authorized BRP dealer receives a proof that the former owner agreed to the transfer of ownership, in addition to the coordinates of the new owner.

## 9) CONSUMER ASSISTANCE

- a) In the event of a controversy or a dispute in connection with this limited warranty, BRP suggests that you try to resolve the issue at the dealership level. We recommend discussing the issue with the authorized dealer's service manager or owner.
- b) If the issue has not yet been resolved, please submit your complaint in writing or call the appropriate number below:

### IN CANADA

BOMBARDIER RECREATIONAL  
PRODUCTS INC.  
CAN-AM ATV  
Consumer Services Group  
Valcourt QC J0E 2L0  
Tel.: (819) 566-3366

### IN USA

BRP US Inc.  
CAN-AM ATV  
Consumer Services Group  
7575 BOMBARDIER COURT  
WAUSAU WI 54401  
Tel.: (715) 848-4957

\* In the USA, products are distributed and serviced by BRP US Inc.

© 2006 Bombardier Recreational Products Inc. All rights reserved.

™ trademark of Bombardier Recreational Products Inc. or its affiliates.

† Carlisle is a trademark of Carlisle Tire & Wheel Company.

---

# **BRP INTERNATIONAL LIMITED WARRANTY: 2007 CAN-AM™ ATV**

## **1) SCOPE OF THE LIMITED WARRANTY**

Bombardier Recreational Products Inc. ("BRP")\* warrants its 2007 Can-Am ATVs Renegade 800™ from defects in material or workmanship for the period and under the conditions described below.

All genuine Can-Am ATV parts and accessories, installed by an authorized Can-Am distributor/dealer (as hereinafter defined) at the time of delivery of the 2007 Can-Am ATV, carry the same warranty as that of the Can-Am ATV.

Use of the product for racing or any other competitive activity, at any point, even by a previous owner will render this warranty null and void.

## **2) EXCLUSIONS ARE NOT WARRANTED**

The following are not warranted under any circumstances:

- Normal wear and tear;
- Routine maintenance items, tune ups, adjustments;
- Damage caused by failure to provide proper maintenance and/or storage, as described in the Operator's Guide;
- Damage resulting from removal of parts, improper repairs, service, maintenance, modifications or use of parts not manufactured or approved by BRP or resulting from repairs done by a person that is not an authorized servicing Can-Am distributor/dealer;
- Damage caused by abuse, abnormal use, neglect or operation of the product in a manner inconsistent with the recommended operation described in the Operator's Guide;
- Damage resulting from accident, submersion, fire, theft, vandalism or any act of God;
- Operation with fuels, oils or lubricants which are not suitable for use with the product (see the Operator's Guide);
- Water or snow ingestion;
- Incidental or consequential damages, or damages of any kind including without limitation towing, storage, telephone, rental, taxi, inconvenience, insurance coverage, loan payments, loss of time, loss of income.

### **3) LIMITATIONS OF LIABILITY**

THIS WARRANTY IS EXPRESSLY GIVEN AND ACCEPTED IN LIEU OF ANY AND ALL OTHER WARRANTIES, EXPRESSED OR IMPLIED, INCLUDING WITHOUT LIMITATION ANY WARRANTY OF MERCHANTABILITY OR FITNESS FOR A PARTICULAR PURPOSE. TO THE EXTENT THAT THEY CANNOT BE DISCLAIMED, THE IMPLIED WARRANTIES ARE LIMITED IN DURATION TO THE LIFE OF THE EXPRESS WARRANTY. INCIDENTAL AND CONSEQUENTIAL DAMAGES ARE EXCLUDED FROM COVERAGE UNDER THIS WARRANTY. SOME JURISDICTIONS DO NOT ALLOW FOR THE DISCLAIMERS, LIMITATIONS AND EXCLUSIONS IDENTIFIED ABOVE, AS A RESULT, THEY MAY NOT APPLY TO YOU. THIS WARRANTY GIVES YOU SPECIFIC RIGHTS, AND YOU MAY ALSO HAVE OTHER LEGAL RIGHTS WHICH MAY VARY FROM COUNTRY TO COUNTRY.

Neither the distributor, any Can-Am dealer nor any other person has been authorized to make any affirmation, representation or warranty regarding the product, other than those contained in this limited warranty, and if made, shall not be enforceable against BRP.

BRP reserves the right to modify this warranty at any time, being understood that such modification will not alter the warranty conditions applicable to the products sold while this warranty is in effect.

### **4) WARRANTY COVERAGE PERIOD**

This warranty will be in effect from the date of delivery to the first retail consumer or the date the product is first put into use, whichever occurs first and for a period of:

SIX (6) CONSECUTIVE MONTHS, for private use or commercial use.

The repair or replacement of parts or the performance of service under this warranty does not extend the life of this warranty beyond its original expiration date.

### **5) CONDITIONS TO HAVE WARRANTY COVERAGE**

This warranty coverage is available **only** if **each** of the following conditions has been fulfilled:

- The 2007 Can-Am ATV must be purchased as new and unused by its first owner from a Can-Am distributor/dealer authorized to distribute Can-Am ATVs in the country in which the sale occurred (“Can-Am distributor/dealer”);
- The BRP specified pre-delivery inspection process must be completed and documented;
- The product must have undergone proper registration by an authorized Can-Am distributor/dealer;
- The 2007 Can-Am ATV must be purchased in the country or union of countries in which the purchaser resides;
- Routine maintenance outlined in the Operator’s Guide must be timely performed in order to maintain warranty coverage. BRP reserves the right to make warranty coverage contingent upon proof of proper maintenance.

BRP will not honour this limited warranty to any private use owner or commercial use owner if the preceding conditions have not been met. Such limitations are necessary in order to allow BRP to preserve both the safety of its products, and also that of its consumers and the general public.

## **6) WHAT TO DO TO OBTAIN WARRANTY COVERAGE**

The customer must notify a servicing Can-Am distributor/dealer within two (2) days of the appearance of a defect, and provide it with reasonable access to the product and reasonable opportunity to repair it. The customer must also present to the authorized Can-Am distributor/dealer, proof of purchase of the product and must sign the repair/work order prior to starting the repair in order to validate the warranty repair. All parts replaced under this limited warranty become the property of BRP.

## **7) WHAT BRP WILL DO**

BRP's obligations under this warranty are limited to, at its sole discretion, repairing parts found defective under normal use, maintenance and service; or replacing such parts with new genuine Can-Am ATV parts without charge for parts and labour, at any authorized Can-Am distributor/dealer.

BRP reserves the right to improve or modify products from time to time without assuming any obligation to modify products previously manufactured.

## **8) TRANSFER**

If the ownership of a product is transferred during the warranty coverage period, this warranty shall also be transferred and be valid for the remaining coverage period provided BRP or an authorized Can-Am distributor/dealer receives a proof that the former owner agreed to the transfer of ownership, in addition to the co-ordinates of the new owner.

## **9) CONSUMER ASSISTANCE**

- a) In the event of a controversy or a dispute in connection with this limited warranty, BRP suggests that you try to resolve the issue at the dealership level. We recommend discussing the issue with the authorized dealer's service manager or owner.
- b) If further assistance is required, the distributor's service department should be contacted in order to resolve the matter.
- c) If the matter still remains unresolved then contact BRP by writing to us at the address listed below.

For countries within Europe, Middle East, Africa, Russia & CIS, please contact our European office:

**BRP EUROPE N.V.**

Consumer Service Center  
SKALDENSTRAAT 125  
9042 GENT  
Belgium  
Tel.: + 32-9-218-26-00

For Scandinavian countries, please contact our Finland office:

**BRP FINLAND OY**

Service Department  
Ahjotie 30  
Fin-96320 Rovaniemi  
Finland  
Tel.: + 358 16 3208 111

For all other countries, please contact your local distributor or our North America office:

Bombardier Recreational Products Inc.  
Consumer Services Group  
Valcourt QC J0E 2L0  
Tel.: 1-819-566-3366

You will find your distributor's coordinates on [www.brp.com](http://www.brp.com).

\* For the territory covered by this limited warranty, products are distributed and serviced by Bombardier Recreational Products Inc. or its affiliates.

© 2006 Bombardier Recreational Products Inc. All rights reserved.

™ trademark of Bombardier Recreational Products Inc. or its affiliates.

---

# **BRP EUROPEAN UNION MEMBER STATES LIMITED WARRANTY: 2007 CAN-AM™ ATVS**

## **1) SCOPE OF THE LIMITED WARRANTY**

Bombardier Recreational Product Inc. ("BRP")\* warrants its new and unused model-year 2007 Can-Am ATVs Renegade™ 800 sold by authorized BRP distributors/dealers ("Distributors/Dealers") in the European Union member states from defects in material or workmanship for the period and under the conditions described below.

All genuine Can-Am ATV parts and accessories, installed by an authorized BRP Distributors/Dealers at the time of delivery of the 2007 Can-Am ATV, carry the same warranty as that of the ATV.

Use of the product for racing or any other competitive activity, at any point, even by a previous owner, will render this warranty null and void.

## **2) EXCLUSIONS ARE NOT WARRANTED**

The following are not warranted under any circumstances:

- Normal wear and tear;
- Routine maintenance items, tune ups, adjustments;
- Damage caused by failure to provide proper maintenance and/or storage, as described in the Operator's Guide;
- Damage resulting from removal of parts, improper repairs, service, maintenance, modifications or use of parts not manufactured or approved by BRP or resulting from repairs done by a person that is not an authorized servicing Distributor/Dealer;
- Damage caused by abuse, abnormal use, neglect or operation of the product in a manner inconsistent with the recommended operation described in the Operator's Guide;
- Damage resulting from accident, submersion, fire, theft, vandalism or any act of God;
- Operation with fuels, oils or lubricants which are not suitable for use with the product (see the Operator's Guide);
- Water or snow ingestion;
- Incidental or consequential damages, or damages of any kind including without limitation towing, storage, telephone, rental, taxi, inconvenience, insurance coverage, loan payments, loss of time, loss of income.

### **3) LIMITATIONS OF LIABILITY**

THIS WARRANTY IS EXPRESSLY GIVEN AND ACCEPTED IN LIEU OF ANY AND ALL OTHER WARRANTIES, EXPRESSED OR IMPLIED, INCLUDING WITHOUT LIMITATION ANY WARRANTY OF MERCHANTABILITY OR FITNESS FOR A PARTICULAR PURPOSE. TO THE EXTENT THAT THEY CANNOT BE DISCLAIMED, THE IMPLIED WARRANTIES ARE LIMITED IN DURATION TO THE LIFE OF THE EXPRESS WARRANTY. INCIDENTAL AND CONSEQUENTIAL DAMAGES ARE EXCLUDED FROM COVERAGE UNDER THIS WARRANTY. SOME JURISDICTIONS DO NOT ALLOW FOR THE DISCLAIMERS, LIMITATIONS AND EXCLUSIONS IDENTIFIED ABOVE, AS A RESULT, THEY MAY NOT APPLY TO YOU. THIS WARRANTY GIVES YOU SPECIFIC RIGHTS, AND YOU MAY ALSO HAVE OTHER LEGAL RIGHTS WHICH MAY VARY FROM COUNTRY TO COUNTRY.

Neither the distributor, any BRP Distributor/Dealer nor any other person has been authorized to make any affirmation, representation or warranty regarding the product, other than those contained in this limited warranty, and if made, shall not be enforceable against BRP.

BRP reserves the right to modify this warranty at any time, being understood that such modification will not alter the warranty conditions applicable to the products sold while this warranty is in effect.

### **4) WARRANTY COVERAGE PERIOD**

This warranty will be in effect from the date of delivery to the first retail consumer or the date the product is first put into use, whichever occurs first and for a period of:

TWENTY-FOUR (24) CONSECUTIVE MONTHS for private and commercial use.

The repair or replacement of parts or the performance of service under this warranty does not extend the life of this warranty beyond its original expiration date.

Note that the duration and any other modalities of the warranty coverage are subject to the applicable national or local legislation in your country.

### **5) CONDITIONS TO HAVE WARRANTY COVERAGE**

This warranty coverage is available **only** if **each** of the following conditions has been fulfilled:

- The 2007 Can-Am ATV must be purchased as new and unused by its first owner from a Can-Am Distributor/Dealer authorized to distribute Can-Am ATVs in the country in which the sale occurred;
- The BRP specified pre-delivery inspection process must be completed and documented;
- The product must have undergone proper registration by an authorized Can-Am Distributor/Dealer;
- The 2007 Can-Am ATV must be purchased in the country or union of countries in which the purchaser resides;
- Routine maintenance outlined in the Operator's Guide must be timely performed in order to maintain warranty coverage. BRP reserves the right to make warranty coverage contingent upon proof of proper maintenance.

BRP will not honour this limited warranty to any private use owner or commercial use owner if the preceding conditions have not been met. Such limitations are necessary in order to allow BRP to preserve both the safety of its products, and also that of its consumers and the general public.

## **6) WHAT TO DO TO OBTAIN WARRANTY COVERAGE**

The customer must notify a servicing BRP Distributor/Dealer within two (2) months of the appearance of a defect, and provide it with reasonable access to the product and reasonable opportunity to repair it. The customer must also present to the authorized BRP Distributor/Dealer, proof of purchase of the product and must sign the repair/work order prior to starting the repair in order to validate the warranty repair. All parts replaced under this limited warranty become the property of BRP.

Note that the notification period is subject to the applicable national or local legislation in your country.

## **7) WHAT BRP WILL DO**

BRP's obligations under this warranty are limited to, at its sole discretion, repairing parts found defective under normal use, maintenance and service, or replacing such parts with new genuine Can-Am parts without charge for parts and labor, at any authorized BRP Distributor/Dealer during the warranty coverage period.

BRP reserves the right to improve or modify products from time to time without assuming any obligation to modify products previously manufactured.

## **8) TRANSFER**

If the ownership of a product is transferred during the warranty coverage period, this warranty shall also be transferred and be valid for the remaining coverage period provided BRP or an authorized BRP Distributor/Dealer receives a proof that the former owner agreed to the transfer of ownership, in addition to the co-ordinates of the new owner.

## **9) CONSUMER ASSISTANCE**

In the event of a controversy or a dispute in connection with this limited warranty, BRP suggests that you try to resolve the issue at the dealership level. We recommend discussing the issue with the authorized Distributor/Dealer's service manager or owner.

If further assistance is required, the distributor's service department should be contacted in order to resolve the matter.

If the matter still remains unresolved then contact BRP at the address listed below.



For countries within Europe, Middle East, Africa, Russia & CIS, please contact our European office:

**BRP EUROPE N.V.**

Consumer Service Center  
SKALDENSTRAAT 125  
9042 GENT  
Belgium  
Tel.: + 32-9-218-26-00

For Scandinavian countries, please contact our Finland office:

**BRP FINLAND OY**

Service Department  
Ahjotie 30  
Fin-96320 Rovaniemi  
Finland  
Tel.: + 358 16 3208 111

For all other countries, please contact your local distributor or our North America office:

Bombardier Recreational Products Inc.  
Consumer Services Group  
Valcourt QC J0E 2L0  
Tel.: 1-819-566-3366

You will find your distributor's coordinates on [www.brp.com](http://www.brp.com).

\* For the territory covered by this limited warranty, products are distributed and serviced by Bombardier Recreational Products Inc. or its affiliates.

© 2006 Bombardier Recreational Products Inc. All rights reserved.

™ trademark of Bombardier Recreational Products Inc. or its affiliates.

---

## **PRIVACY OBLIGATION/DISCLAIMER**

We wish to inform you that your coordinates will be used for safety and warranty purposes. Sometimes, we also use the coordinates of our clients to inform them about our products and to present them offers. Should you prefer not to receive information on our product, services and offers, please let us know by writing to the address below.

Also note that, from time to time, carefully selected and trustworthy organizations may be permitted to use the coordinates of our clients to promote quality products and services. If you prefer not to have your name and address released, please let us know by writing to the address below.

### **IN CANADA**

**Bombardier Recreational Products Inc.**  
Warranty Department  
75 J.A. Bombardier Street  
Sherbrooke, Québec J1L 1W3  
Fax Number: (819) 566-3590

### **IN USA**

**BRP US Inc.**  
Warranty Department  
7575 Bombardier Court  
Wausau WI 54401  
Tel.: (715) 848-4957

### **OTHER COUNTRIES IN THE WORLD**

**BRP European Distribution**  
Warranty Department  
Chemin de Messidor 5-7  
1006 Lausanne Switzerland  
Fax Number: +41213187801

# CHANGE OF ADDRESS/OWNERSHIP

If your address has changed or if you are the new owner of the ATV, be sure to notify BRP by either:

- mailing one of the following card below;
- **North America Only:** calling at (715) 848-4957 (USA) or (819) 566-3366 (Canada);
- notifying an authorized Can-Am dealer.

In case of change of ownership, please join a proof that the former owner agreed to the transfer.

**IN NORTH AMERICA**  
 Bombardier Recreational Products Inc.  
 Warranty Department  
 75 J.A. Bombardier Street  
 Sherbrooke, Québec J1L 1W3  
 Canada

Notifying BRP, even after the expiration of the limited warranty, is very important as it enables BRP to reach the ATV owner if necessary, like when safety recalls are initiated. It is the owner's responsibility to notify BRP.

**STOLEN UNITS:** If your personal ATV is stolen, you should notify BRP or an authorized Can-Am dealer. We will ask you to provide your name, address, phone number, the vehicle identification number and the date it was stolen.

**OTHER COUNTRIES IN THE WORLD**  
 BRP European Distribution  
 Warranty Department  
 Chemin de Messidor 5-7  
 1006 Lausanne  
 Switzerland



CHANGE OF ADDRESS <input type="checkbox"/>	CHANGE OF OWNERSHIP <input type="checkbox"/>	
VEHICLE IDENTIFICATION NUMBER		
Model Number	Vehicle Identification Number (V.I.N.)	
OLD ADDRESS OR PREVIOUS OWNER:		
NAME		
NO.	STREET	APT
CITY	STATE/PROVINCE	ZIP/POSTAL CODE
COUNTRY	TELEPHONE	
NEW ADDRESS OR NEW OWNER:		
NAME		
NO.	STREET	APT
CITY	STATE/PROVINCE	ZIP/POSTAL CODE
COUNTRY	TELEPHONE	

V00A2F







**ATV MODEL No.** \_\_\_\_\_

**VEHICLE**

**IDENTIFICATION NUMBER (V.I.N.)** \_\_\_\_\_

**ENGINE**

**IDENTIFICATION NUMBER (E.I.N.)** \_\_\_\_\_

**Owner:** \_\_\_\_\_  
NAME

\_\_\_\_\_  
No. STREET APT

\_\_\_\_\_  
CITY STATE/PROVINCE ZIP/POSTAL CODE

**Purchase Date** \_\_\_\_\_  
YEAR MONTH DAY

**Warranty Expiry Date** \_\_\_\_\_  
YEAR MONTH DAY

To be completed by the dealer at the time of the sale.

DEALER IMPRINT AREA

V00A21L

Please verify with your dealer to ensure your vehicle has been registered with BRP.

While reading this Operator's Guide, remember that:

 **WARNING**

Indicates a potential hazard that, if not avoided, could result in serious injury or death.



## WARNING

### **THIS VEHICLE CAN BE HAZARDOUS TO OPERATE.**

A collision or rollover can occur quickly, even during routine maneuvers such as turning and driving on hills or over obstacles, if you fail to take proper precautions.

**SEVERE INJURY OR DEATH** can result if you do not follow these instructions:

- **BEFORE YOU OPERATE THIS VEHICLE, READ THIS OPERATOR'S GUIDE AND ALL ON-PRODUCT LABELS.**
- **NEVER OPERATE THIS VEHICLE WITHOUT PROPER INSTRUCTIONS.** Beginners should complete a certified training course.
- **NEVER CARRY A PASSENGER.** You increase your risk of losing control if you carry a passenger.
- **NEVER OPERATE THIS VEHICLE ON A PAVED SURFACE.** You increase your risk of losing control if you operate this vehicle on pavement.
- **NEVER OPERATE THIS VEHICLE ON PUBLIC ROADS.** You can collide with another vehicle if you operate this vehicle on a public road.
- **ALWAYS WEAR AN APPROVED HELMET,** eye protection, and protective clothing.
- **NEVER CONSUME ALCOHOL OR DRUGS** before or while operating this vehicle.
- **NEVER OPERATE THIS VEHICLE AT EXCESSIVE SPEEDS.** You increase your risk of losing control if you operate this vehicle at speeds too fast for the terrain, visibility conditions, or your experience.
- **NEVER ATTEMPT WHEELIES, JUMPS, OR OTHER STUNTS.**

219 000 433

CA

OP. GUIDE, RENEGADE / ENGLISH  
GUIDE DU COND RENEGADE / ANGLAIS

FAIT AU / MADE IN CANADA U/M:P.C.