



# 2012 OPERATOR'S GUIDE

Includes  
Safety, Vehicle and  
Maintenance Information

**GTS™ / GTI™ /  
GTR™ / WAKE™**  
SERIES

**⚠ WARNING**

Read this guide thoroughly.  
It contains important safety information.  
Minimum recommended operator's age: 16 years old.  
Keep this Operator's Guide in the watercraft.

2 1 9 0 0 0 8 3 0

## **WARNING**

Disregarding any of the safety precautions and instructions contained in this Operator's Guide, *SAFETY DVD* and on-product safety labels could cause injury including the possibility of death!

### CALIFORNIA PROPOSITION 65 WARNING

## **WARNING**

This product contains or emits chemicals known to the state of California to cause cancer and birth defects or other reproductive harm.



In Canada, products are distributed by Bombardier Recreational Products Inc. (BRP).

In USA, products are distributed by BRP US Inc.

Knight's Spray-Nine<sup>†</sup> is a trademark of Korkay System Ltd.

GTx<sup>†</sup> is a trademark of Castrol Ltd. Used under license.

This is a non-exhaustive list of trademarks that are the property of Bombardier Recreational Products Inc. or its affiliates:

4-TEC™	O.T.A.S.™	T.O.P.S.™
D.E.S.S.™	Rotax®	VTST™
iBR™	GTI™ 130	XPST™
iControl™	Sea-Doo®	GTI™ SE 130
Learning Key™	Sea-Doo LK™	GTI™ SE 155
iTC™	S³Hull™	GTI™ Limited 155
WAKE™ 155	GTR™ 215	

# FOREWORD

Congratulations on your purchase of a new Sea-Doo® personal watercraft (PWC). It is backed by the BRP warranty and a network of authorized Sea-Doo personal watercraft dealers ready to provide the parts, service or accessories you may require.

Your dealer is committed to your satisfaction. He has taken training to perform the initial setup and inspection of your watercraft as well as completed the final adjustment before you took possession. If you need more complete servicing information, please ask your dealer.

At delivery, you were also informed of the warranty coverage and signed the *PREDELIVERY CHECK LIST* to ensure your new watercraft was prepared to your entire satisfaction.

## Know Before you Go

To learn how to reduce the risk for you or other persons being injured or killed, read the following sections before you operate the watercraft:

- SAFETY INFORMATION
- WATERCRAFT INFORMATION.

Read and understand all safety labels on your watercraft and watch attentively your *SAFETY DVD*.

Failure to follow the warnings contained in this Operator's Guide can result in serious injury or death.

BRP highly recommends that you take a safe boating course. Please check with your dealer or local authorities for availability in your area.

In certain areas, an operator competency card is mandatory to operate a pleasure craft.

### WARNING

Get familiar with this PWC; it may exceed the performance of other PWCs you have ridden.

## Safety Messages

This Operator's Guide utilizes the following symbols and words to emphasize particular information:

### WARNING

Indicates a potential hazard which, if not avoided, could result in serious injury or death.

 CAUTION Indicates a potentially hazardous situation which, if not avoided, could result in minor or moderate injury.

**NOTICE** Indicates an instruction which, if not followed, could severely damage watercraft components or other property.

## About this Operator's Guide

This Operator's Guide has been prepared to acquaint the owner/operator or passenger with this personal watercraft and its various controls, maintenance and safe riding instructions.

Keep this Operator's Guide in the watercraft as you can refer to it for operation, instructing others, maintenance and troubleshooting.

Note that this guide is available in several languages. In the event of any discrepancy, the English version shall prevail.

If you want to view and/or print an extra copy of your Operator's Guide, simply visit the following website [www.operatorsguide.brp.com](http://www.operatorsguide.brp.com).

The informations contained in this document are correct at the time of publication. However, BRP maintains a policy of continuous improvement of its products without imposing upon itself any obligation to install them on products previously manufactured. Due to late changes, some differences between the manufactured product and

the descriptions and/or specifications in this guide may occur. BRP reserves the right at any time to discontinue or change specifications, designs, features, models or equipment without incurring any obligation upon itself.

This Operator's Guide and the *SAFETY DVD* should remain with the watercraft when it's sold.

---

# TABLE OF CONTENTS

<b>FOREWORD</b> .....	<b>1</b>
Know Before you Go .....	1
Safety Messages .....	1
About this Operator's Guide .....	1

## ***SAFETY INFORMATION***

<b>GENERAL PRECAUTIONS</b> .....	<b>8</b>
Avoid Carbon Monoxide Poisoning .....	8
Avoid Gasoline Fires and Other Hazards .....	8
Avoid Burns from Hot Parts .....	8
Accessories and Modifications .....	8
<b>SPECIAL SAFETY MESSAGES</b> .....	<b>9</b>
Reminders Regarding Safe Operation .....	9
Water Sports (Towing with the Watercraft) .....	13
Hypothermia .....	14
Safe Boating Courses .....	15
<b>ACTIVE TECHNOLOGIES (iCONTROL)</b> .....	<b>16</b>
Introduction .....	16
iTC (intelligent Throttle Control) .....	16
iBR (intelligent Brake and Reverse System) .....	17
<b>SAFETY EQUIPMENT</b> .....	<b>19</b>
Required Safety Equipment .....	19
Additional Recommended Equipment .....	21
<b>PRACTICE EXERCISES</b> .....	<b>22</b>
Where to Practice Exercises .....	22
Practice Exercises .....	22
Important Factors Not to Neglect .....	23
<b>NAVIGATION RULES</b> .....	<b>24</b>
Operating Rules .....	24
<b>FUELING</b> .....	<b>26</b>
Fueling Procedure .....	26
Recommended Fuel .....	26
<b>TRAILERING INFORMATION</b> .....	<b>28</b>
<b>IMPORTANT ON-PRODUCT LABELS</b> .....	<b>29</b>
Watercraft Safety Labels .....	29
Compliance Labels .....	34
<b>PRE-RIDE INSPECTION</b> .....	<b>36</b>
What to Do Before Launching the Watercraft .....	36
What to Do After Launching the Watercraft .....	39

**WATERCRAFT INFORMATION**

**CONTROLS** ..... **42**

    1) Handlebar ..... 45

    2) Engine START/STOP Button ..... 45

    3) Engine Cut-Off Switch ..... 45

    4) Throttle Lever ..... 47

    5) iBR Lever (intelligent Brake and Reverse) ..... 47

    6) MODE/SET Buttons ..... 48

    7) UP/DOWN Buttons ..... 48

    8) Cruise Button ..... 48

    9) VTS Button (Variable Trim System) ..... 49

    10) Sport Button ..... 49

    11) ECO Button ..... 49

**INFORMATION CENTER (GAUGE) (GTS)** ..... **50**

    Multifunction Gauge Description ..... 50

    Gauge Setup ..... 52

**INFORMATION CENTER (GAUGES) (GTI/GTR/WAKE)** ..... **53**

    Analog Speedometer Description ..... 54

    Analog Tachometer Description ..... 54

    Multifunction Gauge Features ..... 54

    Multifunction Gauge Description ..... 55

    Navigating the Multifunction Display ..... 60

    Changing Numerical Display Indication ..... 63

    Resetting Numerical Display Indication ..... 64

    Multifunction Gauge Setup ..... 64

    Analog Speedometer Description ..... 65

    Analog Tachometer Description ..... 65

**EQUIPMENT** ..... **66**

    1) Glove Box ..... 66

    2) Front Storage Compartment ..... 66

    3) Seat ..... 67

    4) Passenger Handhold ..... 67

    5) Boarding Step ..... 68

    6) Boarding Platform ..... 68

    7) Front and Rear Eyelets ..... 69

    8) Bilge Drain Plugs ..... 69

    9) Ski/Wakeboard Post ..... 70

    10) Wakeboard Rack ..... 70

**BREAK-IN PERIOD** ..... **73**

    Operation During Break-In Period ..... 73

**OPERATING INSTRUCTIONS** ..... **74**

    Boarding the Watercraft ..... 74

    How to Start Engine ..... 77

    How to Stop the Engine ..... 77

    How to Steer the Watercraft ..... 78

<b>OPERATING INSTRUCTIONS (cont'd)</b>	
How to Engage Neutral .....	79
How to Engage Forward .....	79
How to Engage and Use Reverse .....	79
How to Engage and Use Braking .....	81
How to Use the Variable Trim System (VTS) .....	82
General Operating Recommendations .....	85
<b>OPERATING MODES .....</b>	<b>88</b>
Touring Mode .....	88
Sport Mode .....	88
ECO Mode (Fuel Economy Mode) .....	90
Cruise Mode .....	91
Slow Speed Mode .....	93
Ski Mode .....	95
Learning Key and Rental Key Modes .....	98
<b>SPECIAL PROCEDURES .....</b>	<b>100</b>
Jet Pump Water Intake and Impeller Cleaning .....	100
Capsized Watercraft .....	103
Submerged Watercraft .....	103
Water-Flooded Engine .....	104
Towing the Watercraft in Water .....	104

***MAINTENANCE INFORMATION***

<b>MAINTENANCE SCHEDULE .....</b>	<b>106</b>
<b>MAINTENANCE PROCEDURES .....</b>	<b>110</b>
Engine Oil .....	110
Engine Coolant .....	112
Ignition Coils .....	113
Spark Plugs .....	114
Exhaust System .....	115
Ride Plate and Water Intake Grate .....	116
Ski/Wakeboard Post (Wake) .....	116
Fuses .....	117
<b>WATERCRAFT CARE .....</b>	<b>119</b>
Post-Operation Care .....	119
Watercraft Cleaning .....	119
<b>STORAGE AND PRESEASON PREPARATION .....</b>	<b>120</b>
Storage .....	120
Preseason Preparation .....	122

***TECHNICAL INFORMATION***

<b>WATERCRAFT IDENTIFICATION .....</b>	<b>124</b>
Hull Identification Number .....	124
Engine Identification Number .....	124

<b>ENGINE EMISSIONS INFORMATION</b> .....	<b>125</b>
Manufacturer's Responsibility .....	125
Dealer's Responsibility .....	125
Owner Responsibility .....	125
EPA Emission Regulations .....	125
<b>SPECIFICATIONS</b> .....	<b>126</b>

***TROUBLESHOOTING***

<b>TROUBLESHOOTING GUIDELINES</b> .....	<b>136</b>
<b>MONITORING SYSTEM</b> .....	<b>140</b>
Fault Codes .....	140
Fault Indicators and Message Display Information.....	141
Beeper Code Information .....	143

***WARRANTY***

<b>BRP LIMITED WARRANTY – USA AND CANADA: 2012 SEA-DOO® PERSONAL WATERCRAFT</b> .....	<b>146</b>
<b>CALIFORNIA EMISSION CONTROL WARRANTY STATEMENT FOR MODEL YEAR 2012 SEA-DOO® PERSONAL WATERCRAFT WITH 4-TEC® ENGINES</b> .....	<b>150</b>
<b>BRP INTERNATIONAL LIMITED WARRANTY: 2012 SEA-DOO® PERSONAL WATERCRAFT</b> .....	<b>154</b>
<b>BRP LIMITED WARRANTY FOR THE EUROPEAN AND THE RUSSIAN ECONOMIC AREAS AND TURKEY: 2012 SEA-DOO® PERSONAL WATERCRAFT</b> .....	<b>158</b>

***CUSTOMER INFORMATION***

<b>PRIVACY INFORMATION</b> .....	<b>164</b>
<b>CHANGE OF ADDRESS/OWNERSHIP</b> .....	<b>165</b>



# ***SAFETY INFORMATION***

---

# GENERAL PRECAUTIONS

## Avoid Carbon Monoxide Poisoning

All engine exhaust contains carbon monoxide, a deadly gas. Breathing carbon monoxide can cause headaches, dizziness, drowsiness, nausea, confusion and eventually death.

Carbon monoxide is a colorless, odorless, tasteless gas that may be present even if you do not see or smell any engine exhaust. Deadly levels of carbon monoxide can collect rapidly, and you can quickly be overcome and unable to save yourself. Also, deadly levels of carbon monoxide can linger for hours or days in enclosed or poorly ventilated areas. If you experience any symptoms of carbon monoxide poisoning, leave the area immediately, get fresh air and seek medical treatment.

To prevent serious injury or death from carbon monoxide:

- Never run the watercraft in poorly ventilated or partially enclosed areas such as watercraft houses, seawalls or other boats in close proximity. Even if you try to ventilate engine exhaust, carbon monoxide can rapidly reach dangerous levels.
- Never run the watercraft outdoors where engine exhaust can be drawn into a building through openings such as windows and doors.
- Never stand behind the watercraft while the engine is running. A person standing behind a running engine may inhale high concentrations of exhaust fumes. Inhalation of concentrated exhaust fumes that contain carbon monoxide can result in CO poisoning, serious health problems and death.

## Avoid Gasoline Fires and Other Hazards

Gasoline is extremely flammable and highly explosive. Fuel vapors can spread and be ignited by a spark or

flame many feet away from the engine. To reduce the risk of fire or explosion, follow these instructions:

- Use only an approved red gasoline container to store fuel.
- Strictly adhere to the instructions in *FUELING* section.
- Never start watercraft if gasoline or gasoline vapor odors is present in the engine compartment.
- Never start or operate the engine if the fuel cap is not properly secured.
- Do not carry gasoline containers in the front storage compartment or anywhere else on the watercraft.

Gasoline is poisonous and can cause injury or death.

- Never siphon gasoline with your mouth.
- If you swallow gasoline, get any in your eyes, or inhale gasoline vapors, see a doctor immediately.

If gasoline is spilled on you, wash thoroughly with soap and water and change your clothes.

## Avoid Burns from Hot Parts

Certain components may become hot during operation. Avoid contact with those parts.

## Accessories and Modifications

Do not make unauthorized modifications, or use accessories that are not approved by BRP. Since these changes have not been tested by BRP, they may increase the risk of accidents or injuries, and they can make the watercraft illegal for use on water.

See your authorized Sea-Doo dealer for available accessories for your watercraft.

# SPECIAL SAFETY MESSAGES

## Reminders Regarding Safe Operation

The performance of this watercraft may significantly exceed that of other watercraft you may have operated. Make sure you read and understand the content of this Operator's Guide to become completely familiar with the controls and operation of the watercraft before embarking on your first trip, or taking on a passenger(s). If you have not had the opportunity to do so, practice driving solo in a suitable traffic free area to become accustomed to the feel and response of each control. Be fully familiar with all controls before accelerating above idle speed. Do not assume that all PWCs handle identically. Each model differs, often substantially.

Always keep in mind that as the throttle lever is returned to the idle position, less directional control is available. To turn the watercraft, both steering and throttle are necessary. Do not release throttle when trying to steer away from objects. Your need throttle to steer. If the engine is shut off, directional control is lost.

Although most watercraft have no means of braking, advancement in technologies now permit us to offer models that are equipped with a braking system called the iBR™ system. Practice braking maneuvers in a safe traffic-free area to become familiar with handling under braking and with stopping distances under various operating conditions.

### **WARNING**

Stopping distance will vary depending on initial speed, load, wind, number of riders and water conditions. The amount of braking power commanded by the operator using the iBR lever (intelligent Brake and Reverse) will also affect stopping distance.

When braking, riders must brace themselves against the deceleration force to prevent from moving forward on the watercraft and losing balance.

When operating an iBR equipped watercraft, be aware that other boats following or operating in close proximity may not be able to stop as quickly.

When at speed and the brake is first applied, a plume of water will shoot up in the air behind the watercraft which may cause the operator of a following watercraft to momentarily lose sight of your PWC. It is important to inform the operator of a watercraft who intends to follow in a convoy formation, of the braking and maneuvering capability of your PWC, what the plume of water indicates, and that a greater distance should be maintained between watercraft.

When actuating the iBR control lever while the watercraft has some forward speed, the braking mode will engage and generate a deceleration proportional to the iBR lever position. The more you pull in the iBR lever, the greater the braking force becomes. Be careful to gradually actuate the iBR lever to adjust the intensity of the braking force, and to simultaneously release the throttle lever.

The brake feature of the iBR system cannot prevent your PWC from drifting due to current or wind. It has no braking effect on the rearward motion. Also note that your engine must be running to be able to use the brake.

The personal watercraft jet thrust can cause injury. The jet pump may pick up debris and throw it rearward causing a risk of injuring people, damaging the jet pump, or other property.

Observe the instructions on all safety labels. They are there to help assure that you have a safe and enjoyable outing.

Do not store any objects in areas that are not designed specifically for storage.

Riding with passenger(s), pulling tubes, a skier, or a wake boarder makes the PWC handle differently and requires greater skill.

Certain PWC models come equipped with tow eyelets or a ski pole which, can be used to attach a tow rope for a skier, tube or wake boarder. Do not use these attachment points or any other portion of the watercraft to tow a para-sail or any other craft. Personal injury or severe damage may occur.

Combustion engines need air to operate; consequently this PWC cannot be totally watertight. Any maneuvers such as turning constantly in tight circles, plunging the bow through waves, or capsizing the watercraft, that cause the air inlet openings to be under water may cause severe engine problems due to water ingestion. Refer to *OPERATING INSTRUCTIONS* subsection and the *WARRANTY* section contained in this Operator's Guide.

Engine exhaust contains carbon monoxide (CO), which can cause serious health problems or death if inhaled in sufficient quantities. Do not operate the PWC in a confined area or allow CO to accumulate around the PWC, or in enclosed or sheltered areas such as when docked, or when rafting. Be aware of the risk of CO emanations from exhaust of other PWCs.

Know the waters in which the watercraft is to be operated. Current, tides, rapids, hidden obstacles, wakes and waves etc. can affect safe operation. It is not advisable to operate the watercraft in rough waters or inclement weather.

In shallow water, proceed with caution and at very low speeds. Grounding or abrupt stops may result in injury and watercraft damage. Debris may also be picked up and thrown rearward by the jet pump onto people or property.

Keep the tether cord attached to the operator's PFD or wrist (wrist strap required) at all times and keep it free from snagging on the handlebars to help ensure the engine stops should the operator fall off. After riding, remove the tether cord from the engine cut-off switch to avoid unauthorized use by children or others. If the operator falls off the watercraft and the tether cord is not attached as recommended, the watercraft engine will not stop.

Ride within your limits and level of riding ability.

Always ride responsibly and safely. Use common sense and courtesy.

Respect no wake zones, the environment, and the rights of other users of the waterways. As the operator and owner of a PWC, you are responsible for damage by the wake of your PWC. Do not let anyone throw refuse overboard.

While your watercraft has the capacity of operating at high speeds, it is strongly recommended that high speed operation only be applied when ideal conditions exist and are permitted. Higher speed operation requires a higher degree of skill and increases the risk of severe injuries.

The forces generated on the body of riders while turning, negotiating waves or wakes, operating in choppy waters, or falling off the watercraft, especially at higher speeds, may cause injury including the possibility of broken bones or more serious bodily injuries. Remain flexible and avoid sharp turns.

PWCs are not designed for night-time operation.

Avoid riding in very rough waters or practicing extreme maneuvers like jumping wakes or waves.

## Before Getting Underway

For safety reasons and proper care, always perform the pre-ride inspection as specified in your Operator's Guide before operating your watercraft.

Do not exceed the payload or passenger capacities for your watercraft. Overloading can affect maneuverability, stability and performance. Also, heavy seas reduce capacity. A payload or person capacity plate is not an excuse for failure to use common sense or good judgment.

Regularly inspect the PWC, hull, engine, safety equipment, and all other boating gear and keep them in safe operating condition.

Be sure you have the minimum required safety equipment, PFDs and any additional gear needed for your cruise.

Ensure that all lifesaving equipment, including fire extinguisher, are in safe operating condition and easily accessible. Show all passengers where this equipment is stored on the PWC, and make sure they know how to use it.

Keep an eye on the weather. Check local weather broadcasts before departure. Be alert to changing conditions.

Keep accurate and up-to-date charts of the boating area on board. Before getting underway, check water conditions in the planned boating area.

Ensure there is enough fuel on board for the planned trip. Always verify fuel level before use and during the ride. Apply the principle of 1/3 of the fuel to reach your destination, 1/3 to return, and keep 1/3 in reserve. Allow for changes due to adverse weather or other delays.

## Operator and Passenger Awareness

Read and understand all safety labels on the Sea-Doo PWC, the Operator's Guide, all other safety documents, and watch the *SAFETY DVD* before operating the PWC.

Respect applicable laws. Check local and federal boating laws applicable to the waterways where you intend to use your watercraft. Learn the local navigation rules. Know and understand the applicable navigation system (such as buoys and signs).

Remember that sun, wind, fatigue or illness may impair your judgement and reaction time.

Operation of this PWC by a person under 16 years of age, or a person with a disability that impairs vision, reaction time, judgment, or operation of the controls is NOT recommended.

Always properly use the tether cord when operating the watercraft and ensure that all passengers are familiar with its use.

Ensure that any operator and all passengers know how to swim and how to reboard the PWC from the water. Boarding in deep water can be strenuous. Practice in chest-deep water before operating or embarking your watercraft in deep water. If a passenger does not know how to swim, ensure that passenger wears a PFD at all times and take extra precautions when boating.

Never turn handlebar while someone is near the rear of watercraft. Keep away from steering moving parts (nozzle, iBR gate, linkages, etc.).

Do not start the engine or operate the watercraft if anyone is in the water nearby, or near the rear of the watercraft

Be aware of the iBR gate movement when starting the engine, shutting down the engine or using the iBR lever. Automatic movement of the gate may squeeze fingers or toes of people taking a hold on the back or your PWC.

The operator and passenger(s) should be properly seated and have a firm grip on a handhold before starting the watercraft, and at all times when the watercraft is in motion. All passenger(s)

should be instructed to use the handholds provided, or to hold on to the waist of the person in front of them. Each passenger must be able to simultaneously place both feet firmly flat against each footwell when properly seated.

When braking, riders must brace themselves against the deceleration force to prevent from moving forward on the watercraft and losing balance.

When accelerating on a PWC with a passenger(s), whether from a complete stop or while underway, always do so progressively. Fast acceleration may cause your passenger(s) to lose their balance and fall rearward off the watercraft. Make sure that your passenger(s) are aware of or can anticipate any rapid acceleration.

Severe internal injuries can occur if water is forced into body cavities as a result of falling into water or being near a jet thrust nozzle. Consequently, the wearing of a wet suit bottom is highly recommended.

Keep away from the intake grate while the engine is running. Items such as long hair, loose clothing, or PFD straps can become entangled in moving parts.

If the throttle lever is depressed while braking, the iBR system will disable the throttle command by the user. When releasing the iBR lever while the throttle lever is still depressed, the throttle command will regain control and generate an acceleration after a short delay. Release throttle lever if acceleration is not needed.

Before reboarding, make sure engine is off and the tether cord is removed from the engine cut-off switch.

To prevent accidental starting, always remove the tether cord from the engine cut-off switch when swimmers are boarding, nearby, or during removal of any weeds or debris from the intake grate.

On a PWC, never place your feet and legs in the water to aid turning.

### Operation by Minors

Minors should always be supervised by an adult whenever operating a watercraft. Laws regarding the minimum age and licensing requirements of minors may vary from one jurisdiction to another. Be sure to contact the local boating authorities for information regarding the legal operation of a PWC in the intended jurisdiction of use. BRP recommends a minimum operator age of 16 years old.

### Drugs and Alcohol

Never operate your PWC under the influence of alcohol or drugs. Like driving a car, driving a watercraft requires the operator to be sober, attentive and alert. Operating a watercraft while intoxicated or under the influence of drugs is not only dangerous, but it is also a Federal offense carrying a significant penalty. These laws are vigorously enforced. The use of drugs and alcohol, singly or in combination, decreases reaction time, impedes judgment, impairs vision, and inhibits your ability to safely operate a watercraft.

 <b>WARNING</b>
<b>Alcohol consumption and boating do not mix! Operating under the influence endangers the lives of your passengers, other boaters, and yourself. Federal laws prohibit operating a watercraft under the influence of alcohol or drugs.</b>

## Water Sports (Towing with the Watercraft)

### WARNING

**Avoid personal injury!** Your PWC is not designed for and should not be used for pulling another craft, parasails, kites, gliders, or any device which can become airborne. Use your watercraft only for water sports it was designed for.

Water skiing, wakeboarding, or riding a towed inflatable apparatus are some of the more popular water sports. Taking part in any water sport requires increased safety awareness by the participant and the watercraft operator. If you have never towed someone behind your PWC before, it is a good idea to spend some hours as an observer, working with and learning from an experienced operator. It is also important to be aware of the skill and experience of the person being towed.

Everyone participating in a water sport should observe these guidelines:

- Riding with passenger(s) or pulling a tube, skier or wakeboarder makes the watercraft handle differently and requires greater skill.
- Always respect the safety and comfort of your passenger(s) and person being towed on skis, wakeboard or other water products.
- Always carry an observer when pulling a tube, skier or wakeboarder to observe the person being towed and inform the operator about the participants' hand signals. The operator must focus his attention on operating the watercraft and the waters ahead.
- Proceed with only as much speed as required and follow the observers' instructions.
- When pulling a tube, skier, or a wake boarder, do not make tight sharp turns or use the braking system unless absolutely necessary. Remember that although this PWC is manoeuvrable and has stopping capabilities, the person in tow may not be able to avoid an obstacle, or the PWC with which it is being towed.
- Allow only capable swimmers to take part in any water sport.
- Always wear an approved personal flotation device (PFD). Wearing a properly designed PFD helps a stunned or unconscious person stay afloat.
- Be considerate to others you share the water with.
- Both the operator and observer should monitor the location of the tow rope when participating in watersports. A slack tow rope can become entangled with a person(s) or objects on the PWC or in the water, particularly when making a tight turn or circling, and cause serious personal injury.
- Do not tow a person in any water sport on a short tow rope such that the person inhales exhaust fumes in concentration. Inhalation of concentrated exhaust fumes, which contain carbon monoxide, can result in CO poisoning, personal injury and death.
- Use a tow rope of sufficient length and size, and make sure it is adequately secured to your watercraft. While some watercraft are equipped or can be fitted with a specially designed towing mechanism, avoid installing a tow pole on a PWC. It can become a hazard should someone fall on it.
- Give immediate attention to a person who has fallen. He or she is vulnerable in the water alone and may not be seen by other boaters.

- Approach a person in the water from the lee side (opposite the direction of the wind). Turn off the motor before coming close to the person.
- Participate in water sports only in safe areas. Stay away from other boats, channels, beaches, restricted areas, swimmers, and heavily traveled waterways and underwater obstructions.
- Turn off the engine and anchor the watercraft before swimming.
- Swim only in areas designated as safe for swimming. These are usually marked with a swim area buoy. Do not swim alone or at night.



#### SWIM AREA BUOY

- Do not water ski between sunset and sunrise. It is illegal in most areas.
- Do not drive the watercraft directly behind a water skier, tuber or wakeboarder. At 40 km/h (25 MPH) per hour, the watercraft will overtake a person who falls in the water 60 m (197 ft) in front of your watercraft in about 5 seconds.
- Shut off the engine and remove the tether cord from the engine cut-off switch when anyone is in the water nearby.
- Stay at least 45 m (148 ft) away from areas marked by a diver down float.

**Avoid personal injury!** Do not allow anyone near the propulsion system or intake grate, even when the engine is off. Items such as long hair, loose clothing or personal flotation device

straps can become entangled in moving parts resulting in serious injury or drowning. In shallow water, shells, sand, pebbles or other objects could be drawn up by the jet pump and be thrown rearward.



#### DIVER DOWN FLOAT

For more information on approved, legal and safe practice of water sports, please contact the local legal authority on water sports safety for the area you plan to practice in.

## Hypothermia

Hypothermia, the loss of body heat resulting in a subnormal body temperature, is a significant cause of death in boating accidents. After an individual has succumbed to hypothermia, he or she will lose consciousness and then drown.

PFDs can increase survival time because of the insulation they provide.

Naturally, the warmer the water, the less insulation one will require. When operating in cold water (below 4°C (40°F)) consideration should be given to using a coat or jacket style PFD as they cover more body area than the vest style PFDs.



Some points to remember about hypothermia protection:

- While afloat in the water, do not attempt to swim unless it is to reach a nearby watercraft, fellow survivor, or a floating object onto which you can lean or climb. Unnecessary swimming increases the rate of body heat loss. In cold water, drown-proof methods that require putting your head in the water are not recommended. Keep your head out of the water. This will greatly lessen heat loss and increase your survival time.
- Maintain a positive attitude about your survival and rescue. This will improve your chances of extending your survival time until you can be rescued. Your will to live does make a difference!
- If there is more than one person in the water, huddling together is recommended. This action tends to reduce the rate of heat loss and thus increase the survival time.
- Always wear your PFD. It won't help you fight off the effects of hypothermia if you don't have it on when you go into the water.

## **Safe Boating Courses**

Many countries recommend or require a boating safety course. Check with your local competent authorities.

Check local and federal boating laws applicable to the waterways where you intend to use your watercraft. Learn the local navigation rules. Know and understand the applicable navigation system (such as buoys and signs).

---

# ACTIVE TECHNOLOGIES (iCONTROL)

## Introduction

**NOTE:** Some functions or features described in this section may not apply to every PWC model, or may be available as an option.

iControl™ (intelligent Control systems) provides an environment whereby the operator can control many systems without taking his hands off the handlebars.

All controls are at the operator's finger tips and activated by pressing a button or pulling a lever. The operator's attention can thus remain focused on the water and driving the watercraft.

Each control is electronic and provides a command signal to an electronic module whose function is to assure proper operation of its system within set parameters.

The various systems grouped under iControl are the:

- iTCT™ (intelligent Throttle Control)
- iBR (intelligent Brake and Reverse)
- O.T.A.S. (Off Throttle Assisted Steering).

These systems function together to provide features such as cruise mode, slow speed mode and braking, improved watercraft response to operator inputs, increased maneuverability and control.

It is extremely important for operators to read all information contained in this operator's guide so as to become familiar with this watercraft, its systems, controls, capabilities and limitations.

## iTC (intelligent Throttle Control)

The system uses an electronic throttle control (ETC) that provides command signals to the ECM (Engine Control Module). With this system, there is no need for a traditional throttle cable.

The iTC allows the following operating modes:

- Touring mode
- Sport mode
- ECO mode
- Cruise mode
- Slow speed mode
- Ski mode.

The O.T.A.S.™ (Off Throttle Assisted Steering) is also controlled by the iTC.

## Touring Mode

Touring mode is the default riding mode.

In touring mode, available engine power and acceleration is reduced when accelerating from a complete stop and when operating in the low engine power range under certain conditions.

## Sport Mode

In sport mode, maximum engine power is available throughout the engine operational range.

Refer to *OPERATING MODES* subsection for detailed instructions.

## ECO Mode

When ECO mode is selected (fuel economy mode), engine RPM is limited whereby an optimal cruising speed is maintained in order to reduce fuel consumption.

Refer to *OPERATING MODES* subsection for detailed instructions.

## Cruise Mode

Cruise mode allows the operator to set a desired maximum speed of the watercraft.

Cruise mode limits watercraft speed but does not maintain it. The operator must hold the throttle lever depressed to maintain forward speed,

unlike an automotive type cruise control which maintains a constant speed while throttle pedal is released.

As you proceed under a constant cruising speed setting, hold the throttle lever fully depressed in order to keep your full attention to maintaining good situational awareness.

Refer to *OPERATING MODES* subsection for detailed instructions.

### Slow Speed Mode

Slow speed mode is a function of cruise mode which allows the operator to adjust and set idle speed corresponding to a watercraft speed of 1.6 km/h to 11 km/h (1 MPH to 7 MPH). The throttle lever should not be depressed while operating in slow speed mode.

Refer to *OPERATING MODES* subsection for detailed instructions.

### Ski Mode

Ski mode allows for a controlled launch and accurately maintained maximum towing speed when towing a skier or wake boarder.

Refer to *OPERATING MODES* subsection for detailed instructions.

### O.T.A.S.™ System (Off-Throttle Assisted Steering)

The O.T.A.S. (Off-Throttle Assisted Steering) system provides additional maneuverability in off-throttle situations.

The OTAS system is electronically activated when the operator initiates a full turn and releases the throttle at the same time.

### Limitations

The O.T.A.S. system cannot help you maintain control or prevent collisions in all situations.

Refer to *OPERATING INSTRUCTIONS* subsection for details.

### Learning Key and Rental Key Modes

The Sea-Doo™ learning key limits the speed of the watercraft therefore enabling first time users and less experienced operators to learn how to operate the watercraft while gaining the necessary confidence and control.

The rental key is applicable only to rental models. It functions similarly as a learning key.

### Limitations

The ability of a novice to operate the watercraft can be exceeded even when a learning or rental key is used.

Refer to *OPERATING MODES* subsection for details.

### iBR (intelligent Brake and Reverse System)

#### *All Models Except GTS*

This watercraft uses an electronically controlled braking and reverse system called the iBR system (intelligent Brake and Reverse).

The iBR module controls the position of the iBR gate to provide:

- Forward
- Reverse
- Neutral
- Braking.

The operator commands the position of the iBR gate using either the throttle lever for forward position, or the iBR lever for neutral, reverse, and for the braking function.

**NOTE:** The iBR lever can only be used to command a change in the gate position if the engine is running.

Using the iBR system significantly reduces the stopping distance of this watercraft and can increase its maneuverability as it can be used in a straight line, in a turn, at high or low speeds, or to propel the watercraft in reverse for docking or maneuvering in very close quarters.

Under ideal conditions, experienced operators were consistently able to reduce the stopping distance of a watercraft equipped with an iBR system by approximately 33%, from an initial speed of 80 km/h (50 MPH).

### **Limitations**

Even when equipped with an iBR system, watercraft do not have the ability of land based vehicles.

Stopping distance will vary notably depending on initial speed, load, wind, current, water conditions and the amount of braking.

The iBR system has no effect on the rearward motion.

It cannot prevent your watercraft from drifting in current or wind.

# SAFETY EQUIPMENT

## Required Safety Equipment

The operator and the passenger(s) must wear an approved Personal Flotation Device (PDF) that is suitable for PWC use.

Operator and passenger(s) should have ready access to shatterproof glasses should riding conditions or personal preference warrant.

Wind, water spray and speed may cause a person's eyes to water and create blurred vision.

As the owner of the watercraft, you are responsible for assuring that all required safety equipment is aboard. You should also consider supplying additional equipment as needed for your safety and that of your passengers. Check state and local regulations about required safety equipment.

Safety equipment required by regulations is mandatory. If local regulations require additional equipment, it must be approved by a competent authority. Minimum requirements include the following:

- Personal flotation devices (PFDs)
- A buoyant heaving line of 15 m (50 ft) minimum
- A watertight flashlight or approved flares
- Signaling device
- Sound producing devices (air horn or whistle).

## Recommended Protective Gear

The operator and passenger(s) of PWCs must wear protective gear, including:

- A wet suit bottom, or thick tightly woven and snug fitting clothing that provides equivalent protection. As an example, thin bike shorts would not be appropriate. Severe internal injuries can occur if water is forced into body cavities as a result of falling in the water or being near jet thrust nozzle. Normal swimwear does not adequately protect against forceful entry of water into the lower male or female body opening(s).
- Footwear, gloves, safety goggles or glasses are also recommended. Some type of lightweight, flexible foot protection is recommended. This will help reduce possible injury, should you step on sharp underwater objects.

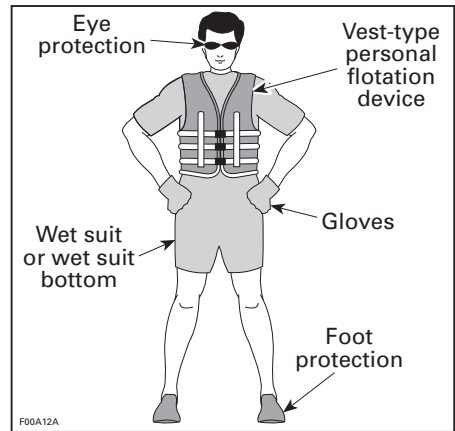

## Personal Flotation Devices (PFDs)

Each person on a recreational watercraft must wear a personal flotation device (PFD) at all times. Ensure that these PFDs meet your country's regulations.

A PFD provides buoyancy to help keep the head and face above the water, and to help maintain a satisfactory body position while in the water. Body weight and age should be considered when selecting a PFD. The buoyancy provided by the PFD should support your weight in water. The size of the PFD should be appropriate for the wearer. Body weight and chest size are common methods used to size PFDs. It is your responsibility to ensure that you have the proper number and types of PFDs on board to comply with federal and local regulations, and that your passengers know where they are and how to use them.

### PFD Types

There are five types of approved PFDs.

**PFD Type I, Wearable**, has the greatest required buoyancy. Its design allows for turning most unconscious persons in the water from face down position to a vertical or slightly backward, face-up position. It can greatly increase the chances of survival. Type I is most effective for all waters, especially offshore when rescue may be delayed. It is also the most effective in rough waters.

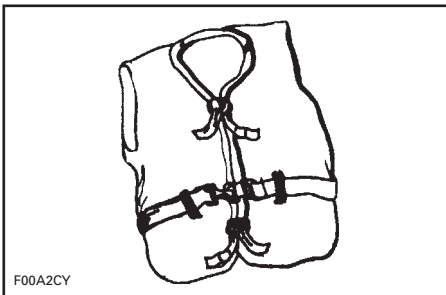

**TYPE I — WEARABLE**

**PFD Type II, Wearable**, turns its wearer in the same way as Type I, but not as effectively. The Type II does not turn as many persons under the same conditions as a Type I. You may prefer to use this PFD where there is a prob-

ability of quick rescue such as in areas where other people are commonly involved in water activities.

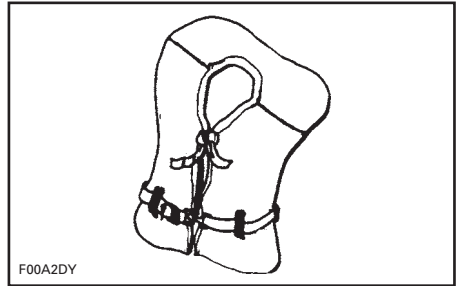

**TYPE II — WEARABLE**

**PFD Type III, Wearable**, allows wearers to place themselves in a vertical or slightly backward position. It does not turn the wearer. It maintains the wearer in a vertical or slightly backward position and has no tendency to turn the wearer face down. It has the same buoyancy as a Type II PFD and may be appropriate in areas where other people are commonly involved in water activities.

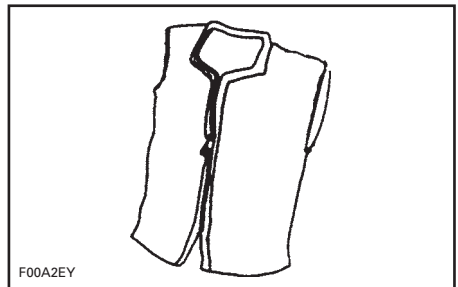

**TYPE III — WEARABLE**

**PFD Type V, Wearable**, must be worn. When inflated, it provides buoyancy equivalent to Type I, II or III PFDs. When it is deflated, however, it may not support some people.

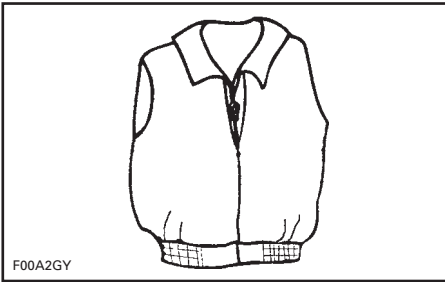

F00A2GY

TYPE V — WEARABLE

## Helmets

### Some Important Considerations

Helmets are designed to offer some degree of protection in case of impacts to the head. In most motorized sports, the benefits of wearing a helmet clearly outweigh the drawbacks. However, in the case of motorized watersports such as riding personal watercraft, this is not necessarily true as there are some particular risks associated with the water.

### Benefits

A helmet helps to reduce the risk of injury in case of a head impact against a hard surface such as another craft in the case of a collision. Similarly, a helmet with a chin guard might help prevent injuries to the face, jaw or teeth.

### Risks

On the other hand, in some situations when falling off the watercraft, helmets have a tendency to catch the water, like a "bucket", and put severe stresses on the neck or spine. This could result in choking, severe or permanent neck or spine injury or death.

Helmets may also interfere with peripheral vision and hearing, or increase fatigue which, could contribute to increase the risk of a collision.

## Weighing the Risks vs Benefits

In order to decide whether or not you should wear a helmet, it is best to consider the particular environment you will be riding in, as well as other factors such as personal experience. Will there be a lot of traffic on the water? What is your riding style?

## The Bottom Line

Since each option minimizes some risks, but increases others, before each ride you must decide whether to wear or not wear a helmet based on your particular situation.

If you decide to wear a helmet, you must then decide what type is the most appropriate for the circumstances. Look for helmets that meet DOT or Snell standards, and if possible, choose one designed for motorized watersports.

## Additional Recommended Equipment

It is recommended that you acquire additional equipment for safe, enjoyable cruising. This list, which is not all inclusive, includes items you should consider acquiring.

- Small tool kit
- Local map
- First aid kit
- Tow rope
- Flares
- Paddle
- Anchor
- Mooring cords.

A cellular telephone in a waterproof bag or container has also been found to be beneficial to boaters when in distress or just for contacting someone on shore.

---

# PRACTICE EXERCISES

It is always a good idea to practice and get familiar with all controls, functions and handling characteristics of your watercraft before venturing on the water.

Always secure the tether cord to the engine cut-off switch and the clip to your PFD or a wrist strap.

## Where to Practice Exercises

Find a suitable area to practice the exercises. Ensure the area meet the following requirements:

- No traffic
- No obstacles
- No swimmers
- No current
- Ample space to maneuver
- Water depth is adequate.

## Practice Exercises

Practice **alone** the following exercises.

### Turning

Practice turning in circles in both directions at slow speed. When comfortable with the exercise, increase difficulty by making some figure 8.

When this is mastered, repeat the above exercises but at increased speed.

### Stopping Distances

#### Watercraft not Equipped with iBR

Practice stopping the watercraft in a straight line at different speeds.

Remember, water drag is the main factor which reduces the watercraft speed and thus the stopping distance.

**NOTE:** The watercraft speed, load, current and wind also play an important role in affecting stopping distances.

#### Watercraft Equipped with iBR

Practice stopping the watercraft in a straight line at various speeds and braking force.

Remember that watercraft speed, load, water conditions, current and wind also affect stopping distances.

### Reverse

#### *Except Watercraft not Equipped with iBR*

Practice reverse operation to learn how the watercraft operates in reverse and reacts with steering inputs.

**NOTE:** Always perform this exercise at slow speeds.

### Avoiding an Obstacle

Practice obstacle avoidance (choose a virtual point on the water) by steering the watercraft and maintaining throttle.

Repeat exercise, but this time release throttle while turning.

**NOTE:** With this exercise, you will learn that you need throttle to steer the watercraft in a different direction.

### Docking

#### Watercraft not Equipped with iBR

Practice docking using the throttle and steering to become familiar with the response of the PWC and to develop good control skills.

#### Watercraft Equipped with iBR

Practice docking using the throttle, iBR lever and the steering to become familiar with the response of the PWC, and to develop good control skills.

**NOTE:** Remember that steering direction is reversed when backing.



## Slow Speed Mode, Ski Mode and Cruise Mode

If your watercraft has any of these modes, it is also important to understand their operation and to become familiar with these features prior to using them on a ride with other people.

### **WARNING**

The ski and the cruise modes are not an automatic pilot; they will not drive the watercraft for you.

## Important Factors Not to Neglect

In addition, always remember that the following conditions have a direct impact on how your watercraft will behave and respond to different inputs:

- Loads
- Currents
- Wind
- Water conditions.

Make sure to be alert to these conditions, and adapt accordingly. If possible, practice further in these conditions.

For delicate maneuvers, the best advice is always to try to reduce your speed to a minimum.

# NAVIGATION RULES

## Operating Rules

Operating a watercraft can be compared with driving on unmarked highways and roads. To prevent collisions or avoid other boaters, a system of operating rules must be followed. It's not only common sense... it's the law!

Generally keep to your right and safely avoid collisions by keeping a safe distance from other watercraft, boats, people and objects.

The following illustration identifies different parts of a boat that are used as directional reference points, the bow being the front of the boat. The port side of boat (left side) is visually identifiable by a RED light off the bow, and the starboard side (right side) by a GREEN light.

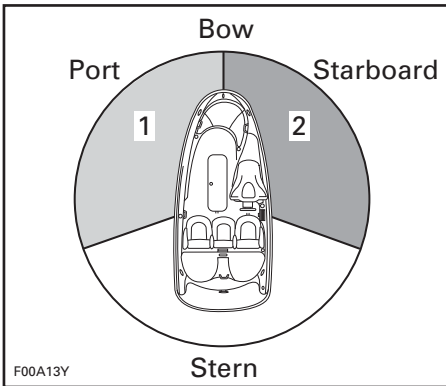

### TYPICAL - DIRECTIONAL REFERENCE POINTS

1. RED light
2. GREEN light (yield zone)

## Crossing

Give the right of way to a watercraft ahead and to your right. Never cross in front of a boat, you should see his RED light, he should see your GREEN light (he has the right of way).

Personal watercraft (PWC) do not have these colored lights, but the rule still applies.

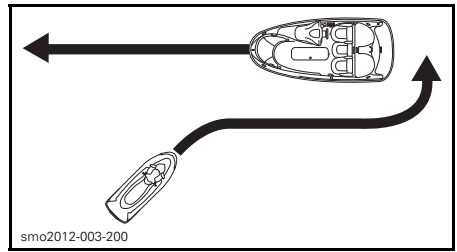

### TYPICAL

Like a street traffic light, if you see a **RED** light, **STOP**, give the right of way. The other boat is to your right and it has the right of way.

If you see a **GREEN** light, **pass with caution**. The other boat is to your left, you have the right of way.

## Meeting Head-On

Keep right.

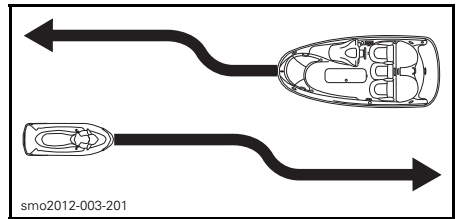

### TYPICAL

## Passing

Give the right of way to other crafts and keep clear.

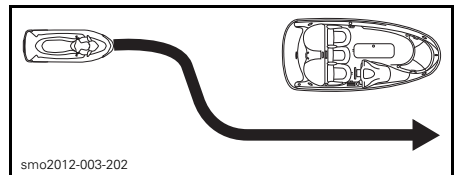

### TYPICAL

## Navigation System

Navigational aids, such as signs or buoys, can assist you in identifying safe waters. Buoys will indicate whether you should keep to the right (starboard) or to the left (port) of the

buoy, or to which channel you can continue. They may also indicate whether you are entering a restricted or controlled area such as a no wake or low speed zone. They may also indicate hazards or pertinent boating information. Markers may be located on shore or on the water. They can also indicate speed limits, no power craft or boating, anchorage and other useful information. (The shape of each type of marker will provide assistance).

Make sure you know and understand the navigation system applicable to the waterways where you intend to use the watercraft.

### **Collision Avoidance**

Do not release the throttle when trying to steer away from an obstacle. Engine power and jet pump thrust is required to steer the watercraft.

Always keep a constant lookout for other water users, other boats or objects, especially when turning. Be alert for conditions that may limit your visibility or block your vision of others.

Respect the rights of other recreationists and/or bystanders and always keep a safe distance from all other watercraft, boats, people and objects.

Do not wake or wave jump, ride the surf line or attempt to spray or splash others with your watercraft. You may misjudge the ability of the watercraft or your own riding skills and strike a boat, watercraft or person.

This watercraft has the capability of turning more sharply than other boats, however, unless in an emergency, do not negotiate sharp, high speed turns. Such maneuvers make it hard for others to avoid you or understand where you are going. Also, you and/or your passenger(s) could be thrown from the watercraft.

### ***Watercraft Equipped with iBR***

Unlike most other watercraft, this PWC has a braking system (iBR).

When operating an iBR equipped watercraft, be aware that other boats following or operating in close proximity may not be able to stop as quickly.

When at speed and the brake is first applied, a plume of water will shoot up in the air behind the watercraft indicating a braking manoeuvre.

It is important to inform the operator of a watercraft who intends to follow in a convoy formation of the braking and maneuvering capability of your PWC, what the plume of water indicates, and that a greater distance should be maintained between both of you.

Stopping distance will vary depending on initial speed, load, wind and water conditions.

Although the preferable maneuver to avoid an obstacle is to steer away while applying throttle, the iBR can also be used by fully braking and turning in the appropriate direction to avoid the obstacle.

# FUELING

## Fueling Procedure

### **⚠ WARNING**

Fuel is flammable and explosive under certain conditions. Always work in a well ventilated area. Do not smoke or allow open flames or sparks in the vicinity.

1. Turn off engine.

### **⚠ WARNING**

Always stop the engine before refueling.

2. Do not allow anyone to remain on the watercraft.
3. Tie watercraft securely to the fueling pier.
4. Have a fire extinguisher close at hand.
5. Open the front storage compartment cover.
6. Locate fuel tank cap.



TYPICAL - FUEL TANK CAP LOCATION

1. Fuel tank cap (front storage cover open)

7. Slowly unscrew the fuel cap counterclockwise.

### **⚠ WARNING**

Fuel tank may be pressurized, fuel vapors may be released while removing the fuel tank cap.

8. Insert the gas pump spout into the filler neck and fill up the fuel tank.

### **⚠ WARNING**

To prevent fuel back-flow, fill tank slowly so the air can escape from the fuel tank.

9. Stop filling immediately after the release of the gas pump nozzle handle and wait a moment before removing the spout. Do not retract the gas pump nozzle to put more fuel in fuel tank.

### **⚠ WARNING**

Do not overfill or top off the fuel tank and leave the watercraft in the sun. As temperature increases, fuel expands and may overflow.

10. Reinstall fuel tank cap and fully tighten it clockwise.

### **⚠ WARNING**

Always wipe off any fuel spillage from the watercraft.

11. After refueling, always open the seat and ensure there is no gasoline vapor odor inside the engine compartment.

### **⚠ WARNING**

Do not start watercraft if gasoline or gasoline vapor odor is present.

## Recommended Fuel

Use unleaded gasoline with the following octane rating.

**NOTICE** Never experiment with other fuels. Never use fuel containing more than 10% ethanol or methanol. The use of a non-recommended fuel can result in decreased engine performance and damage to critical parts in the fuel system and engine.

### Inside North America

MINIMUM OCTANE RATING		
ENGINE	OCTANE	
	87	91
130/155 engines Naturally-aspirated	X	–
215 engine Supercharged Intercooled	X	X <sup>(1)</sup>

<sup>(1)</sup> For optimum engine performance.

### Outside North America

MINIMUM OCTANE RATING		
ENGINE	OCTANE	
	92	95
130/155 engines Naturally-Aspirated	X	–
215 engine Supercharged Intercooled	X	X <sup>(1)</sup>

<sup>(1)</sup> For optimum engine performance.

---

# TRAILERING INFORMATION

**NOTICE** The span of the trailer wood bunks including bunk width should be adjusted to provide support throughout the full length of the hull. The ends of both trailer wood bunks should not exceed the length of the watercraft.

Ensure the trailer wheels are positioned so that the center of gravity of the watercraft is slightly ahead of the wheels to properly support the weight of the watercraft.

## WARNING

Never tip this watercraft on end for transporting. We recommend that you carry the watercraft in its normal operating position.

Check the applicable laws and regulations in your area concerning towing a trailer, especially for the following items:

- Brake system
- Tow vehicle weight
- Mirrors.

Take the following precautions when towing the watercraft:

- Respect tow vehicle maximum weight capacity and the tongue weight capacity as recommended by manufacturer.
- Tie the watercraft to both front and rear (bow/stern) eyelets so that it is firmly secured on the trailer. Use additional tie-downs if necessary.
- Ensure fuel tank cap, front storage compartment cover, glove box cover and seat are properly latched.
- Observe trailering safety precautions.

**NOTICE** Do not route ropes or tie-downs over the seat or grab handle as they could be permanently damaged. Wrap ropes or tie-downs with rags or similar protectors where they can come into contact with the watercraft body.

## WARNING

Make sure seat is securely latched prior to trailering.

A Sea-Doo cover can protect the watercraft, particularly when driving on dirt roads, to prevent dirt entry through the air inlet openings.

## WARNING

When trailering the watercraft, NEVER leave any equipment on the watercraft.

### *WAKE Model*

## WARNING

NEVER leave a wakeboard installed on the rack. Otherwise, wake board fin(s) could cause injury to bystanders or wakeboard could fly off on the road.

## WARNING

Bungee cords are under tension and could spring back and whip someone when released. Use caution.

**NOTE:** When trailering 2 watercraft, it may be necessary to remove the inner wakeboard rack.

# IMPORTANT ON-PRODUCT LABELS

## Watercraft Safety Labels

The labels illustrated on the following pages are on your watercraft. If missing or damaged, they can be replaced free of charge. See an authorized Sea-Doo dealer.

Please read the following labels carefully before operating this watercraft.

**NOTE:** The first illustration of the watercraft indicates the approximate locations of the various labels. A dotted line indicates that the label is not on the outer surface, and that the seat or a cover of some type must be opened to see the label.



WATERCRAFT SAFETY LABEL LOCATION - GTS MODELS



WATERCRAFT SAFETY LABEL LOCATION - GTI SERIES

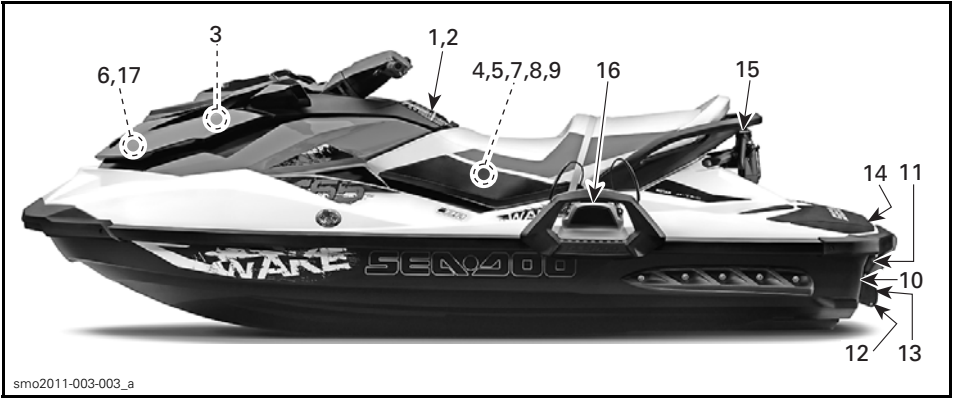

WATERCRAFT SAFETY LABEL LOCATION - WAKE MODEL

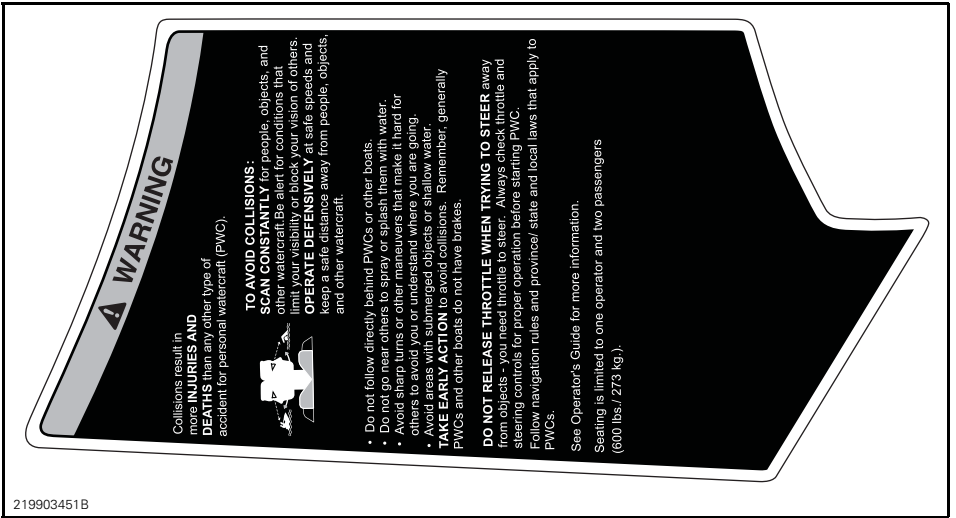

LABEL 1 - MAIN WARNING LH (GTS MODELS ONLY)





**WARNING**

Collisions result in more **INJURIES AND DEATHS** than any other type of accident for personal watercraft (PWC).



**TO AVOID COLLISIONS:**  
**SCAN CONSTANTLY** for people, objects, and other watercraft. Be alert for conditions that limit your visibility or block your vision of others. OPERATE with clearance away from people, objects, and other watercraft.

- Do not follow directly behind PWCs or other boats.
- Do not go near others to spray, or splash them with water.
- Avoid sharp turns or other maneuvers that make it hard for others to avoid you or understand where you are going.
- Avoid areas with submerged objects or shallow water.

**TAKE EARLY ACTION** to avoid collisions. Remember, generally PWCs and other boats do not have brakes.

**DO NOT RELEASE THROTTLE WHEN TRYING TO STEER** away from objects - you need throttle to steer. Always check throttle and steering controls for proper operation before starting the PWC. Follow PWC navigation rules and provincial state and local laws that apply to PWCs.

See Operator's Guide for more information.  
 Sealing is limited to one operator and two passengers (600 lbs / 273 kg.).

219903447B

**IBR INSTRUCTIONS**

**IBR INTELLIGENT BRAKE AND REVERSE FUNCTIONS:**

**How to brake**

- Squeeze brake lever

**How to reverse**

- Maintain brake lever engaged

**How to go forward**

- Tap throttle lever to engage forward movement from neutral position.
- Squeeze throttle lever to accelerate.

**How to get to neutral**

- Tap brake lever

Refer to the operator's guide for more information.

219903447B

LABEL 1 - MAIN WARNING LH (GTI SERIES AND WAKE MODELS)



**WARNING**

To reduce the risk of **SEVERE INJURY DEATH:**  
**WEAR A PERSONAL FLotation DEVICE (PFD)** that is suitable for personal watercraft (PWC) use.

**WEAR PROTECTIVE CLOTHING.** Severe internal injuries can occur if water is forced into body cavities as a result of falling into water or being against forward water entry into lower body openings of jackets or tank tops. Riders must wear a wet suit bottom or clothing that provides equivalent protection. (See Operator's Guide). Footwear, gloves, and goggles/glasses are recommended.

**KNOW BOATING LAWS.** BRP recommends a minimum training course is recommended and may be required in your provincial state.

**ATTACH ENGINE SHUT-OFF CORD (LANYARD) to PFD** and ensure the engine shut-off cord from PWC to operator falls off. After riding, remove the PWC to avoid unauthorized use by children or others.



**RIDE WITHIN YOUR LIMITS AND AVOID AGGRESSIVE MANEUVERS** to reduce the risk of loss of control, ejection, and collision. This is a high performance boat - not a toy. Avoid high speed maneuvers that increase the risk of backspinal injury (paralysis), facial injuries, and broken legs, ankles, and other bones. Do not jump wakes or waves.

**DO NOT APPLY THROTTLE WHEN ANYONE IS AT REAR** of the PWC. The engine will reverse engine. Water and debris striking a child in the back can cause severe injury.

**KEEP AWAY FROM INTAKE GRATE** while engine is on. Items such as long hair, loose clothing, or PFD straps can become entangled in moving parts resulting in severe injury or drowning.

**NEVER RIDE AFTER CONSUMING DRUGS OR ALCOHOL.**

**READ AND FOLLOW OPERATOR'S GUIDE**

219903448B

219903448B

LABEL 2 - MAIN WARNING RH

**WARNING**

- After refueling, always open the seat to ensure there is no gasoline vapor odor inside the engine compartment.
- Gasoline vapor may cause fire or explosion.
- Do not overfill gas tank.
- Keep the craft away from open flames and sparks.
- Do not start watercraft if liquid gasoline or gasoline vapor odor is present.
- Always replace seat before starting.

**AVERTISSEMENT**

- Après avoir fait le plein, toujours ouvrir le siège afin de s'assurer qu'il n'y ait pas d'émission d'essence dans le compartiment moteur.
- Les émanations d'essence peuvent provoquer des incendies ou des explosions.
- Éviter de fumer au-dessus du réservoir d'essence.
- Garder la motomarine à l'écart des flammes et des étincelles.
- Ne pas démarrer la motomarine en présence d'essence liquide ou d'émission d'essence.
- Toujours remettre le siège en place avant de démarrer la motomarine.

219903501

LABEL 3

SAFETY INFORMATION

31

**⚠ CAUTION**

**CHECKING ENGINE OIL LEVEL**

- Make sure engine is at operating temperature. (Never let engine run out of water without the flush kit connected as it may damage the engine)
- Vehicle must be level to perform verification.
- Let engine running at idle for at least 30 seconds.
- Stop engine and wait at least 30 seconds.
- Check oil level using the dipstick.
- Engine oil could be very hot.

219903135A

219903135

LABEL 4

**⚠ WARNING / AVERTISSEMENT**

When disconnecting coil from sparkplug, always disconnect coil from main harness first. Never check for engine ignition spark from an open coil and/or sparkplug in the engine compartment as spark may cause fuel vapor to ignite.

Lorsque vous déconnectez la bobine d'allumage de la bougie, toujours déconnecter la bobine d'allumage du harnais principal en premier. Ne jamais vérifier si le circuit d'allumage du moteur produit une étincelle en utilisant la bobine d'allumage et/ou la bougie dans le compartiment moteur car une étincelle pourrait entraîner l'allumage des vapeurs d'essence.

F18L0NY

LABEL 5

**⚠ WARNING**

- Remove battery from boat before charging.
- Do not overcharge battery.
- Improper charging of battery can cause explosion.

smo2009-002-106\_aen

LABEL 6

**NOTICE**

- To comply with noise regulations, this engine is designed to operate with an air intake silencer.
- Operation without air intake silencer or with one not properly installed may cause engine damage.

219903177A

219903177

LABEL 7

**⚠ CAUTION**

Certain components in the engine compartment may be very hot. Direct contact may result in skin burn.

219903132A

219903132

LABEL 8



F00A2TY

LABEL 9

**⚠ CAUTION**

When operating the engine while the watercraft is out of the water, the heat exchanger in the ride plate may become very hot. Avoid any contact with plate as burns may occur.

219903301



- Roll boat on bumper rail.
- Grab inter grate and step.
- Make sure engine is off.

**NOTICE**

219903301

LABEL 10



smo2009-002-109\_a

LABEL 11

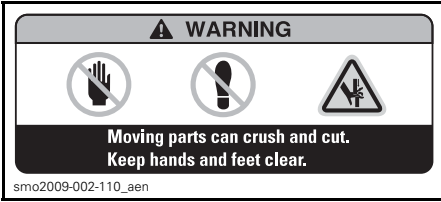

LABEL 12



LABEL 13

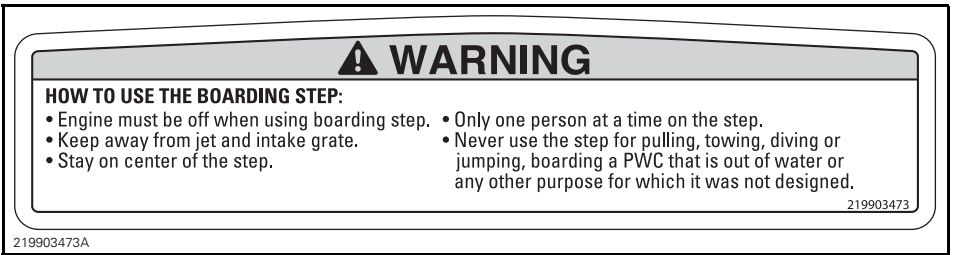

219903473A

LABEL 14 - GTI SE, GTI LTD AND WAKE MODELS

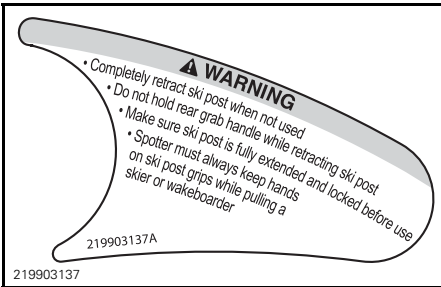

219903137

LABEL 15

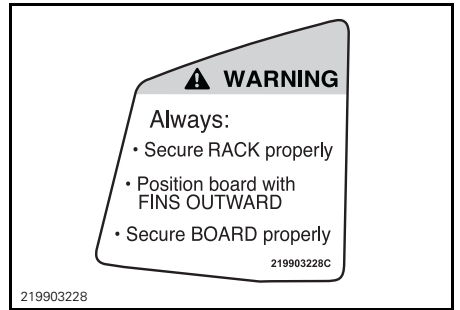

219903228

LABEL 16

**⚠ WARNING**

**Inside the storage compartment:**

- Never carry loose, fragile or hard sharp-edged objects.
- Maximum load: 9 kg (20 lb).
- Always close the cover before riding.

This is not a watertight compartment.

219903502

219903502

LABEL 17

## Compliance Labels



COMPLIANCE LABEL LOCATION



LABEL 1- EMISSION CONTROL LABEL

**EMISSION CONTROL INFORMATION**

THIS ENGINE IS CERTIFIED TO OPERATE ON UNLEADED GASOLINE AND CONFORMS TO  U.S. EPA & CALIFORNIA EMISSION / EVAP REGULATIONS FOR MARINE SI ENGINES.

ENGINE FAMILY	FAMILLE DE MOTEUR
FEL	LIMITE DES EMISSIONS DE LA FAMILLE
ENGINE DISPLACEMENT	CYLINDRÉE
EXHAUST EMISSION CONTROL SYSTEM	SYSTÈME DE CONTRÔLE DES EMISSIONS
POWER	PUISSANCE

**RENSEIGNEMENTS SUR LE DISPOSITIF ANTIPOLLUTION**

CE MOTEUR EST CERTIFIÉ POUR FONCTIONNER À L'ESSENCE SANS PLOMB ET IL RÉPOND AUX NORMES  DE L'EPA DES É.U. & RÉGLEMENTATIONS CALIFORNIENNES POUR LES MOTEURS MARINS À ALLUMAGE COMMANDE.

SEE OPERATOR'S GUIDE FOR MAINTENANCE SPECIFICATIONS  
VOIR GUIDE DU CONDUCTEUR POUR LES SPÉCIFICATIONS D'ENTRETIEN

**BOMBARDIER RECREATIONAL PRODUCTS INC.**

219903139

219903139

LABEL 2

<b>CANADIAN COMPLIANCE NOTICE AVIS DE CONFORMITÉ CANADIEN</b>	
MAXIMUM RECOMMENDED SAFE LIMITS LIMITES MAXIMALES DE SÉCURITÉ RECOMMANDÉES	
	kg lbs/lb
 + 	kg lbs/lb
CATEGORY / CATÉGORIE: C	
MAXIMUM WAVE / VAGUE MAXIMALE	2.0 m
MAXIMUM WIND SPEED / VITESSE DE VENT MAXIMALE	33.0 knots/noeuds
BOMBARDIER RECREATIONAL PRODUCT INC. BOMBARDIER PRODUITS RECREATIF INC. VALCOURT, QUÉBEC, CANADA (YDV) 	
MODEL / MODÈLE:	
<small>THE MANUFACTURER DECLARES THAT THIS PRODUCT COMPLIES WITH THE CONSTRUCTION REQUIREMENTS OF THE SMALL VESSEL REGULATIONS, AS THEY READ ON THE DAY ON WHICH THE CONSTRUCTION OF THE VESSEL WAS STARTED OR ON THE DAY ON WHICH THE VESSEL WAS IMPORTED. LE FABRICANT ATTESTE QUE CE PRODUIT EST CONFORME AUX EXIGENCES DE CONSTRUCTION DU RÉGLEMENT SUR LES PETITS BÂTIMENTS EN VIGUEUR À LA DATE DU DÉBUT DE SA CONSTRUCTION OU DE SON IMPORTATION.</small>	

219903554

LABEL 3 - CANADIAN COMPLIANCE NOTICE (CAN MODELS ONLY)

 0609 

**BOAT CATEGORY: C**

Max.  = 3

Max.  +  = 273 kg

Bombardier Recreational Products Inc. 219902637

219902637

LABEL 4 - TYPICAL (WATERCRAFT OUTSIDE NORTH AMERICA)

**THIS BOAT IS NOT REQUIRED TO COMPLY WITH THE FOLLOWING U.S. COAST GUARD SAFETY STANDARDS IN EFFECT ON THE DATE OF CERTIFICATION:**

• FUEL SYSTEM	• SAFE LOADING
• DISPLAY OF CAPACITY INFORMATION	• FLOTATION
• POWERED VENTILATION	

**AS AUTHORIZED BY U.S. COAST GUARD GRANT OF EXEMPTION (CGB 88-001).**

BOMBARDIER RECREATIONAL PRODUCTS INC.  
565 DE LA MONTAGNE STREET VALCOURT, QUÉBEC CANADA J0E 2L0

**ASSEMBLED IN CANADA**

219903510

LABEL 5 - TYPICAL

# PRE-RIDE INSPECTION

## WARNING

Perform a pre-ride inspection before each ride to detect potential problems during operation. The pre-ride inspection can help you monitor wear and deterioration before they become a problem. Correct any problems that you discover to reduce the risk of a breakdown or crash. See an authorized Sea-Doo dealer as necessary.

Before performing the pre-ride inspection, read and understand the *CONTROLS* section.

## What to Do Before Launching the Watercraft

## WARNING

Engine should be off and the tether cord cap should always be removed from the engine cut-off switch prior to verifying any of the following points. Only start watercraft once all items have been checked and operate properly.

Check the items listed in the following table before launching the watercraft.

ITEM	OPERATION	✓
Hull	Inspect.	
Jet pump water intake	Inspect/clean.	
Drain plugs	Tighten.	
Fuel tank	Refill.	
Engine compartment	Check for any fluid leaks and gasoline vapor odor.	
Engine oil level	Check/refill.	
Engine coolant level	Check/refill.	
Steering system	Check operation.	
Throttle lever	Check operation.	
iBR lever (except GTS models)	Check operation.	
Front storage compartment cover, glove box and seat	Ensure they are closed and latched.	
Wakeboard rack (WAKE model)	<ul style="list-style-type: none"><li>– Ensure rack is properly installed and secured.</li><li>– Make sure bungee cords are in good condition.</li><li>– Ensure wakeboard is correctly installed in rack and secured.</li></ul>	
Ski/wakeboard post (WAKE model)	Inspect and check operation.	
Engine cut-off switch and engine START/STOP button	Check operation.	

## Hull

Inspect hull for cracks and other damages.

## Jet Pump Water Intake

Remove weeds, shells, debris or anything else that could restrict the flow of water and damage the propulsion unit. Clean as necessary. If any obstruction cannot be removed, refer to an authorized Sea-Doo dealer for servicing.

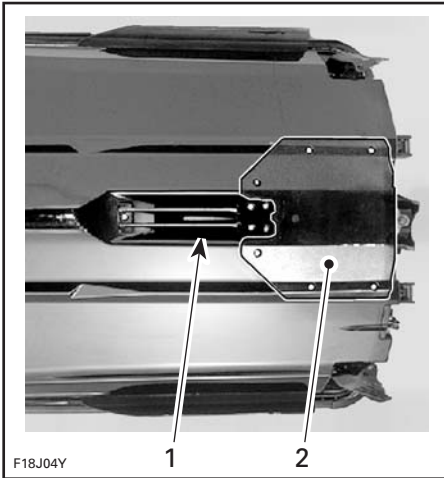

### TYPICAL — INSPECT THESE AREAS

1. Water intake
2. Ride plate

## Drain Plugs

Secure bilge drain plugs.

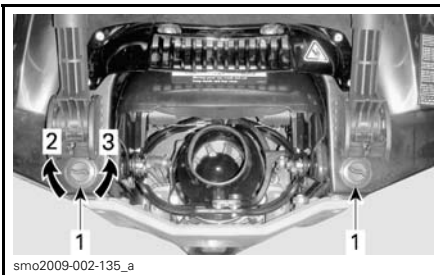

### TYPICAL - BILGE DRAIN PLUG LOCATIONS

1. Bilge drain plugs
2. Tighten
3. Untighten

## WARNING

Ensure bilge drain plugs are properly secured prior to launching the watercraft in water.

## Fuel Tank

Fill the fuel tank.

## WARNING

Strictly adhere to instructions detailed in *FUELING PROCEDURE*.

## Engine Compartment

Inspect the engine compartment for fuel vapor odor.

## WARNING

Should any leak or gasoline odor be present, do not apply electrical power or start the engine. Refer to an authorized Sea-Doo dealer before use.

To access the engine compartment, open the seat.



### ENGINE COMPARTMENT, SEAT REMOVED

## Engine Oil

Ensure oil level is within specification as described in *MAINTENANCE PROCEDURES* section.

## Engine Coolant

Ensure coolant level is within specification as described in *MAINTENANCE PROCEDURES* section.

Check for coolant leaks on engine, in bilge and from ride plate.

**⚠ CAUTION** When operating the engine with the watercraft out of the water, the engine and heat exchanger in the ride plate may become very hot. Avoid any contact with hot engine parts and the ride plate as burns may occur.

## Steering System

Assisted by another person, check steering operation for free movement.

When the handlebar is horizontal, the jet pump nozzle should be in the straight ahead position. Ensure the jet pump nozzle pivots easily and in the same direction as the handlebar (e.g.: when handlebar is turned to the left, the nozzle opening must point towards the LH side of watercraft).

### ⚠ WARNING

Check handlebar and corresponding steering nozzle operation before starting. Never turn handlebar while someone is near the rear of the watercraft. Keep away from steering moving parts (nozzle, iBR gate, linkages etc.).

## Throttle Lever

Check the Electronic Throttle Control lever (ETC) for free and smooth operation. It should return to its initial position immediately after it is released.

### ⚠ WARNING

Check throttle lever operation before starting the engine. If any friction is felt in the throttle lever, refer to an authorized Sea-Doo dealer.

## iBR Lever

### *All Models Except GTS*

Check the iBR lever for free and smooth operation. It should return to its initial position immediately after it is released.

### ⚠ WARNING

Check iBR lever operation before starting the engine. If any friction is felt in the iBR lever, refer to an authorized Sea-Doo dealer.

## Storage Compartment, Glove Box and Seat

Ensure all required safety and survival equipment and any additional cargo is properly stored in the storage compartment provided.

Ensure the front cover, glove box, and seat are closed and latched.

### ⚠ WARNING

Ensure the seat, glove box, and front storage compartment cover are securely latched.

## Wakeboard Rack

### *WAKE Model*

### ⚠ WARNING

Ensure wakeboard rack is properly secured to watercraft body, and that the wakeboard is properly positioned and secured to the rack prior to using watercraft. Ensure wakeboard retaining straps are in good condition.

## Ski/Wakeboard Post

### *WAKE Model*

Make sure ski/wakeboard post is fully extended and locked before use.

Completely retract and lock when not used.



**⚠ WARNING**

Use caution with skier/wakeboarder in tow as tow rope may backlash to watercraft when released. Never perform a sharp turn when towing a skier, wakeboarder or any toy.

**NOTICE** The ski/wakeboard post is designed for towing a skier or wakeboarder with a maximum gross weight of 114 kg (250 lb).

**Engine Cut-Off Switch and Engine START/STOP Button**

Press the start button once without installing the tether cord cap on the engine cut-off switch.

Install the tether cord cap on the engine cut-off switch.

Press the START/STOP button to start the engine, then stop it by pressing the START/STOP button a second time.

**NOTE:** To allow engine starting, the tether cord cap must be properly installed on the engine cut-off switch within 5 seconds of pressing the START/STOP button.

Restart the engine, then stop it by removing the tether cord from the engine cut-off switch.

**⚠ WARNING**

Should the tether cord cap be loose or fail to remain on the engine cut-off switch, replace the tether cord immediately in order to avoid unsafe use. If removing the tether cord cap from the engine cut-off switch or pressing the START/STOP button does not stop the engine, do not use the watercraft. See your authorized Sea-Doo dealer.

**What to Do After Launching the Watercraft**

Check the items listed in the following table after launching the watercraft and before going for a ride.

ITEM	OPERATION	✓
Information Center	Check operation	
Intelligent Brake and Reverse System (iBR)	Check operation	
Variable Trim System (VTS) (as applicable)	Check operation	

**Information Center (Gauge)**

1. Press START/STOP button and install the tether cord cap on the engine cut-off switch.
2. As the information center cycles through its self-test function, ensure all indications come on.

**⚠ WARNING**

Always attach the tether cord clip to your PFD or to the wrist (wrist strap required).

**iBR System**

*All Models Except GTS*

**NOTICE** Ensure there is sufficient space ahead and behind watercraft to safely carry out the iBR system test to avoid a collision. Watercraft will move during test.

1. Remove the moorings securing the watercraft to the dock.
2. Start the engine and ensure the watercraft does not move.
3. On the left handlebar, depress the iBR lever completely in, the watercraft should move slowly backwards.
4. Release the iBR lever, there should not be any reverse thrust.

 **WARNING**

Always ensure proper iBR system operation before taking the watercraft out for a ride.

**Variable Trim System (VTS)**

*All Models Except GTS*

With the engine running in forward position, use the VTS system to move the jet pump nozzle up and down alternately to check VTS operation. Confirm the VTS position indicator movement in the information center.

Also test the VTS preset trim positions by double clicking the VTS UP/DOWN button (as applicable to model).

Refer to *OPERATING INSTRUCTIONS* subsection for detailed instructions.

# ***WATERCRAFT INFORMATION***

# CONTROLS

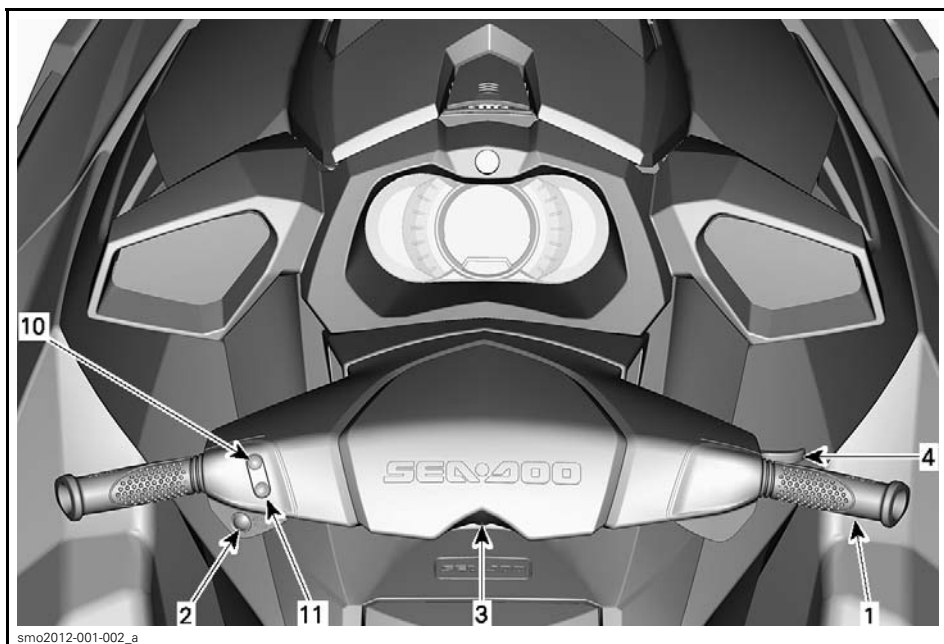

*GTS MODELS*

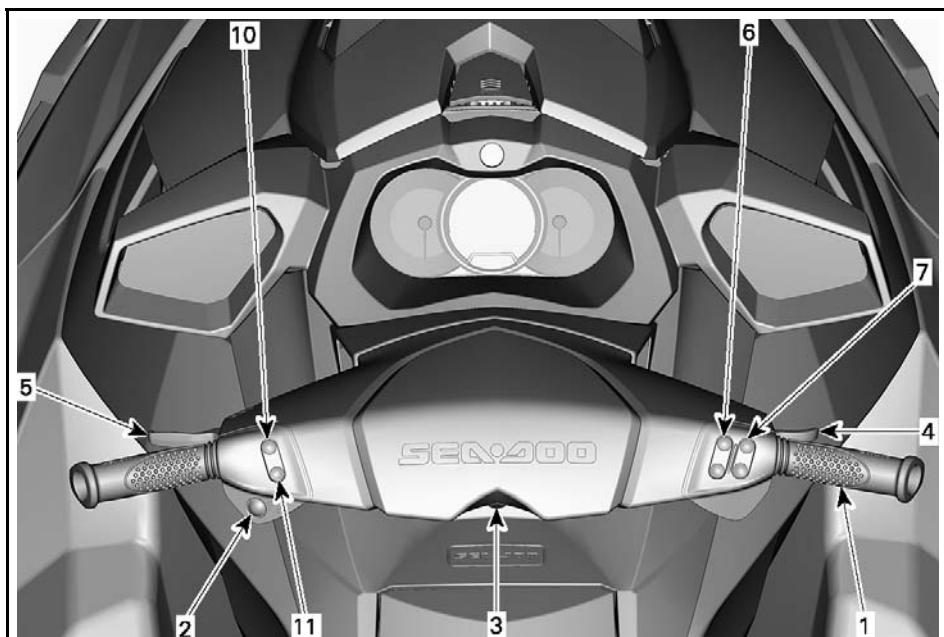

smo2012-001-005\_a

GTI AND GTI SE MODELS

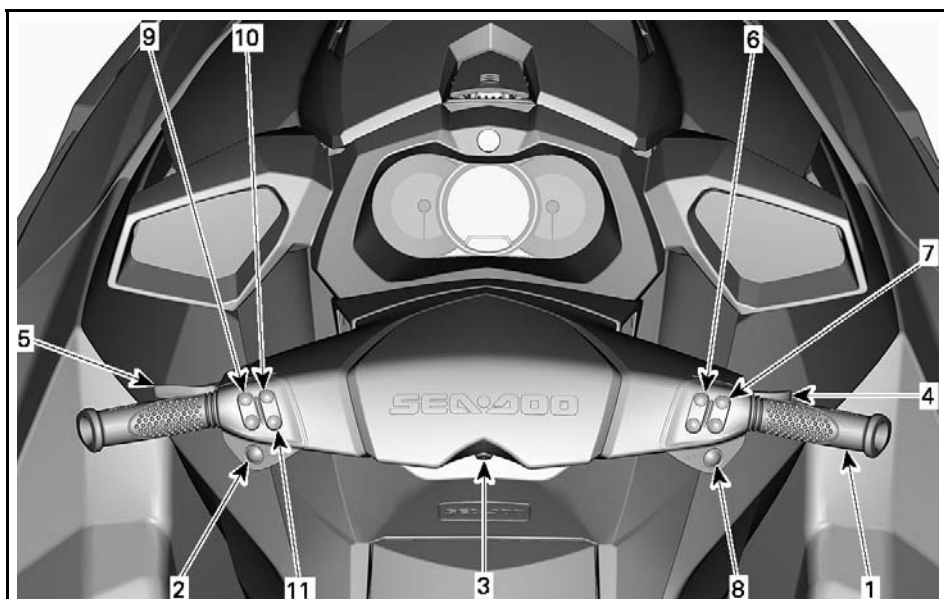

smo2012-001-004\_a

GTI LIMITED MODEL

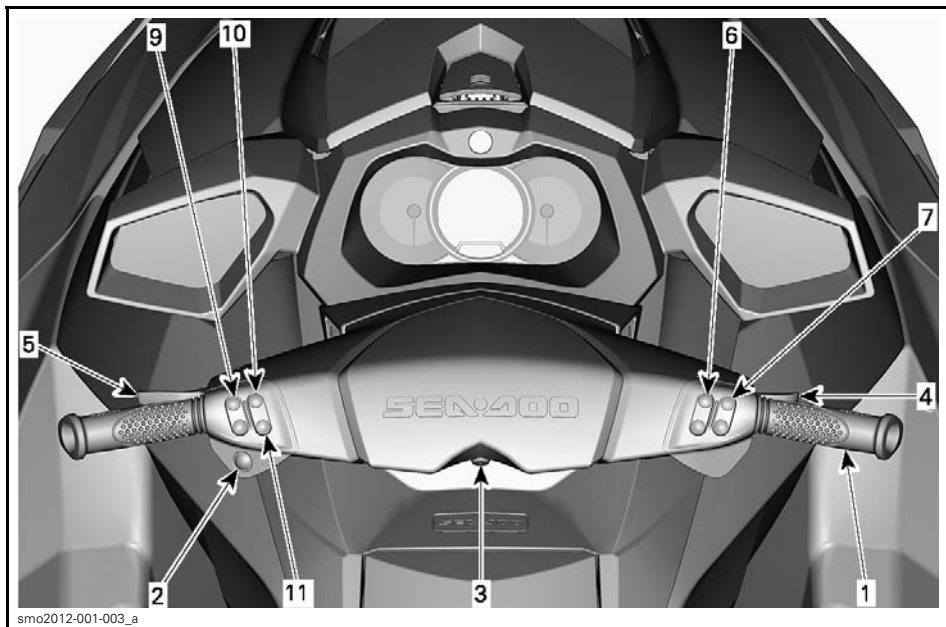

GTR MODEL

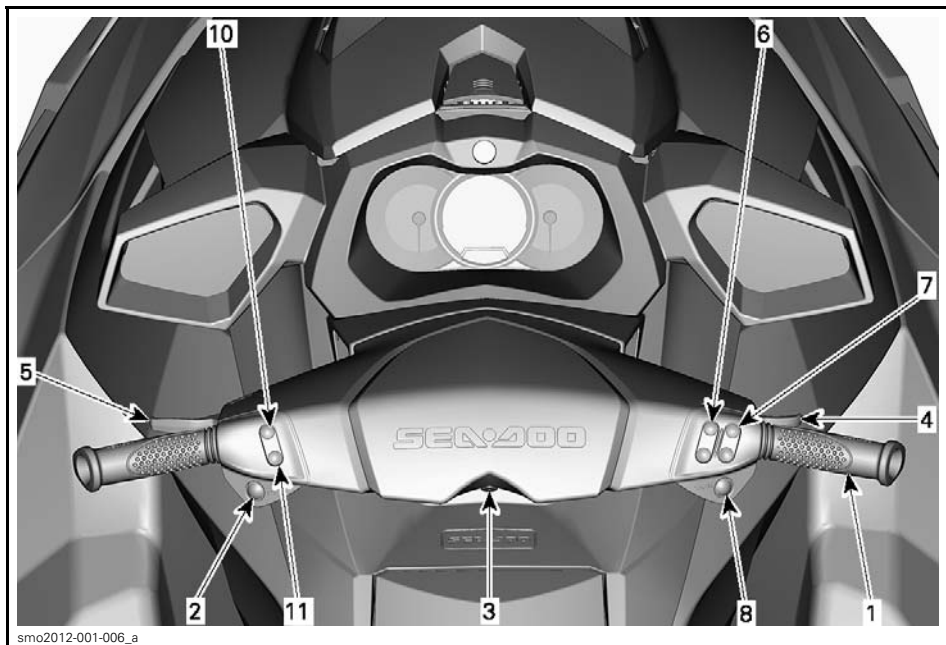

WAKE MODEL

## 1) Handlebar

The handlebar controls the direction of the watercraft. During forward operation, turning the handlebar to the right steers the watercraft to the right and inversely.

### **⚠ WARNING**

Check handlebar and corresponding steering nozzle operation before starting. Never turn handlebar while someone is near the rear of the watercraft. Keep away from the propulsion system.

### *All Models Except GTS*

When operating in reverse, steering direction is reversed. Turning the handlebar to the right while backing up steers the watercraft to the left. Refer to *OPERATING INSTRUCTIONS* subsection for detailed instructions.

## 2) Engine START/STOP Button

The engine START/STOP button is located on the LH handlebar.

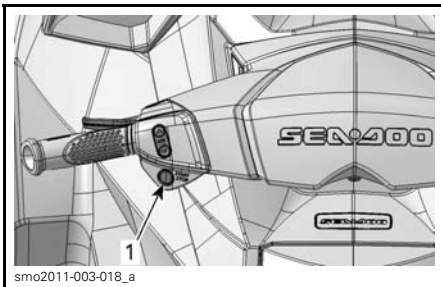

### **TYPICAL**

1. START/STOP button

### **Engine Starting and Stopping**

Refer to *OPERATING INSTRUCTIONS* subsection for detailed instructions.

## Waking Up the Electrical System

Press the START/STOP button once without installing the tether cord on the engine cut-off switch.

This will power up the electrical system; the information center will cycle through a self-test function and will then go blank after a few seconds.

The electrical system will stay powered up for approximately 3 minutes after the START/STOP button was depressed.

**NOTE:** If the START/STOP button is pressed and held without the tether cord installed, the information center displays will stay on as long as the START/STOP button is held.

## 3) Engine Cut-Off Switch

The engine cut-off switch is located in the middle of the handlebar.

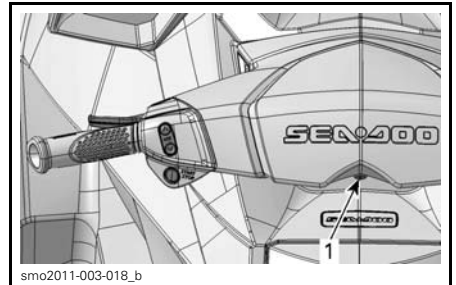

### **TYPICAL**

1. Engine cut-off switch

To allow engine starting, the tether cord cap must be securely snapped onto the engine cut-off switch.

### **⚠ WARNING**

Always attach the tether cord clip to the operator's personal flotation device (PFD) or wrist (wrist strap required).



**TYPICAL**

1. Tether cord cap on the engine cut-off switch
2. Tether cord clip secured to operator's PFD

To stop engine, pull the tether cord cap from the engine cut-off switch.

**⚠ WARNING**

Should the engine be stopped, the brake function (models with iBR) and watercraft directional control is lost.

**⚠ WARNING**

Always disconnect the tether cord when the watercraft is not in operation in order to prevent accidental engine starting or to avoid unauthorized use by others, children, and to prevent theft.

**Digitally Encoded Security System (D.E.S.S.)**

The tether cord cap contains a D.E.S.S. key that is programmed to give it a unique electronic serial number. This is the equivalent of a conventional key.

The D.E.S.S. system reads the key in the tether cord cap that is installed on the engine cut-off switch, and only allows engine starting for keys it recognizes.

The D.E.S.S. system brings great flexibility. You can buy additional tether cords and have the D.E.S.S. keys programmed to your watercraft.

A total of ten D.E.S.S. keys can be programmed to the same watercraft.

To have a key programmed to your watercraft, see your authorized BRP Sea-Doo dealer.

**D.E.S.S. Key Recognition**

Two short beeps indicate the system is ready to allow engine starting. Otherwise, refer to the *TROUBLESHOOTING* section.

**D.E.S.S. Key Types**

Three types of keys can be used:

- Normal key
- Learning key
- Rental key (rental models).

To ease key type recognition, the tether cord float comes in different colors.

KEY TYPE	FLOAT COLOR
Normal	Yellow or Black
Learning	Green
Rental	Orange



**TYPICAL - D.E.S.S. KEYS (TETHER CORDS)**

1. Learning key, green float
2. Rental key, orange float

The information center displays the type of key used.



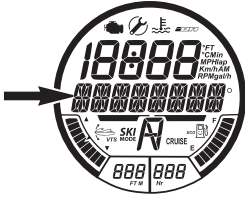

#### TYPE OF KEY IS DISPLAYED HERE

Message possibilities:

- NORMAL KEY
- LEARNING KEY
- RENTAL KEY.

The SEA-DOO learning key or rental key, limits the speed of the watercraft and the engine torque, therefore enabling first time users and less experienced operators to learn how to operate the watercraft while gaining the necessary confidence and control.

The learning and rental modes also offer the possibility of setting the maximum speed of the watercraft.

Refer to *OPERATING MODES* subsection for details.

## 4) Throttle Lever

The throttle lever on the RH handlebar electronically controls the engine speed.

To increase or maintain watercraft speed, pull on the throttle lever with your finger.

To decrease watercraft speed, release the throttle lever.

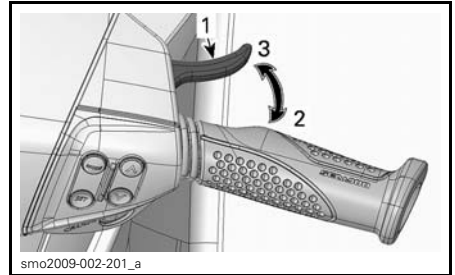

smo2009-002-201\_a

#### TYPICAL

1. Throttle lever
2. To accelerate
3. To decelerate

The throttle lever is spring loaded and should return to rest position (idle) when not pressed.

## 5) iBR Lever (intelligent Brake and Reverse)

The iBR lever on the LH handlebar can electronically command:

- Reverse
- Neutral
- Braking.

**NOTE:** A minimum of 25% lever travel is required to activate iBR functions.

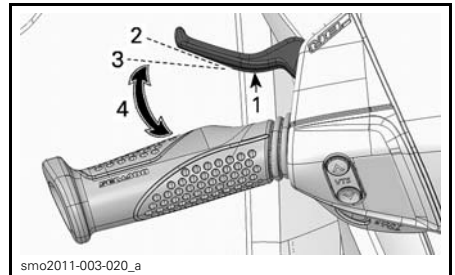

smo2011-003-020\_a

#### TYPICAL - iBR LEVER

1. iBR lever
2. Lever rest position
3. 25% stroke required to activate iBR function
4. Operating range

At speeds below 8 km/h (5 MPH), pulling the iBR lever in will engage reverse.

**NOTE:** If water current is 8 km/h (5 MPH) or above, the reverse can not be engaged as the speed threshold for the reverse is exceeded.

At speeds above 8 km/h (5 MPH), pulling the iBR lever in will engage the brake.

When the iBR lever is released after braking or reverse operation, neutral is engaged.

**⚠ WARNING**

If the throttle lever is still pulled in when releasing the iBR lever, forward movement will be initiated after a short delay. If forward acceleration is not desired, release the throttle lever.

**NOTE:** The neutral position can be fine tuned by trimming the iBR system.

Refer to *OPERATING INSTRUCTIONS* subsection for detailed instructions.

**6) MODE/SET Buttons**

*All Models Except GTS*

These buttons are located on the RH side of the handlebar.

Press MODE button to scroll through various functions available through the information center.

Press SET button to select the desired function, navigate through a function submenu, or to save any modified setting.

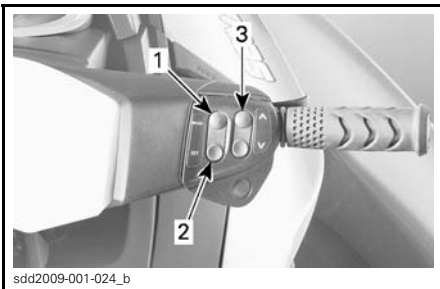

sdd2009-001-024\_b

**TYPICAL**

1. MODE
2. SET
3. UP/DOWN button

Refer to *OPERATING INSTRUCTIONS* subsection for detailed instructions.

**7) UP/DOWN Buttons**

*All Models Except GTS*

These buttons located on the RH side of the handlebar.

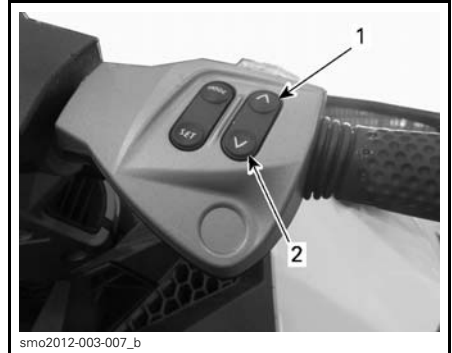

smo2012-003-007\_b

**TYPICAL**

1. Up button
2. Down button

The UP/DOWN buttons are used to make a selection or change a setting through the information center such as:

- Gauge functions
- Ski mode
- Cruise mode
- Slow speed mode
- iBR neutral adjustment.

**8) Cruise Button**

*GTI Limited and WAKE Models*

The Cruise button is located on the RH side of the handlebar, just below the UP/DOWN buttons.

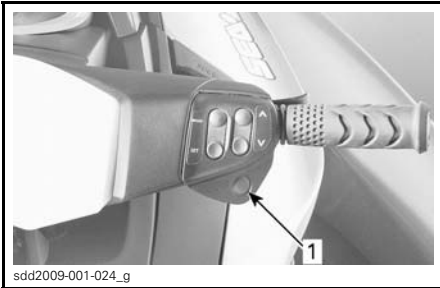

sdd2009-001-024\_g

**TYPICAL**

1. Cruise button

It is used to activate or deactivate CRUISE mode or to engage SLOW SPEED MODE.

Refer to *OPERATING MODES* subsection for detailed instructions.

## 9) VTS Button (Variable Trim System)

### *GTI Limited and GTR Models*

The VTS button is located on the LH handlebar.

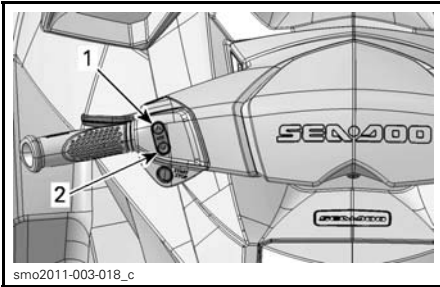

smo2011-003-018\_c

**TYPICAL - VTS CONTROL BUTTON**

1. Bow up
2. Bow down

This model watercraft is equipped with a programmable high performance VTS.

It provides watercraft pitch trim adjustments by adjusting the vertical position of the jet nozzle.

The VTS can be electrically trimmed to the desired attitude, or to one of two preset trim positions.

Press the VTS control button (up/down arrow) to adjust the riding attitude of the watercraft.

Refer to *OPERATING INSTRUCTIONS* subsection for details.

## 10) Sport Button

The Sport button is located on the LH handlebar.

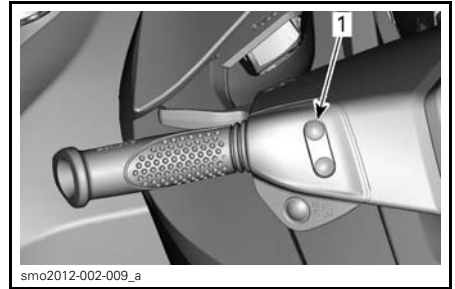

smo2012-002-009\_a

**TYPICAL**

1. Sport button

It is used to activate or deactivate SPORT mode.

Refer to *OPERATING MODES* subsection for details.

## 11) ECO Button

The ECO button is located on the LH handlebar.

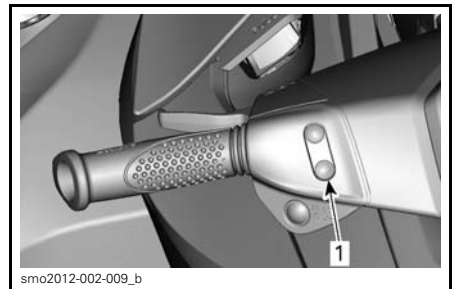

smo2012-002-009\_b

**TYPICAL**

1. ECO button

It is used to activate or deactivate ECO mode.

Refer to *OPERATING MODES* subsection for details.

# INFORMATION CENTER (GAUGE) (GTS)

## ⚠ WARNING

Do not adjust the display while riding, you could lose control.



smo2011-003-024\_a

### TYPICAL - GTS MODELS

#### 1. Multifunction gauge

## Multifunction Gauge Description

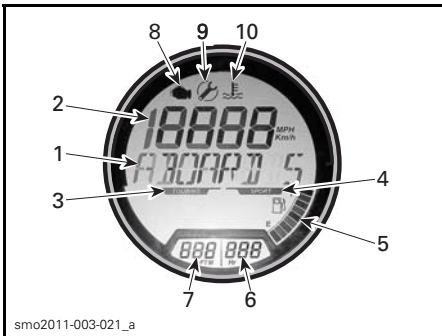

smo2011-003-021\_a

### 1) Multifunction Display

The multifunction display is used to:

- Display the WELCOME message on power up
- Display the KEY recognition message

- Display the engine RPM
- Display fault messages.

**NOTE:** If a fault occurs, it will periodically scroll the applicable fault message in the display and revert to the RPM indication depending on the severity of the fault detected.

### 2) Numerical Display

The numerical display provides an indication of estimated watercraft speed.

### 3) Touring Mode Indicator

When the TOURING mode indicator is ON, the default TOURING mode is active.

Refer to *OPERATING MODES* subsection for details.

### 4) Sport Mode Indicator

The SPORT mode indicator is normally off.

When sport mode of operation is selected, the SPORT mode indicator will come on and stay on until sport mode is deactivated, or the watercraft is shut down.

**NOTE:** Sport mode is not the default riding mode. To be active, it must be selected on after starting the engine.

Refer to *OPERATING MODES* subsection for detailed instructions.

### 5) Fuel Level Indication

A bar gauge located in the bottom RH side of the multifunction display continuously indicates the amount of fuel in the fuel tank while riding.

When the fuel tank is full, 8 segments (bars) of the indicator are turned on. The top segment is not used.

#### Low Fuel Level Indication

When there is only 2 segments of fuel indicated (approximately 25% fuel tank capacity or 14 L (3.7 U.S. gal.)), the following indications will come ON to advise you that a low fuel condition exists.

LOW FUEL LEVEL INDICATIONS	
Last 2 fuel gauge segments	Flashing
Fuel tank symbol	
Audible advisory (one long beep)	Periodically
Scrolling LOW FUEL advisory message	

### 6) Hour Meter Display

Continuously displays the accumulated engine hours.

### 7) Water Depth Display

The water depth display provides an indication of the lake water depth.

The system is capable of indicating water depth under the hull in single increments up to 50 m (164 ft).

**NOTE:** Under certain conditions, the display may stop indicating. The display's ability to provide an indication of the water's depth depends on the conditions of use.

**NOTE:** The water depth indication is only available when a depth sounder is installed and detected.

**⚠ WARNING**

**Never use the depth sounder as a warning device to ride in shallow water.**

### 8) Check Engine Light

The check engine light comes ON when a fault is detected by the engine management system.

The check engine light may be accompanied by the applicable scrolling fault message in the multifunction display.

When the check engine light comes on, contact your authorized Sea-Doo dealer.

### 9) Maintenance Reminder Indicator

The maintenance reminder indicator comes ON when required maintenance is due.

When this indicator comes on, bring your watercraft to your authorized Sea-Doo dealer to have it serviced and to have the maintenance reminder indicator reset.

### 10) High Temperature Indicator

The high temperature indicator comes ON when a high engine temperature or a high exhaust system temperature is detected. Refer to *TROUBLESHOOTING* section.

## **Gauge Setup**

The multifunction gauge is capable of providing speed indications in km/h or in MPH. It is also capable of displaying messages in various languages.

To have your gauge set up to your preferred unit of measurement and available language, see your authorized Sea-Doo dealer.

# INFORMATION CENTER (GAUGES) (GTI/GTR/WAKE)

## WARNING

Do not adjust the display while riding, you could lose control.



TYPICAL - GTI AND GTI SE MODELS

1. Multifunction gauge

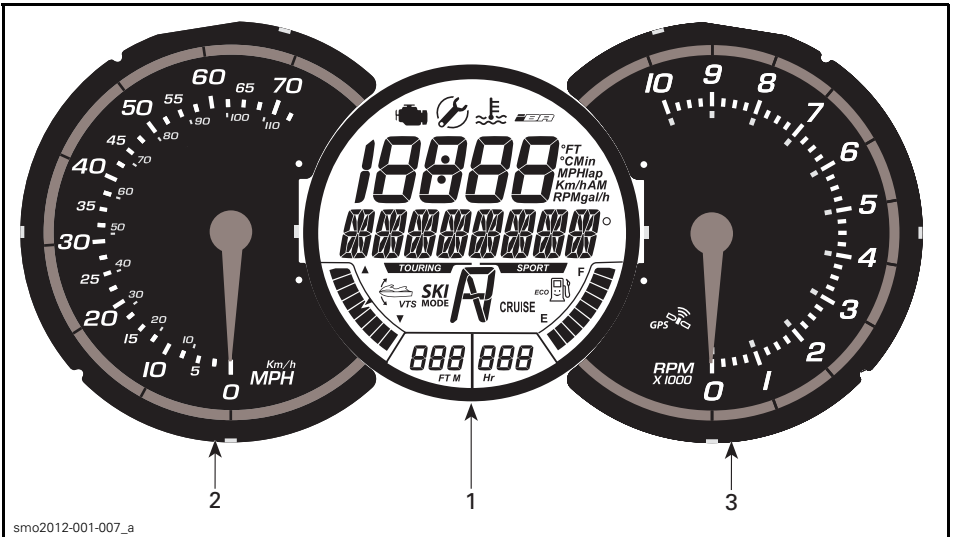

TYPICAL - GTI LIMITED, GTR AND WAKE MODELS

1. Multifunction gauge
2. Analog speedometer
3. Analog tachometer

## Analog Speedometer Description

The speedometer, located in the LH side of the information center, provides an analog indication of the speed of the watercraft in miles per hour (MPH) and kilometers per hour (km/h).

The speed indication is based on a GPS (Global Positioning System) incorporated within the information center.

If for some reason the GPS signal is lost, a default mode is used whereby, the speed is calculated using infor-

mation received from other systems to provide an estimated watercraft speed.

## Analog Tachometer Description

The tachometer provides an analog indication of the revolutions per minute (RPM) of the engine. Multiply the indicated number by 1000 to obtain the actual engine RPM.

## Multifunction Gauge Features

	GTI	GTI SE	GTI LIMITED	GTR	WAKE
Touring mode indicator	X	X	X	X	X
Sport mode indicator	X	X	X	X	X
Fuel level indication	X	X	X	X	X
Hour meter display	X	X	X	X	X
Water depth indication	Opt	Opt	Opt	Opt	Opt
ECO mode indicator	X	X	X	X	X
CRUISE mode indicator	Opt	Opt	X	Opt	X
iBR position indicator	X	X	X	X	X
SKI mode indicator	Opt	Opt	Opt	Opt	X
VTS position indication	Opt	X	X	X	X

X = Indicates a **standard** feature

Opt = Indicates a feature available as an **option**



## Multifunction Gauge Description

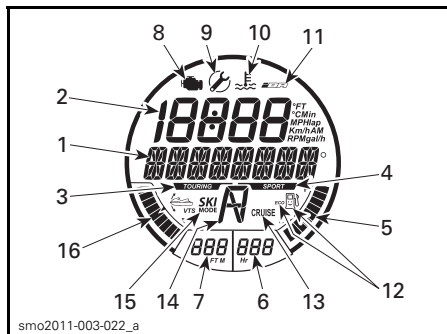

### 1) Multifunction Display

The multifunction display is used to:

- Display the WELCOME message on power up
- Display the KEY recognition message
- Provide various indications as selected by the operator
- Activating or changing various functions or modes of operation
- Display scrolling messages of function activation or system faults
- Display fault codes.

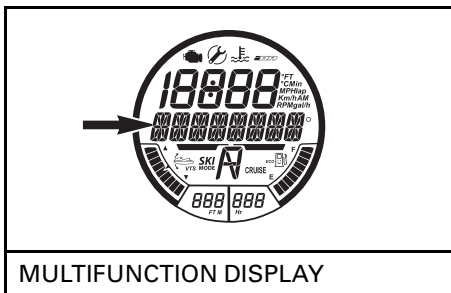

### 2) Numerical Display

The numerical display is used to provide a variety of indications as selected by the operator using the DISPLAY function in the multifunction display.

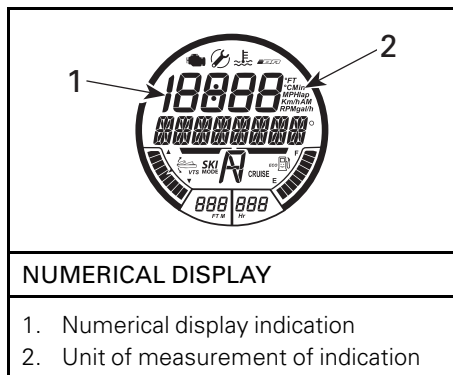

**NOTE:** The default indication in the multifunction display is the compass direction.

AVAILABLE INDICATIONS IN NUMERICAL DISPLAY					
	GTI	GTI SE	GTI Limited	GTR	WAKE
Watercraft speed	Indication by default				
Engine RPM	X	X	X	X	X
Engine temperature	Opt	Opt	Opt	Opt	Opt
Clock	N.A.	X	X	X	X
Learning key settings	X	X	X	X	X
CRUISE SPEED setting	Opt	Opt	X	Opt	X
SLOW SPEED MODE setting	Opt	Opt	X	Opt	X
VTS preset	Opt	Opt	X	Opt	Opt
VTS settings	Opt	X	N.A.	X	X
SKI MODE settings	Opt	Opt	Opt	Opt	X
Fuel consumption (instant and average)	Opt	X	X	X	X
Fuel autonomy (distance and time to empty)	Opt	Opt	X	Opt	Opt
Lap timer	Opt	Opt	Opt	Opt	Opt
Top speed/RPM Average speed/RPM	Opt	Opt	Opt	Opt	Opt
Altitude	N.A.	N.A.	Std	N.A.	N.A.
X = An X indicates a <b>standard</b> feature Opt = Feature available as an <b>option</b> N.A. = Not Available					

When the information center is first powered up, the numerical display defaults to the last selected indication.

### 3) Touring Mode Indicator

When the TOURING mode indicator is ON, the default TOURING mode of operation is active.

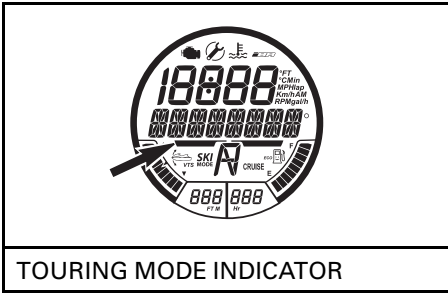

Refer to *OPERATING MODES* subsection for detailed instructions.

### 4) Sport Mode Indicator

The sport mode indicator is normally off.

When sport mode of operation is selected, the SPORT mode indicator will come on and stay on until sport mode is deactivated, or the watercraft is shut down.

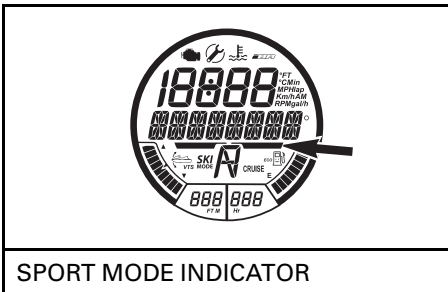

**NOTE:** Sport mode is not the default riding mode. To be active, it must be selected after starting the engine.

Refer to *OPERATING MODES* subsection for detailed instructions.

### 5) Fuel Level Indication

A bar gauge located in the bottom RH side of the multifunction display continuously indicates the amount of fuel in the fuel tank while riding.

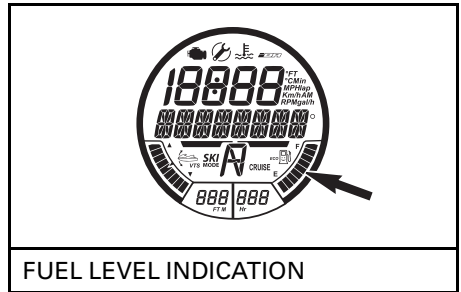

When the fuel tank is full, 8 segments (bars) of the indicator are turned on. The top segment is not used.

### Low Fuel Level Warning

When there is only 2 segments of fuel indicated (approximately 25% fuel tank capacity or 14 L (3.7 U.S. gal.), the following warnings will be ON.

LOW FUEL LEVEL WARNING	
Last 2 fuel gauge segments	Flashing
Fuel tank symbol	
Audible warning (one long beep)	Periodically
Scrolling LOW FUEL WARNING message	

### 6) Hour Meter Display (HR)

Continuously displays the accumulated engine hours.

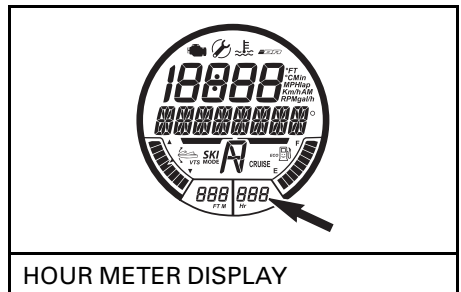

### 7) Water Depth Display

The water depth display provides an indication of the lake water depth.

The system is capable of indicating water depth under the hull in single increments up to 50 m (164 ft).

**NOTE:** Under certain conditions, the display may stop indicating. The display's ability to provide an indication of the water's depth depends on the conditions of use.

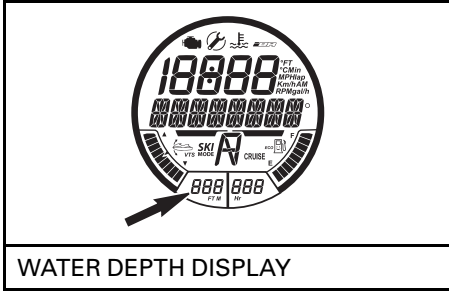

WATER DEPTH DISPLAY

**NOTE:** The water depth indication is only available when a depth sounder is installed and detected.



Never use the depth sounder as a warning device to ride in shallow water.

### 8) Check Engine Light

The check engine light comes ON when a fault is detected by the engine management system.

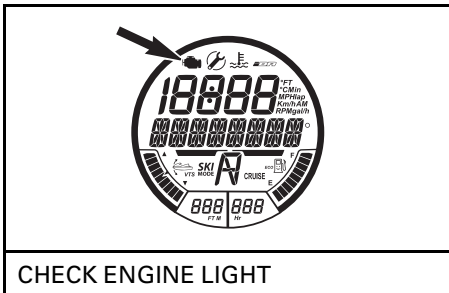

CHECK ENGINE LIGHT

When the check engine light comes on, contact your authorized Sea-Doo dealer.

### 9) Maintenance Reminder Indicator

The maintenance reminder indicator comes ON when required maintenance is due.

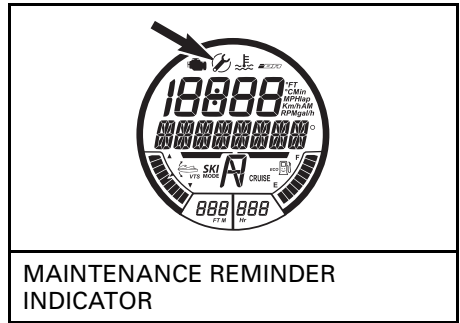

MAINTENANCE REMINDER INDICATOR

When this indicator comes on, bring your watercraft to your authorized Sea-Doo dealer to have it serviced and to have the maintenance reminder indicator reset.

### 10) High Temperature Indicator

The high temperature indicator comes ON when a high engine temperature or a high exhaust system temperature is detected.

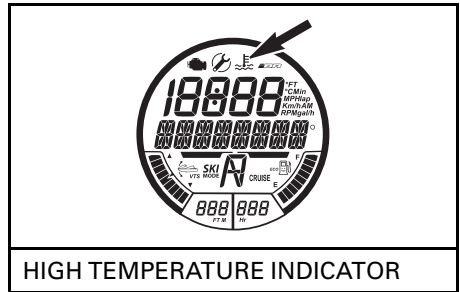

HIGH TEMPERATURE INDICATOR

Refer to *TROUBLESHOOTING* subsection for details.

### 11) iBR Fault Indicator

The iBR fault indicator comes ON when a fault in the iBR system has been detected.

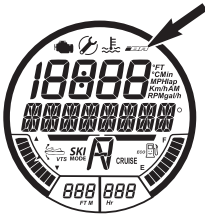

iBR FAULT INDICATOR

Refer to *TROUBLESHOOTING* subsection for details.

**12) ECO Indicator**

The ECO indicator and a smile in the fuel tank symbol comes ON when FUEL ECONOMY MODE is activated.

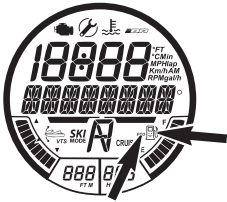

ECO MODE INDICATOR  
(Fuel Economy Mode)

Refer to *OPERATING MODES* subsection for detailed instructions.

**13) CRUISE Mode Indicator**

The cruise mode indicator comes ON when:

- CRUISE MODE has been activated.
- SLOW SPEED MODE has been activated.

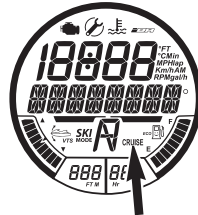

CRUISE MODE INDICATOR

Refer to *OPERATING MODES* subsection for detailed instructions.

**14) iBR Position Indicator**

Provides an indication of the iBR gate position.

- N (neutral)
- F (forward)
- R (reverse).



iBR POSITION INDICATOR

**15) SKI MODE Indicator**

The ski mode indicator is ON when SKI MODE is active.



SKI MODE INDICATOR

Refer to *OPERATING MODES* subsection for detailed instructions.

## 16) VTS Position Indication

The VTS position indication provides an indication of the pump nozzle position.

A single segment of a bar gauge type indicator is turned on to indicate the relative position of the watercraft bow.

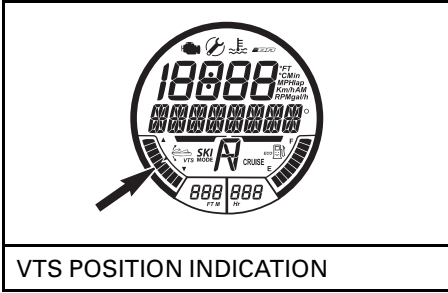

VTS POSITION INDICATION

Refer to *OPERATING INSTRUCTIONS* subsection for detailed instructions.

## Navigating the Multifunction Display

### ⚠ WARNING

Do not adjust display while riding, you could lose control.

### Selecting Functions

When operating at speed, the multifunction display provides an indication of the compass direction and azimuth of the watercraft is traveling by default.

- To select the various functions available through the multifunction display, press the MODE button repeatedly until the desired function is visible:
  - LAP TIMER
  - SKI MODE
  - FUEL ECONOMY MODE
  - FUEL CONSUMPTION
  - VTS MODE
  - DISPLAY
  - FAULT CODES
  - KEY MODE
  - SETTINGS.

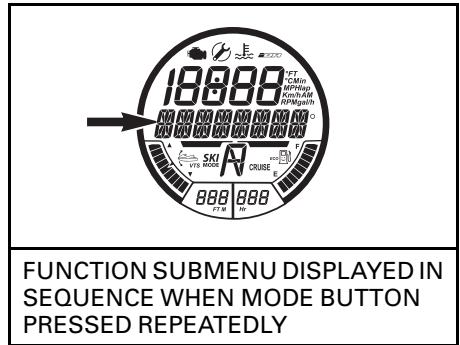

FUNCTION SUBMENU DISPLAYED IN SEQUENCE WHEN MODE BUTTON PRESSED REPEATEDLY

- Then press the SET button to enter that function.

**NOTE:** The available functions and the order in which they appear depends on the watercraft model. The fault code function is only available when there is an active fault. The settings function is only available when the engine is shut off. The key mode function is only available with a normal key.

### Function Description

#### Compass

A GPS incorporated in the information center provides the indication in the multifunction display.

The cardinal points, intermediate cardinal points, as well as the azimuth the watercraft is travelling are displayed in the multifunction display by default when the watercraft is moving.

For a compass indication to be displayed, the GPS must have a good link with the navigation satellites.

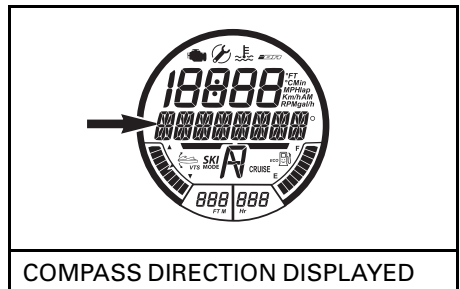

COMPASS DIRECTION DISPLAYED

**NOTE:** The compass indication is only available above 5 km/h (3 MPH).

**⚠ WARNING**  
 Use the compass as a guide only.  
 Not to be used for precision navigation purposes.

**Lap Timer**

The lap timer can be used to record up to 50 individual lap times.

To activate and use the lap timer, carry out the following:

1. Press the MODE button repeatedly until LAP TIME is visible in the multi-function display.

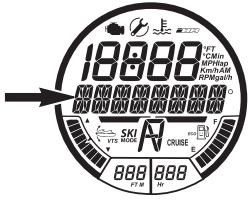

MESSAGE DISPLAYED
LAP TIME

2. Press the SET button to enter the function, the lap timer will be activated and visible in the display.

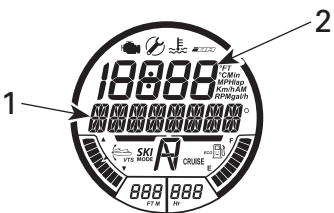

LAP TIMER FUNCTION
1. 00'00'00 lap time displayed here
2. Lap number "0" displayed here

3. To start the timer, press the SET button.

**NOTE:** The timer starts immediately when pressing the SET button.

4. To record each lap time, press the SET button at the start of each lap.

**NOTE:** The lap time will be recorded, the lap counter in the numerical display will count the number of laps recorded, and the timer will continue to run.

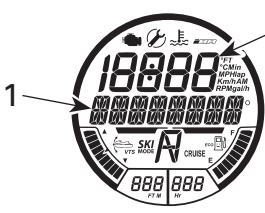

**LAP TIMER FUNCTION EXAMPLE**

1. 01'02'34 lap time displayed here
2. Lap number "1" displayed here

5. To save the last lap and stop the timer, press the MODE button.

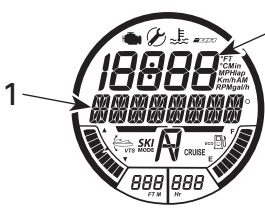

**LAP TIMER FUNCTION EXAMPLE**

1. 01'21'03 lap time displayed here
2. Lap number "2" displayed here

To view each lap time, use the UP/DOWN button. The lap counter will indicate which lap is indicated.

To view the cumulative lap time of all laps recorded, use the UP/DOWN button until ALL is visible in the lap counter.

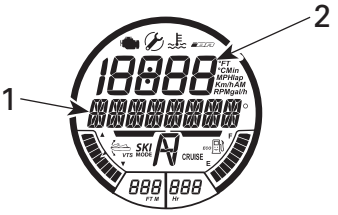

**LAP TIMER FUNCTION EXAMPLE**

1. Total lap times 02'23'37 displayed here
2. Lap count "ALL" displayed here

To reset the lap timer and lap counter, press and hold the SET button until the timer and counter are reset to 0 (zero).

### Ski Mode

Ski mode is used for repeated controlled launches when towing a skier or wakeboarder. Refer to *OPERATING MODES* for more details.

### ECO Mode

ECO mode is a function by which engine fuel consumption is reduced. Refer to *OPERATING MODES* subsection for detailed instructions.

### Fuel Consumption

The FUEL CONSUMPTION function is used to display the watercraft fuel consumption four different ways:

- Instant fuel flow per hour (gal/h or L/h)
- Average fuel flow per hour (gal/h or L/h)
- Distance to empty (Mi or Km)
- Time to empty (h or min).

The fuel consumption functions are not continuously active.

The fuel consumption function selected becomes active only when selected as the indication in the numerical display.

When the LOW FUEL indications come on in the multifunction gauge, the "TIME TO EMPTY" and "DISTANCE TO EMPTY" functions will indicate "0" (zero) if they are the selected indication.

To display the watercraft fuel consumption, carry out the following:

1. Press the MODE button repeatedly until FUEL CONSUMPTION is visible in the multifunction display.

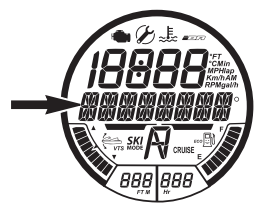

**MESSAGE DISPLAYED**

**FUEL CONSUMPTION**

2. Press the UP/DOWN button to toggle to the desired fuel consumption display mode.

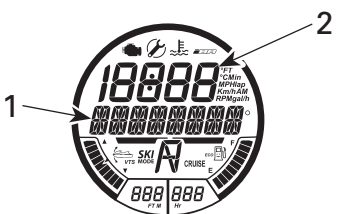

**FUEL CONSUMPTION DISPLAY MODE**

1. INSTANT FUEL CONSUMPTION message
2. Applicable value

3. Press the SET button to save the setting and return to the main display.



**NOTE:** The fuel consumption value selected will be displayed in the numerical display. Double click the SET button to reset the average fuel consumption indication. The display will momentarily indicate zero (0).

**VTS Mode**

The VTS MODE function is used to manually set the VTS or change VTS PRESET settings.

Refer to *OPERATING INSTRUCTIONS* subsection for detailed instructions.

**Display**

The DISPLAY function is used to change the indication in the numerical display. Refer to *CHANGING NUMERICAL DISPLAY INDICATION*.

**Fault Codes**

The FAULT CODES function is used to display active fault codes.

Refer to *MONITORING SYSTEM* subsection for details.

**Key Mode**

The KEY MODE function is used for changing LEARNING key settings.

Refer to *OPERATING MODES* subsection for detailed instructions.

**Settings**

The SETTINGS function is used for:

- Changing the clock setting, refer to *MULTIFUNCTION GAUGE SETUP*.
- Activating the iBR override function, refer to *SPECIAL PROCEDURES*

**Changing Numerical Display Indication**

To change the indication in the numerical display, carry out the following:

1. Press the MODE button on the RH handlebar repeatedly until DISPLAY is visible in the multifunction display.

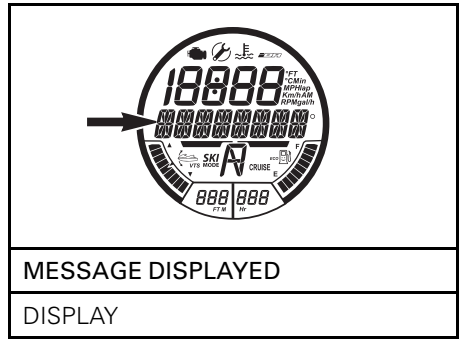

2. Press the SET button to enter the DISPLAY function.
3. Press the UP/DOWN button until the preferred indication is visible in the multifunction display (as applicable to model).
  - RPM
  - SPEED
  - CLOCK
  - ENGINE TEMP
  - ALTITUDE
  - TOP SPEED
  - AVG SPEED
  - TOP RPM
  - AVG RPM.

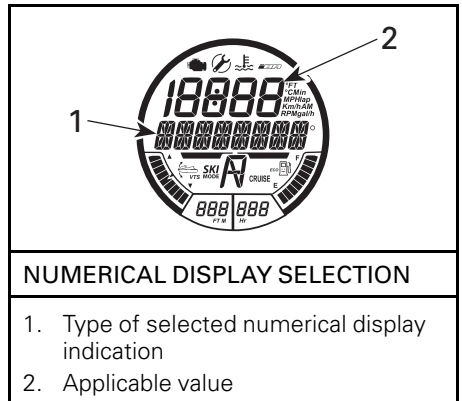

4. Press the SET button to select and save the preferred indication, or wait for the display function to time out. The last indication visible will be automatically saved.

## Resetting Numerical Display Indication

The following numerical display indications can be reset when selected:

- Average fuel consumption
- Top speed
- Average speed
- Top RPM
- Average RPM.

To reset the indication, double click the SET button. The numerical display will momentarily indicate zero (0).

**NOTE:** Each of these functions become active **ONLY** when selected as the numerical display indication.

## Multifunction Gauge Setup

### Clock Setting

1. Press the MODE button repeatedly until SETTINGS is visible in the multifunction display.

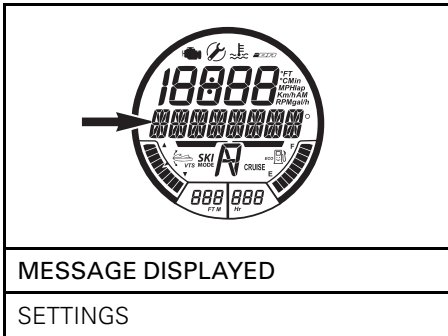

2. Press the UP/DOWN button repeatedly until CLOCK is visible.

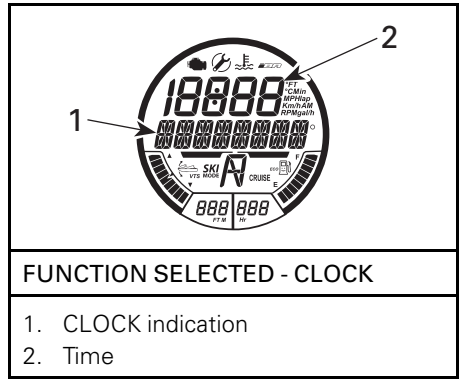

3. Press the SET button to enter the function. CHANGE CLOCK OFFSET message will be displayed.

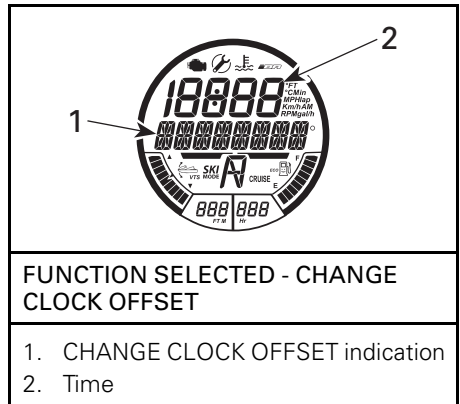

4. Press the UP/DOWN button to adjust the clock to the correct local time.
5. Press the SET button to save the setting and return to the main display.

**NOTE:** The clock uses the GPS signal to maintain the appropriate time referenced to Greenwich Mean Time (GMT). When setting the clock, only the hour indication may be changed.

### Units of Measurement and Language Setting

The multifunction gauge is capable of displaying information in metric or imperial units and in various languages.

To change the units of measurement or to change the language displayed in the multifunction gauge, see your authorized Sea-Doo dealer.

## **Analog Speedometer Description**

The speedometer, located in the LH side of the information center, provides an analog indication of the speed of the watercraft in miles per hour (MPH) and kilometers per hour (km/h).

The speed indication is based on a GPS (Global Positioning System) incorporated within the information center.

If for some reason the GPS signal is lost, a default mode is used whereby, the speed is calculated using information received from other systems to provide an estimated watercraft speed.

## **Analog Tachometer Description**

The tachometer provides an analog indication of the revolutions per minute (RPM) of the engine. Multiply the indicated number by 1000 to obtain the actual engine RPM.

# EQUIPMENT

**NOTE:** Illustrations may not be accurate for every model and are only provided as a visual guide.

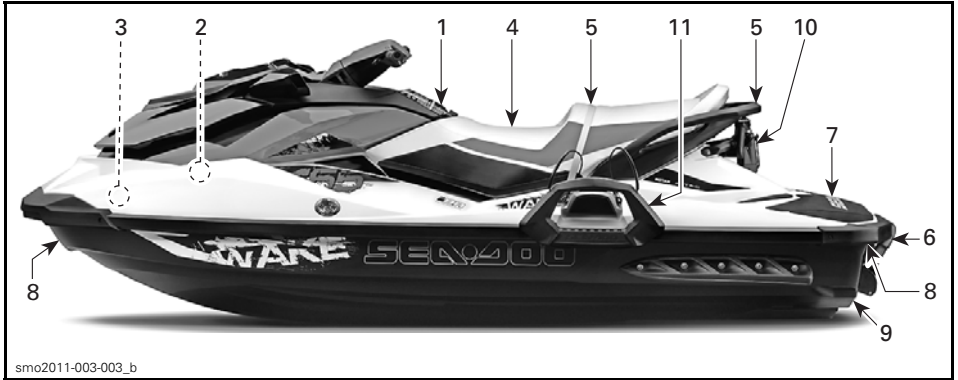

TYPICAL - WAKE MODEL ILLUSTRATED

## 1) Glove Box

A small, storage compartment for personal articles.

Pull up on cover latch to open glove box.



TYPICAL — GLOVE BOX

1. Cover latch

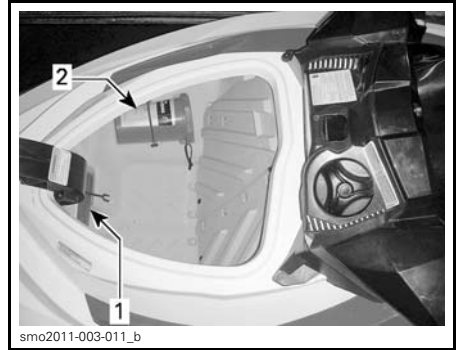

FRONT STORAGE COMPARTMENT

1. Fire extinguisher secured in holder  
2. Emergency kit secured in holder

To open the front storage compartment cover, pull the latch lever upward. Always close and latch cover when riding.

## 2) Front Storage Compartment

A convenient area to carry personal articles.

The front storage compartment also contains two holders for safety equipment; one for a fire extinguisher and another for the emergency kit (these are not provided).

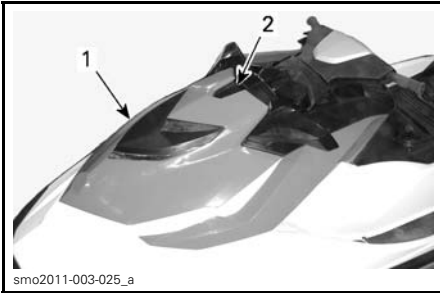

smo2011-003-025\_a

**TYPICAL**

1. Front storage compartment cover
2. Latch lever

**⚠ WARNING**

Never carry any loose, heavy, sharp, or breakable objects in the storage compartment. Do not exceed maximum load capacity; 9 kg (20 lb). Never operate the watercraft with the front storage compartment cover open. This is not a watertight compartment.

### 3) Seat

Removing the seat provides access to the engine compartment.

The seat latch is located at the back end of the seat.

To remove the seat, pull up on the latch handle and lift the back end of the seat off the latch pin. Then pull the seat up and backwards to unhook the front of the seat from its retainer and remove the seat from the watercraft.

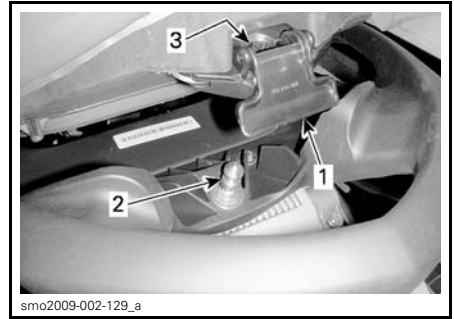

smo2009-002-129\_a

**TYPICAL - SEAT LATCH**

1. Seat latch handle
2. Latch pin
3. Pin insertion hole

To install the seat, insert the forward end of the seat in its retainer.

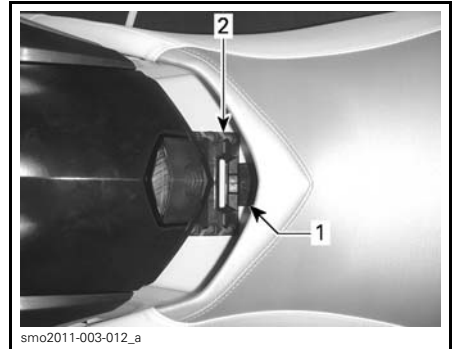

smo2011-003-012\_a

1. Forward seat tab
2. Forward seat retainer

Align the seat latch with the latch pin and firmly press down on the rear portion of the seat to lock it in place.

Pull up on the rear portion of the seat to ensure it is properly latched.

**⚠ CAUTION** Ensure the latch is properly locked onto the pin.

### 4) Passenger Handhold

The seat strap provides a handhold for a passenger to hold on to when riding.

The sides of the molded grab handle at the rear of the seat also provide a handhold for a passenger. The rear portion of the molded grab handle provides

a handhold for the skier/wakeboarder spotter or boarding the watercraft from the water.

**NOTICE** Never use the molded grab handle to tow anything or to lift the watercraft.



TYPICAL - PASSENGER HANDHOLDS  
 1. Seat strap  
 2. Molded grab handle



BOARDING STEP HELD DOWN FOR BOARDING FROM WATER

**NOTICE**

- Never use the step for boarding a watercraft that is out of water.
- Never use the step for pulling, towing, diving or jumping, or any other purpose other than as a boarding step.
- Stay on center of the step.
- Only one person at a time on the step.

### 5) Boarding Step

A convenient step used for boarding the watercraft from the water.

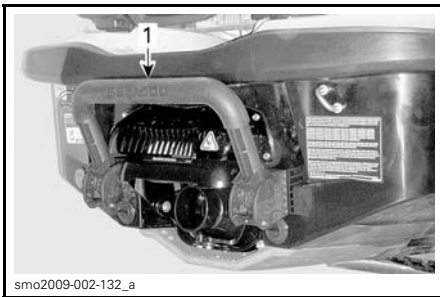

TYPICAL  
 1. Boarding step

*iBR Equipped Models Only*

**⚠ WARNING**

Be aware of the iBR gate movement when starting the engine, shutting down the engine or using the iBR lever. Automatic movement of the gate may squeeze fingers or toes of people taking a hold on the back or your PWC.

**⚠ WARNING**

The engine must be shut off before attempting to board the watercraft using the boarding step.

### 6) Boarding Platform

The rear deck area serves as the boarding platform.

The aft portion of the foot wells near the boarding platform are used as foot rests for the rear facing spotter when towing a skier or tuber.

Pull down the step with your hand and hold until a foot or a knee is put on the step.



smo2011-003-014\_a

1. Boarding platform
2. Spotter foot rests (each side)

## 7) Front and Rear Eyelets

Eyelets can be used for mooring, towing a water skier, wakeboarder or tuber, and as tie-down points when trailering your watercraft.

### Front Eyelet

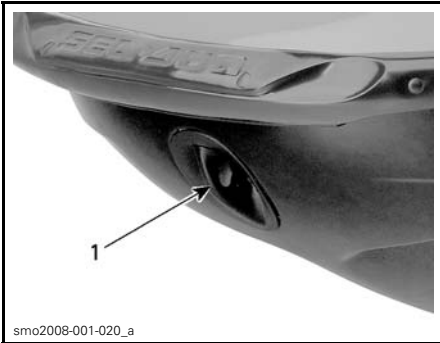

smo2008-001-020\_a

- TYPICAL**
1. Front eyelet

### Rear Eyelets

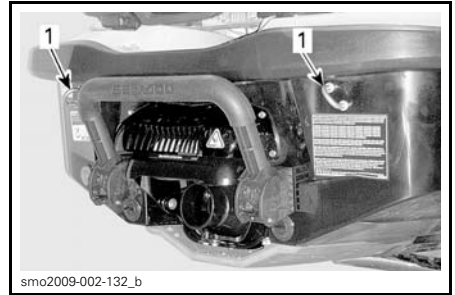

smo2009-002-132\_b

- TYPICAL**
1. Rear eyelets

*All Models Except WAKE*

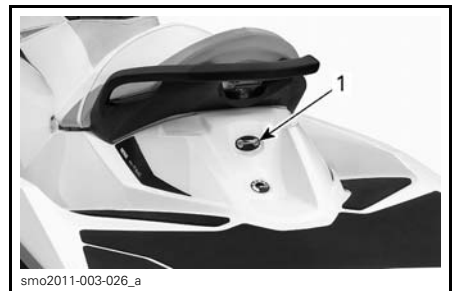

smo2011-003-026\_a

1. Rear eyelet

## 8) Bilge Drain Plugs

Unscrew drain plugs whenever watercraft is on the trailer. This will allow water accumulated in the bilge to be evacuated and helps to reduce condensation.

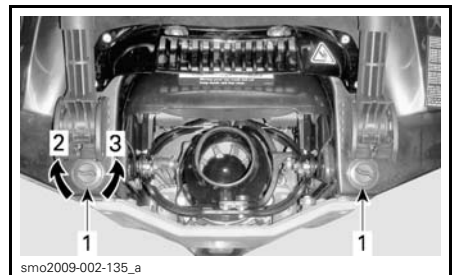

smo2009-002-135\_a

- TYPICAL**
1. Drain plugs
  2. Tighten
  3. Loosen

**NOTICE** Ensure drain plugs are properly secured prior to launching the watercraft in water.

## 9) Ski/Wakeboard Post

### WAKE Model

Pull up on the knob to extend the post. Ensure both sections of post are fully extended and properly locked before attaching ski or wakeboard rope.



TYPICAL - SKI/WAKEBOARD POST RETRACTED

1. Pull on this knob to extend



TYPICAL - SKI/WAKEBOARD POST EXTENDED

To retract the post, push straight down on the top of the post.

If the post becomes difficult to extend or retract, simultaneously push in on both sides of the locking clip toward front of watercraft.

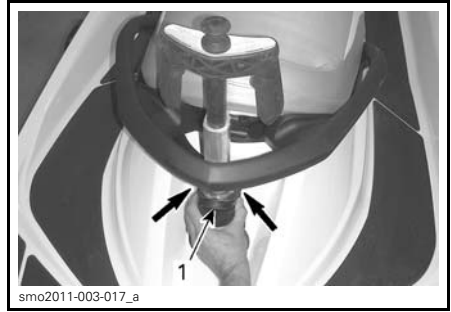

TYPICAL - PUSH TOWARD FRONT TO UNLOCK AND REMOVE POST  
1. Locking clip

### **WARNING**

Make sure ski/wakeboard post is fully extended and locked before use. Completely retract and lock when not used. Use caution with skier/wakeboarder in tow as tow rope may backlash to watercraft when released. Never perform a sharp turn when towing a skier, wakeboarder or any toy.

**NOTICE** The ski/wakeboard post is designed for towing a skier or wakeboarder with a maximum gross weight of 114 kg (250 lb).

Always have one person other than the operator as an observer.

NOTE: The handles on the ski/wakeboard post are provided as a handhold for the observer.

**NOTICE** Never use the ski/wakeboard post to tow other watercraft. Respect the maximum load limit rating of the ski/wakeboard post. Overloading can affect maneuverability, stability and performance.

## 10) Wakeboard Rack

### WAKE Model

A convenient removable rack to carry a wakeboard on the watercraft when on the water.





smo2011-003-014\_b

1. Wakeboard rack

**NOTE:** The wakeboard rack can be installed on the LH side of the watercraft.

To install:

1. Insert the hooks on the lower portion of the rack into the lower retaining bracket located on the hull under the LH side bumper.

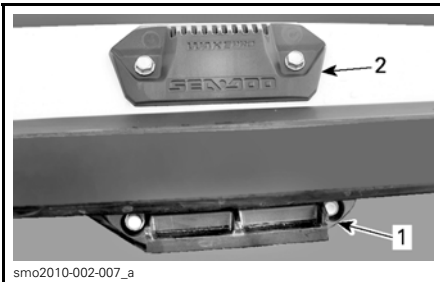

smo2010-002-007\_a

#### RETAINING BRACKETS FOR WAKEBOARD RACK

1. Lower retaining bracket
2. Upper retaining bracket

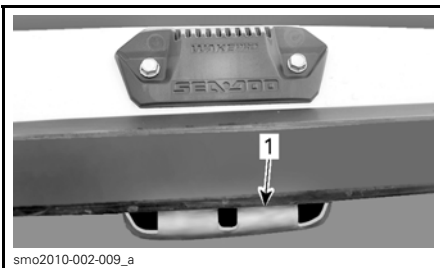

smo2010-002-009\_a

1. Hooked portion of rack in lower bracket

2. Rotate the rack upwards and push the top of the rack inboard until the handle locks into the top retaining bracket.

### **⚠ WARNING**

If rack is not properly secured on the watercraft, it could become loose and detach unexpectedly, creating a risk of injury to people nearby. Periodically ensure the rack is properly locked on its support.

3. When installing a wakeboard on the rack, position wakeboard fin(s) outward with the heel of the boots facing down near freeboard of the PWC.
4. Secure wakeboard using bungee cords.

### **⚠ WARNING**

To avoid possible injuries and cuts from the wakeboards fin(s), always place FIN(S) OUTWARDS.

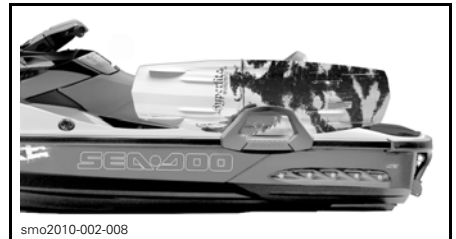

smo2010-002-008

#### TYPICAL - WAKEBOARD INSTALLED WITH FINS OUTWARD

5. After installation, pull and push wakeboard to ensure it is tightly secured to rack.

**⚠ WARNING**

If the wakeboard is not properly secured on the rack, it could become loose and detach unexpectedly, creating a risk of injury to people nearby. To avoid:

- Inspect bungee cords condition and replace if damaged.
- Secure wakeboard properly on rack.
- Periodically ensure the board is properly attached.

**NOTE:** When the wakeboard is removed from its rack, secure the bungee cords so that they will not move freely when riding watercraft.

**NOTICE** The rack is designed to hold one wakeboard. Do not use to hold more than one wakeboard or to transport skis or any other object. Do not use rack(s) as mooring points or to reboard.

**⚠ WARNING**

With wakeboard and/or rack installed, operate with extra caution:

- NEVER perform aggressive maneuvers including a spin-out.
- NEVER jump waves.
- Use common sense and limit speed.

Otherwise, the wakeboard could detach or occupants could fall off and injure themselves against the wakeboard or rack.

**⚠ WARNING**

When trailering the watercraft, NEVER leave a wakeboard installed on the rack. Otherwise, wakeboard fin(s) could cause injury to bystanders or wakeboard could fly off on the road. The bungee cords are under tension and could spring back and whip someone when released. Use caution.

To remove the wakeboard rack, depress the lever at the top of the rack and remove it from its retaining brackets.



**WAKEBOARD RACK REMOVAL**

1. Press this handle to release wakeboard rack

---

## BREAK-IN PERIOD

### Operation During Break-In Period

A break-in period of 10 operating hours is required before running the watercraft at sustained full throttle.

During this period, maximum throttle should not exceed 1/2 to 3/4 opening. However, brief full acceleration and speed variations contribute to a good break-in.

**NOTICE** Continued wide open throttle accelerations or operation, prolonged cruising speeds are detrimental during the break-in period.

**NOTE: GTR 215:** During the first 5 hours of operation, the engine management limits the engine maximum speed for engine protection. The engine performance will progressively increase during this period.

# OPERATING INSTRUCTIONS

## **⚠ WARNING**

Always perform the *PRE-RIDE INSPECTION* before operating this watercraft. Be sure to read the *SAFETY INFORMATION* and the *WATERCRAFT INFORMATION* sections and be thoroughly familiar with the iControl technology.

Should any control or instruction not be fully understood, refer to an authorized Sea-Doo dealer.

## **Boarding the Watercraft**

As with any watercraft, boarding should be done carefully and engine must not be running.

## **⚠ WARNING**

Engine must be OFF and tether cord must be removed when boarding the watercraft or when using the boarding step. Never use propulsion system components as a supporting point to board the watercraft.

## **Boarding from a Dock**

When boarding from a dock, slowly place one foot on the watercraft footboard nearest the dock while holding the handlebar, and at the same time, transfer the body weight to the other side in order to balance the watercraft.

Then bring the other foot over the seat and place it on the other footboard. Push the watercraft away from the dock.



## **Boarding from Water**

Ensure there is at least 90 cm (3 ft) of water underneath the lowest rear portion of the hull.

Take into account that the hull will be lower in the water when all passengers are aboard. Be certain to maintain the specified depth so sand, pebbles and rocks will not be drawn up in the propulsion system.

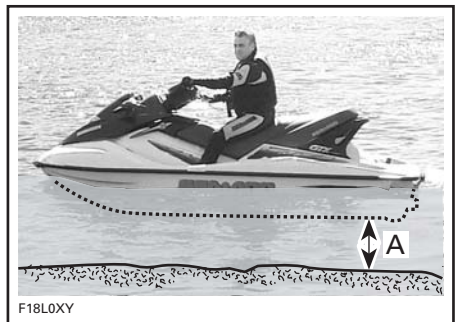

A. Maintain at least 90 cm (3 ft) underneath the lowest rear portion of the hull when all passengers are aboard

**NOTICE** Starting the engine or riding the watercraft in shallower water may damage the propulsion system.

## **Operator Alone**

### **Models Without a Boarding Step**

1. Using one hand, grab the rear handle.

2. With the other hand on the boarding platform, lift your body until you can lay one knee on the boarding platform.
3. Lay the other knee on the boarding platform.



4. Take hold of the seat strap to help maintain your balance and step forward onto the footboards on either side of the seat.



Sit astride the seat.

### ***Models With a Boarding Step***

Using one hand, lower the boarding step.



Using the other hand, take hold of the edge of the boarding platform, then pull yourself up so that you can kneel onto the boarding step.



### **NOTICE**

- Stay on center of the step.
- Only one person at a time on the step.
- Never use propulsion system components to board.

Reach forward with one hand and take hold of the molded handle behind the seat, then stand on the boarding step.



With both hands on the handle behind the seat, step up onto the boarding platform.





Take hold of the seat strap to help maintain your balance and step forward onto the footboards on either side of the seat.



Sit astride the seat.

### Operator with a Passenger

The operator climbs on the watercraft in the same way as explained previously.

### **⚠ WARNING**

Engine must be OFF and tether cord must be removed when boarding the watercraft or when using the boarding step. Never use propulsion system components as a supporting point to board the watercraft.

In choppy water, while in the water, the passenger may hold the watercraft steady to help the operator climb aboard.



The passenger then climbs onto the watercraft while the operator maintains balance by sitting as close as possible to the console.



**TYPICAL - MODEL WITH BOARDING STEP SHOWN**



**TYPICAL - MODEL WITH BOARDING STEP SHOWN**





smo2009-002-150

## How to Start Engine

### **⚠ WARNING**

Before starting the engine, the operator and passenger(s) should always:

- Be properly seated on the watercraft
- Have a firm grip on a handhold or hold on to the waist of the person in front of them
- Wear appropriate protective clothing including a PFD approved by local authorities and a wet suit bottom.

**NOTICE** Ensure there is at least 90 cm (3 ft) of water under the lowest rear portion of the hull when all passengers are aboard prior to starting the engine. Otherwise damage to the propulsion system components may occur.

1. Attach the tether cord clip to your PFD.
2. Firmly grip the handlebar with your left hand and place both feet on the footboards.
3. Press the engine START/STOP button once to wake up the electrical system.
4. Within 5 seconds of pressing START/STOP button, install the tether cord on the engine cut-off switch.
5. Depress the START/STOP button to crank the engine.

6. Release engine START/STOP button immediately after engine is started.

### **⚠ WARNING**

The tether cord clip should always be attached to the operators personal flotation device when starting or operating the watercraft.

**NOTICE** Do not hold START/STOP button more than 10 seconds to avoid starter overheating. A rest period should be observed between the cranking cycles to allow the starter to cool down.

**NOTE:** If the engine is stopped using the START/STOP button without removing the tether cord, it can be restarted within 3 minutes. After this delay, remove the tether cord and carry out the engine starting procedure from the beginning.

## How to Stop the Engine

### **⚠ WARNING**

To maintain watercraft directional control, the engine should be running until the watercraft is stopped.

The engine may be shut off using one of two methods:

- Pressing the engine START/STOP button, or
- Removing the tether cord from the engine cut-off switch.

### **⚠ WARNING**

Never leave the tether cord on the engine cut-off switch when disembarking watercraft to prevent theft, accidental engine starting, and to avoid unauthorized use by children or others.

## How to Steer the Watercraft



F18J09Y

Turning the handlebar pivots the jet pump nozzle which controls the watercraft direction. Turning the handlebar to the right will turn the watercraft to the right, turning the handlebar to the left turns the watercraft to the left. The throttle should be applied to turn the watercraft.

### **⚠ WARNING**

Throttle should be applied and handlebar turned to change the direction of the watercraft. Steering efficiency will differ depending on the amount of throttle applied, the number of passengers, the load, the water conditions and the environmental factors such as the wind.

Unlike a car, a watercraft needs some throttle to turn. Practice in a safe area applying the throttle and turning away from an imaginary object. This is a good collision avoidance technique.

### **⚠ WARNING**

Directional control is reduced when the throttle is released and lost when the engine is off.

The watercraft behaves differently with a passenger and requires greater skill. The passenger(s) should always grip the seat strap, the molded grab handle, or the waist of the person ahead of them. Reduce speed and avoid sharp turns. Avoid choppy water conditions when carrying a passenger.

### **Tight Turns and Other Special Maneuvers**

Any tight turns or special maneuvers that will cause the air inlet openings to be kept under water for a prolonged time, water will seep into the bilge.

Combustion engines need air to operate; consequently this watercraft cannot be totally watertight.

**NOTICE** If the air inlet openings are kept under water, such as turning constantly in tight circles, plunging the bow through waves, or capsizing the watercraft, water may seep into the bilge, which may cause severe damage to internal parts of the engine. Refer to the *WARRANTY* section contained in this guide.

### **O.T.A.S.™ System (Off-Throttle Assisted Steering)**

The O.T.A.S. (Off-Throttle Assisted Steering) system provides additional maneuverability in off-throttle situations.

If the driver releases the throttle to idle when initiating a full turn, the O.T.A.S. system will be electronically activated, and will slightly increase engine speed to allow completion of the turn.

When the handlebar is brought back towards its center position, the throttle reverts to idle.

We recommend that you familiarize yourself with this feature during your first ride.



## How to Engage Neutral

### *iBR Equipped Models Only*

#### **⚠ WARNING**

The drive shaft and impeller are always turning when the engine is running, even in neutral position. Keep away from the propulsion system of the watercraft.

When the watercraft is first started, the iBR system automatically sets the neutral position by default.

To engage neutral from forward position, tap the iBR lever.

To engage neutral from reverse position, release the iBR lever and throttle lever.

### How to Trim the Neutral Position of the iBR

When in NEUTRAL, if the watercraft creeps forward or backward, the iBR system may be trimmed.

**NOTE:** Movement of the watercraft when operating in neutral may be due to wind or water current.

If the watercraft is moving forwards, momentarily press the DOWN button.

If the watercraft is moving backwards, momentarily press the UP button.

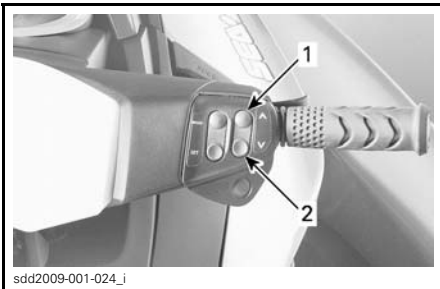

#### **TRIMMING THE iBR NEUTRAL POSITION**

1. UP button (to stop rearward movement)
2. DOWN button (to stop forward movement)

**NOTE:** Press the UP/DOWN button repeatedly until proper adjustment of the neutral position is attained and the watercraft stops moving.

## How to Engage Forward

### *iBR Equipped Models Only*

To engage forward from neutral position, tap on the throttle lever. The watercraft will accelerate forward.

To engage forward from reverse position, release the iBR lever, then tap the throttle lever.

To re-engage forward from braking, simultaneously pull in the throttle lever while releasing the iBR lever. The watercraft will accelerate forward after a short delay.

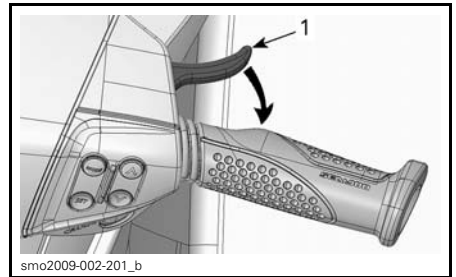

#### **ENGAGING NEUTRAL**

1. Throttle lever

## How to Engage and Use Reverse

### *iBR Equipped Models Only*

Reverse can only be engaged between idle speed and the threshold forward speed of 8 km/h (5 MPH).

To engage reverse position, the iBR lever on the LH handlebar must be pulled in at least 25% of the lever travel.

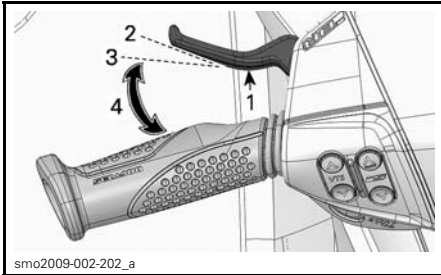

smo2009-002-202\_a

**TYPICAL - iBR LEVER**

1. iBR lever
2. Lever released position
3. Approximate 25% position
4. Operating range

When operating the iBR lever in reverse mode, the throttle lever can be used to control engine RPM, and thus the amount of reverse thrust produced.

By modulating both the iBR and throttle levers simultaneously, reverse thrust can be more precisely controlled. Too much RPM will create water turbulence and reduce reverse efficiency.

**NOTE:** Engine power will be reduced to idle whenever the iBR lever position is changed.

Release the iBR lever to end reverse operation.

To stop rearward motion after iBR lever release, apply enough throttle to stop rearward movement.

**⚠ WARNING**  
 The brake function has no effect when travelling in reverse.

Available engine power is limited in reverse mode, which limits reverse speed.

**⚠ WARNING**  
 Only use reverse at slow speed and for the shortest time possible. Always ensure the path behind is clear of objects, obstacles and people.

When operating in reverse, turn the handlebar in the opposite direction that you want to move the rear of the watercraft.

For example, to steer the rear of the watercraft to port (left), turn the handlebar to starboard (right).



F18J08Z

**TYPICAL - STEERING DIRECTION REVERSED WHEN BACKING**

**⚠ CAUTION** Steering direction in reverse is opposite of forward. To steer the stern to port (left) in reverse, turn the handlebar to starboard (right). To steer the stern to starboard (right), turn the handlebar to port (left). Reverse operation should be practiced in open waters in order to become fully familiar with the controls and watercraft handling characteristics before operating in close quarters.

## How to Engage and Use Braking

### *iBR Equipped Models Only*

#### **⚠ WARNING**

- The engine must be running to be able to use the brake.
- The brake is only applicable when operating in forward movement, it has no effect on rearward motion.
- The brake cannot prevent your PWC from drifting due to current or wind.

The braking function can only be engaged during forward operation at or above the threshold speed of 8 km/h (5 MPH).

Braking is engaged and controlled when the iBR lever on the LH handlebar is pulled in at least 25% of its travel.

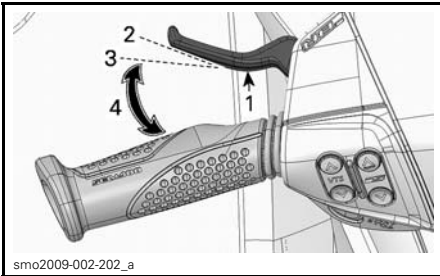

#### **TYPICAL - iBR LEVER**

1. iBR lever
2. Lever released position
3. Approximate 25% position
4. Operating range

#### **⚠ WARNING**

Braking should be practiced in open waters and at gradually increasing speeds in order to become fully familiar with the controls and watercraft handling characteristics.

When iBR lever is applied, the throttle lever command is overridden and engine throttle control is now dependant on the iBR lever position. Braking can thus be modulated by using only the iBR lever.

Watercraft deceleration is proportional to the braking force. The more the iBR lever is pulled in, the greater the braking force applied.

**NOTE:** Be careful to gradually actuate the iBR lever to adjust intensity of the braking force and simultaneously release the throttle lever.

**⚠ CAUTION** When braking, riders must brace themselves against the deceleration force to prevent from moving forward on the watercraft and losing balance. The operator should always keep both hands on the handlebars, and all passengers should maintain a firm grip of a handhold or the waist of the person in front of them.

#### **⚠ WARNING**

Stopping distance will vary depending on initial speed, load, wind, number of riders, water conditions, and the amount of braking power commanded by the operator. Always adjust your riding style accordingly.

When the watercraft slows to less than 8 km/h (5 MPH), braking mode ends and reverse mode is engaged. Release the iBR lever once the watercraft is stopped. Otherwise, a rearward movement will be initiated.

**⚠ CAUTION** As the watercraft slows to a stop, the wake created by the watercraft will catch up and tend to push the watercraft forward. Ensure there are no obstacles or bathers in the direction of travel.

If the throttle lever is still pulled in when releasing the iBR lever, the watercraft will accelerate forward after a short delay. Acceleration will be proportional to the throttle lever position.

### **⚠ WARNING**

If forward acceleration is not desired when the brake lever is released, release the throttle lever.

When at speed and the brake is first applied, a plume of water will shoot up in the air behind the watercraft which may cause the operator of a following watercraft to momentarily lose sight of your PWC.

### **⚠ WARNING**

- It is important to inform the operator of a watercraft who intends to follow in a convoy formation, of the braking and maneuvering capability of your PWC, what the plume of water indicates, and that a greater distance must be maintained between watercraft.
- Be aware that other boats following or operating in close proximity may not be able to stop as quickly.

## **Braking in a Turn**

### *iBR Equipped Models Only*

Throttle must be applied for turning to ensure directional control. However braking can be initiated during a turn using the iBR lever as previously described. Get ready to maintain your balance while the wake is crossing your PWC.

**⚠ CAUTION** As the watercraft slows to a stop while braking in a turn, the wake created by the watercraft will catch up and tend to push the watercraft sideways. Be prepared to maintain balance as the wake crossed the watercraft.

## **How to Use the Variable Trim System (VTS)**

The variable trim system (VTS) changes the vertical position of the jet pump nozzle to provide the operator with a fast, effective system to compensate for load, thrust, riding position and water conditions. Correctly adjusted, it can improve handling, reduce porpoising, and position the watercraft at its best riding attitude to attain maximum performance.

When first using the watercraft, the operator should become familiar with the use of the variable trim system (VTS) at varying speeds and water conditions. A mid-range trim is generally used when cruising. Experience alone will dictate the best trim for the conditions. During the watercraft break-in period, when lower speeds are recommended, it is an excellent opportunity to become familiar with trim adjustment and its effects.

When the nozzle is positioned in an upward angle, the water jet directs the bow of the watercraft upward. This position is used to optimize high speed.

When the nozzle is directed downward, the bow is forced downward and increases the watercraft turning capabilities. As with any watercraft, speed and operator body position and movement (body English), will determine the degree and sharpness of the watercraft turn. Porpoising can be reduced or eliminated if the nozzle is downward and speed is adjusted proportionately.

**NOTE:** VTS position is indicated on a bar gauge in the information center.

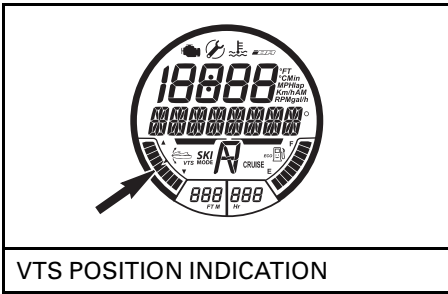

VTS POSITION INDICATION

The VTS system allows for manually adjusting the trim position of the nozzle, or selecting two preset trim positions and recording or changing preset trim positions on certain models.

### VTS Trimming Methods

AVAILABLE VTS TRIMMING METHODS					
	GTI	GTI SE	GTI Limited	GTR	WAKE
VTS trim button	Opt	Opt	X	X	Opt
VTS "Double Click" trimming	Opt	Opt	X	X	Opt
VTS "Presets"	Opt	Opt	X	X	Opt
VTS trimming through multifunction gauge	N.A.	X	N.A.	N.A.	X

X = Indicates a **standard** feature  
 Opt = Feature available as an **option**  
 N.A. = Not Available

### Trimming the VTS Using the VTS Button

Five trim positions are available.

With the watercraft operating in forward position, proceed as follows:

1. Press the VTS UP button once to trim the bow of the watercraft up to the next trim position.

**NOTE:** Pressing the VTS trim button without the engine in forward position will only change the indication. The nozzle will move to the selected VTS trim position when forward position is engaged.

2. Press the VTS DOWN button once to trim the bow of the watercraft down to the next trim position.

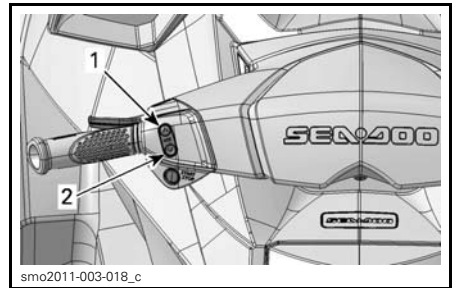

TYPICAL - VTS CONTROL BUTTON

1. Bow up
2. Bow down

**NOTE:** If the VTS UP/Down button is pressed and held, the pump nozzle will keep moving until the button is released at the desired trim attitude, or the maximum trim position (up or down) is reached.

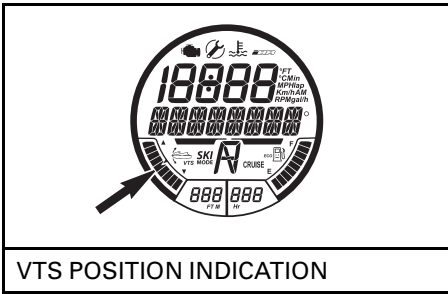

### Using Preset Trim Positions

Two preset trim positions can be selected.

To select the highest trim position recorded, double-click on the VTS UP button (bow up).

To select the lowest trim position recorded, double-click on the VTS DOWN button (bow down).

**NOTE:** If only one preset trim position is recorded, double-click either UP or DOWN of the VTS button.

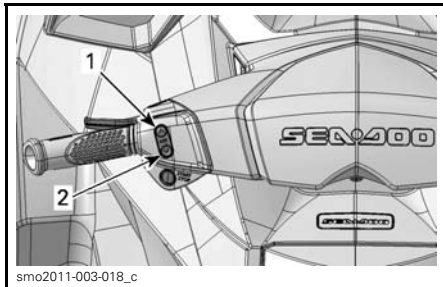

### DOUBLE-CLICK UP OR DOWN VTS BUTTON TO USE PRESET POSITIONS

1. Highest preset position on UP arrow
2. Lowest preset position on DOWN arrow

### Recording Preset Trim Positions

Two different VTS trim positions may be recorded for quickly selecting the preferred watercraft trim attitude.

Both VTS PRESET trim positions are factory set to 3 but may be changed as per operator preference. When the VTS PRESET trim positions are changed by an operator, the new set-

tings will remain recorded in memory even after complete watercraft power down.

To record VTS preset trim positions:

1. Turn ON the electrical power by pressing the START/STOP button once.
2. Install the tether cord on the engine cut-off switch.
3. On the RH handlebar, press the MODE button repeatedly until VTS MODE is displayed.

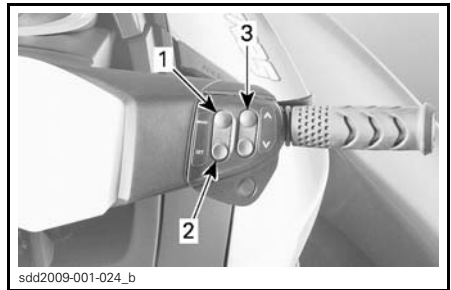

1. MODE button
2. SET button
3. UP/DOWN button

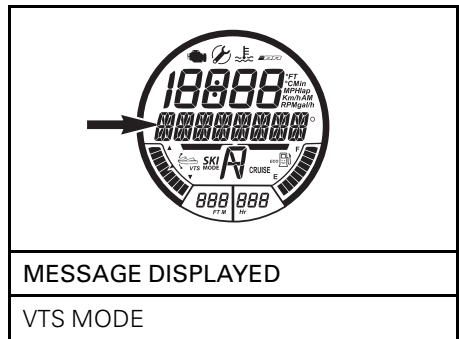

4. On the RH handlebar, press the SET button to display PRESET 1.
5. Press the VTS UP/DOWN button to change the PRESET 1 VTS position. Gauge will display setting 1 through 5 in the digital screen above PRESET 1.

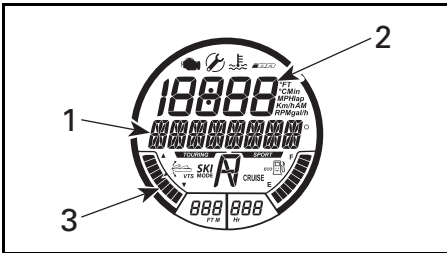

FUNCTION SELECTED - PRESET 1

1. PRESET 1 message
  2. VTS setting number
  3. VTS position indicator at setting 1 (bow down)
6. Press the SET button to save PRESET 1 and display PRESET 2.
  7. Press the VTS UP/DOWN button to change the PRESET 2 VTS position. Gauge will display setting 1 through 5 in the digital screen above PRESET 2.
  8. Press the SET button to save the settings and return to the main display.

The VTS system will compare the preset trim settings recorded, the highest position will be assigned to the UP arrow (bow up), the lowest to the DOWN arrow (bow down).

If both trim positions are identical, both buttons will have the same trim settings.

### Trimming the VTS Using the Mode/Set Buttons

With the engine running in forward position, proceed as follows:

1. Press the MODE button to display the VTS function in the multifunction display.
2. On the RH handlebar, press the UP/DOWN button to change the VTS setting.

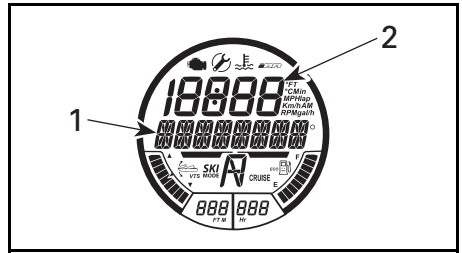

FUNCTION SELECTED - VTS

1. VTS message
  2. VTS setting number
3. Confirm VTS operation by looking for the VTS position indicator movement in the digital display.
  4. Press the SET button to save the desired setting and return to the main display.

**NOTE:** The available VTS settings are between 1 and 5.

**NOTE:** The VTS system cannot be fully tested without the engine operating in forward position. If the engine is not running in forward position, only the VTS indication will change when the VTS control switches are pressed; the nozzle will not change position.

## General Operating Recommendations

### Rough Water or Poor Visibility Operation

Avoid operation in these conditions. If you must do so, proceed with caution using minimum speed.

### Crossing Waves

Reduce speed.

Always be prepared to steer and maintain your balance as necessary.

When crossing wakes, always keep a safe distance from watercraft ahead.

**⚠ WARNING**

When crossing wakes, slow down. Operator and passenger(s) should brace themselves and adopt a semi-standing position to help absorb the bumps. Do not jump waves or wakes.

**Stopping/Docking**

When the throttle is released, the watercraft is slowed by water drag against the hull. The stopping distance will vary depending on the watercraft size, weight, speed, water surface condition, presence and direction of wind and current.



The operator should practice in open waters at various speeds to become familiar with the stopping distances under different conditions.

**⚠ WARNING**

Always practice braking in open waters ensuring there are no watercraft or boats in your immediate vicinity, especially astern. Other users of the waterways may not be able to maneuver or stop in time to avoid you should you unexpectedly come to a full stop in front of them.

*iBR Equipped Models Only*

The iBR system can also be used for slowing down or for stopping the watercraft more quickly, and for increasing maneuverability especially when docking. Stopping using the iBR system in a straight line and in a turn should be practiced extensively to become familiar with the handling characteristics of the watercraft under partial or full braking conditions.

When at speed and the brake is first applied, a plume of water will shoot up in the air behind the watercraft and may cause the operator of a following watercraft to momentarily lose sight of your PWC.

**⚠ WARNING**

It is important to inform the operator of a watercraft who intends to follow in a convoy formation of the braking and maneuvering capability of your PWC, what the plume of water indicates, and that a greater distance should be maintained between both of you.

The operator should also practice docking with an imaginary dock using the various controls available (iBR lever and throttle lever).

Release the throttle at a sufficient distance before the expected landing area.

Reduce speed to idle.

Maneuver using a combination of the iBR lever and throttle lever, shifting to neutral, reverse, or forward as required.

Remember that when operating in reverse, steering direction is reversed. Turning the handlebars to the left will move the stern to the right when backing up, and vice-versa.



**⚠ WARNING**

Directional control is reduced when the throttle is released and/or when engine is off. Steering direction is reversed when operating the watercraft in reverse.

**Beaching**

**NOTICE** It is not recommended to run the watercraft to the beach.

Drive slowly towards the beach and shut off the engine before the water is less than 90 cm (3 ft) deep under the lowest rear portion of the hull. Then pull the watercraft to the beach.

**NOTICE** Riding the watercraft in shallow water may result in damage to the propulsion system components. Always shut off the engine before the water is less than 90 cm (3 ft) deep, and never use reverse or braking.

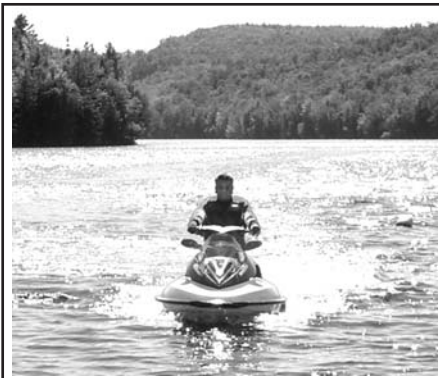

F18A03Y

# OPERATING MODES

	GTS	GTI	GTI SE	GTI LIMITED	GTR	WAKE
Touring mode	X	X	X	X	X	X
Sport mode	X	X	X	X	X	X
ECO mode	X	X	X	X	X	X
Cruise mode	N.A.	Opt	Opt	X	Opt	X
Slow speed mode	N.A.	Opt	Opt	X	Opt	X
Ski mode	N.A.	Opt	Opt	Opt	Opt	X
Learning key modes	X	X	X	X	X	X

X = Indicates a **standard** feature  
 Opt = Indicates a feature available as an **option**  
 N.A. = Not Applicable

## Touring Mode

By default, the watercraft is in TOURING mode of operation when first started.

A TOURING mode indicator is ON in the multifunction gauge to confirm the active mode of operation.

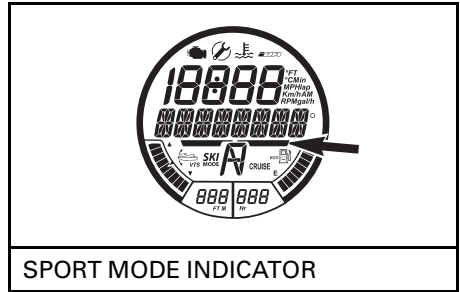
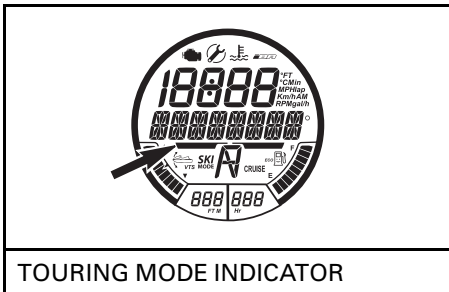

Once activated, SPORT MODE will remain active until it is deactivated by the operator, or the engine is shut down whereby it defaults back to TOURING MODE.

## Activating Sport Mode

To activate sport mode while riding at speed, carry out the following:

**⚠ WARNING**

When activating sport mode, be sure to maintain situational awareness of other watercraft, obstacles, or persons in the water.

1. Depress and hold the SPORT button for at least 3 seconds.

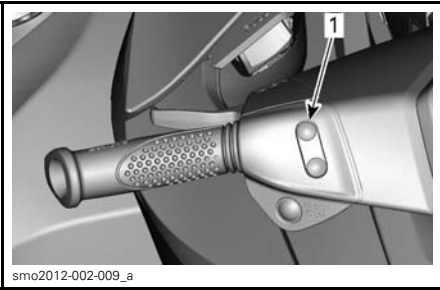

smo2012-002-009\_a

**TYPICAL**

1. Sport button

**NOTE:** The following **important** message will scroll across the multifunction display:

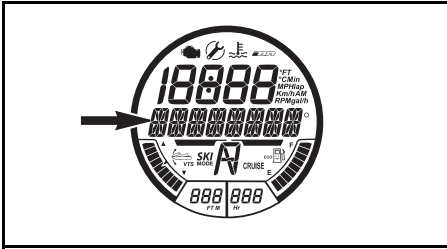

MESSAGE DISPLAYED

ENTERING SPORT MODE -  
INCREASED ACCELERATION -  
INSTRUCT PASSENGERS TO HOLD -  
PRESS\_SPORT\_BUTTON

**⚠ WARNING**

Ensure passengers are advised that sport mode provides for increased accelerations and that they are to hold on tightly.

2. Press the SPORT button again to activate sport mode.

A scrolling SPORT MODE ACTIVATED message will momentarily confirm that sport mode has been activated.

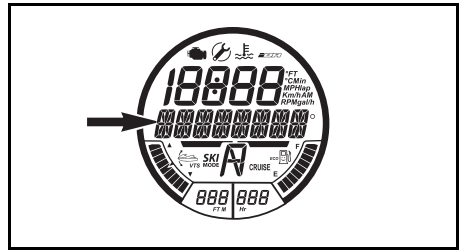

MESSAGE DISPLAYED

SPORT MODE ACTIVATED

**NOTE:** After a few seconds, the gauge will revert to its normal display.

3. Ensure the SPORT mode indicator is turned on.

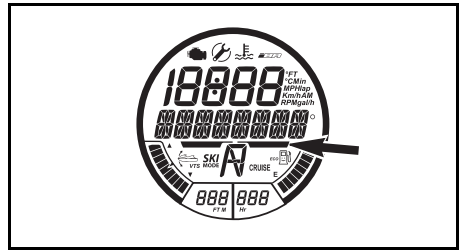

SPORT MODE INDICATOR

**NOTE:** The SPORT mode indicator will come on and stay on as long as sport mode is active.

**Deactivating Sport Mode**

To deactivate sport mode while riding at speed, carry out the following:

**⚠ WARNING**

When activating sport mode, be sure to maintain situational awareness of other watercraft, obstacles, or persons in the water.

1. Depress and hold the SPORT button for at least 3 seconds.

**NOTE:** The following message will scroll in the multifunction display: SPORT MODE DEACTIVATED.

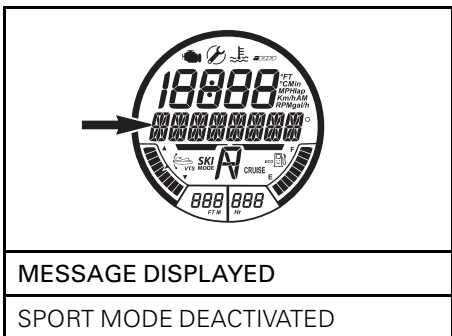

NOTE: After a few seconds, the gauge will revert to its normal display.

2. Ensure the TOURING mode indicator is on.

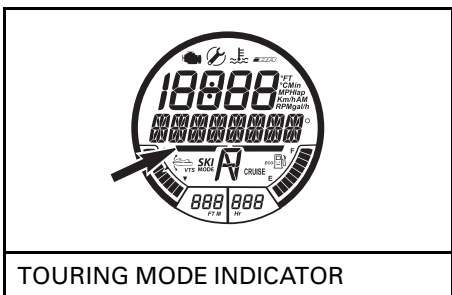

## ECO Mode (Fuel Economy Mode)

### How to Activate ECO Mode

1. Depress the Eco button for at least 3 seconds.

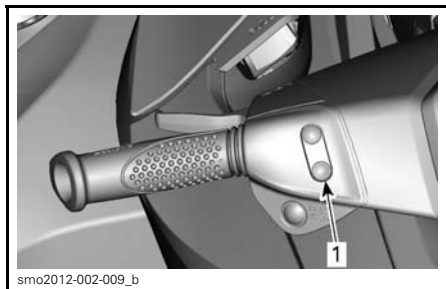

TYPICAL  
1. ECO button

The following message will be displayed on the multifunction display:

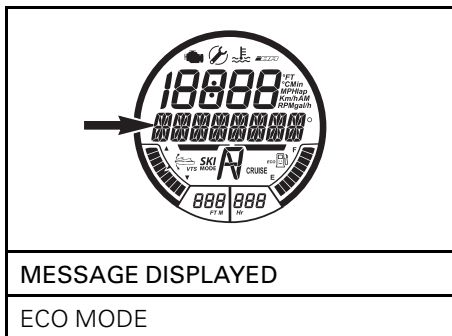

The ECO mode indicator will also be activated.

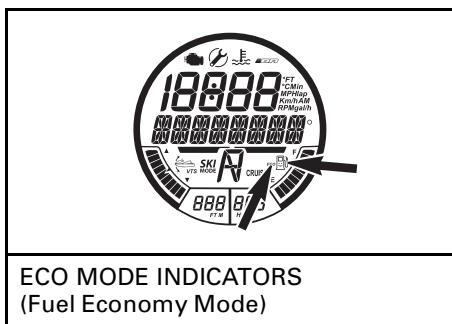

### How to Deactivate ECO Mode

1. Depress the Eco button for at least 3 seconds.

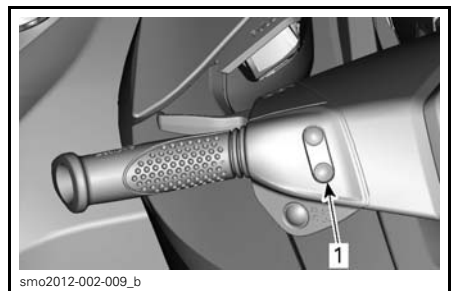

TYPICAL  
1. Eco button

The ECO mode indicator will be deactivated.

## Cruise Mode

Cruise mode is a function of iTC (intelligent Throttle Control) system that allows the operator to set the desired maximum watercraft speed.

This is useful when cruising for long distances, operating in limited speed zones, or towing a tuber, skier or wake boarder.

Cruise mode only limits forward speed, the operator must keep the throttle depressed to maintain forward speed.

Once the maximum cruise speed is set, the operator can vary the watercraft speed from idle speed up to the set cruise speed using the throttle lever. The set cruise speed will not be exceeded even if the throttle lever is fully depressed.

As you proceed under a constant cruising speed setting, keep your attention level up to maintain good situational awareness.

Slowing down is a matter of releasing the throttle lever further than the set point, or by pulling the iBR lever in.

If the iBR lever is pulled in for braking, CRUISE mode is overridden but **not deactivated**.

Once the iBR lever is released and the throttle is pulled in to engage forward position, the cruise function will reengage to limit the watercraft speed as it was set before.

**NOTE:** Cruise mode is **not** available if slow speed mode or ski mode mode is engaged.

### Activating Cruise Mode

#### Cruise Mode Activation at Idle Speed

**NOTE:** This function is available up to approximately 10 km/h (6 MPH).

To activate and preset CRUISE MODE at idle speed, carry out the following:

1. Tap the throttle lever to move the iBR to the forward position.
2. Press and hold the cruise button.

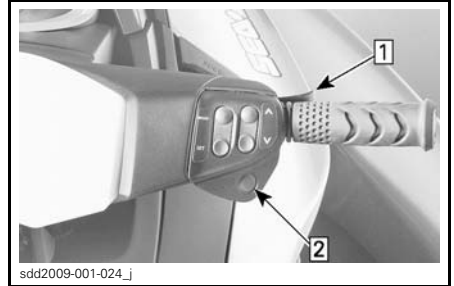

#### ENGAGING CRUISE AT IDLE

Step 1: Tap throttle to engage FORWARD

Step 2: Press cruise button

The following message will appear in the multifunction display.

MESSAGE DISPLAYED

CRUISE MODE \_ SELECT SPEED \_  
PRESS SET TO ACCEPT OR MODE TO  
EXIT

3. Press the UP button until the desired cruise speed is indicated in the numerical display.

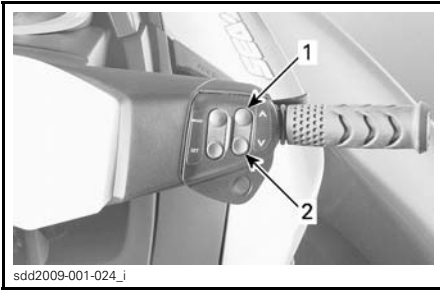

1. UP button
2. DOWN button

The following will be displayed in the multifunction gauge.

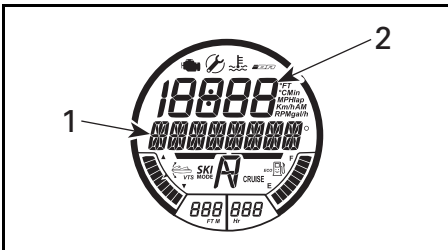

**FUNCTION SELECTED - CRUISE MODE**

1. CRUISE MODE \_ SPEED ADJUSTING
2. Cruise speed set point indication

4. Press the SET button to save the cruise speed selected and engage cruise mode. The following scrolling message will appear in the multifunction display.

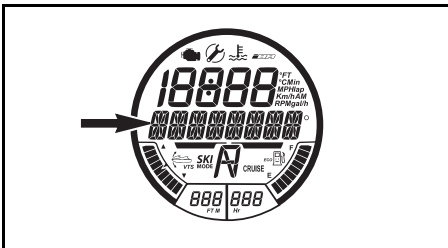

**MESSAGE DISPLAYED**

CRUISE MODE ACTIVE

A beep indicating that you are now in cruise mode will sound, and a CRUISE indicator will come on in the multifunction gauge.

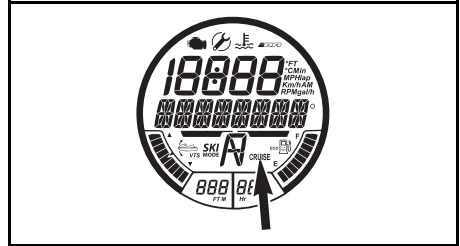

**CRUISE MODE INDICATOR**

**Cruise Mode Activation Above Idle Speed**

To activate cruise mode above idle speed (10 km/h (6 MPH)):

1. Accelerate to the desired watercraft speed and hold throttle lever steady.
2. Press and hold the cruise button for approximately 1 second.

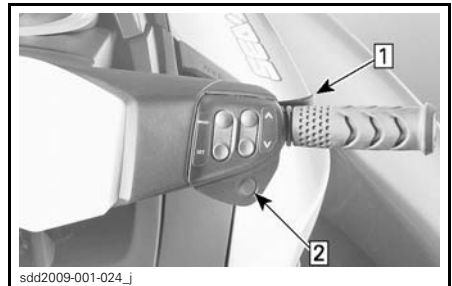

**ENGAGING CRUISE AT SPEED**

- Step 1: Accelerate to desired speed and hold throttle steady  
 Step 2: Press cruise button

A beep indicating that you are now in cruise mode will sound, and a CRUISE indicator will come on in the multifunction gauge.

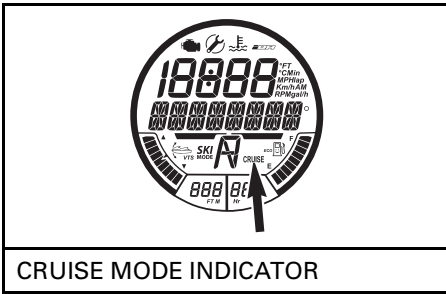

CRUISE MODE INDICATOR

### Changing Set Cruise Speed

To increase or decrease the set cruise speed:

1. Hold the throttle lever all the way in to the handlebar.
2. On the RH handlebar, press UP/DOWN button.

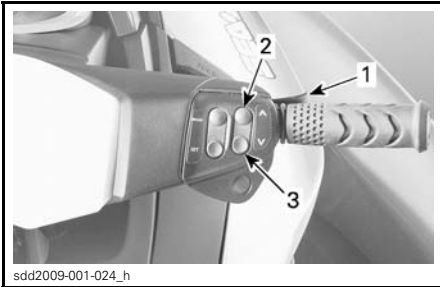

sdd2009-001-024\_h

#### CHANGING SET CRUISE SPEED

1. Throttle lever
2. UP button
3. DOWN button

While the UP/Down is being pressed to change the speed setting, the following will appear in the multifunction gauge.

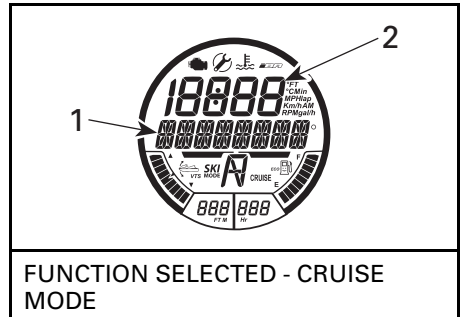

FUNCTION SELECTED - CRUISE MODE

1. CRUISE MODE \_ SPEED ADJUSTING
2. Cruise speed set point indication

**NOTE:** Pressing the UP/DOWN button repeatedly will change the cruise set speed in single increments. Pressing and holding the button will increase or decrease the speed until the button is released.

### Deactivating Cruise Mode

To deactivate cruise mode:

1. Release the throttle lever.
2. Press the cruise button.

Deactivation of cruise mode is indicated by:

- The CRUISE indicator will turn off.
- A BEEP will be heard.

**NOTE:** If the throttle lever is not fully released when the cruise button is pressed to deactivate cruise mode, the BEEP will not be heard and the cruise indicator will remain on. The speed limiting function of cruise mode will stay active until the throttle is fully released, then the BEEP will be heard and the cruise indicator will go out.

### Slow Speed Mode

The Intelligent Throttle Control also allows for a Slow Speed Mode where the driver can adjust and set idle speed. This is useful when operating in slow speed zones where the driver must be especially attentive to possible obstacle avoidance.

The operator can select an idle speed set point (slow speed) between 1 and 5 (1.6 km/h to 11 km/h (1 MPH to 7 MPH)).

If you accelerate above approximately 14 km/h (9 MPH), Slow Speed Mode will be deactivated and the engine will return to its normal idle RPM when the throttle is released.

Should a situation arise where the operator must stop or accelerate quickly away from a hazardous situation, pull in the iBR lever, or pull in on the throttle lever to deactivate slow speed mode and regain normal control of the watercraft.

### Activating Slow Speed Mode

To activate slow speed mode of operation:

1. Release the throttle lever to idle RPM.
2. Pull in and release the iBR lever to engage neutral.
3. Press and hold the cruise button for approximately 1 second.

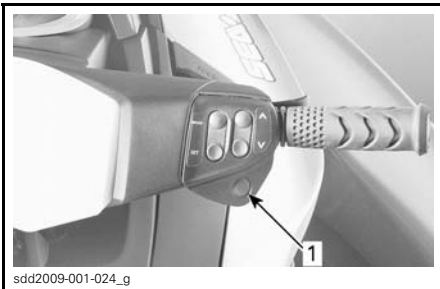

TYPICAL  
1. CRUISE button

The CRUISE indicator will come on in the multifunction gauge to indicate cruise activation.

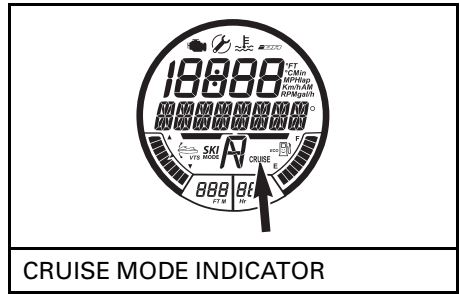

CRUISE MODE INDICATOR

A scrolling message will appear in the multifunction display to specify that you are now in slow speed mode. The default slow speed set point of 1 will also come on for a few seconds in the numerical display.

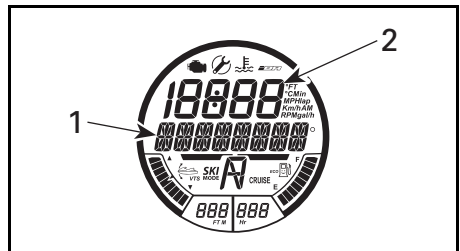

FUNCTION SELECTED - SLOW SPEED MODE

1. SLOW SPEED MODE message
2. Slow speed set point of "1" indication

**NOTE:** The scrolling SLOW SPEED MODE message repeats itself as long as slow speed mode is activated. The numerical display reverts back to the previous indication after a few seconds.

### Changing Set Slow Speed

There are 5 slow speed set points available (1 through 5), 1 being the slowest.

To **increase** or **decrease** the slow speed set point, press the UP/DOWN button on the RH handlebar once, or repeatedly.



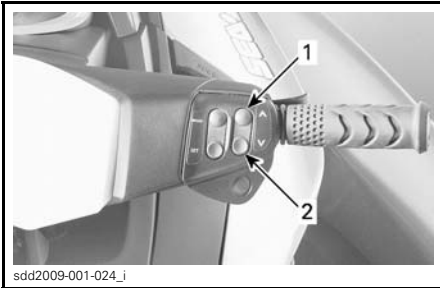

sdd2009-001-024\_i

1. UP button to increase speed
2. DOWN button to decrease speed

While the UP/DOWN is being pressed to change the slow speed set point, the following will appear in the multi-function gauge.

FUNCTION SELECTED - SLOW SPEED MODE
<ol style="list-style-type: none"> <li>1. SLOW SPEED MODE - SPEED ADJUSTING message</li> <li>2. Slow speed set point indication</li> </ol>

The displays will revert back to their previous indication a few seconds after the last activation of the UP/DOWN button.

**NOTE:** As a reminder, the following message will scroll across the multi-function display periodically.

MESSAGE DISPLAYED
SLOW SPEED MODE ACTIVE

### Deactivating Slow Speed Mode

Slow speed mode can be deactivated using any of the following methods:

- Pressing the cruise button
- Depressing the iBR lever
- Accelerating above the highest slow speed that can be set (approximately 14 km/h (9 MPH)).

When deactivating SLOW SPEED MODE:

- By pressing the cruise button, the iBR system maintains forward position.
- By pressing the iBR lever, the iBR system will shift to neutral position.

SLOW SPEED MODE deactivation will be indicated in the following manner:

1. The CRUISE indicator will go out
2. The scrolling SLOW SPEED MODE ACTIVE message will cease.

### Ski Mode

Ski mode allows for repeated and precisely controlled launches, and a set towing speed, specifically for towing a skier or wake boarder.

Ski mode is not available if using a LEARNING key or a RENTAL key.

### RAMP Function

The RAMP function offers a pre-programmed setting for launching and accelerating the PWC.

RAMP 1 provides:

- Slowest launch (smoothest)
- Slowest acceleration rate
- Slowest TARGET SPEED range.

RAMP 5 provides:

- Quickest launch
- Quickest acceleration rate
- Highest TARGET SPEED range.

### TARGET SPEED Function

The TARGET SPEED function limits the maximum towing speed.

Once the RAMP has been selected, an average PWC target speed for that RAMP will be visible in the numerical display.

The average speed displayed and the speed range available is dependent on the RAMP selected. The higher the RAMP number, the higher the speed range.

The operator may increase or decrease the target speed to any value within the selected RAMP speed range.

**NOTE:** If the desired target speed cannot be set in the selected RAMP, you must exit then reengage SKI MODE, and select a different RAMP.

### Engaging and Using Ski Mode

To engage ski mode, carry out the following steps:

1. Release throttle lever.

**NOTE:** Ski mode cannot be engaged if the throttle lever is not fully released, and if CRUISE or SLOW SPEED mode is engaged. A message will appear in the multifunction display advising you of the situation. Follow the instructions in the display.

2. Press the MODE button repeatedly until SKI MODE is visible in the multifunction display.

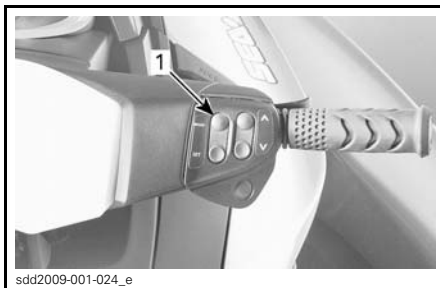

TYPICAL  
1. MODE button

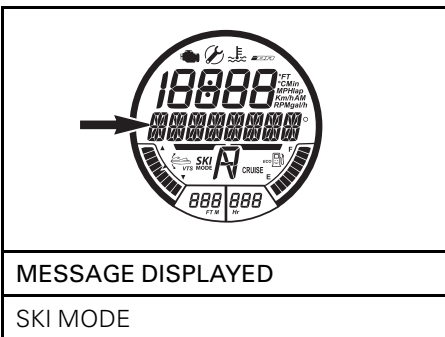

3. Press SET to enter the function. The multifunction gauge message will change to RAMP. The RAMP setting number will be visible in the numerical display.



1. SET button

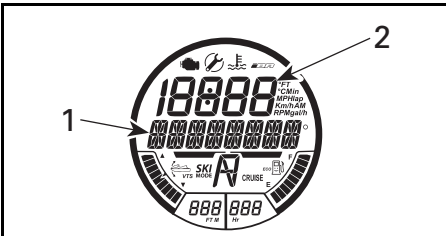

**FIRST SETTING AVAILABLE - RAMP**

1. RAMP message
2. Ramp setting

4. To change the RAMP setting, press the UP/DOWN button until the desired ramp number is visible in the numerical display.
5. Press SET to lock in the ramp setting; the multifunction display will change to the TARGET SPEED setting function.

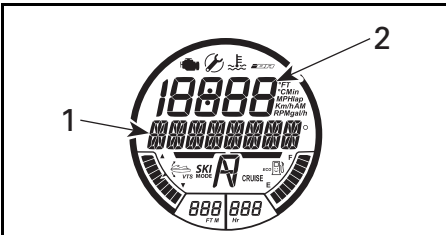

**SECOND SETTING AVAILABLE - TARGET SPEED**

1. TARGET SPEED message
2. Target speed setting

6. Press the UP/DOWN button to increase or decrease the target speed.
7. Press SET to lock in the target speed; the display will switch to the following scrolling message.

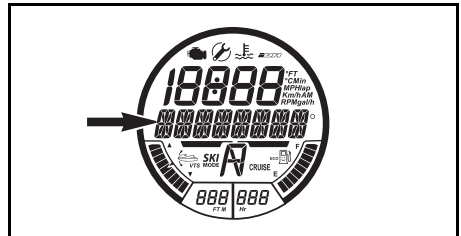

**MESSAGE DISPLAYED**

SKI MODE\_PRESS\_SET\_TO START OR MODE TO EXIT

**NOTE:** A BEEP will be heard every 5 seconds as a SKI MODE engaged reminder.

8. Press SET again; the following confirmation message will appear.

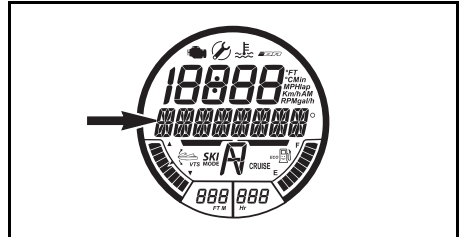

**MESSAGE DISPLAYED**

SKI MODE  
ACTIVE\_PRESS\_MODE\_AND  
RETURN TO IDLE TO CANCEL

**NOTE:** The SKI MODE indicator will also come ON and blink when ski mode becomes active. It will be ON steady when the operator pulls and holds the throttle lever all the way in to the handlebar.

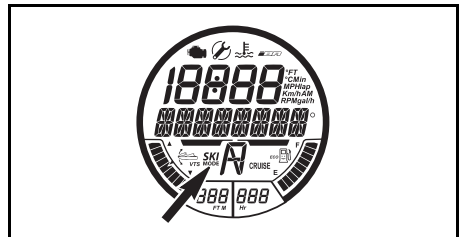

**SKI MODE INDICATOR**

9. To launch the PWC in ski mode, pull in and hold the throttle lever all the way to the handlebar grip. The PWC will accelerate to the set TARGET SPEED and the SKI MODE indicator will be on steady.
10. To increase or decrease the TARGET SPEED during a ski run, press the UP/DOWN button, **do not** release the throttle lever.

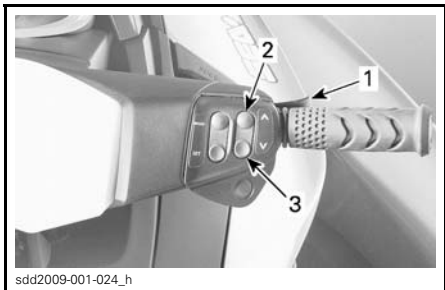

1. Hold throttle lever in
2. Press UP button to increase speed
3. Press DOWN button to decrease speed

**NOTE:** If the throttle is partly released during a ski run, the SKI MODE indicator light will start to blink and the speed adjust function using the UP/DOWN arrow button will be deactivated.

11. To end a ski run or to pick up a fallen skier or wakeboarder, fully release the throttle to regain normal throttle control.

**NOTE:** When the throttle is fully released during ski mode operation, the system returns to ski mode engaged status. The SKI MODE indicator light will go out but, ski mode will remain engaged and a message to that effect will reappear in the multifunction display.

12. Press SET to reactivate ski mode and fully pull in the throttle lever to start another ski run.

### Deactivating Ski Mode

To exit ski mode at any given point during the ski mode setting process, press the MODE button.

To end a ski run and completely deactivate ski mode, release the throttle to idle, then press the MODE button.

## Learning Key and Rental Key Modes

Both learning and rental keys provide a mode of operation whereby engine power and speed is limited.

There are 5 speed settings available for the learning key mode. By default, the key modes are preset to the speed setting (3).

**NOTE:** Changing key settings is only available when the engine is not running.

### Changing Learning Key Speed Settings

#### GTS Models

The default learning key setting is 74 km/h (46 MPH) and cannot be changed on these models.

#### All Models Except GTS

To change learning or rental key settings, carry out the following:

1. Press the START/STOP button to wake up the electrical system and install the NORMAL key on the engine cut-off switch.
2. Wait for the information center to complete its self-test and display the key recognition message.
3. Press the MODE button repeatedly until KEY MODE is visible in the digital screen of the information center.

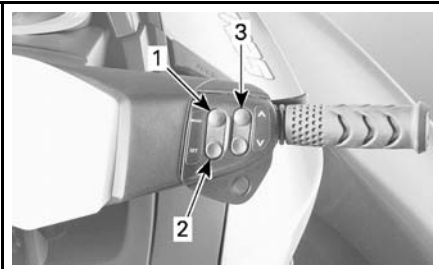

sdd2009-001-024\_b

**TYPICAL - GAUGE CONTROL BUTTONS**

1. MODE button
2. SET button
3. UP/DOWN button

<b>MESSAGE DISPLAYED</b>
KEY MODE

4. Press the SET button once to enable learning key mode setting function. The display will change to L-Key.

<b>FUNCTION SELECTED - LEARNING KEY</b>
<ol style="list-style-type: none"> <li>1. L-KEY message</li> <li>2. Learning key setting</li> </ol>

5. Press the UP/DOWN button to toggle the key setting between 1 and 5. See table for speed limitations according to setting.

6. Press the SET button once to save the setting, twice to exit the function, or simply wait for the function to time-out. The change in key setting will automatically be saved.

**NOTE:** The key speed setting is applicable to any key of the same type used on a specific watercraft. The same key type used on a different watercraft may therefore have a different key speed setting.

D.E.S.S. KEY TYPE	KEY SPEED SETTING	APPROX. MAX. SPEED
Learning key	5	80 km/h (50 MPH)
	4	74 km/h (46 MPH)
	3	68 km/h (42 MPH)
	2	58 km/h (36 MPH)
	1	51 km/h (32 MPH)

# SPECIAL PROCEDURES

## Jet Pump Water Intake and Impeller Cleaning

### **⚠ WARNING**

Keep away from intake grate while engine is running. Items such as long hair, loose clothing or personal flotation device straps can become entangled in moving parts.

Weeds, shells or debris can get caught on the intake grate, drive shaft and/or impeller. A clogged water intake may cause troubles such as:

- **Cavitation:** Engine speed is high but watercraft moves slowly due to reduced jet thrust, jet pump components may be damaged.
- **Overheating:** Since the jet pump operation controls the flow of water to cool the exhaust system, a clogged intake will cause the engine to overheat and damage engine internal components.

A weed clogged area can be cleaned as follows:

### **⚠ WARNING**

If it is necessary to reach in to remove any foreign object caught in the propulsion system, the tether cord **MUST BE REMOVED** from the engine cut-off switch

## In-Water Cleaning

Rock the watercraft several times while repeatedly pressing engine START/STOP button for short periods without starting the engine. Most of the time, this will remove the blockage. Start engine and make sure watercraft operates properly.

If the aforementioned method does not work, the following can be performed:

- With engine running and before applying throttle, pull the iBR lever in to select reverse operation and vary throttle quickly several times.
- Repeat procedure if necessary.

If system is still blocked, move the watercraft out of the water for cleaning. Refer to *ON-BEACH WATER CLEANING*.

## On-Beach Water Cleaning

### **⚠ WARNING**

The tether cord **MUST BE REMOVED** from the engine cut-off switch to prevent accidental engine starting before cleaning the propulsion system components.

Place a cardboard or a carpet beside the watercraft to prevent scratching when turning the watercraft for cleaning.

Rotate the watercraft to any side for cleaning.

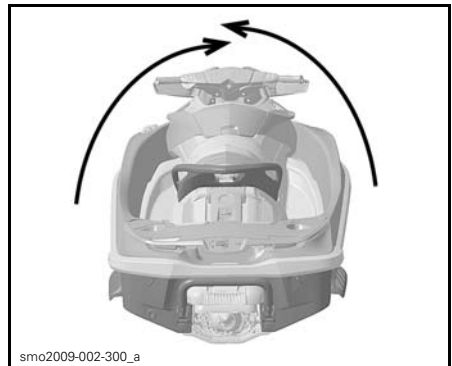

*TYPICAL*

Clean the water intake area. If the system is still clogged, refer to an authorized Sea-Doo dealer for servicing.

**NOTICE** Inspect water intake grate for damage. Refer to an authorized Sea-Doo dealer for repair as necessary.

### *Watercrafts Equipped with iBR*

For ease of access to the propulsion system, move the iBR to the forward position, refer to *iBR OVERRIDE FUNCTION* for detailed instructions.

### **iBR Override Function**

When the iBR override function is activated, it allows the user to electrically move the iBR gate and nozzle through its full range of motion using the VTS control button.

**NOTE:** The iBR override function is only available when the engine is not running.

### **⚠ WARNING**

When moving the iBR gate using the iBR override function, ensure no-one is near the rear of the watercraft. Movement of the gate may squeeze fingers.

**NOTICE** An object or tool caught in the iBR system when using the iBR override function may cause damage to the iBR components. Remove all rigid foreign objects that may obstruct the iBR gate travel before moving it.

### **⚠ WARNING**

If it is necessary to reach in to remove any foreign object caught in the propulsion system, strictly observe the following before proceeding:

- Remove tether cord from the engine cut-off switch.
- Wait at least 5 minutes.
- Do not press on START/STOP button. Should the START/STOP button is pressed, wait another 5 minutes.

### **Activating iBR Override Function**

To activate the iBR override function, carry out the following step.

1. Power up the electrical system by pressing the START/STOP button.
2. Install the tether cord on the engine cut-off switch.

**NOTE:** The tether cord must be installed to ensure the information center will not shut off all indications after its self test function. Electrical power will stay on for approximately 3 minutes.

3. Press the Mode button on the RH handlebar repeatedly until SETTINGS is visible in the digital display of the information center.

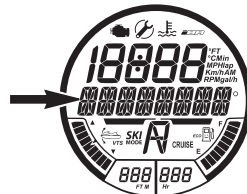

MESSAGE DISPLAYED

SETTINGS

4. Press the SET button (RH handlebar) to display iBR OVR.

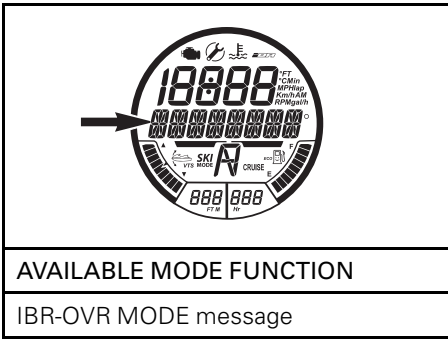

5. Press the SET button to enter IBR OVR function and display OVR OFF.

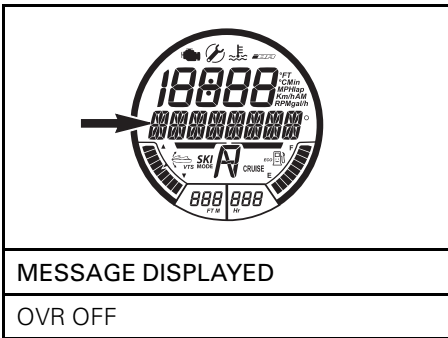

6. Press the UP/DOWN button (RH handlebar) to display OVR ON.

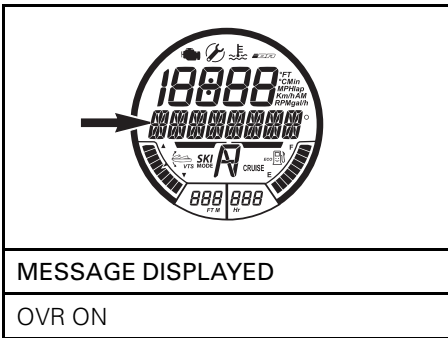

7. Press the SET button to select the OVR ON function. The gauge will return to its normal display.

8. Press the VTS UP/DOWN arrow button to move the iBR gate to the desired position.

### Models Without a VTS UP/DOWN Button

**NOTE:** On models without the VTS UP/DOWN button, use the UP/DOWN button on the RH handlebar to move the iBR to the desired position once the iBR override function has been activated as described in the previous steps.

### All Models

9. Remove the tether cord from the engine cut-off switch.

**⚠ WARNING**

If it is necessary to reach in to remove any foreign object caught in the propulsion system, strictly observe the following before proceeding:

- Remove tether cord from the engine cut-off switch.
- Wait at least 5 minutes.
- Do not press on START/STOP button. Should the START/STOP button be pressed, wait another 5 minutes.

### Deactivating iBR Override Function

There are three ways to deactivate the iBR override function:

- Repeat steps in *ACTIVATING iBR OVERRIDE FUNCTION* and press the SET button when OVR OFF is visible.
- Wait for the electrical power to shut off.
- Start the engine.

**NOTE:** When the engine is started, the iBR OVR function is deactivated and the iBR gate will move to the neutral position.



**⚠ WARNING**

When moving the iBR gate using the iBR override function, ensure no-one stands near the rear of the watercraft. Movement of the gate may squeeze fingers.

**Capsized Watercraft**

The watercraft is designed so that it should not turn over easily. Two spoilers mounted on the side of the hull assist watercraft stability. If it turns over, it will remain capsized.

**⚠ WARNING**

When watercraft is capsized, do not attempt to restart the engine. Operator and passengers should always wear approved personal flotation devices.

To turn the watercraft upright, ensure the engine is off and the tether cord is **NOT** on the engine cut-off switch. Then grab the inlet grate, step on a side bumper rail, and use your weight to rotate the watercraft towards you.

**NOTE:** A label on the stern near the flushing connector provides instructions on how to turn the watercraft right side up. The label is upside down so that it can be read when the watercraft is overturned.



smo2009-002-153\_a

The 4-TEC™ engine features a tip-over protection system (T.O.P.S.™). When the watercraft tips over, the engine is automatically stopped.

When the watercraft is returned to its normal operating position, the engine can be started normally.

**NOTICE** If the watercraft has been capsized for more than 5 minutes, do not attempt to crank the engine to avoid water ingestion that would damage the engine. See an authorized Sea-Doo dealer as soon as possible.

**NOTICE** If the engine does not crank, do not attempt to start it anymore. Otherwise, the engine could be damaged. See an authorized Sea-Doo dealer as soon as possible.

As soon as possible, check for presence of water in the bilge. Drain as necessary when back to the shore.

**Submerged Watercraft**

To limit damages to the engine, perform the following procedure as soon as possible.

Drain bilge.

If it was submerged in salt water, spray bilge and all components with fresh water using a garden hose to stop the salt corroding effect.

**NOTICE** Never try to crank or start the engine. Water trapped in intake manifold would flow towards the engine and possibly cause severe engine damage.

Bring the watercraft to an authorized Sea-Doo dealer as soon as possible to have it serviced.

**NOTICE** The longer the delay before you have the engine serviced, the greater the damage to the engine will be.

## Water-Flooded Engine

**NOTICE** Never try to crank or start the engine. Water trapped in intake manifold would flow towards the engine and possibly cause severe engine damage.

Bring the watercraft to an authorized Sea-Doo dealer as soon as possible to have it serviced.

**NOTICE** The longer the delay before you have the engine serviced, the greater the damage to the engine will be. Failure to have the engine properly serviced may cause severe engine damage.

## Towing the Watercraft in Water

Special precautions should be taken when towing a Sea-Doo watercraft in water.

The maximum recommended towing speed is 24 km/h (15 MPH).

This will prevent the exhaust system from filling with water, which may lead to water being injected into and filling the engine. Without the engine running, there isn't any exhaust pressure to push the water out the exhaust outlet.

**NOTICE** Failure to follow these instructions may result in damage to the engine. If you must tow a stranded watercraft in water, be sure not to exceed the maximum towing speed of 24 km/h (15 MPH).

# ***MAINTENANCE INFORMATION***

# MAINTENANCE SCHEDULE

Maintenance is very important for keeping your watercraft in a safe operating condition. Proper maintenance is the owners responsibility.

Disregard the information pertaining to the following systems if your watercraft is not equipped with these features:

- iBR (intelligent Brake and Reverse)
- iS (intelligent Suspension)
- aS (adjustable Suspension).

The watercraft should be serviced as per the maintenance schedule. Carry out all maintenance as listed in the schedule whenever the hours or time of each column is reached.

**NOTE:** As an example, at 100 hours or 1 year, complete all items in this column and ALSO in the EVERY 50 hours or 6 months column.

## ! WARNING

Failure to properly maintain the watercraft according to the maintenance schedule and procedures can make it unsafe to operate.

The maintenance schedule does not exempt the pre-ride inspection.

A: ADJUST C: CLEAN I: INSPECT L: LUBRICATE R: REPLACE  O: OPERATOR D: DEALER <b>PART/TASK</b>	FIRST 25 HOURS OR 3 MONTHS					
	EVERY 50 HOURS OR 6 MONTHS					
	EVERY 100 HOURS OR 1 YEAR					
	EVERY 200 HOURS OR 2 YEARS					
	TO BE PERFORMED BY					
					NOTE	
<b>ENGINE</b>						
Engine oil and filter	R		R		D	(1) Replace supercharger clutch only if required.
Rubber mounts	I		I		D	
Corrosion protection		L			O	
Supercharger clutch (215/260 engines)			I, R <sup>(1)</sup>		D	
<b>EXHAUST SYSTEM</b>						
Exhaust system	I		I, C (2)		O/D	(2) Daily flushing in salt water or foul water use.
<b>COOLING SYSTEM</b>						
Hose and fasteners	I			I	D	—
Coolant	I			R	D	

A: ADJUST C: CLEAN I: INSPECT L: LUBRICATE R: REPLACE  O: OPERATOR D: DEALER	FIRST 25 HOURS OR 3 MONTHS					
	EVERY 50 HOURS OR 6 MONTHS					
	EVERY 100 HOURS OR 1 YEAR					
	EVERY 200 HOURS OR 2 YEARS					
	TO BE PERFORMED BY					
PART/TASK						NOTE
<b>FUEL SYSTEM</b>						
iTC lever <sup>(3)</sup>			I, L		O/D	(3) See NOTE 1 after maintenance schedule.
Fuel cap, filler neck, fuel tank, fuel tank straps, fuel lines and connections	I		I <sup>(4)</sup>		D	(4) At storage period or after 100 hours of use whichever comes first.
Fuel system leak test	I		I		D	
Throttle body	I		I		D	
<b>AIR INTAKE SYSTEM</b>						
Air intake silencer	I		I, C		D	—
Blow-by valve hose			I, C		D	
<b>ELECTRONIC MANAGEMENT SYSTEMS</b>						
EMS sensors	I		I		D	—
Fault codes	I		I		D	
<b>ELECTRICAL SYSTEM</b>						
Spark plugs	I		I	R	D	(5) Inspect once a month. Add electrolyte as required.
Ignition coils			I, L		D	
Electrical connections and fastening (ignition system, starting system, fuel injectors, fuse boxes etc.)	I		I		D	
Engine cut-off switch	I		I		D	
Monitoring beeper	I		I		D	
Battery and fasteners			I <sup>(5)</sup>		D	
<b>STEERING SYSTEM</b>						
Steering cable and connections	I		I		D	(6) Inspect operation.
Steering nozzle bushings	I		I		D	
O.T.A.S. <sup>(6)</sup>	I		I		D	

**MAINTENANCE SCHEDULE**

A: ADJUST C: CLEAN I: INSPECT L: LUBRICATE R: REPLACE  O: OPERATOR D: DEALER <b>PART/TASK</b>	FIRST 25 HOURS OR 3 MONTHS					<b>NOTE</b>
	EVERY 50 HOURS OR 6 MONTHS					
	EVERY 100 HOURS OR 1 YEAR					
	EVERY 200 HOURS OR 2 YEARS					
	TO BE PERFORMED BY					
<b>PROPULSION SYSTEM</b>						
Carbon ring and rubber boot (drive shaft)	I		I		D	(4) At storage period or after 100 hours of use whichever comes first. (8) Inspect each month (more often in salt water use) and change when necessary.
Impeller boot	I		I		D	
Impeller shaft seal, sleeve and O-ring			I <sup>(4)</sup>		D	
Drive shaft/impeller splines			I, L		D	
Sacrificial anode (if so equipped)			I <sup>(8)</sup>		D	
Impeller and impeller wear ring clearance	I		I		D	
Pump mounts	I		I		D	
<b>iBR SYSTEM (intelligent Brake and Reverse)</b>						
iBR lever <sup>(3)</sup>			I, L		O/D	(3) See NOTE 1 after maintenance schedule. (4) At storage period or after 100 hours of use whichever comes first. (9) See NOTE 2 after maintenance schedule.
iBR gate backlash	I		I		D	
iBR support plates	I		I		D	
iBR friction sleeves	I		R		D	
iBR connecting arms, sleeves and bushings	I		I		D	
iBR U lever, VTS trim ring, iBR gate and bushings	I		I		D	
iBR U arm retaining screws	I <sup>(9)</sup>		I <sup>(4)</sup> I <sup>(9)</sup>		D	
iBR protective guard	I		I		D	
<b>iS SYSTEM (intelligent Suspension)</b>						
iS oil <sup>(7)</sup>			I		D	(7) Check pump reservoir oil level and for system leaks.
iS position sensor			I		D	
<b>aS SYSTEM (adjustable Suspension)</b>						
Nitrogen remote reservoir (adjustment knob, mounts)			I		D	—

A: ADJUST C: CLEAN I: INSPECT L: LUBRICATE R: REPLACE  O: OPERATOR D: DEALER	FIRST 25 HOURS OR 3 MONTHS				TO BE PERFORMED BY  <b>NOTE</b>
	EVERY 50 HOURS OR 6 MONTHS				
	EVERY 100 HOURS OR 1 YEAR				
	EVERY 200 HOURS OR 2 YEARS				
	TO BE PERFORMED BY				
<b>PART/TASK</b>					
<b>HULL AND BODY</b>					
Hull			I		O
Ride plate and water intake grate			I		O

**NOTE 1:** The iTC and iBR levers should be inspected by depressing and releasing the levers to check for freedom of movement. If any friction is felt, the lever must be taken apart, cleaned, inspected for wear and lubricated by an authorized Sea-Doo dealer.

**NOTE 2:** Ensure proper torque of iBR U arm to iBR actuator shaft retaining screws. If retaining screws found loose, do not re-torque them. Replace them with new ones.

---

# MAINTENANCE PROCEDURES

This section includes instructions for basic maintenance procedures. If you have the necessary mechanical skills and the required tools, you can perform these procedures. If not, see your authorized Sea-Doo watercraft dealer.

## WARNING

Turn off the engine and follow these maintenance procedures when performing maintenance. If you do not follow proper maintenance procedures you can be injured by hot parts, moving parts, electricity, chemicals or other hazards.

## WARNING

Should removal of a locking device (e.g. lock tabs, self-locking fasteners, etc.) be required, always replace with a new one.

**NOTICE** Never leave any object, rag, tool, etc., in the engine compartment or in the bilge.

## Engine Oil

### Recommended Engine Oil

#### *100/130/155 Engines*

Use XPS 4-STROKE SYNTH. BLEND OIL (SUMMER) (P/N 293 600 121).

If the recommended XPST<sup>™</sup> engine oil is not available, use a 5W40 or 10W40 engine oil meeting the requirements for API service classification SM, SL or SJ. Always check the API service label certification on the oil container, it must contain at least one of the above standards.

#### *215 Engine*

Use XPS 4-STROKE SYNTH. BLEND OIL (SUMMER) (P/N 293 600 121).

**NOTICE** These engines have been developed and validated using the BRP XPS Synthetic blend oil. BRP strongly recommends the use of its XPS Synthetic blend oil at all times. Damages caused by oil which is not suitable for the engine will not be covered by the BRP limited warranty.

If the recommended XPS engine oil is not available, use a 10W40 mineral engine oil compatible with wet clutches.

**NOTICE** NEVER use synthetic oil. This would impair the proper operation of the supercharger clutch. Do not add any additives to the recommended oil. Mineral oils for API service classification SM contain additives (friction modifiers) that may cause inappropriate slippage of the supercharger and eventually lead to premature wear.

### Engine Oil Level

**NOTICE** Check level frequently and refill if necessary. Do not overfill. Operating the engine with an improper level may severely damage engine.

**CAUTION** Certain components in the engine compartment may be very hot. Direct contact may result in skin burn.

Oil level can be checked with watercraft either in or out of water.

### If Watercraft is Out of the Water

**NOTICE** Watercraft must be level.



**⚠ CAUTION** When operating the engine out of water, the heat exchanger in the ride plate may become very hot. Avoid any contact with the ride plate as burns may occur.

1. Raise trailer tow pole, then block in position when bumper rail is level.
2. Open the seat.
3. Install a garden hose on the exhaust system flushing connector. Refer to *EXHAUST SYSTEM* in this section and follow the procedure.

**NOTICE**

- Never run engine without supplying water to the exhaust system. Failure to cool exhaust system may severely damage it.
  - Never run engine longer than 2 minutes. Drive line seal has no cooling when watercraft is out of water.
4. With the engine already at normal operating condition, let engine **idle for 30 seconds** then stop engine.
  5. Wait at least 30 seconds for the oil to settle in the engine, then pull dipstick out and wipe clean.

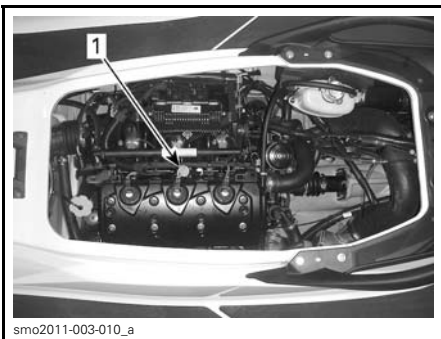

**TYPICAL - RXT IS ILLUSTRATED**  
1. Oil dipstick location

6. Reinstall dipstick, push in completely.

7. Remove dipstick again and read oil level. It should be between the FULL and ADD marks.

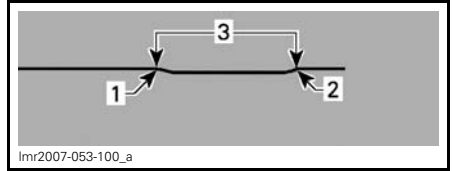

1. Full
2. Add
3. Operating range

8. Add oil to ensure the level is between marks as required.

To add oil:

- Unscrew oil cap.
- Place a funnel in the oil filler neck opening.
- Add the recommended oil to the proper level.

**NOTE:** Do not overfill.



**TYPICAL**  
1. Oil filler cap location

**NOTE:** Every time oil is added in the engine, the complete procedure explained in this section must be carried out again. Otherwise, you will obtain a false oil level reading.

9. Properly reinstall oil cap and dipstick.

## Engine Oil Change and Oil Filter Replacement

The oil change and filter replacement should be performed by an authorized Sea-Doo dealer.

## Engine Coolant

### Recommended Engine Coolant

Always use ethylene-glycol antifreeze containing corrosion inhibitors specifically formulated for internal combustion aluminum engines.

**NOTE:** When available, it is recommended to use biodegradable antifreeze compatible with internal combustion aluminum engines. This will contribute to protect the environment.

Fill cooling system with BRP PRE-MIXED COOLANT (P/N 219 700 362), or with a water and antifreeze solution (50% distilled water, 50% antifreeze).

**NOTE:** Using a blend of 40% antifreeze with 60% demineralized water will improve the cooling efficiency when watercraft is used in particularly hot weather and/or hot water condition.

To prevent antifreeze deterioration, always use the same brand. Never mix different brands unless cooling system is completely flushed and refilled. Refer to an authorized Sea-Doo dealer.

### Engine Coolant Level

**⚠ WARNING**

Check coolant level with engine cold. Never add coolant in cooling system when engine is hot.

**⚠ CAUTION** Certain components in the engine compartment may be very hot. Direct contact may result in skin burn.

Open seat.

Locate the expansion tank cap.

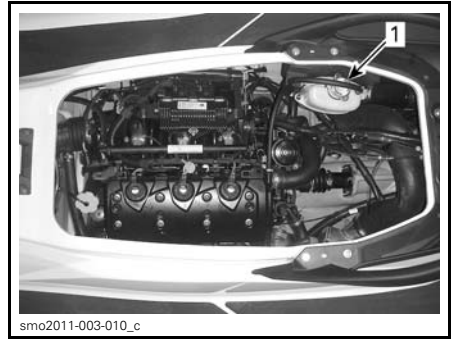

smo2011-003-010\_c

**TYPICAL**  
1. Expansion tank cap

With watercraft on a level surface, coolant level should be between MIN. and MAX. marks on coolant reservoir when engine is cold.

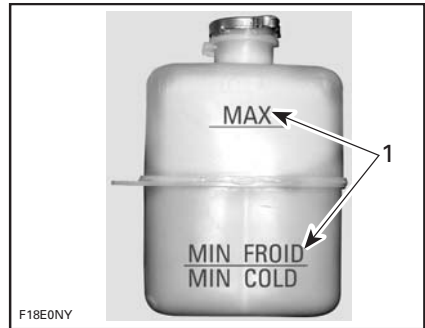

F18E0NY

**TYPICAL - COOLANT EXPANSION TANK**  
1. Level between marks when engine is cold

**NOTE:** The watercraft is level when it is in water. When on a trailer, raise trailer tow pole and block in this position when bumper rail is level.

Add coolant/demineralized water to adjust coolant level between marks as required. Use a funnel to avoid spillage. Do not overfill.

Properly reinstall and tighten filler cap, then reinstall ventilation box and close seat.

**NOTE:** A cooling system that frequently requires coolant is an indication of leaks or engine problems. See an authorized Sea-Doo dealer.

## Engine Coolant Replacement

Coolant replacement should be performed by an authorized Sea-Doo dealer.

## Ignition Coils

### Ignition Coil Removal

1. Open seat.
2. Remove engine cover (as applicable to model).
3. Disconnect ignition coil connector.

**NOTICE** Do not remove the ignition coil before disconnecting the input connector or the wires may be damaged. Do not pry up ignition coil with a screwdriver to avoid damage.

**NOTE:** Twist ignition coil in both directions as you pull it up to ease removal. Remove ignition coil from spark plug.

### Ignition Coil Lubrication

1. Pull rubber seal down.

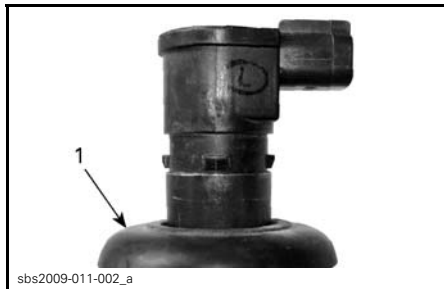

1. Rubber seal pulled down
2. Apply DOW CORNING 111 (P/N 413 707 000) to rubber seal seat as shown.

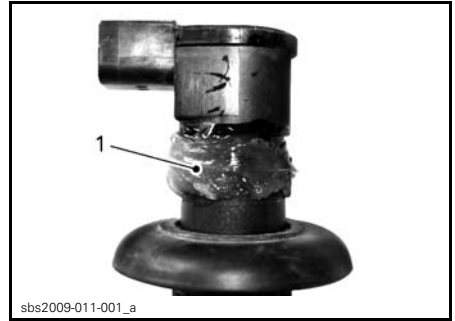

1. Apply product here
3. Pull rubber seal back on its seat making sure the tabs on the ignition coil and the slots in the seal properly match together.
4. Leave a ring of grease on top of the seal as shown to act as a water barrier. Wipe off the excess.

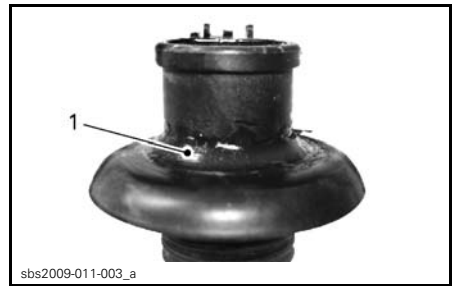

1. Correctly shaped excess of product
5. Apply DOW CORNING 111 (P/N 413 707 000) on rubber seal contact area.

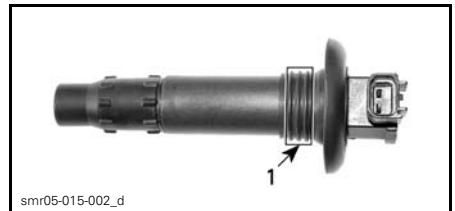

1. Apply product here

## Ignition Coil Installation

**NOTE:** Prior to inserting the ignition coil on its spark plug, apply sealant as described in *IGNITION COIL LUBRICATION*.

1. Install coil in cylinder head hole.
2. Push the ignition coil down to securely install it on the spark plug tip.
3. Ensure the seal seats properly with top surface of engine valve cover.

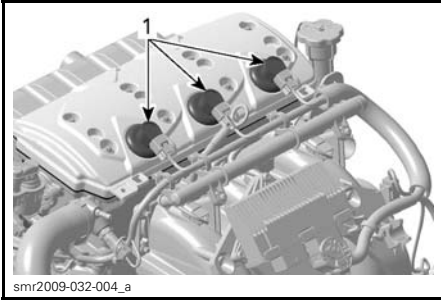

smr2009-032-004\_a  
**TYPICAL**  
1. Seal properly seated

## Spark Plugs

### Spark Plug Removal

1. Open seat.
2. Disconnect the ignition coil input connector.
3. Remove ignition coil. Refer to *IGNITION COIL REMOVAL*.

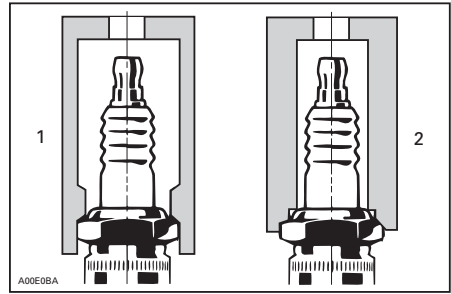

1. Approved socket
2. Improper socket

5. Clean the spark plug and cylinder head with pressurized air.
6. Unscrew spark plug then use the ignition coil to take spark plug out of spark plug hole.

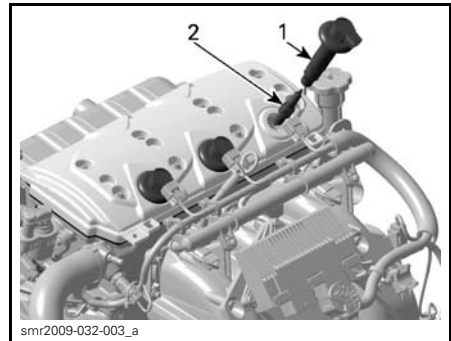

1. Ignition coil
2. Spark plug

### Spark Plug Installation

Prior to installation, ensure the contact surfaces of the cylinder head and spark plug are free of grime.

1. Using a wire feeler gauge, set electrode gap as specified in the following chart.

ENGINE	SPARK PLUG	TORQUE	GAP mm (in)
1503	NGK DCPR8E	Hand tighten + 1/4 turn with a socket	0.75 (.030)

4. Using a spark plug socket, release the torque applied to the spark plug.

2. Apply anti-seize lubricant over the spark plug threads to prevent possible seizure.
3. Hand screw spark plug into cylinder head. Then, tighten the spark plug clockwise an additional 1/4 turn with an approved spark plug socket.
4. Install ignition coil. Refer to *IGNITION COIL INSTALLATION*.
5. Close seat.

## Exhaust System

### Exhaust System Flushing

Flushing the exhaust system and intercooler (supercharged models) with fresh water is essential to neutralize corroding effects of salt or other chemical products present in water. It will help to remove sand, salt, shells or other particles in water jackets and/or hoses.

Flushing should be performed when the watercraft is not expected to be used further the same day or when the watercraft is stored for any extended time.

### WARNING

Perform this operation in a well ventilated area.

Proceed as follows:

Clean propulsion system by spraying water in its inlet and outlet and then apply a coating of XPS Lube or equivalent.

 **CAUTION** When operating the engine while the watercraft is out of the water, the heat exchanger in the ride plate may become very hot. Avoid any contact with ride plate as burns may occur.

Connect a garden hose to the connector located at the rear of watercraft (on the port side of the stern). Do not open water tap at this time.

**NOTICE** Always run the engine before opening the water tap. If not, water will get inside the engine.

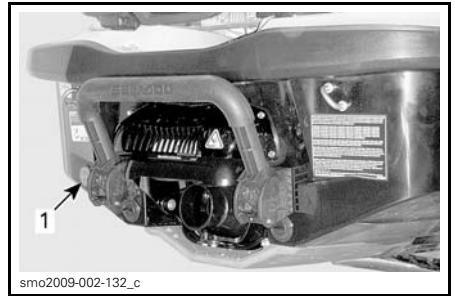

#### TYPICAL

1. Flushing connector location

**NOTE:** An optional quick connect hose adapter and hose fitting can be used (P/N 295 500 473). No hose pincher is required to flush engine.



#### TYPICAL - QUICK CONNECT HOSE ADAPTER

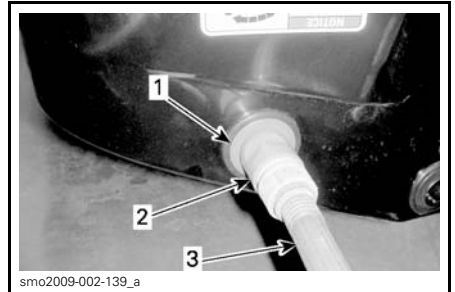

#### TYPICAL

1. Hose adapter (optional, not mandatory)
2. Quick connect fitting (optional, not mandatory)
3. Garden hose

To flush, start engine then immediately open the water tap.

**CAUTION** Certain components in the engine compartment may be very hot. Direct contact may result in skin burn. Do not touch any electrical parts or propulsion system component when the engine is running.

**NOTICE** Never flush a hot engine. Always start the engine before opening the water tap. Open water tap immediately after engine is started to prevent overheating.

Run the engine about 20 seconds at a fast idle between 4000 - 5000 RPM.

**NOTICE** Never run engine without supplying water to the exhaust system when watercraft is out of water.

Ensure water flows out of jet pump while flushing. Otherwise, refer to an authorized Sea-Doo dealer for servicing.

**NOTICE** Never run engine longer than 2 minutes. Drive line seal has no cooling when watercraft is out of water.

Close the water tap, then stop the engine.

**NOTICE** Always close the water tap before stopping the engine. If not, water will get inside the engine.

**NOTICE** Remove quick connect adapter after flushing operation (if used).

## Ride Plate and Water Intake Grate

### Ride Plate and Water Intake Grate Inspection

Inspect ride plate and jet pump water intake grate for damage. See your Sea-Doo dealer to have any damaged part repaired or replaced.

### WARNING

The tether cord must always be removed from the engine cut-off switch prior to inspecting the intake grate.

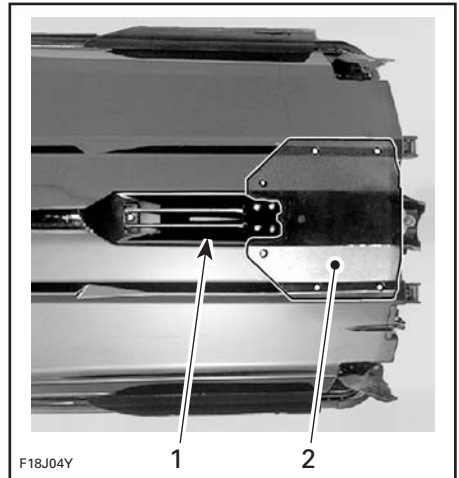

TYPICAL — INSPECT THESE AREAS

1. Water intake
2. Ride plate

## Ski/Wakeboard Post (Wake)

### Ski/Wakeboard Post Inspection

Check ski/wakeboard post operation. Ensure it slides up and down easily. Check locking mechanism operation. Check fasteners tightness. If something is found defective, don't use ski/wakeboard post and see an authorized Sea-Doo dealer for repair.

## Ski/Wakeboard Post Lubrication

Clean ski/wakeboard post and apply a light coat of SUPER LUBE GREASE (P/N 293 550 030).

Lubricate post throughout its length.

Wipe off all excess grease and reinstall post.

Extend and retract several times to distribute the lubricant.

## Fuses

### Fuse Removal and Installation

Use the fuse remover/installer included in the fuse box to ease fuse removal.

### Fuse Inspection

If an electrical problem occurs, check the fuses. If a fuse is burnt, replace by one of the same rating.

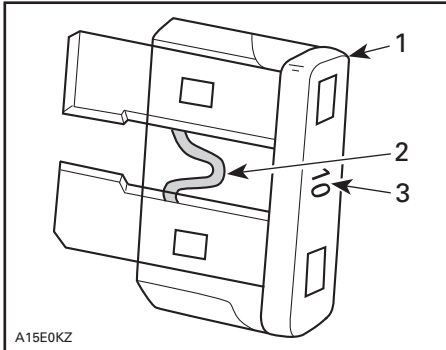

#### TYPICAL

1. Fuse
2. Check if melted
3. Ampere rating

## **⚠ WARNING**

Do not use a higher rated fuse as this can cause severe damage. If a fuse has burnt out, the source of the malfunction should be determined and corrected before restarting. See an authorized Sea-Doo dealer for servicing.

## Fuse Location

All fuses are located inside a single fuse box.

To access the fuse box, open the front storage cover.

Remove the two plastic rivets and the rubber tie securing the battery access panel at the back of the storage compartment. The fuse box is located ahead of the fuel tank just under the gauge area, attached to the battery holder.

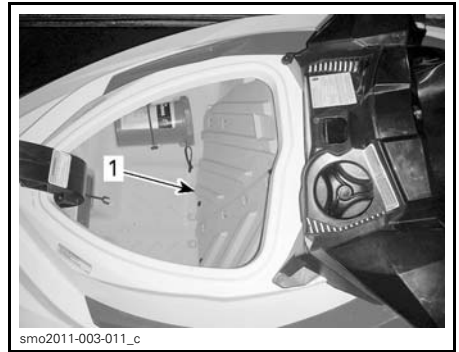

### BATTERY AND FUSE ACCESS, FRONT STORAGE COMPARTMENT

1. Battery access panel

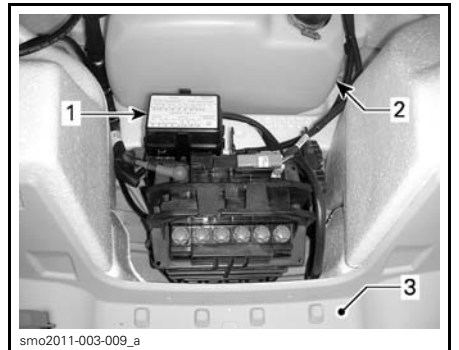

#### TYPICAL

1. Fuse box
2. Fuel tank
3. Front storage compartment (access panel removed)

To remove the fuse box cover, squeeze and hold locking tabs on both sides of the fuse box and pull the cover off the fuse box.

**NOTE:** Fuse ratings and positions are illustrated on the fuse box cover.

**Fuse Description**

FUSE	RATING	DESCRIPTION
1	—	Not used
2	15 A	Diagnostic connector
3	3 A	START/STOP button
4	3 A	GPS (except GTS models)
5	30 A	iBR (except GTS models)
6	30 A	Charge
7	—	Not used
8	30 A	Battery
9	—	Not used
10	—	Not used
11	3 A	Depth sounder (if so equipped)
12	3 A	Gauge, OTAS and CAPS
13	10 A	Cylinder 1 (ignition coil and injection)
14	10 A	Cylinder 2 (ignition coil and injection)
15	10 A	Cylinder 3 (ignition coil and injection)
16	5 A	Starter solenoid
17	5 A	iBR control (except GTS models)
18	10 A	Fuel pump
19	15 A	ECM



---

# WATERCRAFT CARE

Remove the watercraft from the water every day.

## Post-Operation Care

### Exhaust System Flushing

The exhaust system should be flushed daily when watercraft is used in salt or foul water.

Refer to *MAINTENANCE PROCEDURES*.

**NOTE:** On supercharged models, the intercooler is flushed at the same time.

### Additional Care for Foul Water or Salt Water Operation

When the watercraft is operated in foul water and particularly in salt water, additional care should be taken to protect the watercraft and its components.

Rinse watercraft bilge area with fresh water.

Never use a high pressure washer to clean the bilge. **USE LOW PRESSURE ONLY (such as a garden hose).**

High pressure can cause damages to electrical or mechanical systems.

**⚠ CAUTION** Allow engine to cool before performing any maintenance.

**NOTICE** Failure to perform proper care such as: watercraft rinsing, exhaust system flushing and anticorrosion treatment, when watercraft is used in salt water, will result in damage to the watercraft and its components. Never leave the watercraft stored in direct sunlight.

## Watercraft Cleaning

### Body and Hull

Occasionally, wash the hull and various body components with water and soap (use only mild detergent). Remove any

marine organisms from engine and/or hull. Apply non-abrasive wax such as silicone wax.

**NOTICE** Never clean fiberglass and plastic parts with strong detergent, degreasing agent, paint thinner, acetone, or other strong chemical or petroleum type cleaner.

Stains may be removed from the seat and fiberglass using Knight's Spray-Nine<sup>+</sup> or the equivalent.

To clean the carpets, use 3M™ Citrus Base Cleaner (24 oz spray can) or an equivalent.

### **⚠ WARNING**

Never apply plastic or vinyl protector on the carpets or seat as the surface will become slippery and the occupants may slip off the watercraft.

Respect the environment by ensuring fuel, oil or cleaning solutions do not drain into the waterways.

# STORAGE AND PRESEASON PREPARATION

## Storage

### WARNING

Because fuel and oil are flammable, have an authorized Sea-Doo dealer inspect the fuel system integrity as specified in the periodic inspection chart.

It is recommended that the watercraft be serviced by an authorized Sea-Doo dealer for storage, however the following operations can be performed by you with a minimum of tools.

**NOTE:** Carry out the following tasks in the same order as detailed in this section.

**NOTICE** Do not run the engine during the storage period.

## Propulsion System

### Jet Pump Cleaning

Clean jet pump by spraying water in its inlet and outlet and then apply a coat of XPS LUBE (P/N 293 600 016) or equivalent.

### WARNING

Always remove tether cord from the engine cut-off switch to prevent unexpected engine starting before cleaning the propulsion system components. Engine must not be running for this operation.

### Jet Pump Inspection

Remove impeller cover and check if jet pump is water contaminated; if so, see your authorized Sea-Doo dealer.

## Fuel System

### Fuel System Protection

(P/N 413 408 600) (or equivalent) should be added in the fuel tank to prevent fuel deterioration and fuel system gumming. Follow stabilizer manufacturers' instructions for proper use.

**NOTICE** It is highly recommended to add fuel stabilizer at storage in order to maintain fuel system in good condition. Fuel stabilizer should be added prior to engine lubrication and fuel tank top up to ensure fuel system components protection against varnish deposits.

### WARNING

Always stop the engine before refueling. Fuel is inflammable and explosive under certain conditions. Always work in a well ventilated area. Do not smoke or allow open flames or sparks in the vicinity. Fuel tank may be pressurized, slowly turn cap when opening. When fueling, keep watercraft level. Do not overfill or top off the fuel tank and leave watercraft in the sun. As temperature increases, fuel expands and might overflow. Always wipe off any fuel spillage from the watercraft. Periodically inspect fuel system.

**NOTICE** Should any water be trapped inside fuel tank, severe internal damage will occur to the fuel injection system.

## Engine and Exhaust Systems

### Exhaust System Flushing

Perform procedure as described in *MAINTENANCE PROCEDURES*.

## Engine Oil and Filter Replacement

The oil change and filter should be performed by an authorized Sea-Doo dealer.

## Exhaust System Draining

In areas where temperature may freeze, water trapped in the exhaust system must be removed.

Using the flushing connector located on the port (LH) side of the stern, inject pressurized air at 379 kPa (55 PSI) into system until there is no more water flowing from jet pump.

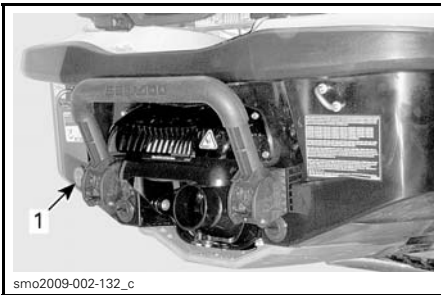

smo2009-002-132\_c

### TYPICAL

1. Flushing connector

The following hose can be fabricated to ease draining procedure.

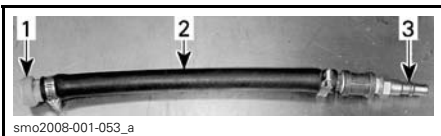

smo2008-001-053\_a

### TYPICAL

1. Flushing connector adapter
2. Hose 12.7 mm (1/2 in)
3. Air hose male adapter

**NOTICE** Failure to drain the exhaust system may cause severe damage to the intercooler (super-charged models) and exhaust manifold.

Remove special tools.

## Engine Internal Lubrication

1. Open the seat.

2. Remove ignition coils, refer to *MAINTENANCE PROCEDURES*.
3. Remove spark plugs, refer to *MAINTENANCE PROCEDURES*.
4. Spray XPS LUBE (P/N 293 600 016) or equivalent in spark plug holes.
5. To prevent fuel from being injected and to disable the ignition during engine cranking, fully depress throttle lever and HOLD against handlebar.
6. Press the START/STOP button to crank the engine a few turns. This will distribute the oil on the cylinder walls.
7. Apply anti-seize lubricant on spark plug threads, then reinstall them in the engine. Refer to *MAINTENANCE PROCEDURES*.
8. Install the ignition coils, refer to *MAINTENANCE PROCEDURES*.

## Engine Coolant Test

If antifreeze is not replaced, test its density.

The antifreeze replacement and a density test should be performed by an authorized Sea-Doo dealer.

**NOTE:** Antifreeze should be replaced every 200 hours or every 2 years to prevent antifreeze deterioration.

**NOTICE** Improper antifreeze density may result in freezing of the liquid in the cooling system if the watercraft is stored in an area where the freezing point is attained. This could seriously damage the engine.

## Electrical System

### Battery Removal and Charging

Contact your authorized Sea-Doo dealer.

### **⚠ WARNING**

Never charge or boost the battery while installed in the watercraft.

## Engine Compartment

### Engine Compartment Cleaning

Clean the bilge using hot water and a mild detergent or with bilge cleaner.

Rinse thoroughly.

Lift front end of watercraft to completely drain bilge through the bilge drain plugs.

### Anticorrosion Treatment

Wipe off any residual water in the engine compartment.

Spray XPS LUBE (P/N 293 600 016) over all metallic components in engine compartment.

**NOTE:** The seat should be left partially open during storage. This will prevent engine compartment condensation and possible corrosion.

## Body and Hull

### Body and Hull Cleaning

Wash the body with a soap and water solution (use only mild detergent). Rinse thoroughly with fresh water. Remove marine organisms from the hull.

**NOTICE** Never clean fiberglass and plastic parts with strong detergent, de-greasing agent, paint thinner, acetone, or other strong chemical or petroleum cleaners.

### Body and Hull Repair

If any repairs are needed to body components or to the hull, contact your authorized Sea-Doo dealer.

### Body and Hull Protection

Apply a good quality marine wax to the body.

If the watercraft is to be stored outside, cover it with an opaque tarpaulin to prevent sun rays and grime from affecting the plastic components, watercraft finish, as well as preventing dust accumulation.

**NOTICE** The watercraft should never be left in water for storage. Never leave the watercraft stored in direct sunlight. Never store watercraft in a plastic bag.

## Preseason Preparation

Maintenance preparation must be performed in conjunction with *PERIODIC MAINTENANCE CHART*.

Ensure to perform all tasks included in the **100 HOURS OR 1 YEAR** column.

Since technical skills and special tools are required, some operations should be performed by an authorized Sea-Doo dealer.

**NOTE:** It is highly recommended that an authorized Sea-Doo dealer perform factory campaigns in addition to the preseason preparation, all at the same time.

### WARNING

Only perform procedures as detailed in the *PERIODIC MAINTENANCE CHART*. It is recommended that the assistance of an authorized Sea-Doo dealer be periodically obtained on other components and systems not covered in this guide.

**NOTICE** When component conditions seem less than satisfactory, replace using only genuine BRP parts, or approved equivalents.

# ***TECHNICAL INFORMATION***

# WATERCRAFT IDENTIFICATION

The main components of the watercraft (engine and hull) are identified by different serial numbers. It may sometimes become necessary to locate these numbers for warranty purposes or to trace the watercraft in the event of theft.

## Hull Identification Number

The Hull Identification Number (HIN) is located on the boarding platform at the rear of watercraft.



*TYPICAL*

1. Hull Identification Number (HIN)

It is composed of 12 digits:

YDV	12345	L	8	09	
					Model year
					Year of production
					Month of production
					Serial number (a letter may also be used as a digit)
					Manufacturer

## Engine Identification Number

The Engine Identification Number (EIN) is located on the front end of the engine.



*TYPICAL*

1. Engine Identification Number (EIN)

---

# ENGINE EMISSIONS INFORMATION

**NOTE:** Maintenance, replacement, or repair of the emission control devices and systems may be performed by any marine SI (Spark Ignition) engine repair establishments or individual.

## **Manufacturer's Responsibility**

Beginning with 1999 model year engines, PWC manufacturers of marine engines must determine the exhaust emission levels for each engine horsepower family and certify these engines with the United States of America Environmental Protection Agency (EPA). An emissions control information label, showing emission levels and engine specifications, must be placed on each watercraft at the time of manufacture.

## **Dealer's Responsibility**

When performing service on all 1999 and more recent Sea-Doo watercraft that carry an emissions control information label, adjustments must be kept within published factory specifications.

Replacement or repair of any emission related component must be executed in a manner that maintains emission levels within the prescribed certification standards.

Dealers are not to modify the engine in any manner that would alter the horsepower or allow emission levels to exceed their predetermined factory specifications.

Exceptions include manufacturer's prescribed changes, such as altitude adjustments for example.

## **Owner Responsibility**

The owner/operator is required to have engine maintenance performed to maintain emission levels within prescribed certification standards.

The owner/operator is not to, and should not allow anyone to modify the engine in any manner that would alter the horsepower or allow emissions levels to exceed their predetermined factory specifications.

## **EPA Emission Regulations**

All 1999 and more recent Sea-Doo watercraft manufactured by BRP are certified to the EPA as conforming to the requirements of the regulations for the control of air pollution from new watercraft engines. This certification is contingent on certain adjustments being set to factory standards. For this reason, the factory procedure for servicing the product must be strictly followed and, whenever practicable, returned to the original intent of the design.

The responsibilities listed above are general and in no way a complete listing of the rules and regulations pertaining to the EPA requirements on exhaust emissions for marine products. For more detailed information on this subject, you may contact:

U.S. Environmental Protection Agency  
Office of Transportation and Air Quality  
1200 Pennsylvania Ave. NW  
Mail Code 6403J  
Washington D.C. 20460

**EPA INTERNET WEB SITE:**  
<http://www.epa.gov/otaq>

# SPECIFICATIONS

WATERCRAFT		GTS MODELS
<b>ENGINE</b>		
Type	Rotax®1503 4-TEC®. Single Over Head Camshaft (SOHC)	
Induction	Naturally-aspirated	
Number of cylinders	3	
Number of valves	12 valves (4 per cylinder) with hydraulic lifters (no adjustment)	
Bore	100 mm (3.9 in)	
Stroke	63.4 mm (2.5 in)	
Displacement	1 494 cm <sup>3</sup> (91.2 in <sup>3</sup> )	
Compression ratio	10.6:1	
<b>COOLING SYSTEM</b>		
Type	Closed-loop system (CLCS)	
<b>FUEL SYSTEM</b>		
Fuel injection type	Multipoint fuel injection with iTC (intelligent Throttle Control). Single throttle body (62 mm) with actuator.	
<b>ELECTRICAL SYSTEM</b>		
Ignition	IDI (inductive discharge ignition)	
Spark plug	Make and type	NGK, DCPR8E
	Gap	0.75 mm (.03 in)
Battery	12 V, 30 A•h. Electrolyte type	
<b>PROPULSION</b>		
Propulsion system	Sea-Doo® jet pump	
Jet pump	Type	Axial flow, single stage. Large hub with 10-vane stator
	Material	Aluminum
Impeller	Stainless steel	
Transmission	Type	Direct drive



WATERCRAFT		GTS MODELS
<b>DIMENSION AND WEIGHT</b>		
Length		336.8 cm (132.6 in)
Width		123.1 cm (48.5 in)
Height		111.8 cm (44 in)
Weight (dry)		333 kg (734 lb)
<b>LOADING CAPACITY</b>		
Rider capacity		3 (refer to load limit)
Storage capacity		116.6 L (30.8 U.S. gal.)
Load limit (passengers + luggage)		273 kg (600 lb)
<b>FLUIDS</b>		
Fuel	Type	Unleaded
	Minimum octane	<b>Inside North America:</b> (87 (RON + MON)/2)
		<b>Outside North America: 92 RON</b>
Tank capacity	60 L (15.9 U.S. gal.)	
Engine oil	Type	XPS synthetic blend oil (summer grade). If not available, use SAE 5W40 API service SM motor oil
	Capacity	3 L (3.2 qt (U.S. liq.)) oil change w/filter
Cooling system	Coolant type	Ethylene-glycol 50%/50% antifreeze and demineralized water. Coolant containing corrosion inhibitors for internal combustion aluminum engines
	Capacity	5.5 L (5.8 qt (U.S. liq.))

**SPECIFICATIONS**

<b>WATERCRAFT</b>		<b>GTI MODELS</b>			
		<b>GTI 130</b>	<b>GTI SE 130</b>	<b>GTI SE 155</b>	<b>GTI LTD 155</b>
<b>ENGINE</b>					
Type		Rotax® 1503 4-TEC®. Single Over Head Camshaft (SOHC)			
Induction		Naturally-aspirated			
Number of cylinders		3			
Number of valves		12 valves (4 per cylinder) with hydraulic lifters (no adjustment)			
Bore		100 mm (3.9 in)			
Stroke		63.4 mm (2.5 in)			
Displacement		1 494 cm <sup>3</sup> (91.2 in <sup>3</sup> )			
Compression ratio		10.6:1			
<b>COOLING SYSTEM</b>					
Type		Closed-loop system (CLCS)			
<b>FUEL SYSTEM</b>					
Fuel injection type		Multipoint fuel injection with iTC (intelligent Throttle Control). Single throttle body (62 mm) with actuator.			
<b>ELECTRICAL SYSTEM</b>					
Ignition		IDI (Inductive Discharge Ignition)			
Spark plug	Make and type	NGK, DCPR8E			
	Gap	0.75 mm (.03 in)			
Battery		12 V, 30 A•h. Electrolyte type			
<b>PROPULSION</b>					
Propulsion system		Sea-Doo® jet pump with iBR (intelligent brake and reverse)			
Jet pump	Type	Axial flow, single stage. Large hub with 10-vane stator			
	Material	Aluminum			
Impeller		Stainless steel			
Transmission		Direct drive			
VTS	Type	Optional	Electronic, gauge interface, no VTS switch	Electronic, gauge interface, no VTS switch	Electronic with VTS switch and preset positioning

WATERCRAFT		GTI MODELS			
		GTI 130	GTI SE 130	GTI SE 155	GTI LTD 155
<b>DIMENSION AND WEIGHT</b>					
Length		336.8 cm (132.6 in)			
Width		123.1 cm (48.5 in)			
Height		111.8 cm (44 in)			
Weight (dry)		338 kg (745 lb)			
<b>LOADING CAPACITY</b>					
Rider capacity		3 (refer to load limit)			
Storage capacity		116.6 L (30.8 U.S. gal.)			
Load limit (passengers + luggage)		273 kg (600 lb)			
<b>FLUIDS</b>					
Fuel	Type	Unleaded			
	Minimum octane	Inside North America: (87 (RON + MON)/2)			
		Outside North America: 92 RON			
Tank capacity	60 L (15.9 U.S. gal.)				
Engine oil	Type	XPS synthetic blend oil (summer grade). If not available, use SAE 5W40 API service SM motor oil			
	Capacity	3 L (3.2 qt (U.S. liq.)) oil change w/filter			
Cooling system	Coolant type	Ethylene-glycol 50%/50% antifreeze and demineralized water. Coolant containing corrosion inhibitors for internal combustion aluminum engines			
	Capacity	5.5 L (5.8 qt (U.S. liq.)) total			

**SPECIFICATIONS**

<b>WATERCRAFT</b>		<b>GTR MODELS</b>
<b>ENGINE</b>		
Type	Rotax®1503 4-TEC®. Single Over Head Camshaft (SOHC)	
Induction	Gear driven supercharger with slip clutch. Water/air intercooler.	
Number of cylinders	3	
Number of valves	12 valves (4 per cylinder) with hydraulic lifters (no adjustment)	
Displacement	1 494 cm <sup>3</sup> (91.2 in <sup>3</sup> )	
Bore	100 mm (3.9 in)	
Stroke	63.4 mm (2.5 in)	
Compression ratio	8.4:1	
<b>COOLING SYSTEM</b>		
Type	Closed-loop system (CLCS)	
<b>FUEL SYSTEM</b>		
Fuel injection type	Multipoint fuel injection with iTC (intelligent Throttle Control). Single throttle body (62 mm) with actuator.	
<b>ELECTRICAL SYSTEM</b>		
Ignition	IDI (Inductive Discharge Ignition)	
Battery	12 V, 30 A•h. Electrolyte type	
Spark plug	Make and type	NGK, DCPR8E
	Gap	0.75 mm (.03 in)
<b>PROPULSION</b>		
Propulsion system	Sea-Doo® jet pump with iBR (intelligent brake and reverse)	
Jet pump	Type	Axial flow, single stage. Large hub with 10-vane stator
	Material	Aluminum
Impeller	Stainless steel	
Transmission	Type	Direct drive

WATERCRAFT		GTR MODELS
<b>DIMENSION AND WEIGHT</b>		
Length	336.8 cm (132.6 in)	
Width	123.1 cm (48.5 in)	
Height	111.8 cm (44 in)	
Weight (dry)	348 kg (767 lb)	
<b>LOADING CAPACITY</b>		
Rider capacity	3 (refer to load limit)	
Storage capacity	116.6 L (30.8 U.S. gal.)	
Load limit (passengers + luggage)	273 kg (600 lb)	
<b>FLUIDS</b>		
Fuel	Type	Unleaded
	Minimum octane	<b>Inside North America:</b> (87 (RON + MON)/2)
		<b>Outside North America:</b> 92 RON
	Recommended octane rating for optimum performance	<b>Inside North America:</b> (91 (RON + MON)/2)
		<b>Outside North America:</b> 95 RON
Tank capacity	60 L (15.9 U.S. gal.)	
Engine oil	Type	XPS synthetic blend oil (summer grade). Refer to <i>MAINTENANCE</i> section for more information
	Capacity	3 L (3.2 qt (U.S. liq.)) oil change w/filter
Cooling system	Coolant type	Ethylene-glycol 50%/50% antifreeze and demineralized water. Coolant containing corrosion inhibitors for internal combustion aluminum engines
	Capacity	5.5 L (5.8 qt (U.S. liq.))

**SPECIFICATIONS**

<b>WATERCRAFT</b>		<b>WAKE MODEL</b>
<b>ENGINE</b>		
Type		Rotax®1503 4-TEC®, Single Over Head Camshaft (SOHC)
Induction		Naturally-aspirated
Number of cylinders		3
Number of valves		12 valves (4 per cylinder) with hydraulic lifters (no adjustment)
Displacement		1 494 cm <sup>3</sup> (91.2 in <sup>3</sup> )
Bore		100 mm (3.9 in)
Stroke		63.4 mm (2.5 in)
Compression ratio		10.6:1
<b>COOLING SYSTEM</b>		
Type		Closed-loop system (CLCS)
<b>FUEL SYSTEM</b>		
Fuel injection type		Multipoint fuel injection with iTC (intelligent Throttle Control). Single throttle body (62 mm) with actuator.
<b>ELECTRICAL SYSTEM</b>		
Ignition		IDI (inductive discharge ignition)
Battery		12 V, 30 A•h. Electrolyte type
Spark plug	Make and type	NGK, DCPR8E
	Gap	0.75 mm (.03 in)
<b>PROPULSION</b>		
Propulsion system		Sea-Doo® jet pump with iBR (intelligent brake and reverse)
Jet pump	Type	Axial flow, single stage. Large hub with 10-vane stator
	Material	Aluminum
Impeller		Stainless steel
Transmission	Type	Direct drive
VTS	Type	Electronic, gauge interface

WATERCRAFT		WAKE MODEL	
<b>DIMENSION AND WEIGHT</b>			
Length	336.8 cm (132.6 in)		
Width	123.1 cm (48.5 in)		
Height	111.8 cm (44 in)		
Weight (dry)	339 kg (748 lb)		
<b>LOADING CAPACITY</b>			
Rider capacity	3 (refer to load limit)		
Storage capacity	116.6 L (30.8 U.S. gal.)		
Load limit (passengers + luggage)	273 kg (600 lb)		
<b>FLUIDS</b>			
Fuel	Type	Unleaded	
	Minimum octane	<b>Inside North America:</b> (87 (RON + MON)/2)	
		<b>Outside North America: 92 RON</b>	
Tank capacity	60 L (15.9 U.S. gal.)		
Engine oil	Type	XPS synthetic blend oil (summer grade). If not available, use SAE 5W40 API service SM motor oil	
	Capacity	3 L (3.2 qt (U.S. liq.)) oil change w/filter	
Cooling system	Coolant type	Ethylene-glycol 50%/50% antifreeze and demineralized water. Coolant containing corrosion inhibitors for internal combustion aluminum engines	
	Capacity	5.5 L (5.8 qt (U.S. liq.))	

**NOTE:** BRP reserves the right to make changes in design and specifications and/or to make additions to, or improvements in its products without imposing any obligation upon itself to install them on its products previously manufactured.

***This page is  
intentionally blank***



# ***TROUBLESHOOTING***

---

# TROUBLESHOOTING GUIDELINES

---

## ENGINE WILL NOT START

---

1. Tether cord removed.
  - Press *START/STOP* button.
  - Properly install tether cord cap on engine cut-off switch within 5 seconds of pressing *START/STOP* button.
  - After double “beep”, press *START/STOP* button to start engine.
2. ECM does not recognize the D.E.S.S. key.
  - Refer to an authorized *Sea-Doo* dealer.
3. Burnt fuse: main, electric starter or ECM.
  - Check wiring then replace fuse(s).
4. Discharged battery.
  - Refer to an authorized *Sea-Doo* dealer.

### **WARNING**

Do not charge or boost the battery while installed on the watercraft. Electrolyte is poisonous and dangerous. Avoid contact with eyes, skin and clothing.

5. Battery connections, corroded or loose. Bad ground.
  - Refer to an authorized *Sea-Doo* dealer.
6. Water-flooded engine.
  - Refer to *WATER-FLOODED ENGINE* in *SPECIAL PROCEDURES*.
7. Faulty sensor or ECM.
  - Refer to an authorized *Sea-Doo* dealer.
8. Seized jet pump.
  - Try to clean. Otherwise, refer to an authorized *Sea-Doo* dealer.

## ENGINE CRANKS SLOWLY

---

1. Loose battery cable connections.
  - Check/clean/tighten.
2. Discharged or weak battery.
  - Refer to an authorized *Sea-Doo* dealer.
3. Worn starter.
  - Refer to an authorized *Sea-Doo* dealer.

## ENGINE TURNS NORMALLY BUT WILL NOT START

---

1. Fuel tank empty or water-contaminated.
  - Refill. Siphon and fill with fresh fuel.
2. Fouled/defective spark plugs.
  - Replace.

---

**ENGINE TURNS NORMALLY BUT WILL NOT START (cont'd)**

---

- 3. Blown fuse.**
  - *Check wiring then replace fuse(s).*
- 4. Water-flooded engine.**
  - *Refer to WATER-FLOODED ENGINE in SPECIAL PROCEDURES.*
- 5. Engine management system fault detected (check engine pilot lamp is ON).**
  - *Refer to an authorized Sea-Doo dealer.*
- 6. Faulty fuel pump.**
  - *Refer to an authorized Sea-Doo dealer.*

---

**ENGINE MISFIRES, RUNS IRREGULARLY**

---

- 1. Fouled/defective/worn spark plugs.**
  - *Replace.*
- 2. Fuel: Level too low, stale or water-contaminated.**
  - *Siphon and/or refill.*
- 3. Faulty ignition coil(s).**
  - *Refer to an authorized Sea-Doo dealer.*
- 4. Clogged injectors.**
  - *Refer to an authorized Sea-Doo dealer.*
- 5. Engine management system fault detected (check engine pilot lamp is ON).**
  - *Refer to MONITORING SYSTEM.*

---

**ENGINE SMOKE**

---

- 1. Oil level too high.**
  - *Refer to an authorized Sea-Doo dealer.*
- 2. Water ingestion, coolant leak or damaged cylinder head gasket.**
  - *Refer to an authorized Sea-Doo dealer.*
- 3. Internal engine damage.**
  - *Refer to an authorized Sea-Doo dealer.*

---

**ENGINE OVERHEATS**

---

- 1. Clogged exhaust system.**
  - *Flush exhaust system.*
- 2. Engine coolant level too low.**
  - *Refer to MAINTENANCE PROCEDURES.*
- 3. Quick connect adapter left in flushing connector.**
  - *Remove adapter from flushing connector and retry watercraft. If problem persists, refer to an authorized Sea-Doo dealer.*

**ENGINE LACKS ACCELERATION OR POWER**

---

1. **Learning or Rental key used.**
  - *Use a Normal key.*
2. **Not in Sport mode.**
  - *Select Sport mode.*
3. **Jet pump water intake clogged.**
  - *Clean. Refer to JET PUMP WATER INTAKE AND IMPELLER CLEANING in SPECIAL PROCEDURES section.*
4. **Damaged impeller or worn-out wear ring.**
  - *Replace. Refer to an authorized Sea-Doo dealer.*
5. **Engine oil level too high.**
  - *Refer to an authorized Sea-Doo dealer.*
6. **Weak spark.**
  - *Refer to ENGINE MISFIRES, RUNS IRREGULARLY.*
7. **Engine management system fault detected (check engine pilot lamp is ON).**
  - *Refer to MONITORING SYSTEM.*
8. **Clogged injectors.**
  - *Refer to an authorized Sea-Doo dealer.*
9. **Low fuel pressure.**
  - *Refer to an authorized Sea-Doo dealer.*
10. **Water in fuel.**
  - *Siphon and replace.*
11. **Engine damaged by water ingestion.**
  - *Refer to an authorized Sea-Doo dealer.*

**WATERCRAFT CANNOT REACH TOP SPEED**

---

1. **Jet pump water intake clogged.**
  - *Clean. Refer to JET PUMP WATER INTAKE AND IMPELLER CLEANING in SPECIAL PROCEDURES section.*
2. **Damaged impeller or worn-out wear ring.**
  - *Replace. Refer to an authorized Sea-Doo dealer.*
3. **Engine management system fault detected (check engine pilot lamp is ON).**
  - *Refer to MONITORING SYSTEM.*
4. **Faulty supercharger and/or intercooler (supercharged models).**
  - *Refer to an authorized Sea-Doo dealer.*

---

**WATERCRAFT STAYS IN NEUTRAL AFTER OPERATING THE iBR LEVER**

---

**1. The iBR gate stays in neutral.**

- *Release the throttle to idle RPM.*
- *Press the CRUISE button to activate the slow speed mode.*
- *Return to shore using the slow speed mode. Refer to an authorized Sea-Doo dealer.*

---

**iBR WILL NOT RETURN TO NEUTRAL POSITION (iBR INDICATOR LIGHT ON)**

---

**1. iBR jammed with debris.**

- *Clean and check for damage in the iBR gate and nozzle area.*

**2. iBR system malfunction.**

- *Remove tether cord and wait 5 minutes.*
- *Press START/STOP button.*
- *Install tether cord and check iBR light to ensure fault is cleared.*
- *Refer to an authorized Sea-Doo dealer if fault persists or reoccurs frequently.*

---

**iBR WILL NOT RETURN TO NEUTRAL POSITION (iBR FAULT INDICATOR OFF)**

---

**1. Throttle lever not fully released during operation.**

- *Release throttle lever fully to ensure iBR gate returns to neutral.*

**2. Throttle lever does not fully return to null when released.**

- *Refer to an authorized Sea-Doo dealer.*

---

**ABNORMAL NOISE FROM PROPULSION SYSTEM**

---

**1. Weeds or debris jammed around impeller.**

- *Clean. Refer to JET PUMP WATER INTAKE AND IMPELLER CLEANING in SPECIAL PROCEDURES section.*
- *Check for damage.*

**2. Damaged impeller shaft or drive shaft.**

- *Refer to an authorized Sea-Doo dealer.*

**3. Water intrusion in jet pump causing bearing seizure.**

- *Refer to an authorized Sea-Doo dealer.*

---

**WATER FOUND IN BILGE**

---

**1. Bailer system malfunction.**

- *Have system inspected by an authorized Sea-Doo dealer.*

**2. Exhaust system leak.**

- *Refer to an authorized Sea-Doo dealer.*

**3. Carbon ring at drive shaft worn.**

- *Refer to an authorized Sea-Doo dealer.*

# MONITORING SYSTEM

A system monitors the electronic components of the EMS (engine management system) iBR, and other components of the electrical system. When a fault occurs, it sends visual messages through the information center and/or audible signals through a beeper to inform you of a particular condition.

A fault code may also be recorded.

When a minor or transient fault occurs, the fault message and beeper will cease automatically if the condition that caused the fault does not exist anymore.

Releasing the throttle and letting the engine return to idle speed may allow normal operation to return. If this does not work, try removing the tether cord from the engine cut-off switch, waiting 5 minutes, then restarting.

The electronic system will react differently depending on the fault type. If a severe failure occurred, the engine may not be allowed to be started. In other cases, the engine will operate in limp home mode (reduced speed).

When a fault occurs, see an authorized Sea-Doo dealer as soon as possible for inspection.

## Fault Codes

When a fault occurs, a numerical fault code may be recorded depending on the fault type and system.

These fault codes are used by authorized Sea-Doo dealers for troubleshooting the watercraft systems when comparing them to a fault list.

Fault codes can be viewed in the information center multifunction display however, this function is only available if a fault is still active.

If there is an active fault code, it may be viewed by the operator on the multifunction display. The operator may then choose to call his authorized Sea-Doo dealer to pass on the fault code. The dealer will then advise the

operator on the steps to take to solve the problem, or to stop using the watercraft and to bring it in to the dealer for repairs.

## Displaying Fault Codes

Press the MODE button repeatedly until the FAULT CODE function is visible in the multifunction display.

Press the SET or the UP/DOWN button to enter the function and display the first fault code, then press the UP/DOWN button repeatedly to display each subsequent code.

**NOTE:** When the last fault code has been displayed and the button is pressed again, the system loops back to the first fault code displayed, and all fault codes can again be displayed. If there was one active fault code when entering the FAULT CODE mode, and it becomes occurred (no longer active), a NO ACTIVE FAULT CODE message will scroll in the display.

To exit the FAULT CODE display function, the MODE or SET button must be pressed once. There is no time out on this function.

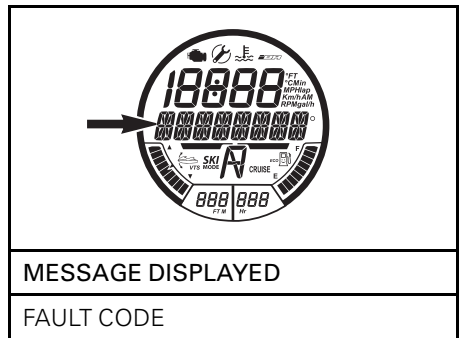

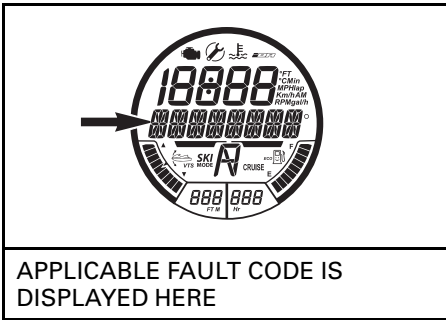



APPLICABLE FAULT CODE IS  
DISPLAYED HERE

## Fault Indicators and Message Display Information

The fault indicators and messages displayed in the information center will inform you of a particular condition or if an anomaly occurs.

If a fault indicator or a fault message comes ON in the multifunction gauge, contact your authorized Sea-Doo dealer.

For information on usual function indicators, refer to *MULTIFUNCTION GAUGE* section as applicable to model.

FAULT INDICATOR (ON)	MESSAGE DISPLAY	DESCRIPTION
	HIGH TEMPERATURE	Engine or exhaust system overheating
	CHECK ENGINE or LIMP HOME MODE	Check engine (minor fault requiring maintenance) or iBR system fault or LIMP HOME MODE (major engine fault)
	LOW or HIGH BATTERY VOLTAGE	Low/high battery voltage
	LOW OIL PRESSURE	Low engine oil pressure detected
	iBR MODULE ERROR_	iBR system fault

MESSAGE DISPLAY INFORMATION	
RIGHT KEYPAD ERROR	Gauge control button malfunction
LOW OIL PRESSURE	Engine low oil pressure detected
HIGH EXHAUST TEMPERATURE	High exhaust temperature detected
HIGH TEMPERATURE	High engine temperature detected
CHECK ENGINE	Engine system malfunction or maintenance required
HIGH BATTERY VOLTAGE	High battery voltage detected
LOW BATTERY VOLTAGE	Low battery voltage detected
LIMP HOME MODE	Major fault detected, engine power limited
FUEL SENSOR DEFECTIVE	Fuel level sensor fault
IBR MODULE ERROR	iBR system malfunction
CALIBRATION CHECKSUM ERROR	Cluster programming corrupted
MAINTENANCE REQUIRED	Watercraft maintenance required

**NOTICE** Running engine with low oil pressure may severely damage the engine.



## Beeper Code Information

BEEPER CODES	DESCRIPTION
1 long beep (when installing tether cord on engine cut-off switch)	<b>Bad D.E.S.S. system connection.</b> Reinstall tether cord correctly on engine cut-off switch.
	<b>Wrong D.E.S.S. key.</b> Use a tether cord that has been programmed for the watercraft.
	<b>Defective D.E.S.S. key.</b> Use another programmed tether cord.
	<b>Dried salt water in tether cord cap.</b> Clean tether cord cap to remove salt water.
	<b>Defective engine cut-off switch.</b> Refer to an authorized Sea-Doo dealer.
	<b>Improper operation of ECM or defective wiring harness.</b> Refer to an authorized Sea-Doo dealer.
A 2 second beep every 15 minute interval	<b>Watercraft is upside down.</b> Turn watercraft upright. Refer to <i>SPECIAL PROCEDURES</i> .
	<b>Engine management system fault.</b> Refer to an authorized Sea-Doo dealer.
A 2 second beep every 5 minute interval	<b>Low fuel level.</b> Refill fuel tank. If problem persists, refer to an authorized Sea-Doo dealer.
	<b>Fuel tank level sensor or circuit malfunction.</b> Refer to an authorized Sea-Doo dealer.
Continuously beeps	<b>High engine coolant temperature.</b> See <i>ENGINE OVERHEATING</i> .
	<b>High exhaust temperature.</b> Refer to an authorized Sea-Doo dealer.
	<b>Low oil pressure.</b> Turn off engine as soon as possible. Check oil level and refill. Refer to an authorized Sea-Doo dealer.

**NOTICE** If the monitoring beeper continuously sounds, stop engine as soon as possible.

***This page is  
intentionally blank***

# ***WARRANTY***

---

# **BRP LIMITED WARRANTY – USA AND CANADA: 2012 SEA-DOO® PERSONAL WATERCRAFT**

## **1. SCOPE**

Bombardier Recreational Products Inc. (“BRP”)\* warrants its model-year 2012 Sea-Doo personal watercraft sold by authorized BRP Dealers (as defined below) in the fifty United States and in Canada from defects in material or workmanship for the period and under the conditions described below. This limited warranty will become null and void if: (1) the Sea-Doo personal watercraft was used for racing or any other competitive activity, at any point, even by a previous owner; or (2) the Sea-Doo personal watercraft has been altered or modified in such a way so as to adversely affect its operation, performance or durability, or has been altered or modified to change its intended use.

All genuine BRP parts and accessories, installed by an authorized BRP dealer (as hereinafter defined) at the time of delivery of the 2012 Sea-Doo personal watercraft, carry the same warranty as that of the personal watercraft.

A GPS receiver may be supplied by BRP as standard equipment on certain 2012 Sea-Doo personal watercraft. The GPS receiver is covered by the limited warranty issued by the GPS receiver’s manufacturer and is not covered by this limited warranty.

## **2. LIMITATIONS OF LIABILITY**

THIS WARRANTY IS EXPRESSLY GIVEN AND ACCEPTED IN LIEU OF ANY AND ALL OTHER WARRANTIES, EXPRESSED OR IMPLIED, INCLUDING WITHOUT LIMITATION ANY WARRANTY OF MERCHANTABILITY OR FITNESS FOR A PARTICULAR PURPOSE. TO THE EXTENT THAT THEY CANNOT BE DISCLAIMED, THE IMPLIED WARRANTIES ARE LIMITED IN DURATION TO THE LIFE OF THE EXPRESS WARRANTY. INCIDENTAL AND CONSEQUENTIAL DAMAGES ARE EXCLUDED FROM COVERAGE UNDER THIS WARRANTY. SOME STATES/PROVINCES DO NOT ALLOW FOR THE DISCLAIMERS, LIMITATIONS AND EXCLUSIONS IDENTIFIED ABOVE, AS A RESULT, THEY MAY NOT APPLY TO YOU. THIS WARRANTY GIVES YOU SPECIFIC RIGHTS, AND YOU MAY ALSO HAVE OTHER LEGAL RIGHTS WHICH MAY VARY FROM STATE TO STATE, OR PROVINCE TO PROVINCE.

Neither the distributor, any BRP dealer nor any other person has been authorized to make any affirmation, representation or warranty regarding the product, other than those contained in this limited warranty, and if made, shall not be enforceable against BRP. BRP reserves the right to modify this warranty at any time, being understood that such modification will not alter the warranty conditions applicable to the products sold while this warranty is in effect.

## **3. EXCLUSIONS – ARE NOT WARRANTED**

The following are not warranted under any circumstances:

- Normal wear and tear;
- Routine maintenance items, tune ups, adjustments;
- Damage caused by failure to provide proper maintenance and/or storage, as described in the Operator’s Guide;

- Damage resulting from removal of parts, improper repairs, service, maintenance, modifications or use of parts not manufactured or approved by BRP or resulting from repairs done by a person that is not an authorized servicing BRP dealer;
- Damage caused by abuse, abnormal use, neglect, or operation of the product in a manner inconsistent with the recommended operation described in the Operator’s Guide;
- Damage resulting from accident, submersion, fire, theft, vandalism or any act of God;
- Operation with fuels, oils or lubricants which are not suitable for use with the product (see the Operator’s Guide);
- Damage from rust, corrosion or exposure to the elements;
- Damage from cooling system or jet pump blockage by foreign material;
- Water damages caused by water ingestion;
- Damages related to gel coat finish including but not limited to cosmetic gel coat finish, blisters or fiberglass delamination caused by blisters, crazing, spider or hairline cracks; and
- Incidental or consequential damages, or damages of any kind including without limitation towing, storage, telephone, rental, taxi, inconvenience, insurance coverage, loan payments, loss of time, loss of income.

#### **4. WARRANTY COVERAGE DURATION**

This limited warranty will be in effect from (1) the date of delivery to the first retail consumer or (2) the date the product is first put into use, whichever occurs first and for the applicable period below:

1. TWELVE (12) CONSECUTIVE MONTHS for private use owners.
2. FOUR (4) CONSECUTIVE MONTHS for commercial use owners. A personal watercraft is used commercially when it is used in connection with generating income or any work or employment during any part of the warranty period. A personal watercraft is also used commercially when, at any point during the warranty period, it has commercial tags or is licensed for commercial use.
3. Emission-related components that are installed on EPA certified Sea-Doo personal watercrafts registered in the USA are covered for thirty (30) consecutive months or one hundred seventy five (175) hours of engine use, whichever occurs first; and evaporative emission related components are warranted for twenty-four (24) consecutive months. If the one hundred seventy five (175) hours of engine use are reached during another applicable warranty coverage period described herein, the emission-related components are still covered by BRP’s standard limited warranty until the end of such regular coverage period. The list of the current warranted emission-related components is known by and available from your authorized BRP dealer.
4. For Sea-Doo personal watercrafts produced by BRP for sale in the State of California that are originally sold to a resident or subsequently warranty registered to a resident in the State of California, please also refer to the applicable California Emissions Control Warranty Statement contained herein.

The repair or replacement of parts or the performance of service under any applicable warranty does not extend the life of such warranty beyond its original expiration date.

## **5. CONDITIONS REQUIRED FOR WARRANTY COVERAGE**

This limited warranty coverage is available only if each of the following conditions has been fulfilled:

- The 2012 Sea-Doo personal watercraft must be purchased as new and unused by its first owner from a BRP dealer authorized to distribute Sea-Doo personal watercraft in the country in which the sale occurred;
- The BRP specified predelivery inspection process must be completed and documented and signed by the purchaser;
- The 2012 Sea-Doo personal watercraft must have undergone proper registration by an authorized BRP dealer;
- The 2012 Sea-Doo personal watercraft must be purchased in the country in which the purchaser resides; and
- Routine maintenance outlined in the Operator's Guide must be timely performed in order to maintain warranty coverage. BRP reserves the right to make warranty coverage contingent upon proof of proper maintenance.

BRP will not honour this limited warranty to any private use owner or commercial use owner if one of the preceding conditions has not been met. Such limitations are necessary in order to allow BRP to preserve both the safety of its products, and also that of its consumers and the general public.

## **6. WHAT TO DO TO OBTAIN WARRANTY COVERAGE**

The customer must cease using the Sea-Doo personal watercraft upon the appearance of an anomaly. The customer must notify an authorized servicing BRP dealer within two (2) days of the appearance of a defect, and provide it with reasonable access to the product and reasonable opportunity to repair it. The customer must also present to the authorized BRP dealer, proof of purchase of the product and must sign the repair/work order prior to the start of the repair in order to validate the warranty repair. All parts replaced under this limited warranty become the property of BRP.

## **7. WHAT BRP WILL DO**

BRP's obligations under this warranty are limited to, at its sole discretion, repairing parts found defective under normal use, maintenance and service, or replacing such parts with new genuine BRP parts without charge for parts and labor, at any authorized BRP dealer during the applicable warranty coverage period under the conditions described herein. No claim of breach of warranty shall be the cause for cancellation or rescission of the sale of the Sea-Doo personal watercraft to the owner.

In the event that service is required outside of the country of original sale, the owner will bear responsibility for any additional charges due to local practices and conditions, such as, but not limited to freight, insurance, taxes, license fees, import duties, and any and all other financial charges, including those levied by governments, states, territories and their respective agencies.

BRP reserves the right to improve or modify products from time to time without assuming any obligation to modify products previously manufactured.

## 8. TRANSFER

If the ownership of a product is transferred during the warranty coverage period, this warranty shall also be transferred and be valid for the remaining coverage period provided that BRP is notified of such transfer of ownership in the following way:

1. The former owner contacts BRP (at the phone number provided below) or an authorized BRP dealer and gives the coordinates of the new owner; or
2. BRP or an authorized BRP dealer receives a proof that the former owner agreed to the transfer of ownership, in addition to the coordinates of the new owner.

## 9. CONSUMER ASSISTANCE

In the event of a controversy or a dispute in connection with this BRP limited warranty, BRP suggests that you try to resolve the issue at the dealership level. We recommend discussing the issue with the authorized BRP dealer's service manager or owner.

If the issue has not yet been resolved, please submit your complaint in writing or call the appropriate number below:

### In CANADA

Bombardier Recreational Products Inc.  
Customer Assistance Center  
75 J.-A. Bombardier Street  
Sherbrooke QC J1L 1W3  
Tel.: 819 566-3366

### In USA

BRP US Inc.  
Customer Assistance Center  
7575 Bombardier Court  
Wausau WI 54401  
Tel.: 715 848-4957

\* In the USA, products are distributed and serviced by BRP US Inc.

© 2011 Bombardier Recreational Products Inc. All rights reserved.

® Registered trademark of Bombardier Recreational Products Inc. or its affiliates.

---

# CALIFORNIA EMISSION CONTROL WARRANTY STATEMENT FOR MODEL YEAR 2012 SEA-DOO® PERSONAL WATERCRAFT WITH 4-TEC® ENGINES

For California, your 2012 Sea-Doo personal watercraft has a special environmental label required by the California Air Resources Board. The label has 1, 2, 3 or 4 stars. A hangtag, provided with your personal watercraft, describes the meaning of the star rating system.

## The Star Label Means Cleaner Marine Engines

The Symbol for Cleaner Marine Engines:



F18L3CQ

## Cleaner Air and Water

For a healthier lifestyle and environment.

## Better Fuel Economy

Burns up to 30 - 40 percent less gas and oil than conventional carbureted two-stroke engines saving money and resources.

## Longer Emission Warranty

Protects consumer for worry free operation.

## One Star – Low Emission

The one-star label identifies personal watercraft, outboard, stern drive and inboard engines that meet the Air Resources Board's Personal Watercraft and Outboard marine engine 2001 exhaust emission standards. Engines meeting these standards have 75% lower emissions than conventional carbureted two-stroke engines. These engines are equivalent to the U.S. EPA's 2006 standards for marine engines.

## Two Stars – Very Low Emission

The two-star label identifies personal watercraft, outboard, stern drive and inboard engines that meet the Air Resources Board's Personal Watercraft and Outboard marine engine 2004 exhaust emission standards. Engines meeting these standards have 20% lower emissions than One Star - Low-Emission engines.



## **Three Stars – Ultra Low Emission**

The three-star label identifies engines that meet the Air Resources Board's Personal Watercraft and Outboard marine engine 2008 exhaust emission standards or the Stern drive and Inboard marine engine 2003 exhaust emission standards. Engines meeting these standards have 65% lower emissions than One Star – Low Emission engines.

## **Four Stars – Super Ultra Low Emission**

The four-star label identifies engines that meet the Air Resources Board's Stern-drive and Inboard marine engine 2012 exhaust emission standards. Personal Watercraft and Outboard marine engines may also comply with these standards. Engines meeting these standards have 90% lower emissions than One Star – Low Emission engines.

For more information: Cleaner Watercraft – Get the Facts  
1 800 END-SMOG  
[www.arb.ca.gov](http://www.arb.ca.gov)

## **Your Emission Control Warranty Rights and Obligations**

The California Air Resources Board and Bombardier Recreational Products Inc. ("BRP") are pleased to explain the emission control system warranty on your Model Year 2012 Sea-Doo personal watercraft. In California, new personal watercraft engines must be designed, built and equipped to meet the State's stringent anti-smog standards. BRP must warrant the emission control system on your personal watercraft engine for the period of time listed below provided there has been no abuse, neglect or improper maintenance of your personal watercraft engine.

Your emission control system may include parts such as the fuel injection system, the ignition system and catalytic converter. Also included may be hoses, belts, connectors and other emission related assemblies.

Where a warrantable condition exists, BRP will repair your personal watercraft engine at no cost to you including diagnosis, parts and labor provided that such work is performed by an authorized BRP dealer.

## **Manufacturer's Limited Warranty Coverage**

This emission limited warranty covers Model Year 2012 Sea-Doo personal watercrafts certified and produced by BRP for sale in California, that are originally sold in California to a California resident or subsequently warranty registered to a California resident. The BRP limited warranty conditions for Sea-Doo personal watercrafts are still applicable to these models with the necessary modifications. Select emission control parts of your 2012 Sea-Doo personal watercrafts are warranted from the date of delivery to the first retail consumer for a period of 4 years, or for 250 hours of use, whichever occurs first. However, warranty coverage based on the hourly period is only permitted for personal watercraft equipped with the appropriate hour meters or their equivalent. If any emission-related part on your engine is defective under warranty, the part will be repaired or replaced by BRP.

**Parts covered for a Model Year 2012 Sea-Doo® personal watercraft equipped with 4-TEC® engines:**

Idle bypass valve	Air intake adapter
Throttle position sensor	Spark plugs
Intake manifold air pressure sensor	Ignition coils
Intake manifold air temperature sensor	Air box
Engine temperature sensor	Intake and exhaust valve and seals
Knock sensor	Intake manifold
Engine control module ECM	Crankcase ventilation valve
Throttle body	Throttle body seal
Fuel rail	Intake manifold seal
Fuel injectors	Wire harness and connectors
Fuel pressure regulator	Fuel filter
Fuel pump	Supercharger

The emission warranty covers damage to other engine components that is caused by the failure of a warranted part. The BRP Operator's Guide provided contains written instructions for the proper maintenance and use of your personal watercraft. All emission warranty parts are warranted by BRP for the entire warranty period of the personal watercraft, unless the part is scheduled for replacement as required maintenance in the Operator's Guide.

Emission warranty parts that are scheduled for replacement, as required maintenance, are warranted by BRP for the period of time before the first scheduled replacement date for that part. Emission warranty parts that are scheduled for regular inspection, but not regular replacement, are warranted by BRP for the entire warranty period of the personal watercraft. Any emission warranty part repaired or replaced under the terms of this warranty statement is warranted by BRP for the remainder of the warranty period of the original part. All parts replaced under this limited warranty become the property of BRP.

Maintenance receipts and records should be transferred to each subsequent owner of the personal watercraft.

## **Owner's Warranty Responsibilities**

As the owner of a 2012 Sea-Doo personal watercraft, you are responsible for the performance of the required maintenance listed in your Operator's Guide. BRP recommends that you retain all receipts covering maintenance your personal watercraft engine, but BRP cannot deny warranty solely for the lack of receipts or your failure to ensure the performance of all scheduled maintenance.

As the owner of a Sea-Doo® personal watercraft, you should however be aware that BRP may deny you warranty coverage if your engine(s) or a part has failed due to abuse, neglect, improper maintenance or unapproved modifications.

You are responsible for presenting your engine to an authorized BRP Dealer as soon as a problem exists. The warranty repairs will be completed in a reasonable amount of time, not to exceed 30 days.

If you have any questions regarding your warranty rights and responsibilities or for the name and location of the nearest authorized BRP Dealer you should contact the Customer Assistance Center at 1-715-848-4957.

---

# **BRP INTERNATIONAL LIMITED WARRANTY: 2012 SEA-DOO® PERSONAL WATERCRAFT**

## **1. SCOPE**

Bombardier Recreational Products Inc. ("BRP")\* warrants its model year 2012 SEA-DOO PERSONAL WATERCRAFT sold by authorized BRP distributors/dealers (defined below) outside of the United States, Canada and states members of the European Economic Area (which is comprised of the states member of the European Union plus Norway, Iceland and Liechtenstein) Turkey, and states members of the Commonwealth of the Independent States ("CIS") (which is comprised of the Russian Federation and ex-members states of the USSR), will be free from defects in material or workmanship for the period and under the conditions described below. This limited warranty will become null and void if: (1) the Sea-Doo personal watercraft was used for racing or any other competitive activity, at any point, even by a previous owner; or (2) the Sea-Doo personal watercraft has been altered or modified in such a way so as to adversely affect its operation, performance or durability; (3) or has been altered or modified to change its intended use.

All genuine BRP parts and accessories, installed by an authorized BRP distributor/dealer at the time of delivery of the 2012 Sea-Doo personal watercraft, carry the same warranty as that of the personal watercraft.

## **2. LIMITATIONS OF LIABILITY**

THIS WARRANTY IS EXPRESSLY GIVEN AND ACCEPTED IN LIEU OF ANY AND ALL OTHER WARRANTIES, EXPRESSED OR IMPLIED, INCLUDING WITHOUT LIMITATION ANY WARRANTY OF MERCHANTABILITY OR FITNESS FOR A PARTICULAR PURPOSE. TO THE EXTENT THAT THEY CANNOT BE DISCLAIMED, THE IMPLIED WARRANTIES ARE LIMITED IN DURATION TO THE LIFE OF THE EXPRESS WARRANTY. INCIDENTAL AND CONSEQUENTIAL DAMAGES ARE EXCLUDED FROM COVERAGE UNDER THIS WARRANTY. SOME JURISDICTIONS DO NOT ALLOW FOR THE DISCLAIMERS, LIMITATIONS AND EXCLUSIONS IDENTIFIED ABOVE, AS A RESULT, THEY MAY NOT APPLY TO YOU. THIS WARRANTY GIVES YOU SPECIFIC RIGHTS, AND YOU MAY ALSO HAVE OTHER LEGAL RIGHTS WHICH MAY VARY FROM COUNTRY TO COUNTRY.

Neither the BRP distributor, any BRP dealer nor any other person has been authorized to make any affirmation, representation or warranty regarding the product, other than those contained in this limited warranty, and if made, shall not be enforceable against BRP. BRP reserves the right to modify this warranty at any time, being understood that such modification will not alter the warranty conditions applicable to the products sold while this warranty is in effect.

## **3. EXCLUSIONS**

The following are not warranted under any circumstances:

- Normal wear and tear;
- Routine maintenance items, tune ups, adjustments;
- Damage caused by failure to provide proper maintenance and/or storage, as described in the Operator's Guide;

- Damage resulting from removal of parts, improper repairs, service, maintenance, modifications or use of parts not manufactured or approved by BRP or resulting from repairs done by a person that is not an authorized servicing BRP distributor/dealer;
- Damage caused by abuse, abnormal use, neglect or operation of the product in a manner inconsistent with the recommended operation described in the Operator's Guide;
- Damage resulting from external damage, submersion, water or foreign object ingestion, accident, fire, theft, vandalism or any act of God;
- Operation with fuels, oils or lubricants which are not suitable for use with the product (see the Operator's Guide);
- Damage from rust, corrosion or exposure to the elements;
- Damages from cooling system or jet pump blockage by foreign material;
- Damages related to gel coat finish including but not limited to cosmetic gel coat finish defects, blisters, spider or hairline cracks; and fiberglass delamination caused by blisters, crazing, spider or hairline cracks; and
- Incidental or consequential damages, or damages of any kind including without limitation towing, storage, telephone, rental, taxi, inconvenience, insurance coverage, loan payments, loss of time, loss of income.

#### **4. WARRANTY COVERAGE DURATION**

This warranty will be in effect from the date of delivery to the first retail consumer or the date the product is first put into use, whichever occurs first and for a period of:

1. TWELVE (12) CONSECUTIVE MONTHS, for private, recreational use.
2. FOUR (4) CONSECUTIVE MONTHS for commercial use owners. A personal watercraft is used commercially when it is used in connection with generating income or any work or employment during any part of the warranty period. A personal watercraft is also used commercially when, at any point during the warranty period, it has commercial tags or is licensed for commercial use.

The repair or replacement of parts or the performance of service under this warranty does not extend the life of this warranty beyond its original expiration date.

#### **FOR PRODUCTS SOLD IN AUSTRALIA ONLY**

"Our goods come with guarantees that cannot be excluded under the Australian Consumer Law. You are entitled to a replacement or refund for a major failure and for compensation for any other reasonably foreseeable loss or damage. You are also entitled to have the goods repaired or replaced if the goods fail to be of acceptable quality and the failure does not amount to a major failure."

## 5. CONDITIONS TO HAVE WARRANTY COVERAGE

This warranty coverage is available **only** if **each** of the following conditions has been fulfilled:

- The 2012 Sea-Doo personal watercraft must be purchased as new and unused by its first owner from a BRP distributor/dealer authorized to distribute Sea-Doo personal watercraft in the country in which the sale occurred ("BRP distributor/dealer");
- The BRP specified pre-delivery inspection process must be completed and documented;
- The 2012 Sea-Doo personal watercraft must have undergone proper registration by an authorized BRP distributor/dealer;
- The 2012 Sea-Doo personal watercraft must be purchased in the country in which the purchaser resides.
- Routine maintenance outlined in the Operator's Guide must be timely performed in order to maintain warranty coverage. BRP reserves the right to make warranty coverage contingent upon proof of proper maintenance.

BRP will not honor this limited warranty to any private use owner or commercial use owner if the preceding conditions have not been met. Such limitations are necessary in order to allow BRP to preserve both the safety of its products, and also that of its consumers and the general public.

## 6. WHAT TO DO TO OBTAIN WARRANTY COVERAGE

The customer must cease using the Sea-Doo personal watercraft upon the appearance of an anomaly. The customer must notify a servicing BRP distributor/dealer within two (2) days of the appearance of a defect, and provide it with reasonable access to the product and reasonable opportunity to repair it. The customer must also present to the BRP distributor/dealer, proof of purchase of the product and must sign the repair/work order prior to the start of the repair in order to validate the warranty repair. All parts replaced under this limited warranty become the property of BRP.

## 7. WHAT BRP WILL DO

BRP's obligations under this warranty are limited to, at its sole discretion, repairing parts found defective under normal use, maintenance and service, or replacing such parts with new genuine BRP parts without charge for parts and labor, at any authorized BRP distributor/dealer during the warranty coverage period under the conditions described herein. No claim of breach of warranty shall be the cause for cancellation or rescission of the sale of the Sea-Doo personal watercraft to the owner.

In the event that service is required outside of the country of original sale, the owner will bear responsibility for any additional charges due to local practices and conditions, such as, but not limited to, freight, insurance, taxes, license fees, import duties, and any and all other financial charges, including those levied by governments, states, territories and their respective agencies.

BRP reserves the right to improve or modify products from time to time without assuming any obligation to modify products previously manufactured.

## **8. TRANSFER**

If the ownership of a product is transferred during the warranty coverage period, this warranty shall also be transferred and be valid for the remaining coverage period provided BRP is notified of such transfer of ownership in the following way:

BRP or an authorized BRP distributor/dealer receives a proof that the former owner agreed to the transfer of ownership, in addition to the coordinates of the new owner. The distributor will then forward this information directly to BRP.

## **9. CONSUMER ASSISTANCE**

1. In the event of a controversy or a dispute in connection with this limited warranty, BRP suggests that you try to resolve the issue at the dealership level. We recommend discussing the issue with the authorised dealer's service manager or owner.
2. If further assistance is required, the distributor's service department should be contacted in order to resolve the matter. You will find your distributor's coordinates on [www.brp.com](http://www.brp.com).
3. If the matter still remains unresolved then contact BRP by writing to us at the address listed below.

**For countries within Europe, Middle East, Africa, please contact our European office:**

**BRP EUROPE N.V.**

Consumer Assistance Center  
Skaldenstraat 125  
9042 Gent  
Belgium  
Tel.: +32-9-218-26-00

**For all other countries, please contact your local distributor or our North America office:**

**BOMBARDIER RECREATIONAL PRODUCTS INC.**

Consumer Assistance Center  
75 J.-A. Bombardier Street  
Sherbrooke QC J1L 1W3  
Tel.: 819 566-3366

\* For the territory covered by this limited warranty, products are distributed and serviced by Bombardier Recreational Products Inc. or its affiliates.

© 2011 Bombardier Recreational Products Inc. All rights reserved.

® Registered trademark of Bombardier Recreational Products Inc. or its affiliates.

---

# **BRP LIMITED WARRANTY FOR THE EUROPEAN AND THE RUSSIAN ECONOMIC AREAS AND TURKEY: 2012 SEA-DOO® PERSONAL WATERCRAFT**

## **1. SCOPE OF THE LIMITED WARRANTY**

Bombardier Recreational Product Inc. ("BRP")\* warrants its model year 2012 SEA-DOO PERSONAL WATERCRAFT sold by authorized BRP distributors/dealers ("Distributors/Dealers") in member states of the European Economic Area ("EEA") (which is comprised of the state members of the European Union plus Norway, Iceland and Liechtenstein), in member states of the Commonwealth of the Independent States ("CIS") (which is comprised of the Russian Federation and ex-members states of the USSR), and Turkey from defects in material or workmanship for the period and under the conditions described below. This limited warranty will become null and void if: (1) the Sea-Doo personal watercraft was used for racing or any other competitive activity, at any point, even by a previous owner; or (2) the Sea-Doo personal watercraft has been altered or modified in such a way so as to adversely affect its operation, performance or durability; (3) or has been altered or modified to change its intended use.

All genuine Sea-Doo personal watercraft parts and accessories, installed by an authorized BRP Distributors/Dealers at the time of delivery of the 2012 Sea-Doo personal watercraft carry the same warranty as that of the personal watercraft.

## **2. LIMITATIONS OF LIABILITY**

THIS WARRANTY IS EXPRESSLY GIVEN AND ACCEPTED IN LIEU OF ANY AND ALL OTHER WARRANTIES, EXPRESSED OR IMPLIED, INCLUDING WITHOUT LIMITATION ANY WARRANTY OF MERCHANTABILITY OR FITNESS FOR A PARTICULAR PURPOSE. TO THE EXTENT THAT THEY CANNOT BE DISCLAIMED, THE IMPLIED WARRANTIES ARE LIMITED IN DURATION TO THE LIFE OF THE EXPRESS WARRANTY. INCIDENTAL AND CONSEQUENTIAL DAMAGES ARE EXCLUDED FROM COVERAGE UNDER THIS WARRANTY. SOME JURISDICTIONS DO NOT ALLOW FOR THE DISCLAIMERS, LIMITATIONS AND EXCLUSIONS IDENTIFIED ABOVE, AS A RESULT, THEY MAY NOT APPLY TO YOU. THIS WARRANTY GIVES YOU SPECIFIC RIGHTS, AND YOU MAY ALSO HAVE OTHER LEGAL RIGHTS WHICH MAY VARY FROM COUNTRY TO COUNTRY.

Neither the distributor, any BRP Distributor/Dealer nor any other person has been authorized to make any affirmation, representation or warranty regarding the product, other than those contained in this limited warranty, and if made, shall not be enforceable against BRP. BRP reserves the right to modify this warranty at any time, being understood that such modification will not alter the warranty conditions applicable to the products sold while this warranty is in effect.

## **3. EXCLUSIONS – ARE NOT WARRANTED**

The following are not warranted under any circumstances:

- Normal wear and tear;
- Routine maintenance items, tune ups, adjustments;
- Damage caused by failure to provide proper maintenance and/or storage, as described in the Operator's Guide;



- Damage resulting from removal of parts, improper repairs, service, maintenance, modifications or use of parts or accessories not manufactured or approved by BRP, which in its reasonable judgement are either incompatible with the product or adversely affect its operations, performance and durability, or resulting from repairs done by a person that is not an authorized servicing BRP distributor/dealer;
- Damage caused by abuse, abnormal use, neglect, racing or operation of the product in a manner inconsistent with the recommended operation described in the Operator’s Guide;
- Damage resulting from external damage, submersion, water or foreign object ingestion, accident, fire, theft, vandalism or any act of God;
- Operation with fuels, oils or lubricants which are not suitable for use with the product (see the Operator’s Guide);
- Damage from rust, corrosion or exposure to the elements;
- Damages from cooling system or jet pump blockage by foreign material;
- Damages related to gel coat finish including but not limited to cosmetic gel coat finish, defects, blisters, spider or hairline cracks; and blisters or fiberglass delamination caused by blisters, crazing, spider or hairline cracks; and
- Incidental or consequential damages, or damages of any kind including without limitation towing, storage, telephone, rental, taxi, inconvenience, insurance coverage, loan payments, loss of time, loss of income.

#### **4. WARRANTY COVERAGE PERIOD**

This warranty will be in effect from the date of delivery to the first retail consumer or the date the product is first put into use, whichever occurs first and for a period of:

1. Twenty four (24) CONSECUTIVE MONTHS, for private, recreational use.
2. FOUR (4) CONSECUTIVE MONTHS for commercial use owners. A personal watercraft is used commercially when it is used in connection with generating income or any work or employment during any part of the warranty period. A personal watercraft is also used commercially when, at any point during the warranty period, it has commercial tags or is licensed for commercial use.

The repair or replacement of parts or the performance of service under this warranty does not extend the life of this warranty beyond its original expiration date.

Note that the duration and any other modalities of the warranty coverage are subject to the applicable national or local legislation in your country.

#### **5. CONDITIONS TO HAVE WARRANTY COVERAGE**

This warranty coverage is available **only** if **each** of the following conditions has been fulfilled:

- The 2012 Sea-Doo personal watercraft must be purchased as new and unused by its first owner from a Distributor/Dealer authorized to distribute Sea-Doo personal watercraft in the country in which the sale occurred;
- The BRP specified pre-delivery inspection process must be completed and documented;
- The product must have undergone proper registration by an authorized Distributor/Dealer;

- The 2012 Sea-Doo personal watercraft must be purchased in the country or in the union of country in which the purchaser resides.
- Routine maintenance outlined in the Operator's Guide must be timely performed in order to maintain warranty coverage. BRP reserves the right to make warranty coverage contingent upon proof of proper maintenance.

BRP will not honor this limited warranty to any private use owner or commercial use owner if the preceding conditions have not been met. Such limitations are necessary in order to allow BRP to preserve both the safety of its products, and also that of its consumers and the general public.

## **6. WHAT TO DO TO OBTAIN WARRANTY COVERAGE**

The customer must cease using the Sea-Doo personal watercraft upon the appearance of an anomaly. The customer must notify a servicing BRP Distributor/Dealer within two (2) months of the appearance of a defect, and provide it with reasonable access to the product and reasonable opportunity to repair it. The customer must also present to the authorized BRP Distributor/Dealer, proof of purchase of the product and must sign the repair/work order prior to starting the repair in order to validate the warranty repair. All parts replaced under this limited warranty become the property of BRP.

Note that the notification period is subject to the applicable national or local legislation in your country.

## **7. WHAT BRP WILL DO**

BRP's obligations under this warranty are limited to, at its sole discretion, repairing parts found defective under normal use, maintenance and service, or replacing such parts with new genuine Sea-Doo parts without charge for parts and labor, at any authorized BRP Distributor/Dealer during the warranty coverage period under the conditions described herein. No claim of breach of warranty shall be the cause for cancellation or rescission of the sale of the Sea-Doo personal watercraft to the owner.

In the event that service is required outside of the country of original sale, the owner will bear responsibility for any additional charges due to local practices and conditions, such as, but not limited to, freight, insurance, taxes, license fees, import duties, and any and all other financial charges, including those levied by governments, states, territories and their respective agencies.

BRP reserves the right to improve or modify products from time to time without assuming any obligation to modify products previously manufactured.

## **8. TRANSFER**

If the ownership of a product is transferred during the warranty coverage period, this warranty shall also be transferred and be valid for the remaining coverage period provided BRP or an authorized BRP Distributor/Dealer receives a proof that the former owner agreed to the transfer of ownership, in addition to the co-ordinates of the new owner.

## **9. CONSUMER ASSISTANCE**

1. In the event of a controversy or a dispute in connection with this limited warranty, BRP suggests that you try to resolve the issue at the dealership level. We recommend discussing the issue with the authorized Distributor/Dealer's service manager or owner.
2. If further assistance is required, the distributor's service department should be contacted in order to resolve the matter. You will find your distributor's coordinates on [www.brp.com](http://www.brp.com).
3. If the matter still remains unresolved then contact BRP at the address listed below.

**For countries within Europe, (to the exception of the Scandinavian countries), Turkey and Russia & CIS, please contact our European office:**

**BRP EUROPE N.V.**

Consumer Assistance Center  
Skaldenstraat 125  
9042 Gent  
Belgium  
Tel.: +32-9-218-26-00

**For Scandinavian countries, please contact our Finland office:**

**BRP FINLAND OY**

Service Department  
Isoaavantie 7  
Fin-96320 Rovaniemi  
Finland  
Tel.: +358 16 3208 111

\* For the territory covered by this limited warranty, products are distributed and serviced by Bombardier Recreational Products Inc. or its affiliates.

© 2011 Bombardier Recreational Products Inc. All rights reserved.

® are registered trademarks, and ™ are trademarks of Bombardier Recreational Products Inc. or its affiliates.



# ***CUSTOMER INFORMATION***

---

## **PRIVACY INFORMATION**

BRP wishes to inform you that your coordinates will be used for safety and warranty related purposes. Furthermore, BRP and its affiliates may use its customer list to distribute marketing and promotional information about BRP and related products.

To exercise your right to consult or correct your data, or to be removed from the addressee-list for direct marketing, please contact BRP.

By E-mail:            [privacyofficer@brp.com](mailto:privacyofficer@brp.com)

By mail:             BRP  
Senior Legal Counsel-Privacy Officer  
726 St-Joseph  
Valcourt, QC  
Canada  
JOE 2L0

---

## CHANGE OF ADDRESS/OWNERSHIP

If your address has changed or if you are the new owner of the watercraft, be sure to notify BRP by either:

- Mailing one of the following card below;
- **North America Only:** calling at 715 848-4957 (USA) or 819 566-3366 (Canada);
- Contacting an authorized BRP distributor/dealer.

In case of change of ownership, please join a proof that the former owner agreed to the transfer.

Notifying BRP, even after the expiration of the limited warranty, is very important as it enables BRP to reach the watercraft owner if necessary, like when safety recalls are initiated. It is the owner's responsibility to notify BRP.

**STOLEN UNITS:** In the event that your watercraft is stolen, you should notify your area's distributor warranty department of such. We will ask you to provide your name, address, phone number, Hull Identification Number and date it was stolen.

### NORTH AMERICA

Bombardier Recreational Products Inc.  
Warranty Department  
75 J.-A. Bombardier Street  
Sherbrooke, QC J1L 1W3  
Canada

### SCANDINAVIAN COUNTRIES

BRP Finland OY  
Service Department  
Isoaavantie 7  
Fin-96320 Rovaniemi  
Finland

### OTHER COUNTRIES IN THE WORLD

BRP European Distribution  
Warranty Department  
Chemin de Messidor 5-7  
1006 Lausanne  
Switzerland

***This page is  
intentionally blank***



CHANGE OF ADDRESS

CHANGE OF OWNERSHIP



VEHICLE IDENTIFICATION NUMBER

Grid for vehicle identification number

Model Number

Vehicle Identification Number (V.I.N.)

OLD ADDRESS OR PREVIOUS OWNER:

NAME

NO. STREET APT

CITY STATE/PROVINCE ZIP/POSTAL CODE

COUNTRY TELEPHONE

NEW ADDRESS OR NEW OWNER:

NAME

NO. STREET APT

CITY STATE/PROVINCE ZIP/POSTAL CODE

COUNTRY TELEPHONE

E-MAIL ADDRESS

V00A2F

CHANGE OF ADDRESS

CHANGE OF OWNERSHIP



VEHICLE IDENTIFICATION NUMBER

Grid for vehicle identification number

Model Number

Vehicle Identification Number (V.I.N.)

OLD ADDRESS OR PREVIOUS OWNER:

NAME

NO. STREET APT

CITY STATE/PROVINCE ZIP/POSTAL CODE

COUNTRY TELEPHONE

NEW ADDRESS OR NEW OWNER:

NAME

NO. STREET APT

CITY STATE/PROVINCE ZIP/POSTAL CODE

COUNTRY TELEPHONE

E-MAIL ADDRESS

V00A2F



**WATERCRAFT** MODEL No. \_\_\_\_\_

**HULL**  
IDENTIFICATION NUMBER (H.I.N.) \_\_\_\_\_

**ENGINE**  
IDENTIFICATION NUMBER (E.I.N.) \_\_\_\_\_

**Owner:** \_\_\_\_\_  
NAME

\_\_\_\_\_  
No. STREET APT

\_\_\_\_\_  
CITY STATE/PROVINCE ZIP/POSTAL CODE

**Purchase Date** \_\_\_\_\_  
YEAR MONTH DAY

**Warranty Expiry Date** \_\_\_\_\_  
YEAR MONTH DAY

To be completed by the authorized Sea-Doo dealer at the time of the sale.

DEALER IMPRINT AREA



219 000 830

CA

OPERATOR'S GUIDE, GTS / GTI / GTR / WAKE SERIES / ENGLISH  
GUIDE DU CONDUCTEUR, SÉRIE GTS / GTI / GTR / WAKE / ANGLAIS

FAIT AU / MADE IN CANADA

U/M.P.C.