



SEA-DOO®



2009 OPERATOR'S GUIDE

Includes
Safety, Vehicle and
Maintenance Information

RXT™ iS™ 255
GTX† Limited iS™ 255

 **WARNING**

Read this guide thoroughly. It contains important safety information.

Minimum recommended operator age: 16 years.

Do not remove this *Operator's Guide* from the vehicle.

2 1 9 0 0 0 5 2 0

⚠ WARNING

Disregarding any of the safety precautions and instructions contained in this Operator's Guide, *SAFETY DVD* and on-product safety labels could cause injury including the possibility of death!

⚠ WARNING

This watercraft may exceed the performance of other boats you may have ridden in the past. Take time to familiarize yourself with your new watercraft.

CALIFORNIA PROPOSITION 65 WARNING

⚠ WARNING

This product contains or emits chemicals known to the state of California to cause cancer and birth defects or other reproductive harm.

In Canada, products are distributed by Bombardier Recreational Products Inc. (BRP).

In USA, products are distributed by BRP US Inc.

Knight's Spray-Nine[†] is a trademark of Korkay System Ltd.

GTX[†] is a trademark of Castrol Ltd. Used under license

This is a non-exhaustive list of trademarks that are the property of Bombardier Recreational Products Inc. or its affiliates:

4-TEC™

O.T.A.S.™

T.O.P.S.™

D.E.S.S.™

Rotax®

VTST™

iBR™

RXT®

XPST™

iControl™

Sea-Doo®

iST™

Sea-Doo LK™

iTC™

S³Hull™

FOREWORD

Congratulations on your purchase of a new Sea-Doo® personal watercraft (PWC). It is backed by the BRP warranty and a network of authorized Sea-Doo personal watercraft dealers ready to provide the parts, service or accessories you may require.

Your dealer is committed to your satisfaction. He has taken training to perform the initial setup and inspection of your watercraft as well as completed the final adjustment before you took possession. If you need more complete servicing information, please ask your dealer.

At delivery, you were also informed of the warranty coverage and signed the *PREDELIVERY CHECK LIST* to ensure your new watercraft was prepared to your entire satisfaction.

Know Before you Go

To learn how to reduce the risk for you or other persons being injured or killed, read the following sections before you operate the vehicle:

- *SAFETY INFORMATION*
- *VEHICLE INFORMATION*.

Read and understand also all safety labels on your watercraft and watch properly your *SAFETY DVD*.

We highly recommend that you take a safe boating course. Please check your dealer or local authorities for availability in your area.

In certain areas, an operator competency card is mandatory to operate a pleasure craft.

Safety Messages

This Operator's Guide utilizes the following symbols and words to emphasize particular information:

WARNING

Indicates a potentially hazardous situation which, if not avoided, could result in serious injury or death.

 **CAUTION** Indicates a potentially hazardous situation which, if not avoided, could result in minor or moderate injury.

NOTICE Indicates an instruction which, if not followed, could severely damage vehicle components or other property.

About this Operator's Guide

This Operator's Guide has been prepared to acquaint the owner/operator or passenger with this personal watercraft and its various controls, maintenance and safe riding instructions.

This guide is indispensable for the proper use of the product and should be kept in a waterproof bag with the watercraft at all times.

Note that this guide is available in several languages. In the event of any discrepancy, the English version shall prevail.

If you want to view and/or print an extra copy of your Operator's Guide, simply visit the following website www.operatorsguide.brp.com.

The informations contained in this document are correct at the time of publication. However, BRP maintains a policy of continuous improvement of its products without imposing upon itself any obligation to install them on products previously manufactured. Due to late changes, some differences between the manufactured product and the descriptions and/or specifications in this guide may occur. BRP reserves the right at any time to discontinue or

change specifications, designs, features, models or equipment without incurring any obligation upon itself.

This Operator's Guide and the *SAFETY DVD* should remain with the watercraft when it's sold.

TABLE OF CONTENTS

FOREWORD **1**
 Know Before you Go 1
 Safety Messages..... 1
 About this Operator's Guide 1

SAFETY INFORMATION

GENERAL PRECAUTIONS..... **8**
 Avoid Carbon Monoxide Poisoning 8
 Avoid Gasoline Fires and Other Hazards 8
 Avoid Burns from Hot Parts 8
 Accessories and Modifications 8

SPECIAL SAFETY MESSAGES **9**
 Reminders Regarding Safe Operation..... 9
 Water Sports 14
 Hypothermia..... 16
 Safe Boating Courses 16

ACTIVE TECHNOLOGIES (iCONTROL) **17**
 Introduction..... 17
 iTC (intelligent Throttle Control)..... 17
 iBR (intelligent Brake and Reverse System) 18
 iS (intelligent Suspension) 18

SAFETY EQUIPMENT **19**
 Required Safety Equipment 19
 Additional Recommended Equipment 21

NAVIGATION RULES..... **22**
 Operating Rules 22

FUELING **25**
 Fueling Procedure..... 25
 Recommended Fuel 26

TRAILERING INFORMATION **27**

LOCATION OF IMPORTANT LABELS **28**

PRE-RIDE INSPECTION **32**
 What to Do Before Launching the Watercraft 32
 What to Do After Launching the Watercraft 35

VEHICLE INFORMATION

CONTROLS **38**
 1) Handlebar 38
 2) Throttle Lever..... 39
 3) iBR Lever (intelligent Brake and Reverse) 40
 4) D.E.S.S. Post 40
 5) Engine Start/Stop Button 44

CONTROLS (cont'd)	
6) VTS Button (Variable Trim System).....	44
7) iS Button (intelligent Suspension).....	47
8) MODE and SET Button	48
9) UP and DOWN Arrow Button	49
10) Cruise Button.....	49
INFORMATION CENTER	52
1) Speedometer	54
2) Tachometer	54
3) Digital Screen	54
4) Indicator Lights	54
5) Fuel Level	55
6) VTS Position	56
7) iS Position	56
8) Numerical Display	56
9) Multifunction Display	57
10) Depth Sounder Indicator	58
11) Water Temperature Display	58
12) Hour Meter Display (HR)	59
13) iBR Position	59
14) Compass.....	59
EQUIPMENT	60
1) Glove Box	61
2) Front Storage Bin	61
3) Rear Storage Bins	63
4) Fire Extinguisher Holder	64
5) Seat Latch.....	64
6) Seat Grab Handles.....	64
7) Boarding Step.....	64
8) Boarding Platform	65
9) Speed-Ties	65
10) Front and Rear Eyelets	68
11) Mooring Cleats	68
12) Bilge Drain Plugs	68
OPERATING INSTRUCTIONS	69
Boarding the Watercraft	69
How to Start Engine.....	71
How to Shut Off the Engine	73
How to Steer Watercraft	73
How to Engage Neutral	74
How to Engage Forward.....	74
How to Engage and Use Reverse.....	74
How to Engage and Use Braking.....	75
How to Use the Variable Trim System (VTS)	77
How to Use Cruise Mode.....	78
How to Use Slow Speed Mode	78
iS (intelligent Suspension) Operation.....	79

OPERATING INSTRUCTIONS (cont'd)
 General Recommendations 81

SPECIAL PROCEDURES **84**
 Jet Pump Water Intake and Impeller Cleaning 84
 Capsized Watercraft 84
 Submerged Watercraft 85
 Water-Flooded Engine 85
 Towing the Watercraft in Water 86

MAINTENANCE INFORMATION

MAINTENANCE SCHEDULE **88**
10-HOUR INSPECTION **92**
MAINTENANCE PROCEDURES **93**
 Engine Oil 93
 Engine Coolant 95
 Exhaust System 96
 Ride Plate and Water Intake Grate 97
 Jet Pump, Nozzle and iBR Gate 97
 Body and Hull 99
 Fuses 100

POST-OPERATION CARE **102**
 Exhaust System Flushing 102
 Additional Care for Foul Water or Salt Water Operation 102

STORAGE AND PRESEASON PREPARATION **103**
 Storage 103
 Preseason Preparation 106

TECHNICAL INFORMATION

VEHICLE IDENTIFICATION **108**
 Hull Identification Number 108
 Engine Identification Number 108
 EPA Compliance Label 108

ENGINE EMISSIONS INFORMATION **110**
 Manufacturer's Responsibility 110
 Dealer's Responsibility 110
 Owner Responsibility 110
 EPA Emission Regulations 110

SPECIFICATIONS **111**

TROUBLESHOOTING

TROUBLESHOOTING GUIDELINES **114**

MONITORING SYSTEM **118**
 Fault Codes 118
 Indicator Lights and Message Display Information..... 119
 Beeper Code Information 120

WARRANTY

BRP LIMITED WARRANTY – USA AND CANADA: 2009 SEA-DOO® PERSONAL WATERCRAFT **122**
CALIFORNIA AND NEW YORK EMISSION CONTROL WARRANTY STATEMENT FOR MODEL YEAR 2009 SEA-DOO® PERSONAL WATERCRAFT WITH 4-TEC® ENGINES..... **126**
BRP INTERNATIONAL LIMITED WARRANTY: 2009 SEA-DOO® PERSONAL WATERCRAFT..... **130**
BRP LIMITED WARRANTY FOR THE EUROPEAN ECONOMIC AREA: 2009 SEA-DOO® PERSONAL WATERCRAFT..... **134**

CUSTOMER INFORMATION

PRIVACY INFORMATION/DISCLAIMER..... **140**
CHANGE OF ADDRESS/OWNERSHIP..... **141**

SAFETY INFORMATION

GENERAL PRECAUTIONS

Avoid Carbon Monoxide Poisoning

All engine exhaust contains carbon monoxide, a deadly gas. Breathing carbon monoxide can cause headaches, dizziness, drowsiness, nausea, confusion and eventually death.

Carbon monoxide is a colorless, odorless, tasteless gas that may be present even if you do not see or smell any engine exhaust. Deadly levels of carbon monoxide can collect rapidly, and you can quickly be overcome and unable to save yourself. Also, deadly levels of carbon monoxide can linger for hours or days in enclosed or poorly ventilated areas. If you experience any symptoms of carbon monoxide poisoning, leave the area immediately, get fresh air and seek medical treatment.

To prevent serious injury or death from carbon monoxide:

- Never run the watercraft in poorly ventilated or partially enclosed areas such as boat houses, seawalls or other boats in close proximity. Even if you try to ventilate engine exhaust, carbon monoxide can rapidly reach dangerous levels.
- Never run the watercraft outdoors where engine exhaust can be drawn into a building through openings such as windows and doors.
- Never stand behind the watercraft while the engine is running. A person standing behind a running engine may inhale high concentrations of exhaust fumes. Inhalation of concentrated exhaust fumes that contain carbon monoxide can result in CO poisoning, serious health problems and death.

Avoid Gasoline Fires and Other Hazards

Gasoline is extremely flammable and highly explosive. Fuel vapors can spread and be ignited by a spark or

flame many feet away from the engine. To reduce the risk of fire or explosion, follow these instructions:

- Use only an approved red gasoline container to store fuel.
- Strictly adhere to the instructions in *FUELING* section.
- Never start watercraft if gasoline or gasoline vapor is present in the engine compartment.
- Never start or operate the engine with the fuel cap is not properly latched.
- Do not carry gasoline containers in the front storage compartment or anywhere else on the watercraft.

Gasoline is poisonous and can cause injury or death.

- Never siphon gasoline with your mouth.
- If you swallow gasoline, get any in your eyes, or inhale gasoline vapors, see a doctor immediately.

If gasoline is spilled on you, wash thoroughly with soap and water and change your clothes.

Avoid Burns from Hot Parts

The ride plate, exhaust system and engine become hot during operation. Avoid contact during and shortly after operation to avoid burns.

Accessories and Modifications

Do not make unauthorized modifications, or use accessories that are not approved by BRP. Since these changes have not been tested by BRP, they may increase the risk of accidents or injuries, and they can make the watercraft illegal for use on water.

See your authorized Sea-Doo dealer for available accessories for your watercraft.

SPECIAL SAFETY MESSAGES

Reminders Regarding Safe Operation

- The performance of this watercraft may significantly exceed that of other crafts you may have operated. Make sure you read and understand the content of the Operator's Guide to become completely familiar with the controls and operation of the watercraft before embarking on your first trip, or taking on a passenger(s). If you have not had the opportunity to do so, practice driving solo in a suitable traffic free area to become accustomed to the feel and response of each control. Be fully familiar with all controls before accelerating above idle speed. Do not assume that all PWCs handle identically. Each model differs, often substantially.
- Always keep in mind that as the throttle lever is returned to the idle position, less directional control is available. To turn the watercraft, both steering and throttle are necessary. If the engine is shut off, directional control is lost.
- Although most watercrafts have no means of braking, advancement in technologies now permit us to offer models that are equipped with a braking system called the iBR™ system. Practice braking maneuvers in a safe traffic-free area to become familiar with handling under braking and with stopping distances under various operating conditions.

WARNING

Stopping distance will vary depending on initial speed, load, wind, number of riders and water conditions. The amount of braking power commanded by the operator using the iBR lever (Intelligent Brake and Reverse) will also affect stopping distance.

- When braking, riders must brace themselves against the deceleration force to prevent from moving forward on the watercraft and losing balance.
- When operating an iBR equipped watercraft, be aware that other boats following or operating in close proximity may not be able to stop as quickly.
- When at speed and the brake is first applied, a plume of water will shoot up in the air behind the watercraft which may cause the operator of a following watercraft to momentarily lose sight of your PWC. It is important to inform the operator of a watercraft who intends to follow in a convoy formation, of the braking and maneuvering capability of your PWC, what the plume of water indicates, and that a greater distance should be maintained between watercrafts.
- When actuating the iBR control lever while the watercraft has some forward speed, the braking mode will engage and generate a deceleration proportional to the iBR lever position. The more you pull in the iBR lever, the greater the braking force becomes. Be careful to gradually actuate the iBR lever to adjust the intensity of the braking force, and to simultaneously release the throttle lever.
- Do not release throttle to steer.

⚠ WARNING

Do not release the throttle when trying to steer away from objects without the use of the braking system. Engine power and jet pump thrust is required to steer the watercraft.

- The brake feature of the iBR system cannot prevent your PWC from drifting due to current or wind. It has no braking effect on the rearward velocity. Also note that your engine must be running to be able to use the brake.
- Do not start or operate the watercraft if any person on board is not properly seated, or if a person is nearby in the water.
- The personal watercrafts' jet thrust can cause injury. The jet pump may pick up debris and throw it rearward causing a risk of injuring people, damaging the jet pump, or other property.
- Observe the instructions on all safety labels. They are there to help assure that you have a safe and enjoyable outing.
- Do not store any objects in areas that are not designed specifically for storage.
- Riding with passenger(s), pulling tubes, a skier, or a wake boarder makes the PWC handle differently and requires greater skill.
- Certain PWCs may come equipped with tow eyelets or a ski pole which, can be used to attach a tow rope for a skier, tube or wake boarder. Do not use these attachment points or any other portion of the watercraft to tow a para-sail or another craft. Personal injury or severe damage may occur.
- Combustion engines need air to operate; consequently this PWC cannot be totally watertight. Any maneuvers such as turning constantly in tight circles, plunging the bow through waves, or capsizing the watercraft, that cause the air inlet openings to be under water may cause severe engine problems due to water ingestion. Refer to *HOW TO STEER WATERCRAFT* in the *OPERATING INSTRUCTIONS* section and the *WARRANTY* section contained in this Operator's Guide.
- Engine exhaust contains carbon monoxide (CO), which can cause serious health problems or death if inhaled in sufficient quantities. Do not operate the PWC in a confined area or allow CO to accumulate around the PWC, or in enclosed or sheltered areas such as when docked, or when rafting. Be aware of the risk of CO emanations from exhaust of other PWCs.
- Know the waters in which the watercraft is to be operated. Current, tides, rapids, hidden obstacles, wakes and waves etc. can affect safe operation. It is not advisable to operate the watercraft in rough waters or inclement weather.
- In shallow water, proceed with caution and at very low speeds. Grounding or abrupt stops may result in injury and watercraft damage. Debris may also be picked up and thrown rearward by the jet pump onto people or property.

- Keep the safety lanyard attached to the operators' PFD at all times and keep it free from snagging on the handlebars to help ensure the engine stops should the operator fall off. After riding, remove the D.E.S.S.™ key from its post to avoid unauthorized use by children or others. If the operator falls off the watercraft and the safety lanyard is not attached as recommended, the watercraft engine will not stop.
- Ride within your limits and level of riding ability.
- PWCs are not designed for night-time operation.
- Your PWC is equipped with an intelligent suspension. Although the system absorbs part of the vertical forces and therefore reduces the impact force to the body, it cannot eliminate it completely. To prevent you and your passenger from being bounced and eventually be ejected from the watercraft, reduce your speed.
- Do not jump wakes or wakes.

WARNING

Avoid aggressive maneuvers to reduce the risk of loss of control, ejection and collision. Understand and respect the performance of your watercraft.

- Always ride responsibly and safely. Use common sense and courtesy.
- Respect no wake zones, the environment, and the rights of other users of the waterways. As the operator and owner of a PWC, you are responsible for damage by the wake of your PWC. Do not let anyone throw refuse overboard.
- While your watercraft has the capacity of operating at high speeds, it is strongly recommended that high speed operation only be applied when ideal conditions exist and are permitted. Higher speed operation requires a higher degree of skill and increases the risk of severe injuries.
- The forces generated on the body of riders while turning, negotiating waves or wakes, operating in choppy waters, or falling off the watercraft, especially at higher speeds, may cause injury including the possibility of broken bones or more serious bodily injuries. Remain flexible and avoid sharp turns.

WARNING

Avoid riding in very rough waters or practicing extreme maneuvers like jumping wakes or waves.

Before Getting Underway

- For safety reasons and proper care, always perform the pre-ride inspection as specified in your Operator's Guide before operating your watercraft.
- Do not exceed the payload or passenger capacities for your watercraft, which are listed on the capacity plate and in the specifications. Overloading can affect maneuverability, stability and performance. Also, heavy seas reduce capacity. A payload or person capacity plate is not an excuse for failure to use common sense or good judgment.
- Regularly inspect the PWC, hull, engine, safety equipment, and all other boating gear and keep them in safe operating condition.
- Be sure you have the minimum required safety equipment, PFDs and any additional gear needed for your cruise.
- Check that all lifesaving equipment, including fire extinguisher, is in safe operating condition and easily accessible. Show all passengers where this equipment is stored on the PWC, and make sure they know how to use it.

- Keep an eye on the weather. Check local weather broadcasts before departure. Be alert to changing conditions.
- Keep accurate and up-to-date charts of the boating area on board. Before getting underway, check water conditions in the planned boating area.
- Keep enough fuel on board for the planned trip. Always verify fuel level before use and during the ride. Apply the principle of 1/3 of the fuel to reach your destination, 1/3 to return, and keep 1/3 in reserve. Allow for changes due to adverse weather or other delays.

Operator and Passenger Awareness

- Read and understand all safety labels on the Sea-Doo PWC, the operator's guide, all other safety documents, and watch the *SAFETY DVD* before operating the PWC.
- Respect applicable laws.

WARNING

Check local and federal boating laws applicable to the waterways where you intend to use your watercraft. Learn the local navigation rules. Know and understand the applicable navigation system (such as buoys and signs).

- Remember that sun, wind, fatigue or illness may impair your judgement and reaction time.
- Don't drink and drive.

WARNING

Never ride under the influence of alcohol or drugs. They slow reaction time and impair judgment.

- Operation of this PWC by a person under 16 years of age, or a person with a disability that impairs vision, reaction time, judgment, or operation of the controls is NOT recommended.
- Always use the safety lanyard when operating the watercraft and ensure that all passengers are familiar with its use.
- Ensure that any operator and all passengers know how to swim and how to re-board the PWC from the water. Boarding in deep water can be strenuous. Practice in chest-deep water before operating or embarking your watercraft in deep water. If a passenger does not know how to swim, ensure that passenger wears a PFD at all times and take extra precautions when boating.
- Never turn handlebar while someone is near the rear of watercraft. Keep away from steering moving parts (nozzle, iBR gate, linkages, etc.).
- Do not start engine when anyone is near the rear of the watercraft.

WARNING

Do not start or operate the watercraft if anyone is nearby in the water.

- Be aware of the iBR gate movement when starting the engine, shutting down the engine or using the iBR lever. Automatic movement of the gate may squeeze fingers or toes of people taking a hold on the back or your PWC.

- The operator and passenger(s) should be properly seated before starting or moving the watercraft, and at all times when the watercraft is in motion. All passenger(s) should be instructed to use the handholds or seat straps provided, or to hold the waist of the person in front of them. Each passenger must be able to simultaneously place both feet firmly flat against each footwell when properly seated.
- When braking, riders must brace themselves against the deceleration force to prevent from moving forward on the watercraft and losing balance.
- When accelerating on a PWC with a passenger(s), whether from a complete stop or while underway, always do so progressively. Fast acceleration may cause your passenger(s) to lose their balance and fall rearward off the watercraft. Make sure that your passenger(s) are aware of or can anticipate any rapid acceleration.
- Keep away from intake grate.
- Severe internal injuries can occur if water is forced into body cavities as a result of falling into water or being near a jet thrust nozzle.
- Before reboarding, make sure engine is off and D.E.S.S. key is removed.

WARNING

To prevent accidental starting, always detach the D.E.S.S. key from its post when swimmers are boarding or nearby, or during removal of any weeds or debris from the intake grate.

- On a PWC, never place your feet and legs in the water to aid turning.

Operation by Minors

Minors should always be supervised by an adult whenever operating a watercraft. Laws regarding the minimum age and licensing requirements of minors may vary from one jurisdiction to another. Be sure to contact the local boating authorities for information regarding the legal operation of a PWC in the intended jurisdiction of use. BRP recommends a minimum operator age of 16 years old.

Adding Accessories or Towing with the Watercraft

- If the throttle lever is depressed while braking, the iBR system will disable the throttle command by the user. When releasing the iBR lever while the throttle lever is still depressed, the throttle command will regain control and generate an acceleration after a short delay. Release throttle lever if acceleration is not needed.
- Avoid adding on accessories or equipment which, may alter your control of the watercraft.
- Certain PWCs may come with or can be equipped with tow eyelets or a ski pole which, can be used to attach a tow rope for a skier, tube or wakeboarder. Do not use these attachment points or any other portion of the PWC to tow a parasail or another craft. Doing so may affect control and stability possibly resulting in personal injury or severe damage.

WARNING

Keep away from the intake grate while the engine is on. Items such as long hair, loose clothing, or PFD straps can become entangled in moving parts.

- Riding with passenger(s) or pulling a tube, skier or wakeboarder makes the watercraft handle differently and requires greater skill.
- Always respect the safety and comfort of your passenger(s) and person being towed on skis, wakeboard or other water products.
- Always carry an observer when pulling a tube, skier or wakeboarder, proceed with only as much speed as required and follow the observers' instructions.
- Unless absolutely necessary, do not make tight sharp turns or use the braking system. Remember that although this PWC is maneuverable and has stopping capabilities, the person in tow may not be able to avoid an obstacle, or the PWC with which it is being towed.
- Even with the iBR system, always use vigilance especially when heading towards swimmers, another boat or any fixed object. Reduce your speed early and change your heading to clear the obstacle in case you run out of stopping distance.
- Use a tow rope of sufficient length and size and make sure it is adequately secured to your watercraft. While some watercrafts are equipped or can be fitted with a specially designed towing mechanism, avoid installing a tow pole on a PWC. It can become a hazard should someone fall on it.
- Be advised that serious injury can result if the tow rope becomes slack during a tight turn or when circling. The rope could become wrapped around the neck or limbs of a person that has fallen in the water.

Drugs and Alcohol

Never operate your PWC under the influence of alcohol or drugs. Like driving a car, driving a watercraft requires the operator to be sober, attentive and alert. Operating a watercraft while intoxicated or under the influence of

drugs is not only dangerous, but it is also a Federal offense carrying a significant penalty. These laws are vigorously enforced. The use of drugs and alcohol, singly or in combination, decreases reaction time, impedes judgment, impairs vision, and inhibits your ability to safely operate a watercraft.

WARNING

Alcohol consumption and boating do not mix! Operating under the influence endangers the lives of your passengers, other boaters, and yourself. Federal laws prohibit operating a watercraft under the influence of alcohol or drugs.

Water Sports

WARNING

Avoid personal injury! Your PWC is not designed for and should not be used for pulling parasails, kites, gliders, or any device which can become airborne. Use your watercraft only for water sports it was designed for.

Water skiing, wakeboarding, or riding a towed inflatable apparatus are some of the more popular water sports. Taking part in any water sport requires increased safety awareness by the participant and the watercraft operator. If you have never towed someone behind your PWC before, it is a good idea to spend some hours as an observer, working with and learning from an experienced operator. It is also important to be aware of the skill and experience of the person being towed.

Have a second person aboard to observe the person being towed and inform the operator about the participants' hand signals. The operator must focus his attention on operating the watercraft and the waters ahead.

Both the operator and observer should monitor the location of the tow rope when participating in watersports. A slack tow rope can become entangled with a person(s) or objects on the PWC or in the water, particularly when making a tight turn or circling, and cause serious personal injury.

Everyone participating in a water sport should observe these guidelines:

- When pulling a tube, skier, or a wake boarder, be aware that the person in tow may not be able to avoid the towing PWC if it stops suddenly under aggressive active braking. To avoid this, proceed with only as much braking as required, or follow the observer's instructions.
- Allow only capable swimmers to take part in any water sport.
- Always wear an approved personal flotation device (PFD). Wearing a properly designed PFD helps a stunned or unconscious person stay afloat.
- Be considerate to others you share the water with.
- Do not tow a person in any water sport on a short tow rope such that the person inhales exhaust fumes in concentration. Inhalation of concentrated exhaust fumes, which contain carbon monoxide, can result in CO poisoning, personal injury and death.
- Give immediate attention to a person who has fallen. He or she is vulnerable in the water alone and may not be seen by other boaters.
- Approach a person in the water from the lee side (opposite the direction of the wind). Turn off the motor before coming close to the person.
- Participate in water sports only in safe areas. Stay away from other boats, channels, beaches, restricted areas, swimmers, and heavily traveled waterways and underwater obstructions.

- Turn off the engine and anchor the watercraft before swimming.
- Swim only in areas designated as safe for swimming. These are usually marked with a swim area buoy. Do not swim alone or at night.



SWIM AREA BUOY

- Do not water ski between sunset and sunrise. It is illegal in most areas.
- Do not drive the watercraft directly behind a water skier, tuber or wakeboarder. At 40 km/h (25 MPH) per hour, the watercraft will overtake a person who falls in the water 60 m (197 ft) in front of your watercraft in about 5 seconds.
- Shut off the engine and remove the D.E.S.S.TM key from its post (lan-yard) when anyone is in the water nearby.
- Stay at least 45 m (148 ft) away from areas marked by a diver down float.

WARNING

Avoid personal injury! Do not allow anyone near the jet pump or intake grate, even when the engine is off. Items such as long hair, loose clothing or personal flotation device straps can become entangled in moving parts resulting in serious injury or drowning. In shallow water, shells, sand, pebbles or other objects could be drawn up by the jet pump and be thrown rearward.

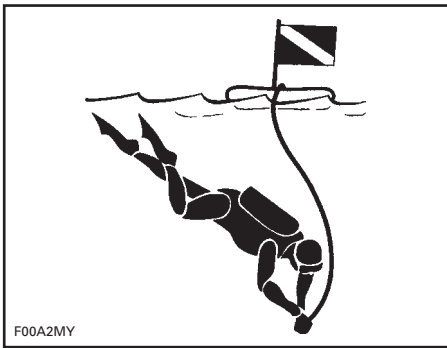

DIVER DOWN FLOAT

For more information on approved, legal and safe practice of water sports, please contact the local legal authority on water sports safety for the area you plan to practice in.

Hypothermia

Hypothermia, the loss of body heat resulting in a subnormal body temperature, is a significant cause of death in boating accidents. After an individual has succumbed to hypothermia, he or she will lose consciousness and then drown.

PFDs can increase survival time because of the insulation they provide.

Naturally, the warmer the water, the less insulation one will require. When operating in cold water (below 4°C (40°F)) consideration should be given to using a coat or jacket style PFD as they cover more body area than the vest style PFDs.

Some points to remember about hypothermia protection:

- While afloat in the water, do not attempt to swim unless it is to reach a nearby boat, fellow survivor, or a floating object onto which you can lean or climb. Unnecessary swimming increases the rate of body heat loss. In cold water, drown-proof methods that require putting your head in the water are not recommended. Keep your head out of the water. This will greatly lessen heat loss and increase your survival time.
- Maintain a positive attitude about your survival and rescue. This will improve your chances of extending your survival time until you can be rescued. Your will to live does make a difference!
- If there is more than one person in the water, huddling together is recommended. This action tends to reduce the rate of heat loss and thus increase the survival time.
- Always wear your PFD. It won't help you fight off the effects of hypothermia if you don't have it on when you go into the water.

Safe Boating Courses

Many countries recommend or require a boating safety course. Check with your local competent authorities.

Check local and federal boating laws applicable to the waterways where you intend to use your watercraft. Learn the local navigation rules. Know and understand the applicable navigation system (such as buoys and signs).

ACTIVE TECHNOLOGIES (iCONTROL)

Introduction

iControl™ (intelligent Control systems) provides an environment whereby the operator can control many systems without taking his hands off the handlebars.

All controls are at the operator's finger tips and activated by pressing a button or pulling a lever. The operator's attention can thus remain focused on the water and driving the watercraft.

Each control is electronic and provides a command signal to an electronic module whose function is to assure proper operation of its system within set parameters.

The various systems grouped under iControl are the:

- iTC™ (intelligent Throttle Control)
- iBR (intelligent Brake and Reverse)
- iS™ (intelligent suspension)
- O.T.A.S. (Off Throttle Assisted Steering).

These systems function together to provide new features such as cruise control, slow speed mode and braking, improved vehicle response to operator inputs, increased maneuverability and control.

It is extremely important for operators to read all information contained in this operator's guide so as to become familiar with this watercraft, its systems, controls, capabilities and limitations.

iTC (intelligent Throttle Control)

The system uses an electronic throttle control (ETC) that provides command signals to the ECM (Engine Control Module). With this system, there is no need for a traditional throttle cable.

The iTC allows new functions such as cruise control, slow speed mode, and O.T.A.S.™ as well as a more precise control of the engine power.

Cruise Control

Cruise control allows the operator to set a desired maximum speed of the watercraft when operating above 3800 RPM.

Cruise control limits watercraft speed but does not maintain it. The operator must hold the throttle lever depressed to maintain forward speed, unlike an automotive type cruise control which maintains a constant speed while throttle pedal is released.

As you proceed under a constant cruising speed setting, hold the throttle lever fully depressed in order to keep your full attention to maintaining good situational awareness.

Slow Speed Mode

Slow speed mode is a function of cruise control which allows the operator to adjust and set idle speed corresponding to a watercraft speed of 1.6 km/h to 8 km/h (1 MPH to 5 MPH). The throttle lever should not be depressed while operating in slow speed mode.

O.T.A.S.™ System (Off-Throttle Assisted Steering)

The O.T.A.S. (Off-Throttle Assisted Steering) system provides additional maneuverability in off-throttle situations. The O.T.A.S. system is electronically activated and slightly increases engine speed under a pre-programmed RPM when the driver initiates a full turn. When handlebar is brought back to its center position, the throttle reverts to idle.

Limitations

The O.T.A.S. system cannot help you maintain control or prevent collisions in all situations.

Learning Key

The Sea-Doo™ learning key can be programmed to limit the speed of the watercraft therefore enabling first time users and less experienced operators to learn how to operate the watercraft while gaining the necessary confidence and control.

Limitations

The ability of a novice to operate the watercraft can be exceeded even if a learning key is used.

iBR (intelligent Brake and Reverse System)

This watercraft uses an electronically controlled braking and reverse system called the iBR system (intelligent Brake and Reverse).

The iBR module controls the position of the iBR gate to provide forward thrust, reverse thrust, braking thrust, and neutral.

The operator commands the position of the iBR gate using either the throttle lever for forward thrust, or the iBR lever for neutral, reverse, and for the braking function.

NOTE: The iBR lever can only be used to command a change in the gate position if the engine is running.

Using the iBR system significantly reduces the stopping distance of this watercraft and can increase its maneuverability as it can be used in a straight line, in a turn, at high or low speeds, or to propel the watercraft in reverse for docking or maneuvering in very close quarters.

Under ideal conditions, experienced operators were consistently able to reduce by approximately 33%, the stopping distance of a watercraft equipped with an iBR system from an initial speed of 80 km/h (50 MPH).

Limitations

Even if equipped with the iBR system, watercrafts do not have the ability of land based vehicles.

Stopping distance will vary notably depending on initial speed, load, wind, current, water conditions and the amount of braking.

The iBR system has no effect on the rearward motion.

It cannot prevent your watercraft from drifting in current or wind.

iS (intelligent Suspension)

The suspension system of this watercraft is designed so that the occupants sit on what is known as the moving deck. When the suspension system is active, the moving deck is usually in an "up" position. This means the moving deck is raised above the fixed deck sufficiently for the suspension system to absorb the up and down movement of the watercraft as it travels through the water.

The iS system incorporates a function known as DOCK MODE. When activated manually or automatically, DOCK MODE moves the suspension down to lower the center of gravity of the watercraft. This function is useful when transporting the watercraft, operating at slow speed or when O.T.A.S. is activated as it reduces the possibility of overturning.

Limitations

Although the system absorbs a part of the vertical forces transferred to the occupants when riding, it cannot eliminate them completely. Sudden jolts can cause the suspension to bottom.

SAFETY EQUIPMENT

Required Safety Equipment

The operator and the passenger(s) must wear an approved Personal Flotation Device (PDF) that is suitable for PWC use.

Operator and passenger(s) should have ready access to shatterproof glasses should riding conditions or personal preference warrant.

Wind, water spray and speed may cause a person's eyes to water and create blurred vision.

As the owner of the watercraft, you are responsible for assuring that all required safety equipment is aboard. You should also consider supplying additional equipment as needed for your safety and that of your passengers. Check state and local regulations about required safety equipment.

Safety equipment required by regulations is mandatory. If local regulations require additional equipment, it must be approved by a competent authority. Minimum requirements include the following:

- Personal flotation devices (PFDs)
- A buoyant heaving line of 15 m (50 ft) minimum
- A watertight flashlight or approved flares
- Signaling device
- Sound producing devices (air horn or whistle).

The operator and passenger(s) of PWCs must wear protective clothing, including:

- A wet suit bottom, or thick tightly woven and snug fitting clothing that provides equivalent protection. As an example, thin bike shorts would not be appropriate. Severe internal injuries can occur if water is forced into body cavities as a result of falling in the water or being near jet thrust nozzle. Normal swimwear does not adequately protect against forceful entry of water into the lower male or female body opening(s).
- Footwear, gloves, safety goggles or glasses are also recommended. Some type of lightweight, flexible foot protection is recommended. This will help reduce possible injury, should you step on sharp underwater objects.

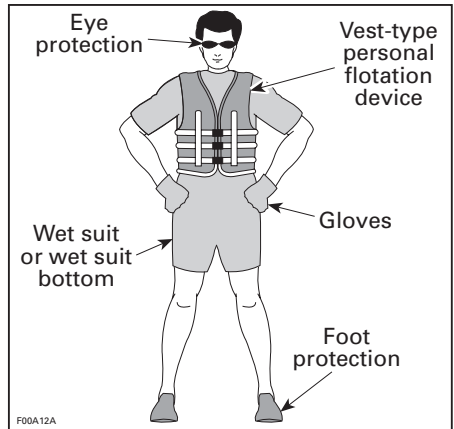

Personal Flotation Devices (PFDs)

In many countries, regulations require that you have at least one approved personal flotation device (PFD) for each person on a recreational watercraft and require that all children under 13 years of age wear a PFD at all times when the watercraft is underway. You may not use your watercraft unless all PFDs are in serviceable condition,

readily accessible, legibly marked with the approval number, and of an appropriate size (within the weight range and chest size marked on the PFD) for each person on board.

A PFD provides buoyancy to help keep the head and face above the water, and to help maintain a satisfactory body position while in the water. Body weight and age should be considered when selecting a PFD. The buoyancy provided by the PFD should support your weight in water. The size of the PFD should be appropriate for the wearer. Body weight and chest size are common methods used to size PFDs. It is your responsibility to ensure that you have the proper number and types of PFDs on board to comply with federal and local regulations, and that your passengers know where they are and how to use them.

PFD Types

There are five types of approved PFDs.

PFD Type I, Wearable, has the greatest required buoyancy. Its design allows for turning most unconscious persons in the water from face down position to a vertical or slightly backward, face-up position. It can greatly increase the chances of survival. Type I is most effective for all waters, especially offshore when rescue may be delayed. It is also the most effective in rough waters.

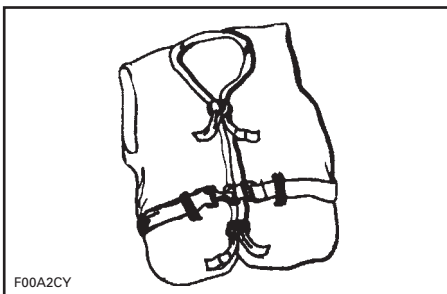

TYPE I — WEARABLE

PFD Type II, Wearable, turns its wearer in the same way as Type I, but not as effectively. The Type II does not turn as many persons under the same conditions as a Type I. You may prefer to use this PFD where there is a probability of quick rescue such as in areas where other people are commonly involved in water activities.

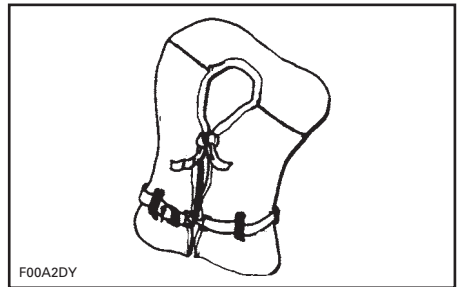

TYPE II — WEARABLE

PFD Type III, Wearable, allows wearers to place themselves in a vertical or slightly backward position. It does not turn the wearer. It maintains the wearer in a vertical or slightly backward position and has no tendency to turn the wearer face down. It has the same buoyancy as a Type II PFD and may be appropriate in areas where other people are commonly involved in water activities.

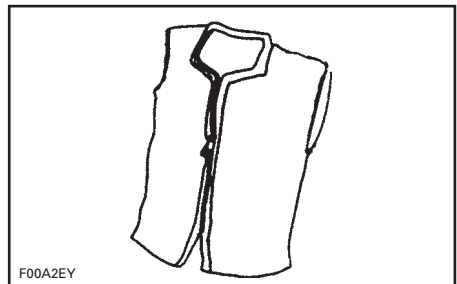

TYPE III — WEARABLE

PFD Type V, Wearable, must be worn. When inflated, it provides buoyancy equivalent to Type I, II or III PFDs. When it is deflated, however, it may not support some people.

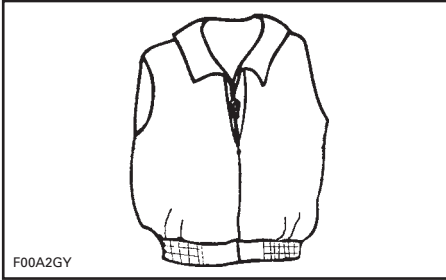

TYPE V — WEARABLE

Helmets

Some Important Considerations

Helmets are designed to offer some degree of protection in case of impacts to the head. In most motorized sports, the benefits of wearing a helmet clearly outweigh the drawbacks. However, in the case of motorized watersports such as riding personal watercraft, this is not necessarily true as there are some particular risks associated with the water.

Benefits

A helmet helps to reduce the risk of injury in case of a head impact against a hard surface such as another craft in the case of a collision. Similarly, a helmet with a chin guard might help prevent injuries to the face, jaw or teeth.

Risks

On the other hand, in some situations when falling off the watercraft, helmets have a tendency to catch the water, like a "bucket", and put severe stresses on the neck or spine. This could result in choking, severe or permanent neck or spine injury or death.

Helmets may also interfere with peripheral vision and hearing, or increase fatigue which, could contribute to increase the risk of a collision.

Weighing the Risks vs Benefits

In order to decide whether or not you should wear a helmet, it is best to consider the particular environment you will be riding in, as well as other factors such as personal experience. Will there be a lot of traffic on the water? What is your riding style?

The Bottom Line

Since each option minimizes some risks, but increases others, before each ride you must decide whether to wear or not wear a helmet based on your particular situation.

If you decide to wear a helmet, you must then decide what type is the most appropriate for the circumstances. Look for helmets that meet DOT or Snell standards, and if possible, choose one designed for motorized watersports.

Additional Recommended Equipment

It is recommended that you acquire additional equipment for safe, enjoyable cruising. This list, which is not all inclusive, includes items you should consider acquiring.

- Small tool kit
- Local map
- First aid kit
- Tow rope
- Flares
- Paddle
- Anchor
- Mooring cords.

A cellular telephone in a waterproof bag or container has also been found to be beneficial to boaters when in distress or just for contacting someone on shore.

NAVIGATION RULES

Operating Rules

Operating a watercraft can be compared with driving on unmarked highways and roads. To prevent collisions or avoid other boaters, a system of operating rules must be followed. It's not only common sense... it's the law!

Generally keep to your right and safely avoid collisions by keeping a safe distance from other watercrafts, boats, people and objects.

The following illustration identifies different parts of the boat that are used as directional reference points, the bow being the front of the boat. The port side of boat (left side) is visually identifiable by a RED light off the bow, and the starboard side (right side) by a GREEN light.

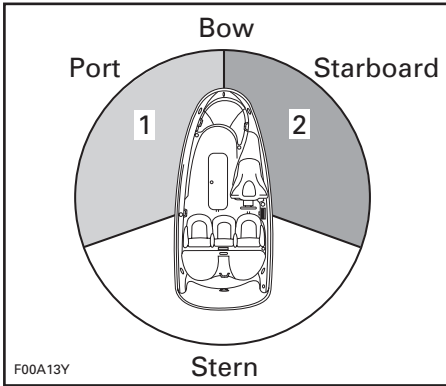

TYPICAL

1. RED light
2. GREEN light (yield zone)

An easy way to associate the color of the light to the correct side is by associating it to a traffic light. Pass through a GREEN light and you're right (right side), pass through a RED light and you're dead.

Crossing

Give the right of way to a watercraft **ahead and to your right**. Never cross in front of a boat, you should see his RED light, he should see your GREEN light (he has the right of way).

Personal watercrafts (PWC) do not have these colored lights, but the rule still applies.

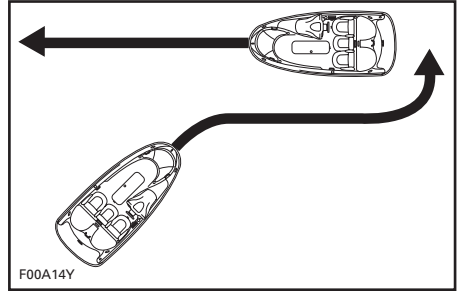

TYPICAL

Meeting Head-On

Keep right.

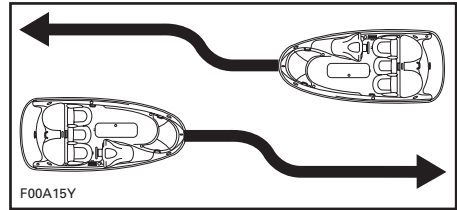

TYPICAL

Passing

Give the right of way to other crafts and keep clear.

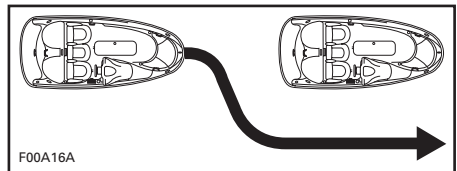

TYPICAL

Navigation System

Navigational aids, such as signs or buoys, can assist you in identifying safe waters. Buoys will indicate whether you should keep to the right (starboard) or to the left (port) of the buoy, or to which channel you can continue. They may also indicate whether you are entering a restricted or controlled area such as a no wake or low speed zone. They may also indicate hazards or pertinent boating information. Markers may be located on shore or on the water. They can also indicate speed limits, no power craft or boating, anchorage and other useful information. (The shape of each type of marker will provide assistance).

Make sure you know and understand the navigation system applicable to the waterways where you intend to use the watercraft.

Collision Avoidance

- Do not release throttle to steer.

WARNING

Do not release the throttle when trying to steer away from objects without the use of the braking system. Engine power and jet pump thrust is required to steer the watercraft.

- Always keep a constant lookout for other water users, other boats or objects, especially when turning. Be alert for conditions that may limit your visibility or block your vision of others.
- Respect the rights of other recreationists and/or bystanders and always keep a safe distance from all other watercrafts, boats, people and objects.
- Do not jump wakes or wakes.

WARNING

Do not wake or wave jump, ride the surf line or attempt to spray or splash others with your watercraft. You may misjudge the ability of the watercraft or your own riding skills and strike a boat or person.

- This watercraft has the capability of turning more sharply than other boats, however, unless in an emergency, do not negotiate sharp, high speed turns. Such maneuvers make it hard for others to avoid you or understand where you are going. Also, you and / or your passenger(s) could be thrown from the watercraft.
- Unlike most other watercrafts, this PWC has a braking system. Practice stopping and docking in a safe, traffic free area to become familiar with the watercrafts stopping distance under varying conditions.
- When operating an iBR equipped watercraft, be aware that other boats following or operating in close proximity may not be able to stop as quickly.
- When at speed and the brake is first applied, a plume of water will shoot up in the air behind the watercraft and may cause the operator of the following watercraft loose sign of your PWC.
- It is important to inform the operator of a watercraft who intends to follow in a convoy formation of the braking and maneuvering capability of your PWC, what the plume of water indicates, and that a greater distance should be maintained between both of you.

 **WARNING**

Stopping distance will vary depending on initial speed, load, wind and water conditions.

- Maintaining or increasing speed may be necessary to avoid a collision.

FUELING

Fueling Procedure

⚠ WARNING

Fuel is flammable and explosive under certain conditions. Always work in a well ventilated area. Do not smoke or allow open flames or sparks in the vicinity.

Turn off engine.

⚠ WARNING

Always stop the engine before refueling.

Do not allow anyone to remain on the watercraft.

Tie watercraft securely to the fueling pier.

Have a fire extinguisher close at hand.



TYPICAL - FUEL TANK CAP

Lightly press down on the cap with your LH hand as you pull up on the latch with your fingers to release it. The cap will pop open as it is pushed open by spring pressure.

⚠ WARNING

Fuel tank may be pressurized, place one hand over the fuel cap when releasing the cap retaining latch.

Insert the gas pump spout into the filler neck and fill up fuel tank.

⚠ WARNING

To prevent fuel back-flow, fill up tank slowly so the air can escape from the fuel tank.

Stop filling immediately after the release of the gas pump nozzle handle and wait a moment before removing the spout. Do not retract the gas pump nozzle to put more fuel in fuel tank.

⚠ WARNING

Do not overfill or top off the fuel tank and leave the watercraft in the sun. As temperature increases, fuel expands and may overflow.

Close the fuel tank cap and ensure it is properly latched.

⚠ WARNING

Always wipe off any fuel spillage from the watercraft.

After refueling always, open seat, remove the ventilation box, and ensure there is no gasoline vapor odor inside the engine compartment.

⚠ WARNING

Do not start watercraft if gasoline or gasoline vapor odor is present.

Recommended Fuel

Use unleaded gasoline with the following octane rating.

FUEL OCTANE RATING	
INSIDE NORTH AMERICA	
Recommended	Minimum
91 (RON + MON)/2)	87 (RON + MON)/2) ⁽¹⁾
⁽¹⁾ Use premium unleaded fuel for optimum engine performance.	

FUEL OCTANE RATING	
OUTSIDE NORTH AMERICA	
Recommended	Minimum
95 RON	92 RON ⁽¹⁾
⁽¹⁾ Use premium unleaded fuel for optimum engine performance.	

NOTICE Never experiment with other fuels or fuel ratios. Never use fuel containing more than 10% ethanol or methanol. The use of a non-recommended fuel can result in decreased engine performance and damage to critical parts in the fuel system and engine.

TRAILERING INFORMATION

NOTICE The span of the trailer wood bunks including bunk width should be adjusted to provide support throughout the full length of the hull. The wood bunks should not be positioned under the stepped portion of the hull. The ends of both trailer wood bunks should not exceed the length of the watercraft.

Ensure the trailer wheels are positioned so that the center of gravity of the watercraft is slightly ahead of the wheels to properly support the weight of the watercraft.

⚠ WARNING
Never tip this vehicle on end for transporting. We recommend that you carry the vehicle in its normal operating position.

Check the applicable laws and regulations in your area concerning towing a trailer, especially for the following items:

- Brake system
- Tow vehicle weight
- Mirrors.

Take the following precautions when towing the watercraft:

Respect tow vehicle maximum weight capacity and the tongue weight capacity as recommended by manufacturer.

Tie the watercraft to both front and rear (bow/stern) eyelets so that it is firmly secured on the trailer. Use additional tie-downs if necessary.

NOTICE Do not route ropes or tie-downs over the seat or grab handle as they could be permanently damaged. Wrap ropes or tie-downs with rags or similar protectors where they can come into contact with the watercraft body.

Ensure fuel tank cap, front storage compartment cover, glove box cover, boarding platform and seat are properly latched.

⚠ WARNING
Ensure the watercraft moving deck is down in the DOCK MODE position before trailering. This will lower the center of gravity and improve trailer stability.

A Sea-Doo cover can protect the watercraft, particularly when driving on dirt roads, to prevent dirt entry through the air inlet openings.

Observe trailering safety precautions.

⚠ WARNING
When trailering the watercraft, NEVER leave any equipment on the watercraft. Injury to bystanders or property damage may occur should anything fly off during transport.

LOCATION OF IMPORTANT LABELS

The labels illustrated on the following pages are on your watercraft. If missing or damaged, they can be replaced free of charge. See an authorized Sea-Doo dealer. Please read the following labels carefully before operating this watercraft.

NOTE: The first illustration of the watercraft indicates the approximate locations of the various labels. A dotted line indicates that the label is not on the outer surface, and that the seat or a cover of some type must be opened to see the label.



TYPICAL

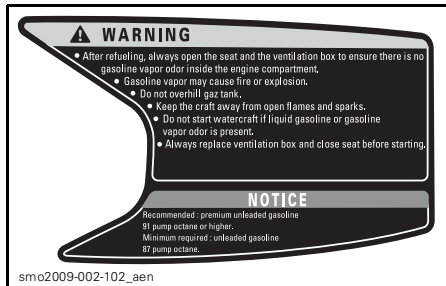

LABEL 1: TYPICAL



LABEL 2: TYPICAL

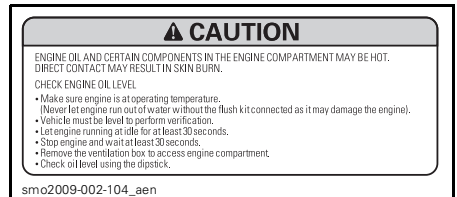

LABEL 3: TYPICAL

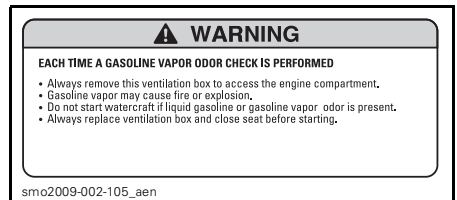

LABEL 4: TYPICAL



LABEL 5: TYPICAL



LABEL 6: TYPICAL



LABEL 7: TYPICAL

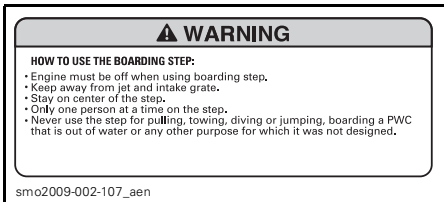

LABEL 8: TYPICAL



LABEL 9: TYPICAL

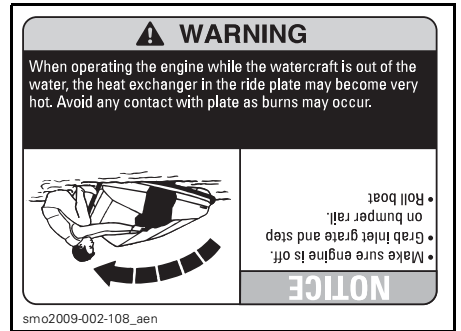

LABEL 10: TYPICAL



LABEL 11: TYPICAL



LABEL 12: TYPICAL



LABEL 13: TYPICAL



**LABEL 14: TYPICAL (WATERCRAFT
OUTSIDE NORTH AMERICA)**

PRE-RIDE INSPECTION

WARNING

Perform a pre-ride inspection before each ride to detect potential problems during operation. The pre-ride inspection can help you monitor wear and deterioration before they become a problem. Correct any problems that you discover to reduce the risk of a breakdown or crash. See an authorized Sea-Doo dealer as necessary.

Before performing the pre-ride inspection, read and understand the *CONTROLS* section.

What to Do Before Launching the Watercraft

WARNING

Engine should be off and the D.E.S.S. key should always be removed from its post prior to verifying any of the following points. Only start watercraft once all items have been checked and operate properly.

Check the items listed in the following table before launching the watercraft.

ITEM	OPERATION	✓
Hull	Inspect.	
Jet pump water intake	Inspect/clean.	
Drain plugs	Tighten.	
Fuel tank	Refill.	
Engine compartment	Verify for leaks or gasoline odor.	
Engine oil level	Check/refill.	
Engine coolant level	Check/refill.	
Steering system	Check operation.	
Throttle lever	Check operation.	
iBR lever	Check operation.	
Intelligent Suspension (iS)	Check operation.	
Front storage compartment cover, boarding platform and seat	Ensure they are closed and latched.	
Self-contained removable storage bin	Ensure it is installed on vehicle and properly closed and latched.	
D.E.S.S. post and engine start/stop button	Check operation.	

Hull

Inspect hull for cracks and other damages.

Jet Pump Water Intake

Remove weeds, shells, debris or anything else that could restrict the flow of water and damage the propulsion unit. Clean as necessary. If any obstruction cannot be removed, refer to an authorized Sea-Doo dealer for servicing

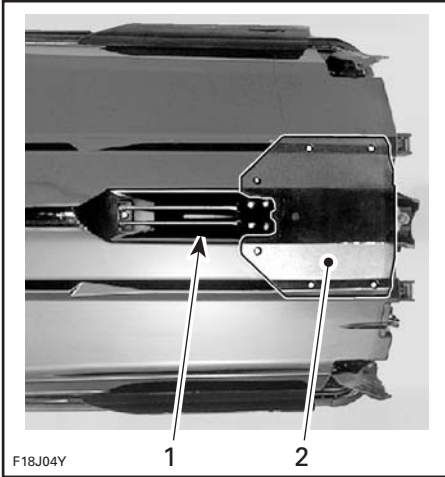

F18J04Y

1

2

TYPICAL — INSPECT THESE AREAS

1. Water intake
2. Ride plate

Drain Plugs

Secure bilge drain plugs.

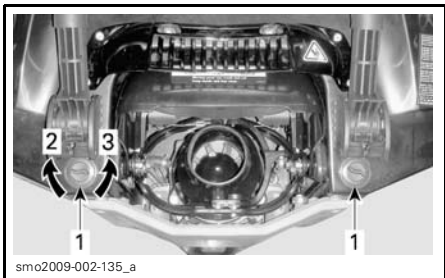

smo2009-002-135_a

1

2

3

1. Bilge drain plugs
2. Tighten
3. Untighten

⚠ WARNING

Ensure bilge drain plugs are properly secured prior to launching the watercraft in water.

Fuel Tank

Fill the fuel tank.

⚠ WARNING

Strictly adhere to instructions in the *FUELING PROCEDURE*.

Engine Compartment

Inspect the engine compartment for fuel vapor odor.

To access the engine compartment, open the seat and remove the ventilation box by depressing the 3 locking tabs and lifting it off the deck extension.

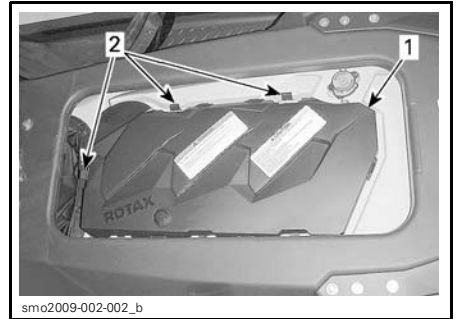

smo2009-002-002_b

2

1

1. Ventilation box
2. Locking tabs



smo2009-002-003

VENTILATION BOX REMOVED

⚠ WARNING

Should any leak or gasoline odor be present, do not apply electrical power or start the engine. Refer to an authorized Sea-Doo dealer before use.

Engine Oil

Ensure oil level is appropriate as specified in *MAINTENANCE PROCEDURES* section.

Engine Coolant

Ensure coolant level is appropriate as specified in *MAINTENANCE PROCEDURES* section.

Steering System

Assisted by another person, check steering operation for free movement. When the handlebar is horizontal, the jet pump nozzle should be in the straight ahead position. Ensure the jet pump nozzle pivots easily and in the same direction as the handlebar (e.g.: when handlebar is turned to the left, the nozzle opening must point towards the LH side of watercraft).

⚠ WARNING

Check handlebar and corresponding steering nozzle operation before starting. Never turn handlebar while someone is near the rear of the watercraft. Keep away from steering moving parts (nozzle, iBR gate, linkages etc.).

Throttle System

Check the Electronic Throttle Control lever (ETC) for free and smooth operation. It should return to its initial position immediately after it is released.

⚠ WARNING

Check throttle lever operation before starting the engine. If any friction is felt in the throttle lever, refer to an authorized Sea-Doo dealer.

iBR Lever (intelligent Brake and Reverse)

Check the iBR lever for free and smooth operation. It should return to its initial position immediately after it is released.

⚠ WARNING

Check iBR lever operation before starting the engine. If any friction is felt in the iBR lever, refer to an authorized Sea-Doo dealer.

iS Suspension

1. Press briefly the start/stop button to wake-up the ECM.
2. Press on iS UP and DOWN arrow button to confirm suspension operation.

Storage Compartments, Boarding Platform and Seat

Ensure all required safety and survival equipment and any additional cargo is properly stored in the storage bins provided.

Ensure there are no items of cargo, or other material, between the moving deck and fixed deck.

Ensure the self-contained storage bin cover, front cover, glove box, boarding platform and seat are closed and latched.

⚠ WARNING

Ensure the seat, boarding platform, and all storage compartment covers are securely latched.

⚠ WARNING

Do not store cargo or material of any type in the space between the moving and fixed deck, or near the rear suspension control arm. These areas must remain free of all obstructions to permit free movement of the deck and any water which may accumulate in the foot well areas. Use only provide storage compartments.

D.E.S.S. Post and Engine Start/Stop Button

Press the start button once without installing the lanyard on the D.E.S.S. post. The information center will come ON, proceed through its self test function, and shut down all indications after a few seconds.

Install the D.E.S.S. key (lanyard) on the D.E.S.S. post. The information center will come back ON, cycle through its self test and stay on for approximately 3 minutes.

Press the start/stop button to start the engine, then stop it by pressing the start/stop button a second time.

Restart the engine, then stop it by removing the lanyard from the D.E.S.S. post.

⚠ WARNING

Should the D.E.S.S. key be loose or fail to remain on its post, replace it immediately in order to avoid unsafe use. If removing the lanyard or pressing the start/stop button does not stop the engine, do not use the watercraft. See your authorized Sea-Doo dealer for system testing and repairs.

What to Do After Launching the Watercraft

Check the items listed in the following table after launching the watercraft and before going for a ride.

ITEM	OPERATION	✓
Information Center	Check operation.	
Intelligent Brake and Reverse System (iBR)	Check operation.	
Variable Trim System (VTS)	Check operation.	

Information Center

1. Press start/stop button and install D.E.S.S. key.
2. As information center cycles through its self-test function, ensure that all indications and indicator lights come on.

⚠ WARNING

Attach the safety lanyard to your PFD.

iBR System

NOTICE Ensure there is sufficient space ahead and behind watercraft to safely carry out the iBR system test to avoid a collision. Watercraft will move during test.

1. Remove the moorings securing the watercraft to the dock.
2. Start the engine and ensure the watercraft does not move.
3. On the left handlebar, depress the iBR lever completely in, the watercraft should move slowly backwards.
4. Release the iBR lever, there should not be any reverse thrust.

⚠ WARNING

Always ensure proper iBR system operation before taking the watercraft out for a ride.

Variable Trim System (VTS)

With the engine running in forward thrust, push the VTS up and down arrow button alternately to check VTS operation. Confirm the VTS position indicator movement in the information center.

Test also the VTS preset trim positions by double clicking the VTS UP and DOWN buttons.

NOTE: The VTS system cannot be tested without the engine operating in forward thrust. If the engine is not running in forward thrust, only the VTS indication will change when the VTS control switches are pressed; the nozzle will not change position.

VEHICLE INFORMATION

CONTROLS



TYPICAL

1. Handlebar
2. Throttle lever
3. iBR lever (intelligent Brake and Reverse)
4. D.E.S.S. post
5. Engine start/stop button
6. VTS button (Variable Trim System)
7. iS button (intelligent Suspension)
8. MODE and SET button
9. UP and DOWN arrow button
10. Cruise button

1) Handlebar

The handlebar controls the direction of the watercraft. During forward operation, turning the handlebar to the right steers the watercraft to the right and inversely.

However, when operating in reverse, steering direction is reversed. Turning the handlebar to the right while backing up steers the watercraft to the left.

WARNING

Check handlebar and corresponding steering nozzle operation before starting. Never turn handlebar while someone is near the rear of the watercraft. Keep away from steering moving parts (nozzle, iBR gate, linkages etc.).

Tilt Adjustment

The handlebar position can be adjusted to suit rider preferences.

The entire information center, handlebars, and steering column tilts up or down as a unit.

To perform this adjustment, pull on the release handle at the base of the steering column just ahead of the glove box, and tilt the handlebars to the desired position.

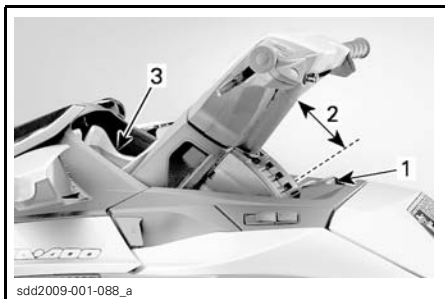

1. Release handle
2. Available tilt adjustment
3. Information center

When the handlebars are at the desired position, release the latch and ensure the latch pawl properly engages a groove in the steering column. Also ensure the latch handle is in the forward position.

⚠ WARNING

To prevent sudden movement of the steering column, always ensure the pawl on the steering column latch is properly engaged in one of the grooves on the steering column.

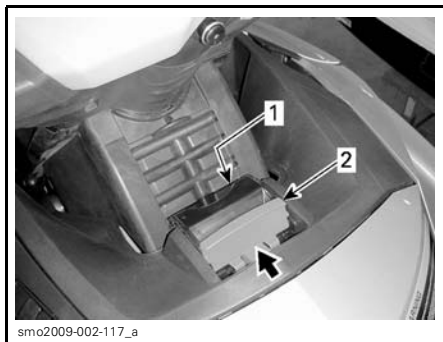

STEERING COLUMN ADJUSTMENT LATCH PROPERLY SECURED

1. Latch pawl engaged
2. Release handle locked forward

2) Throttle Lever

This watercraft is equipped with an intelligent Throttle Control system (iTTC) that uses an electronic throttle control lever (ETC).

This provides for a more comfortable throttle operation under demanding conditions, more precise control, and allows for interaction with other electronic control systems such as O.T.A.S. (Off Throttle Assisted Steering) and iBR (intelligent Brake and Reverse). It also allows for speed limiting when using cruise mode or slow speed mode.

When the throttle lever is pulled, the watercraft accelerates. When fully released, the engine automatically slows down to idle speed and the watercraft will continue forward travel at idle speed unless the iBR lever is pulled in for braking or reverse operation, then released to engage neutral.

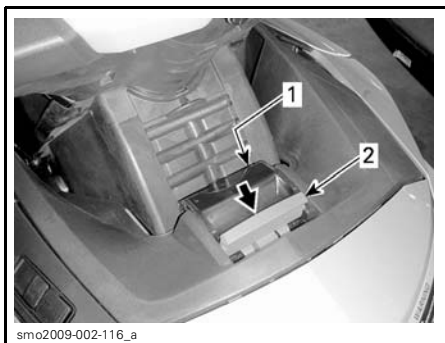

STEERING COLUMN ADJUSTMENT LATCH NOT SECURED

1. Latch pawl engaged in steering column groove
2. Release handle unlocked

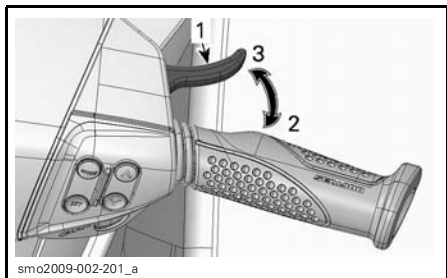

1. Throttle lever
2. To accelerate
3. To decelerate

3) iBR Lever (intelligent Brake and Reverse)

The iBR lever on the LH handlebar can electronically command either reverse or braking modes.

To activate either reverse or braking modes, release the throttle lever and pull in the iBR lever.

NOTE: Less than 25% of lever travel will not activate reverse or braking modes.

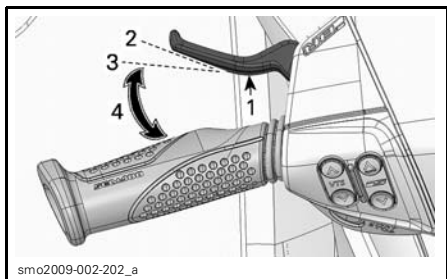

iBR LEVER

1. iBR lever
2. Lever released position
3. Approximate 25% position
4. Operating range

If the engine is not running, the iBR lever will not have any effect on the iBR gate position. The engine must be running for the iBR gate to move when the iBR lever is pulled in.

When the iBR lever is released after braking or reverse operation, the iBR gate will move to the neutral position.

If throttle lever is still pulled in when releasing the iBR lever, forward movement will then be initiated after a short delay. This function is useful when it is necessary to accelerate rapidly after a braking maneuver, or stop rearward velocity after reverse operation.

⚠ WARNING

If throttle lever is still pulled in when releasing the iBR lever, forward movement will then be initiated after a short delay. If an acceleration is not needed release the throttle lever.

To engage forward from neutral, tap on the throttle lever. The iBR gate will move to the forward thrust position.

4) D.E.S.S. Post

The D.E.S.S. post (Digitally Encoded Security System) requires that a programmed D.E.S.S. key attached to a safety lanyard be securely snapped onto it for the watercraft to be fully operational.

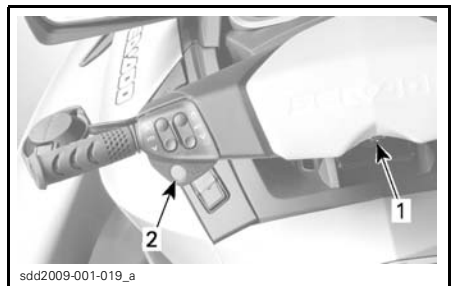

TYPICAL

1. D.E.S.S. post
2. Start/stop button

Always attach the safety lanyard to the operator's Personal Flotation Device (PFD) and snap the key onto the D.E.S.S. post to enable engine starting.

Two short beeps indicate the system is ready to allow engine starting. Otherwise, refer to the *TROUBLESHOOTING* section.



TYPICAL

1. Key on the D.E.S.S. post
2. Safety lanyard secured to operators' PFD

During engine operation, pulling the key from the D.E.S.S. post stops the engine operation.

If the engine is shut off using the start/stop button and the D.E.S.S. key is left on its post, the information center and all electrical power will shut off after approximately three minutes to prevent battery discharge.

⚠ WARNING

While the engine can be stopped using the engine start/stop button, good habits recommend that the D.E.S.S. key also be disconnected when stopping the engine and disembarking.

⚠ WARNING

Should the engine be stopped, the brake function and all watercraft directional control is lost. Always disconnect D.E.S.S. key when watercraft is not in operation in order to prevent accidental engine starting or to avoid unauthorized use by others, children, and to prevent theft.

Digitally Encoded Security System (D.E.S.S.)

Each D.E.S.S. key contains an electronic circuit that is programmed to give it a unique electronic serial number. This is the equivalent of a conventional key.

The D.E.S.S. system reads the key installed on the post and only allows engine starting for keys it recognizes.

The D.E.S.S. system brings great flexibility. You can buy an additional D.E.S.S. key and have it programmed for your watercraft.

A total of ten D.E.S.S. keys can be programmed.

D.E.S.S. Key Types

Three types of keys can be used:

- Normal key
- Learning key
- Rental key (sold separately).

Each key has a safety lanyard with float attached to it. This prevents the key from sinking should it be dropped in the water.

To ease key recognition, the key float comes in different colors.

KEY TYPE	FLOAT COLOR
Normal	Yellow or Black
Learning	Green
Rental	Orange

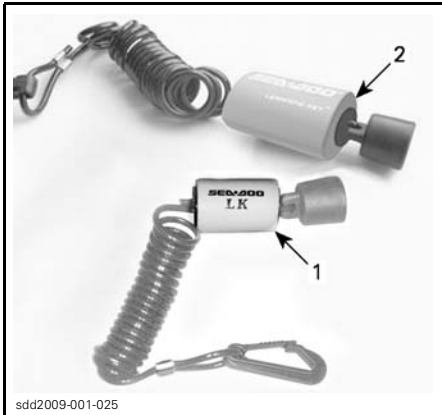

TYPICAL - D.E.S.S. KEYS (LANYARDS)

1. Learning key, green float
2. Rental key, orange float

When the start/stop button is pressed and a key is installed on the D.E.S.S. post, the information center will execute its self test function, display a scrolling welcome message, and then display a message of key recognition (NORMAL KEY, LEARNING KEY, RENTAL KEY).

The Normal D.E.S.S. key allows full use of available engine power.

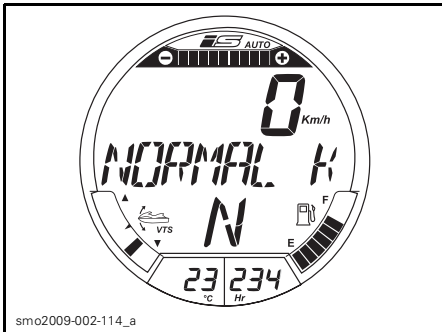

NORMAL KEY RECOGNIZED

The SEA-DOO Learning Key™ or the Rental Key, limits the speed of the watercraft and the engine torque, therefore enabling first time users and less experienced operators to learn how to operate the watercraft while gaining the necessary confidence and control.

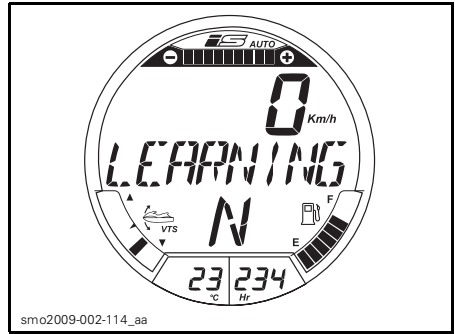

LEARNING KEY RECOGNIZED

Changing Learning or Rental Key Speed Settings

Both the rental and learning keys each offer five speed limitation settings with the slowest at setting 1 increasing to setting number 5. By default, the Learning key and Rental key are preset to the highest speed setting (5).

NOTE: Changing key settings is only available when the engine is not running.

To change Learning or Rental Key settings, carry out the following:

1. Press the start/stop button to wake up the electrical system and install the NORMAL key on the D.E.S.S. post.
2. Wait for the information center to complete its self-test and display the key recognition message.
3. Press the MODE button repeatedly until KEY MODE is visible in the digital screen of the information center.

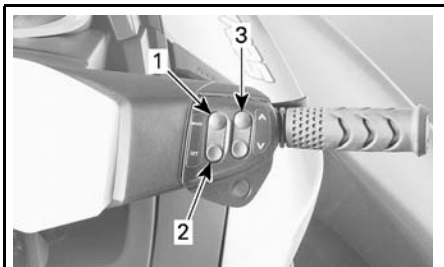

sdd2009-001-024_b

TYPICAL - GAUGE CONTROL BUTTONS

1. *MODE* button
2. *SET* button
3. *UP and DOWN* arrow button

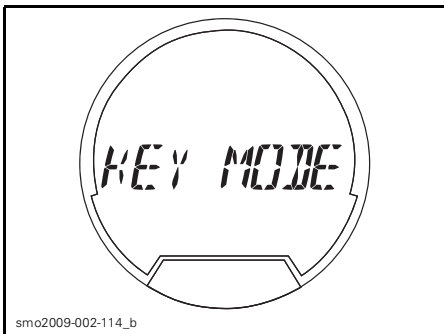

smo2009-002-114_b

4. Press the SET button once to enable Learning key mode setting function. The display will change to L-Key.

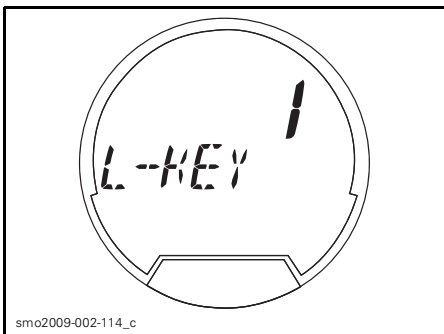

smo2009-002-114_c

EXAMPLE - LEARNING KEY SET TO 1

NOTE: Pressing the SET button twice will enable the Rental key setting function. The display will change to R-Key.

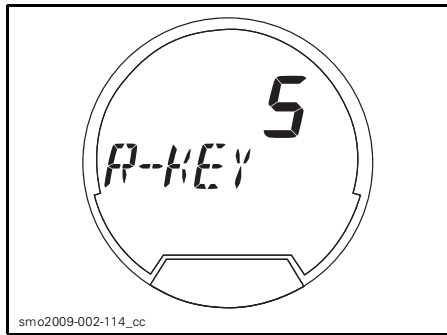

smo2009-002-114_cc

EXAMPLE - RENTAL KEY SET TO 5

5. Press the UP or DOWN arrow button to toggle the key setting between 1 and 5. See table for speed limitations according to setting.
6. Press the SET button once to save the setting, or simply wait for the function to time-out. The change in key setting will automatically be saved.

Learning keys may be programmed to more than one watercraft. The key setting is programmed into the watercraft, not the key. The learning key setting is applicable to any programmed learning key used on a specific watercraft. The same key used on different watercrafts may therefore have a different key setting on each watercraft. If you have several learning keys programmed to the same watercraft, they cannot each have a different setting. The same applies to the rental key setting.

D.E.S.S. KEY TYPE	KEY SETTING	APPROX. MAX. SPEED
Learning key	5	58 km/h (36 MPH)
	4	55 km/h (34 MPH)
	3	50 km/h (31 MPH)
	2	47 km/h (29 MPH)
	1	42 km/h (26 MPH)
Rental key	5	74 km/h (46 MPH)
	4	69 km/h (43 MPH)
	3	63 km/h (39 MPH)
	2	58 km/h (36 MPH)
	1	51 km/h (32 MPH)

5) Engine Start/Stop Button

The engine start/stop button is located on the LH handlebar. It is used to wake up the electrical system as well as to start and stop the engine.

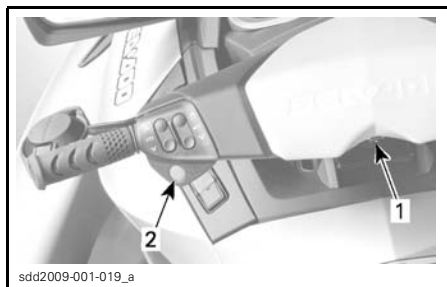

TYPICAL

1. D.E.S.S. post
2. Start/stop button

Waking Up the Electrical System

Press the start/stop button once without installing the D.E.S.S. key on its post.

This will power up the electrical system; the information center will cycle through a self-test function and its display will go blank after a few seconds.

The electrical system will stay powered up for approximately 3 minutes after the start/stop button was depressed.

This function allows the suspension to be activated without starting the engine.

NOTE: If the start/stop button is pressed and held without the D.E.S.S. key installed, the information center displays will stay on as long as the start/stop button is held.

Engine Starting and Stopping

Refer to *OPERATING INSTRUCTIONS* for complete procedure to start and stop the engine.

6) VTS Button (Variable Trim System)

This watercraft is equipped with a programmable high performance VTS.

It provides watercraft pitch trim adjustments by adjusting the vertical position of the jet nozzle.

The VTS can be manually trimmed to desired attitude, or to one of two preset trim positions.

Press VTS control button (up or down arrow) to adjust riding attitude of the watercraft.

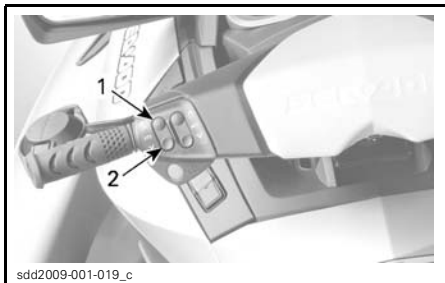

TYPICAL - VTS CONTROL BUTTON

1. Bow up
2. Bow down

Watercraft trim position can be seen on the VTS position indicator in the information center digital screen.

NOTE: Changing the VTS trim position without the engine running in forward thrust mode only changes the indication and presets the desired nozzle position. The nozzle will move to the selected VTS trim position when forward thrust is engaged.

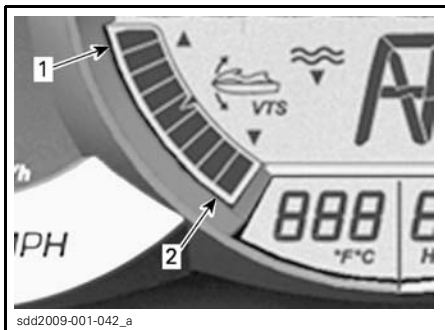

INFORMATION CENTER — VTS POSITION INDICATOR

1. Bow up
2. Bow down

NOTE: Only the segment indicating the relative position of the VTS will be on. The illustration shows all segments on as visible during the self test function.

Manually Trimming The VTS

1. To manually trim the VTS, click (press) the VTS UP or DOWN arrow button once to trim the VTS one increment (up or down as selected).
2. After a short delay, click it again to move the VTS one more increment. Repeat previous step until desired trim attitude is achieved.

NOTE: A total of nine trim positions are available.

NOTE: The VTS UP or Down button can also be pressed and held until the desired attitude is obtained. The jet pump nozzle will keep moving until the trim button is released, or the maximum trim position (up or down) is reached.

Using Preset Trim Positions

Two preset trim positions can be selected.

To select the highest trim position recorded, double-click on the VTS UP arrow button (bow up).

To select the lowest trim position recorded, double-click on the VTS DOWN arrow button (bow down).

NOTE: If only one preset trim position is recorded, double-click either UP or DOWN arrow of the VTS button.

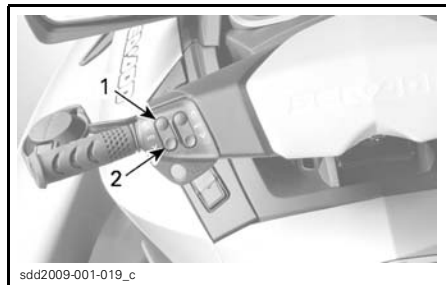

DOUBLE-CLICK UP OR DOWN TO USE PRESET POSITIONS

1. Highest preset position on UP arrow
2. Lowest preset position on DOWN arrow

Recording Preset Trim Positions

You can preset VTS positions for quick settings when adjusting watercraft trim.

Two different trim positions can be recorded, one for each UP or DOWN arrow of the VTS button. As an example, one can be preset for operating the watercraft with operator only, the other for operator and a passenger.

The VTS system will compare trim settings recorded, the highest position will be assigned to the UP arrow (bow up), the lowest to the DOWN arrow (bow down).

If both trim positions are identical, both buttons will have the same trim settings.

During preset adjustment, any of the 9 indicated VTS positions can be selected for each preset position. The factory default settings are PRESET 1 is set to 4, and PRESET 2 is set to 5.

To record VTS preset trim positions:

1. Turn on the electrical power by pressing the start/stop button once without installing the D.E.S.S. key on its post.
2. On the RH handlebar, press the MODE button repeatedly until VTS MODE is displayed.

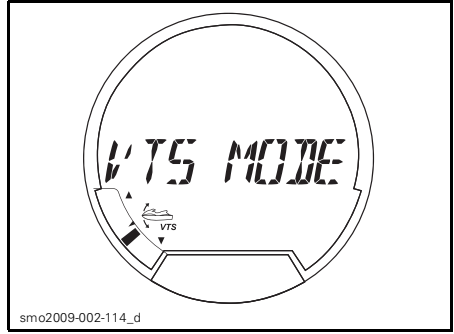

smo2009-002-114_d
VTS MODE FUNCTION SELECTED

3. On the RH handlebar, press the SET button to display PRESET 1.
4. Press the VTS UP or DOWN button to change the PRESET 1 VTS position. Gauge will display setting 1 through 9 in the digital screen above PRESET 1.

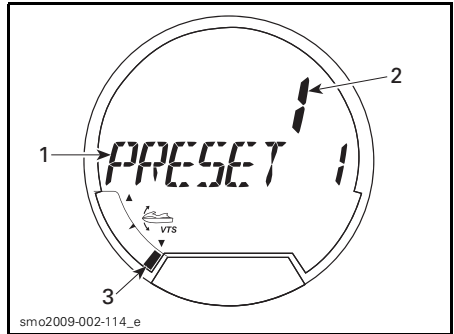

- smo2009-002-114_e
1. Preset 1 function
 2. VTS setting selected to 1
 3. VTS position indicator at setting 1 (bow down)

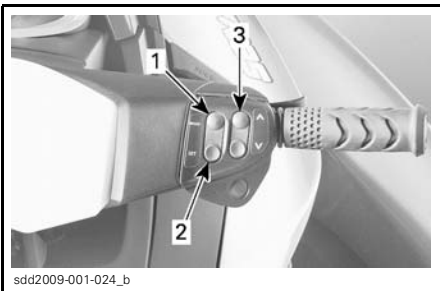

sdd2009-001-024_b

1. MODE button
2. SET button
3. UP and DOWN arrow button

5. Press the SET button to save PRESET 1 and display PRESET 2.
6. Press the VTS UP or DOWN button to change the PRESET 2 VTS position. Gauge will display setting 1 through 9 in the digital screen above PRESET 2.

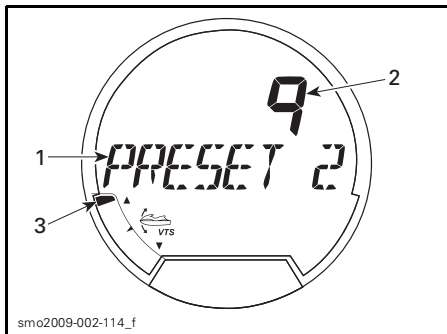

1. Preset 2 function
2. VTS setting selected to 9
3. VTS position indicator at setting 9 (bow up)

7. Press the SET button to save the settings and return to the main display.

7) iS Button (intelligent Suspension)

The suspension height (up position) is factory calibrated to a preset height for most riding conditions while cruising in AUTO SUSPENSION MODE. The factory calibrated height is the same regardless of the number of passengers or weight on the moving deck.

! WARNING

Do not overload the watercraft or take on more passengers than designated. Refer to *SPECIFICATIONS* for details.

The iS button is primarily used to manually fine-tune the suspension height to operator preference.

Using the iS button to change the suspension height overrides the AUTO SUSPENSION MODE function. The iS system switches to MANUAL SUSPENSION MODE and the operator can select a different suspension height as preferred in accordance with riding style and riding conditions.

Suspension height and mode of operation is indicated in the information center digital screen.

! WARNING

Your PWC is equipped with an intelligent suspension. Although the system absorbs part of the vertical forces and therefore reduces the impact force to the body, it cannot eliminate it completely. To prevent you and your passenger from being bounced and eventually be ejected from the watercraft, reduce your speed.

! WARNING

Avoid riding in very rough waters or practicing extreme maneuvers like jumping wakes or waves.

Manually Adjusting Ride Height

Press the iS UP or Down arrow button once to move the suspension to the next height increment, or press and hold the button until the desired ride height is obtained.

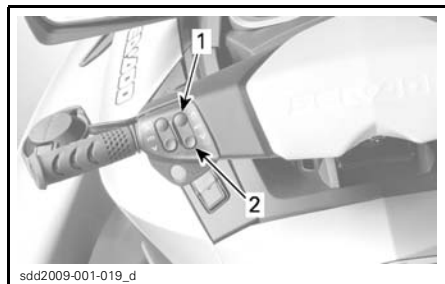

TYPICAL

1. iS UP arrow button
2. iS DOWN arrow button

The following indications of manual suspension mode can be observed in the digital screen of the information center:

- A scrolling message in the digital screen that states MANUAL SUSPENSION.

- The AUTO indication in the iS display will disappear.
- The suspension position indicator will indicate the relative suspension height (only one segment of the indicator will be on).

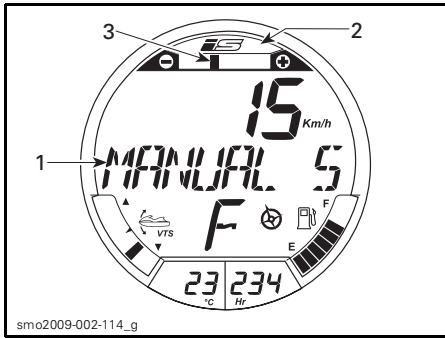

1. MANUAL SUSPENSION message
2. AUTO mode indicator OFF
3. Relative suspension position indication

Selecting Auto Suspension Mode

To revert back to AUTO selection mode, double click the iS UP arrow button.

The following indications of automatic suspension mode can be observed in the digital screen of the information center:

- A scrolling message in the digital screen stating AUTOMATIC SUSPENSION.
- The AUTO indication in the iS display will appear.
- All segments of the suspension position indicator will be on.

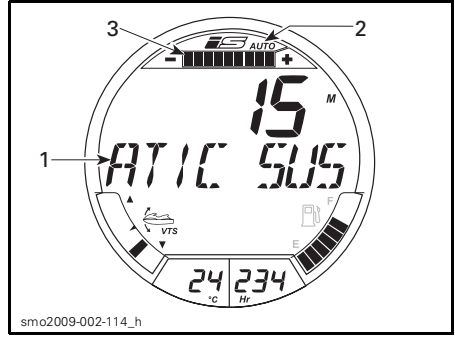

1. AUTOMATIC SUSPENSION message
2. AUTO mode indicator on
3. All segments of suspension position indicator ON

8) MODE and SET Button

These buttons located on the RH handlebar.

Press MODE to scroll various functions through the digital screen in the information center.

Press SET to select the desired function or to save any modified settings.

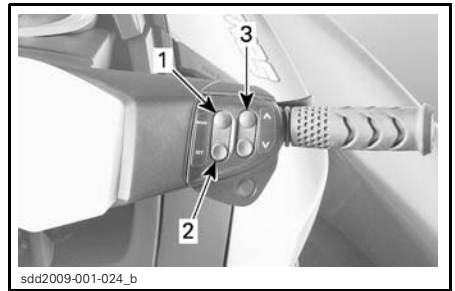

1. MODE
2. SET
3. UP and DOWN arrow button

NOTE: The UP and DOWN arrow buttons are also used for adjusting watercraft speed when operating in CRUISE or SLOW SPEED modes.

For further details on the information center and the display modes, refer to *INFORMATION CENTER*.

9) UP and DOWN Arrow Button

These buttons located on the RH handlebar.

Press UP or DOWN arrow button to navigate through the selected function using SET or to modify settings.

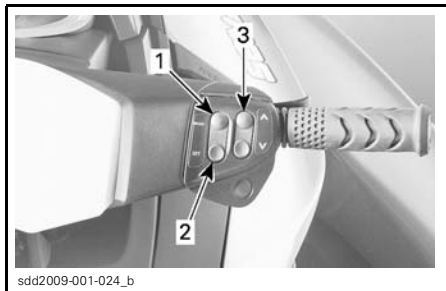

1. *MODE*
2. *SET*
3. *UP and DOWN arrow button*

NOTE: The UP and DOWN arrow buttons are also used for adjusting watercraft speed when operating in CRUISE or SLOW SPEED modes.

For further details on the information center and the display modes, refer to *INFORMATION CENTER*.

10) Cruise Button

The Cruise button is located on the RH handle bar, just below the UP and DOWN arrow button. It is used to activate or deactivate CRUISE mode or to engage SLOW SPEED MODE.

Activating Cruise Mode

To activate cruise mode of operation:

1. Accelerate to the desired watercraft speed above 3800 RPM.
2. Press and hold the cruise button for approximately 1 second.

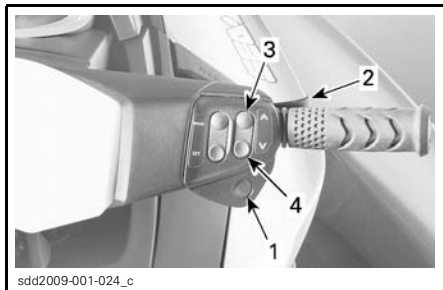

TYPICAL

1. *CRUISE button*
2. *Throttle lever*
3. *UP arrow button*
4. *DOWN arrow button*

You will hear a beep indicating that you are now in cruise mode, and a green CRUISE indicator light will come on in the speedometer display of the information center.



CRUISE MODE INDICATOR LIGHT

NOTE: Activating cruise mode of operation only limits the maximum speed available when depressing the throttle lever. The throttle lever must be held in to maintain forward speed. Watercraft speed can be varied from idle up to the set cruise speed using the throttle lever once the cruise function is activated. Watercraft speed may vary depending on water conditions during use.

Changing Set Cruise Speed

To **increase** the set maximum cruise speed:

1. Pull the throttle lever all the way to the handlebar.
2. Press and hold the UP arrow button on the RH handlebar until the new desired speed is obtained.

To **decrease** the set maximum cruise speed:

1. Hold the throttle lever steady.
2. Press and hold the DOWN arrow button on the RH handlebar until the new desired speed is obtained.

NOTE: Pressing the UP or DOWN arrow button repeatedly will change the set speed in single increments. Pressing and holding the button will increase or decrease the speed until the button is released.

Deactivating Cruise Mode

To deactivate cruise mode:

1. Release the throttle lever.
2. Press the cruise button.

Deactivation of cruise mode is indicated by:

- The CRUISE indicator light in the speedometer display will go off.
- A BEEP will be heard.

NOTE: If the throttle lever is not fully released when the cruise button is pressed to deactivate cruise mode, the BEEP will not be heard and the cruise light will remain on. The speed limiting function of cruise mode will stay active until the throttle is fully released, then the BEEP will be heard and the cruise light will go out.

Activating Slow Speed Mode

To activate slow speed mode of operation:

1. Release the throttle lever to idle RPM.

2. Pull in and release the iBR lever to engage neutral.
3. Press and hold the cruise button for approximately 1 second.

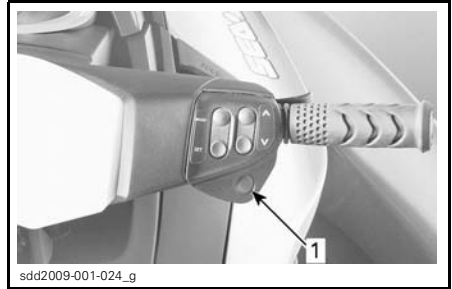

TYPICAL
1. CRUISE button

The green CRUISE indicator light will come on in the speedometer display to indicate cruise activation.

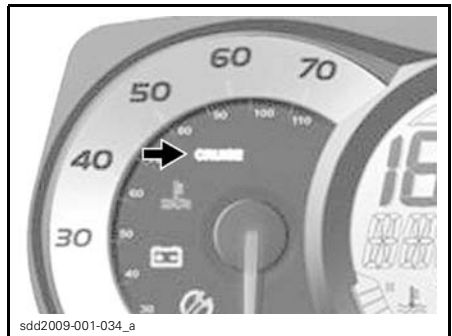

CRUISE MODE ON INDICATOR LIGHT

A message will scroll in the digital screen to specify that you are now in slow speed mode. The default slow speed setting of 1 will also come on for a few seconds in the digital screen.

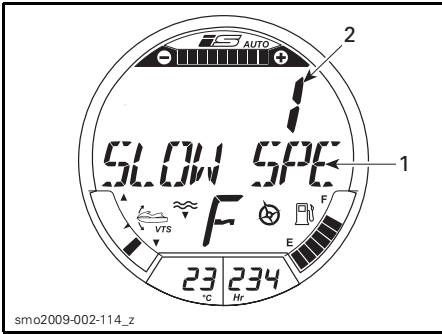

SLOW SPEED MODE INDICATION

1. Scrolling SLOW SPEED MODE message
2. The slow speed setting appears for a few seconds

NOTE: The scrolling SLOW SPEED message repeats itself as long as slow speed mode is activated. The digital screen reverts back to the previous indication after a few seconds.

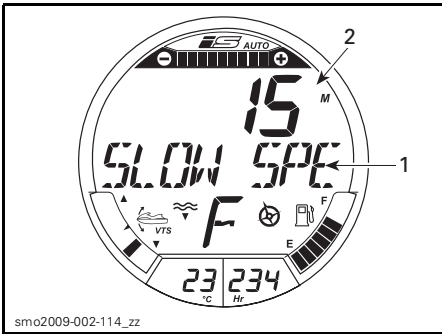

1. Scrolling SLOW SPEED MODE message
2. Digital display reverts to previous indication

Changing Set Slow Speed

To **increase** the set slow speed, press the UP arrow button on the RH handlebar once, or repeatedly. The setting point indication in the digital screen will come back on to indicate the slow speed setting change.

To **decrease** the set slow speed, press the DOWN arrow button on the RH handlebar once, or repeatedly. The setting point indication in the digital screen will come back on to indicate the slow speed setting change.

NOTE: There are 5 slow speed settings available (1 through 5).

Deactivating Slow Speed Mode

To deactivate slow speed mode:

- Press the cruise button, or
- Depress the iBR lever more than 25% of total travel, or
- Accelerate past the highest slow speed that can be set.

The CRUISE indicator light in the speedometer display will go out, the scrolling SLOW SPEED MODE message will disappear and the information center will revert to the compass indication.

When deactivating SLOW SPEED MODE by pressing the cruise button, or accelerating using the throttle lever, the iBR gate stays in the forward position.

When using the iBR lever, the iBR gate will move towards the reverse position, then neutral when the lever is released.

INFORMATION CENTER

The information center is a cluster of gauge, indicator lights and a digital screen to display operational information to the operator.

The text message can be displayed in different languages. See an authorized Sea-Doo dealer for more details and to have the information center set to an available language of your choice.

It allows the operator to view at a glance several indications such as speed, engine RPM, fuel level and engine temperature. The gauge can also be used to navigate through and select several functions, modes of operation and change certain settings and system parameters.

Indicator lamps advise the operator of selected functions or malfunctions.

The gauge incorporates a GPS (global positioning system) that it uses for the compass and speedometer indications, and provides signals to other systems as required for their operation.

An information center self test can be initiated by pressing the start/stop button (**without** the D.E.S.S. key installed). All LCD segments and indicator lights will turn on for approximately 3 seconds. The analog speedometer and RPM indications will also cycle through their full scale of operation. This allows the operator to validate that all indicators are working properly.

Should a fault be detected during the self-test function, an error message will be displayed, an indicator light may come on, and an audible signal (beep code) may be heard to signal that a fault has been detected.

A fault code can be generated and memorized to assist your authorized Sea-Doo dealer in troubleshooting the faulty system. Refer to *FAULT CODE DISPLAY* in this section for instructions on how to display fault codes.

WARNING

Reading the message on the information center digital screen can distract from the operation of the watercraft, particularly from constantly scanning the environment. This could lead to a collision resulting in severe injuries or death. Before reading, ensure your environment is clear and free from obstacles, and bring the watercraft to a low speed. Before proceeding with any adjustments, make sure the surroundings are clear and safe to do so.

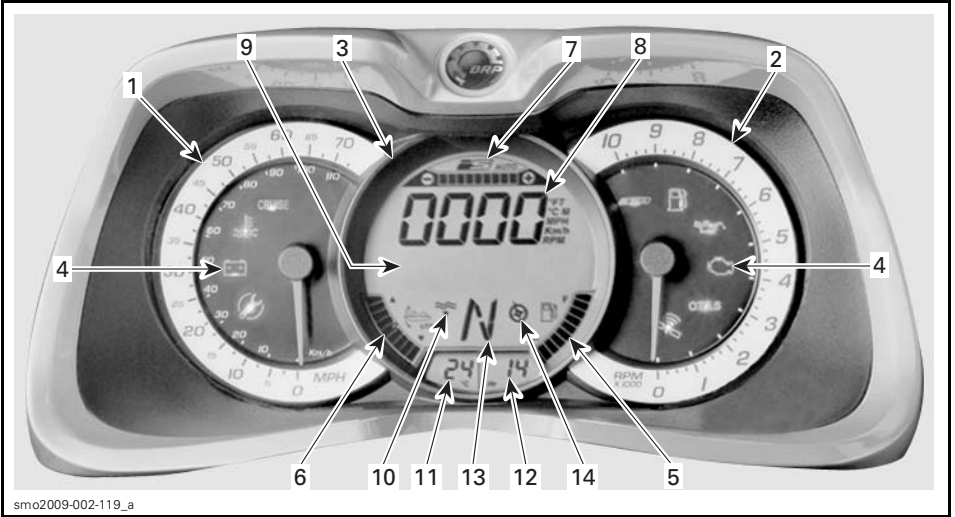

smo2009-002-119_a

INFORMATION CENTER FUNCTIONS

1. Speedometer
2. Tachometer
3. Digital screen
4. Indicator lights
5. Fuel level
6. VTS position
7. iS position
8. Numerical display
9. Multifunction display
10. Depth sounder indicator
11. Water temperature display
12. Hour meter display
13. iBR position
14. Compass

1) Speedometer

The speedometer, located in the LH side of the information center, provides an analog indication of the speed of the watercraft in miles per hour (MPH) and kilometers per hour (km/h).

The speed indication is based on a GPS (Global Positioning System) incorporated within the information center.

An indicator light seen in the tachometer lights up when the GPS is receiving a good signal.



GPS INDICATOR LIGHT

If for some reason the GPS signal is lost, a default mode is used whereby, the speed is calculated using information received from other systems to provide an estimated watercraft speed.

2) Tachometer

The tachometer provides an analog indication of the revolutions per minute (RPM) of the engine. Multiply the indicated number by 1000 to obtain the actual engine RPM.

3) Digital Screen

The digital screen, located in the center of the information center, is capable of displaying 10 separate indications simultaneously.

- Fuel level
- VTS position
- iS position and mode
- Multifunction display
- Water temperature
- Engine hourmeter

- iBR position
- Compass active indicator
- Depth finder indicator.



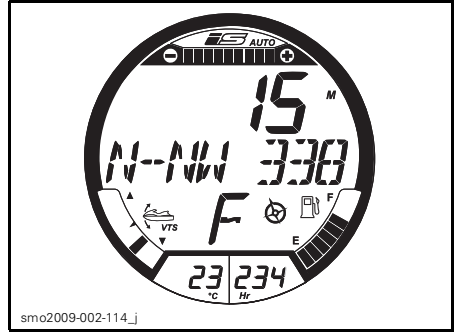







Numerical and multifunction displays in the digital screen indicator can be used to display various indications, or for selecting modes of operation and changing settings as explained in their respective sections.



4) Indicator Lights

Indicator lights (pilot lamps), located in the speedometer and tachometer indicator, inform you of a selected function, a normal condition, a system anomaly, or a serious malfunction.

An indicator light may be accompanied by a scrolling message in the multifunction display.

PILOT LAMPS (ON)	MESSAGE DISPLAY	DESCRIPTION
	MAINTENANCE REMINDER	Maintenance required
	LOW or HIGH BATTERY VOLTAGE	Low/high battery voltage
	LOW-FUEL	Low fuel level, approx. 25% tank capacity, 14 L (3.7 U.S. gal.) or fuel level sensor disconnected
	HIGH TEMPERATURE	Engine or exhaust system overheating
	CHECK ENGINE or LIMP HOME MODE	Check engine (minor fault req. maint.) or LIMP HOME MODE (major eng. fault)
	LOW OIL PRESSURE	Low oil pressure
	–	CRUISE mode or SLOW SPEED MODE engaged
	–	iBR system fault
	–	OTAS system fault
	–	Good GPS uplink

5) Fuel Level

A bar gauge located in the bottom RH side of the digital screen continuously indicates the amount of fuel in the fuel tank while riding.

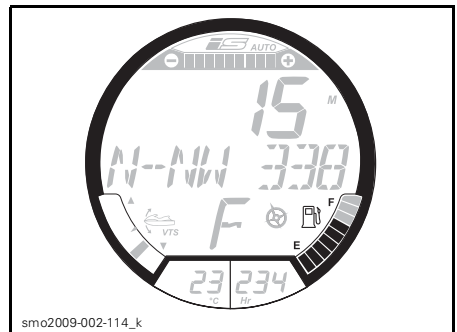

When the fuel tank is full, 8 segments (bars) of the indicator are turned on. The top segment is not used.

When there is only 2 segments of fuel indicated (approximately 25% fuel tank capacity or 14 L (3.7 U.S. gal.), the low fuel indicator light will come on to advise you of the low fuel condition.

An audible warning (one long beep) will be heard periodically as long as the low fuel condition exists.

6) VTS Position

The VTS position indication located in the bottom LH side of the digital screen shows the riding attitude of the watercraft.

A single segment of a bar gauge type indicator is turned on to indicate the relative position of the watercraft bow.

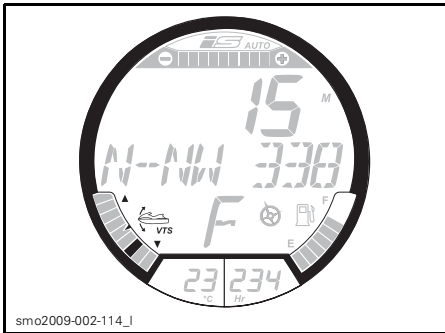

Refer to *OPERATING INSTRUCTIONS* for more details on using the VTS.

7) iS Position

The iS display (intelligent Suspension) provides a visual indication of the relative height of the suspension.

It also indicates if the suspension is in AUTO mode of operation.

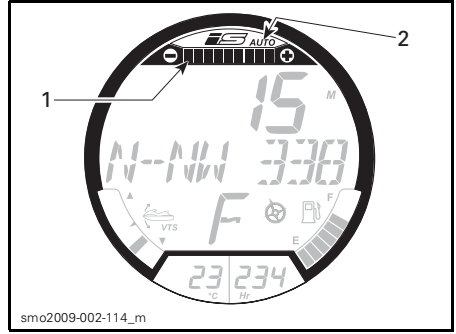

1. iS position indicator
2. iS AUTO mode indicator

When the suspension height is adjusted manually using the iS button, the system switches to MANUAL mode of operation. The AUTO indication disappears and all bar segments of the position indicator will be on.

When the system is operating in MANUAL mode, a single segment of the bar gauge is turned on to indicate the height of the suspension.

Refer to *OPERATING INSTRUCTIONS* for more information on using the suspension.

8) Numerical Display

A numerical display is used to provide a variety of indications as selected by the operator:

- Engine RPM
- Watercraft speed
- Lake temperature
- Water depth (GTX LTD iS).

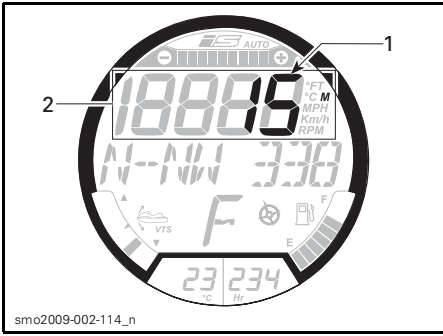

EXAMPLE
 1. Water depth indication (GTX LTD iS)
 2. Numerical display

When the information center is first powered up, the numerical display defaults to the last selected indication.

The numerical display is also used to display various system mode settings such as:

- VTS PRESET
- LEARNING KEY setting
- RENTAL KEY setting
- SLOW SPEED MODE setting.

Changing Numerical Display Indication

To change the indication in the numerical display, press the MODE button on the RH handlebar repeatedly until DISPLAY is visible in the multifunction display.

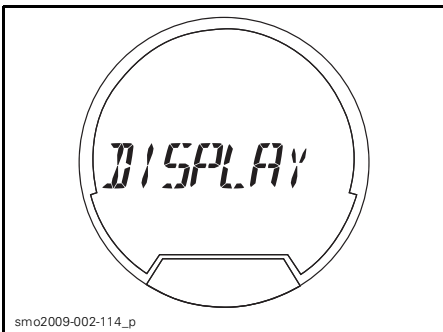

smo2009-002-114_p

Press the UP or DOWN arrow button until the preferred indication selection is visible in the multifunction display.

- RPM
- SPEED
- LAKE TEMPERATURE
- DEPTH.

NOTE: The DEPTH selection is only available if a depth sounder is installed.

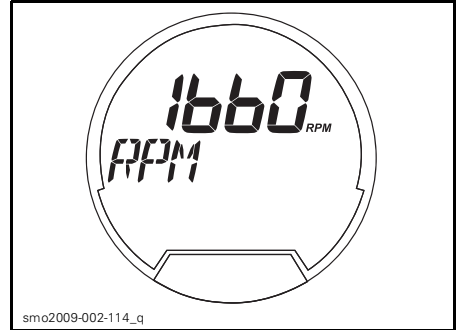

smo2009-002-114_q

EXAMPLE - RPM SELECTION

Press the SET button to select and save the preferred indication, or wait for the display function to time out. The last indication visible will be automatically save. The numerical display will then switch to the new indication with a small abbreviation of the indication type to its right:

- FT or M
- RPM
- MPH or KM/H
- °F or °C.

9) Multifunction Display

When the watercraft is being operated, the multifunction display provides an indication of compass heading, scrolling messages from the monitoring system, or a scrolling DOCK MODE ON message when the function is active.

It also displays a menu for the selection of various functions which, permit changing the numerical display indi-

cation, system modes of operation, settings, and displaying system fault codes (refer to *TROUBLESHOOTING*).

⚠ WARNING

Selecting various numerical displays, system modes of operation or changing settings should only be carried out with the watercraft stopped. Selecting these various functions while operating the watercraft at speed is not recommended as it deters your attention from situational awareness.

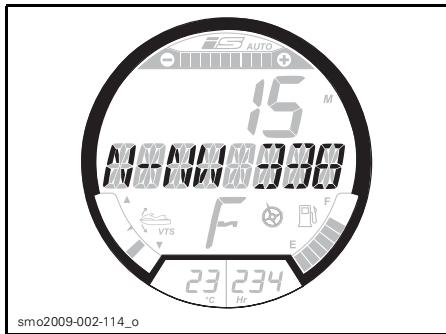

MULTIFUNCTION DISPLAY - COMPASS HEADING INDICATED

Selecting Functions

When operating at speed, the multifunction display normally provides an indication of the compass direction and azimuth the watercraft is traveling.

To select the various functions available through the multifunction display, press the MODE button repeatedly until the desired function is visible:

- DISPLAY
- VTS MODE
- FAULT CODES
- KEY MODE
- SETTINGS.

Then press the SET button to enter that function.

Each available function is explained in its applicable section.

10) Depth Sounder Indicator

GTX Limited iS Model

The *NUMERICAL DISPLAY* can be selected to provide an indication of the lake water depth.

The system is capable of indicating water depth under the hull in single increments up to 50 m (164 ft).

NOTE: Under certain conditions, the digital screen may stop displaying. The digital screen's ability to display the depth depends on the conditions of use.

To activate depth indication, refer to *NUMERICAL DISPLAY* in this subsection.

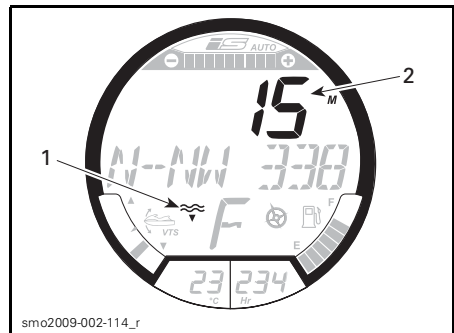

1. Depth finder indicator
2. Water depth indication

NOTE: The DEPTH sounder indicator is only on when a depth sounder is installed and detected.

⚠ WARNING

Never use the depth sounder as a warning device to ride in shallow water.

11) Water Temperature Display

Continuously displays surface water temperature in degrees Celsius (°C) or Fahrenheit (°F).

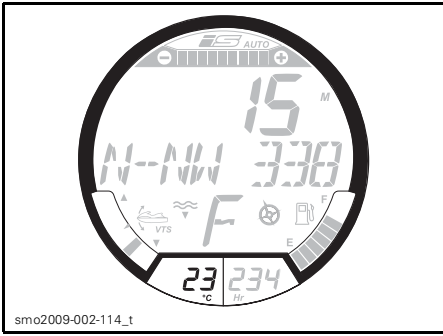

smo2009-002-114_t
WATER TEMPERATURE DISPLAY

The numerical display may also be selected to display water temperature. See *NUMERICAL DISPLAY* in this section.

To change the unit of measurement (°C or °F), see your authorized Sea-Doo dealer.

12) Hour Meter Display (HR)

Continuously displays the time in hours of the watercraft usage.

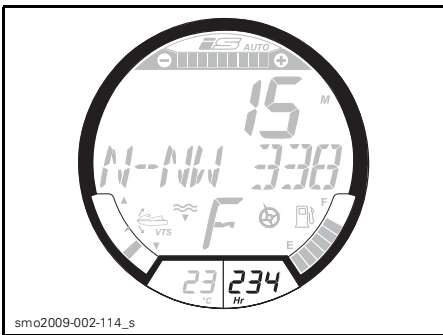

smo2009-002-114_s
HOUR METER

13) iBR Position

Provides an indication of the iBR gate position.

- N (neutral)
- F (forward)
- R (reverse).

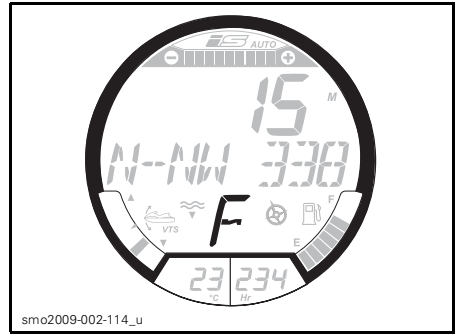

14) Compass

A GPS incorporated in the information center provides the indication in the multifunction display.

The cardinal points, intermediate cardinal points, as well as the azimuth the watercraft is travelling are displayed in the multifunction display by default when the watercraft is moving.

For a compass indication to be displayed, the GPS must have a good link with the navigation satellites. This is confirmed when the COMPASS active indicator is visible in the digital screen.

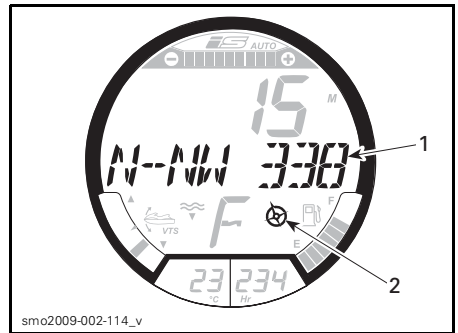

TYPICAL

1. Compass indication
2. Compass active indicator

⚠ WARNING

Use the compass as a guide only.
Not to be used for precision navigation purposes.

EQUIPMENT

NOTE: Some components may not apply or are optional on certain models.



TYPICAL

1. Glove box
2. Front storage bin
3. Rear storage bins
4. Fire extinguisher holder
5. Seat latch
6. Seat grab handles
7. Boarding step
8. Boarding platform
9. Speed ties (GTX LTD iS)
10. Front and rear eyelets (bow/stern)
11. Mooring cleats
12. Bilge drain plugs

1) Glove Box

A small, storage compartment for personal articles.

Pull up on cover latch to open glove box.



smo2009-002-120_a

TYPICAL — GLOVE BOX

1. Cover latch

Glove Box Organizer

GTX Limited iS

A removable glove box organizer can be used for storing and carrying personal items.



sdd2009-001-051

Glove Box Liner Bag

GTX Limited iS

A glove box liner bag protects items stored in the glove box. The liner bag is easily removed from the glove box by pulling it out using the two eyelets.



smo2009-002-121

2) Front Storage Bin

A watertight storage bin that can be used to carry larger personal articles is located under the front cover. The storage bin is self-contained and removable.



smo2009-002-136

Storage Bin Access

Open the front storage compartment cover by pulling upwards on the two cover latch handles (one each side).



smo2009-002-122_a

TYPICAL

1. Front cover latch handles (one each side)

Opening Storage Bin Cover

Release cover latches then pull on cover handle to open.

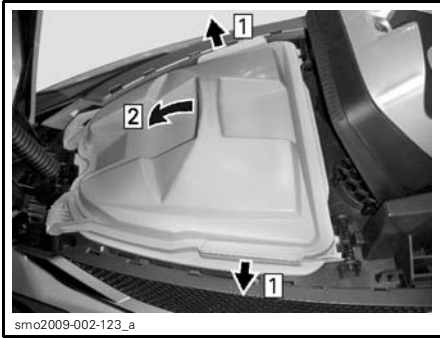

Step 1: Release cover latches
Step 2: Pull cover open

NOTICE The maximum load allowable for the front storage bin is 9 kg (20 lb) evenly distributed.

⚠ WARNING

Never leave any heavy or breakable objects loose in the front storage bin. Do not overload. Never operate the watercraft with any storage compartment cover open.

Storage Bin Removal

Ensure the latches on the storage bin cover are properly locked.

Push back on the latches that lock the storage bin in position. Then pull up on the storage bin handle while tilting the bin forward to release the front tabs, and remove it from the watercraft.

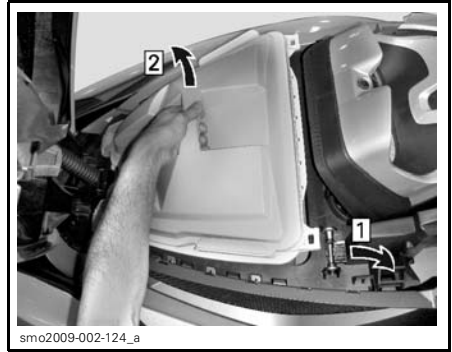

Step 1: Push back on storage bin latches
Step 2: Lift and tilt forward to release front tabs

⚠ WARNING

Never store or carry anything underneath storage bin, or between the moving deck and fixed deck.

Storage Bin Installation

As you insert the storage bin in the front storage compartment, tilt it forward to insert the storage bin front tabs in their retainers underneath the storage cover shock support.

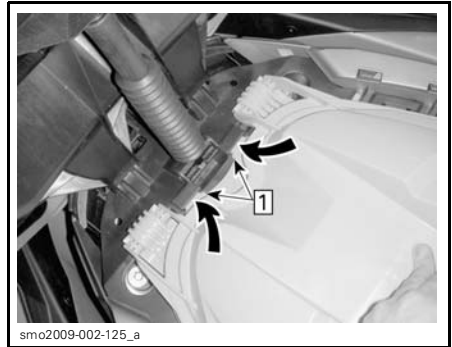

Step 1: Insert storage bin front tabs

Push down on aft end of storage bin to secure in place with locking latches (one each side).



smo2009-002-126_a

Step 1: Push down onto latches to secure

Ensure storage bin is properly inserted in the locking latches, and ensure the latches are locked forward.

NOTICE Never operate the watercraft if the storage bin is not properly secured.

NOTE: This watercraft can be operated without the front storage bin installed.

3) Rear Storage Bins

Two storage bins are located under the rear boarding platform. They are ideal for storing items such as a towrope, first aid kit, fire extinguisher, and other items.

When the boarding platform is closed, it serves as the cover for both storage bins.

The RH storage bin is specially designed for storing an approved fire extinguisher (sold separately).



smo2009-002-127_a

1. Fire extinguisher

The RH storage bin can be removed for servicing the watercraft.

To remove storage bin, pull off the two plastic rivets within the bin (fore and aft) then lift the storage bin out of the fixed deck.



smo2009-002-128

NOTICE Never operate the watercraft without both rear storage bins installed. Always ensure the rear boarding platform is properly closed and latched over the storage bins. If not properly latch, water rushing over the platform during extreme maneuvers may open the platform and dislodge the RH storage bin. Should this happen, water will enter the bilge and may lead to engine damages or electrical problems.

4) Fire Extinguisher Holder

Use the support inside the RH storage bin under the rear boarding platform, and secure the extinguisher using the rubber tie-down.

Refer to *REAR STORAGE BINS* for illustration.

NOTE: Fire extinguisher is sold separately.

5) Seat Latch

The seat latch is located at the back end of the seat. The forward end of the seat is mounted on a hinge.

To open the seat, pull up on the latch handle and lift the seat fully open. A cylinder at the front of the seat serves to hold the seat in the fully open position.

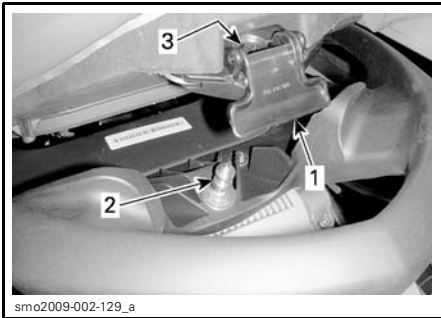

TYPICAL

1. Seat latch handle
2. Latch pin
3. Pin insertion hole

To latch seat, close the seat and firmly push down on the rear portion of the seat.

CAUTION Ensure the latch is properly locked onto the pin.

6) Seat Grab Handles

The seat grab handles provide a handhold for boarding the watercraft when needed and as a handhold for the passenger or spotter.

NOTICE Never use the grab handle to tow anything or to lift the watercraft.

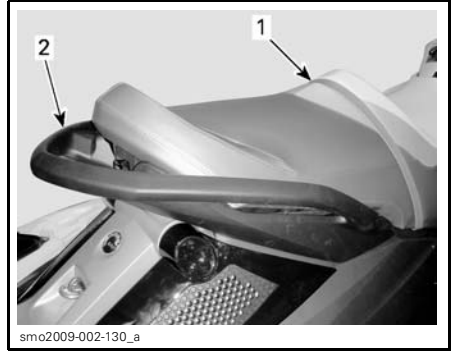

TYPICAL

1. Leather grab handle
2. Molded grab handle

7) Boarding Step

A step used for boarding the watercraft from the water.

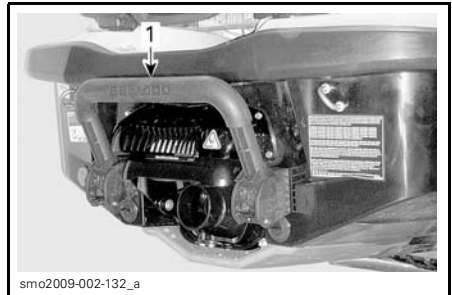

TYPICAL

1. Boarding step

WARNING

Engine must be shut off before attempting to board the watercraft using the boarding step.

⚠ WARNING

Be aware of the iBR gate movement when starting the engine, shutting down the engine or using the iBR lever. Automatic movement of the gate may squeeze fingers or toes of people taking a hold on the back or your PWC.

Pull down the step with your hand and hold until a foot or a knee is put on the step.



smo2009-002-133

BOARDING STEP

NOTICE

- Never use the step for boarding a watercraft that is out of water.
- Never use the step for pulling, towing, diving or jumping, or any other purpose other than as a boarding step.
- Stay on center of the step.
- Only one person at a time on the step.

8) Boarding Platform

A boarding platform covers the rear deck area.

Two indentations in the platform are used as foot rests for the rear facing spotter when towing a skier or tuber.

Two grab handles near the rear edge of the platform provide hand holds for a person boarding from the water.

The platform also serves as a water-tight cover for two rear storage bins that are accessible when opening the platform. It is hinged to the fixed deck at the rear, and held closed by two latches at its front corners.

To open the boarding platform, pull up on each latch handle and lift the deck fully up. A cylinder on the left side is capable of holding the platform open.

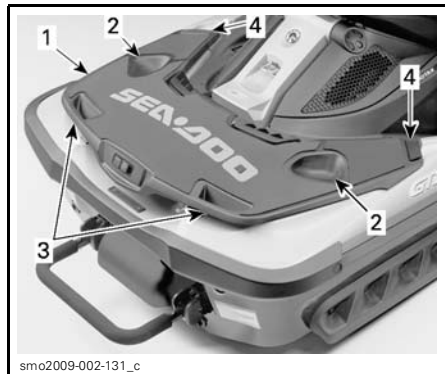

smo2009-002-131_c

GTX LIMITED iS MODEL ILLUSTRATED

1. Boarding platform
2. Spotter foot rests
3. Grab handles
4. Latch handles

9) Speed-Ties

GTX LIMITED iS

Two speed-ties are provided for mooring of the watercraft.

One speed-tie is located just below the LH handlebar, the other is located in the center rear edge of the boarding platform.

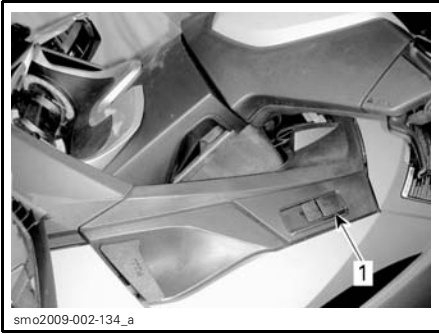

1. Front speed-tie



1. Rear speed-tie

⚠ WARNING

- Do not use retractable ropes when watercraft engine is running.
- Do not use to tow a vehicle. Do not use to pull a person or any object behind or to the side of the watercraft.
- Do not use speed-tie rope as a tie-down on a trailer.

NOTICE

- This system is designed for temporary use in normal conditions. Do not use as a permanent mooring system, or in extreme conditions (strong winds, waves, etc.).
- Regularly inspect rope condition; do not tie up watercraft with a damaged rope. Replacing BRP rope by any other rope will void the speed-tie warranty.
- If speed ties are used in salt water conditions, the rope should be regularly rinsed thoroughly with fresh water to prevent salt buildup in the rope and speed-tie mechanism. This will help extend the life of the rope and ensure proper operation the mechanism.

NOTE: The rope of the speed-tie is a wear item that is not covered under normal warranty.

Refer to *MAINTENANCE* section for speed-tie cleaning instructions.

Mooring your PWC Using the Speed-Ties

1. With your watercraft parallel to the dock and at a standstill next to the dock mooring cleat, release the front speed-tie by lifting the lever.
2. Grasp and pull on the mooring line stopper to extract enough line to reach and tie off to the mooring cleat.

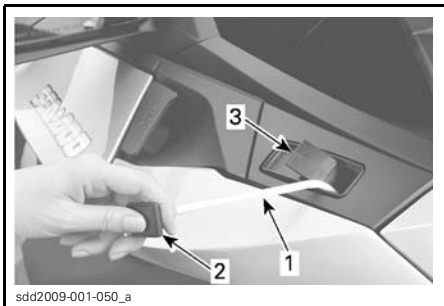

sdd2009-001-050_a

TYPICAL - FRONT SPEED TIE

1. Speed-tie mooring line
2. Mooring line stopper
3. Speed-tie locking lever

3. Push down on the speed-tie locking lever to lock the mooring line.

NOTICE Always ensure the speed-tie rope is properly locked. Make sure mooring rope is not in contact with any components that could lead to watercraft damaged or premature rope wear.

4. When speed-tie rope is secured to the dock cleat with the watercraft still parallel to the dock, carefully step onto the dock. Step from the foot well or seat of the watercraft, **do not** stand on the rail of the watercraft as this could cause it to become unstable.
5. Hold the watercraft parallel with the dock and repeat the tying operation with the rear speed-tie. When using the rear rope, be careful not to fall.

NOTE: Docking procedure is basically the same if there are passengers aboard. However, the operator should ask that passengers remain still and maintain their weight centered over the seat during docking. The passengers must step onto the dock only after front mooring rope is secured to dock cleat. The operator must remain on the watercraft to keep the watercraft parallel with the dock during passengers landing.

NOTICE

- Do not moor watercraft with only one retractable rope. Always use front and rear systems together.
- During mooring, do not over-tighten ropes. Always leave a little slack. Take tides into consideration if applicable. Always moor watercraft with the rope and not with its plastic end.
- The mooring system does not protect watercraft against impacts with the dock. Use dock bumpers (cushions) in combination with retractable ropes to protect your vehicle.
- Always moor watercraft to a dock of appropriate height using strong mooring cleats.

Casting Off Using Speed-Ties

1. When casting off, first untie the rear speed-tie. Retract the mooring rope, hold the mooring rope stopper near its receptacle and lift the locking lever. Once the mooring rope is retracted, snap the mooring rope stopper into its receptacle.
2. Step onto the watercraft. Be sure to position your weight over the center of the watercraft as much as possible to maintain watercraft stability.
3. Carefully move to the operators' position.
4. Release the front mooring rope from the dock cleat, retract it and lock the stopper as with the rear speed-tie.
5. Push or drift the watercraft away from the dock.

CAUTION Be careful when retracting mooring rope. Always hold the stopper near its receptacle before unlocking the lever. Do not stand in the path of a retracting rope.

⚠ CAUTION Ensure that ropes are properly retracted and that stoppers are properly snapped in before starting watercraft.

10) Front and Rear Eyelets

Eyelets can be used for mooring, towing and as tie-down points during trailering.

Front Eyelet

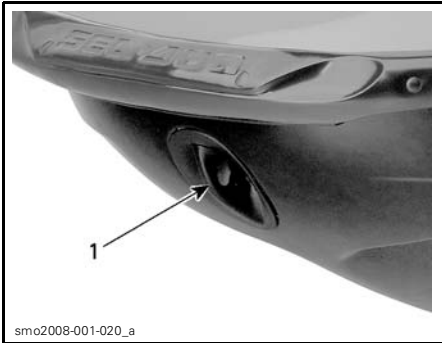

smo2008-001-020_a

TYPICAL
1. Front Eyelet

Rear Eyelets

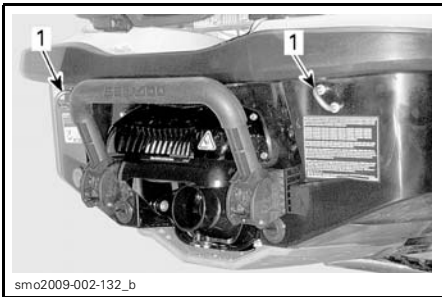

smo2009-002-132_b

1. Rear eyelets

11) Mooring Cleats

These cleats can be used for temporary docking such as when refueling.



smo2009-002-134_b

TYPICAL — ALL MODELS
1. Mooring cleats

NOTICE Never use mooring cleats to pull or lift the watercraft.

12) Bilge Drain Plugs

Unscrew drain plugs whenever watercraft is on the trailer. This will allow water accumulated in the bilge to be evacuated and helps to reduce condensation.

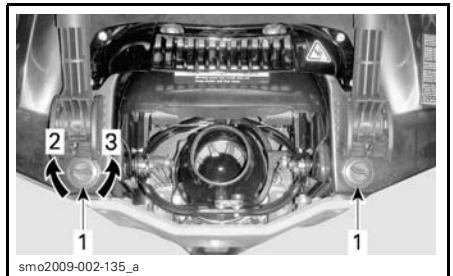

smo2009-002-135_a

TYPICAL
1. Drain plugs
2. Tighten
3. Loosen

NOTICE Ensure drain plugs are properly secured prior to launching the watercraft in water.

OPERATING INSTRUCTIONS

⚠ WARNING

Always perform the *PRE-RIDE INSPECTION* before operating this watercraft. Be sure to read the *SAFETY INFORMATION* and the *VEHICLE INFORMATION* sections and be thoroughly familiar with the iControl technology.

Should any control or instruction not be fully understood, refer to an authorized Sea-Doo dealer.

Boarding the Watercraft

As with any watercraft, boarding should be done carefully and engine must not be running.

⚠ WARNING

Engine must be OFF when boarding the watercraft or when using the boarding step.

Boarding from a Dock

When boarding from a dock, slowly place one foot on the watercraft footboard nearest the dock while holding the handlebar, and at the same time, transfer the body weight to the other side in order to balance the watercraft.

Then bring the other foot over the seat and place it on the other footboard. Push the watercraft away from the dock.



Boarding from Shallow Water

In shallow water, board the watercraft from either the side or the rear.

⚠ WARNING

- Be aware of the iBR gate movement when starting the engine, shutting down the engine or using the iBR lever. Automatic movement of the gate may squeeze fingers or toes of people taking a hold on the back or your PWC.
- Keep limbs away from jet or intake grate.
- Never use jet pump components, pump guard, or iBR gate as a supporting point to board the watercraft.

Ensure there is at least 90 cm (3 ft) of water underneath the lowest rear portion of the hull.

Take into account that the hull will be lower in the water when all passengers are aboard. Be certain to maintain the specified depth so sand, pebbles and rocks will not be drawn up in the jet pump.

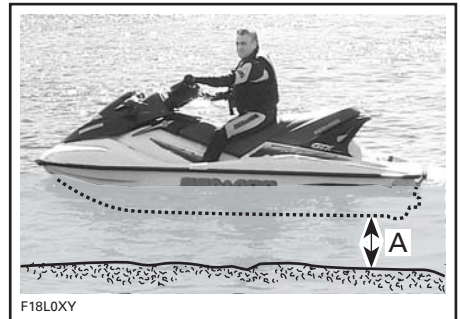

- A. Maintain at least 90 cm (3 ft) underneath the lowest rear portion of the hull when all passengers are aboard

NOTICE

- Starting the engine or riding the watercraft in shallower water may damage the impeller or other jet pump components.
- Stay on center of the step.
- Only one person at a time on the step.

Boarding in Deep Water

⚠ WARNING

- Be aware of the iBR gate movement when starting the engine, shutting down the engine or using the iBR lever. Automatic movement of the gate may squeeze fingers or toes of people taking a hold on the back or your PWC.
- Keep limbs away from jet or intake grate.
- Never use jet pump components, pump guard, or iBR gate as a supporting point to board the watercraft.
- Inexperienced riders should practice how to board the watercraft close to shore (all methods explained here) before venturing into deep water.

Operator Alone

Swim to the rear of the watercraft.

Using one hand, lower the boarding step.



Using other hand, take hold of one of the boarding platform grab handles, then pull yourself up so that you can knee onto the boarding step.



NOTICE

- Stay on center of the step.
- Only one person at a time on the step.

Reach forward with one hand and take hold of the handle behind the seat, then stand on the boarding step.



With both hands on the handle behind the seat, step up onto the boarding platform.





smo2009-002-144

Take hold of the seat strap to help maintain your balance and step forward onto the footboards on either side of the seat.



smo2009-002-145

Sit astride the seat.

Operator with a Passenger

The operator climbs on the watercraft in the same way as explained previously.

In choppy water, while in the water, the passenger may hold the watercraft steady to help the operator climb aboard.



smo2009-002-146

The passenger then climbs onto the watercraft while the operator maintains balance by sitting as close as possible to the console.



smo2009-002-147



smo2009-002-148



smo2009-002-149



smo2009-002-150

NOTICE

- Stay on center of the step.
- Only one person at a time on the step.

How to Start Engine

1. Attach the safety lanyard (D.E.S.S. key) to your PFD.

⚠ WARNING

Before starting the engine, the operator and passengers should always be properly seated on the watercraft wearing appropriate protective clothing including an approved PFD by local authorities and a wet suit bottom.

2. Firmly grip handlebar with your left hand and place both feet on the footboards.
3. Press the engine start/stop button to wake up the electrical system.
4. As the information center cycles through its self test function, install the D.E.S.S. key on its post.

⚠ WARNING

The safety lanyard should always be attached to the operator's personal flotation device when starting or operating the watercraft.

NOTE: If you hear anything other than 2 short beeps from the D.E.S.S. system, it indicates a condition that should be corrected. Refer to the *TROUBLESHOOTING* section for BEEP code signal identification.

5. Depress and hold the start button to crank the engine.

NOTICE Ensure there is at least 90 cm (3 ft) of water under the lowest rear portion of the hull when all passengers are aboard prior to starting the engine. Otherwise damage to the impeller or other jet pump components may occur. Do not accelerate abruptly.

NOTE: Do not depress the throttle lever to start a cold or warm engine.

If the engine fails to start after 10 seconds, wait a few seconds then repeat procedure.

6. Release engine start/stop button immediately after engine is started.

NOTICE Do not hold start/stop button more than 30 seconds to avoid starter overheating. A rest period should be observed between the cranking cycles to allow the starter to cool down. Pay attention not to discharge battery.

7. Slowly accelerate and drive to deeper open water. Do not apply full throttle until the engine is warm. Apply safe boating practices.



NOTICE Avoid watercraft operation in weeded areas. If unavoidable, vary watercraft speed.

NOTE: If the engine is stopped with the start/stop button while the D.E.S.S. key remains on the D.E.S.S. post, it can be restarted within approximately 3 minutes by pressing the engine start/stop button. After this delay, it is necessary to apply a slight pressure or the removal and reinstallation of the D.E.S.S. key on the D.E.S.S. post to allow engine starting. Two short beeps should sound indicating the system is ready again to allow engine starting.

How to Shut Off the Engine

⚠ WARNING

To maintain watercraft directional control, the engine should be running until the watercraft is stopped.

To shut off the engine:

1. Press the engine start/stop button.
2. Release the start/stop button as soon as the engine is shut down.
3. Remove the D.E.S.S. KEY from its post if you disembarking the watercraft.

NOTE: Removing the D.E.S.S. key from its post without depressing the start/stop button will also shut off the engine. This is designed as a safety feature should the operator be ejected from the watercraft.

⚠ WARNING

Never leave the D.E.S.S. key on its post when disembarking watercraft to prevent theft, accidental engine starting, and to avoid unauthorized use by children or others.

How to Steer Watercraft



F18J09Y

Turning the handlebar pivots the jet pump nozzle which controls the watercraft direction. Turning the handlebar

to the right will turn the watercraft to the right and inversely. The throttle should be applied to turn the watercraft.

⚠ WARNING

Throttle should be applied and handlebar turned to change the direction of the watercraft. Steering efficiency will differ depending on the number of passengers, load, water conditions and environmental factors such as the wind.

Unlike a car, a watercraft needs some throttle to turn. Practice in a safe area applying the throttle and turning away from an imaginary object. This is a good collision avoidance technique.

⚠ WARNING

Directional control is reduced when the throttle is released and lost when the engine is off.

The watercraft behaves differently with a passenger and requires greater skill. The passenger should always grip the seat strap or grab handle. Reduce speed and avoid sharp turns. Avoid choppy water conditions when carrying a passenger.

Tight Turns and Other Special Maneuvers

Any tight turns or special maneuvers that will cause the air inlet openings to be kept under water for a prolonged time, water will seep into the bilge.

Combustion engines need air to operate; consequently this watercraft cannot be totally watertight.

NOTICE If the air inlet openings are kept under water, such as turning constantly in tight circles, plunging the bow through waves, or capsizing the watercraft, water may seep into the bilge, which may cause severe damage to internal parts of the engine. Refer to the *WARRANTY* section contained in this guide.

O.T.A.S.[™] System (Off-Throttle Assisted Steering)

The O.T.A.S. (Off-Throttle Assisted Steering) system provides additional maneuverability in off-throttle situations. The O.T.A.S. system is electronically activated and slightly increases engine speed when the driver initiates a full turn without throttle. When handlebar is brought back to its center position, the throttle reverts to idle.

We recommend that you familiarize yourself with this feature during your first ride.

How to Engage Neutral

⚠ WARNING

The drive shaft and impeller are always turning when the engine is running, even when the iBR gate is set to the neutral position. Keep away from the propulsion system of the watercraft.

When the watercraft is first started, the iBR system automatically sets the iBR gate to the neutral position by default.

If the gate is in forward thrust position, tap the iBR lever. The gate will move to neutral.

If braking or reverse is used, the iBR gate will move to the neutral position when the iBR lever is released, if throttle is not applied.

NOTE: The throttle lever must be fully released for the iBR gate to move to the neutral position when the iBR lever is released.

If the engine is stopped in forward or reverse, the iBR gate will move to the neutral position on engine shutdown.

How to Engage Forward

To engage forward thrust from neutral, tap on the throttle lever. The gate will move to forward thrust position and the watercraft will accelerate forward.

To engage forward thrust from reverse, release the iBR lever while applying throttle moderately.

To re-engage forward thrust from braking, simultaneously pull in the throttle lever while releasing the iBR lever. The watercraft will accelerate forward after a short delay.

How to Engage and Use Reverse

Reverse can only be engaged between idle speed and the threshold forward speed of 8 km/h (5 MPH).

To engage reverse thrust, the iBR lever on the LH handlebar must be pulled in at least 25% of the lever travel.

When operating the iBR lever in reverse mode, the throttle lever can be used to control engine RPM, and thus the amount of reverse thrust produced.

By modulating both the iBR and throttle levers simultaneously, reverse thrust can be more precisely controlled. Too much RPM will create water turbulence and reduce reverse efficiency.

NOTE: Engine power will be reduced to idle whenever the iBR lever position is changed.

Release the iBR lever to end reverse operation.

To stop rearward velocity after iBR lever release, apply enough throttle to stop rearward movement.

⚠ WARNING

The brake function has no effect when travelling in reverse.

Available engine power is limited in reverse mode, which limits reverse speed. However, speeds above 8 km/h (5 MPH) may be obtained in reverse depending on conditions.

⚠ WARNING

Only use reverse at slow speed and for the shortest time possible. Always ensure the path behind is clear of objects, obstacles and people.

When operating in reverse, turn the handlebar in the opposite direction that you want to move the rear of the watercraft.

For example, to steer the rear of the watercraft to port (left), turn the handlebar to starboard (right).

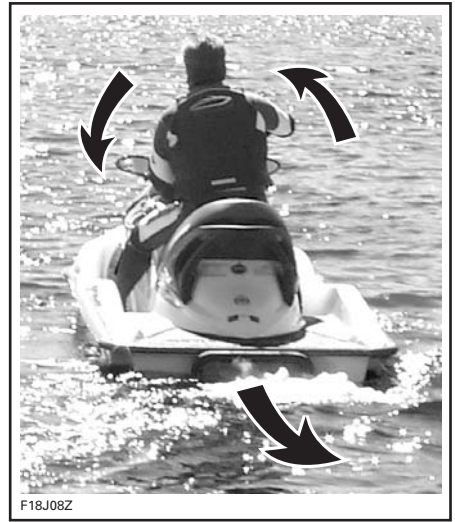

TYPICAL - STEERING DIRECTION REVERSED WHEN BACKING

⚠ CAUTION Steering direction in reverse thrust is opposite of forward thrust. To steer the stern to port (left) in reverse, turn the handlebar to starboard (right). To steer the stern to starboard (right), turn the handlebar to port (left). Reverse thrust operation should be practiced in open waters in order to become fully familiar with the controls and watercraft handling characteristics before operating in close quarters.

How to Engage and Use Braking

⚠ WARNING

- The engine must be running to be able to use the brake.
- The brake is only applicable when operating in forward movement, it has no effect on rearward velocity.
- The brake cannot prevent your PWC from drifting due to current or wind.

The braking function can only be engaged during forward operation at or above the threshold speed of 8 km/h (5 MPH).

Braking is engaged and controlled when the iBR lever on the LH handlebar is pulled in at least 25% of its travel.

⚠ WARNING

Braking should be practiced in open waters and at gradually increasing speeds in order to become fully familiar with the controls and watercraft handling characteristics.

When iBR lever is applied, the throttle lever command is overridden and engine throttle control is now dependant on the iBR lever position. Braking can thus be modulated by using only the iBR lever.

Watercraft deceleration is proportional to the braking force. The more the iBR lever is pulled in, the greater the braking force applied.

NOTE: Be careful to gradually actuate the iBR lever to adjust intensity of the braking force and simultaneously release the throttle lever.

⚠ CAUTION When braking, riders must brace themselves against the deceleration force to prevent from moving forward on the watercraft and losing balance. The operator should always keep both hands on the handlebars, and all passengers should maintain a firm grip of the handholds, seat strap, or the waist of the person in front of them.

⚠ WARNING

Stopping distance will vary depending on initial speed, load, wind, number of riders, water conditions, and the amount of braking power commanded by the operator. Always adjust your riding style accordingly.

When the watercraft slows to less than 8 km/h (5 MPH), braking mode ends and reverse mode is engaged. Release the iBR lever once the watercraft is stopped. Otherwise, a rearward movement will be initiated.

⚠ CAUTION As the watercraft slows to a stop, the wake created by the watercraft will catch up and tend to push the watercraft forward. Ensure there are no obstacles or bathers in the direction of travel.

If the throttle lever is still pulled in when releasing the iBR lever, the watercraft will accelerate forward after a short delay. Acceleration will be proportional to the throttle lever position.

⚠ WARNING

If forward acceleration is not desired when the brake lever is released, release the throttle lever.

When at speed and the brake is first applied, a plume of water will shoot up in the air behind the watercraft which may cause the operator of a following watercraft to momentarily loose sight of your PWC.

⚠ WARNING

- It is important to inform the operator of a watercraft who intends to follow in a convoy formation, of the braking and maneuvering capability of your PWC, what the plume of water indicates, and that a greater distance must be maintained between watercrafts.
- Be aware that other boats following or operating in close proximity may not be able to stop as quickly.

Braking in a Turn

Throttle must be applied for turning to ensure directional control. However braking can be initiated during a turn using the iBR lever as previously described. Get ready to maintain your balance while the wake is crossing your PWC.

⚠ CAUTION As the watercraft slows to a stop while braking in a turn, the wake created by the watercraft will catch up and tend to push the watercraft sideways. Be prepared to maintain balance as the wake crossed the watercraft.

How to Use the Variable Trim System (VTS)

The variable trim system (VTS) changes the vertical position of the jet pump nozzle to provide the operator with a fast, effective system to compensate for load, thrust, riding position and water conditions. Correctly adjusted, it can improve handling, reduce porpoising, and position the watercraft at its best riding attitude to attain maximum performance.

When first using the watercraft, the operator should become familiar with the use of the variable trim system (VTS) at varying speeds and water conditions. A mid-range trim is generally

used when cruising. Experience alone will dictate the best trim for the conditions. During the watercraft break-in period, when lower speeds are recommended, it is an excellent opportunity to become familiar with trim adjustment and its effects.

When the nozzle is positioned in an upward angle, the water thrust directs the bow of the watercraft upward. This position is used to optimize high speed.

When the nozzle is directed downward, the bow is forced downward and increases the watercraft turning capabilities. As with any watercraft, speed and operator body position and movement (body English), will determine the degree and sharpness of the watercraft turn. Porpoising can be reduced or eliminated if the nozzle is downward and speed is adjusted proportionately.

NOTE: VTS position is indicated on a bar gauge in the information center.

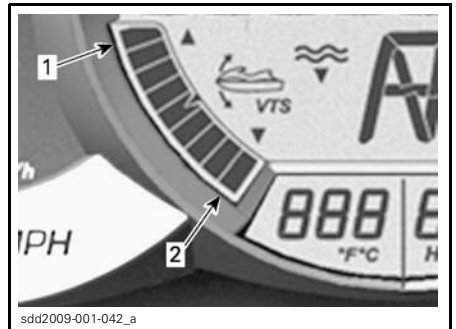

INFORMATION CENTER — VTS POSITION INDICATOR

1. Bow up
2. Bow down

The VTS system allows for manually adjusting the trim position of the nozzle, selecting two preset trim positions, and recording or changing preset trim positions.

How to Use Cruise Mode

Cruise mode is a function of iTC (Intelligent Throttle Control) system that allows the operator to set the desired maximum watercraft speed with an engine speed above approximately 3800 RPM.

This is useful when cruising for long distances, operating in limited speed zones, or towing a tuber, skier or wake boarder.

The operator must keep the throttle depressed to maintain forward speed.

Once the maximum cruise speed is set, the operator can vary the watercraft speed from idle speed up to the set cruise speed using the throttle lever. The set cruise speed will not be exceeded even if the throttle lever is fully depressed.

To set cruise mode:

- Accelerate to the desired maximum cruise speed.
- Press the CRUISE button on the RH handlebar for approximately 1 second.
- Pull the throttle lever all the way in to maintain the set cruise speed.

NOTE: A BEEP signal will be heard and green CRUISE indicator light will be on to confirm cruise mode activation.

As you proceed under a constant cruising speed setting, keep your attention level up to maintain good situational awareness.

Slowing down is a matter of releasing the throttle lever further than the set point, or by pulling the iBR lever in.

If the iBR lever is pulled in for braking, CRUISE mode is overridden but **not deactivated**.

Once the iBR lever is released and the throttle is pulled in to engage forward thrust, the cruise function will reengage to limit the watercraft speed as it was set before.

To deactivate CRUISE mode:

- Release the throttle lever completely.
- Press and release the cruise button.

NOTE: The CRUISE light will go out and a BEEP signal will be heard to confirm that cruise mode is deactivated.

If the throttle is not completely released before the cruise button is pressed, the CRUISE indicator light will stay on in the speedometer display to indicate that speed limiting is still active. Cruise mode will be deactivated only when the throttle lever is completely released.

How to Use Slow Speed Mode

The Intelligent Throttle Control also allows for a Slow Speed Mode where the driver can adjust and set idle speed. This is useful when operating in slow speed zones where the driver must be especially attentive to possible obstacle avoidance.

The operator can set idle speed between 1.6 km/h to 8 km/h (1 MPH to 5 MPH).

To engage SLOW SPEED MODE:

- Release the throttle lever to idle RPM.
- Pull in and release the iBR lever to engage neutral.
- Press and hold the cruise button for approximately 1 second.

Slow Speed Mode allows normal acceleration to a speed that is close to but less than 32 km/h (20 MPH) without deactivating it. If you accelerate above that speed, Slow Speed Mode will be deactivated and the engine will return to idle RPM when the throttle is released.

Should a situation arise where the operator must stop or accelerate quickly away from a hazardous situation, pulling in the iBR lever, or pulling in on the throttle lever will deactivate slow

speed mode and normal control of the watercraft will be returned to the operator.

iS (intelligent Suspension) Operation

The intelligent suspension system (iS), is designed so that the riders sits on what is known as the moving deck.

The seat, console, handlebars, front cover area and foot wells are grouped together to form the MOVING DECK.

The suspension system allows the hull to move independently of the moving deck, smoothing the ride as the watercraft travels through rough water.

The iS system provides multiple modes of operation.

The system always starts up in AUTOMATIC SUSPENSION mode and shuts down in DOCK MODE.

WARNING

Your PWC is equipped with an intelligent suspension. Although the system absorbs part of the vertical forces and therefore reduces the impact force to the body, it cannot eliminate it completely. To prevent you and your passenger from being bounced and eventually ejected from the watercraft, reduce your speed.

WARNING

Avoid riding in very rough waters or practicing extreme maneuvers like jumping wakes or waves.

Automatic Suspension Mode

When the engine has been operating at a predetermined RPM for a given time, the suspension will automatically move up to a factory preset height. This height is ideal for most riding conditions at cruising speeds.

The iS system constantly monitors the stroke of the suspension and automatically compensates for changing water conditions and passenger load.

When the moving deck is raised above the hull, it proportionally elevates the center of gravity of the watercraft higher above the water.

If the watercraft slows down below a predetermined RPM for a given time, the suspension will automatically lower itself to DOCK MODE height.

If the watercraft is operated above a predetermined RPM for a given time and put into a hard braking turn with the handlebars turned fully to the left or right, the suspension will lower itself to DOCK MODE height to lower the center of gravity.

NOTE: When performing certain maneuvers at low speed the watercraft's propensity to overturn can increase.

Manual Suspension Mode

MANUAL SUSPENSION mode allows fine-tuning the suspension calibration to the operator's preference. The **suspension height** can be adjusted using the iS button (UP or DOWN arrow) on the left handlebar.

Suspension height can be adjusted a total of nine increments.

NOTE: Changing the suspension height using the iS button puts the iS system in MANUAL SUSPENSION MODE. The suspension will remain in MANUAL SUSPENSION MODE until selected to AUTO SUSPENSION MODE, or until the watercraft is shut down and powered up again.

If the suspension is being used in MANUAL SUSPENSION mode and you wish to revert back to AUTOMATIC SUSPENSION mode by double-clicking the iS button (UP or DOWN arrow). Refer to the *CONTROLS* subsection for more details.

Dock Mode

The iS system can be set to DOCK MODE AUTO or DOCK MODE OFF.

Dock Mode AUTO

In DOCK MODE AUTO, the suspension lowers to DOCK mode height to lower the center of gravity when certain conditions are met.

- When the engine is shut down after normal operation of the watercraft (always).
- If OTAS is activated.
- If the operator releases the throttle to idle RPM for approximately 10 seconds, after operating at or above a calibrated RPM for a given period of time.

NOTE: When the suspension moves down to dock mode height, a DOCK MODE ON message will scroll across in the multifunction display.

Dock Mode OFF

If the suspension is set to DOCK MODE OFF, the suspension will not lower itself to dock mode height when the throttle is released to idle for more than ten seconds. However, it will lower itself automatically when the engine is shut off, or when O.T.A.S. is activated during a full LH or RH braking turn.

If the suspension is in the up position with the watercraft powered up and the iS DOWN button is double clicked, the suspension will lower itself to DOCK MODE height even if the suspension is set to DOCK MODE OFF.

If the suspension is in the down position (dock mode height) with the watercraft powered up and the iS UP button is double clicked, the suspension will move up to the factory preset height.

WARNING

When performing certain maneuvers at low speed or when docking, the watercraft's propensity to overturn can increase. The more riders (or weight) on the moving deck, the more unstable the watercraft may become.

NOTE: DOCK MODE AUTO is always active when using a RENTAL or a LEARNING key.

Selecting DOCK MODE AUTO or DOCK MODE OFF

Selecting DOCK MODE AUTO or DOCK MODE OFF is only available when the engine is not running.

To change the DOCK mode of operation, carry out the following steps.

1. Press the start/stop button to power up the information center.
2. Install the D.E.S.S. key on its post.
3. Press the MODE button repeatedly until SETTINGS is displayed in the Information Center.

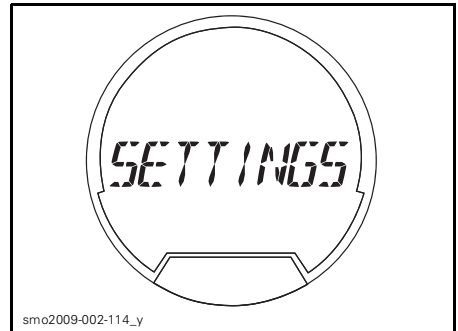

4. Press the SET button to display DOCK MODE.

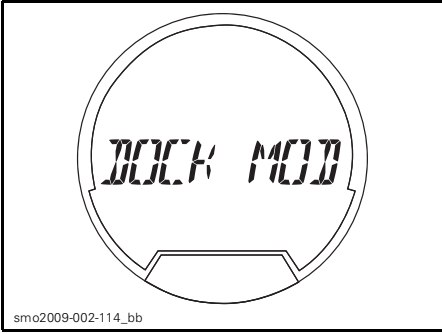

5. Press the SET button to display DOCK MODE AUTO.

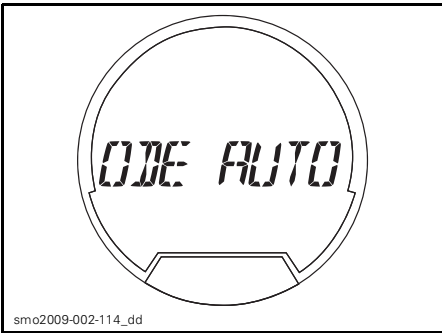

6. Press the UP/DOWN arrow button to toggle the display to DOCK MODE OFF.

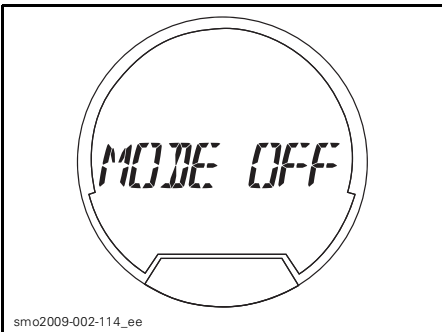

7. Press the SET button, or wait for the function to time out to save the setting and return to main display.

You may now start the engine and drive away using the selected DOCK MODE.

⚠ CAUTION Operating the watercraft in DOCK MODE OFF prevents the suspension from automatically moving to the "down" position when operating the watercraft at slow speed or when stopping. This maintains a higher center of gravity, reduces stability, and makes the watercraft more prone to overturning.

General Recommendations

Rough Water or Poor Visibility Operation

Avoid operation in these conditions. If you must do so, proceed with caution using minimum speed.

Crossing Waves

Reduce speed.

Always be prepared to steer and balance as necessary.

When crossing wakes, always keep a safe distance from watercraft ahead.

⚠ WARNING

When crossing wakes, slow down. Operator and passenger(s) should brace themselves and adopt a semi-standing position to help absorb the bumps. Do not jump waves or wakes.

NOTE: This watercraft is equipped with a suspension system (iS) which is capable of smoothing out the bumps when riding through rough water or a wake. Adopting a semi-standing position may be necessary in very rough water or large wakes. Operator should reduce speed as required to prevent losing control of the watercraft, or prevent personnel from being ejected.

Stopping/Docking

When the throttle is released, the watercraft is slowed by water drag against the hull. The stopping distance will

vary depending on the watercraft size, weight, speed, water surface condition, presence and direction of wind and current.

The iBR system can also be used for slowing down or for stopping more quickly, and for increasing maneuverability especially when docking.



The operator should practice in open waters at various speeds to become familiarized with the stopping distances under different conditions. Stopping using the iBR system in a straight line and in a turn should be practiced extensively to become familiar with the handling characteristics of the watercraft under partial or full braking conditions.

⚠ WARNING

Always practice braking in open waters ensuring there are no watercrafts or boats in your immediate vicinity, especially astern. Other users of the waterways may not be able to maneuver or stop in time to avoid you should you unexpectedly come to a full stop in front of them.

When at speed and the brake is first applied, a plume of water will shoot up in the air behind the watercraft and

may cause the operator of a following watercraft to momentarily lose sight of your PWC.

⚠ WARNING

It is important to inform the operator of a watercraft who intends to follow in a convoy formation of the braking and maneuvering capability of your PWC, what the plume of water indicates, and that a greater distance should be maintained between both of you.

The operator should also practice docking with an imaginary dock using the various controls available (iBR lever and throttle lever).

Release the throttle at a sufficient distance before the expected landing area.

Reduce speed to idle.

Maneuver using a combination of the iBR lever and throttle lever, shifting to neutral, reverse, or forward as required.

Remember that when operating in reverse, steering direction is reversed. Turning the handlebars to the left will move the stern to the right when backing up, and vice-versa.

⚠ WARNING

Directional control is reduced when the throttle is released and/or when engine is off. Steering direction is reversed when operating the watercraft in reverse.

Beaching

NOTICE It is not recommended to run the watercraft to the beach.

Drive slowly towards the beach and shut off the engine using start/stop button, or the D.E.S.S. key, before the

water depth is less than 90 cm (3 ft) under the lowest rear portion of the hull, then pull the watercraft to the beach.

NOTICE Riding the watercraft in shallow water may damage the impeller, iBR components, or other jet pump components. Always shut off the engine before water depth is less than 90 cm (3 ft) and never use reverse or braking.



F18A03Y

SPECIAL PROCEDURES

Jet Pump Water Intake and Impeller Cleaning

⚠ WARNING

Keep away from intake grate while engine is running. Items such as long hair, loose clothing or personal flotation device straps can become entangled in moving parts.

Weeds, shells or debris can get caught on the intake grate, drive shaft and/or impeller. A clogged water intake may cause troubles such as:

- **Cavitation:** Engine speed is high but watercraft moves slowly due to reduced jet thrust, jet pump components may be damaged.
- **Overheating:** Since the jet pump operation controls the flow of water to cool the exhaust system, a clogged intake will cause the engine to overheat and damage engine internal components.

A weed clogged area can be cleaned as follows:

In-Water Cleaning

Rock the watercraft several times while repeatedly pressing engine start/stop button for short period without starting engine. Most of the time, this will remove the blockage. Start engine and make sure watercraft operates properly.

If the aforementioned method does not work, the following can be performed:

- With engine running and before applying throttle, pull the iBR lever in to select reverse operation and vary throttle quickly several times.
- Repeat procedure if necessary.

If system is still blocked, move the watercraft out of the water for cleaning. Refer to *ON-BEACH WATER CLEANING*.

On-Beach Water Cleaning

⚠ WARNING

Always remove the D.E.S.S. key from its post to prevent accidental engine starting before cleaning the jet pump area.

Place a cardboard or a carpet beside the watercraft to prevent scratching when turning the watercraft for cleaning.

Rotate the watercraft to any side for cleaning.

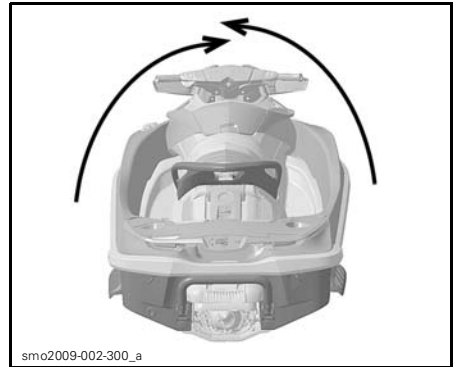

TYPICAL

Clean the water intake area. If the system is still clogged, refer to an authorized Sea-Doo dealer for servicing.

NOTICE Inspect water intake grate for damage. Refer to an authorized Sea-Doo dealer for repair as necessary.

Capsized Watercraft

The watercraft is designed so that it should not turn over easily. Two spoilers mounted on the side of the hull assist watercraft stability. If it turns over, it will remain capsized.

⚠ WARNING

When watercraft is capsized, do not attempt to restart the engine. Operator and passengers should always wear approved personal flotation devices.

To turn the watercraft upright, ensure the engine is off and the **D.E.S.S. key** is **NOT** on its post, then grab the inlet grate, step on a side bumper rail and use your weight to rotate the watercraft towards you.

NOTE: A label on the stern near the flushing connector provides instructions on how to turn watercraft right side up. The label is upside down so that it can be read when the watercraft is overturned.



The 4-TEC™ engine features a tip-over protection system (T.O.P.S.™). When the watercraft tips over, the engine is automatically stopped.

When the watercraft is returned to its normal operating position, the engine can be started normally.

NOTICE If the watercraft has been capsized for more than 5 minutes, do not attempt to crank the engine to avoid water ingestion that would damage the engine. See an authorized Sea-Doo dealer as soon as possible.

NOTICE If the engine does not crank, do not attempt to start it anymore. Otherwise, the engine could be damaged. See an authorized Sea-Doo dealer as soon as possible.

As soon as possible, check for presence of water in the bilge. Drain as necessary when back to the shore.

Submerged Watercraft

To limit damages to the engine, perform the following procedure as soon as possible.

Drain bilge.

If it was submerged in salt water, spray bilge and all components with fresh water using a garden hose to stop the salt corroding effect.

NOTICE Never try to crank or start the engine. Water trapped in intake manifold would flow towards the engine and possibly cause severe engine damage.

Bring the watercraft to an authorized Sea-Doo dealer as soon as possible to have it serviced.

NOTICE The longer the delay before you have the engine serviced, the greater the damage to the engine will be.

Water-Flooded Engine

NOTICE Never try to crank or start the engine. Water trapped in intake manifold would flow towards the engine and possibly cause severe engine damage.

Bring the watercraft to an authorized Sea-Doo dealer as soon as possible to have it serviced.

NOTICE The longer the delay before you have the engine serviced, the greater the damage to the engine will be. Failure to have the engine properly serviced may cause severe engine damage.

Towing the Watercraft in Water

Special precautions should be taken when towing a Sea-Doo watercraft in water.

Maximum recommended towing speed is 24 km/h (15 MPH).

This will prevent the exhaust system from filling with water, which may lead to water being injected into and filling the engine. Without the engine running there is not any exhaust pressure to push the water out the exhaust outlet.

NOTICE Failure to do this may result in damage to the engine. If you must tow a stranded watercraft in water, be sure to stay well below the maximum towing speed of 24 km/h (15 MPH).

MAINTENANCE INFORMATION

MAINTENANCE SCHEDULE

Maintenance is very important for keeping your watercraft in a safe operating condition. Proper maintenance is the owner's responsibility. Perform periodic checks and follow the maintenance schedule.



WARNING

Failure to properly maintain the watercraft according to the maintenance schedule and procedures can make it unsafe to operate.

The schedule should be adjusted according to operating conditions and use. Intensive use of watercraft will require greater frequency of inspection and maintenance.

A: Adjust C: Clean I: Inspect L: Lubricate R: Replace O: Operator D: Dealer	FIRST 10 HOURS						To be performed by NOTE
	25 HOURS or 3 MONTHS						
	50 HOURS or 6 MONTHS						
	100 HOURS or 1 YEAR						
	200 HOURS or 2 YEAR						
PART/TASK							
ENGINE							
Engine oil ⁽¹⁾ and filter	R			R		D	(1) Check level before each ride.
Rubber mounts	I			I		D	
Corrosion protection			L			O	
Supercharger clutch	R ⁽²⁾					D	(2) See NOTE 1 after maintenance chart.
EXHAUST SYSTEM							
Exhaust system	I			I, C ⁽³⁾		D/O	(3) Daily flushing in salt water or foul water use.
COOLING SYSTEM							
Hose and fasteners	I					D	(1) Check level before each ride.
Coolant ⁽¹⁾	I				R	D	
FUEL SYSTEM							
Fuel cap, filler neck, fuel tank, fuel tank straps, fuel lines and connections	I			I ⁽⁴⁾		D	(4) At storage period or after 100 hours of use whichever comes first.
Fuel system leak test	I			I		D	
Throttle body	I			I		D	
AIR INTAKE SYSTEM							
Air intake silencer	I			I, C		D	—
Crankcase ventilation hose				I, C		D	
ELECTRONIC MANAGEMENT SYSTEMS							
EMS sensors	I			I		D	—
Fault codes (ECM, iBR, iS, Cluster)	I			I		D	

A: Adjust C: Clean I: Inspect L: Lubricate R: Replace O: Operator D: Dealer	FIRST 10 HOURS							NOTE
	25 HOURS or 3 MONTHS							
	50 HOURS or 6 MONTHS							
	100 HOURS or 1 YEAR							
	200 HOURS or 2 YEAR							
	To be performed by							
PART/TASK							NOTE	
ELECTRICAL SYSTEM								
Spark plug	I			I	R	D	—	
Electrical connections and fastening (ignition system, starting system, fuel injectors, fuse boxes etc.)	I			I		D	(5) Inspect before each ride. (6) Inspect once a month. Add electrolyte as required.	
D.E.S.S. key/post ⁽⁵⁾	I			I		D		
Monitoring beeper	I			I		D		
Battery and fasteners	I			I ⁽⁶⁾		D		
STEERING SYSTEM								
Steering cable and connections	I			I		D	—	
Steering nozzle bushings	I			I		D		
ETC and iBR levers				I, L ⁽⁷⁾		D	(7) See NOTE 2 after maintenance chart	
PROPULSION SYSTEM								
Carbon ring and rubber boot (drive shaft)	I			I		D	(4) At storage period or after 100 hours of use whichever comes first. (8) Inspect each month (more often in salt water use) and change when necessary.	
Impeller boot	I			I		D		
Impeller shaft seal, sleeve and O-ring				I ⁽⁴⁾		D		
Drive shaft/impeller splines				I, L		D		
Sacrificial anode (if so equipped)				I ⁽⁸⁾		D		
Impeller and impeller wear ring clearance	I			I		D		
Pump mounts	I			I		D		

A: Adjust C: Clean I: Inspect L: Lubricate R: Replace O: Operator D: Dealer	FIRST 10 HOURS						NOTE
	25 HOURS or 3 MONTHS						
	50 HOURS or 6 MONTHS						
	100 HOURS or 1 YEAR						
	200 HOURS or 2 YEAR						
To be performed by							
PART/TASK							NOTE
iBR SYSTEM (intelligent Brake and Reverse)							
iBR gate backlash	I			I		D	—
iBR support plates	I			I		D	
iBR friction plates	I			I		D	
iBR connecting arms and sleeves	I			I		D	
iBR U lever	I			I		D	
iBR locking sleeve	I			I		D	
iBR protective guard	I			I		D	
iS SYSTEM (intelligent Suspension)							
iS oil ⁽⁹⁾	I			I		D	(9) Check pump reservoir oil level and for system leaks.
iS position sensor	I			I		D	
HULL AND BODY							
Hull	I			I		O	—
Ride plate and water intake grate	I			I		O	

NOTE 1: The supercharger clutch requires replacement when the “MAINTENANCE SUPERCHARGER” message is displayed in the information center, at every 100 hours of operation or earlier depending on the riding style (speed, engine RPM’s, water conditions). This is determined by the engine management system. The supercharger clutch will need to be replaced within 5 hours of the message display by an authorized Sea-Doo dealer. The supercharger maintenance reminder must be reset using B.U.D.S. in order to reset the supercharger maintenance hour counter, even if the maintenance was carried out before the reminder appeared in the information center.

NOTE 2: The iTC and iBR levers should be inspected by depressing and releasing the levers to check for freedom of movement. If any friction is felt in the internal lever and spring mechanism, the lever must be taken apart, cleaned, inspected for wear and lubricated.

10-HOUR INSPECTION

We suggest that after the first 10 hours of operation, the boat be checked by an authorized Sea-Doo Watercrafts dealer. The initial maintenance is very important and must not be neglected.

NOTE: The 10-hour inspection is at the expense of the PWC owner.

We recommend that this inspection be signed by an authorized Sea-Doo Watercrafts dealer.

Date of 10-hour inspection

Authorized dealer signature

Dealer name

MAINTENANCE PROCEDURES

This section includes instructions for basic maintenance procedures. If you have the necessary mechanical skills and the required tools, you can perform these procedures. If not, see your authorized Sea-Doo watercraft dealer.

WARNING

Turn off the engine and follow these maintenance procedures when performing maintenance. If you do not follow proper maintenance procedures you can be injured by hot parts, moving parts, electricity, chemicals or other hazards.

WARNING

Should removal of a locking device (e.g. lock tabs, self-locking fasteners, etc.) be required, always replace with a new one.

NOTICE Never leave any object, rag, tool, etc., in the engine compartment or in the bilge.

Engine Oil

Recommended Engine Oil

Use XPS SUMMER GRADE OIL (P/N 293 600 121).

If XPS™ engine oil is not available, use a 10W40 mineral engine oil compatible with wet clutches.

NOTE: The XPS engine oil has been thoroughly tested to be free of any additives that could impair the functionality of the supercharger clutch.

NOTICE NEVER use synthetic oil. This would impair the proper operation of the supercharger clutch. Do not add any additives to the recommended oil. Mineral oils not recommended by BRP may also contain additives (friction modifiers) that may cause inappropriate slippage of the supercharger and eventually lead to premature wear. For this reason, XPS Summer Grade oil or a BRP approved equivalent are the only recommended oils. Use of any oil not recommended by BRP may void BRP's limited warranty.

Engine Oil Level

NOTICE Check level frequently and refill if necessary. Do not overfill. Operating the engine with an improper level may severely damage engine.

CAUTION Certain components in the engine compartment may be very hot. Direct contact may result in skin burn.

Oil level can be checked with watercraft either in or out of water.

If Watercraft is Out of the Water

NOTICE Watercraft must be level.

WARNING

When operating the engine out of water, the heat exchanger in the ride plate may become very hot. Avoid any contact with the ride plate as burns may occur.

1. Raise trailer tow pole, then block in position when bumper rail is level.
2. Open seat and remove the ventilation box from the deck extension to gain partial access to engine compartment.

NOTE: To remove the ventilation box, simply release the 3 clips retaining it and lift it off the deck extension.

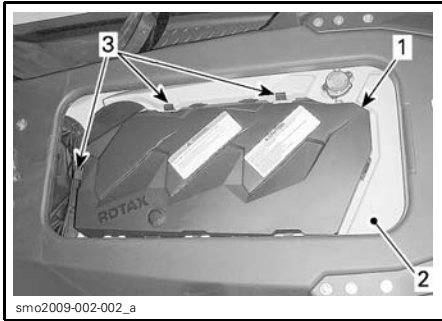

1. Ventilation box
2. Deck extension
3. Retaining clips

3. Install a garden hose on the exhaust system flushing connector. Refer to *EXHAUST SYSTEM* in this section and follow the procedure.

NOTICE

- Never run engine without supplying water to the exhaust system. Failure to cool exhaust system may severely damage it.
 - Never run engine longer than 5 minutes. Drive line seal has no cooling when watercraft is out of water.
4. With the engine already at normal operating condition, let engine **idle for 30 seconds** then stop engine.
 5. Wait at least 30 seconds for the oil to settle in the engine, then pull dipstick out and wipe clean.

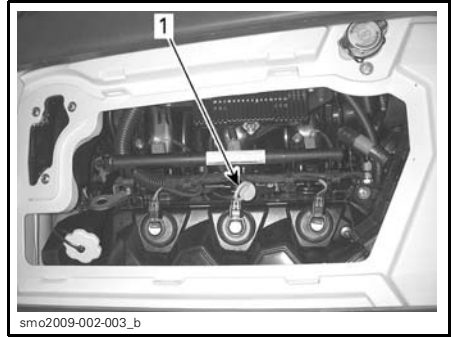

1. Oil dipstick

6. Reinstall dipstick, push in completely.
7. Remove dipstick again and read oil level. It should be between the FULL and ADD marks.

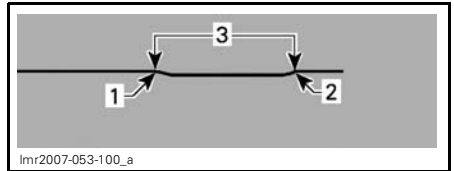

1. Full
2. Add
3. Operating range

8. Add oil to ensure the level is between marks as required.

To add oil:

- Unscrew oil cap.
- Place a funnel in the oil filler neck opening.
- Add the recommended oil to the proper level.

NOTE: Do not overfill.

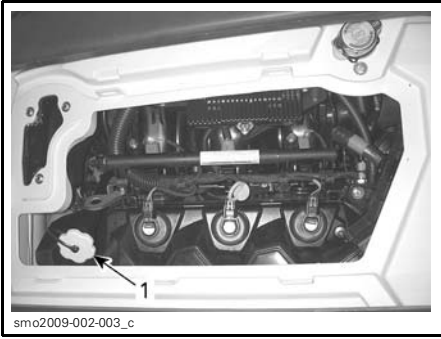

1. Oil filler cap

NOTE: Every time oil is added in the engine, the complete procedure explained in this section must be carried out. Otherwise, you will obtain a false oil level reading.

9. Properly reinstall oil cap and dipstick.

Engine Oil Change and Oil Filter Replacement

The oil change and filter replacement should be performed by an authorized Sea-Doo dealer.

Engine Coolant

Recommended Engine Coolant

Always use ethylene-glycol antifreeze containing corrosion inhibitors specifically for internal combustion aluminum engines.

NOTE: When available, it is recommended to use biodegradable antifreeze compatible with internal combustion aluminum engines. This will contribute to protect the environment.

Cooling system must be filled with water and antifreeze solution (50% demineralized water, 50% antifreeze).

BRP sells premixed coolant with freezing protection up to -37°C (-35°F) (P/N 293 600 038).

NOTE: Using a blend of 40% antifreeze with 60% demineralized water will improve the cooling efficiency when watercraft is used in particularly hot weather and/or hot water condition.

To prevent antifreeze deterioration, always use the same brand. Never mix different brands unless cooling system is completely flushed and refilled. Refer to an authorized Sea-Doo dealer.

Engine Coolant Level

⚠ WARNING

Check coolant level with engine cold. Never add coolant in cooling system when engine is hot.

⚠ CAUTION Certain components in the engine compartment may be very hot. Direct contact may result in skin burn.

Open seat.

Remove ventilation box. Refer to ENGINE OIL LEVEL for the procedure.

Locate the expansion tank cap.

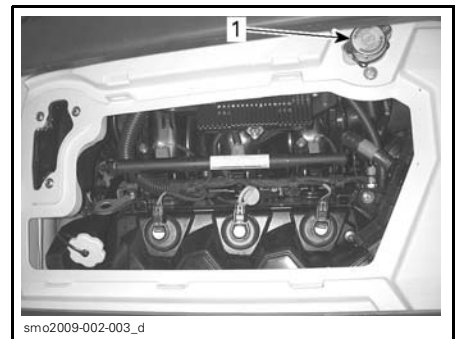

TYPICAL
1. Expansion tank cap

With vehicle on a level surface, coolant level should be between MIN. and MAX. marks on coolant reservoir when engine is cold.

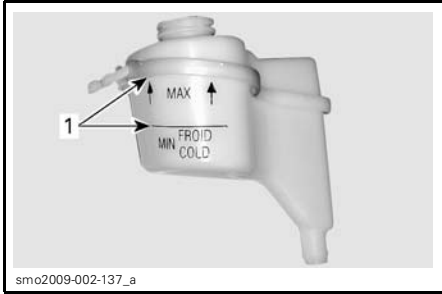

TYPICAL - COOLANT EXPANSION TANK
 1. Level between marks when engine is cold

NOTE: The watercraft is level when it is in water. When on a trailer, raise trailer tow pole and block in this position when bumper rail is level.

Add coolant/demineralized water to adjust coolant level between marks as required. Use a funnel to avoid spillage. Do not overfill.

Properly reinstall and tighten filler cap, then reinstall ventilation box and close seat.

NOTE: A cooling system that frequently requires coolant is an indication of leaks or engine problems. See an authorized Sea-Doo dealer.

Engine Coolant Replacement

Coolant replacement should be performed by an authorized Sea-Doo dealer.

Exhaust System

Exhaust System Flushing

Flushing the exhaust system and intercooler with fresh water is essential to neutralize corroding effects of salt or other chemical products present in water. It will help to remove sand, salt, shells or other particles in water jackets and/or hoses.

⚠ WARNING
 Perform this operation in a well ventilated area.

Proceed as follows:

Clean jet pump by spraying water in its inlet and outlet and then apply a coating of XPS Lube or equivalent.

⚠ WARNING
 When operating the engine while the watercraft is out of the water, the heat exchanger in the ride plate may become very hot. Avoid any contact with ride plate as burns may occur.

Connect a garden hose to the connector located at the rear of watercraft (on the port side of the stern). Do not open water tap at this time.

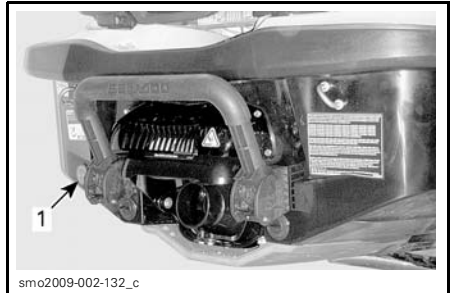

1. Flushing connector location

NOTE: An optional quick connect hose adapter and hose fitting can be used (P/N 295 500 473). No hose pincher is required to flush engine.



QUICK CONNECT HOSE ADAPTER

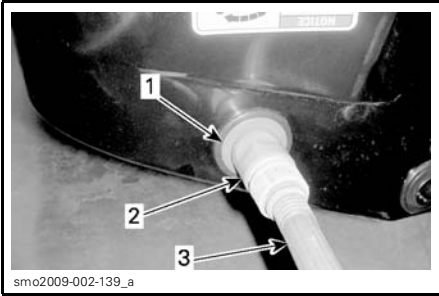

smo2009-002-139_a

TYPICAL

1. Hose adapter (optional, not mandatory)
2. Quick connect fitting (optional, not mandatory)
3. Garden hose

To flush, start engine then immediately open the water tap.

CAUTION Certain components in the engine compartment may be very hot. Direct contact may result in skin burn. Do not touch any electrical parts or jet pump area when engine is running.

NOTICE Never flush a hot engine. Always start the engine before opening the water tap. Open water tap immediately after engine is started to prevent overheating.

Run the engine about 20 seconds at a fast idle between 4000 - 5000 RPM.

NOTICE Never run engine without supplying water to the exhaust system when watercraft is out of water.

Ensure water flows out of jet pump while flushing. Otherwise, refer to an authorized Sea-Doo dealer for servicing.

NOTICE Never run engine longer than 5 minutes. Drive line seal has no cooling when watercraft is out of water.

Close the water tap, then stop the engine.

NOTICE Always close the water tap before stopping the engine.

NOTICE Remove quick connect adapter after flushing operation (if used).

Ride Plate and Water Intake Grate

Ride Plate and Water Intake Grate Inspection

Inspect ride plate and jet pump water intake grate for damage. See your Sea-Doo dealer to have any damaged part repaired or replaced.

⚠ WARNING

The D.E.S.S. key must always be removed from its post prior to inspecting the intake grate.

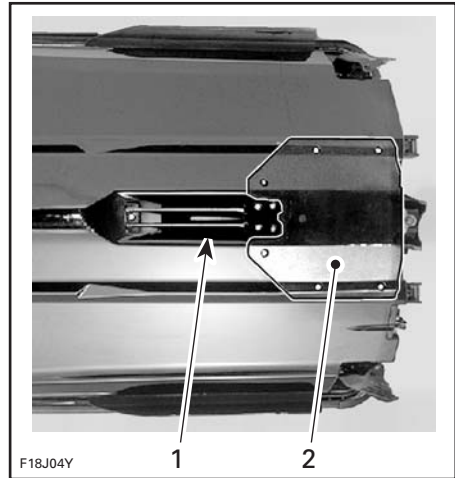

TYPICAL — INSPECT THESE AREAS

1. Water intake
2. Ride plate

Jet Pump, Nozzle and iBR Gate

To permit easy access to the jet pump, nozzle, iBR gate, and various linkages for inspection, maintenance, cleaning or removal of debris, the iBR system

provides for an iBR override function which, is accessible through the information center.

When iBR override is activated, it allows the user to electrically move the iBR gate and nozzle through its full range of motion using the VTS control button.

NOTE: The iBR override function is only available when the engine is not running.

⚠ WARNING

When moving the iBR gate using the iBR override function, ensure nobody stands near the rear of the watercraft. Movement of the gate may squeeze fingers.

NOTICE An object or tool caught in the iBR gate, nozzle or linkages when the iBR gate is moved using the iBR override function may cause damage to the iBR components, nozzle and linkages. Remove all rigid foreign objects that may obstruct the iBR gate travel before moving it.

⚠ WARNING

If it is necessary to reach in to remove any foreign object caught in the iBR gate, nozzle or linkages, strictly observe the following before proceeding:

- Remove D.E.S.S. key from post.
- Wait at least 5 minutes.
- Do not press on start/stop button. If ever start/stop button is pressed, wait 5 minutes again.

iBR Override Function

To activate the iBR override function, carry out the following step.

1. Power up the electrical system by installing the lanyard and momentarily pressing the start/stop button.

NOTE: Do not start the engine. The lanyard must be installed to ensure the information center will not shut off all indications after its self test function. Electrical power will stay for approximately 3 minutes.

2. Press the Mode button on the RH handlebar repeatedly until SETTINGS is visible in the digital display of the information center.



3. Press the SET button (RH handlebar) to display DOCK MODE.

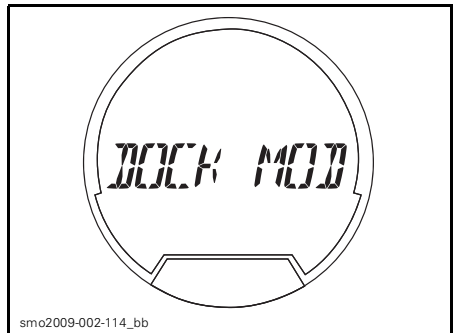

4. Press the UP/DOWN arrow button to display iBR OVR.

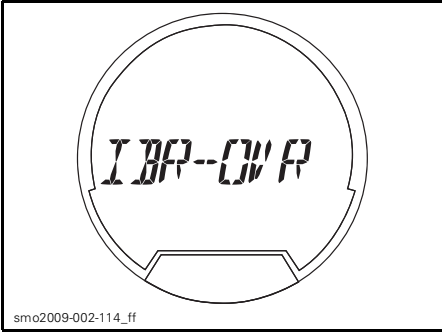

5. Press the SET button to enter iBR OVR function and display OVR OFF.

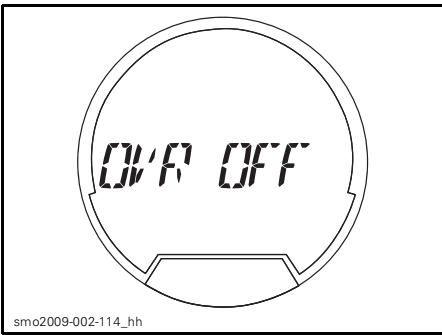

6. Press the UP/DOWN arrow button (RH handlebar) to display OVR ON.

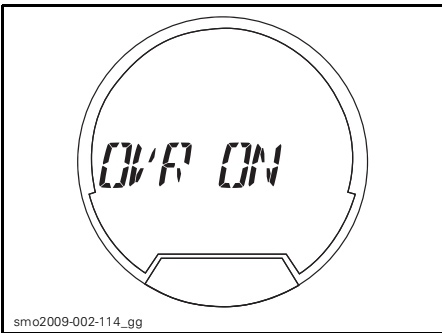

7. Press the SET button to select the OVR ON function. The gauge will return to its normal display.
8. Press the VTS UP or DOWN arrow button to move the iBR gate.

There are three ways to deactivate the iBR override function:

1. Repeat previous steps and press the SET button when OVR OFF is visible.
2. Wait for the electrical power to shut off.
3. Start the engine.

NOTE: When the engine is started, the iBR OVR function is deactivated and the iBR gate will move to the neutral position.

⚠ WARNING

When moving the iBR gate using the iBR override function, ensure nobody stands near the rear of the watercraft. Movement of the gate may squeeze fingers.

Body and Hull

Body and Hull Cleaning

Occasionally, wash the hull and various body components with water and soap (use only mild detergent). Remove any marine organisms from engine and/or hull. Apply non-abrasive wax such as silicone wax.

NOTICE Never clean fiberglass and plastic parts with strong detergent, degreasing agent, paint thinner, acetone, or other strong chemical or petroleum type cleaner.

Stains may be removed from the seat and fiberglass using Knight's Spray-Nine[†] or the equivalent.

To clean the carpets, use 3M™ Citrus Base Cleaner (24 oz spray can) or an equivalent.

⚠ WARNING

Never apply plastic or vinyl protector on the carpets or seat as the surface will become slippery and the occupants may slip off the watercraft.

Respect the environment by ensuring fuel, oil or cleaning solutions do not drain into the waterways.

Speed-Tie Rope Cleaning

A minimum of maintenance is required to keep the speed-tie unit and the mooring rope in serviceable condition.

Clean the locking mechanism and mooring rope with fresh water to remove salt, sand or other deposits.

NOTICE Do not use a high pressure washer to clean the speed-tie unit.

Let dry.

Fuses

Fuse Removal and Installation

Use the fuse remover/installer included in the fuse box to ease fuse removal.

Fuse Inspection

If an electrical problem occurs, check the fuses. If a fuse is burnt, replace by one of the same rating.

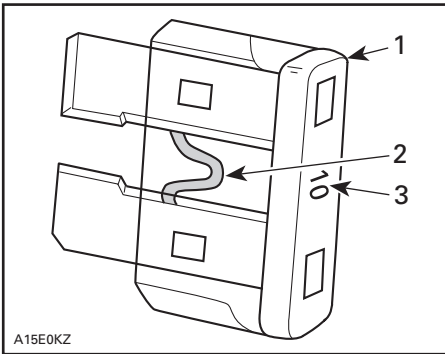

TYPICAL

1. Fuse
2. Check if melted
3. Ampere rating

⚠ WARNING

Do not use a higher rated fuse as this can cause severe damage. If a fuse has burnt out, the source of the malfunction should be determined and corrected before restarting. See an authorized Sea-Doo dealer for servicing.

Fuse Location and Description

To access the fuse boxes, open the boarding platform.

Remove the two plastic rivets securing the RH aft storage bin and remove the storage bin from the fixed deck. The fuse boxes are located just under the storage bin, attached to the battery holder.

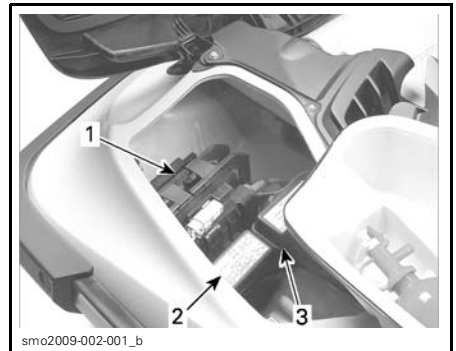

TYPICAL

1. Battery holder
2. Fuse box
3. Relay fuse box

To remove a fuse box cover, squeeze locking tabs together, hold and pull fuse box cover to open.

NOTE: Fuse ratings and positions are illustrated on the fuse box cover.

FUSE	DESCRIPTION	LOCATION
3 A	Information center gauge	Fuse box
3 A	Depth sounder (if so equipped)	
5 A	iS control	
5 A	iBR control	
10 A	Fuel pump	
10 A	Cylinder 1 (ignition coil and injection)	
10 A	Cylinder 2 (ignition coil and injection)	
10 A	Cylinder 3 (ignition coil and injection)	
3 A	O.T.A.S. switch	
5 A	Starter solenoid	
3 A	CAPS	
30 A	Charge	
30 A	Battery	
30 A	iS	
30 A	iBR	
15 A	ECM	
3 A	start/stop button	
3 A	GPS	
15 A	Diagnostic connector	

POST-OPERATION CARE

Remove the watercraft from the water every day to prevent growth of marine organisms.

WARNING

Allow engine to cool before performing any maintenance.

Exhaust System Flushing

The exhaust system should be flushed daily when watercraft is used in salt or foul water.

Refer to *MAINTENANCE PROCEDURES*.

NOTE: On supercharged models, the intercooler is flushed at the same time.

Additional Care for Foul Water or Salt Water Operation

When the watercraft is operated in foul water and particularly in salt water, additional care should be taken to protect the watercraft and its components.

Rinse watercraft bilge area with fresh water.

Never use a high pressure washer to clean the bilge. **USE LOW PRESSURE ONLY** (such as a garden hose).

High pressure can cause damages to electrical or mechanical systems.

NOTICE Failure to perform proper care such as: watercraft rinsing, exhaust system flushing and anticorrosion treatment, when watercraft is used in salt water, will result in damage to the watercraft and its components. Never leave the watercraft stored in direct sunlight.

STORAGE AND PRESEASON PREPARATION

Storage

WARNING

Because fuel and oil are flammable, have an authorized Sea-Doo dealer inspect the fuel system integrity as specified in the periodic inspection chart.

It is recommended that the watercraft be serviced by an authorized Sea-Doo dealer for storage, however the following operations can be performed by you with a minimum of tools.

NOTE: Carry out the following tasks in the same order as detailed in this section.

NOTICE Do not run the engine during the storage period.

Fuel System Protection

Sea-Doo fuel stabilizer (or equivalent), should be added in the fuel tank to prevent fuel deterioration and fuel system gumming. Follow stabilizer manufacturers' instructions for proper use.

NOTICE It is highly recommended to add fuel stabilizer at storage in order to maintain fuel system in good condition.

WARNING

Always stop the engine before refueling. Fuel is flammable and explosive under certain conditions. Always work in a well ventilated area. Do not smoke or allow open flames or sparks in the vicinity. Fuel tank may be pressurized, turn cap slowly when opening. Never use an open flame to check fuel level. When fueling, keep watercraft level. Do not overfill or top off the fuel tank and leave watercraft in the sun. As temperature increases, fuel expands and may overflow. Always wipe off any fuel spillage from the watercraft. Periodically verify fuel system.

Exhaust System Flushing

Perform procedure as described in *MAINTENANCE* section.

Engine Oil and Filter Replacement

The oil change and filter should be performed by an authorized Sea-Doo dealer.

Intercooler Draining

It is important to expel any trapped water that may have accumulated from condensation in the intercooler.

Proceed as follows:

1. Open the boarding platform and remove the RH storage bin.
2. Ensure there is an alignment line drawn on the intercooler outlet hose. This will ensure the hose is not twisted or kinked on reinstallation.
3. Loosen the clamp retaining the intercooler outlet hose.
4. Remove the intercooler outlet hose from the intercooler.

NOTE: This hose feeds the inlet of the throttle body.

5. Drape a couple of shop rags over the iS module to protect it from any expelled water from the intercooler.

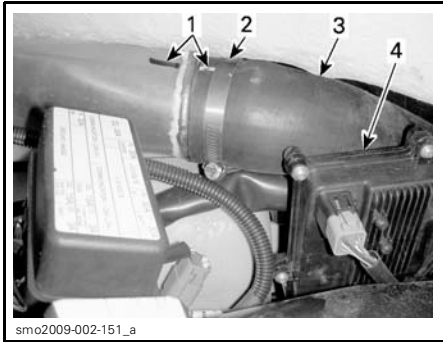

1. Hose alignment lines
2. Hose clamp
3. Intercooler outlet hose
4. iS module

6. Start and rev the engine up to 4000 RPM several times.

NOTE: Prevent air intake system from aspirating foreign objects which may cause severe engine or damage.

7. Stop engine.
8. Reinstall the intercooler air outlet hose, ensure it is properly aligned as prior to removal to ensure proper engine operation.

Exhaust System Protection

In areas where temperature may freeze, water trapped in the exhaust system and intercooler must be removed.

Using the flushing connector located on the port (LH) side of the stern, inject pressurized air at 379 kPa (55 PSI) into system until there is no more water flowing from jet pump.

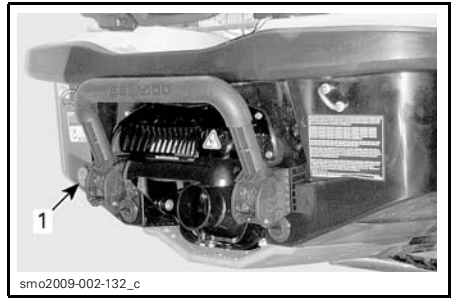

1. Flushing connector

The following hose can be fabricated to ease draining procedure.

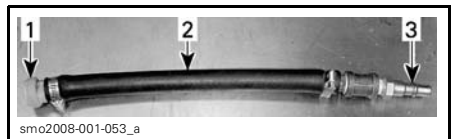

- TYPICAL**
1. Flushing connector adapter
 2. Hose 12.7 mm (1/2 in)
 3. Air hose male adapter

NOTICE Failure to drain the exhaust system may cause severe damage to the intercooler (supercharged models) and exhaust manifold.

Engine Internal Lubrication

Open the seat.

Remove the air ventilation box over the engine.

Disconnect ignition coil connectors.

⚠ WARNING

When disconnecting coil from spark plug, always disconnect coil from main harness first. Never check for engine ignition spark from an open coil and/or spark plug in the engine compartment as a spark may cause fuel vapors to ignite.

IMPORTANT: Never cut the locking ties securing the ignition coil connectors. This would allow mixing the wires between cylinders.

Remove ignition coils.

NOTICE Ensure there is no dirt in the spark plug holes prior to removing the spark plugs. Otherwise, dirt would fall into cylinder and damage the internal components.

Remove spark plugs.

NOTE: After loosening the spark plugs, a coil may be used to pull the spark plugs out. Simply insert the coil down to spark plug and snap it on the plug to then extract the spark plug from the hole.

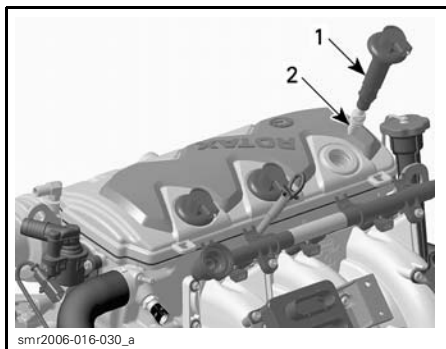

1. Ignition coil
2. Spark plug

Spray XPS Lube or equivalent, in spark plug holes.

To prevent fuel from being injected, and to disable the ignition during engine cranking, proceed as follows.

While engine is stopped, fully depress throttle lever and HOLD against handlebar for cranking.

Crank the engine a few turns to distribute the oil on cylinder wall.

Apply anti-seize lubricant on spark plug threads, then reinstall them in the engine.

NOTE: Prior to inserting the ignition coils onto the spark plugs, apply some DOW CORNING 111 (P/N 413 707 000) grease around the seal area that touches the spark plug hole. After installation, ensure the seal seats properly with the top surface of the engine.

Reinstall ignition coils. Reconnect ignition coil connectors.

Wipe up any residual water from the engine.

Disconnect the garden hose.

NOTE: It is recommended to fog the engine valves with XPS Lube. Contact your authorized Sea-Doo dealer.

Engine Coolant Test

If antifreeze is not replaced, test its density.

The antifreeze replacement (P/N and a density test should be performed by an authorized Sea-Doo dealer.

NOTE: Antifreeze should be replaced every 200 hours or every 2 years to prevent antifreeze deterioration.

NOTICE Improper antifreeze density may allow freezing of the liquid in the cooling system if the vehicle is stored in an area where the freezing point is attained. This would seriously damage the engine.

Battery Removal and Charging

Contact your authorized Sea-Doo dealer.

⚠ WARNING

Never charge or boost the battery while installed in the watercraft.

Bilge Cleaning

Clean the bilge with hot water and detergent or with bilge cleaner. Rinse thoroughly. Lift front end of watercraft to completely drain bilge through the bilge drain plugs.

Body and Hull Cleaning

Wash the body with a soap and water solution (use only mild detergent). Rinse thoroughly with fresh water. Remove marine organisms from the hull.

NOTICE Never clean fiberglass and plastic parts with strong detergent, de-greasing agent, paint thinner, acetone, or other strong chemical or petroleum cleaners.

For gelcoat repairs, refer to an authorized Sea-Doo dealer. Replace damaged labels/decals.

Body and Hull Repair

If any repairs are needed to body components or to the hull, contact your authorized Sea-Doo dealer. For paint touch up of mechanical parts use BRP spray paint.

Watercraft Protection

Apply a good quality marine wax to the body.

The seat should be left partially open. This will prevent engine compartment condensation and possible corrosion.

If the watercraft is to be stored outside, cover it with an opaque tarpaulin to prevent sun rays and grime from affecting the plastic components, watercraft finish, as well as preventing dust accumulation.

NOTICE The watercraft should never be left in water for storage. Never leave the watercraft stored in direct sunlight. Never store watercraft in a plastic bag.

Preseason Preparation

Maintenance preparation must be performed in conjunction with *PERIODIC MAINTENANCE CHART*.

Ensure to perform all tasks included in the **100 HOURS OR 1 YEAR** column.

Since technical skills and special tools are required, some operations should be performed by an authorized Sea-Doo dealer.

NOTE: It is highly recommended that an authorized Sea-Doo dealer perform factory campaigns in addition to the preseason preparation all at the same time.

WARNING

Only perform procedures as detailed in the *PERIODIC MAINTENANCE CHART*. It is recommended that the assistance of an authorized Sea-Doo dealer be periodically obtained on other components and systems not covered in this guide.

NOTICE When component conditions seem less than satisfactory, replace using only genuine BRP parts, or approved equivalents.

TECHNICAL INFORMATION

VEHICLE IDENTIFICATION

The main components of the watercraft (engine and hull) are identified by different serial numbers. It may sometimes become necessary to locate these numbers for warranty purposes or to trace the watercraft in the event of theft.

Hull Identification Number

The Hull Identification Number (H.I.N.) is located on footboard at the rear of watercraft.



TYPICAL

1. Hull Identification Number (H.I.N.)

It is composed of 12 digits:

YDV 12345 L 8 09	
	Model year
	Year of production
	Month of production
	Serial number (a letter may also be used as a digit)
	Manufacturer

Engine Identification Number

NOTE: Refer to *SPECIFICATIONS* section to find what engine is used on each model.

The Engine Identification Number (E.I.N.) is located on the front end of the engine.

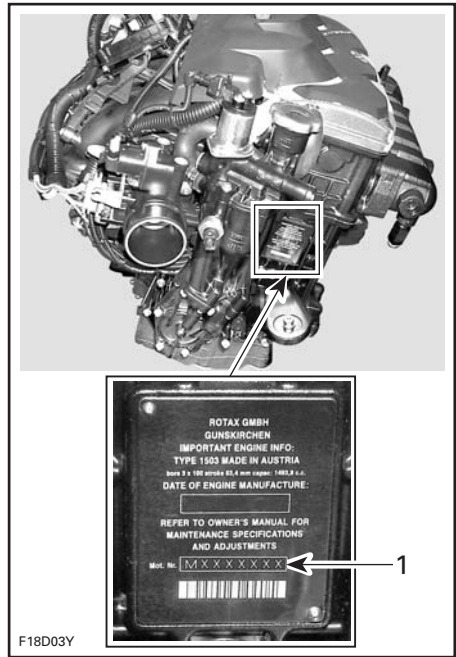

TYPICAL

1. Engine Identification Number (E.I.N.)

EPA Compliance Label

EMISSION CONTROL INFORMATION			
THIS VEHICLE IS CERTIFIED TO OPERATE ON UNLEADED GASOLINE AND MEETS TO [XXXX] U.S. EPA AND CALIFORNIA REGULATIONS FOR ATV'S/ENGINES.			
ENGINE FAMILY	XXXXXXXXXXXX	FAMILLE DE MOTEUR	
CERTIFICATION STANDARD (FEL)	XXXXXXXXXXXX	LIMITE DES ÉMISSIONS DE LA FAMILLE	
ENGINE DISPLACEMENT	XXXXXXXXXX	CYLINDRÉE	
EXHAUST EMISSION CONTROL SYSTEM	XXXX	SYSTÈME DE CONTRÔLE DES ÉMISSIONS	
RENSEIGNEMENTS SUR LE DISPOSITIF ANTIPOLLUTION			
CE VÉHICULE EST CERTIFIÉ POUR FONCTIONNER À L'ESSENCE SANS PLOMB ET IL RÉPOND AUX NORMES [XXXX] DE L'EPA ET RÉGLEMENTATIONS CALIFORNIENNES POUR LES VTT À MOTEUR SI.			
SEE OPERATOR'S GUIDE FOR MAINTENANCE SPECIFICATIONS VOIR GUIDE DU CONDUCTEUR POUR LES SPÉCIFICATIONS D'ENTRETIENS BOMBARDIER RECREATIONAL PRODUCTS INC.			

vmo2007-002-002

The EPA compliance label is located on the front ventilation box riser.

It can be seen by opening the front cover, removing the front storage bin and looking aft.



1. Compliance label
2. Ventilation box
3. Riser

ENGINE EMISSIONS INFORMATION

NOTE: Maintenance, replacement, or repair of the emission control devices and systems may be performed by any marine SI (spark ignition) engine repair establishments or individual.

Manufacturer's Responsibility

Beginning with 1999 model year engines, PWC manufacturers of marine engines must determine the exhaust emission levels for each engine horsepower family and certify these engines with the United States of America Environmental Protection Agency (EPA). An emissions control information label, showing emission levels and engine specifications, must be placed on each vehicle at the time of manufacture.

Dealer's Responsibility

When performing service on all 1999 and more recent Sea-Doo watercraft that carry an emissions control information label, adjustments must be kept within published factory specifications.

Replacement or repair of any emission related component must be executed in a manner that maintains emission levels within the prescribed certification standards.

Dealers are not to modify the engine in any manner that would alter the horsepower or allow emission levels to exceed their predetermined factory specifications.

Exceptions include manufacturer's prescribed changes, such as altitude adjustments for example.

Owner Responsibility

The owner/operator is required to have engine maintenance performed to maintain emission levels within prescribed certification standards.

The owner/operator is not to, and should not allow anyone to modify the engine in any manner that would alter the horsepower or allow emissions levels to exceed their predetermined factory specifications.

EPA Emission Regulations

All 1999 and more recent Sea-Doo watercraft manufactured by BRP are certified to the EPA as conforming to the requirements of the regulations for the control of air pollution from new watercraft engines. This certification is contingent on certain adjustments being set to factory standards. For this reason, the factory procedure for servicing the product must be strictly followed and, whenever practicable, returned to the original intent of the design.

The responsibilities listed above are general and in no way a complete listing of the rules and regulations pertaining to the EPA requirements on exhaust emissions for marine products. For more detailed information on this subject, you may contact:

U.S. Environmental Protection Agency
Office of Transportation and Air Quality
1200 Pennsylvania Ave. NW
Mail Code 6403J
Washington D.C. 20460

EPA INTERNET WEB SITE:
<http://www.epa.gov/otaq>

SPECIFICATIONS

VEHICLE		RXT IS 255	GTX LIMITED IS 255
ENGINE			
Type		Rotax® 4-TECT™, Single Over Head Camshaft (SOHC)	
		255 hp	
Number of cylinder		3	
Number of valve		12 valves (4 per cylinder) with hydraulic lifters (no adjustment)	
Displacement		1 494 cm ³ (91.2 in ³)	
Intake system	Type	Supercharged with external intercooler	
	Electronic Throttle body	60 mm (2.4 in)	
Bore		100 mm (3.9 in)	
Stroke		63.4 mm (2.5 in)	
Compression ratio		8.4:1	
Cooling		Closed-loop system	
ELECTRICAL SYSTEM			
Ignition		IDI (inductive discharge ignition)	
Starter		Electric	
Battery		12 V, 30 A•h. Electrolyte type	
Spark plug	Make and type	NGK, DCPR8E	
	Gap	0.75 mm (.03 in)	
PROPULSION			
Propulsion system		Sea-Doo direct drive	
Jet pump	Type	Axial flow, single stage. Large hub with 10-vane stator	
	Material	Aluminum	
Impeller		Stainless steel	
Transmission	Type	Electronic: iBR, Direct drive (forward/neutral/reverse)	
VTS	Type	Electronic with Manual and Preset positioning	

SPECIFICATIONS

VEHICLE		RXT IS 255	GTX LIMITED IS 255
DIMENSIONS			
Length		353.5 cm (139.2 in)	
Width		122.4 cm (48.2 in)	
Height		127.7 cm (50.3 in)	
WEIGHT AND LOADING CAPACITY			
Weight (dry)		430 kg (948 lb)	
Rider capacity (refer to load limit)		1, 2 or 3	
Storage capacity		62 L (16.4 U.S. gal.)	
Load limit (passengers + luggage)		226 kg (500 lb)	
FLUIDS			
Fuel	Type	Unleaded	
	Minimum octane	Inside North America: (87 (RON + MON)/2)	
		Outside North America: 92 RON	
	Recommended octane rating for optimum performance	Inside North America: (91 (RON + MON)/2)	
		Outside North America: 95 RON	
Tank capacity	70 L (18.5 U.S. gal.)		
Engine oil	Type	XPS summer grade. Refer to <i>MAINTENANCE</i> section for more information.	
	Capacity	3 L (2.7 U.S. qt) oil change w/filter	
Cooling system	Coolant type	Ethylene-glycol 50%/50% antifreeze and demineralized water. Coolant containing corrosion inhibitors for internal combustion aluminum engines	
	Capacity	5.5 L (5 U.S. qt) total	

NOTE: BRP reserves the right to make changes in design and specifications and/or to make additions to, or improvements in its products without imposing any obligation upon itself to install them on its products previously manufactured.

TROUBLESHOOTING

TROUBLESHOOTING GUIDELINES

ENGINE WILL NOT START

1. D.E.S.S. key removed.
 - *Install D.E.S.S. key over post.*
2. ECM does not recognize the D.E.S.S. key.
 - *Refer to an authorized Sea-Doo dealer.*
3. Burnt fuse: main, electric starter or ECM.
 - *Check wiring then replace fuse(s).*
4. Discharged battery.
 - *Refer to an authorized Sea-Doo dealer.*

WARNING

Do not charge or boost the battery while installed on the watercraft. Electrolyte is poisonous and dangerous. Avoid contact with eyes, skin and clothing.

5. Battery connections, corroded or loose. Bad ground.
 - *Refer to an authorized Sea-Doo dealer.*
6. Water-flooded engine.
 - *Refer to WATER-FLOODED ENGINE in SPECIAL PROCEDURES.*
7. Faulty sensor or ECM.
 - *Refer to an authorized Sea-Doo dealer.*
8. Seized jet pump.
 - *Try to clean. Otherwise, refer to an authorized Sea-Doo dealer.*

ENGINE TURNS SLOWLY

1. Loose battery cable connections.
 - *Check/clean/tighten.*
2. Discharged or weak battery.
 - *Refer to an authorized Sea-Doo dealer.*
3. Worn starter.
 - *Refer to an authorized Sea-Doo dealer.*

ENGINE TURNS NORMALLY BUT WILL NOT START

1. Fuel tank empty or water-contaminated.
 - *Refill. Siphon and fill with fresh fuel.*
2. Fouled/defective spark plugs.
 - *Replace.*
3. Blown fuse.
 - *Check wiring then replace fuse(s).*
4. Water-flooded engine.
 - *Refer to WATER-FLOODED ENGINE in SPECIAL PROCEDURES.*

ENGINE TURNS NORMALLY BUT WILL NOT START (cont'd)

5. Engine management system fault detected (check engine pilot lamp is ON).
 - Refer to an authorized Sea-Doo dealer.
6. Faulty fuel pump.
 - Refer to an authorized Sea-Doo dealer.

ENGINE MISFIRES, RUNS IRREGULARLY

1. Fouled/defective/worn spark plugs.
 - Replace.
2. Fuel: Level too low, stale or water-contaminated.
 - Siphon and/or refill.
3. Faulty ignition coil(s).
 - Refer to an authorized Sea-Doo dealer.
4. Clogged injectors.
 - Refer to an authorized Sea-Doo dealer.
5. Engine management system fault detected (check engine pilot lamp is ON).
 - Refer to MONITORING SYSTEM.

ENGINE SMOKE

1. Oil level too high.
 - Refer to an authorized Sea-Doo dealer.
2. Water ingestion, coolant leak or damaged cylinder head gasket.
 - Refer to an authorized Sea-Doo dealer.
3. Internal engine damage.
 - Refer to an authorized Sea-Doo dealer.

ENGINE OVERHEATS

1. Clogged exhaust system.
 - Flush exhaust system.
2. Engine coolant level too low.
 - Refer to MAINTENANCE PROCEDURES.
3. Quick connect adapter left in flushing connector.
 - Remove adapter from flushing connector and retry watercraft. If problem persists, refer to an authorized Sea-Doo dealer.

ENGINE LACKS ACCELERATION OR POWER

1. Jet pump water intake clogged.
 - Clean. Refer to JET PUMP WATER INTAKE AND IMPELLER CLEANING in SPECIAL PROCEDURES section.
2. Damaged impeller or worn-out wear ring.
 - Replace. Refer to an authorized Sea-Doo dealer.

ENGINE LACKS ACCELERATION OR POWER (cont'd)

3. **Engine oil level too high.**
 - *Refer to an authorized Sea-Doo dealer.*
4. **Weak spark.**
 - *Refer to ENGINE MISFIRES, RUNS IRREGULARLY.*
5. **Engine management system fault detected (check engine pilot lamp is ON).**
 - *Refer to MONITORING SYSTEM.*
6. **Clogged injectors.**
 - *Refer to an authorized Sea-Doo dealer.*
7. **Low fuel pressure.**
 - *Refer to an authorized Sea-Doo dealer.*
8. **Water in fuel.**
 - *Siphon and replace.*
9. **Engine damaged by water ingestion.**
 - *Refer to an authorized Sea-Doo dealer.*

WATERCRAFT CAN NOT REACH TOP SPEED

1. **Jet pump water intake clogged.**
 - *Clean. Refer to JET PUMP WATER INTAKE AND IMPELLER CLEANING in SPECIAL PROCEDURES section.*
2. **Damaged impeller or worn-out wear ring.**
 - *Replace. Refer to an authorized Sea-Doo dealer.*
3. **Engine management system fault detected (check engine pilot lamp is ON).**
 - *Refer to MONITORING SYSTEM.*
4. **Faulty supercharger and/or intercooler (supercharged models).**
 - *Refer to an authorized Sea-Doo dealer.*

WATERCRAFT STAYS IN NEUTRAL AFTER OPERATING THE iBR LEVER

1. **The iBR gate stays in neutral.**
 - *Release the throttle to idle RPM.*
 - *Press the CRUISE button to activate the slow speed mode.*
 - *Return to shore using the slow speed mode. Refer to an authorized Sea-Doo dealer.*

iBR WILL NOT RETURN TO NEUTRAL POSITION (iBR INDICATOR LIGHT ON)

1. **iBR jammed with debris.**
 - *Clean and check for damage in the iBR gate and nozzle area.*
2. **iBR system malfunction.**
 - *Remove D.E.S.S. key, wait four minutes, reinstall key and check iBR light to ensure fault is cleared.*
 - *Refer to an authorized Sea-Doo dealer if fault persists or reoccurs frequently.*

iBR WILL NOT RETURN TO NEUTRAL POSITION (iBR INDICATOR LIGHT OFF)

- 1. Throttle lever not fully released during operation.**
 - *Release throttle lever fully to ensure iBR gate returns to neutral.*
- 2. Throttle lever does not fully return to null when released.**
 - *Refer to an authorized Sea-Doo dealer.*

ABNORMAL NOISE FROM PROPULSION SYSTEM

- 1. Weeds or debris jammed around impeller.**
 - *Clean. Refer to JET PUMP WATER INTAKE AND IMPELLER CLEANING in SPECIAL PROCEDURES section.*
 - *Ceck for damage.*
- 2. Damaged impeller shaft or drive shaft.**
 - *Refer to an authorized Sea-Doo dealer.*
- 3. Water intrusion in jet pump causing bearing seizure.**
 - *Refer to an authorized Sea-Doo dealer.*

WATER FOUND IN BILGE

- 1. Bailer system malfunction.**
 - *Have system inspected by an authorized Sea-Doo dealer.*
- 2. Exhaust system leak.**
 - *Refer to an authorized Sea-Doo dealer.*
- 3. Carbon ring at drive shaft worn.**
 - *Refer to an authorized Sea-Doo dealer.*

MONITORING SYSTEM

A system monitors the electronic components of the EMS (engine management system) iBR, iS, and other components of the electrical system. When a fault occurs, it sends visual messages through the information center and/or audible signals through a beeper to inform you of a particular condition.

A fault code may also be recorded.

When a minor or transient fault occurs, the fault message and beeper will cease automatically if the condition that caused the fault does not exist anymore.

Releasing the throttle and letting the engine return to idle speed may allow normal operation to come back. If this does not work, try removing and reinstalling the D.E.S.S. key on its post.

The electronic system will react differently depending on the fault type. In severe failure, the engine may not be allowed to be started. In other cases, the engine will operate in limp home mode (reduced speed).

When a fault occurs, see an authorized Sea-Doo dealer as soon as possible for inspection.

Fault Codes

When a fault occurs, a numerical fault code may be recorded depending on the fault type and system.

These fault codes are used by authorized Sea-Doo dealers for troubleshooting the watercraft systems when comparing them to a fault list.

Fault codes can be viewed in the information center multifunction display however, this function is only available if a fault is still active.

If there is an active fault code, it may be viewed by the operator on the multifunction display. The operator may then choose to call his authorized Sea-Doo dealer to pass on the fault code. The dealer will then advise the

operator on the steps to take to solve the problem, or to stop using the watercraft and to bring it in to the dealer for repairs.

Displaying Fault Codes

Press the MODE button repeatedly until the FAULT CODE function is visible in the multifunction display.

Press the SET or the UP or DOWN arrow button to enter the function and display the first fault code, then press the UP or DOWN arrow button repeatedly to display each subsequent code.

NOTE: When the last fault code has been displayed and the button is pressed again, the system loops back to the first fault code displayed, and all fault codes can again be displayed. If there was one active fault code when entering the FAULT CODE mode, and it becomes occurred (no longer active), a NO ACTIVE FAULT CODE message will scroll in the display.

To exit the FAULT CODE display function, the MODE or SET button must be pressed once. There is no time out on this function.

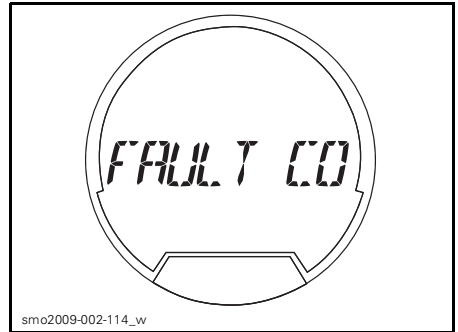

FAULT CODE DISPLAY FUNCTION

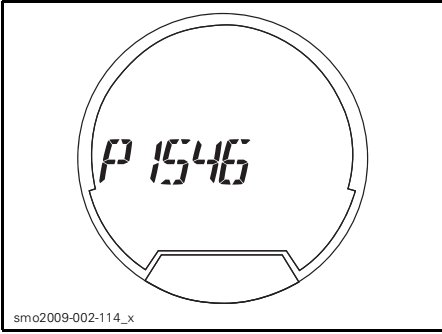

Indicator Lights and Message Display Information

The indicator lights (pilot lamps) and messages displayed in the information center will inform you of a particular condition or if an anomaly occurs.

For information on indicator lights, refer to *INFORMATION CENTER (GAUGE)*.

TYPICAL - ENGINE FAULT CODE EXAMPLE

MESSAGE DISPLAY INFORMATION	
RIGHT KEYPAD ERROR	Gauge control button malfunction
LOW OIL PRESSURE	Engine low oil pressure detected
HIGH EXHAUST TEMPERATURE	High exhaust temperature detected
HIGH TEMPERATURE	High engine temperature detected
CHECK ENGINE	Engine system malfunction or maintenance required
HIGH BATTERY VOLTAGE	High battery voltage detected
LOW BATTERY VOLTAGE	Low battery voltage detected
LIMP HOME MODE	Major fault detected, engine power limited
FUEL SENSOR DEFECTIVE	Fuel level sensor fault
WATER TEMP SENSOR DEFECTIVE	Problem in iBR, not sending water temperature info.
DEPTH SENSOR DEFECTIVE	Depth sensor problem
CALIBRATION CHECKSUM ERROR	Cluster programming corrupted
MAINTENANCE REQUIRED	Watercraft maintenance required
SUPERCHARGER MAINTENANCE REQUIRED	Maintenance on supercharger required

NOTICE Running engine with low oil pressure may severely damage the engine.

Beeper Code Information

BEEPER CODES	DESCRIPTION
1 Long Beep (while installing D.E.S.S. key on watercraft post)	Bad D.E.S.S. system connection. Reinstall D.E.S.S. key correctly over post.
	Wrong D.E.S.S. key. Use a D.E.S.S. key that has been programmed for the watercraft.
	Defective D.E.S.S. key. Use another programmed D.E.S.S. key.
	Dried salt water in D.E.S.S. key. Clean D.E.S.S. key to remove salt water.
	Defective D.E.S.S. post. Refer to an authorized Sea-Doo dealer.
	Improper operation of ECM or defective wiring harness. Refer to an authorized Sea-Doo dealer.
A 2 Seconds Beep every 15 minutes interval	Watercraft is upside down. Turn watercraft upright. Refer to <i>SPECIAL PROCEDURES</i> .
	Engine management system fault. Refer to an authorized Sea-Doo dealer.
A 2 Seconds Beep every 5 minutes interval	Low fuel level. Refill fuel tank. If problem persists, refer to an authorized Sea-Doo dealer.
	Fuel tank level sensor or circuit malfunction. Refer to an authorized Sea-Doo dealer.
Continuously Beeps	High engine temperature coolant. See <i>ENGINE OVERHEATING</i> .
	High exhaust temperature. Refer to an authorized Sea-Doo dealer.
	Low oil pressure. Turn off engine as soon as possible. Check oil level and refill. Refer to an authorized Sea-Doo dealer.

NOTICE If the monitoring beeper continuously sounds, stop engine as soon as possible.

WARRANTY

BRP LIMITED WARRANTY – USA AND CANADA: 2009 SEA-DOO® PERSONAL WATERCRAFT

1. SCOPE

Bombardier Recreational Products Inc. ("BRP")* warrants its model-year 2009 Sea-Doo personal watercraft sold by authorized Sea-Doo Dealers (as defined below) in the fifty United States and in Canada from defects in material or workmanship for the period and under the conditions described below. This limited warranty will become null and void if: (1) the Sea-Doo personal watercraft was used for racing or any other competitive activity, at any point, even by a previous owner; or (2) the Sea-Doo personal watercraft has been altered or modified in such a way so as to adversely affect its operation, performance or durability; (3) or has been altered or modified to change its intended use.

All genuine BRP parts and accessories, installed by an authorized BRP dealer (as hereinafter defined) at the time of delivery of the Sea-Doo personal watercraft, carry the same warranty as that of the personal watercraft.

A GPS receiver may be supplied by BRP as standard equipment on certain 2009 Sea-Doo personal watercraft. The GPS receiver is covered by the limited warranty issued by the GPS receiver's manufacturer and is not covered by this limited warranty.

2. LIMITATIONS OF LIABILITY

THIS WARRANTY IS EXPRESSLY GIVEN AND ACCEPTED IN LIEU OF ANY AND ALL OTHER WARRANTIES, EXPRESSED OR IMPLIED, INCLUDING WITHOUT LIMITATION ANY WARRANTY OF MERCHANTABILITY OR FITNESS FOR A PARTICULAR PURPOSE. TO THE EXTENT THAT THEY CANNOT BE DISCLAIMED, THE IMPLIED WARRANTIES ARE LIMITED IN DURATION TO THE LIFE OF THE EXPRESS WARRANTY. INCIDENTAL AND CONSEQUENTIAL DAMAGES ARE EXCLUDED FROM COVERAGE UNDER THIS WARRANTY. SOME STATES/PROVINCES DO NOT ALLOW FOR THE DISCLAIMERS, LIMITATIONS AND EXCLUSIONS IDENTIFIED ABOVE, AS A RESULT, THEY MAY NOT APPLY TO YOU. THIS WARRANTY GIVES YOU SPECIFIC RIGHTS, AND YOU MAY ALSO HAVE OTHER LEGAL RIGHTS WHICH MAY VARY FROM STATE TO STATE, OR PROVINCE TO PROVINCE.

Neither the distributor, any BRP dealer nor any other person has been authorized to make any affirmation, representation or warranty regarding the product, other than those contained in this limited warranty, and if made, shall not be enforceable against BRP. BRP reserves the right to modify this warranty at any time, being understood that such modification will not alter the warranty conditions applicable to the products sold while this warranty is in effect.

3. EXCLUSIONS

The following are not warranted under any circumstances:

- Normal wear and tear;
- Routine maintenance items, tune ups, adjustments;
- Damage caused by failure to provide proper maintenance and/or storage, as described in the Operator's Guide;

- Damage resulting from removal of parts, improper repairs, service, maintenance, modifications or use of parts not manufactured or approved by BRP or resulting from repairs done by a person that is not an authorized servicing BRP dealer;
- Damage caused by abuse, abnormal use, neglect, or operation of the product in a manner inconsistent with the recommended operation described in the Operator's Guide;
- Damage resulting from accident, submersion, fire, theft, vandalism or any act of God;
- Operation with fuels, oils or lubricants which are not suitable for use with the product (see the Operator's Guide);
- Water damages caused by water ingestion;
- Damages related to gel coat finish including but not limited to cosmetic gel coat finish, blisters or fiberglass delamination caused by blisters, crazing, spider or hairline cracks; and
- Incidental or consequential damages, or damages of any kind including without limitation towing, storage, telephone, rental, taxi, inconvenience, insurance coverage, loan payments, loss of time, loss of income.

4. WARRANTY COVERAGE DURATION

The repair or replacement of parts or the performance of service under this warranty does not extend the life of this warranty beyond its original expiration date.

For Sea-Doo personal watercraft produced for sale in the states of California or New York, that are originally sold to a resident or subsequently warranty registered to a resident in the state of California or New York, please also refer to the applicable California and New York Emissions Control Warranty Statement.

This warranty will be in effect from the date of delivery to the first retail consumer or the date the product is first put into use, whichever occurs first and for a period of:

1. TWELVE (12) CONSECUTIVE MONTHS for private use owners.
2. FOUR (4) CONSECUTIVE MONTHS for commercial use owners. A personal watercraft is used commercially when it is used in connection with generating income or any work or employment during any part of the warranty period. A personal watercraft is also used commercially when, at any point during the warranty period, it has commercial tags or is licensed for commercial use.
3. In addition to the above, the emission related components providing input to emission control (see list below) are covered for TWENTY-FOUR (24) CONSECUTIVE MONTHS OR 200 HOURS OF ENGINE USE whichever occurs first.

EMISSION RELATED COMPONENTS
Throttle Position Sensor (TPS)
Air Temperature sensor (ATS)
Air Pressure Sensor (APS)

5. CONDITIONS FOR WARRANTY COVERAGE

This warranty coverage is available only if each of the following conditions has been fulfilled:

- The 2009 Sea-Doo personal watercraft must be purchased as new and unused by its first owner from a BRP dealer authorized to distribute Sea-Doo personal watercraft in the country in which the sale occurred (“BRP dealer”);
- The BRP specified predelivery inspection process must be completed and documented;
- The 2009 Sea-Doo personal watercraft must have undergone proper registration by an authorized BRP dealer;
- The 2009 Sea-Doo personal watercraft must be purchased in the country in which the purchaser resides;
- Routine maintenance outlined in the Operator’s Guide must be timely performed in order to maintain warranty coverage. BRP reserves the right to make warranty coverage contingent upon proof of proper maintenance.

BRP will not honour this limited warranty to any private use owner or commercial use owner if the preceding conditions have not been met. Such limitations are necessary in order to allow BRP to preserve both the safety of its products, and also that of its consumers and the general public.

6. WHAT TO DO TO OBTAIN WARRANTY COVERAGE

The customer must cease using the Sea-Doo personal watercraft upon the appearance of an anomaly. The customer must notify an authorized servicing BRP dealer within two (2) days of the appearance of a defect, and provide it with reasonable access to the product and reasonable opportunity to repair it. The customer must also present to the authorized BRP dealer, proof of purchase of the product and must sign the repair/work order prior to the start of the repair in order to validate the warranty repair. All parts replaced under this limited warranty become the property of BRP.

7. WHAT BRP WILL DO

BRP’s obligations under this warranty are limited to, at its sole discretion, repairing parts found defective under normal use, maintenance and service, or replacing such parts with new genuine BRP parts without charge for parts and labor, at any authorized BRP dealer during the warranty coverage period under the conditions described herein. No claim of breach of warranty shall be the cause for cancellation or rescission of the sale of the Sea-Doo personal watercraft to the owner.

In the event that service is required outside of the country of original sale, the owner will bear responsibility for any additional charges due to local practices and conditions, such as, but not limited to, freight, insurance, taxes, license fees, import duties, and any and all other financial charges, including those levied by governments, states, territories and their respective agencies.

BRP reserves the right to improve or modify products from time to time without assuming any obligation to modify products previously manufactured.

8. TRANSFER

If the ownership of a product is transferred during the warranty coverage period, this warranty shall also be transferred and be valid for the remaining coverage period provided that BRP is notified of such transfer of ownership in the following way:

1. The former owner contacts BRP (at the phone number provided below) or an authorized BRP dealer and gives the coordinates of the new owner; or
2. BRP or an authorized BRP dealer receives a proof that the former owner agreed to the transfer of ownership, in addition to the coordinates of the new owner.

9. CONSUMER ASSISTANCE

In the event of a controversy or a dispute in connection with this BRP limited warranty, BRP suggests that you try to resolve the issue at the dealership level. We recommend discussing the issue with the authorized dealer's service manager or owner.

If the issue has not yet been resolved, please submit your complaint in writing or call the appropriate number below:

In CANADA

Bombardier Recreational Products Inc.
Customer Assistance Center
75, J.-A. Bombardier Street
Sherbrooke, QC J1L 1W3
Tel.: 819 566-3366

In USA

BRP US Inc.
Customer Assistance Center
7575 Bombardier Court
Wausau WI 54401
Tel.: 715 848-4957

* In the USA, products are distributed and serviced by BRP US Inc.

© 2008 Bombardier Recreational Products Inc. All rights reserved.

® Registered trademark of Bombardier Recreational Products Inc. or its affiliates.

CALIFORNIA AND NEW YORK EMISSION CONTROL WARRANTY STATEMENT FOR MODEL YEAR 2009 SEA-DOO® PERSONAL WATERCRAFT WITH 4-TEC® ENGINES

For California, your Sea-Doo personal watercraft has a special environmental label required by the California Air Resources Board. The label has 1, 2, 3 or 4 stars. A hangtag, provided with your personal watercraft, describes the meaning of the star rating system.

The Star Label Means Cleaner Marine Engines

The Symbol for Cleaner Marine Engines:



F18L3CQ

Cleaner Air and Water

For a healthier lifestyle and environment.

Better Fuel Economy

Burns up to 30 - 40 percent less gas and oil than conventional carbureted two-stroke engines, saving money and resources.

Longer Emission Warranty

Protects consumer for worry free operation.

One Star – Low Emission

The one-star label identifies personal watercraft, outboard, stern drive and inboard engines that meet the Air Resources Board's Personal Watercraft and Outboard marine engine 2001 exhaust emission standards. Engines meeting these standards have 75% lower emissions than conventional carbureted two-stroke engines. These engines are equivalent to the U.S. EPA's 2006 standards for marine engines.

Two Stars – Very Low Emission

The two-star label identifies personal watercraft, outboard, stern drive and inboard engines that meet the Air Resources Board's Personal Watercraft and Outboard marine engine 2004 exhaust emission standards. Engines meeting these standards have 20% lower emissions than One Star - Low-Emission engines.

Three Stars – Ultra Low Emission

The three-star label identifies engines that meet the Air Resources Board's Personal Watercraft and Outboard marine engine 2008 exhaust emission standards or the Stern drive and Inboard marine engine 2003 exhaust emission standards. Engines meeting these standards have 65% lower emissions than One Star – Low Emission engines.

Four Stars – Super Ultra Low Emission

The four-star label identifies engines that meet the Air Resources Board's Stern-drive and Inboard marine engine 2009 exhaust emission standards. Personal Watercraft and Outboard marine engines may also comply with these standards. Engines meeting these standards have 90% lower emissions than One Star – Low Emission engines.

For more information: Cleaner Watercraft – Get the Facts
1 800 END-SMOG
www.arb.ca.gov

Your Emission Control Warranty Rights and Obligations

The California Air Resources Board, the New York State Department of Environmental Conservation, and BRP US Inc. ("BRP") on behalf of Bombardier Recreational Products Inc. are pleased to explain the emission control system warranty on your model year 2009 Sea-Doo personal watercraft. In the states of California and New York, new personal watercraft engines must be designed, built and equipped to meet the State's stringent anti-smog standards. BRP must warrant the emission control system on your personal watercraft engine for the periods of time listed below provided there has been no abuse, neglect or improper maintenance of your personal watercraft engine.

Your emission control system may include parts such as the carburetor or fuel injection system, the ignition system and catalytic converter. Also included may be hoses, belts, connectors and other emission related assemblies.

Where a warrantable condition exists, BRP will repair your 2009 Sea-Doo personal watercraft engine at no cost to you including diagnosis, parts and labor provided that such work is performed by an authorized BRP dealer.

Manufacturer's Limited Warranty Coverage

This emission warranty covers model year 2009 Sea-Doo personal watercraft certified and produced by BRP for sale in the states of California and New York, that are originally sold to a resident or subsequently warranty registered to a resident in the state of California or New York. The BRP limited warranty conditions for Sea-Doo personal watercraft are still applicable to these models with the necessary modifications.

Select emission control parts of your 2009 Sea-Doo personal watercraft are warranted from the date of delivery to the first retail consumer for a period of 4 years, or for 250 hours of use, whichever occurs first. However, warranty coverage based on the hourly period is only permitted for personal watercraft equipped with the appropriate hour meters or their equivalent. If any emission-related part on your engine is defective under warranty, the part will be repaired or replaced by BRP.

Parts covered for a model year 2009 Sea-Doo personal watercraft equipped with 4-TEC® engines:

Digital linear actuator (low idle control)	Supercharger
Throttle position sensor	All fuel system components
Intake manifold air temperature sensor	Ignition coils
Intake manifold air pressure sensor	Piston and rings
Engine temperature sensor	Intake and exhaust valve gear/train
Knock sensor	Crankcase ventilation valve
Emission control unit	Wire harness and connectors
Injectors	Emission related seals, gaskets and hoses
Fuel pressure regulator	Exhaust manifold
Intake manifold	Valves, valve guides and valve guide sealing
Intercooler	

The emission warranty covers damage to other engine components that is caused by the failure of a warranted part.

The BRP Operator’s Guide provided contains written instructions for the proper maintenance and use of your personal watercraft. All emission warranty parts are warranted by BRP for the entire warranty period of the personal watercraft, unless the part is scheduled for replacement as required maintenance in the Operator’s Guide.

Emission warranty parts that are scheduled for replacement, as required maintenance, are warranted by BRP for the period of time before the first scheduled replacement date for that part. Emission warranty parts that are scheduled for regular inspection, but not regular replacement, are warranted by BRP for the entire warranty period of the personal watercraft. Any emission warranty part repaired or replaced under the terms of this warranty statement is warranted by BRP for the remainder of the warranty period of the original part. All parts replaced under this limited warranty become the property of BRP.

Maintenance receipts and records should be transferred to each subsequent owner of the personal watercraft.

Owner's Warranty Responsibilities

As the personal watercraft owner, you are responsible for the performance of the required maintenance listed in your Operator's Guide. BRP recommends that you retain all receipts covering maintenance on your personal watercraft engine, but BRP cannot deny warranty solely for the lack of receipts or your failure to ensure the performance of all scheduled maintenance.

As the personal watercraft owner, you should however be aware that BRP may deny you warranty coverage if your personal watercraft engine or a part has failed due to abuse, neglect, improper maintenance or unapproved modifications.

You are responsible for presenting your personal watercraft engine to an authorized BRP dealer as soon as a problem exists. The warranty repairs will be completed in a reasonable amount of time, not to exceed 30 days.

If you have any questions regarding your warranty rights and responsibilities or for the name and location of the nearest authorized BRP dealer you should contact the Customer Services Group at 1 715 848-4957.

* In the USA, products are distributed and serviced by BRP US Inc.

© 2008 Bombardier Recreational Products Inc. All rights reserved.

® Registered trademark and TMtrademark of Bombardier Recreational Products Inc. or its affiliates.

BRP INTERNATIONAL LIMITED WARRANTY: 2009 SEA-DOO® PERSONAL WATERCRAFT

1. SCOPE

Bombardier Recreational Products Inc. ("BRP")* warrants its model year 2009 Sea-Doo personal watercraft sold by authorized BRP distributors/dealers (defined below) outside of the fifty United States, Canada and states members of the European Economic Area (which is comprised of the states member of the European Union plus Norway, Iceland and Liechtenstein), will be free from defects in material or workmanship for the period and under the conditions described below. This limited warranty will become null and void if: (1) the Sea-Doo personal watercraft was used for racing or any other competitive activity, at any point, even by a previous owner; or (2) the Sea-Doo personal watercraft has been altered or modified in such a way so as to adversely affect its operation, performance or durability; (3) or has been altered or modified to change its intended use.

All genuine BRP parts and accessories, installed by an authorized BRP distributor/dealer at the time of delivery of the 2009 Sea-Doo personal watercraft, carry the same warranty as that of the personal watercraft.

2. LIMITATIONS OF LIABILITY

THIS WARRANTY IS EXPRESSLY GIVEN AND ACCEPTED IN LIEU OF ANY AND ALL OTHER WARRANTIES, EXPRESSED OR IMPLIED, INCLUDING WITHOUT LIMITATION ANY WARRANTY OF MERCHANTABILITY OR FITNESS FOR A PARTICULAR PURPOSE. TO THE EXTENT THAT THEY CANNOT BE DISCLAIMED, THE IMPLIED WARRANTIES ARE LIMITED IN DURATION TO THE LIFE OF THE EXPRESS WARRANTY. INCIDENTAL AND CONSEQUENTIAL DAMAGES ARE EXCLUDED FROM COVERAGE UNDER THIS WARRANTY. SOME JURISDICTIONS DO NOT ALLOW FOR THE DISCLAIMERS, LIMITATIONS AND EXCLUSIONS IDENTIFIED ABOVE, AS A RESULT, THEY MAY NOT APPLY TO YOU. THIS WARRANTY GIVES YOU SPECIFIC RIGHTS, AND YOU MAY ALSO HAVE OTHER LEGAL RIGHTS WHICH MAY VARY FROM COUNTRY TO COUNTRY.

Neither the BRP distributor, any BRP dealer nor any other person has been authorized to make any affirmation, representation or warranty regarding the product, other than those contained in this limited warranty, and if made, shall not be enforceable against BRP. BRP reserves the right to modify this warranty at any time, being understood that such modification will not alter the warranty conditions applicable to the products sold while this warranty is in effect.

3. EXCLUSIONS

The following are not warranted under any circumstances:

- Normal wear and tear;
- Routine maintenance items, tune ups, adjustments;
- Damage caused by failure to provide proper maintenance and/or storage, as described in the Operator's Guide;
- Damage resulting from removal of parts, improper repairs, service, maintenance, modifications or use of parts not manufactured or approved by BRP or resulting from repairs done by a person that is not an authorized servicing BRP distributor/dealer;

- Damage caused by abuse, abnormal use, neglect or operation of the product in a manner inconsistent with the recommended operation described in the Operator’s Guide;
- Damage resulting from accident, submersion, fire, theft, vandalism or any act of God;
- Operation with fuels, oils or lubricants which are not suitable for use with the product (see the Operator’s Guide);
- Water damages caused by water ingestion;
- Damages related to gel coat finish including but not limited to cosmetic gel coat finish, blisters or fiberglass delamination caused by blisters, crazing, spider or hairline cracks; and
- Incidental or consequential damages, or damages of any kind including without limitation towing, storage, telephone, rental, taxi, inconvenience, insurance coverage, loan payments, loss of time, loss of income.

4. WARRANTY COVERAGE DURATION

This warranty will be in effect from the date of delivery to the first retail consumer or the date the product is first put into use, whichever occurs first and for a period of:

1. TWELVE (12) CONSECUTIVE MONTHS, for private, recreational use.
2. FOUR (4) CONSECUTIVE MONTHS for commercial use owners. A personal watercraft is used commercially when it is used in connection with generating income or any work or employment during any part of the warranty period. A personal watercraft is also used commercially when, at any point during the warranty period, it has commercial tags or is licensed for commercial use.

The repair or replacement of parts or the performance of service under this warranty does not extend the life of this warranty beyond its original expiration date.

5. CONDITIONS TO HAVE WARRANTY COVERAGE

This warranty coverage is available **only** if **each** of the following conditions has been fulfilled:

- The 2009 Sea-Doo personal watercraft must be purchased as new and unused by its first owner from a BRP distributor/dealer authorized to distribute Sea-Doo personal watercraft in the country in which the sale occurred (“BRP distributor/dealer”);
- The BRP specified pre-delivery inspection process must be completed and documented;
- The 2009 Sea-Doo personal watercraft must have undergone proper registration by an authorized BRP distributor/dealer;
- The 2009 Sea-Doo personal watercraft must be purchased in the country or union of countries in which the purchaser resides.
- Routine maintenance outlined in the Operator’s Guide must be timely performed in order to maintain warranty coverage. BRP reserves the right to make warranty coverage contingent upon proof of proper maintenance.

BRP will not honor this limited warranty to any private use owner or commercial use owner if the preceding conditions have not been met. Such limitations are necessary in order to allow BRP to preserve both the safety of its products, and also that of its consumers and the general public.

6. WHAT TO DO TO OBTAIN WARRANTY COVERAGE

The customer must cease using the Sea-Doo personal watercraft upon the appearance of an anomaly. The customer must notify a servicing BRP distributor/dealer within two (2) days of the appearance of a defect, and provide it with reasonable access to the product and reasonable opportunity to repair it. The customer must also present to the BRP distributor/dealer, proof of purchase of the product and must sign the repair/work order prior to the start of the repair in order to validate the warranty repair. All parts replaced under this limited warranty become the property of BRP.

7. WHAT BRP WILL DO

BRP's obligations under this warranty are limited to, at its sole discretion, repairing parts found defective under normal use, maintenance and service, or replacing such parts with new genuine BRP parts without charge for parts and labor, at any authorized BRP distributor/dealer during the warranty coverage period under the conditions described herein. No claim of breach of warranty shall be the cause for cancellation or rescission of the sale of the Sea-Doo personal watercraft to the owner.

In the event that service is required outside of the country of original sale, the owner will bear responsibility for any additional charges due to local practices and conditions, such as, but not limited to, freight, insurance, taxes, license fees, import duties, and any and all other financial charges, including those levied by governments, states, territories and their respective agencies.

BRP reserves the right to improve or modify products from time to time without assuming any obligation to modify products previously manufactured.

8. TRANSFER

If the ownership of a product is transferred during the warranty coverage period, this warranty shall also be transferred and be valid for the remaining coverage period provided BRP is notified of such transfer of ownership in the following way:

BRP or an authorized BRP distributor/dealer receives a proof that the former owner agreed to the transfer of ownership, in addition to the coordinates of the new owner. The distributor will then forward this information directly to BRP.

9. CONSUMER ASSISTANCE

1. In the event of a controversy or a dispute in connection with this limited warranty, BRP suggests that you try to resolve the issue at the dealership level. We recommend discussing the issue with the authorised dealer's service manager or owner.
2. If further assistance is required, the distributor's service department should be contacted in order to resolve the matter.
3. If the matter still remains unresolved then contact BRP by writing to us at the address listed below.

For countries within Europe, Middle East, Africa, Russia & CIS, please contact our European office:

BRP EUROPE N.V.

Consumer Assistance Center
Skaldenstraat 125
9042 Gent
Belgium
Tel.: + 32-9-218-26-00

For Scandinavian countries, please contact our Finland office:

BRP FINLAND OY

Service Department
Isoaavantie 7
Fin-96320 Rovaniemi
Finland
Tel.: + 358 16 3208 111

For all other countries, please contact your local distributor or our North America office:

BOMBARDIER RECREATIONAL PRODUCTS INC.

Consumer Assistance Center
75, J.-A. Bombardier Street
Sherbrooke, QC J1L 1W3
Tel.: 819 566-3366

* For the territory covered by this limited warranty, products are distributed and serviced by Bombardier Recreational Products Inc. or its affiliates.
© 2008 Bombardier Recreational Products Inc. All rights reserved.
® Registered trademark of Bombardier Recreational Products Inc. or its affiliates.

BRP LIMITED WARRANTY FOR THE EUROPEAN ECONOMIC AREA: 2009 SEA-DOO® PERSONAL WATERCRAFT

1. SCOPE OF THE LIMITED WARRANTY

Bombardier Recreational Product Inc. ("BRP")* warrants its model year 2009 Sea-Doo® personal watercraft sold by authorized BRP ("Distributors/Dealers") in member states of the European Economic Area ("EEA") (which is comprised of the states member of the European Union plus Norway, Iceland and Liechtenstein) from defects in material or workmanship for the period and under the conditions described below. This limited warranty will become null and void if: (1) the Sea-Doo personal watercraft was used for racing or any other competitive activity, at any point, even by a previous owner; or (2) the Sea-Doo personal watercraft has been altered or modified in such a way so as to adversely affect its operation, performance or durability; (3) or has been altered or modified to change its intended use.

All genuine Sea-Doo personal watercraft parts and accessories, installed by an authorized BRP Distributors/Dealers at the time of delivery of the 2009 Sea-Doo personal watercraft carry the same warranty as that of the personal watercraft.

2. LIMITATIONS OF LIABILITY

THIS WARRANTY IS EXPRESSLY GIVEN AND ACCEPTED IN LIEU OF ANY AND ALL OTHER WARRANTIES, EXPRESSED OR IMPLIED, INCLUDING WITHOUT LIMITATION ANY WARRANTY OF MERCHANTABILITY OR FITNESS FOR A PARTICULAR PURPOSE. TO THE EXTENT THAT THEY CANNOT BE DISCLAIMED, THE IMPLIED WARRANTIES ARE LIMITED IN DURATION TO THE LIFE OF THE EXPRESS WARRANTY. INCIDENTAL AND CONSEQUENTIAL DAMAGES ARE EXCLUDED FROM COVERAGE UNDER THIS WARRANTY. SOME JURISDICTIONS DO NOT ALLOW FOR THE DISCLAIMERS, LIMITATIONS AND EXCLUSIONS IDENTIFIED ABOVE, AS A RESULT, THEY MAY NOT APPLY TO YOU. THIS WARRANTY GIVES YOU SPECIFIC RIGHTS, AND YOU MAY ALSO HAVE OTHER LEGAL RIGHTS WHICH MAY VARY FROM COUNTRY TO COUNTRY.

Neither the distributor, any BRP Distributor/Dealer nor any other person has been authorized to make any affirmation, representation or warranty regarding the product, other than those contained in this limited warranty, and if made, shall not be enforceable against BRP. BRP reserves the right to modify this warranty at any time, being understood that such modification will not alter the warranty conditions applicable to the products sold while this warranty is in effect.

3. EXCLUSIONS – ARE NOT WARRANTED

The following are not warranted under any circumstances:

- Normal wear and tear;
- Routine maintenance items, tune ups, adjustments;
- Damage caused by failure to provide proper maintenance and/or storage, as described in the Operator's Guide;
- Damage resulting from removal of parts, improper repairs, service, maintenance, modifications or use of parts not manufactured or approved by BRP or resulting from repairs done by a person that is not an authorized servicing BRP Distributor/Dealer;

- Damage caused by abuse, abnormal use, neglect or operation of the product in a manner inconsistent with the recommended operation described in the Operator’s Guide;
- Damage resulting from accident, submersion, fire, theft, vandalism or any act of God;
- Operation with fuels, oils or lubricants which are not suitable for use with the product (see the Operator’s Guide);
- Water damages caused by water ingestion;
- Damages related to gel coat finish including but not limited to cosmetic gel coat finish, blisters or fiberglass delamination caused by blisters, crazing, spider or hairline cracks; and
- Incidental or consequential damages, or damages of any kind including without limitation towing, storage, telephone, rental, taxi, inconvenience, insurance coverage, loan payments, loss of time, loss of income.

4. WARRANTY COVERAGE PERIOD

This warranty will be in effect from the date of delivery to the first retail consumer or the date the product is first put into use, whichever occurs first and for a period of:

1. Twenty four (24) CONSECUTIVE MONTHS, for private, recreational use.
2. FOUR (4) CONSECUTIVE MONTHS for commercial use owners. A personal watercraft is used commercially when it is used in connection with generating income or any work or employment during any part of the warranty period. A personal watercraft is also used commercially when, at any point during the warranty period, it has commercial tags or is licensed for commercial use.

The repair or replacement of parts or the performance of service under this warranty does not extend the life of this warranty beyond its original expiration date.

Note that the duration and any other modalities of the warranty coverage are subject to the applicable national or local legislation in your country.

5. CONDITIONS TO HAVE WARRANTY COVERAGE

This warranty coverage is available **only** if **each** of the following conditions has been fulfilled:

- The 2009 Sea-Doo personal watercraft must be purchased as new and unused by its first owner from a Distributor/Dealer authorized to distribute Sea-Doo personal watercraft in the country in which the sale occurred;
- The BRP specified pre-delivery inspection process must be completed and documented;
- The product must have undergone proper registration by an authorized Distributor/Dealer;
- The 2009 Sea-Doo personal watercraft must be purchased within the EEA by an EEA resident.
- Routine maintenance outlined in the Operator’s Guide must be timely performed in order to maintain warranty coverage. BRP reserves the right to make warranty coverage contingent upon proof of proper maintenance.

BRP will not honor this limited warranty to any private use owner or commercial use owner if the preceding conditions have not been met. Such limitations are necessary in order to allow BRP to preserve both the safety of its products, and also that of its consumers and the general public.

6. WHAT TO DO TO OBTAIN WARRANTY COVERAGE

The customer must cease using the Sea-Doo personal watercraft upon the appearance of an anomaly. The customer must notify a servicing BRP Distributor/Dealer within two (2) months of the appearance of a defect, and provide it with reasonable access to the product and reasonable opportunity to repair it. The customer must also present to the authorized BRP Distributor/Dealer, proof of purchase of the product and must sign the repair/work order prior to starting the repair in order to validate the warranty repair. All parts replaced under this limited warranty become the property of BRP.

Note that the notification period is subject to the applicable national or local legislation in your country.

7. WHAT BRP WILL DO

BRP's obligations under this warranty are limited to, at its sole discretion, repairing parts found defective under normal use, maintenance and service, or replacing such parts with new genuine SEA-DOO parts without charge for parts and labor, at any authorized BRP Distributor/Dealer during the warranty coverage period under the conditions described herein. No claim of breach of warranty shall be the cause for cancellation or rescission of the sale of the Sea-Doo personal watercraft to the owner.

In the event that service is required outside of the country of original sale, the owner will bear responsibility for any additional charges due to local practices and conditions, such as, but not limited to, freight, insurance, taxes, license fees, import duties, and any and all other financial charges, including those levied by governments, states, territories and their respective agencies.

BRP reserves the right to improve or modify products from time to time without assuming any obligation to modify products previously manufactured.

8. TRANSFER

If the ownership of a product is transferred during the warranty coverage period, this warranty shall also be transferred and be valid for the remaining coverage period provided BRP or an authorized BRP Distributor/Dealer receives a proof that the former owner agreed to the transfer of ownership, in addition to the co-ordinates of the new owner.

9. CONSUMER ASSISTANCE

1. In the event of a controversy or a dispute in connection with this limited warranty, BRP suggests that you try to resolve the issue at the dealership level. We recommend discussing the issue with the authorized Distributor/Dealer's service manager or owner.
2. If further assistance is required, the distributor's service department should be contacted in order to resolve the matter.

3. If the matter still remains unresolved then contact BRP at the address listed below.

For countries within Europe, Middle East, Africa, Russia & CIS, please contact our European office:

BRP EUROPE N.V.

Consumer Assistance Center
Skaldenstraat 125
9042 Gent
Belgium
Tel.: + 32-9-218-26-00

For Scandinavian countries, please contact our Finland office:

BRP FINLAND OY

Service Department
Isoaavantie 7
Fin-96320 Rovaniemi
Finland
Tel.: + 358 16 3208 111

For all other countries, please contact your local distributor or our North America office:

BOMBARDIER RECREATIONAL PRODUCTS INC.

Consumer Assistance Center
75, J.-A. Bombardier Street
Sherbrooke, QC J1L 1W3
Tel.: 819 566-3366

You will find your distributor's coordinates on www.brp.com.

* For the territory covered by this limited warranty, products are distributed and serviced by Bombardier Recreational Products Inc. or its affiliates.
© 2008 Bombardier Recreational Products Inc. All rights reserved.
® are registered trademarks, and TM are trademarks of Bombardier Recreational Products Inc. or its affiliates.

CUSTOMER INFORMATION

PRIVACY INFORMATION/DISCLAIMER

We wish to inform you that your coordinates will be used for safety and warranty purposes. Sometimes, we also use the coordinates of our clients to inform them about our products and to present them offers. Should you prefer not to receive information on our products, services and offers, please let us know by writing to the address below.

Also note that, from time to time, carefully selected and trustworthy organizations may be permitted to use the coordinates of our clients to promote quality products and services. If you prefer not to have your name and address released, please let us know by writing to the address below:

IN CANADA:

Bombardier Recreational Products Inc.
75, J.-A. Bombardier Street
Sherbrooke, Québec J1L 1W3
Fax Number: 819 566-3590
Warranty Department

IN USA:

BRP US Inc.
Warranty Department
7575 Bombardier Court
Wausau WI 54401
Tel.: 715 848-4957

SCANDINAVIAN COUNTRIES:

BRP Finland OY
Service Department
Isoaavantie 7
Fin-96320 Rovaniemi
Finland
Tel.: + 358 16 3208 111

OTHER COUNTRIES IN THE WORLD:

BRP European Distribution
Warranty Department
Chemin de Messidor 5-7
1006 Lausanne Switzerland
Fax Number: + 41213187801

CHANGE OF ADDRESS/OWNERSHIP

If your address has changed or if you are the new owner of the boat, be sure to notify BRP by either:

- Mailing one of the following card below;
- **North America Only:** calling at 715 848-4957 (USA) or 819 566-3366 (Canada);
- Contacting an authorized BRP distributor/dealer.

In case of change of ownership, please join a proof that the former owner agreed to the transfer.

Notifying BRP, even after the expiration of the limited warranty, is very important as it enables BRP to reach the boat owner if necessary, like when safety recalls are initiated. It is the owner's responsibility to notify BRP.

STOLEN UNITS: In the event that your boat is stolen, you should notify your area's distributor warranty department of such. We will ask you to provide your name, address, phone number, Hull Identification Number and date it was stolen.

NORTH AMERICA

Bombardier Recreational Products Inc.
Warranty Department
75, J.-A. Bombardier Street
Sherbrooke, Québec J1L 1W3
Canada

SCANDINAVIAN COUNTRIES

BRP Finland OY
Service Department
Isoaavantie 7
Fin-96320 Rovaniemi
Finland

OTHER COUNTRIES IN THE WORLD

BRP European Distribution
Warranty Department
Chemin de Messidor 5-7
1006 Lausanne
Switzerland

CHANGE OF ADDRESS CHANGE OF OWNERSHIP

VEHICLE IDENTIFICATION NUMBER

Model Number

Vehicle Identification Number (V.I.N.)

OLD ADDRESS
OR PREVIOUS OWNER:

NAME

NO.

STREET

APT

CITY

STATE/PROVINCE

ZIP/POSTAL CODE

COUNTRY

TELEPHONE

NEW ADDRESS
OR NEW OWNER:

NAME

NO.

STREET

APT

CITY

STATE/PROVINCE

ZIP/POSTAL CODE

COUNTRY

TELEPHONE

V00A2F

CHANGE OF ADDRESS CHANGE OF OWNERSHIP

VEHICLE IDENTIFICATION NUMBER

Model Number

Vehicle Identification Number (V.I.N.)

OLD ADDRESS
OR PREVIOUS OWNER:

NAME

NO.

STREET

APT

CITY

STATE/PROVINCE

ZIP/POSTAL CODE

COUNTRY

TELEPHONE

NEW ADDRESS
OR NEW OWNER:

NAME

NO.

STREET

APT

CITY

STATE/PROVINCE

ZIP/POSTAL CODE

COUNTRY

TELEPHONE

V00A2F

WATERCRAFT MODEL No. _____

HULL IDENTIFICATION NUMBER (H.I.N.) _____

ENGINE IDENTIFICATION NUMBER (E.I.N.) _____

Owner: _____
NAME

No. STREET APT

CITY STATE/PROVINCE ZIP/POSTAL CODE

Purchase Date _____
YEAR MONTH DAY

Warranty Expiry Date _____
YEAR MONTH DAY

To be completed by the authorized Sea-Doo dealer at the time of the sale.

DEALER IMPRINT AREA

219 000 520

CA

OPERATOR'S GUIDE, RXT iS 255, GTX Limited iS 255 / ENGLISH
GUIDE DU CONDUCTEUR, RXT iS 255, GTX Limited iS 255 / ANGLAIS

FAIT AU / MADE IN CANADA

U/M.P.C.