



SEA-DOO® 2003

OPERATOR'S GUIDE

**GTI, GTI LE,
GTI LE RFI,
RX DI, GTX DI**



WARNING

**Read this guide thoroughly.
It contains important safety information.**

®™ TRADEMARKS OF BOMBARDIER INC. OR ITS SUBSIDIARIES.
©2003 BOMBARDIER INC. ALL RIGHTS RESERVED. PRINTED IN THE EU.

219 000 290



SAFETY WARNING

Disregarding any of the safety precautions and instructions contained in this *Operator's Guide*, the *Safety Handbook*, the *Safety Videocassette* and on the on-product warning labels could cause injury, including the possibility of death. The operator has the responsibility to inform passenger(s) of safety precautions.

This *Operator's Guide*, the *Safety Handbook* and *Safety Videocassette* should remain with the craft at the time of resale.

BOMBARDIER
RECREATIONAL PRODUCTS



DECLARATION  OF CONFORMITY

2003 PWC Electro Magnetic Compatibility (EMC) Compliance with 93/68 EC Directive.

The 2003 Sea-Doo Personal Watercraft do comply with the above mentioned directive and 89/336 EC directive in order to match the current European requirements on Personal Watercraft (PWC).

Knight's Spray-Nine[†] is a trademark of Korkay System Ltd

GTX[†] is a trademark of Castrol Ltd. Used under license

The following trademarks are the property of Bombardier Inc. or its subsidiaries:

SEA-DOO[®]

BOMBARDIER-ROTAX[®]

BOMBARDIER LUBE[®]

BOMBARDIER-ROTAX Formula XP-S Synthetic Injection Oil

BOMBARDIER Formula XP-S DI Synthetic Injection Oil

BOMBARDIER-ROTAX Injection Oil

Sea-Doo Synthetic Grease

Sea-Doo LK[™]

Rotax[®]

O.P.A.S.[™]

Doin'it on your new SEA-DOO watercraft

Congratulations, you are now the proud owner of a SEA-DOO personal watercraft. Whether you are an experienced boater or are new to the sport of boating, we ask you to take the time to view the safety videocassette provided with the watercraft, to read this *Operator's Guide*, the *Safety Handbook* and on-product warning/caution labels and familiarize yourself with the contents. These manuals contain pertinent information which, if followed, will provide you with the necessary knowledge to help you fully enjoy the pleasures of this watercraft.

We strongly recommend that all watercraft operators complete a safety boating course. Check with your local Coast Guard or Power and Sail Squadron in your area for course availability. More serious boaters may want to obtain *Chapman Piloting* by Elbert S. Maloney, available at most book stores.

When introducing your family or friends to the sport, be sure they fully understand the controls and operation of the watercraft and the importance of courteous, responsible riding.

Each operator has a responsibility to ensure the safety of his/her passenger(s) and of other water users. Please follow all safety instructions and operate your craft with care.

We encourage you to have an Annual Safety Inspection of your watercraft. Please contact your dealer for further details.

Finally, we urge you to visit your dealer regularly for regular and safety maintenance as well as any watercraft accessories you may require.

Have fun and... Bon Voyage.

Please keep this guide and *Safety Handbook* on board at all times. These manuals along with the *Safety Videocassette* should remain with the watercraft at time of resale.

TABLE OF CONTENTS

FOREWORD	5
SAFETY MEASURES	6
General	6
Operation.....	6
Maintenance.....	8
LIST OF DISTRIBUTORS	9
BOMBARDIER LIMITED WARRANTY INTERNATIONAL: SEA-DOO® WATERCRAFT	10
REGISTRATION NUMBER LOCATION	13
LOCATION OF THE IMPORTANT LABELS	14
IDENTIFICATION NUMBERS	21
Hull	21
Engine.....	21
CONTROLS, COMPONENTS AND INSTRUMENTS LOCATION	23
CONTROLS, COMPONENTS AND INSTRUMENTS FUNCTIONS	28
1) Safety Lanyard (engine cut-off cord)	28
2) Handlebar	29
3) Throttle Lever.....	29
4) Engine Start/Stop Button	29
5) Variable Trim System (VTS) Button (if so equipped)	30
6) Choke Lever.....	30
7) Shift Lever.....	30
8) Fuel Gauge/Low Oil Warning Light (if so equipped)	31
9) Speedometer (if so equipped).....	31
10) Tachometer (if so equipped)	31
11) Information Center Gauge/Buttons (if so equipped)	32
12) Glove Box.....	35
13) Fuel Tank Valve	35
14) Fuel Tank Cap	35
15) Oil Injection Reservoir Cap.....	36
16) Front Storage Compartment Cover	36
17) Front Storage Compartment Cover Latch	37
18) Tool Kit	37
19) Air Intake Opening	37
20) Seat Strap	37
21) Seat Latch	37
22) Seat Extension Latch (if so equipped).....	39
23) Rear Grab Handle	39
24) Rear Storage Basket (if so equipped).....	39
25) Bow and Stern Eyelets	40

26) Mooring Cleats	40
27) Footboard	40
28) Boarding Pads	41
29) Boarding Platform	41
30) Boarding Step (if so equipped)	41
31) Cooling System Bleed Outlet	41
32) Flushing Connector (if so equipped)	42
33) Bilge Drain Plugs	42
34) Jet Pump Nozzle	42
35) Reverse Gate	43
36) Jet Pump Water Intake	43
37) Fuses	43
38) Battery	43
39) Side Vanes (if so equipped)	43
FUEL AND LUBRICATION	44
Fueling Procedure	44
Recommended Fuel	44
Recommended Oil	45
Oil Injection System	45
BREAK-IN PERIOD	46
10-Hour Inspection	46
PRE-OPERATION CHECKS	47
Hull	48
Jet Pump Water Intake	48
Bilge	48
Battery	48
Fuel Tank and Oil Reservoir	48
Engine Compartment	48
Steering System	48
Throttle System	49
Shifter System	49
VTS (Variable Trim System) (if so equipped)	49
Storage Compartment Covers and Seat	49
Safety Lanyard and Engine Start/Stop Button	49
OPERATING INSTRUCTIONS	50
Principle of Operation	50
Boarding the Watercraft	54
Starting	56
Rough Water or Poor Visibility Operation	57
Crossing Waves	57
Stopping/Docking	58
Beaching	58
Shutting Off the Engine	58

POST-OPERATION CARE	59
General Care	59
Additional Care for Foul Water or Salt Water	59
Cooling System Flushing and Engine Internal Lubrication.....	59
Anticorrosion Treatment.....	61
SPECIAL PROCEDURES	62
Monitoring System	62
Limp Home Mode	62
Engine Overheating	62
Jet Pump Water Intake and Impeller Cleaning	62
Capsized Watercraft	64
Submerged Watercraft	64
Water-Flooded Engine	64
Fuel-Flooded Engine	65
Out of Fuel.....	66
Towing the Watercraft in Water	66
Low-Charge Battery Condition	67
MAINTENANCE	68
Engine Emissions Information.....	68
Lubrication	69
Periodic Inspection	70
Periodic Inspection Chart.....	71
Throttle and Choke Cable Inspection.....	73
Carburetor Adjustment	73
Fuel Injection System	73
Fuel and Oil Filters.....	73
Steering Alignment.....	74
VTS Adjustment (if so equipped)	74
Vacuum Bailer Pick-Ups.....	74
Fuses	75
O.P.A.S. System (if so equipped)	78
General Inspection and Cleaning	79
TRAILERING, STORAGE AND PRE-SEASON PREPARATION	80
Trailering.....	80
Storage	81
Pre-Season Preparation	90
TROUBLESHOOTING	92
SPECIFICATIONS.....	97
SI* METRIC INFORMATION	101
ABBREVIATIONS USED IN THIS MANUAL.....	102
CHANGE OF ADDRESS	103

FOREWORD

The *Operator's Guide* and *Safety Handbook* have been prepared to acquaint the owner/operator or passenger with this personal watercraft and its various controls, maintenance and safe riding instructions. Each is indispensable for the proper use of the product, and should be kept in a waterproof bag with the watercraft at all times.

Make sure you read and understand the content of the *Operator's Guide* and *Safety Handbook*.

For any questions pertaining to the warranty and its application, consult the WARRANTY section in this guide, and/or an authorized SEA-DOO dealer.

This guide uses the following safety alert symbol in conjunction with signal words to indicate a potential personal injury hazard.

WARNING

Indicates a potentially hazardous situation which, if not avoided, could result in death or serious injury.

CAUTION

Indicates a potentially hazardous situation which, if not avoided, may result in minor or moderate injury. When used without the safety alert symbol , potential hazard exists for property damage only.

NOTE: Indicates supplementary information needed to fully complete an instruction.

Although the mere reading of such information does not eliminate the hazard, the understanding and application of the information will promote the correct use of the watercraft.

The information and components/ system descriptions contained in this guide are correct at the time of writing. Bombardier Inc. however, maintains a policy of continuous improvement of its products without imposing upon itself any obligation to install them on products previously manufactured.

Because of its ongoing commitment to product quality and innovation, Bombardier reserves the right at any time to discontinue or change specifications, designs, features, models or equipment without incurring obligation.

The illustrations in this document show the typical construction of the different assemblies and may not represent the full detail or exact shape of the parts. However, they represent parts that have the same or similar function.

It is understood that this guide may be translated into another language. In the event of any discrepancy, the English version shall prevail.

Specifications are given in the SI metric system with the SAE U.S. equivalent in parenthesis. Where precise accuracy is not required, some conversions are rounded off for easier use.

A *Shop Manual* can be obtained for complete service, maintenance and more repair information.

⚠ SAFETY MEASURES

General

- ⚠ To fully appreciate the pleasures, enjoyment and excitement of boating there are some basic rules that should be observed and followed by any rider. Some rules may be new to you or covered in the *Sea-Doo Safety Handbook* or *Safety Videocassette*, others may be common sense or obvious... irrespective, we ask that you please take a few minutes of your time to read these safety instructions completely together with your *Safety Handbook* before you operate your watercraft. **Failure to follow this safety information and safe boating rules could result in injury, including the possibility of death to you, your passenger(s), or other water users.**
- ⚠ Bombardier recommends not to operate a watercraft under the age of 16.
- ⚠ Become completely familiar with the controls and operation of the watercraft before embarking on your first trip or taking on a passenger(s). If you have not had the opportunity to do so with your authorized Sea-Doo dealer, practice driving solo in a suitable area and feel the response of each control. Be fully familiar with all controls before applying throttle above idle speed. As its operator, you control and are responsible for the watercraft's safe operation.
- ⚠ Always carry the regulatory required safety items on board. Check the local regulations or consult your authorized Sea-Doo dealer.
- ⚠ Make sure that all users of the watercraft read and understand all on-product warnings.

Operation

- ⚠ Always perform the pre-operation checks as specified in this guide.
- ⚠ Operator and passenger(s) should at all times wear a coast guard approved personal flotation device (PFD) that is suitable for personal watercraft.
- ⚠ Operator and passenger(s) should wear protective clothing. Severe internal injuries can occur if water is forced into body cavities of males or females as a result of falling into water or being near jet thrust nozzle. Wet suit bottom (or thick, tightly woven, snug fitting clothing that provides equivalent protection. Thin bike shorts for example would not be appropriate), footwear, gloves and goggles/glasses are recommended.
- ⚠ Always keep in mind that as the throttle lever is released to idle position, less directional control is available. **To turn the watercraft, both steering and throttle are necessary.**
- ⚠ Like any other craft, this watercraft has no brake. Stopping distance will vary depending on initial speed, load, wind, and water conditions. Practice stopping and docking in a safe, traffic free area to have an idea of how long it will take to stop the watercraft under varying conditions. Do not release throttle when trying to steer away from objects. You need throttle to steer. Do not use the watercraft's reverse, **if so equipped**, to stop.
- ⚠ Ensure that all passengers know how to swim and how to reboard the watercraft from the water.
- ⚠ The operator and passenger(s) should be properly seated before starting or moving the watercraft, and at all times when watercraft is in motion.



- ⚠ **Do not** start or operate the watercraft if someone is seated on the sun deck (if so equipped) or swim platform, or is nearby in the water. The watercraft's jet thrust can cause injury. Always accelerate slowly.
- ⚠ To prevent accidental starting or unauthorized use, always detach the safety lanyard from the watercraft especially when swimmers are boarding or nearby, or during removal of any weeds or debris from the intake grate.
- ⚠ Never turn handlebar while someone is nearby rear of watercraft. Keep away from steering moving parts (nozzle, side vanes, linkage, etc.).
- ⚠ Keep away from intake grate while engine is on. Items such as long hair, loose clothing, or PFD straps can become entangled in moving parts resulting in severe injury or drowning.
- ⚠ Ride within your limits and avoid aggressive maneuvers to reduce the risk of loss of control, ejection and collision.
- ⚠ Riding with a passenger(s) or pulling other crafts, tubes, skies or wakeboards makes the watercraft handle differently and requires greater skill. Do not overload the watercraft or take on more passengers than designated for the particular watercraft. Overloading can affect maneuverability, stability and performance.
- ⚠ Avoid adding on accessories, or equipment which may alter the configuration, balance or control of the watercraft. The watercraft maybe fitted with tow eyelets which can be used to attach a ski rope. However, do not use these eyelets or the watercraft's cleats to tow a parasail. Severe injury or watercraft damage may occur.
- ⚠ In shallow water, proceed with caution and at very low speeds. Grounding or abrupt stops may result in injury. Debris may also be picked up and be thrown rearward by the jet pump onto people or property.
- ⚠ Respect no wake zones, the rights of other water users and the environment. As the "skipper" and owner of a watercraft you are responsible for damage to other crafts caused by the wake of your watercraft. Allow no one to throw refuse overboard.
- ⚠ Remember that a watercraft is not designed for night time operation.
- ⚠ Remember, gasoline fumes are inflammable and explosive. Always adhere to the fueling procedure contained in this guide and those given to you by the marina. Always verify fuel level before use and during the ride. Apply the principle of 1/3 fuel to destination, 1/3 back and 1/3 reserve fuel supply. Do not carry spare fuel or inflammable liquids in any of the storage or engine compartments.
- ⚠ Combustion engine needs air to operate; consequently this watercraft can not be totally watertight. Any maneuvers such as figure eights etc., that cause the upper deck to be under water may cause severe engine problems due to water ingestion. Refer to SPECIAL PROCEDURES and LIMITED WARRANTY contained in this guide.
- ⚠ Due to the close proximity of other racers, it is recommended that an approved personal watercraft helmet be used during racing events. Read and follow all instructions and warnings provided with the helmet.
- ⚠ Never ride after consuming drugs or alcohol or if you feel tired or ill. Operate your watercraft prudently and have fun.
- ⚠ Don't forget that all persons must assist other boaters in an emergency.

Maintenance

- ⚠ Only perform servicing procedures which are detailed in this guide. Further assistance or information can be obtained from your authorized Sea-Doo dealer. In many instances proper tools and training is required for certain servicing or repair procedures.
- ⚠ Maintain the watercraft and equipment in top condition at all times. Adhere to the prescribed maintenance schedules. An annual inspection of the watercraft is always a good recommendation that should be followed.
- ⚠ Always use spark plug cable grounding device when removing spark plugs.
- ⚠ The bilge should be kept clean of oil, water or other foreign materials.
- ⚠ Do not attempt to lift the watercraft without special equipment and training.
- ⚠ The engine and the corresponding components identified in this guide should not be utilized on product(s) other than for those they were designed. Maintenance procedures and specified tightening torque should be strictly adhered to. Never attempt repairs unless the appropriate tools are available. These watercrafts are designed with parts dimensioned in both the metric and the imperial systems. When replacing fasteners, make sure to use only those recommended by Bombardier. If required, contact your authorized Sea-Doo dealer for further servicing information.

LIST OF DISTRIBUTORS

NORTH AMERICA

<p>USA</p>  <p>(Except Puerto Rico)</p>	<p>BOMBARDIER MOTOR CORPORATION OF AMERICA 7575 Bombardier Court WAUSAU, WI. 54401 Phone: (715) 848-4957 Fax: (715) 847-6879 www.bombardier.com</p>
<p>CANADA</p> 	<p>BOMBARDIER INC. RECREATIONAL PRODUCTS 75 J. A. BOMBARDIER ST. SHERBROOKE, QC J1L 1W3 Phone: (819) 566-3366 Fax: (819) 566-3062 www.bombardier.com</p>

If your Sea-Doo watercraft requires warranty service, you should take it to any authorized Sea-Doo dealer. Be sure to bring your warranty registration card or other valid proof of the original date of purchase. If a question or problem arises regarding warranty, first contact the service manager or owner of the Sea-Doo dealership.

To find the nearest authorized Sea-Doo dealer, dial: 1-800-882-2900.

NOTE: If outside Canada or USA, consult your local authorized Sea-Doo distributor.

BOMBARDIER LIMITED WARRANTY INTERNATIONAL: SEA-DOO® WATERCRAFT

1. SCOPE OF THE LIMITED WARRANTY

BOMBARDIER INC. (hereinafter "BOMBARDIER") warrants its SEA-DOO personal watercraft from defects in material or workmanship for the period described below.

All genuine BOMBARDIER parts and accessories, installed by an authorized BOMBARDIER distributor/dealer (as hereinafter defined) at the time of delivery of the SEA-DOO personal watercraft, carry the same warranty as that of the personal watercraft.

Use of the product for racing or any other competitive activity, at any point, even by a prior owner will render this warranty null and void.

2. WARRANTY COVERAGE PERIOD

This warranty will be in effect FROM THE DATE OF DELIVERY TO THE FIRST RETAIL CONSUMER or the date the product is first put into use, whichever occurs first and for a period of:

(a) TWELVE (12) CONSECUTIVE MONTHS, for private use owners ⁽¹⁾.

(b) FOUR (4) CONSECUTIVE MONTHS, for commercial use owners.

The repair or replacement of parts or the performance of service under this warranty does not extend the life of this warranty beyond its original expiration date.

3. CONDITIONS TO HAVE WARRANTY COVERAGE

This warranty coverage is available only on SEA-DOO personal watercraft purchased as new and unused by its first owner from a BOMBARDIER distributor/dealer authorized to distribute SEA-DOO products in the country in which the sale occurred (hereinafter "BOMBARDIER distributor/dealer"), and then only after the BOMBARDIER specified predelivery inspection process is completed and documented. Warranty coverage only becomes available upon proper registration of the product by a BOMBARDIER dealer. Such limitations are necessary in order to allow BOMBARDIER to preserve both the safety of its products, and also that of its consumers and the public.

Routine maintenance outlined in the *Operator's Guide* must be timely performed in order to maintain warranty coverage. BOMBARDIER reserves the right to make warranty coverage contingent upon proof of proper maintenance.

4. WHAT TO DO TO OBTAIN WARRANTY COVERAGE

The customer must notify a servicing BOMBARDIER distributor/dealer within two (2) days of the appearance of a defect, and provide it with reasonable access to the product and reasonable opportunity to repair it. The customer must also present to the BOMBARDIER distributor/dealer, proof of purchase of the product and must sign the repair/work order prior to the start of the repair in order to validate the warranty repair. All parts replaced under this limited warranty become the property of BOMBARDIER.

5. WHAT BOMBARDIER WILL DO

BOMBARDIER's obligations under this warranty are limited to, at its sole discretion, repairing parts found defective under normal use, maintenance and service, or replacing such parts with new genuine BOMBARDIER parts without charge for parts and labor, at any authorized BOMBARDIER distributor/dealer.

BOMBARDIER reserves the right to improve or modify products from time to time without assuming any obligation to modify products previously manufactured.

1.The warranty is TWENTY FOUR (24) consecutive months if the product was sold in any of the member states of the European Union (EC directive 1999/44/EC).

The warranty period, however, is FOUR (4) consecutive months if the product is used for commercial purposes.

6. EXCLUSIONS — ARE NOT WARRANTED

- Normal wear and tear;
- Routine maintenance items, tune ups, adjustments;
- Damage caused by failure to provide proper maintenance and/or storage, as described in the *Operator's Guide*;
- Damage resulting from removal of parts, improper repairs, service, maintenance, modifications or use of parts not manufactured or approved by BOMBARDIER or resulting from repairs done by a person that is not an authorized servicing BOMBARDIER distributor/ dealer;
- Damage caused by abuse, abnormal use, neglect or operation of the product in a manner inconsistent with the recommended operation described in the *Operator's Guide*;
- Damage resulting from accident, submersion, fire, theft, vandalism or any act of God;
- Operation with fuels, oils or lubricants which are not suitable for use with the product (see the *Operator's Guide*);
- Water ingestion;
- Damages related to gel coat finish including but not limited to cosmetic gel coat finish, blisters or fiberglass delamination caused by blisters, crazing, spider or hairline cracks; and
- Incidental or consequential damages, or damages of any kind including without limitation towing, storage, telephone, rental, taxi, inconvenience, insurance coverage, loan payments, loss of time, loss of income.

7. LIMITATIONS OF LIABILITY

THIS WARRANTY IS EXPRESSLY GIVEN AND ACCEPTED IN LIEU OF ANY AND ALL OTHER WARRANTIES, EXPRESSED OR IMPLIED, INCLUDING WITHOUT LIMITATION ANY WARRANTY OF MERCHANTABILITY OR FITNESS FOR A PARTICULAR PURPOSE. TO THE EXTENT THAT THEY CANNOT BE DISCLAIMED, THE IMPLIED WARRANTIES ARE LIMITED IN DURATION TO THE LIFE OF THE EXPRESS WARRANTY. INCIDENTAL AND CONSEQUENTIAL DAMAGES ARE EXCLUDED FROM COVERAGE UNDER THIS WARRANTY. SOME COUNTRIES DO NOT ALLOW FOR THE DISCLAIMERS, LIMITATIONS AND EXCLUSIONS IDENTIFIED ABOVE, AS A RESULT, THEY MAY NOT APPLY TO YOU. THIS WARRANTY GIVES YOU SPECIFIC RIGHTS, AND YOU MAY ALSO HAVE OTHER LEGAL RIGHTS WHICH MAY VARY FROM COUNTRY TO COUNTRY.

Neither the BOMBARDIER distributor nor any other person has been authorized to make any affirmation, representation or warranty regarding the product, other than those contained in this limited warranty, and if made, shall not be enforceable against BOMBARDIER.

BOMBARDIER reserves the right to modify this warranty at any time, being understood that such modification will not alter the warranty conditions applicable to the products sold while this warranty is in effect.

8. TRANSFER

If the ownership of a product is transferred during the warranty coverage period, this warranty shall also be transferred and be valid for the remaining coverage period provided that BOMBARDIER is notified of such transfer of ownership in the following way:

- (a) The former owner contacts BOMBARDIER or an authorized BOMBARDIER distributor/ dealer and gives the coordinates of the new owner; or
- (b) BOMBARDIER or an authorized BOMBARDIER distributor/dealer receives a proof that the former owner agreed to the transfer of ownership, in addition to the coordinates of the new owner.

9. CONSUMER ASSISTANCE

- (a) In the event of a controversy or a dispute in connection with this BOMBARDIER LIMITED WARRANTY, BOMBARDIER suggests that you try to resolve the issue at the distributorship/dealership level. We recommend discussing the issue with the authorized dealer's service manager or owner.
- (b) If further assistance is required, the distributor's service department should be contacted in order to resolve the matter.

© 2003 Bombardier Inc. All rights reserved

® Registered trademark of Bombardier Inc. or its subsidiaries.

REGISTRATION NUMBER LOCATION

All personal watercraft are required by federal law to be registered and legally numbered. Due to space availability for proper display of registration number, refer to following illustration for location. The registration number should appear on each side of the watercraft. On **applicable models** install registration number to the left of the star label.



TYPICAL

1. *Registration number location*

NOTE: The registration number must be above the water line. Ensure also that the numbers are of the correct size and color. Check with local applicable regulations.

LOCATION OF THE IMPORTANT LABELS

The following labels are on your watercraft. If missing or damaged, they can be replaced free of charge. See an authorized Sea-Doo dealer.

Please read the following labels carefully before operating this watercraft.

GTI, GTI LE and GTI LE RFI Models



TYPICAL

RX DI Models

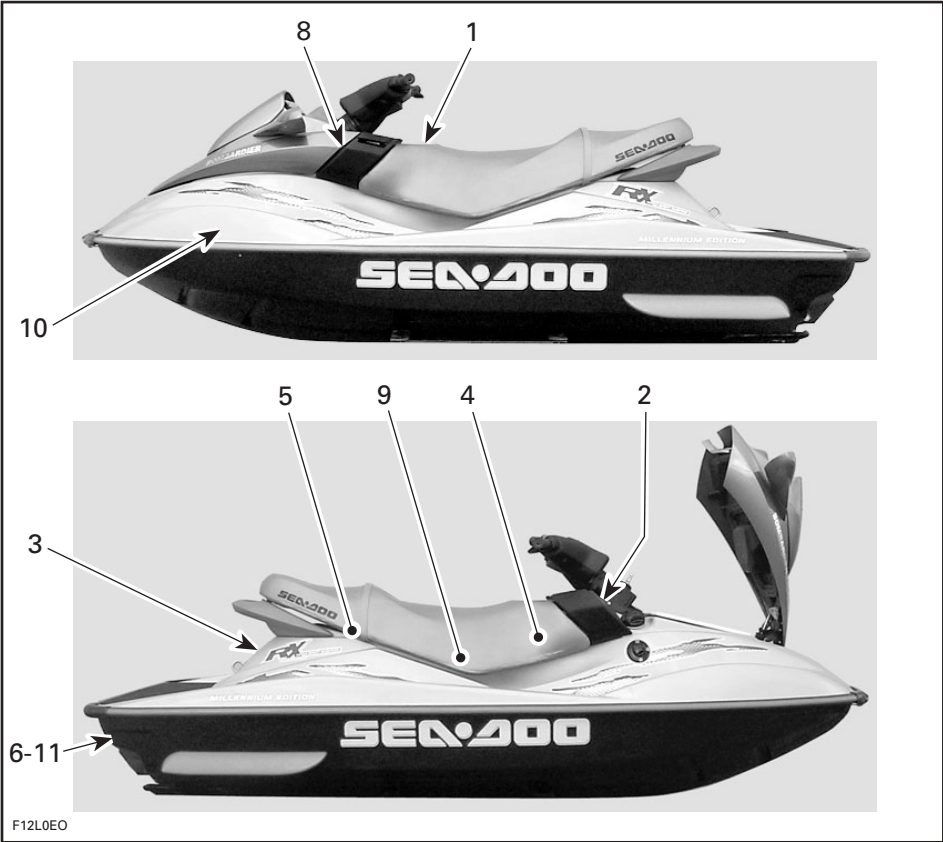

F12L0EO

GTX DI Models



F18L03P

Label 1

⚠ WARNING

To reduce the risk of **SEVERE INJURY** or **DEATH**:

WEAR A PERSONAL FLOTATION DEVICE (PFD). All riders must wear a Coast Guard approved PFD that is suitable for personal watercraft (PWC) use.

WEAR PROTECTIVE CLOTHING. Severe internal injuries can occur if water is forced into body cavities as a result of falling into water or being near jet thrust nozzle. Normal swimwear does not adequately protect against forceful water entry into lower body opening(s) of males or females. All riders must wear a wet suit bottom or clothing that provides equivalent protection (see Operator's Guide). Footwear, gloves and goggles/glasses are recommended.

KNOW BOATING LAWS. Bombardier recommends a minimum operator age of 16 years old. Know the operator age and training requirements for your province/state. A boating safety course is recommended and may be required in your province/state.

ATTACH ENGINE SHUT-OFF CORD (LANYARD) to PFD and keep it free from handlebars so that engine stops if operator falls off. After riding, remove cord from PWC to avoid unauthorized use by children or others.

RIDE WITHIN YOUR LIMITS AND AVOID AGGRESSIVE MANEUVERS to reduce the risk of loss of control, ejection and collision. This is a high performance boat - not a toy. Sharp turns or jumping wakes or waves can increase the risk of back/spinal injury (paralysis), facial injuries, and broken legs, ankles, and other bones. **Do not jump wakes or waves.**

DO NOT APPLY THROTTLE WHEN ANYONE IS AT REAR OF PWC - turn engine off or keep engine at idle. Water and/or debris exiting jet thrust nozzle can cause severe injury.

KEEP AWAY FROM INTAKE GRATE while engine is on. Items such as long hair, loose clothing, or PFD straps can become entangled in moving parts resulting in severe injury or drowning.

NEVER RIDE AFTER CONSUMING DRUGS OR ALCOHOL

READ AND FOLLOW OPERATOR'S GUIDE

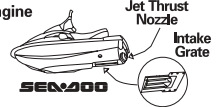

⚠ WARNING

Collisions result in more **INJURIES AND DEATHS** than any other type of accident for personal watercraft (PWC).

TO AVOID COLLISIONS:

SCAN CONSTANTLY for people, objects, and other watercraft. Be alert for conditions that limit your visibility or block your vision of others.

OPERATE DEFENSIVELY at safe speeds and keep a safe distance away from people, objects, and other watercraft.

- Do not follow directly behind PWCs or other boats.
- Do not go near others to spray or splash them with water.
- Avoid sharp turns or other maneuvers that make it hard for others to avoid you or understand where you are going.
- Avoid areas with submerged objects or shallow water.

TAKE EARLY ACTION to avoid collisions. Remember, PWCs and other boats **do not have brakes**.

DO NOT RELEASE THROTTLE WHEN TRYING TO STEER away from objects - **you need throttle to steer**. Always check throttle and steering controls for proper operation before starting PWC.

Follow navigation rules and province/state and local laws that apply to PWCs. See Operator's Guide for more information. Seating is limited to XX operator and XX passengers (XXX lbs./XXX kg).



F12L0FL

219 901 713

ACCORDING TO WATERCRAFT MODEL

Label 1 (cont'd)

⚠ WARNING

To reduce the risk of SEVERE INJURY or DEATH:
WEAR A PERSONAL FLOTATION DEVICE (PFD). All riders must wear a Coast Guard approved PFD that is suitable for personal watercraft (PWC) use.

WEAR PROTECTIVE CLOTHING. Severe internal injuries can occur if water is forced into body cavities as a result of falling into water or being near jet thrust nozzle. Normal swimwear does not adequately protect against forceful water entry into lower body opening(s) of males or females. All riders must wear a wet suit bottom or clothing that provides equivalent protection (see Operator's Guide). Footwear, gloves and goggles/glasses are recommended.

KNOW BOATING LAWS. Bombardier recommends a minimum operator age of 16 years old. Know the operator age and training requirements for your province/state. A boating safety course is recommended and may be required in your province/state.

ATTACH ENGINE SHUT-OFF CORD (LANYARD) to PFD and keep it free from handlebars so that engine stops if operator falls off. After riding, remove cord from PWC to avoid unauthorized use by children or others.

RIDE WITHIN YOUR LIMITS AND AVOID AGGRESSIVE MANEUVERS to reduce the risk of loss of control, ejection and collision. This is a high performance boat - not a toy. Sharp turns or jumping wakes or waves can increase the risk of back/spinal injury (paralysis), facial injuries, and broken legs, ankles, and other bones. **Do not jump wakes or waves.**

DO NOT APPLY THROTTLE WHEN ANYONE IS AT REAR OF PWC - turn engine off or keep engine at idle. Water and/or debris exiting jet thrust nozzle can cause severe injury.

KEEP AWAY FROM INTAKE GRATE while engine is on. Items such as long hair, loose clothing, or PFD straps can become entangled in moving parts resulting in severe injury or drowning.

NEVER RIDE AFTER CONSUMING DRUGS OR ALCOHOL

READ AND FOLLOW OPERATOR'S GUIDE

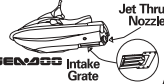

⚠ WARNING

Collisions result in more INJURIES AND DEATHS than any other type of accident for personal watercraft (PWC).

TO AVOID COLLISIONS:

SCAN CONSTANTLY for people, objects, and other watercraft. Be alert for conditions that limit your visibility or block your vision of others.

OPERATE DEFENSIVELY at safe speeds and keep a safe distance away from people, objects, and other watercraft.

- Do not follow directly behind PWCs or other boats.
- Do not go near others to spray or splash them with water.
- Avoid sharp turns or other maneuvers that make it hard for others to avoid you or understand where you are going.
- Avoid areas with submerged objects or shallow water.



TAKE EARLY ACTION to avoid collisions. Remember, PWCs and other boats do not have brakes.

DO NOT RELEASE THROTTLE WHEN TRYING TO STEER away from objects - you need throttle to steer. Always check throttle and steering controls for proper operation before starting PWC.

Follow navigation rules and province/state and local laws that apply to PWCs. See Operator's Guide for more information.

Seating is limited to XX operator and XX passengers (XXX lbs./XXX kg.).

F16L0PL

ACCORDING TO WATERCRAFT MODEL

Label 2

CAUTION/ ATTENTION
 Use Bombardier Formula XP-S II synthetic oil or Bombardier injection oil. See operator's guide.

Utiliser de l'huile synthétique Bombardier Formula XP-S II ou l'huile à injection Bombardier. Voir le guide du conducteur.

F00A21Y 219902054

ACCORDING TO WATERCRAFT MODEL

CAUTION/ ATTENTION
 Use Bombardier Formula XP-S II synthetic oil only. See Operator's guide.

Utiliser seulement l'huile synthétique Bombardier Formula XP-S II. Voir le guide du conducteur.

F00A22Y 219902055

ACCORDING TO WATERCRAFT MODEL

Label 3

"THIS BOAT IS NOT REQUIRED TO COMPLY WITH THE FOLLOWING U.S. COAST GUARD SAFETY STANDARDS IN EFFECT ON THE DATE OF CERTIFICATION:

- Fuel System
- Safe Loading
- Display of Capacity Information
- Flotation
- Powered Ventilation

AS AUTHORIZED BY U.S. COAST GUARD GRANT OF EXEMPTION (CGB 88-001)."

Bombardier Corp. 7575 Bombardier Court, Wausau, WI 54401

Made in Canada/Fabriqué au Canada Bombardier Inc. Rd./Enr.,1988

F02L2D0

Label 4

Emission Control Information

This engine is certified to operate on unleaded regular gasoline and conforms to XXXX U.S. EPA regulations for Marine SI Engines.

BOMBARDIER
RECREATIONAL PRODUCTS

Engine Family: XBCXM,XXXXCR
 FEL: XXX gm/kW-hr HC + NO_x
 Engine Displacement: XXX cc
 Exhaust Emission Control System: XXX

Tune-Up Specifications
 Idle Speed: XXXX RPM ± XXX
 Spark Plug Type: XXX
 Spark Plug Gap: XXX in./XXX mm

F00L29Y

ACCORDING TO WATERCRAFT MODEL

Emission Control Information

This engine conforms to MY XXXX U.S. EPA and California emission regulations for SI marine engines.

BOMBARDIER
RECREATIONAL PRODUCTS

Engine Family: XBCXM,XXXXCR
 FEL: XXX gm/kW-hr HC + NO_x
 Engine Displacement: XXX cc
 Exhaust Emission Control System: XXX

Spark Plug Type: XXX
 Spark Plug Gap: XXX in./XXX mm
 Power: XXXX kW

See Operator's Guide for maintenance specifications

F00L2XY

ACCORDING TO WATERCRAFT MODEL

Label 5

▲ WARNING / AVERTISSEMENT
 DO NOT CHARGE OR BOOST THE BATTERY WHILE INSTALLED ON THE WATERCRAFT

NE PAS CHARGER OU SURVOLTER LA BATTERIE LORSQU'ELLE EST INSTALLÉE DANS LA MOTOMARINE

F00A23Y 219902201

Label 6

▲ WARNING / AVERTISSEMENT

- Make sure engine is off
- Grab inlet grate and step on bumper rail
- Roll boat clockwise
- S'assurer que le moteur est arrêté
- Agripper la grille d'admission et monter sur le rebord du pare-choc
- Retourner la motomarine dans le sens horaire



F00A24Y 219902058

ACCORDING TO WATERCRAFT MODEL

▲ WARNING / AVERTISSEMENT

- Make sure engine is off
- Grab inlet grate and step on bumper rail
- Roll boat counterclockwise
- S'assurer que le moteur est arrêté
- Agripper la grille d'admission et monter sur le rebord du pare-choc
- Retourner la motomarine dans le sens antihoraire



F00A25Y 219902057

ACCORDING TO WATERCRAFT MODEL

Label 7

▲ WARNING / AVERTISSEMENT	
<ul style="list-style-type: none"> • Engine must be off when using boarding step. • Keep away from jet and intake grate. • Stay on center of the step. • Only one person at a time on the step. • Never use the step for pulling, towing, diving or jumping, boarding a PWC that is out of water or any other purpose for which it was not designed. 	<ul style="list-style-type: none"> • Le moteur doit être arrêté lorsqu'on utilise la marche d'embarquement. • Se tenir à l'écart de la turbine et de la grille d'admission. • Rester au centre de la marche. • Une personne à la fois sur la marche. • La marche ne doit jamais servir à tirer ou à remorquer la motomarine, à plonger, à sauter à l'eau, à embarquer sur la motomarine si elle n'est pas à l'eau ou pour toute autre activité pour laquelle elle n'a pas été conçue.
F00A26Y	

SOME MODELS

Label 8

▲ WARNING / AVERTISSEMENT	
<ul style="list-style-type: none"> • Gasoline vapors may cause fires or explosions. • Do not overfill fuel tank. • Keep the craft away from open flames and sparks. • Do not start watercraft if liquid gasoline or vapors are present. • Always replace seat (or engine cover) before starting. 	<ul style="list-style-type: none"> • Les émanations d'essence peuvent provoquer des incendies ou des explosions. • Éviter de trop remplir le réservoir de carburant. • Garder la motomarine à l'écart des flammes et des étincelles. • Ne pas démarrer la motomarine en présence d'essence liquide ou d'émanation d'essence. • Toujours remettre le siège (ou le couvercle du compartiment-moteur) en place avant de démarrer la motomarine.
F00A27Y	

Label 9

▲ WARNING	▲ AVERTISSEMENT
<p>Certain components in the engine compartment may be very hot. Direct contact may result in skin burn.</p>	<p>Certains composants dans l'habitacle du moteur peuvent être très chaudes. Le contact direct sur la peau peut causer des brûlures.</p>
F00A1AY	

SOME MODELS

Label 10

VERY • LOW
CALIFORNIA EMISSION STANDARDS
EMISSION

F00L2YY

SOME MODELS

Label 11

<p>This product maybe covered by one or more of the following US patents and/or applications and their non-US equivalents / Ce produit peut être protégé aux États-Unis par un ou plusieurs des brevets et/ou demandes de brevet ci-après, ainsi que par leurs équivalents à l'extérieur des États-Unis: 6,283,099; 6,276,291; 6,174,210; 6,102,756; 6,019,648; 5,746,054; 5,603,281; 5,542,371; 5,369,360; D399,162; D343,160; D326,639.</p> <p>BOMBARDIER, SEA-DOO, XP, RX, RXX, GTI, GTS, Learning Key, OPAS, TOPS, and their associated graphic designs are trademarks of Bombardier Inc. ROTAX, 4-TEC, RFI, and their associated graphic designs are trademarks of Bombardier-Rotax GmbH & Co KG used under license. GTX is a trademark of Castrol Limited used under license. BOMBARDIER, SEA-DOO, XP, RX, RXX, GTI, GTS, Learning Key, OPAS, TOPS et les représentations graphiques qui y sont associées sont des marques de commerce de Bombardier Inc. ROTAX, 4-TEC, RFI et les représentations graphiques qui y sont associées sont des marques de commerce de Bombardier-Rotax GmbH & Co KG, utilisées sous licence. GTX est une marque de commerce enregistrée de Castrol Litée, utilisée sous licence.</p> <p>© & © 2000-2002 Bombardier Inc. All rights reserved/ tous droits réservés.</p>	219892202
F00A28Y	

947 DI Engine

The Engine Identification Number (E.I.N.) is located on the upper crankcase on MAGNETO side.

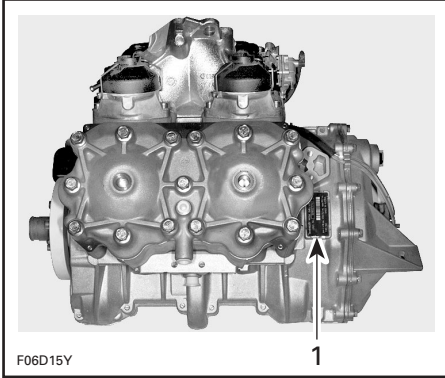

TYPICAL

1. Engine Identification Number (E.I.N.)

CONTROLS, COMPONENTS AND INSTRUMENTS LOCATION

NOTE: Some components do not apply or are optional on some models.

GTI, GTI LE Series

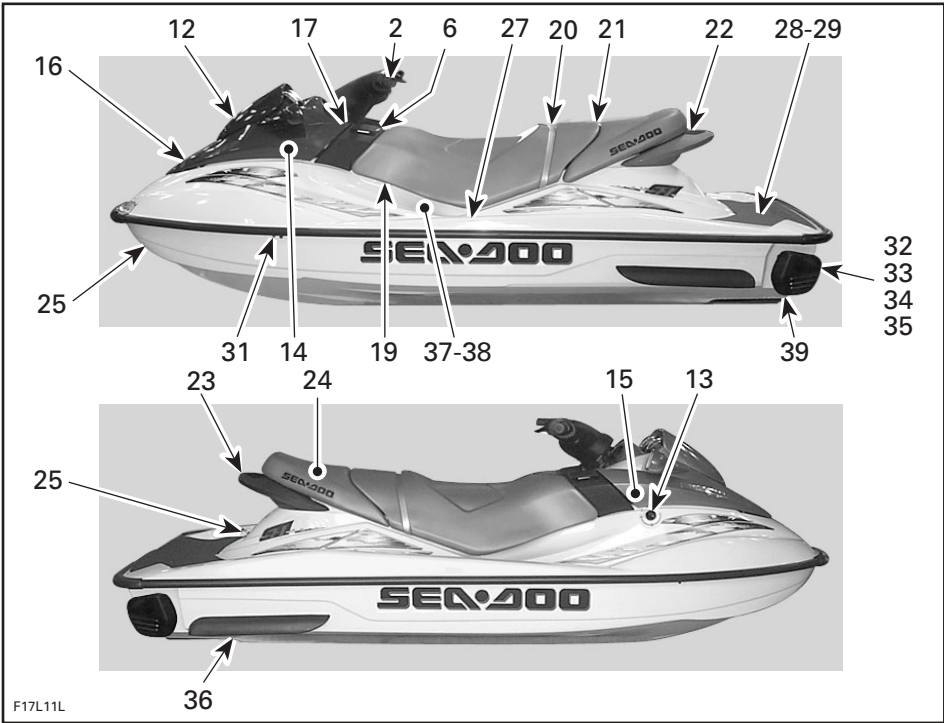

GTI, GTI LE

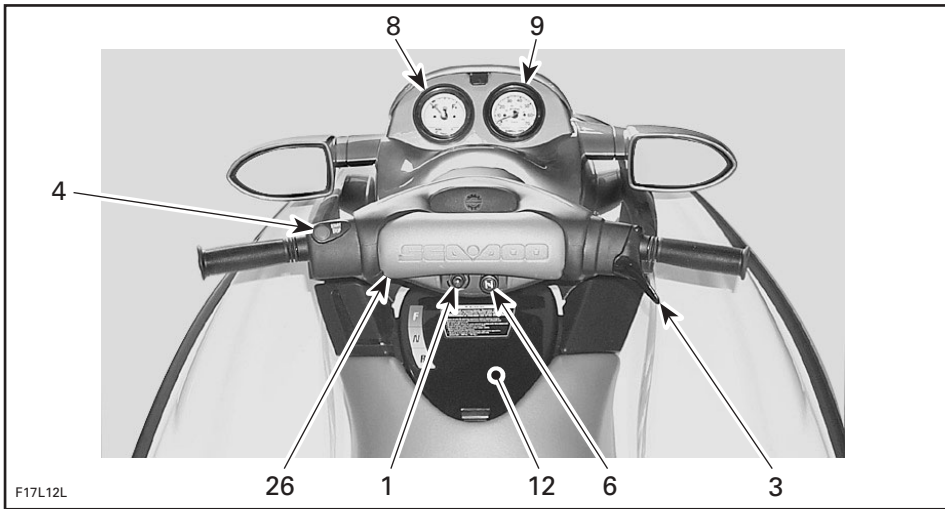

GTI LE RFI

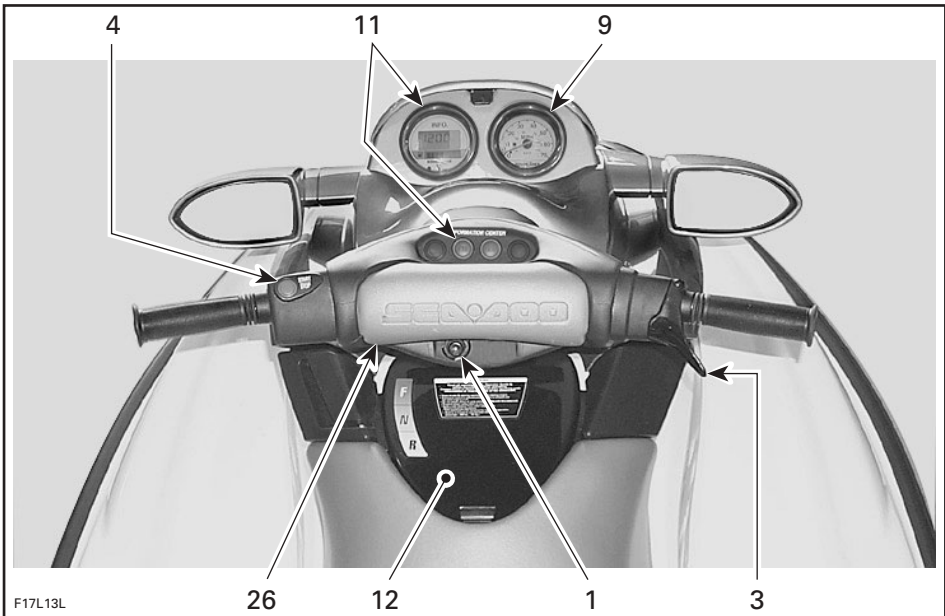

RX DI Models

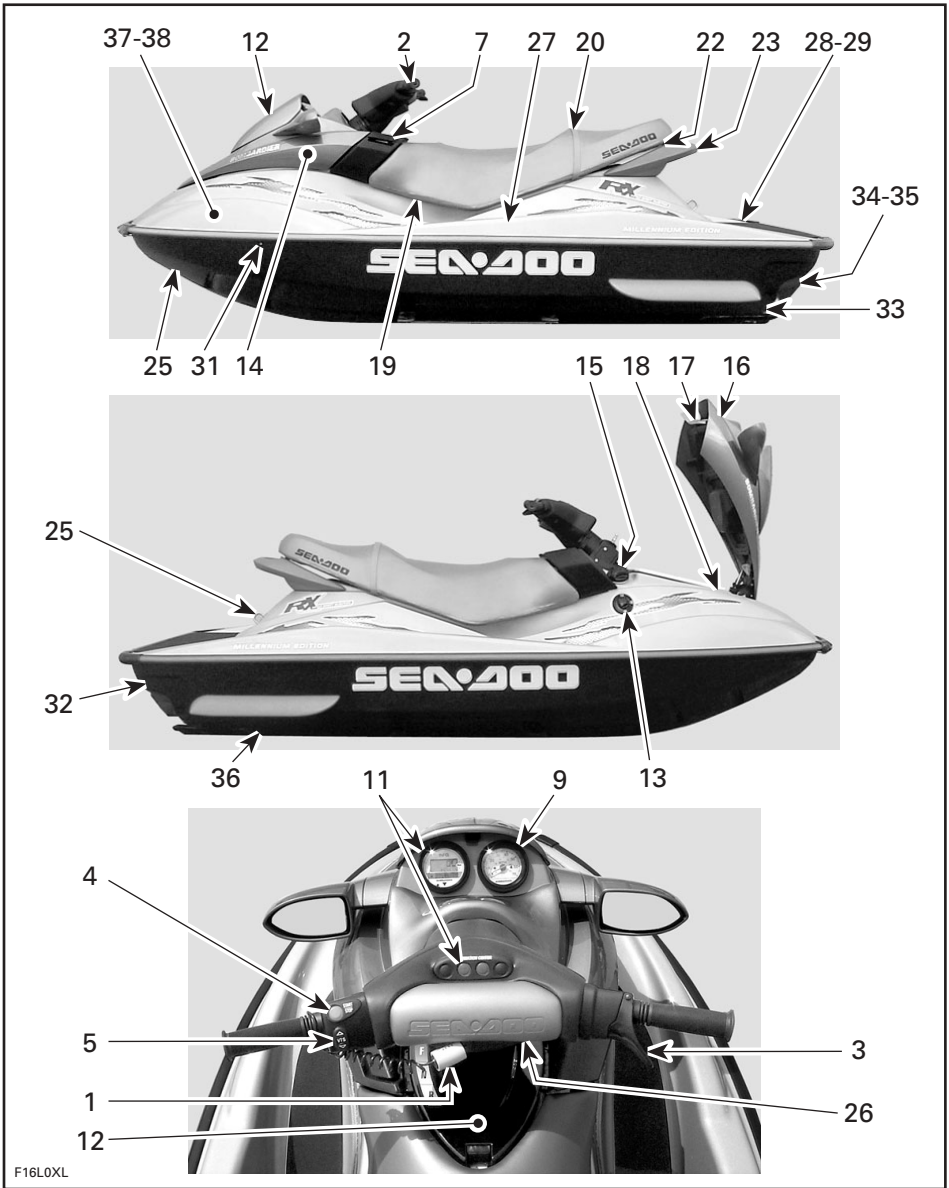

F16LOXL

GTX DI Models

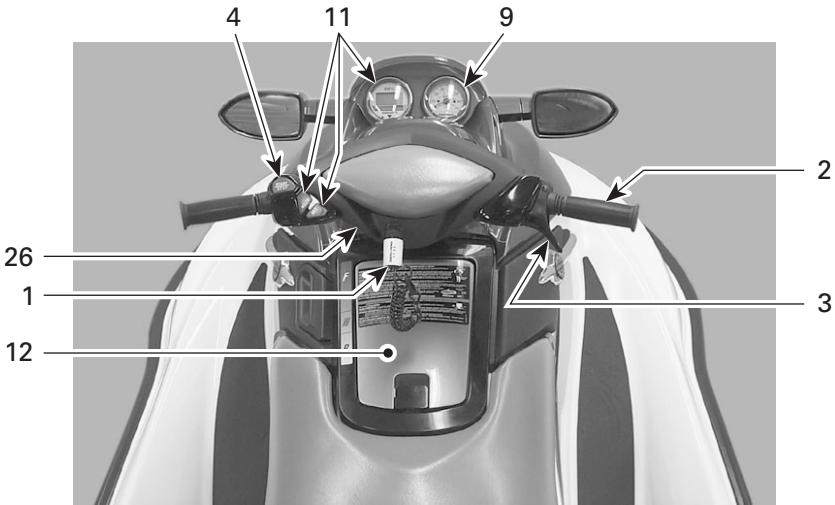
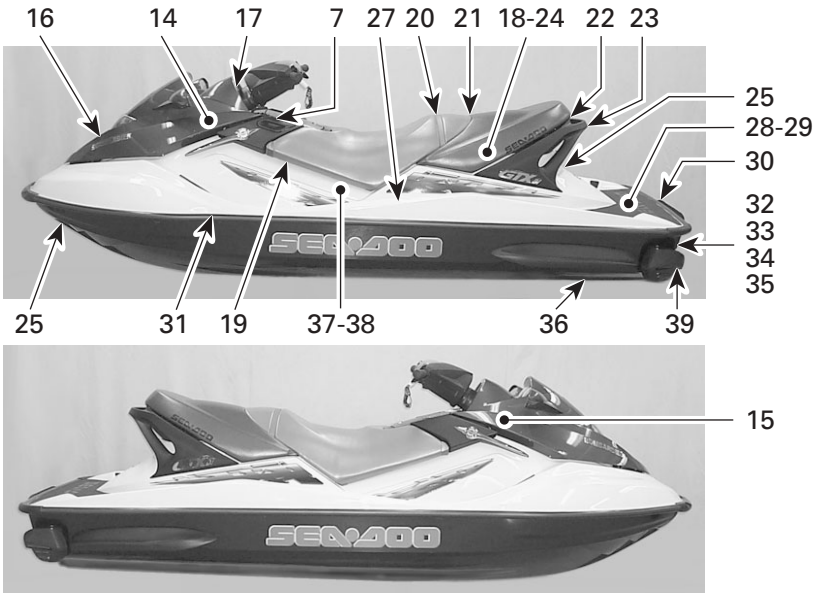

F18L2XL

1. Safety Lanyard
2. Handlebar
3. Throttle Lever
4. Engine Start/Stop Button
5. Variable Trim System (VTS) Button
6. Choke Lever
7. Shift Lever
8. Fuel Gauge/Low Oil Warning Light
9. Speedometer
10. Tachometer
11. Information Center Gauge/Buttons
12. Glove Box
13. Fuel Tank Valve
14. Fuel Tank Cap
15. Oil Injection Reservoir Cap
16. Front Storage Compartment Cover
17. Front Storage Compartment Cover Latch
18. Tool Kit
19. Air Intake Opening
20. Seat Strap
21. Seat Latch
22. Seat Extension Latch
23. Rear Grab Handle
24. Rear Storage Basket
25. Bow and Stern Eyelets
26. Mooring Cleats
27. Footboard
28. Boarding Pads
29. Boarding Platform
30. Boarding Step
31. Cooling System Bleed Outlet
32. Flushing Connector
33. Bilge Drain Plugs
34. Jet Pump Nozzle
35. Reverse Gate
36. Jet Pump Water Intake
37. Fuses
38. Battery
39. Side Vanes

CONTROLS, COMPONENTS AND INSTRUMENTS FUNCTIONS

1) Safety Lanyard (engine cut-off cord)

The safety lanyard cap should be securely snapped onto its post to be fully operational. Pulling the safety lanyard cap from its post stops the engine operation. Attach the safety lanyard to the operator's Personal Flotation Device (PFD) and snap the cap to the post to be able to start the engine.

WARNING

While engine can be stopped using the engine start/stop button, good habits recommend that the safety lanyard also be disconnected when stopping.

Two short beeps indicates the system is ready to allow engine starting. Otherwise, refer to the TROUBLESHOOTING section for the coded signals chart.

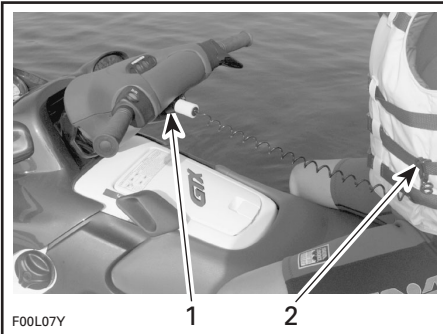

1. Safety lanyard cap on the post
2. Safety lanyard secured on operator's PFD

The **DI models** also offers a special safety lanyard — the SEA-DOO LK™ (SEA-DOO Learning Key™) — which electronically limits the speed of the watercraft to approximately 55 km/h (35 MPH) therefore enabling first time users and less experienced operators to learn how to operate the watercraft while gaining the necessary confidence and control.

WARNING

Should the engine be stopped, watercraft directional control is lost (reduced on models with O.P.A.S.™). Always disconnect safety lanyard when watercraft is not in operation in order to prevent accidental engine starting or to avoid unauthorized use by children or others or theft.

If engine is not started within 5 seconds after installing the safety lanyard on its post, 4 short beeps every 3 second interval will sound for approximately 2 hours to remind you to start the engine or to remove safety lanyard. Afterwards, the beeps will stop. The same will occur when safety lanyard is left on its post 5 seconds after engine is stopped.

Always ensure safety lanyard is not left on its post after engine is stopped.

IMPORTANT: Leaving the safety lanyard on its post when engine is not running will slowly discharge the battery.

Digitally Encoded Security System (DESS)

The safety lanyard cap specifically contains an electronic circuit that gives it a unique electronic serial number. This is the equivalent of a conventional key.

This safety lanyard cannot be used on another watercraft and conversely, the one from another watercraft cannot be used on your watercraft.

However, the DESS brings a great flexibility. You can buy an additional safety lanyard and have it programmed for your watercraft.



To have additional safety lanyard, refer to an authorized SEA-DOO dealer.

WARNING

While engine can be stopped using the engine start/stop button, good habits recommend that the safety lanyard also be disconnected when stopping.

2) Handlebar

The handlebar controls the direction of the watercraft. Turning the handlebar to the right steers the watercraft to the right and inversely.

WARNING

Check handlebar and corresponding steering nozzle and side vanes (**if so equipped**) operation before starting. Never turn handlebar while someone is nearby rear of watercraft. Keep away from steering moving parts (nozzle, side vanes, linkage etc.).

3) Throttle Lever

When the throttle lever is squeezed, the watercraft accelerates. When fully released, engine automatically slows down to idle speed and watercraft is gradually stopped by water drag.

Carburetor-Equipped Models

Do not depress lever unnecessarily when engine is not running. A fuel accelerator pump delivers fuel to the engine each time throttle lever is applied.

CAUTION: Engine can be flooded if throttle lever is unnecessarily applied several times. If engine is flooded, it will not start. Refer to SPECIAL PROCEDURES for instructions.

4) Engine Start/Stop Button

All Models

To start engine, depress and hold the start/stop button. Release immediately after engine is started.

To stop engine, fully release throttle lever then depress the start/stop button and disconnect safety lanyard from the post.

WARNING

On models **without** O.P.A.S. directional control is reduced when the throttle is released and lost when engine is off.

WARNING

On models **with** O.P.A.S. directional control is reduced when the throttle is released or when engine is off.

All Models except GTX DI

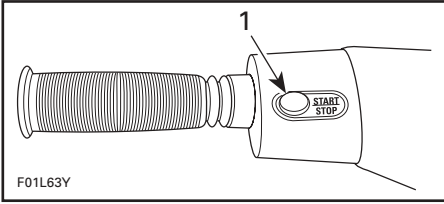

1. Engine start/stop button

GTX DI Models

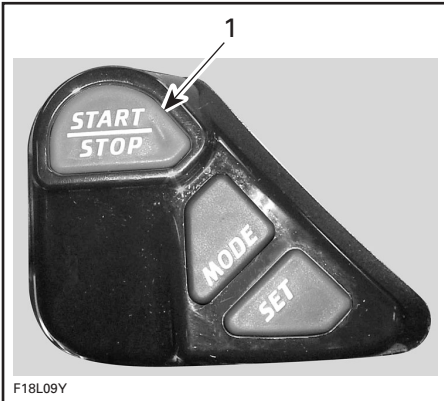

1. Engine Start/Stop button

5) Variable Trim System (VTS) Button (if so equipped)

Located just below engine start/stop button, this button is used to change pump jet nozzle position and to adjust ride to suit watercraft load and water conditions.

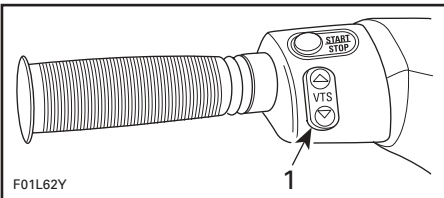

1. VTS button

A VTS position indicator is included in the information center gauge. See elsewhere in this section.

6) Choke Lever

Carburetor-Equipped Models

The choke is provided to supply a richer fuel/air mixture when starting a cold engine. Choke lever should be pulled and held to operate. Lever will automatically return to its normal position when released.

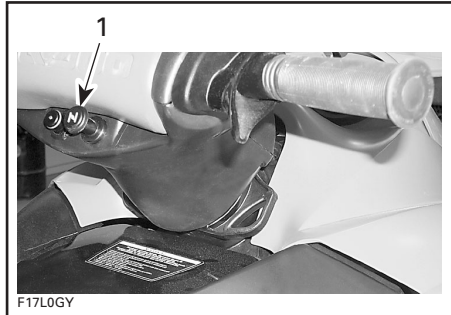

1. Choke lever

7) Shift Lever

A push-pull lever:

- forward
- neutral
- reverse.

WARNING

Shift lever should only be used when the engine is idling and craft is completely stopped. Do not use as a grab handle.

WARNING

Only use reverse at slow speed and for the shortest time possible. Always ensure the path behind is clear of objects and persons including children playing in shallow water.

CAUTION: Never rev the engine at high RPM in reverse.

From the forward position, pull the lever to reverse. Push back to go to forward. Always set in forward when finished. To find the neutral, set in reverse then push back until the watercraft stops moving backwards.

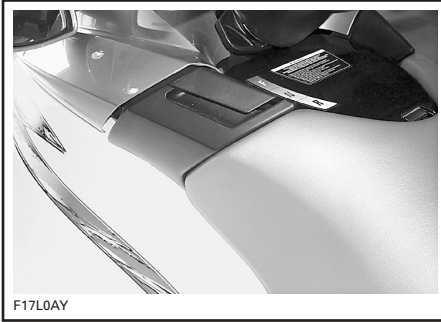

FORWARD POSITION

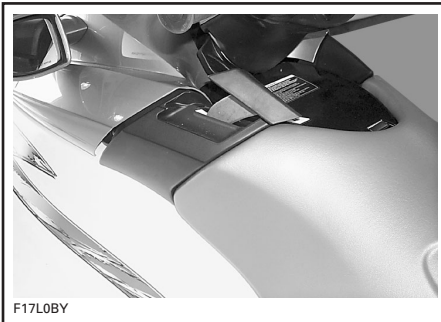

NEUTRAL POSITION



REVERSE POSITION

8) Fuel Gauge/Low Oil Warning Light (if so equipped)

Analog gauge indicates the amount of fuel in the fuel tank and a warning light turns on when level is low in oil reservoir.

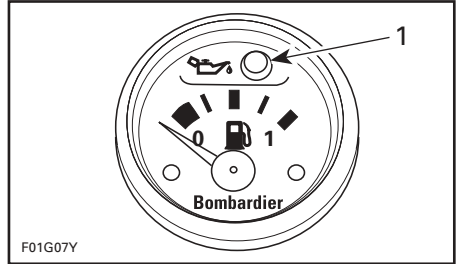

1. Low oil warning light

9) Speedometer (if so equipped)

Analog speedometer indicates the speed of watercraft in miles per hour (MPH) and kilometers per hour (km/h).

The speed sensor mounted on the ride plate sends the signal to the speedometer and information center (if so equipped).

10) Tachometer (if so equipped)

An analog tachometer indicates the revolutions per minute (RPM) of the engine. Multiply by 1000 to obtain the actual revolutions.

11) Information Center Gauge/Buttons (if so equipped)

This is a LCD multifunction gauge. Different displays and functions can be activated using 2 buttons — MODE and SET — following specific sequences as described below.

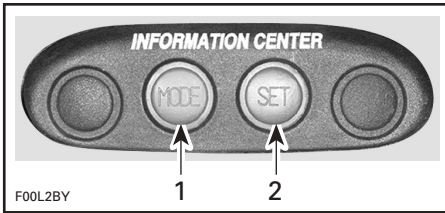

1. To change display mode
2. To set or reset a function

NOTE: Some models have the MODE and SET buttons at a different location and differ in appearance. However, the functionality is the same. The following explanations apply to both types of buttons.

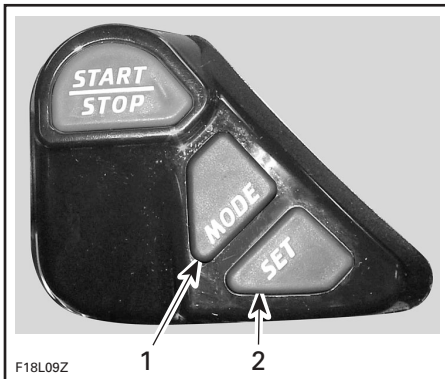

1. To change display mode
2. To set or reset a function

Resetting a Function

To reset a function (such as the chronometer, distance, etc.) press and hold the SET button for 2 seconds while in the appropriate mode.

The information center includes the following display areas.

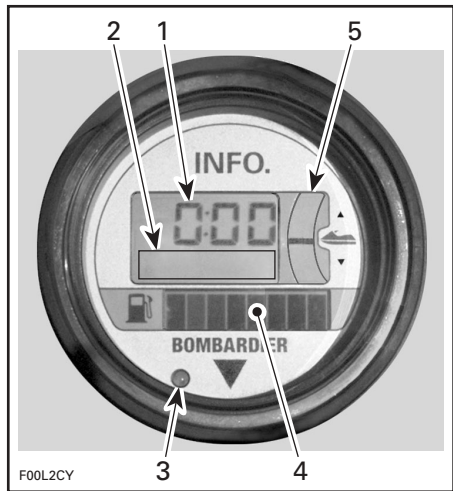

1. General display
2. Message/units display
3. Warning light
4. Fuel level display
5. VTS position indicator (if so equipped)

General Display

Repeatedly pressing the MODE button scrolls the following displays: Compass (if so equipped), Tachometer, speedometer, average speed, trip meter, hourmeter, water temperature, exterior temperature (if so equipped) and chronometer.

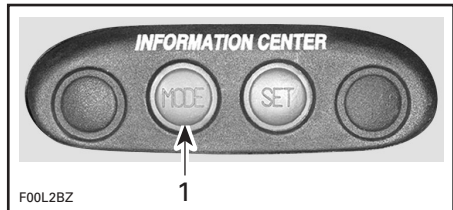

1. Press to change display mode

When you are satisfied with your choice, stop pressing the button. The display you have chosen will remain until it is changed. When safety lanyard is installed, the last chosen display will come back.

Compass (if so equipped): Displays the cardinal points to indicate the orientation of the watercraft.

WARNING

Use the compass as a guide only. Not to be used for navigation purposes.

Tachometer: Indicates the revolutions per minute (RPM) of the engine.

Speedometer: Indicates the speed of watercraft in kilometers per hour (KPH) or miles per hour (MPH).

Average Speed: The information center approximately calculates and displays the average speed (AV KPH or AV MPH) of the watercraft since the last engine start.

Trip Meter: The information center approximately calculates the distance based on the operation time and the watercraft speed and displays the result in kilometers (KM) or miles (MILES).

Hourmeter: Displays the time in hours of the watercraft usage.

Water Temperature: Displays the water temperature of the water surface (L TEMP) in degrees Celsius (°C) or Fahrenheit (°F).

Exterior Temperature (if so equipped): Displays the exterior air temperature (E TEMP) in degrees Celsius (°C) or Fahrenheit (°F).

Chronometer: Allows to measure an interval of time in hours and minutes (hh:mm).

Message Display

The information center features a display area that blinks a message whenever one of the following circumstances occurs:

- fuel injection system sensors and major components (MAINT) (DI models)
- compass error (COMPAS) (if so equipped)
- maintenance (MAINT)
- engine overheating (H-TEMP)
- low fuel (FUEL-LO)
- low oil (OIL LOW)
- low voltage (12 V LOW).

A buzzer will sound when one of the four last circumstances occurs.

Except for low fuel and low oil, which can be corrected by refilling, it is recommended to see an authorized SEA-DOO dealer when other messages occur.

The warning light will blink at the same time.

Warning Light

The red warning LED (Light-Emitting Diode) blinks along with the message display to catch your attention.

Fuel Level Display

Bar gauge continuously indicates the amount of fuel in the fuel tank while riding. A low-fuel condition is also indicated when it occurs. See MESSAGE DISPLAY above.

VTS Position Indicator (if so equipped)

The VTS position indicator shows the riding angle of the watercraft.

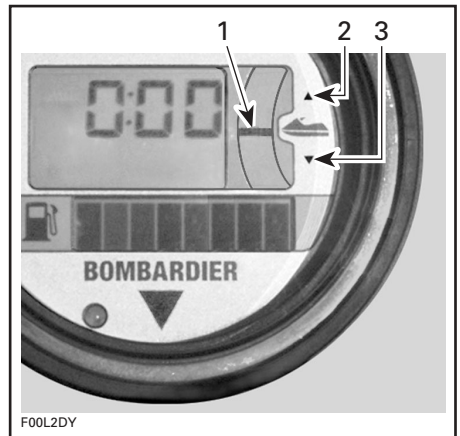

1. Position indicator
2. Bow up
3. Bow down

Display Priorities

As a self test, all LCD segments and the LED will turn on for 3 seconds each time the information center is activated (when safety lanyard is installed).

When the information center is activated, the last function set will be displayed if it was the tachometer, speedometer or chronometer. If another function was set, the compass will be displayed. **On models without** the compass function, the word "SeaDoo" will be displayed.

In the event of a warning message, the message will blink and override the units display.

If more than one warning message occurs, the blinking messages will scroll every 4 seconds.

Other Functions

The following describes how to select other available functions.

Language Option

While in the compass mode (while "SeaDoo" is displayed **on models without** compass):

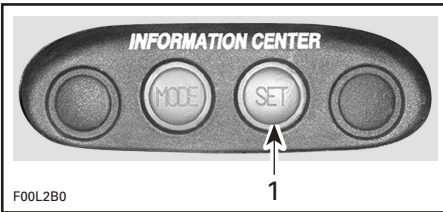

1. Press and hold for 2 seconds

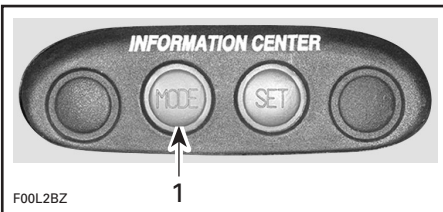

1. Repeatedly press

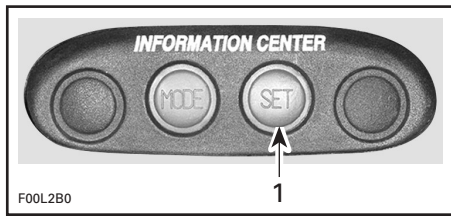

1. Press to end

English/Metric System

Allows to display the units in the metric system or in the SAE English system.

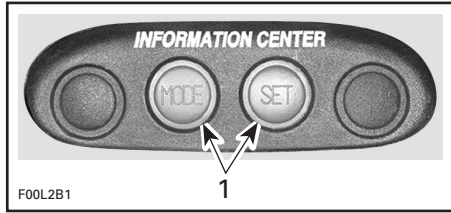

1. Press **TOGETHER** and hold for 2 seconds

Chronometer

While in the chronometer mode:

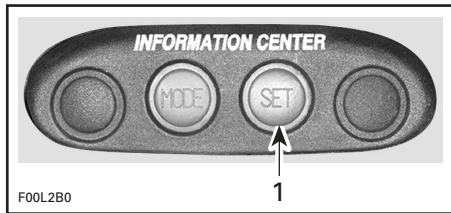

1. Press to start or stop chronometer

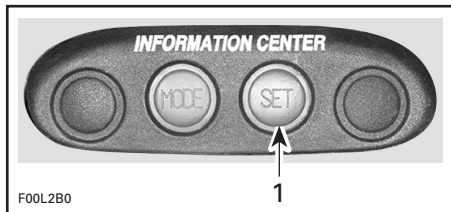

1. Press and hold for 2 seconds to reset

Chronometer is reset every time engine is turned off.

Maintenance Information

When the watercraft is due for a maintenance inspection, the message MAINT will blink.

To clear the warning message while it is blinking:

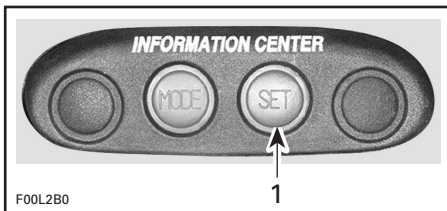

1. Press and hold for 2 seconds to reset

NOTE: If maintenance message (MAINT) continues to blink, it indicates a fault with the fuel injection system on Di models. Refer to an authorized SEA-DOO dealer for servicing.

12) Glove Box

A small, convenient storage compartment for personal articles.

13) Fuel Tank Valve

Carburetor-Equipped Models

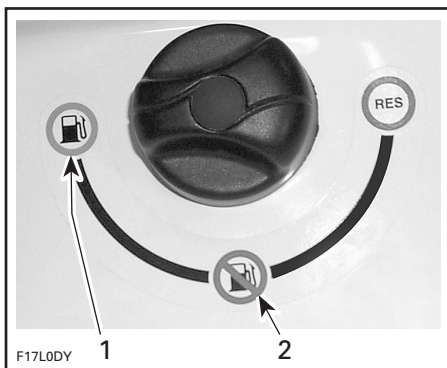

1. ON
2. OFF

A 3-position rotating valve: OFF, ON and RESERVE:

OFF: Stop fuel supply to carburetor(s).

CAUTION: Turn valve to OFF position when watercraft is not operated.

ON: Allows fuel to flow to carburetor(s). This is the normal position for operation of watercraft.

CAUTION: Improper opening of fuel valve may restrict flow of fuel and may lead to engine damage. Make sure valve is fully opened while running.

RES (RESERVE): Use when the watercraft has run out of fuel in the ON position.

Always refill the fuel tank at the first opportunity. After refueling, turn the fuel tank valve to the ON position to continue operation.

14) Fuel Tank Cap

Some Models

Open the front storage compartment cover to expose fuel tank cap.

All Models

Refer to the vehicle illustration for fuel tank cap location.

Unscrew the cap counterclockwise. After fueling, reinstall cap and fully tighten.

⚠ WARNING

Always stop the engine before refueling. Fuel is flammable and explosive under certain conditions. Always work in a well ventilated area. Do not smoke or allow open flames or sparks in the vicinity. Fuel tank may be pressurized, turn cap slowly when opening. Never use an open flame to check fuel level. When fueling, keep watercraft level. Do not overfill or top off the fuel tank and leave watercraft in the sun. As temperature increases, fuel expands and might overflow. Always wipe off any fuel spillage from the watercraft. Periodically verify fuel system. Always turn the fuel tank valve (if so equipped) to OFF position when the watercraft is not in use.

15) Oil Injection Reservoir Cap

Refer to the vehicle illustration for oil injection reservoir cap location.

To add injection oil in the reservoir, unscrew the cap counterclockwise. Do not overfill. Reinstall cap and fully tighten it.

WARNING

Do not overfill. Reinstall cap and fully tighten. Oil is inflammable. Always wipe off any oil spillage from the bilge.

Open the front storage compartment cover to expose reservoir cap.

16) Front Storage Compartment Cover

It gives access to the front storage compartment. Always relatch cover after closing.

Front Storage Compartment

A convenient watertight area, (removable basket on **some models**) to carry personal articles. Ideal location for spare spark plugs, towrope, first aid kit, etc.

WARNING

Never leave any heavy or breakable objects loose in the storage area/ basket. Never store or carry anything below basket (**if so equipped**). Never operate the watercraft with any storage compartment cover open.

GTI, GTI LE, GTI LE RFI and GTX DI Models

If there is water in the storage area, pull out the drain plug to let water go out. Reinstall the plug when done.

NOTE: The water will flow to the bilge. If there is an important quantity of water, ensure to drain the bilge (out of water) prior to using the watercraft.

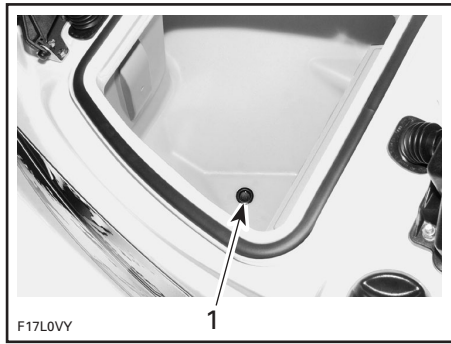

1. Drain plug

GTI and GTI LE Models

The rear storage basket includes a latch to hold an approved fire extinguisher (sold separately).



RX DI Models

Lift the basket to get access to the holder to store an approved fire extinguisher (sold separately). It also contains the *Operator's Guide*, the *Safety Handbook* and the tool kit.



GTX DI Models

The front storage area includes a latch to hold an approved fire extinguisher (sold separately).

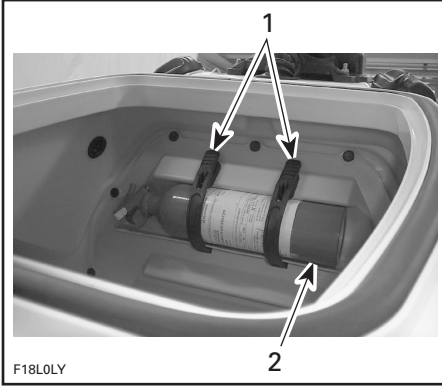

1. Retaining straps
2. Extinguisher (sold separately)

WARNING

Ensure to properly secure extinguisher with the supplied retaining straps.

17) Front Storage Compartment Cover Latch

Pull the latch lever upward in order to open the front storage compartment cover. Always relatch.

NOTE: Verify periodically the lock pin tightness of storage cover. Tighten if needed and make sure storage cover latches properly.

18) Tool Kit

Contains tools needed to perform basic watercraft maintenance.

19) Air Intake Opening

This is where air enters to supply the engine and to ventilate the engine compartment. If the air intake opening is kept under water, water will get inside bilge.

CAUTION: If the air intake opening is kept under water, such as turning constantly in tight circles, water will get inside bilge, which may cause severe damage to internal parts of the engine.

20) Seat Strap

The seat strap provides a handhold to assist boarding and is used as a handhold for the passenger.

21) Seat Latch

Removing the seat allows access to the engine compartment.

The seat latch is located at the rear end and underneath the seat.

2-Up Seat Models

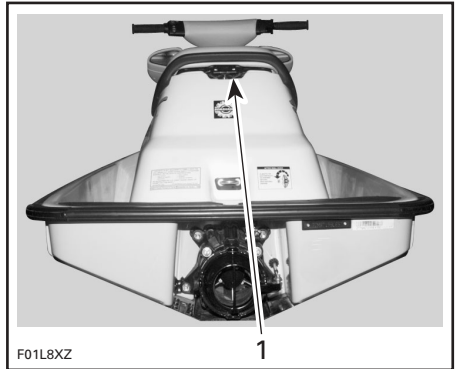

TYPICAL

1. Seat latch

3-Up Seat Models

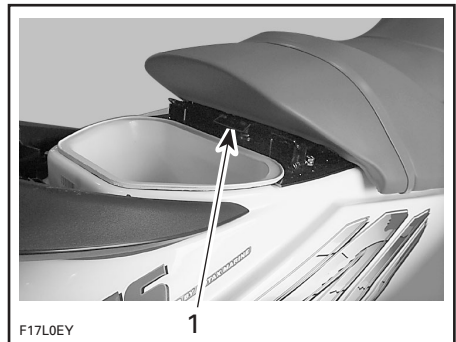

1. Seat latch

All Models

To remove seat, pull the latch lever upward and hold. Lift and pull the seat rearward.

NOTE: On the 3-up seat models, it is necessary to remove the seat extension first and repeat the same procedure to remove the seat.

Engine Compartment

This is where the mechanical, electrical and fuel/oil systems are located.

WARNING

Components inside engine compartment may be hot. When starting or operating the engine, do not touch any electrical part. Never leave any object, rag, tool, etc., in the engine compartment or in the bilge.

Some Models

When reinstalling the seat, insert seat front tab into body hook.

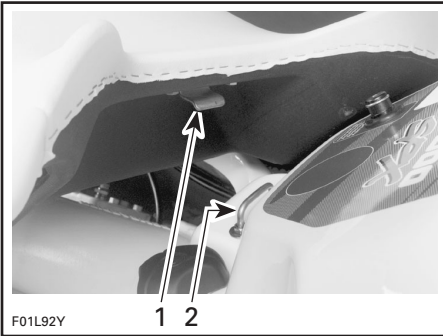

1. Insert this tab in hook
2. Hook

Some Models

When reinstalling the seat, insert seat hook into body front tab for each portion of the seat.

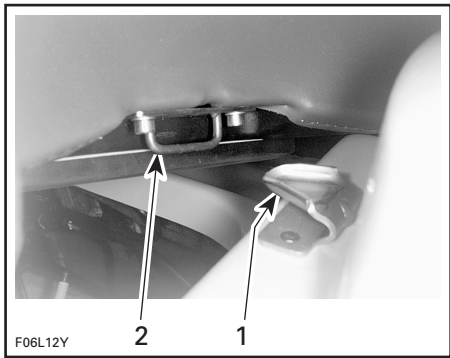

1. Insert this tab in hook
2. Hook

Some Models

When reinstalling the seat, place seat cavity over body hook.

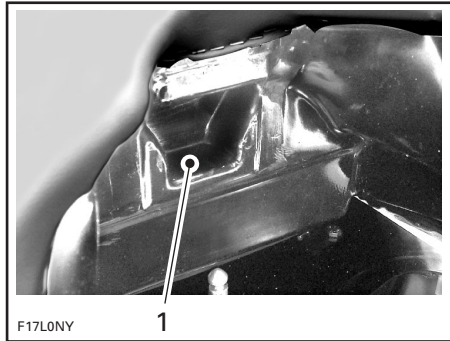

1. Seat cavity

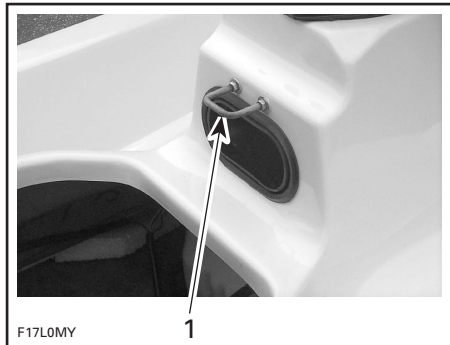

1. Body hook

All Models

To latch seat, align latch hole with pin then, firmly push downward on rear of the seat.

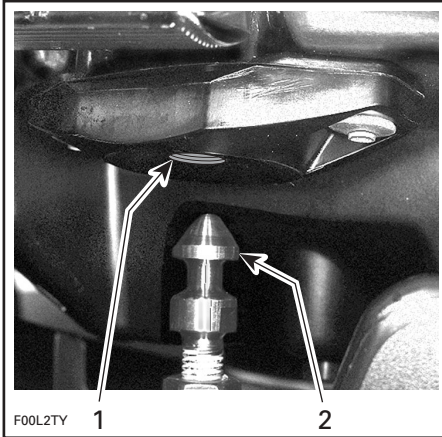

1. Latch hole
2. Pin

22) Seat Extension Latch (if so equipped)

Removing the seat extension allows access to the rear storage basket. It also gives access to the seat latch on models with a seat extension.

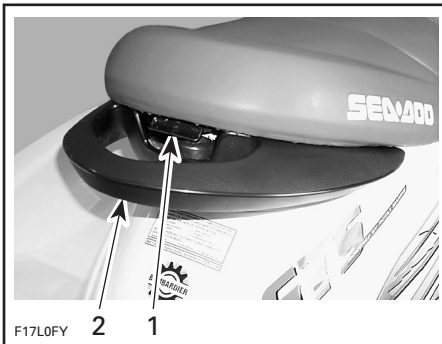

1. Seat extension latch
2. Rear grab handle

23) Rear Grab Handle

Provides a handhold for boarding when needed and a handhold for the passenger or the spotter on 3-up seat models. See illustration above.

CAUTION: Never use the grab handle to tow anything or to lift the watercraft.

24) Rear Storage Basket (if so equipped)

A convenient watertight, removable basket to carry personal articles.



TYPICAL

GTX DI Models

Spare Spark Plug Holder

The storage basket features a spare spark plug holder.

To keep spare spark plugs dry and prevent shocks that might affect the adjustment or break them, a holder is provided.

Unscrew cap counterclockwise to expose the holder and insert spark plug in their holes. Reinstall cap.

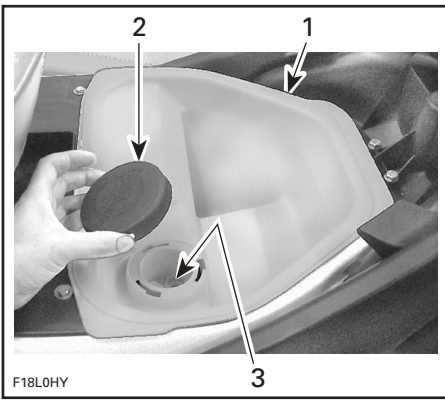

F18L0HY

1. Storage basket
2. Spare spark plug holder cap
3. Spark plug holder

NOTE: Adjust spare spark plug gap according to SPECIFICATIONS before installation.

NOTE: Spare spark plugs are not supplied with the watercraft.

All Models

25) Bow and Stern Eyelets

Bow Eyelet

Eyelets can be used for mooring, towing and as a tie-down point during trailering.

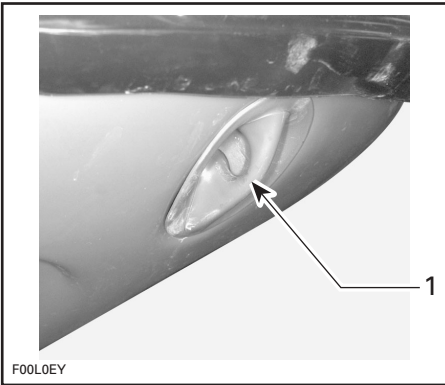

FO0L0EY

1. Bow eyelet

Stern Eyelet

Some Models

This eyelet allows a rope with a hook, a closed end or an open end to be attached.

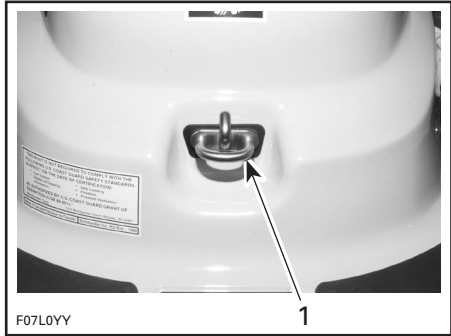

F07L0YY

1. Stern eyelet

26) Mooring Cleats

All Models

These cleats can be temporarily used for docking, while refueling for example.

CAUTION: Never use mooring cleats to pull or lift the watercraft.

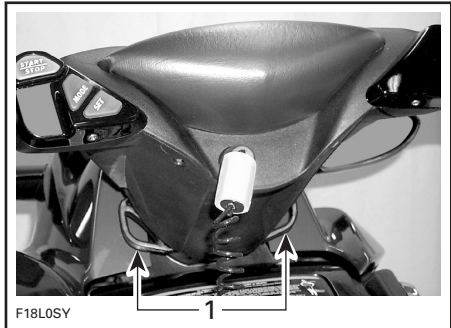

F18L0SY

1. Mooring cleats

27) Footboard

User's feet should rest on the footboard when riding.

28) Boarding Pads

Provide a cushioned surface for the knees when boarding from rear of watercraft.

All Models

29) Boarding Platform

Provides a large surface for easier boarding from rear of watercraft.

30) Boarding Step (if so equipped)

A convenient step to help reboarding the watercraft.

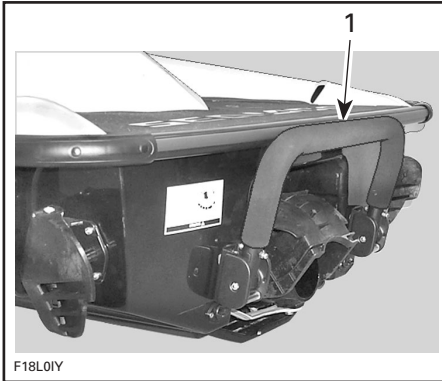

1. Boarding step

Pull down the step with your hand and hold until a foot is put on the step.

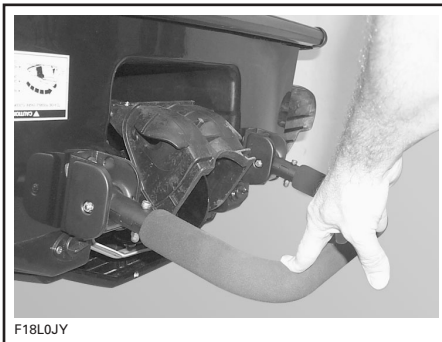

31) Cooling System Bleed Outlet

All Models



TYPICAL

1. Bleed outlet

When engine is running, water should flow from the outlet. This allows air in engine cooling system to escape. It also indicates that water is circulating in the cooling system.

NOTE: It may be required to increase slightly the engine RPM to see the water flowing out.

CAUTION: Should water not flow from outlet a few seconds after engine starts, immediately stop engine and refer to **POST-OPERATION CARE** and look for **COOLING SYSTEM FLUSHING** or refer to an authorized SEA-DOO dealer for servicing.

32) Flushing Connector (if so equipped)

A convenient connector is provided to allow easy installation of a garden hose to flush the cooling system.

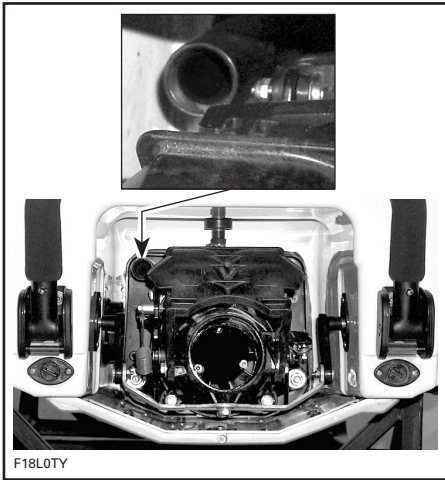

TYPICAL

Refer to POST-OPERATION CARE section for proper use.

33) Bilge Drain Plugs

Should water be found in the bilge, it can be easily drained by unscrewing the drain plugs when engine is off and watercraft is out of water.

CAUTION: Remove boat from water prior to unscrewing drain plugs.

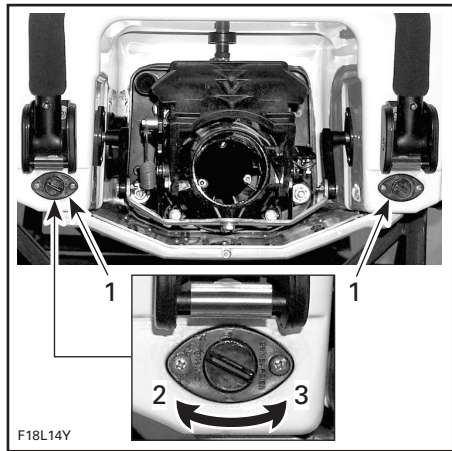

TYPICAL

1. Drain plugs
2. Tighten
3. Unscrew

Tilt the watercraft slightly to the rear so that the water can completely flow out of the bilge.

It is suggested to drain bilge on a ramp.

CAUTION: Make sure drain plugs are properly secured prior to launching the watercraft in water.

34) Jet Pump Nozzle

Jet pump nozzle turns side to side via rider input at the handlebar. This provides directional control when engine is running.

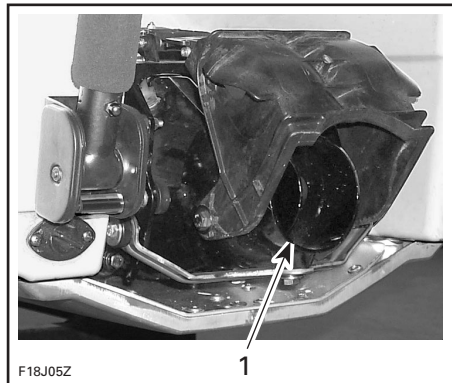

TYPICAL

1. Jet pump nozzle

35) Reverse Gate

When selecting the neutral or reverse position with the shift lever, the reverse gate moves up or down to obtain the desired position.

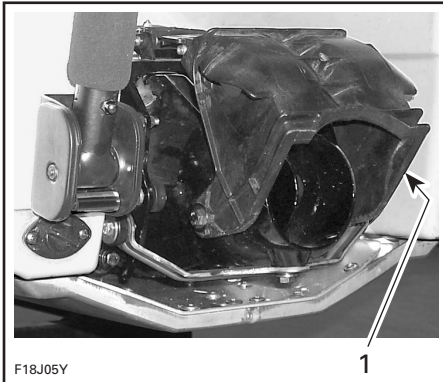

TYPICAL

1. Reverse gate

36) Jet Pump Water Intake

The water is drawn up by the impeller through this opening. The water intake grate minimizes the entry of foreign objects into the propulsion system.

⚠ WARNING

Keep away from intake grate while engine is on. Items such as long hair, loose clothing or personal flotation device straps can become entangled in moving parts resulting in severe injury or drowning.

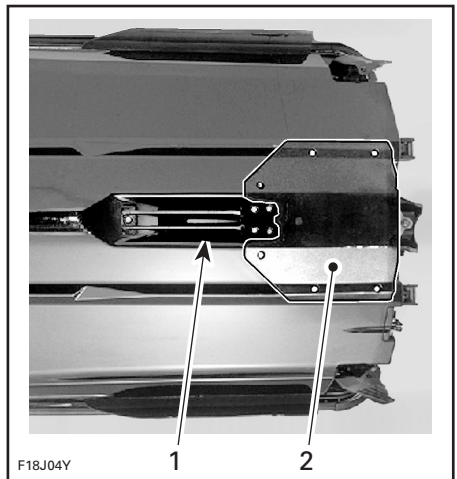

1. Water intake
2. Ride plate

37) Fuses

Fuses are located under seat in bilge. Refer to MAINTENANCE for more details.

38) Battery

Battery is located inside engine compartment. Refer to SPECIAL PROCEDURES.

39) Side Vanes (if so equipped)

Side vanes are part of Off-Power Assisted Steering (O.P.A.S.) system. When engine RPM is reduced, the side vanes are lowered to assist the steering system.

⚠ WARNING

Check handlebar and corresponding side vanes operation before starting. Never use side vanes as a supporting point to board the watercraft or to lift it. Never turn handlebar while someone is nearby rear of watercraft. Keep away from steering moving parts (nozzle, side vanes, linkage etc.).

FUEL AND LUBRICATION

CAUTION: Scrupulously follow the instructions of this section. Failure to do so may reduce the engine's life and/or performance.

Fueling Procedure

WARNING

Follow these safe boating fueling instructions explicitly.

Turn off engine.

Do not allow anyone to remain on the watercraft.

Tie watercraft securely to the fueling pier.

Have a fire extinguisher close at hand.

Do not insert the spout too far in filler neck.

Pour fuel slowly so that air can escape from the tank and prevent fuel flowback. Be careful not to spill fuel.

Stop filling when the fuel reaches the bottom of filler neck. Do not fill into the filler tube to prevent fuel spill out. **Do not overfill.** Fully tighten fuel tank cap.

WARNING

Always stop the engine before refueling. Fuel is inflammable and explosive under certain conditions. Always work in a well ventilated area. Do not smoke or allow open flames or sparks in the vicinity. Fuel tank may be pressurized, turn cap slowly when opening. Never use an open flame to check fuel level. When fueling, keep watercraft level. Do not overfill or top off the fuel tank and leave watercraft in the sun. As temperature increases, fuel expands and might overflow. Always wipe off any fuel spillage from the watercraft. Periodically verify fuel system. Always turn the fuel tank valve (**if so equipped**) to OFF position when the watercraft is not in use.

Recommended Fuel

Use unleaded regular gasoline with 87 octane (Ron + Mon)/2 specification.

All Models

NOTE: Do not mix oil with fuel except if otherwise specified, at engine break-in. Refer to BREAK-IN PERIOD. Always check injection oil reservoir level when refueling.

CAUTION: Never experiment with other fuels or fuel ratios. Never use fuel containing more than 10% alcohol, (ethanol or methanol). The use of non-recommended fuel can result in watercraft performance deterioration and damage to critical parts in the fuel system and engine components.

CAUTION: On RFI and DI models, never use injector cleaning products. They may contain additive that could damage injector components.

Recommended Oil

WARNING

Do not overfill. Reinstall cap and fully tighten. Oil is inflammable. Always wipe off any oil spillage from the bilge.

Use only two-stroke engine injection oil sold by authorized SEA-DOO dealers.

MODELS	OIL TYPE
GTI, GTI LE	<ul style="list-style-type: none">• BOMBARDIER Formula XP-S II synthetic injection oil OR• BOMBARDIER injection oil (or equivalent) ① ②
GTI LE RFI, RX DI, GTX DI ③	<ul style="list-style-type: none">• BOMBARDIER Formula XP-S II synthetic injection oil

- ① If BOMBARDIER injection oil is not available, API TC high-quality low ash two-stroke injection oil may be used.
- ② BOMBARDIER FORMULA XP-S II synthetic injection oil and BOMBARDIER injection oil are compatible, they can be mixed together.
- ③ **CAUTION:** The BOMBARDIER Formula XP-S II oil is specially formulated and tested for the severe requirements of the **787 RFI and 947 DI** engines. Use of any other brand two-stroke oil may void the limited warranty. Use only BOMBARDIER Formula XP-S II oil. There is no known equivalent on the market for the moment. If a high quality equivalent were available, it could be used.

BOMBARDIER injection oil is a special blend of basic oil and additives especially selected to ensure unequalled lubrication, engine cleanliness and minimum spark plug fouling.

The BOMBARDIER Formula XP-S II synthetic injection oil provides superior lubrication, reduced engine component wear and oil deposit, thus maintaining maximum-level performance and antifriction properties. This synthetic injection oil meets the latest ASTM and JASO standards by ensuring high biodegradability and low exhaust smoke.

CAUTION: Never use four-stroke petroleum or synthetic motor oil and never mix these with outboard motor oil. Do not use NMMA TC-W, TC-W2 or TC-W3 outboard two-stroke engine oils or ashless two-stroke engine oils. Avoid mixing different brands of API TC oil as resulting chemical reactions may cause severe engine damage.

Oil Injection System

This watercraft features an oil injection system which does not require manual fuel/oil mixing.

A sufficient amount of injection oil should be maintained in the reservoir.

NOTE: It is recommended to carry a 1 L of spare injection oil.

The use of a funnel is recommended to pour the oil into the reservoir. Stop filling as soon as oil appears at approximately 13 mm (1/2 in) from top of reservoir. Do not overfill.

CAUTION: Always maintain a sufficient amount of injection oil in the oil reservoir. Check and refill every time you refuel if necessary. Do not overfill. If the engine runs out of oil, severe engine damage will occur. If the oil reservoir is found almost empty, air can enter in the system and it should be bled. Immediately refer to an authorized SEA-DOO dealer to have the oil injection system inspected.

BREAK-IN PERIOD

CAUTION: Scrupulously follow the instructions of this section. Failure to do so may reduce the engine's life and/or performance.

With SEA-DOO watercraft powered by Rotax® engines, a break-in period of 10 hours is required before continuous operation at full throttle.

All Models except DI Models

To achieve a good break-in, throttle lever should not be depressed more than 3/4, however, brief acceleration and speed variations contribute to a good break-in.

DI Models

To achieve a good break-in, vary the engine speed every few minutes with brief wide open throttle accelerations of up to 15 seconds.

All Models

CAUTION: Continued wide open throttle runs and prolonged cruising without speed variations should be avoided, this can cause engine damage during the break-in period.

All Models except DI Models

To assure additional protection during the initial engine break-in, it is recommended to add 1 L of the same oil as in the injection oil reservoir in the fuel tank for the first full fuel tank filling only.

To add injection oil in the fuel tank, proceed as follows:

Fill fuel tank with approximately 15 liters (4 gal) of gasoline; then, add the injection oil in the fuel.

Fill up fuel tank with gasoline. Do not overfill.

NOTE: It is important to proceed in this order to allow a proper mixing of the oil in the gasoline. If oil is added first in an empty fuel tank, fuel lines will be filled up with injection oil leading in a no start condition of the engine.

CAUTION: Remove and clean spark plugs after engine break-in.

DI Models

NOTE: Do not add injection oil in the fuel tank for the break-in.

All Models

10-Hour Inspection

It is highly recommended that after the first 10 hours of operation, the watercraft be checked by an authorized SEA-DOO dealer. This inspection will also provide the opportunity to discuss the unanswered questions you may have encountered during the first hours of operation.

The 10-hour inspection is at the expense of the watercraft owner.

PRE-OPERATION CHECKS

WARNING

The pre-operation check is very important prior to operating the watercraft. Always check the proper operation of critical controls, safety features and mechanical components, before starting as listed hereinafter. If not done as specified here, severe injury or death might occur. Bring all safety equipment required by local laws.

Some of the following items may not have been previously covered in this guide, however they will be described in the MAINTENANCE or SPECIAL PROCEDURES section. Please refer to these sections to have more detailed information.

WARNING

Engine should be off and the safety lanyard should always be removed from its post prior to verifying any of the following points. Only start watercraft once all items have been checked and operate properly.

ITEM	OPERATION	✓
Hull	Inspect.	
Jet pump water intake	Inspect/clean.	
Bilge	Drain. Ensure plugs are secured.	
Battery	Inspect tightness of cables and retaining strap(s).	
Fuel tank and oil reservoir	Refill.	
Engine compartment	Check fuel line connections for tightness. Verify for any fuel leak/odor.	
Steering system and side vanes (if so equipped)	Check operation.	
Throttle system	Check operation.	
Shifter system	Check operation.	
VTS (if so equipped)	Check operation.	
Storage compartment covers and seat	Ensure they are closed and latched.	
Safety lanyard and engine start/stop button	Check operation.	

NOTE: See the detailed instructions hereinafter.

Hull

Inspect hull for cracks or damage.

Jet Pump Water Intake

Remove weeds, shells, debris or anything else that could restrict the flow of water and damage cooling system or propulsion unit. Clean as necessary. If any obstruction can not be removed, refer to an authorized SEA-DOO dealer for servicing.

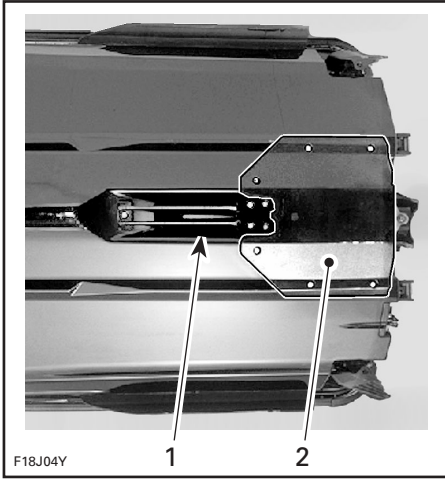

1. Water intake
2. Ride plate

Inspect leading edges of the impeller, if they have nicks or bends performance will be greatly reduced.

Bilge

Should water be present in the bilge, tilt the watercraft to the rear and unscrew drain plugs to completely empty the bilge. Secure bilge drain plugs.

WARNING

Make sure drain plugs are properly secured prior to launching the watercraft in water.

Battery

WARNING

Verify tightness of battery cables to their posts and condition of battery retaining strap(s)/fasteners. Do not charge or boost battery while installed.

Fuel Tank and Oil Reservoir

With the watercraft horizontal, fill the fuel tank to specified level.

Check the oil level and refill reservoir as necessary.

Check fuel tank and oil reservoir retaining straps/fasteners.

Engine Compartment

WARNING

Should any leak or gasoline odor be present, do not start the engine. Refer to an authorized SEA-DOO dealer before use.

Steering System

Assisted by another person, check steering operation for free movement. When the handlebar is horizontal, the jet pump nozzle should be in the straight ahead position. The rear edge of side vanes (if so equipped) should be pointing outside of watercraft by approximately 20°. Ensure the jet pump nozzle and side vanes (if so equipped) pivot easily and in the same direction as the handlebar.

WARNING

Check handlebar and corresponding steering nozzle operation before starting. Never turn handlebar while someone is nearby rear of watercraft. Keep away from steering moving parts (nozzle, side vanes, linkage etc.).

Throttle System

Check throttle lever for free and smooth operation. It should return to its initial position immediately after it is released.

WARNING

Check throttle lever operation before starting the engine.

All Models except RFI and DI

CAUTION: Engine can be flooded if throttle lever is applied several times when engine is not running. If engine is flooded, it will not start.

All Models

Shifter System

Check reverse gate operation for free movement. With shift lever in forward position, the gate should be in upward position and offering a resistance to go downward. With the shift lever in neutral position, gate should be in middle position. With shift lever in reverse position, gate should be in downward position.

WARNING

Verify the reverse gate operation before starting the engine.

VTS (Variable Trim System) (if so equipped)

Push on arrows on VTS button to check nozzle movement.

Storage Compartment Covers and Seat

Ensure they are closed and latched.

WARNING

Make sure seat is securely latched.

Safety Lanyard and Engine Start/Stop Button

Position shift lever in neutral. Ensure that both switches operate properly. Start engine and stop it using each switch individually.

WARNING

Should the safety lanyard cap is loose or fail to remain on its post, replace it immediately in order to avoid unsafe use.

WARNING

If engine does not shut-off when pushing engine start/stop button or by disconnecting the safety lanyard, stop the engine by applying the choke and turning fuel tank valve (**if so equipped**) to OFF position. Do not operate the watercraft further, see an authorized SEA-DOO dealer.

OPERATING INSTRUCTIONS

WARNING

Always perform the PRE-OPERATION CHECKS before operating the watercraft. Become thoroughly familiar with all controls and the function of each. Should any control or instruction not be fully understood, refer to an authorized SEA-DOO dealer.

Principle of Operation Propulsion

The engine is directly coupled to a drive shaft which, in turn, rotates an impeller. This impeller is accurately adjusted in a housing where the water is drawn up from underneath the watercraft. Then the water flows through the impeller to a venturi. The venturi accelerates the water and produces thrust to move the watercraft. Depressing the throttle lever increases engine speed and therefore watercraft speed.



TYPICAL

WARNING

Whenever the engine is to be started, the operator and passenger(s) should always be properly sitting on the watercraft and be wearing protective clothing including a Coast Guard approved PFD and a wet suit bottom.

WARNING

Keep away from intake grate while engine is on. Items such as long hair, loose clothing or personal flotation device straps can become entangled in moving parts resulting in severe injury or drowning.

The shift lever should be in the forward position in order for the watercraft to advance.

Neutral and Reverse

WARNING

Never use jet pump components as a supporting point to board the watercraft. Shift lever should only be used when the engine is idling and watercraft is completely stopped. Never rev the engine at high RPM in reverse. Do not use reverse to stop the watercraft. Only use reverse at slow speed and for the shortest time possible. Always ensure the path behind is clear of objects and persons including children playing in shallow water.

To find the neutral, set in reverse then push back until the watercraft stops moving backwards.

The reverse gate will be in the middle position, directing half of the thrust toward the front of the watercraft to minimize watercraft movement.

WARNING

When the watercraft is in neutral position, the drive shaft and impeller are still turning.

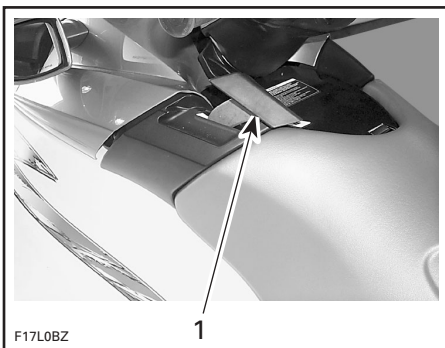

1. Shift lever in neutral position

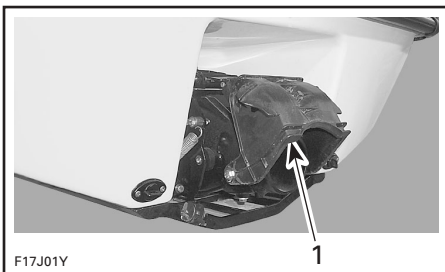

1. Reverse gate in middle position

To obtain reverse, pull shift lever completely. The reverse gate will be in downward position, directing all the thrust toward the front of the watercraft.

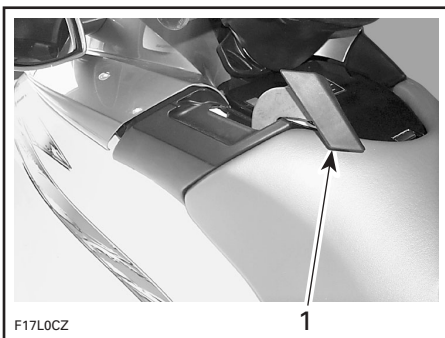

1. Shift lever in reverse position

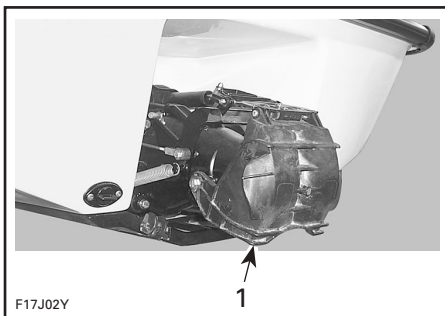

1. Reverse gate in downward position

NOTE: To obtain maximum efficiency and control from the reverse, increase engine speed to slightly above idle. Too much RPM will create water turbulence and reduce reverse efficiency.

In reverse position, turn the handlebar in the same direction that you want to move the rear of the watercraft.

For example, to steer the rear of the watercraft to the left side, turn the handlebar to the left side.

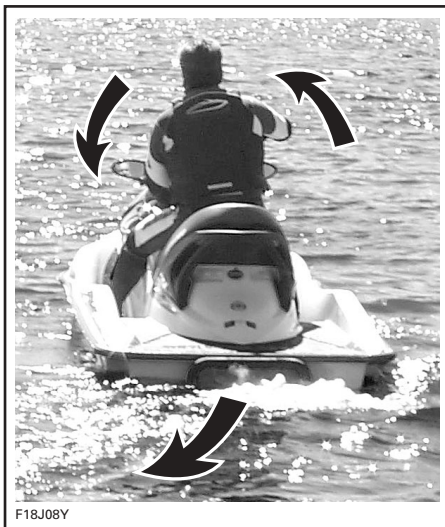

F18J08Y

WARNING

Shift lever should only be used when the engine is idling and watercraft is completely stopped. Do not use reverse to stop the watercraft.

Variable Trim System (if so equipped)

The variable trim system (VTS) changes the angle of the jet pump nozzle to provide the operator with a fast, effective system to compensate for load, thrust, riding position and water conditions. Correctly adjusted, it can improve handling, reduce porpoising, and position the watercraft at its best riding angle to attain maximum performance.

When first using the watercraft, the operator should become familiar with the use of the variable trim system (VTS) at varying speeds and water conditions. A mid-range trim is generally used when cruising. Experience alone will dictate the best trim for the conditions. During the watercraft break-in period, when lower speeds are recommended, it is an excellent opportunity to gain familiarity of trim adjustment and its effects.

When the nozzle is positioned in an upward angle, the water thrust directs the bow of the watercraft upward. This position is used to optimize high speed.

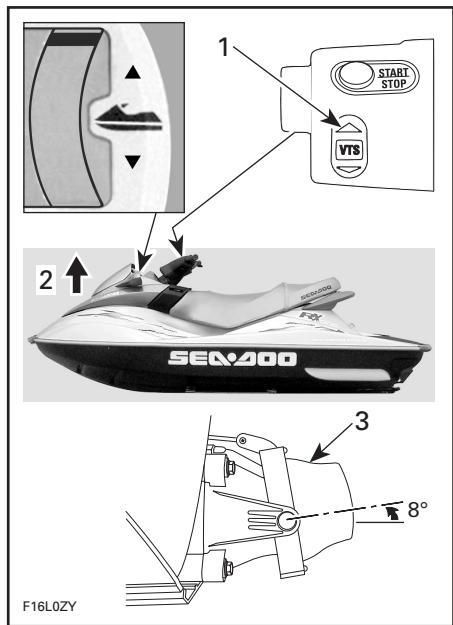

TYPICAL

1. Push on arrow pointing upward on VTS button
2. Bow up
3. Nozzle up

NOTE: VTS position is indicated on a bar gauge in the information center.

When the nozzle is directed downward, the bow is forced downward and enhances the watercraft turning capabilities. As with any watercraft, speed and operator body position and movement (body English), will determine the degree and sharpness of the watercraft turn. Porpoising can be reduced or eliminated if the nozzle is downward and speed is adjusted proportionately.

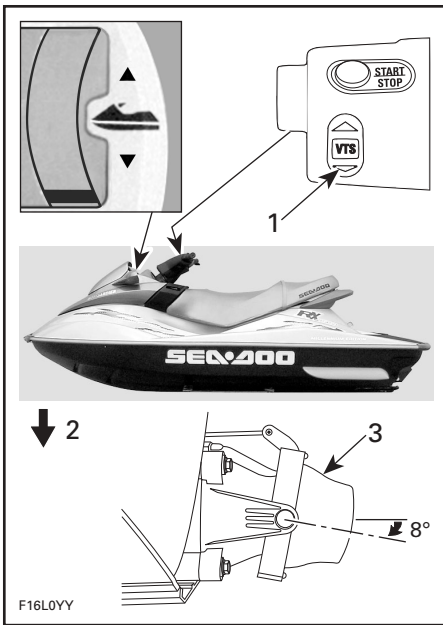

TYPICAL

1. Push on arrow pointing downward on VTS button
2. Bow down
3. Nozzle down

Steering



Turning the handlebar pivots the jet pump nozzle which controls the watercraft direction. Turning the handlebar to the right will turn the watercraft to the right and inversely. The throttle should be applied to turn the watercraft.

⚠ WARNING

Throttle should be applied and handlebar turned to change the direction of the watercraft. Steering efficiency will differ depending on the number of passengers, load, water conditions and environmental factors such as the wind.

Unlike a car, a watercraft needs some throttle to turn. Practice in a safe area applying the throttle and turning away from an imaginary object. This is a good collision avoidance technique.

⚠ WARNING

On models **without** O.P.A.S. directional control is reduced when the throttle is released and lost when engine is off.

⚠ WARNING

On models **with** O.P.A.S. directional control is reduced when the throttle is released and/or when engine is off.

The watercraft behaves differently with a passenger and requires greater skill. The passenger should always grip the seat strap or grab handle. Reduce speed and avoid sharp turns. Avoid choppy water conditions when carrying a passenger.

Models with Off-Power Assisted Steering System (O.P.A.S.)

Two side vanes on the rear sides of the hull, turn as the steering is turned to assist the watercraft turning. At first, carefully experiment turning with this system.

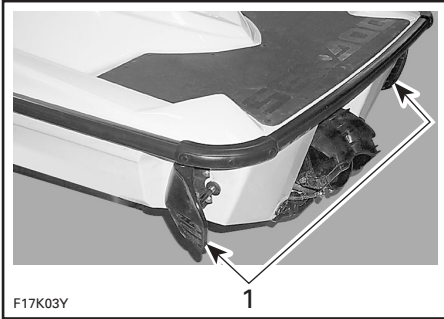

1. Side vanes turn following steering movement

When engine is running at approximately 75% or more RPM, the side vanes are automatically raised to upper position since they are not required at that vehicle speed range. Between 30% and 75% engine RPM, side vanes gradually raised from lower position to upper position.



1. Side vane in upper position

When throttle is released and engine RPM drops, the side vanes are automatically lowered thus assisting steering control.



1. Side vane in lower position

Boarding the Watercraft

General

As with any watercraft, boarding should be done carefully and engine should not be running.

WARNING

Engine should be OFF when boarding the watercraft or when using boarding step (if so equipped). Keep limbs away from jet or intake grate. Stay on center of the step. Only one person at a time on the step. Never use the step for pulling, towing, diving or jumping, boarding a watercraft that is out of water or any other purpose other than a boarding step.

On some models, boarding is facilitated by using a step.

WARNING

Inexperienced riders should practice how to get aboard (all methods explained here) close to shore first before venturing into deep water.

WARNING

Never use jet pump components as a supporting point to board the watercraft.

Boarding from a Dock or in Shallow Water

When boarding from a dock, slowly place one foot on the watercraft footboard nearest the dock and, at the same time, transfer the body weight to the other side in order to balance the watercraft while holding the handlebar. Then, bring the other foot over the the seat and put it on the other footboard. Push the watercraft away from the dock.

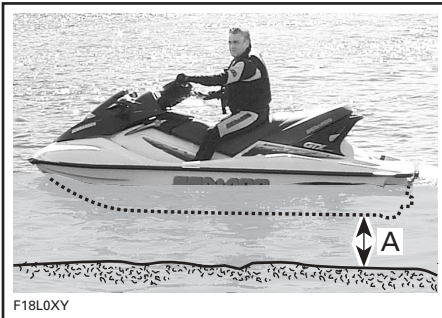

A. 90 cm (3 ft)

In shallow water, board the watercraft either from the side or the rear.

Boarding in Deep Water

Operator Alone

Swim to the rear of the watercraft.

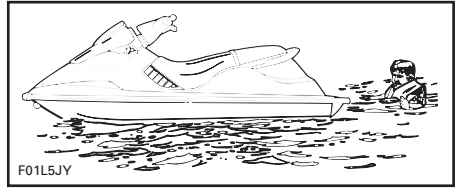

Grip the grab handle and pull yourself upward until your knee can reach the boarding platform then grip the seat strap.

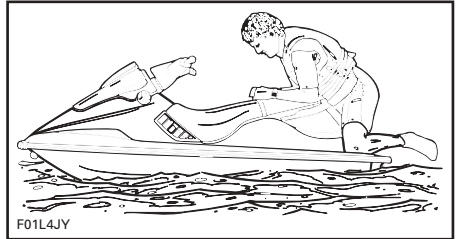

Bring your feet on the footboard while maintaining balance using the handlebar (except 3-up seat models).

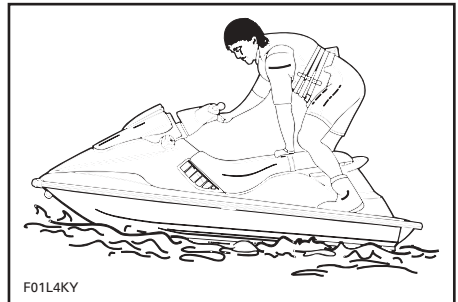

Sit astride the seat.

Operator with a Passenger

The operator climbs on the watercraft the same way as explained previously.

In choppy water, the passenger, while in the water, may hold the watercraft to help the operator in climbing aboard.

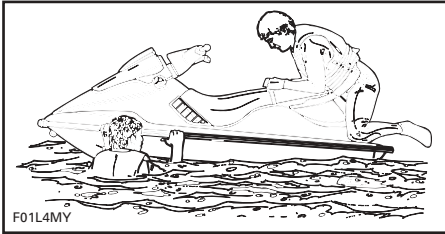

The passenger then climbs on the watercraft while the operator maintains balance by sitting as close as possible to the console.

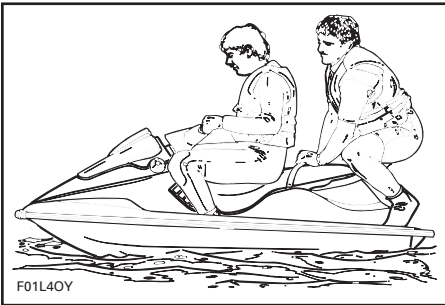
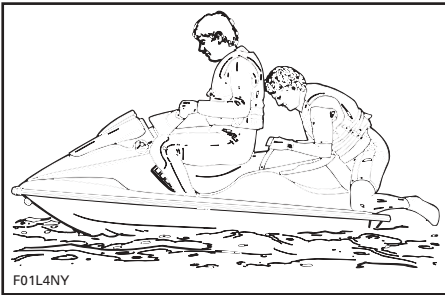

Starting Preparation

Before unloading the watercraft from the trailer, it can be started for about 10 seconds to verify proper operation.

WARNING

Components inside engine compartment may be hot. Do not touch electrical parts or jet pump area when engine is running.

Attach the safety lanyard to your PFD and snap the cap to its post before starting the engine.

NOTE: If you hear anything else than 2 short beeps from DESS system, it indicates a particular condition that should be corrected. Refer to the TROUBLESHOOTING section for the meaning of the coded signal.

WARNING

Before starting the engine, the operator and passengers should always be properly seated.

Position shift lever to neutral.

Turn the fuel tank valve (if so equipped) to ON position.

Firmly grip handlebar with your left hand and place both feet on the footboard.

To start engine, depress and hold the engine start/stop button. Follow procedure below for cold or warm engine starting.

If engine fails to start after 10 seconds, wait a few seconds then repeat procedure.

CAUTION: Do not hold start/stop button more than 30 seconds to avoid starter overheating. A rest period should be observed between the cranking cycles to let starter cool down. Pay attention not to discharge battery. The engine should be started only after boarding, when there is at least 90 cm (3 ft) of water below the hull. Do not accelerate fast.

Release engine start/stop button immediately after engine is started.

Carburetor-Equipped Models

Cold Engine

The choke is provided to supply a richer fuel/air mixture when starting a cold engine. Fully pull the choke lever and hold while starting the engine.

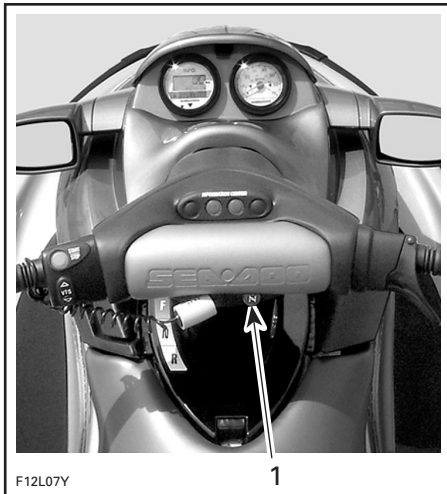

TYPICAL

1. Fully pull

After engine is started, release choke lever. It may be necessary to reapply the choke and if necessary, slightly apply throttle to keep engine running.

Warm Engine

The choke does not need to be applied.

RFI and DI Models

Cold and Warm Engine

Do not depress the throttle lever to start either a cold or warm engine.

All Models

Riding

Slowly accelerate to reach deeper water. Do not apply full throttle until the engine is warm.

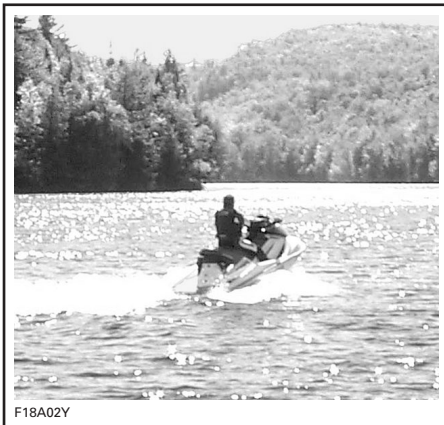

CAUTION: Avoid watercraft operation in weeded areas. If unavoidable, vary watercraft speed.

Rough Water or Poor Visibility Operation

Avoid operation in these conditions. If you must do so, proceed with caution and prudence using minimum speed.

Crossing Waves

Reduce speed.

Always be prepared to steer and balance as necessary.

When crossing wakes, always keep a safe distance from watercraft ahead.

WARNING

When crossing wakes, slow down. Operator and passenger(s) can brace themselves by posting. Do not jump waves or wakes.

Stopping/Docking

The watercraft is slowed by water drag. The stopping distance will vary depending on the watercraft size, weight, speed, water surface condition, presence and direction of wind and current.

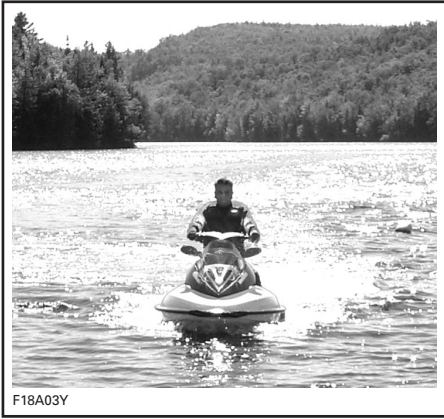

The operator should become familiarized with the stopping distance under different conditions.

Release the throttle at a sufficient distance before the expected landing area.

Reduce speed to idle.

Shift to neutral, reverse or forward, as required.

WARNING

On models **without** O.P.A.S. directional control is reduced when the throttle is released and lost when engine is off.

WARNING

On models **with** O.P.A.S. directional control is reduced when the throttle is released and/or when engine is off.

Beaching

CAUTION: It is not recommended to run the watercraft to the beach.

Come slowly to the beach and shut off the using the safety lanyard when water depth is 90 cm (3 ft) under the hull, then pull the watercraft to the beach.

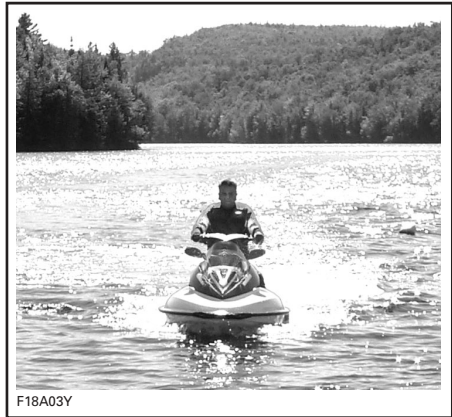

Shutting Off the Engine

To keep watercraft directional control, the engine should be running until the watercraft is at idle.

To shut off the engine, completely release throttle lever and press the engine start/stop button. Remove safety lanyard from watercraft.

WARNING

Should the engine be shut off, watercraft directional control is lost (reduced on models with O.P.A.S.). Never leave the safety lanyard on its post when watercraft is not in operation in order to prevent accidental engine starting or to avoid unauthorized use by children or others or theft.

POST-OPERATION CARE

WARNING

Allow engine to cool before performing any maintenance.

General Care

Remove the watercraft from the water every day to prevent marine organisms growth.

Should any water be present in the hull, unscrew the drain plugs and tilt the watercraft to the rear in order to allow water to flow out.

Wipe up any remaining fluid in the engine compartment (bilge, engine, battery, etc.) with clean dry rags (this is particularly important in salt water use).

Additional Care for Foul Water or Salt Water

When the watercraft is operated in foul water and particularly in salt water, additional care should be taken to protect the watercraft and its components. Rinse trailer and watercraft's bilge area with fresh water.

CAUTION: Failure to perform proper care such as: watercraft rinsing, cooling system flushing and anticorrosion treatment, when watercraft is used in salt water, will result in damage to the watercraft and its components. Never leave the watercraft stored in direct sunlight.

Cooling System Flushing and Engine Internal Lubrication

General

Flushing the cooling system with fresh water is essential to neutralize corroding effects of salt or other chemical products present in water. It will help to remove sand, salt, shells or other particles in water jackets (engine, exhaust manifold, tuned pipe) and/or hoses.

Engine lubrication and flushing should be performed when the watercraft is not expected to be used further the same day or when the watercraft is stored for any extended time.

WARNING

Perform this operation in a well ventilated area.

Proceed as follows:

Clean jet pump by spraying water in its inlet and outlet and then apply a coating of BOMBARDIER LUBE lubricant or equivalent. Connect a garden hose to connector located at the rear of watercraft on jet pump support.

NOTE: A quick connect adapter can be used (P/N 295 500 473). No hose pincher is required to flush engine.

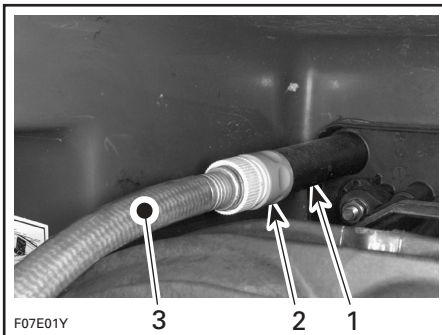

TYPICAL

1. Hose adapter
2. Quick connect adapter (not mandatory)
3. Garden hose

NOTE: The quick connect adapter may be supplied with some models. It has to be removed if you do not use a quick connect adapter on your garden hose.

Flushing

To flush cooling system, start the engine then immediately open the water tap.

WARNING

Components inside engine compartment may be hot. Do not touch any electrical parts or jet pump area when engine is running.

CAUTION: Never flush a hot engine. Always start the engine before opening the water tap. Open water tap immediately after engine is started to prevent overheating.

Run the engine about 3 minutes at a fast idle around 3500 RPM.

Ensure water flows out of drain lines (engine crankcase, engine cylinder and air compressor (DI models) while flushing. Otherwise, clean the lines.

CAUTION: Never run engine longer than 5 minutes. Drive line seal has no cooling when watercraft is out of water.

Lubrication

717 and 787 RFI Engines

Spray BOMBARDIER LUBE lubricant or equivalent, through hole of air intake silencer keeping engine at fast idle during one minute.

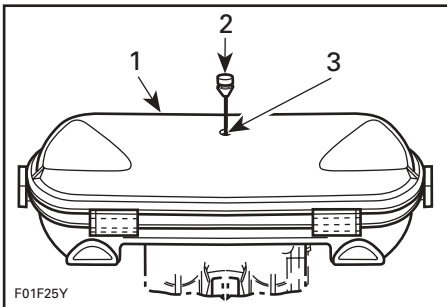

1. Air intake silencer
2. Pull plug
3. Spray BOMBARDIER LUBE here

947 DI Engines

Spray BOMBARDIER LUBE lubricant or equivalent, through hole of air intake silencer keeping engine at fast idle during one minute.

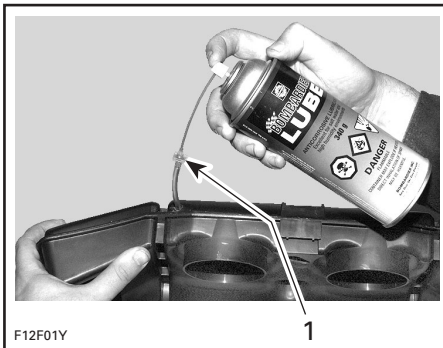

1. Partially pull tube out of air box to inject BOMBARDIER LUBE lubricant or equivalent. Push tube in when finished

All Models

Close the water tap then stop the engine.

CAUTION: Always close the water tap before stopping the engine.

Final Steps

Disconnect the garden hose.

Remove spark plug cables and connect them on the grounding device.

WARNING

Always use spark plug cable grounding device when removing spark plugs.

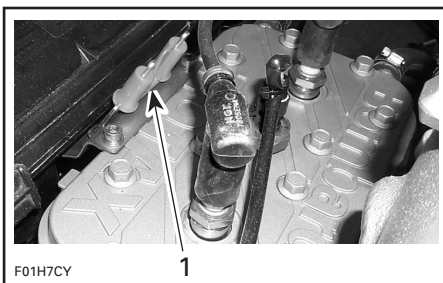

GTI, GTI LE MODELS

1. Grounding device

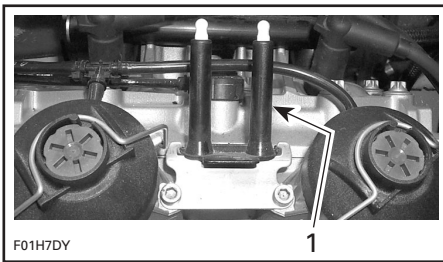

RX DI, GTI LE RFI AND GTX DI MODELS

1. Grounding device

Remove both spark plugs and spray BOMBARDIER LUBE lubricant or equivalent into each cylinder.

Carburetor-Equipped Models

Crank the engine a few turns to distribute the oil on cylinder wall.

RFI Models

Remove safety lanyard from its post. Depress the throttle lever at full throttle position and hold.

Reinstall the safety lanyard cap on its post. Crank the engine a few turns to distribute the oil on cylinder wall.

NOTE: Proceeding in this order, no fuel will be injected into the engine.

DI Models

To prevent fuel to be injected and also to cut the ignition at the engine starting, proceed as follows.

While engine is stopped, fully depress throttle lever and HOLD for cranking.

NOTE: A 1 second beep every second indicates the drowned mode is active.

Crank the engine a few turns to distribute the oil on cylinder wall.

All Models

Apply anti-seize lubricant on spark plug threads then reinstall them.

Properly reconnect spark plug cables to spark plugs.

⚠ WARNING

On DI models always reconnect spark plug cables at the same spark plugs where they come from. The cable coming out the edge of the electrical box must be connected to the MAG side spark plug.

Wipe up any residual water from the engine.

717 and 787 RFI Engines

Reinstall plug on air intake silencer cover.

Anticorrosion Treatment

To prevent corrosion, spray a corrosion inhibitor (salt water resistant) such as BOMBARDIER LUBE lubricant or equivalent over metallic components in engine compartment.

Apply dielectric grease (salt water resistant) on battery posts and cable connectors.

CAUTION: Never leave rags or tools in the engine compartment or in the bilge.

SPECIAL PROCEDURES

Monitoring System

All Models except DI Models

To assist you when using the watercraft, a system monitors some component of the watercraft and sends audible signals through a beeper to inform you of a particular condition. Refer to the TROUBLESHOOTING section for the coded signals chart.

Limp Home Mode

DI Models

Monitoring System

To assist you when using the watercraft, a system monitors the electronic components of the fuel injection system and some components of the electrical system. When a fault occurs, it sends visual messages through the information center and/or audible signals through a beeper to inform you of a particular condition. Refer to the INFORMATION CENTER for the displayed messages and the TROUBLESHOOTING section for the beeper coded signals chart.

Limp Home Modes

Besides the signals as seen above, the system may automatically set default parameters to the MPPEM to ensure the adequate operation of the watercraft if a component of the fuel injection system is not operating properly.

Depending on the severity of the malfunction, the watercraft speed may be reduced and not allowed to reach its top speed as usual. In this case, letting the engine returning at idle speed may allow normal operation to come back.

The engine RPM may be limited to idle if some critical components fail. In this case, removing and reinstalling the safety lanyard on its post may allow normal operation to come back.

A weed clogged area can be cleaned as follows:

In-Water Cleaning

Rock the watercraft several times while repeatedly pressing engine start/stop button for short period without starting engine. Most of the time, this will remove the blockage. Start engine and make sure water flows out from bleed outlet and watercraft oper-

These performance-reduced modes allow the rider to go back home which would not be possible without this advanced system. If this occurs, see an authorized SEA-DOO dealer as soon as possible for inspection.

Engine Overheating

All Models

CAUTION: If the monitoring beeper continuously sounds, **stop engine immediately.**

Perform JET PUMP WATER INTAKE AND IMPELLER CLEANING procedure described in this section.

When back to shore, flush cooling system, refer to POST-OPERATION CARE.

If engine still overheats, refer to an authorized SEA-DOO dealer for servicing.

Jet Pump Water Intake and Impeller Cleaning

WARNING

Keep away from intake grate while engine is on. Items such as long hair, loose clothing or personal flotation device straps can become entangled in moving parts resulting in severe injury or drowning.

Weeds, shells or debris can get caught on the intake grate, drive shaft and/or impeller. A clogged water intake may cause troubles such as:

1. **Cavitation:** Engine speed is high but watercraft moves slowly due to reduced jet thrust, jet pump components may be damaged.
2. **Overheating:** Since the jet pump operation controls the flow of water to cool the engine, a clogged intake will cause the engine to overheat and damage engine internal components.

ates properly.

If system is still blocked, move the **watercraft** out of the water and remove blockage manually.

If the aforementioned method does not work, the following can be performed:

- **With engine running and before applying throttle, put shift lever in reverse position and vary throttle quickly several times.**

- Repeat procedure if necessary.

On-Beach Water Cleaning

WARNING

Always remove safety lanyard cap from its post to prevent accidental engine starting before cleaning the jet pump area.

All Models

Place a cardboard or a carpet beside the watercraft to prevent scratching when turning the watercraft for cleaning.

Rotating watercraft in the proper direction eliminates the possibility of residual water in the tuned pipe entering the engine and causing engine damage.

GTI, GTI LE Models

Rotate the watercraft **counterclockwise** (seen from rear) to its **left** side for cleaning.

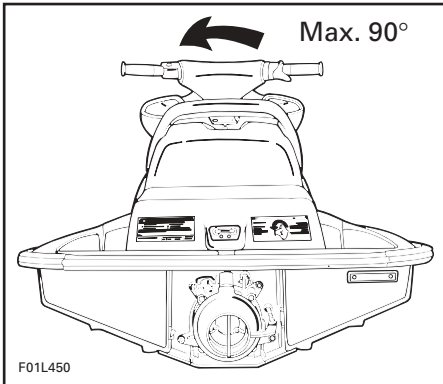

TYPICAL

Other Models

Rotate the watercraft **clockwise** (seen from rear) to its **right** side for cleaning.

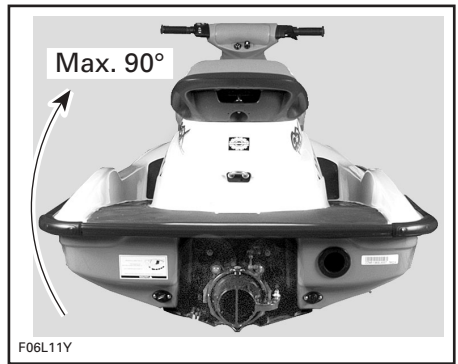

All Models

Clean the water intake area. If the system is still clogged, refer to an authorized SEA-DOO dealer for servicing.

CAUTION: Inspect water intake grate for damage. Refer to an authorized SEA-DOO dealer for repair as necessary.

Capsized Watercraft

The watercraft is designed so that it should not turn over easily. Also two sponsons mounted on the side of the hull assist watercraft stability. If it turns over, it will remain capsized.

WARNING

When watercraft is capsized, do not attempt to restart the engine. Operator and passengers should always wear approved personal flotation devices.

CAUTION: Always refer to decal located on stern of watercraft.

To return the watercraft upright, ensure the engine is off, grab the inlet grate, step on bumper rail and use your weight to rotate the watercraft.

GTI, GTI LE Models

Rotate the watercraft **clockwise** (seen from rear).

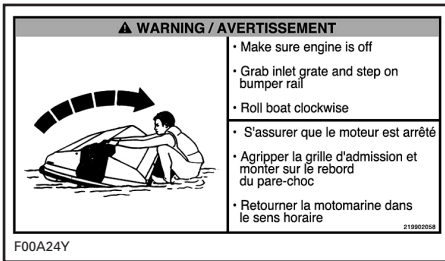

Other Models

Rotate the watercraft **counterclockwise** (seen from rear).

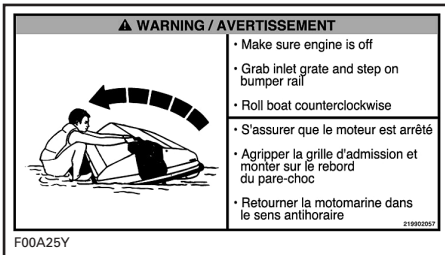

Submerged Watercraft

If the watercraft is submerged and engine is water-flooded, it is strongly recommended that the watercraft be serviced by an authorized SEA-DOO dealer.

Water-Flooded Engine

In the event the engine cannot be serviced within a few hours, remove spark plug cables and connect them on the grounding device.

WARNING

Never crank engine with spark plugs removed unless spark plug cables are connected to the grounding device. Be careful when cranking engine, water will spray out from spark plug holes.

Remove spark plugs and dry them with a clean and dry cloth.

Cover spark plug holes with a rag.

Carburetor-Equipped Models

Ensure choke lever is completely pushed in. Fully depress the throttle lever and hold.

RFI Models

To prevent fuel to be injected in the engine, proceed as follows.

Remove safety lanyard from its post.

Depress and hold the throttle lever at full throttle position. Wait 2 seconds then, reinstall the safety lanyard cap.

DI Models

To prevent fuel to be injected and also to cut the ignition at the engine starting, proceed as follows.

While engine is stopped, fully depress throttle lever and HOLD for cranking.

NOTE: A 1 second beep every second indicates the drowned mode is active.

All Models

Crank engine several times to allow water to escape from spark plug openings.
Release throttle lever.

DI Models

If water does not completely go out, it may be necessary to remove the air intake silencer then to lean the vehicle so that water can flow out from throttle bodies.

All Models

Spray BOMBARDIER LUBE lubricant or equivalent into spark plug holes.
Crank engine again.
Reinstall spark plugs. Install clean dry spark plugs if possible. Reconnect cables.

WARNING

Always reconnect spark plug cables at the same spark plugs where they come from. The cable coming out the edge of the electrical box must be connected to the MAG side spark plug.

Start engine normally.

Fuel-Flooded Engine

When the engine does not start after several attempts, the engine may be fuel-flooded. Proceed as follows.

Carburetor-Equipped Models

Install the safety lanyard cap on its post.
Ensure choke lever is completely pushed in.
Fully depress the throttle lever and hold while starting the engine. Try several times.

RFI Models

To prevent fuel to be injected in the engine, proceed as follows.
Remove safety lanyard from its post.
Depress and hold the throttle lever at full throttle position. Wait 2 seconds then, reinstall the safety lanyard cap.
Crank engine several times.

DI Models

To prevent fuel to be injected and also to cut the ignition at the engine starting, proceed as follows.
While engine is stopped, fully depress throttle lever and HOLD for cranking.
Crank engine several times.
NOTE: A 1 second beep every second indicates the drowned mode is active.

Carburetor-Equipped Models

As soon as the engine starts, release throttle lever. Do not race engine.

All Models

If it does not work:

Remove spark plug cables and connect them on the grounding device.

WARNING

Always use spark plug cable grounding device when removing spark plugs.

Remove spark plugs and dry them using a rag.
Cover spark plug holes with a rag.
Crank engine several times.
Reinstall spark plugs. Install clean dry spark plugs if possible. Reconnect cables.

DI Models

WARNING

Always reconnect spark plug cables at the same spark plugs where they come from. The cable coming out the edge of the electrical box must be connected to the MAG side spark plug.

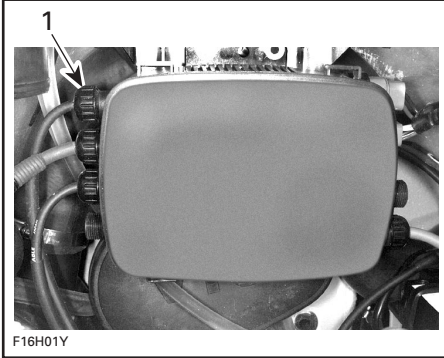

TYPICAL

1. PTO side spark plug cable

All Models

Start engine as explained above. If engine continues to flood, see an authorized SEA-DOO dealer.

Out of Fuel

DI Models

When running the engine out of fuel, it may be necessary to remove and install the safety lanyard 2 - 3 times to initially feed the fuel system after fuel tank refill.

Towing the Watercraft in Water

All Models

Special precautions should be taken when towing a SEA-DOO watercraft in water. Maximum recommended towing speed is 24 km/h (15 MPH).

When towing your watercraft in water, pinch the water supply hose from the impeller housing to the engine with a large hose pincher (P/N 529 032 500).

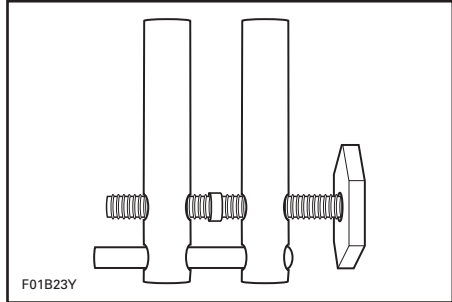

This will prevent the cooling system from filling which may lead to water being injected into and filling the exhaust system. Without the engine running there isn't any exhaust pressure to carry the water out the exhaust outlet.

CAUTION: Failure to do this may result in damage to the engine. If you must tow a stranded watercraft in water and do not have a hose pincher, be sure to stay well below the maximum towing speed of 24 km/h (15 MPH).

Snugly install the hose pincher on the water supply hose as shown.

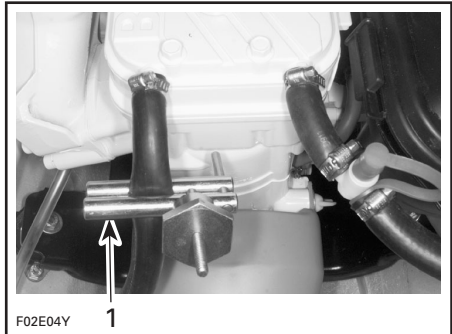

GTI, GTI LE MODELS

1. Hose pincher

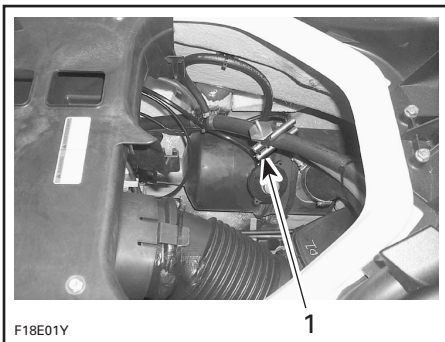

F18E01Y

GTX DI MODELS

1. Hose pincher on water supply hose on this side of the T-fitting

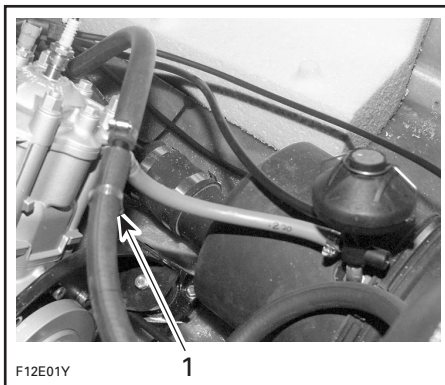

F12E01Y

TYPICAL — RX DI MODELS

1. Hose pincher on water supply hose on this side of the T-fitting

CAUTION: When finished towing the watercraft, hose pincher should be removed before operating it. Failure to do so will result in damage to the engine.

Low-Charge Battery Condition

See an authorized SEA-DOO dealer to have it charged or replaced.

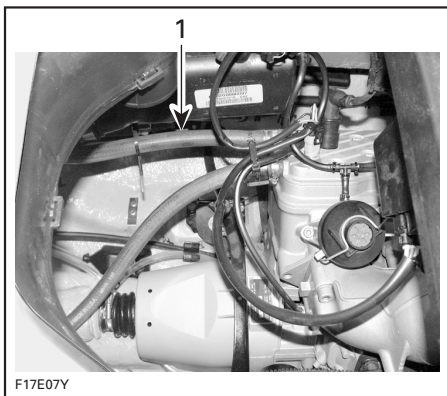

F17E07Y

GTI LE RFI MODELS

1. Install hose pincher here

⚠ WARNING

Do not charge or boost the battery while installed on the watercraft. Electrolyte is poisonous and dangerous. Avoid contact with eyes, skin and clothing.

MAINTENANCE

Maintenance, replacement, or repair of the emission control devices and systems may be performed by any marine SI (spark ignition) engine repair establishments or individual.

Engine Emissions Information

Manufacturer's Responsibility

Beginning with 1999 model year engines, PWC manufacturers of marine engines must determine the exhaust emission levels for each engine horsepower family and certify these engines with the United States of America Environmental Protection Agency (EPA). An emissions control information label, showing emission levels and engine specifications, must be placed on each vehicle at the time of manufacture.

Dealer's Responsibility

When performing service on all 1999 and more recent SEA-DOO watercrafts that carry an emissions control information label, adjustments must be kept within published factory specifications.

Replacement or repair of any emission related component must be executed in a manner that maintains emission levels within the prescribed certification standards.

Dealers are not to modify the engine in any manner that would alter the horsepower or allow emission levels to exceed their predetermined factory specifications.

Exceptions include manufacturer's prescribed changes, such as altitude adjustments for example.

Owner Responsibility

The owner/operator is required to have engine maintenance performed to maintain emission levels within prescribed certification standards.

The owner/operator is not to, and should not allow anyone to modify the engine in any manner that would alter the horsepower or allow emissions levels to exceed their predetermined factory specifications.

EPA Emission Regulations

All new 1999 and more recent SEA-DOO watercraft manufactured by Bombardier are certified to the EPA as conforming to the requirements of the regulations for the control of air pollution from new watercraft engines. This certification is contingent on certain adjustments being set to factory standards. For this reason, the factory procedure for servicing the product must be strictly followed and, whenever practicable, returned to the original intent of the design.

The responsibilities listed above are general and in no way a complete listing of the rules and regulations pertaining to the EPA requirements on exhaust emissions for marine products. For more detailed information on this subject, you may contact the following locations:

VIA U.S. POSTAL SERVICE:

Office of Mobile Sources
Engine Programs and Compliance
Division
Engine Compliance Programs
Group (6403J)
401 M St. NW
Washington, DC 20460

VIA EXPRESS or COURIER MAIL:

Office of Mobile Sources
Engine Programs and Compliance
Division
Engine Compliance Programs
Group (6403J)
501 3rd St. NW
Washington, DC 20001

EPA INTERNET WEB SITE:

www.epa.gov

WARNING

Only perform procedures as detailed in this guide. It is recommended that the assistance of an authorized SEA-DOO dealer be periodically obtained on other components/systems not covered in this guide. Unless otherwise specified, engine must not be running and the safety lanyard must be removed from its post for all maintenance procedures. Components inside engine compartment may be hot. Never use jet pump components or side vanes to lift the watercraft.

Lubrication

Use SEA-DOO synthetic grease or equivalent and lubricate PTO flywheel.

Proceed as follows:

Remove seat to expose engine compartment.

Remove vent tube support (if so equipped).

PTO Flywheel

Remove the fasteners and pull out PTO flywheel guard.

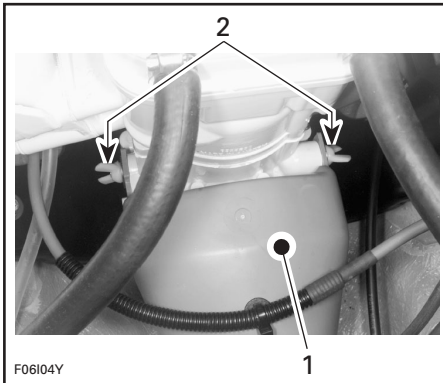

GTI, GTI LE AND GTI LE RFI MODELS

1. Flywheel guard
2. Wing nuts

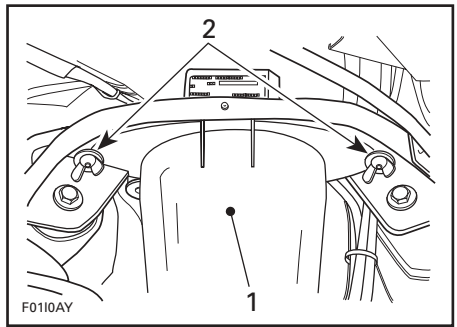

TYPICAL — OTHER MODELS

1. Flywheel guard
2. Fasteners

Using a grease gun, carefully lubricate PTO flywheel at grease fitting until PTO flywheel boot begins to expand.

CAUTION: Immediately stop lubricating as soon as PTO flywheel boot begins to expand to prevent damage or slipping.

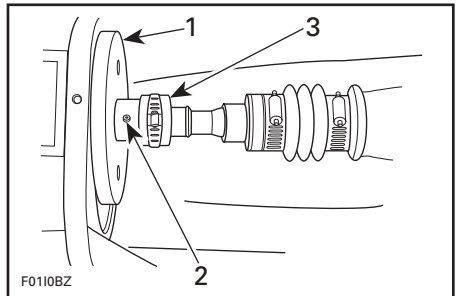

1. PTO flywheel
2. Grease fitting
3. PTO flywheel boot

Reinstall and secure PTO flywheel guard.

Anticorrosion Protection

Throttle/Choke Cables

Lubricate the throttle and choke cables (if so equipped) with BOMBARDIER LUBE lubricant or equivalent.

Electrical Connections

As necessary, apply anticorrosion product such as dielectric grease on battery posts and all exposed cable connectors.

CAUTION: Do not lubricate connectors of the Multi-Purpose Electronic Module.

Additional Lubrication

BOMBARDIER LUBE lubricant or equivalent will help prevent corrosion of metallic parts and maintain proper operation of moving mechanisms.

WARNING

Do not lubricate the safety lanyard post.

Carburetor-Equipped Models

Choke Lever

Fully pull choke lever and lubricate the metallic portion.

All Models

Seat Opening Mechanism, Tab, Hook and Lock Pin

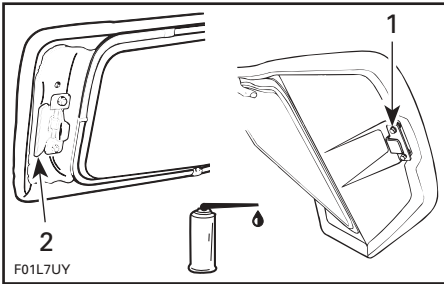

TYPICAL

1. Front tab
2. Rear mechanism

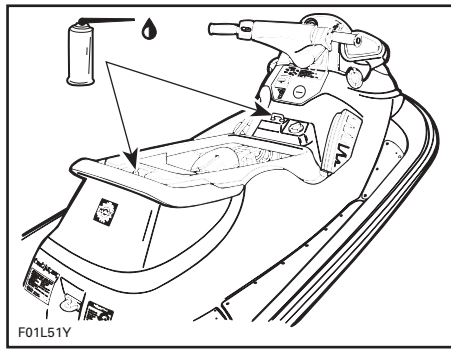

TYPICAL

Carburetor/Throttle Body and Oil Injection Pump

Lubricate springs, shafts and exposed portion of cables.

Reverse Gate

Lubricate pivoting points and mechanism.

Periodic Inspection

Routine maintenance is necessary for all mechanized products. A periodic inspection contributes to the product's life span.

The following maintenance chart gives guidelines for regular watercraft servicing scheduled to be performed by you and/or by an authorized SEA-DOO dealer. The schedule should be adjusted according to operating conditions and use.

IMPORTANT: Schedule for watercraft rental operations or higher number of hour use, will require greater frequency of inspection and maintenance.

Periodic Inspection Chart

DESCRIPTION		FREQUENCY				
		FIRST 10 HOURS	EVERY 25 HOURS OR 3 MONTHS	EVERY 50 HOURS OR 6 MONTHS	EVERY 100 HOURS OR 1 YEAR	TO BE PERFORMED BY
GENERAL	I: Inspect, verify, clean, adjust, lubricate, replace if necessary C: Clean L: Lubricate R: Replace					
	Lubrication/corrosion protection	①		C		C
ENGINE	Support and rubber mount	I		I		D
	Exhaust system fasteners ⑤	I		I		D
	RAVE valve (if so equipped) ⑤			C	C	D
	Top end (leak test, piston and ring clearance) (DI models only) ⑤				⑨	D
	Counterbalance shaft oil level (if so equipped)			I	I	D
	Spark plug	④ I		R		D
	Ignition timing (all models except DI) ⑤				I	D
	TDC setting (DI models only) ⑤				⑨	D
COOLING SYSTEM	Flushing		③ C			C
	Hose condition and fasteners	I		I		D
	Engine drain tubes		① I			C
	Water flow regulator valve (if so equipped)				I	D
FUEL SYSTEM	Carburetor including choke/throttle cable (carburetor-equipped models)	I			I	D
	Throttle/choke cables (carburetor-equipped models)	①	I			C
	Fuel filter (except RFI models) and lines	I	I			D
	Fuel filter (except DI and RFI models)				R	D
	Fuel filter (DI models only)				⑧	D
	Oil leakage between cylinder head and injector (DI models) ⑤	I		I		D
	Fuel injection system sensors (except throttle body), (RFI and DI models) ⑤	I			I	D
	Throttle body and their sensors (DI models) ⑤ ⑥	I		I		D
	Fuel vent line pressure relief valve		I			D
	Fuel lines, connections (DI models), check-valve and fuel system pressurization ⑤	I	I			D
	Carburetors/throttle bodies, sensors, fuel lines, fuel rail and fittings (if so equipped) ⑤	I		I		D
	Air intake silencer fit/tightness	I			I	D
	Fuel tank straps	I			I	C
LUBRICATION SYSTEM	Oil injection pump ⑤	I			I	D
	Oil filter and lines	I	I			D
	Oil filter				R	D
	Oil reservoir straps	I				C

DESCRIPTION		FREQUENCY				
		FIRST 10 HOURS	EVERY 25 HOURS OR 3 MONTHS	EVERY 50 HOURS OR 6 MONTHS	EVERY 100 HOURS OR 1 YEAR	TO BE PERFORMED BY
I: Inspect, verify, clean, adjust, lubricate, replace if necessary C: Clean L: Lubricate R: Replace						
ELECTRICAL SYSTEM	Electrical connections condition and fastening (ignition system, electrical box(es), starting system, fuel injectors (RFI and DI models), etc.)	I		I		D
	MPEM mounting brackets/fasteners			I		D
	Digitally Encoded Security System	I			I	D
	Monitoring beeper	I		I		D
	Battery condition and strap(s)/fasteners	I		I		D
STEERING SYSTEM	Steering cable	I		I		D
O.P.A.S. SYSTEM	O.P.A.S. system	I		I		D
PROPULSION SYSTEM	Drive shaft boot and spline condition (if so equipped)			I ②		D
	Drive shaft protection hose			I ②		D
	PTO flywheel	L	L			C
	Shifter system/cable	I			I	D
	VTS (Variable Trim System) (if so equipped)	I		I		D
	Jet pump reservoir oil level/oil condition	R	I	R		D
	Jet pump cover pusher (if so equipped)				I	D
	Impeller shaft seal				⑦	D
	Impeller condition and impeller/wear ring clearance			R ②		D
Water intake grate condition			I ②		C	
HULL AND BODY	Bailer pick-ups, check for obstructions	I			I	C
	Hull condition	I			I	C

NOTE: Some items are included in the PRE-OPERATION CHECKS and not necessarily repeated in this chart.

D: Dealer

C: Customer

① Every 10 hours in salt water use.

② These items have to be initially checked after 25 hours. Thereafter, servicing to be made as specified in this chart.

③ Daily flushing in salt water or foul water use.

④ Except DI models.

⑤ Emission-related component.

⑥ In salt water use.

⑦ Replace at 150 hours.

⑧ Replace at 250 hours.

⑨ Check at 350 hours or 5 years.

Throttle and Choke Cable Inspection

Throttle Cable

Depress and release the throttle lever. It should operate smoothly and return to its initial position without any hesitation. Refer to an authorized SEA-DOO dealer if necessary.

Carburetor-Equipped Models

Do not activate throttle lever unnecessarily, when engine is not running. Carburetors are equipped with fuel accelerator pumps. These pumps deliver fuel to the engine each time throttle lever is depressed.

All Models

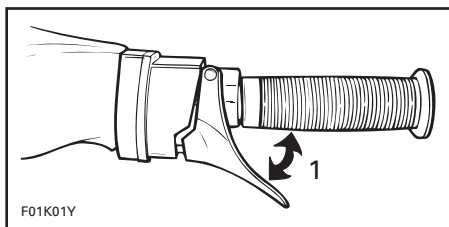
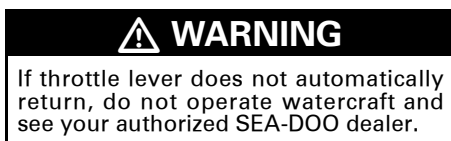

1. Should move freely

Carburetor-Equipped Models

Choke Cable

Ensure choke cable operates smoothly and without any hesitation from fully opened to fully closed. When the choke lever is fully pulled, choke should be fully applied. Refer to an authorized SEA-DOO dealer if necessary.

Carburetor Adjustment

Carburetor adjustment is very important to allow good engine operation and therefore watercraft performance. Carburetor adjustment requires technical knowledge and experience to have the correct mixture supplied to the engine.

CAUTION: Serious engine damage can occur with improper carburetor adjustment.

GTI California Models

There is no mixture adjustment to be performed by the dealer.

IMPORTANT: Trying to bypass the tamper-proof screws could damage the carburetor. It could also change the engine emission level and lead the engine not to meet the California emission control regulations.

Fuel Injection System

RFI and DI Models

The fuel injection system inspection should be performed by an authorized SEA-DOO dealer.

CAUTION: Never use injector cleaning products. They may contain additives that could damage injector components.

All Models

Fuel and Oil Filters

The fuel filter and the oil filter should be replaced by an authorized SEA-DOO dealer. Fuel system pressurization should be conducted at the same time.

CAUTION: An obstructed oil filter will cause oil starvation resulting in serious engine damage.

Steering Alignment

When the handlebar is directed in straight ahead position, the jet pump nozzle should be in the same direction allowing the watercraft to run in a straight line. The rear edge of side vanes (if so equipped) should be pointing out side by approximately 20° when the handlebar is pointing straight ahead.

Refer to an authorized SEA-DOO dealer if an adjustment is necessary.

WARNING

Ensure the handlebar and jet pump nozzle operate freely from side to side and are not stressing the steering cable or brackets. Never turn handlebar while someone is nearby rear of watercraft. Keep away from steering moving parts (nozzle, side vanes, linkage etc.).

VTS Adjustment (if so equipped)

Push on arrow pointing upward on VTS button until the VTS stops. The nozzle should be up without interfering with the venturi.

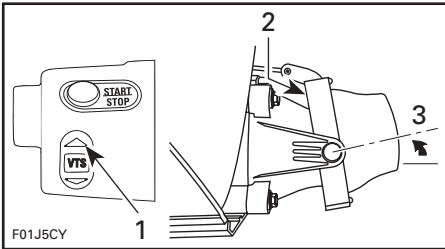

TYPICAL

1. Push on arrow pointing upward on VTS button
2. No interference
3. Nozzle up

Push on arrow pointing downward on VTS button until VTS stops. The nozzle must be down and it must not interfere with the venturi.

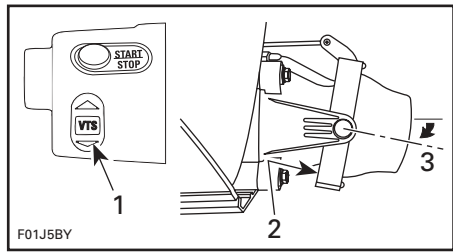

1. Push on arrow pointing downward on VTS button
2. No interference
3. Nozzle down

If VTS needs to be readjusted, refer to an authorized SEA-DOO dealer.

CAUTION: Trim ring and/or nozzle should not interfere at any position.

Vacuum Bailer Pick-Ups

They are located each side of the drive shaft tunnel.

Two pick-ups use a low pressure area in the jet pump to siphon the water out of the bilge when the engine is operating.

Inspect each pick-up screen for obstructions, clean as necessary.

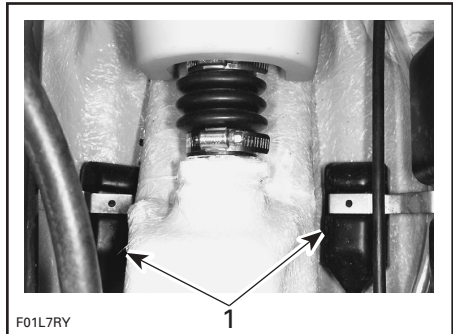

TYPICAL

1. Vacuum bailer pick-ups

Fuses

If an electrical problem occurs, check the fuses. If a fuse is burnt, replace by one of the same rating. Follow procedures below.

WARNING

Do not use a higher rated fuse as this can cause severe damage. If a fuse has burnt out, source of malfunction should be determined and corrected before restarting. See an authorized SEA-DOO dealer for servicing.

Fuses can be found on the MPEM. There are other fuses in the rear electrical box on all models except RFI.

MPEM

To access fuses on the MPEM, remove seat.

GTI, GTI LE Models

Locate MPEM besides engine.

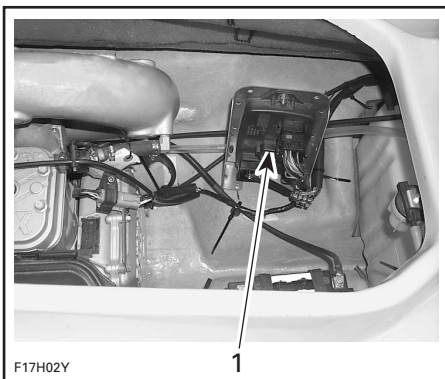

F17H02Y

TYPICAL

1. MPEM

Fuses are identified, look besides the fuse holder. SPR means spare (fuse).

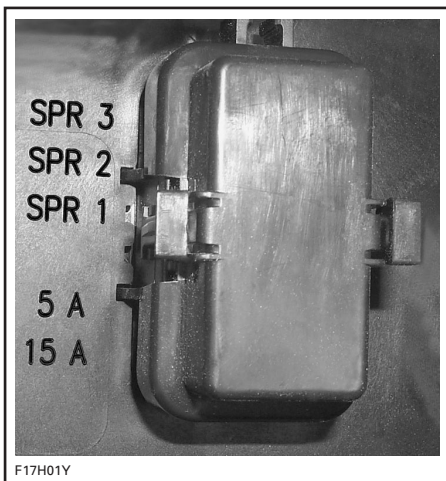

F17H01Y

FUSE IDENTIFICATION

5 A: MPEM

15 A: Battery

GTI LE RFI Models

Locate MPEM in front of engine.

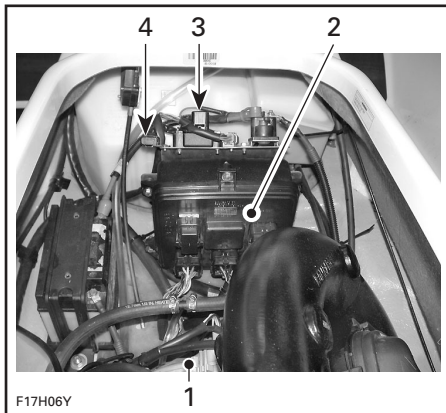

F17H06Y

1. Engine
2. MPEM
3. Main fuse
4. Charging system fuse

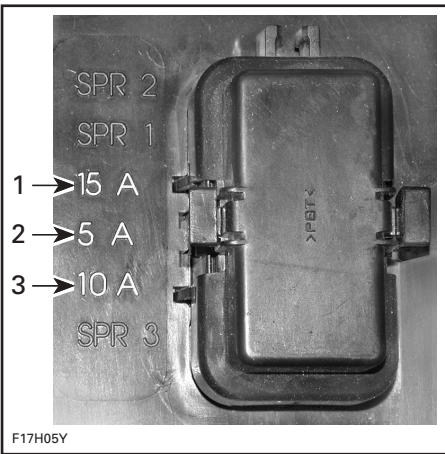

1. Battery
2. MPEM
3. Fuel pump

SPR means spare (fuse).

RX DI Models

To access fuses on the MPEM, open front storage compartment cover and remove storage basket. Locate MPEM on the left side of watercraft.

GTX DI Models

Locate MPEM besides engine.

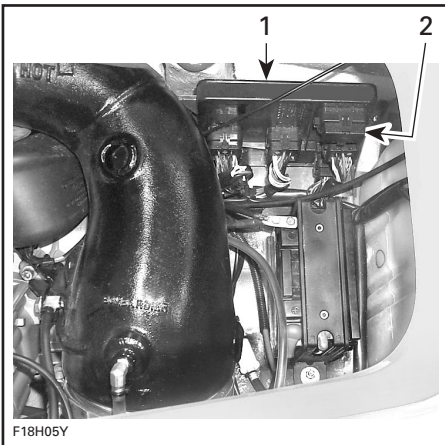

TYPICAL

1. MPEM
2. Fuses location

Fuses are identified, look above and besides the fuse holder.

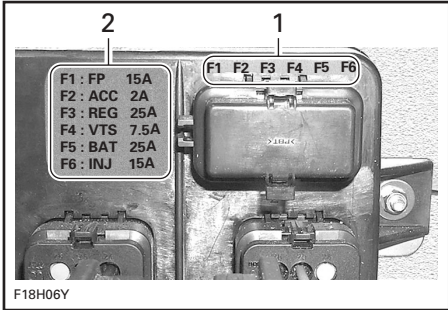

FUSE IDENTIFICATION

1. Fuse identification
2. Fuse description

Fuse identification: The fuses (F) are identified from 1 to 6.

Fuse description: The fuses are described with abbreviation as follows:

- FP: Fuel pump
 - ACC: Accessories (information center)
 - REG: Regulator (charging system)
 - VTS: Variable Trim System. Fuse is installed but not in use
 - BAT: Battery
 - INJ: Injection system
- The fuse description is followed by the amperage rating (A).

All Models

Remove fuse cover from the MPEM.

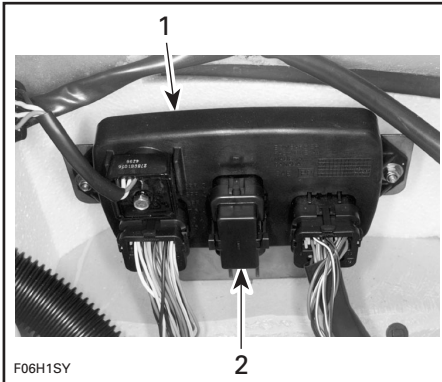

TYPICAL

1. MPEM
2. Fuse cover

Use the tabs of the fuse cover to remove and reinstall fuses.

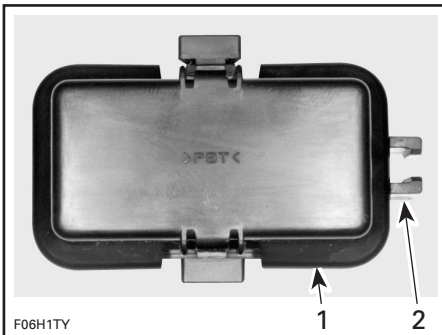

1. Fuse cover
2. Fuse tabs

Rear Electrical Box

Remove seat.

GTI, GTI LE and RX DI Models

Remove darts retaining tubes then pull out both vent tubes each side of electrical box at rear of hull.

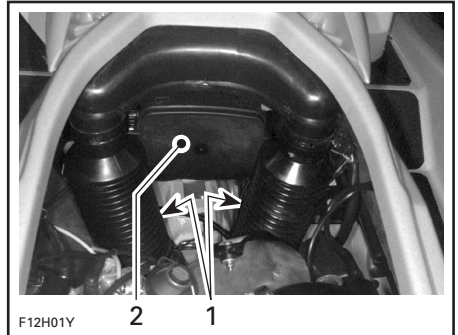

TYPICAL

1. Rear electrical box
2. Remove vent tubes

GTX DI Models

Locate electrical box at the back of the bilge.

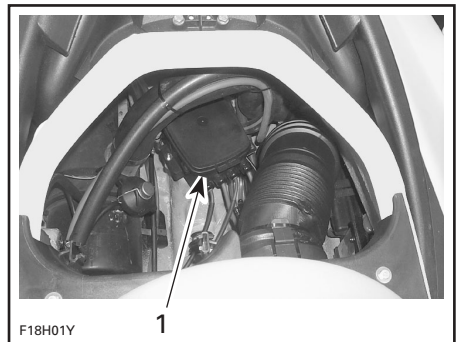

1. Electrical box

Some Models

Unclip and remove cover of the electrical box to expose the holder of the main fuse.

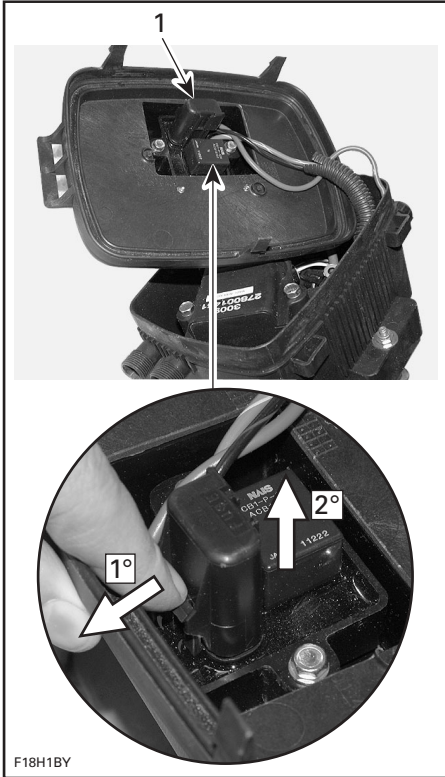

TYPICAL

1. Fuse holder

Properly reinstall removed components.

Some Models

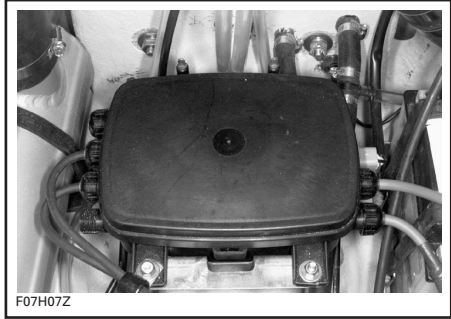

TYPICAL

Unclip and remove cover of the electrical box.

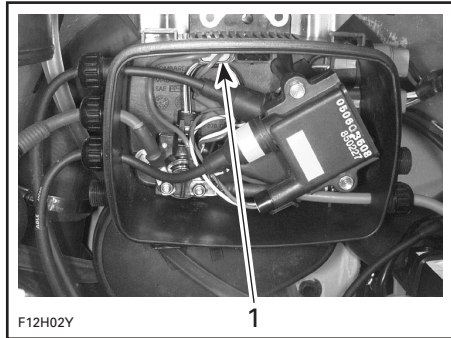

TYPICAL

1. Fuse holder

All Models

Properly reinstall removed components.

O.P.A.S. System (if so equipped)

The O.P.A.S. system operation and condition should be checked by an authorized SEA-DOO dealer.

General Inspection and Cleaning

Inspection

Check engine compartment for any damage and fuel/oil injection systems for leaks. Ensure all hose clamps are properly secured and no hose is cracked, kinked or presenting any other damage.

WARNING

If any gasoline leak and/or odor are present, do not start the engine. Have the watercraft serviced by an authorized SEA-DOO dealer.

Inspect muffler, battery, fuel tank and oil reservoir fastening devices. Visually check electrical connections for corrosion and tightness.

Inspect hull and jet pump water intake grate for damage. Replace or have damaged parts repaired.

WARNING

Periodically verify the seat lock pin and tighten if needed. Make sure seat securely latches.

Cleaning

The bilge should be cleaned by an authorized SEA-DOO dealer to remove any fuel/oil/electrolyte deposits and mildew.

Occasionally, wash the body with water and soap (only use mild detergent). Remove any marine organisms from engine and/or hull. Apply non-abrasive wax such as silicone wax.

CAUTION: Never clean fiberglass and plastic parts with strong detergent, degreasing agent, paint thinner, acetone, etc.

Stains may be removed from seat and fiberglass with Knight's Spray-Nine from Korkay System Ltd or the equivalent.

Respect the environment by ensuring fuel, oil or cleaning solutions do not drain into the waterways.

TRAILERING, STORAGE AND PRE-SEASON PREPARATION

Trailering

Models with O.P.A.S. System

CAUTION: To avoid damaging O.P.A.S. side vanes, the maximum trailer wood bunks span including bunk width should not exceed 71 cm (28 in). Ends of both trailer wood bunks should not be more than 2.59 m (102 in) away from watercraft bow attachment point. See following illustration.

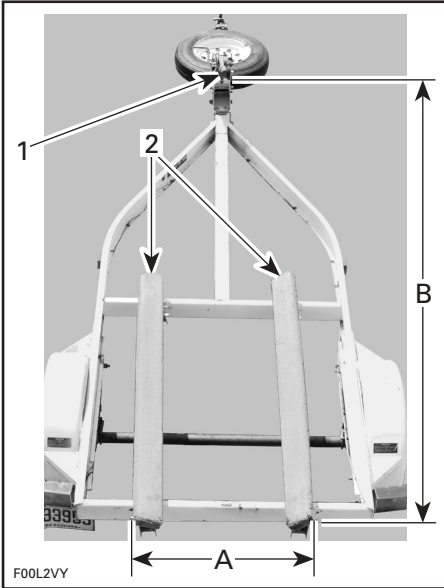

TRAILER FOR O.P.A.S. EQUIPPED WATERCRAFT

1. Watercraft bow attachment point
 2. Wood bunks
- A. 71 cm (28 in)
B. 2.59 m (102 in)

All Models

WARNING

Always turn the fuel tank valve (if so equipped) to OFF position when trailering or docking the watercraft.

Make sure that oil reservoir and fuel tank caps are properly installed.

WARNING

Never tip this vehicle on end for transporting. We recommend that you carry the vehicle in its normal operating position.

Check the applicable laws and regulations in your area concerning towing a trailer, especially the following rules:

- brake system
- tow vehicle weight
- mirrors.

Take the following precautions when towing the watercraft:

Tie the watercraft to both bow and stern (front/rear) eyelets so that it is firmly retained on the trailer. Use additional tie-downs if necessary.

CAUTION: Do not route ropes or tie-downs over the seat as they could produce permanent damage. Wrap ropes or tie-downs with rags or similar protectors where they can touch the watercraft body. Ensure all storage compartment covers and seat are properly latched.

WARNING

Make sure seat is securely latched before prior to trailering.

A SEA-DOO cover can protect the watercraft, particularly before driving on dirt roads, to prevent dirt entry through the air intake opening(s).

Observe trailering safety precautions.

Launching/Loading

CAUTION: Before launching the watercraft, ensure the bilge plugs are fully screwed. After loading the watercraft, ensure they are removed to drain bilge.

Storage

WARNING

Because fuel and oil are inflammable, have an authorized SEA-DOO dealer inspect the fuel and oil systems integrity as specified in the periodic inspection chart.

It is recommended that the watercraft be serviced by an authorized SEA-DOO dealer for storage but the following operations can be performed by you with a minimum of tools.

CAUTION: Do not run the engine during the storage period.

Engine Draining

Check engine drain hose (lowest hose of engine). Make sure there is no sand or other particles in it and that it is not obstructed so that water can exit the engine. Clean hose and fitting as necessary.

CAUTION: Water in engine drain hose should be free to flow out, otherwise water could be trapped in engine. Should water freeze in engine, severe damage will occur. Check engine drain hose for obstructions.

Carburetor-Equipped Models

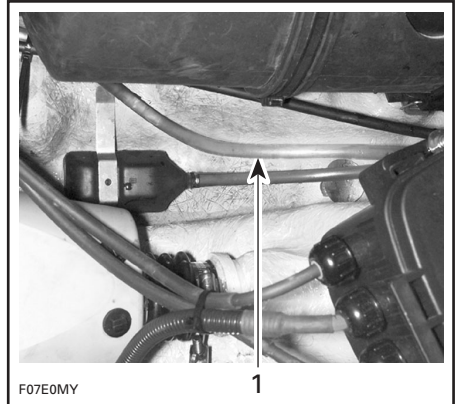

TYPICAL

1. Engine drain hose

RFI Models

Disconnect the water supply hose used to cool the magneto. It features a quick connect fitting. Press both tabs and pull fitting in order to disconnect hose.

This hose is located at the bottom of the magneto cover beside the engine support.

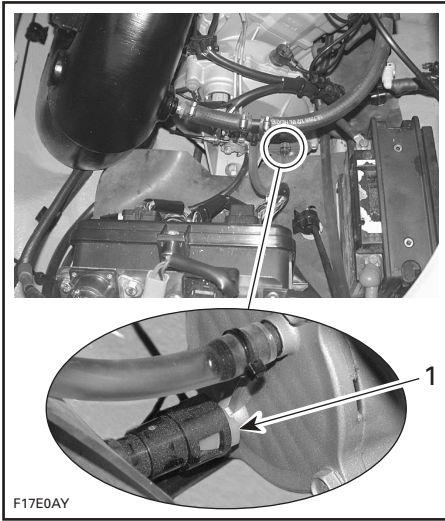

TYPICAL

1. Press tabs here and disconnect hose

Water should flow out of the fitting (magneto cooling circuit) and hose (crankcase heat exchanger). Push and hold hose against bilge so that draining can take place.

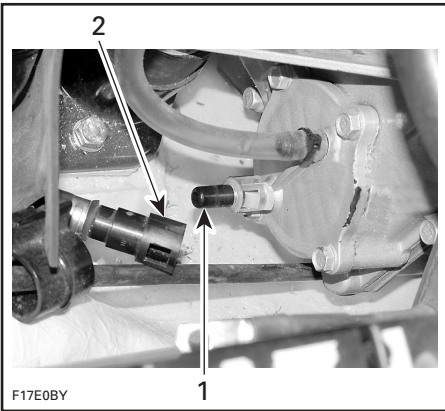

TYPICAL

1. Fitting
2. Hose

Reconnect hose when done.

RX DI Models

Disconnect the quick connect fitting. Press both tabs and pull fitting.

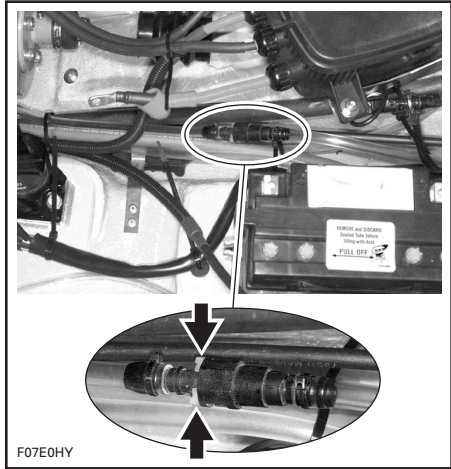

DISCONNECT THIS HOSE

GTX DI Models

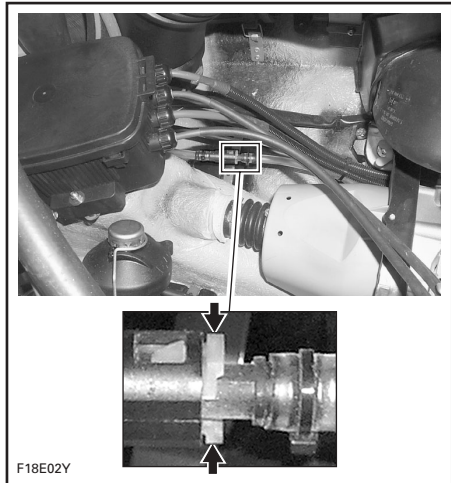

DISCONNECT THIS HOSE

All Models

Lower hose as necessary so that draining can take place.

Reconnect fitting when done.

Also ensure air compressor drain line is not obstructed. Clean as necessary.

All Models

Body Rinsing/Repair

Wash the body with soap and water solution (only use mild detergent). Rinse thoroughly with **fresh water**. Remove marine organisms from the hull.

CAUTION: Never clean fiberglass and plastic parts with strong detergent, degreasing agent, paint thinner, acetone, etc.

For small gelcoat repairs, refer to an authorized SEA-DOO dealer. Replace damaged labels/decals.

Propulsion System

Lubricant in jet pump reservoir should be drained and reservoir cleaned. Refer to an authorized SEA-DOO dealer for this operation.

Grease lubrication point(s) of propulsion system as explained in MAINTENANCE section.

Fuel System

SEA-DOO fuel stabilizer (or equivalent), can be added in fuel tank to prevent fuel deterioration and carburetor gumming. Follow manufacturer's instructions for proper use.

CAUTION: Fuel stabilizer should be added prior to engine lubrication to ensure fuel system components protection against varnish deposits.

WARNING

Always stop the engine before refueling. Fuel is inflammable and explosive under certain conditions. Always work in a well ventilated area. Do not smoke or allow open flames or sparks in the vicinity. Fuel tank may be pressurized, turn cap slowly when opening. Never use an open flame to check fuel level. When fueling, keep watercraft level. Do not overfill or top off the fuel tank and leave watercraft in the sun. As temperature increases, fuel expands and might overflow. Always wipe off any fuel spillage from the watercraft. Periodically verify fuel system. Always turn the fuel tank valve (**if so equipped**) to OFF position when the watercraft is not in use.

Cooling System Flushing and Engine Internal Lubrication

Refer to procedure in POST-OPERATION CARE.

Battery

Contact your authorized SEA-DOO dealer.

Antifreezing Protection

NOTE: This procedure requires approximately 2.5 L (2.6 U.S. qt.) of antifreeze.

In cool regions where freezing point may be encountered, cooling system should be filled with an equal part of water and antifreeze solution.

CAUTION: Antifreeze mix must be fed in cooling system. Otherwise remaining water will freeze. This operation requires a good technical knowledge of the cooling system path. If antifreezing is not performed adequately engine/exhaust system may freeze and cause severe engine damage. We strongly recommend this operation be performed by an authorized SEA-DOO dealer.

CAUTION: Always use ethylene glycol antifreeze containing corrosion inhibitors specifically recommended for aluminum engines.

NOTE: When available, it is recommended to use biodegradable antifreeze compatible with internal combustion aluminum engines. This will contribute to protect the environment.

NOTE: The engine will not have to run during this operation but should have been ran before, to exhaust as much water as possible, from cooling system components.

NOTE: On **some models**, it may be easier to reach hoses when you remove the vent tube support.

Hose Pinchers Installation

Some hoses have to be plugged to prevent draining, before filling cooling system jackets with the antifreeze.

All Models except DI Models

Install hose pinchers at the following location:

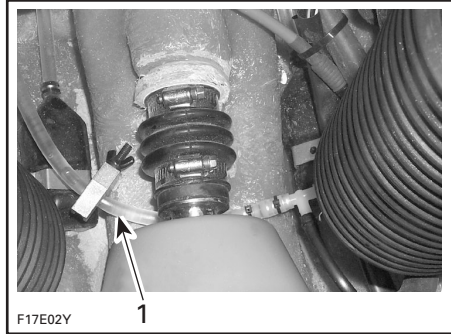

GTI, GTI LE MODELS (717 ENGINES)

1. Engine drain hose

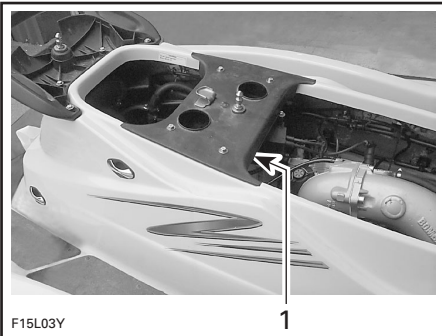

TYPICAL

1. Vent tube support



787 RFI ENGINES

1. Engine drain hose

Make sure the fitting is properly connected to the magneto cover.

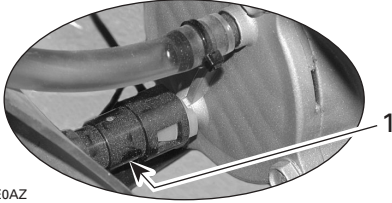
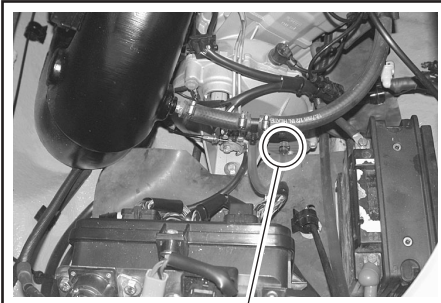

F17E0AZ

1. Fitting properly connected

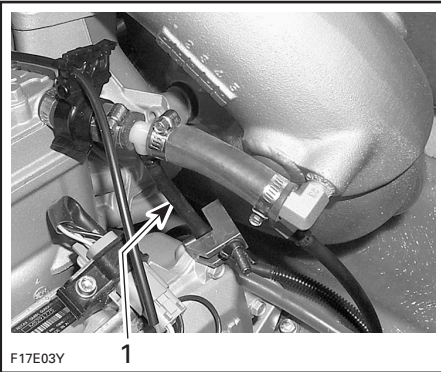

F17E03Y

GTI, GTI LE MODELS (717 ENGINES)

1. Hose pincher on injection hose going to tuned pipe

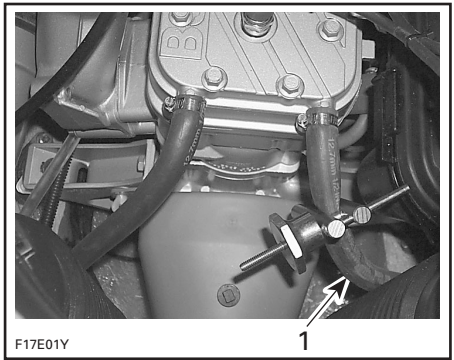

F17E01Y

**TYPICAL — GTI, GTI LE
(717 AND 787 RFI ENGINES)**

1. Engine water outlet hose

Hose Disconnection

Some hoses have to be disconnected. Disconnect hoses at the following location:

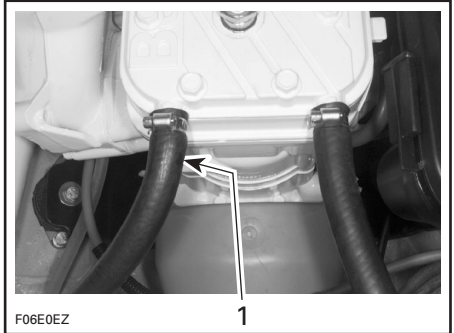

F06E0EZ

717 AND 787 RFI ENGINES

1. Disconnect engine water inlet hose

Antifreeze

717 engines only: Temporarily install a short piece of hose to engine water inlet at cylinder head.

Insert a funnel into hose and pour antifreeze mixed with water in engine until the colored solution appears at the cooling system bleed outlet.



787 RFI Engines

Disconnect hose just above T-fitting from as shown.

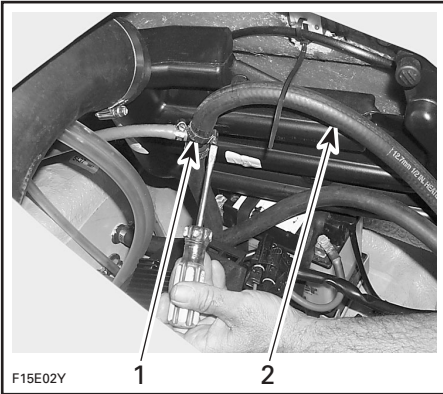

TYPICAL

1. Hose connecting to inlet fitting of cylinder head
2. Disconnect hose above T-fitting

Install a hose pincher just below T-fitting.

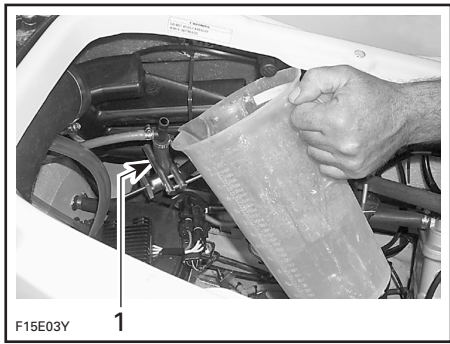

TYPICAL

1. Hose pincher below T-fitting

Pour approximately 300 mL (10 oz) of anti-freeze in the water regulator valve supply hose to allow antifreeze flowing through the valve and into muffler to protect it.

Reconnect hose to T-fitting and remove hose pincher (if applicable).

Remove temporary hose (on 717 engines) and reconnect engine water outlet hose.

Remove remaining hose pinchers.

DI Models

Hose Pinchers Installation

Some hoses have to be plugged to prevent draining, before filling cooling system jackets with the antifreeze.

Install hose pinchers at the following location:

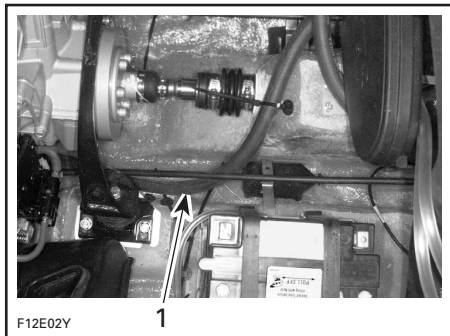

RX DI MODELS

1. Water outlet hose

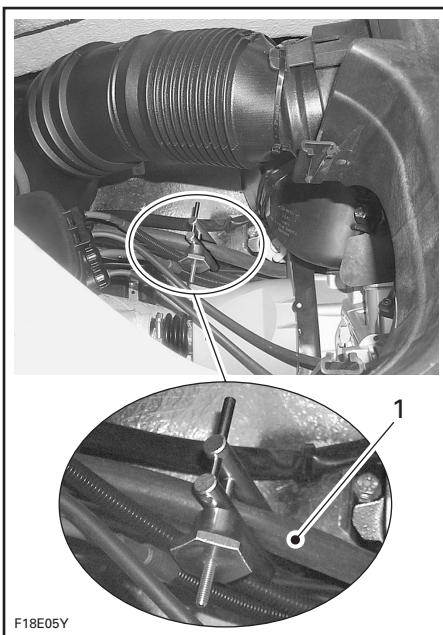

F18E05Y

GTX DI MODELS

1. Water outlet hose

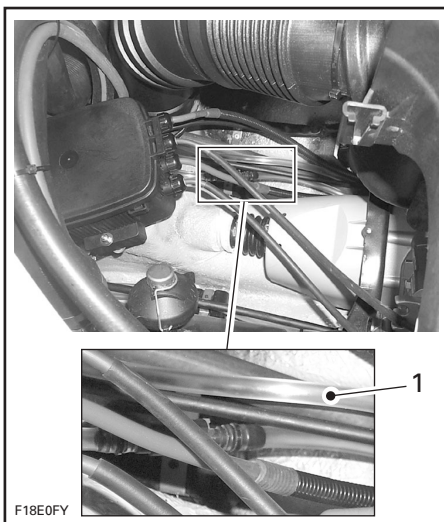

F18E0FY

GTX DI MODELS

1. Crankcase cooling cover outlet hose

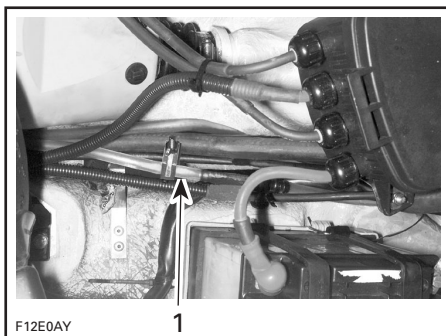

F12E0AY

RX DI MODELS

1. Crankcase cooling cover outlet hose

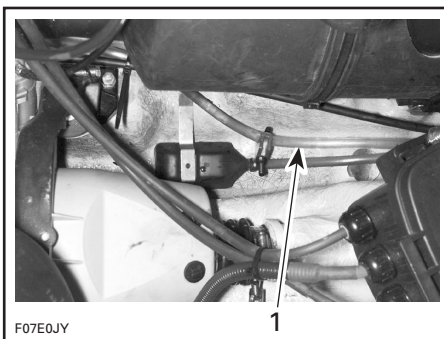

F07E0JY

RX DI MODELS

1. Engine cylinder drain hose

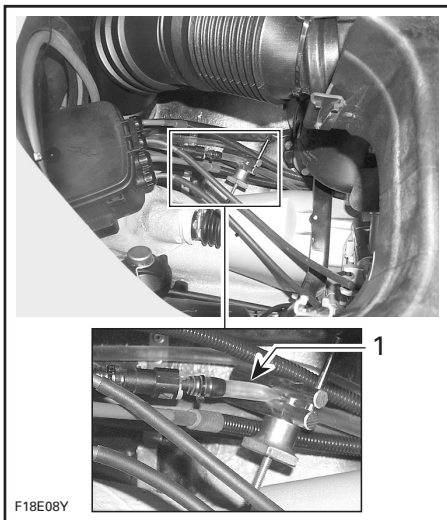

GTX DI MODELS

1. Engine cylinder drain hose

Hose Disconnection

Disconnect water INLET hose at engine between T-fitting and cylinder head fitting.

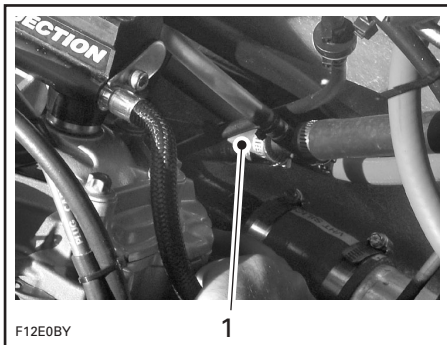

RX DI MODELS

1. Disconnect this side of the T-fitting

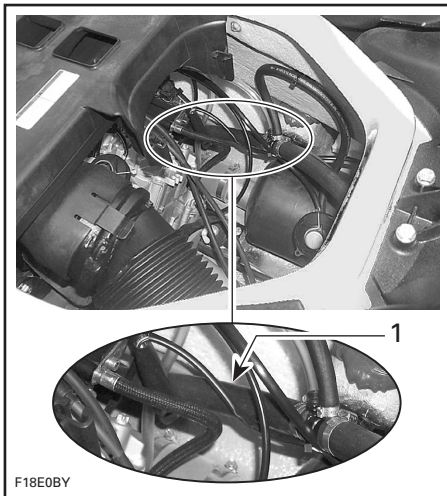

GTX DI MODELS

1. Disconnect this side of the T-fitting

Temporarily install a short piece of hose to replace the one removed.

Antifreeze

Insert a funnel into the temporary hose and pour antifreeze mix in engine until the colored solution appears at cooling system bleed outlet.



At this point, install a hose pincher on bleed outlet hose.

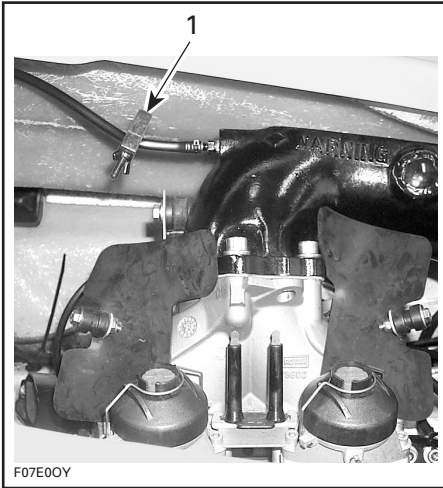

RX DI MODELS
1. Bleed outlet hose

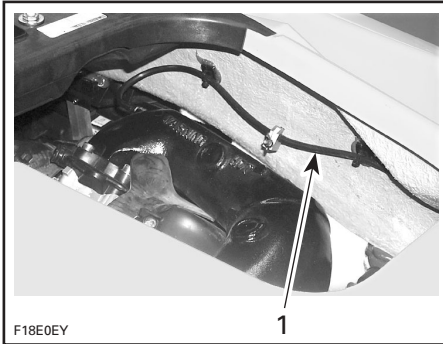

GTX DI MODELS
1. Bleed outlet hose

Continue to pour until antifreeze flows in air compressor water outlet hose.

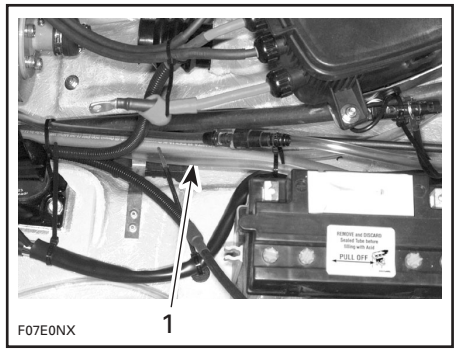

RX DI MODELS
1. Air compressor water outlet hose

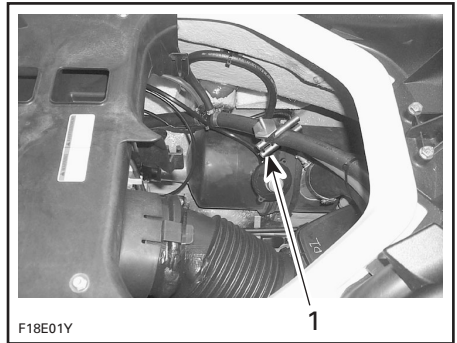

GTX DI MODELS
1. Air compressor water outlet hose

Remove pinchers in this order to allow proper flow of antifreeze.

1. Bleed outlet hose.
2. Crankcase cooling cover outlet hose.
3. Engine cylinder drain hose.
4. Water outlet hose.

Pour approximately 200 ml (7 oz) of anti-freeze in the water regulator valve supply hose to allow antifreeze flowing through the valve and into muffler to protect it.

Remove temporary hose and reconnect engine water outlet hose.

All Models

Most of the antifreeze will drain out when removing the hose pinchers. Use a container to recover it. **DISPOSE ANTIFREEZE AS PER YOUR LOCAL LAWS AND REGULATIONS.**

NOTE: Although antifreeze will mainly drain out, the antifreeze has mixed with the water that was possibly trapped in the water jackets and thus preventing freezing problems.

At pre-season preparation, drain the remaining antifreeze from cooling system prior to using the watercraft.

The following steps should be performed to provide the watercraft enhanced protection.

Clean the bilge with hot water and detergent or with bilge cleaner. Rinse thoroughly. Lift front end of watercraft to completely drain bilge. If any repairs are needed to body or to the hull contact your authorized SEA-DOO dealer. For paint touch up to mechanical parts use Bombardier spray paint.

Reinstall vent tube support (if applicable).

Anticorrosion Treatment

Wipe off any residual water in the engine compartment.

Spray BOMBARDIER LUBE lubricant or equivalent over metallic components in engine compartment.

WARNING

Do not lubricate the safety lanyard post.

Lubricate the throttle cable with BOMBARDIER LUBE lubricant or equivalent.

Final Steps

Apply a good quality marine wax to the body.

The seat and the seat extension (if so equipped) should be partially left opened and storage baskets (if so equipped) should be removed during storage. This will prevent engine compartment condensation and possible corrosion.

If the watercraft is to be stored outside, cover it with an opaque tarpaulin to prevent sun rays and grime from affecting the plastic components, watercraft finish as well as preventing dust accumulation.

CAUTION: The watercraft should never be left in water for storage. Never leave the watercraft stored in direct sunlight. Never completely seal watercraft in a plastic wrap. Ventilation must be provided to avoid condensation and possible corrosion.

Pre-Season Preparation

Use the following chart.

Since technical skills and special tools are required, some operations should be performed by an authorized SEA-DOO dealer.

WARNING

Only perform procedures as detailed in this guide. It is recommended that the assistance of an authorized SEA-DOO dealer be periodically obtained on other components/ systems not covered in this guide. Unless otherwise specified, engine must not be running and the safety lanyard must be removed from its post for all maintenance procedures. Components inside engine compartment may be hot. When component conditions seem less than satisfactory, replace with genuine BOMBARDIER parts or approved equivalents.

Pre-Season Preparation Chart

NOTE: It is highly recommended that an authorized SEA-DOO dealer perform the annual safety inspection and factory campaigns in addition to the pre-season preparation all at the same time.

OPERATIONS		TO BE PERFORMED BY
GENERAL	Lubrication/corrosion protection	Operator
	Spark plug replacement ①	Dealer
ENGINE	Exhaust system condition (fasteners, hoses etc.)	Dealer
	RAVE valve cleaning (if so equipped)	Dealer
	Counterbalance shaft oil level (if so equipped)	Dealer
	TDC setting (RFI and DI models)	Dealer
	Air compressor, visual condition of hoses. Check for leaks (DI models) CAUTION: Main hose between compressor and fuel rail may be hot.	Dealer
COOLING SYSTEM	Inspection of cooling system hoses and components	Dealer
FUEL SYSTEM	Carburetor adjustment (carburetor-equipped models)	Dealer
	Throttle ② and choke (carburetor-equipped models) cable inspection/adjustment	Dealer
	Fuel filter replacement (except RFI models)	Dealer
	Fuel injection sensors verification (RFI and DI models)	Dealer
	Fuel system; check valves, lines, fasteners, pressurization ②	Dealer
	Direct injector, check for leakage (DI models)	Dealer
	Filler neck, fuel tank and fuel cap condition ②	Dealer
	Flame arrester inspection (DI models) ②	Dealer
	Fuel tank straps	Operator
Refill fuel tank		
LUBRICATION SYSTEM	Oil injection pump adjustment and bleeding	Dealer
	Oil filter replacement	Dealer
	Oil injection reservoir straps	Operator
	Oil injection reservoir filling	Operator
ELECTRICAL SYSTEM	Battery condition/charging and reinstallation	Dealer
	Battery, starter connections and routing ②	Dealer
	Monitoring beeper	Dealer
	Digitally encoded security system	Dealer
STEERING SYSTEM	Steering system adjustment/inspection ②	Dealer
O.P.A.S. SYSTEM	Check O.P.A.S. system condition including filter. Replace all 8 square rings	Dealer
PROPULSION SYSTEM	Shifter system condition and cable adjustment	Dealer
	VTS (Variable Trim System, if so equipped)	Dealer
	Propulsion system inspection	Dealer
	Jet pump oil replacement	Dealer
HULL AND BODY	Inspection of bailer pick-ups	Dealer

① Before installing new spark plugs, it is suggested to burn the excess BOMBARDIER LUBE lubricant or equivalent by starting the engine using the old spark plugs.

② Safety item covered in the annual safety inspection.

TROUBLESHOOTING

The following chart is provided to help in diagnosing the probable source of simple troubles. You may be able to solve many of these problems rather quickly, but others may require the skills of a mechanical technician. In such cases, consult an authorized SEA-DOO dealer for servicing.

Monitoring Beeper Coded Signals

CODED SIGNALS	POSSIBLE CAUSE	REMEDY
2 short beeps (while installing safety lanyard on post).	<ul style="list-style-type: none"> • Confirms safety lanyard signal operation. 	Engine can be started.
1 long beep (while installing safety lanyard on watercraft post or when pressing engine start/stop button).	<ul style="list-style-type: none"> • Bad connection. • Wrong safety lanyard. • Defective safety lanyard. • Dried salt water in safety lanyard cap. • Improper operation of MPEM or defective wiring harness. 	Reinstall safety lanyard cap correctly over post. Use a safety lanyard that has been programmed for the watercraft. Use another programmed safety lanyard. Clean safety lanyard cap to remove salt water. Refer to an authorized SEA-DOO dealer.
1 second beep every second intervals (DI models).	<ul style="list-style-type: none"> • Engine drowned mode is active. 	Release throttle to cancel this mode.
4 short beeps (RFI models).	<ul style="list-style-type: none"> • Low battery voltage. • No communication between ECU and MPEM. 	Refer to an authorized SEA-DOO dealer. Refer to an authorized SEA-DOO dealer.
A 2 seconds beep every minute intervals (RFI models).	<ul style="list-style-type: none"> • Fuel tank level is low. 	Refill.
4 short beeps every 3 seconds interval for 2 hours.	<ul style="list-style-type: none"> • Safety lanyard has been left on its post without starting engine or after engine was stopped. 	To prevent battery discharge, remove the safety lanyard from its post.
A 2 seconds beep every 2 seconds intervals (DI models).	<ul style="list-style-type: none"> • Exhaust system overheat. 	See engine OVERHEATING.
A 2 seconds beep every minute intervals (DI models).	<ul style="list-style-type: none"> • Fuel tank level is low. • Very low battery voltage. • Coolant and exhaust gas temperature sensors or TPS (throttle position sensor) or CPS (crankshaft position sensor) malfunction. • MPEM malfunction. 	Refill as soon as possible. Refer to an authorized SEA-DOO dealer. Refer to an authorized SEA-DOO dealer. Refer to an authorized SEA-DOO dealer.
A 2 seconds beep every 15 minutes intervals (DI models).	<ul style="list-style-type: none"> • Oil injection reservoir level is low. 	Refill.
8 short beeps (carburetor-equipped models).	<ul style="list-style-type: none"> • Defective MPEM. 	Refer to an authorized SEA-DOO dealer.
Continuously beeps.	<ul style="list-style-type: none"> • Engine overheats. 	See engine OVERHEATING.

Engine Will Not Start

OTHER OBSERVATION	POSSIBLE CAUSE	REMEDY
Engine does not turn over.	<ul style="list-style-type: none"> • Safety lanyard removed. • Burnt fuse on MPEM or in rear electrical box: battery, starting system, fuel pump (DI models). • Discharged battery. • Battery connections, corroded or loose. • Water-flooded engine. • Faulty sensor (RFI and DI models) or MPEM. • Seized engine. • Seized jet pump. 	<p>Install cap over post.</p> <p>Check wiring then replace fuse(s).</p> <p>Refer to an authorized SEA-DOO dealer.</p> <p>Refer to an authorized SEA-DOO dealer.</p> <p>Refer to WATER-FLOODED ENGINE in SPECIAL PROCEDURES.</p> <p>Refer to an authorized SEA-DOO dealer.</p> <p>Refer to an authorized SEA-DOO dealer.</p> <p>Try to clean. Otherwise, refer to an authorized SEA-DOO dealer.</p>
Engine turns slowly.	<ul style="list-style-type: none"> • Loose battery cable connections. • Discharged or weak battery. • Worn starter. 	<p>Check/clean/tighten.</p> <p>Refer to an authorized SEA-DOO dealer.</p> <p>Refer to an authorized SEA-DOO dealer.</p>
Engine turns normally.	<ul style="list-style-type: none"> • Closed fuel tank valve (carburetor-equipped models). • Fuel tank empty or water-contaminated. • Fuel filter clogged or water-contaminated (carburetor-equipped models). • Fouled/defective spark plugs. • Misuse of choke (carburetor-equipped models). • Fuel-flooded engine. • Faulty component in the fuel injection system (RFI and DI models). • Burnt fuel pump fuse (RFI and DI models). • Electrical problem (RFI and DI models). 	<p>Turn fuel tank valve to ON position.</p> <p>Refill. Siphon and fill with fresh fuel.</p> <p>Clean, check fuel tank for water.</p> <p>Replace.</p> <p>Use only with cold engine. Replace spark plugs.</p> <p>Refer to FUEL-FLOODED ENGINE in SPECIAL PROCEDURES.</p> <p>Refer to an authorized SEA-DOO dealer.</p> <p>Check wiring then replace fuse.</p> <p>Refer to an authorized SEA-DOO dealer.</p>

Engine Misfires, Runs Irregularly

OTHER OBSERVATION	POSSIBLE CAUSE	REMEDY
Weak spark.	<ul style="list-style-type: none"> Fouled/defective/worn spark plugs. Faulty MPEM. Too much oil supplied to engine. 	<p>Replace.</p> <p>Refer to an authorized SEA-DOO dealer.</p> <p>Improper oil pump adjustment, refer to an authorized SEA-DOO dealer.</p>
Lean fuel mixture.	<ul style="list-style-type: none"> Fuel: Level too low, stale or water-contaminated. Fuel filter, clogged or water-contaminated (carburetor-equipped models). Fuel tank valve (carburetor-equipped models) partially open. Clogged injectors (RFI and DI models). Defective sensor or MPEM (RFI and DI models). 	<p>Siphon and/or refill.</p> <p>Refer to an authorized SEA-DOO dealer.</p> <p>Turn fuel tank valve to ON position.</p> <p>Refer to an authorized SEA-DOO dealer.</p> <p>Refer to an authorized SEA-DOO dealer.</p>
Rich fuel mixture (high fuel consumption).	<ul style="list-style-type: none"> Flame arrester dirty/clogged (if so equipped). Partially closed choke (carburetor-equipped models). Defective sensor or MPEM (RFI and DI models). 	<p>Clean or replace.</p> <p>Refer to an authorized SEA-DOO dealer.</p> <p>Refer to an authorized SEA-DOO dealer.</p>

Engine Overheats

OTHER OBSERVATION	POSSIBLE CAUSE	REMEDY
Monitoring beeper sounds continuously.	<ul style="list-style-type: none"> Clogged jet pump water intake. Clogged coolant system. 	<p>Clean.</p> <p>Flush cooling system.</p>

Engine Continually Backfires

OTHER OBSERVATION	POSSIBLE CAUSE	REMEDY
Weak spark.	<ul style="list-style-type: none"> Fouled/defective/worn spark plugs. 	<p>Replace.</p>
Overheated engine.	<ul style="list-style-type: none"> See engine OVERHEATS. Faulty rev limiter in MPEM (carburetor-equipped models). Spark plug leads or wiring reversed. 	<p>Refer to an authorized SEA-DOO dealer.</p> <p>Refer to an authorized SEA-DOO dealer.</p> <p>Connect spark plug cables at their proper location. Otherwise, refer to an authorized SEA-DOO dealer.</p>

Engine Pinging or Knocking

OTHER OBSERVATION	POSSIBLE CAUSE	REMEDY
	<ul style="list-style-type: none"> Poor quality gasoline/low octane. Spark plug heat range too high. Ignition timing or TDC setting). 	<p>Use well known quality and recommended gasoline.</p> <p>Use recommended spark plugs.</p> <p>Refer to an authorized SEA-DOO dealer.</p>

Engine Lacks Acceleration or Power

OTHER OBSERVATION	POSSIBLE CAUSE	REMEDY
	<ul style="list-style-type: none"> • Weak spark. • Incorrect fuel mixture (carburetor-equipped models). • Water in fuel or injection oil. 	<p>Refer to engine MISFIRES, RUNS IRREGULARLY.</p> <p>Refer to engine MISFIRES, RUNS IRREGULARLY.</p> <p>Siphon and replace.</p>
Overheated engine.	<ul style="list-style-type: none"> • Clogged injectors (RFI and DI models). • Low fuel pressure (RFI and DI models). • Stuck RAVE valves (if so equipped). 	<p>See engine OVERHEATS.</p> <p>Refer to an authorized SEA-DOO dealer.</p> <p>Refer to an authorized SEA-DOO dealer.</p> <p>Refer to an authorized SEA-DOO dealer.</p>

Watercraft Engine Cannot Run Above Idle Speed

OTHER OBSERVATION	POSSIBLE CAUSE	REMEDY
	<ul style="list-style-type: none"> • The monitoring system put the watercraft in limp home mode due to a component malfunction (DI models). 	<p>Try removing and reinstalling the safety lanyard on its post. Refer to an authorized SEA-DOO dealer.</p>

Watercraft Can Not Reach Top Speed

OTHER OBSERVATION	POSSIBLE CAUSE	REMEDY
Cavitation.	<ul style="list-style-type: none"> • Jet pump water intake clogged. • Damaged impeller. • The safety lanyard used purposefully does not allow watercraft top speed (DI models). • The monitoring system put the watercraft in limp home mode due to a component malfunction (DI models). 	<p>Clean.</p> <p>Replace. Refer to an authorized SEA-DOO dealer.</p> <p>Use a safety lanyard that allows to reach the top speed.</p> <p>Release throttle so that engine returns to idle speed. Refer to an authorized SEA-DOO dealer.</p>
O.P.A.S. side vanes (if so equipped) do not go up while watercraft is at speed.	<ul style="list-style-type: none"> • Clogged filter, square rings damaged, leakage in hoses or mechanical malfunction. 	<p>Refer to an authorized SEA-DOO dealer.</p>
O.P.A.S. side vanes (if so equipped) do not go down while engine is at idle.	<ul style="list-style-type: none"> • Broken spring inside side vane cylinder. 	<p>Refer to an authorized SEA-DOO dealer.</p>

O.P.A.S. System Faults

OTHER OBSERVATION	POSSIBLE CAUSE	REMEDY
Watercraft is more responsive than usual while turning.	<ul style="list-style-type: none">• Side vanes do not go up while watercraft is at speed.	Refer to an authorized SEA-DOO dealer.
Watercraft pulls on one side.	<ul style="list-style-type: none">• One side vane does not go up while watercraft is at speed.	Refer to an authorized SEA-DOO dealer.
O.P.A.S. side vanes do not go up while watercraft is at speed.	<ul style="list-style-type: none">• Clogged filter, square rings damaged, leakage in hoses or mechanical malfunction.	Refer to an authorized SEA-DOO dealer.
O.P.A.S. side vanes do not go down while engine is at idle.	<ul style="list-style-type: none">• Broken spring inside side vane cylinder.	Refer to an authorized SEA-DOO dealer.

Abnormal Noise From Propulsion System

OTHER OBSERVATION	POSSIBLE CAUSE	REMEDY
Cavitation.	<ul style="list-style-type: none">• Weeds or debris jammed around impeller.• Damaged impeller shaft or drive shaft.	Clean and check for damage. Refer to an authorized SEA-DOO dealer.

SPECIFICATIONS

MODELS		GTI, GTI LE (5567/5597/5598/ 6101/6102)	GTI LE RFI (6103/6104)
ENGINE			
Engine type		Rotax® 717, 2-stroke	Rotax® 787, 2-stroke
Induction type		Rotary valve	
Exhaust system		Water cooled/water injected	Water cooled/water injected with regulator
Exhaust valve		N.A.	Rotax Adjustable Variable Exhaust (RAVE)
Lubrication	Type	Oil injection	
	Oil type	BOMBARDIER Formula XP-S II synthetic injection oil OR BOMBARDIER injection oil (or equivalent)	BOMBARDIER Formula XP-S II synthetic injection oil
Number of cylinders		2	
Displacement		718.2 cm ³ (43.81 in ³)	781.6 cm ³ (47.7 in ³)
Rev limiter setting		7100 ± 50 RPM	7200 ± 50 RPM
COOLING SYSTEM			
Type		Water cooled, total loss type. Direct flow from propulsion unit	
ELECTRICAL SYSTEM			
Magneto generator output		160 W @ 6000 RPM	270 W @ 6000 RPM
Ignition system type		Digital CDI	Digital inductive type
Spark plug	Make and type	NGK, BR8ES	
	Gap	0.45 mm (.018 in)	
Starting system		Electric starter	
Battery		12 V, 19 A•h	
Fuse	Battery	N.A.	15 A
	Main	15 A	20 A
	MPEM	5 A	
	Charging system	15 A	20 A
	VTS system	N.A.	7.5 A (installed but not in use)
	Info center	N.A.	
	Accessory	N.A.	
	Injection system	N.A.	
Fuel pump		N.A.	10 A

MODELS		GTI, GTI LE (5567/5597/5598/ 6101/6102)	GTI LE RFI (6103/6104)
FUEL SYSTEM			
Fuel type		Regular unleaded gasoline	
Carburetor		BN 40i (diaphragm). Fuel accelerator pump. Quantity: 1	N.A.
Fuel injection		N.A.	Rotax Fuel Injection (semi direct), single throttle body (56 mm (2.21 in))
PROPULSION			
Propulsion system		Bombardier Formula pump	
Jet pump type		Axial flow, single stage	
Transmission		Direct drive	
Reverse system		Yes	
Pivoting angle of direction (nozzle)		~ 20°	
Minimum required water level for jet pump		90 cm (3 ft)	
DIMENSIONS			
Number of passengers ①		3	
Overall length		307 cm (121 in)	
Overall width		120 cm (47 in)	
Overall height		104 cm (41 in)	
Weight		272 kg (600 lb)	315 kg (695 lb)
Load limit (passengers + luggage)		243 kg (536 lb)	
CAPACITIES			
Fuel tank		56.5 L (15 U.S. gal)	
Oil injection reservoir		6 L (1.6 U.S. gal)	
Impeller shaft reservoir	Capacity	115 mL (3.9 U.S. oz)	95 mL (3.9 U.S. oz)
	Oil level	Up to plug	

N.A.: Not applicable

① Refer to load limit

BOMBARDIER INC. reserves the right to make changes in design and specifications and/or to make additions to, or improvements in its products without imposing any obligation upon itself to install them on its products previously manufactured.

MODELS		RX DI (6122/6123)	GTX DI (6118/6119)
ENGINE			
Engine type		Rotax® 947, 2-stroke	
Induction type		Reed valve	
Exhaust system		Water cooled/water injected with regulator	
Exhaust valve		Rotax Adjustable Variable Exhaust (RAVE)	
Lubrication	Type	Oil injection	
	Oil type	BOMBARDIER Formula XP-S II synthetic injection oil	
Number of cylinders		2	
Displacement		951.2 cm ³ (58 in ³)	
Rev limiter setting		7300 ± 50 RPM	
COOLING SYSTEM			
Type		Open circuit. Direct flow from propulsion unit	
ELECTRICAL SYSTEM			
Magneto generator output		270 W @ 6000 RPM	
Ignition system type		Digital inductive	
Spark plug	Make and type	NGK, ZFR4F	
	Gap	1.1 mm (.043 in)	
Starting system		Electric starter with reduction gear	
Battery		12 V, 19 A•h	
Fuse	Battery	25 A	
	Main	30 A	
	MPEM	N.A.	
	Charging system (REG)	25 A	
	VTS system	7.5 A	Installed but not in use
	Information center (ACC)	N.A.	
	Injection system (INJ)	15 A	
Fuel pump (FP)	15 A		
FUEL SYSTEM			
Fuel type		Unleaded regular gasoline with 87 octane (R+M)/2	
Fuel injection		Orbital direct fuel injection, twin throttle body (46 mm (1.81 in))	

MODELS		RX DI (6122/6123)	GTX DI (6118/6119)
PROPULSION			
Propulsion system		Bombardier Formula pump	
Jet pump type		Axial flow, single stage	
Transmission		Direct drive	
Reverse system		Yes	
Jet pump oil type		SEA-DOO synthetic polyolester oil SAE 75W90 GL5	
Minimum required water level for jet pump		90 cm (3 ft)	
DIMENSIONS			
Number of passengers ①		2	3
Overall length		285 cm (112 in)	331 cm (130 in)
Overall width		120 cm (47 in)	122 cm (48 in)
Overall height		104 cm (41 in)	113 cm (44 in)
Weight		285 kg (628 lb)	325 kg (715 lb)
Load limit (passengers + luggage)		181 kg (400 lb)	272 kg (600 lb)
CAPACITIES			
Fuel tank (including reserve)		56.5 L (15 U.S. gal)	
Fuel tank reserve (from low level signal on DI models)		9.8 L (2.6 U.S. gal)	
Oil injection reservoir		6 L (1.6 U.S. gal)	
Impeller shaft reservoir	Capacity	115 mL (3.9 U.S. oz)	
	Oil level	Up to plug	

N.A.: Not applicable

① Refer to load limit

BOMBARDIER INC. reserves the right to make changes in design and specifications and/or to make additions to, or improvements in its products without imposing any obligation upon itself to install them on its products previously manufactured.

SI* METRIC INFORMATION

BASE UNITS			
DESCRIPTION		UNIT	SYMBOL
length		meter	m
mass		kilogram	kg
force		newton	N
liquid		liter	L
temperature		Celsius	°C
pressure		kilopascal	kPa
torque		newton-meter	N•m
land velocity		kilometer per hour	km/h
navigation velocity		knot	kn

PREFIXES			
PREFIX	SYMBOL	MEANING	VALUE
kilo	k	one thousand	1000
centi	c	one hundredth of	0.01
milli	m	one thousandth of	0.001
micro	μ	one millionth of	0.000001

CONVERSION FACTORS			
TO CONVERT		TO ①	MULTIPLY BY
in		mm	25.4
in		cm	2.54
in ²		cm ²	6.45
in ³		cm ³	16.39
ft		m	0.3
oz		g	28.35
lb		kg	0.45
lbf		N	4.4
lbf•in		N•m	0.11
lbf•ft		N•m	1.36
lbf•ft		lbf•in	12
PSI		kPa	6.89
imp. oz		U.S. oz	0.96
imp. oz		mL	28.41
imp. gal		U.S. gal	1.2
imp. gal		L	4.55
U.S. oz		mL	29.57
U.S. gal		L	3.79
knot		MPH	1.15
MPH		km/h	1.61
Fahrenheit		Celsius	(°F - 32) ÷ 1.8
Celsius		Fahrenheit	(°C × 1.8) + 32
hp		kW75

* The international system of units abbreviates SI in all languages.

① To obtain the reverse sequence, divide by the given factor. Example: to convert millimeters to inches, divide by 25.4.

NOTE: Conversion factors are rounded off to 2 decimals for easier use.

ABBREVIATIONS USED IN THIS MANUAL

	DESCRIPTION
AC	Alternate current
API	American petroleum institute
CARB	California air resource board
DC	Direct current
DESS	Digitally encoded security system
EMS	Engine management system
ECU	Electronic control unit
E.I.N.	Engine identification number
EPA	Environmental protection agency
HP	Horse power
LCD	Liquid Crystal Display
LED	Light-emitting diode
MAG	Magneto
MPEM	Multi-purpose electronic module
MPH	Mile per hour
N.A.	Not applicable
O.P.A.S.	Off-power assisted steering
OPT	Optional
PFD	Personal flotation device
P/N	Part number
PTO	Power take off
STD	Standard
TBD	To be determined
TDC	Top dead center
T.O.P.S.	Tip-over protection system



AFFIX
PROPER
POSTAGE

BOMBARDIER
RECREATIONAL PRODUCTS
WARRANTY DEPARTMENT
75, J.A. BOMBARDIER ST.
SHERBROOKE (QUEBEC)
CANADA J1L 1W3



AFFIX
PROPER
POSTAGE

BOMBARDIER
RECREATIONAL PRODUCTS
WARRANTY DEPARTMENT
75, J.A. BOMBARDIER ST.
SHERBROOKE (QUEBEC)
CANADA J1L 1W3

WATERCRAFT MODEL No. _____

HULL IDENTIFICATION NUMBER (H.I.N.) _____

ENGINE IDENTIFICATION NUMBER (E.I.N.) _____

Owner:

Purchase Date _____
YEAR MONTH DAY

Warranty Expiry Date _____
YEAR MONTH DAY

To be completed by the authorized Sea-Doo dealer at the time of the sale.

DEALER IMPRINT AREA

Please verify with your selling dealer to ensure your SEA-DOO watercraft has been registered with Bombardier.

