

# SEAWOO®

## OPERATOR'S GUIDE



# 2000

219 000 104

**GS** 5644, 5827

**XP** 5651, 5655

**GTS** 5639

**GTI** 5647, 5657

**GTX** 5653, 5690

**GTX RFI** 5648, 5658

**GSX RFI** 5645, 5654

## SAFETY WARNING

Disregarding any of the safety precautions and instructions contained in this *Operator's Guide*, the *Safety Handbook* and on *Product Warning Labels* could cause injury, including the possibility of death. The operator has the responsibility to inform passenger(s) of safety precautions.

This *Operator's Guide*, the *Safety Handbook* and *Videocassette* should remain with the watercraft at the time of resale.

**BOMBARDIER**  
Recreational Products  
After-Sales Service  
Sherbrooke (Quebec)  
Canada J1L 1W3



Gelcote® is a trademark of Gelcote International  
Knight's Spray-Nine® is a trademark of Korkay  
System Ltd

**The following trademarks are property of  
Bombardier Inc. and/or its subsidiaries:**

SEA-DOO®

BOMBARDIER-ROTAX®

Bombardier Lube

BOMBARDIER-ROTAX Formula XP-S Synthetic  
Injection Oil

BOMBARDIER-ROTAX Injection Oil

Sea-Doo Synthetic Grease

## **Doin'it on your new Sea-Doo Watercraft**

Congratulations, you are now the proud owner of a Sea-Doo personal watercraft. Whether you are an experienced boater or are new to the sport of boating, we ask you to take the time to view the Videocassette provided with the watercraft, to read this *Operator's Guide*, the *Safety Handbook* and familiarize yourself with the contents. These Guides contain pertinent information which, if followed, will provide you with the necessary knowledge to help you fully enjoy the pleasures of this watercraft.

We strongly recommend that any watercraft operator complete a safety boating course. Check with your local Coast Guard or Power and Sail Squadron in your area for course availability. More serious boaters may want to obtain *Chapman Piloting* by Elbert S. Maloney, available at most book stores.

When introducing your family or friends to the sport, be sure they fully understand the controls and operation of the watercraft and the importance of courteous, responsible riding.

Each operator has a responsibility to ensure the passenger safety and the safety of other water users. Please follow all safety instructions and drive with care.

We encourage you to have an Annual Safety Inspection of your watercraft. Please contact your dealer for further details.

Finally, we urge you to visit your dealer regularly for regular and safety maintenance as well as any watercraft accessories you may require.

Have fun and... Bon Voyage.

**Please keep this *Guide* and *Safety Handbook* on board. These manuals should remain with the watercraft at time of resale.**

---

# TABLE OF CONTENTS

<b>FOREWORD</b> .....	<b>5</b>
<b>△ SAFETY WARNING</b> .....	<b>6</b>
General .....	6
Operation.....	6
Maintenance.....	9
<b>LIST OF DISTRIBUTORS</b> .....	<b>10</b>
<b>BOMBARDIER LIMITED WARRANTY NORTH AMERICA: 2000 SEA-DOO®</b> .....	<b>11</b>
<b>BOMBARDIER INTERNATIONAL LIMITED WARRANTY: 2000 SEA-DOO®</b> .....	<b>13</b>
<b>REGISTRATION NUMBER LOCATION</b> .....	<b>15</b>
<b>LOCATION OF THE IMPORTANT LABELS</b> .....	<b>16</b>
<b>IDENTIFICATION NUMBERS</b> .....	<b>22</b>
Hull .....	22
Engine .....	22
<b>CONTROLS AND COMPONENT LOCATION</b> .....	<b>24</b>
<b>COMPONENTS FUNCTIONS</b> .....	<b>29</b>
1) Safety Lanyard .....	29
2) Handlebar.....	30
3) Throttle Lever .....	30
4) Engine Start/Stop Button .....	30
5) Variable Trim System Button (VTS) (if so equipped) .....	31
6) Choke Lever.....	31
7) Shift Lever (if so equipped).....	31
8) Fuel Gauge/Low Oil Warning Light (if so equipped) .....	31
9) Speedometer (if so equipped) .....	31
10) Tachometer (if so equipped) .....	32
11) Variable Trim System (VTS) Gauge (if so equipped) .....	32
12) Info Center Gauge/Buttons (if so equipped) .....	32
13) Glove Box (if so equipped).....	33
14) Fuel Tank Valve .....	33
15) Fuel Tank Cap .....	34
16) Oil Injection Reservoir Cap .....	34
17) Front Storage Compartment Cover .....	34
18) Front Storage Compartment Cover Latch.....	35
19) Front Storage Compartment Cover Hinge/Locking Mechanism .....	35
20) Front Storage Compartment Cover Lock (if so equipped) .....	35
21) Tool Kit.....	36
22) Storage Compartment/Engine Cover (if so equipped) .....	36
23) Storage Compartment/Engine Cover Latches (if so equipped).....	36
24) Water Tank Trap Drains (if so equipped).....	36
25) Air Intake Opening .....	36
26) Rear Vent Grills (if so equipped) .....	37
27) Seat Strap .....	37



28) Seat Latch.....	37
29) Rear Seat Latch (if so equipped).....	38
30) Rear Grab Handle .....	38
31) Rear Storage Basket (if so equipped) .....	38
32) Rear Access Cover (if so equipped).....	38
33) Bow and Stern Eyelets .....	38
34) Mooring Cleats .....	38
35) Cargo Cleats (if so equipped).....	39
36) Footboard .....	39
37) Boarding Pads.....	39
38) Boarding Platform.....	39
39) Boarding Step (if so equipped) .....	39
40) Cooling System Bleed Outlet .....	40
41) Flushing Connector (if so equipped) .....	40
42) Bilge Drain Plugs .....	40
43) Automatic Bilge Pump (if so equipped) .....	40
44) Jet Pump Nozzle.....	41
45) Reverse Gate (if so equipped) .....	41
46) Jet Pump Water Intake.....	41
<b>FUEL AND LUBRICATION .....</b>	<b>42</b>
Fueling Procedure .....	42
Recommended Fuel.....	42
Recommended Oil .....	42
Oil Injection System .....	43
<b>BREAK-IN PERIOD .....</b>	<b>44</b>
Engine .....	44
10-Hour Inspection.....	44
<b>DAILY PRE-OPERATION CHECKS .....</b>	<b>45</b>
Hull.....	46
Jet Pump Water Intake .....	46
Bilge .....	46
Battery.....	46
Fuel Tank and Oil Reservoir .....	46
Engine Compartment.....	46
Steering System.....	46
Throttle System.....	46
Shifter System (if so equipped).....	47
VTS (Variable Trim System) (if so equipped) .....	47
Safety Lanyard and Engine Start/Stop Button.....	47
Storage Compartment Covers .....	47
<b>OPERATING INSTRUCTIONS .....</b>	<b>48</b>
Principle of Operation.....	48
Boarding the Watercraft.....	51
Starting the Engine.....	53
Rough Water or Poor Visibility Operation.....	54
Crossing Waves .....	54
Stopping/Docking .....	55
Beaching .....	55
Shutting Off the Engine .....	55

<b>POST-OPERATION CARE .....</b>	<b>56</b>
General Care.....	56
Additional Care for Foul Water or Salt Water .....	56
Cooling System Flushing and Engine Internal Lubrication .....	56
Anticorrosion Treatment.....	59
<b>SPECIAL PROCEDURES.....</b>	<b>60</b>
Engine Overheating.....	60
Jet Pump Water Intake and Impeller Cleaning.....	60
Capsized Watercraft .....	61
Submerged Watercraft.....	61
Water-Flooded Engine.....	61
Fuel-Flooded Engine .....	62
Towing the Watercraft in Water.....	63
Low-Charge Battery Condition .....	64
<b>MAINTENANCE .....</b>	<b>65</b>
Lubrication.....	65
Periodic Inspection .....	67
Periodic Inspection Chart .....	68
Throttle and Choke Cable Inspection .....	70
Carburetor Adjustment.....	70
Fuel and Oil Filters.....	70
Steering Alignment.....	70
VTS Adjustment (if so equipped).....	71
Vacuum Bailer Pick-Ups .....	71
Water Tank Trap Drains.....	71
Fuses.....	72
General Inspection and Cleaning.....	74
<b>TRAILERING, STORAGE AND PRE-SEASON PREPARATION.....</b>	<b>75</b>
Trailerling.....	75
Storage .....	75
Pre-Season Preparation .....	79
<b>TROUBLESHOOTING .....</b>	<b>81</b>
<b>SPECIFICATIONS.....</b>	<b>85</b>
<b>SI METRIC INFORMATION .....</b>	<b>95</b>
<b>ABBREVIATIONS USED IN THIS MANUAL .....</b>	<b>96</b>
<b>CHANGE OF ADDRESS.....</b>	<b>99</b>

---

## FOREWORD

The *Operator's Guide* and *Safety Handbook* have been prepared to acquaint the owner/operator or passenger with this personal watercraft and its various controls, maintenance and safe riding instructions. Each is indispensable for the proper use of the product, and should be kept in a waterproof bag with the watercraft at all times.

For any questions pertaining to the warranty and its application, consult the WARRANTY section in this guide, and/or an authorized SEA-DOO dealer.

This guide uses the following symbols to emphasize particular information.

**WARNING**

Identifies an instruction which, if not followed, may cause serious personal injuries including the possibility of death.

**CAUTION:** Denotes an instruction which, if not followed, might damage the watercraft and/or components.

**NOTE:** Indicates supplementary information needed to fully complete an instruction.

Although the mere reading of such information does not eliminate the hazard, the understanding and application of the information will promote its correct use.

The information and components/system descriptions contained in this guide are correct at the time of publication. Bombardier Inc. however, maintains a policy of continuous improvement of its products without imposing upon itself any obligation to install them on products previously manufactured.

Because of our ongoing commitment to product quality and innovation, Bombardier Inc. reserves the right at any time to discontinue or change specifications, designs, features, models or equipment without incurring obligation.

The illustrations in this document show the typical construction of the different assemblies and may not represent the full detail or exact shape of the parts. However, they represent parts that have the same or similar function.

It is understood that this guide may be translated into another language. In the event of any discrepancy, the English version shall prevail.

Specifications are given in the SI metric system with the SAE U.S. equivalent in parenthesis. Where precise accuracy is not required, some conversions are rounded off for easier use.

A *Shop Manual* can be obtained for complete service, maintenance and more repair information.

---

## ⚠ SAFETY WARNING

### General

- ⚠ To fully appreciate the pleasures, enjoyment and excitement of boating there are some basic rules that should be observed and followed by any rider. Some rules may be new to you or covered in the *Personal Watercraft Safety Handbook* or *Safety Video*, others may be common sense or obvious... irrespective, we ask that you please take a few minutes of your time to completely read these safety instructions completely before you operate your watercraft. **Failure to follow this safety information and safe boating rules could result in injury, including the possibility of death to you, your passenger(s), or other water users.**
- ⚠ Information in this guide is limited. It is strongly recommended that you obtain further boating information from the local Coast Guard or Power Squadron. We also recommend all operators to take a boating safety course. Please check local and federal boating laws applicable to the waterways where you intend to use the watercraft. Learn the local rules of the road. Always carry the regulatory required safety items on board.
- ⚠ The performance of this watercraft may significantly exceed that of other crafts you have operated. Therefore, use of this watercraft by a novice or inexperienced operator, or an underage or disabled person, is NOT RECOMMENDED.
- ⚠ Observe and follow all on-product warning labels.

- ⚠ Become completely familiar with the controls and operation of the watercraft before embarking on your first trip or taking on a passenger(s). If you have not had the opportunity to do so with your authorized Sea-Doo dealer, practice driving solo in a suitable area and feel the response of each control. Be fully familiar with all controls before applying throttle above idle speed. As its operator, you control and are responsible for the watercraft's safe operation.
- ⚠ Always carry the regulatory required safety items on board. Check the local regulations or consult your dealer.
- ⚠ Make sure that all users of the watercraft read and are aware of all warnings.

### Operation

- ⚠ Always perform the daily pre-operation checks as specified in this guide.
- ⚠ Operator and passenger(s) should at all times wear a coast guard approved personal flotation device (PFD) that is suitable for personal watercraft.
- ⚠ Operator and passenger(s) should wear protective clothing. Severe internal injuries can occur if water is forced into body cavities as a result of falling into water or being near jet thrust nozzle. Wet suit bottom (or clothing that provides equivalent protection), footwear, gloves and goggles/glasses are recommended.

- ⚠ Always keep in mind that as the throttle lever is released to idle position, less directional control is available. **To turn the watercraft, both steering and throttle are necessary.** This watercraft has the capability of turning more sharply than other crafts, however, unless in an emergency, do not negotiate sharp, high speed turns. You and your passenger(s) could be thrown from the watercraft. It should also be remembered that sun, wind, alcohol or drugs, may impair your judgment and reaction time.
- ⚠ While your watercraft has the capacity of operating at high speeds, it is strongly recommended that high speed operation only be applied when ideal conditions exist and are permitted. Higher speed operation requires a higher degree of skill and increases the risk of severe injuries.
- ⚠ The forces generated on the body of riders while turning, negotiating waves or wakes, operating in choppy waters, or falling off the watercraft, especially at higher speeds, may cause injury including the possibility of broken legs and other bones. Remain flexible and avoid sharp turns. Never place your feet and legs in the water to aid turning.
- ⚠ **Ensure operator all-round visibility is unrestricted. Always keep a constant lookout for other water users or other potential hazards especially when turning. Make sure to keep a safe distance from all other crafts, other waterusers or other objects.**
- ⚠ Like any other craft, this watercraft has no brake. Stopping distance will vary depending on initial speed, load, wind, and water conditions. Practice stopping and docking in a safe, traffic free area to have an idea of how long it will take to stop the watercraft under varying conditions. Do not release throttle when trying to steer away from objects. You need throttle to steer. Do not use the watercraft's reverse, if so equipped, to stop.
- ⚠ Ensure that all passengers know how to swim and how to reboard the watercraft from the water. The operator and passenger(s) should be properly seated before starting or moving the watercraft, and at all times when watercraft is in motion. **Do not** start or operate the watercraft if a person(s) is seated on the sun deck or swim platform, or are nearby in the water. The watercraft's jet thrust can cause injury. Always accelerate slowly. To prevent accidental starting or unauthorized use, always detach the safety lanyard from the watercraft especially when swimmers are boarding or nearby, or during removal of any weeds or debris from the intake grate. Keep away from intake grate while engine is on. Items such as long hair, loose clothing, or PFD straps can become entangled in moving parts resulting in severe injury or drowning.
- ⚠ Ride within your limits and avoid aggressive maneuvers to reduce the risk of loss of control, ejection and collision.

- ⚠ Riding with a passenger(s) or pulling other crafts, tubes, skies or wakeboards makes the watercraft handle differently and requires greater skill. Do not overload the watercraft or take on more passengers than designated for the particular watercraft. Overloading can affect maneuverability, stability and performance. Avoid adding on accessories, or equipment which may alter your control of the watercraft. The watercraft maybe fitted with tow eyelets which can be used to attach a ski rope. However, do not use these eyelets or the watercraft's cleats to tow a parasail. Severe watercraft damage may occur.
- ⚠ Always respect the safety and comfort of your passenger(s) and persons being towed on skis, wakeboards or other water products. Always have an observer while towing a skier, proceed with only as much speed as required, and follow the observers instructions. Unless absolutely necessary, do not make tight, sharp turns.
- ⚠ Know the waters in which the watercraft is to be operated. Current, tides, rapids, hidden obstacles, wakes and waves etc., can affect safe operation. It is not advisable to operate the watercraft in rough or inclement weather.
- ⚠ Wake or wave jumping or riding the surf line can cause severe personal injury and damage the watercraft. Never attempt to splash others with your watercraft. You may misjudge the ability of the watercraft or your own riding skills and strike a craft or person.
- ⚠ In shallow water, proceed with caution and at very low speeds. Grounding or abrupt stops may result in injury. Debris may also be picked up and be thrown rearward by the jet pump onto people or property.
- ⚠ Respect no wake zones, the rights of other water users and the environment. As the "skipper" and owner of a watercraft you are responsible for damage to other crafts caused by the wake of your watercraft. Allow no one to throw refuse overboard.
- ⚠ Remember that a watercraft is not designed for night time operation.
- ⚠ Avoid adding on accessories or equipment which may alter the craft's configuration or balance.
- ⚠ Remember, gasoline fumes are inflammable and explosive. Always adhere to the fueling procedure contained in this guide and those given to you by the marina. Always verify fuel level before use and during the ride. Apply the principle of 1/3 fuel to destination, 1/3 back and 1/3 reserve fuel supply. Do not carry spare fuel or inflammable liquids in any of the storage or engine compartments.
- ⚠ Combustion engine needs air to operate; consequently this watercraft can not be totally watertight. Any maneuvers such as figure eights etc., that cause the upper deck to be under water may cause severe engine problems due to water ingestion. Refer to "Special procedures" and Limited Warranty contained in this guide.
- ⚠ Due to the close proximity of other racers, it is recommended that an approved personal watercraft helmet be used during racing events. Read and follow all instructions and warnings provided with the helmet.



## Maintenance

- ⚠ Only perform servicing procedures which are detailed in this guide. Further assistance or information can be obtained from your authorized Sea-Doo dealer. In many instances proper tools and training is required for certain servicing or repair procedures.
- ⚠ Maintain the watercraft and equipment in top condition at all times. Adhere to the prescribed maintenance schedules. An annual inspection of the watercraft is always a good recommendation that should be followed.
- ⚠ Always use spark plug cable grounding device when removing spark plugs.
- ⚠ The bilge should be kept clean of oil, water or other foreign materials.
- ⚠ Do not attempt to lift the watercraft without special equipment and training.
- ⚠ The engine and the corresponding components identified in this guide should not be utilized on product(s) other than for those they were designed. Maintenance procedures and specified tightening torque should be strictly adhered to. Never attempt repairs unless the appropriate tools are available. These watercrafts are designed with parts dimensioned in both the metric and the imperial systems. When replacing fasteners, make sure to use only those recommended by Bombardier. If required, contact your authorized Sea-Doo dealer for further servicing information.
- ⚠ Never ride after consuming drugs or alcohol. Operate your craft prudently and have fun. Don't forget that all persons must assist other boaters in an emergency.



# LIST OF DISTRIBUTORS

## NORTH AMERICA

<p><b>U.S.A.</b></p>  <p>(Except Puerto Rico)</p>	<p><b>BOMBARDIER MOTOR CORPORATION OF AMERICA</b> 5000 STEWART AVENUE WAUSAU, WI 54401 Phone: (715) 842-8886 Fax: (715) 848-3455 <a href="http://www.bombardier.com">http://www.bombardier.com</a></p>
<p><b>CANADA</b></p>  <p>Alberta British Columbia Manitoba North West Territories Nunavut Ontario Quebec Saskatchewan Yukon New-Brunswick Nova Scotia Prince Edward Island</p>	<p><b>BOMBARDIER</b> RECREATIONAL PRODUCTS 75, J. A. BOMBARDIER ST. SHERBROOKE, QC J1L 1W3 Phone: (819) 566-3366 Fax: (819) 566-3062 <a href="http://www.bombardier.com">http://www.bombardier.com</a></p>
<p>Newfoundland</p>	<p><b>CHARLES R. BELL</b> P.O. BOX 1050 RIVERSIDE DRIVE CORNER BROOK, NFLD A2H 6J3 Phone: (709) 634-3533 Fax: (709) 634-2444</p>

If your SEA-DOO watercraft requires warranty service, you should take it to any authorized Sea-Doo dealer. Be sure to bring your warranty registration card or other valid proof of the original date of purchase. If a question or problem arises regarding warranty, first contact the service manager or owner of the Sea-Doo dealership.

To find the nearest authorized Sea-Doo dealer, dial: 1-800-882-2900.

**NOTE:** If outside North America, consult the local authorized Sea-Doo distributor.

---

# **BOMBARDIER LIMITED WARRANTY NORTH AMERICA: 2000 SEA-DOO®**

## **1. WARRANTY COVERAGE PERIOD**

In Canada, BOMBARDIER INC. ("Bombardier"), and in the U.S.A., Bombardier on behalf of BOMBARDIER MOTOR CORPORATION OF AMERICA (B.M.C.A.), warrants FROM THE DATE OF DELIVERY TO THE FIRST CONSUMER that each 2000 SEA-DOO watercraft sold, as NEW and UNUSED and PREDELIVERED by an authorized North American SEA-DOO watercraft dealer, will be free from any defects in material and/or workmanship for a PERIOD of:

TWELVE (12) CONSECUTIVE MONTHS, for private use owners, or

FOUR (4) CONSECUTIVE MONTHS for commercial use owners.

All genuine Bombardier accessories, installed by an authorized SEA-DOO dealer at the time of delivery of the new and unused SEA-DOO, carry the same Warranty Coverage Period as for the SEA-DOO watercraft.

## **2. WHAT BOMBARDIER WILL DO**

BOMBARDIER will repair or replace, at its option, all genuine BOMBARDIER part found defective in material and/or workmanship, under normal use, maintenance and service, with a genuine BOMBARDIER part without charge for parts and labor, at any authorized SEA-DOO dealer during the Warranty Coverage Period.

## **3. CONDITION TO HAVE WARRANTY WORK VALIDATED**

The customer must notify an authorized SEA-DOO watercraft dealer within two (2) days of the appearance of the defect in material and/or workmanship and present to the servicing authorized SEA-DOO dealer the SEA-DOO Warranty Registration Card or a proof of purchase of the NEW and UNUSED 2000 SEA-DOO watercraft and must sign the repair/work order prior to the start of the repair in order to validate a warranty repair. All parts replaced under this limited warranty become the property of BOMBARDIER.

## **4. EXCLUSIONS - ARE NOT WARRANTED**

- Normal wear and tear items;
- Labor, parts and lubricant costs of all maintenance services;
- Damage caused by failure to provide proper maintenance and/or storage, as described in the "2000 SEA-DOO Watercraft *Operator's Guide*";
- Damage resulting from improper repairs, modifications or use of non-approved parts or, repairs done by a non-authorized SEA-DOO dealer;
- Damage resulting from abuse, misuse, neglect, racing;
- Damage resulting from accident, fire, theft, vandalism or any act of God;
- Incidental or consequential damages, or damages of any kind such as, without limitation, towing charges, telephone calls or taxi;
- Water damages caused by water ingestion;
- Damage related to gel coat finish including but not limited to cosmetic gel coat finish, blisters or fiberglass delamination caused by blisters, crazing, spider or hairline cracks; and
- Damages resulting from improper service or maintenance.

## 5. LIMITATIONS OF LIABILITY

This warranty gives you specific rights, and you may also have other legal rights which may vary from state to state, or province to province. **WHERE APPLICABLE, THIS WARRANTY IS EXPRESSLY GIVEN AND ACCEPTED IN LIEU OF ANY AND ALL OTHER WARRANTIES, EXPRESSED OR IMPLIED, INCLUDING WITHOUT LIMITATION ANY WARRANTY OF MERCHANTABILITY OR FITNESS FOR ANY PARTICULAR PURPOSE.**

Neither the SEA-DOO distributor, any authorized SEA-DOO dealer nor any other person has been authorized to make any affirmation, representation or warranty other than those contained in this warranty, and if made, such affirmation, representation or warranty shall not be enforceable against BOMBARDIER or any other person.

In no event shall BOMBARDIER be liable for special, consequential or incidental damages, including but not limited to loss of use and transportation costs. Some states or provinces do not allow the exclusion or limitation of incidental or consequential damages, or limitations on how long an implied warranty lasts, so the above limitation or exclusion may not apply.

BOMBARDIER reserves the right to modify this warranty at any time, being understood that such modification will not alter the warranty conditions applicable to the SEA-DOO watercraft sold while this warranty is in effect.

## 6. TRANSFER

If the customer sells the watercraft guaranteed under the present, he shall assign and transfer this warranty, which shall be valid for the rest of the relevant PERIOD as defined in section 1 hereinabove, to the new customer.

## 7. CONSUMER ASSISTANCE

- a) In the event of a controversy or a dispute arising in connection with this BOMBARDIER LIMITED WARRANTY, BOMBARDIER suggests that you try to resolve the issue at the dealership level. We recommend discussing the issue with the authorized dealer's service manager or owner.
- b) If further assistance is required, the DISTRIBUTOR's service department should be contacted in order to resolve the matter. In the U.S.A., SEA-DOO products are distributed by B.M.C.A.
- c) If the issue has still not been resolved, please submit in writing your complaint to:

In Canada and U.S.A.:



BOMBARDIER INC.  
RECREATIONAL PRODUCTS  
SEA-DOO  
CUSTOMER ASSISTANCE CENTER  
75, J. A. BOMBARDIER ST.  
SHERBROOKE, QC  
J1L 1W3  
Tel: (819) 566-3366

© MARCH 1999 Bombardier Inc. All rights reserved

® Registered trademark of Bombardier Inc. and/or its subsidiaries.

---

# **BOMBARDIER INTERNATIONAL LIMITED WARRANTY: 2000 SEA-DOO®**

## **1. WARRANTY COVERAGE PERIOD**

BOMBARDIER INC. ("Bombardier"), as manufacturer, warrants FROM THE DATE OF DELIVERY TO THE FIRST CONSUMER that each 2000 SEA-DOO watercraft sold anywhere in the world except the United States and Canada, as NEW and UNUSED and PREDELIVERED by an authorized SEA-DOO watercraft dealer, duly appointed by an authorized SEA-DOO International Distributor, will be free from any defects in material and/or workmanship for a PERIOD of:

TWELVE (12) CONSECUTIVE MONTHS, for private use owners, or

FOUR (4) CONSECUTIVE MONTHS for commercial use owners.

All genuine Bombardier accessories, installed by an authorized SEA-DOO dealer at the time of delivery of the new and unused SEA-DOO watercraft, carry the same Warranty Coverage Period as for the SEA-DOO watercraft.

## **2. WHAT BOMBARDIER WILL DO**

BOMBARDIER through the local SEA-DOO International Distributor will, during the Warranty Coverage Period, repair or replace, at its option, all genuine BOMBARDIER part found defective in material and/or workmanship, under normal use, maintenance and service, with a genuine BOMBARDIER part without charge for parts and labor, at any local authorized SEA-DOO dealer.

## **3. CONDITION TO HAVE WARRANTY WORK VALIDATED**

The customer must notify a local authorized SEA-DOO dealer within two (2) days of the appearance of the defect in material and/or workmanship and present to the servicing authorized SEA-DOO watercraft dealer the SEA-DOO Warranty Registration Card or a proof of purchase of the NEW and UNUSED 2000 SEA-DOO watercraft and must sign the repair/work order prior to the start of the repair in order to validate a warranty repair. All parts replaced under this limited warranty become the property of BOMBARDIER.

## **4. EXCLUSIONS - ARE NOT WARRANTED**

- Normal wear and tear items;
- Labor, parts and lubricant costs of all maintenance services;
- Damage caused by failure to provide proper maintenance and/or storage, as described in the "2000 SEA-DOO Watercraft *Operator's Guide*";
- Damage resulting from improper repairs, modifications or use of non-approved parts or, repairs done by a non-authorized SEA-DOO dealer;
- Damage resulting from abuse, misuse, neglect, racing;
- Damage resulting from accident, fire, theft, vandalism or any act of God;
- Incidental or consequential damages, or damages of any kind such as, without limitation, towing charges, telephone calls or taxi;
- Water damages caused by water ingestion;
- Damage related to gel coat finish including but not limited to cosmetic gel coat finish, blisters or fiberglass delamination caused by blisters, crazing, spider or hairline cracks; and
- Damages resulting from improper service or maintenance.

## 5. LIMITATIONS OF LIABILITY

This warranty gives you specific rights, and you may also have other legal rights resulting from the application of mandatory national laws which may vary from country to country. **WHERE APPLICABLE, THIS WARRANTY IS EXPRESSLY GIVEN AND ACCEPTED IN LIEU OF ANY AND ALL OTHER WARRANTIES, EXPRESSED OR IMPLIED, INCLUDING WITHOUT LIMITATION ANY WARRANTY OF MERCHANTABILITY OR FITNESS FOR ANY PARTICULAR PURPOSE.**

In no event shall BOMBARDIER be liable for special, consequential or incidental damages, including but not limited to loss of use and transportation costs. Some countries do not allow the exclusion or limitation of incidental or consequential damages, or limitations on how long an implied warranty lasts, so the above limitation or exclusion may not apply.

Neither the SEA-DOO International Distributor, the selling local SEA-DOO dealer nor any other person has been authorized to make any affirmation, representation or warranty other than those contained in this warranty, and if made, such affirmation, representation or warranty shall not be enforceable against BOMBARDIER or any other person.

Every SEA-DOO watercraft is sold with the English version of this warranty. A specific SEA-DOO International Distributor may elect to translate this warranty into local language, it is then understood and agreed that in the event of any discrepancy among the two versions, the English version shall prevail.

It is the customer's responsibility to ensure that the SEA-DOO watercraft complies with all boating regulations and standards of any country, other than the original country of sale, where the SEA-DOO watercraft is intended to be used.

BOMBARDIER reserves the right to modify this warranty at any time, being understood that such modification will not alter the warranty conditions applicable to the SEA-DOO watercraft sold while this warranty is in effect.

## 6. TRANSFER

If the customer sells the watercraft guaranteed under the present, he shall assign and transfer this warranty, which shall be valid for the rest of the relevant PERIOD as defined in section 1 hereinabove, to the new customer.

## 7. CONSUMER ASSISTANCE

- a) In the event of a controversy or a dispute arising in connection with this BOMBARDIER INTERNATIONAL LIMITED WARRANTY, BOMBARDIER suggests that you try to resolve the issue at the dealership level. We recommend discussing the issue with the authorized dealer's service manager or owner.
- b) If further assistance is required, the authorized local SEA-DOO INTERNATIONAL DISTRIBUTOR's service department should be contacted in order to resolve the matter.
- c) If the issue has still not been resolved, please submit in writing your complaint to:

BOMBARDIER RECREATIONAL PRODUCTS  
SEA-DOO  
INTERNATIONAL SERVICE DEPARTMENT  
75, J. A. BOMBARDIER ST.  
SHERBROOKE, QC  
J1L 1W3  
CANADA

---

## REGISTRATION NUMBER LOCATION

All personal watercraft are required by federal law to be registered and legally numbered.

Due to space availability for proper display of registration number, refer to following illustration for location. The registration number should appear on each side of the watercraft.

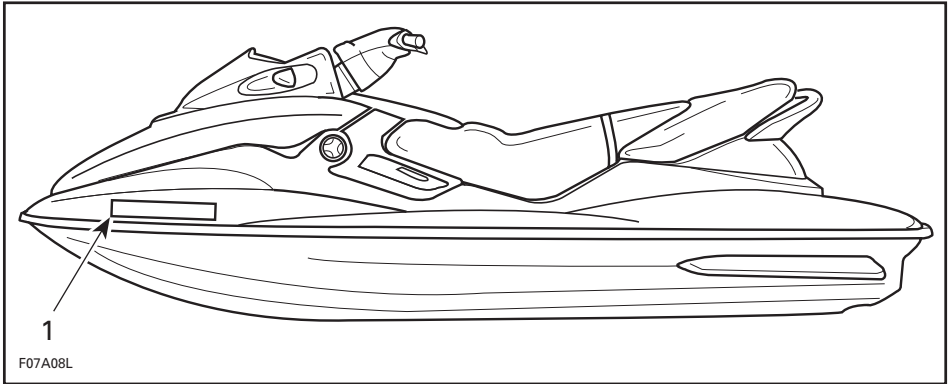

### *TYPICAL*

1. Registration number location

**NOTE:** The registration number must be above the water line. Ensure also that the numbers are of the correct size and color. Check with local regulations.

# LOCATION OF THE IMPORTANT LABELS

Please read the following labels carefully before operating this watercraft.

## GS Models



F06L0RM

TYPICAL



**XP Models**



**TYPICAL**

**GTS Models**

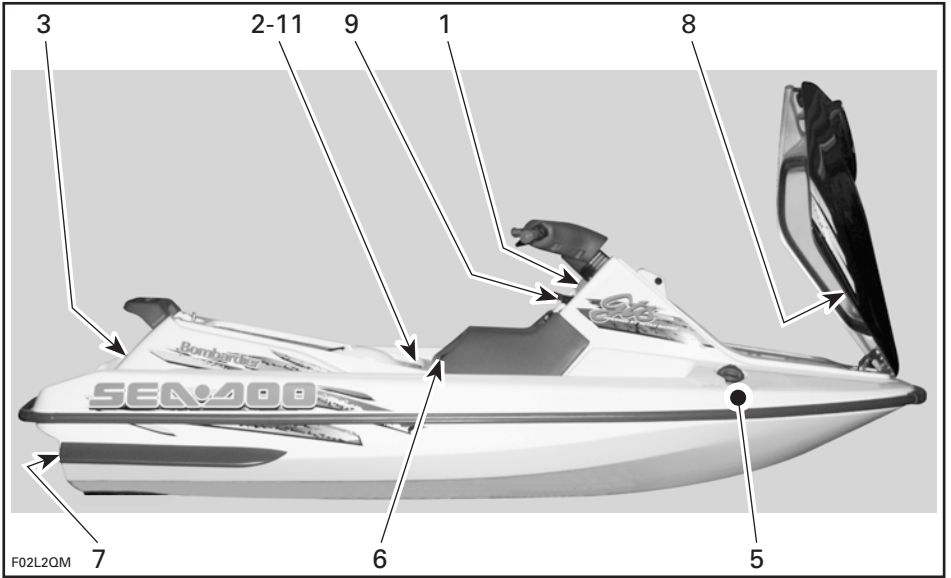

**TYPICAL**

**GTI/GTX and GTX RFI Models**

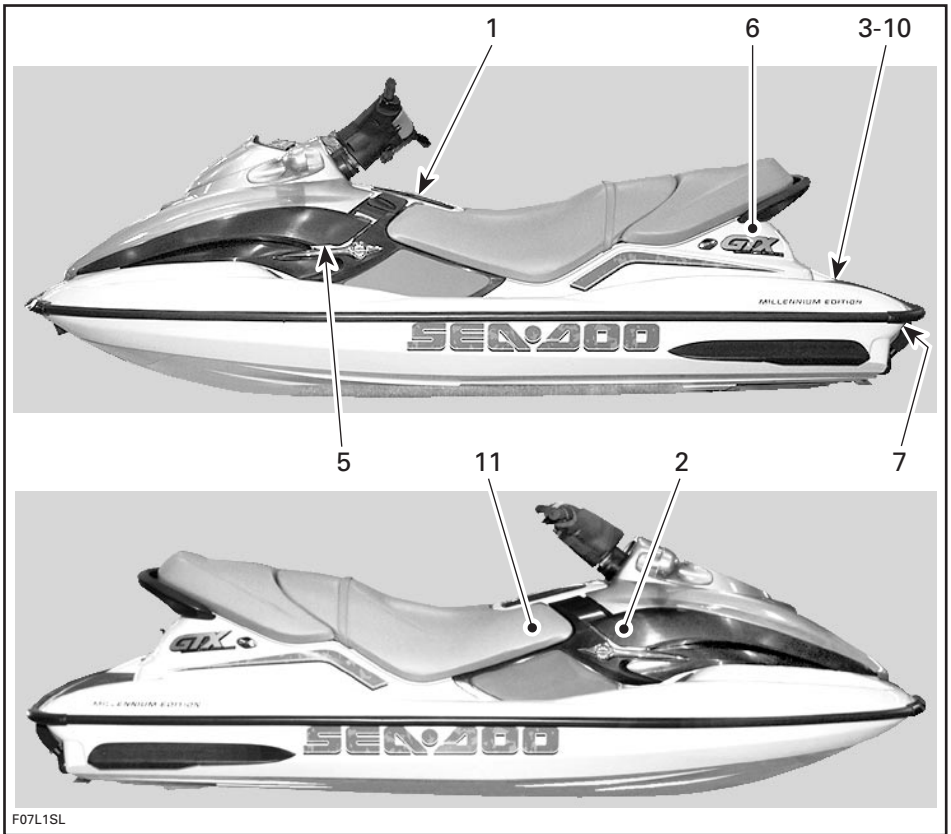

F07L1SL

**TYPICAL**

## Label 1

### ▲ WARNING

**Read all warning labels, Operator Guide & safety documents before operating.  
Severe injury or death can result from ignoring such information or improper use of the watercraft.**

- Check throttle & steering operation before starting engine.
- Directional control is reduced when throttle is released and lost when engine is off.
- Do not splash others or jump waves or wakes with this watercraft.
- Properly attach safety tether to your PFD.
- Keep a safe distance from other water users. Observe boating regulations.
- This watercraft is not designed for night-time operation.
- Seating is limited to one operator and two passengers (xxx lbs./xxx kg.).

F00A10L

ALL MODELS EXCEPT XP

## Label 2

### ▲ WARNING

Read all warning labels, Operator Guide & safety documents before operating. Severe injury or death can result from ignoring such information or improper use of the watercraft.

- Check throttle & steering before starting engine.
- Directional control is reduced when throttle is released and lost when engine off.
- Do not splash other or jump waves or wakes.
- Properly attach safety tether to your PFD.
- Keep a safe distance from other water users. Observe boating regulations.
- This watercraft is not design for night time operation.
- Seating is limited to one operator and one passenger (xxx lbs./xxx kg.).

- Gasoline vapors may cause fires or explosions.
- Do not overfill fuel tank.
- Keep the craft away from open flames and sparks.
- Do not start craft if liquid gasoline or vapors are present.
- Always replace engine cover before starting.

F08L1NL

XP MODELS

## Label 3

### ▼ CAUTION

USE BOMBARDIER-ROTAX INJECTION OIL OR HIGHER QUALITY LOW ASH API TC INJECTION OIL FOR 2 CYCLES ENGINES.

NEVER USE NMMA TC-W, TC-WII or TC-W3 outboard motor oils.

F00L060

GS, GTS AND GTI MODELS

## Label 5

**"THIS BOAT IS NOT REQUIRED TO COMPLY WITH THE FOLLOWING U.S. COAST GUARD SAFETY STANDARDS IN EFFECT ON THE DATE OF CERTIFICATION:**

- Fuel System
- Display of Capacity Information
- Safe Loading
- Flotation
- Powered Ventilation

**AS AUTHORIZED BY U.S. COAST GUARD GRANT OF EXEMPTION (CGB 88-001)."**

Bombardier Corp.

7575 Bombardier Court, Wausau, WI 54401

Made in Canada/Fabriqu  au Canada

Bombardier Inc. Rd./Enr.,1988

F02L2D0

## Label 4

### ▼ CAUTION

USE BOMBARDIER-ROTAX SYNTHETIC TWO-STROKE OIL OR EQUIVALENT HIGH QUALITY SYNTHETIC OIL.

Use of any other oil during the warranty coverage period will void the limited warranty.

Never use NMMA TC-W, TC-WII or TC-W3 outboard motor oils.

F01L9EY

XP, GTX AND RFI MODELS

## Label 6

**TO CLOSE / POUR FERMER**

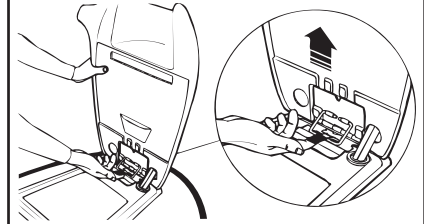

F06A03Z

### Label 7

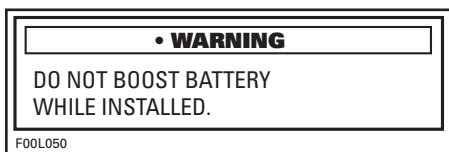

### Label 8

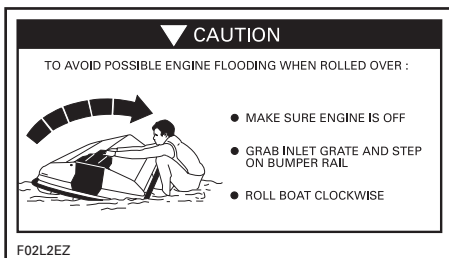

GS, GTS AND GTI MODELS

### Label 9

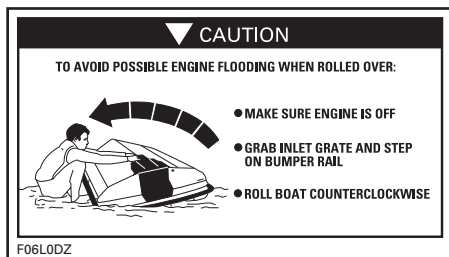

XP, GTX AND RFI MODELS

### Label 10

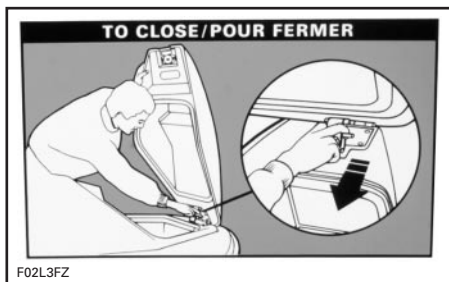

GTS MODELS

### Label 11



GTS MODELS

### Label 12

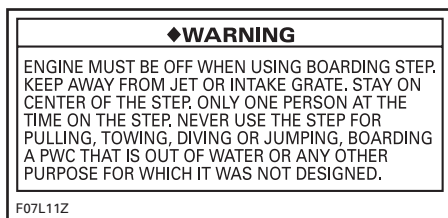

### Label 13

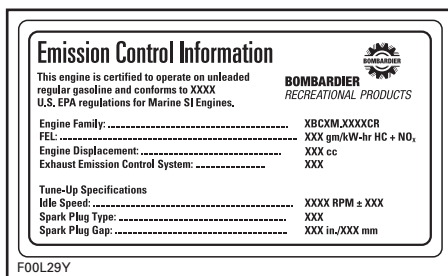

# IDENTIFICATION NUMBERS

The main components of the watercraft (engine and hull) are identified by different serial numbers. It may sometimes become necessary to locate these numbers for warranty purposes or to trace the watercraft in the event of theft.

## Hull

### GTS Models

The Hull Identification Number (H.I.N.) is located at right hand rear side of hull.

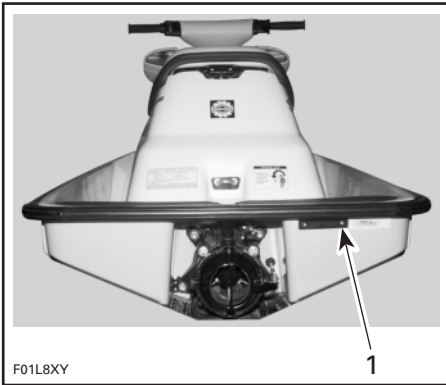

1. Hull Identification Number (H.I.N.)

### Other Models

The Hull Identification Number (H.I.N.) is located on footboard at the rear of watercraft.

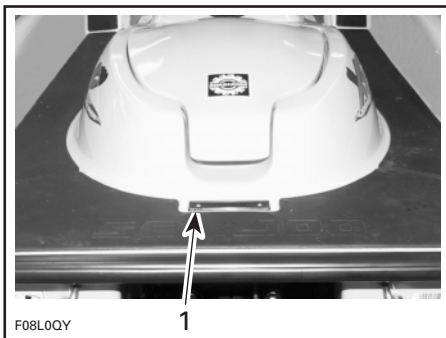

1. Hull Identification Number (H.I.N.)

It is composed of 12 digits:

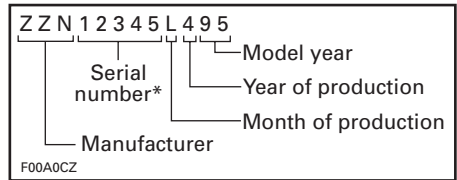

\*A letter may also be used as a digit.

## Engine

### 717 Engine

The Engine Identification Number (E.I.N.) is located on the upper side of the magneto housing.

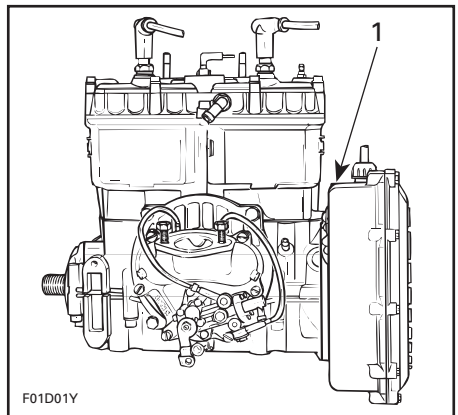

### TYPICAL

1. Engine Identification Number (E.I.N.)

### **787 Engine**

The Engine Identification Number (E.I.N.) is located on the upper crankcase on PTO (Power Take-Off) side.

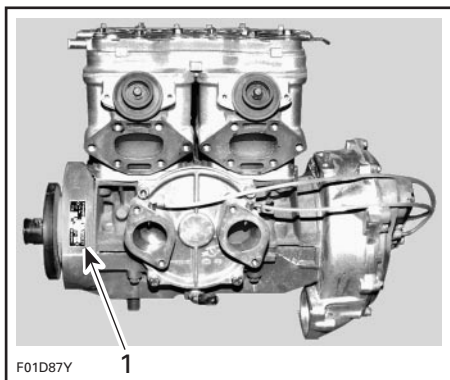

1. Engine Identification Number (E.I.N.)

### **947 Engine**

The Engine Identification Number (E.I.N.) is located on the upper crankcase on MAGNETO side.

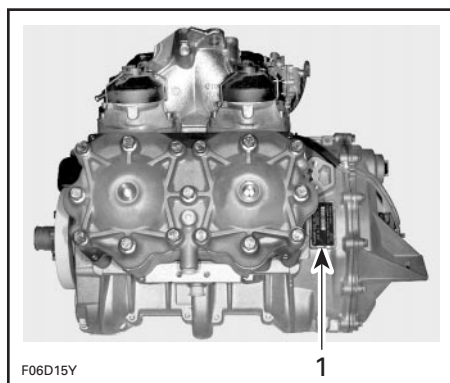

1. Engine Identification Number (E.I.N.)



# CONTROLS AND COMPONENT LOCATION

NOTE: Some components do not apply or are optional on some models.

## GS Models

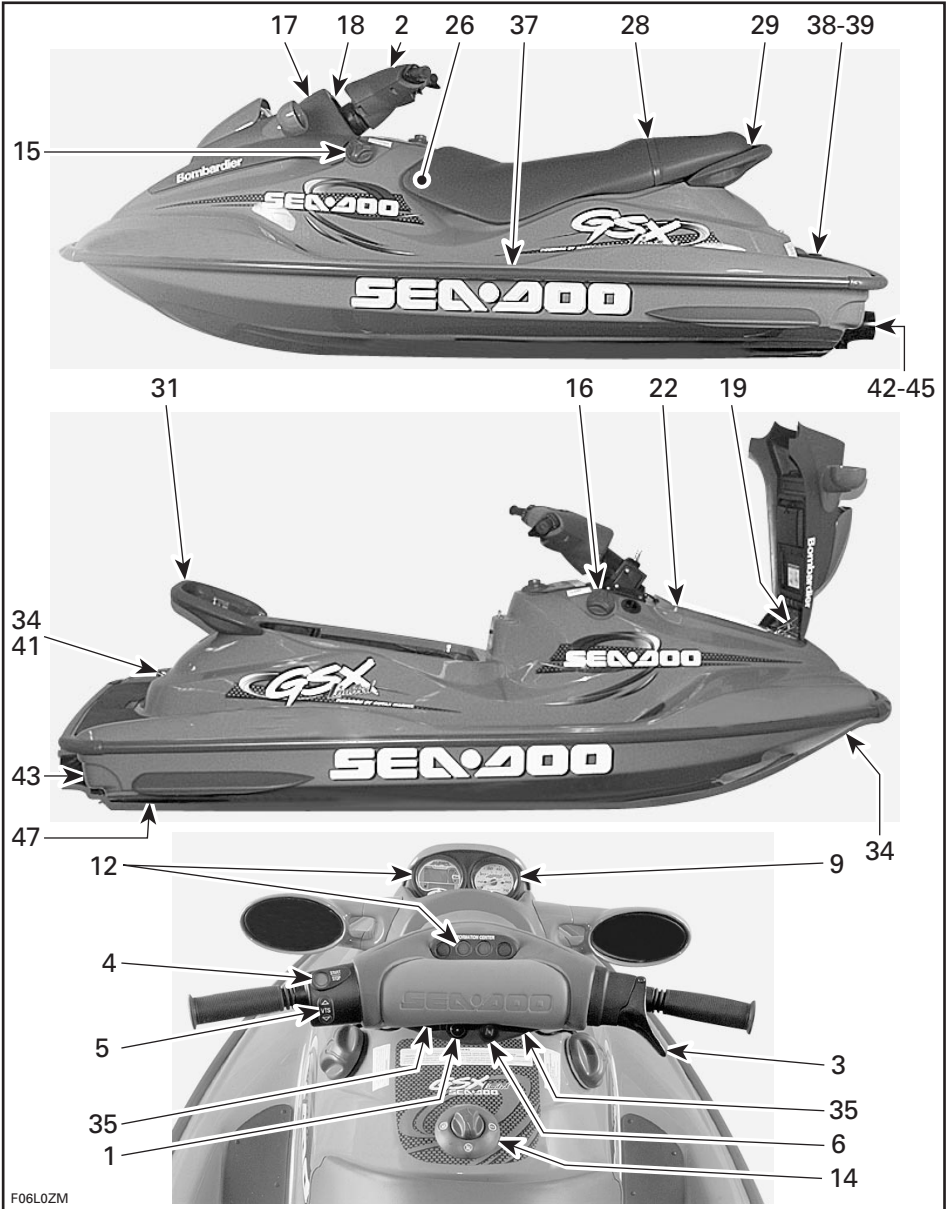

F06LOZM

TYPICAL

**XP Models**

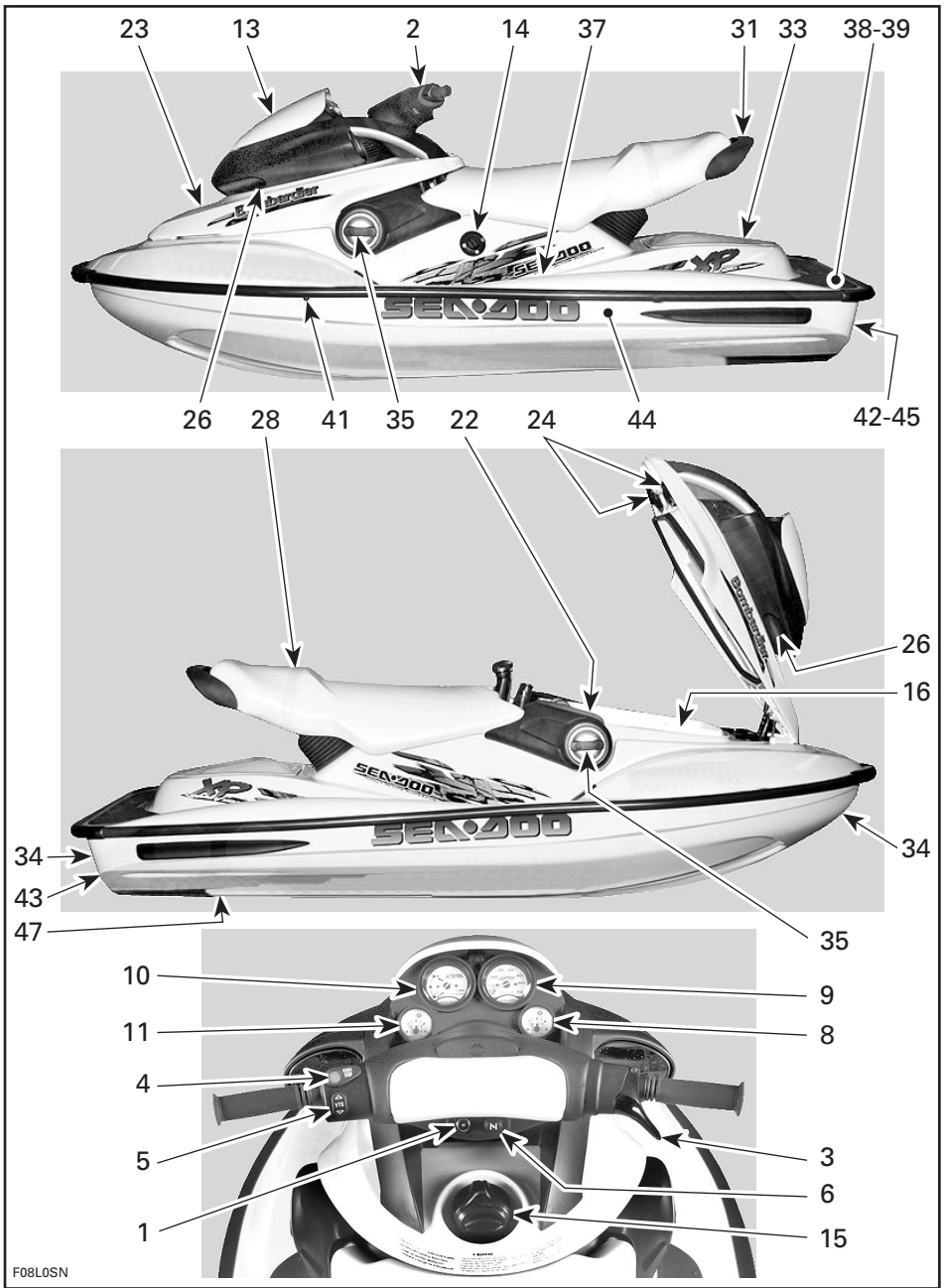

F08LOS N

**TYPICAL**

**GTS Models**

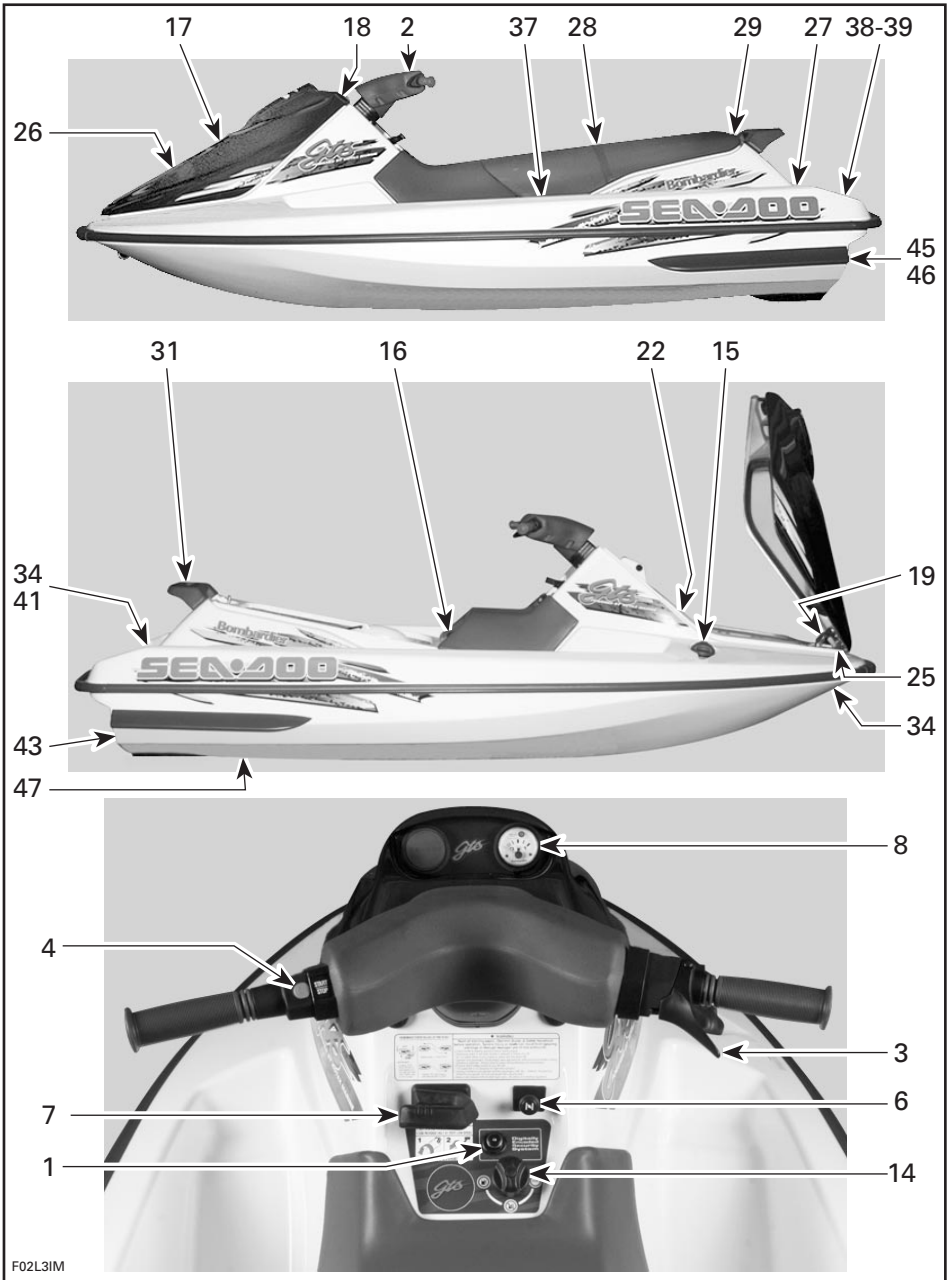

F02L31M

TYPICAL

**GTI, GTX and GTX RFI Models**

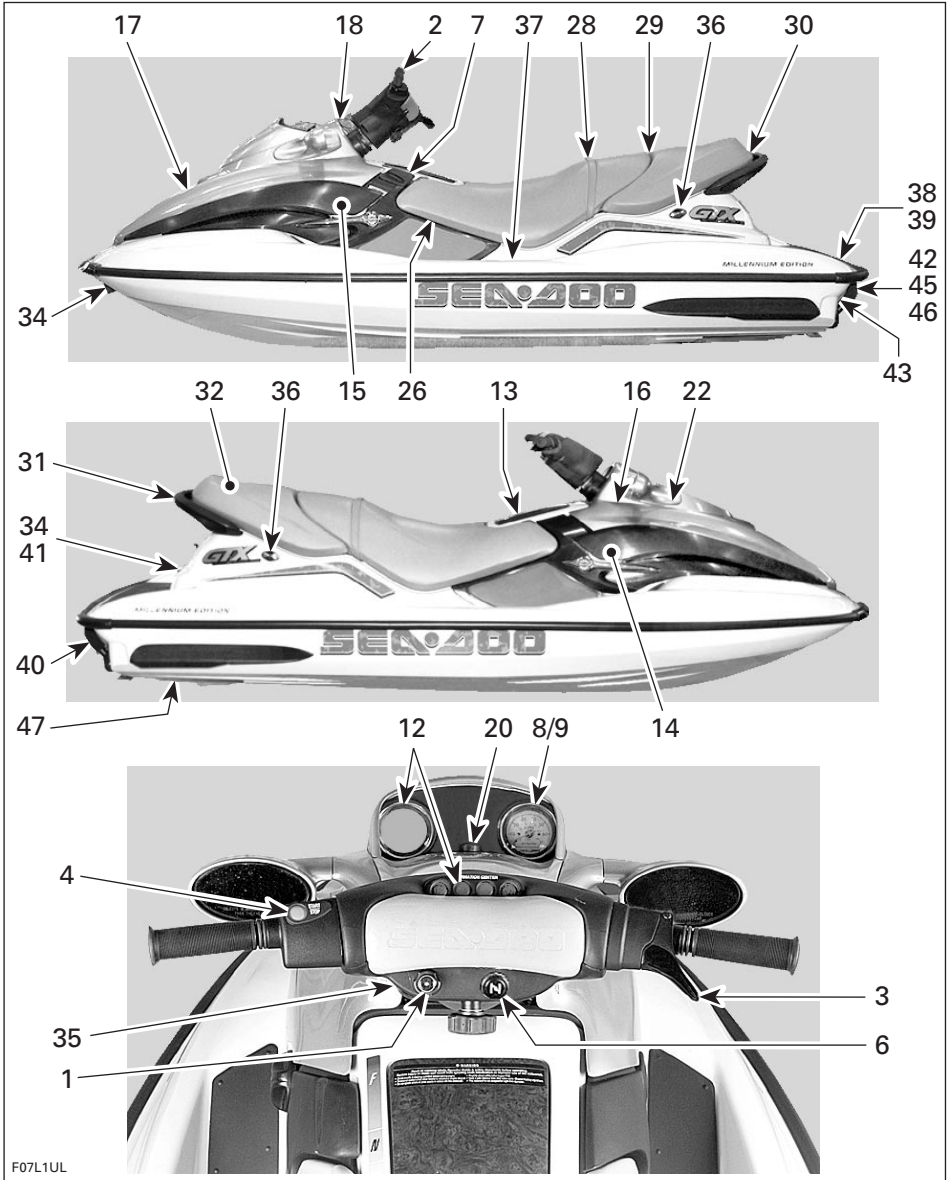

F07L1UL

TYPICAL

1. Safety Lanyard
2. Handlebar
3. Throttle Lever
4. Engine Start/Stop Button
5. Variable Trim System (VTS) Button
6. Choke Lever
7. Shift Lever
8. Fuel Gauge/Low Oil Warning Light
9. Speedometer
10. Tachometer
11. Variable Trim System (VTS) Gauge
12. Info Center Gauge/Buttons
13. Glove Box
14. Fuel Tank Valve
15. Fuel Tank Cap
16. Oil Injection Reservoir Cap
17. Front Storage Compartment Cover
18. Front Storage Compartment Cover Latch
19. Front Storage Compartment Cover Hinge/Locking Mechanism
20. Front Storage Compartment Cover Lock
21. Tool Kit
22. Storage Compartment/Engine Cover
23. Storage Compartment/Engine Cover Latches
24. Water Tank Trap Drains
25. Air Intake Opening
26. Rear Vent Grills
27. Seat Strap
28. Seat Latch
29. Rear Seat Latch
30. Rear Grab Handle
31. Rear Storage Basket
32. Rear Access Cover
33. Bow and Stern Eyelets
34. Mooring Cleats
35. Cargo Cleats
36. Footboard
37. Boarding Pads
38. Boarding Platform
39. Boarding Step
40. Cooling System Bleed Outlet
41. Flushing Connector
42. Bilge Drain Plug(s)
43. Automatic Bilge Pump
44. Jet Pump Nozzle
45. Reverse Gate
46. Jet Pump Water Intake

# COMPONENTS FUNCTIONS

## 1) Safety Lanyard

The safety lanyard cap must be securely snapped onto its switch to be fully operational.

Pulling the safety lanyard cap from the switch stops the engine operation. Attach the safety lanyard to the operator's Personal Flotation Device (PFD) and snap the cap to the switch to be able to start the engine.

### WARNING

Should the safety lanyard cap become loose or fail to remain on its switch, replace it immediately.

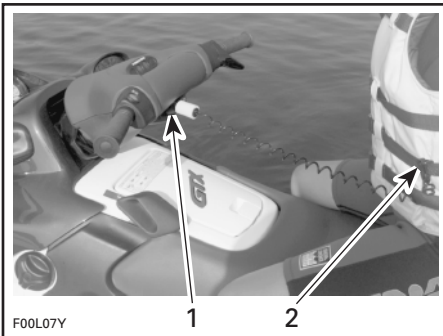

1. Safety lanyard cap on the switch
2. Safety lanyard secured on operator's PFD

### WARNING

Should the engine be stopped, watercraft directional control is lost. Always disconnect safety lanyard when leaving watercraft.

### WARNING

Do not lubricate the safety lanyard post.

## Digitally Encoded Security System (DESS)

The safety lanyard cap specifically contains an electronic circuit that gives it a unique electronic serial number.

This safety lanyard cannot be used on another watercraft and conversely, the one from another watercraft cannot be used on your watercraft.

However, the DESS brings a great flexibility. You can buy additional safety lanyard and have it programmed for your watercraft. To have additional safety lanyard programmed, refer to an authorized Sea-Doo dealer.

If the engine is stopped with the start/stop button while the safety lanyard remains on the switch, it can be restarted within approximately 10 minutes by pressing the engine start/stop button. After this delay, it is necessary to apply a slight pressure or the removal and re-installation of the safety lanyard on the switch to allow engine starting. Two short beeps should sound indicating the system is ready again to allow engine starting.

### WARNING

While engine can be stopped using the engine start/stop button, good habits recommend that the safety lanyard also be disconnected when stopping.

## Monitoring System

To assist you when using the watercraft, a system monitors some component of the watercraft and sends audible signals through a beeper to inform you of a particular condition. Refer to the TROUBLESHOOTING section for the coded signals chart.

## 2) Handlebar

The handlebar controls the direction of the watercraft. Turning the handlebar to the right steers the watercraft to the right and inversely.

### **WARNING**

Check handlebar and corresponding steering nozzle operation before starting.

### **Adjustment (if so equipped)**

The handlebar height can be adjusted to suit rider preferences.

To perform this adjustment, turn the knob underneath the handlebar.

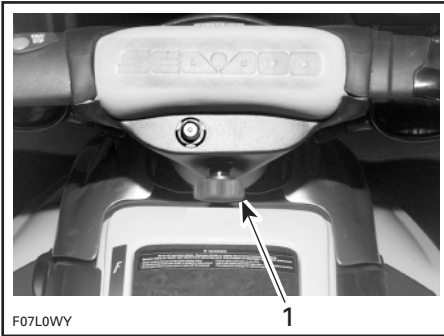

TYPICAL

1. Adjustment knob

## 3) Throttle Lever

When squeezed, watercraft accelerates. When fully released, engine automatically returns to idle speed and watercraft is gradually stopped by water drag.

### **WARNING**

Check throttle lever operation before starting the engine.

Do not depress lever unnecessarily when engine is not running. A fuel accelerator pump delivers fuel to the engine each time throttle lever is applied (except RFI models).

**CAUTION:** Engine can be flooded if throttle lever is applied several times. If engine is flooded, it will not start.

## 4) Engine Start/Stop Button

To start engine, depress and hold the button. Release immediately after engine is started.

To stop engine, fully release throttle lever then depress the button and disconnect safety lanyard from the switch.

### **WARNING**

Directional control is lost when engine is stopped.

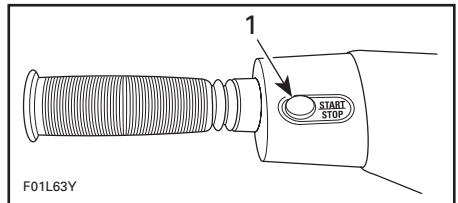

1. Engine start/stop button

With the Digitally Encoded Security System, leaving the safety lanyard for more than 10 minutes after stopping the engine will require a slight pressure or the removal and reinstallation of the safety lanyard on the switch to allow engine starting.



## 5) Variable Trim System Button (VTS) (if so equipped)

Located just below engine start/stop button, this button is used to change pump nozzle position and to adjust ride to suit watercraft load and water conditions.

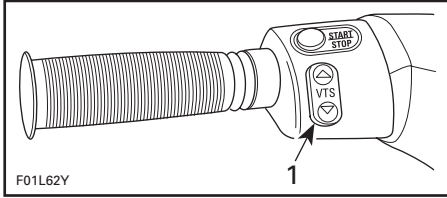

1. VTS button

## 6) Choke Lever

### Carburetor-Equipped Models

The choke is provided to supply a richer fuel/air mixture when starting a cold engine.

Choke lever should be pulled and held to operate. Lever will automatically return to its normal position when released.

## 7) Shift Lever (if so equipped)

A 3-position lever:

- forward
- neutral
- reverse

## **⚠ WARNING**

Shift lever should only be used when the engine is idling and watercraft is completely stopped. Only use reverse at slow speed and for the shortest time possible. Always ensure the path behind is clear of obstacles, swimmers and children playing in shallow water.

**CAUTION:** Never rev the engine at high RPM in reverse.

## GTS Models

When pushed in, the watercraft is in forward. To obtain neutral, unlock lever by turning it counterclockwise, then pull lever until neutral mark appears on rod. To engage reverse, repeat same procedure as for neutral, but pull lever until reverse mark appears on rod. Lever locks in forward and in neutral positions only.

## 8) Fuel Gauge/Low Oil Warning Light (if so equipped)

Analog gauge indicates the amount of fuel in the fuel tank and a warning light when level is low in oil reservoir.

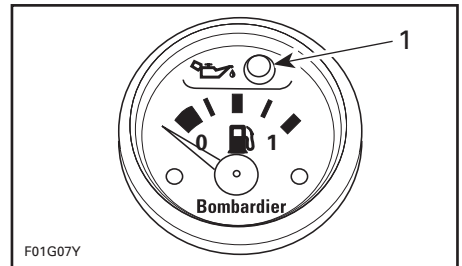

1. Low oil warning light

**NOTE:** With the safety lanyard disconnected, electrical system can be activated for approximately 33 seconds by depressing the engine start/stop button.

## 9) Speedometer (if so equipped)

Analog speedometer indicates the speed of watercraft in miles per hour (MPH) and kilometers per hour (km/h).

The speed sensor mounted on the ride plate sends the signal to the speedometer (and info center if so equipped).

## 10) Tachometer (if so equipped)

An analog tachometer indicates the revolutions per minute (RPM) of the engine. Multiply by 1000 to obtain the actual revolutions.

## 11) Variable Trim System (VTS) Gauge (if so equipped)

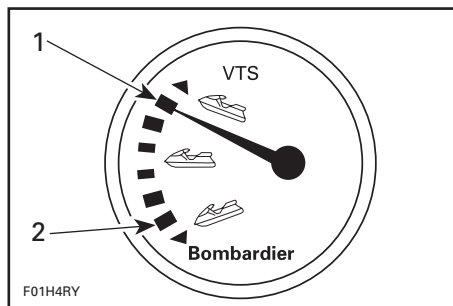

*TYPICAL*

1. Bow up
2. Bow down

The VTS gauge shows the riding angle of the watercraft.

## 12) Info Center Gauge/ Buttons (if so equipped)

This is a LCD (Liquid Crystal Display) multifunction gauge.

The MODE button is used to change display functions.

The SET button is used to set or reset a function.

It features the following functions:

### **GSX RFI Models**

- clock
- tachometer
- speedometer
- peak speed
- average speed
- trip meter
- engine hourmeter

- water temperature
- chronometer
- VTS (if so equipped)
- fuel level
- low fuel
- low oil
- low voltage
- overheating
- maintenance information

### **GTX and GTX RFI Models**

The info center includes the same functions as above and features the following additional ones.

- clock/compass
- exterior temperature

### **Multifunction Gauge Operation**

#### **Display Priorities**

The clock/compass function is the basic mode of the Info Center gauge. **Use the compass as a guide only. Not to be used for navigation purposes.**

The chronometer, tachometer and speedometer are the only other modes that may be chosen to replace the clock/compass mode.

If another mode is chosen, the clock/compass mode will be displayed again after 4 seconds.

The Info Center also features a red warning LED (Light-Emitting Diode) which blinks whenever one of the following circumstances occur: engine overheating, low fuel, low oil and low voltage.

For example, if the fuel level is low, the LED and the message LOW FUEL will blink.

As a self test, all LCD segments and the LED will turn on for 3 seconds each time the watercraft is started.

In the event of a warning message such as low fuel, hi-temp, etc., the message will blink and override all other display functions.

If more than one warning message occurs, the messages will blink and reappear every 4 seconds.

### Scrolling Functions

Press the MODE button until the desired function is displayed on the Info Center gauge.

### Reset a Function

To reset a function such as the chronometer, peak speed, distance, etc., press and hold the SET button for 2 seconds while in the appropriate mode.

### Language Option

While in the clock/compass mode, press and hold the SET button for at least 2 seconds. Language option will be displayed.

Press the MODE button to scroll language (English, French and Spanish).

Press the SET button to confirm the desired language and return to the clock/compass mode.

### English/Metric Option

Press and hold both MODE and SET buttons for at least 2 seconds. The system will be automatically changed.

### Chronometer

While in the chronometer mode, press the SET button to start and stop the chronometer.

Press the SET button for 2 seconds to reset the chronometer.

### Clock Adjustment

While in the clock/compass mode, press and hold the MODE and SET buttons for 2 seconds.

Press the MODE button to adjust the hours and the SET button to adjust the minutes.

Press again on the MODE and SET buttons to return to the normal mode (or it will return to the normal mode after 10 seconds).

### Maintenance Information

When the watercraft is due for a maintenance inspection, the message MAINT will blink.

To clear the warning message, press the SET button for 2 seconds during the message blinking.

## 13) Glove Box (if so equipped)

A small, convenient watertight storage compartment for gloves, keys, wallet, maps, etc.

## 14) Fuel Tank Valve *Carburetor-Equipped Models*

A 3-position rotating valve: OFF, ON and RESERVE:

OFF: Stop fuel supply to carburetor(s).

**CAUTION:** Turn valve to OFF position when watercraft is not operated.

ON: Allows fuel to flow to carburetor(s). This is the normal position for operation of watercraft.

**CAUTION:** Improper opening of fuel valve may restrict flow of fuel and may lead to engine damage. Make sure valve is fully opened while running.

RES: Use when the watercraft has run out of fuel in the ON position.

Always refill the fuel tank at the first opportunity. After refueling, turn the fuel tank valve to the ON position to continue operation.

## 15) Fuel Tank Cap

### *GTI, GTX and GTX RFI Models*

Open the front storage compartment cover to expose fuel tank cap.

### *All Models*

Unscrew the cap counterclockwise. After fueling, reinstall cap and fully tighten.

### **WARNING**

Never use a lit match or open flame to check fuel level.

## 16) Oil Injection Reservoir Cap

To add injection oil in the reservoir, unscrew the cap counterclockwise. Do not overfill. Reinstall cap and fully tighten it.

### *GTS Models*

Remove seat to expose reservoir cap. Pull cap to expose the dipstick.



1. Dipstick

The dipstick indicates the amount of oil left in the reservoir. Oil level should be maintained between FULL and ADD marks. Before checking oil level, place the watercraft level, then wipe the dipstick and insert it in the reservoir neck. Do not screw cap. Remove dipstick and read the level.

### *GS and GSX RFI Models*

The reservoir cap is located on the right hand side of the watercraft.

### *XP Models*

Open engine cover and remove storage basket.

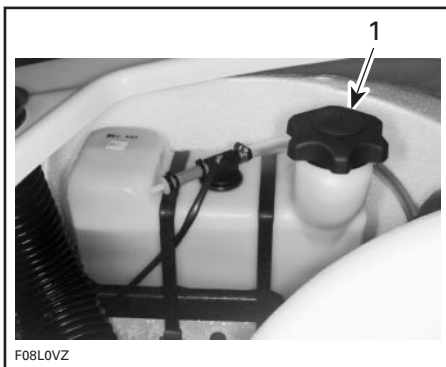

### *TYPICAL*

1. Oil injection reservoir cap

### *GTI, GTX and GTX RFI Models*

Open the front storage compartment cover to expose reservoir cap.

The reservoir cap is located on the right hand side of the watercraft.

## 17) Front Storage Compartment Cover

It gives access to the front storage compartment. Always relatch cover after closing.

### **Front Storage Compartment**

A convenient watertight, removable basket to carry personal articles. Ideal location for spare spark plugs, tow-ropes, first aid kit, etc.

### **WARNING**

Never leave any heavy or breakable objects in the storage basket. Never store or carry anything below basket. Never operate the craft with the storage compartment cover open.

### All Models Except XP

The basket is provided with a holder to store an approved fire extinguisher. Fire extinguisher (sold separately) should not be loose in the front storage compartment. A second holder contains the *Operator's Guide*, *Safety Handbook* and a tool kit. It can be used to carry personal articles.

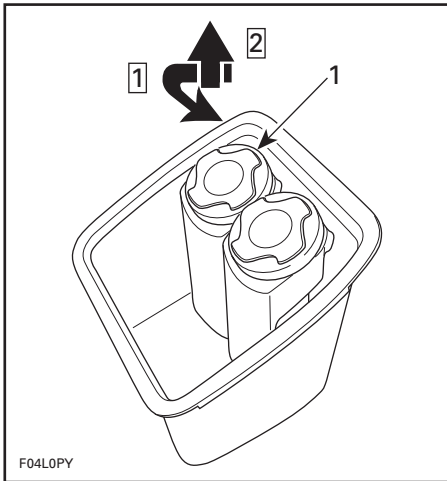

#### TYPICAL

Step 1: Turn cover counterclockwise

Step 2: Lift

1. Holder

### XP Models

The basket is provided with separate compartments.

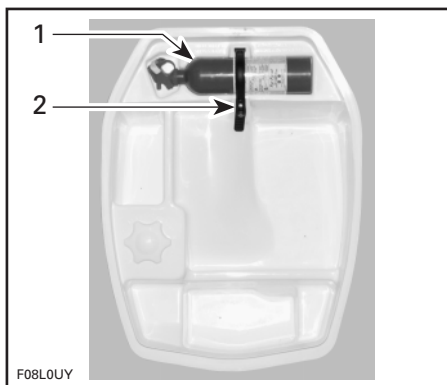

1. Fire extinguisher (sold separately)

2. Retaining strap

### 18) Front Storage Compartment Cover Latch

Pull the latch lever upward in order to open the front storage compartment cover. Always relatch.

**NOTE:** Verify periodically the lock pin tightness of storage cover. Tighten if needed and make sure storage cover latches properly.

### 19) Front Storage Compartment Cover Hinge/Locking Mechanism

#### GS and GSX RFI Models

Hinge is provided with a locking mechanism to hold front storage compartment cover when fully open. To close cover, pull tab.

#### GTS Models

Hinge is provided with a locking mechanism to hold front storage compartment cover when fully open. To close cover, pull side pins.

### 20) Front Storage Compartment Cover Lock (if so equipped)

A convenient lock is provided to protect personal articles when the watercraft is unattended.

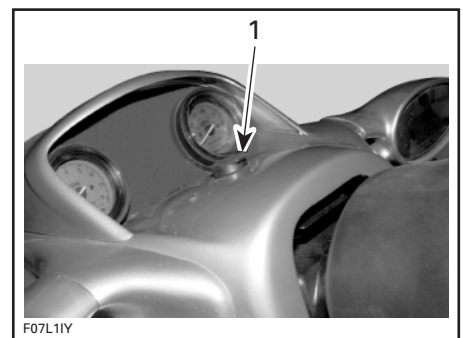

#### TYPICAL

1. Safety lock

To lock the front storage compartment cover, insert key and rotate it 1/2 turn.

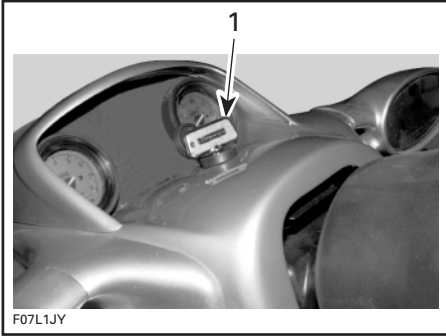

**TYPICAL**

1. Insert key and rotate it 1/2 turn to lock cover

To unlock the front storage compartment cover, turn key in the opposite direction.

## 21) Tool Kit

Contains tools needed to perform basic watercraft maintenance.

## 22) Storage Compartment/ Engine Cover (if so equipped)

It gives access to the storage compartment and engine compartment.

### Storage Compartment

A convenient watertight, removable basket to carry personal articles. Ideal location for spare spark plugs, tow-rope, first aid kit, etc.

### WARNING

Never leave any heavy or breakable objects in the storage basket. Never store or carry anything below basket. Never operate the craft with the storage compartment cover open.

## Engine Compartment

This is where the mechanical, electrical and fuel/oil systems are located.

### WARNING

When starting or operating the engine, do not touch any electrical part. Never leave any object, rag, tool, etc., in the engine compartment or in the bilge.

Always relatch cover after closing.

## 23) Storage Compartment/ Engine Cover Latches (if so equipped)

Pull both latch levers upward in order to open the engine cover. Always relatch engine cover on both sides.

**NOTE:** Verify periodically the lock pins tightness. Tighten if needed and make sure engine cover latches properly.

## 24) Water Tank Trap Drains (if so equipped)

If water enters the air intake opening, a water tank trap with a baffle separates water from the air then evacuates the water through the front of storage cover.

**CAUTION:** Unusual maneuvers such as circles with the nose of the watercraft under water will fill the bilge.

## 25) Air Intake Opening

This is where air enters to supply the engine and ventilate the engine compartment. If the air intake opening is kept under water for a long period, water will get inside bilge.

**CAUTION:** If the air intake opening is kept under water for a long period, such as turning constantly in tight circles, water will get inside bilge, which may cause severe damage to internal parts of the engine.

## 26) Rear Vent Grills (if so equipped)

Allows air to get in or out depending on engine operation.

**CAUTION:** If grills are kept below water level for a long period (e.g.: when boarding 2 passengers) water will enter the bilge.

## 27) Seat Strap

The seat strap provides a handhold to assist boarding and is used as a handhold for the passenger.

## 28) Seat Latch

Removing the seat allows access to the engine compartment and to oil reservoir cap/dipstick.

The seat latch is located at the rear end and underneath the seat.

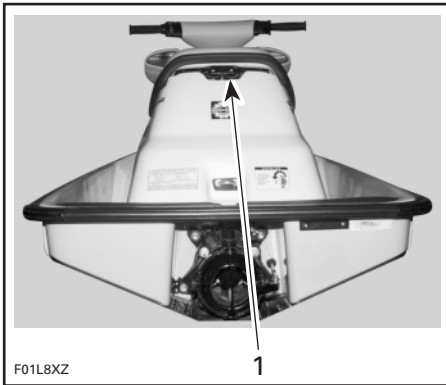

**TYPICAL**

1. Seat latch

To remove seat, pull the latch lever upward and hold. Lift and pull the seat rearward.

**NOTE:** On the GTI, GTX and GTX RFI models, it is necessary to remove the rear seat first and repeat the same procedure to remove the front portion of the seat.

## Engine Compartment

This is where the mechanical, electrical and fuel/oil systems are located.

### **WARNING**

When starting or operating the engine, do not touch any electrical part. Never leave any object, rag, tool, etc., in the engine compartment or in the bilge.

When reinstalling the seat, insert seat front tab into body hook (for each portion of the seat on the GTI, GTX and GTX RFI models).

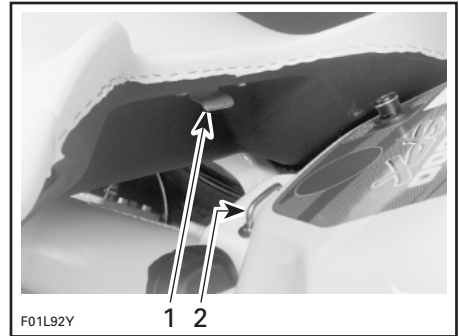

**GTX MODELS**

1. Insert this tab in hook
2. Hook

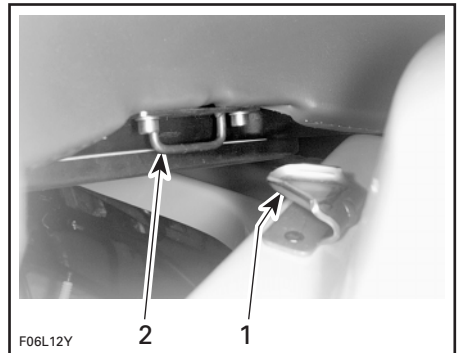

**ALL MODELS EXCEPT GTX**

1. Insert this tab in hook
2. Hook

Pull latch lever to insert it over the rear lock pin. Release latch lever then firmly push on rear of the seat to relatch.

## **⚠ WARNING**

Periodically verify the seat lock pin and tighten if needed. Make sure seat is securely latched.

### **29) Rear Seat Latch (if so equipped)**

Removing the rear seat allows access to the rear storage basket. It also gives access to the seat latch of the front seat on models with 2 seats.

### **30) Rear Grab Handle**

Provides a handhold for boarding when needed and a handhold for the passenger.

**CAUTION:** Never use the grab handle to tow anything or to lift the watercraft.

### **31) Rear Storage Basket (if so equipped)**

A convenient watertight, removable basket to carry personal articles.

### **32) Rear Access Cover (if so equipped)**

It gives access to the drive system, suspension, exhaust system and bailer pick-ups. Always relatch cover.

### **33) Bow and Stern Eyelets**

#### **Bow Eyelet**

Eyelets can be used for mooring, towing and as a tie-down point during trailering.

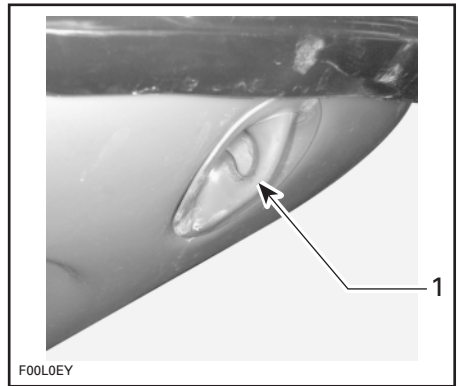

1. Bow eyelet

#### **Stern Eyelet**

This eyelet allows a rope with a hook, a closed end or an open end to be attached.

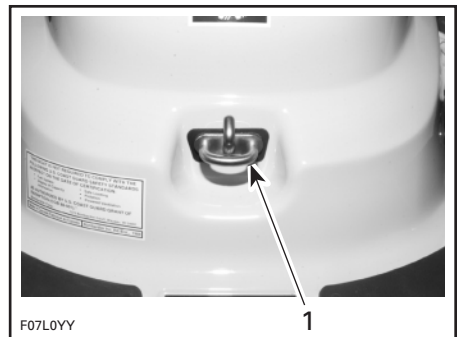

1. Stern eyelet

### **34) Mooring Cleats**

These cleats can be temporarily used for docking, while refueling for example.

**CAUTION:** Never use mooring cleats to pull or lift the watercraft.



## All Models Except XP

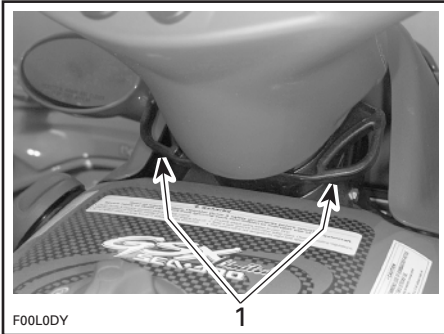

1. Mooring cleats

## XP Models

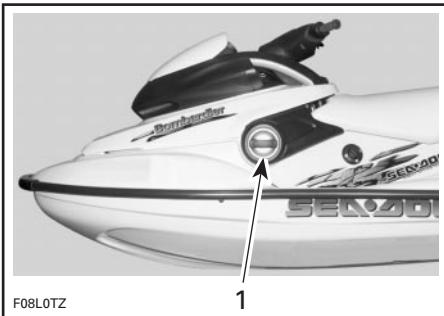

1. Mooring cleats

## 35) Cargo Cleats (if so equipped)

These cleats are provided for securing baggage.

**CAUTION:** Do not use the cleats as a tie-down point for trailering or mooring.

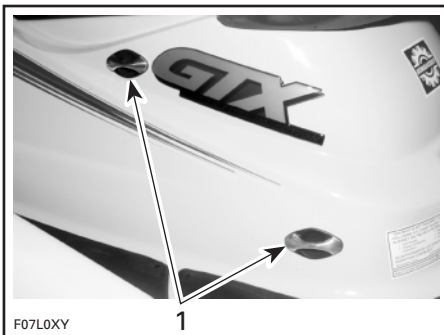

1. Cargo cleats (each side)

## 36) Footboard

User's feet should rest on the footboard when riding.

## 37) Boarding Pads

Provide a cushioned surface for the knees when boarding from rear of watercraft.

## 38) Boarding Platform

Provides a large surface for easier boarding from rear of watercraft.

## 39) Boarding Step (if so equipped)

A convenient step to help reboarding the watercraft.

### **⚠ WARNING**

Engine should be OFF when using boarding step. Keep limbs away from jet or intake grate. Stay on center of the step. Only one person at the time on the step. Never use the step for pulling, towing, diving or jumping, boarding a watercraft that is out of water or any other purpose other than a boarding step.

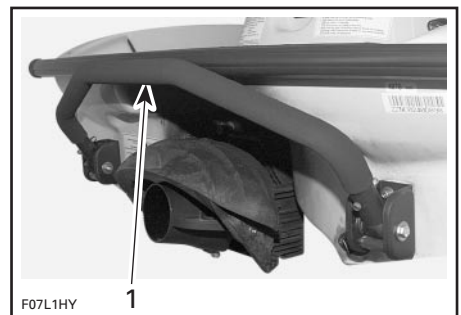

1. Boarding step

## 40) Cooling System Bleed Outlet

All Models Except XP

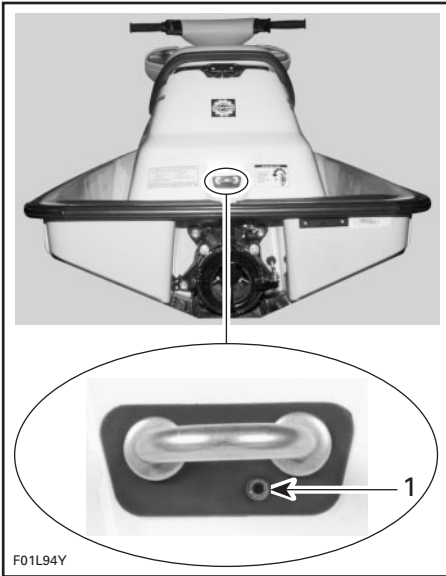

1. Bleed outlet

### XP Models

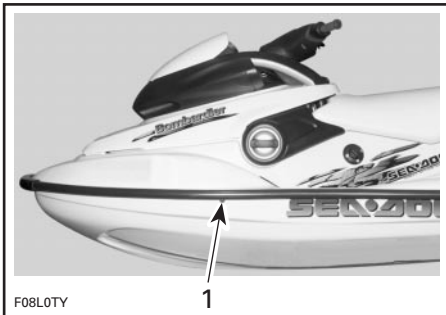

1. Bleed outlet

When engine is running, water should flow from the outlet. This allows air in engine cooling system to escape. It also indicates that water is circulating in the cooling system.

**NOTE:** It may be required to increase slightly the engine RPM to see the water flowing out.

**CAUTION:** Should water not flow from outlet a few seconds after engine starts, immediately stop engine and refer to POST-OPERATION CARE and look for cooling system flushing or refer to an authorized Sea-Doo dealer for servicing.

## 41) Flushing Connector (if so equipped)

A convenient connector is provided to allow easy installation of a garden hose to flush the cooling system.

Refer to POST-OPERATION CARE section for proper use.

## 42) Bilge Drain Plugs

Should water be found in the bilge, it can be easily drained by unscrewing the drain plugs.

**CAUTION:** Make sure drain plugs are properly secured prior to launching the watercraft in water.

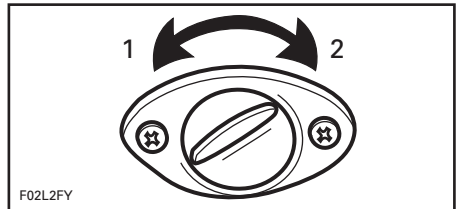

1. Unscrew
2. Tighten

Tilt the watercraft slightly to the rear so that the water can completely flow out of the bilge.

## 43) Automatic Bilge Pump (if so equipped)

Bilge pump evacuates water from the bilge.

When safety lanyard cap is plugged to the switch, bilge pump automatically turns on. It will remain on until all water is evacuated, if any, then it will shut down automatically.

When engine is running, bilge pump will automatically start periodically to evacuate water.

## 44) Jet Pump Nozzle

Jet pump nozzle turns side to side via rider input at the handlebar. This provides directional control when engine is running.

### **WARNING**

Never use nozzle as a supporting point to board the watercraft or to lift it.

## 45) Reverse Gate (if so equipped)

When selecting the neutral or reverse position with the shift lever, the reverse gate moves up or down to obtain the desired position.

### **WARNING**

Never use gate as a supporting point to board the watercraft. Do not reverse while at speed.

## 46) Jet Pump Water Intake

The water is drawn up by the impeller through this opening. The water intake grate minimizes the entry of foreign objects into the propulsion system.

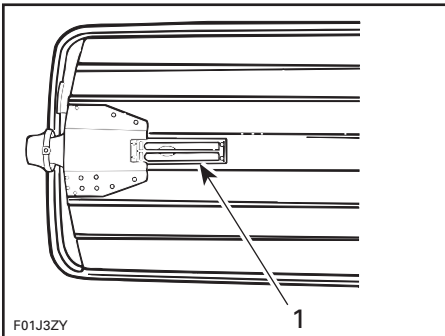

TYPICAL

1. Water intake

---

# FUEL AND LUBRICATION

## Fueling Procedure

### WARNING

Follow these safe boating fueling instructions explicitly.

Do not allow anyone to remain on the watercraft.

Tie watercraft securely to the fueling pier.

Have a fire extinguisher close at hand.

Do not insert the spout too far in filler neck.

Pour fuel slowly so that air can escape from the tank and prevent fuel flow-back.

Fill fuel tank to bottom of filler neck. Do not overfill. Fully tighten fuel tank cap.

### WARNING

The tank design makes provision for fuel expansion of about 5%. If this area is filled, fuel will expand and may come out through fuel vent. Always stop the engine before refueling. Fuel is inflammable and explosive under certain conditions. Always work in a well ventilated area. Do not smoke or allow open flames or sparks in the vicinity. Never top off the fuel tank and leave watercraft in the sun. As temperature increases, fuel expands and might overflow. Always wipe off any fuel spillage from the watercraft.

## Recommended Fuel

Use regular unleaded gasoline with 87 octane (Ron + Mon)/2 specification.

**NOTE:** Do not mix oil with fuel except at engine break-in. Refer to BREAK-IN PERIOD. Always check injection oil reservoir level when refueling.

**CAUTION:** Never experiment with other fuels or fuel ratios. Never use fuel containing more than 10% alcohol, (ethanol or methanol). The use of non-recommended fuel can result in watercraft performance deterioration and damage to critical parts in the fuel system and engine components.

## Recommended Oil

### **GS, GTS and GTI Models**

Use of BOMBARDIER-ROTAX injection oil (or the equivalent) available from an authorized Sea-Doo dealer.

It is a blend of specially selected base oils and additives which provides proper lubrication, engine cleanliness and minimum spark plug fouling.

**NOTE:** High quality low ash API TC injection oil for 2-stroke engines can be used if BOMBARDIER-ROTAX injection oil is not available.

**CAUTION:** Never use 4-stroke petroleum or synthetic motor oil and never mix these with outboard motor oil. Do not use NMMA TC-W, TC-W2 or TC-W3 outboard motor oils or other ashless type 2-stroke oil. Avoid mixing different brands of API TC oil as resulting chemical reaction may cause severe engine damage.

### **XP, GTX, and RFI Models**

Use BOMBARDIER-ROTAX Formula XP-S synthetic injection oil (or equivalent high quality synthetic oil) available from an authorized Sea-Doo dealer.

This fully synthetic oil provides outstanding lubrication and cleanliness, less friction and wear for greater engine performance and durability.

**CAUTION:** The 787 RFI and the 947 engine types require the use of BOMBARDIER-ROTAX Formula XP-S synthetic injection oil (or the equivalent high quality synthetic oil).

## Oil Injection System

This watercraft features an oil injection system which does not require manual fuel/oil mixing.

A sufficient amount of injection oil should be maintained in the reservoir.

**NOTE:** It is recommended to carry a 1 L of spare injection oil.

The use of a funnel is recommended to pour the oil into the reservoir. Stop filling as soon as oil appears at approximately 13 mm (1/2 in) from top of reservoir. Do not overfill.

**CAUTION:** Always maintain a sufficient amount of injection oil in the oil reservoir. Check and refill every time you refuel. Do not overfill. If the engine runs out of oil, severe engine damage will occur. If the oil reservoir is found almost empty, air can enter in the system and it should be bled. Immediately refer to an authorized Sea-Doo dealer to have the oil injection system inspected.

---

# BREAK-IN PERIOD

## Engine

With BOMBARDIER-ROTAX® watercraft engines, a break-in period is required before operating the engine at full throttle. We recommend a break-in of about 10 operating hours.

During this period, maximum throttle should not exceed 3/4, however, brief acceleration and speed variations contribute to a good break-in. Continued wide open throttle accelerations, prolonged cruising speeds and overloading the engine are detrimental during the break-in period.

To assure additional protection during the initial engine break-in, it is recommended to add 1 L of the same oil as in the injection oil reservoir in the fuel tank **for the first full fuel tank filling only**.

To add injection oil in the fuel tank, proceed as follows:

Fill fuel tank with approximately 15 liters (4 gal) of gasoline; then, add the injection oil in the fuel.

Fill up fuel tank with gasoline. Do not overfill.

**NOTE:** It is important to proceed in this order to allow a proper mixing of the oil in the gasoline. If oil is added first in an empty fuel tank, fuel lines will be filled up with injection oil leading in a no start condition of the engine.

**CAUTION:** Remove and clean spark plugs after engine break-in.

## 10-Hour Inspection

It is highly recommended that after the first 10 hours of operation, the watercraft be checked by an authorized Sea-Doo dealer. This inspection will also provide the opportunity to discuss the unanswered questions you may have encountered during the first hours of operation.

---

**The 10-hour inspection is at the expense of the watercraft owner.**

---

## DAILY PRE-OPERATION CHECKS

Some of the following items may not have been previously covered in this guide, however they will be described in the MAINTENANCE or SPECIAL PROCEDURES section. Please refer to these sections to have more detailed information.

### WARNING

Only start watercraft once all items have been checked and operate properly.

### WARNING

Safety lanyard should always be removed from its switch prior to verifying any of the following.

ITEM	OPERATION	✓
Hull	Inspect.	
Jet pump water intake	Inspect/clean.	
Bilge	Drain. Ensure plugs are secured.	
Battery	Inspect tightness of cables and retaining strap.	
Fuel tank and oil reservoir	Refill.	
Engine compartment	Verify for any fuel leak/odor.	
Steering system	Check operation.	
Throttle system	Check operation.	
Shifter system (if so equipped)	Check operation.	
VTS (if so equipped)	Check operation.	
Safety lanyard and engine start/stop button	Check operation.	
Storage compartment covers	Ensure they are closed and latched.	

## Hull

Inspect hull for cracks or damage.

## Jet Pump Water Intake

Remove weeds, shells, debris or anything else that could restrict the flow of water and damage cooling system or propulsion unit. Clean as necessary. If any obstruction can not be removed, refer to an authorized Sea-Doo dealer for servicing.

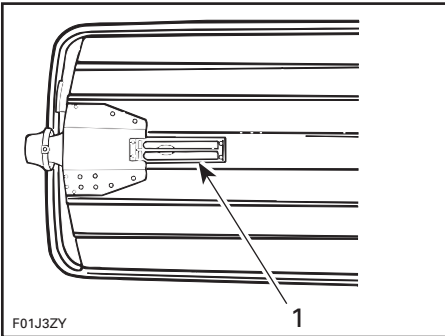

**TYPICAL**

1. Inspect this area

Inspect leading edges of the impeller, if they have nicks or bends performance will be greatly reduced.

## Bilge

Should water be present in the bilge, tilt the watercraft to the rear and unscrew drain plugs to completely empty the bilge.

Secure bilge drain plugs.

## Battery

### **WARNING**

Verify tightness of battery cables to their posts and condition of retaining straps/fasteners.

## Fuel Tank and Oil Reservoir

With the watercraft horizontal, fill the fuel tank to specified level.

Check the oil level and refill reservoir as necessary.

Check fuel tank and oil reservoir retaining straps/fasteners.

## Engine Compartment

### **WARNING**

Should any leak or gasoline odor be present, do not start the engine. Refer to an authorized Sea-Doo dealer before use.

## Steering System

Assisted by another person, check steering operation for free movement. When the handlebar is horizontal, the jet pump nozzle should be in the straight ahead position. Ensure the jet pump nozzle pivots easily when handlebar is turned.

## Throttle System

Check throttle lever for free and smooth operation. It should return to its initial position immediately after it is released.

**CAUTION:** Engine can be flooded if throttle lever is applied several times when engine is not running. If engine is flooded, it will not start.



## Shifter System (if so equipped)

Check reverse gate operation for free movement. With shift lever in forward position, the gate should be in upward position and locked. With the shift lever in neutral position, gate should be in middle position. With shift lever in reverse position, gate should be in downward position.

### **WARNING**

Verify the reverse gate locking operation before starting the engine.

## VTS (Variable Trim System) (if so equipped)

Push on arrows on VTS button to check nozzle movement.

**NOTE:** With the safety lanyard disconnected, electrical system can be activated for approximately 33 seconds by depressing the engine start/stop button.

## Safety Lanyard and Engine Start/Stop Button

If craft is equipped with shift lever, position lever in neutral. Ensure that both switches operate properly. Start engine and stop it using each switch individually.

### **WARNING**

If engine does not shut-off when pushing engine start/stop button or by disconnecting the safety lanyard, stop the engine by applying the choke and turning fuel tank valve (**if so equipped**) to OFF position. Do not operate the watercraft further, see an authorized Sea-Doo dealer.

## Storage Compartment Covers

Ensure they are closed and latched.

# OPERATING INSTRUCTIONS

## WARNING

Always perform the DAILY PRE-OPERATION CHECKS before operating the watercraft. Become thoroughly familiar with all controls and the function of each. Should any control or instruction not be fully understood, refer to an authorized Sea-Doo dealer.

## Principle of Operation

### Propulsion

The engine is directly coupled to a drive shaft which, in turn, rotates an impeller. This impeller is accurately adjusted in a housing where the water is drawn up from underneath the watercraft. Then the water flows through the impeller to a venturi. The venturi accelerates the water and produces thrust to move the watercraft. Depressing the throttle lever increases engine speed and therefore watercraft speed.

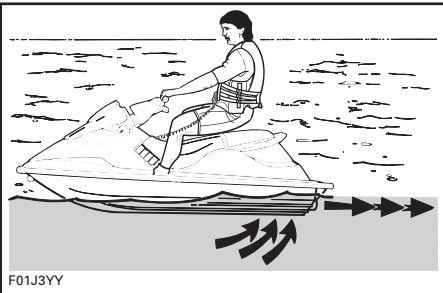

TYPICAL

## WARNING

Whenever the engine is to be started, the operator and passenger should always be sitting on the watercraft.

## Neutral and Reverse (if so equipped)

The shift lever should be in the forward position in order for the craft to advance.

To obtain neutral, pull shift lever halfway. The reverse gate will be in the middle position, directing half of the thrust toward the front of the craft to minimize watercraft movement.

## WARNING

When the watercraft is in neutral position, the drive shaft and impeller are turning.

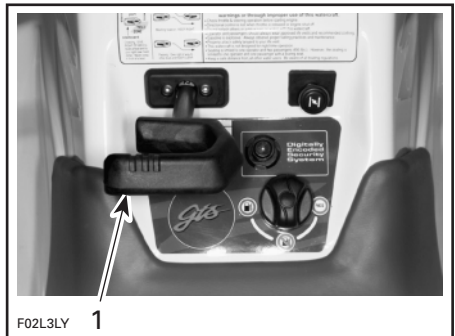

GTS MODELS

1. Shift lever in neutral position



GTI, GTX AND GTX RFI MODELS

1. Shift lever in neutral position

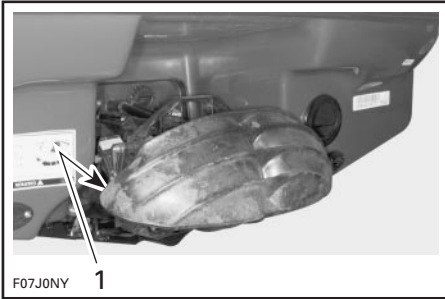

F07J0NY

**TYPICAL**  
1. Reverse gate in middle position

To obtain reverse, pull shift lever completely. The reverse gate will be in downward position, directing all the thrust toward the front of the watercraft.

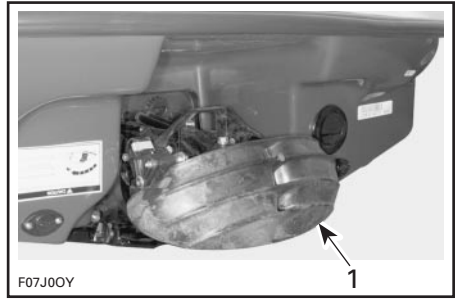

F07J0OY

**TYPICAL**  
1. Reverse gate in downward position

**NOTE:** To obtain maximum efficiency and control from the reverse, increase engine speed to slightly above idle. Too much RPM will create water turbulence and reduce reverse efficiency.

In reverse position, turn the handlebar in the opposite direction that you want to move the rear of the watercraft.

For example, to steer the rear of the watercraft to the left side, turn the handlebar to the right side.

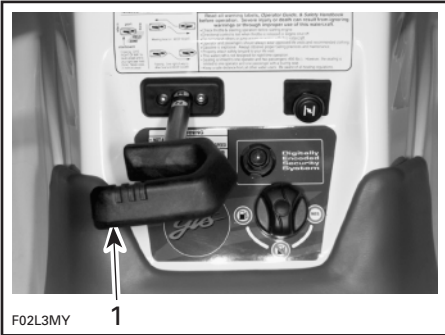

F02L3MY

**GTS MODELS**  
1. Shift lever in reverse position

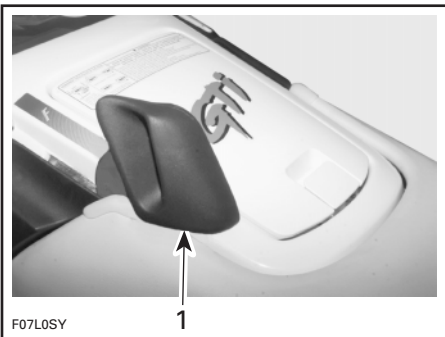

F07L0SY

**GTI, GTX AND GTX RFI MODELS**  
1. Shift lever in reverse position

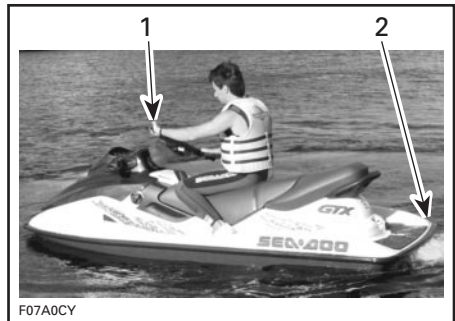

F07A0CY

1. Handlebar turned to the right side  
2. Rear of watercraft moving to the left side

**⚠ WARNING**

Shift lever should only be used when the engine is idling.

## Variable Trim System (if so equipped)

The variable trim system (VTS) changes the angle of the jet pump nozzle to provide the operator with a fast, effective system to compensate for load, thrust, riding position and water conditions. Correctly adjusted, it can improve handling, reduce porpoising, and position the watercraft at its best riding angle to attain maximum performance.

When first using the watercraft, the operator should become familiar with the use of the variable trim system (VTS) at varying speeds and water conditions. A mid-range trim is generally used when cruising. Experience alone will dictate the best trim for the conditions. During the watercraft break-in period, when lower speeds are recommended, it is an excellent opportunity to gain familiarity of trim adjustment and its effects.

When the nozzle is positioned in an upward angle, the water thrust directs the bow of the watercraft upward. This position is used to optimize high speed.

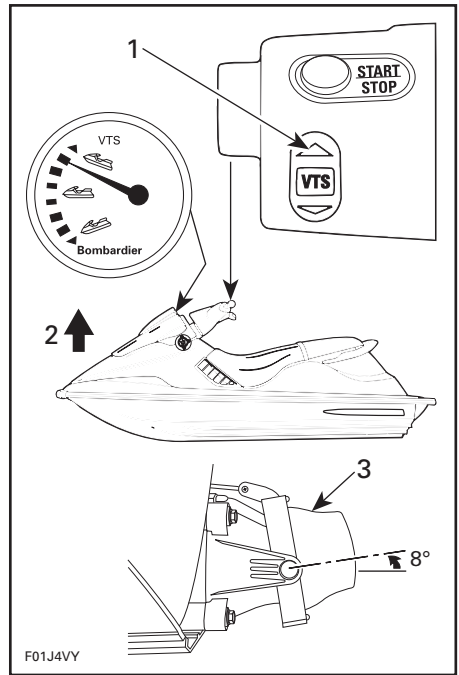

### TYPICAL

1. Push on arrow pointing upward on VTS button
2. Bow up
3. Nozzle up

**NOTE: Models equipped with an Info Center, VTS position is indicated on a bar graph.**

When the nozzle is directed downward, the bow is forced downward and enhances the watercraft turning capabilities. As with any watercraft, speed and operator body position and movement (body English), will determine the degree and sharpness of the watercraft turn. Porpoising can be reduced or eliminated if the nozzle is downward and speed is adjusted proportionately.

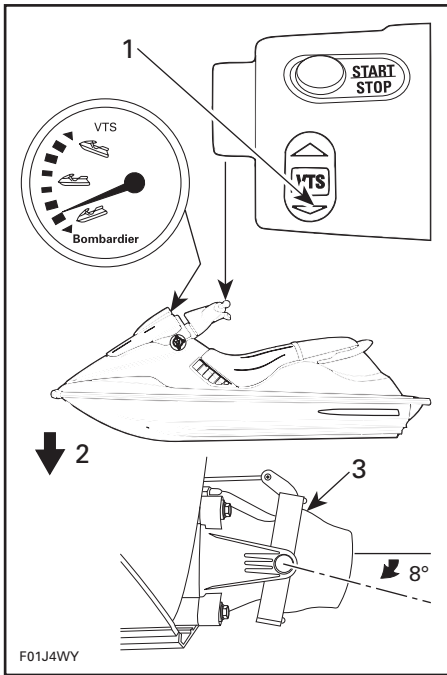

#### TYPICAL

1. Push on arrow pointing downward on VTS button
2. Bow down
3. Nozzle down

## Steering



Turning the handlebar pivots the jet pump nozzle which controls the watercraft direction. Turning the handlebar to the right will turn the watercraft to the right and inversely. The throttle should be applied to turn the watercraft.

### **⚠ WARNING**

Throttle should be applied and handlebar turned to change the direction of the watercraft. Steering efficiency will differ depending on the number of passengers, load and water conditions.

Unlike a car, a watercraft needs some throttle to turn. Practice in a safe area applying the throttle and turning away from an imaginary object. This is a good collision avoidance technique.

The watercraft behaves differently with a passenger and requires greater skill. The passenger should always grip the seat strap or grab handle. Reduce speed and avoid sharp turns. Avoid choppy water conditions when carrying a passenger.

## Boarding the Watercraft

### General

As with any watercraft, boarding should be done carefully and engine should not be running.

On some models, boarding is facilitated by using a step.

### **⚠ WARNING**

Inexperienced riders should practice how to get aboard (all methods explained here) close to shore first before venturing into deep water.

**CAUTION:** Never use jet pump components as a supporting point to board the watercraft.

**CAUTION:** The engine should be started only after boarding, when there is at least 90 cm (3 ft) of water below the hull. Do not start engine until the passenger(s) are properly seated. Do not accelerate fast.

### Boarding from a Dock or in Shallow Water

When boarding from a dock, slowly place one foot on the watercraft footboard nearest the dock and, at the same time, transfer the body weight to the other side in order to balance the watercraft while holding the handlebar. Then, bring the other foot over the seat and put it on the other footboard. Push the watercraft away from the dock.



F07A0BY

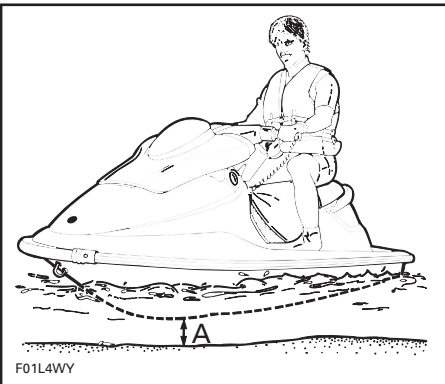

F01L4WY

A. 90 cm (3 ft)

In shallow water, board the watercraft either from the side or the rear.

### Boarding in Deep Water

#### Operator Alone

Swim to the rear of the watercraft.

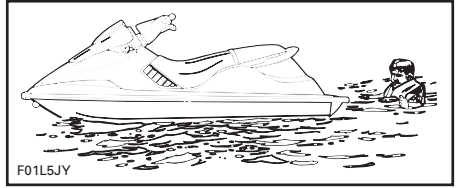

F01L5JY

Grip the grab handle and pull yourself upward until your knee can reach the boarding platform then grip the seat strap.

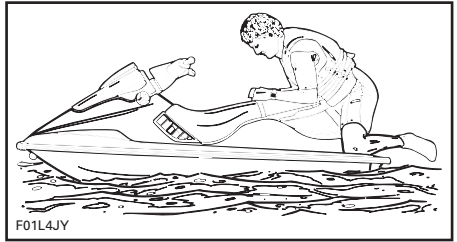

F01L4JY

Bring your feet on the footboard while maintaining balance using the handlebar (except GTI and GTX models).

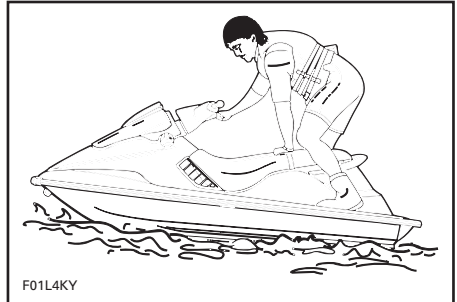

F01L4KY

Sit astride the seat.

## Operator with a Passenger

The operator climbs on the watercraft the same way as explained previously.

In choppy water, the passenger, while in the water, may hold the watercraft to help the operator in climbing aboard.

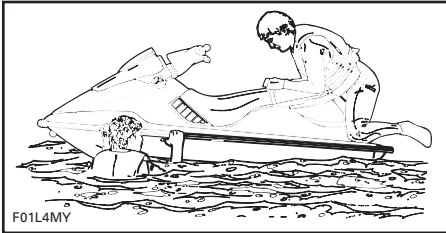

The passenger then climbs on the watercraft while the operator maintains balance by sitting as close as possible to the console.

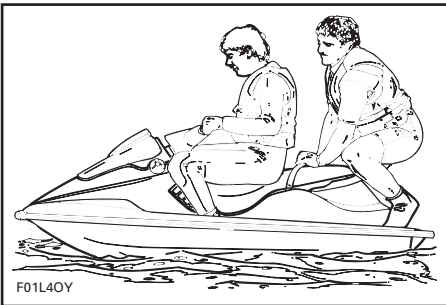
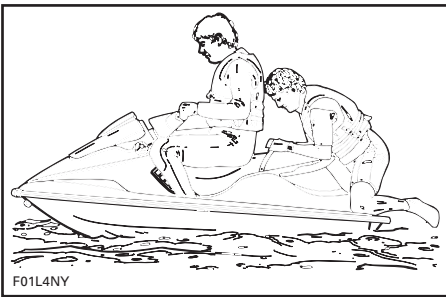

## Starting the Engine

### Preparation

Before unloading the watercraft from the trailer, it can be started for about 10 seconds to verify proper operation.

### WARNING

Do not touch electrical parts or jet pump area when engine is running.

Attach the safety lanyard to your PFD and snap the cap to its switch before starting the engine.

**NOTE:** If you hear more than 2 short beeps from DESS system, it indicates a particular condition that should be corrected. Refer to the TROUBLE-SHOOTING section for the meaning of the coded signal.

### WARNING

Before starting, the operator and passengers should always be properly seated.

Position shift lever to neutral.

Turn the fuel tank valve (if so equipped) to ON position.

Firmly grip handlebar with your left hand and place both feet on the footboard.

To start engine, depress and hold the engine start/stop button. Follow procedure below for cold or warm engine starting.

If engine fails to start after 10 seconds, wait a few seconds then repeat procedure.

**CAUTION:** To avoid starter motor overheating, the cranking period should not exceed 5-10 seconds and a rest period should be observed between cranking cycles to let the starter cool down and its mechanism disengage.

Release engine start/stop button immediately after engine is started.

## Carburetor-Equipped Models

### Cold Engine

The choke is provided to supply a richer fuel/air mixture when starting a cold engine.

Fully pull the choke lever and hold while starting the engine.



#### TYPICAL

1. Fully pulled

After engine is started, release choke lever.

It may be necessary to reapply the choke lever and if necessary, slightly apply throttle to keep engine running.

### Warm Engine

The choke does not need to be applied and throttle lever has to be slightly depressed.

#### RFI Models

### Cold and Warm Engine

Do not depress the throttle lever to start either a cold or warm engine.

## Riding

### All Models

Slowly accelerate to reach deeper water. Do not apply full throttle until the engine is warm.



**CAUTION:** Avoid watercraft operation in weeded areas. If unavoidable, vary watercraft speed.

### Rough Water or Poor Visibility Operation

Avoid operation in these conditions. If you should do so, proceed with caution and prudence using minimum speed.

### Crossing Waves

Reduce speed.

Always be prepared to steer and balance as necessary.

When crossing wakes, always keep a safe distance from craft ahead.

## WARNING

When crossing wakes, slow down. Operator and passenger(s) can brace themselves by posting. Do not jump waves or wakes.



## Stopping/Docking

The watercraft is slowed by water drag. The stopping distance will vary depending on the craft size, weight, speed, water surface condition, presence and direction of wind and current.

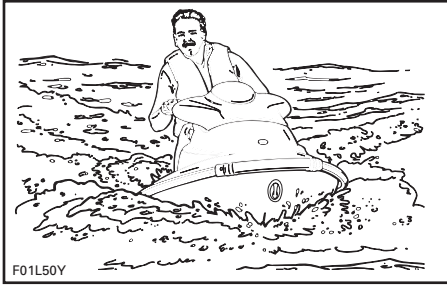

The operator should become familiarized with the stopping distance under different conditions.

Release the throttle at a sufficient distance before the expected landing area.

Reduce speed to idle.

**On models equipped with shifter system**, shift to neutral, reverse or forward, as required.

### **WARNING**

Directional control is reduced when throttle is released and lost when engine is off.

## Beaching

**CAUTION:** It is not recommended to run the watercraft to the beach.

Come slowly to the beach and shut off the using the safety lanyard when water depth is 90 cm (3 ft) under the hull, then pull the watercraft to the beach.



## Shutting Off the Engine

To keep watercraft directional control, the engine should be running until the watercraft is at idle.

To shut off the engine, completely release throttle lever and press the engine start/stop button. Remove safety lanyard from watercraft.

### **WARNING**

Should the engine be shut off, watercraft directional control is lost. Never leave the safety lanyard on an unattended watercraft.

---

## POST-OPERATION CARE

### **WARNING**

Allow engine to cool before performing any maintenance.

### **General Care**

Remove the watercraft from the water every day to prevent marine organisms growth.

Should any water be present in the hull, unscrew the drain plugs and tilt the watercraft to the rear in order to allow water to flow out.

Wipe up any remaining fluid in the engine compartment (bilge, engine, battery, etc.) with clean dry rags (this is particularly important in salt water use).

### **Additional Care for Foul Water or Salt Water**

When the watercraft is operated in foul water and particularly in salt water, additional care should be taken to protect the watercraft and its components. Rinse trailer and watercraft's bilge area with fresh water.

**CAUTION:** Failure to perform proper care such as: watercraft rinsing, cooling system flushing and anticorrosion treatment, when watercraft is used in salt water, will result in damage to the watercraft and its components. Never leave the watercraft stored in direct sunlight.

## **Cooling System Flushing and Engine Internal Lubrication**

### **General**

Flushing the cooling system with fresh water is essential to neutralize corroding effects of salt or other chemical products present in water. It will help to remove sand, salt, shells or other particles in water jackets (engine, exhaust manifold, tuned pipe) and/or hoses.

Engine lubrication and flushing should be performed when the watercraft is not expected to be used further the same day or when the watercraft is stored for any extended time.

### **WARNING**

Perform this operation in a well ventilated area.

Proceed as follows:

Clean jet pump by spraying water in its inlet and outlet and then apply a coating of BOMBARDIER LUBE lubricant or equivalent.

### **GTS Models**

Remove seat to allow access to cooling system.

Remove dust cap from fitting spigot and attach coupler hose (P/N 295 500 258). Make sure coupler hose is properly locked to fitting spigot.

Install a hose pincher on water outlet hose.

**NOTE:** This prevents water from directly exiting cooling system.

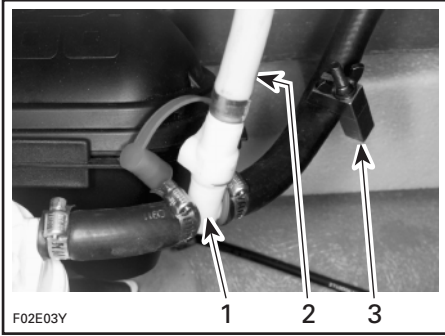

F02E03Y

**GTS MODELS**

1. Fitting spigot
2. Coupler hose
3. Hose pincher

Attach other end of coupler hose to a garden hose. **Do not open water tap yet.**

**Other Models**

Connect a garden hose to connector located at the rear of watercraft on jet pump support.

**NOTE:** A quick connect adapter can be used (P/N 295 500 473). No hose pincher is required to flush engine.

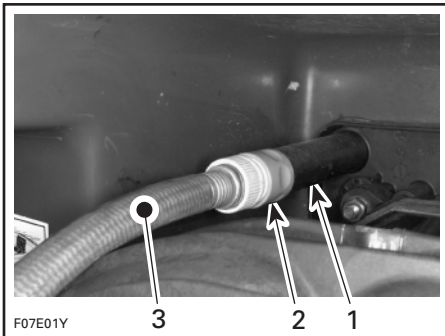

F07E01Y

**TYPICAL**

1. Hose adapter
2. Quick connect adapter (not mandatory)
3. Garden hose

**NOTE:** The quick connect adapter may be supplied with **some models**. It has to be removed if you do not use a quick connect adapter on your garden hose.

**Flushing**

**All Models**

To flush cooling system, start the engine **then** immediately open the water tap.

**⚠ WARNING**

Do not touch any electrical parts or jet pump area when engine is running.

**CAUTION:** Never flush a hot engine. Always start the engine before opening the water tap. Open water tap immediately after engine is started to prevent overheating.

Run the engine about 3 minutes at a fast idle around 3500 RPM.

**CAUTION:** Never run engine longer than 5 minutes. Drive line seal has no cooling when watercraft is out of water.

**Lubrication**

Spray BOMBARDIER LUBE lubricant or equivalent, through hole of air intake silencer keeping engine at fast idle during one minute.

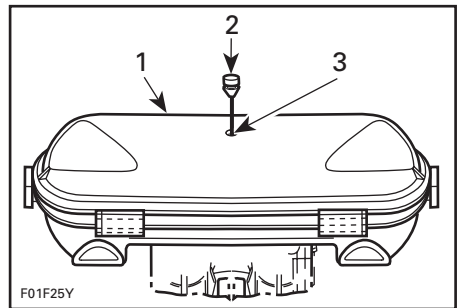

F01F25Y

**GS, GTS, GTI, GTX RFI AND GSX RFI MODELS**

1. Air intake silencer
2. Pull plug
3. Spray BOMBARDIER LUBE here

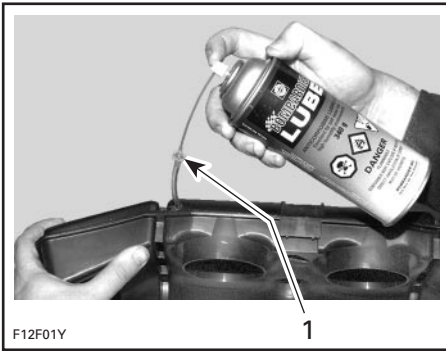

F12F01Y

**SOME GTX AND XP MODELS WITH A FOGGING TUBE**

1. Partially pull tube out of air box to inject BOMBARDIER LUBE. Push tube in when finished

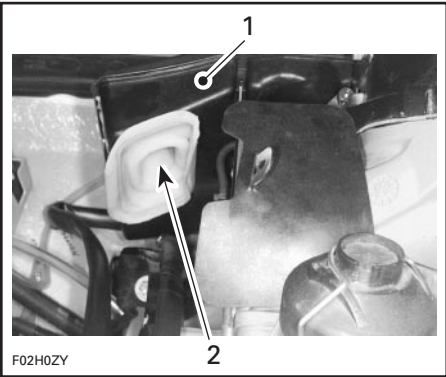

F02H0ZY

**OTHER GTX AND XP MODELS WITHOUT A FOGGING TUBE**

1. Air intake silencer
2. Spray BOMBARDIER LUBE here

**CAUTION:** Ensure to properly reposition rubber flap when done.

**NOTE:** After approximately half a minute, close fuel tank valve (if so equipped) to run engine out of fuel while lubricating.

**CAUTION:** When engine begins to run irregularly because of fuel starvation, immediately stop water flow before engine dies.

Close the water tap then stop the engine.

**CAUTION:** Always close the water tap before stopping the engine.

**Final Steps**

Disconnect the garden hose.

**GTS Models**

Unlock and remove coupler hose. Re-install dust cap over fitting spigot.

Remove hose pincher from water outlet hose.

**CAUTION:** Serious engine damage can occur if hose pincher is not removed.

**All Models**

Remove spark plug cables and connect them on the grounding device.

**⚠ WARNING**

Always use spark plug cable grounding device when removing spark plugs.

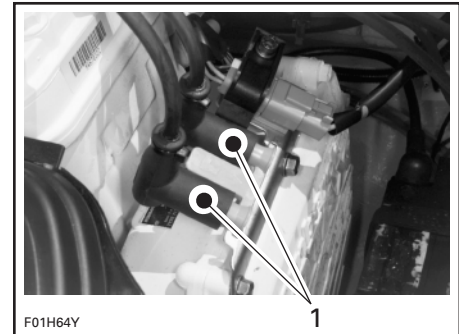

F01H64Y

**GTS MODELS**

1. Spark plug cables on grounding device

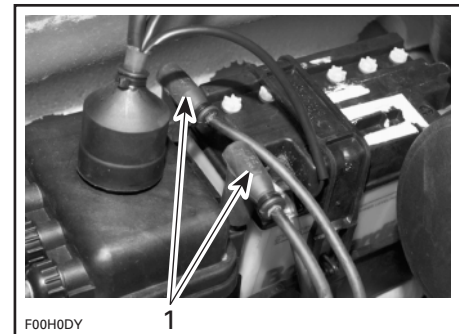

F00H0DY

**GS AND GTI MODELS**

1. Spark plug cables on grounding device

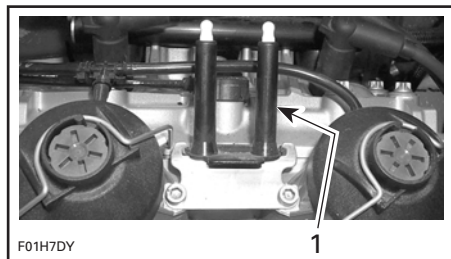

**CARBURETOR-EQUIPPED GTX MODELS**

1. Grounding device

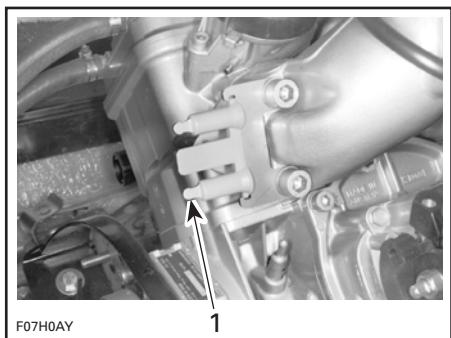

**RFI MODELS**

1. Grounding device

Remove both spark plugs and spray BOMBARDIER LUBE lubricant or equivalent into each cylinder.

**Carburetor-Equipped Models**

Crank the engine a few turns to distribute the oil on cylinder wall.

**RFI Models**

Remove safety lanyard from its switch.  
Depress the throttle lever at full throttle position and hold.

Reinstall the safety lanyard cap on its switch.

Crank the engine a few turns to distribute the oil on cylinder wall.

**NOTE:** Proceeding in this order, no fuel will be injected into the engine.

**All Models**

Apply anti-seize lubricant on spark plug threads then reinstall them.

Reinstall plug on air intake silencer cover.

Properly reconnect spark plug cables to spark plugs.

Wipe up any residual water from the engine.

**Anticorrosion Treatment**

To prevent corrosion, spray a corrosion inhibitor (salt water resistant) such as BOMBARDIER LUBE lubricant or equivalent over metallic components in engine compartment.

Apply dielectric grease (salt water resistant) on battery posts and cable connectors.

**CAUTION:** Never leave rags or tools in the engine compartment or in the bilge.

# SPECIAL PROCEDURES

## Engine Overheating

If the monitoring beeper continuously sounds, **stop engine immediately.**

Perform **Jet Pump Water Intake and Impeller Cleaning** procedure described in this section.

Flush cooling system, refer to POST-OPERATION CARE.

If engine still overheats, refer to an authorized Sea-Doo dealer for servicing.

## Jet Pump Water Intake and Impeller Cleaning

Weeds, shells or debris can get caught on the intake grate, drive shaft and/or impeller. A clogged water intake may cause troubles such as:

1. **Cavitation:** Engine speed is high but watercraft moves slowly due to reduced jet thrust, jet pump components may be damaged.
2. **Overheating:** Since the jet pump operation controls the flow of water to cool the engine, a clogged intake will cause the engine to overheat and damage engine internal components.

A weed clogged area can be cleaned as follows:

### **WARNING**

Always remove safety lanyard cap from its switch to prevent accidental engine starting before cleaning the jet pump area.

## In-Water Cleaning

Rock the watercraft several times while repeatedly pressing engine start/stop button for short period without starting engine. Most of the time, this will remove the blockage. Start engine and make sure water flows out from bleed outlet and watercraft operates properly.

If system is still blocked, move the craft out of the water and remove blockage manually.

## Models with Reverse System

If the aforementioned method does not work, the following can be performed:

- With engine running and before applying throttle, put shift lever in reverse position and vary throttle quickly several times.
- Repeat procedure if necessary.

## On-Beach Cleaning

### All Models

Place a cardboard or a carpet beside the watercraft to prevent scratching when turning the watercraft for cleaning.

Rotating watercraft in the proper direction eliminates the possibility of residual water in the tuned pipe entering the engine and causing engine damage.

### GS, GTS and GTI Models

Rotate the watercraft **counterclockwise** (seen from rear) to its **left side** for cleaning.

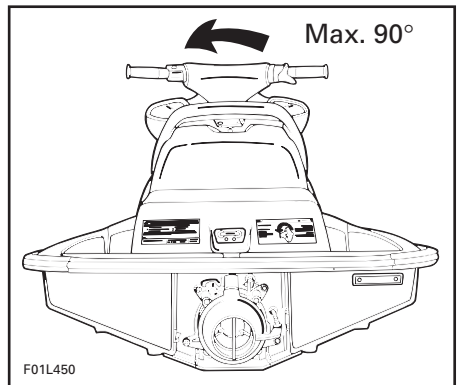

## XP, GTX and RFI Models

Rotate the watercraft **clockwise** (seen from rear) to its **right side** for cleaning.

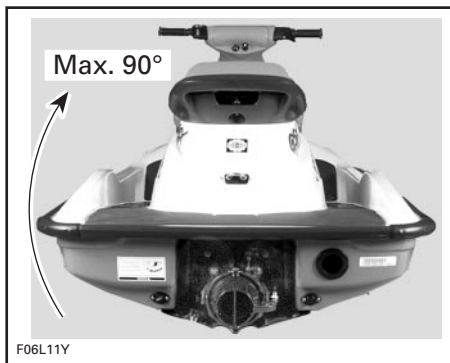

## All Models

Clean the water intake area. If the system is still clogged, refer to an authorized Sea-Doo dealer for servicing.

**CAUTION:** Inspect water intake grate for damage. Refer to an authorized Sea-Doo dealer for repair as necessary.

## Capsized Watercraft

The watercraft is designed so that it should not turn over easily. Also two sponsons mounted on the side of the hull assist watercraft stability. If it turns over, it will remain capsized.

**CAUTION:** Always refer to decal located on stern of watercraft.

## GS, GTS and GTI Models

To return the watercraft upright, ensure engine is off, grab the inlet grate, step on bumper rail and use your weight to rotate the watercraft **clockwise** (seen from rear).

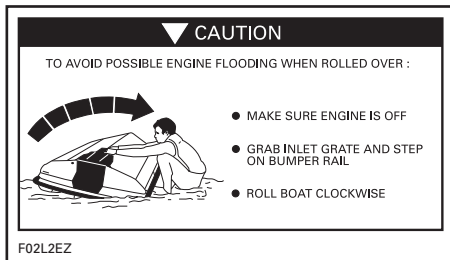

## XP, GTX and RFI Models

To return the watercraft upright, ensure engine is off, grab the inlet grate, step on bumper rail and use your weight to rotate the watercraft **counterclockwise** (seen from rear).

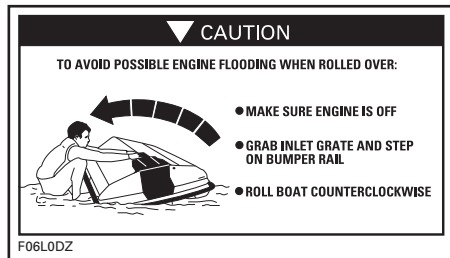

## Submerged Watercraft

If the watercraft is submerged and engine is water-flooded, it is strongly recommended that the watercraft be serviced by an authorized Sea-Doo dealer.

## Water-Flooded Engine

In the event the engine cannot be serviced within a few hours, remove spark plug cables and connect them on the grounding device.

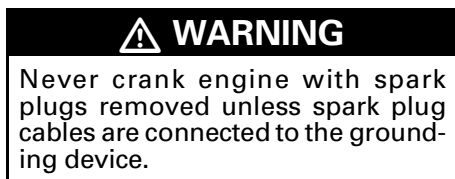

Remove spark plugs and dry them with a clean and dry cloth.

Cover spark plug holes with a rag.

Ensure choke lever is completely pushed in (**carburetor-equipped models**).

### ***RFI Models***

To prevent fuel to be injected in the engine, proceed as follows.

Remove safety lanyard from its switch.

Depress and hold the throttle lever at full throttle position.

Reinstall the safety lanyard cap.

### ***All Models***

Crank engine several times to allow water to escape from spark plug openings.

Spray BOMBARDIER LUBE lubricant or equivalent into spark plug holes.

Crank engine again.

Reinstall spark plugs. Install clean dry spark plugs if possible. Reconnect cables.

Start engine normally.

## **Fuel-Flooded Engine**

When the engine does not start after several attempts, the engine may be fuel-flooded. Proceed as follows.

### ***Carburetor-Equipped Models***

Install the safety lanyard cap on its switch.

Ensure choke lever is completely pushed in.

Depress the throttle lever at full throttle position and hold while starting the engine. Try several times.

### ***RFI Models***

To prevent fuel to be injected in the engine, proceed as follows.

Remove safety lanyard from its switch.

Depress the throttle lever at full throttle position and hold.

Reinstall the safety lanyard cap on its switch.

Try to start engine several times while holding throttle lever.

### ***All Models***

As soon as the engine starts, release throttle lever. Do not race engine.

#### **If it does not work:**

Remove spark plug cables and connect them on the grounding device.

### **WARNING**

**Always use spark plug cable grounding device when removing spark plugs.**

Remove spark plugs and dry them using a rag.

Cover spark plug holes with a rag.

Crank engine several times.

Reinstall spark plugs. Install clean dry spark plugs if possible. Reconnect cables.

Start engine as explained above. If engine continues to flood, see an authorized Sea-Doo dealer.



## Towing the Watercraft in Water

Special precautions should be taken when towing a Sea-Doo watercraft in water.

Maximum recommended towing speed is 24 km/h (15 MPH).

When towing your watercraft in water, pinch the water supply hose from the impeller housing to the engine with a large hose pincher (P/N 529 032 500).

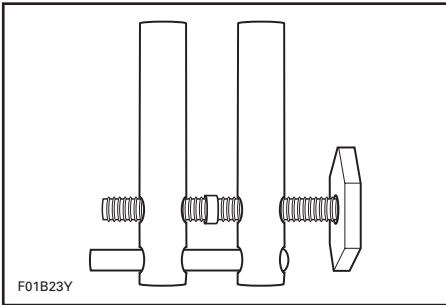

This will prevent the cooling system from filling which may lead to water being injected into and filling the exhaust system. Without the engine running there isn't any exhaust pressure to carry the water out the exhaust outlet.

**CAUTION:** Failure to do this may result in damage to the engine. If you must tow a stranded watercraft in water and do not have a hose pincher, be sure to stay well below the maximum towing speed of 24 km/h (15 MPH).

Snugly install the hose pincher on the water supply hose as shown.

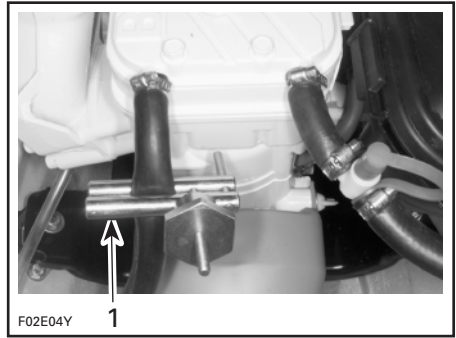

### GS, GTS AND GTI MODELS

1. Hose pincher

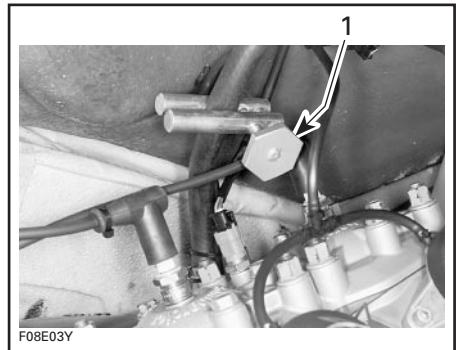

### XP MODELS

1. Hose pincher

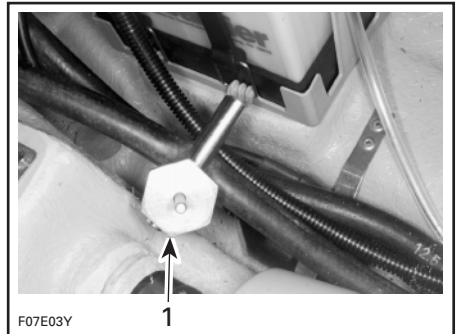

### GTX MODELS

1. Hose pincher

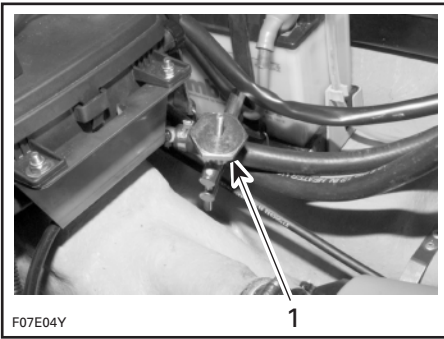

F07E04Y

1

#### *RFI MODELS*

1. *Hose pincher*

**CAUTION:** When finished towing the watercraft, hose pincher should be removed before operating it. Failure to do so will result in damage to the engine.

### **Low-Charge Battery Condition**

See an authorized Sea-Doo dealer to have it charged or replaced.

#### **⚠ WARNING**

Do not charge or boost the battery while installed on the watercraft.

# MAINTENANCE

## WARNING

Only perform procedures as detailed in this guide. It is recommended that the assistance of an authorized Sea-Doo dealer be periodically obtained on other components/systems not covered in this guide. Unless otherwise specified, engine must not be running and the safety lanyard must be removed from its switch for all maintenance procedures.

## Lubrication

Use SEA-DOO synthetic grease or equivalent and lubricate PTO flywheel.

Proceed as follows:

Remove seat(s) to expose engine compartment (for the **XP models**, remove rear access panel).

On **GS models**, remove vent tube support.

## PTO Flywheel

### All Models Except XP

Remove the wing nuts, washers and pull out PTO flywheel guard.

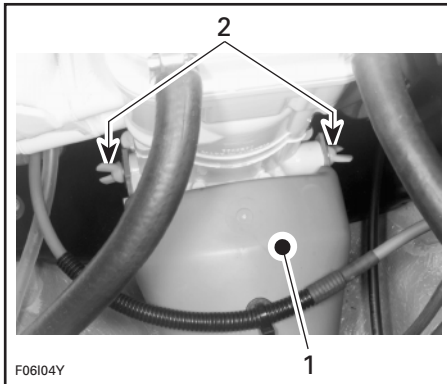

### GS, GTS AND GTI MODELS

1. Flywheel guard
2. Wing nuts

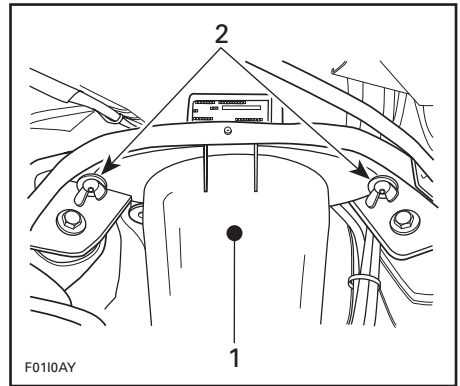

### GTX AND RFI MODELS

1. Flywheel guard
2. Wing nuts

Using a grease gun, carefully lubricate PTO flywheel at grease fitting until PTO flywheel boot **begins** to expand.

**CAUTION:** Immediately stop lubricating as soon as PTO flywheel boot begins to expand to prevent damage or slipping.

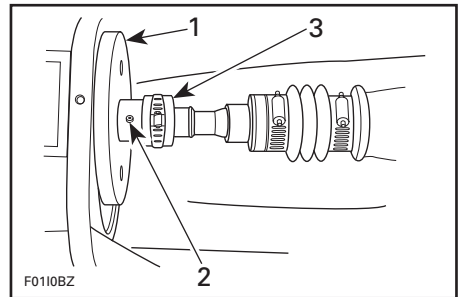

1. PTO flywheel
2. Grease fitting
3. PTO flywheel boot

Reinstall and secure PTO flywheel guard.

## Seal Carrier

### XP Models

Using a grease gun, carefully lubricate seal carrier of mid bearing until grease is just coming out of seal.

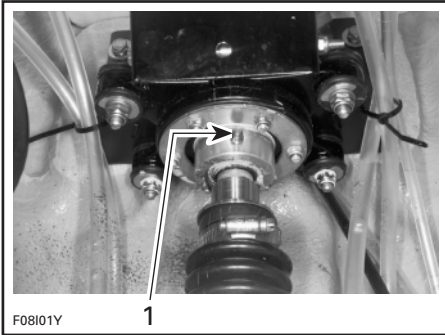

1. Grease seal carrier of mid bearing

## Anticorrosion Protection

### Throttle/Choke Cables

Lubricate the throttle and choke cables with BOMBARDIER LUBE lubricant or equivalent.

### Electrical Connections

As necessary, apply anticorrosion product such as dielectric grease on battery posts and all exposed cable connectors.

**CAUTION:** Do not lubricate connectors of the Multi-Purpose Electronic Module.

### Additional Lubrication

BOMBARDIER LUBE lubricant or equivalent will help prevent corrosion and metallic parts and maintain proper operation of moving mechanisms.

### Choke Lever

Fully pull choke lever and lubricate the metallic portion.

## Seat Opening Mechanism, Tab, Hook and Lock Pin

### All Models Except XP

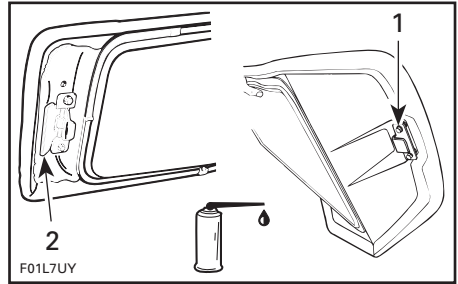

1. Front tab
2. Rear mechanism

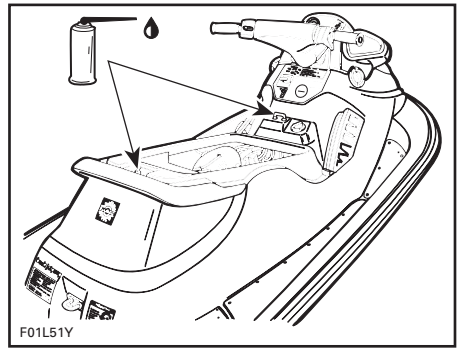

TYPICAL

## Carburetor/Throttle Body and Oil Injection Pump

Lubricate springs, shafts and exposed portion of cables.

**NOTE:** Grease carburetor linkage with synthetic grease (twin-carburetor models).

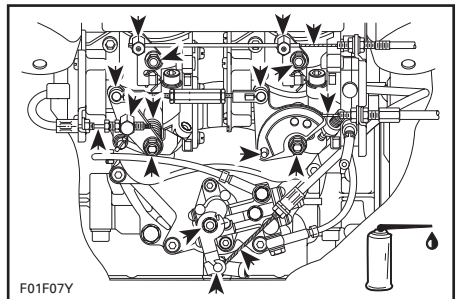

TYPICAL

## Shifter System

### **GTS Models**

Lubricate support plate sliding area of sliding block and triangular lever with synthetic grease.

Also lubricate sliding washer and shift lever stem.

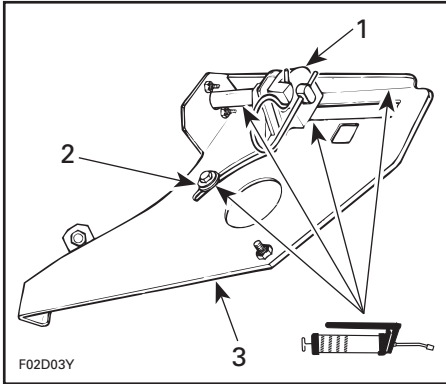

1. Sliding block
2. Sliding washer
3. Support plate

## Reverse Gate

### **All Models**

Lubricate pivoting points and mechanism.

## Periodic Inspection

Routine maintenance is necessary for all mechanized products. A periodic inspection contributes to the product's life span.

The following maintenance chart gives guidelines for regular watercraft servicing scheduled to be performed by you and/or by an authorized Sea-Doo dealer. The schedule should be adjusted according to operating conditions and use.

**IMPORTANT:** Schedule for watercraft rental operations or higher number of hour use, will require greater frequency of inspection and maintenance.

# Periodic Inspection Chart

DESCRIPTION		FREQUENCY				
		FIRST 10 HOURS	EVERY 25 HOURS	EVERY 50 HOURS	EVERY 100 HOURS OR SEASONALLY	TO BE PERFORMED BY
GENERAL	Lubrication/corrosion protection	①		✓		O
ENGINE	Head bolts, retorque	✓			✓	D
	Support and rubber mount condition/tightness	✓		✓		D
	Exhaust system fasteners	✓		✓		D
	RAVE valve cleaning (if so equipped)			✓	✓	D
	Counterbalance shaft oil level (if so equipped)			✓	✓	D
	Spark plug inspection, cleaning and adjustment	✓④				D
	Spark plug replacement			✓		D
Ignition timing (RFI models)	✓④			✓	D	
COOLING SYSTEM	Flushing		✓③			O
	Hose condition and fasteners	✓		✓		O
	Inspect/clean engine drain tube	✓①	✓			D
	Water flow regulator valve inspection (if so equipped)				✓	D
FUEL SYSTEM	Carburetor adjustment including choke/throttle cable adjustments (carburetor-equipped models)				✓	D
	Throttle/choke cables, inspection/lubrication	①	✓			O
	Fuel filter (carburetor-equipped models) and lines inspection	✓	✓			D
	Fuel filter replacement (carburetor-equipped models)				✓	D
	Fuel injector cleaning (RFI models)				✓	D
	Fuel injector sensors visual inspection (RFI models)	✓			✓	D
	Fuel vent line pressure relief valve inspection		✓			D
	Fuel lines, check-valve and fuel system pressurization	✓	✓			D
	Fastener tightening (flame arrester, carburetor(s)/throttle body, fuel lines, fuel rail (if so equipped))	✓		✓		
Fuel tank straps	✓				O	
LUBRICATION SYSTEM	Oil injection pump adjustment	✓			✓	D
	Oil filter and lines inspection	✓	✓			D
	Oil filter replacement				✓	D
	Oil reservoir straps	✓				O

DESCRIPTION		FREQUENCY				
		FIRST 10 HOURS	EVERY 25 HOURS	EVERY 50 HOURS	EVERY 100 HOURS OR SEASONALLY	TO BE PERFORMED BY
ELECTRICAL SYSTEM	Electrical connections (ignition system, electrical box(es), starting system, etc.)	✓	✓			D
	Digitally Encoded Security System	✓			✓	D
	Monitoring beeper	✓		✓		D
	Battery condition and straps	✓		✓		D
STEERING SYSTEM	Inspection and cable adjustment	✓		✓		D
PROPULSION SYSTEM	Drive shaft boot and spline condition (if so equipped)			✓ <sup>②</sup>		D
	PTO flywheel and seal carrier lubrication (if so equipped)	✓	✓			O
	Shifter system cable adjustment (if so equipped)	✓			✓	D
	VTS (Variable Trim System, (if so equipped)	✓		✓		D
	Jet pump reservoir oil level/oil condition	Replace	✓		Replace	D
	Jet pump cover pusher inspection				✓	D
	Impeller condition and impeller/wear ring clearance			✓ <sup>②</sup>		D
	Water intake grate condition			✓ <sup>②</sup>		O
HULL AND BODY	Bailer pick-ups, check for obstructions	✓			✓	O
	Water tank trap drains inspection (GTS models)			✓		O
	Hull condition	✓			✓	O

NOTE: Some items are included in the PRE-OPERATION CHECKS and not necessarily repeated in this chart.

D: Dealer

O: Operator

① Every 10 hours in salt water use.

② These items have to be initially checked after 25 hours. Thereafter, servicing to be made as specified in this chart.

③ Daily flushing in salt water or foul water use.

④ Except RFI models.

## Throttle and Choke Cable Inspection

### Throttle Cable

Depress and release the throttle lever. It should operate smoothly and return to its initial position without any hesitation. Refer to an authorized Sea-Doo dealer if necessary.

### Carburetor-Equipped Models

Do not activate throttle lever unnecessarily, when engine is not running. Carburetors are equipped with fuel accelerator pumps. These pumps deliver fuel to the engine each time throttle lever is depressed.

#### All Models

### WARNING

Do not alter or tamper with throttle cable adjustment or routing.

### WARNING

If throttle lever does not automatically return, do not operate watercraft and see your authorized Sea-Doo dealer.

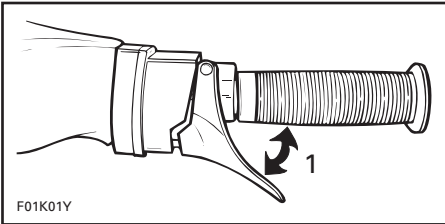

1. Should move freely

### Carburetor-Equipped Models

### Choke Cable

Ensure choke cable operates smoothly and without any hesitation from fully opened to fully closed. When the choke lever is fully pulled, choke should be fully applied. Refer to an authorized Sea-Doo dealer if necessary.

## Carburetor Adjustment

Carburetor adjustment is very important to allow good engine operation and therefore watercraft performance. Carburetor adjustment requires technical knowledge and experience to have the correct mixture supplied to the engine.

**CAUTION:** Serious engine damage can occur with improper carburetor adjustment.

#### All Models

### Fuel and Oil Filters

The fuel filter (carburetor-equipped models) and the oil filter should be replaced by an authorized Sea-Doo dealer. Fuel system pressurization should be conducted at the same time.

**CAUTION:** An obstructed oil filter will cause oil starvation resulting in serious engine damage.

## Steering Alignment

When the handlebar is directed in straight ahead position, the jet pump nozzle should be in the same direction allowing the watercraft to run in a straight line.

Refer to an authorized Sea-Doo dealer if an adjustment is necessary.

### WARNING

Ensure the handlebar and jet pump nozzle operate freely from side to side and are not stressing the steering cable or brackets.



## VTS Adjustment (if so equipped)

Push on arrow pointing upward on VTS button until the VTS stops. The nozzle should be up without interfering with the venturi.

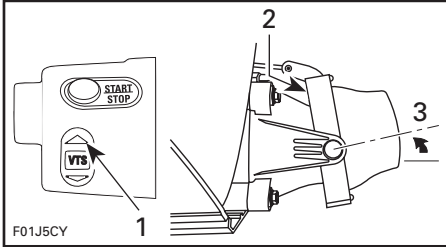

### TYPICAL

1. Push on arrow pointing upward on VTS button
2. No interference
3. Nozzle up

Push on arrow pointing downward on VTS button until VTS stops. The nozzle must be down and it must not interfere with the venturi.

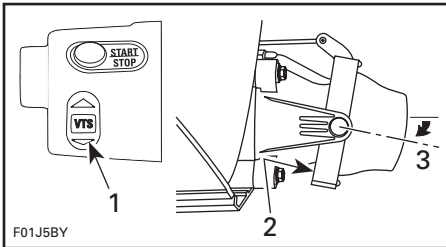

1. Push on arrow pointing downward on VTS button
2. No interference
3. Nozzle down

If VTS needs to be readjusted, refer to an authorized Sea-Doo dealer.

**CAUTION:** Trim ring and/or nozzle should not interfere at any position.

## Vacuum Bailer Pick-Ups

They are located each side of the drive shaft tunnel.

Two pick-ups use a low pressure area in the jet pump to siphon the water out of the bilge when the engine is operating.

Inspect each pick-up screen for obstructions, clean as necessary.

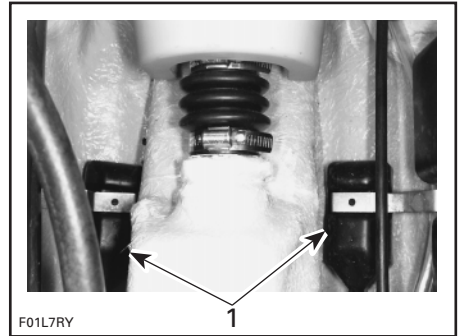

### TYPICAL

1. Vacuum bailer pick-ups

## Water Tank Trap Drains

### GTS Models

Open storage cover and check for possible obstructions at drain outlets.

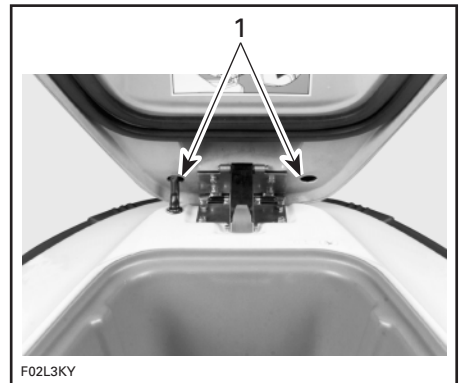

1. Outlets

# Fuses

If an electrical problem occurs, check the fuses. If a fuse is burnt, replace by one of the same rating. Follow procedures below.

**CAUTION:** Do not use a higher rated fuse as this can cause severe damage. If a fuse is regularly burnt, refer to an authorized Sea-Doo dealer.

## GTS Models

Fuses are located in the electrical box, mounted on the MPEM.

To access fuses, unclip and move away electrical box from its seat.

Open the electrical box.

Remove fuse caps.

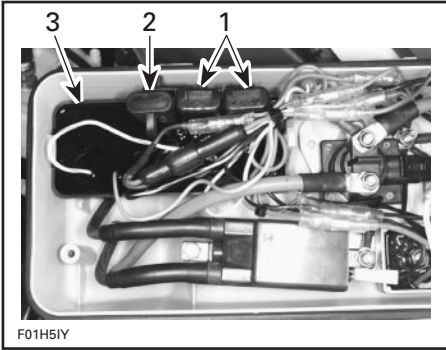

- 1. Fuse caps
- 2. Spare fuse holder
- 3. MPEM

Check fuse condition.

Make sure to properly close the fuse cap.

Properly close the electrical box cover making sure its seal is well positioned.

## RFI Models

To access fuses on the Multi-Purpose Electronic Module, open front storage compartment cover and remove basket.

Locate MPEM on the left side of wa-  
tercraft.

Unclip the fuse cover from the MPEM.

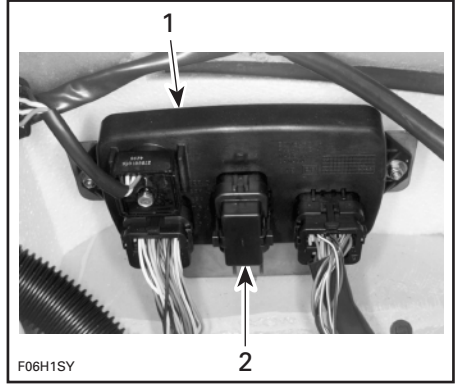

### TYPICAL

- 1. MPEM
- 2. Fuse cover

Use the tabs of the fuse cover to re-  
move and reinstall fuses.

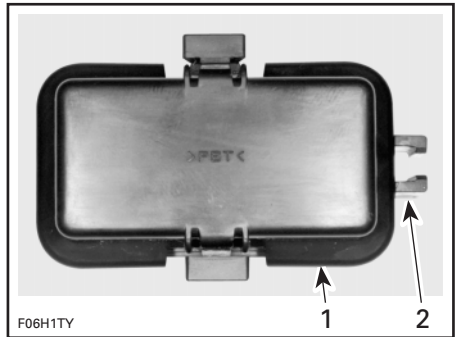

- 1. Fuse cover
- 2. Fuse tabs

**NOTE:** There are 3 spare fuses on the MPEM.

To access the fuses in the rear electri-  
cal box, remove seats.

Remove basket.

Unclip and remove cover of the rear electrical box.

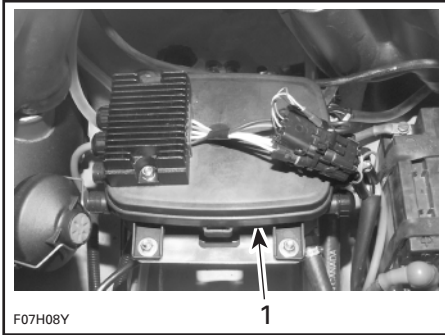

1. Rear electrical box

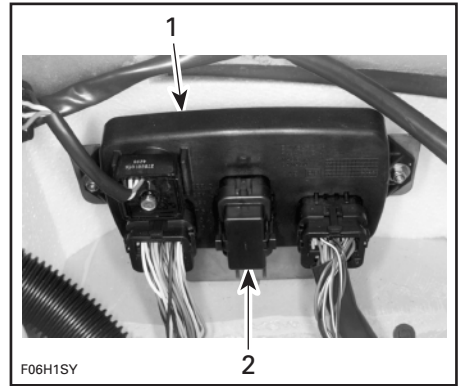

**TYPICAL**

1. MPPEM
2. Fuse cover

Use the tabs of the fuse cover to remove and reinstall fuses.

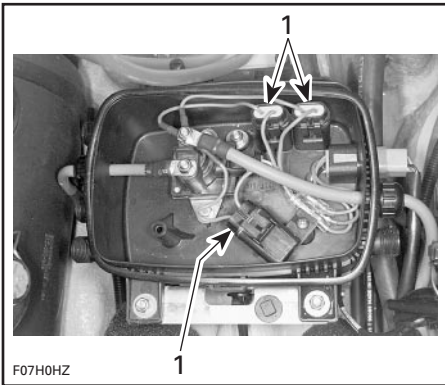

**REAR ELECTRICAL BOX OPENED**

1. Fuse holders

Unclip and pull out fuse holders to check fuse condition.

**All Models Except GTS**

To access fuses on the MPPEM, open front storage compartment cover (cover for the **XP models**) and remove storage basket.

Locate MPPEM on the left side of watercraft.

Remove fuse cover from the MPPEM.

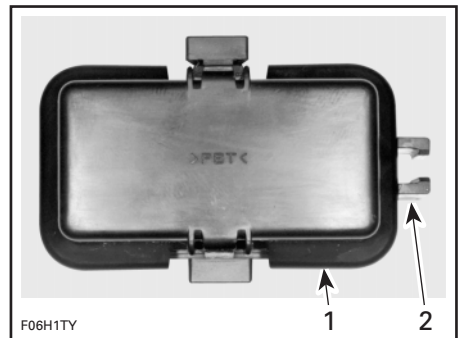

1. Fuse cover
2. Fuse tabs

To access fuse in the electrical box, proceed as follows:

Open the engine cover and remove storage basket (**XP models**).

Remove seat (**except XP models**).

Remove vent tube support (**GS models**).

Locate the electrical box.

Unclip and remove cover of the electrical box.

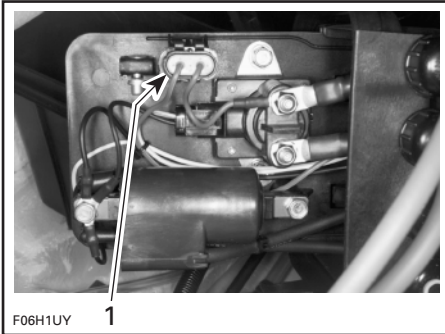

#### GS AND GTI MODELS

1. Fuse holder

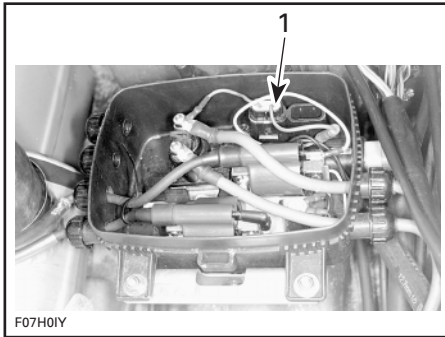

#### GTX AND XP MODELS

1. Fuse holder

## General Inspection and Cleaning

### Inspection

Check engine compartment for any damage and fuel/oil injection systems for leaks. Ensure all hose clamps are properly secured and no hose is cracked, kinked or presenting any other damage.

## WARNING

If any gasoline leak and/or odor are present, do not start the engine. Have the watercraft serviced by an authorized Sea-Doo dealer.

Inspect muffler, battery, fuel tank and oil reservoir fastening devices. Visually check electrical connections for corrosion and tightness.

Inspect hull and jet pump water intake grate for damage. Replace or have damaged parts repaired.

### Cleaning

The bilge should be cleaned by your dealer to remove any fuel/oil/electrolyte deposits and mildew.

Occasionally, wash the body with water and soap (only use mild detergent). Remove any marine organisms from engine and/or hull. Apply non-abrasive wax such as silicone wax.

**CAUTION:** Never clean fiberglass and plastic parts with strong detergent, degreasing agent, paint thinner, acetone, etc.

Stains may be removed from seats and fiberglass with Knight's Spray-Nine from Korkay System Ltd or the equivalent.

Respect the environment by ensuring fuel, oil or cleaning solutions do not drain into the waterways.

# TRAILERING, STORAGE AND PRE-SEASON PREPARATION

## Trailerling

### **WARNING**

Always turn the fuel tank valve (if so equipped) to OFF position when trailerling or docking the watercraft.

Check the regulations in your area concerning towing a trailer, especially the following rules:

- brake system
- tow vehicle weight
- mirrors

Take the following precautions when towing the watercraft:

Tie the watercraft to both bow and stern (front/rear) eyelets so that it is firmly retained on the trailer. Use additional tie-downs if necessary.

**CAUTION:** Do not route ropes or tie-downs over the seat as they could produce permanent damage. Wrap ropes or tie-downs with rags or similar protectors where they can touch the watercraft body.

Ensure all storage compartment covers and seat are properly latched.

A SEA-DOO cover can protect the watercraft, particularly before driving on dirt roads, to prevent dirt entry through the air intake opening(s).

Observe trailerling safety precautions.

## Launching/Loading

Before launching the watercraft, ensure the bilge plugs are fully screwed. After loading the watercraft, ensure they are removed to drain bilge.

## Storage

It is recommended that the watercraft be serviced by an authorized Sea-Doo dealer for storage but the following operations can be performed by you with a minimum of tools.

**CAUTION:** Do not run the engine during the storage period.

## Engine Draining

### **All Models Except RFI Models**

Check engine drain hose. Make sure there is no sand or other particles in it and that it is not obstructed so that water can exit the engine. Clean hose and fitting as necessary.

**CAUTION:** Water in engine drain hose should be free to flow out, otherwise water could be trapped in engine. Should water freeze in engine, severe damage will occur. Check engine drain hose for obstructions.

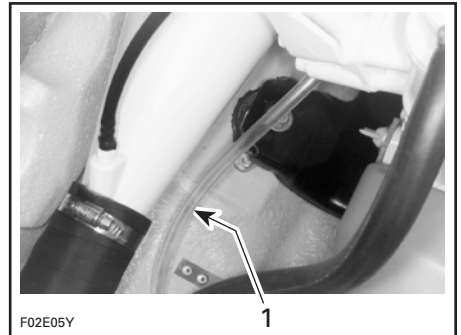

TYPICAL

1. Engine drain hose

## RFI Models

Disconnect the water supply hose used to cool the magneto. It features a quick connect fitting. Press both tabs and pull fitting in order to disconnect hose.

This hose is located at the bottom of the magneto cover beside the engine support.

Wash the body with soap and water solution (only use mild detergent). Rinse thoroughly with fresh water. Remove marine organisms from the hull.

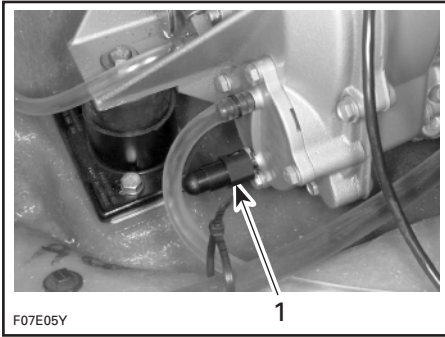

1. Disconnect this hose

Water should flow out of the fitting (magneto cooling circuit) and hose (crankcase heat exchanger).

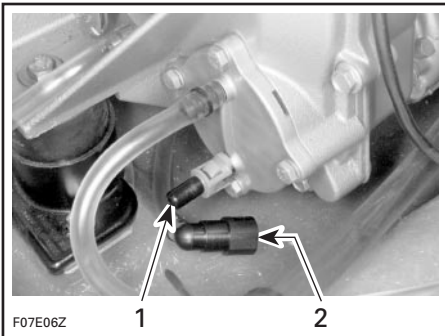

1. Fitting  
2. Hose

## Body Rinsing/Repair

Thoroughly rinse the watercraft's with fresh water.

**CAUTION:** Never clean fiberglass and plastic parts with strong detergent, degreasing agent, paint thinner, acetone, etc.

For small gelcoat repairs, a Bombardier repair kit is available. Replace damaged labels/decals.

## Propulsion System

Lubricant in jet pump reservoir should be drained and reservoir cleaned. Refer to an authorized Sea-Doo dealer for this operation.

Grease lubrication point(s) of propulsion system as explained in MAINTENANCE section.

## Fuel System

SEA-DOO fuel stabilizer (or equivalent), can be added in fuel tank to prevent fuel deterioration and carburetor gumming. Follow manufacturer's instructions for proper use.

**CAUTION:** Fuel stabilizer should be added prior to engine lubrication to ensure carburetor protection against varnish deposits.

## WARNING

Fuel is flammable and explosive under certain conditions. Always work in a well ventilated area. Always wipe off any fuel spillage from the watercraft. Always turn the fuel tank valve (if so equipped) to OFF position when storing the watercraft.

## Cooling System Flushing and Engine Internal Lubrication

Refer to procedure in POST-OPERATION CARE.

## Battery

Contact your authorized Sea-Doo dealer.

## Antifreezing Protection

In cool regions (where freezing point may be encountered), cooling system should be filled with an equal part of water and antifreeze solution.

**CAUTION:** Always use ethylene glycol antifreeze containing corrosion inhibitors specifically recommended for aluminums.

### GTS Models

Install a hose pincher to engine drain hose near the PTO flywheel guard.

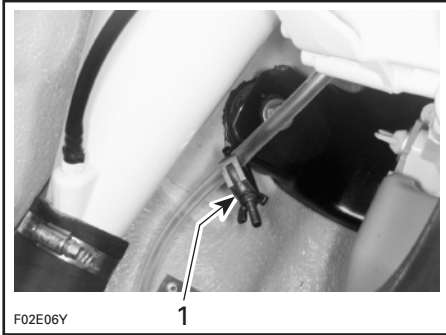

*TYPICAL*

1. Hose pincher installed on engine drain hose

Install coupler hose to fitting spigot.

Install a hose pincher to engine water outlet hose (beside fitting spigot).

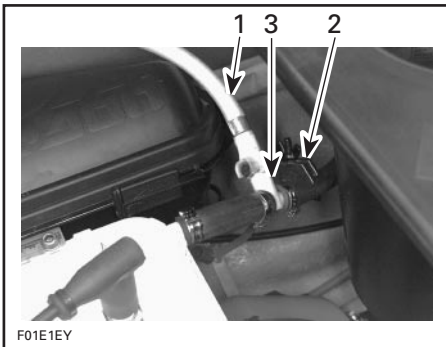

1. Coupler hose
2. Hose pincher
3. Fitting spigot

Pour the antifreeze slowly mixed with water in coupler hose until the colored solution appears in the engine drain hose.

Remove hose pincher.

### All Models Except GTS

Install a hose pincher to engine drain hose.

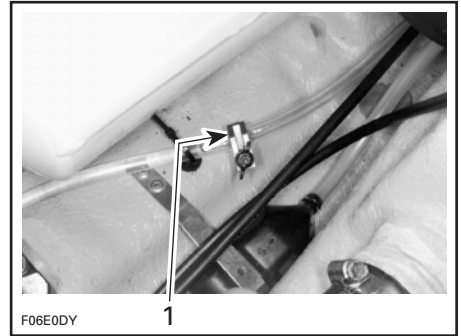

*TYPICAL*

1. Hose pincher installed on engine drain hose

Disconnect engine water outlet hose.

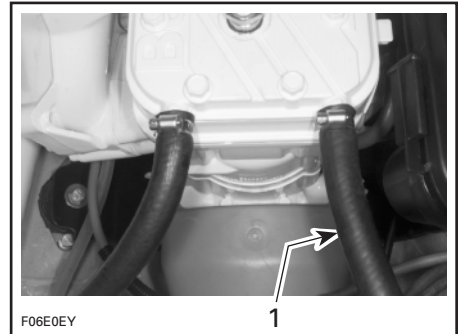

*717 AND 787 ENGINES*

1. Disconnect engine water outlet hose



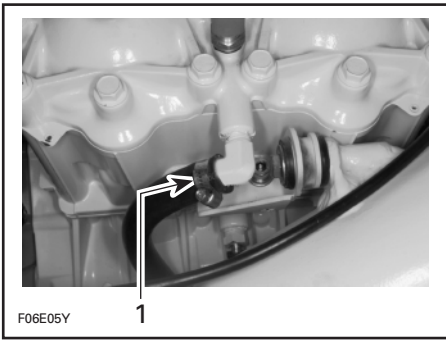

**947 ENGINE**

1. Disconnect engine water inlet hose

Install a hose pincher to engine water inlet hose (except the 947 engine).

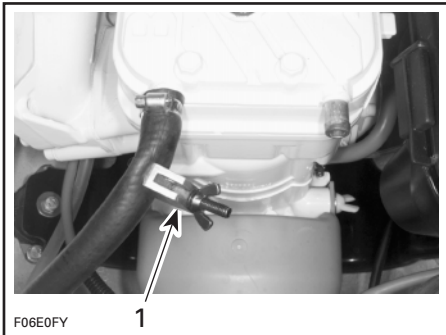

**717 AND 787 ENGINES**

1. Hose pincher installed on the engine water inlet hose

Temporarily install a short piece of hose to engine water outlet at cylinder head.

Insert a funnel into hose and pour antifreeze mixed with water in engine until the colored solution appears in the engine drain hose.

**RFI Models**

Install a hose pincher to water return hose of the magneto cooling circuit.

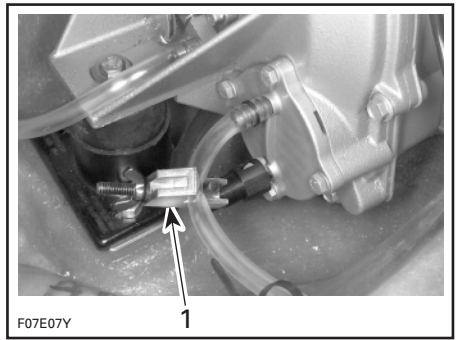

1. Hose pincher to water return hose

Insert a funnel into hose and pour antifreeze mixed with water in engine until the colored solution appears in the water return hose of the magneto cooling circuit.

Remove temporary hose and reconnect engine water outlet hose.

Remove hose pinchers.

**All Models**

Most of the antifreeze will drain out when removing the hose pincher(s). Use a container to recover it. **DISPOSE ANTIFREEZE AS PER YOUR LOCAL LAWS AND REGULATIONS.**

**NOTE:** Although antifreeze will mainly drain out, the antifreeze has mixed with the water that was possibly trapped in the water jackets and thus preventing freezing problems.

At pre-season preparation, drain the remaining antifreeze from cooling system prior using the watercraft.

The following steps should be performed to provide the watercraft enhanced protection.

Clean the bilge with hot water and detergent or with bilge cleaner. Rinse thoroughly. Lift front end of watercraft to completely drain bilge. If any repairs are needed to body or to the hull contact your authorized Sea-Doo dealer. For paint touch up to mechanical parts use Bombardier spray paint.



## Anticorrosion Treatment

Wipe off any residual water in the engine compartment.

Spray BOMBARDIER LUBE lubricant or equivalent over metallic components in engine compartment.

Lubricate the throttle cable with BOMBARDIER LUBE lubricant or equivalent.

## Final Steps

Apply a good quality marine wax to the body.

The front and rear portion of the seat (if **so equipped**) should be partially left opened, rear access cover (**XP models**) and storage baskets (if so equipped) should be removed during storage. This will avoid engine compartment condensation and possible corrosion.

If the watercraft is to be stored outside, cover it with an opaque tarpaulin to prevent sun rays and grime from affecting the plastic components, watercraft finish as well as preventing dust accumulation.

**CAUTION:** The watercraft should never be left in water for storage. Never leave the watercraft stored in direct sunlight.

## Pre-Season Preparation

Use the following chart.

Since technical skills and special tools are required, some operations should be performed by an authorized Sea-Doo dealer.



### WARNING

Observe all WARNINGS and CAUTIONS mentioned throughout this guide which are pertinent to the item being checked. When component conditions seem less than satisfactory, replace with genuine BOMBARDIER parts or approved equivalents.

## Pre-Season Preparation Chart

NOTE: It is highly recommended that an authorized Sea-Doo dealer perform the annual safety inspection and factory campaigns in addition to the pre-season preparation all at the same time.

OPERATIONS		TO BE PERFORMED BY
<b>GENERAL</b>	Lubrication/corrosion protection	Operator
	Spark plug replacement ①	Operator
<b>ENGINE</b>	Exhaust system condition (fasteners, hoses etc.)	Dealer
	RAVE valve cleaning (if so equipped)	Dealer
	Counterbalance shaft oil level (if so equipped)	Dealer
	Ignition timing (RFI models)	Dealer
<b>COOLING SYSTEM</b>	Inspection of cooling system hoses and components	Dealer
<b>FUEL SYSTEM</b>	Carburetor adjustment (carburetor-equipped models)	Dealer
	Throttle ② and choke (carburetor-equipped models) cable inspection/adjustment	Dealer
	Fuel filter replacement (carburetor-equipped models)	Dealer
	Fuel injection sensors verification (RFI models)	Dealer
	Fuel system; check valves, lines, fasteners, pressurization ②	Dealer
	Filler neck, fuel tank and fuel cap condition ②	Dealer
	Flame arrester inspection ② (except 947 engine)	Dealer
	Fuel tank straps	Operator
Refill fuel tank	Operator	
<b>LUBRICATION SYSTEM</b>	Oil injection pump adjustment	Dealer
	Oil filter replacement	Dealer
	Oil injection reservoir straps	Operator
	Oil injection reservoir filling	Operator
	Oil injection pump adjustment and bleeding	Dealer
<b>ELECTRICAL SYSTEM</b>	Battery condition/charging and reinstallation	Dealer
	Battery, starter connections and routing ②	Dealer
	Monitoring beeper	Dealer
	Digitally encoded security system	Dealer
<b>STEERING SYSTEM</b>	Steering system adjustment/inspection ②	Dealer
<b>PROPULSION SYSTEM</b>	Shifter system condition and cable adjustment (if so equipped)	Dealer
	VTS (Variable Trim System, (if so equipped))	Dealer
	Propulsion system inspection	Dealer
	Jet pump oil replacement	Dealer
<b>HULL AND BODY</b>	Inspection of bailer pick-ups	Dealer

① Before installing new spark plugs, it is suggested to burn the excess BOMBARDIER LUBE lubricant or equivalent by starting the engine using the old spark plugs.

② Safety item covered in the annual safety inspection.

---

# TROUBLESHOOTING

The following chart is provided to help in diagnosing the probable source of simple troubles. You may be able to solve many of these problems rather quickly, but others may require the skills of a mechanical technician. In such cases, consult an authorized Sea-Doo dealer for servicing.

## Monitoring Beeper Coded Signals

CODED SIGNALS	POSSIBLE CAUSE	REMEDY
2 short beeps (while installing safety lanyard on switch).	<ul style="list-style-type: none"><li>• Confirms safety lanyard signal operation.</li></ul>	Engine can be started.
1 long beep (while installing safety lanyard on watercraft switch or when pressing engine start/stop button).	<ul style="list-style-type: none"><li>• Safety lanyard on switch for more than 10 minutes without starting engine.</li><li>• Bad connection.</li><li>• Wrong safety lanyard.</li><li>• Defective safety lanyard.</li><li>• Dried salt water in safety lanyard cap.</li><li>• Improper operation of MPEM or defective wiring harness.</li></ul>	<p>Apply a slight pressure or remove and reinstall safety lanyard on switch.</p> <p>Reinstall safety lanyard cap correctly over switch.</p> <p>Use a safety lanyard that has been programmed for the watercraft.</p> <p>Use another programmed safety lanyard.</p> <p>Clean safety lanyard cap to remove salt water.</p> <p>Refer to an authorized Sea-Doo dealer.</p>
4 short beeps (RFI models).	<ul style="list-style-type: none"><li>• Discharged battery.</li><li>• No communication between ECU and MPEM.</li></ul>	<p>Refer to an authorized Sea-Doo dealer.</p> <p>Refer to an authorized Sea-Doo dealer.</p>
A 2 seconds beep every minute intervals (RFI models).	<ul style="list-style-type: none"><li>• Fuel tank level is low.</li></ul>	Refill.
8 short beeps.	<ul style="list-style-type: none"><li>• Defective MPEM.</li></ul>	Refer to an authorized Sea-Doo dealer.
Continuously beeps.	<ul style="list-style-type: none"><li>• Engine overheats.</li></ul>	See engine OVERHEATING.

## Engine Will Not Start

OTHER OBSERVATION	POSSIBLE CAUSE	REMEDY
Engine does not turn over.	<ul style="list-style-type: none"> <li>• Safety lanyard removed.</li> <li>• Burnt fuse.</li> <li>• Discharged battery.</li>   <li>• Battery connections, corroded or loose.</li> <li>• Water-flooded engine.</li> </ul>	<p>Install cap over switch.</p> <p>Check wiring then replace fuse.</p> <p>Refer to an authorized Sea-Doo dealer.</p> <p>Refer to an authorized Sea-Doo dealer.</p> <p>Refer to <b>Water-Flooded Engine</b> in SPECIAL PROCEDURES.</p>
Engine turns slowly.	<ul style="list-style-type: none"> <li>• Discharged or weak battery.</li> </ul>	<p>Refer to an authorized Sea-Doo dealer.</p>
Engine turns normally.	<ul style="list-style-type: none"> <li>• Closed fuel tank valve (<b>except RFI models</b>).</li> <li>• Fuel tank empty or water-contaminated.</li> <li>• Fuel filter clogged or water-contaminated (<b>except RFI models</b>).</li> <li>• Fouled/defective spark plugs.</li> <li>• Misuse of choke (<b>except RFI models</b>).</li> <li>• Fuel-flooded engine.</li>   <li>• Burnt fuel pump fuse (<b>RFI models</b>).</li> <li>• Electrical problem (<b>RFI models</b>).</li> </ul>	<p>Turn fuel tank valve to ON position.</p> <p>Refill. Siphon and fill with fresh fuel.</p> <p>Clean, check fuel tank for water.</p> <p>Replace.</p> <p>Use only with cold engine. Replace spark plugs.</p> <p>Refer to <b>Fuel-Flooded Engine</b> in SPECIAL PROCEDURES.</p> <p>Check wiring then replace fuse.</p> <p>Refer to an authorized Sea-Doo dealer.</p>

## Engine Misfires, Runs Irregularly

OTHER OBSERVATION	POSSIBLE CAUSE	REMEDY
Weak spark.	<ul style="list-style-type: none"> <li>Fouled/defective/worn spark plugs.</li> <li>Faulty rev limiter (except RFI models).</li> <li>Too much oil supplied to engine.</li> </ul>	<p>Replace.</p> <p>Refer to an authorized Sea-Doo dealer.</p> <p>Improper oil pump adjustment, refer to an authorized Sea-Doo dealer.</p>
Lean fuel mixture.	<ul style="list-style-type: none"> <li>Fuel: Level too low, stale or water-contaminated.</li> <li>Fuel filter, clogged or water-contaminated (except RFI models).</li> <li>fuel tank valve (except RFI models) partially open.</li> <li>Clogged fuel injectors (RFI models).</li> <li>Defective sensor or ECU (RFI models).</li> </ul>	<p>Siphon and/or refill.</p> <p>Refer to an authorized Sea-Doo dealer.</p> <p>Turn fuel tank valve to ON position.</p> <p>Refer to an authorized Sea-Doo dealer.</p> <p>Refer to an authorized Sea-Doo dealer.</p>
Rich fuel mixture (high fuel consumption).	<ul style="list-style-type: none"> <li>Flame arrester dirty/clogged (if so equipped).</li> <li>Partially closed choke (except RFI models).</li> <li>Defective sensor or ECU (RFI models).</li> </ul>	<p>Clean or replace.</p> <p>Refer to an authorized Sea-Doo dealer.</p> <p>Refer to an authorized Sea-Doo dealer.</p>

## Engine Overheats

OTHER OBSERVATION	POSSIBLE CAUSE	REMEDY
Monitoring beeper sounds continuously.	<ul style="list-style-type: none"> <li>Clogged jet pump water intake.</li> <li>Clogged coolant system.</li> </ul>	<p>Clean.</p> <p>Flush cooling system.</p>

## Engine Continually Backfires

OTHER OBSERVATION	POSSIBLE CAUSE	REMEDY
Weak spark.	<ul style="list-style-type: none"> <li>Fouled/defective/worn spark plugs.</li> </ul>	<p>Replace.</p>
Overheated engine.	<ul style="list-style-type: none"> <li>See engine OVERHEATS.</li> <li>Faulty rev limiter (except RFI models).</li> </ul>	<p>Refer to an authorized Sea-Doo dealer.</p> <p>Refer to an authorized Sea-Doo dealer.</p>

## Engine Pinging or Knocking

OTHER OBSERVATION	POSSIBLE CAUSE	REMEDY
	<ul style="list-style-type: none"> <li>Poor quality gasoline/low octane.</li> <li>Spark plug heat range too high.</li> <li>Ignition timing.</li> </ul>	<p>Use well known quality and recommended gasoline.</p> <p>Use recommended spark plugs.</p> <p>Refer to an authorized Sea-Doo dealer.</p>

## Engine Lacks Acceleration or Power

OTHER OBSERVATION	POSSIBLE CAUSE	REMEDY
	<ul style="list-style-type: none"> <li>• Weak spark</li> <li>• Incorrect fuel mixture (carburetor-equipped models).</li> <li>• Water in fuel or injection oil.</li> </ul>	<p>Refer to engine MISFIRES, RUNS IRREGULARLY.</p> <p>Refer to engine MISFIRES, RUNS IRREGULARLY.</p> <p>Siphon and replace.</p>
Overheated engine.	<ul style="list-style-type: none"> <li>• See engine OVERHEATS.</li> <li>• Clogged fuel injectors (RFI models).</li> <li>• Low fuel pressure (RFI models).</li> <li>• Stuck RAVE valves (if so equipped).</li> </ul>	<p>Refer to an authorized Sea-Doo dealer.</p> <p>Refer to an authorized Sea-Doo dealer.</p> <p>Refer to an authorized Sea-Doo dealer.</p>

## Watercraft Can Not Reach Top Speed

OTHER OBSERVATION	POSSIBLE CAUSE	REMEDY
Cavitation.	<ul style="list-style-type: none"> <li>• Jet pump water intake clogged.</li> <li>• Damaged impeller.</li> </ul>	<p>Clean.</p> <p>Replace. Refer to an authorized Sea-Doo dealer.</p>

## Abnormal Noise From Propulsion System

OTHER OBSERVATION	POSSIBLE CAUSE	REMEDY
Cavitation.	<ul style="list-style-type: none"> <li>• Weeds or debris jammed around impeller.</li> <li>• Damaged impeller shaft or drive shaft.</li> </ul>	<p>Clean and check for damage.</p> <p>Refer to an authorized Sea-Doo dealer.</p>

# SPECIFICATIONS

<b>ENGINE</b>		<b>GS (5644/5827)</b>
Engine type		Rotax 717, 2-stroke
Induction type		Rotary valve
Exhaust system		Water cooled/water injected
Exhaust valve		N.A.
Lubrication	Type	Oil injection
	Oil type	BOMBARDIER-ROTAX injection oil
Number of cylinders		2
Displacement		718.2 cm <sup>3</sup> (43.81 in <sup>3</sup> )
Rev limiter setting		7000 RPM ± 50
<b>COOLING</b>		
Type		Open circuit. Direct flow from propulsion unit
<b>ELECTRICAL</b>		
Magneto generator output		160 W @ 6000 RPM
Ignition system type		Digital CDI
Spark plug	Make and type	NGK, BR8ES
	Gap	0.5 - 0.6 mm (.020 - .024 in)
Starting system		Electric starter
Battery		12 V, 19 A•h
Fuse	MPEM	5 A
	Electrical system	2 x 15 A
	VTS system	N.A.
<b>CARBURETION</b>		
Fuel type		Regular unleaded gasoline
Carburetor		BN 40i (diaphragm). Fuel accelerator pump. Quantity: 1
<b>PROPULSION</b>		
Propulsion system		Bombardier Formula pump
Jet pump type		Axial flow, single stage
Transmission		Direct drive
Jet pump oil type		SEA-DOO synthetic polyolester oil SAE 75W90 GL5
Pivoting angle of direction (nozzle)		~20°
Minimum required water level for jet pump		90 cm (3 ft)

N.A.: Not Applicable.

<b>DIMENSIONS</b>		<b>GS (5644/5827)</b>
Number of passengers ①		2
Overall length		270 cm (106 in)
Overall width		116 cm (45.7 in)
Overall height		99 cm (39 in)
Weight		219 kg (482 lb)
Load limit (passengers + luggage)		159 kg (350 lb)
<b>CAPACITIES</b>		
Fuel tank		56.5 L (15 U.S. gal)
Oil injection tank		6 L (1.6 U.S. gal)
Impeller shaft reservoir	Capacity	100 mL (2.7 U.S. oz)
	Oil level	Up to plug

① Refer to load limit.

BOMBARDIER INC. reserves the right to make changes in design and specifications and/or to make additions to, or improvements in its products without imposing any obligation upon itself to install them on its products previously manufactured.



<b>ENGINE</b>		<b>XP (5651/5655)</b>
Engine type		Rotax 947, 2-stroke
Induction type		Reed valve
Exhaust system		Water cooled/water injected with regulator
Exhaust valve		Rotax Adjustable Variable Exhaust (RAVE)
Lubrication	Type	Oil injection
	Oil type	XP-S synthetic injection oil
Number of cylinders		2
Displacement		951.2 cm <sup>3</sup> (58 in <sup>3</sup> )
Rev limiter setting		7200 RPM ± 50
<b>COOLING</b>		
Type		Open circuit. Direct flow from propulsion unit
<b>ELECTRICAL</b>		
Magneto generator output		180 W @ 6000 RPM
Ignition system type		Digital DC-CDI
Spark plug	Make and type	NGK, BR8ES
	Gap	0.5 - 0.6 mm (.020 - .024 in)
Starting system		Electric starter with reduction gear
Battery		12 V, 19 A•h
Fuse	MPEM	5 A
	Electrical system	2 x 15 A
	VTS system	7.5 A
	Bilge pump	3 A
<b>CARBURETION</b>		
Fuel type		Regular unleaded gasoline
Carburetor		BN 46i (diaphragm). Fuel accelerator pump. Quantity: 2
<b>PROPULSION</b>		
Propulsion system		Bombardier Formula pump
Jet pump type		Axial flow, single stage
Transmission		Direct drive/split front and rear
Jet pump oil type		SEA-DOO synthetic polyolester oil SAE 75W90 GL5
Pivoting angle of direction (nozzle)		~20°
Minimum required water level for jet pump		90 cm (3 ft)

N.A.: Not Applicable.

<b>DIMENSIONS</b>		<b>XP (5651/5655)</b>
Number of passengers ①		2
Overall length		272 cm (107 in)
Overall width		112 cm (44.1 in)
Overall height		104 cm (40.6 in)
Weight		255 kg (561 lb)
Load limit (passengers + luggage)		159 kg (350)
<b>CAPACITIES</b>		
Fuel tank		54 L (14 U.S. gal)
Oil injection tank		4 L (1.1 U.S. gal)
Impeller shaft reservoir	Capacity	120 mL (4.0 U.S. oz)
	Oil level	Up to plug

① Refer to load limit.

BOMBARDIER INC. reserves the right to make changes in design and specifications and/or to make additions to, or improvements in its products without imposing any obligation upon itself to install them on its products previously manufactured.

<b>ENGINE</b>		<b>GTS (5639)</b>
Engine type		Rotax 717, 2-stroke
Induction type		Rotary valve
Exhaust system		Water cooled/water injected
Lubrication	Type	Oil injection
	Oil type	BOMBARDIER-ROTAX injection oil
Number of cylinders		2
Displacement		718.2 cm <sup>3</sup> (43.81 in <sup>3</sup> )
Rev limiter setting		7000 RPM ± 50
<b>COOLING</b>		
Type		Open circuit. Direct flow from propulsion unit
<b>ELECTRICAL</b>		
Magneto generator output		160 W @ 6000 RPM
Ignition system type		Digital CDI
Spark plug	Make and type	NGK, BR8ES
	Gap	0.5 - 0.6 mm (.020 - .024 in)
Starting system		Electric starter
Battery		12 V, 19 A•h
Fuse	MPEM	5 A
	Electrical system	15 A
<b>CARBURETION</b>		
Fuel type		Regular unleaded gasoline
Carburetor		BN 40i (diaphragm). Fuel accelerator pump. Quantity: 1
<b>PROPULSION</b>		
Propulsion system		Bombardier Formula pump
Jet pump type		Axial flow, single stage
Transmission		Direct drive
Jet pump oil type		SEA-DOO synthetic polyolester oil SAE 75W90 GL5
Pivoting angle of direction (nozzle)		~26°
Minimum required water level for jet pump		90 cm (3 ft)

N.A.: Not Applicable.

<b>DIMENSIONS</b>		<b>GTS (5639)</b>
Number of passengers ①		3
Overall length		302 cm (119 in)
Overall width		119 cm (46.9 in)
Overall height		95 cm (37.4 in)
Weight		222 kg (488 lb)
Load limit (passengers + luggage)		225 kg (495 lb)
<b>CAPACITIES</b>		
Fuel tank		47 L (12 U.S. gal)
Oil injection tank		4.5 L (1.2 U.S. gal)
Impeller shaft reservoir	Capacity	80 mL (2.7 U.S. oz)
	Oil level	Up to plug

① Refer to load limit.

N.A.: Not Applicable.

BOMBARDIER INC. reserves the right to make changes in design and specifications and/or to make additions to, or improvements in its products without imposing any obligation upon itself to install them on its products previously manufactured.

<b>ENGINE</b>		<b>GTI (5647/5657)</b>	<b>GTX (5653/5690)</b>
Engine type		Rotax 717, 2-stroke	Rotax 947, 2-stroke
Induction type		Rotary valve	Reed valve
Exhaust system		Water cooled/water injected	Water cooled/water injected with regulator
Exhaust valve		N.A.	Rotax Adjustable Variable Exhaust (RAVE)
Lubrication	Type	Oil injection	
	Oil type	BOMBARDIER-ROTAX injection oil	XP-S synthetic injection oil
Number of cylinders		2	
Displacement		718.2 cm <sup>3</sup> (43.81 in <sup>3</sup> )	951.2 cm <sup>3</sup> (58 in <sup>3</sup> )
Rev limiter setting		7000 RPM ± 50	7200 RPM ± 50
<b>COOLING</b>			
Type		Water cooled, total loss type. Direct flow from propulsion unit	
<b>ELECTRICAL</b>			
Magneto generator output		160 W @ 6000 RPM	180 W @ 6000 RPM
Ignition system type		Digital CDI	Digital DC-CDI
Spark plug	Make and type	NGK, BR8ES	
	Gap	0.5 - 0.6 mm (.020 - .024 in)	
Starting system		Electric starter	Electric starter with reduction gear
Battery		12 V, 19 A•h	
Fuse	MPEM	5 A	
	Electrical system	2 x 15 A	
	VTS system	N.A.	
<b>CARBURETION</b>			
Fuel type		Regular unleaded gasoline	
Carburetor		BN 40i (diaphragm). Fuel accelerator pump. Quantity: 1	BN 46i (diaphragm). Fuel accelerator pump. Quantity: 2
<b>PROPULSION</b>			
Propulsion system		Bombardier Formula pump	
Jet pump type		Axial flow, single stage	
Transmission		Direct drive	
Jet pump oil type		SEA-DOO synthetic polyolester oil SAE 75W90 GL5	
Pivoting angle of direction (nozzle)		~23°	
Minimum required water level for jet pump		90 cm (3 ft)	

N.A.: Not Applicable.

<b>DIMENSIONS</b>		<b>GTI (5647/5657)</b>	<b>GTX (5653/5690)</b>
Number of passengers ①		3	
Overall length		315 cm (124 in)	
Overall width		123 cm (48.4 in)	
Overall height		104 cm (41.9 in)	
Weight		275 kg (605 lb)	301 kg (662 lb)
Load limit (passengers + luggage)		243 kg (535 lb)	
<b>CAPACITIES</b>			
Fuel tank		56.5 L (15 U.S. gal)	
Oil injection tank		6 L (1.6 U.S. gal)	
Impeller shaft reservoir	Capacity	100 mL (2.7 U.S. oz)	120 mL (4.0 U.S. oz)
	Oil level	Up to plug	

① Refer to load limit.

BOMBARDIER INC. reserves the right to make changes in design and specifications and/or to make additions to, or improvements in its products without imposing any obligation upon itself to install them on its products previously manufactured.

<b>ENGINE</b>		<b>GTX RFI (5648/5658)</b>	<b>GSX RFI (5645/5654)</b>
Engine type		BOMBARDIER-ROTAX 787, 2-stroke	
Induction type		Rotary valve	
Exhaust system		Water cooled/water injected with regulator	
Exhaust valve		Rotax Adjustable Variable Exhaust (RAVE)	
Lubrication	Type	Oil injection	
	Oil type	XP-S synthetic injection oil	
Number of cylinders		2	
Displacement		781.6 cm <sup>3</sup> (47.7 in <sup>3</sup> )	
Rev limiter setting		7100 (± 50) RPM	
<b>COOLING SYSTEM</b>			
Type		Open circuit. Direct flow from propulsion unit	
<b>ELECTRICAL SYSTEM</b>			
Magneto generator output		270 W @ 6000 RPM	
Ignition system type		Digital inductive type	
Spark plug	Make and type	NGK, BR8ES	
	Gap	0.5 - 0.6 mm (.020 - .024 in)	
Starting system		Electric starter	
Battery		12 V, 19 A•h	
Fuse	MPEM	5 A	
	Electrical system	2 x 20 A, 1 x 15 A	
	Fuel pump	10 A	
	Info center	1 A	
	VTS system	N.A.	20 A
<b>FUEL SYSTEM</b>			
Fuel type		Regular unleaded gasoline	
Fuel injection		Rotax Fuel Injection, single throttle body (56 mm (2.21 in))	
<b>PROPULSION</b>			
Propulsion system		Bombardier Formula pump	
Jet pump type		Axial flow, single stage	
Transmission		Direct drive	
Impeller shaft reservoir oil type		SEA-DOO jet pump synthetic polyolester oil SAE 75W90 GL5	
Pivoting angle of direction (nozzle)		~ 20°	
Minimum required water level for jet pump		90 cm (3 ft)	

N.A.: Not Applicable.

<b>DIMENSIONS</b>		<b>GTX RFI (5648/5658)</b>	<b>GSX RFI (5645/5654)</b>
Number of passengers ①		3	2
Overall length		315 cm (124 in)	270 cm (106.3 in)
Overall width		123 cm (48.4 in)	116 cm (45.7 in)
Overall height		107 cm (42.1 in)	99 cm (39 in)
Weight		292 kg (642 lb)	234 kg (515 lb)
Load limit (passengers + luggage)		243 kg (535 lb)	159 kg (350)
<b>CAPACITIES</b>			
Fuel tank		56.5 L (15 U.S. gal)	
Impeller shaft reservoir	Capacity	100 mL (4.0 U.S. oz)	
	Oil level	Up to plug	
Oil injection reservoir		6 L (1.6 U.S. gal)	

① Refer to load limit.

BOMBARDIER INC. reserves the right to make changes in design and specifications and/or to make additions to, or improvements in its products without imposing any obligation upon itself to install them on its products previously manufactured.



# SI\* METRIC INFORMATION

BASE UNITS			
DESCRIPTION	UNIT	SYMBOL	
length .....	meter .....	m	
mass .....	kilogram .....	kg	
force .....	newton .....	N	
liquid .....	liter .....	L	
temperature .....	Celsius .....	°C	
pressure .....	kilopascal .....	kPa	
torque .....	newton-meter .....	N•m	
land velocity .....	kilometer per hour .....	km/h	
navigation velocity .....	knot .....	kn	

PREFIXES			
PREFIX	SYMBOL	MEANING	VALUE
kilo .....	k .....	one thousand .....	1000
centi .....	c .....	one hundredth of .....	0.01
milli .....	m .....	one thousandth of .....	0.001
micro .....	μ .....	one millionth of .....	0.000001

CONVERSION FACTORS			
TO CONVERT	TO ①	MULTIPLY BY	
in .....	mm .....	25.4	
in .....	cm .....	2.54	
in <sup>2</sup> .....	cm <sup>2</sup> .....	6.45	
in <sup>3</sup> .....	cm <sup>3</sup> .....	16.39	
ft .....	m .....	0.3	
oz .....	g .....	28.35	
lb .....	kg .....	0.45	
lbf .....	N .....	4.4	
lbf•in .....	N•m .....	0.11	
lbf•ft .....	N•m .....	1.36	
lbf•ft .....	lbf•in .....	12	
PSI .....	kPa .....	6.89	
imp. oz .....	U.S. oz .....	0.96	
imp. oz .....	mL .....	28.41	
imp. gal .....	U.S. gal .....	1.2	
imp. gal .....	L .....	4.55	
U.S. oz .....	mL .....	29.57	
U.S. gal .....	L .....	3.79	
knot .....	MPH .....	1.15	
MPH .....	km/h .....	1.61	
Fahrenheit .....	Celsius .....	$(°F - 32) \div 1.8$	
Celsius .....	Fahrenheit .....	$(°C \times 1.8) + 32$	
hp .....	kW .....	.75	

\* The international system of units abbreviates SI in all languages.

① To obtain the reverse sequence, divide by the given factor. Example: to convert millimeters to inches, divide by 25.4.

NOTE: Conversion factors are rounded off to 2 decimals for easier use.

---

## ABBREVIATIONS USED IN THIS MANUAL

	DESCRIPTION
AC	Alternate Current
CDI	Capacitor discharge ignition
DC	Direct current
DESS	Digitally encoded security system
E.I.N.	Engine identification number
ECU	Electronic control unit
HP	Horse power
LCD	Liquid Crystal Display
LED	Light-emitting diode
MAG	Magneto
MPEM	Multi-purpose electronic module
MPH	Mile per hour
N.A.	Not applicable
OPT	Optional
P/N	Part number
PFD	Personal flotation device
PTO	Power take off
RAVE	Rotax adjustable variable exhaust
RFI	Rotax fuel injection
RPM	Revolution per minute
STD	Standard
VROI	Variable rate oil injection
VTS	Variable trim system

**WATERCRAFT MODEL No.** \_\_\_\_\_

**HULL**

IDENTIFICATION NUMBER (H.I.N.) \_\_\_\_\_

**ENGINE**

IDENTIFICATION NUMBER (E.I.N.) \_\_\_\_\_

**Purchase Date** \_\_\_\_\_

year month day

**Warranty Expiry Date** \_\_\_\_\_

year month day

To be completed by the authorized Sea-Doo dealer at the time of the sale.

DEALER IMPRINT AREA

**Please verify with your selling dealer to ensure your SEA-DOO watercraft has been registered with Bombardier.**







AFFIX  
PROPER  
POSTAGE

**BOMBARDIER**  
RECREATIONAL PRODUCTS  
WARRANTY DEPARTMENT  
75, J.A. BOMBARDIER ST.  
SHERBROOKE (QUEBEC)  
CANADA J1L 1W3





AFFIX  
PROPER  
POSTAGE

**BOMBARDIER**  
RECREATIONAL PRODUCTS  
WARRANTY DEPARTMENT  
75, J.A. BOMBARDIER ST.  
SHERBROOKE (QUEBEC)  
CANADA J1L 1W3







AFFIX  
PROPER  
POSTAGE

**BOMBARDIER**  
RECREATIONAL PRODUCTS  
WARRANTY DEPARTMENT  
75, J.A. BOMBARDIER ST.  
SHERBROOKE (QUEBEC)  
CANADA J1L 1W3

# SEA-DOO



## SEA-DOO

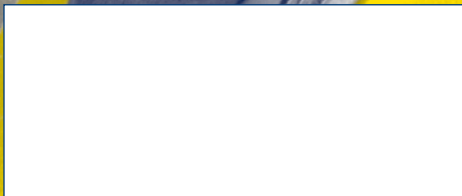

® Trademarks of Bombardier Inc. and/or its subsidiaries.  
© 1999 Bombardier Inc. All rights reserved.  
Printed in Canada

**BOMBARDIER**  
RECREATIONAL PRODUCTS



VERSION FRANÇAISE ÉGALEMENT DISPONIBLE