

can-am®



2016

User's Guide

Can-Am® Freedom Trailer

⚠ WARNING

Read this User's Guide. It contains important safety information. **Keep** this guide in the trailer.

 **WARNING**

Disregarding any of the safety precautions and instructions contained in this guide and on-product labels could cause injury including the possibility of death!

In Canada, products are distributed by Bombardier Recreational Products Inc. (BRP).

In USA, products are distributed by BRP US Inc.

This is a non-exhaustive list of trademarks that are the property of Bombardier Recreational Products Inc. or its affiliates:

Can-Am®

Spyder®

INTRODUCTION

Congratulations on your purchase of your new BRP Can-Am® Freedom Trailer . It is backed by the BRP warranty and a network of authorized Can-Am Spyder™ dealers ready to provide the parts or service you may require.

Please take the time to enter your trailer key code with its corresponding BRP part number using the table provided below.

MY TRAILER KEY CODE IS:

THE CORRESPONDING BRP PART NUMBER IS:

KEY CODE	BRP PART NUMBER
1010	705 009 379
1011	705 009 380
1012	705 009 381
1013	705 009 382
1014	705 009 383
1015	705 009 384
1016	705 009 385
1017	705 009 386
1018	705 009 387
1019	705 009 388

Know Before you Go

Read this guide and follow all instructions before installing or using this product.

Read the *VEHICLE OPERATOR'S GUIDE* and all on-product warning labels carefully and follow the operating procedures described.

Failure to follow the warnings contained in this User's Guide can result in **SERIOUS INJURY or DEATH.**

About this User's Guide

The following guide will help you become better acquainted with your new trailer and its safe operation.

If you want to view and/or print an extra copy of this User's Guide, simply visit the following website:

www.operatorsguide.brp.com

It is understood that this User's Guide may be translated into another language. In the event of any discrepancy, the English version shall prevail.

The information and components/system descriptions contained in this document are correct at the time of publication. BRP, however, maintains a policy of continuous improvement of its products without imposing upon itself any obligation to install them on products previously manufactured. Due to late changes, some differences between the manufactured product and the descriptions and/or specifications in this guide may occur. BRP reserves the right at any time to discontinue or change specifications, designs, features or equipment without incurring any obligation upon itself.

The illustrations in this document show the typical construction of the different assemblies and may not reproduce the full detail or exact shape of the parts. However, they represent parts that have the same or similar function.

Safety Messages

The types of safety messages, what they look like and how they are used in this guide are explained as follows:

▲ WARNING
Indicates a potential hazard which, if not avoided, could result in serious injury or death.

⚠ CAUTION Indicates a hazard situation which, if not avoided, could result in minor or moderate injury.

NOTICE Indicates an instruction which, if not followed, could severely damage trailer components or other property.

TABLE OF CONTENTS

INTRODUCTION	1
Know Before you Go	1
About this User's Guide	1
Safety Messages	1

SAFETY INFORMATION

SPECIAL SAFETY MESSAGES	6
Important Warnings	6
Important Information	6
LOCATION OF THE SAFETY LABELS	8
PRE-RIDE INSPECTION	9

OPERATING INSTRUCTIONS

ATTACHING YOUR TRAILER	12
Coupling Trailer to Hitch	12
Connecting Trailer Lights	13
LOADING YOUR TRAILER	14
Opening and Closing the Cover	14
Maximum Load	14
Load Distribution	15
Inappropriate Cargo	16
Adjusting the Suspension	16
ON THE ROAD	18
Driving Tips	18
Riding Speed	18

TECHNICAL INFORMATION

TRAILER IDENTIFICATION	20
REPORTING SAFETY DEFECTS	21

MAINTENANCE

MAINTENANCE SCHEDULE	24
MAINTENANCE PROCEDURES	25
Coupler	25
Tires	25
Wheels	25
Wheel Bearings	25
Wheel Bearing Seal	26
Lights	26
Wiring Harness	27

STORAGE AND PRESEASON PREPARATION **28**

TRAILER CARE **29**

 Trailer Cleaning 29

 Trailer Waxing 29

WARRANTY

BRP LIMITED WARRANTY - USA AND CANADA: 2016 Can-Am FREEDOM TRAILER..... **32**

CUSTOMER INFORMATION

PRIVACY INFORMATION..... **38**

CHANGE OF ADDRESS/OWNERSHIP..... **39**

SAFETY INFORMATION

SPECIAL SAFETY MESSAGES

Important Warnings

SEVERE INJURY OR DEATH can result if you do not follow these instructions:

Before taking the first trip with the trailer coupled to a Can-Am Spyder, it is recommended performing exercises as indicated in the *VEHICLE'S OPERATOR'S GUIDE* to become familiar with different handling characteristics. If you are planning to use this Can-Am Spyder trailer with any other vehicle, make at least one short trial run. This will help you learn about the new behavior of your vehicle.

When riding, pay particular attention to the following:

- Do not use the cruise control.
- Use a longer following distance from the vehicle in front of you.
- When towing a trailer, more time and distance is needed when passing or stopping.
- Reduce your speed and slow down more than usual before turning and avoid sharp turns.
- When cornering, achieve the turn on a larger radius. It takes more space to turn with a trailer.
- Always move slowly when backing up. Ask someone to guide you when possible. Practice in an open area at the first opportunity.
- Be prepared for sudden changes in air pressure or wind buffering when trucks pass from either direction. Slow down and keep a firm grip on handlebar. Do not apply brakes to correct trailer swaying. Continued pulling of the trailer provides a stabilizing force to correct swaying.
- When going downhill, reduce speed and shift into lower gears before starting down.

Loss of control of the trailer or trailer/Spyder combination can result in death or serious injury. The most common causes of loss of control of the trailer are:

- Driving too fast for the conditions.
- Overloading the trailer or loading the trailer incorrectly.
- Trailer improperly coupled to the hitch.
- Inadequate towing hitch.
- Not maintaining proper tire pressure.
- Not keeping wheel lug nuts tight.

Always perform the pre-ride inspection for safe riding.

Maintain your trailer as per the maintenance schedule.

Important Information

WARNING

All safety rules should be followed as per *VEHICLE OPERATOR'S GUIDE*, the specific instructions included in this guide should also be observed when using this trailer with a Can-Am Spyder.

Trailer

This BRP Can-Am Freedom Trailer has been specially designed to be used with your Can-Am Spyder in conjunction with the BRP Spyder hitch.

Hitch

Use only the hitch and the lights control module sold by BRP or an approved equivalent. The BRP hitch is specially designed to fit properly on the swing arm of a Can-Am Spyder.

NOTICE The use of a non-recommended light control module may lead to vehicle electrical system failure.

The BRP hitch has an integrated damper to protect the vehicle's swing arm and the trailer.

WARNING

The use of hitch with an insufficient load rating can result in a loss of control and hitch breakdown.

NOTICE The use of a non-approved hitch may lead to rear swing arm failure.

Be sure the hitch ball size matches the coupler size.

Inspect the hitch for wear, corrosion and cracks before coupling. Replace the required components if any of the above conditions are observed.

WARNING

Do not tow whenever a component is defective.

NOTICE The coupling socket should not be allowed to rest on the ground where dirt and sand can enter the socket. This will lead to excessive wear or cause the locking mechanism to jam.

Ensure hitch is tight before coupling the trailer to the vehicle.

WARNING

An improperly coupled trailer can result in serious injury or death. Never move the trailer with the tow vehicle until pre-ride inspection is completed.

Tow Vehicle

Even if this trailer is designed to be used with a Can-Am Spyder, some models cannot tow a trailer. Each Spyder is equipped with the vehicle stability system (VSS), it is important

to ensure the trailer and the Spyder remain stable during normal operation and it does not interfere with the VSS.

WARNING

Using this trailer with a non-recommended vehicle may lead to a loss of control.

SE5/SE6 Models

If this trailer is towed by SE5/SE6 models, the trailer mode must be activated to adapt gear changes. Refer to the Spyder ST/ Spyder RT Operator's Guide.

NOTICE If trailer mode is not activated when towing a trailer, engine components might be damaged.

Accessories and Modifications

We recommend genuine BRP products for replacement parts and accessories. They've been especially designed for your trailer and manufactured to meet BRP's demanding standards.

Do not make unauthorized modifications, or use accessories that are not approved by BRP. Since these changes have not been tested by BRP, they may increase the risk of accidents or injuries, and they can make the trailer illegal for use.

LOCATION OF THE SAFETY LABELS

The following labels are on your trailer. If missing or damaged, they can be replaced free of charge. See an authorized Can-Am Spyder dealer.

Please read the following labels carefully before using your trailer.

NOTE: The illustrations of the trailer indicate the approximate locations of the labels. A dotted line indicates that the label is not on the outer surface, and that the cover must be opened to see the label.

▲ WARNING

704902271

Serious injury or death can result if this trailer is towed before familiarizing yourself with the manufacturer's operation instructions listed below. Do not exceed the tow vehicle's 'low rating' or exceed the GVWR or GCWR.

Read user's guide before using this trailer. You are required to comply with local and state requirements regarding brakes, flooring and any additional equipment that may be necessary. Contact your state motor vehicle department for more information.

Before towing this trailer check that:

- Coupler hitch and trailer ball are the same size. Coupler is latched.
- Safety chains or cables are crisscrossed under tongue and attached to towing vehicle.
- All trailer lighting is working correctly. Load is secured to trailer (front and rear).
- Tongue jack (if trailer is equipped) is retracted.
- Wheel lug nuts are properly tightened. Tires are inflated to the recommended pressure.
- Load is within trailer capacity and distributed properly to maintain proper tongue weight.

704902271

WARNING LABEL

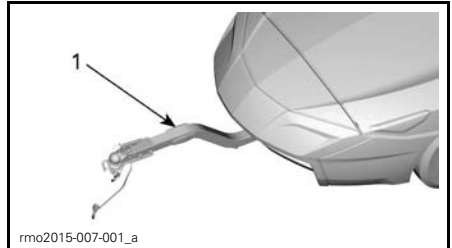

1. Warning label location

TIRE AND LOADING INFORMATION
RENSEIGNEMENTS SUR LES PNEUS ET LE CHARGEMENT

THE WEIGHT OF CARGO SHOULD NOT EXCEED 91 KG / 200 LBS.
LE POIDS DU CHARGEMENT NE DOIT JAMAIS DÉPASSER 91 KG / 200 LB

TIRE PNEU	SIZE DIMENSIONS	COLD TIRE PRESSURE PRESSION DES PNEUS À FROID	SEE USER'S GUIDE FOR ADDITIONAL INFORMATION
LEFT GAUCHE	4.80 X 12	241 KPA (35 PSI)	VOIR LE GUIDE DE L'UTILISATEUR POUR PLUS DE RENSEIGNEMENTS
RIGHT DROIT	4.80 X 12	241 KPA (35 PSI)	

704904744

TIRE PRESSURE AND TRAILER LOAD

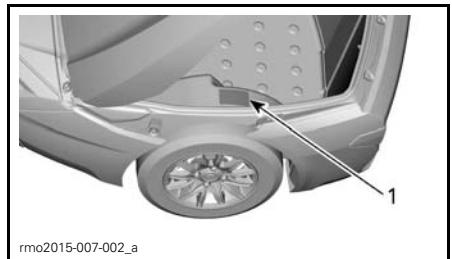

INSIDE COVER

1. Tire pressure and trailer load location

PRE-RIDE INSPECTION

WARNING

Perform a pre-ride inspection before each use to detect potential problems during operation. The pre-ride inspection can help you monitor wear and deterioration before they become a problem. Correct any problems that you discover to reduce the risk of a breakdown or crash. See an authorized Can-Am Spyder dealer as necessary.

OPERATION	✓
Check if there is any play between the hitch ball and the coupler.	
Check all fasteners and connections.	
Check tires condition and if they are properly inflated.	
Check tightness of wheel lug nuts.	
Check if load is properly distributed.	
Check if load is within maximum load carrying capacity.	
Check if cargo is properly secured to make sure load will not shift during towing.	
Check if coupler is latched.	
Check if safety chains are crisscrossed under tongue and attached to hitch.	
Check that all lights are in proper working order and they work with related components.	
Clean all reflectors.	
Make sure cover is properly latched.	
When using with SE5/SE6 models, make sure the multifunction gauge is set to trailer mode.	

***This page is
intentionally blank***

OPERATING INSTRUCTIONS

ATTACHING YOUR TRAILER

Coupling Trailer to Hitch

1. Make sure hitch ball and coupler are the same size (the factory coupler accepts a 1-7/8 in hitch ball).
2. Back the tow vehicle as close as possible to the trailer. This is easier and safer than pulling the trailer to the vehicle.
3. Be sure the coupler-locking mechanism is released.
4. Raise the front end of the trailer. Position the coupler directly over the hitch ball and lower until it is all the way down.

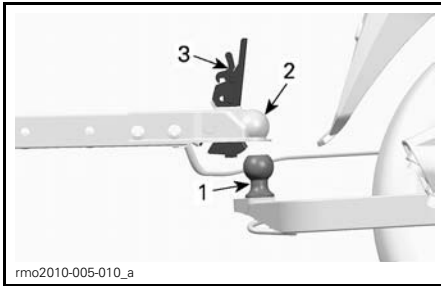

1. Hitch ball
 2. Coupler
 3. Coupler-locking mechanism in unlocked position
5. Check under the coupling to be certain that the ball clamp is below the ball and not resting on top of the ball.

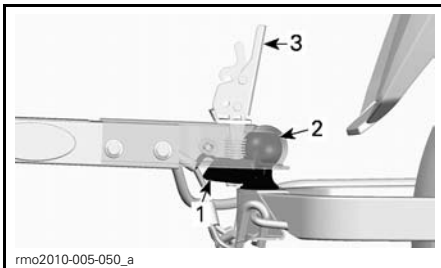

1. Ball clamp
2. Hitch ball in coupler
3. Coupler-locking mechanism in unlocked position

6. Lock the coupler to the hitch ball. Be sure the coupler is in the locked position and the locking pin is placed through the coupler-locking mechanism. Try to lift up the trailer tongue. If it comes loose from the ball, unlock and start procedure again.

NOTE: You can adjust the play by tightening or loosening the nut under the coupler.

⚠ WARNING

If the coupler cannot be secured to hitch ball, do not tow the trailer. Refer to an authorized Can-Am Spyder dealer to have the trailer inspected.

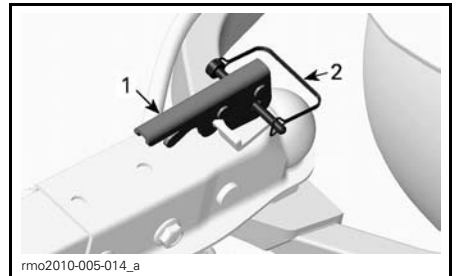

1. Coupler-locking mechanism in locked position
2. Locking pin

NOTE: At this point the tow vehicle and the trailer should be level.

Securing Trailer to Hitch

1. Attach safety chains to hitch. Attach the left chain to the bracket on the right side of hitch and the right chain to the left bracket.

NOTE: Chains should be crossed underneath the coupler with just enough slack to permit tight turns. Ensure chains will not drag on the ground.

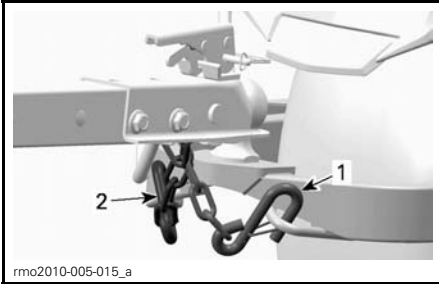

1. Left safety chain attaches on right side of hitch
2. Right safety chain attaches on left side of hitch

Connecting Trailer Lights

NOTICE To avoid damaging wiring harness, ensure the harness does not pass between chains.

1. Remove the protective cap from vehicle connector.

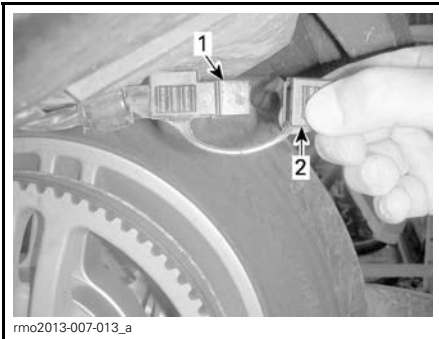

RT MODEL SHOWN

1. Vehicle connector
2. Protective cap

NOTE: On Spyder RT models, the vehicle connector is located on the LH side of vehicle, under the rear side storage compartment. On Spyder ST models, the vehicle connector is located on the RH side of vehicle close to the muffler.

CAUTION Be careful not to touch the muffler when reaching for vehicle connector.

2. Align trailer connector with vehicle connector.

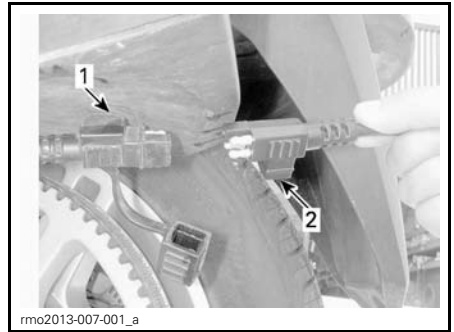

RT MODEL SHOWN

1. Vehicle connector
2. Trailer connector

3. Connect trailer connector to vehicle connector by firmly squeezing them in place. Make sure they are well secured into one another, if needed, lubricate the tips. Place protective cap on specially designed hump, see illustration below for reference.



ST MODEL SHOWN

LOADING YOUR TRAILER

Opening and Closing the Cover

Opening Cover

The cover stays open with the help of 2 cover struts.

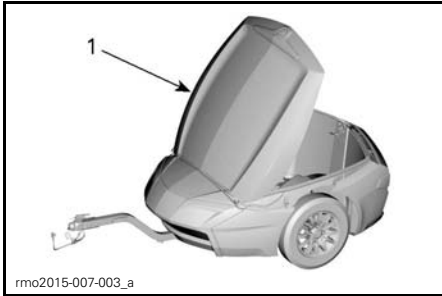

1. Cover

The cover can be opened by pulling opening latch located on the back of trailer.

NOTE: Trailer comes with 2 keys. The trailer has its own key and key match. Please take the time to note your key number on key and in provided table. Refer to *INTRODUCTION* section.

Emergency Cover Handle

In case a person locks themselves in the trailer, an emergency handle has been installed to open the cover from the inside.

This handle is located on the cover latch mechanism inside the trailer and is luminescent.

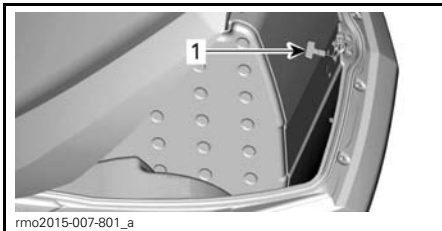

1. Emergency cover handle

Pull on the emergency cover handle to open the cover from the inside.

Closing Cover

Simply close the cover and press gently near the locking pin to lock it.

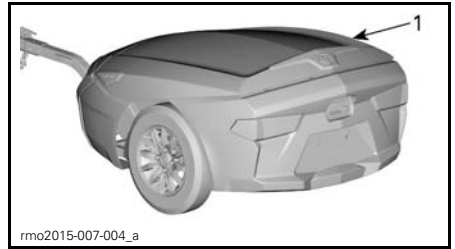

1. Press here to lock the cover

Maximum Load

⚠ WARNING

Exceeding the maximum towed weight can seriously affect handling or cause damage to the vehicle and trailer. Always respect the maximum load allowed. Failure to follow the recommendations could affect the vehicle handling and lead to loss of control.

The quantity of cargo inside the trailer compartment may vary according to the object weight. The maximum cargo weight allow for this trailer is 91 kg (200 lb).

⚠ WARNING

Even if the trailer capacity is 566 L (150 U.S. gal.), never use this capacity as a guide to determine if the trailer is enough or not enough load. Always use cargo weight.

MAXIMUM CARGO WEIGHT	91 kg (200 lb)
-----------------------------	----------------

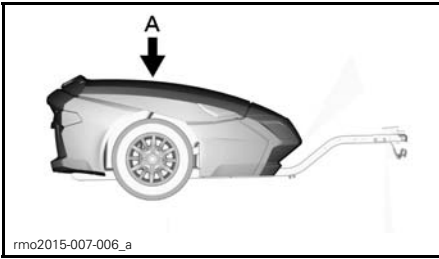

rmo2015-007-006_a

A. 91 kg (200 lb)

NOTICE Exceeding the maximum towed weight can damage vehicle or trailer.

Load Distribution

⚠ WARNING

The vehicle handling, stability, acceleration and braking distance are affected when towing a trailer. Correct loading and weight distribution are important. Never overload, tow or carry cargo improperly. Failure to follow the recommendations could affect the vehicle handling and lead to loss of control.

Since the road can be bumpy, place the cargo so that it does not shift while the trailer is being towed. Always secure cargo as low as possible in the trailer.

⚠ WARNING

Shifting cargo can result in loss of control.

Improper weight distribution in trailer can cause a trailer swaying (sway from side to side).

Load distribution has a direct effect on tongue weight and handling. More weight at the tongue reduces steering control. Less weight at the tongue can render the trailer unstable and make it sway.

The most effective way to guard against swaying is proper distribution of the cargo. Position 55% of cargo weight forward of trailer axle and 45% to rear of the trailer axle.

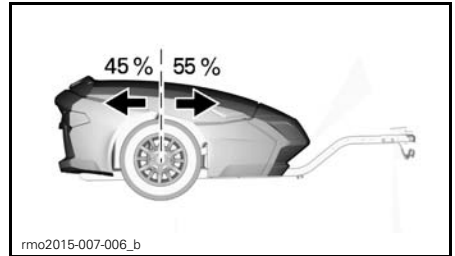

rmo2015-007-006_b

For partial loading of trailer, place cargo at the front. If the maximum tongue weight is reached, distribute remaining cargo toward rear.

MAXIMUM TONGUE WEIGHT	18 kg (40 lb)
------------------------------	---------------

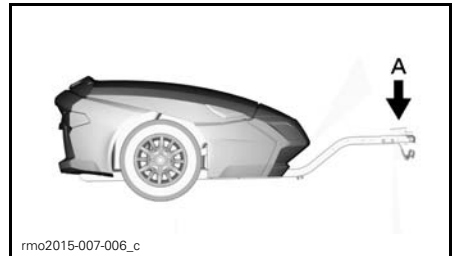

rmo2015-007-006_c

A. 18 kg (40 lb)

Tongue Weight

A spring weighting scale can be used to measure the weight at the tongue when it is not latched to the hitch.

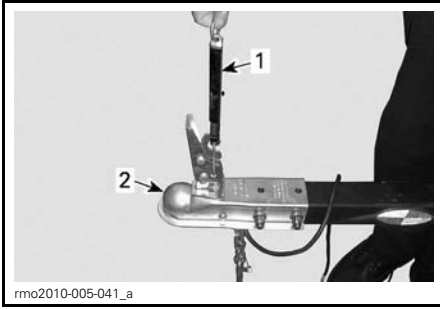

1. Spring weighting sale
2. Coupler

If necessary, redistribute the weight in the trailer to meet the maximum allowable tongue weight.

Inappropriate Cargo

⚠ WARNING

Never carry passengers in the back of any trailer. Passengers in the trailer risk injury due to shifting cargo, asphyxiation and lack of collision protection.

NOTICE Avoid transporting heavy parts with sharp edges that could damage the trailer.

Do not transport flammable, explosive, poisonous or other dangerous materials in the trailer. An empty or partially full container is just as dangerous as a full one. Flammables may explode or ignite because of vehicle movement, road vibrations or cargo shifting.

Never load cargo on the outside of the trailer. These items may be ejected and cause a roadway hazard.

Do not load with cargo that prevents closure of the trailer cover.

Adjusting the Suspension

Unloaded Trailer Spring Preload

1. Lift the rear of trailer, using the side of fender as a lifting point, until shock absorbers are fully extended. Make sure both wheels stay on ground.

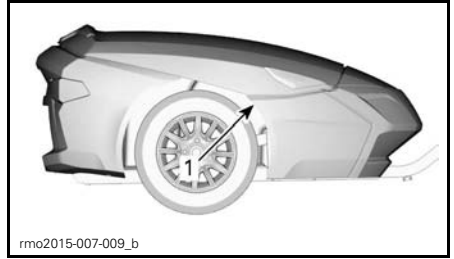

1. Lifting location

2. While shock absorbers are extended, measure the height between the fender edge and the ground.

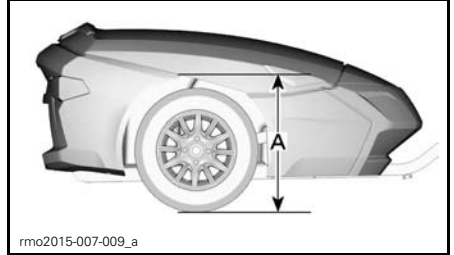

- A. Suspension height

3. Lower trailer and using the same measurement points, measure the height again.

The difference between both measures should be approximately 25 mm to 32 mm (1 in to 1.25 in). Increase or decrease spring preload to be within this recommended range. See *SPRING PRELOAD ADJUSTMENT*.

Loaded Trailer Spring Preload

Before beginning, adjust the unloaded trailer spring preload. See procedure above.

1. While the trailer is empty, measure the height between the fender edge and the ground.
2. Load the trailer. Make sure to respect the maximum load allowed for the trailer, the tongue weight and the load distribution.
3. Using the same measurement points, measure the height again.

The difference between both measures should be approximately 19 mm to 25 mm (.75 in to 1 in). Increase or decrease spring preload to be within this recommended range. See *SPRING PRELOAD ADJUSTMENT*.

Spring Preload Adjustment

NOTE: This procedure should be performed with an unloaded trailer.

The suspension can be adjusted for a softer or stiffer ride.

To adjust spring preload do the following:

1. Remove a wheel.
 - 1.1 Loosen wheel lug nuts.
 - 1.2 Install a jack under trailer frame.

NOTICE Make sure to place the jack under frame and not under trailer shell. Severe damages will occur if the trailer is raised by its shell.

- 1.3 Remove the four wheel lug nuts.
- 1.4 Remove the wheel.
2. Using a suspension adjustment tool, turn cam appropriately to increase or decrease spring preload.

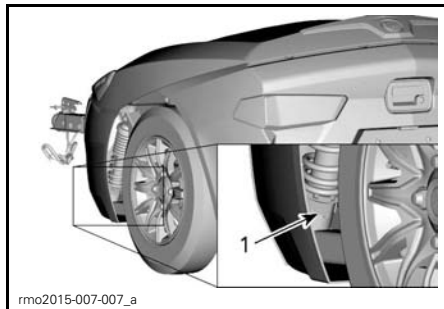

1. To increase preload

⚠ WARNING

The left and right shock adjustment must always be set to the same position. Uneven adjustment can result in loss of control and can lead to an accident.

3. Reinstall wheel and tighten lug nuts to the specified torque in a criss-cross sequence.

TIGHTENING TORQUE

Wheel lug nuts	105 N•m ± 15 N•m (77 lbf•ft ± 11 lbf•ft)
----------------	---

4. Repeat steps 1 to 3 on the other side of trailer.
5. Make at least one short trial run before taking a ride to confirm suspension calibration and to become familiar with different handling characteristics.

ON THE ROAD

Driving Tips

Crosswinds and air turbulence caused when crossing or being passed by can disrupt the steering and make the trailer sway. To minimize the effect, do not make quick steering or braking corrections. Reduce speed slowly and stay in your way.

If a wheel goes off the paved roadway, DO NOT steer sharply and DO NOT brake. Let off the gas handle and slow down below 40 km/h (25 MPH). Then steer gradually back onto the roadway. Proceed with caution entering traffic.

When possible, avoid swerving, twist and turns, sharp and abrupt turns as well as sudden braking. This could cause the trailer to jackknife. It is easier to unstabilize an empty trailer.

Try to anticipate the riding ahead to avoid having to backup with a trailer.

When accelerating, it is normal to shift at a higher RPM to avoid loading excessively the engine.

NOTICE Avoid spinning the rear wheel. Rocks or pebbles could be projected on the trailer and damage it.

Flat tire

A sudden bumping or "swaying" may occur. DO NOT induce hard braking. Slowly pull over in a safe area.

Riding Speed

With ideal road conditions, the maximum speed to safely towing this trailer should never exceed maximum speed road. Always respect speed limit all time.

WARNING

Driving too fast for conditions can result in serious loss of control and cause injury or death. Decrease vehicle speed as road, weather or lighting conditions deteriorate.

TECHNICAL INFORMATION

TRAILER IDENTIFICATION

The trailer is identified by a serial number. It may sometimes become necessary to locate this number for warranty purposes or to trace the trailer in the event of theft. The serial number is located on the frame and can be saw by the LH rear wheel housing.

MANUFACTURED BY/FABRIQUÉ PAR: BOMBARDIER RECREATIONAL PRODUCTS INC. / BOMBARDIER PRODUITS RÉCRÉATIFS INC.		DATE :
		ASSEMBLED IN / ASSEMBLÉ AU CANADA
	GVWR / PNBV : 182 KG (400 LB)	GAWR / PNBE : 182 KG (400 LB)
	TIRES / PNEUS : 4.80 X 12 LRB	RIMS / JANTES : 12 X 4 JA
COLD TIRE INFLATE / PRESSION DE GONFLAGE À FROID : 241 KPA (35 PSI)		
THIS VEHICLE CONFORMS TO ALL APPLICABLE U.S. FEDERAL MOTOR VEHICLE SAFETY STANDARDS (FMVSS) IN EFFECT ON THE DATE OF MANUFACTURE SHOWN ABOVE.		
TYPE OF VEHICLE : TRA		TYPE DE VEHICULE : REM
V.I.N. / N.I.V. :	MODÈLE: MODEL :	704904021

704904021

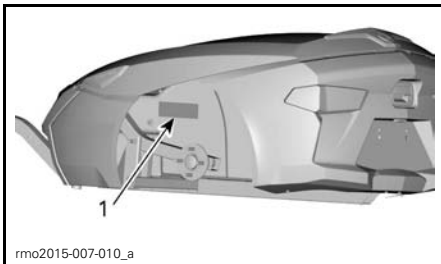

WHEEL REMOVED FOR CLARITY PURPOSE ONLY

1. Trailer serial number

REPORTING SAFETY DEFECTS

Your safety is very important to BRP. If you have any concerns you should immediately contact BRP's customer service.

In the USA, if you believe that your vehicle has a defect which could cause a crash or could cause injury or death, you should immediately inform the National Highway Traffic Safety Administration (NHTSA) in addition to notifying BRP.

If NHTSA receives similar complaints, it may open an investigation, and if it finds that a safety defect exists in a group of vehicles, it may order a recall and remedy campaign. However, NHTSA cannot become involved in any individual problems between you, your dealer or Bombardier Recreational Products Inc.

To contact NHTSA:

By phone: Safety Hotline toll-free:
1 888-327-4236 (TTY: 1 800-424-9153)

By mail: Administrator NHTSA
400 7th Street SW
Washington DC 20590

By E-mail: www.safercar.gov

You can also obtain other information about motor vehicle safety from the website www.safercar.gov.

***This page is
intentionally blank***

MAINTENANCE

MAINTENANCE SCHEDULE

Maintenance is very important for keeping your trailer in safe operating condition. The maintenance schedule does not exempt the pre-ride inspection.

Every year:

- Check coupler condition and tighten coupler fasteners.
- Check tires condition and wear.
- Inspect wheels for damages.
- Check cover latch operation.
- Check tightness of frame fasteners.
- Verify ground cable condition and connection.

MAINTENANCE PROCEDURES

This section includes instructions for basic maintenance procedures. If you have the necessary mechanical skills and the required tools, you can perform these procedures. If not, see your authorized Can-Am Spyder dealer.

⚠ WARNING

Torque wrench tightening specifications must be strictly adhered to.

Locking devices (e.g.: locking tabs, elastic stop nuts, cotter pins, etc.) must be replaced.

Hoses, cables or locking ties removed during a procedure must be reinstalled as per factory standards.

Coupler

Coupler Inspection

Check tightness of coupler bolts. If bolts are loose, check coupler and tongue for damage. Retighten bolts to the specified torque.

TIGHTENING TORQUE	
Coupler bolts	48 N•m ± 6 N•m (35 lbf•ft ± 4 lbf•ft)

Check locking mechanism operation. Lubricate and adjust as required.

Tires

Tire Pressure

Check tires pressure. Tire pressure must be checked while the tire is cold.

NOTE: Do not check the tire pressure immediately after towing the trailer. Allow at least three hours for a tire to cool, if the trailer has been towed for as much as 1.6 km (1 mi).

TIRE PRESSURE	
Cold tire	241 kPa (35 PSI)

Tire Inspection

Replace the tire before towing the trailer if the tire tread has less than 1.6 mm (1/16 in) depth or if the built-in wear indicator bars are visible and flush with the remainder of the tire tread.

Inspect both sidewalls of each tire for any bubble, cut or bulge; and replace a damaged tire before towing the trailer.

⚠ WARNING

A bubble, cut or bulge in the sidewall can result in a tire blowout and loss of control which can lead to serious injury or death.

Wheels

Wheel Inspection

Check wheel for cracks, bumps or other damages. Replace wheel as required.

Wheel Bearings

Wheel Bearing Inspection

Install a jack under trailer frame.

NOTICE Make sure to place the jack under frame and not under trailer shell. Severe damages will occur if the trailer is raised by its shell.

Push and pull the wheel from the upper edge to feel the play.

If any play is felt, replace wheel hub. See *WHEEL HUB REMOVAL* and *WHEEL HUB INSTALLATION*.

Check if the wheel turns freely. If wheel is hard to turn, replace wheel hub.

Wheel Hub Removal

NOTE: Bearings are not available as spare parts. When bearing replacement is required, replace wheel hub as an assembly.

1. Install a jack under trailer frame.

NOTICE Make sure to place the jack under frame and not under trailer shell. Severe damage will occur if the trailer is raised by its shell.

2. Remove the wheel.
3. Remove the protective cap.
4. Remove the wheel hub nut and washer. Discard nut.

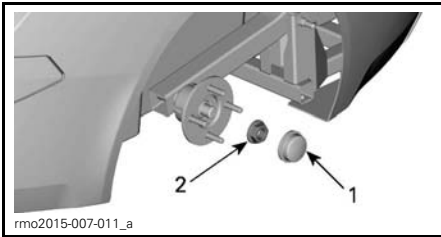

1. Protective cap
2. Wheel hub nut (discard) and washer (keep)

5. Remove the wheel hub from the spindle and discard it.

Wheel Hub Installation

1. Apply grease on spindle when rubber seal meets spindle.

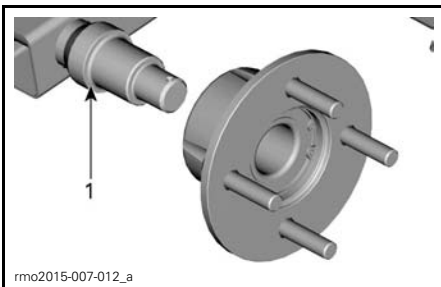

1. Spindle
2. Place hub on the spindle and secure it loosely using the hub nut and its washer.

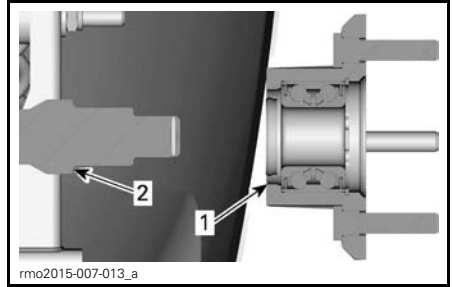

1. Wheel hub
2. Spindle

3. Apply final tightening torque

FINAL TIGHTENING TORQUE

Wheel hub nut	290 N•m ± 10 N•m (214 lbf•ft ± 7 lbf•ft)
---------------	---

Wheel Bearing Seal

Wheel Bearing Seal Inspection

Check if the seal is damaged replace wheel hub if needed.

Lights

Rear Light Module Replacement

The rear light modules are built with LEDs (light emitting diode) and this technology proved to be reliable. In the unlikely event they do not work, the rear light module must be replaced completely. See an authorized Can-Am Spyder dealer.

Position Light Replacement

The position lights are built with LEDs. The complete light must be replaced. LEDs are not available separately.

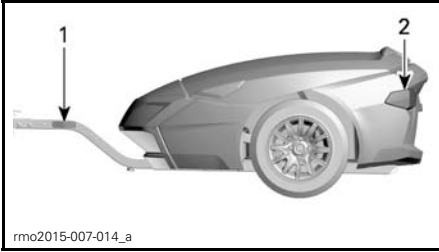

1. Position lights (LH side view)
2. Taillights (LH side view)

1. Remove screws securing position light in place.
2. Pull out the position light.
3. Insert wires of the new position light through the trailer body hole.
4. Connect the connectors (match color).
5. Secure the light on trailer body with previously removed bolts and nuts.
6. Tighten screws to the specified torque.

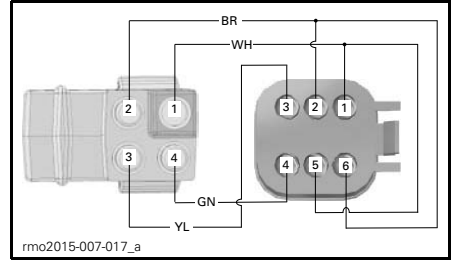

1. WH=WHITE (ground)
2. BR=BROWN (position lights/tail light)
3. YL=YELLOW (LH brake/turn signal)
4. GN=GREEN (RH brake/turn signal)
5. WH=WHITE (ground)
6. BR=BROWN (position lights/tail light)

TIGHTENING TORQUE	
Position light nuts	1.75 N•m ± 0.25 N•m (15 lbf•in ± 2 lbf•in)

License Plate Light Replacement

The licence plate light is built with LEDs (light emitting diode) and this technology proved to be reliable. In the unlikely event they do not work, have them checked by an authorized Can-Am roadster dealer.

Wiring Harness

Wiring Harness Inspection

Check trailer harness and connector for damages. Repair or replace as required.

Wiring and Connector Identification

When making wiring or connector repairs on trailer connector, refer to illustration below to identify the appropriate and necessary connections.

STORAGE AND PRESEASON PREPARATION

If trailer will not be in use for several months, the following steps will help insure proper performance when removed from storage and extend trailer life.

- If possible, park trailer in a protected area, garage, carport, etc.
- Raise trailer and place blocks under trailer frame to take most of the weight off trailer shocks and tires.
- Inflate tires to recommended pressure.
- Tighten loose fasteners and connections.
- Touch up all scratches and spots of rust.
- Apply DIELECTRIC GREASE (P/N 293 550 004) in all electric connectors and bulb socket to prevent corrosion.

TRAILER CARE

Trailer Cleaning

1. Rinse the trailer thoroughly with water to remove loose dirt.
2. Using a soft, clean cloth, wash the trailer with water mixed with a mild detergent, such as soap specially formulated for motorcycles or automobiles.

NOTE: Using warm water works well to remove bugs.

3. While washing the trailer, check for grease or oil. You can use XPS ALL PURPOSE CLEANER (P/N 219 701 709) or a mild automotive degreaser. Thoroughly follow the manufacturer's instructions.

NOTICE For Matte finishes, do not use wax, detail spray, or other products used on regular paint. Do not wash with abrasive materials. Do not use mechanical cleaners or polishers, and do not rub the surfaces vigorously.

4. Dry the trailer with a chamois or a soft towel.

Trailer Waxing

Apply only nonabrasive wax safe for clear coat paints on glossy finishes.

NOTICE For Matte finishes, do not use wax, detail spray, or other products used on regular paint. Do not wash with abrasive materials. Do not use mechanical cleaners or polishers, and do not rub the surfaces vigorously.

***This page is
intentionally blank***

WARRANTY

BRP LIMITED WARRANTY - USA AND CANADA: 2016 Can-Am FREEDOM TRAILER

1. SCOPE OF THE LIMITED WARRANTY

Bombardier Recreational Products Inc. ("BRP")™* warrants its model-year 2016 Can-Am Freedom trailer ("Trailer") sold by authorized Can-Am Spyder dealers ("Dealers") in the fifty United States and in Canada from defects in material or workmanship for the period and under the conditions described below. This limited warranty will become null and void if the Trailer has been altered or modified in such a way so as to adversely affect its operation, performance or durability, or has been altered or modified to change its intended use.

2. LIMITATIONS OF LIABILITY

THIS WARRANTY IS EXPRESSLY GIVEN AND ACCEPTED IN LIEU OF ANY AND ALL OTHER WARRANTIES, EXPRESSED OR IMPLIED, INCLUDING WITHOUT LIMITATION ANY WARRANTY OF MERCHANTABILITY OR FITNESS FOR A PARTICULAR PURPOSE. TO THE EXTENT THAT THEY CANNOT BE DISCLAIMED, THE IMPLIED WARRANTIES ARE LIMITED IN DURATION TO THE LIFE OF THE EXPRESS WARRANTY. INCIDENTAL AND CONSEQUENTIAL DAMAGES ARE EXCLUDED FROM COVERAGE UNDER THIS WARRANTY. SOME STATES/PROVINCES DO NOT ALLOW FOR THE DISCLAIMERS, LIMITATIONS AND EXCLUSIONS IDENTIFIED ABOVE, AS A RESULT, THEY MAY NOT APPLY TO YOU. THIS WARRANTY GIVES YOU SPECIFIC RIGHTS, AND YOU MAY ALSO HAVE OTHER LEGAL RIGHTS WHICH MAY VARY FROM STATE TO STATE, OR PROVINCE TO PROVINCE.

Neither the distributor, any Dealer nor any other person has been authorized to make any affirmation, representation or warranty regarding the Trailer, other than those contained in this limited warranty, and if made, shall not be enforceable against BRP. BRP reserves the right to modify this warranty at any time, being understood that such modification will not alter the warranty conditions applicable to the Trailer and in effect when purchased.

3. EXCLUSIONS – ARE NOT WARRANTED

The following are not warranted under any circumstances:

- Normal wear and tear.
- Routine maintenance items, tune ups, adjustments.
- Damages related to the appearance of the Trailer, including without limitation scratches, dents, fading, flaking, and peeling.
- Damage caused by failure to provide proper maintenance or storage, as described in the Operator's Guide.
- Damage resulting from removal of parts, improper repairs, improper service or improper maintenance, modifications, alterations that are outside of the original specifications of the Trailer, or damage resulting from repairs done by a person that is not an authorized servicing Dealer.
- Damage resulting from the installation of parts with specifications that differ from the original Trailer parts, such as, without limitation, different tires or wheels.
- Damage caused by abuse, abnormal use, neglect, or operation of the product in a manner inconsistent with the recommended operation described in the Operator's Guide.

- Damage resulting from accident, road hazards, submersion, fire, theft, vandalism or any act of God.
- Damage resulting from corrosion from road salts, environmental influences or treatment contrary to the Operator’s Guide.
- Incidental or consequential damages, including without limitation towing, storage, telephone, rental, taxi, inconvenience, insurance coverage, loan payments, loss of time or loss of income.

4. WARRANTY COVERAGE PERIOD

This warranty will be in effect from the date of delivery to the first retail consumer or the date the Trailer is first put into use, whichever occurs first and for the following period:

1. TWENTY-FOUR (24) CONSECUTIVE MONTHS for private use owners.
2. TWELVE (12) CONSECUTIVE MONTHS for commercial use. A Trailer is used commercially when it is used in connection with any work or employment that generates income during any part of the warranty period. A Trailer is also used commercially when, at any point during the warranty period, it is licensed for commercial use.

The repair or replacement of parts or the performance of service under this warranty does not extend the life of this warranty beyond its original expiration date.

5. CONDITIONS TO HAVE WARRANTY COVERAGE

This warranty coverage is available only if each of the following conditions has been fulfilled:

- The Trailer must be purchased as new and unused by its first owner from a dealer authorized to distribute Trailers in the country in which the sale occurred (“Dealer”).
- The BRP specified pre-delivery inspection process must be completed, documented and signed by the purchaser.
- The Trailer must have undergone proper warranty registration by an authorized Dealer.
- The Trailer must be purchased in the country in which the purchaser resides.
- Routine maintenance outlined in the Operator’s Guide must be timely performed in order to maintain warranty coverage. BRP reserves the right to make warranty coverage contingent upon proof of proper maintenance.

BRP will not honor this limited warranty to any private use owner or commercial use owner if one of the preceding conditions has not been met. Such limitations are necessary in order to allow BRP to preserve both the safety of its products, and also that of its consumers and the general public.

6. WHAT TO DO TO OBTAIN WARRANTY COVERAGE

The customer must cease using the Trailer upon the appearance of an anomaly. The customer must notify a servicing Dealer within three (3) days of the appearance of a defect, and provide it with reasonable access to the product and reasonable opportunity to repair it. The customer must also present to the authorized Dealer proof of purchase of the product and must sign the repair/work order prior to starting the repair in order to validate the warranty repair. All parts replaced under this limited warranty become the property of BRP.

7. WHAT BRP WILL DO

BRP's obligations under this warranty are limited to, at its sole discretion, repairing parts found defective under normal use, maintenance and service, or replacing such parts with new genuine Trailer parts without charge for parts and labor, at any authorized Dealer during the warranty coverage period under the conditions described herein. No claim of breach of warranty shall be the cause for cancellation or rescission of the sale of the Trailer to the owner.

In the event that service is required outside of the country of original sale, the owner will bear responsibility for any additional charges due to local practices and conditions, such as, but not limited to, freight, insurance, taxes, license fees, import duties, and any and all other financial charges, including those levied by governments, states, territories and their respective agencies.

BRP reserves the right to improve or modify products from time to time without assuming any obligation to modify any products previously manufactured.

8. TRANSFER

If the ownership of a Trailer is transferred during the warranty coverage period, this warranty shall also be transferred and be valid for the remaining coverage period provided that BRP is notified of such transfer of ownership in the following way:

1. The former owner contacts BRP (at the phone number provided below) or an authorized Dealer and gives the coordinates of the new owner; or
2. BRP or an authorized Dealer receives a proof that the former owner agreed to the transfer of ownership, in addition to the coordinates of the new owner.

9. CONSUMER ASSISTANCE

In the event of a controversy or a dispute in connection with this limited warranty, BRP suggests that you try to resolve the issue with your BRP Authorized Dealer. We recommend discussing the issue with the authorized Dealer's service manager or owner.

If further assistance is required, please contact us:

<http://can-am.brp.com/spyder/form/contact-us.html>

Tel: 1 888 272-9222

* In the USA, products are distributed and serviced by BRP US Inc.

© 2015 Bombardier Recreational Products Inc. All rights reserved.

® Registered Trademarks of Bombardier Recreational Products Inc. or its affiliates.

™ Trademarks of Bombardier Recreational Products Inc. or its affiliates.

***This page is
intentionally blank***

CUSTOMER INFORMATION

PRIVACY INFORMATION

BRP wishes to inform you that your coordinates will be used for safety and warranty related purposes. Furthermore, BRP and its affiliates may use its customer list to distribute marketing and promotional information about BRP and related products.

To exercise your right to consult or correct your data, or to be removed from the addressee-list for direct marketing, please contact BRP.

By E-mail: privacyofficer@brp.com

By mail: BRP
Senior Legal Counsel-Privacy Officer
726 St-Joseph
Valcourt QC
Canada
J0E 2L0

CHANGE OF ADDRESS/OWNERSHIP

If your address has changed or if you are the new owner of the trailer, be sure to notify BRP by either:

- Contacting an authorized BRP distributor/dealer.
- Mailing one of the following card below;
- **North America only:** calling at 1 888 272-9222;

In case of change of ownership, please join a proof that the former owner agreed to the transfer.

Notifying BRP, even after the expiration of the limited warranty, is very important as it enables BRP to reach the trailer owner if necessary, like when safety recalls are initiated. It is the owner's responsibility to notify BRP.

STOLEN UNITS: In the event that your trailer is stolen, you should notify your area's distributor warranty department of such. We will ask you to provide your name, address, phone number, Trailer Identification Number and date it was stolen.

In North America

BOMBARDIER RECREATIONAL PRODUCTS INC.

Warranty Department
75 J.-A. Bombardier Street
Sherbrooke QC J1L 1W3
Canada

Scandinavian Countries

BRP FINLAND OY

Service Department
Isoaavantie 7
FIN-96320 Rovaniemi
Tel.: + 358 16 3208 111

In Other Countries in the World

BRP EUROPEAN DISTRIBUTION

Avenue d'Ouchy 4-6
1006 Lausanne
Switzerland

***This page is
intentionally blank***

CHANGE OF ADDRESS

CHANGE OF OWNERSHIP



VEHICLE IDENTIFICATION NUMBER

Model Number

Vehicle Identification Number (V.I.N.)

OLD ADDRESS
OR PREVIOUS OWNER:

NAME

NO. STREET APT

CITY STATE/PROVINCE ZIP/POSTAL CODE

COUNTRY TELEPHONE

NEW ADDRESS
OR NEW OWNER:

NAME

NO. STREET APT

CITY STATE/PROVINCE ZIP/POSTAL CODE

COUNTRY TELEPHONE

E-MAIL ADDRESS

V00A2F

CHANGE OF ADDRESS

CHANGE OF OWNERSHIP



VEHICLE IDENTIFICATION NUMBER

Model Number

Vehicle Identification Number (V.I.N.)

OLD ADDRESS
OR PREVIOUS OWNER:

NAME

NO. STREET APT

CITY STATE/PROVINCE ZIP/POSTAL CODE

COUNTRY TELEPHONE

NEW ADDRESS
OR NEW OWNER:

NAME

NO. STREET APT

CITY STATE/PROVINCE ZIP/POSTAL CODE

COUNTRY TELEPHONE

E-MAIL ADDRESS

V00A2F

***This page is
intentionally blank***

CHANGE OF ADDRESS

CHANGE OF OWNERSHIP



VEHICLE IDENTIFICATION NUMBER

Model Number

Vehicle Identification Number (V.I.N.)

OLD ADDRESS
OR PREVIOUS OWNER:

NAME

NO. STREET APT

CITY STATE/PROVINCE ZIP/POSTAL CODE

COUNTRY TELEPHONE

NEW ADDRESS
OR NEW OWNER:

NAME

NO. STREET APT

CITY STATE/PROVINCE ZIP/POSTAL CODE

COUNTRY TELEPHONE

E-MAIL ADDRESS

V00A2F

CHANGE OF ADDRESS

CHANGE OF OWNERSHIP



VEHICLE IDENTIFICATION NUMBER

Model Number

Vehicle Identification Number (V.I.N.)

OLD ADDRESS
OR PREVIOUS OWNER:

NAME

NO. STREET APT

CITY STATE/PROVINCE ZIP/POSTAL CODE

COUNTRY TELEPHONE

NEW ADDRESS
OR NEW OWNER:

NAME

NO. STREET APT

CITY STATE/PROVINCE ZIP/POSTAL CODE

COUNTRY TELEPHONE

E-MAIL ADDRESS

V00A2F

***This page is
intentionally blank***

NOTES

219 001 673

USER'S GUIDE, Can-Am Freedom Trailer / ENGLISH
GUIDE DE L'UTILISATEUR Remorque Can-Am Freedom/ ANGLAIS

FAIT AU / MADE IN CANADA

U/M:P.C.