

can-am

SPYDER® F3 Series

OPERATOR'S GUIDE

Includes
Safety, Vehicle and
Maintenance Information

**N
O
N
E**

⚠ WARNING

Learn how the Spyder is different.

Read this operator's guide and watch the safety video on:

<https://can-am.brp.com/spyder/owners/safety/safety-information.html>

Complete a training course (if available), practice and become proficient with the controls.

Consult local laws - license requirements vary by location.

Keep this guide in the front storage compartment.

2 1 9 0 0 2 1 4 1

Original Instructions

WARNING

Disregarding any of the safety precautions and instructions contained in this Operator's Guide, the Safety video and on-product safety labels could cause injury including the possibility of death!

CALIFORNIA PROPOSITION 65 WARNING

 **WARNING:** Operating, servicing and maintaining a passenger vehicle can expose you to chemicals including engine exhaust, carbon monoxide, phthalates, and lead, which are known to the State of California to cause cancer and birth defects or other reproductive harm. To minimize exposure, avoid breathing exhaust, do not idle the engine except as necessary, service your vehicle in a well-ventilated area and wear gloves or wash your hands frequently when servicing your vehicle. For more information go to www.p65warnings.ca.gov/products/passenger-vehicle.



In Canada, products are distributed by Bombardier Recreational Products Inc.
In USA, products are distributed by BRP US Inc.

This is a non-exhaustive list of trademarks that are the property of Bombardier Recreational Products Inc. or its affiliates:

BRP Connect™	F3™	Spyder®
Can-Am®	Rotax®	XPST™

Apple® is a registered trademarks of Apple Inc.

Apple App Store is a service mark of Apple Inc.

The Bluetooth® word mark and logos are registered trademarks owned by the Bluetooth SIG, Inc.

Google Play Store is a registered trademark of Google Inc.

Deutsch	Dieses Handbuch ist möglicherweise in Ihrer Landessprache verfügbar. Bitte wenden Sie sich an Ihren Händler oder besuchen Sie: www.operatorsguides.brp.com
English	This guide may be available in your language. Check with your dealer or go to: www.operatorsguides.brp.com
Español	Es posible que este manual esté disponible en su idioma. Consulte a su distribuidor o visite: www.operatorsguides.brp.com
Français	Ce guide peut être disponible dans votre langue. Vérifier avec votre concessionnaire ou aller à: www.operatorsguides.brp.com
Italiano	Questa guida potrebbe essere disponibile nella propria lingua. Contattare il concessionario o consultare: www.operatorsguides.brp.com
中文	本手册可能有您的语种的翻译版本。请向经销商询问，或者登录 www.operatorsguides.brp.com 查询。
日本語	このガイドは、言語によって翻訳版が用意されています。ディーラーに問い合わせるか、次のアドレスでご確認ください： www.operatorsguides.brp.com
Nederlands	Deze handleiding kan beschikbaar zijn in uw taal. Vraag het aan uw dealer of ga naar: www.operatorsguides.brp.com
Norsk	Denne boken kan finnes tilgjengelig på ditt eget språk. Kontakt din forhandler eller gå til: www.operatorsguides.brp.com
Português	Este manual pode estar disponível em seu idioma. Fale com sua concessionária ou visite o site: www.operatorsguides.brp.com
Русский	Воспользуйтесь руководством на вашем языке. Узнайте о его наличии у дилера или на странице по адресу www.operatorsguides.brp.com
Suomi	Käyttöohjekirja voi olla saatavissa omalla kielelläsi. Tarkista jälleenmyyjältä tai käy osoitteessa: www.operatorsguides.brp.com
Svenska	Denna bok kan finnas tillgänglig på ditt språk. Kontakta din återförsäljare eller gå till: www.operatorsguides.brp.com

This operator's Guide covers the following models:

MODELS
Spyder F3 Spyder F3-S Spyder F3-T Spyder F3 Limited

TABLE OF CONTENTS

GENERAL INFORMATION

FOREWORD	8
Know Before you Go	8
Safety Messages	8
About this Operator's Guide	8
Refer to Other Sources of Information	9
Acknowledgment	9
GENERAL PRECAUTIONS	10
Avoid Carbon Monoxide Poisoning	10
Avoid Gasoline Fires and Other Hazards	10
Avoid Burns from Hot Parts	10
Accessories and Modifications	10

VEHICLE INFORMATION

PRIMARY CONTROLS	14
1) Brake Pedal	15
2) Throttle	15
3) Handlebar	16
4) Parking Brake Button	16
5) Gearshift Selector	17
SECONDARY CONTROLS	19
1) Ignition Switch	20
2) Button Cluster	20
3) Keypad	21
4) Engine Start Button	22
5) Cruise Control Switch	22
6) Engine Stop Switch	24
7) Hazard Warning Switch	24
8) Reverse Button	24
9) BRP Connect Button	25
10) Headlights Switch	25
11) Turn Signal Button	26
12) Horn Button	26
13) Audio Volume Control	26
14) Electronic Command Center(ECC)	27
4.5" DIGITAL DISPLAY (F3 MODELS)	28
Multifunction Display	28
Warning Lamps and Indicators	30
Settings	31
7.5" DIGITAL DISPLAY	33
Basic Functions	33
Settings	36

LARGE PANORAMIC 7.8" WIDE LCD DISPLAY	37
Basic Functions	37
Settings	39
Pairing your Smartphone Via Bluetooth	42
Pairing a Helmet	42
BRP Connect App	42
Quick Tour of the BRP Connect App	43
EQUIPMENT	45
Customer Accessory Circuits	45
Adjustable Handlebar and Driver Footpegs	45
Mirrors	46
Front Storage Compartment	46
Tool Kit	47
Operator's Guide	47
Seat	47
Mono Seat Cowl (If Equipped)	48
Rear Storage Compartment (If equipped)	48
Saddlebags	49
Top Storage Compartment	50
Glove Box	51
Body Panels	51
Diagnostic Connector	54
BASIC PROCEDURES	56
Starting and Stopping the Engine	56
Operating in Reverse	57
Operating During Break-In	57
Fueling	57
Adjusting Suspension	59
SAFE OPERATING INSTRUCTIONS	
WHAT'S DIFFERENT FROM OTHER VEHICLES	62
Stability	62
Response to Road Conditions	62
Brake Pedal	62
Parking Brake	62
Steering	62
Width	63
Reverse	63
Driver's License and Local Laws	63
DRIVING AID TECHNOLOGIES	64
Vehicle Stability System (VSS)	64
Hill Hold Control (HHC)	65
Dynamic Power Steering (DPS)	65
UNDERSTANDING RISK ON THE ROAD	66
Type of Vehicle	66

UNDERSTANDING RISK ON THE ROAD (cont'd)	
Operator Skills and Judgment.....	66
Rider Condition.....	67
Vehicle Condition.....	67
Road and Weather Conditions.....	67
RIDING GEAR	68
Helmets.....	68
Other Riding Gear.....	68
REQUIRED RIDING SKILLS AND PRACTICE EXERCISES	71
Choosing a Practice Area.....	71
Preparing to Ride.....	72
Riding Posture.....	72
Practice Exercises.....	72
Developing Advanced Riding Skills.....	79
STREET STRATEGIES.....	81
Plan your Trip.....	81
Defensive Riding.....	81
Being Visible.....	82
Lane Position.....	83
Common Riding Situations.....	83
Road Conditions and Hazards.....	85
On-Road Emergencies.....	87
Tire Failure.....	87
CARRYING A PASSENGER OR CARGO	88
Weight Limits.....	88
Operating with Extra Weight.....	88
Carrying a Passenger.....	88
Where to Store Cargo.....	89
Towing a Trailer.....	90
Load Limits.....	90
Hitch.....	91
Safety Cables.....	92
KNOWLEDGE SELF-TEST	93
Questionnaire.....	93
Answers.....	95
SAFETY INFORMATION ON THE VEHICLE	97
Hang Tag.....	97
Safety Card.....	98
Safety Labels.....	100
REPORTING SAFETY DEFECTS	105
<i>PRE-RIDE INSPECTION</i>	
PRE-RIDE CHECKLIST.....	108
Before Starting the Vehicle, Inspect the Following:.....	108

PRE-RIDE CHECKLIST (cont'd)
Turn Ignition Key to the ON Position: 109

MAINTENANCE

MAINTENANCE SCHEDULE **112**
FIRST INSPECTION..... **115**
MAINTENANCE PROCEDURES **116**
 Engine Oil 116
 Air Filter 119
 Engine Coolant 121
 Radiator Fan 122
 Battery 122
 Drive Belt 123
 Wheels and Tires 125
 Brakes..... 127
 Headlights 128
VEHICLE CARE **131**
 Cleaning the Vehicle 131
 Vehicle Protection..... 131
STORAGE AND PRESEASON PREPARATION..... **132**
 Storage..... 132
 Preseason Preparation 132

ROAD SIDE REPAIRS

DIAGNOSTIC GUIDELINES **134**
 Will not Shift into Neutral 134
 Will not Shift 134
 Engine will not Start..... 134
MESSAGES IN MULTIFUNCTION GAUGE **136**
WHAT TO DO IN THE FOLLOWING CIRCUMSTANCES **140**
 Lost Keys 140
 Flat Tire..... 140
 Dead Battery..... 140
HOW CHANGING A BULB..... **142**
 Lights..... 142
HOW TO REPLACING A FUSE **154**
 Fuse Locations 154
 Fuse Description 154
 Replacing a Fuse 155
HOW TO TRANSPORT THE VEHICLE..... **157**

TECHNICAL INFORMATION

VEHICLE IDENTIFICATION **160**
 Vehicle Identification Number..... 160
 Engine Identification Number 161
 Compliance Labels..... 161
 EPA Compliance Label..... 161
 Deployment of Alternative Fuel Infrastructure Compliance Label 162

NOISE EMISSION CONTROL SYSTEM REGULATION **163**
 Tampering with Noise Control System Is Prohibited! 163
 Among those Acts Presumed to Constitute Tampering Are the Acts Listed
 Below:..... 163

**RADIO FREQUENCY DIGITALLY ENCODED SECURITY SYSTEM (RF D.E.S.S.
 KEY)** **164**

**MULTIFUNCTION GAUGE REGULATORY INFORMATION (LARGE
 PANORAMIC 7.8" WIDE LCD DISPLAY)**..... **165**

SPECIFICATIONS **169**

WARRANTY

**BRP LIMITED WARRANTY — USA AND CANADA: 2021 Can-Am® SPYDER®
 SERIES** **178**

**BRP INTERNATIONAL LIMITED WARRANTY: 2021 Can-Am® SPYDER®
 SERIES** **185**

**BRP LIMITED WARRANTY FOR THE EUROPEAN ECONOMIC AREA, THE
 COMMONWEALTH OF THE INDEPENDENT STATES AND TURKEY: 2021
 Can-Am® SPYDER® SERIES**..... **190**

MAINTENANCE RECORDS **195**

CUSTOMER INFORMATION

PRIVACY INFORMATION **200**

CONTACT US..... **201**
 Web Site 201
 Asia 201
 Europe 201
 North America 201
 Oceania 201
 South America..... 201

CHANGE OF ADDRESS/OWNERSHIP..... **202**

GENERAL INFORMATION

FOREWORD

Congratulations on your purchase of a new Can-Am® Spyder. It is backed by the Bombardier Recreational Products Inc. (BRP) warranty and a network of authorized dealers ready to provide the parts, service or accessories you may require.

Your dealer is committed to your satisfaction. He has taken training to prepare, inspect and performed the final adjustment of your new vehicle before that you took possession of it.

If you need more information concerning the servicing of your vehicle, please ask your dealer.

At delivery, you were informed about the warranty coverage and also, you signed the *PREDELIVERY CHECK LIST* to ensure your new vehicle was prepared to your entire satisfaction.

Know Before you Go

For your safety and the safety of passengers and bystanders, read the following sections before you operate this vehicle:

- GENERAL PRECAUTIONS
- VEHICLE INFORMATION
- SAFE OPERATING INSTRUCTIONS
- PRE-RIDE INSPECTION.

Experienced motorcyclists should pay special attention to *WHAT'S DIFFERENT FROM OTHER VEHICLES*.

Safety Messages

The types of safety messages, what they look like and how they are used in this guide are explained as follows:

The safety alert symbol  indicates a potential injury hazard.

WARNING

Indicates a potential hazard, if not avoided, could result in serious injury or death.

 **CAUTION** Indicates a hazard situation which, if not avoided, could result in minor or moderate injury.

NOTICE Indicates an instruction which, if not followed, could severely damage vehicle components or other property.

About this Operator's Guide

This Operator's Guide was written in North America in a right-lane driving environment. Please adapt your application of these maneuvers to your jurisdiction and rules of the road.

In this Operator's Guide, the word motorcycle typically refers to a two-wheeled motorcycle.

Keep this Operator's Guide in the vehicle so that you can refer to it for things such as maintenance, road side repairs and instructing others.

If you want to view and/or print an extra copy of your Operator's Guide, simply visit the following website:

www.operatorsguides.brp.com.

The information contained in this document are correct at the time of publication. BRP, however, maintains a policy of continuous improvement of its products without imposing upon itself any obligation to install them on products previously manufactured. Due to late changes, some differences between the manufactured product and the descriptions and/or specifications in this guide may occur. BRP reserves the right at any time to discontinue or change specifications, designs, features, models or equipment without incurring any obligation upon itself.

This Operator's Guide should remain with the vehicle when it is sold.

Refer to Other Sources of Information

In addition to reading this Operator's Guide, you should read the Safety Card on the vehicle, all on-product safety labels and watch the *SAFETY VIDEO* located at:

<https://can-am.brp.com/spyder/owners/safety/safety-information.html>

Or, use the following QR code.



If possible, take a training course that is specifically designed for a three-wheel vehicle.

For more information about upcoming training course availability, visit our web site at:

www.can-am.brp.com

If a training course specifically designed for a three-wheel vehicle is not available in your area, it could be a good idea to take a training course for motorcycles.

Many of the skills required are similar and also, the received information about managing the risk on the road are suitable for a three-wheel vehicle.

Acknowledgment

BRP wishes to thank the Motorcycle Safety Foundation (MSF) for giving permission to BRP to use their material related to street motorcycle safety found in this Operator's Guide.

The MSF is an internationally recognized not for profit foundation and is supported by motorcycle manufacturers. It provides training, tools and partnerships to the motorcycle safety community. Visit its website at:

www.msf-usa.org

GENERAL PRECAUTIONS

Avoid Carbon Monoxide Poisoning

All engine exhaust contains carbon monoxide, a deadly gas. Breathing carbon monoxide can cause headaches, dizziness, drowsiness, nausea, confusion and eventually death.

Carbon monoxide is a colorless, odorless, tasteless gas that may be present even if you do not see or smell any engine exhaust. Deadly levels of carbon monoxide can collect rapidly, and you can quickly be overcome and unable to save yourself. Also, deadly levels of carbon monoxide can linger for hours or days in enclosed or poorly ventilated areas. If you experience any symptoms of carbon monoxide poisoning, leave the area immediately, get fresh air and seek medical treatment.

To prevent serious injury or death from carbon monoxide:

- Never run the vehicle in poorly ventilated or partially enclosed areas such as garages, carports or barns. Even if you try to ventilate engine exhaust with fans or open windows and doors, carbon monoxide can rapidly reach dangerous levels.
- Never run the vehicle outdoors where engine exhaust can be drawn into a building through openings such as windows and doors.

Avoid Gasoline Fires and Other Hazards

Gasoline is extremely flammable and highly explosive. Fuel vapors can spread and be ignited by a spark or flame many feet away from the engine. To reduce the risk of fire or explosion, follow these instructions:

- Refuel outdoors in a well-ventilated area away from flames, sparks, lit cigarettes and other sources of ignition.
- Never add fuel with engine running.

- Never top off the fuel tank. Leave some room for the fuel to expand with temperature changes.
- Wipe up any spilled fuel.
- Never start or operate the engine with the fuel cap opened.
- Use only an approved red gasoline container to store fuel.
- Do not carry gasoline containers in the front storage compartment or anywhere else on the vehicle.

Gasoline is poisonous and can cause injury or death.

- Never siphon gasoline by mouth.
- If you swallow gasoline, get any in your eye or inhale gasoline vapor, see your doctor immediately.

If gasoline spills on you, wash with soap and water and change your clothes.

Avoid Burns from Hot Parts

The exhaust, oil, and cooling systems, as well as the engine become hot during operation. Other vehicle parts, such as multifunction gauge glass, can also be hot if operated at an ambient temperature higher than 60°C (140°F). Avoid contact during and shortly after operation to avoid burns.

Accessories and Modifications

Do not make unauthorized modifications, or use attachments or accessories that are not approved by BRP. Since these changes have not been tested by BRP, they may increase the risk of crashes on the road or injuries, and they can make the vehicle illegal for use on the road.

Unlike most motorcycles, this vehicle is equipped with a Vehicle Stability System (VSS), which is calibrated for the vehicle normal configuration. VSS may not function properly if the vehicle

is modified, such as changing weight distribution, wheelbase, tires, suspension, brakes or steering.

See your authorized Can-Am On-Road dealer for available BRP accessories for your vehicle.

***This page is
intentionally blank***

VEHICLE INFORMATION

PRIMARY CONTROLS

It is important to know the location and operation of all controls, and to develop and practice smooth and coordinated use of them.

Handlebar and driver footpegs can be adjusted to meet the driver needs. It is however important for the person driving the vehicle to be able to use and reach all controls adequately. For example, the brake pedal activation should be easily accessible, workable and go all the way through its function activation.

Adjustments must be made by an authorized Can-Am On-Road dealer to keep vehicle safety integrity.

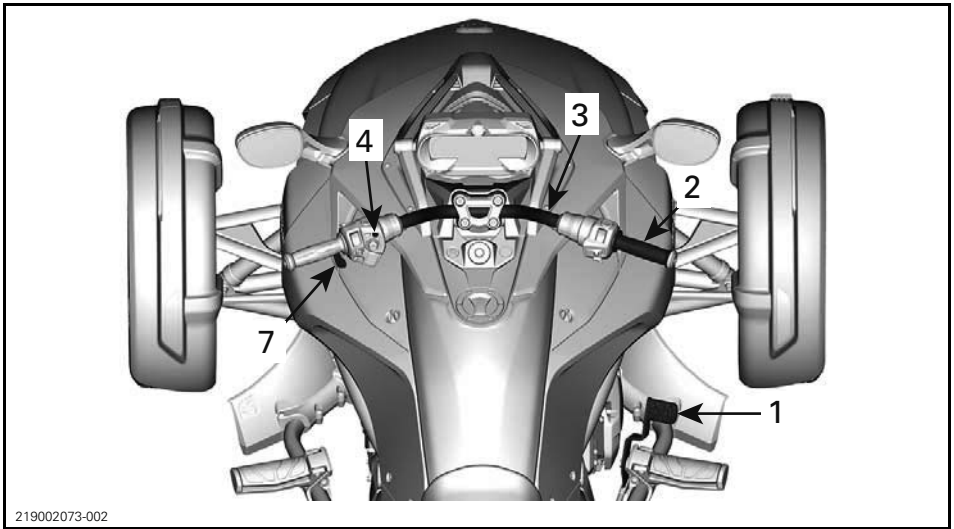

F3 STD AND S MODELS

1. Brake pedal
2. Throttle
3. Handlebar
4. Parking brake button
5. Gearshift selector

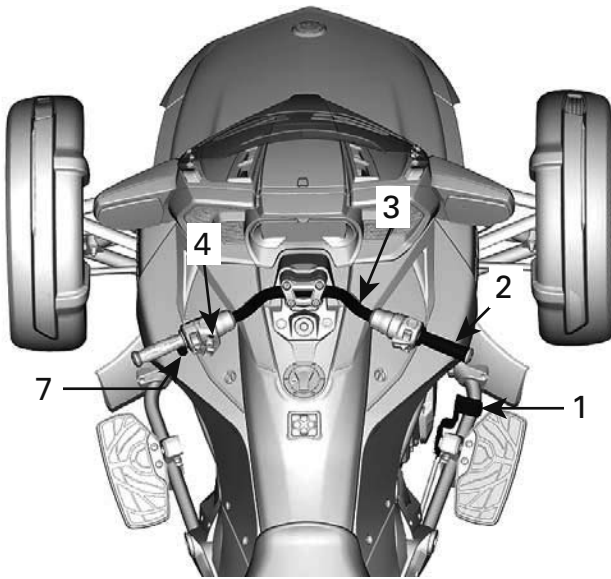

219002073-004

F3 T AND LIMITED MODELS

1. Brake pedal
2. Throttle
3. Handlebar
4. Parking brake button
5. Gearshift selector

1) Brake Pedal

The brake pedal is in front of the right footrest. Press it down to operate. This pedal brakes all three wheels.

NOTICE When riding, make sure not to lean your foot on brake pedal. Otherwise, the engine management will activate the limp home mode to protect the braking system.

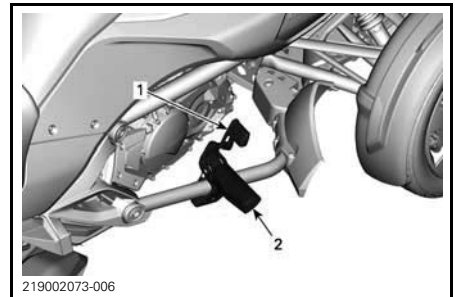

219002073-006

1. Brake pedal
2. Footrest

2) Throttle

Twist the right handgrip to operate the throttle. This controls the vehicle's speed by controlling the flow of fuel to the engine.

To speed up, twist the throttle toward you (lower your wrist).

To slow down, twist it away from you (raise your wrist).

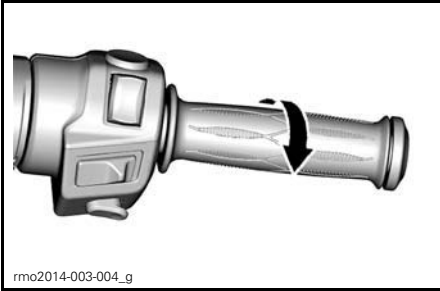

TO INCREASE SPEED

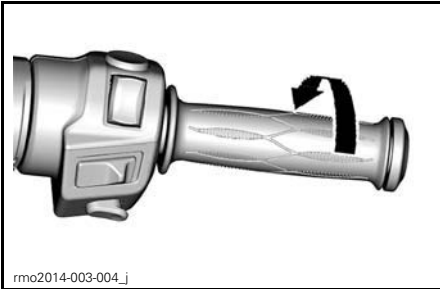

TO DECREASE SPEED

The throttle is spring loaded and should return to idle when you release your grip.

This vehicle is equipped with an Electronic Throttle Control (ETC). The throttle plates in the throttle body are controlled electronically and can be opened or closed irrespective of the throttle twist grip position when necessary.

It may happen that when you accelerate, the Vehicle Stability System (VSS) prevents engine acceleration in order to maintain vehicle stability. Then, when the vehicle is stabilized, the engine RPM would increase as requested if the throttle was maintained. This would be felt as a "delayed" acceleration.

The VSS can never accelerate the vehicle. All it can do is to open the throttle slightly to decrease the amount of engine braking on slippery surfaces. This prevents the rear tire from slipping because of engine braking.

3) Handlebar

Grip the handlebar with both hands. Steer the handlebar in the direction you want to go.

4) Parking Brake Button

The parking brake button is located on the LH side handlebar. It allows to engage or release the electric parking brake.

There will be a 20 second beep sound when stopping the engine while the parking brake is not engaged.

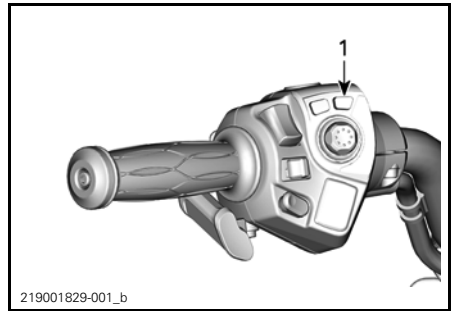

1. Parking brake button

Applying Parking Brake

With the vehicle stopped and ignition key turned ON, press button to apply the parking brake. The brake indicator lamp will turn on.

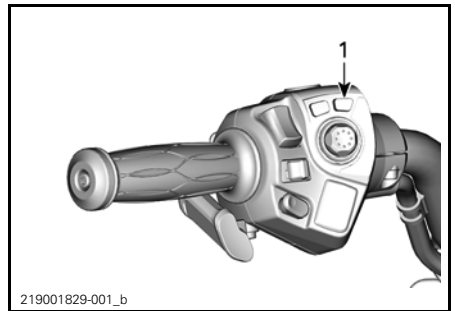

1. Parking brake button

NOTE: A minimum of 11 V is required to activate the parking brake. If the battery voltage is below 11 V, the parking brake indicator lamp will flashing and a message will appear in the cluster display.

⚠ CAUTION To avoid personal injury or vehicle damages, the parking brake cannot be activated when the vehicle is running above 10 km/h (6 MPH).

Check that the parking brake is fully engaged. Rock the vehicle back and forth.

Releasing Parking Brake

To release parking brake, press button and make sure brake indicator lamp will turn OFF.

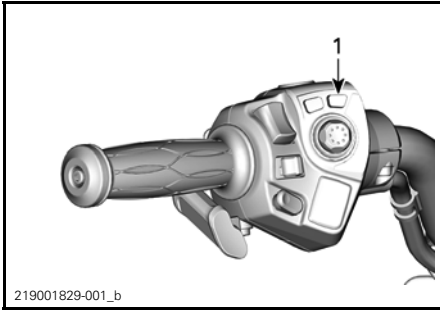

219001829-001_b

1. Parking brake button

5) Gearshift Selector

The gearshift selector is underneath the left handgrip.

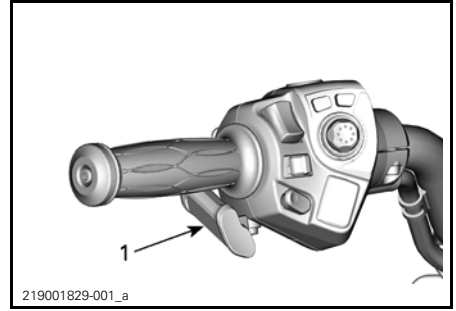

219001829-001_a

1. Gearshift selector

Press selector forward to upshift. Pull selector toward you to downshift.

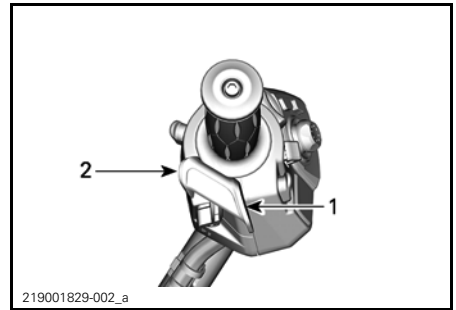

219001829-002_a

1. Upshift
2. Downshift

This shifts sequentially from one gear to the next. Release the selector after shifting.

- To shift through multiple gears, use the selector multiple times.
- To shift into neutral from first gear or reverse, briefly press or pull the gear selector. A longer activation will shift over neutral.
- To shift out of reverse into 1st gear, press the brake pedal and shift up.
- To shift from neutral to 1st gear, press the brake pedal and shift up.

When the gearshift selector is released, the mechanism resets for the next shift up or down.

If operator does not downshift when slowing down and engine RPM drops below a threshold value, the gearbox will automatically downshift to the next available gear.

If the engine is started with the gear-box in gear, it will automatically shift to neutral position.

SECONDARY CONTROLS

Some features may not apply to your model or could be optional.

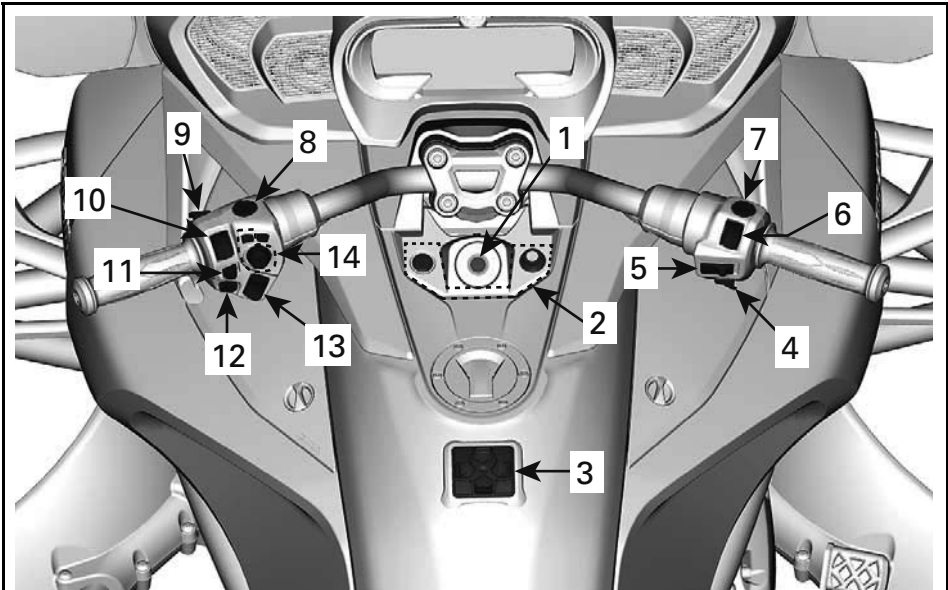

219002073-008

TYPICAL - LIMITED MODEL SHOWN

1. Ignition switch
2. Switch cluster
3. Keypad
4. Engine start button
5. Cruise control switch
6. Engine stop switch
7. Hazard warning switch
8. Reverse button
9. BRP Connect button
10. Headlights switch
11. Turn signal button
12. Horn button
13. Audio volume control
14. Electronic command center (ECC)

1) Ignition Switch

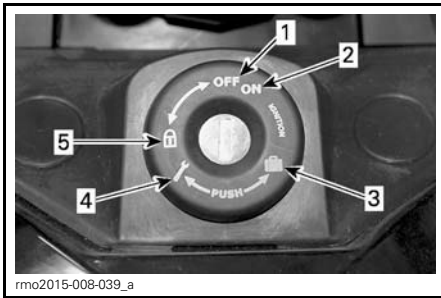

IGNITION SWITCH

1. OFF
2. ON
3. Front storage compartment opening
4. Passenger seat opening
5. Steering lock position

The ignition switch is located in the center of the handlebar.

NOTICE If the key does not turn easily, do not force it. Pull it out and reinsert.

⚠ WARNING

If you turn the ignition switch to OFF, it shuts off the engine and all the electrical systems including the VSS and DPS. If you do this while the vehicle is moving, you could lose control and crash.

Two keys are provided with your vehicle. Each key contains a transponder chip specifically pre-programmed that is read via radio frequency by the immobilizer system to allow starting the engine. The keys do not contain batteries. Do not take the key apart. If the immobilizer system cannot read the key, the engine will not start. For the conditions that can lead to the immobilizer system failing to read the key, refer to the *DIAGNOSTIC GUIDELINES*. Store the spare key in a safe place because you **must** have your spare key to have another one made by an authorized Can-Am On-Road dealer.

Ignition Function

OFF

The key can be inserted or removed in this position.

In the OFF position, the electrical system of the vehicle is disabled.

The engine is shut down by turning the ignition switch to the OFF position.

ON

When the key is turned to this position, the electrical system of the vehicle is activated.

The gauge should wake-up.

The vehicle lights are turned on.

The engine can be started.

Locking the Handlebar/Glove Box

To lock the steering mechanism and the glove box:

1. Insert key in ignition switch.
2. Rotate the handlebar all the way to the right or to the left.
3. Turn the key 1/4 turn counterclockwise to the steering lock position then remove key.

2) Button Cluster

The button cluster is located on the central console.

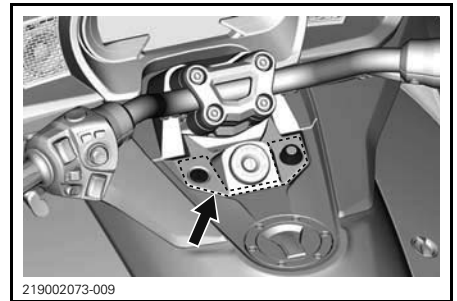

It includes many buttons that control of numerous electrical accessories.

NOTE: The battery voltage must be at 11V minimum to activate these accessory buttons.

Driver's Heated Grip Button

Limited Models Only

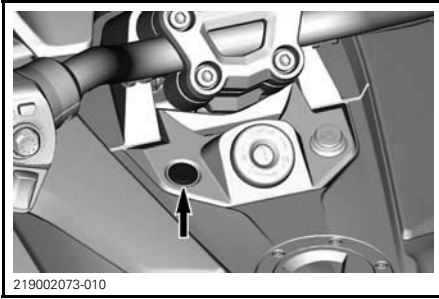

The heated grip button allows to turn on and off the driver's heated grips.

To activate or turn OFF the heating grip, press the button.

Rear Fog Light (Chinese model) / Accessory Light Button (All other models - Option Package)

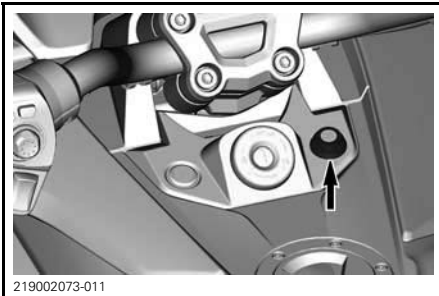

Chinese Models

Press this button to turn ON or OFF the rear fog light.

All Other Models

Location to place the button when adding an accessory light.

3) Keypad



The keypad is located on the central panel.

The keypad is used to control the audio system. It controls:

- Source (radio or bluetooth)
- Volume
- Preset/Seek
- Mute/play
- Output (speakers or headset)



When FM audio source is selected, the Preset/Seek buttons work as follow:

- Short press: Previous or Next Preset
- Long press: Seek - up or down

When Bluetooth audio source is selected, the Preset/Seek buttons work as follow:

- Left: Previous song
- Right: Next song

When IN AUX audio source is selected, the Preset/Seek buttons do not function.

NOTE: When using an Apple device, it is possible that the Preset/Seek buttons do not function with the BRP Connect is selected.

4) Engine Start Button

The engine start button is located at the bottom of the right handlebar housing.

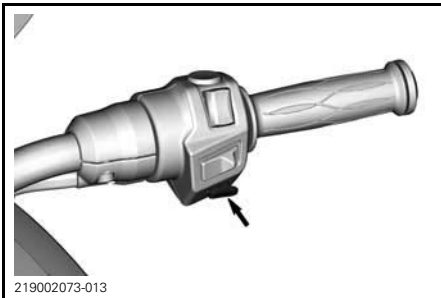

When depressed and held, it starts the engine.

5) Cruise Control Switch

The cruise control switch is located near the center of the right handlebar housing.

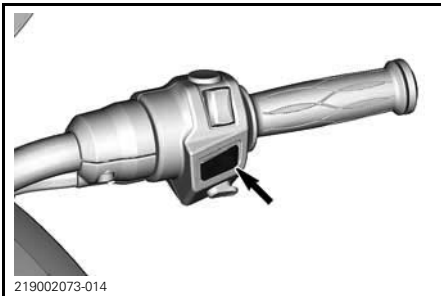

This switch is multifunctional. It allows to activate, set and stop the function of the cruise control.

The following icon appears inside the digital display when the cruise control is activated.



⚠ WARNING

It is not recommended to use the cruise control when towing a trailer.

When set, the cruise control allows to maintain a steady speed while riding the vehicle. It will increase or reduce engine speed as necessary.

NOTE: The vehicle torque may vary slightly depending on the road conditions such as the wind, going downhill or uphill.

The cruise control is designed to be used for prolonged drives on low traffic highways. Never ride the vehicle with the cruise control activated in city streets, winding roads, in adverse weather or in any circumstances when you need the throttle control.

Cruise Control Limitations

The cruise control is not an automatic pilot, it will not drive the vehicle.

The cruise control is not aware of what is going on the road and it does not steer or apply the brakes for you.

⚠ WARNING

Improper use of the cruise control can lead the vehicle to a loss of control.

Setting the Cruise Control

To use the cruise control, the vehicle speed must be above approximately 40 km/h (25 MPH).

Turn the cruise control to ON by sliding the cruise control button to the right.

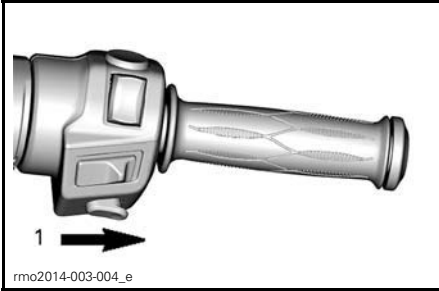

1. Slide button to the right

NOTE: The cruise control icon will light in **gray** in the digital display.

Bring the vehicle at the speed you want to maintain then press the cruise button downward to SET the speed.

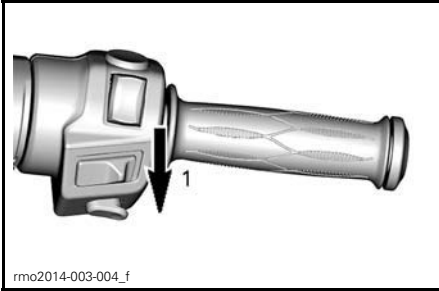

1. Push button downward to SET

NOTE: The cruise control icon will light in **green** in the digital display.

You can now release the throttle.

⚠ WARNING

Always keep both hands on the handlebar while riding. Otherwise, this could cause a vehicle loss of control.

NOTE: You can increase engine speed using the throttle grip if you need to go faster than the set speed. Releasing the throttle will allow the cruise control to recover the set speed.

Once the cruise control has been set, the speed setting may be increased or reduced by pushing the button UP or DOWN. Each press of the button will change the speed setting by incre-

ments of 1.6 km/h (1 MPH). Holding the button will change the speed setting until released or the operating limit has been reached.

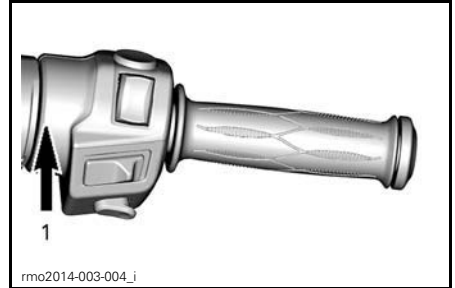

1. Push up button to increase the speed setting

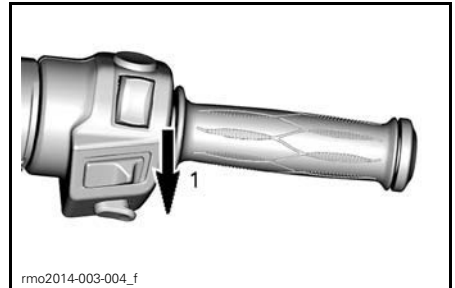

1. Push down button to reduce the speed setting

Canceling the Cruise Control

Any of the following event will cancel the cruise control.

- Pressing the brake pedal.
- Gear change.
- Any vehicle stability system intervention.

Resuming the Cruise Control

If the cruise control was cancelled and the cruise control switch is still at the ON position, the cruise control operation can be resumed by pushing the cruise control button up. The cruise control will then recover the previous set speed.

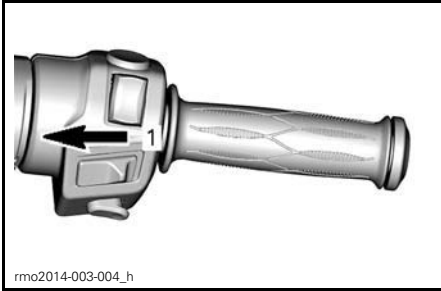

1. Slide button to the left

NOTE: The cruise control status will show CRUISE SET in the digital display.

Stopping the Cruise Control

To completely stop the cruise control operation, slide the cruise control button to the left.

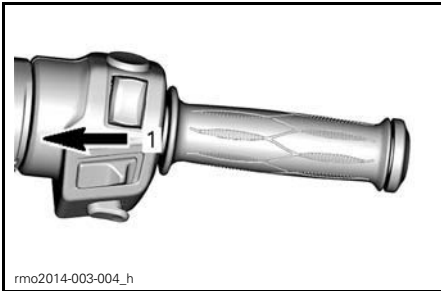

1. Slide button to OFF

NOTE: The CRUISE ON status will disappear in the digital display.

6) Engine Stop Switch

The engine stop switch is located in the top portion of the right handlebar housing.

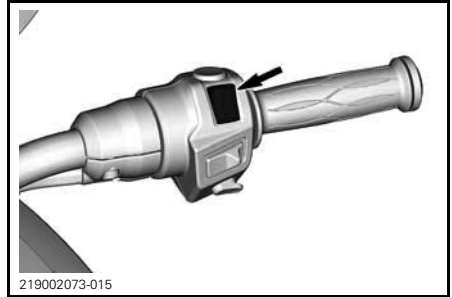

The switch has two positions and must be set to the run position before you can start the engine. It allows you to stop the engine anytime without removing your hand from the handlebar.

7) Hazard Warning Switch

The hazard warning button is located on the top of the right handlebar housing.

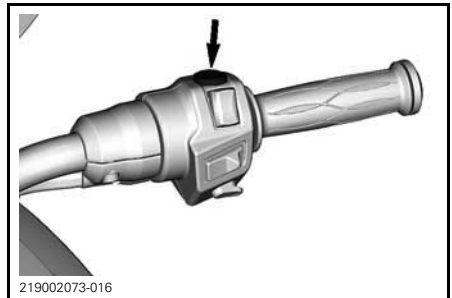

Push the button to turn on or off the hazard warning lights.

8) Reverse Button

The reverse button is located on top of the left handlebar housing.

The reverse button is located near the left handgrip.

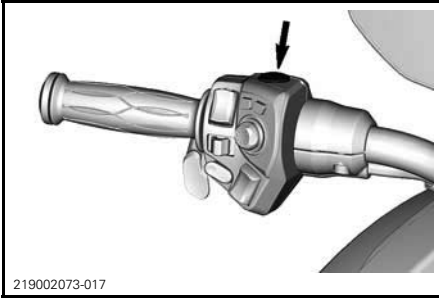

Push and hold the reverse button to allow shifting into reverse. Refer to *OPERATING IN REVERSE IN BASIC PROCEDURES* for detailed instructions.

The backup lights turn on when the vehicle is in reverse.

9) BRP Connect Button

The BRP Connect button is located on the back of the left handlebar housing.

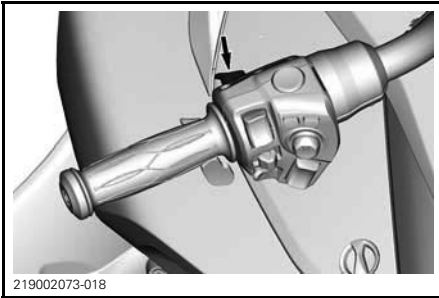

NOTE: The BRP Connect button is used for quick access to BRP Connect. Each click will swap between apps view and functions view of the multi-function gauge.

10) Headlights Switch

The headlight switch is located in the left top portion of the left handlebar housing.

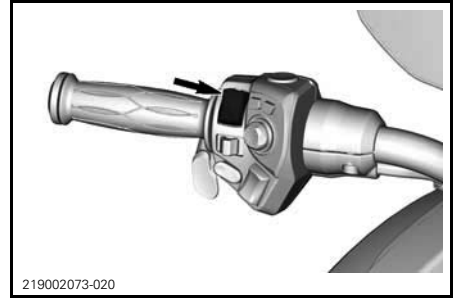

The following icon appears inside the digital display when the headlight are turn on.

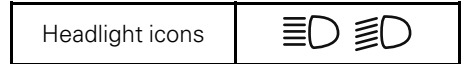

The switch is used to select high or low beam for the headlight. The headlights automatically turn on when the engine reaches 800 RPM and turn off after approximately 20 seconds when engine has been stopped.

To select high beams, push the switch to the front position. To select low beams, push the switch to the back position.

To flash the high beams, push the switch down, then release it. The high beams will stay on as long as you hold down the switch.

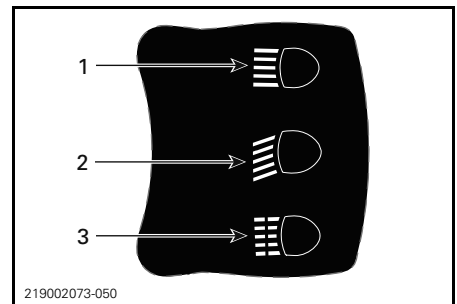

CHINESE MODEL

1. High beams
2. Low beams
3. Flash high beams

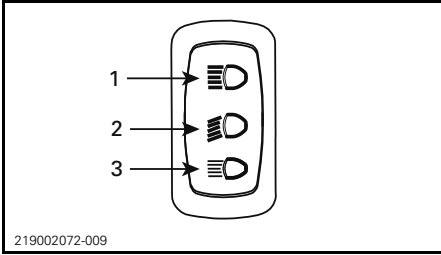

219002072-009

ALL OTHER MODELS

1. High beams
2. Low beams
3. Flash high beams

11) Turn Signal Button

The turn signal button is located on the center of the left handlebar housing.

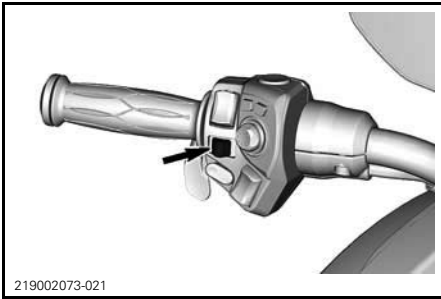

219002073-021

The following icon appears inside the digital display when the turn signal is activated.

Left side turn signal	
Right side turn signal	

The turn signal button turns off automatically after a normal turn, but you may have to turn it off manually after a shallow turn or lane change.

To turn the signal off, press the button in.

Turn signals will automatically turn off after 30 seconds while the vehicle is moving.

12) Horn Button

The horn button is located at the bottom of the left handlebar housing.

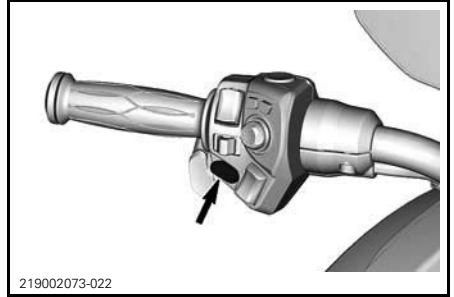

219002073-022

13) Audio Volume Control

The audio volume control is located at the bottom of the left handlebar housing.

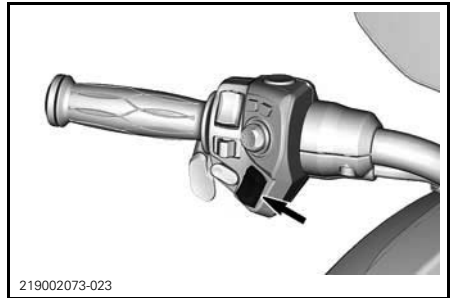

219002073-023

The button allows to raise or lower the volume of the audio system to your convenience.

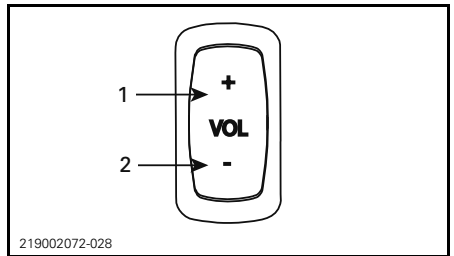

219002072-028

1. Volume up
2. Volume down

14) Electronic Command Center (ECC)

The ECC is located near the left hand-grip.

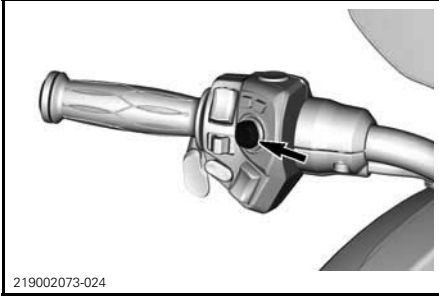

219002073-024

The ECC is a multifunction switch, it allows the control of numerous functions of the multifunction gauge.

NOTE: Inputs given to the ECC may be halted for a short delay as the vehicle electronic modules prioritize vehicle main functions. This should not be considered a malfunction.

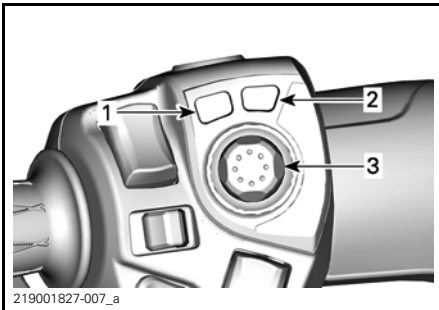

219001827-007_a

1. *MODE* button
2. *Parking brake* button
3. *JOYSTICK*

⚠ WARNING

Using the ECC while driving can distract the driver from operating the vehicle. Always use buttons with caution and always keep your eyes on the road.

Audio Control

When in the home screen, pushing the joystick UP or DOWN will increase or decrease the audio volume.

NOTE: The audio volume level can be self-adjusting according to the automatic volume control setting as set in the Preferences Screen.

To enable the audio automatic volume level control, go to:

- Audio
- Configuration
- Auto vol CTRL

Push the JOYSTICK DOWN and hold it more than one second. The audio volume will mute.

From the mute setting, pushing the joystick UP will reset the audio volume to its last setting.

4.5" DIGITAL DISPLAY (F3 MODELS)

Multifunction Display

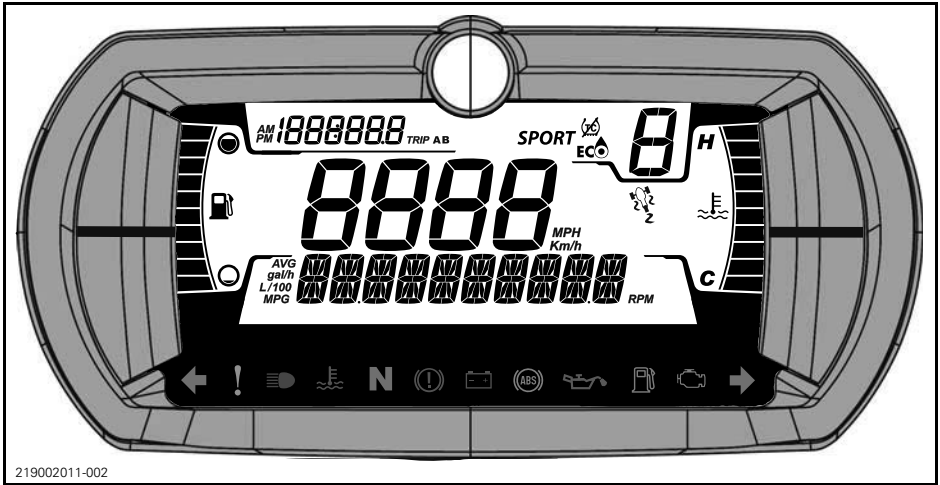

⚠ WARNING

Reading or tempering with the multifunction gauge can distract you from the operation of the vehicle, particularly from constantly scanning the environment. Always pay attention to road conditions, ensure your environment is clear and free from obstacles. Furthermore, when riding, only glance at the multifunction gauge briefly to maintain awareness of road conditions.

The multifunction gauge includes digital gauges (temperature and tachometer), telltale lights, icons and a digital screen to see important information (speed, RPM, etc.).

Lower Display

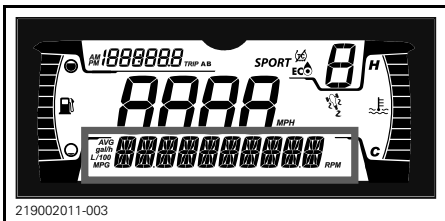

May display the following:

- RPM
- AVG - Average Fuel Consumption
- Distance to Empty
- Settings
- Messages

Left Lateral Display

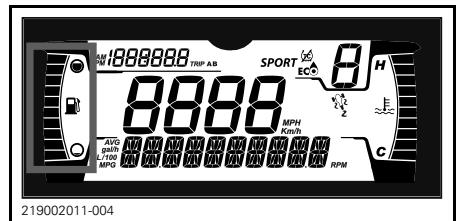

The left lateral display includes:

- Fuel level indicator

Right Lateral Display

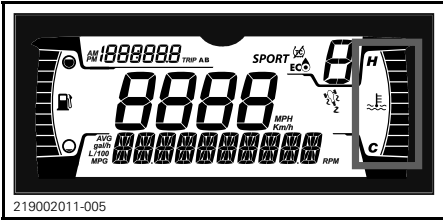

The right lateral display includes:

- Engine Temperature

Central Display

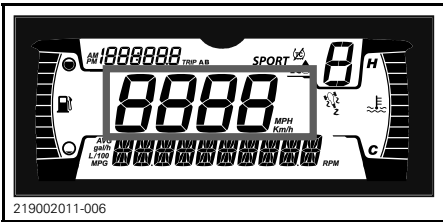

Display the vehicle speed in Km/h or MPH.

Selected Gear Display

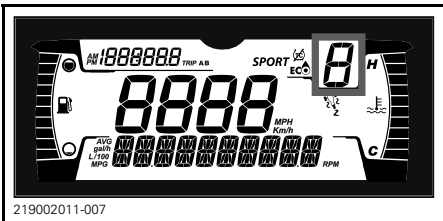

This display indicates the gear position of the gearbox:

- Neutral
- Gear 1 to 6
- R (reverse)

Trip Display

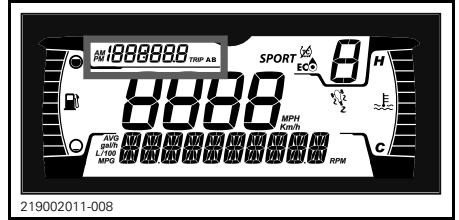

This display shows trip informations:

- Cumulative distance odometer
- Trip A
- Trip B
- Clock

MODE Display

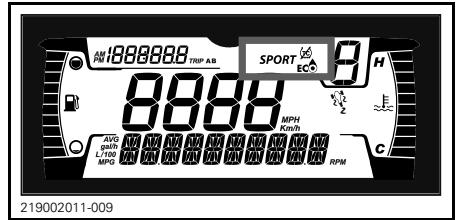

The MODE display indicates the selected driving mode:

- ECO
- SPORT

When a mode is selected, a message is displayed in the lower display. At the same time one or more icons will turn on to confirm your choice.

When in NORMAL mode, no information is displayed.

DRIVING MODE	ICONS
NORMAL	No icon
ECO	
SPORT	SPORT and and

Warning Lamps and Indicators

The following indicator lamps will alert you to a vehicle condition that may become serious. Some lamps will illuminate when starting the vehicle to make sure they work. If any lamps remain on after starting the vehicle, refer to the respective system warning lamp for further information.

NOTE: Some warning indicators appear in the display of the multifunction gauge and function the same as an indicator lamp but do not display when starting the vehicle.

Telltale Lights - Lower Bar

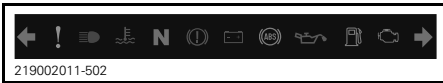





LIGHTS	DESCRIPTION
	GREEN - Left or right turn signal is turned on,
	Hazard Warning Flasher - All front and rear turn signals will flash
	ORANGE - Vehicle malfunction
	BLUE - The high beam are selected
	RED - The engine temperature is too high.
	GREEN - The neutral gear is selected
	RED - Parking brake is engaged or malfunction of the brake system

LIGHTS	DESCRIPTION
	RED - If illuminate while driving, it indicates a malfunction. Turn off all unnecessary electrical equipment and have the electrical and charging systems checked.
	ORANGE - Malfunction of the ABS system
	RED - If illuminate while the engine running or while driving, this indicates a malfunction. Stop the vehicle as soon as it is safe to do so and turn the engine off. Check the engine oil level. Have the lubrication system checked as soon as possible, even if the level being correct.
	ORANGE - Illuminate when the fuel level is low or when the fuel tank is near empty. Refuel as soon as possible.
	ORANGE Turned on: Malfunction of the vehicle emissions control system Blink: Engine limitation, the limp home mode is activated. Have the vehicle serviced immediately.

Icons and Indicators - Multifunction Display

ICONS	DESCRIPTION
	Fuel indicator
	Temperature indicator

ICONS	DESCRIPTION
	Passenger icon - this icon turns on when the LH passenger footpeg is deployed
	VSS icon Turn on: When the VSS is activated or when there is a malfunction Blink: If the VSS is doing an intervention.
	Indicates that the Traction Control system is partially deactivated. The system allows to have all engine power, but with reduced driving stability. It is therefore necessary to drive with appropriate caution.
	Denote ECO mode is selected.
SPORT	Denote SPORT mode is selected.

Settings

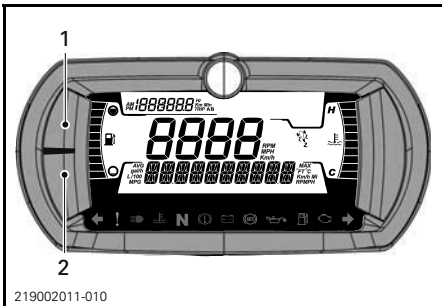

1. UPPER button
2. LOWER button

NOTE: The joystick of the E.C.C. can be used instead of the Menu buttons.

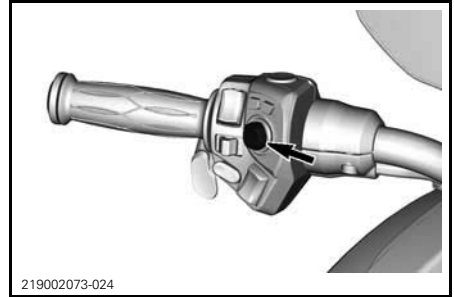

Display Brightness

The brightness of the display is factory setup by default at the maximum level. The brightness may be modified by an authorized Can-Am On-Road dealer.

Setting Language

The language of the display is factory setup by default in English. See an authorized Can-Am On-Road dealer for available languages and change the setup at your convenience.

Menu Buttons

Upper Button

The following informations may be displayed by pressing the UPPER button:

- Odometer - Cumulative distance
- Trip A
- Trip B
- Clock.

Lower Button

The following informations may be displayed by pressing the LOWER button:

- RPM
- Fuel Statistic (average)
- Settings.
 - Fault codes
 - Units
 - Reset Statistics
 - Clock settings
 - Exit

The LOWER button may also be used to select a driving mode.

How Choosing, Resetting or Changing a Value

Upper Menu

Press on the UPPER button until the information to display are selected.

To Reset Trip A or B

Select trip A or B.

Press and hold the UPPER button until the value is reset.

Lower Menu

To Select Specific Information

Press the LOWER button until the name of the desired information is displayed.

Except for SETTINGS, wait 2-3 seconds to select and view the information.

To enter in the SETTINGS menu, hold the LOWER button 2-3 seconds.

NOTE: If no selection is done within 10 seconds, the cluster go out of the SETTINGS menu

To Reset a Value (AVG)

Select the value to be reset.

Press and hold the LOWER button until the value is reset.

To Modify a Value (Clock)

Press the LOWER button to select the information to be modified.

When selected, hold the LOWER button to enter in the modification mode.

Press LOWER button until the new value is displayed.

Wait 2-3 second to accept the change.

Selecting or Changing the Driving Mode

Press and hold the LOWER button until the message in the lower display changes.

Press the LOWER button to scroll all available driving modes.

Wait 2-3 seconds to select and view the new information.

To return to the NORMAL mode, select ECO OFF.

7.5" DIGITAL DISPLAY

Basic Functions

Multifunction Gauge Description

General View

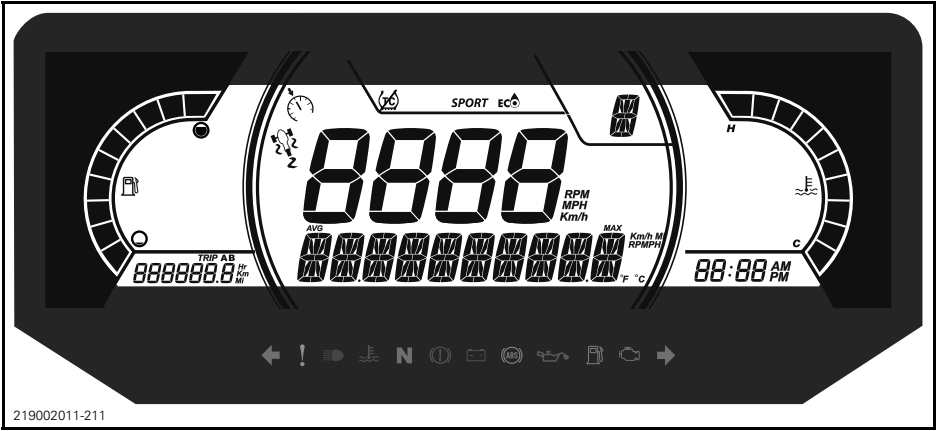

219002011-211

⚠ WARNING

Reading or tampering with the multifunction gauge can distract you from the operation of the vehicle, particularly from constantly scanning the environment. Always pay attention to road conditions, ensure your environment is clear and free from obstacles. Furthermore, when riding, only glance at the multifunction gauge briefly to maintain awareness of road conditions.

The multifunction gauge includes digital gauges (temperature and tachometer), telltale lights, icons and a digital screen to see important information (speed, RPM, etc.).

Lower Display

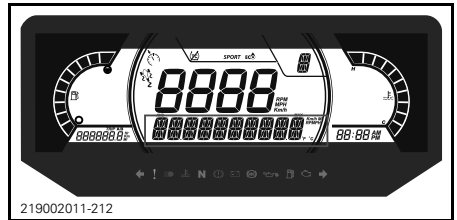

219002011-212

May display the following:

- RPM
- AVG - Average Fuel Consumption
- Settings
- Messages

Left Lateral Display



219002011-213

The left lateral display includes:

- Fuel level indicator
- Tripmeter (A - B)
- Odometer
- Vehicle Hour meter
- Distance to empty

Right Lateral Display

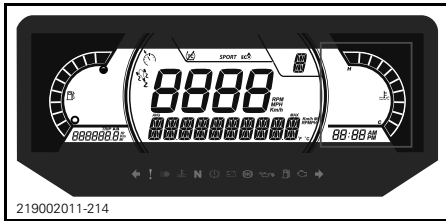

The right lateral display includes:

- Engine Temperature
- Clock

Central Display



Displays the vehicle speed either in Km/h or MPH.

Selected Gear Display



This display shows gears position of gearbox:

- Neutral

- Gear 1 to 6
- R (reverse)

MODE Display

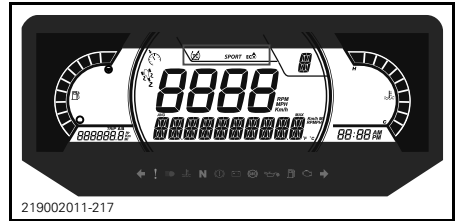

The MODE display indicates the selected mode of operation:

- SPORT
- ECO

When a mode is selected, a message is displayed in the lower display. At the same time one or more icons will turn on to confirm your choice.







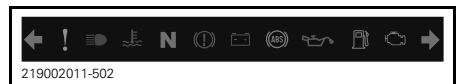

When in NORMAL mode, no information is displayed.



DRIVING MODE	ICONS
NORMAL	No icon
ECO	
SPORT	SPORT and and

Indicator Lamps



Warning and Telltale Lights





LIGHTS	DESCRIPTION
	GREEN - Left or right turn signal is turned on,
	Hazard Warning Flasher - All front and rear turn signals will flash
	ORANGE - Vehicle malfunction
	BLUE - The high beam are selected
	RED - The engine temperature is too high.
	GREEN - The neutral gear is selected
	RED - Parking brake is engaged or malfunction of the brake system
	RED - If illuminate while driving, it indicates a malfunction. Turn off all unnecessary electrical equipment and have the electrical and charging systems checked.
	ORANGE - Malfunction of the ABS system

LIGHTS	DESCRIPTION
	RED - If illuminate while the engine running or while driving, this indicates a malfunction. Stop the vehicle as soon as it is safe to do so and turn the engine off. Check the engine oil level. Have the lubrication system checked as soon as possible, even if the level being correct.
	ORANGE - Illuminate when the fuel level is low or when the fuel tank is near empty. Refuel as soon as possible.
	ORANGE Turned on: Malfunction of the vehicle emissions control system Blink: Engine limitation, the limp home mode is activated. Have the vehicle serviced immediately.

Icons and Indicators

ICON	DESCRIPTION
	Denotes SPORT mode is selected.
	Denotes ECO mode is selected.

ICON	DESCRIPTION
	Denotes Cruise control is selected.
	VSS icon Turn on: When the VSS is activated or when there is a malfunction Blink: If the VSS is doing an intervention.
	Indicates that the Traction Control system is partially deactivated. The system allows to have all engine power, but with reduced driving stability. It is therefore necessary to drive with appropriate caution.

Settings

Setup

Using MENU button, select **SETTINGS** and hold to enter setting menu.

Fault Codes

NOTE: Only when fault codes are active.

Using MENU button, select **CODES** and hold to see active and occurred fault codes. Fault codes will be scrolled on the Lower Display.

Reset Stats

Using MENU button, select **RESET STAT** and hold to reset.

Unit Selection

This multifunction gauge is factory pre-set in Imperial units but it is possible to change it to Metric units.

Using MENU button, select **UNITS** and hold button to change units.

Setting Clock

Using MENU button, Select **CLOCK** and hold to change time.

Press the LOWER button to select the information to be modified.

When selected, hold the LOWER button to enter in the modification mode.

Press LOWER button until the new value is displayed.

Wait 2-3 second to accept the change.

Setting Language

The gauge display language can be changed. Refer to an authorized Can-Am On-Road dealer for language availability and to setup the gauge to your preference.

How Selecting or Changing the Driving Mode

Press the MODE button until the message in the lower display changes.

To return to the NORMAL mode, select ECO OFF.

LARGE PANORAMIC 7.8" WIDE LCD DISPLAY

Basic Functions

LCD Display

Default Display



Multifunction Display



Left Lateral Display

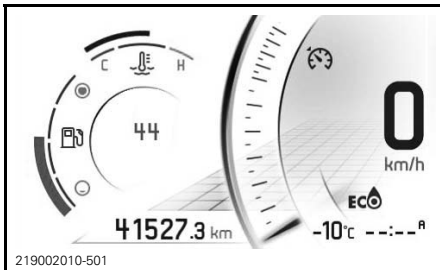

The left lateral display includes:

- Fuel level indicator
- Speedometer
- Tripmeter
- Cruise control
- Gear indicator
- Clock
- Engine temperature
- Driving modes
- Warning pop-up
- Distance to empty

To select the value to be displayed in the tripmeter;

1. Access the Stats/Trip screen
2. Select the desired set of statistic to be shown (Total, A or B)
3. **JOYSTICK UP** will change the value shown on the left display with the distance value of the selected statistic set.

Right Lateral Display

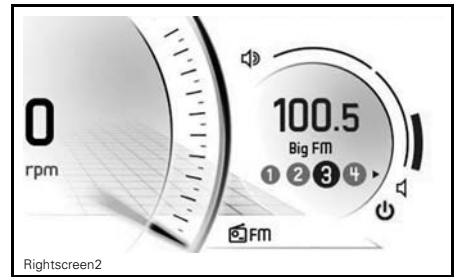

The right lateral display includes:

- Tachometer
- Audio volume
- Audio output indicator
- Radio station pre-set
- Menu
 - BRP Connect
 - Phone
 - Statistics
 - Audio
 - Settings

Navigating in the Digital Display

⚠ WARNING

Reading or tampering with the multifunction gauge can distract you from the operation of the vehicle, particularly from constantly scanning the environment. Always pay attention to road conditions, ensure your environment is clear and free from obstacles. Furthermore, when riding, only glance at the multifunction gauge briefly to maintain awareness of road conditions.

The multifunction gauge includes analog gauges (speedometer and tachometer), indicator lamps and an infotainment center with a digital screen.

We recommend you practice selecting some functions on the infotainment center before getting on the road. You will get used to them and they will be easier to use on the road.

Use the ECC (Electronic Command Center) to control the display functions. Refer to *ECC (ELECTRONIC COMMAND CENTER)* in *SECONDARY CONTROLS*.

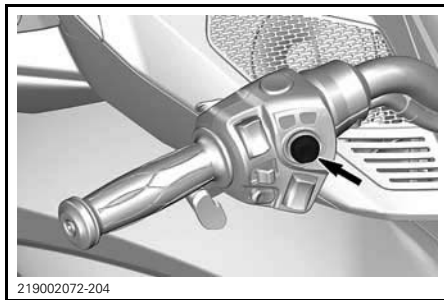

Pressing the joystick (center button) will get the Menu selection in the right screen, in this order:

- BRP Connect
- Phone
- Statistics

- Audio
- Settings

When an icon is selected, its related screen will appear.

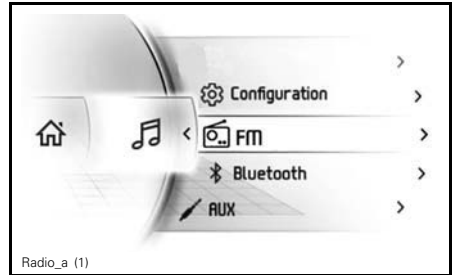



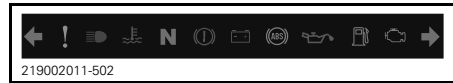

When an item is selected, this sets the item to the current value.

Indicator Lamps



Warning and Telltale Lights









LIGHTS	DESCRIPTION
↔	GREEN - Left or right turn signal is turned on, Hazard Warning Flasher - All front and rear turn signals will flash
!	ORANGE - Vehicle malfunction
☰	BLUE - The high beam are selected
🌡️	RED - The engine temperature is too high.
N	GREEN - The neutral gear is selected
Ⓜ️	RED - Parking brake is engaged or malfunction of the brake system

LIGHTS	DESCRIPTION
	RED - If illuminate while driving, it indicates a malfunction. Turn off all unnecessary electrical equipment and have the electrical and charging systems checked.
	ORANGE - Malfunction of the ABS system
	RED - If illuminate while the engine running or while driving, this indicates a malfunction. Stop the vehicle as soon as it is safe to do so and turn the engine off. Check the engine oil level. Have the lubrication system checked a soon as possible, even if the level being correct.
	ORANGE - Illuminate when the fuel level is low or when the fuel tank is near empty. Refuel as soon as possible.
	ORANGE Turned on: Malfunction of the vehicle emissions control system Blink: Engine limitation, the limp home mode is activated. Have the vehicle serviced immediately.

Icons and Indicators

ICON	DESCRIPTION
	Smartphone Network connection
	Bluetooth device
	Smartphone battery level indicator

ICON	DESCRIPTION
	Helmet pairing indicator
	Fuel indicator
	Temperature indicator
	Cruise control indicator
	Speakers audio output
	Helmet audio output

Settings

Menu Switches

Use the ECC to control of numerous functions of the multifunction gauge.

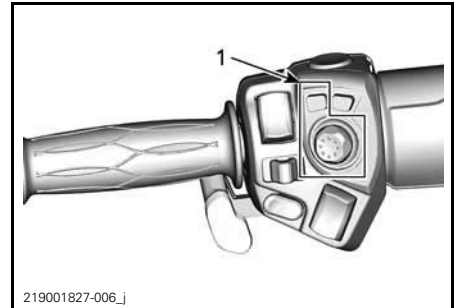

1. ECC

Use the BRP Connect button for quick access to BRP Connect. Each click will swap between apps view and functions view of the multifunction gauge.

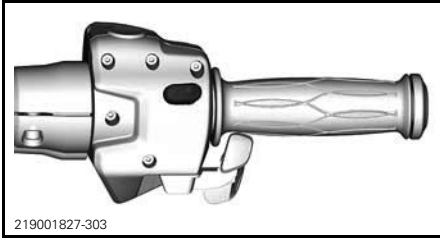

Menu

BRP Connect



Before using BRP Connect, the app must be downloaded to the phone. The app can be downloaded from the Apple App Store or Google Play Store via a simple search. Not all phones are compatible.

Visit our website for more details

www.brpconnecttutorial.com

NOTE: The smartphone must be connected via Bluetooth and with a USB cable to the USB port located in the glove box.

User's personal data will be deleted from the cluster when phone pairing is deleted.

User agree that personal data (contact list and call history) be transferred to the cluster when smartphone is connected.

Contact list and call history are stored in cluster permanently. To delete these information you must un-pair your smartphone or overwrite using another smartphone.

Phone



The phone menu is to access:

- The phone history
- The phone contact list

NOTE: To have access to the Phone menu, a phone and rider helmet must be paired. Refer to *PAIR YOUR SMARTPHONE VIA BLUETOOTH*.

Statistics



The Statistics menu is used to get :

- Trip distance information
- Trip elapsed time information
- Instant fuel consumption
- Average fuel consumption
- Maximum speed
- Average speed

3 sets of statistics are kept in memory. Each set of statistic can be reset independently.

The joystick **LEFT** and **RIGHT** will navigate between the 3 sets of statistic.

Holding the joystick **DOWN** when showing a statistic will reset it.

Audio

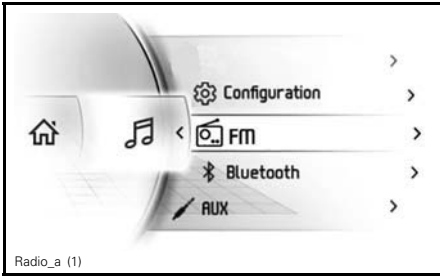

The Audio menu is to:

- Adjust the configuration of:
 - Auto presets
 - Auto volume control
 - Equalizer
 - Fade/Balance
 - Audio output
- Access FM source audio
- Access Bluetooth Audio Player
- Access Aux Audio Player

Audio Control

The joystick controls the audio commands when in the Home Screen or in the Audio Source screen (FM, AUX, Bluetooth).

To turn the radio ON, push the joystick **UP**. To turn the radio OFF, push the joystick **DOWN** when the volume is at its lowest setting (Mute).

Use the joystick to control the audio volume. Joystick **UP** for louder.

To mute the audio, push the joystick **DOWN** and hold it for more than one second. From the Mute setting, pushing **UP** will reset the audio volume to its previous level.

A separate volume level is used for announcement (i.e.: Voice command from the BRP Connect Navigation App). During an announcement, the volume bar will display the announcement volume level. The volume bar will be yellow and the audio source will

show **ANNOUNCEMENT**. It is possible to adjust the announcement volume level during the announcement.

When FM audio source is selected, the left and right joystick functions will be as follows:

- Short Left: Previous preset
- Long Left: Seek down
- Short Right: Next preset
- Long Right: Seek up

When Bluetooth audio source is selected, the left and right functions will be as follows:

- Left: Previous song
- Right: Next song

When In AUX and BRP Connect (Iphone only) audio sources, left and right have no effects.

Audio Configuration

The Audio Configuration menu is as follows:

- Automatic FM presets
- Automatic volume control
- Equalizer
- Fade / Balance
- Audio Output

Audio Output selection is used to select the desired audio output: Speaker or Helmet.

NOTE: A different volume level is used when helmet is selected. This allows to keep the volume previously selected when music was sent to the helmet.

To access the FM tune and preset screen, press the **JOYSTICK** for more than 1 second.

FM Tune and Preset

In the FM tune and preset screen, it is possible to select an FM station and store it in the desired preset number.

- Select FM station to store.

- Press the **JOYSTICK** to select the desired preset number.
- Press joystick **DOWN** for more than 1 second to store the FM station in the selected preset number.

Press the **JOYSTICK** to exit the FM tune and preset screen.

Settings

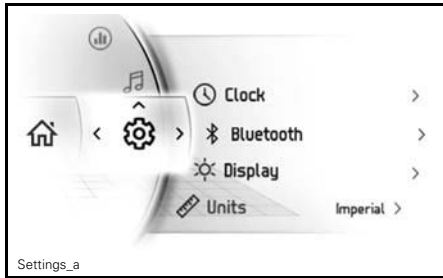

The Settings menu is to:

- Adjust clock
- Pair Bluetooth devices
 - Phone
 - Driver headset
 - Passenger headset
- Adjust the display brightness
- Adjust the units (Imperial/Metric)
- Set the language
- Get the version
- Show vehicle fault codes.

Pairing your Smartphone Via Bluetooth

On the vehicle

1. Short press the **JOYSTICK** to access menu.
2. Go down and select "Settings" and press **RIGHT**.
3. Select "Bluetooth" and press **RIGHT**.
4. Select "Phone" and press **RIGHT**.
5. Select "Add Phone" and press **RIGHT**.

Bluetooth is now visible.

On the phone

1. Activate your phone's bluetooth function.

Refer to your manufacturer's user guide for detailed procedure.

2. Choose "BRP Connect"
3. A confirmation number will appear on your phone screen and the vehicle gauge screen. Make sure these numbers match.
4. Press Pair on your phone and select the green check mark on the vehicle gauge
5. Allow Contacts and Favorite Sync on your phone

Pairing a Helmet

To pair a helmet, go to the "Settings" page and select "Add helmet".

BRP Connect App

Follow these steps to setup your smartphone with BRP Connect.

1) Download the BRP Connect Smartphone App

Download the BRP Connect app via the App Store for Apple™ or the Google™ Play Store for Android.

2) Download Apps Compatible With BRP Connect

Visit our website to know more about the compatible apps. These apps will improve your riding experience. Some apps may require additional purchase to be compatible with the system or may require additional devices to be used.

www.brpconnecttutorial.com

3) Connect your smartphone using your charging / data transfer cable

It is recommended to use an original charging cable from the smartphone OEM to optimize transfer between the phone and the vehicle. Use the front USB port.

1. Unlock your phone screen
2. Connect your phone charging cable
3. A checkmark will appear on your phone screen once the connection is done.

4) Access your Apps

Quick press the **JOYSTICK** to access Menu.

Push the joystick **UP** to select "Launch BRP Connect" and push the joystick **RIGHT**.

Select the app you would like to use and press the **JOYSTICK**.

- To leave the app, long press the **JOYSTICK**.
- To return to the Main Menu, press the BRP Connect Button.

Quick Tour of the BRP Connect App

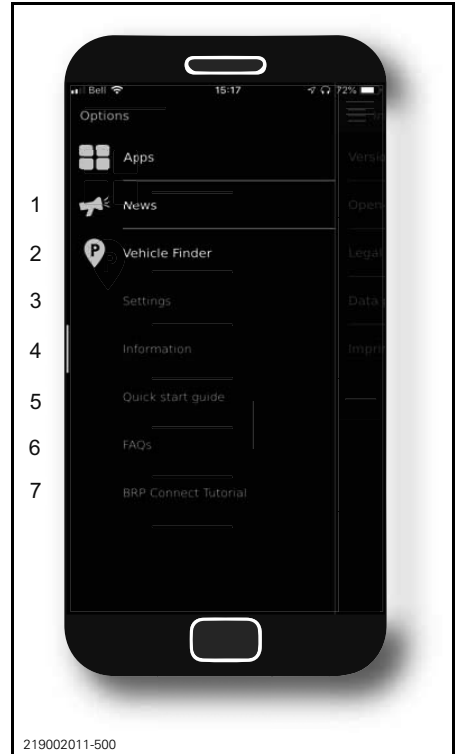

1. News: Communications may occasionally be issued through the BRP Connect app and can be found through this menu.
2. Vehicle Finder: Allows you to store the location of your vehicle (or any other location you wish to remember). The feature is relatively rich as it also allows you to take a picture of the location you left your vehicle at, take notes (e.g. number of the parking spot) and also navigate back to your stored location. Only one location can be saved at a time.

3. Settings: Set BRP connect to your choosing. In which country do you intend to use the BRP Connect App? What should be worth your attention? Note: Elementary settings of the BRP Connect app change be changed from within this menu.
4. Information: General information about the BRPConnect app. States the current version and all legal information.
5. Quick Start Guide: Want to learn how to use this app? Here is how it works.
6. FAQ: This link takes you to answers of common questions asked by riders like you. An internet connection is required.
7. BRP Connect Tutorial: Need to know more? This link takes you to detailed instructions videos. An internet connection is required.



1. *Currently Installed Apps*
2. *Available Apps*

EQUIPMENT

Customer Accessory Circuits

The vehicle has power and ground wires for installing accessories.

Open harness at indicated locations.

1. Behind front storage compartment.

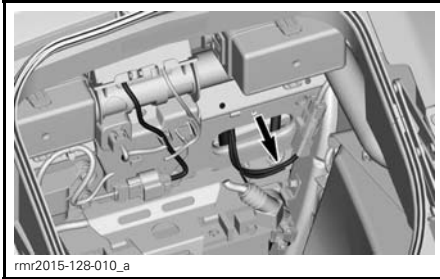

DC12 - FRONT CUSTOMER ACCESSORY CIRCUIT - BEHIND STORAGE COMPARTMENT

2. Behind lateral service cover.

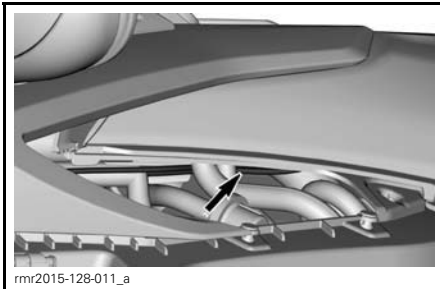

DC34 - MIDDLE CUSTOMER ACCESSORY CIRCUIT - BEHIND LEFT LATERAL SERVICE PANEL

3. Under passenger seat.

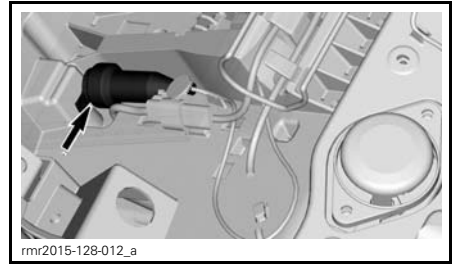

DC56 - REAR CUSTOMER ACCESSORY CIRCUIT - UNDER PASSENGER SEAT

Adjustable Handlebar and Driver Footpegs

Handlebar and driver footpegs can be adjusted to meet the driver needs. It is however important for the person driving the vehicle to be able to use and reach all controls adequately. For example, the brake pedal activation should be easily accessible, workable and go all the way through its function activation.

Adjustments should be made by an authorized Can-Am On-Road dealer to keep vehicle safety integrity.

⚠ WARNING

Controls should be properly and fully accessible to the driver at all times.

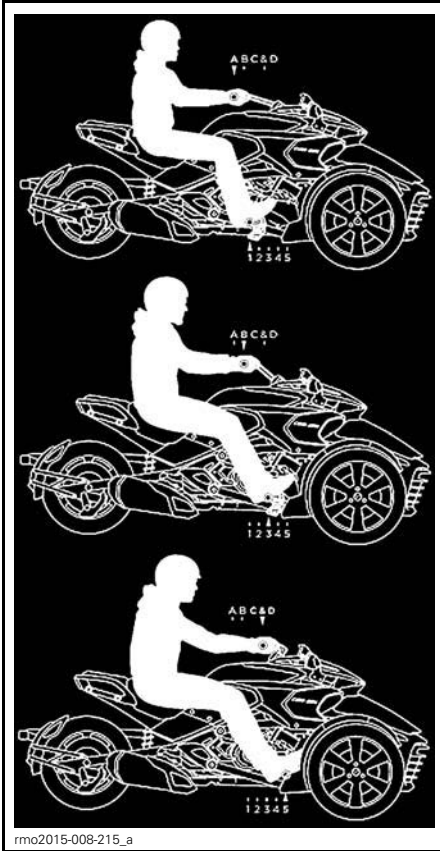

EXAMPLES OF HANDLEBAR AND FOOTPEG POSITIONS

Mirrors

Adjusting Mirrors

With your fingers, press the mirror at the points shown below to adjust its position in the four directions.

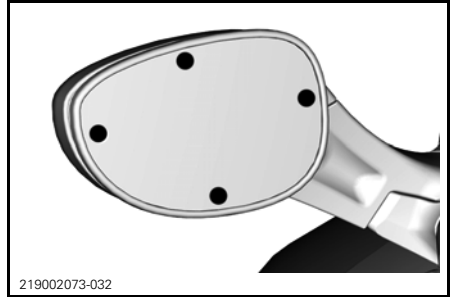

MIRROR ADJUSTMENT POINTS - STD AND S MODELS

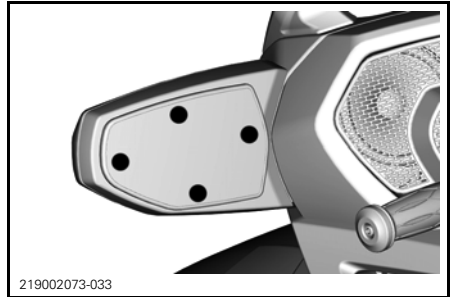

MIRROR ADJUSTMENT POINTS - T AND LIMITED MODELS

Front Storage Compartment

Opening the Front Storage Compartment

1. Insert key in ignition switch.
2. Push and turn the key 1/4 turn counterclockwise to the front storage compartment position and hold while lifting cover.

NOTE: It is possible to open the front storage compartment with the engine running.

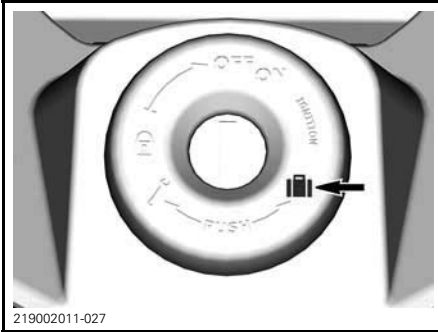

KEY POSITION TO OPEN FRONT STORAGE COMPARTMENT

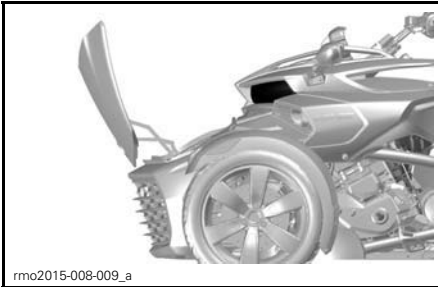

TYPICAL - FRONT STORAGE COMPARTMENT OPENED

Tool Kit

STD and S Models

The tool kit is located in the rear storage compartment.

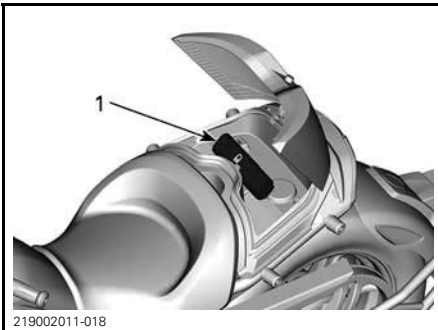

1. Tool kit

T and Limited Models

The tool kit is located under passenger seat.

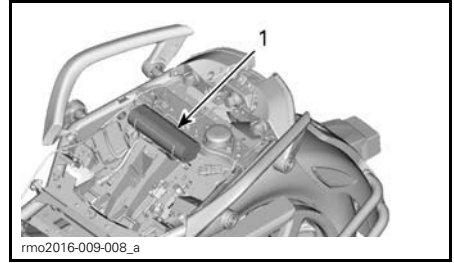

1. Tool kit

Operator's Guide

The operator's guide is located in the front storage compartment.

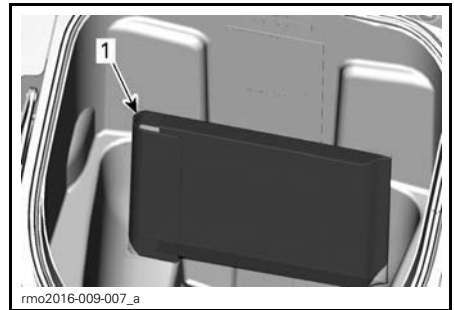

1. Operator's guide

Keep *OPERATOR'S GUIDE* inside vehicle.

Seat

Opening the Passenger Seat (If equipped)

1. Insert key in ignition switch.
2. Push and turn the key 1/4 turn clockwise to the seat opening position and hold while lifting passenger seat.

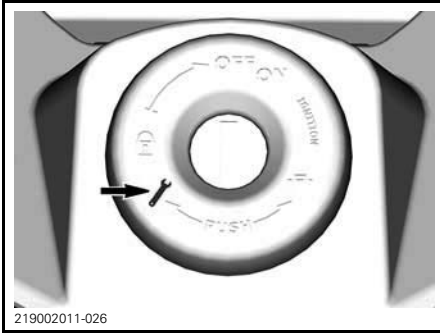

219002011-026

KEY POSITION TO OPEN SEAT

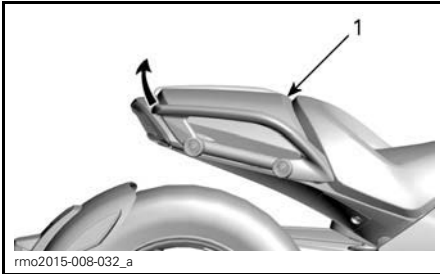

rmo2015-008-032_a

1. Passenger seat

3. Detach seat tether cord from retaining clip.



rmo2015-008-222_a

TYPICAL

1. Tether cord
2. Retaining clip

⚠ WARNING

Part detachment could result in a road hazard. To avoid a potential road hazard, always attach tether cord to the part that covers this compartment.

Mono Seat Cowl (If Equipped)

Mounts on passenger seat in seconds to transform your vehicle into a sporty 1-UP configuration.

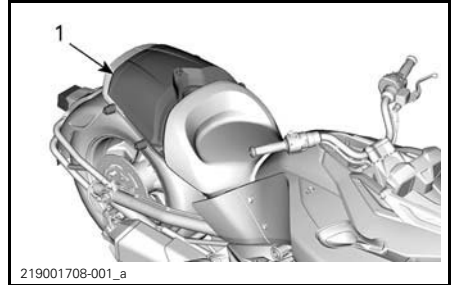

219001708-001_a

1. Mono seat cowl

⚠ WARNING

Part detachment could result in a road hazard. To avoid a potential road hazard, always attach tether cord to the part that covers this compartment.

Rear Storage Compartment (If equipped)

Unlock using the provided key.

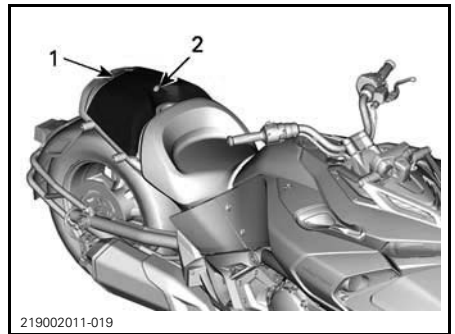

219002011-019

1. Rear storage compartment
2. Lock

Saddlebags

T and Limited Models

These models come equipped with two saddlebags to carry convenient items.

NOTICE Follow maximum loading capacity. Refer to *SPECIFICATIONS* for details.

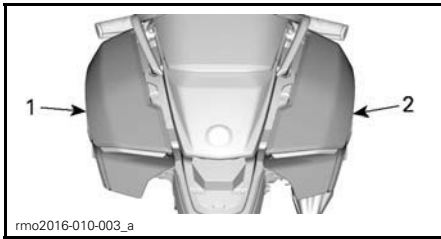

TYPICAL

1. LH saddlebag
2. RH saddlebag

Unlock saddlebag and pull on handle to open them.

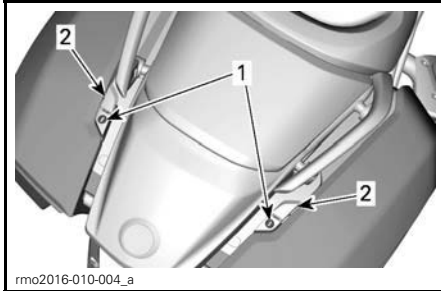

TYPICAL

1. Saddlebag lock location
2. Saddlebag handle

Removing the Saddlebag

Open saddlebag.

Remove the three retaining screws inside saddlebag.

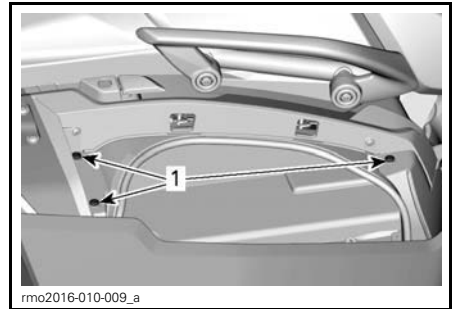

1. Retaining screws

Remove plastic rivet under front of saddlebag.

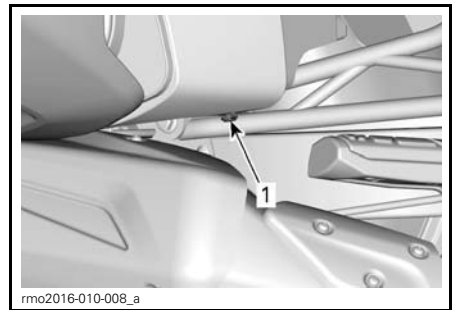

1. Plastic rivet

Remove plastic rivet at the rear of saddlebag.

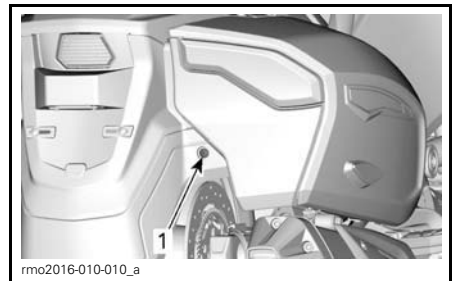

1. Plastic rivet

Slide saddlebag out enough to disconnect taillight/turn signal/brake light connector and remove saddlebag.

Installing the Saddlebag

The installation of the saddlebag is the reverse of the removal procedure.

⚠ WARNING

Make sure saddlebags are properly installed and closed. Verify that all lights at the rear of the vehicle work properly after saddlebag installation.

Top Storage Compartment**Opening the Top Storage Compartment Cover**

The top storage compartment latch is located at the rear of vehicle.

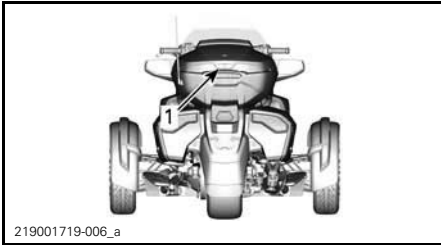

1. Latch for the top storage compartment

Push the latch to open the cover. If lock, use the ignition key to unlock it.

NOTE: If the cover refuses to open, gently move it back and forth and side to side while pressing the latch. See your authorized Can-Am dealer to perform the latch adjustment.

Closing the Top Storage Compartment Cover

NOTICE The cover mechanism must be UNLOCKED to close the top storage compartment. If the cover cannot be closed, DO NOT FORCE. Check if something block the cover and if the latch moves.

Bring the cover at closing position.

Put your hand just above the latch in the center of the cover then push to lock.

Removing the Top Storage Compartment**⚠ WARNING**

Always have the top storage compartment installed and properly locked when riding. Do not use the vehicle if the top storage compartment is missing.

1. Open the top storage compartment cover.
2. Unlock the center LinQ knob by turning it 1/4 turn counterclockwise.

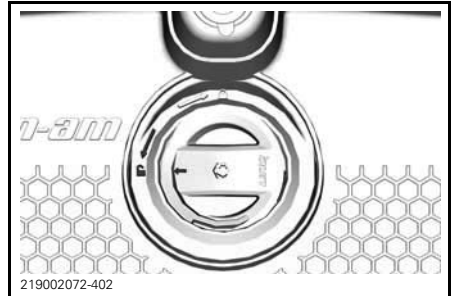

3. Using the rear handle, unlatch the top storage compartment from the vehicle.

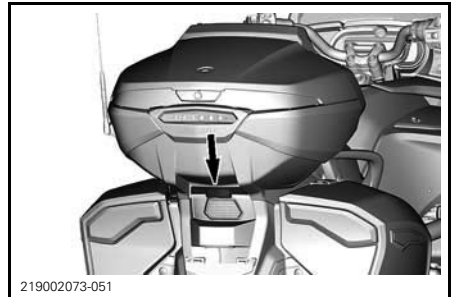

4. Lift the storage compartment slightly and slide your hand underneath to disconnect the connector located near the passenger seat.
5. Pull the storage compartment rearwards to remove it from the vehicle.

Installing the Top Storage Compartment

⚠ WARNING

Always have the top storage compartment installed and properly locked when riding. Do not use the vehicle if the top storage compartment is missing.

1. Align both arms of the storage compartment with the support located on each side of the passenger's seat.
2. Hold the storage compartment in the raise position and connect the connector near the passenger's seat.
3. Lower the storage compartment and push down to lock it.
4. Open the top storage compartment cover.
5. Secure the storage compartment by turning the center LinQ knob 1/4 turn clockwise.

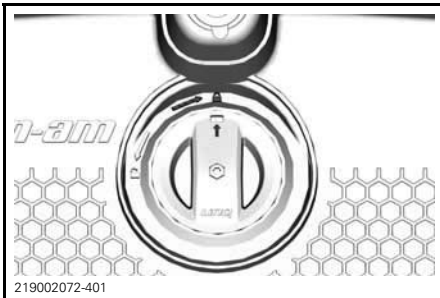

6. Grab the storage compartment firmly and check if it is properly installed and locked on the vehicle.
7. Close the top storage compartment cover.

Glove Box

T and Limited Models

These models come equipped with a glove box to carry small personal items.

Audio in jack and USB connector are also located here.

Pull on the rear cover tab of glove box to open.

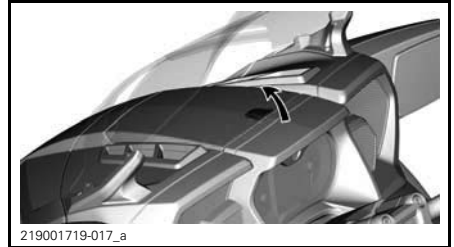

TYPICAL

Body Panels

The body panels on the vehicle can be removed for maintenance.

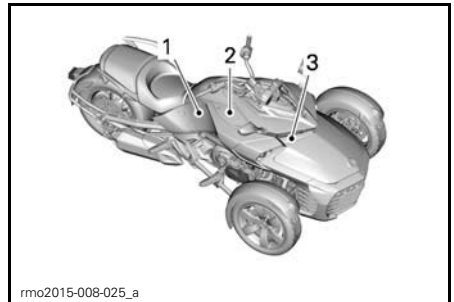

TYPICAL - RIGHT HAND SIDE PANELS

1. Side panel
2. Lateral service covers
3. Front service cover

Lateral Service Cover

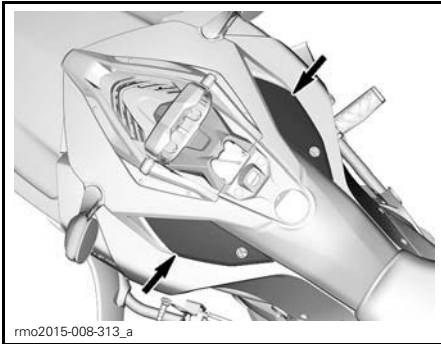

rmr2015-008-313_a

TYPICAL - LATERAL SERVICE COVERS

Lateral Service Cover Removal

1. Rotate lock counterclockwise (RH service cover) or clockwise (LH service cover).

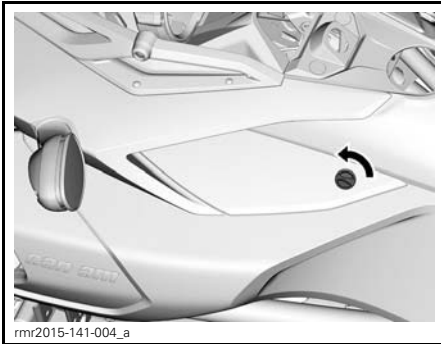

rmr2015-141-004_a

TYPICAL - LH SERVICE COVER SHOWN

2. Pull out service cover

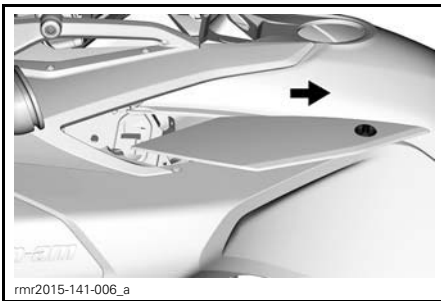

rmr2015-141-006_a

TYPICAL

Lateral Service Cover Installation

1. Install lateral service cover in place taking care to align tabs properly.

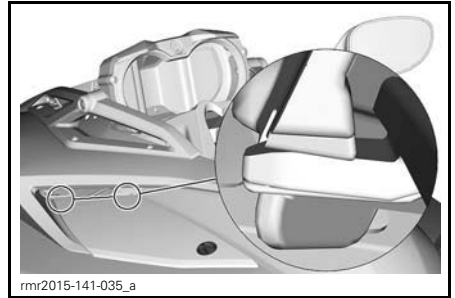

rmr2015-141-035_a

TYPICAL

NOTICE Make sure lateral service cover does not overlap on side panel.

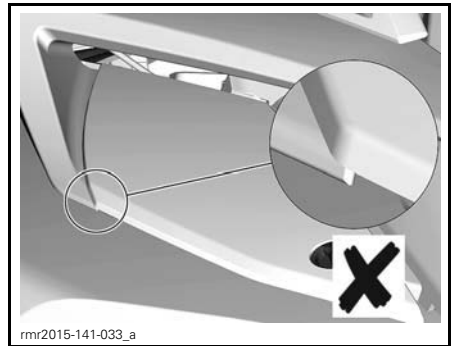

rmr2015-141-033_a

TYPICAL - OVERLAPPING INSTALLATION

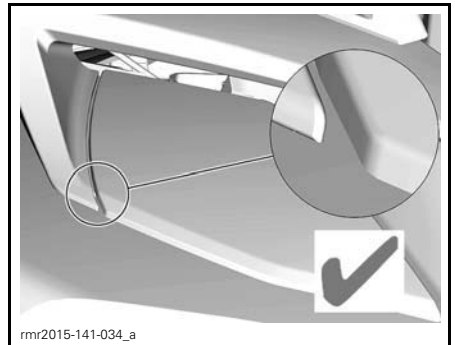

rmr2015-141-034_a

TYPICAL - CORRECT INSTALLATION

Front Service Cover

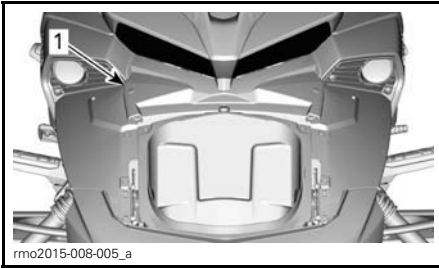

TYPICAL

1. Front service cover

Front Service Cover Removal

1. Lift front of service cover to clear grommets

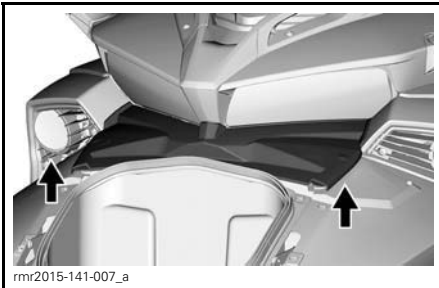

TYPICAL - LIFTING SERVICE COVER

2. Remove service cover from vehicle

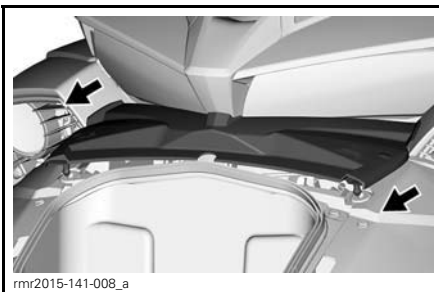

TYPICAL - REMOVING SERVICE COVER

Front Service Cover Installation

1. Slide front service cover back in place.

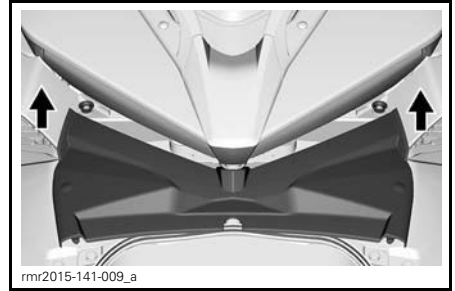

TYPICAL - SLIDING SERVICE COVER IN POSITION

NOTE: Make sure front service cover tab are positioned properly on vehicle.

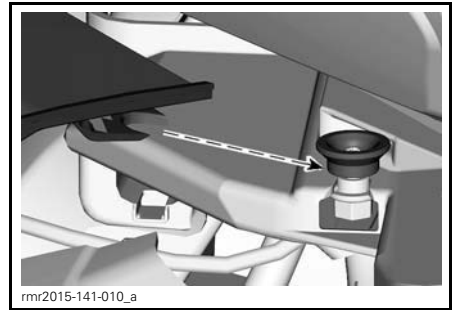

TYPICAL - ALIGNING TABS IN CORRECT INSTALLATION LOCATION

Side Panel

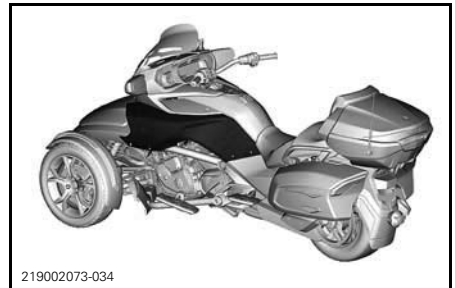

Side Panel Removal

1. Remove screws and plastic rivets securing side panel to vehicle.

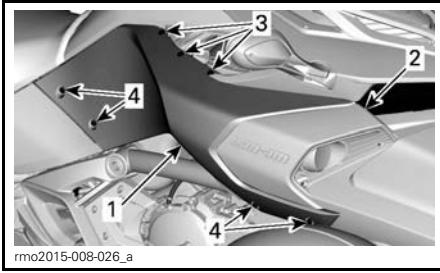
**TYPICAL**

1. Side panel
2. Clip
3. Plastic rivets
4. Retaining screws

2. Lift side panel to remove it.

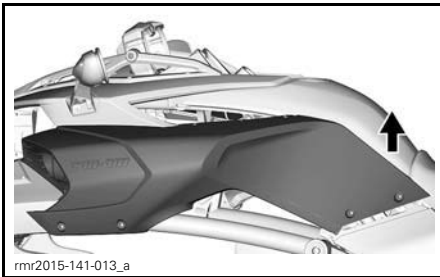
**TYPICAL****Side Panel Installation**

1. Slide the inner side panel back in position.

NOTE: Take care to align side panel retaining screw tab to air scoop retaining screw tab.

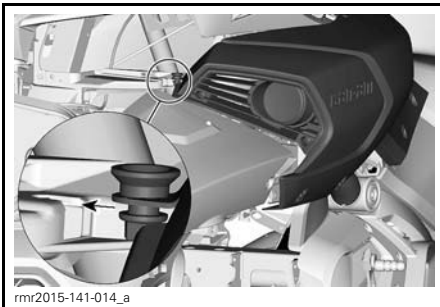
**TYPICAL - ALIGNING PANELS PROPERLY**

2. Install plastic rivets and screw in Torx screw.

NOTICE Do not over tighten. Any deformation on the panel around the screw is an indication that it is too tight. You may damage the panel.

Diagnostic Connector

All vehicles are equipped with a diagnostic connector to connect the BRP Diagnostic Software (BUDS2). This connector is usually used by an authorized Can-Am On-Road dealer to servicing the vehicle.

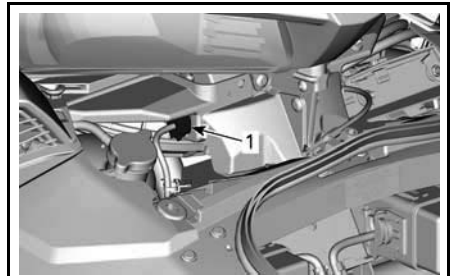

1. Diagnostic connector (for BUDS2)

In some countries, the vehicles is also equipped with an OBD2 6-pin connector to read the vehicle fault codes. This connector may be used by your preferred repair shop, any person of your own choosing, or by yourself.

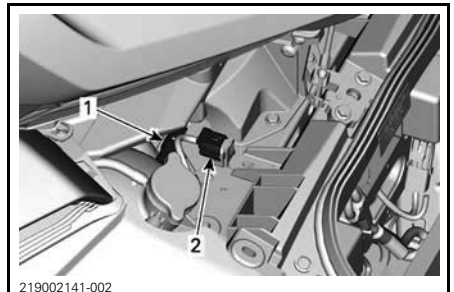

1. Diagnostic connector (for BUDS2)

2. OBD2 6-pin connector

NOTE: If a 16-pin automotive OBD2 reader is used, an adapter is required. This adapter must be purchased locally.

Diagnostic Connector Location

1. Open the front storage compartment cover.
2. Remove the front service cover. Refer to *SERVICE COVER* in *EQUIPMENT* section.

BASIC PROCEDURES

Starting and Stopping the Engine

Starting the Engine

WARNING

Exhaust gas contains poisonous carbon monoxide that can rapidly accumulate in an enclosed or poorly ventilated area. If inhaled, it can cause serious injury or death.

Only run the engine in an unenclosed, well ventilated area. See *AVOID CARBON MONOXIDE POISONING*.

NOTE: The vehicle can be started in any gear with the brake pedal depressed. The transmission automatically shifts to neutral when the engine started.

1. Push down and hold the brake pedal.
2. Turn the key to ON.

NOTICE Do not apply throttle while electrical system is initializing.

3. Refer to the Safety Card as needed to prepare yourself, your passenger and the vehicle, then press the MODE button to enable the starter.
4. Set the engine stop switch to the RUN/ON position.
5. Press and hold the engine start button until the engine starts. Do not hold the start button for more than 15 seconds. If it does not start, release the button and wait 30 seconds to let the starter cool down before trying again.

NOTICE Do not apply throttle while starting the engine.

6. Check the display for problems and to ensure that the oil light turns off.

7. Release the parking brake. Make sure the parking brake indicator on the multifunction gauge cluster is off.

Stopping the Engine

1. Shift into neutral.
2. Set the engine stop switch to OFF.
3. Engage the parking brake. The brake locks in the depressed position, and a scrolling message PARK BRAKE will appear on the display.
4. Turn the key to OFF.

NOTE: If the parking brake is not engaged while the key is OFF, the park brake indicator light will flash and a beeper will sound.

5. Before dismounting, check that the parking brake is fully engaged. Rock the vehicle back and forth.

WARNING

Always engage the parking brake. The vehicle can roll if the parking brake is not engaged, regardless of what gear it is in. The clutch is always disengaged when the vehicle is stopped, so the transmission will not hold the vehicle in place.

Pushing the Vehicle

CAUTION Avoid pushing the vehicle on a slope. If you must push the vehicle on a slope, take extra care to stay within reach of the brake pedal in case the vehicle starts to roll.

To move the vehicle a short distance without starting the engine:

1. While seated on the vehicle, push down and hold the brake pedal.
2. Disengage the parking brake.
3. Dismount on the right side of the vehicle, keeping your foot on the brake pedal.

4. Push the vehicle, using the brake as needed.

⚠ CAUTION Only push from the right side, so you can reach the brake pedal. Stay clear of the hot exhaust pipe.

When pulling the vehicle backward, be careful that the front wheel does not roll over your feet.

5. Remount the vehicle and park as specified above.

Operating in Reverse

For safe operation in reverse, refer to *SAFE OPERATING INSTRUCTIONS* section.

Shifting Into Reverse

1. With engine running, the vehicle stopped, and the brake depressed, shift into first gear or neutral.
2. Press and hold the reverse button.
3. Pull the gearshift selector toward you to downshift to reverse.

Driving in Reverse

Check that the area behind you is clear and continue to look backwards while you operate in reverse. Keep your speed low and do not back up for long distances.

Shifting Out of Reverse

Stop vehicle and push on upshift selector quickly to shift into neutral and more longer to shift in 1st gear.

Operating During Break-In

A break-in period of 1 000 km (600 mi) is required for the vehicle.

During the first 300 km (200 mi), avoid hard braking.

⚠ WARNING

New brakes and tires do not operate at their maximum efficiency until their break-in is completed. Braking, steering and VSS performance may be reduced, so use extra caution.

Brakes and tires take about 300 km (200 mi) of riding with frequent braking and steering to break-in. For riding with infrequent braking and steering, allow extra time to break-in the brakes and tires.

During the first 1 000 km (600 mi):

- Avoid full throttle acceleration.
- Avoid maintaining constant RPM.
- If the cooling fan operates continuously during stop and go traffic, pull over and shut off the engine to let it cool off or speed up to let air cool off the engine.

After the break-in period, your vehicle should be inspected as per the *MAINTENANCE SCHEDULE*.

Fueling

Fuel Requirements

NOTICE Always use fresh gasoline. Gasoline will oxidize; the result is loss of octane, volatile compounds, and the production of gum and varnish deposits which can damage the fuel system.

Alcohol fuel blending varies by country and region. Your vehicle has been designed to operate using the recommended fuels, however, be aware of the following:

- Use of fuel containing alcohol above the percentage specified by government regulations is not recommended and can result in the following problems in the fuel system components:
 - Starting and operating difficulties.
 - Deterioration of rubber or plastic parts.
 - Corrosion of metal parts.
 - Damage to internal engine parts.
- Inspect frequently for the presence of fuel leaks or other fuel system abnormalities if you suspect the presence of alcohol in gasoline exceeds the current government regulations.
- Alcohol blended fuels attract and hold moisture which may lead to fuel phase separation and can result in engine performance problems or engine damage.

Recommended Fuel

Use premium unleaded gasoline with an AKI (RON+MON)/2 octane rating of 91, or an RON octane rating of 95.

NOTICE Never experiment with other fuels. Engine or fuel system damages may occur with the use of an inadequate fuel.

NOTICE Do NOT use fuel from fuel pumps labeled E85.

Use of fuel labeled E15 is prohibited by U.S. EPA Regulations.

Refueling Procedure

⚠ WARNING

Gasoline is extremely flammable and highly explosive. Follow the refueling procedure to reduce the risk of fire or explosion. See *GENERAL PRECAUTIONS* section.

To refuel the vehicle:

1. Park outdoors in a well-ventilated area away from flames, sparks, anyone smoking and other sources of ignition.
2. Stop the engine.
3. Lift fuel cap key cover.

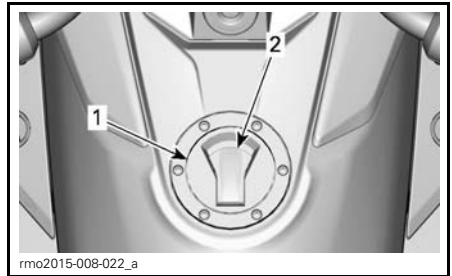

1. Fuel cap
2. Fuel cap key cover

4. Insert key in fuel cap and rotate 1/4 turn clockwise to unlock and remove cap.

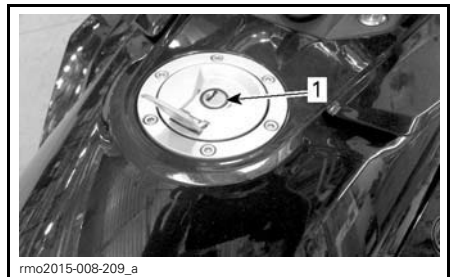

1. Fuel cap keyhole

5. Fill the tank until the fuel level reaches the filler tube.

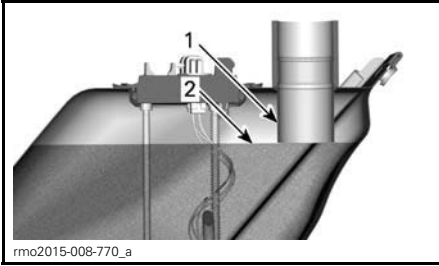

1. Filler tube
2. Fuel level

NOTE: Do not try to top off the fuel tank. Leave some room for the fuel to expand with temperature changes.

6. Wipe up any spilled fuel. If fuel spills on you, wash with soap and water and change your clothes.
7. To close fuel cap, push fuel cap into position with the key inserted in the lock. Turn key counterclockwise to the original position to lock fuel cap. Then remove key and close fuel cap lock cover.

NOTE: Fuel cap will not close properly with the key out of the lock. The key cannot be removed from fuel cap unless it is locked in position.

⚠ WARNING

Always make sure fuel cap is properly closed after refuelling and before operating vehicle.

Adjusting Suspension

Front Suspension (All Models Except F3 Base Models)

See a Can-Am dealer for front suspension adjustment.

Rear Suspension

T Models

The rear air suspension is pressurized for general operation. If the vehicle load changes (adding a passenger, riding with more cargo etc.) or if a softer

or a harder setting is desired, the pressure of the rear suspension can be changed to your preferences.

NOTE: The air suspension might deflate over time, it is recommended to check it regularly even if the loading does not change.

The suspension pressure is adjustable by deflating or inflating the air spring. Use a regulated air compressor or hand pump and a pressure gauge.

To soften suspension, reduce air pressure and to harden suspension, increase air pressure.

NOTE: The following chart is a guideline only. You may adjust the pressure to your riding preference as long as you do not exceed the maximum allowed pressure.

NOTICE Do not exceed the maximum allowed pressure. This might damage the air suspension.

⚠ WARNING

MINIMUM PRESSURE 70 kPa / 10 Psi / 0.7 bar
DO NOT EXCEED RECOMMENDED PRESSURE BY 70 kPa / 10 Psi / 0.70 bar

LOAD		(PASSENGER + CARGO) Kg / Lb			
		0	45/100	70/150	90/200
		5966			
DRIVER	Kg/Lb	kPa/Psi/bar			
	70/150	105/15/1.05	240/25/2.40	380/55/3.80	415/60/4.15
	90/200	205/30/2.05	345/50/3.45	415/60/4.15	480/70/4.80
	115/250	275/40/2.75	415/60/4.15	480/70/4.80	

704905966

NOTE: When adjusting the pressure, do not put your weight on the vehicle and do not load cargo in the storage compartment.

The air spring is connected directly to an air hose with a schrader valve located under the seat.

To change the air pressure, proceed the same way as for setting the pressure in a tire.

When finished, ensure to reinstall cap on the valve.

Limited Models

The rear suspension is calibrated for a general riding and will adjust automatically, using an integrated compressor, while riding to maintain this preset when the road conditions change or if the vehicle load changes (adding a passenger, riding with more cargo etc.).

NOTE: It is normal to hear pressure release or the air compressor operating while engine is running. It indicates the suspension is self-adjusting.

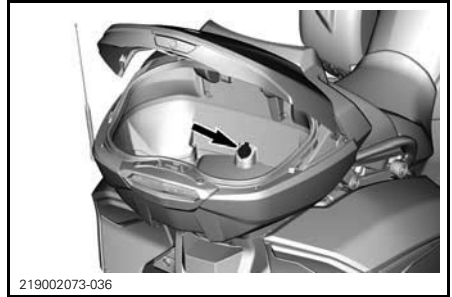

Using the Audio in Jack

An audio input jack is provided in the glove box.

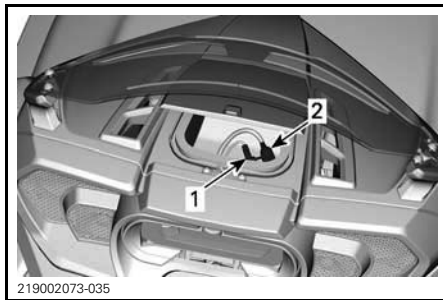

1. Audio in jack
2. USB jack

Any audio player connected in this jack will be played through the audio system. Depending your device, it can be totally, partially or not controlled through the ECC and the keypad.

The front USB port must be used to run the BRP Connect app. Refer to *LARGE PANORAMIC 7.8" WIDE LCD DISPLAY* section for complete information.

The USB ports located inside the top storage compartment are only used to charge a smartphone. No data is transferred through the rear USB port.

SAFE OPERATING INSTRUCTIONS

WHAT'S DIFFERENT FROM OTHER VEHICLES

This section will help you understand some of the vehicle distinctive features and operating characteristics.

Stability

The three-wheeled “Y” configuration provides greater low-speed stability than a motorcycle. However, it is not as stable as a four-wheeled vehicle such as an automobile. Driving aid technologies, like the electronic Vehicle Stability System (VSS), help maintain stability during maneuvers, but you can still lose control, tip or roll the vehicle due to extreme maneuvers (such as hard turns), overloading the vehicle or striking uneven surfaces or objects. In addition, the operator or passenger can fall off due to hard turns, acceleration, braking or impacts.

Response to Road Conditions

This vehicle responds differently than other vehicles to certain road conditions.

- Do not ride off-road or on ice or snow.
- Avoid puddles and running water. The vehicle hydroplanes more easily than a car. If you must go through water, slow down.
- Slow down on gravel, dirt or sand covered roads.
- Driving at temperature lower than 6°C (43°F) will result in reduced adherence.

Refer to *STREET STRATEGIES* for detailed instructions.

Brake Pedal

One pedal applies brakes on all three wheels. There is no hand-operated brake, and there is no way to brake front and rear wheels separately.

The braking and steering are similar to a motorcycle. Be aware of vehicle behind you, they may not be able to stop or react as quickly as you.

Anti-lock Braking System (ABS)

The vehicle is equipped with an Anti-lock Braking System (ABS) as part of the Vehicle Stability System (VSS). For hard braking, press and hold the brake pedal. ABS will prevent wheels from locking.

This system helps to maintain the steering control during an emergency braking situation by keeping the brakes from locking.

Parking Brake

The parking brake mechanically brakes the rear wheel only, and it locks in place when engaged. It is not controlled by driving aid technologies (e.g., ABS, Electronic Brake Distribution).

Steering

Direct Steering

To steer this vehicle, always steer in the direction of the turn.

Motorcyclists — Do not countersteer as it is done on a motorcycle. Unlike a motorcycle, this vehicle cannot lean while turning. If you are a motorcyclist, you must relearn how to turn. Practice steering in the direction of the turn at all speeds until you are proficient.

Sideways Forces in Turns

Unlike a motorcycle, this vehicle does not lean in turns. You will feel sideways forces pushing you to the outside of the turn.

To maintain balance, the operator and passenger must hold back with their both hands and keep their feet firmly planted on the footpegs.

In tight turns, it may help to lean your upper body forward and toward the inside of the turn.

Width

Because this vehicle is wider than a typical motorcycle:

- Always keep the front wheels in your lane. Be especially aware of the front wheels location when entering in a curve or during an overtaking.
- Do not share lanes or split lanes (ride between two lanes of traffic). Group riding should proceed in a single file, even with motorcycles.
- Be prepared to swerve farther to avoid obstacles.

NOTE: Clearing an obstacle with the front wheels does not guarantee clearing the obstacle with the rear wheel.

Reverse



This vehicle operates in reverse like a car. However, there are some important differences:

- If necessary, have the passenger dismount if your visibility is limited.
- Remember that the front is wider than the rear. Do not back up too close to objects or you may hit them with the front tires.
- Keep your speed low and do not back up for long distances.
- When possible, park so that you do not have to back out of the parking space.

⚠ CAUTION Always keep both feet on the pegs while operating in reverse. Never put your feet on the ground while backing-up.

Driver's License and Local Laws

Driver's license requirements for operating this vehicle vary by location. Depending on local laws, you may need a motorcycle endorsement, a specific endorsement for a three-wheeled vehicle, or just a standard automobile driver's license.

Check with local authorities to make sure you have the proper license before operating the vehicle on public roads.

DRIVING AID TECHNOLOGIES

Vehicle Stability System (VSS)

This vehicle is equipped with a Vehicle Stability System (VSS).

This system helps to keeping the control of the direction and reduce the risk of tipping or rolling over in some situations.

The VSS is composed of:

- An **Antilock Braking System (ABS)** that helps maintain steering control during an emergency braking situation by keeping the brakes from locking.
- An **Electronic Brake Distribution (EBD)** system that automatically adjusts the brake balance between all three wheels. With the ABS, EBD helps maintain directional control and maximize the braking force depending on the traction available.
- A **Traction Control System (TCS)** that helps prevent the rear wheel from slipping. The TCS will limit rear wheel spin only if you turn the handlebar (steer out of straight line) or if traction conditions or vehicle stability require engine torque to be reduced.
- A **Stability Control System (SCS)** is designed to limit the power driving the rear tire and to brake individual wheels, which reduces the risk of losing control of the vehicle or rolling over.

NOTE: The VSS light in the gauge will turn on when VSS intervenes and will remain on for 2 seconds after VSS intervention.

Limitations

VSS cannot help you maintain control in all situations.

Surfaces with Poor Traction

The grip of tires on the road surface limits the maximum braking. Even with ABS and EBD, your stopping distance will be longer on surfaces with

poor traction if you do not maintain the recommended tire pressure or if tire tread condition is degraded.

If your tires lose traction with the road surface you may lose control of the vehicle, even with VSS.

If the paved road surface is covered or partially covered with ice, snow or slush, there is not enough traction available to maintain control of the vehicle, even with VSS. Do not operate on snow, ice or slush.

NOTE: Tire traction level begins to decrease below 6°C (43°F).

Like other on-road vehicles, this vehicle can hydroplane on water (lose traction on a layer of water). If you ride too fast into a layer of water, such as a large puddle or flowing water on the road, the vehicle can lose traction and spin out, and the VSS cannot keep you in control. Avoid large water puddles or water streams, and slow down or pull off the road during heavy rains. If you must pass through water, slow down as much as possible before you reach it.

Reduce speed on surfaces with poor traction, like mud, sand, gravel or wet pavement. This vehicle is not for off-road operation. Always operate the vehicle on maintained roadways. Do not use the vehicle on any other terrain.

Tires

The VSS on the vehicle has been calibrated to perform best with a tire of a specific size, material and tread pattern. Replacing your tires with ones not approved by BRP can cause the VSS to be less effective.

Use only BRP recommended tires, which can be ordered only from an authorized Can-Am On-Road dealer.

Proper tire inflation pressure and tread condition are important for maintaining traction, especially on loose or wet surfaces. Tire pressure that is too low

may result in hydroplaning and excessive tire heat build up, while a tire pressure that is too high can reduce VSS effectiveness.

Hard Turns

The VSS does not control or limit steering input — it cannot keep you from turning too sharply. Large and rapid steering handlebar movements can cause the vehicle to go out of control, spin, tip or roll over.

Excess Speed

The VSS does not control the vehicle speed, except when SCS intervenes during a turn. VSS does not prevent the vehicle from entering a turn too fast. If you drive too fast for conditions, you can lose control, even with VSS.

Excess Weight

Never load vehicle above specified values.

TOTAL VEHICLE LOAD ALLOWED	
Limited models	209 kg (460.8 lb)
All other models	199 kg (438 lb)

Hill Hold Control (HHC)

This vehicles has a hill hold control (HHC) function.

While in gear (forward or reverse) and when going up on a slope from standstill, the VSS will hold the brakes when brake pedal is released, and automatically release the brakes as soon as the throttle is applied.

NOTE: A minimum slope of 5% is required to activate the hill hold control.

This function is automatic and does not need to be activated by the driver.

NOTE: The HHC is active for 1 second when the brake pedal is released.

Dynamic Power Steering (DPS)

The DPS (Dynamic Power Steering) provides a computer controlled, variable power assist, achieved by an electric motor to optimize the amount of steering effort required by the rider.

The steering assist level is dependent of the handlebar effort, the steering angle and the vehicle speed.

When vehicle is in the reverse gear, power steering assist will decrease as vehicle speed increases.

UNDERSTANDING RISK ON THE ROAD

Before operating this three-wheel vehicle, read the safety card and all on-product safety labels.

Consider your risk of being hurt or killed in a crash, think how you can reduce this risk and whether, you are willing to take this risk.

There are many factors that contribute to the risk that you face. You can control some of these factors, but others, like the behavior of other drivers, are beyond your control.

Here are some of the factors that affect your risk:

Type of Vehicle

Different types of vehicles vary in terms of size, visibility and maneuverability and provide different degrees of protection.

This vehicle is small and maneuverable. Maneuverability can help avoid crashes. However, smaller vehicles are harder to see, which increases the chance that other motorists will cause a crash. In some situations, this vehicle is less likely to be in a crash than a motorcycle. For example, you are less likely to tip over at low speeds while operating the vehicle. However, in other situations, the vehicle is more likely to be in a crash. For example, because the vehicle is wider, it will not fit through as small an opening as many motorcycles.

In cars and trucks, the structure of the vehicle provides protection in crashes and from other road hazards. In addition, passengers can protect themselves by wearing seat belts. You should expect that riding this vehicle is riskier than riding in a car and that the risk of injury is more like riding a motorcycle.

As when riding a motorcycle, you can reduce the risk of injuries by wearing a helmet and riding gear.

Operator Skills and Judgment

Every driver has some control over their own risk on the road. Drivers who develop good skills will have better control of their vehicle. Do not rely on your experience with motorcycles, automobiles, ATVs, snowmobiles or any other kind of vehicle to prepare you to operate this vehicle. Learn how this vehicle is different. Read this Operator's Guide and if available, take a training course. Become proficient with the controls and be able to do the practice exercises accurately and with confidence before going on the road.

In addition to reading this Operator's Guide, you should watch the video located at:

<https://can-am.brp.com/spyder/owners/safety/safety-information.html>

Or, use the following QR code.



When you begin riding on the road, start with less challenging situations (e.g., light traffic, lower speeds, good weather, no passenger) and gradually move on to more challenging riding situations as you develop your skills. Plan ahead to avoid situations that are too difficult for your skill level, or that present more risk than you want to take on.

Even skilled drivers cause crashes. For example, if you use your skills to do extreme maneuvers or stunts, you increase your risk. The smart driver uses good judgment along with skills to increase the margin of safety and minimize risk. Learn the defensive driving techniques in *STREET STRATEGIES*.

Rider Condition

A driver needs to be alert, sober, and physically ready to ride. Never use this vehicle with drugs or alcohol. Riding when intoxicated, tired or otherwise impaired increases the risk of a crash.

Alcohol, drugs, medications, fatigue, drowsiness and emotions can all inhibit your ability to ride safely. Like riding a motorcycle, riding this vehicle is a challenging activity — being in good physical and mental condition is even more important than for a car. The safest policy is to never operate the vehicle unless you are alert and completely sober. Even if your blood alcohol level is not over the legal limit, your judgment and skills are impaired by any alcohol consumption.

You must be physically able to operate all controls, turn the handlebar through the full range of steering, mount and dismount, and monitor your surroundings to operate the vehicle.

Passengers also need to be alert, sober and physically able to maintain their posture, hold on and react appropriately to curves, bumps, acceleration and stops.

Vehicle Condition

Keep your vehicle in good condition.

Do pre-operation checks and perform regular maintenance. Watch for any messages on the multifunction gauge cluster when you start the vehicle, and address any problems before you ride.

Always use the multifunction gauge with extreme caution. Prolonged attention to the display while riding significantly increases the risk of a crash.

Road and Weather Conditions

Roads with heavy traffic, poor visibility or poor traction surfaces increase your risk. Choose routes that are appropriate for your skill level and the level of risk you are willing to accept.

RIDING GEAR

Riding this three-wheeled, open-air vehicle requires the same protective gear as motorcycling. Even though the vehicle is more stable at low speeds than a motorcycle, you can still be thrown off.

This section is based on guidance for motorcyclists given by the Motorcycle Safety Foundation (MSF).

In the event of a crash, protective gear may prevent or reduce injuries. Protective gear also helps you stay comfortable and can help provide protection against the elements.

Recommended basic protective gear for riders and passenger includes sturdy over-the-ankle footwear with non-slip soles, long pants, a jacket, full-fingered gloves and, above all, an approved helmet with proper eye protection.

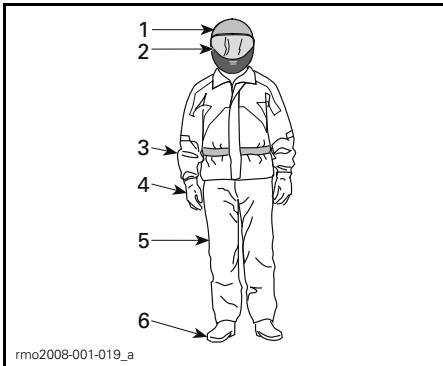

RIDING GEAR

1. Approved helmet
2. Eye and face protection
3. Jacket with long sleeves
4. Gloves
5. Long pants
6. Over-the-ankle footwear

Proper apparel can reduce the severity of injuries in case of a crash, either for the operator and/or passenger.

Helmets

Helmets protect the head and brain from injury. A helmet can also protect the passenger's face from impact

with the back of the operator's helmet. Even the best helmet is no guarantee against injury, but statistics indicate that helmet use significantly reduces the risk of brain injury. So, be safe and always wear a helmet while riding.

Choosing a Helmet

Helmets should be manufactured to meet the appropriate standard in your state, province or country.

A full-face helmet gives the most protection against impacts since it covers all of the head and face. It can also protect against debris, stones, insects, etc.

A three-quarter or open-face helmet can also offer protection. It is constructed with the same basic components but does not offer the face and chin protection of full-face helmets. If you wear an open-face helmet, you should use a snap-on face shield or a pair of goggles.

NOTE: Ordinary glasses or sunglasses are not sufficient eye protection for a motorcyclist. They can shatter or fly off, and they allow wind and airborne objects to reach the eyes.

Use tinted face shields, goggles or glasses in the daytime only; do not use them at night or in poor illumination. Do not use them if they impair your ability to discern color.

Other Riding Gear

Footwear

Always wear closed toe footwear. Sturdy over-the-ankle boots protect against a variety of riding hazards, such as stones that get thrown up from the roadway and burns from the hot exhaust pipe.

Avoid long shoelaces that can be tangled in the gearshift lever, brake pedal or other parts. Rubber soles and low heels are a good idea to help keep feet on the footrests.

Gloves

Full-fingered gloves protect hands from the wind, sun, heat, cold and flying objects. Gloves that fit snugly will improve grip on the handlebar and help reduce hand fatigue. Sturdy, reinforced motorcycle gloves help protect hands in the event of a fall. Gloves made specifically for motorcyclists have seams on the outside to prevent irritation, and are curved to provide a natural grip when curled around the handgrips. If gloves are too bulky, it may be difficult to operate the controls. Gauntlets keep cold air from going up sleeves and protect the wrists.

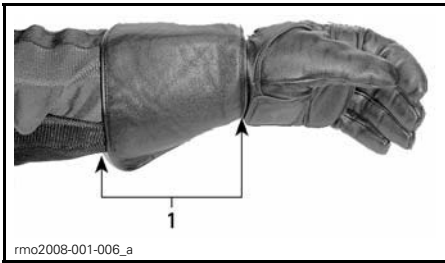

1. Glove gauntlet

Jackets, Pants and Riding Suits

Wear a jacket and long pants, or a full riding suit. Quality motorcycle-type protective gear will provide comfort, and it can help you avoid being distracted by adverse environmental elements. In case of a crash, good quality protective gear made of sturdy material may prevent or reduce injury. Some gear includes padding or hard armor that may further reduce the risk of injury in a crash. Pants also help protect against burns from hot parts.

Protective gear sold for motorcycling will often provide the best combination of fit and protection. These garments are designed to fit while sitting in a riding position. They are cut longer in the sleeves and legs and are fuller across the shoulders. Riding suits are available in both one-piece and two-piece sets.

Leather is a good choice because it is durable and wind-resistant and provides protection against injury. Other abrasive-resistant protective gear made of synthetic fabrics are good choices, too. Do not wear loose or long clothing or scarves that can become tangled in the moving parts.

Flaps and fasteners seal out the wind. A jacket with a zippered front will be more wind resistant than a jacket with buttons or snaps. A flap of material over the zipper of a jacket gives additional protection against the wind. Jackets with snug cuffs and waist are recommended to keep wind from blowing in. A large, loose collar can flap when riding and may irritate skin or be a distraction.

In cool-weather riding, protect yourself against hypothermia. A low body temperature, can cause loss of concentration, slowed reactions and loss of smooth, precise muscle movement. In cool conditions, proper protective gear like a windproof jacket and insulated layers of clothing are essential. Even at moderate temperatures, you can feel cold due to the wind while riding.

Protective gear that is appropriate for cold-weather riding may be too hot when stopped. Dress in layers so that clothing can be removed as desired. Topping the protective gear with a windproof outer layer can prevent cold air from reaching the skin.

Riding gear can also help a rider be more visible. Wearing bright colors is a wise choice. If a dark jacket is worn, an inexpensive reflective vest can be worn over it. It is a good idea to put extra reflective tape on garments worn regularly while riding.

Rain Gear

If you must ride in wet weather, a rain suit or a waterproof riding suit is recommended. On long rides, it is a good

idea to carry rain gear. A dry rider will be much more comfortable and alert than a rider who is wet and cold.

One or two-piece styles are available, and those designed specifically for motorcycling are best. High-visibility orange or yellow colors are good choices. A feature to look for is elastic in the waist, pant legs and sleeves. The jacket should have a high collar and zip up with wide flaps across the opening. When purchasing a rain suit, consider adding waterproof gloves and footwear.

Remember, if the weather is wet, it is best to avoid riding. If you do ride in wet weather, you may need to stop if water starts to accumulate on the road.

Hearing Protection

Long-term exposure to wind and motor noise when riding can cause permanent hearing loss. Properly worn hearing protective devices such as earplugs can help prevent hearing loss. Check local laws before using any hearing protective devices.

REQUIRED RIDING SKILLS AND PRACTICE EXERCISES

Before you take this vehicle on the road, you need to develop riding skills and strategies for managing risk on the road.

If you have experience with motorcycles or other motor vehicles, pay particular attention to how the operation and performance of this vehicle are different from vehicles you are used to.

The following exercises will familiarize you with the basic operation of the vehicle. Practice each exercise until you can perform it proficiently before moving on to the next.

This section includes the following exercises:

1. Revving the engine and using the engine stop switch
2. Starting, stopping, and basic handling
3. Engine stop while in motion
4. Basic turns
5. Quick stops
6. Weaves
7. Shifting
8. Swerve
9. Operating in reverse.

Choosing a Practice Area

Perform these exercises in a paved area at least 30 m - 76 m (100 ft - 250 ft) that is not open to traffic. A closed, well marked parking lot without obstacles (light poles, curbs, etc.) makes a good practice area. Be aware of oil left by parked cars. Look for parking lots that are empty during off hours, such as schools, churches, community centers or shopping centers. Do not trespass on private property.

Once you have selected a suitable location, get permission to use it from the owner. If there are obstructions, such as light poles or islands, be sure that

they do not interfere with the required open paths shown in the diagram below.

Keep this basic parking lot diagram in mind when setting up the exercises. 3 m (10 ft) wide parking lot spaces are indicated in the diagrams for convenience, but the size of the spaces in the lot you use may be different. If the parking lot you choose does not have lines or if the parking spaces are sized much larger or smaller than the ones in the diagrams, use the dimensions shown below. Mark them using a tape measure and chalk or markers such as cones or milk containers weighted with water or sand.

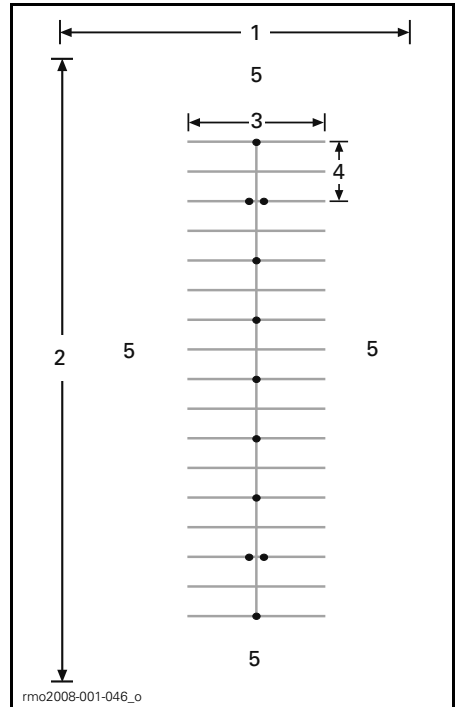

TYPICAL PARKING LOT

1. At least 30 m (100 ft)
2. At least 75 m (250 ft)
3. 12 m (40 ft)
4. 6 m (20 ft)
5. Open area

Even in a closed lot, be aware of potential traffic. Check to the front, sides and rear before doing an exercise. Also, watch out for children and animals.

Preparing to Ride

Know the location and operation of all the vehicle controls.

Perform the pre-ride inspection. Refer to *PRE-RIDE INSPECTION* section.

Always start and stop the engine according to the instructions in *STARTING AND STOPPING THE ENGINE* in *BASIC PROCEDURES*.

Riding Posture

Good posture helps you maneuver the vehicle more easily. Always keep both hands and both feet in position so that you can operate the controls easily. The wrist should typically be aligned straight with the arm (this position helps you apply the amount of throttle you want). Arms should be relaxed and bent. Keep your back straight and your head and eyes up. Keep both feet on the pegs near the controls.

Never operate the vehicle, even for a short distance, unless you are in the proper riding posture.



RIDING POSTURE

Practice Exercises

1) Revving the Engine and Using the Engine Stop Switch

Purpose

- Become familiar with the operation of the twist throttle.
- Become familiar with the sound of the engine at different RPMs. This will help you to know when to up-shift and downshift based on the engine sound.
- Become familiar with using the engine stop switch.

Directions

- Start with the vehicle in NEUTRAL, the parking brake engaged, and your right foot on the brake pedal. Check the multifunction gauge cluster to be sure you are in NEUTRAL — if you are in first gear, the vehicle will try to start moving when you apply the throttle.
- Watch the tachometer and apply throttle (twist by lowering your wrist) a few times to raise the RPM to no more than 4000. Practice applying the throttle gently and smoothly, holding it steady at about 3000 RPM, and releasing it. As long as the transmission is in neutral the power will not transfer to the rear wheel.
- Use the engine stop switch to cut all power to the vehicle. Press the switch with your right thumb while keeping your hand on the handgrip.

Tips for Additional Practice

- Practice pressing the engine stop switch without looking at it.

2) Starting, Stopping and Basic Handling

Purpose

- Learn throttle control and how to get the vehicle moving.
- Become familiar with low speed deceleration and braking.

Directions

If you feel like you are losing control while doing these exercises, release the throttle to stop accelerating and apply the brake as needed to slow down. You can also use the engine stop switch to cut power entirely.

2a) Apply and Immediately Release Throttle

Directions

At first, you will only use the throttle for a moment at a time, then release it and coast.

- Start the engine and release the parking brake.
- With the brake pedal depressed, shift the transmission into first gear by pressing the gear selector forward.
- Release the brake.
- Slowly apply throttle until the vehicle starts to creep forward. As soon as you start moving release the throttle and coast, then press the brake to stop. Repeat to the end of the straightaway.
- To turn around at the end of the straightaway, stop, turn the handlebar all the way to the right, then briefly apply and release the throttle, and coast through the turn. You may need to briefly apply the throttle more than once to complete the turn. Stop when you are in line with the straightaway in the opposite direction.
- Continue with this part of the exercise until you are comfortable with applying and releasing the throttle.

2b) Hold Throttle, Release and Stop Every 12 m (40 ft)

Next, you will be holding the throttle a little longer, then stopping every 12 m (40 ft) (every other marker/every fourth line).

- Again, slowly apply throttle until the vehicle starts to creep forward. This time, hold the throttle at this point.
- As you approach the stopping point, release the throttle and press the brake to stop.
- Turn around at the end of the straightaway as before, except now you do not need to release the throttle during the turn. Pay attention to maintaining a steady throttle position as you turn. Stop when you are in line with the straightaway in the opposite direction.

2c) Hold Throttle, Release and Stop at Ends

Next, use the entire straightaway, stopping only at the ends. Keep the throttle moderate.

3) Engine Stop while in Motion

Purpose

- Become familiar with using the engine stop switch when in motion so you know how the vehicle will react if you need to use it later.

Directions

- Partway down the straightaway, while operating at 8 km/h (5 MPH), toggle the engine stop switch to OFF position and coast to a stop.
- Restart the engine and repeat the exercise. Try increasing your speed (to a maximum of 20 km/h (12 MPH) before using the engine stop switch.

NOTE: Vehicle will not start in gear without brake pedal depressed.

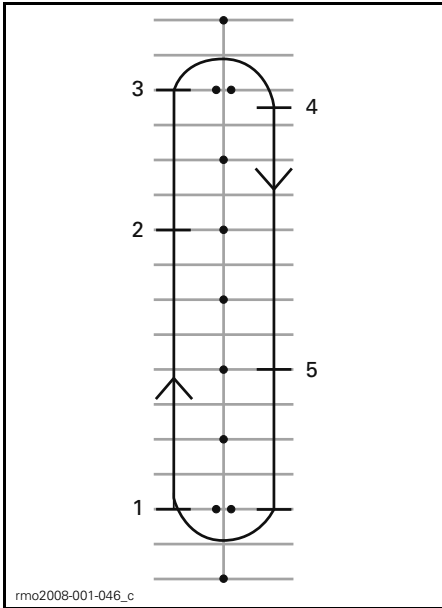

1. Start
2. Press engine stop switch
3. Proceed to end of straightaway, stop and turn as before
4. Stop
5. Press engine stop switch

Restart the engine and proceed to the next exercise.

4) Basic Turns

Purpose

- Get comfortable turning in a controlled manner.

Directions

This exercise is similar to what you did before, except that now instead of stopping for each turn, you will make the turn at low speed.

- Roll in a straight line. Ride a little farther from the cones so you can make a wide arcing turn at the end of the straightaway.
- As you approach the curve, slow down to no more than 8km/h (5 MPH) by releasing the throttle and apply brake if needed.
- Hold the throttle to maintain your low speed.

- Look in the direction of the curve.
- Turn the handlebar in the direction of the curve, pulling on the inside handgrip and pushing on the outside, being careful not to apply throttle.
- Leaning forward and into the curve may help you turn the handlebar more easily.
- Straighten your handlebar after the turn and proceed down the straightaway.



TYPICAL - RIDING POSTURE WHEN TURNING

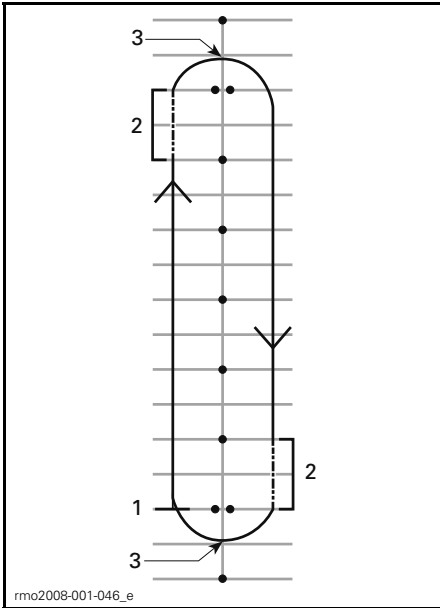

1. Start
2. Friction zone
3. Apex

NOTE: Motorcyclists - Riding through turns and curves with this vehicle is different than on a motorcycle. The vehicle does not lean during a turn, so you may need to shift your body weight towards the inside of the turn to keep a comfortable posture on the vehicle. You will need to exert more force to turn the handlebar of your vehicle than is needed to turn a motorcycle. However, it is easier to stop while turning than with a motorcycle.

Tips for Additional Practice

- After you are comfortable turning in one direction, try going around the course the other way. Be careful not to apply more throttle than you intend when turning left.
- Stop at the apex of the turn to see what it is like to use your brakes in a curve or turn.

5) Quick Stops

Purpose

- Become familiar with the vehicle braking ability.
- Learn to apply brakes with maximum force.

Directions

This exercise is similar to what you did before, except you'll be applying the brake more firmly, working up to braking as hard as possible. The Antilock Braking System (ABS) will prevent the wheels from locking and help you maintain steering control while applying maximum braking force. Always release the throttle completely for quick stops. If you apply throttle and brake at the same time, your stopping distance will be longer.

- Start at one end of the straightaway and accelerate to 8 km/h (5 MPH). Partway down the straightaway, release the throttle completely and brake quickly. Never pump the brake as the ABS will prevent wheel lock.
- Keep head and eyes up, keep handlebar straight, and do not release the brake until fully stopped.
- Repeat, increasing your speed and braking harder.

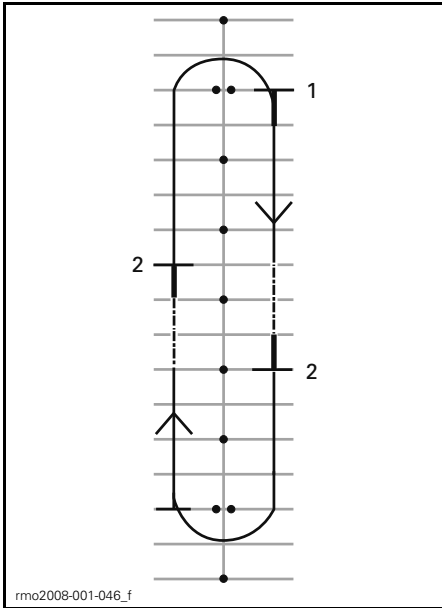

1. Start
2. Stop

Tips for Additional Practice

- Practice checking your mirrors before braking hard.

6) Weaves

Purpose

- Get more experience with the vehicle handling and rider position.

Directions

6 m (20 ft) Weave

1. Weave between every marker/intersection of every other parking spot. Keep your speed low initially as you get used to making the changes of direction.
2. Lean into each turn and turn the handlebar in the direction you want to go by pulling and pushing the grips.

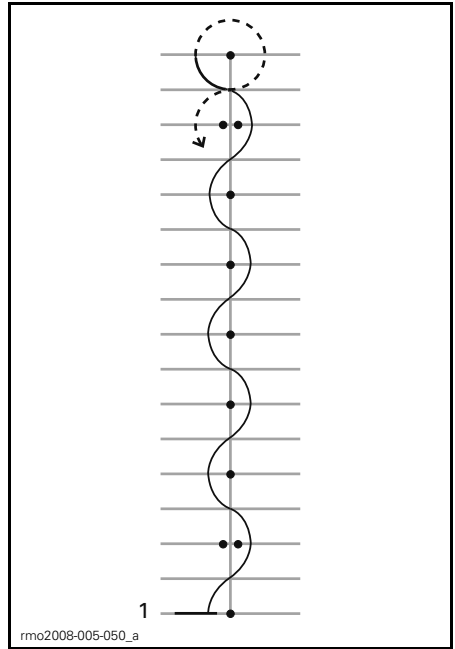

1. Start

12 m (40 ft) Weave

Once you're comfortable, try doing 12 m (40 ft) weaves between every other cone/every fourth parking space.

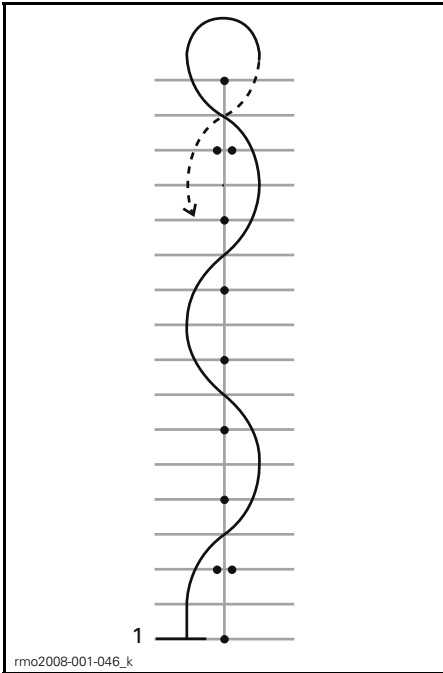

1. Start

Tips for Additional Practice

- You can gradually increase speed as you get comfortable to 16 km/h - 19 km/h (10 MPH - 12 MPH) for the weaves, but slow down for the U-turns at the ends.

7) Shifting

When riding, you must change gears to match the engine speed with road speed. Lower gears are used for lower speeds and higher gears are used for higher speeds, just like on a manual transmission car or truck.

The transmission will automatically downshift if the engine speed drops under 1800 RPMs.

Purpose

- Learn to upshift and downshift.

Directions

This exercise is similar to what you did before, except now you will be upshifting on the straightaways, then coming to a stop at the end of each straightaway. You may want to use the parking lot aisles for this exercise rather than riding in the spaces.

7a) Practice Using the Gear Selector at a Stop

First, while stopped, practice to single shift between reverse, neutral and first gear. Then practice to:

- Double shift from reverse to first gear
- Double shift from first to reverse gear
- Repeat until you are comfortable.

7b) Upshifting from First into Second Gear

- In the straightaway, accelerate until the engine speed reaches 3000 RPM.
- Press the gear selector forward to shift into second gear. You do not have to release the throttle while shifting.
- Once you are comfortable, if space allows, you can adjust the throttle to increase speed in second gear.

As you approach the end of the straightaway, come to a stop:

- Release the throttle
- Apply brake
- The transmission will downshift automatically as the speed slows. You can also manually downshift by pulling the gear selector towards you.

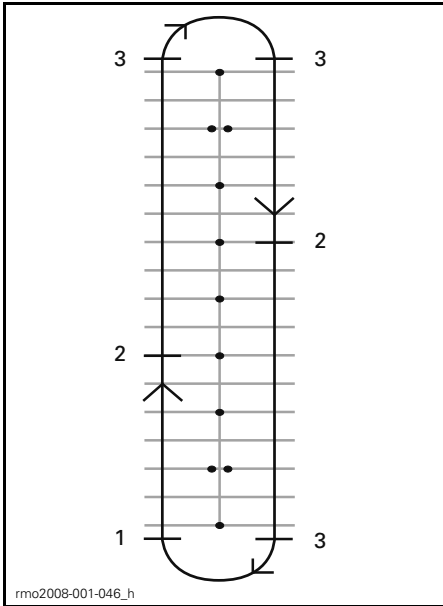

1. Start
2. Shift into second at 25 km/h (16 MPH)
3. Stop

7c) If Space Allows, Practice Downshifting into First While Moving

In the straightaway:

- Pull the gear selector toward you without releasing throttle.
- You will feel more engine braking when you downshift without throttle.

7d) Other Gears

If space allows, you can try shifting into and out of higher gears as well. Follow the same process and shift up or down one gear at a time.

NOTE: Applying slightly more throttle while downshifting can help the engine rev up to match vehicle speed more quickly and make the downshift smoother. When you do not apply throttle while downshifting, engine braking will slow the vehicle. This can help you decrease speed, but remember that VSS does not control engine braking. If you shift into too low a gear when you are at high speed, the rear tire can skid and you can lose control, spin out, tip or roll over, particularly in a curve.

8) Swerve

Purpose

- Become familiar with the vehicle's handling for quick maneuvers.
- Try different variations of braking and swerving.

Directions

At this point you will need to change your course. Set up your markers as shown in the diagram below. Do not use any fixed or hard, heavy objects as markers for this exercise.

- Enter between the double cones at about 8 km/h (5 MPH) and maintain that speed throughout.
- Steer around the line of cones.
- Exit through the second set of double cones.
- Repeat the exercise multiple times, swerving in both directions.

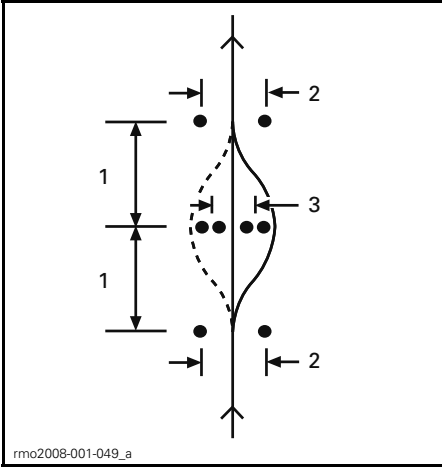

1. 6 m (20 ft)
2. 3 m (10 ft)
3. 2.5 m (8 ft)

Tips for Additional Practice

- You can gradually increase your entry speed (to no more than 13 km/h to 19 km/h (8 MPH to 12 MPH) and try some variations. For example, approach faster and slow before entering the exercise, apply brakes during the swerve, etc.
- A helper can add an element of surprise to the exercise by deciding which direction you should swerve, or if you should come to a stop instead. Have your helper stand at a safe distance (e.g., beyond the end of your practice area). As you reach the first set of cones, the helper can use hand signals to indicate which direction to swerve or for you to stop.
- Practice checking your mirrors and blind spot before you swerve.

9) Operating in Reverse

Purpose

- Become familiar with the vehicle handling and turning radius in reverse.

Directions

- Shift into reverse. See *BASIC PROCEDURES*.
- Check that the area behind you is clear. Continue to look backwards. Be careful not to strike anything with your front wheels as you back up. Slow and stop by releasing throttle and using brake, just like when operating normally.
- Back for a few feet at a time, stopping in between.
- Keep your speed low and do not back up for long distances.
- After you are comfortable with reverse, back into a parking space as shown in the diagram below.

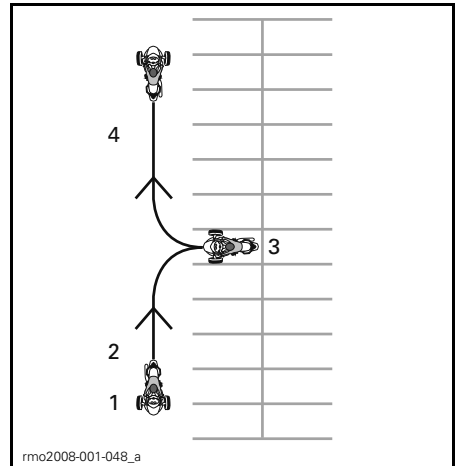

1. Start
2. Reverse
3. Stop
4. Forward

Developing Advanced Riding Skills

Once you have mastered basic riding skills, you can begin developing more advanced skills. First, learn the *STREET STRATEGIES* covered in the next section. Then you can take the vehicle on the road in relatively low-risk situations.

Start by riding in less challenging situations:

- Short distances
- Good weather
- Low traffic
- Daytime
- Lower speeds
- No passenger.

You can gradually move on to more challenging riding situations as you develop your skills.

STREET STRATEGIES

This section provides some strategies to reduce your risk on the road. Many of these strategies are similar to those used for motorcycles.

This section is based on guidance for motorcyclists given by the Motorcycle Safety Foundation (MSF). However, even experienced motorcyclists should read this section, as some strategies are different for this vehicle.

Plan your Trip

Always check weather conditions before riding the vehicle. Take appropriate gear for any weather you might encounter.

Plan a route and ride in conditions that are appropriate for your skill level.

The vehicle has a 27 L (7.1 U.S. gal.) fuel tank. When the low fuel indicator light flashes, fill fuel tank as soon as possible. Plan your refueling stops, particularly in unpopulated areas.

Defensive Riding

As with a motorcycle, defensive riding can help you avoid crashes. You need to stay alert at all times. Never stop watching your surroundings, including the area behind you. Always scan for potential hazards, plan ahead, and leave space and time to avoid trouble. Do not assume other motorists will see you or follow the rules of the road.

Following Distance

Always leave at least a two-second following distance between you and the vehicle in front of you when operating under ideal riding conditions. This means that you should pass any fixed point on the road at least two full seconds after the vehicle in front of you.

When conditions make braking distance longer, or visibility is limited, use a longer following distance for a greater margin of safety. For example, braking distance is longer on slippery

road surfaces, down hills, or when carrying more weight, and visibility may be limited in fog, in curves or at night.

Scanning Ahead

In addition to leaving adequate following distance to the next vehicle, scan ahead and plan your path even farther in advance.

Plan your immediate path at least four seconds ahead. Watch this path for hazards, such as anything in the road or anything entering the road.

Scan ahead 12 seconds along your anticipated path to identify potential hazardous situations before they happen. For example, look for intersections where other vehicles may appear or places where pedestrians might enter the road. Be prepared to respond if a hazardous situation develops.

Watch Behind and to the Sides

Vehicles and other hazards can approach from all directions. Constantly be aware of your surroundings. Check your mirrors frequently to see directly behind you. Also do frequent head checks (turn your head to look) to monitor your blind spot.

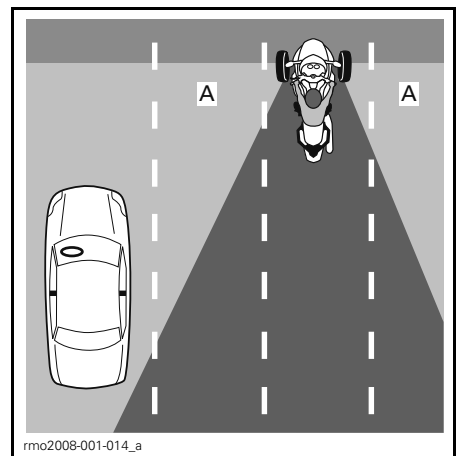

A. Operator's blind spots

When braking, be particularly aware of vehicles behind you that may not be able to stop as quickly as you.

Keep your Eyes Moving

To stay aware of your surroundings, do not fixate on any one thing. Move your eyes constantly to monitor the road, traffic control markings and devices and other vehicles. Look near and far, in all directions.

Anticipate Trouble

Whenever you notice a potential hazard, plan a way to avoid it. This might mean adjusting your speed or lane position, or changing lanes. You should be ready for evasive maneuvers such as swerving and/or braking if something enters your path. Always leave time and space to react to trouble.

Being Visible

Motorists tend not to see smaller vehicles like motorcycles. Therefore you should use strategies to become more visible.

To Be More Visible to Other Motorists

Lighting and Reflectors

Make sure that the headlights, running lights and taillights on your vehicle work properly. Your vehicle is equipped with reflectors on the fenders, sides, and back. Make sure that all reflectors are clean and not broken or missing.

Use your high beams whenever possible, both day and night. Use low beams to avoid blinding other motorists at night or when too much light reflects back, such as in fog.

Signals

Use your turn signals to inform others of your intentions. This vehicle has automatic canceling turn signals, but they may not cancel after shallow

turns. Make sure turn signals are off after you have completed your maneuver; leaving them on may confuse other motorists.

When possible, flash your brake lights before slowing and when waiting at intersections, to alert motorists behind you.

Use your emergency flashers to make yourself visible when needed.

You can also use your horn to attempt to alert other motorists of your presence.

Do not assume that other motorists will notice your lights, signals or horn.

Blind Spots

Avoid riding in the blind spots of other vehicles. Position yourself so that drivers ahead can see you in their mirrors. In some cases, such as when you are following a truck or a bus, you must be farther behind the vehicle in front of you.

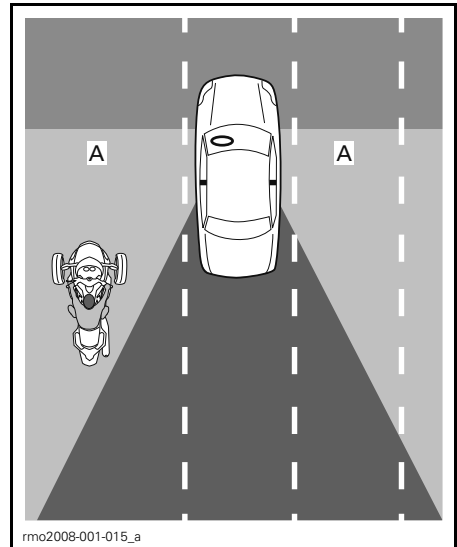

A. Blind spots of other vehicles

Time of Day and Weather

In dim light, such as at night, at dawn or dusk, or in poor weather such as rain or fog, you may be harder to see. Glare at dawn and dusk or very bright sunlight can also make it harder for other motorists to see you.

Clothing

Bright colors or reflective clothing can increase your visibility.

Be Careful Even When Motorists See You

Even when motorists seem to notice you, they may still drive in a way that puts you at risk of a crash. Drive defensively, and do not rely on other motorists to operate their vehicles safely.

Lane Position

Normally, position the vehicle in the center of the lane. This position keeps the front tires in the lane. It also provides distance from vehicles in other lanes, reducing wind from large vehicles and reducing the risk of being struck by vehicles that leave their lane. This position also keeps your front wheels out of the slippery area in the middle of the lane, helping maintain braking and steering ability. If you are used to driving a car, remember that you are centered on this vehicle, rather than seated to the side, so your perspective is different.

You can move to the left or right part of the lane, to avoid hazards, keep distance from other vehicles, or handle curves. You can also move to the left or right part of the lane to get a better view or to be seen by other vehicles. Because of this vehicle center seat position and width, it may be harder to see around traffic, even when you are near the edge of the lane. You may need a greater following distance behind wide or tall vehicles. Avoid putting your wheel outside of the lane to see around traffic. In order for drivers

ahead to see you, you must be able to see their mirrors. When you are being followed by a large vehicle, passing vehicles may not be able to see you easily if you are not in the left part of the lane.

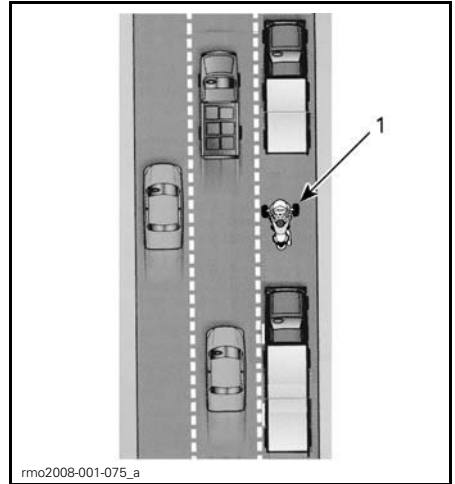

1. Vehicle in left portion of lane

Because this vehicle is wider than a motorcycle, the range of lane positions is smaller. When riding in the left or right part of the lane be sure that the front wheels stay in the lane.

On multilane roads, choose a lane that is appropriate for your speed in the flow of traffic, and also consider your ability to see and be seen, and possible paths for evasive maneuvers (such as swerving into other lanes or onto the shoulder).

Common Riding Situations

Intersections

Intersections, including small intersections with alleys and driveways, present an additional risk due to the cross traffic. Always watch for traffic in all directions: behind, in front and to the left and right.

When stopping at an intersection, stop in the middle of the lane, even if you are preparing to turn. This can make you more visible and discourage other motorists from trying to drive around you. Watch for vehicles approaching from behind. Flash your brake lights as they approach. Be in first gear and be prepared to move if necessary, to avoid a collision.

Lane Changes and Passing

Remember that this vehicle is wider than a motorcycle and needs more lateral space to pass another vehicle. Also remember that the vehicle is less visible than a car, so it is particularly important to signal your lane change well in advance and check your mirrors and blind spots. Be sure to turn off your turn signal after changing lanes; a lane change will not turn the handlebar far enough to automatically cancel the signal.

Never drive on the line between two lanes of traffic (split lanes). The vehicle is too wide.

Never drive on the shoulder to pass vehicles. If you put one wheel off the road, you can lose control.

Turns

Remember to slow, look, and steer through turns.

- **Slow:** Reduce speed as needed before entering a turn by rolling off the throttle, using the brakes, and/or downshifting to a lower gear. Enter the turn at a speed that you can maintain throughout the turn.

Although this vehicle is better able to brake while turning than a motorcycle, it is still important to slow down before you enter a turn or curve rather than braking in the turn. Braking and turning both require traction. The more traction you use for braking, the less there is available for turning at the same time.

When you take a turn or curve too fast, you may notice the inside front wheel lifting off the pavement and feel and hear VSS cutting back engine power. While VSS can help you maintain control, it is still possible to spin or roll over if you turn too hard and fast.

- **Look:** Search through the entire turn and keep your eyes moving. Evaluate the entire turn as soon as possible — surface characteristics, sharpness of the turn, and overall traffic conditions — so you have time to make decisions about speed and position. Sometimes turning your head in the direction of the turn helps to keep a good visual picture.
- **Steer:** Turn the handlebar to steer the vehicle in the direction of the turn. This vehicle is not like a motorcycle, so it does not countersteer, and the vehicle does not lean. Remember, you will experience the lateral force generated by turning, so you may need to shift your body weight to the inside of the turn to keep a comfortable posture on the vehicle. You will need to exert more force to turn the handlebar of your vehicle than is needed to turn a motorcycle.

Curves

Because this vehicle is narrower than a car, you can move from side to side in the lane in curves to straighten your path of travel. But this vehicle is wider than a motorcycle, so less lateral movement is possible, and it is important to make sure that your front tires do not leave the lane.

For typical curves, an outside, inside, outside path is best.

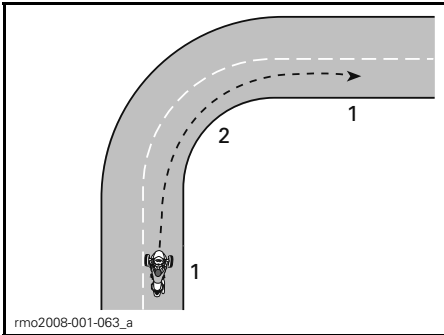

PATH FOR TYPICAL CURVES

1. Outside
2. Inside (at the apex)

Hills

Select an appropriate gear for the incline. Going up hills, a lower gear can help maintain enough power. Going down hills, a lower gear can provide engine braking to control your speed.

When stopped, the vehicle can roll regardless of what gear it is in. The clutch is always disengaged when the vehicle is stopped, so the transmission will not hold the vehicle in place. Hold the brake pedal when stopped on an incline. To start while on an incline, hold the brake pedal as you increase throttle. Release the brake pedal as you feel the clutch engage (at about 1800 RPM).

Night Riding

In addition to using your lights and signals to be seen by other motorists, consider your own ability to see at

night. Use high beams when appropriate. Avoid overriding your headlight (riding so fast that you can't see as far as your stopping distance). You can also use other vehicles headlights to see the road ahead.

Do not use tinted or colored visors or lenses at night, and be particularly careful that your visor does not have scratches or smudges.

Group Riding

Ride single file only. Never share lanes, even with a motorcycle.

When riding with motorcycles, maintain proper following distance from the motorcycle in front of you, even if they are riding to one side of the lane. In curves, do not try to follow the path of motorcycles. Motorcycles can move farther to the edges of the lane in curves — if you follow them exactly, your front wheel can leave the lane. Motorcycles may be able to take curves faster than this vehicle. Do not try to match their speed.

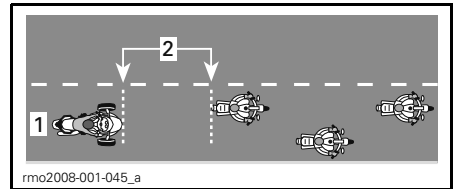

GROUP RIDING POSITION

1. Center of lane
2. Distance of 2 seconds

Particularly on curvy roads, riders might become tired sooner than motorcyclists. Do not push yourself to keep up with motorcycles; stop if you are tired.

Road Conditions and Hazards

Ice, Snow and Slush

Do not ride on ice, snow or slush. Even with VSS, there will not be enough traction to maintain control on these

slippery surfaces. This vehicle is more likely than a car to spin out of control in slippery surfaces.

Gravel, Dirt and Sand

On gravel, dirt, or sand-covered roads, use extra caution and reduce your speed, particularly for curves. These surfaces do not provide as much traction as paved surfaces and you can lose control, even with VSS.

Wet Pavement and Puddles

There is normally enough traction to maintain control on pavement that is moist or wet, as long as there is not a layer of water on top of the pavement (like a puddle or flowing water on the road). As with other vehicles, this vehicle can hydroplane if you drive too fast over water that has accumulated on the road, but hydroplaning occurs at lower speeds than with most cars or motorcycles. You are more likely to hydroplane in deeper water. Watch for splashing or spraying when other vehicles go through water as an indicator of depth.

When hydroplaning occurs, one or more wheels rise up on a layer of water, losing contact with the road. If this happens to the rear wheel, you may feel it slide sideways. Hydroplaning wheels do not have the traction necessary to control the vehicle. You can lose control and spin out, and the VSS cannot keep you in control.

Avoid large water puddles or water streams, and slow down or pull off the road during heavy rains. If you must pass through water, slow down as much as possible before you reach it.

After passing through water, test your brakes. Apply them several times if necessary to let friction dry the brake pads.

Properly maintained tires reduce the risk of hydroplaning. Always maintain recommended tire pressure:

Refer to *TIRE PRESSURE* in *MAINTENANCE PROCEDURES* section.

NOTE: The pressure difference between the left and right side tire should not exceed 3.4 kPa (.5 PSI).

Immediately replace any tire that shows the maximum tread wear indicator to minimize risk of hydroplaning.

The middle of a lane can be particularly slick in the first few minutes of rain, as oil and dirt combine with the water. After more rain, water can accumulate in ruts in worn pavement. Avoid both of these low traction areas. When possible, keep your front tires in areas with the best traction.

Off-Road Use

Do not use this vehicle off road. The vehicle cannot handle the rough, low-traction, uneven surfaces that you may encounter in off-road riding. You could easily get stuck, lose control or roll over. Also, it may be illegal for off-road use in certain areas.

Obstacles, Holes and Bumps

Whenever possible, avoid riding over obstacles, holes and bumps. If you must ride over them, slow down as much as possible before you get there, then release the brake as you go over. For wide obstacles or bumps, approach straight on if possible, so that both front tires go over at the same time. When going over an obstacle, bump or hole with both front wheels, riders should stand up slightly on the pegs and use legs to absorb the shock. Be prepared for the rear wheel to strike the obstacle. For narrower obstacles, bumps or holes, it is better to ride over it with the rear tire. If you ride over them with a front tire, maintain a firm grip on the handlebar, take care not to accidentally applying the throttle and be prepared to correct your trajectory if necessary.

If you strike a large enough obstacle, bump or hole, the impact can make the vehicle jump and strike you, eject riders, make you lose control, spin or roll over.

If you can't come to a complete stop in time to avoid an obstacle, you can swerve to avoid it. You can swerve and brake at the same time if necessary.

If you encounter a large animal in the road, like a deer, it is best to stop before reaching it and wait until the animal leaves, or go past slowly. If a dog chases you, a good strategy is to slow down and downshift as the dog approaches, then accelerate away as you get closer to where the dog would intercept you.

On-Road Emergencies

A vehicle malfunction or an unexpected situation can occur any time during a ride. A well-maintained vehicle can help reduce the risk of malfunction, but you should still be prepared for an emergency.

- Always have the Operator's Guide and tool kit in the vehicle.
- When stopping on the road, follow these precautions:
 - If the road has paved shoulders, signal your intention to pull off the highway, pull off at near traffic speed, then slow down to a complete stop.
 - If the shoulder is unpaved, signal a right turn and slow down to a safe speed before pulling off the paved roadway.
 - To increase your visibility, turn on the hazard warning lights.
- If you have cellular phone or other communication device, fully charge it before long rides.

- If you are involved in an accident, BRP strongly recommends that you have your vehicle transported (see *TRANSPORTING THE VEHICLE*) to the nearest Can-Am On-Road dealer to have it thoroughly inspected for safety before riding again.
- Fill in the BRP accident/incident report.

Tire Failure

If a tire failure or a blowout suddenly occurs, firmly grip the handlebar, gradually slow down and carefully steer to a safe place to stop. Avoid hard braking, downshifting, or sharp steering. If a front tire fails, the vehicle may tend to pull in the direction of the failed tire, so you will need to maintain a firm grip on the handlebar to control your direction. Refer to *ROAD SIDE REPAIRS* section for instructions on tire repair.

CARRYING A PASSENGER OR CARGO

Weight Limits

Do not exceed the weight limits for riders and cargo.

WEIGHT LIMITS		
Vehicle load limit (including operator, passenger, cargo and added accessories)	Limited models	209 kg (460.8 lb)
	All other models	199 kg (438 lb)
Front storage compartment		6.8 kg (15 lb)
Each saddlebag		6.8 kg (15 lb)
Top Storage Compartment		6.8 kg (15 lb)

Excess weight will:

- Reduce your ability to accelerate, brake and turn.
- Reduce the effectiveness of the VSS.
- Increase the risk of rolling over if the weight is high or toward the rear.
- Reduce ground clearance, increasing the risk of striking low obstacles or uneven road surfaces.
- Increase the risk of tire failure.

Operating with Extra Weight

Carrying a passenger or heavy cargo affects the way the vehicle handles because of the greater weight, and because the weight distribution will be different.

1. You will not be able to accelerate as quickly. Allow more time and space for passing.

2. You will not be able to stop as quickly. Use a longer following distance from the vehicle in front of you, at least three seconds. Use an even longer distance if riding conditions are not ideal (e.g., low visibility, poor road surface).
3. You will not be able to turn as sharply or at as high a speed. Slow down more than usual before turning and avoid sharp turns.
4. This vehicle may be less stable. There is a greater risk of tipping or rolling during extreme maneuvers with weight that is higher or farther to the rear (like a passenger).

NOTE: VSS effectiveness is decreased when operating above maximum allowed load.

Carrying a Passenger

This section applies for all F3 Models including STD and S models if a complete passenger kit from BRP is installed.

This vehicle is designed for only one passenger, seated behind the operator. Never carry multiple passengers.

Do not carry a passenger until you have experience riding alone in a variety of conditions and can proficiently handle the vehicle.

The passenger must be sober, alert, able to reach the passenger footrests and handholds, maintain balance and hold on in sudden maneuvers, and not distract the operator.

WARNING

Never carry a passenger if passenger handles are not installed on vehicle.

Be sure the passenger is wearing appropriate protective gear. The passenger should wear all of the protective gear recommended for the operator, particularly a helmet. A full-face hel-

met is recommended; in a sudden stop, the passenger's face can strike the back of the operator's helmet.

Keep the brakes applied and the transmission in neutral until the passenger is in riding position.

Instruct the passenger on how to ride before starting out. Have the passenger follow these rules:

1. Maintain proper riding position. Hold the passenger handholds and keep feet on the passenger footrests at all times, even with the accessory backrest. The passenger should not hold on to the operator as the operator may not be able to withstand the lateral force generated by both. Different gripping positions on the handholds may be more comfortable for different maneuvers. (e.g., one hand at the front corner of and one hand at the opposite back corner for turns, both hands further forward or back for other situations).

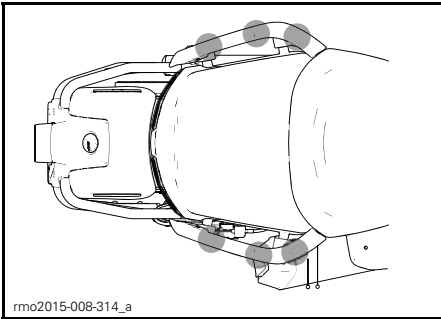

DIFFERENT GRIPPING POSITIONS ON THE HANDHOLDS

NOTICE Never use handholds to tie down, lift or transport vehicle.

2. Stay clear of the exhaust pipe, the rear wheel and the drive belt.
3. Avoid turning around or leaning except to keep balance in a turn. In an unexpected maneuver, a passenger who is not in the normal riding position is more likely to fall off.

4. Watch the road and respond to upcoming road conditions. Lean into curves as needed to resist any sideways force. When crossing an obstacle, hole or bump, rise slightly off the seat without locking your elbows.

Avoid abrupt acceleration, braking and turns, especially with inexperienced passengers. Sudden, unexpected maneuvers can make the passenger fall off.

Where to Store Cargo

You can carry cargo in the front storage compartment, glove box, top storage compartment and rear saddlebags. Do not carry cargo in any other location unless the vehicle is equipped with approved BRP accessories.

⚠ WARNING

Never tie down cargo onto passenger seat, as this will depress the PRS (Pillion Rider Switch). This effectively changes the VSS calibration to the 2-up calibration, so the VSS interventions might be more intrusive and stronger than expected if the driver is alone with only cargo on the passenger seat.

Storage Compartment

The front storage compartment and rear saddlebags have room to store light objects. Do not put more than 6.8 kg (15 lb) in each storage compartment, even if the items fit. Never store flammable items, such as fuel, in the front storage compartment.

Make sure the front storage compartment latch and saddlebags covers are secure before riding.

Towing a Trailer

IMPORTANT

Only T and Limited models are built to tow a trailer

The Vehicle Stability System (VSS) on these vehicles incorporates a program that allows to tow a BRP trailer while maintaining appropriate vehicle stability control.

Use only a BRP trailer designed specifically for this vehicle or a BRP approved equivalent. This is important to ensure the trailer and the vehicle remain stable during normal operation and it does not interfere with the vehicle stability system.

NOTICE The use of a non-recommended wiring harness may lead to vehicle electrical system failure.

WARNING

The use of any other trailer could damage the vehicle or interfere with the proper operation of the vehicle stability system. It is not recommended to use the cruise control when towing a trailer.

Towing a trailer affects the way the vehicle handles due to the greater weight and the different weight distribution.

- Allow more time and space for passing.
- Allow a greater distance for braking.
- Use a longer following distance from the vehicle in front of you.
- Reduce your speed and slow down more than usual before turning and avoid sharp turns.
- There is a greater risk of tipping or rolling during extreme maneuvers.

Crosswinds and air turbulence caused when crossing or being passed by others can disrupt the steering and make the trailer to sway. To minimize the effect, keep a constant speed and do not make quick steering or braking corrections.

Reduce your speed before entering in a curve.

When cornering, achieve the turn on a larger radius. It takes more space to turn with a trailer.

Try to anticipate the riding ahead to avoid having to backup with a trailer.

Always move slowly when backing up. Ask someone to guide you when possible. Practice in an open area at the first opportunity. Refer to *REQUIRED RIDING SKILLS AND PRACTICE EXERCISES*.

When possible, avoid swerving, twist and turns, sharp and abrupt turns as well as sudden braking. This could cause the trailer to jackknife or to turn over. It is easier to unstabilize an empty trailer. When accelerating, it is normal to shift at a higher RPM to avoid loading excessively the engine.

NOTICE Avoid spinning the rear wheel. Rocks or pebbles could be projected on the trailer and damage it.

Load Limits

WARNING

Never add cargo on the trailer cover as it will increase the risk of tipping over. All cargo must be stored and secured inside the trailer.

Load limits must be observed with the appropriate towing equipment.

TOWING SPECIFICATIONS	
Maximum weight on trailer tongue	18 kg (40 lb)
Maximum towed weight (trailer and cargo)	182 kg (400 lb)

NOTE: For information about the maximum cargo that can be loaded in trailer, refer to the *CAN-AM FREEDOM TRAILER OPERATOR'S GUIDE*.

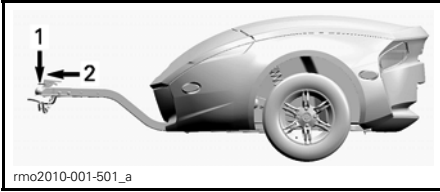

1. 18 kg (40 lb)
2. 182 kg (400 lb)

The weight at the tongue applies when the trailer is loaded. A scale can be used to measure the weight at the tongue when it is not latched to the vehicle. If the trailer is not fully loaded, place cargo in the front part of the trailer then, if the weight at the tongue is reached, place the remaining cargo at the rear in the trailer. The weight distribution in the trailer affects the weight at the tongue. Redistribute the weight in the trailer to meet the weight at the tongue specification. Too much weight at the tongue reduces steering control. Too little weight at the tongue can render the trailer unstable and make it sway.

⚠ WARNING

Exceeding the maximum towed weight can seriously affect handling and performance of the vehicle. The vehicle handling, stability, acceleration and braking distance are affected when towing a trailer. Correct loading and weight distribution are important. Never overload, tow or carry cargo improperly. Always ensure the cargo is safely secured and properly distributed in the trailer before operating the vehicle. Always secure cargo as low as possible in the trailer to reduce the effect of a higher center of gravity. Failure to follow the recommendations here could cause affect the vehicle handling which could lead to the vehicle loss of control.

NOTICE Exceeding the maximum towed weight can damage vehicle or trailer. Avoid transporting heavy parts with sharp edges that could damage the trailer. Place the cargo so that it does not shift while the trailer is being towed.

Hitch

Use only a BRP hitch or a BRP approved equivalent. The BRP hitch properly fits the vehicle swing arm and is securely bolted to the wheel axle.

NOTICE The use of a non-approved hitch may lead to rear swing arm failure.

⚠ WARNING

If the hitch is removed from vehicle, always install a new cotter pin to lock the wheel axle nut.

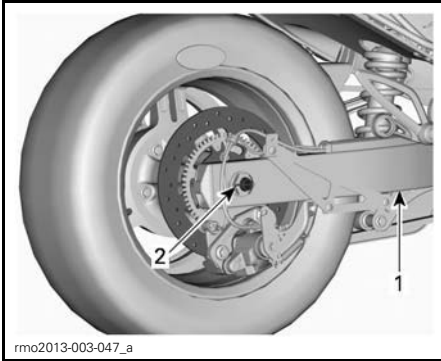

**TYPICAL - WHEEL AXLE CAP AND MUFFLER
REMOVED FOR CLARITY PURPOSE**

1. Swing arm
2. New cotter pin here

Safety Cables

Always use safety cables when towing a trailer. Ensure they are secured to the trailer and to the hitch, and that they cross under the tongue. Leave enough slack in cables to allow the trailer to turn corners. When trailer is in straight line with the vehicle, ensure chains will not drag on the ground.

KNOWLEDGE SELF-TEST

The following provides a sample of information that you should have learned by reading this guide. It does not include all of the important information, but should give you an idea of whether you have a general understanding of the vehicle and its operation.

See the *ANSWERS* on the page following the questionnaire.

Questionnaire

1. If you need to stop quickly, press both the brake pedal and the parking brake.

True False

2. A pre-ride inspection should be performed once a week.

True False

3. VSS allows you to use the vehicle in any kind of weather.

True False

4. You should only replace the tires with those approved by BRP obtained from an authorized Can-Am On-Road dealer.

True False

5. It is important for the passenger to be alert and sober.

True False

6. Name six items of protective gear that can reduce your risk of injury.

1. _____
2. _____
3. _____
4. _____
5. _____
6. _____

7. Protective gear is important for preventing and reducing injuries, keeping you comfortable, and providing protection against the elements.

True False

8. Which of the following is not one of the vehicle driving controls?

- a. Handlebar
- b. Twist throttle
- c. Front brake lever

9. You should leave your low beam lights on during the day for added visibility.

True False

10. You should normally position the vehicle in the center of the lane.

True False

11. Unlike a typical motorcycle, you should make it common practice to brake and turn at the same time.

True False

12. Under normal conditions, following distance should be at least _____.

- a. 1 second
- b. 2 seconds
- c. 3 seconds

13. You should never carry flammable liquids such as gasoline in the front storage compartment, even if they are in approved containers.

True False

14. List 5 ways of being more noticeable to other drivers.
1. _____
 2. _____
 3. _____
 4. _____
 5. _____
15. When braking on surfaces with less than ideal traction, you should pump the brakes to help maintain control of the vehicle.
- True False
16. The vehicle's maximum load includes: the operator, the passenger, the cargo and all accessories
- True False
17. The vehicle can safely tow a trailer as long as the total towed weight does not exceed 200 kg (441 lb).
- True False
18. A passenger should hold onto the operator.
- True False
19. Riding this vehicle is as safe as riding in a car.
- True False
20. ABS allows you to press the brake pedal hard without locking the wheels.
- True False

Answers

1. **False**
To stop quickly, press the brake pedal only. Never use the parking brake while the vehicle is moving.
2. **False**
You should do a pre-ride inspection every time you ride.
3. **False**
If there is ice, snow, slush or enough water on the road to cause hydroplaning, VSS can not help you maintain control.
4. **True**
5. **True**
6. 1) Helmet
2) Eye and face protection
3) Jacket with long sleeves
4) Gloves
5) Long pants
6) Closed-toe footwear, preferably over the ankle.
7. **True**
8. **c. Front brake lever**
The vehicle does not have a front brake lever.
9. **False**
You should use your high beams during the day.
10. **True**
11. **False**
You can brake and turn at the same time if you need to, but generally it is better to brake before the turn.
12. **b. 2 seconds**
Under normal conditions, following distance should be at least two seconds.
13. **True**
14. 1) Make sure your lights and reflectors are clean.
2) Use your high beams whenever possible.
3) Use your turn signals.
4) Flash your brake lights before slowing.
5) Use your emergency flashers as needed.
6) Use your horn to alert others of your presence.
7) Avoid riding in blind spots.
8) Wear bright colors and reflective clothing.
15. **False**
You should press and hold the brake pedal, not pump. The vehicle is equipped with ABS, which keeps the wheels from locking.

F3 Base Models: True
F3-S Models: True
F3-T Models: True
F3 Limited Models: False
16. **False**

F3 Base Models; You should never tow a trailer with the vehicle.
F3-S Models: You should never tow a trailer with the vehicle.
F3-T Models: You can tow a trailer with the vehicle as long as all the recommendations are strictly followed.
F3 Limited Models: You can tow a trailer with the vehicle as long as all the recommendations are strictly followed.
17. **False**

F3 Base Models; You should never tow a trailer with the vehicle.
F3-S Models: You should never tow a trailer with the vehicle.
F3-T Models: You can tow a trailer with the vehicle as long as all the recommendations are strictly followed.
F3 Limited Models: You can tow a trailer with the vehicle as long as all the recommendations are strictly followed.

18. False

The passenger should always hold on to the handholds.

19. False

In cars and trucks, the structure of the vehicle provides protection. In addition, passengers can protect themselves by wearing seat belts. You should expect that riding this vehicle is much riskier than riding in a car and that the risk of injury is more like the risk of injury when riding a motorcycle.

20. True

SAFETY INFORMATION ON THE VEHICLE

This vehicle comes with a hang tag and labels containing important safety information.

Any person who rides this vehicle should read and understand this information on the vehicle before riding.

Hang Tag

⚠ WARNING. Operating, servicing and maintaining a passenger Vehicle can expose you to chemicals including engine exhaust, carbon monoxide, phthalates, and lead, which are known to the State of California to cause cancer and birth defects or other reproductive harm.

To minimize exposure, avoid breathing exhaust, do not idle the engine except as necessary, service your vehicle in a well-ventilated area and wear gloves or wash your hands frequently when servicing your vehicle.

For more information go to
www.P65Warnings.ca.gov/products/passenger-vehicle



704906973

⚠ WARNING

This Can-Am On-Road is a different type of vehicle - It requires special skills and knowledge. Learn how this product is different.

Read the operator's guide and watch the safety video using the QR code link or visit Can-Am On-Road web site.

Complete a training course (if available), **practice**, become proficient with the controls, and get a proper licence.

Refer to the Safety Card before riding.



Always wear a helmet and riding gear.

With this type of vehicle, riders are exposed to more road risks than in a car. Even skilled operators can be struck by other vehicles or lose control. This vehicle will not protect you in a crash.

Handling limits and road conditions

The Vehicle Stability System (VSS) cannot stop you from losing control, flipping over, or falling off if you exceed this vehicle's limits. Know the limits for different road conditions. Do not ride on ice, snow, or off road. Avoid puddles and running water. This type of vehicle can hydroplane on water and slip on gravel, dirt and sand covered roads. If you must go through these road conditions, slow down.

This hangtag may only be removed by the customer.

704907713



⚠ AVERTISSEMENT

Ce produit routier est différent.

Il nécessite des habiletés et des connaissances spéciales. Sachez ce qui distingue ce produit Can-Am des autres véhicules.

Lisez le guide du conducteur et visionnez la vidéo de sécurité via le lien QR code ou en visitant le site internet Can-Am On-Road.

Suivez une formation (si disponible), **exercez-vous**, apprenez à maîtriser les commandes et obtenez le permis approprié.

Consultez la carte de sécurité avant de conduire le véhicule.



Portez toujours un casque et des vêtements appropriés.

Sur ce type de véhicule, les utilisateurs sont exposés à davantage de risques routiers qu'en automobile. Même un conducteur habile peut être frappé par un autre véhicule ou perdre le contrôle. Ce véhicule ne vous protégera pas en cas de collision.

Limites de manoeuvrabilité et conditions routières

Le système de stabilité du véhicule (VSS) ne peut pas vous empêcher de perdre le contrôle, de faire des tonneaux ou de tomber si vous dépassez les limites du véhicule. Apprenez à connaître ces limites dans différentes conditions routières. Ne conduisez pas sur la glace, sur la neige ou hors route. Évitez les flaques et les ruissellements d'eau. Ce type de véhicule peut faire de l'aquaplanage sur les chaussées détrempées et déraiser sur les routes recouvertes de gravier, de terre ou de sable. Si vous devez conduire dans ces conditions, ralentissez. Seul le client doit enlever cette étiquette.

704907713

Safety Card

The Safety Card is found under the LH lateral service cover. Remove LH lateral service cover and make sure to secure service cover back in place before riding.

Use the Safety Card to review key information and when you are teaching new operators and passengers how to ride the vehicle. It also includes frequently referenced information.

NOTE: The following illustration used in this Operator's Guide is a general representation only. Your model may differ.

 **WARNING**

This Can-Am On-Road product is a different type of vehicle. It requires special skills and knowledge.

Learn how this product is different. Read the operator's guide and watch the safety video using the QR code link or visit **Can-Am On-Road** web site. **Complete** a training course (if available), **practice**, become proficient with the controls, and get a proper license.



The Vehicle Stability System (VSS) cannot stop you from losing control, flipping over, or falling off if you exceed this vehicle's limits.

Do not ride on ice, snow, or off road.

Avoid puddles and running water. This type of vehicle can hydroplane on water and slip on gravel, dirt and sand covered roads. If you must go through these road conditions, slow down.

Wear a helmet and riding gear.

With this type of vehicle, riders are exposed to more road risks than in a car. Even skilled operators can be struck by other vehicles or lose control. This vehicle will not protect you in a crash.

Instruct the passenger.

- Always hold handholds and keep feet on pegs.
- Watch the road. Lean into curves. Brace for bumps.

Always keep in mind:

- Brake with the foot pedal.
- Steer in the direction of a turn; do not countersteer.
- Keep all wheels in your lane, always ride in a single file, and do not split lanes.
- Perform Pre-ride Inspection.

704907545

Press Mode button to enable starter

Patents : www.brp.com/en/about-brp/patents.html



EN-704907545-DEC

SAFETY CARD

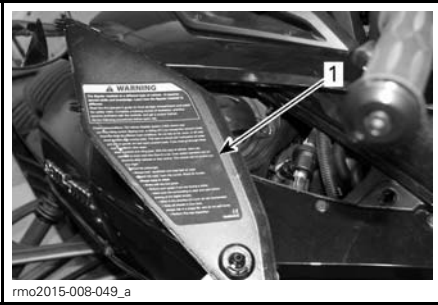

TYPICAL - SAFETY CARD UNDER LH
LATERAL SERVICE COVER



Safety Labels

These labels are affixed to the vehicle for the safety of the operator, passenger (2-UP) or bystanders



The following labels are on your vehicle, and they should be considered permanent parts of the vehicle. If missing or damaged, they can be replaced free of charge. See an authorized Can-Am On-Road dealer.

NOTE: In the event of any discrepancy between this guide and the vehicle, the safety labels on the vehicle have precedence over the labels in this guide.

Tires Pressure and Maximum Load

TIRE AND LOADING INFORMATION / RENSEIGNEMENTS SUR LES PNEUS ET LE CHARGEMENT							
 SEATING CAPACITY / NOMBRE DE PLACES	TOTAL	2	FRONT AVANT		1	REAR ARRIÈRE	1
The combined weight of occupants and cargo should never exceed 209 kg or 460 lb Le poids total des occupants et du chargement ne doit jamais dépasser 209 kg ou 460 lb							
TIRE / PNEU	SIZE/ DIMENSION	COLD TIRE PRESSURE/ PRESSION PNEUS A FROID	RIM SIZE/ DIMENSION JANTE				
FRONT/AVANT	MC165/55R15 55H	103 kPa / 15 psi	15 x 5 in				
REAR/ARRIÈRE	MC225/50R15 76H	193 kPa / 28 psi	15 x 7 in				
SPARE / SECOURS	NONE / AUCUN	NONE / AUCUN	NONE/AUCUN				
En-704908593-DEC							

LIMITED MODELS

TIRE AND LOADING INFORMATION / RENSEIGNEMENTS SUR LES PNEUS ET LE CHARGEMENT							
 SEATING CAPACITY / NOMBRE DE PLACES	TOTAL	2	FRONT AVANT		1	REAR ARRIÈRE	1
The combined weight of occupants and cargo should never exceed 199 kg or 438 lb Le poids total des occupants et du chargement ne doit jamais dépasser 199 kg ou 438 lb							
TIRE / PNEU	SIZE/ DIMENSION	COLD TIRE PRESSURE/ PRESSION PNEUS A FROID	RIM SIZE/ DIMENSION JANTE				
FRONT/AVANT	MC165/55R15 55H	103 kPa / 15 psi	15 x 5 in				
REAR/ARRIÈRE	MC225/50R15 76H	193 kPa / 28 psi	15 x 7 in				
SPARE / SECOURS	NONE / AUCUN	NONE / AUCUN	NONE/AUCUN				
En-704908592-DEC							

ALL OTHER MODELS

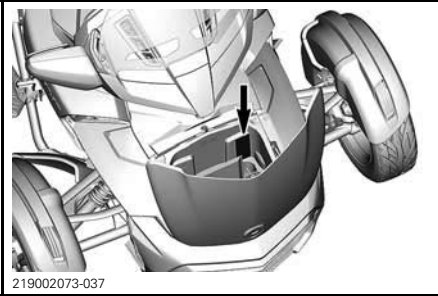

219002073-037

TYPICAL - LOCATED INSIDE THE FRONT STORAGE COMPARTMENT

Carrying Passenger

⚠ WARNING

To reduce the risks of severe injury or death.

- Never carry a passenger without lateral handgrips fixed on vehicle.
- Passenger should always hold handholds while riding.

6121

EN-704906121-Dec

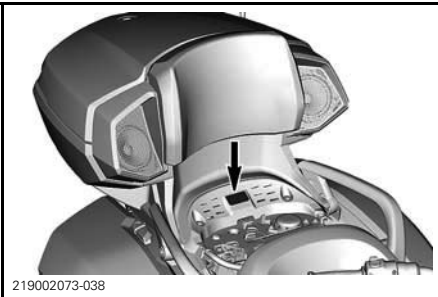

219002073-038

TYPICAL - UNDER PASSENGER SEAT - LIMITED MODEL SHOWN

Checking Engine Oil Level

⚠ CAUTION

ENGINE OIL AND CERTAIN COMPONENTS IN THE ENGINE COMPARTMENT MAY BE HOT.
DIRECT CONTACT MAY RESULT IN SKIN BURNS.

Checking Engine Oil Level:

- **Make sure engine is at operating temperature.**
- For procedure refer to the operator's guide.
- Ride at least 15 km (9 miles).
- Can-Am Spyder must be on a level surface.
- Let engine idle for 10 minutes.
- Stop engine.
- Take measurement within 2 minutes after the engine stop.
- Dipstick must be screwed in completely before checking oil level.
- Use XPS 4-stroke SW40 synthetic blend oil or equivalent motorcycle oil.



8335

En-704908335-DEC

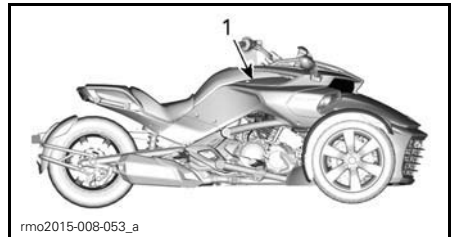

rmo2015-008-053_a

TYPICAL

1. Located under the RH lateral service cover

Cooling Hot - Do Not Open



rmo2008-003-003

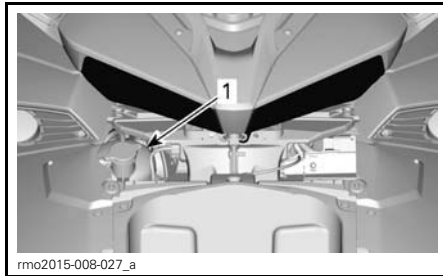

1. Located underneath front service cover

Brake Fluid - Clean and Refill



WARNING

Clean filler cap before removing.
Use only DOT 4 brake fluid from
a sealed container.

704903119

704903119

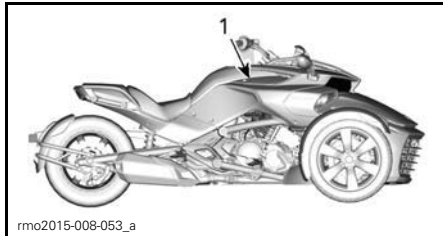

TYPICAL

1. Located under RH lateral service cover

Vehicle Cleaning

NOTICE

-Matt finish paint needs special care to maintain its appearance.
See operator's guide

-PVD chrome wheel should be washed with water and a mild soap. Do not polish, use acid based or abrasive chrome cleaner on the PVD chrome wheel.

-Do not clean windshield with alkaline or acid cleaner, gasoline or solvent to avoid windshield damage.
See operator's guide.

704904936A

704904936

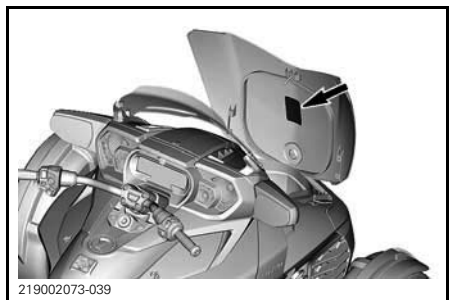

INSIDE THE BACK OF THE FRONT STORAGE COMPARTMENT COVER

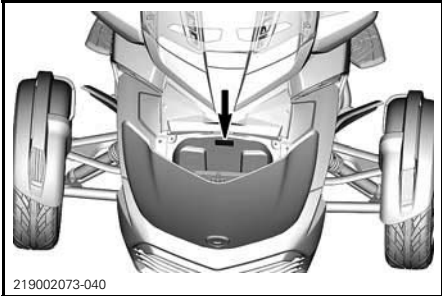
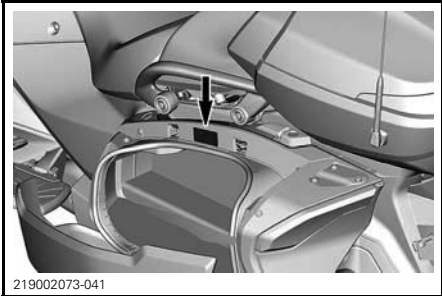
Front Storage Compartment Load**Side Storage Compartment Load**

INSIDE THE SIDE COMPARTMENT COVER

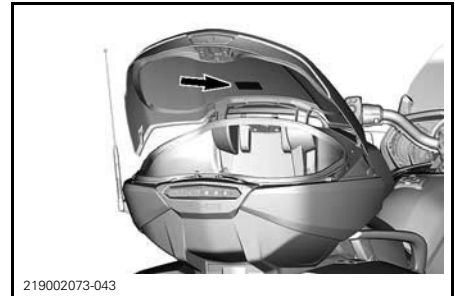
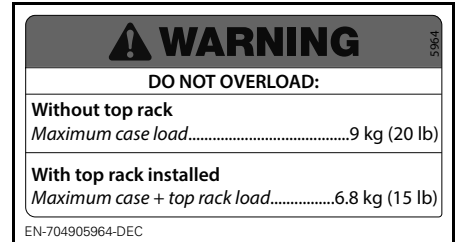
Top Storage Compartment Load*Limited Models*

INSIDE THE BACK OF THE TOP STORAGE COMPARTMENT COVER

Rear Suspension Pressure*T and Limited Models*

WARNING
MINIMUM PRESSURE 70 kPa / 10 Psi / 0.7 bar
DO NOT EXCEED RECOMMENDED PRESSURE BY 70 kPa / 10 Psi / 0.70 bar

LOAD	(PASSENGER + CARGO) Kg / Lb			
	0	45/100	70/150	90/200
DRIVER				
70/150	105/15/1.05	240/35/2.40	380/55/3.80	415/60/4.15
90/200	205/30/2.05	345/50/3.45	415/60/4.15	480/70/4.80
115/250	275/40/2.75	415/60/4.15	480/70/4.80	

704905966

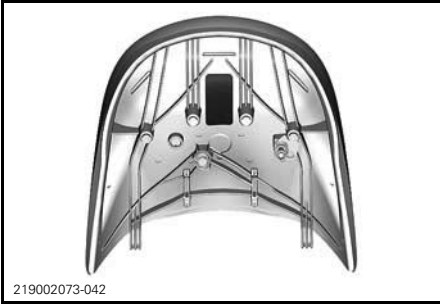

219002073-042

LOCATED UNDERNEATH THE PASSENGER SEAT

Shifting Pattern (Japanese Model)

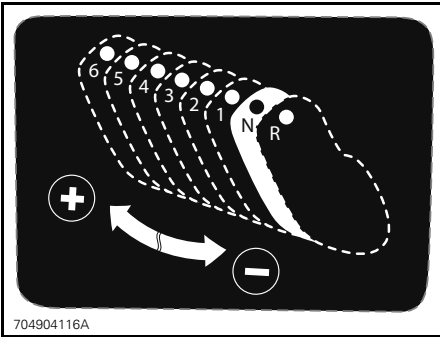

704904116A

JAPANESE MODELS ONLY- INSTALLED BY DEALER

REPORTING SAFETY DEFECTS

Your safety is very important to Bombardier Recreational Products Inc. (BRP). If you have any concerns you should immediately contact BRP customer service.

In the USA, if you believe that your vehicle has a defect which could cause a crash or could cause injury or death, you should immediately inform the National Highway Traffic Safety Administration (NHTSA) in addition to notifying Bombardier Recreational Products Inc.

If NHTSA receives similar complaints, it may open an investigation, and if it finds that a safety defect exists in a group of vehicles, it may order a recall and remedy campaign. However, NHTSA cannot become involved in any individual problems between you, your dealer or Bombardier Recreational Products Inc.

TO CONTACT NHTSA	
	888-327-4236
	1 800-424-9153
	National Highway Traffic Safety Administration 1200 New Jersey Avenue, SE Washington, DC 20590
	www.safercar.gov

***This page is
intentionally blank***

PRE-RIDE INSPECTION

PRE-RIDE CHECKLIST

We encourage you to have an Annual Safety Inspection of your vehicle. Please contact an authorized BRP dealer for further details. Though not required, it is recommended that an authorized BRP On-Road dealer performs the preseason preparation of your vehicle. Each visit to your authorized BRP dealer is a great opportunity for your dealer to verify if your vehicle is included in any warranty campaign. We also urge you to visit your authorized BRP On-Road dealer in a timely manner if you become aware of any safety related campaigns.

WARNING

Perform a pre-ride inspection before each ride to detect potential problems during operation. The pre-ride inspection can help you monitor wear and deterioration before they become a problem. Correct any problems that you discover to reduce the risk of a breakdown or crash. See an authorized Can-Am On-Road dealer as necessary.

Always lock lateral service covers back in position.

Before Starting the Vehicle, Inspect the Following:

ITEM	PROCEDURE	
TIRES	Look for damage. Inspect inflation and tread wear. Refer to <i>MAINTENANCE PROCEDURES</i> .	
WHEELS AND LUG NUTS	Look for damage. Twist each front wheel lug nut by hand to be sure it is not loose. Be sure the rear wheel axle nut is in place.	
DRIVE BELT	Look for fraying, cuts, punctures and missing teeth. Verify alignment. For additional information, refer to <i>MAINTENANCE PROCEDURES</i>	
LEAKS	Look under the vehicle for any leaks.	
ALL STORAGE COMPARTMENT COVERS	Pull to check that it is properly latched.	
MIRRORS	Clean and adjust: (see <i>MIRRORS</i> in <i>EQUIPMENT</i> .)	
BRAKE PEDAL	Press and make sure you feel firm resistance. Pedal must fully return when released.	
THROTTLE HANDLE	Twist several times. Be sure it operates freely and returns to idle position when released.	

ITEM	PROCEDURE	
GEARSHIFT SELECTOR	Be sure gearshift selector operates normally in both directions and returns to center when released.	
WEIGHT	Ensure that total load on the vehicle (including operator, passenger, cargo and added accessories) does not exceed recommended load as indicate in the <i>TECHNICAL SPECIFICATIONS</i> section.	
PNEUMATIC SUSPENSION (T MODELS)	Inspect inflation, refer to <i>BASIC PROCEDURES</i> .	

Turn Ignition Key to the ON Position:

ITEM	PROCEDURE	
MULTIFUNCTION GAUGE	Check the gauges, indicators, messages and the fuel level	
LIGHTS	Check operation of headlights, taillight, brake light, turn signals and hazard warning lights.	
HORN	Check operation.	
STEERING	Start engine and verify that steering operates freely.	
ENGINE STOP SWITCH	Check that the engine stop switch is working properly.	
PARKING BRAKE	Start engine, release parking brake and ensure brake indicator lamp is off on the multifunction gauge.	
BRAKE	Drive a short distance forward slowly then apply brake to test.	

***This page is
intentionally blank***

MAINTENANCE

MAINTENANCE SCHEDULE

Maintenance is very important for keeping your vehicle in safe operating condition. Proper maintenance is the owner's responsibility. A warranty claim may be denied if, among other things, the owner or operator caused the problem through improper maintenance or use.

Perform periodic checks and follow the maintenance schedule. **The maintenance schedule does not exempt the pre-ride inspection.**

Verifying fault codes, as first maintenance step, is a good practice and is highly recommended.

WARNING

Failure to properly maintain the vehicle according to the maintenance schedule and procedures can make it unsafe to operate.

EPA Regulation - Canadian and USA Vehicles

A repair shop or person of the owner's choosing may maintain, replace, or repair emission control devices and systems. These instructions do not require components or service by BRP or authorized Can-Am On-Road dealers.

Although an authorized Can-Am On-Road dealer has an in-depth technical knowledge and tools to service your vehicle, the emission-related warranty is not conditioned on the use of an authorized Can-Am On-Road dealer or any other establishment with which BRP has a commercial relationship.

Proper maintenance is the owner's responsibility. A warranty claim may be denied if, among other things, the owner or operator caused the problem through improper maintenance or use.

For emission-related warranty claims, BRP is limiting the diagnosis and repair of emission-related parts to the authorized Can-Am On-Road dealers. For more information, please refer to the *US EPA EMISSIONS PERFORMANCE WARRANTY* contained in the *WARRANTY* section.

You must follow the instructions for fuel requirements in the fueling section of this manual. Even if gasoline containing greater than ten volume percent ethanol is readily available, the US EPA issued a prohibition against the use of gasoline containing greater than 10 vol% ethanol that applies to this vehicle. The use of gasoline containing greater than 10 vol% ethanol with this engine may harm the emission control system.

FIRST INSPECTION - 5 000 KM (3,000 MI)

Perform all items indicated in the *PRE-RIDE INSPECTION*.

Replace engine oil and oil filter.

Check brake fluid level.

Check reverse mechanism operation.

Check engine coolant level.

Check operation of control switches.

Check the drive belt condition and its tension. (Performed by an authorized Can-Am On-Road dealer)

Check tightening torque of the rear wheel axle nut. (Performed by an authorized Can-Am On-Road dealer)

Visually check brake pads and discs condition.

Check passenger handholds looseness.

Check footrests looseness.

Check body panels looseness.

Check operation of storage compartment latches, hinges and key barrels. Clean and lubricate if needed.

Remove front grill and clear all debris from radiator air duct.

EVERY 1 500 KM (1,000 MI)

Check oil level.

EVERY 15 000 KM (9,300 MI) OR 1 YEAR (WHICHEVER COMES FIRST)

Perform all items indicated in the *PRE-RIDE INSPECTION*.

Replace engine oil and oil filter.

Check brake fluid level. Replace every 2 years.

Check brake hoses

Check reverse mechanism operation.

Check radiator, hoses and water pump.

Check engine coolant level.

Perform a pressure test of cooling system.

Check operation of control switches and passenger switches.

Check condition of fuel hoses, fuel evaporation lines and canister.

Check battery connections tightening.

EVERY 15 000 KM (9,300 MI) OR 1 YEAR (WHICHEVER COMES FIRST)

Check the drive belt condition and its tension (Performed by an authorized Can-Am On-Road dealer)

Check and retighten exhaust pipe, clamping rings, joints, and gaskets condition.

Check steering for abnormal play.

Check tie-rods condition.

Check shock absorbers for leaks or other damages.

Check tightening torque of the rear wheel axle nut. (Performed by an authorized Can-Am On-Road dealer)

Check ball joints condition.

Check front and rear wheel bearings condition.

Check brake pads and discs condition.

Check passenger handholds looseness.

Check footrests looseness.

Check body panels looseness.

Lubricate and check operation of storage compartment latches, hinges and key barrels.

Remove front grill and clear all debris from radiator air duct.

Lubricate all key barrels with two drops of XPS storage oil.

EVERY 30 000 KM (19,000 MI)

Replace air filter and clean air filter housing.

EVERY 45 000 KM (28,000 MI)

Replace the fuel filter (or every 5 years).

Replace the Hydraulic Control Module (HCM) oil filter.

Replace the canister pre-filter.

Replace engine coolant (or every 5 years).

Replace the spark plugs.

Check front suspension arms rubber bushings.

FIRST INSPECTION

We recommend that after the first 5 000 km (3,000 mi) of operation, your vehicle be inspected by an authorized Can-Am On-Road dealer, repair shop, or person of your own choosing. The first maintenance is very important and must not be neglected.

NOTE: The first inspection is at the expense of the vehicle owner.

We recommend that this inspection be signed by the authorized Can-Am On-Road dealer, repair shop, or person of your own choosing having performed the first inspection.

Date of inspection

Signature of the Authorized Can-Am
On-Road dealer, repair shop, or person

Name of the Authorized Can-Am
On-Road dealer, repair shop, or person

MAINTENANCE PROCEDURES

This section includes instructions for basic maintenance procedures.

Due to the complexity of some maintenance procedures, good mechanical skills are required.

Several procedures must be done by an authorized Can-Am On-road dealer, repair shop, or person of your own choosing.

If you are not comfortable with the mechanics, do not hesitate to contact an authorized Can-Am On-road dealer, repair shop, or person of your own choosing.

WARNING

Turn off the engine and follow these maintenance procedures when performing maintenance. If you do not follow proper maintenance procedures you can be injured by hot parts, moving parts, electricity, chemicals or other hazards.

Engine Oil

Recommended Engine Oil

The same oil is used for the engine, gearbox, clutch, and the Hydraulic Control Module (HCM) on the SE6 model.

Rotax® engines were developed and validated using the XPS™ oil.

BRP recommends the use of its XPS engine oil or an equivalent at all time.

NOTICE Do not add any additives to the recommended engine oil.

Damages caused by the use of an oil not suitable for the engine or by adding of an additives may not be covered by the BRP Limited Warranty.

XPS™ RECOMMENDED ENGINE OIL

4T 5W40 Synthetic blend oil

IF THE RECOMMENDED XPS ENGINE OIL IS NOT AVAILABLE

Use a 5W40 4-stroke SAE synthetic engine oil meeting or exceeding the following lubricant industry specifications:

**API service classification
SJ, SL, SM or SN**

Always check the API service label certification on the oil container, it must contain at least one of the indicated standards.

Verifying the Engine Oil Level

NOTICE Operating the engine with an improper engine oil level may cause severe engine damages. Follow this procedure to obtain a precise reading of the engine oil level.

In order to perform the engine oil level verification, the engine must be at normal operating temperature.

NOTICE Adjusting the oil level on a cold engine will result in overfilling.

1. Take a ride of at least 15 km (9 mi).
2. Park the vehicle on a level surface.
3. Let the engine idle at least 20 seconds.

WARNING

Exhaust gas contains poisonous carbon monoxide that can rapidly accumulate in an enclosed or poorly ventilated area. If inhaled, it can cause serious injury or death. Only run the engine in an unenclosed, well ventilated area.

NOTICE Adjusting the oil level on a cold engine will result in overfilling.

4. Stop engine.

NOTE: Engine oil level verification must be performed within 2 minutes after engine stop.

5. Remove RH lateral service cover. Refer to *BODY PANELS*.

6. Unscrew and remove the oil dipstick.

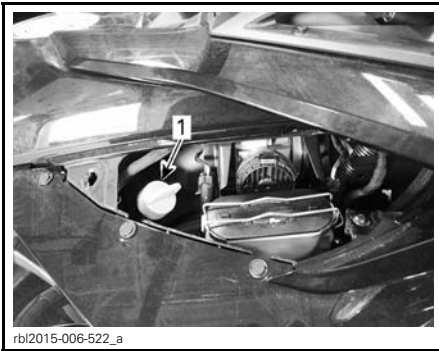

TYPICAL

1. Oil dipstick

7. Wipe off the dipstick.

8. Reinsert and **completely screw in** the dipstick.

9. Unscrew and remove the dipstick again.

10. Check the engine oil level on the dipstick. It should be near or equal to the upper mark.

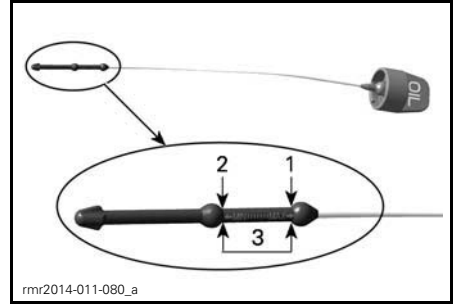

1. MAX
2. MIN
3. Operating range, 500 ml (17 U.S. oz)

Oil Level between Lower (MIN) and Upper (MAX) Marks:

1. Do not add oil.
2. Properly insert and tighten dipstick.
3. Install RH lateral service cover.

Oil Level under MIN Mark Adjustment:

1. Add approximately 500 ml (17 U.S. oz) of recommended oil.

NOTE: The oil quantity between MIN and MAX marks is 500 ml (17 U.S. oz).

2. Restart the engine and let it idle for 10 minutes.

⚠ WARNING

Exhaust gas contains poisonous carbon monoxide that can rapidly accumulate in an enclosed or poorly ventilated area. If inhaled, it can cause serious injury or death. Only run the engine in an unenclosed, well ventilated area.

NOTICE Adjusting the oil level on a cold engine will result in overfilling.

3. Stop the engine.
4. Recheck oil level.

NOTE: Engine oil level verification must be performed within 2 minutes after engine stop.

- Repeat the above steps until oil level reaches the dipstick between the lower and upper marks. **Do not overfill.**
- Properly insert and tighten dipstick.
- Install RH lateral service cover.

Changing the Engine Oil and Oil Filter

- Prior to changing the oil, ensure vehicle is on a level surface.

NOTICE The engine oil and the engine oil filter must be replaced at the same time. The oil change should be carried out with a warm engine.

CAUTION Engine oil can be very hot.

- Remove the following RH body panels, refer to *BODY*:
 - Lateral service cover
 - Side panel
- Clean area around drain plug under oil sump cover.
- Place an appropriate drain pan under oil sump cover.
- Remove the drain plug and discard the sealing washer and O-rings.

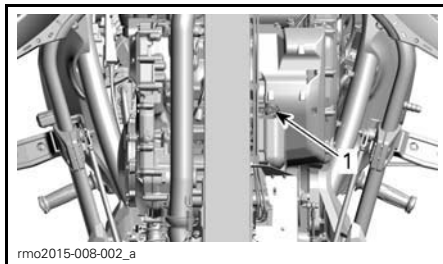

TYPICAL

- Drain plug

- Remove the dipstick.
- Allow sufficient time for oil to completely drain.
- Clean area around magnetic drain plug in the clutch cover.

- Place an appropriate drain pan under the clutch cover.
- Remove the magnetic oil drain plug and discard the sealing ring.

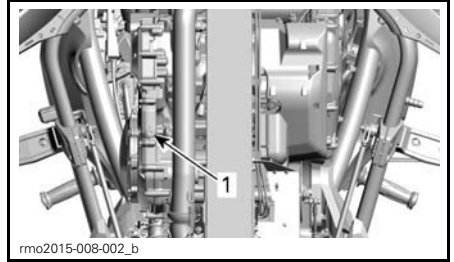

TYPICAL

- Magnetic drain plug

- Remove oil filter cover and discard its O-rings.
- Remove and discard oil filter.

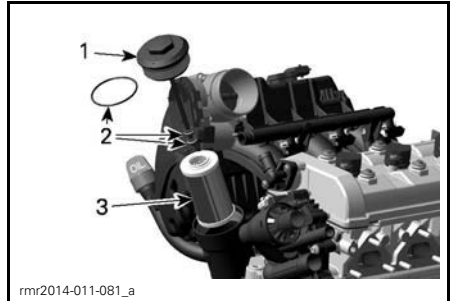

- Oil filter cover
- O-rings
- Oil filter

- Allow sufficient time for oil to completely drain from clutch cover.
- Check and clean oil filter cavity for dirt and contamination.
- Clean the magnet on the magnetic drain plug.
- Using **NEW** sealing washers and O-rings and install both drain plugs.

NOTICE Never reuse the drain plug sealing washers and O-rings. Always replace it with a new one.

- Tighten drain plugs as specified.

TIGHTENING TORQUE	
Drain plug (oil sump cover)	28 N•m ± 2 N•m (21 lbf•ft ± 1 lbf•ft)

TIGHTENING TORQUE	
Magnetic drain plug (clutch cover)	20 N•m ± 2 N•m (15 lbf•ft ± 1 lbf•ft)

18. Insert **NEW** engine oil filter.
19. Install **NEW** O-rings on oil filter cover.
20. Install oil filter cover and tighten to specification.

TIGHTENING TORQUE	
Oil filter cover	25 N•m ± 3 N•m (18 lbf•ft ± 2 lbf•ft)

21. Pour following amount of the recommended oil into the oil tank.

OIL CAPACITY	
WHEN DOING...	QUANTITY
Engine oil and engine oil filter replacement	4.7 L (5 qt (U.S. liq.))
Engine oil, engine oil filter and HCM surface filter replacement	4.9 L (5.2 qt (U.S. liq.))

22. Reinsert and completely screw in the dipstick.
23. Check engine oil level. Refer to *ENGINE OIL LEVEL VERIFICATION* in this section.

NOTICE Ensure oil pressure warning lamp goes out within 5 seconds from engine start. If oil pressure warning lamp stays ON for more than 5 seconds, STOP ENGINE and recheck oil level.

24. Ensure engine oil filter cover, magnetic drain plug (clutch cover) and drain plug (oil sump cover) are not leaking.
25. Reinstall all removed body panels.
26. Dispose of used oil as per your local environmental regulations.

Air Filter

Removing the Air Filter

Remove the LH service cover. Refer to *BODY PANELS* in *EQUIPMENT* if needed.

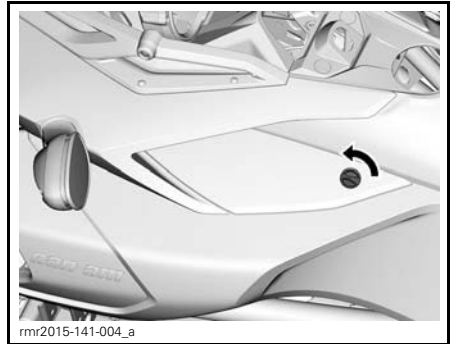

UNLOCK

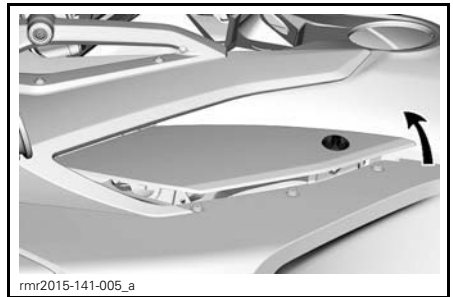

LIFT THE REAR OF THE COVER

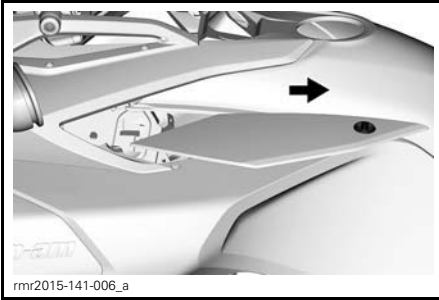

SLIDE THE COVER REARWARDS

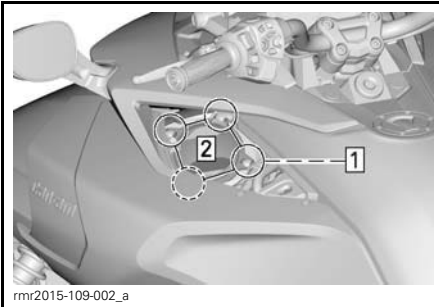

TYPICAL
 Step 1: Remove all four screws
 Step 2: Remove air filter cover

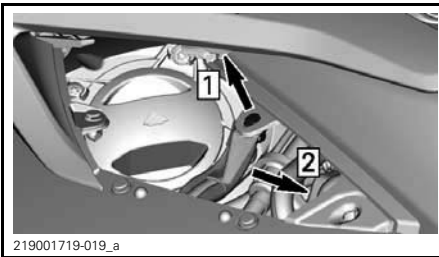

T AND LIMITED MODELS
 1. Remove plastic rivet
 2. Displace electrical harness

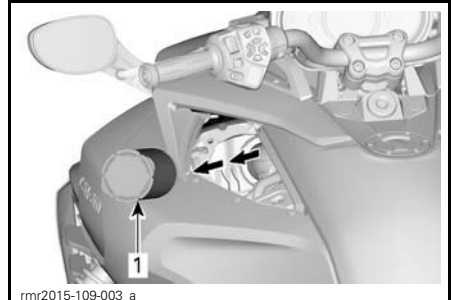

TYPICAL - REMOVE AIR FILTER FROM AIR INTAKE SILENCER.
 1. Air filter

NOTICE Remove air filter slowly to keep dust and debris from falling into the clean area of the air intake silencer (passed air filter).

Inspecting the Air Filter

Inspect air filter for cleanliness and damage.

NOTICE It is not recommended to blow compressed air on the paper filter. This could damage the paper fibers and reduce its filtration ability when used in dusty environments.

NOTICE Do not wash the paper filter with any cleaning solution.

NOTICE Inspect air intake silencer and remove any dust or debris taking care not to blow or move anything inside the clean side of the engine air inlet (passed air filter).

NOTICE Remove any dust or debris that may have moved or shifted inside the clean side of the air intake silencer (passed air filter). Clean by pulling on the dust and not pushing it inside.

Replace air filter as necessary according to recommended maintenance schedule and particular use (especially in dusty environments).

Installing the Air Filter

The installation is the reverse of the removal procedure. However, pay attention to the following.

Make sure the ring on which the air filter sits is flat and well positioned before seating the air filter.

Make sure the air filter is positioned in the correct orientation.

NOTE: A special area is present on the filter for writing down date and mileage at which new filter was installed.

Position air filter cover onto air intake silencer.

Tighten screws in a star pattern.

TIGHTENING TORQUE	
Air filter cover retaining screws	3 N•m ± 0.5 N•m (27 lbf•in ± 4 lbf•in)

Engine Coolant

Recommended Engine Coolant

NOTICE Always use ethylene-glycol antifreeze containing corrosion inhibitors specifically for internal combustion aluminum engines.

To prevent antifreeze deterioration, always use the same brand and grade. Never mix different brands or grades unless cooling system is completely flushed and refilled.

XPS RECOMMENDED COOLANT
Extended life pre-mixed coolant
IF THE RECOMMENDED XPS COOLANT IS NOT AVAILABLE
Use a low silicate, extended life ethylene-glycol premixed coolant (50%-50%) specifically formulated for internal combustion aluminum engines.

Verifying the Engine Coolant Level

⚠ WARNING

When opening the reservoir, the coolant can be very hot and spray out if the engine is hot. In order to avoid getting burned, check the coolant level when the engine is cold.

With the engine cold, check the coolant level as follows:

1. Park the vehicle on a firm, level surface.
2. Open the front storage compartment.
3. Remove front service cover. Refer to *BODY*.
4. Check the coolant level on the right hand side. Coolant must be visible slightly above the COLD level mark.

NOTE: If engine is hot, coolant must be visible without exceeding the HOT level mark.

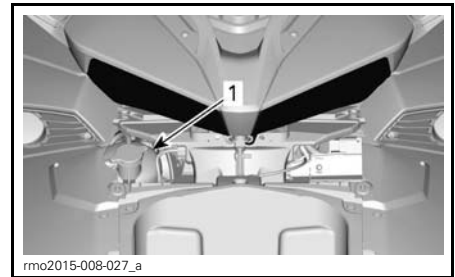

1. Coolant reservoir cap

5. If required, add coolant until it is visible in the reservoir slightly above the COLD level mark. Use a funnel to avoid spillage.

Do not overfill.

6. Stop adding coolant once coolant starts to appear in the tube.

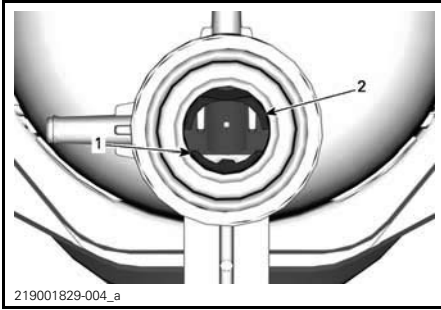

- 1. COLD coolant level reference line
- 2. HOT coolant level reference line

7. Reinstall the service cover.

NOTE: A coolant system that frequently requires coolant indicates leaks or engine problems. See an authorized Can-Am On-Road dealer.

Radiator Fan

Remove any debris from the grilles.

NOTICE Do not clean with a pressure washer because it can damage the radiator fins. Clean only with compressed air from behind (blow the air from the back towards the front).

To access radiators, remove screws retaining the front grille.

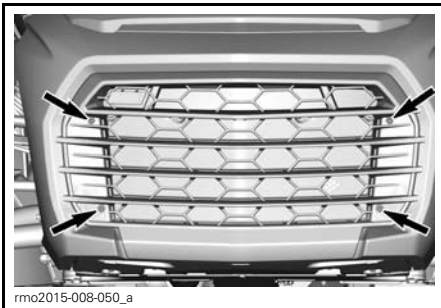

FRONT GRILLE SCREWS

Pull front grille to remove it.

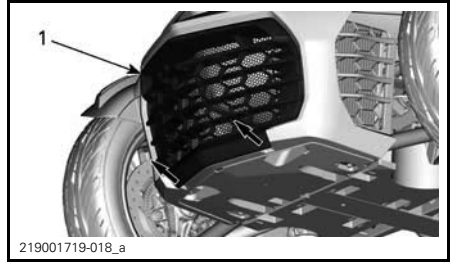

1. Front grille

Battery

Battery Location

The battery is located in the front storage compartment. To access the battery, open the front storage compartment.

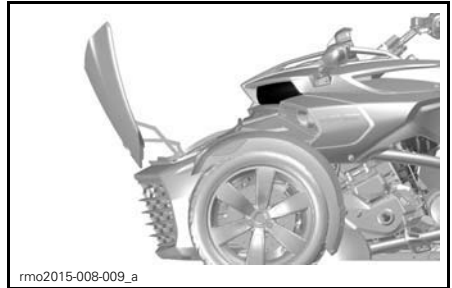

TYPICAL - FRONT STORAGE COMPARTMENT OPENED

Remove basket. Refer to *BODY PANELS*.

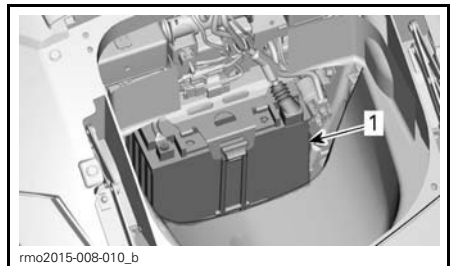

1. Battery

Charging the Battery

The vehicle is equipped with a maintenance-free type battery and is completely sealed; there is no need to add

water to adjust the electrolyte level. The battery may need to be charged if the vehicle has not been ridden for at least one month.

Always have the battery replaced by an authorized Can-Am On-Road dealer.

⚠ WARNING

Do not use conventional lead-acid type batteries. Acid may leak out through the battery vent of a conventional lead-acid type battery. Acid may also leak if the battery case is cracked or damaged, which can cause severe burns.

The battery can be charged while it is installed on the vehicle.

NOTICE Follow the instructions provided with your battery charger. Improper charging may damage the battery.

To charge the battery, proceed as follows:

1. Open the front storage compartment.
2. Remove basket. Refer to *BODY PANELS*.
3. First connect the RED (+) cable to the corresponding terminal.
4. Connect the BLACK (-) cable to the corresponding terminal.

NOTICE Always connect the RED (+) cable first to avoid damaging the electrical system of the vehicle.

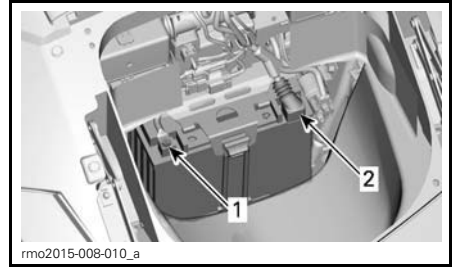

1. BLACK (-) terminal
2. RED (+) terminal

5. Start the battery charger. Charging time will depend on the charging rate.

When the battery is charged:

6. First disconnect the BLACK (-) cable.
7. Disconnect the RED (+) cable.

NOTICE Always disconnect the BLACK (-) cable first to avoid damaging the electrical system of the vehicle.

8. Put basket back and close front storage compartment.

A standard battery charger can be used. The recommended charge rate is 2 A. If the battery is dead, it can be jump started with a car battery (see *ROADSIDE REPAIRS* section).

For home charging, a "trickle" charger can be used to slow charge the battery. This type of charger can be left connected for a long period of time without damaging the battery. Always follow the charging time as recommended in the charger instructions.

Drive Belt

Visually inspect belt alignment and condition before each ride.

Belt alignment and deflection adjustment should always be performed by an authorized Can-Am On-Road dealer according to the *MAINTENANCE SCHEDULE*.

Drive Belt Alignment

If belt goes beyond the outside edge of sprocket, have the belt properly aligned by an authorized Can-Am On-Road dealer as soon as possible.

NOTE: Belt must **NOT** be in contact with flange from **FRONT SPROCKET**.

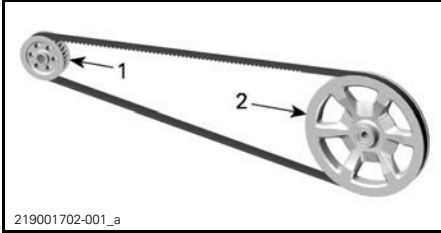

219001702-001_a

TYPICAL

1. Front sprocket
2. Rear sprocket

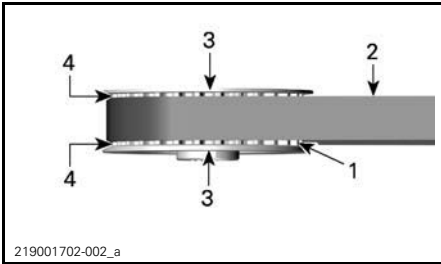

219001702-002_a

TYPICAL - FRONT SPROCKET

1. Front sprocket teeth
2. Belt
3. Sprocket flange
4. Gap between flange and belt

Drive Belt Wear

Inspect the drive belt with the vehicle in neutral, engine off, on a level surface with plenty of room — you will have to roll the vehicle forward or backward to see the full length of the belt.

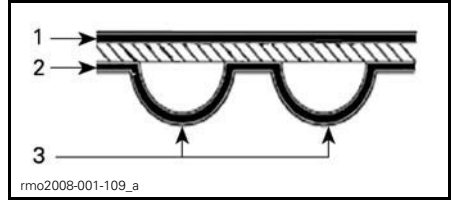

rmo2008-001-109_a



DRIVE BELT SURFACES

1. Outer surface
2. Teeth side surface
3. Tooth

Inspect for the following conditions:

WEAR CONDITION	REQUIRED ACTION
 Good condition	None
 Hairline cracks	Monitor condition
 Minor chipping	Monitor condition
 Opened cracks	Replace belt
 Hook wear	Replace belt
 Missing teeth	Replace belt

Wheels and Tires

WEAR CONDITION	REQUIRED ACTION
Belt fabric worn, exposing internal components 	Replace belt
Stone damage 	Replace belt

NOTE: Hairline cracks do not require the replacement of the belt, but must be monitored closely — they may lead to opened cracks or missing teeth, requiring belt replacement. Damage to the center of the belt will eventually require belt replacement, but when cracks extend to the edge of the belt, belt failure is imminent.

When a drive belt is replaced, also replace the sprockets to increase the longevity of the new drive belt.

Drive Belt Tension

While riding, if you feel vibrations or noise in the belt or if the belt is skipping sprocket teeth, have the belt tension adjusted as soon as possible by an authorized Can-Am On-Road dealer. Pay particular attention during break-in period (first 1 000 km (600 mi)).

⚠ WARNING

Tires that are not the recommended type, damaged, worn down below the minimum tread wear limit indicator or improperly inflated can cause loss of control. New tires will not operate at their maximum efficiency until their break-in is completed. Braking, steering and VSS performance may be reduced, so use extra caution. Tires take about 300 km (200 mi) of riding with frequent braking to break-in. For riding with infrequent braking, allow extra time to break-in the tires.

The tires have been specifically designed for this vehicle. Use only the BRP recommended radial tires, which can be ordered only from an authorized Can-Am On-Road dealer.

When the rear tire is removed or replaced, perform the following:

- Check and clean the rear sprocket bearing and seal. Replace if damaged or broken.
- Check and clean the rear axle bearings. Replace if damaged or broken.
- Replace and lubricate the bearing seal of the rear axle.
- Replace and lubricate rear axle O-ring.
- Check and clean the rear axle wear sleeves. Replace if damaged or broken.

When the rear wheel is removed or replaced, perform the following:

- Replace rear axle nut.
- Replace and lubricate the bearing seal of the rear axle.
- Replace and lubricate rear axle O-ring.
- Check rubber damper condition. Replace if damaged or broken.

Tire Pressure

Use the recommended cold inflation pressure for optimum tire performance and wear. Under-inflation or over-inflation may cause uneven tread wear patterns.

Recommended tire inflation pressure is found on the Tire Label located inside the right side service cover.

When weather temperature changes occur, tire inflation pressures also change. A drop of 6°C (10°F) can cause a corresponding drop of 1 PSI (7 kPa) in inflation pressure. Check your tire pressures frequently and adjust them to the proper pressure.

NOTE: The pressure difference between the left and right side tire should not exceed 3.4 kPa (.5 PSI).

Tire Damage

Check all tires for:

- Cuts, slits and cracks in the tires.
- Bumps or bulges in the side of the tire or the tread.
- Nails or other foreign objects in the side of the tire or tread.
- Air leaks (hissing sound) caused by an ill-fitting rim or a faulty tire valve.

If any of the above occurs, have the tire repaired or replaced as soon as possible by an authorized Can-Am On-Road dealer.

Tire Tread Wear

Check minimum tread depth by using the tread-wear indicators (hard rubber bars molded at the base of the tread; 1 in figure below). Check in three locations across the tire tread:

- Outer edge
- Center
- Inside edge.

The tread-wear indicators will appear across the treads that have been worn down to the minimum tread depth. When at least one tread-wear indicator

appears across the tread, have the tire replaced as soon as possible by an authorized Can-Am On-Road dealer.

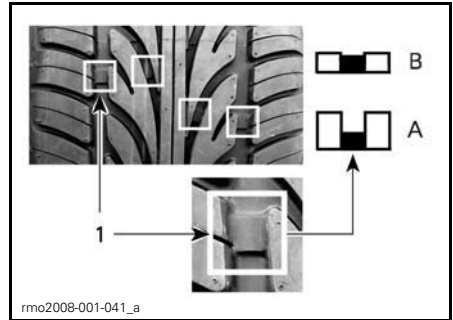

TIRE TREAD WEAR

1. Tread-wear limit indicator

A. Appropriate tread depth

B. Minimum tread depth, replace tire

It is normal to see uneven wear on tires depending on how the vehicle is driven and road conditions. The front tires external or internal edges and the rear tire center tread will wear unevenly depending on if the vehicle is driven smoothly or aggressively.

⚠ WARNING

The tires are designed to rotate only in one direction. Do not switch the left and right front wheels. If a tire is mounted on the incorrect side, you will have less traction and could lose control.

⚠ CAUTION Do not hold the front wheel spoke while attempting to spin the front wheel as your fingers may be caught between the wheel and the brake caliper.

Tire Rotation

Rotate front tires when tread depth reaches 4 mm (5/32 in). This will maximize tire life.

⚠ WARNING

The tires are designed to rotate only in one direction. Do not switch the left and right front wheels. The tires must be dismounted from the wheels for tire rotation. If a tire is mounted on the incorrect side, you will have less traction and could lose control.

⚠ CAUTION Do not hold the front wheel spoke while attempting to spin the front wheel as your fingers may be caught between the wheel and the brake caliper.

Tire Registration Form

In the event of a tire recall, we can only contact you if we have your name and address. As a vehicle manufacturer, BRP keeps a record of the Tire Identification Number (T.I.N.) associated with the Vehicle Identification Number (V.I.N.) (see *VEHICLE IDENTIFICATION*) and its current owner information.

If you replace any tire on your vehicle, a "Tire Registration Form" must be completed and sent to the tire manufacturer consumer service group. The "Tire Registration Form" is available at an authorized Can-Am On-Road dealer.

Brakes

⚠ WARNING

New brakes will not operate at their maximum efficiency until their break-in is completed. Braking performance may be reduced, so use extra caution. Brakes take about 300 km (200 mi) of riding with frequent braking to break-in. For riding with infrequent braking, allow extra time to break-in the brakes.

Verifying the Brake Fluid Level

Use only DOT 4 brake fluid from a sealed container.

Check the brake fluid level as follows:

1. Park the vehicle on a firm, level surface.
2. On RH side, remove the lateral service cover and the side panel. Refer to *BODY PANELS*.
3. Check the brake fluid level in reservoir. They should both be above the MIN. mark.

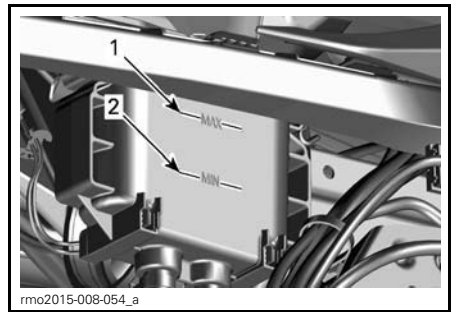

1. Brake fluid MAX. level mark
2. Brake fluid MIN. level mark

4. Add fluid as required. Refer to *ADDING BRAKE FLUID*.

⚠ CAUTION Low brake fluid may indicate leaks or worn brake pads. See an authorized Can-Am On-Road dealer.

Adding Brake Fluid

1. Remove the filler cap.

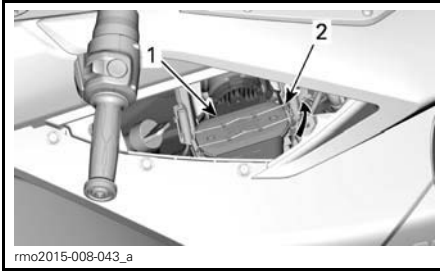

1. Filler cap
2. Filler cap locking mechanism

⚠ WARNING
 Clean filler cap before removing. Use only DOT 4 brake fluid from a sealed container.

2. Add fluid to MAX level.

NOTE: Replacing brake pads will increase brake fluid level. If replaced when at MAX level, brake fluid spills may occur.

NOTICE Brake fluid can damage painted surfaces or plastic parts. Wipe up any spills.

3. Reinstall filler cap and lock in place.
4. Reinstall the side panel and the lateral service cover. Refer to *BODY PANELS*.

Verifying the Brake System

The front and rear brakes are hydraulic disc types. These brakes are self-adjusting and do not require adjustment.

The brake pedal also requires no adjustment.

To keep brakes in good condition, check the following as per the *MAINTENANCE SCHEDULE*:

1. Entire brake system for fluid leaks
2. Brake pedal for spongy feel
3. Brake discs for excessive wear and surface condition
4. Brake pads for wear, damage or looseness.

See an authorized Can-Am On-Road dealer if there are any problems with the brake system.

Headlights

Verifying the Headlights Aiming

1. Verify tires are correctly inflated. Refer to *SPECIFICATIONS*.
2. Position vehicle 10 m (33 ft) in front of a test surface as shown. Make sure vehicle is on leveled ground.

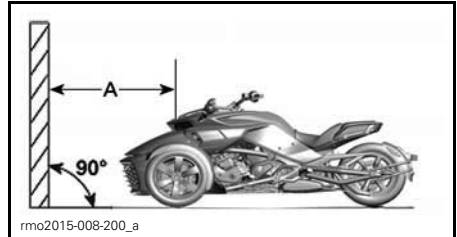

TYPICAL
 A. 10 m (33 ft)

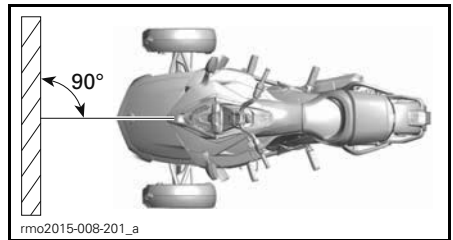

TYPICAL

North American Models

1. Trace 2 lines parallel to the ground on the test surface as follows:

LINES ON THE TEST SURFACE	
Line A	644 mm (25-23/64 in) above ground
Line B	554 mm (21-13/16 in) above ground

2. Have driver take place on the driver's seat.
3. Select **low** beam.

- Beam aiming is correct when the top line of the headlight reflection is between the marks.

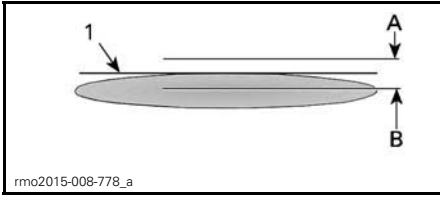

- Top line
- Mark at 644 mm (25-23/64 in) above ground
- Mark at 554 mm (21-13/16 in) above ground

European, Australian and Japanese Models

- Trace 4 lines parallel to the ground on the test surface as follows:

LINES ON THE TEST SURFACE	
Line A	688 mm (27-3/32 in)
Line B	618 mm (24-21/64 in)
Line C	564 mm (22-13/64 in)
Line D	514 mm (20-15/64 in)

- Have driver take place on the driver's seat.
- Select **high** beam.
- Beam aiming is correct when the focus point (brightest spot) of the headlight reflection is between the upper marks.

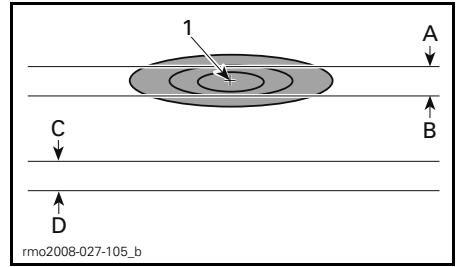

TYPICAL - HEADLIGHT REFLECTION ON TEST SURFACE — HIGH BEAM (SINGLE HEADLAMP)

- Focus point
- 688 mm (27-3/32 in) above ground
- 618 mm (24-21/64 in) above ground
- 564 mm (22-13/64 in) above ground
- 514 mm (20-15/64 in) above ground

- Select low beam.
- Beam aiming is correct when the focus point (brightest spot) of headlight reflection is between lower marks.

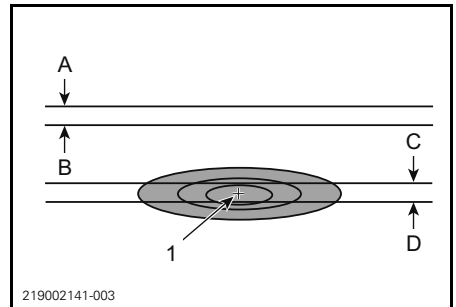

- Focus point
- 688 mm (27-3/32 in) above ground
- 618 mm (24-21/64 in) above ground
- 564 mm (22-13/64 in) above ground
- 514 mm (20-15/64 in) above ground

NOTE: For countries driving on the left, light peak should be on the left of vehicle.

Headlights Aiming Adjustment

North American Models

- Using a 10mm wrench, adjust each headlight by turning the headlight adjuster located on the headlight housing. Turn clockwise to raise

headlight and counterclockwise to lower headlight. Adjust both headlights evenly.

NOTE: Do not exceed a torque of 0.8 Nm.

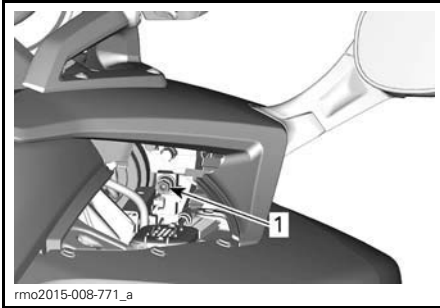

TYPICAL - RH SIDE SHOWN
1. Headlight adjuster

European, Australian and Japanese Models

High Beam

1. Using a 10mm wrench, adjust each headlight by turning the headlight adjuster located on the headlight housing. Turn clockwise to raise headlight and counterclockwise to lower headlight. Adjust both headlights evenly.

NOTE: Do not exceed a torque of 0.8 Nm.

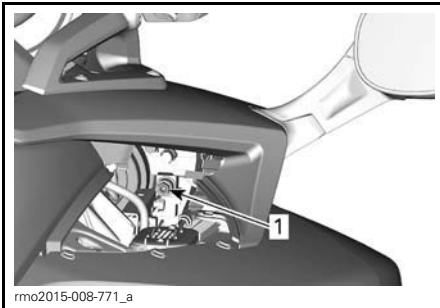

TYPICAL - RH SIDE SHOWN
1. Headlight adjuster

Low Beam

1. Refer to *BODY PANELS* section and remove the following.

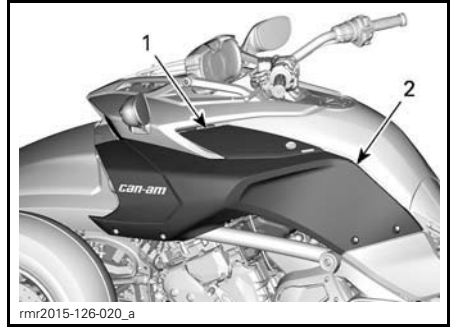

1. Lateral service cover
2. Side panel.

2. Turn adjustment screw to adjust beam height. Adjust both headlights evenly.

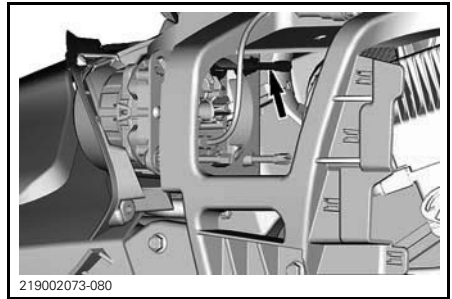

219002073-080

VEHICLE CARE

Cleaning the Vehicle

Do not use high-pressure washers (like the ones found in car washes) as they may damage certain parts of the vehicle.

NOTICE PVD chrome wheel should be washed with water and a mild soap. Do not polish, use acid based or abrasive on the PVD chrome wheel.

NOTICE Do not clean the windshield with alkaline or acid cleaner, gasoline or solvent to avoid windshield damage.

NOTICE For matte finishes, do not use wax, detail spray, or other products used on regular paint. Do not wash with abrasive materials. Do not use mechanical cleaners or polishers, and do not rub the surfaces vigorously.

To clean the vehicle:

1. Rinse the vehicle thoroughly with water to remove loose dirt.
2. Using a soft, clean cloth, wash the vehicle with water mixed with a mild detergent, such as soap specially formulated for motorcycles or automobiles.

NOTE: Using warm water works well to remove bugs in the windshield and front panels.

3. While washing the vehicle, check for grease or oil. You can use service product or a mild automotive degreaser. Thoroughly follow the manufacturer's instructions.

SERVICE PRODUCT
XPS Roadster wash

4. Dry the vehicle with a chamois or a soft towel.

Vehicles with Matte Finishes

NOTICE Do not use wax, detail spray, or other products used on regular paint. Do not wash with abrasive materials. Do not use mechanical cleaners or polishers, and do not rub the surfaces vigorously.

Hand-wash with a soft wash mitt and a mild cleaning product safe for matte paint. To remove foreign substances such as insects, use a soft applicator and a mild solvent. Saturate and soak area before cleaning. Rub lightly.

This paint finish may require more frequent cleaning.

Vehicle Protection

Apply non-abrasive wax to plastic parts.

NOTICE Do not wax or polish matte surfaces (including matte paint finishes).

SURFACE	RECOMMENDATION
Glossy paint finishes	Apply only non-abrasive wax, safe for clear coat paints
Matte finishes	Do not apply wax

NOTICE Do not polish windshield with any plastic cleaner/polisher.

⚠ WARNING

Do not apply a vinyl or plastic protector on the seats as the surface will become slippery and the operator or the passenger may slip off the vehicle.

STORAGE AND PRESEASON PREPARATION

Storage

If the vehicle will not be ridden for at least four months, such as during the winter, proper storage is necessary to keep the vehicle in good condition.

BRP recommends you have your authorized Can-Am On-Road dealer, repair shop, or person of your own choosing fully prepare your vehicle for storage. Or, at your convenience, you can follow the basic procedures below.

To Prepare the Vehicle for Storage

1. Inspect vehicle and have your authorized Can-Am On-Road dealer, repair shop, or person of your own choosing for maintenance, repair, or replacement if necessary.

NOTE: For US and Canadian citizens, please refer to the US EPA EMISSION PERFORMANCE WARRANTY contained in the *WARRANTY* section for information about warranty claims.

2. Change the engine oil and filter. Seek service from an authorized Can-Am On-Road dealer, repair shop, or person of your own choosing for maintenance, repair, or replacement.
3. Check engine coolant, brake fluid and clutch fluid levels.
4. Fill the fuel tank, add fuel stabilizer and run the engine to prevent the tank from rusting and the fuel from deteriorating. Strictly follow instructions on fuel stabilizer container.
5. Inflate all tires to their recommended pressure.
6. Clean the vehicle.
7. Lubricate all control cables, latches, key barrels, and pivoting points of all levers.
8. Close and latch all storage compartments.
9. Cover the vehicle with a permeable materials (e.g., tarpaulin). Avoid using plastic or similar non-breath-

ing, coated materials that restrict air flow and allow heat and moisture to accumulate.

10. Store the vehicle in a dry area, away from sunlight, with a small amount of daily temperature variation.
11. Slow charge the battery once a month at the recommended charging rate of 2 A. It is not necessary to remove the battery.

Preseason Preparation

After a storage period, the vehicle must be prepared and inspected before riding. Perform the following:

1. Uncover and clean the vehicle.
2. Charge the battery if needed.
3. Perform a pre-ride inspection, then test-ride the vehicle at low speed.

ROAD SIDE REPAIRS

DIAGNOSTIC GUIDELINES

NOTICE If the vehicle must be transported, do not have it towed — towing can seriously damage the vehicle. Refer to *TRANSPORTING THE VEHICLE* in this section for detailed instructions.

Will not Shift into Neutral

If the gearbox cannot shift into neutral when vehicle is not moving:

1. The engine speed will be automatically increased to approximately 1300 RPM then it will be brought back to idle speed.
2. If it does not work, retry pressing downshift button.

Will not Shift

Have your vehicle transported to the nearest Can-Am On-Road dealer.

Engine will not Start

ENGINE DOES NOT TURN OVER

1. Scrolling safety message on the multifunction gauge cluster not acknowledged.
 - Press the *MODE (M)* to acknowledge the safety message.
2. Engine stop switch in the OFF position.
 - Make sure that the engine stop switch is in the *ON* position.
3. Ignition switch in the OFF position.
 - Turn the ignition to the *ON* position.
4. Battery dead or poor battery connections.
 - Check the battery charge. Recharge if necessary (see *MAINTENANCE PROCEDURES*).
 - Check the battery connections in the front storage compartment (see *MAINTENANCE PROCEDURES*).

ENGINE DOES NOT TURN OVER (cont'd)

5. Blown fuse.
 - Check fuse condition (see *HOW TO REPLACE FUSES AND LIGHTS* in this section).
6. Transmission is in gear.
 - Depress brake pedal if transmission is in gear.
7. The key is not read.

If the immobilizer system cannot read the key, the engine will not start. The following conditions can lead to the immobilizer system failing to read the key:

 - Damaged computer chip
 - Large metallic object near the key
 - Electronic device near the key
 - Second electronic coded key near the main key
 - Other strong electromagnetic field in the key area
 - If the engine does not start and a key error message is displayed in the cluster, make sure that none of the above conditions are present. If the problem is still present without these conditions, see an authorized Can-Am On-Road dealer.

ENGINE TURNS OVER, BUT DOES NOT START

1. Low fuel.
 - Fill the fuel tank (see *BASIC PROCEDURES*).
2. Weak battery.
 - Check battery charge. Recharge if necessary (see *MAINTENANCE PROCEDURES*).
 - Check the battery connections in the front storage compartment.

ENGINE TURNS OVER, BUT DOES NOT START (cont'd)







3. Engine management problem.





- *Check to see whether the engine indicator lamp is ON while starting. Seek service from an authorized Can-Am On-Road dealer, repair shop, or person of your own choosing for maintenance, repair, or replacement. Please refer to the US EPA EMISSIONS PERFORMANCE WARRANTY contained herein for information about warranty claims.*

MESSAGES IN MULTIFUNCTION GAUGE

Important information about vehicle condition is displayed on the multifunction gauge. When starting the engine, always look at the gauge for any indicator lamps or special messages.







STD and S Models



INDICATOR LAMP(S)	DIGITAL WARNING	CAUSE	WHAT TO DO
 FLASHING	None	Gearbox position sensor malfunction	<ul style="list-style-type: none"> – Stop vehicle and allow to reach neutral. – Have the vehicle transported to the nearest authorized Can-Am On-Road dealer.
None	BAD KEY	Wrong or defective key	Use the right key for the vehicle or contact an authorized Can-Am On-Road dealer.
 ON	HIGH ENGINE TEMPERATURE	Engine is overheating	<ul style="list-style-type: none"> – Stop and wait for engine to cool off. – Check for leaks. – Check coolant level and adjust (see <i>MAINTENANCE PROCEDURES</i>).
 ON	LO BATT VOLT or HI BATT VOLT	Low or high battery voltage	<ul style="list-style-type: none"> – Recharge battery (see <i>MAINTENANCE PROCEDURES</i>). – Check battery connections. – Have the vehicle transported to the nearest authorized Can-Am On-Road dealer.
 ON	ABS FAULT	ABS malfunction. No ABS operation	Have the vehicle transported to the nearest authorized Can-Am On-Road dealer.
 ON	NONE	VSS malfunction	* Have the vehicle transported to the nearest authorized Can-Am On-Road dealer.
NONE		Air controlled suspension malfunction	<ul style="list-style-type: none"> – Check pressure in the air spring – Check rear suspension position sensor – Have the vehicle transported to the nearest authorized Can-Am On-Road Dealer to verify the Air Controlled Suspension Min/Max values calibration.

INDICATOR LAMP(S)	DIGITAL WARNING	CAUSE	WHAT TO DO
 ON	EBD FAULT	EBD malfunction	Have the vehicle transported to the nearest authorized Can-Am On-Road dealer.
	BRAKE FAILURE	Low brake fluid level or faulty sensor	<ul style="list-style-type: none"> - Check for brake fluid leaks. - Check brake fluid level and adjust (see <i>MAINTENANCE PROCEDURES</i>).
 ON+BEEPING AT KEY OFF	NONE	Faulty parking brake or component Parking brake not activated at key off	<ul style="list-style-type: none"> - Make sure battery voltage is at least at 11 V. - Check fuse no. 1 on the right fuse box (see <i>MAINTENANCE PROCEDURES</i>). Have the vehicle transported to the nearest authorized Can-Am On-Road dealer.
 ON	CHECK ENGINE	Engine management component malfunction	Remove key, wait 20 seconds, and reinsert key.
	CHECK DPS	Dynamic power steering component malfunction	Have the vehicle repaired by an authorized Can-Am On-Road dealer.
	CHECK TRANSMISSION	Transmission Control Module component malfunction	<ul style="list-style-type: none"> - Remove key, wait 20 seconds, and reinsert key. - Have the vehicle repaired by an authorized Can-Am On-Road dealer.
 FLASHING	LIMP HOME MODE	Important engine management component or VSS malfunction	* Have the vehicle transported to the nearest authorized Can-Am On-Road dealer.
 ON	NONE	Low oil pressure	<ul style="list-style-type: none"> - Check for oil leaks. - Check oil level and adjust (see <i>MAINTENANCE PROCEDURES</i>).

* BRP recommends having the vehicle transported when in LIMP HOME. If you operate the vehicle in LIMP HOME, avoid abrupt maneuvers and immediately go to the nearest authorized Can-Am On-Road dealer to have your vehicle serviced before riding again. In LIMP HOME, the engine RPM is limited and therefore the vehicle speed.

T and Limited Models

INDICATOR	MESSAGE/ WARNING	CAUSE	WHAT TO DO
	BAD KEY	Defective key	Contact an authorized Can-Am On-Road dealer.
	WRONG KEY	Wrong key	Use the right key for the vehicle or contact an authorized Can-Am On-Road dealer.
	CHECK KEY	Defective key	Contact an authorized Can-Am On-Road dealer.
	HIGH ENGINE TEMPERATURE	Engine is overheating	<ul style="list-style-type: none"> - Stop and wait for engine to cool off. - Check for leaks. - Check coolant level and adjust (see <i>MAINTENANCE PROCEDURES</i>).
	SUSPENSION FAULT	Air controlled suspension malfunction	<ul style="list-style-type: none"> - Check pressure in the air spring - Check rear suspension position sensor - Have the vehicle transported to the nearest authorized Can-Am On-Road Dealer to verify the Air Controlled Suspension Min/Max values calibration.
	BRAKE FAILURE	EBD malfunction	Have the vehicle transported to the nearest authorized Can-Am On-Road dealer.
	TRANSMISSION SIGNAL FAULT	Transmission Control Module component	<ul style="list-style-type: none"> - Remove key, wait 20 seconds, and reinsert key. - Have the vehicle repaired by an authorized Can-Am On-Road dealer.
	BRAKE FAILURE - LOW BRAKE FLUID	Low brake fluid level or faulty sensor	<ul style="list-style-type: none"> - Check for brake fluid leaks. - Check brake fluid level and adjust (see <i>MAINTENANCE PROCEDURES</i>).

INDICATOR	MESSAGE/ WARNING	CAUSE	WHAT TO DO
	CHECK DPS	Dynamic power steering component	Have the vehicle repaired by an authorized Can-Am On-Road dealer.
	LIMP HOME MODE	Important engine management component or VSS malfunction	* Have the vehicle transported to the nearest authorized Can-Am On-Road dealer.
	LOW OIL - STOP ENGINE	Low oil pressure	<ul style="list-style-type: none"> - Check for oil leaks. - Check oil level and adjust (see <i>MAINTENANCE PROCEDURES</i>).

* BRP recommends having the vehicle transported when in LIMP HOME. If you operate the vehicle in LIMP HOME, avoid abrupt maneuvers and immediately go to the nearest authorized Can-Am On-Road dealer to have your vehicle serviced before riding again. In LIMP HOME, the engine RPM is limited and therefore the vehicle speed.

Important information messages can also be displayed temporarily to assist indicator lamps.



TYPICAL

When a digital warning appears, it will show the warning for 6 seconds and then the warning will disappear for 60 seconds. During the 60 seconds, the small digital indicator will flash. This sequence will be repeated three times and then will stop for 15 minutes. During the 15 minutes only the indicator lamps will be activated.

WHAT TO DO IN THE FOLLOWING CIRCUMSTANCES

Lost Keys

Use your spare key to have another one made by an authorized Can-Am On-Road dealer as soon as possible. **If both keys are lost**, the ignition switch and the fuel cap will need to be replaced at the expense of the vehicle owner.

Flat Tire

If a tire has a **major** puncture or cut in the tread and is completely deflated, have the vehicle transported to the nearest Can-Am On-Road dealer. Refer to *TRANSPORTING THE VEHICLE* in this section for transporting instructions.

If a tire has a **minor** nail or stone puncture and is not completely deflated, the tire can be temporarily repaired. To temporarily repair a tire, a self-inflating tire sealer or tire plug repair kit can be used. Follow the manufacturer's instructions that come with the tire sealer or repair kit and have the tire repaired or replaced by an authorized Can-Am On-Road dealer **as soon as possible**.

When a tire is temporarily repaired, ride slowly and carefully, and frequently check tire pressure until it is replaced or permanently repaired.

Dead Battery

If the battery is dead or too low to crank the engine, it can be jump started.

⚠ WARNING

Connect the jumper cables as specified in the jump start procedure.

Batteries can emit explosive gas that can ignite if jumper cables are not properly connected.

To jump start the battery, proceed as follows:

1. If using another vehicle to jump start the battery, move the other vehicle as close as possible and preferably to the front of the vehicle. Make sure the vehicles are not touching.
2. Shift the vehicle into NEUTRAL (N) and engage the parking brake.

NOTE: If battery voltage is below 11 V, parking brake cannot be activated.

3. Turn off the engine of the other vehicle and all electrical accessories.
4. Open the hood of the other vehicle.
5. Open the front storage compartment of the your vehicle.
6. Make sure the ignition switch is set to OFF.
7. Remove basket. Refer to *BODY PANELS*.
8. Connect one end of the RED (+) jumper cable to the POSITIVE (+) terminal of the dead battery.
9. Connect the other end of the RED (+) jumper cable to the POSITIVE (+) terminal of the booster battery.
10. Connect one end of the BLACK (-) jumper cable to the NEGATIVE (-) terminal of the booster battery.
11. Connect the other end of the BLACK (-) jumper cable to the NEGATIVE (-) terminal of the vehicle.

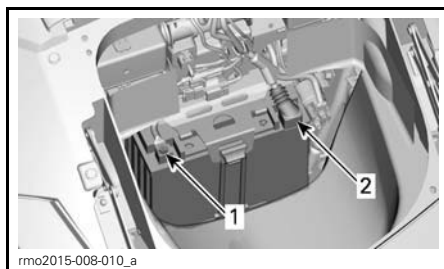

1. BLACK (-) terminal
2. RED (+) terminal

12. Start the vehicle with the booster battery and run the engine at idle for a couple of minutes.
13. Stand on the right side of the vehicle, apply brakes and start the engine. If it does not crank or it cranks slowly, wiggle the jumper cables to make sure they are making good contact and try again. If it still does not start, there might be a problem with the starting system. Have the vehicle transported (see *TRANSPORTING THE VEHICLE* in this section) and repaired by the nearest authorized Can-Am On-Road dealer.
14. As soon the engine starts, disconnect both jumper cables in the reverse connection order, starting with the BLACK (-) cable connected to your vehicle.
15. Have the battery fully recharged with a battery charger (see *MAINTENANCE PROCEDURES*) or by a qualified service station as soon as possible.

If the engine dies shortly after it has been jump started or when the jumper cables are disconnected, there might be a problem with the charging system. Have the vehicle transported (see *TRANSPORTING THE VEHICLE*) and repaired by the nearest authorized Can-Am On-Road dealer.

After recharging the battery, have the vehicle inspected by an authorized Can-Am On-Road dealer.

HOW CHANGING A BULB

Lights

If any light stops working on the vehicle, replace bulb of defective light.

If the light failure still occurs, have the vehicle serviced by an authorized Can-Am On-Road dealer.

CAUTION Always turn the ignition switch to the OFF position before replacing a bulb to avoid electric shock.

Always check light operation after replacement.

Australian Models

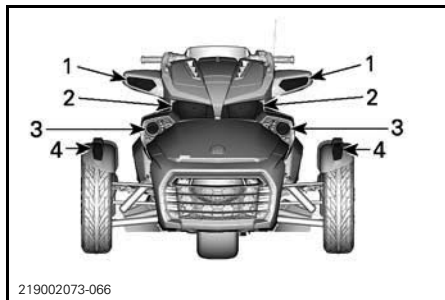

LIMITED MODELS - FRONT

1. Turn signal light
2. Headlight - High beam
3. Headlight - Low beam
4. Position light

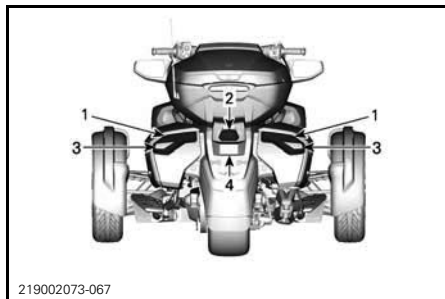

LIMITED MODELS - REAR

1. Taillight/Brake light
2. Backup light
3. Turn signal light
4. License plate light

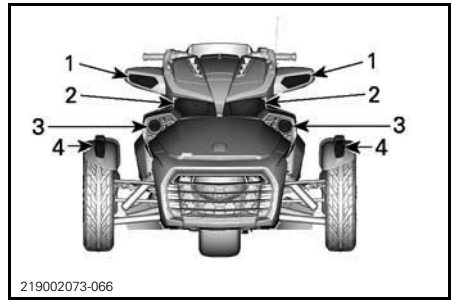

T MODELS - FRONT

1. Turn signal light
2. Headlight - High beam
3. Headlight - Low beam
4. Position light

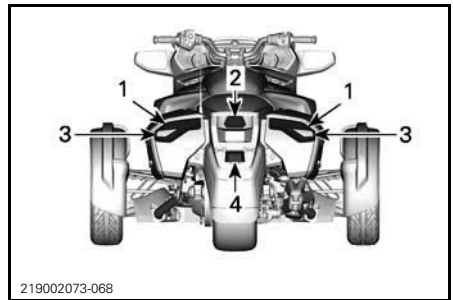

T MODELS - REAR

1. Taillight/Brake light
2. Backup light
3. Turn signal light
4. License plate light

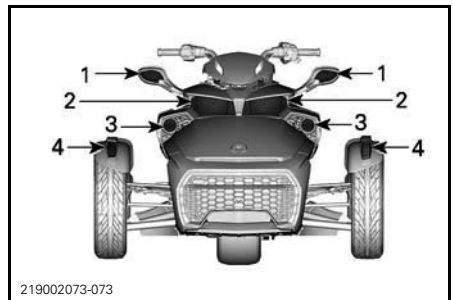

S MODELS - FRONT

1. Turn signal light
2. Headlight - High beam
3. Headlight - Low beam
4. Position light

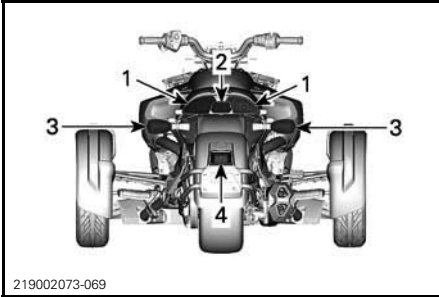

219002073-069

S MODELS - REAR

1. Taillight/Brake light
2. Backup light
3. Turn signal light
4. License plate light

Chinese Models

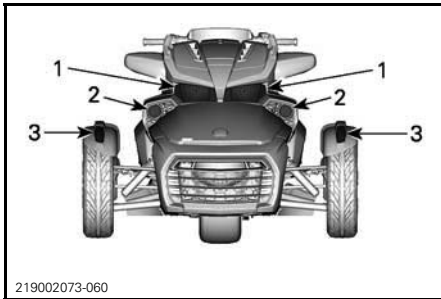

219002073-060

LIMITED MODELS - FRONT

1. Headlight - High beam
2. Headlight - Low beam
3. Turn signal light/Position light

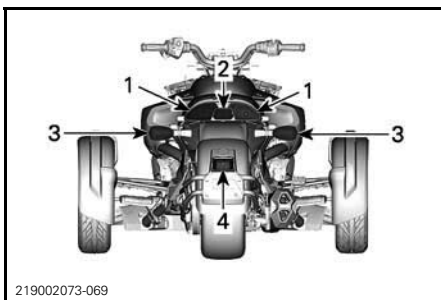

219002073-069

LIMITED MODELS - REAR

1. Taillight/Brake light
2. Backup light
3. Turn signal light
4. License plate light
5. Rear fog light

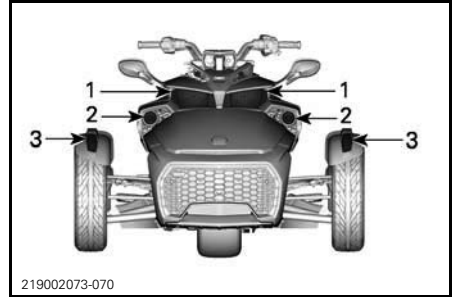

219002073-070

S MODELS - FRONT

1. Headlight - High beam
2. Headlight - Low beam
3. Turn signal light/Position light

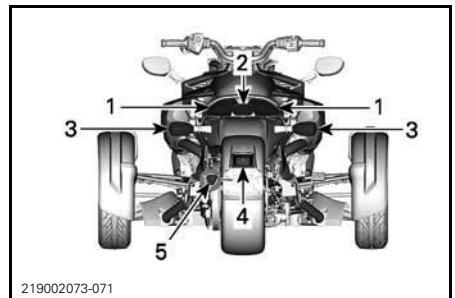

219002073-071

S MODELS - REAR

1. Taillight/Brake light
2. Backup light
3. Turn signal light
4. License plate light
5. Rear fog light

European Models

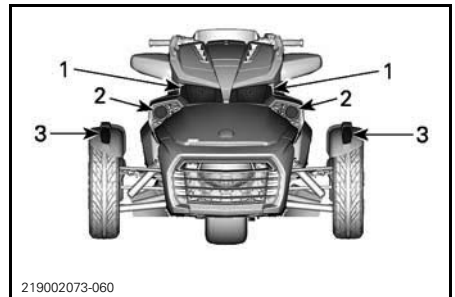

219002073-060

LIMITED MODELS - FRONT

1. Headlight - High beam
2. Headlight - Low beam
3. Turn signal light/Position light

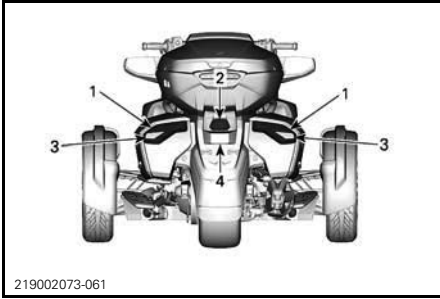

LIMITED MODELS - REAR

1. Taillight/Brake light
2. Backup light
3. Turn signal light
4. License plate light

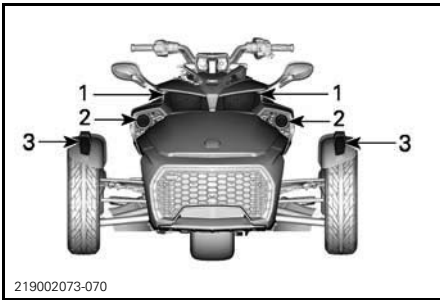

STD AND S MODELS - FRONT

1. Headlight - High beam
2. Headlight - Low beam
3. Turn signal light/Position light

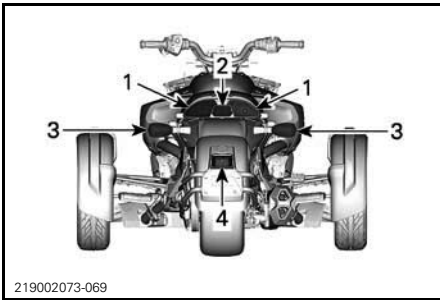

STD AND S MODELS - REAR

1. Taillight/Brake light
2. Backup light
3. Turn signal light
4. License plate light

Japanese Models

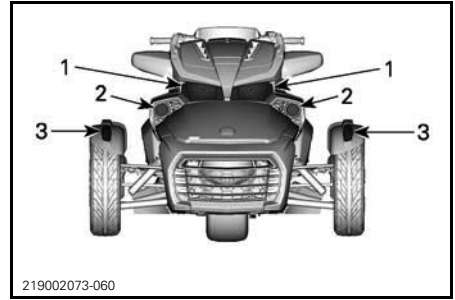

LIMITED MODELS - FRONT

1. Headlight - High beam
2. Headlight - Low beam
3. Turn signal light/Position light

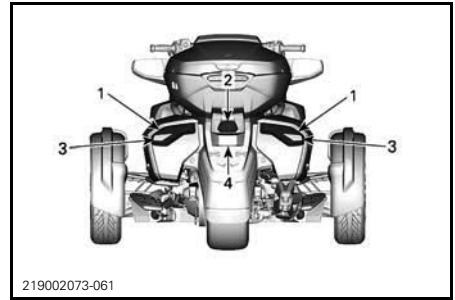

LIMITED MODELS - REAR

1. Taillight/Brake light
2. Backup light
3. Turn signal light
4. License plate light

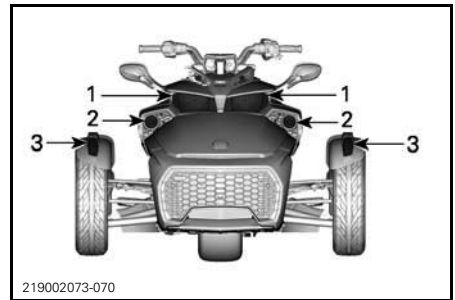

S MODELS - FRONT

1. Headlight - High beam
2. Headlight - Low beam
3. Turn signal light/Position light

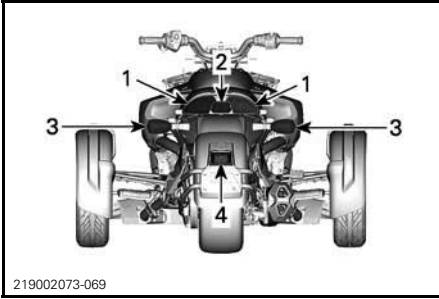

S MODELS - REAR

1. Taillight/Brake light
2. Backup light
3. Turn signal light
4. License plate light

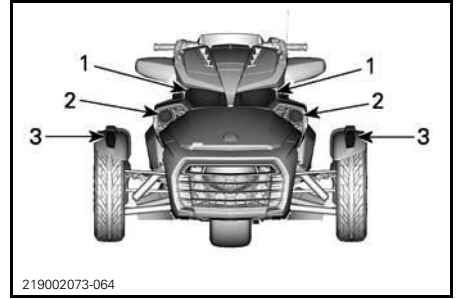

T MODELS - FRONT

1. Headlight
2. Fog light - Optional
3. Turn signal light/Position light

North American Models

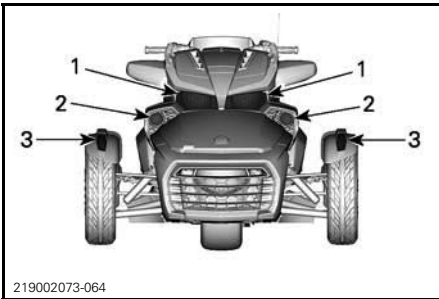

LIMITED MODELS - FRONT

1. Headlight
2. Fog light - Optional
3. Turn signal light/Position light

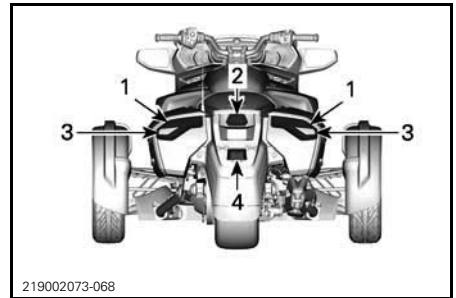

T MODELS - REAR

1. Taillight/Brake light
2. Backup light
3. Turn signal light
4. License plate light

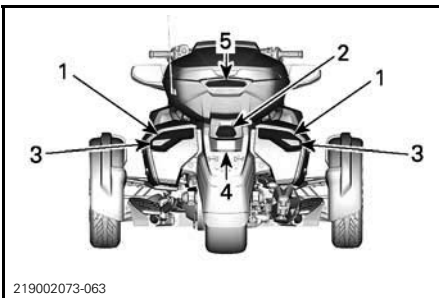

LIMITED MODELS - REAR

1. Taillight/Brake light
2. Backup light
3. Turn signal light
4. License plate light
5. Signature light



STD AND S MODELS - FRONT

1. Headlight
2. Turn signal light/Position light

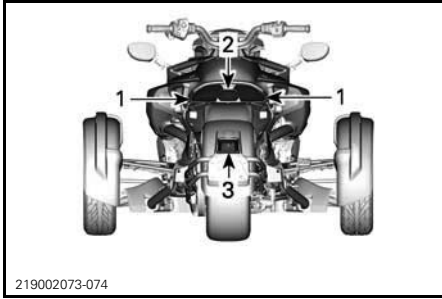

T MODELS - REAR

1. Taillight/Brake light/Turn signal light
2. Backup light
3. License plate light

Headlight — Low Beam

Models Outside North America

The low beam headlight are built with LEDs (light emitting diode) and this technology proved to be reliable. In the unlikely event they do not work, have them checked by an authorized Can-Am On-Road dealer.

Headlight — High Beam

STD Models

1. Remove retaining screws securing top rails cover to top rails.

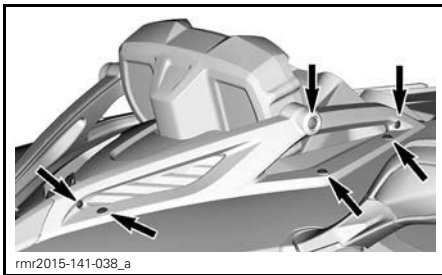

2. Remove retaining screws securing top rails to vehicle.

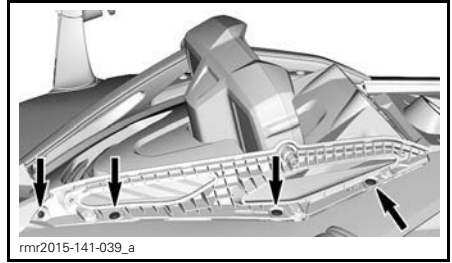

S Models

1. Remove retaining screws securing the gauge spoiler to vehicle.

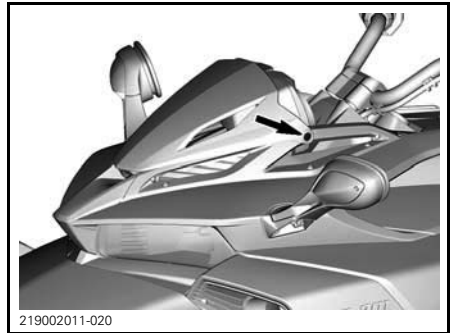

TYPICAL

2. Slide the gauge spoiler toward the front to remove.

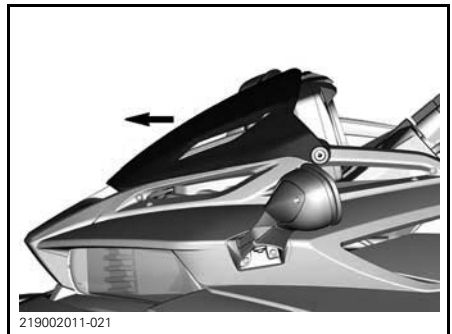

All STD and S Models

1. Loosen console nose lower retaining screw.
2. Unclip upper portion of nose, then pivot forward.

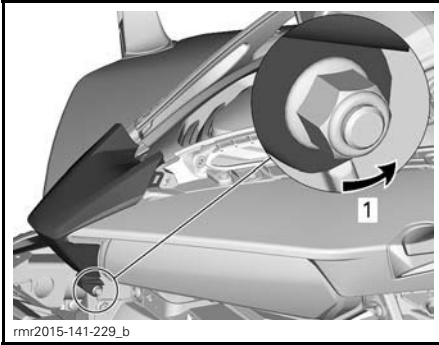

TYPICAL

1. Loosen retaining screw

3. Remove retaining screws and remove gauge trim.

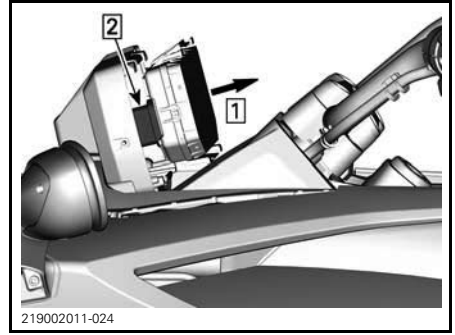

Step 1: Remove gauge

Step 2: Disconnect

5. Remove retaining screws inside gauge support on both sides.

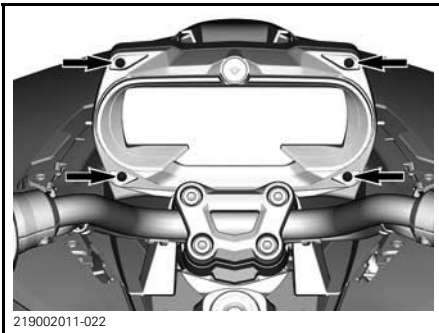

4. Remove gauge by pinching the retaining tabs and disconnect connector.

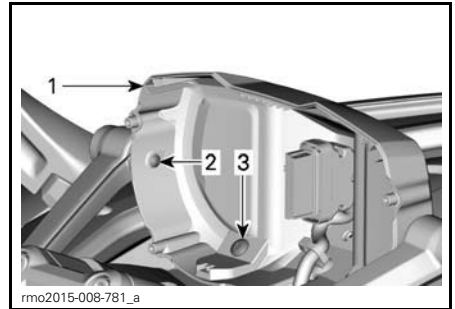

TYPICAL

1. Gauge support

2. Retaining screw attached to top rail

3. Retaining screw attached to console panel

6. Remove key switch cover.

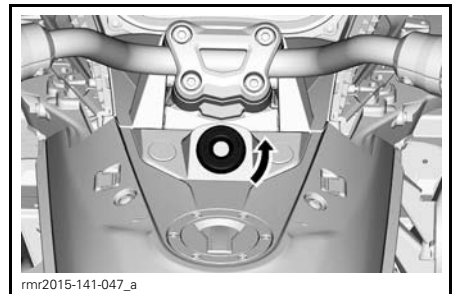
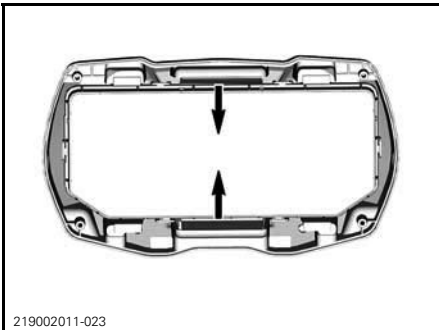

7. Remove switch bezel.

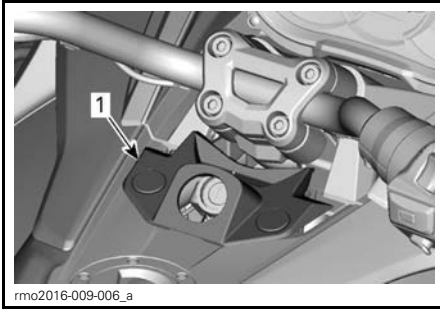

1. Switch bezel

8. Remove console panel.

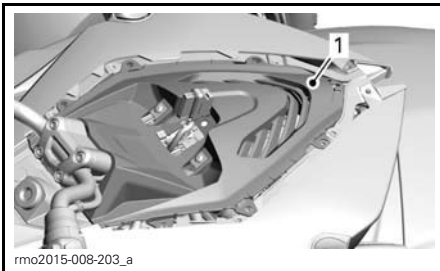

1. Console panel

9. Disconnect headlamp connector.

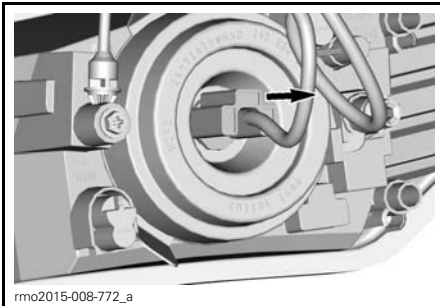

10. Pull out the housing cap.

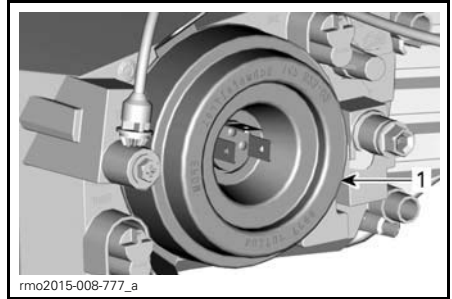

1. Housing cap

11. Unclip light bulb retaining spring.

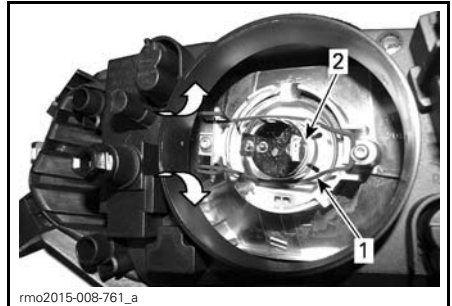

1. Bulb retaining spring
2. Bulb housing

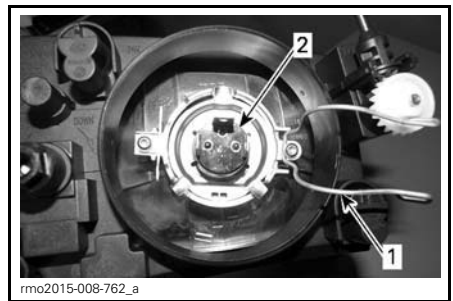

1. Bulb retaining spring
2. Bulb housing

12. Install the new bulb in place and secure with retaining spring.

NOTICE Never touch glass portion of a halogen bulb with bare fingers, it shortens its operating life. If glass is touched, clean it with isopropyl alcohol and a clean cloth.

13. Reinstall housing cap.

14. Install the connector onto light bulb.
15. Properly reinstall the parts in the reverse order of their removal.

T and Limited Models

1. Remove front service cover.

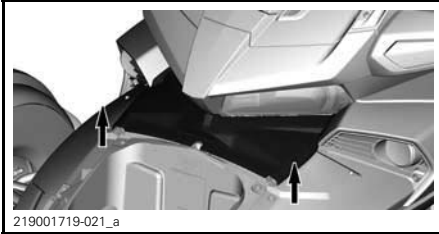

2. Remove lateral service covers.

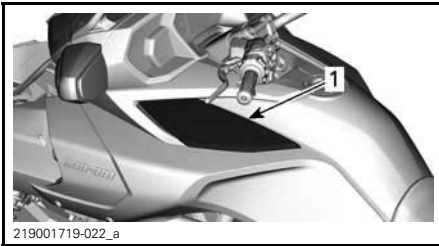

1. *Lateral service cover*

3. Remove lateral side panels.



4. Remove mirror trims.

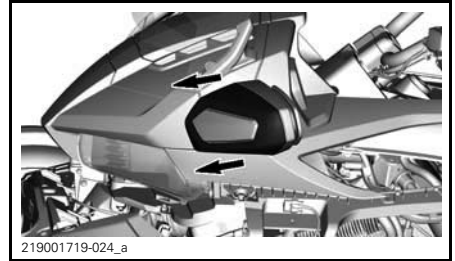

5. Remove console nose.

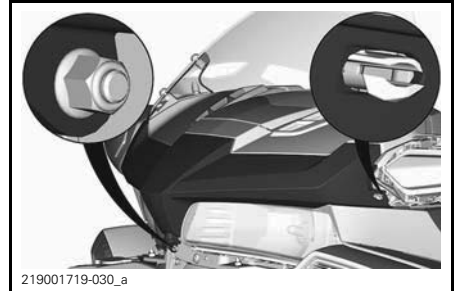

6. Remove speaker trim.

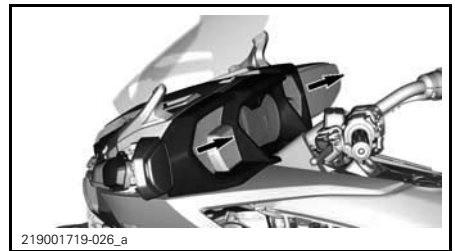

7. Remove lateral console panel.

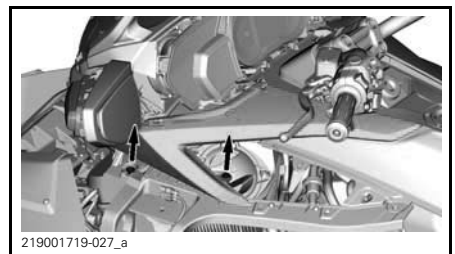

8. Remove headlight.

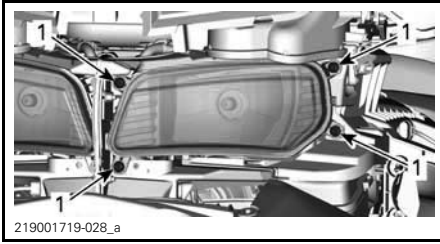

1. Headlight retaining screw

9. Disconnect headlamp connector.

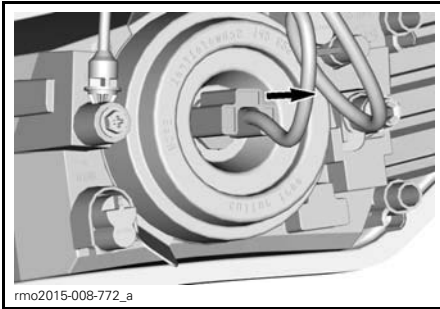

10. Pull out rubber housing cap.

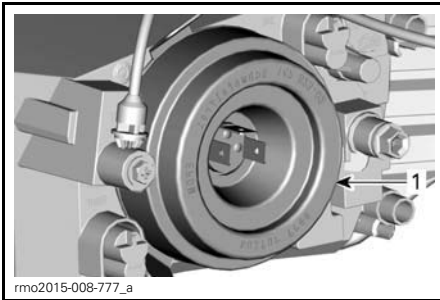

1. Housing cap

11. Unclip light bulb retaining spring.

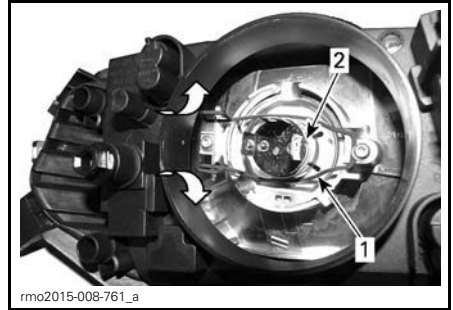

1. Bulb retaining spring
2. Bulb housing

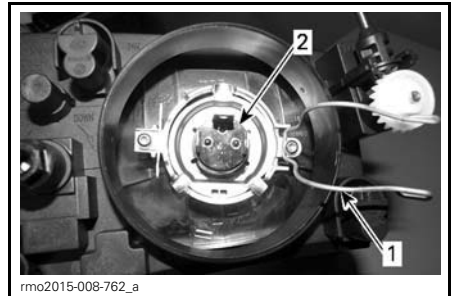

1. Bulb retaining spring
2. Bulb housing

12. Install the new bulb in place and secure with retaining spring.

NOTICE Never touch glass portion of a halogen bulb with bare fingers, it shortens its operating life. If glass is touched, clean it with isopropyl alcohol and a clean cloth.

13. Reinstall housing cap.

14. Install the connector onto light bulb.

15. Properly reinstall the parts in the reverse order of their removal.

Front Turn Signal Light (Australian Models)

S Models

1. Remove the lens.



rmo2008-001-103_a

TYPICAL

1. Front turn signal lens screw

2. Turn the connector counterclockwise as indicated below and remove lens.

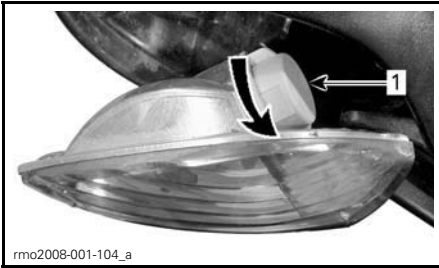

rmo2008-001-104_a

TYPICAL

1. Front turn signal light connector

3. Remove the bulb by pushing it in and turning counterclockwise.
4. Install the new bulb by pushing it in and turning clockwise.
5. Properly reinstall the parts in the reverse order of their removal.

T and Limited Models

The turn signal lights are built with LEDs (light emitting diode) and this technology proved to be reliable. In the unlikely event they do not work, have them checked by an authorized Can-Am On-Road dealer.

Front Turn Signal Light (All Models Outside Australia)

The turn signal lights are built with LEDs (light emitting diode) and this technology proved to be reliable. In

the unlikely event they do not work, have them checked by an authorized Can-Am On-Road dealer.

Rear Turn Signal Light (Models Outside North America)**STD and S Models**

1. Remove the lens

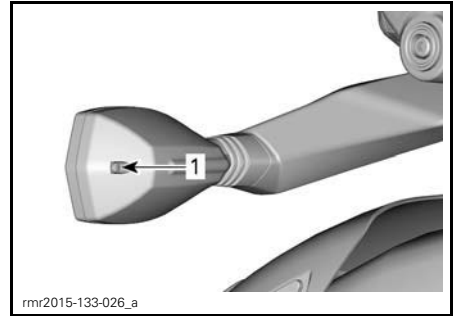

rm2015-133-026_a

1. Rear turn signal lens screw

2. Remove the bulb by pushing in and turning counterclockwise.
3. Install the new bulb by pushing and turning it clockwise.
4. Reinstall the lens.

NOTICE At installation, tighten screws finger tight.

T and Limited Models

1. Remove saddlebag from vehicle. Refer to *SADDLEBAGS (T AND LIMITED MODELS)*.
2. Remove upper retaining screw securing taillight support to saddlebag.

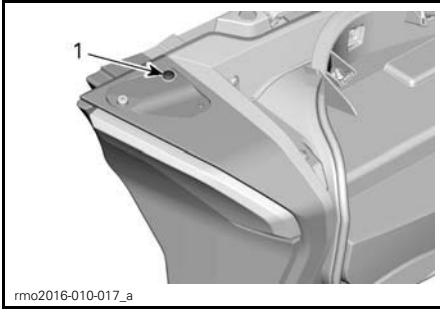

1. Upper retaining screw

3. Remove lower retaining screws securing taillight support to saddlebag and remove taillight support from saddlebag.

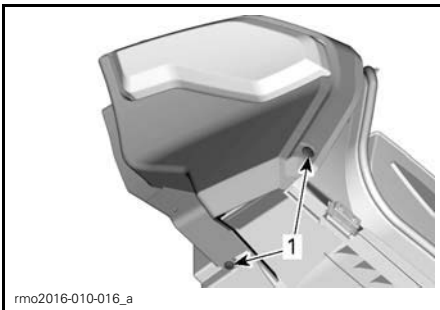

1. Lower retaining screws

4. Remove bulb holder from taillight support.

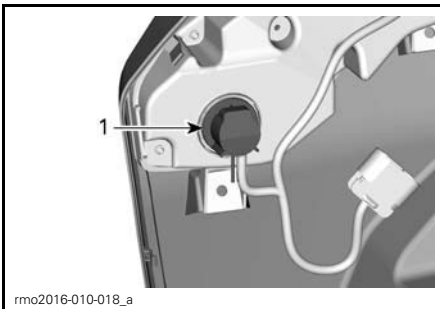

1. Turn bulb holder clockwise to release it

5. Remove the bulb by pushing it in and turning counterclockwise.
6. The installation is the reverse of the removal procedures.

Taillight/Brake Light

STD and S Models

1. Remove passenger seat. Refer to *OPENING SEAT* in *EQUIPMENT*
2. Rotate the bulb socket to remove it from the vehicle.

NOTE: Rotate the center and left bulb sockets counterclockwise. Rotate the right bulb socket clockwise.

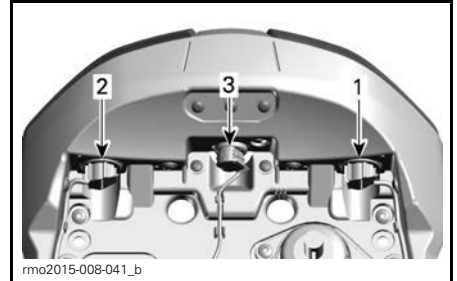

1. LH taillight/brake light
2. RH taillight/brake light
3. Back-up light

3. Remove the bulb by pushing it in and turning counterclockwise.
4. Install the new bulb by pushing it in and turning clockwise.
5. Install seat

T and Limited Models

The position lights are built with LEDs (light emitting diode) and this technology proved to be reliable. In the unlikely event they do not work, have them checked by an authorized Can-Am On-Road dealer.

Position Light

The position lights are built with LEDs (light emitting diode) and this technology proved to be reliable. In the unlikely event they do not work, have them checked by an authorized Can-Am On-Road dealer.

License Plate Light

STD and S Models

1. Remove light cover.

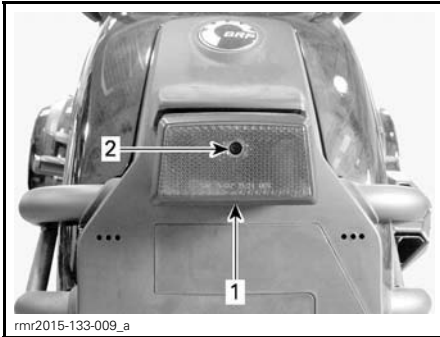

TYPICAL

1. License plate light
2. Cover screw

2. Remove the bulb by pushing it in and turning counterclockwise.

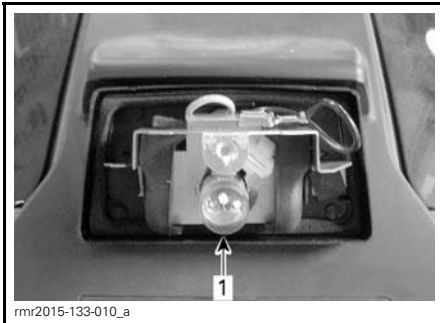

1. Light bulb

3. Install the new bulb by pushing and turning it clockwise.
4. Confirm light operation.
5. Reinstall light cover.

T and Limited Models

The position lights are built with LEDs (light emitting diode) and this technology proved to be reliable. In the unlikely event they do not work, have them checked by an authorized Can-Am On-Road dealer.

Back-up Light

STD and S Models

Refer to procedure in *TAIL-LIGHT/BRAKE LIGHT*.

T and Limited Models

The back-up light is built with LEDs (light emitting diode) and this technology proved to be reliable. In the unlikely event they do not work, have them checked by an authorized Can-Am On-Road dealer.

HOW TO REPLACING A FUSE

If any electrical accessories stop working on the vehicle, check for blown fuses and replace if necessary.

If an electrical failure still occurs, have the vehicle serviced by an authorized Can-Am On-Road dealer.

Fuse Locations

Fuses are located inside the front storage compartment.

To access the fuse boxes, open the front storage compartment.

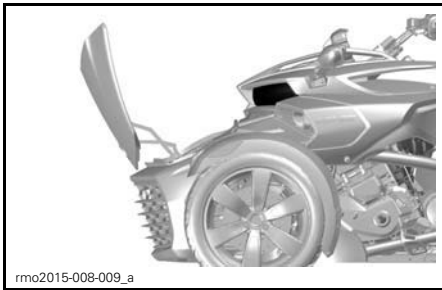

Remove basket from vehicle. Refer to *BODY PANELS*.

Push down on the tabs and carefully remove the fuse box covers.

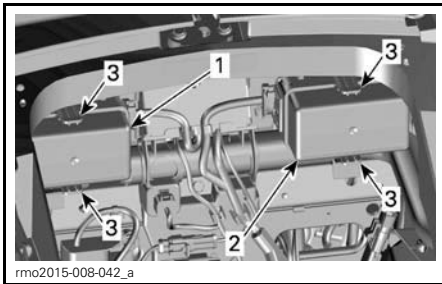

INSIDE FRONT STORAGE COMPARTMENT

1. RH fuse service cover
2. LH fuse service cover
3. Tabs

Fuse Description

Refer to decal located between both fuse boxes for correct identification.

Left Fuse Box

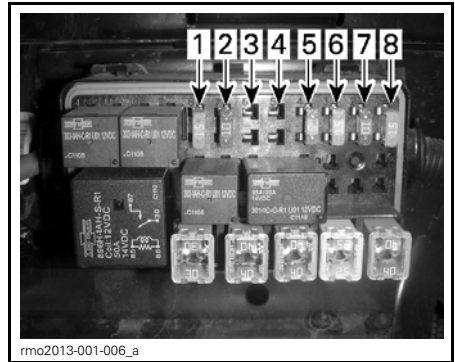

FUSES - LEFT FUSE BOX

FUSE NO.	DESCRIPTION	RATING
1	Cluster / DLC	15 A
2	Wake-up ECM / VCM / MSR and D.E.S.S. / SAS / YAS / PRS	10 A
3	Alternator	10 A
4	PBM	20 A
5	ECM	5 A
6	Injectors / Coils	15 A
7	Wake-up TCM, DPS / Cluster	10 A
8	H02S / CAPS / Fuel Pump / EVAP / CSV	15 A

Right Fuse Box

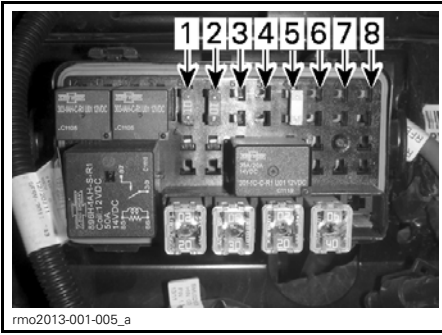

FUSES - RIGHT FUSE BOX

FUSE NO.	DESCRIPTION	RATING
1	Days lights / Parking lamps / Plate lights	15 A
2	Brake lights / Hazard	10 A
3	Amplifier (if equipped)	15 A
4	NOT USED	
5	Load shedding relay acc.	25 A
6	Customer acc. circuits	10 A
7	NOT USED	
8	NOT USED	

Left JCase Fuse Box

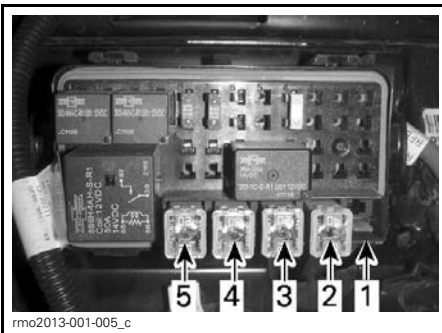

JCASE FUSES - RIGHT FUSE BOX

FUSE NO.	DESCRIPTION	RATING
1	Main control	40 A
2	DPS	25 A
3	VCM pump	40 A
4	VCM pump	40 A
5	Not used	

Right JCase Fuse Box

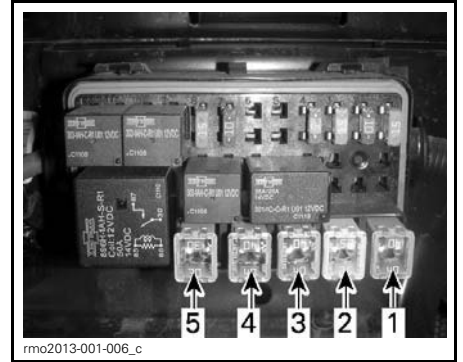

JCASE FUSES - LEFT FUSE BOX

FUSE NO.	DESCRIPTION	RATING
1	Cooling fan	30 A
2	Accessories	40 A
3	TCM solenoids	20 A
4	LO headlamps	30 A
5	HI headlamps	20 A

Replacing a Fuse

1. Set the ignition switch to OFF.
2. Pull the fuse out.
3. Check whether the filament is melted.

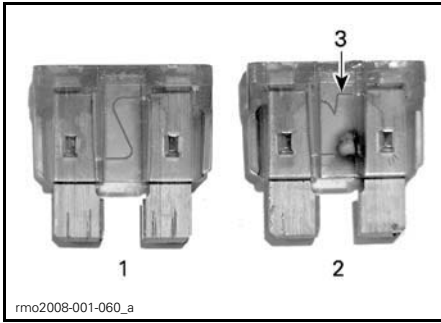

FUSE

1. *Good fuse*
2. *Blown fuse*
3. *Melted filament*

4. Replace the fuse with one with the same rating. Spare fuses are located in the fuse box cover.

NOTICE Using a higher-rated fuse can cause severe damage and may cause fires.

5. To close the fuse box covers, position covers over fuses and carefully push down until they click.
6. To close the fuse service covers, position covers over fuse boxes and push down carefully until the fuse service covers engage.
7. Install basket and close the front storage compartment.

HOW TO TRANSPORT THE VEHICLE

If your vehicle needs to be transported, it should be carried on a flatbed trailer of the proper size and capacity.

CAUTION If you need to push the vehicle, do it from the right-hand side to be able to reach the brake pedal. When pulling the vehicle backwards, be careful that the front wheel does not roll over your feet.

NOTICE Do not tow this vehicle — towing can seriously damage the vehicle drive system.

When contacting a towing or transporting service, be sure to ask if they have a flatbed trailer, loading ramp or power ramp to safely lift the vehicle and tie-down straps. Ensure the vehicle is properly transported as specified in this section.

NOTICE Avoid using chains to tie the vehicle — they may damage the surface finish or plastic components.

To load the vehicle for transport, proceed as follows:

1. Shift the vehicle into NEUTRAL (N).
2. Remove the key from the ignition switch.
3. Put a strap around the lower arm of each front suspension.

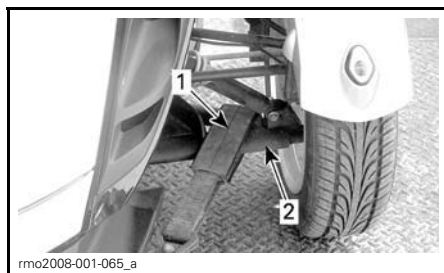

TYPICAL

1. Strap
2. Lower suspension arm

4. Attach the straps to the winch cable. If possible, use chains or additional straps to attach the straps to the winch cable as indicated below to avoid damaging the bumper cover.

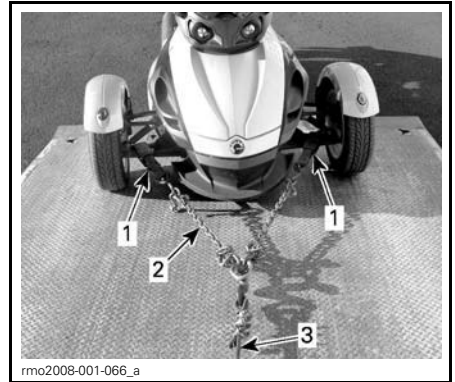

TYPICAL

1. Strap around front suspension lower arms
 2. Chains to avoid damaging the bumper cover
 3. Winch cable
5. Ensure that the parking brake is released.
 6. Pull the vehicle on the flatbed trailer with the winch.
 7. Engage the parking brake.
 8. Ensure that the vehicle is in NEUTRAL (N).
 9. Strap the front tires by using one of the following methods indicated below.

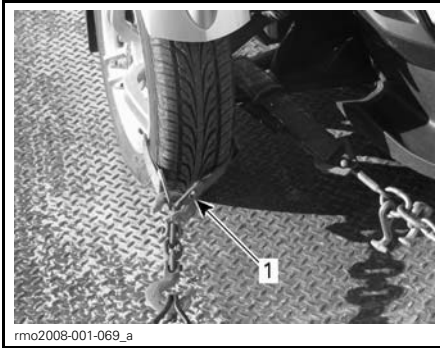

FRONT WHEELS ATTACHMENT — TYPICAL METHOD 1

1. Strap around the rim of each front wheel and attached to the front of trailer

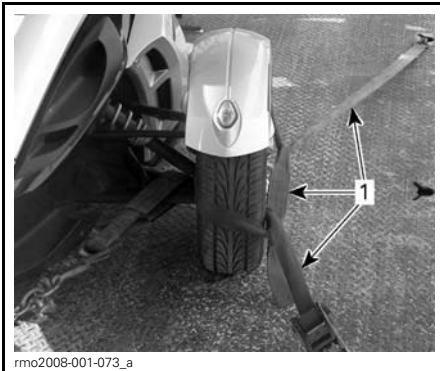

FRONT WHEELS ATTACHMENT — TYPICAL METHOD 2

1. Strap around each wheel and fixed to the front and rear of trailer

10. Pass a tie-down strap inside the rear wheel rim only. Do not pass the tie-down strap inside the rear sprocket.

NOTICE Passing the tie-down strap inside the rear sprocket may seriously damage the drive system.

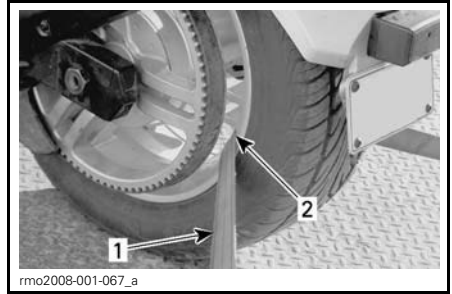

REAR WHEEL ATTACHMENT - TYPICAL

1. Tie-down strap
2. Inside rear wheel rim ONLY

11. Firmly attach the rear wheel tie-down strap to the rear of the trailer with a ratchet.
12. Ensure that both the front and rear wheels are firmly attached to the trailer.

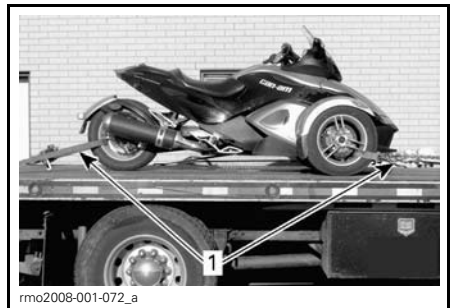

TYPICAL - VEHICLE FACING TOWARDS FRONT OF TOWING

1. Front and rear wheel firmly attached to trailer

TECHNICAL INFORMATION

VEHICLE IDENTIFICATION

The main components of your vehicle (engine and frame) are identified by different serial numbers. It may sometimes become necessary to locate these numbers for warranty purposes or to trace your vehicle in the event of loss. These numbers are required by the authorized Can-Am On-Road dealer to complete warranty claims properly. We strongly recommend that you take note of all the serial numbers on your vehicle and supply them to your insurance company.

Vehicle Identification Number



NORTH AMERICAN MODELS

1. VIN (Vehicle Identification Number)
2. Model number

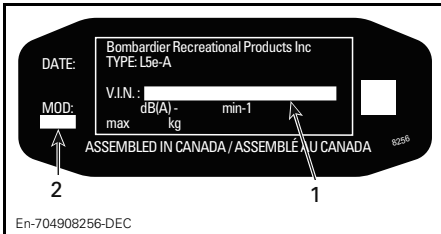

EUROPEAN MODELS

1. VIN (Vehicle Identification Number)
2. Model number

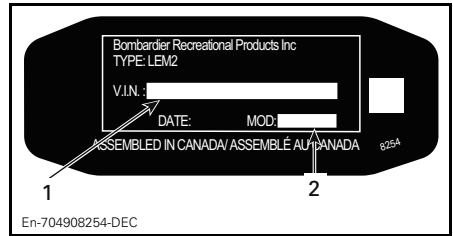

AUSTRALIAN MODELS

1. VIN (Vehicle Identification Number)
2. Model number

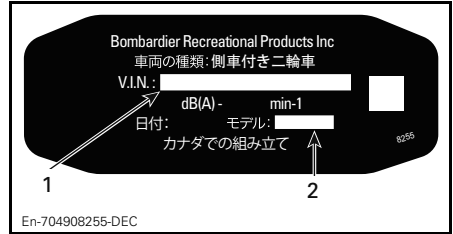

JAPANESE MODELS

1. VIN (Vehicle Identification Number)
2. Model number



CHINESE MODELS

1. VIN (Vehicle Identification Number)

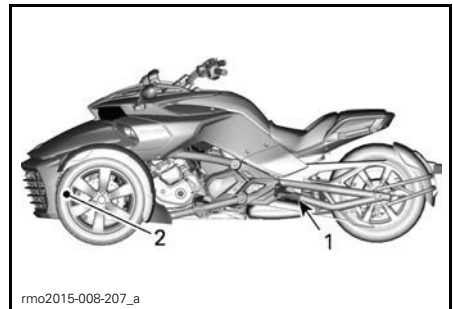

TYPICAL - LOCATION OF VIN

1. Swing arm (VIN label)
2. Lower frame (VIN stamped on the right side)

Engine Identification Number

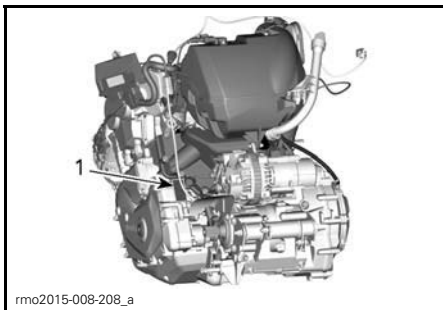

rmo2015-008-208_a

TYPICAL

1. EIN (Engine Identification Number) location

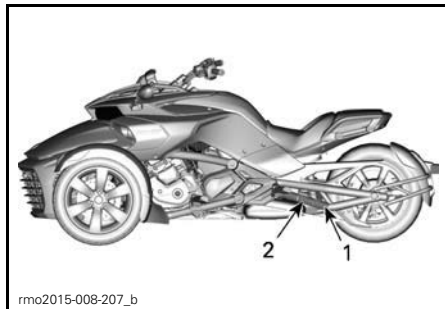

rmo2015-008-207_b

TYPICAL - LOCATION OF COMPLIANCE LABELS

1. Australia ADR Label
2. Australia Noise Label

Compliance Labels

Australian Models

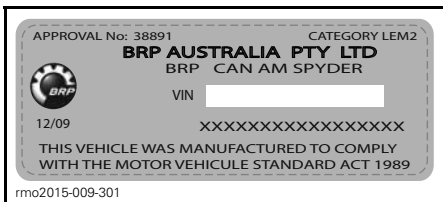

rmo2015-009-301

TYPICAL - AUSTRALIA ADR LABEL

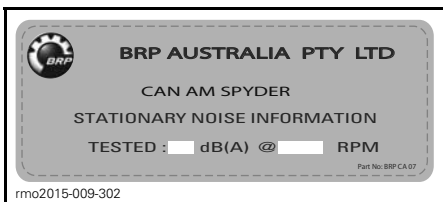

rmo2015-009-302

TYPICAL - AUSTRALIA NOISE LABEL

EPA Compliance Label

North American Models

VEHICLE EMISSION CONTROL INFORMATION

BOMBARDIER RECREATIONAL PRODUCTS INC.
 THIS VEHICLE CONFORMS TO U.S. EPA REGULATIONS APPLICABLE TO MODEL YEAR NEW MOTORCYCLES AND IS CERTIFIED TO AN HC+NOx EMISSION STANDARD OF GRAM/KILOMETER.

CERTIFIED FOR SALE IN ALL U.S. STATES EXCEPT CALIFORNIA.

See operator's guide for maintenance specifications

RENSEIGNEMENT SUR LE DISPOSITIF ANTIPOLLUTION

BOMBARDIER PRODUITS RÉCRÉATIFS INC.
 CE VÉHICULE EST CONFORME AUX RÈGLEMENTS DE L'EPA DES É.U. APPLICABLES AUX MOTOCYCLETTES NEUVES DE L'ANNÉE MODÈLE ET EST CERTIFIÉ À LA NORME D'ÉMISSIONS HC+NOx de GRAMME/KILOMÈTRE.

CERTIFIÉ POUR LA VENTE DANS TOUS LES ÉTATS DES É.U. SAUF LA CALIFORNIE.

Voir guide du conducteur pour les spécifications de maintenance

Engine Displacement		Cylindrée
Engine Family		Famille de moteur
Permeation Family		Famille de perméation
Exhaust Emission Control System		Système de contrôle des émissions
Idle Speed		Ralenti moteur
Fuel		Essence

704908757

MOTORCYCLE NOISE EMISSION CONTROL INFORMATION

THIS MOTORCYCLE, MEETS U.S. EPA NOISE EMISSION REQUIREMENTS OF dB(A) AT RPM BY THE FEDERAL TEST PROCEDURE. MODIFICATIONS WHICH CAUSE THIS MOTORCYCLE TO EXCEED FEDERAL NOISE STANDARDS ARE PROHIBITED BY FEDERAL LAW. SEE OPERATOR'S GUIDE.

EN-704908757-DEC

TYPICAL - INSIDE THE FRONT STORAGE COMPARTMENT

Deployment of Alternative Fuel Infrastructure Compliance Label

Models Outside North America



LOCATED NEAR GAS CAP

Tampering with Noise Control System Is Prohibited!

U.S. Federal law and Canadian provincial laws may prohibit the following acts or the causing there of:

1. The removal or rendering inoperative by any person other than for purposes of maintenance, repair or replacement of any device or element of design incorporated into any new vehicle for the purpose of noise control prior to its sale or delivery to the ultimate purchaser or while it is in use or
2. The use of the vehicle after such device or element of design has been removed or rendered inoperative by any person.

Among those Acts Presumed to Constitute Tampering Are the Acts Listed Below:

1. Removal or alteration or the puncturing of the muffler or any engine component which conducts removal of engine exhaust gases.
2. Removal or alteration or the puncturing of any part of the intake system.
3. Replacing any moving parts of the vehicle or parts of the exhaust or intake system, with non-compliant part.
4. Lack of proper maintenance.

RADIO FREQUENCY DIGITALLY ENCODED SECURITY SYSTEM (RF D.E.S.S. KEY)

This device complies with FCC Part 15 and Industry Canada license exempt RSS standard(s). Operation is subject to the following two conditions: (1) this device may not cause interference, and (2) this device must accept any interference, including interference that may cause undesired operation of the device.

Le présent appareil est conforme aux CNR d'Industrie Canada applicables aux appareils radio exempts de licence. L'exploitation est autorisée aux deux conditions suivantes: (1) l'appareil ne doit pas produire de brouillage, et (2) l'utilisateur de l'appareil doit accepter tout brouillage radioélectrique subi, même si le brouillage est susceptible d'en compromettre le fonctionnement.

Changes or modifications not expressly approved by the party responsible for compliance could void the user's authority to operate the equipment.

IC: 11538A-246416

FCC ID: 2ABBF-246416

MULTIFUNCTION GAUGE REGULATORY INFORMATION (LARGE PANORAMIC 7.8" WIDE LCD DISPLAY)

Technical Information

Transmitter:

- BT operating frequency range: 2402 – 2480 MHz
- BT version: 4.2 (no BTLE)
- BT output power: < 8.5 dBm

Receiver:

- FM operating range: 76 - 108 MHz

Manufacturer and Address

Manufacturer:

- Robert Bosch LLC

Address:

- 38000 Hills Tech Drive,
Farmington Hills, MI 48331,
USA

To display the regulatory information on the vehicle digital display: From the home screen, access the main menu and keep the joystick pressed down for more than 10 seconds.

USA and Canada

This device complies with FCC Part 15 and Industry Canada license exempt RSS standard(s). Operation is subject to the following two conditions:

- (1) this device may not cause interference, and
- (2) this device must accept any interference, including interference that may cause undesired operation of the device.

Le présent appareil est conforme aux CNR d'Industrie Canada applicables aux appareils radio exempts de licence. L'exploitation est autorisée aux deux conditions suivantes:

- (1) l'appareil ne doit pas produire de brouillage, et
- (2) l'utilisateur de l'appareil doit accepter tout brouillage radioélectrique subi, même si le brouillage est susceptible d'en compromettre le fonctionnement.

Changes or modifications not expressly approved by the party responsible for compliance could void the user's authority to operate the equipment.

IC: 22868 - VDIBRHS01

FCC ID: 2AMJS - VDIBRHS01

RF exposure:

1. The equipment complies with FCC RF exposure limits set forth for an uncontrolled environment.
2. This equipment must be installed and operated with a separation distance of at least 20 cm from all persons.
3. The antenna(s) used for this transmitter must not be co-located or operating in conjunction with any other antenna or transmitter.

Mexico

IFETEL

Marca: Robert Bosch LLC

Modelo(s): VIPHI2BT

Número: RCPBOVI18-0967

NOM-121-SCT1-2009

La operación de este equipo está sujeta a las siguientes dos condiciones: (1) es posible que este equipo o dispositivo no cause interferencia perjudicial y (2) este equipo o dispositivo debe aceptar cualquier interferencia, incluyendo la que pueda causar su operación no deseada.

Brazil



Este equipamento opera em caráter secundário, isto é, não tem direito a proteção contra interferência prejudicial, mesmo de estações do mesmo tipo, e não pode causar interferência a sistemas operando em caráter primário.

Japan

This device is granted pursuant to the Japanese Radio Law (電波法) and the Japanese Telecommunications Business Law (電気通信事業法). This device should not be modified (otherwise the granted designation number will become invalid).

Europe

Declaration of Conformity

Simplified EU Declaration of Conformity according Radio Equipment Directive 2014/53/EU



DE

Hiermit erklärt Robert Bosch LLC, dass der Funkanlagentyp VIPHI2BT der Richtlinie 2014/53/EU entspricht. Der vollständige Text der EU-Konformitätserklärung ist unter der folgenden Internetadresse verfügbar: eu-doc.bosch.com

FR

Le soussigné, Robert Bosch LLC, déclare que l'équipement radioélectrique du type VIPHI2BT est conforme à la directive 2014/53/UE.

Le texte complet de la déclaration UE de conformité est disponible à l'adresse internet suivante: eu-doc.bosch.com

BG

С настоящото Robert Bosch LLC декларира, че този тип радиосъоръжение VIPHI2BT е в съответствие с Директива 2014/53/ЕС.

Цялостният текст на ЕС декларацията за съответствие може да се намери на следния интернет адрес: eu-doc.bosch.com

EL

Με την παρούσα ο/η Robert Bosch LLC, δηλώνει ότι ο ραδιοεξοπλισμός VIPHI2BT πληροί την οδηγία 2014/53/ΕΕ. Το πλήρες κείμενο της δήλωσης συμμόρφωσης ΕΕ διατίθεται στην ακόλουθη ιστοσελίδα στο διαδίκτυο: eu-doc.bosch.com

CS

Tímto Robert Bosch LLC prohlašuje, že typ rádiového zařízení VIPHI2BT je v souladu se směrnicí 2014/53/EU. Úplné znění EU prohlášení o shodě je k dispozici na této internetové adrese: eu-doc.bosch.com

DA

Hervede erklærer Robert Bosch LLC, at radioudstyrstypen VIPHI2BT er i overensstemmelse med direktiv 2014/53/EU.

EU-overensstemmelseerklæringens fulde tekst kan findes på følgende internetadresse: eu-doc.bosch.com

ET

Käesolevaga deklareerib Robert Bosch LLC, et käesolev raadioseadme tüüp VIPHI2BT vastab direktiivi 2014/53/EL nõuetele.

ELi vastavusdeklaratsiooni täielik tekst on kättesaadav järgmisel internetiaadressil: eu-doc.bosch.com

ES

Por la presente, Robert Bosch LLC declara que el tipo de equipo radioeléctrico VIPHI2BT es conforme con la Directiva 2014/53/UE.

El texto completo de la declaración UE de conformidad está disponible en la dirección Internet siguiente: eu-doc.bosch.com

FI

Robert Bosch LLC vakuuttaa, että radiolaitetyyppi VIPHI2BT on direktiivin 2014/53/EU mukainen.

EU-vaatimustenmukaisuusvakuutuksen täysimittainen teksti on saatavilla seuraavassa internetosoitteessa: eu-doc.bosch.com

EN

Hereby, Robert Bosch LLC declares that the radio equipment type VIPHI2BT is in compliance with Directive 2014/53/EU.

The full text of the EU declaration of conformity is available at the following internet address: eu-doc.bosch.com

HR

Robert Bosch LLC ovime izjavljuje da je radijska oprema tipa VIPHI2BT u skladu s Direktivom 2014/53/EU. Cjeloviti tekst EU izjave o sukladnosti dostupan je na sljedećoj internetskoj adresi: eu-doc.bosch.com

HU

Robert Bosch LLC igazolja, hogy a VIPHI2BT típusú rádióberendezés megfelel a 2014/53/EU irányelvnek.

Az EU-megfelelőségi nyilatkozat teljes szövege elérhető a következő internetes címen: eu-doc.bosch.com

IT

Il fabbricante, Robert Bosch LLC, dichiara che il tipo di apparecchiatura radio VIPHI2BT è conforme alla direttiva 2014/53/UE.

Il testo completo della dichiarazione di conformità UE è disponibile al seguente indirizzo Internet: eu-doc.bosch.com

219001988-001_a

LT

Aš, Robert Bosch LLC, patvirtinu, kad radijo įrenginių tipas VIPHI2BT atitinka Direktyvą 2014/53/ES.

Visas ES atitikties deklaracijos tekstas prieinamas šiuo interneto adresu: eu-doc.bosch.com

LV

Ar šo Robert Bosch LLC deklarē, ka radioiekārta VIPHI2BT atbilst Direktīvai 2014/53/ES.

Pilns ES atbilstības deklarācijas teksts ir pieejams šādā interneta vietnē: eu-doc.bosch.com

MT

B'dan, Robert Bosch LLC, niddikjara li dan it-tip ta' taghmir tar-radju VIPHI2BT huwa konformi mad-Direttiva 2014/53/UE.

It-test kollu tad-dikjarazzjoni ta' konformità tal-UE huwa disponibbli f'dan l-indirizz tal-Internet li ġej: eu-doc.bosch.com

NL

Hierbij verklaar ik, Robert Bosch LLC, dat het type radioapparatuur VIPHI2BT conform is met Richtlijn 2014/53/EU.

De volledige tekst van de EU-conformiteitsverklaring kan worden geraadpleegd op het volgende internetadres: eu-doc.bosch.com

PL

Robert Bosch LLC niniejszym oświadcza, że typ urządzenia radiowego VIPHI2BT jest zgodny z dyrektywą 2014/53/UE.

Pełny tekst deklaracji zgodności UE jest dostępny pod następującym adresem internetowym: eu-doc.bosch.com

PT

O(a) abaixo assinado(a) Robert Bosch LLC declara que o presente tipo de equipamento de rádio VIPHI2BT está em conformidade com a Diretiva 2014/53/UE.

O texto integral da declaração de conformidade está disponível no seguinte endereço de Internet: eu-doc.bosch.com

RO

Prin prezenta, Robert Bosch LLC declară că tipul de echipamente radio VIPHI2BT este în conformitate cu Directiva 2014/53/UE.

Textul integral al declarației UE de conformitate este disponibil la următoarea adresă internet: eu-doc.bosch.com

SV

Härmed försäkrar Robert Bosch LLC att denna typ av radioutrustning VIPHI2BT överensstämmer med direktiv 2014/53/EU.

Den fullständiga texten till EU-försäkran om överensstämmelse finns på följande webbadress: eu-doc.bosch.com

SL

Robert Bosch LLC potrjuje, da je tip radijske opreme VIPHI2BT skladen z Direktivo 2014/53/EU.

Celotno besedilo izjave EU o skladnosti je na voljo na naslednjem spletnem naslovu: eu-doc.bosch.com

SK

Robert Bosch LLC týmto vyhlasuje, že rádiové zariadenie typu VIPHI2BT je v súlade so smernicou 2014/53/EÚ.

Úplné EÚ vyhlásenie o zhode je k dispozícii na tejto internetovej adrese: eu-doc.bosch.com

IS

Robert Bosch LLC lýsir því hér með yfir að þráðlausri fjarskiptabúnaðurrinn VIPHI2BT er í samræmi við tilskipun 2014/53/ESB.

Óstyttna texta ESB-samræmisýfirlýsingarinnar er að finna á veffanginu: eu-doc.bosch.com

Liechtenstein

Hiermit erklärt Robert Bosch LLC, dass der Funkanlagentyp VIPHI2BT der Richtlinie 2014/53/EU entspricht.

Der vollständige Text der EU-Konformitätserklärung ist unter der folgenden Internetadresse verfügbar: eu-doc.bosch.com

NO

Hermed erklærer Robert Bosch LLC at radioutstyrstypen VIPHI2BT er i samsvar med direktiv 2014/53/EU.

Hele teksten i EU-samsvarserklæringen finnes på følgende internettadresse: eu-doc.bosch.com

RU

Компания Robert Bosch LLC настоящим заявляет, что радиотехническое оборудование

категории VIPHI2BT отвечает требованиям Директивы 2014/53/EU.

Полный текст декларации соответствия ЕС доступен на сайте eu-doc.bosch.com.

219001988-002_a

SPECIFICATIONS

NOTE: Because of our ongoing commitment to product quality and innovation, BRP reserves the right, at any time, to make changes in design and specifications and/or to make additions to, or improvements in its products without imposing any obligation upon itself to install them on its previously manufactured products.

ENGINE			
Engine type		ROTAX® 1330 ACE, 4-stroke, Dual Over Head Camshaft (DOHC), liquid cooled	
Number of cylinders		3	
Number of valves		12	
Bore		84 mm (3.31 in)	
Stroke		80 mm (3.15 in)	
Displacement		1 330 cm ³ (81.16 in ³)	
Compression ratio		12:1	
Lubrication	Type		Dry sump with separate oil tank and oil cooler
	Engine oil filter		BRP Rotax microglass fibre type, replaceable
	Transmission/HCM oil filter		BRP Rotax multi-layer surface filter, replaceable
	Engine oil capacity	Oil change with new engine filter	4.7 L (5 qt (U.S. liq.))
		Oil change with new engine and HCM filters	4.9 L (5.2 qt (U.S. liq.))
Recommended engine oil		See <i>RECOMMENDED ENGINE OIL</i> in the <i>MAINTENANCE PROCEDURES</i> section of this guide	
Clutch	Type		Hydraulic clutch + wet multi-plate clutch automatically controlled by TCM
	Engagement		1100 RPM
Exhaust system		3 into 1 manifold, primary muffler with catalytic converter, with secondary muffler	
Air filter		Paper element	

SPECIFICATIONS

GEARBOX			
Type		Sequential Electronic 6-speed (SE6) with remote electronic reverse interlock	
COOLING SYSTEM			
Type		Liquid cooled, double radiator with cooling fans	
Coolant	Type	See <i>ENGINE COOLANT</i> in the <i>MAINTENANCE PROCEDURES</i> section of this guide	
	Capacity	4.2 L (1.1 U.S. gal.)	
ELECTRICAL SYSTEM			
Ignition system type		Electronic ignition with dual output coil	
Ignition timing		Not adjustable	
Spark plug	Quantity	3	
	Make and type	NGK MR7BI-8 (iridium) or equivalent	
	Gap	0.7 mm - 0.8 mm (.028 in - .031 in)	
Engine RPM limiter setting	Forward	8100 RPM with engaged drivetrain	
		7500 RPM with open clutch or on neutral	
Battery	Type	Maintenance free	
	Voltage	12 volts	
	Nominal rating	21 A•h	
	Recommended charging rate	2 A	
Headlight Hi/Low		North American Models	Halogen, 2 x 55/60 W (type HB2)
		Other Models	High Beam: Halogen, 2 x 60 W (type HB2) Low Beam: Halogen, 2 x 55 W (type H7)

ELECTRICAL SYSTEM			
Taillight/brake light		All models except Japanese, T and Limited Models	2 x 5/21 W
		T Models	2X 0,26W/2,4W
		Limited Models - North America	2X 0,26W/2,4W + 0.14W/2.6W
		All Limited models outside North America	2X 0,26W/2,4W + 2.6W
		S model - Japan	2 x 21 W + LED 3.1 W
Turn signal lights	Front	STD S	2 x 21 W
		T Limited	2 x 3.2 W
	Rear	S - European models	2 x 21 W
		All other models	2 x 10 W
Position lights	Front		LED 2 x 1 W
	Rear	S - Japanese Model	LED 0.6 W
		T Limited	2 x 0.26 W
		All other models	2 x 5 W
License plate light		STD S	10 W
		T Limited	5 W

SPECIFICATIONS

ELECTRICAL SYSTEM		
Backup light		21 W
Rear fog light	Chinese models	LED
Fuses		Refer to <i>FUSES</i> in <i>HOW TO REPLACE FUSES AND LIGHTS</i>

FUEL SYSTEM		
Fuel delivery	Type	Multi-point Electronic Fuel Injection (EFI) with ETC (Electronic Throttle Control) Single throttle body (54 mm) with an actuator
Fuel pump	Type	Electrical module in fuel tank
Idle speed		900 RPM Electronically controlled, not adjustable
Fuel	Type	Premium unleaded gasoline
	Minimum octane	87 Pump Posted AKI (RON+MON)/2
		92 RON
	Recommended octane	91 Pump Posted AKI (RON+MON)/2
95 RON		
Fuel tank capacity		27 L (7.1 U.S. gal.)

DRIVE SYSTEM			
Final drive type		Carbon reinforced drive belt	
Final drive ratio	North America	S models	89/28
		All other models	79/28
	All other countries	79/28	

STEERING	
Type	Dynamic Power Steering (DPS)

FRONT SUSPENSION			
Suspension type		Double A-arm with stabilizer bar	
Suspension travel		129 mm (5.07 in)	
Shock absorber	Qty	2	
	Type	S models	FOX PODIUM mono-tube coil cover
		All other models	SACHS "Big Bore"
Spring preload adjustment		All models except STD models	Threaded rings

REAR SUSPENSION			
Suspension type		T models	Air ride with manual pressure adjustment Swing arm with monoshock
		Limited models	Air controlled suspension with automatic self leveling adjustment Swing arm with monoshock
		Other models	Swing arm with monoshock
Suspension travel		132 mm (5.2 in)	
Shock absorber	Qty	1	
	Type	SACHS twin-tube coil-over	
Spring preload adjustment		T models	Adjustable air pressure: 105 kPa to 515 kPa (15 PSI to 75 PSI)
		All other models	No adjustment

BRAKES	
Type	Foot actuated, fully integrated hydraulic 3 wheel braking system with ABS and EBD
Front brake	Dual 270 mm (11 in) rigid discs, radially mounted Brembo monobloc with 4 piston calipers, 2-pad

SPECIFICATIONS

BRAKES		
Rear brake		Single 270 mm (11 in) disc with 1 piston floating caliper with integrated parking
Brake fluid	Capacity	480 ml (16.2 U.S. oz)
	Type	DOT 4
Parking brake		Mechanical, electrically actuated to the rear caliper
Minimum brake pad thickness		1 mm (.04 in)
Minimum brake disc thickness		6.4 mm (.252 in)
Maximum brake disc warpage		0.100 mm (.004 in)

TIRES		
Type (use only radial tires recommended by BRP)	Front	Kenda KR31 165/55R15
	Rear	Kenda KR21A 225/50R15
Pressure	Front	103 kPa (15 PSI) NOTE: The pressure difference between the left and right side tire should not exceed 3.4 kPa (.5 PSI)
	Rear	193 kPa (28 PSI)
Minimum tire tread depth	Front	2.5 mm (3/32 in)
	Rear	4.0 mm (5/32 in)

WHEELS		
Size (diameter X width)	Front	381 mm (15 in) x 127 mm (5 in)
	Rear	381 mm (15 in) x 178 mm (7 in)
Front wheel nuts torque		109 N•m ± 4 N•m (80 lbf•ft ± 3 lbf•ft)
Rear drive axle nut torque		225 N•m ± 15 N•m (166 lbf•ft ± 11 lbf•ft)

DIMENSIONS		
Overall length	STD models S models	2 642 mm (104 in)
	T models	2 596 mm (102.2 in)
	Limited	2 820 mm (111 in)
Overall width		1 497 mm (58.9 in)
Overall height	STD models S models	1 099 mm (43.3 in)
	T models Limited models	1 241 mm (48.9 in)
Seat height (top)		675 mm (26.6 in)
Wheel base		1 709 mm (67.3 in)
Front wheel track		1 308 mm (51.5 in)
Ground clearance, front and under engine		115 mm (4.5 in)

WEIGHT AND LOADING CAPACITY		
Dry weight	STD models S models	408 kg (899.5 lb)
	T models	430 kg (948 lb)
	Limited models	448 kg (987.7 lb)
Front storage compartment	Capacity	24.4 L (6.45 U.S. gal.)
	Maximum load	6.8 kg (15 lb)
Saddlebags (If equipped)	Right saddlebag capacity	26 L (6.87 U.S. gal.)
	Left saddlebag capacity	24 L (6.34 U.S. gal.)
	Maximum load	6.8 kg (15 lb)
Top storage compartment (if equipped)	Capacity	43 L (11.36 U.S. gal.)
	Maximum load	9 kg (20 lb)
Total vehicle load allowed (including operator, all other loads and added accessories)	Limited models	209 kg (460.8 lb)
	All other models	199 kg (438 lb)

WEIGHT AND LOADING CAPACITY			
Gross vehicle weight rating (GVWR)		STD models S models	627 kg (1,382 lb)
		T models	648 kg (1,429 lb)
		Limited models	677 kg (1,493 lb)
Gross axle weight rating (GAWR)	Front	STD models S models	336 kg (741 lb)
		T models Limited models	340 kg (750 lb)
	Rear	STD models S models	291 kg (642 lb)
		T models	310 kg (683 lb)
		Limited models	341 kg (752 lb)
	Maximum weight on trailer tongue		
Maximum towed weight (trailer and cargo)			182 kg (400 lb)

WARRANTY

BRP LIMITED WARRANTY — USA AND CANADA: 2021 Can-Am® SPYDER® SERIES

1. SCOPE OF THE LIMITED WARRANTY

Bombardier Recreational Products Inc. ("BRP")* warrants its 2021 Can-Am Spyder (the "Product") sold by authorized Can-Am On-Road Dealers ("Dealers") in the United States of America and in Canada from defects in material or workmanship for the period and under the conditions described below. This limited warranty will become null and void if: (1) the Product was used for racing or any other competitive activity, at any point, even by a previous owner; (2) the odometer was removed or has been tampered with; (3) the Product was used off-road; or (4) the Product has been altered or modified in such a way so as to adversely affect its operation, performance or durability, or has been altered or modified to change its intended use.

Non-factory installed parts and accessories are not covered under this limited warranty. Please refer to the applicable parts and accessories limited warranty text.

2. LIMITATIONS OF LIABILITY

THIS WARRANTY IS EXPRESSLY GIVEN AND ACCEPTED IN LIEU OF ANY AND ALL OTHER WARRANTIES, EXPRESSED OR IMPLIED, INCLUDING WITHOUT LIMITATION ANY WARRANTY OF MERCHANTABILITY OR FITNESS FOR A PARTICULAR PURPOSE. TO THE EXTENT THAT THEY CANNOT BE DISCLAIMED, THE IMPLIED WARRANTIES ARE LIMITED IN DURATION TO THE LIFE OF THE EXPRESS WARRANTY. INCIDENTAL AND CONSEQUENTIAL DAMAGES ARE EXCLUDED FROM COVERAGE UNDER THIS WARRANTY. SOME STATES/PROVINCES DO NOT ALLOW FOR THE DISCLAIMERS, LIMITATIONS AND EXCLUSIONS IDENTIFIED ABOVE, AS A RESULT, THEY MAY NOT APPLY TO YOU. THIS WARRANTY GIVES YOU SPECIFIC RIGHTS, AND YOU MAY ALSO HAVE OTHER LEGAL RIGHTS WHICH MAY VARY FROM STATE TO STATE, OR PROVINCE TO PROVINCE.

Neither the distributor, any Dealer nor any other person has been authorized to make any affirmation, representation or warranty regarding the Product, other than those contained in this limited warranty, and if made, shall not be enforceable against BRP. BRP reserves the right to modify this limited warranty at any time, being understood that such modification will not alter the warranty conditions applicable to the Product sold while this limited warranty is in effect.

3. EXCLUSIONS — ARE NOT WARRANTED

The following are not warranted under any circumstances:

- Replacement of routine maintenance items such as, without limitation, oil, lubricants, fluids, filters and spark plugs.
- Normal wear and tear, such as, without limitation, wear and tear of the tires, battery, generator brushes, sealed beams and light bulbs, clutch plates and facings, drive belt, brake pads, brake linings and rotors and sprockets.
- Tune ups and adjustments including without limitation adjustments of belt, alignment and wheel balance.
- Damages related to the appearance of the Product, including without limitation scratches, dents, fading, flaking, peeling and damages to seat cover material.

* In the USA, products are distributed and serviced by BRP US Inc.

- Damage caused by failure to provide proper maintenance or storage, as described in the *OPERATOR'S GUIDE*.
- Damage resulting from removal of parts, improper repairs, improper service or improper maintenance, modifications, alterations that are outside of the original specifications of the Product, or damage resulting from repairs done by a person that is not an authorized servicing Dealer.
- Damage resulting from the installation of parts with specifications that differ from the original Product parts, such as, without limitation, different tires, exhaust system, wheels or brakes.
- Damage resulting from abuse, abnormal use, neglect or operation of the Product in a manner inconsistent with the recommendations of the *OPERATOR'S GUIDE*.
- Damage resulting from water ingestion, accident, road hazards, submersion, fire, theft, vandalism or any act of God.
- Damage resulting from operation with fuels, oils or fluids with specifications different than as recommended in the *OPERATOR'S GUIDE*.
- Damage resulting from corrosion from road salts, battery acid, environmental influences or treatment contrary to the *OPERATOR'S GUIDE*.
- Incidental or consequential damages, including without limitation towing, storage, telephone, rental, taxi, inconvenience, insurance coverage, loan payments, loss of time or loss of income.

4. WARRANTY COVERAGE PERIOD

This limited warranty will be in effect from the date of delivery to the first retail consumer or the date the Product is first put into use, whichever occurs first and for the following periods:

1. For private, recreational use, **TWENTY FOUR (24) CONSECUTIVE MONTHS**, except for the items covered in points (2) to (5) below; and for commercial use **TWELVE (12) CONSECUTIVE MONTHS**, except for the items covered in points (2) to (5) below.
A Product is used commercially when it is used in connection with any work or employment that generates income during any part of the warranty period. A Product is also used commercially when, at any point during the warranty period, it is licensed for commercial use. This is a minimal warranty period which can be extended by any applicable warranty promotional program, as the case may be.
2. For the battery, **SIX (6) CONSECUTIVE MONTHS**.
3. For the tires, **SIX (6) CONSECUTIVE MONTHS** or until tires are worn to the last three thirty-seconds of an inch (3/32 ") (2.38 millimeters) for the front tires and the last five thirty-seconds of an inch (5/32 ") (3.97 millimeters) for the rear tire, whichever occurs first.
4. For emission-related components; please also refer to the *US EPA EMISSIONS PERFORMANCE WARRANTY* contained herein.
5. For Products produced for sale in the state of California, that are originally sold to residents or subsequently warranty registered to residents in the state of California, please also refer to the applicable California Emissions Control Warranty Statement.

The repair or replacement of parts or the performance of service under this warranty does not extend the life of this warranty beyond its original expiration date.

5. CONDITIONS TO HAVE WARRANTY COVERAGE

This warranty coverage is available **only** if each of the following conditions has been fulfilled:

- The Product must be purchased as new and unused by its first owner from a Can-Am On-Road dealer authorized to distribute the Product in the country in which the sale occurred (“Dealer”).
- The BRP-specified pre-delivery inspection process must be completed, documented and signed by the purchaser.
- The Product must have undergone proper warranty registration by an authorized Can-Am On-Road dealer.
- The Product must be purchased in the country in which the purchaser resides.
- Routine maintenance must be performed as indicated in the *OPERATOR'S GUIDE*. BRP reserves the right to make warranty coverage contingent upon proof of proper maintenance.

BRP will not honor this limited warranty to any private use owner or commercial use owner if the preceding conditions have not been met. Such limitations are necessary in order to allow BRP to preserve both the safety of its products, and also that of its consumers and the general public.

6. WHAT TO DO TO OBTAIN WARRANTY COVERAGE

The customer must cease using the Product upon the appearance of an anomaly. The customer must notify a servicing Dealer within three (3) days of the appearance of a defect, and provide it with reasonable access to the product and reasonable opportunity to repair it. The customer must also present to the authorized Dealer proof of purchase of the product and must sign the repair/work order prior to starting the repair in order to validate the warranty repair. All parts replaced under this limited warranty become the property of BRP.

7. WHAT BRP WILL DO

BRP's obligations under this warranty are limited to, at its sole discretion, repairing parts found defective under normal use, maintenance and service, or replacing such parts with new genuine Product parts without charge for parts and labor, at any authorized Dealer during the warranty coverage period. BRP's responsibility is limited to making the required repairs or replacements of parts. No claim of breach of warranty shall be cause for cancellation or rescission of the sale of the Product to the owner.

In the event that service is required outside of the country of original sale, the owner will bear responsibility for any additional charges due to local practices and conditions, such as, but not limited to, freight, insurance, taxes, license fees, import duties, and any and all other financial charges, including those levied by governments, states, territories and their respective agencies.

BRP reserves the right to improve or modify products from time to time without assuming any obligation to modify any products manufactured.

8. TRANSFER

If the ownership of a product is transferred during the warranty coverage period, this limited warranty, subject to its terms and conditions, shall also be transferred and be valid for the remaining coverage period provided BRP or an authorized Distributor/Dealer receives a proof that the former owner agreed to the transfer of ownership, in addition to the coordinates of the new owner.

9. CONSUMER ASSISTANCE

In the event of a controversy or a dispute in connection with this limited warranty, BRP suggests that you try to resolve the issue at the dealership level. We recommend discussing the issue with the authorized Dealer's service manager or owner.

If the matter still remains unresolved, contact BRP by filling out the customer contact form at www.brp.com or contact BRP by mail at one of the addresses listed under the *CONTACT US* section of this guide.

US EPA EMISSIONS PERFORMANCE WARRANTY

Bombardier Recreational Products Inc. ("BRP")* warrants that if:

1. The Product is maintained and operated in accordance with the written instructions for proper maintenance and use, and
2. The Product fails to conform at any time during its useful life to the applicable emission standards or family emission limits as determined by an EPA-approved emission test, and
3. Such nonconformity results or will result in the Product owner having to bear any penalty or other sanction (including the denial of the right to use the Product) under local, State or Federal law, then BRP shall remedy the nonconformity at no cost to the owner; except that, if the Product has been in operation for more than 5 years or 30,000 kilometers (18,641 miles). BRP shall be required to remedy only those non-conformities resulting from the failure of components which have been installed in or on the Product for the sole or primary purpose of reducing Product emissions and that were not in general use prior to model year 1968.

The warranty period begins on the date the Product is delivered to its ultimate purchase, or if the Product is first placed in service as a "demonstrator" or "company" motorcycle prior to delivery, on the date it is first placed in service.

Items which are covered by the Emissions Performance Warranty for the full useful life of the Product:

Fuel System and Air Admission Systems

- Fuel Injectors, Fuel Pump Module, Fuel Filter Ass'y, Throttle Body (Including Throttle Position Sensor), Air Intake Manifold

Ignition Components and Sensors

- Engine Control Module (ECM), Engine Wiring Harness, Ignition Coils, Spark Plugs (covered only up to the first maintenance replacement), Noise Sensor (Knock Sensor), Camshaft Position Sensor, Crankshaft Position Sensor, Temperature Sensor (Coolant), Pressure And Temperature Sensor, Oxygen Sensors

* In the USA, products are distributed and serviced by BRP US Inc.

Exhaust System

- Primary Muffler (Containing Catalytic Converter), Exhaust Manifolds
- Clamps, Gaskets and Seals (from Engine up to Primary Muffler)

Crankcase Ventilation System

- Crankcase Vent Breather, Crankcase Vent Hose, Oil Filler Cap

Evaporative Emission Control System

- Fuel Tank, Fuel Cap, Fuel Hose, Vapor Canister, Vapor Canister Mounting Bracket, Bleed Valve (Purge Valve), Check Valve, Filters, Evaporative Components Mounting Brackets
- Clamp, Seal, Gasket and Fitting (associated with fuel system assembly)

See maintenance information section in this operator's guide for proper maintenance. This operator's guide contains information for proper use of the Product.

Under the Emissions Performance Warranty, BRP shall be liable for the total cost of the remedy for any Product validly presented for repair to any authorized Can-Am On-Road dealer, unless for emergency repairs as required by item 2 of the following list. State or local limitations as to the extent of the penalty or sanction imposed upon an owner of a failed Product shall have no bearing on this liability.

In no case may BRP deny an emission performance warranty claim on the basis of:

1. Warranty work or predelivery service performed by any facility authorized by BRP to perform such work or service; or
2. Work performed in an emergency situation to rectify an unsafe condition, including an unsafe driveability condition, attributable to BRP, provided the Product owner has taken steps to put the Product back in a conforming condition in a timely manner; or
3. The use of any uncertified part or non-compliance with any written instruction for proper maintenance and use which is not relevant to the reason that the Product failed to comply with applicable emission standards; or
4. Any cause attributable to BRP; or
5. The use of any fuel which is commonly available in the geographical area in which the Product is located, unless the written instructions for proper maintenance and use specify that the use of that fuel would adversely affect the emission control devices and systems of the Product, and there is commonly available information for the owner to identify the proper fuel to be used. See maintenance information section and fuel requirements of fueling section.

Except as stated in the previous items; BRP may deny an emission performance warranty claim on the basis of an uncertified aftermarket part used in the maintenance or repair of a Product if the use of the uncertified part caused the Product's failure to meet emission standards. The use of parts not equivalent to the original parts or uncertified aftermarket parts may have a negative impact on the effectiveness of the emission control system and results in the Product's failure to meet emission standards. The use of certified parts does not affect the emission performance warranty. **Maintenance, replacement, or repair of the emission control devices and systems may be performed by any motorcycle repair establishment or individual using any certified part.**

As soon as you become aware of a defect; you are responsible for presenting your Product to an authorized Can-Am On-Road dealer. Authorized Can-Am On-Road dealer will proceed with the warranty claim.

In the case an authorized Can-Am On-Road dealer is unable (for reasons not attributable to the Product owner or events beyond the control of BRP or an authorized Can-Am On-Road dealer) to repair a Product within 30 days after the initial presentation of the Product to an authorized Can-Am On-Road dealer, then the owner shall be entitled to have the warranty remedy performed, at the expense of BRP, by any repair facility of the owner's choosing.

All defective parts replaced under this warranty become the property of BRP.

Contact the Director, Field Operations and Support Division (6406J), Environmental Protection Agency, 401 "M" Street, SW., Washington, DC 20460 (Attention: Warranty Claim) for further information concerning the Emissions Performance Warranty or to report a violations of the terms of the Emissions Performance Warranty.

Bombardier Recreational Products Inc. ("BRP")* also warrants to the ultimate purchaser and each subsequent purchaser that this new Product, including all parts of its exhaust emission-control system and its evaporative emission-control system, meets two conditions:

- It is designed, built, and equipped so it conforms at the time of sale to the ultimate purchaser with the requirements of 40 CFR 86 and with the evaporative emission standards of 40 CFR 1051, as applicable to onroad motorcycles.
- It is free from defects in materials and workmanship that may keep it from meeting the requirements of 40 CFR 86 and with the evaporative emission standards of 40 CFR 1051, as applicable to onroad motorcycles.

Where a warrantable condition exists, BRP will repair or replace, as it elects, any part or component with a defect in materials or workmanship that would increase the engine's emissions of any regulated pollutant within the stated warranty period at no cost to the owner, including expenses related to diagnosing and repairing or replacing emission-related parts.

The emission-related warranty is valid for the following period whichever comes first:

	KILOMETERS/MILES	YEARS
Exhaust and Evaporative emission-related components	30,000/18,641	5

US EPA FEDERAL NOISE EMISSION WARRANTY

Bombardier Recreational Products Inc. ("BRP")* warrants to the ultimate purchaser and each subsequent purchaser that this new Product, at time of sale, was designed, built and equipped to meets all applicable US EPA Federal noise control standards and is free from defects in materials and workmanship that may keep it, when properly maintained and used, from meeting the requirements of all applicable US EPA Federal noise standards for the following period whichever comes first:

KILOMETERS/MILES	YEAR
6,000/3,730	1

CALIFORNIA EMISSION CONTROL WARRANTY STATEMENT

YOUR WARRANTY RIGHTS AND OBLIGATIONS:

The California Air Resources Board and BRP US Inc. on behalf of Bombardier Recreational Products Inc., are pleased to explain the emission control system warranty on your 2021 Can-Am Spyder. In California, new motor vehicles must be designated, built and equipped to meet the State's stringent anti-smog standards. BRP must warrant the emission control system on your Product for the periods of time listed below provided there has been no abuse, neglect or improper maintenance of your Product.

Your emission control system may include parts such as the fuel-injection system, ignition system, catalytic converter and engine computer. Also included may be hoses, connectors and other emission-related assemblies. Where a warrantable condition exists, BRP will repair your Product at no cost to you including diagnosis, parts and labor.

MANUFACTURER'S WARRANTY COVERAGE

– For 5 years or 30 000 kilometers (18,641 miles), whichever occurs first.

OWNER'S WARRANTY RESPONSIBILITIES:

As the Product's owner, you are responsible for the performance of the required maintenance listed in your *OPERATOR'S GUIDE*. BRP recommends that you retain all receipts covering maintenance on your Product, but BRP cannot deny warranty solely for the lack of receipts or for your failure to ensure the performance of all scheduled maintenance.

You are responsible for presenting your Product to a Dealer as soon as a problem exists. The warranty repairs should be completed in a reasonable amount of time, not to exceed 30 days.

As the Product's owner, you should also be aware that BRP may deny you warranty coverage if your Product or a part has failed due to abuse, neglect, improper maintenance or unapproved modifications.

If you have any questions regarding your warranty rights and responsibilities, you should contact BRP's customer assistance center at 1-888-272-9222 or the California Air Resource Board at 9528 Telstar Avenue, El Monte, CA 91731.

* In the USA, products are distributed and serviced by BRP US Inc.

© 2020 Bombardier Recreational Products Inc. All rights reserved.

® and ™ are Trademarks of Bombardier Recreational Products Inc. or its affiliates.

BRP INTERNATIONAL LIMITED WARRANTY: 2021 Can-Am® SPYDER® SERIES

1. SCOPE OF THE LIMITED WARRANTY

Bombardier Recreational Products Inc. ("BRP")* warrants its 2021 Can-Am Spyder (the "Products") sold by distributors or dealers authorized by BRP to distribute Can-Am On-Road products ("Can-Am On-Road Distributor/Dealer") outside of the United States of America ("USA"), Canada, member states of the European Economic Area (which is comprised of the states of the European Union plus the United Kingdom, Norway, Iceland and Liechtenstein) ("EEA"), Turkey and member states of the Commonwealth of the Independent States (including Ukraine and Turkmenistan) ("CIS") from defects in material or workmanship for the period and under the conditions described below. This limited warranty will become null and void if: (1) the Product was used for racing or any other competitive activity, at any point, even by a previous owner; or (2) the odometer was removed or has been tampered with; (3) the Product was used off-road; or (4) the Product has been altered or modified in such a way so as to adversely affect its operation, performance or durability, or has been altered or modified to change its intended use.

Non-factory installed parts and accessories are not covered under this limited warranty. Please refer to the applicable parts and accessories limited warranty text.

2. LIMITATIONS OF LIABILITY

JURISDICTIONS TO THE EXTENT PERMITTED BY LAW. THIS WARRANTY IS EXPRESSLY GIVEN AND ACCEPTED IN LIEU OF ANY AND ALL OTHER WARRANTIES, EXPRESSED OR IMPLIED, INCLUDING WITHOUT LIMITATION ANY WARRANTY OF MERCHANTABILITY OR FITNESS FOR A PARTICULAR PURPOSE. TO THE EXTENT THAT THEY CANNOT BE DISCLAIMED, THE IMPLIED WARRANTIES ARE LIMITED IN DURATION TO THE LIFE OF THE EXPRESS WARRANTY. ALL INCIDENTAL, CONSEQUENTIAL, DIRECT, INDIRECT OR OTHER DAMAGES OF ANY KIND ARE EXCLUDED FROM COVERAGE UNDER THIS WARRANTY. SOME JURISDICTIONS DO NOT ALLOW FOR THE DISCLAIMERS, LIMITATIONS OF INCIDENTAL OR CONSEQUENTIAL DAMAGES OR OTHER EXCLUSIONS IDENTIFIED ABOVE. AS A RESULT, THEY MAY NOT APPLY TO YOU. THIS WARRANTY GIVES YOU SPECIFIC RIGHTS, AND YOU MAY ALSO HAVE OTHER LEGAL RIGHTS WHICH MAY VARY FROM COUNTRY TO COUNTRY, OR JURISDICTION TO JURISDICTION. (FOR PRODUCTS PURCHASED IN AUSTRALIA SEE CLAUSE 4 BELOW).

Neither the authorized Distributors/Dealers nor any other person has been authorized to make any affirmation, representation or warranty regarding the Product, other than those contained in this limited warranty, and if made, shall not be enforceable against BRP. BRP reserves the right to modify this warranty at any time, being understood that such modification will not alter the warranty conditions applicable to the Products sold while this warranty is in effect.

3. EXCLUSIONS — ARE NOT WARRANTED

The following are not warranted under this limited policy under any circumstances:

- Replacement of routine maintenance items such as, without limitation, oil and lubricants, filters and spark plugs.

- Normal wear and tear, such as, without limitation, wear and tear of the tires, battery, generator brushes, sealed beams and light bulbs, clutch plates and facings, drive belt, brake pads, brake linings and rotors and sprockets.
- Tune ups and adjustments including without limitation adjustments of belt, alignment and wheel balance.
- Damages related to the appearance of the Product, including without limitation scratches, dents, fading, flaking, peeling and damages to seat cover material.
- Damage caused by negligence or failure to provide proper maintenance and/or storage, as described in the *OPERATOR'S GUIDE*.
- Damage resulting from removal of parts, improper repairs, improper service or improper maintenance, modifications, alterations that are outside of the original specifications of the Product, or damage resulting from use of parts or accessories not manufactured or approved by BRP which in its reasonable judgement are either incompatible with the product or adversely affect its operation, performance or durability or resulting from repairs done by a person that is not an authorized servicing Distributor/Dealer.
- Damage resulting from the installation of parts with specifications that differ from the original Product parts, such as, without limitation, different tires, exhaust system, wheels or brakes.
- Damage resulting from abuse, abnormal use, neglect, racing or operation of the Product in a manner inconsistent with the recommendations of the *OPERATOR'S GUIDE*.
- Damage resulting from water ingestion, accident, road hazards, submersion, fire, theft, vandalism or any act of God.
- Damage resulting from operation with fuels, oils or lubricants with specifications different than as recommended in the *OPERATOR'S GUIDE*.
- Damage resulting from corrosion from road salts, battery acid, environmental influences or treatment contrary to the *OPERATOR'S GUIDE*.
- Incidental or consequential damages, including without limitation, expense for gasoline, expense for transporting the Product to and from the authorized Distributor/Dealer, mechanic's travel time, trailering or towing, storage, telephone, cell phone, fax or telegram charges, rental of a like or replacement Product during warranty services or down time, taxi, travel, lodging, loss of or damage to personal property, inconvenience, cost of insurance coverage, loan payments, loss of time, loss of income, revenue or profits, or loss of enjoyment or use of Product.

4. WARRANTY COVERAGE PERIOD

This warranty will be in effect from the date of delivery to the first retail consumer or the date the Product is first put into use, whichever occurs first and for the following periods:

1. For private, recreational use, **TWENTY-FOUR (24) CONSECUTIVE MONTHS**, except for the items covered in points (2) and 3) below; and for commercial use **TWELVE (12) CONSECUTIVE MONTHS**, except for the items covered in points (2) and (3) below.
The Product is used commercially when it is used in connection with any work or employment that generates income, during any part of the warranty period. The Product is also used commercially when, at any point during the warranty period, it is licensed for commercial use;

2. For the battery, **SIX (6) CONSECUTIVE MONTHS**;
3. For the tires, **SIX (6) CONSECUTIVE MONTHS** or until tires are worn to the last three thirty-second of an inch (3/32 ") (2.38 millimeters) for the front tires and the last five thirty-second of an inch (5/32 ") (3.97 millimeters) for the rear tire, whichever occurs first.

The repair or replacement of parts or the performance of service under this warranty does not extend the life of this warranty beyond its original expiration date.

Note that the duration and any other modalities of the warranty coverage are subject to the applicable national or local legislation in the customer's country.

FOR PRODUCTS SOLD IN AUSTRALIA ONLY

Nothing in these Warranty terms and conditions should be taken to exclude, restrict or modify the application of any condition, warranty, guarantee, right or remedy conferred or implied under the Competition and Consumer Act 2010 (Cth), including the Australian Consumer Law or any other law, where to do so would contravene that law, or cause any part of these terms and conditions to be void. The benefits given to you under this limited warranty are in addition to other rights and remedies that you have under Australian law.

Our goods come with guarantees that cannot be excluded under the Australian Consumer Law. You are entitled to a replacement or refund for a major failure and for compensation for any other reasonably foreseeable loss or damage. You are also entitled to have the goods repaired or replaced if the goods fail to be of acceptable quality and the failure does not amount to a major failure.

5. CONDITIONS TO HAVE WARRANTY COVERAGE

This warranty coverage is available **only** if **each** of the following conditions has been fulfilled:

- The Product must be purchased as new and unused by its first owner from a Distributor/Dealer authorized to distribute the Product in the country or union of countries in which the sale occurred;
- The BRP specified pre-delivery inspection process has been completed and documented by the purchaser and the authorized Distributor/Dealer and signed by the purchaser;
- The Product must have undergone proper warranty registration by an authorized Distributor/Dealer;
- The Product must be purchased in the country or union of countries in which the purchaser resides.
- Routine maintenance as outlined in the *OPERATOR'S GUIDE* must be performed in a timely manner. BRP reserves the right to make warranty coverage contingent upon proof of proper maintenance.

BRP will not honour this limited warranty to any private use owner or commercial use owner if one of the preceding conditions has not been met. Such limitations are necessary in order to allow BRP to preserve both the safety of its products, and also that of its consumers and the general public.

6. WHAT TO DO TO OBTAIN WARRANTY COVERAGE

The customer must cease using the Product upon the appearance of an anomaly. The customer must notify an authorized servicing Distributor/Dealer within two (2) months of the appearance of a defect, and provide it with reasonable access to the Product and reasonable opportunity to repair it. The customer must also present to the authorized Distributor/Dealer, proof of purchase of the Product and must sign the repair/work order prior to starting the repair in order to validate the warranty repair. All parts replaced under this limited warranty become the property of BRP. Note that the notification period is subject to the applicable national or local legislation in customer's country.

7. WHAT BRP WILL DO

To the extent permitted by law, BRP's obligations under this warranty are limited to, at its sole discretion, repairing parts found defective under normal use, maintenance and service, or replacing such parts with new genuine Product parts without charge for parts and labour, at any authorized Distributor/Dealer during the warranty coverage period under the conditions described herein. BRP's responsibility is limited to making the required repairs or replacements of parts. No claim of breach of warranty shall be cause for cancellation or rescission of the sale of the Product to the owner. You may have other legal rights which may vary from country to country.

In the event that service is required outside of the country of original sale, or for EEA residents, if service is required outside of the EEA, the owner will bear responsibility for any additional charges due to local practices and conditions, such as, but not limited to, freight, insurance, taxes, license fees, import duties, and any and all other financial charges, including those levied by governments, states, territories and their respective agencies.

BRP reserves the right to improve or modify products from time to time without assuming any obligation to modify all products previously manufactured.

8. TRANSFER

If the ownership of a Product is transferred during the warranty coverage period, this limited warranty, subject to its terms and conditions, shall also be transferred and be valid for the remaining coverage period provided BRP or an authorized Distributor/Dealer receives a proof that the former owner agreed to the transfer of ownership, in addition to the coordinates of the new owner.

9. CONSUMER ASSISTANCE

In the event of a controversy or a dispute in connection with this limited warranty, BRP suggests that you try to resolve the issue at the Distributor/Dealer level. We recommend discussing the issue with the authorized Distributor/Dealer's service manager or owner.

If the matter still remains unresolved, contact BRP by filling out the customer contact form at www.brp.com or contact BRP by mail at one of the addresses listed under the *CONTACT US* section of this guide.

* In the European Economic Area and elsewhere, Products are distributed and serviced by BRP European Distribution S.A. and other subsidiaries of BRP.

** The BRP limited warranty offered on Products sold in the USA and Canada is different than the one offered in the EEA and elsewhere.

© 2020 Bombardier Recreational Products Inc. All rights reserved.

® and ™ are trademarks of Bombardier Recreational Products Inc. or its affiliates.

BRP LIMITED WARRANTY FOR THE EUROPEAN ECONOMIC AREA, THE COMMONWEALTH OF THE INDEPENDENT STATES AND TURKEY: 2021 Can-Am® SPYDER® SERIES

1. SCOPE OF THE LIMITED WARRANTY

Bombardier Recreational Products Inc. ("BRP")* warrants its 2021 Can-Am Spyder (the "Products") sold by distributors or dealers authorized by BRP to distribute Can-Am On-Road products ("Can-Am On-Road Distributor/Dealer") in member states of the European Economic Area (which is comprised of the member states of the European Union plus the United Kingdom, Norway, Iceland and Liechtenstein) ("EEA"), in member states of the Commonwealth of the Independent States (including Ukraine and Turkmenistan) ("CIS") and Turkey (the "Distributors/Dealers") from defects in material or workmanship for the period and under the conditions described below. This limited warranty will become null and void if: (1) the Product was used for racing or any other competitive activity, at any point, even by a previous owner; or (2) the odometer was removed or has been tampered with; (3) the Product was used off-road; or (4) the Product has been altered or modified in such a way so as to adversely affect its operation, performance or durability, or has been altered or modified to change its intended use.

Non-factory installed parts and accessories are not covered under this limited warranty. Please refer to the applicable parts and accessories limited warranty text.

2. LIMITATIONS OF LIABILITY

JURISDICTIONS TO THE EXTENT PERMITTED BY LAW. THIS WARRANTY IS EXPRESSLY GIVEN AND ACCEPTED IN LIEU OF ANY AND ALL OTHER WARRANTIES, EXPRESSED OR IMPLIED, INCLUDING WITHOUT LIMITATION ANY WARRANTY OF MERCHANTABILITY OR FITNESS FOR A PARTICULAR PURPOSE. TO THE EXTENT THAT THEY CANNOT BE DISCLAIMED, THE IMPLIED WARRANTIES ARE LIMITED IN DURATION TO THE LIFE OF THE EXPRESS WARRANTY. ALL INCIDENTAL, CONSEQUENTIAL, DIRECT, INDIRECT OR OTHER DAMAGES OF ANY KIND ARE EXCLUDED FROM COVERAGE UNDER THIS WARRANTY. SOME JURISDICTIONS DO NOT ALLOW FOR THE DISCLAIMERS, LIMITATIONS OF INCIDENTAL OR CONSEQUENTIAL DAMAGES OR OTHER EXCLUSIONS IDENTIFIED ABOVE. AS A RESULT, THEY MAY NOT APPLY TO YOU. THIS WARRANTY GIVES YOU SPECIFIC RIGHTS, AND YOU MAY ALSO HAVE OTHER LEGAL RIGHTS WHICH MAY VARY FROM COUNTRY TO COUNTRY, OR JURISDICTION TO JURISDICTION. (FOR PRODUCTS PURCHASED IN AUSTRALIA SEE CLAUSE 4 BELOW).

Neither the authorized Distributors/Dealers nor any other person has been authorized to make any affirmation, representation or warranty regarding the Product, other than those contained in this limited warranty, and if made, shall not be enforceable against BRP. BRP reserves the right to modify this warranty at any time, being understood that such modification will not alter the warranty conditions applicable to the Products sold while this warranty is in effect.

3. EXCLUSIONS — ARE NOT WARRANTED

The following are not warranted under this limited policy under any circumstances:

- Replacement of routine maintenance items such as, without limitation, oil and lubricants, filters and spark plugs.
- Normal wear and tear, such as, without limitation, wear and tear of the tires, battery, generator brushes, sealed beams and light bulbs, clutch plates and facings, drive belt, brake pads, brake linings and rotors and sprockets.
- Tune ups and adjustments including without limitation adjustments of belt, alignment and wheel balance.
- Damages related to the appearance of the Product, including without limitation scratches, dents, fading, flaking, peeling and damages to seat cover material.
- Damage caused by negligence or failure to provide proper maintenance and/or storage, as described in the *OPERATOR'S GUIDE*.
- Damage resulting from removal of parts, improper repairs, improper service or improper maintenance, modifications, alterations that are outside of the original specifications of the Product, or damage resulting from use of parts or accessories not manufactured or approved by BRP which in its reasonable judgement are either incompatible with the product or adversely affect its operation, performance or durability or resulting from repairs done by a person that is not an authorized servicing Distributor/Dealer.
- Damage resulting from the installation of parts with specifications that differ from the original Product parts, such as, without limitation, different tires, exhaust system, wheels or brakes.
- Damage resulting from abuse, abnormal use, neglect, racing or operation of the Product in a manner inconsistent with the recommendations of the *OPERATOR'S GUIDE*.
- Damage resulting from water ingestion, accident, road hazards, submersion, fire, theft, vandalism or any act of God.
- Damage resulting from operation with fuels, oils or lubricants with specifications different than as recommended in the *OPERATOR'S GUIDE*.
- Damage resulting from corrosion from road salts, battery acid, environmental influences or treatment contrary to the *OPERATOR'S GUIDE*.
- Incidental or consequential damages, including without limitation, expense for gasoline, expense for transporting the Product to and from the authorized Distributor/Dealer, mechanic's travel time, trailering or towing, storage, telephone, cell phone, fax or telegram charges, rental of a like or replacement Product during warranty services or down time, taxi, travel, lodging, loss of or damage to personal property, inconvenience, cost of insurance coverage, loan payments, loss of time, loss of income, revenue or profits, or loss of enjoyment or use of Product.

4. WARRANTY COVERAGE PERIOD

This warranty will be in effect from the date of delivery to the first retail consumer or the date the Product is first put into use, whichever occurs first and for the following periods:

1. For private, recreational use, **TWENTY-FOUR (24) CONSECUTIVE MONTHS**, except for the items covered in points (2) and (3) below; and for commercial use **TWELVE (12) CONSECUTIVE MONTHS**, except for the items covered in points (2) and (3) below.
The Product is used commercially when it is used in connection with any work or employment that generates income, during any part of the warranty period. The Product is also used commercially when, at any point during the warranty period, it is licensed for commercial use;
2. For the battery, **SIX (6) CONSECUTIVE MONTHS**;
3. For the tires, **SIX (6) CONSECUTIVE MONTHS** or until tires are worn to the last three thirty-second of an inch (3/32 ") (2.38 millimeters) for the front tires and the last five thirty-second of an inch (5/32 ") (3.97 millimeters) for the rear tire, whichever occurs first.

The repair or replacement of parts or the performance of service under this warranty does not extend the life of this warranty beyond its original expiration date.

Note that the duration and any other modalities of the warranty coverage are subject to the applicable national or local legislation in the customer's country.

5. CONDITIONS TO HAVE WARRANTY COVERAGE

This warranty coverage is available **only** if each of the following conditions has been fulfilled:

- The Product must be purchased as new and unused by its first owner from a Distributor/Dealer authorized to distribute the Product in the country or union of countries in which the sale occurred;
- The BRP specified pre-delivery inspection process has been completed and documented by the purchaser and the authorized Distributor/Dealer and signed by the purchaser;
- The Product must have undergone proper warranty registration by an authorized Distributor/Dealer;
- The Product must be purchased in the country or union of countries in which the purchaser resides.
- Routine maintenance as outlined in the *OPERATOR'S GUIDE* must be performed in a timely manner. BRP reserves the right to make warranty coverage contingent upon proof of proper maintenance.

BRP will not honour this limited warranty to any private use owner or commercial use owner if one of the preceding conditions has not been met. Such limitations are necessary in order to allow BRP to preserve both the safety of its products, and also that of its consumers and the general public.

6. WHAT TO DO TO OBTAIN WARRANTY COVERAGE

The customer must cease using the Product upon the appearance of an anomaly. The customer must notify an authorized servicing Distributor/Dealer within two (2) months of the appearance of a defect, and provide it with reasonable access

to the Product and reasonable opportunity to repair it. The customer must also present to the authorized Distributor/Dealer, proof of purchase of the Product and must sign the repair/work order prior to starting the repair in order to validate the warranty repair. All parts replaced under this limited warranty become the property of BRP. Note that the notification period is subject to the applicable national or local legislation in customer's country.

7. WHAT BRP WILL DO

To the extent permitted by law, BRP's obligations under this warranty are limited to, at its sole discretion, repairing parts found defective under normal use, maintenance and service, or replacing such parts with new genuine Product parts without charge for parts and labour, at any authorized Distributor/Dealer during the warranty coverage period under the conditions described herein. BRP's responsibility is limited to making the required repairs or replacements of parts. No claim of breach of warranty shall be cause for cancellation or rescission of the sale of the Product to the owner. You may have other legal rights which may vary from country to country.

In the event that service is required outside of the country of original sale, or for EEA residents, if service is required outside of the EEA, the owner will bear responsibility for any additional charges due to local practices and conditions, such as, but not limited to, freight, insurance, taxes, license fees, import duties, and any and all other financial charges, including those levied by governments, states, territories and their respective agencies.

BRP reserves the right to improve or modify products from time to time without assuming any obligation to modify all products previously manufactured.

8. TRANSFER

If the ownership of a Product is transferred during the warranty coverage period, this limited warranty, subject to its terms and conditions, shall also be transferred and be valid for the remaining coverage period provided BRP or an authorized Distributor/Dealer receives a proof that the former owner agreed to the transfer of ownership, in addition to the coordinates of the new owner.

9. CONSUMER ASSISTANCE

In the event of a controversy or a dispute in connection with this limited warranty, BRP suggests that you try to resolve the issue at the Distributor/Dealer level. We recommend discussing the issue with the authorized Distributor/Dealer's service manager or owner.

If the matter still remains unresolved, contact BRP by filling out the customer contact form at www.brp.com or contact BRP by mail at one of the addresses listed under the *CONTACT US* section of this guide.

ADDITIONAL TERMS AND CONDITIONS FOR FRANCE ONLY

The following terms and conditions are applicable to products sold in France only:

The seller shall deliver goods that are complying with the contract and shall be responsible for defects existing upon delivery. The seller shall also be responsible for defects resulting from packaging, assembling instructions or the installation when it is its responsibility per the contract or if accomplished under its responsibility. To be compliant with the contract, the good shall:

1. Be fit for normal use for goods similar thereto and, if applicable:
 - 1.1 Correspond to the description provided by the seller and have the qualities presented to the buyer though sample or model;
 - 1.2 Have the qualities that a buyer may legitimately expect considering the public declarations of the seller, the manufacturer of its representative, including in advertising or labeling; or
2. Have the characteristics mutually agreed upon as between the parties or be fit for the specific use intended by the buyer and brought to the attention of the seller and which accepted.

The action for failure to comply is prescribed after two years after delivery of the goods. The seller is responsible for the warranty for hidden defects of the good sold if such hidden defects are rendering the good unfit for the intended use, or if they diminish its use in such a way that the buyer would not have acquired the good or would have given a lesser price, had he known. The action for such hidden defects shall be taken by the buyer within 2 years of the discovery of the defect.

* In the European Economic Area and elsewhere, Products are distributed and serviced by BRP European Distribution S.A. and other subsidiaries of BRP.

© 2020 Bombardier Recreational Products Inc. All rights reserved.

®and ™ are trademarks of Bombardier Recreational Products Inc. or its affiliates.

MAINTENANCE RECORDS

Send photocopy of maintenance record to BRP if needed.

PREDELIVERY	
Serial number: _____ Mileage / km: _____ Hours: _____ Date: _____ Dealer no: _____ Notes: _____ _____	Signature/Print: _____
Refer to vehicle Pre-Delivery Bulletin for detailed installation procedures	

FIRST INSPECTION	
Mileage / km: _____ Hours: _____ Date: _____ Dealer no: _____ Notes: _____ _____	Signature/Print: _____
For maintenance schedule refer to Maintenance Information section of this operator's guide	

SERVICE	
Mileage / km: _____ Hours: _____ Date: _____ Dealer no: _____ Notes: _____ _____	Signature/Print: _____
For maintenance schedule refer to Maintenance Information section of this operator's guide	

SERVICE

Mileage / km: _____

Hours: _____

Date: _____

Dealer no: _____

Notes: _____

Signature/Print:

For maintenance schedule refer to Maintenance Information section of this operator's guide

SERVICE

Mileage / km: _____

Hours: _____

Date: _____

Dealer no: _____

Notes: _____

Signature/Print:

For maintenance schedule refer to Maintenance Information section of this operator's guide

SERVICE

Mileage / km: _____

Hours: _____

Date: _____

Dealer no: _____

Notes: _____

Signature/Print:

For maintenance schedule refer to Maintenance Information section of this operator's guide

SERVICE

Mileage / km:

Hours:

Date:

Dealer no:

Notes:

Signature/Print:

For maintenance schedule refer to Maintenance Information section of this operator's guide

SERVICE

Mileage / km:

Hours:

Date:

Dealer no:

Notes:

Signature/Print:

For maintenance schedule refer to Maintenance Information section of this operator's guide

***This page is
intentionally blank***

CUSTOMER INFORMATION

PRIVACY INFORMATION

BRP wishes to inform you that your coordinates will be used for safety and warranty related purposes. Furthermore, BRP and its affiliates may use its customer list to distribute marketing and promotional information about BRP and related products.

To exercise your right to consult or correct your data, or to be removed from the addressee-list for direct marketing, please contact BRP.

By E-mail: privacyofficer@brp.com

By mail: BRP Legal Service
726 St-Joseph
Valcourt QC
Canada,
J0E 2L0

CONTACT US

Web Site

www.brp.com

Asia

Room 4609, Tower 2,
Grand Gateway 3 Hong Qiao
Road Shanghai,
China 200020

21F Shinagawa East One Tower
2-16-1 Konan, Minatoku-ku,
Tokyo 108-0075
Japan

Europe

Skaldenstraat 125
B-9042 Gent
Belgium

Itterpark 11
D-40724 Hilden
Germany

ARTEPARC Bâtiment B
Route de la côte d'Azur, Le Canet
13590 Meyreuil
France

Ingvald Ystgaardsvei 15
N-7484 Trondheim
Norway

Isoaavantie 7
PL 8040
96101 Rovaniemi

Spinnvägen 15
903 61 Umeå
Sweden

Avenue d'Ouchy 4-6
1006 Lausanne
Switzerland

North America

565 de la Montagne Street
Valcourt (Québec) J0E 2L0
Canada

Sa De Cv, Av. Ferrocarril 202
Parque Ind. Querétaro, Lote2-B
76220
Santa Rosa Jáuregui, Qro., Mexico
Sturtevant, Wisconsin, U.S.A.
10101 Science Drive
Sturtevant, Wisconsin
53177
U.S.A.

Oceania

6 Lord Street
Lakes Business Park
Botany, NSW 2019
Australia

3B Echelon Place, East Tamaki,
Auckland 2013,
New Zealand

South America

Rua James Clerck Maxwell, 230
TechnoPark Campinas SP 13069-380
Brazil

CHANGE OF ADDRESS/OWNERSHIP

If your address has changed or if you are the new owner of the vehicle, be sure to notify BRP by either:

- Notifying an authorized Can-Am roadster dealer.
- **North America Only:** calling at 1-888-272-9222;
- Mailing one of the change of address cards on the following pages at one of the BRP addresses indicated in the *CONTACT US* section of this guide.

In case of change of ownership, please join a proof that the former owner agreed to the transfer.

Notifying BRP, even after the expiration of the limited warranty, is very important as it enables BRP to reach the vehicle owner if necessary, like when safety recalls are initiated. It is the owner's responsibility to notify BRP.

STOLEN UNITS: If your personal vehicle is stolen, you should notify BRP or an authorized Can-Am roadster dealer. We will ask you to provide your name, address, phone number, the vehicle identification number and the date it was stolen.

***This page is
intentionally blank***

Model No. _____

Vehicle

Identification Number (V.I.N.) _____

ENGINE

Identification Number (E.I.N.) _____

OWNER: _____

NAME

No.

STREET

APT

CITY

STATE/PROVINCE

ZIP/POSTAL CODE

Purchase Date

| | |
YEAR MONTH DAY

Warranty Expiry Date

| | |
YEAR MONTH DAY

To be completed by the dealer at the time of the sale.

DEALER IMPRINT AREA

WARNING

This Can-Am On-road product is a different type of vehicle. It requires special skills and knowledge. Learn how this product is different.

- **BEFORE YOU OPERATE THIS VEHICLE, READ THIS OPERATOR'S GUIDE, ALL ON PRODUCT SAFETY LABELS AND WATCH THE SAFETY VIDEO.**



- **COMPLETE** a training course (if available), practice, become proficient with the controls, and get a proper license.
- **REFER** to the Safety Card before riding.

- **ALWAYS WEAR A HELMET AND RIDING GEAR.** With this type of vehicle, riders are exposed to more road risks than in a car. Even skilled operators can be struck by other vehicles or lose control. This vehicle will not protect you in a crash.
- **HANDLING LIMITS AND ROAD CONDITIONS.** The Vehicle Stability System (VSS) cannot stop you from losing control, flipping over, or falling off if you exceed this vehicle's limits. Know the limits for different road conditions. Do not ride on ice, snow, or off road. Avoid puddles and running water. This type of vehicle can hydroplane on water and slip on gravel, dirt and sand covered roads. If you must go through these road conditions, slow down.

