

can-am®



2017 ROADSTER OPERATOR'S GUIDE

Includes Safety, Vehicle
and Maintenance
Information

SPYDER® RT™

WARNING

Learn how the Spyder roadster is different.

Read this operator's guide and watch the safety DVD.

Complete a training course (if available), practice and become proficient with the controls.

Consult local laws - license requirements vary by location.

Keep this guide in the front storage compartment.

2 1 9 0 0 1 7 0 2

Original Instructions

CALIFORNIA PROPOSITION 65 WARNING



This vehicle contains or emits chemicals known to the state of California to cause cancer and birth defects or other reproductive harm.



In Canada, products are distributed by Bombardier Recreational Products Inc.
In USA, products are distributed by BRP US Inc.

This is a non-exhaustive list of trademarks that are the property of Bombardier Recreational Products Inc. or its affiliates:

Can-Am®

Rotax®

Spyder®

XPS™



iPhone, iPod, iPod nano and iPod touch are trademarks of Apple Inc. registered in U.S.A. and other countries.

“Made for iPod” and “Made for iPhone” mean that an electronic accessory has been designed to connect specifically to iPod or iPhone, respectively, and has been certified by the developer to meet Apple performance standards. Apple is not responsible for the operation of this device or its compliance with safety and regulatory standards. Please note that the use of this accessory with iPod or iPhone may affect wireless performance.

FOREWORD

Deutsch	Dieses Handbuch ist möglicherweise in Ihrer Landessprache verfügbar. Bitte wenden Sie sich an Ihren Händler oder besuchen Sie: www.operatorsguide.brp.com
English	This guide may be available in your language. Check with your dealer or go to: www.operatorsguide.brp.com
Español	Es posible que este manual esté disponible en su idioma. Consulte a su distribuidor o visite: www.operatorsguide.brp.com
Français	Ce guide peut être disponible dans votre langue. Vérifier avec votre concessionnaire ou aller à: www.operatorsguide.brp.com
日本語	このガイドは、言語によって翻訳版が用意されています。ディーラーに問い合わせるか、次のアドレスでご確認ください： www.operatorsguide.brp.com
Nederlands	Deze handleiding kan beschikbaar zijn in uw taal. Vraag het aan uw dealer of ga naar: www.operatorsguide.brp.com
Norsk	Denne boken kan finnes tilgjengelig på ditt eget språk. Kontakt din forhandler eller gå til: www.operatorsguide.brp.com
Português	Este manual pode estar disponível em seu idioma. Fale com sua concessionária ou visite o site: www.operatorsguide.brp.com
Suomi	Käyttöohjekirja voi olla saatavissa omalla kielelläsi. Tarkista jälleenmyyjältä tai käy osoitteessa: www.operatorsguide.brp.com
Svenska	Denna bok kan finnas tillgänglig på ditt språk. Kontakta din återförsäljare eller gå till: www.operatorsguide.brp.com

Congratulations on your purchase of a new Can-Am® Spyder® Roadster. It is backed by the Bombardier Recreational Products Inc. (BRP) warranty and a network of authorized dealers ready to provide the parts, service or accessories you may require.

Your dealer is committed to your satisfaction. He has taken training to perform the initial set-up and inspection of your roadster before you took possession.

At delivery, you were informed of the warranty coverage and signed the *PREDELIVERY CHECK LIST* to ensure your new vehicle was prepared to your entire satisfaction.

Know Before you Go

For your safety and the safety of passengers and bystanders, read the following sections before you operate the Spyder roadster:

- GENERAL PRECAUTIONS
- VEHICLE INFORMATION
- SAFE OPERATING INSTRUCTIONS
- PRE-RIDE INSPECTION.

Experienced motorcyclists should pay special attention to the *WHAT'S DIFFERENT ABOUT THE SPYDER ROADSTER* subsection.

Safety Messages

The types of safety messages, what they look like and how they are used in this guide are explained as follows:

The safety alert symbol  indicates a potential injury hazard.

 WARNING
Indicates a potential hazard, if not avoided, could result in serious injury or death.

 **CAUTION** Indicates a hazard situation which, if not avoided, could result in minor or moderate injury.

NOTICE Indicates an instruction which, if not followed, could severely damage vehicle components or other property.

About this Operator's Guide

This Operator's Guide was written in North America in a right-lane driving environment. Please adapt your application of these maneuvers to your jurisdiction and rules of the road.

In this Operator's Guide, the word motorcycle typically refers to a two-wheeled motorcycle.

Keep this Operator's Guide in the front storage compartment so that you can refer to it for things such as maintenance, troubleshooting and instructing others.

If you want to view and/or print an extra copy of your Operator's Guide, simply visit the following website www.operatorsguide.brp.com.

The informations contained in this document are correct at the time of publication. BRP, however, maintains a policy of continuous improvement of its products without imposing upon itself any obligation to install them on products previously manufactured. Due to late changes, some differences between the manufactured product and the descriptions and/or specifications in this guide may occur. BRP reserves

the right at any time to discontinue or change specifications, designs, features, models or equipment without incurring any obligation upon itself.

This Operator's Guide and the *SAFETY DVD* video should remain with the vehicle when it is sold.

Refer to Other Sources of Information

In addition to reading this Operator's Guide, you should read the Safety Card on the vehicle and watch the *SAFETY DVD* video.

If possible, take a training course that is specifically designed for the Spyder roadster. Check our website at www.can-am.brp.com for more information about upcoming training course availability. If you cannot take a training course specifically designed for the Spyder roadster, it is a good idea to take a motorcycle training course, since some of the skills required are similar and information about managing risk on the road is taught and similarly applies to riding your Spyder roadster.

Acknowledgment

BRP wishes to thank the Motorcycle Safety Foundation (MSF) for giving permission to BRP to use their material related to street motorcycle safety found in this Operator's Guide.

The MSF is an internationally recognized not for profit foundation and is supported by motorcycle manufacturers. It provides training, tools and partnerships to the motorcycle safety community. Visit its website at www.msf-usa.org.

TABLE OF CONTENTS

FOREWORD	1
Know Before you Go	1
Safety Messages	1
About this Operator's Guide	2
Refer to Other Sources of Information	2
Acknowledgment	2
GENERAL PRECAUTIONS	8
Avoid Carbon Monoxide Poisoning	8
Avoid Gasoline Fires and Other Hazards	8
Avoid Burns from Hot Parts	8
Accessories and Modifications	8
VEHICLE INFORMATION	
PRIMARY CONTROLS	10
1) Handlebar	11
2) Throttle	11
3) Clutch Lever (SM6 Model)	12
4) Gearshift Lever (SM6 Model)	12
5) Gearshift Selector (SE6 Model)	13
6) Brake Pedal	13
7) Parking Brake Switch	14
SECONDARY CONTROLS	16
1) Ignition Switch	17
2) Engine Start Button	17
3) Engine Stop Switch	18
4) Hazard Warning Switch	18
5) Cruise Control Switch	18
6) Headlight Switch	20
7) Turn Signal Button	21
8) Horn Button	22
9) Windshield Adjustment Button	22
10) RECC (Roadster Electronic Command Center)	22
11) Reverse Button	23
12) PTT (Push To Talk) Button	23
13) Switch Cluster	24
PASSENGER CONTROLS	27
Passenger Heated Grip Switch	27
Passenger Audio Controls	27
MULTIFUNCTION GAUGE	28
Multifunction Gauge Description	28
Multifunction Gauge Startup Information	29
Digital Display Description	30
Navigating in the Digital Display	32
Category Icon Screen Description	33

ANALOG GAUGES (OPTION PACKAGE)	38
Fuel Level Gauge	38
Engine Coolant Temperature Gauge.....	38
AUDIO CONTROLS	39
Audio System Power	39
Audio Volume Control.....	39
Self-Adjusting Audio Volume	39
Audio Mute	39
Radio Band.....	39
AUX (Auxiliary) and USB Port.....	40
NAV Sound.....	41
CB Screen (Optional).....	42
GPS (OPTION PACKAGE)	43
GPS Receiver Installation.....	43
GPS Receiver Removal	43
EQUIPMENT	44
Mirrors	44
Front Storage Compartment	45
Seat	45
Storage Compartments	46
Helmet	48
Tool Kit	48
Operator's Guide.....	48
Body Panels	49
BASIC PROCEDURES	54
Adjusting the Passenger Footrest	54
Starting and Stopping the Engine	54
Operating in Reverse	56
Operation During Break-In.....	56
Fueling	57
Adjusting Suspension.....	58
Using the 12 V Power Outlet	60
Using the Audio in Jack.....	61
SAFE OPERATING INSTRUCTIONS	
WHAT'S DIFFERENT ABOUT THE SPYDER ROADSTER	64
Stability	64
Response to Road Conditions.....	64
Brake Pedal	64
Parking Brake.....	64
Steering.....	64
Width.....	65
Reverse	65
Driver's License and Local Laws.....	65

DRIVING AID TECHNOLOGIES	66
Vehicle Stability System (VSS)	66
Dynamic Power Steering (DPS)	67
UNDERSTANDING RISK ON THE ROAD	68
Type of Vehicle	68
Operator Skills and Judgment	68
Rider Condition	68
Vehicle Condition	69
Road and Weather Conditions	69
RIDING GEAR	70
Helmets	70
Other Riding Gear	70
REQUIRED RIDING SKILLS AND PRACTICE EXERCISES	73
Choosing a Practice Area	73
Preparing to Ride	74
Riding Posture	74
Practice Exercises (SM6 Model)	74
Practice Exercises (SE6 Model)	83
Developing Advanced Riding Skills	90
STREET STRATEGIES	91
Plan your Trip	91
Defensive Riding	91
Being Visible	92
Lane Position	93
Common Riding Situations	94
Road Conditions and Hazards	96
On-Road Emergencies	97
Tire Failure	98
CARRYING A PASSENGER, CARGO OR TOWING A TRAILER	99
Weight Limits	99
Operating with Extra Weight	99
Carrying a Passenger	99
Where to Store Cargo	100
Towing a Trailer	101
KNOWLEDGE SELF-TEST	104
Questionnaire	104
Answers	106
SAFETY INFORMATION ON THE VEHICLE	107
Hang Tag	107
Safety Card	108
Safety Labels (All models except European models)	109
Safety Labels (European models)	113
REPORTING SAFETY DEFECTS	117

PRE-RIDE INSPECTION

PRE-RIDE CHECKLIST **120**
 Before Starting the Vehicle, Inspect the Following: 120
 Turn Ignition Key to the ON Position: 121

MAINTENANCE

MAINTENANCE SCHEDULE **124**
FIRST INSPECTION..... **127**
MAINTENANCE PROCEDURES **128**
 Engine Oil 128
 Air Filter 131
 Engine Coolant 132
 Radiator Fans 133
 Clutch Fluid (SM6 Model)..... 134
 Battery 135
 Drive Belt 136
 Wheels and Tires 138
 Brakes 139
 Headlights 140
VEHICLE CARE **145**
 Vehicle Cleaning 145
 Vehicle Protection 145
STORAGE AND PRESEASON PREPARATION **146**
 Storage 146
 Preseason Preparation 146

ROAD SIDE REPAIRS

DIAGNOSTIC GUIDELINES **148**
 Will not Shift into First Gear (SM6 Model) 148
 Will not Shift into Neutral (SE6 Model) 148
 Will not Shift (SE6 Model) 148
 Engine Does Not Start 148
 Manual is Displayed in the Gauge..... 149
MESSAGES IN MULTIFUNCTION GAUGE **150**
WHAT TO DO IN THE FOLLOWING CIRCUMSTANCES **153**
 Lost Keys 153
 Cannot Open the Side Storage Compartment 153
 Flat Tire 153
 Dead Battery..... 154
HOW TO REPLACE FUSES AND LIGHTS **155**
 Fuses 155
 Lights..... 157

TRANSPORTING THE VEHICLE 165

TECHNICAL INFORMATION

VEHICLE IDENTIFICATION 168
 Vehicle Identification Number..... 168
 Engine Identification Number 168
 EPA Compliance Label..... 169

NOISE EMISSION CONTROL SYSTEM REGULATION 170

RADIO FREQUENCY DIGITALLY ENCODED SECURITY SYSTEM (RF D.E.S.S. KEY) 171

SPECIFICATIONS 172

WARRANTY

BRP LIMITED WARRANTY — USA AND CANADA: 2017 Can-Am® SPYDER® ROADSTER 180

BRP LIMITED WARRANTY OUTSIDE USA AND CANADA: 2017 Can-Am® SPYDER® ROADSTER..... 188

CUSTOMER INFORMATION

PRIVACY INFORMATION 194

CONTACT US..... 195
 North America 195
 Europe 195
 Oceania 195
 South America..... 195
 Asia..... 195

CHANGE OF ADDRESS/OWNERSHIP 196

GENERAL PRECAUTIONS

Avoid Carbon Monoxide Poisoning

All engine exhaust contains carbon monoxide, a deadly gas. Breathing carbon monoxide can cause headaches, dizziness, drowsiness, nausea, confusion and eventually death.

Carbon monoxide is a colorless, odorless, tasteless gas that may be present even if you do not see or smell any engine exhaust. Deadly levels of carbon monoxide can collect rapidly, and you can quickly be overcome and unable to save yourself. Also, deadly levels of carbon monoxide can linger for hours or days in enclosed or poorly ventilated areas. If you experience any symptoms of carbon monoxide poisoning, leave the area immediately, get fresh air and seek medical treatment.

To prevent serious injury or death from carbon monoxide:

- Never run the vehicle in poorly ventilated or partially enclosed areas such as garages, carports or barns. Even if you try to ventilate engine exhaust with fans or open windows and doors, carbon monoxide can rapidly reach dangerous levels.
- Never run the vehicle outdoors where engine exhaust can be drawn into a building through openings such as windows and doors.

Avoid Gasoline Fires and Other Hazards

Gasoline is extremely flammable and highly explosive. Fuel vapors can spread and be ignited by a spark or flame many feet away from the engine. To reduce the risk of fire or explosion, follow these instructions:

- Refuel outdoors in a well ventilated area away from flames, sparks, lit cigarettes and other sources of ignition.
- Never add fuel with engine running.

- Never top off the fuel tank. Leave some room for the fuel to expand with temperature changes.
- Wipe up any spilled fuel.
- Never start or operate the engine with the fuel cap removed.
- Use only an approved red gasoline container to store fuel.
- Do not carry gasoline containers in the front storage compartment or anywhere else on the vehicle.

Gasoline is poisonous and can cause injury or death.

- Never siphon gasoline by mouth.
- If you swallow gasoline, get any in your eye or inhale gasoline vapor, see your doctor immediately.

If gasoline spills on you, wash with soap and water and change your clothes.

Avoid Burns from Hot Parts

The exhaust, oil and cooling systems, and engine become hot during operation. Avoid contact during and shortly after operation to avoid burns.

Accessories and Modifications

Do not make unauthorized modifications, or use attachments or accessories that are not approved by BRP. Since these changes have not been tested by BRP, they may increase the risk of crashes on the road or injuries, and they can make the vehicle illegal for use on the road.

Unlike most motorcycles, the Spyder roadster is equipped with a Vehicle Stability System (VSS), which is calibrated for the vehicle normal configuration. VSS may not function properly if the vehicle is modified, such as changing weight distribution, wheelbase, tires, suspension, brakes or steering.

See your authorized Can-Am roadster dealer for available accessories for your vehicle.

VEHICLE INFORMATION

PRIMARY CONTROLS

It is important to know the location and operation of all controls, and to develop and practice smooth and coordinated use of them.

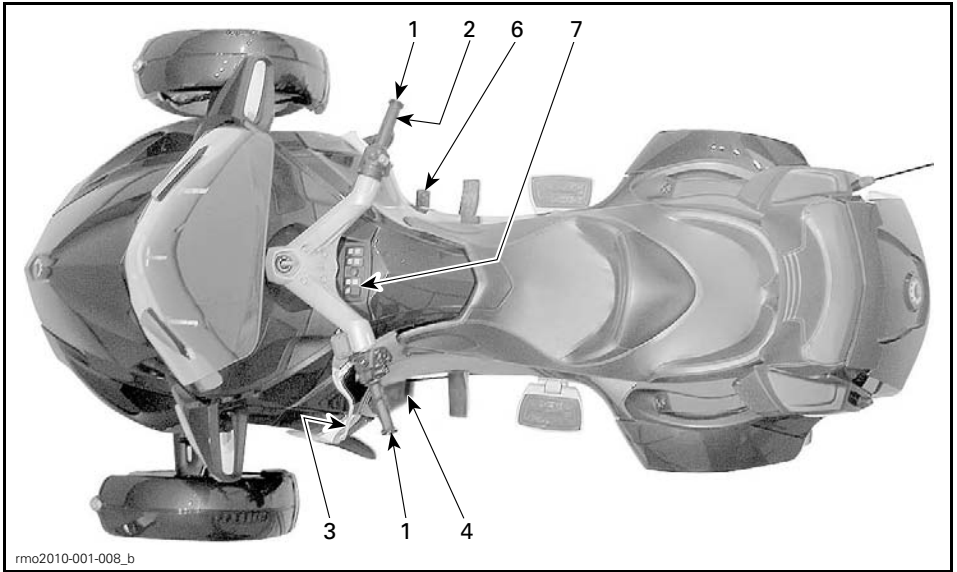

TYPICAL — SM6 MODEL

1	Handlebar
2	Throttle
3	Clutch Lever
4	Gearshift Lever
6	Brake Pedal
7	Parking Brake Switch

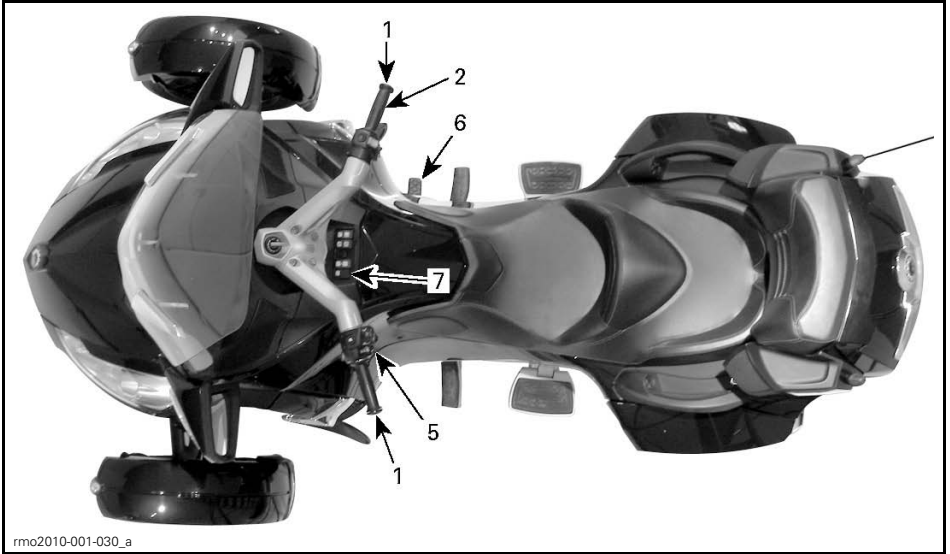

rmo2010-001-030_a

TYPICAL — SE6 MODEL

1	Handlebar
2	Throttle
5	Gearshift Selector
6	Brake Pedal
7	Parking Brake Switch

1) Handlebar

Grip the handlebar with both hands. Steer the handlebar in the direction you want to go.

2) Throttle

The throttle is the right handgrip, and it controls engine speed. To increase engine speed, roll the throttle as shown (lower your wrist).

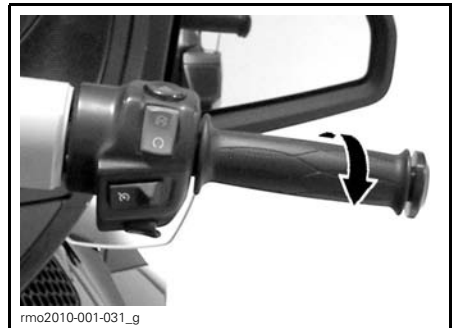

rmo2010-001-031_g

TO INCREASE SPEED

To decrease engine speed, roll the throttle as shown (raise your wrist).

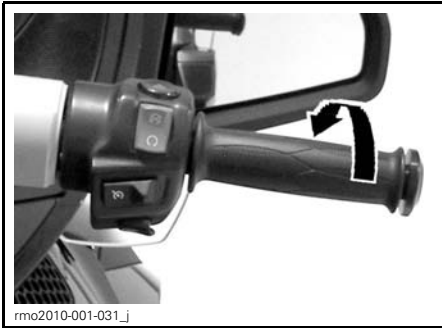

TO DECREASE SPEED

The throttle is spring loaded and should return to idle when you release your grip.

NOTE: This vehicle is equipped with an ETC (Electronic Throttle Control). The throttle plates in the throttle body are controlled electronically and can be opened or closed irrespective of the throttle twist grip position when necessary. It may happen that when you accelerate, the VSS (Vehicle Stability System) prevents engine acceleration in order to maintain vehicle stability. Then, when the vehicle is stabilized, the engine RPM would increase as requested if the throttle was maintained. This would be felt as a "delayed" acceleration.

3) Clutch Lever (SM6 Model)

The clutch lever is in front of the left handgrip. The clutch controls the transmission of power from the engine to the rear wheel. The lever is squeezed in to disengage power and eased out to engage power.

Clutch Lever Position Adjustment

The distance between the clutch lever and handgrip can be adjusted from position 1 (greatest distance) to position 4 (smallest distance).

1. Push the clutch lever forward to release the adjuster dial. Hold in position.
2. Turn the adjuster dial to the desired position aligning the dial number with the dot on the lever.
3. Release the clutch lever.

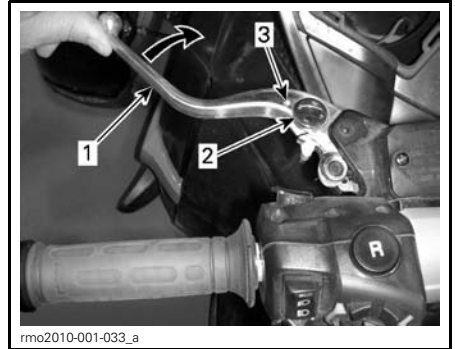

CLUTCH LEVER ADJUSTMENT

1. Clutch lever
2. Adjuster dial
3. Dot

4) Gearshift Lever (SM6 Model)

The gearshift lever is in front of the left footrest.

The gear pattern is Reverse-1-Neutral-2-3-4-5-6.

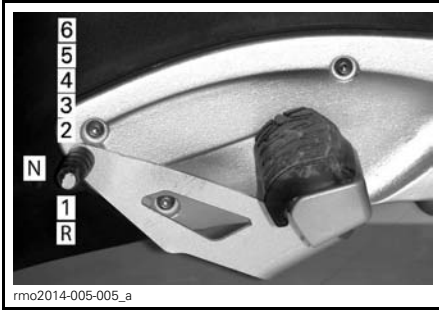

TYPICAL

Lift or press fully to move sequentially from one gear to the next. When the lever is released, it returns to center where the mechanism resets for the next shift UP or DOWN. Neutral (N) is selected by either a half lift from first gear or a half press from second gear.

NOTE: To shift from neutral to first gear, press the brake and shift up.

To shift into reverse, refer to *OPERATING IN REVERSE* in the *BASIC PROCEDURES* subsection for detailed instructions.

5) Gearshift Selector (SE6 Model)

The gearshift selector is below the left handgrip.



TYPICAL

1. Gearshift selector

The gear pattern is Reverse-Neutral-1-2-3-4-5-6.

Press selector forward to upshift. Pull selector toward you to downshift.

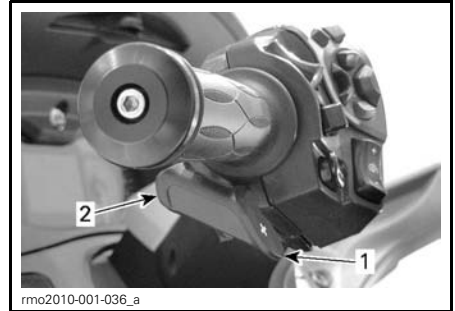

1. Upshift
2. Downshift

This shifts sequentially from one gear to the next. Release the selector after shifting.

To shift through multiple gears, use the selector multiple times.

To shift into neutral from first gear or reverse, briefly press or pull the gear selector. A longer activation will shift over neutral.

NOTE: To shift out of reverse into 1st gear, press the brake pedal and shift up.

NOTE: To shift from neutral to first gear, press the brake pedal and shift up.

When the gearshift selector is released, the mechanism resets for the next shift UP or DOWN.

If operator does not downshift when slowing down and engine RPM drops below a threshold value, the gearbox will automatically downshift to the next available gear.

If the engine is started with gearbox in gear, it will automatically shift to neutral position.

6) Brake Pedal

The brake pedal is in front of the right footrest. Press it down to operate. This pedal brakes all three wheels.

SM6 Models and SE6 Base Model

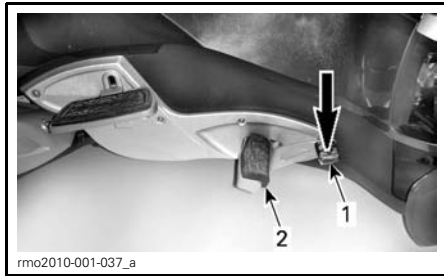

- 1. Brake pedal
- 2. Footrest

NOTE: When riding, make sure not to lean your foot on brake pedal. Otherwise, the engine management will activate the limp home mode to protect the braking system.

RT-S and RT Limited SE6 Models

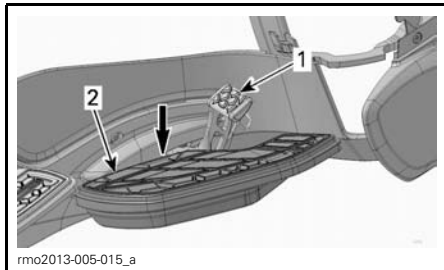

- NORMAL CONDITION**
- 1. Brake pedal
 - 2. Floorboard

A mechanism allows the floorboard to lower if the pedal needs to be pressed more than normal. If that occurs, push on the rear portion of the floorboard until it clicks and test the braking system.

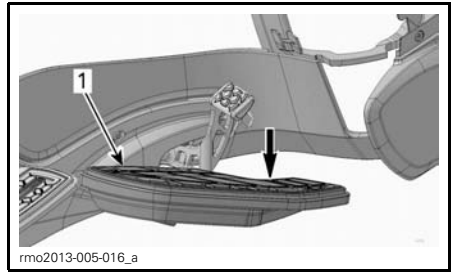

- LOWERED FLOORBOARD**
- 1. Floorboard

If this condition persists or if you find any braking system problems, refer to an authorized Can-Am Spyder roadster dealer.

7) Parking Brake Switch

The parking brake switch is located above the glove box. It allows to engage or release the electric parking brake.

On SE6 models, there will be a 20 second beep sound when stopping the engine while the parking brake is not engaged.



- 1. Parking brake switch

NOTE: To apply or release the parking brake, the ignition key must be turned ON.

NOTE: The battery voltage must be at 11 V minimum to activate the parking brake. If voltage is below 11 V, the parking brake indicator lamp will turn ON and the cluster will display a parking brake failure message.

Applying Parking Brake

With the vehicle stopped, press switch to apply the parking brake. The brake indicator lamp will flash.

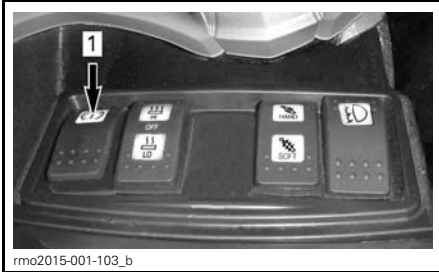

rmo2015-001-103_b

1. Press here

NOTE: The parking brake cannot be activated when the vehicle is above 10 km/h (6 MPH).

Check that the parking brake is fully engaged. Hold the clutch (on SM6 model) and rock the vehicle back and forth.

Releasing Parking Brake

To release parking brake, press and release switch and make sure brake indicator lamp turns OFF.

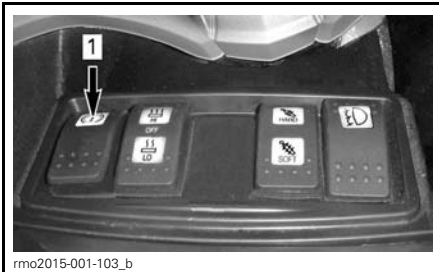

rmo2015-001-103_b

1. Press here

SECONDARY CONTROLS

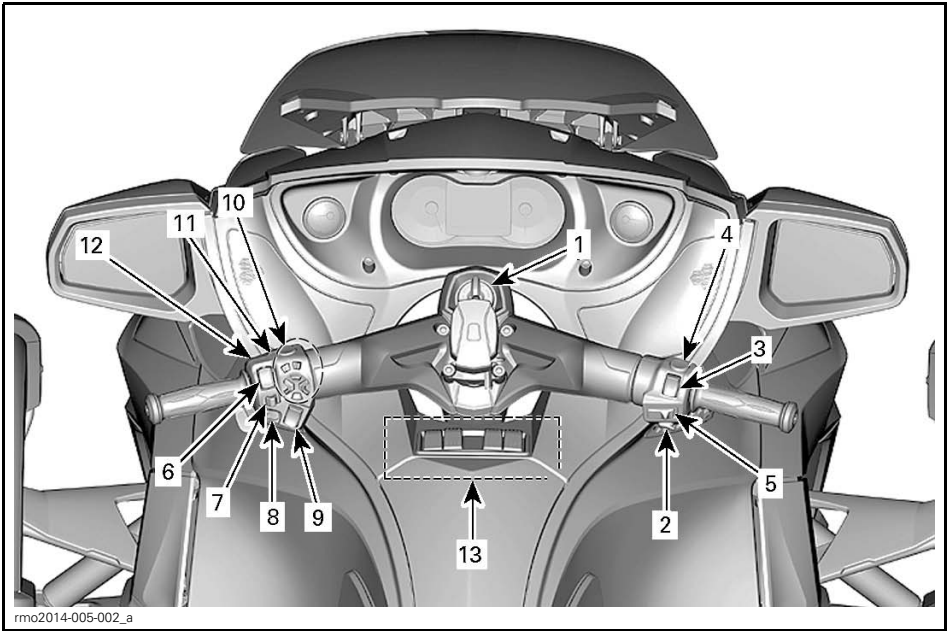

TYPICAL

1	Ignition switch	8	Horn button
2	Engine start button	9	Windshield adjustment button
3	Engine stop switch	10	RECC (Roadster Electronic Command Center)
4	Hazard warning switch	11	Reverse button
5	Cruise control switch	12	PTT (Push To Talk) button
6	Headlight switch	13	Switch cluster
7	Turn signal button		

1) Ignition Switch

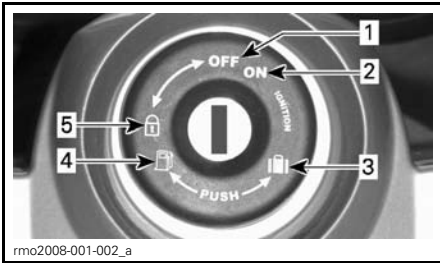

IGNITION SWITCH

1. OFF
2. ON
3. Front storage compartment opening
4. Seat opening/fuel tank access
5. Steering/glove box lock position

The ignition switch is located in the center of the handlebar. It controls:

- Engine ignition
- Seat opening mechanism to access:
 - Fuel tank cap
 - Brake fluid reservoirs
- Front storage compartment opening mechanism to access:
 - Operator's guide
 - Fuses
 - Battery terminals.
- Steering/glove box lock mechanism.

NOTICE If the key does not turn easily, do not force it. Pull it out and reinsert.

⚠ WARNING

If you turn the ignition switch to OFF, it shuts off the engine and all the electrical systems including the VSS and DPS. If you do this while the vehicle is moving, you could lose control and crash.

Two keys are provided with your vehicle. Each Spyder key contains a transponder chip specifically pre-programmed that is read via radio frequency by the immobilizer system to allow starting the engine. The

Spyder keys do not contain batteries. Do not take the key apart. If the immobilizer system cannot read the key, the engine will not start. For the conditions that can lead to the immobilizer system failing to read the key, refer to the *DIAGNOSTIC GUIDELINES*. Store the spare key in a safe place because you **must** have your spare key to have another one made by an authorized Can-Am Spyder roadster dealer.

NOTE: A key barrel is supplied in the glove box to use with the BRP optional trailer. This allows to use the vehicle key for the trailer.

Ignition Function

OFF

The key can be inserted or removed in this position.

In the OFF position, the electrical system of the vehicle is disabled.

The engine is shut down by turning the ignition switch to the OFF position.

ON

When the key is turned to this position, the electrical system of the vehicle is activated.

The gauge should wake-up.

The vehicle lights are turned on.

The engine can be started.

2) Engine Start Button

The engine start button is near the right handgrip.

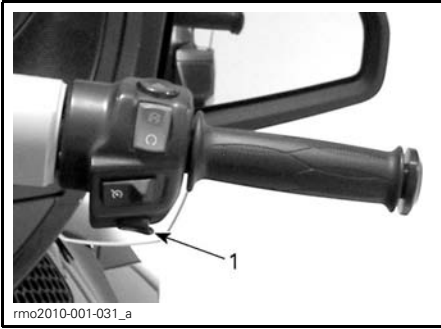

1. Engine start button

When depressed and held, it starts the engine.

3) Engine Stop Switch

The engine stop switch is near the right handgrip.

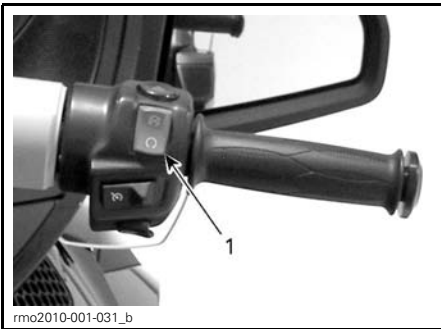

1. Engine stop switch

The switch has two positions and must be set to the run position before you can start the engine. It allows you to stop the engine anytime without removing your hand from the handlebar.

4) Hazard Warning Switch

The hazard warning switch is near the right handgrip.

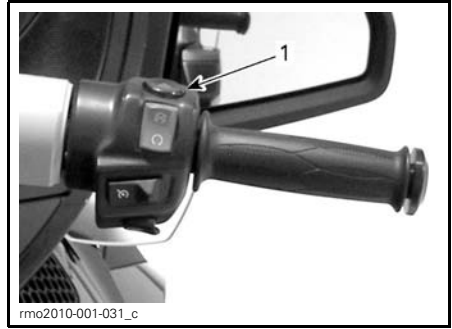

1. Hazard warning switch

Push the button to turn on the hazard warning lights.

5) Cruise Control Switch

The cruise control switch is near the right handgrip.

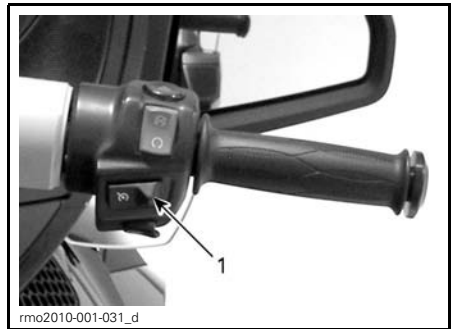

1. Cruise control switch

The switch is a multifunction switch. It allows to activate, set and stop the function of the cruise control.

⚠ WARNING

It is not recommended to use the cruise control when towing a trailer.

When set, the cruise control allows to maintain a steady speed while riding the vehicle. It will increase or reduce engine speed as necessary.

NOTE: The vehicle torque may vary slightly depending on the road conditions such as the wind, going downhill or uphill.

The cruise control is designed to be used for prolonged drives on low traffic highways. Never ride the vehicle with the cruise control activated in city streets, winding roads, in adverse weather or in any circumstances when you need the throttle control.

Cruise Control Limitations

The cruise control is not an automatic pilot, it will not drive the vehicle.

The cruise control is not aware of what is going on the road and it does not steer or apply the brakes for you.

⚠ WARNING

Improper use of the cruise control can lead the vehicle to a loss of control.

Setting the Cruise Control

To use the cruise control, the vehicle speed must be above approximately 40 km/h (25 MPH).

Turn the cruise control to ON by sliding the cruise control button to the right.

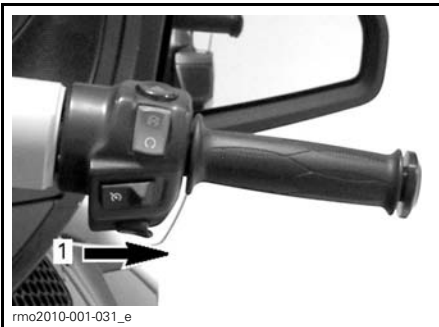

1. Slide button to the right

NOTE: The cruise control status will show CRUISE ON in the digital display.

Bring the vehicle at the speed you want to maintain then press the cruise button downward to SET the speed.

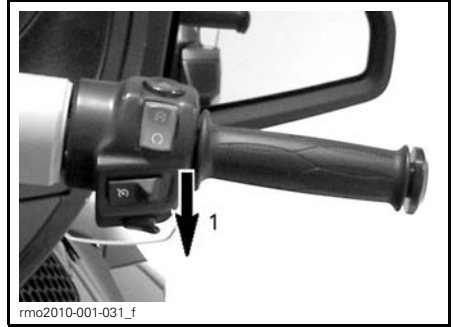

1. Push button downward to SET

NOTE: The cruise control status will show CRUISE SET in the digital display.

You can now release the throttle.

⚠ WARNING

Always keep both hands on the handlebar while riding. Otherwise, this could cause a vehicle loss of control.

NOTE: You can increase engine speed using the throttle grip if you need to go faster than the set speed. Releasing the throttle will allow the cruise control to recover the set speed.

Once the cruise control has been set, the speed setting may be increased or reduced by pushing the button UP or DOWN. Each press of the button will change the speed setting by increments of 1.6 km/h (1 MPH). Holding the button will change the speed setting until released or the operating limit has been reached.



CRUISE CONTROL PREVIOUSLY SET
 1. Push up button to increase the speed setting



CRUISE CONTROL PREVIOUSLY CANCELLED
 1. Push up button to RESUME

NOTE: The cruise control status will show CRUISE SET in the digital display.

Stopping the Cruise Control

To completely stop the cruise control operation, slide the cruise control button to the left.

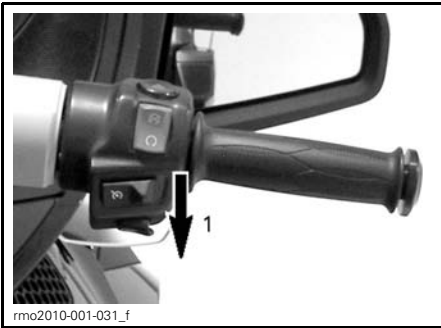

CRUISE CONTROL PREVIOUSLY SET
 1. Push down button to reduce the speed setting

Cancelling the Cruise Control

Any of the following event will cancel the cruise control.

- Pressing the brake pedal.
- Squeezing the clutch lever or if clutch slippage occurs (SM6 models).
- Gear change (SE6 model).
- Any vehicle stability system intervention.

Resuming the Cruise Control

If the cruise control was cancelled and the cruise control switch is still at the ON position, the cruise control operation can be resumed by pushing the cruise control button up. The cruise control will then recover the previous set speed.

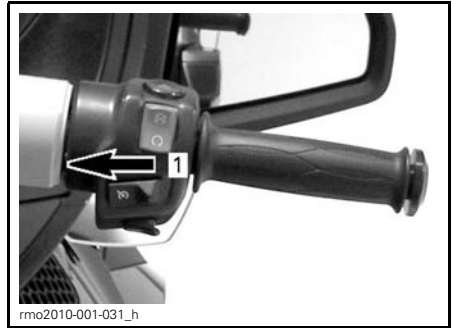

1. Slide button to OFF

NOTE: The CRUISE ON status will disappear in the digital display.

6) Headlight Switch

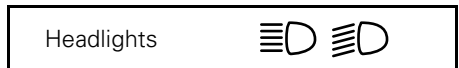

The switch is near the left handgrip.

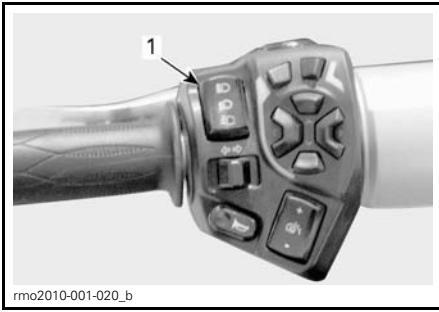

rmo2010-001-020_b

TYPICAL

1. Headlight switch

The switch is used to select high or low beam for the headlight. The headlights automatically turn on when the engine reaches 800 RPM and turn off after approximately 20 seconds when engine has been stopped.

To select high beams, push the switch to the front position. To select low beams, push the switch to the back position.

To flash the high beams, press the switch to the down position, then release it. The high beams will stay on as long as you hold down the switch.

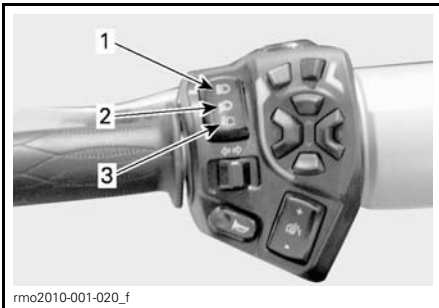

rmo2010-001-020_f

TYPICAL

1. High beams
2. Low beams
3. Flash high beams

7) Turn Signal Button

Left side turn signal	
Right side turn signal	

The turn signal button is located near the left handgrip.

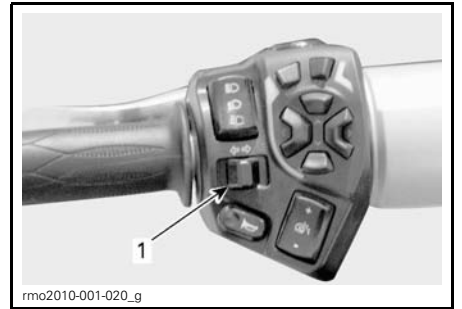

rmo2010-001-020_g

TYPICAL

1. Turn signal button

The turn signal button turns off automatically after a normal turn, but you may have to turn it off manually after a shallow turn or lane change.

To turn the signal off, press the button in.

Turn signals will automatically turn off after 30 seconds while the vehicle is moving.

8) Horn Button

The horn button is located near the left handgrip.

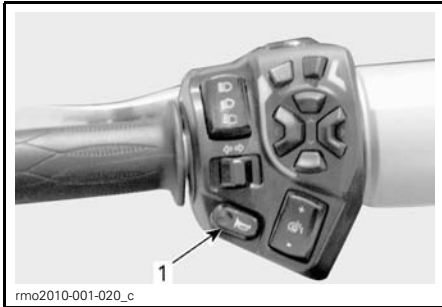

TYPICAL
1. Horn button

9) Windshield Adjustment Button

The windshield adjustment button is located near the left handgrip.

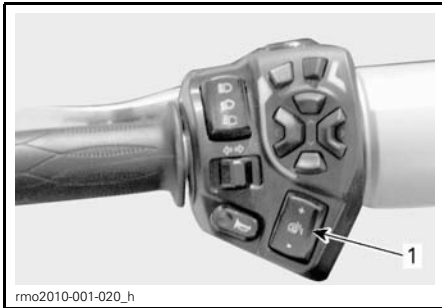

TYPICAL
1. Windshield adjustment button

The button allows to raise or lower the height of the windshield to your convenience.

⚠ CAUTION Ensure there is no object or anyone hand in the windshield area before adjusting the windshield height. It could damage the vehicle or cause injuries.

NOTE: Engine must be turned on to adjust the windshield.

To raise the windshield, press the button (+ sign). Release the button when the desired height is reached.

To lower the windshield, press the button (- sign). Release the button when the desired height is reached.

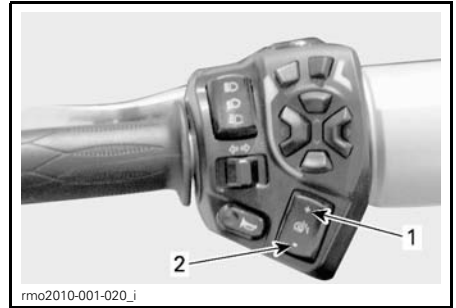

TYPICAL
1. To raise windshield
2. To lower windshield

10) RECC (Roadster Electronic Command Center)

The RECC is located near the left handgrip.

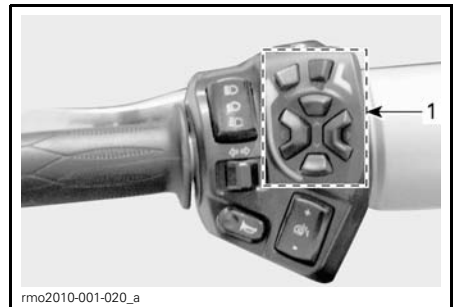

TYPICAL
1. RECC

The RECC is a multifunction switch.

The RECC allows the control of numerous functions of the multifunction gauge.

NOTE: Inputs given to the RECC may be halted for a short delay as the vehicle electronic modules prioritize vehicle main functions. This should not be considered a malfunction.

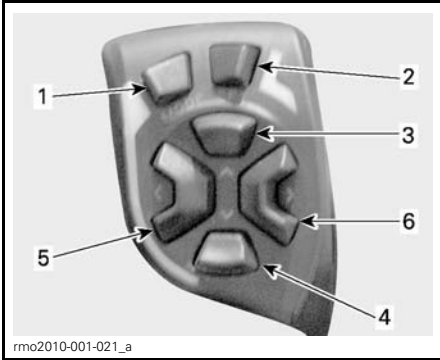

RECC BUTTONS

1. **MODE button:** *Navigate through the screens*
Holding button more than 2 seconds in main screen: *activates or deactivates ECO mode*
2. **SET button:**
Quick press then release: *Navigates through the secondary screens*
Holding button more than 1 second: *Sets a value in the current function or navigate to a setup screen*
3. **UP button:** *Increase the volume (audio) or a value*
4. **DOWN button:** *Decrease the volume (audio) or a value*
5. **LEFT button:** *Move the screen arrows to the left to select a secondary menu or a setting*
6. **RIGHT button:** *Move the screen arrows to the right to select a secondary menu or a setting*

⚠ WARNING

Using the RECC while driving can distract the driver from operating the vehicle. Always use buttons with caution and always keep your eyes on the road.

Audio Control

When in the default riding screen, pressing the UP or DOWN button will increase or decrease the audio volume.

NOTE: On models without a separate analog fuel level gauge, the fuel level bars will be replaced by the volume bars for a few seconds, then the fuel level bars will come back.

NOTE: The audio volume level can be self-adjusting according to the automatic volume control setting as set in the Preferences Screen.

Press the DOWN button and hold it more than one second. The audio volume will mute.

From the mute setting, pressing the UP button will reset the audio volume to its last setting.

11) Reverse Button

The reverse button is located on top of the left handlebar housing.

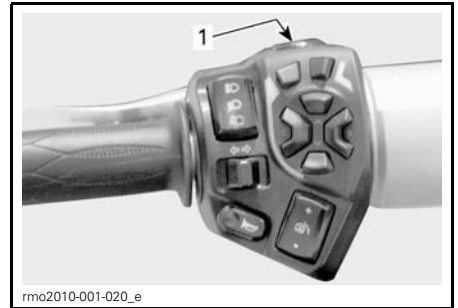

TYPICAL

1. Reverse button

Push and hold the reverse button to allow shifting into reverse. Refer to *OPERATING IN REVERSE* in *BASIC PROCEDURES* subsection for detailed instructions.

The backup lights turn on when the vehicle is in reverse.

12) PTT (Push To Talk) Button

The PTT button is located on the left handlebar housing facing the clutch lever.

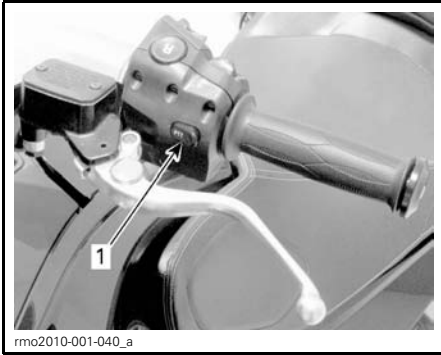

1. PTT button

When an optional CB (Citizens' Band) is installed, pressing the button sets the CB in transmitting mode to talk to other parties.

13) Switch Cluster

The switch cluster is located above the glove box. It gives control of numerous electrical accessories.

NOTE: The switch cluster is operational only when the engine is running and the battery voltage is over 11 Vdc.

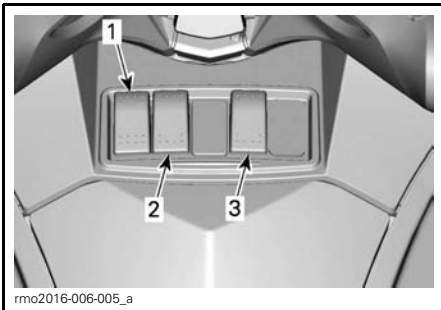

EUROPEAN MODELS

1. Parking brake switch
2. Driver's heated grip switch
3. ACS switch (option package)

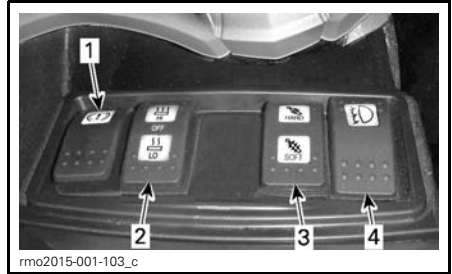

rmo2015-001-103_c

ALL MODELS EXCEPT EUROPEAN MODELS

1. Parking brake switch
2. Driver's heated grip switch
3. ACS switch (option package)
4. Fog light switch (option package)

Parking Brake Switch



rmo2015-001-103_d

1. Parking brake switch

Refer to *PRIMARY CONTROLS* sub-section for detailed instructions.

Driver's Heated Grip Switch

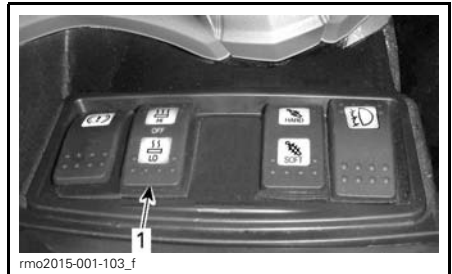

rmo2015-001-103_f

1. Heated grip switch

The heated grip switch allows to turn on and off the heated grips and to control the heating intensity.

For minimum heat, press the LO intensity side of the switch.

For maximum heat, press the HI intensity side of the switch.

To select the OFF position, set the switch to the middle position.



1. HI intensity
2. LO intensity
3. OFF (middle position)

NOTE: The heated grips will automatically turn off when ignition key is turned to OFF.

ACS (Rear Suspension) Switch (Option Package)

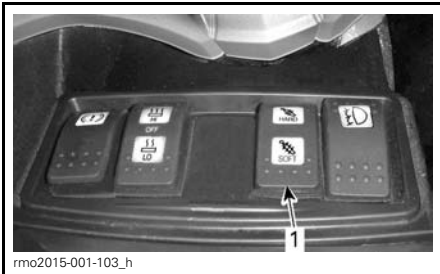

1. ACS switch

The ACS switch allows to stiffen or soften the suspension from factory settings.

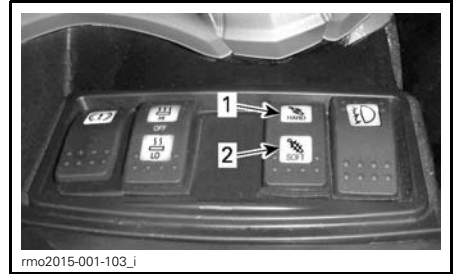

1. Press here to stiffen
2. Press here to soften

To change the ACS suspension setting, refer to *BASIC PROCEDURES* subsection.

Fog Light Switch (Option Package)

All models except European models, Japan, and Australia



1. Fog light switch

Press on the switch icon to turn on the fog lights.

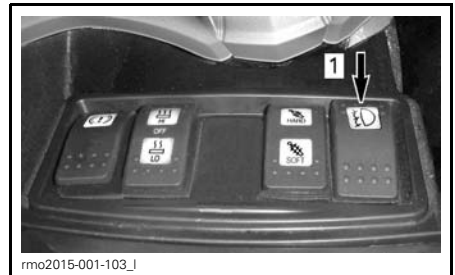

1. Press here to turn on

Press the switch to the opposite icon side to turn off the fog lights.



1. Press here to turn off

PASSENGER CONTROLS

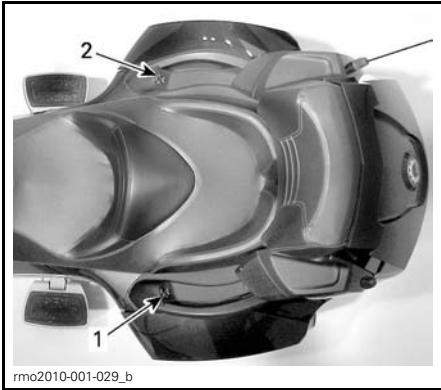

1. Passenger Heated Grip Switch
2. Passenger Audio Control (option)

Passenger Heated Grip Switch

The heated grip switch is located near the left passenger grip.

The heated grip switch allows to turn on and off the heated grips and to control the heating intensity.

For minimum heat, press the LO intensity button.

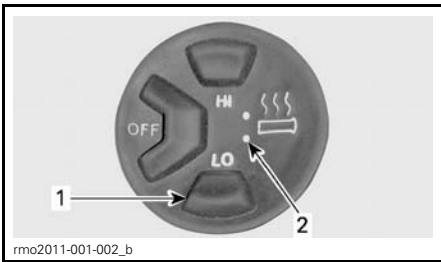

1. LO intensity button
2. LO intensity indicator

For maximum heat, press the HI intensity button.

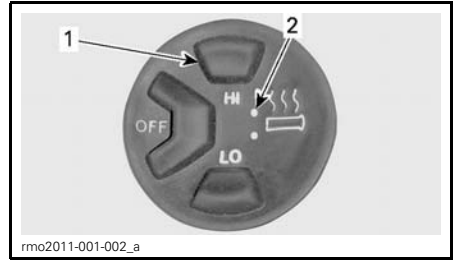

1. HI intensity button (both lights will be on)
2. HI intensity indicator

To select the OFF position, press the OFF button.

NOTE: The heated grips will shut off when engine is under 800 RPM and will not resume automatically.

Passenger Audio Controls

The audio controls are located near the right passenger grip.

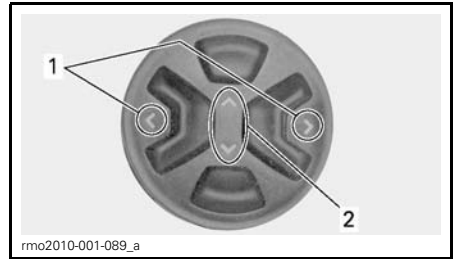

1. LEFT/RIGHT buttons
2. UP/DOWN buttons

The passenger audio controls allow to remotely increase or reduce the passenger headset volume by using the UP/DOWN button.

The radio preset station or the song in an iPod mobile digital device can be changed using the LEFT/RIGHT buttons.

For additional information on audio functions, refer to *AUDIO CONTROLS* subsection.

MULTIFUNCTION GAUGE

⚠ WARNING

Watching or using the multifunction gauge or the infotainment center can distract the driver from the operation of the vehicle. Always keep on observing the traffic and make sure the surrounding is clear and safe before doing so.

The multifunction gauge includes analog gauges (speedometer and tachometer), indicator lamps and an infotainment center with a digital screen.

Multifunction Gauge Description



1) Analog Speedometer







Displays vehicle speed in kilometers (km/h) or miles per hour (MPH). To change units, refer to *PREFERENCES SCREEN*.

2) Analog Tachometer (RPM)

Displays engine revolutions per minute (RPM). Multiply by 1000 to obtain actual revolutions.

3) Indicator Lamps

Indicator lamps will inform you of various conditions or problems (see *MESSAGES IN MULTIFUNCTION GAUGE* in *ROAD SIDE REPAIRS* section).

INDICATOR LAMPS (NORMAL OPERATION)			
INDICATOR LAMP(S)		MAIN SCREEN	DESCRIPTION
All indicator lamps	On	None	Temporarily all 'indicator lamps are activated when ignition switch is ON and the engine is not started
	Flashing	None	Parking brake engaged
	Flashing + Beeper	None	SE6 model: The ignition switch is OFF and the parking brake is not engaged. Always engage the parking brake when parking the vehicle
	On	None	Gearbox in neutral position
	Flashing	None	Gearbox in reverse position
	On	None	Headlights in the HIGH beam position
	Flashing	None	VSS intervention occurring
	Flashing	None	Left side turn signal. Left and right side indicator lights flash at the same time: hazard warning lights
	Flashing	None	Right side turn signal. Left and right side indicator lights flash at the same time: hazard warning lights

4) Digital Display

Displays useful real-time information to the rider and is used as an interface for the infotainment center.

The display will use a light color when the ambient light is bright and will automatically change to a darker color when the ambient light is dusky.

For a complete description of the digital display, refer to *DIGITAL DISPLAY DESCRIPTION*.

Multifunction Gauge Startup Information

A self test is initiated every time the ignition key is turned ON. The default riding screen will turn on and indicator lights will turn on for a moment. This allows the operator to validate that all indicators are working properly.

Any time the ignition switch is turned ON after having been in the OFF position for 5 minutes or more, the digital display will show the following message:

- BEFORE OPERATING READ THE SAFETY CARD ABOVE THEN PRESS MODE BUTTON.

Press the MODE button to acknowledge this message to allow engine starting.

Digital Display Description

The display is divided in several areas as follows.

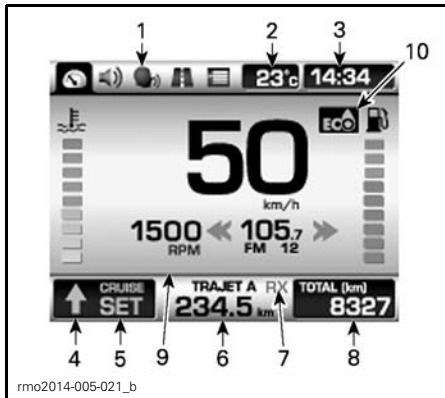

1. Category icons
2. Ambient temperature
3. Clock
4. Gearbox position or upshift indicator arrow
5. Cruise control status
6. Trip meter
7. CB communication status (optional)
8. Odometer
9. Main screen
10. ECO mode icon

1) Category Icons

There are 5 selectable category icons. Each icon is linked to a different screen. See table below.

CATEGORY ICON	CATEGORY ICON SCREEN
	Default riding
	Audio
	CB (optional)
	Trip meter
	Preferences (only available when vehicle is stopped)

For a complete description, refer to *CATEGORY ICON SCREEN DESCRIPTION*.

You can navigate through the category icons to select several functions and to change certain settings using the RECC (Roadster Electronic Command Center). Refer to *RECC (ROADSTER ELECTRONIC COMMAND CENTER)* in *SECONDARY CONTROLS* subsection.

2) Ambient Temperature

The ambient air temperature is displayed in °C or °F. To change units, refer to *PREFERENCES SCREEN*.

3) Clock

The current time is displayed in 24h or AM/PM format. To change the format, refer to *PREFERENCES SCREEN*.

4) Gearbox Position or Upshift Indicator Arrow

Displays the selected gearbox position or the upshift indicator arrow (refer to *ECO MODE ICON*).

5) Cruise Control Status

Displays ON when the cruise control is turned on but not set to any speed.

Displays SET when the cruise control is in operation and a speed has been set.

6) Trip Meter

Distance travelled in kilometers or miles since the last reset. Two trip meters are available and they are identified as "A" and "B". To change units, refer to *PREFERENCES SCREEN*.

As a second function, the trip meter may display an icon to inform the driver of a malfunction. Refer to *MESSAGES IN MULTIFUNCTION GAUGE* in the *ROAD SIDE REPAIRS* section.

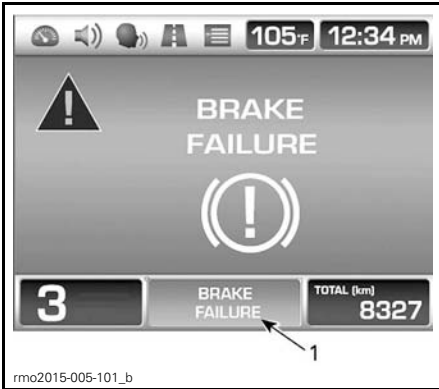

TYPICAL

1. Message/icon

TYPICAL

1. Message/icon

7) CB Communication Status (Optional)

Displays whether the CB (Citizens' Band) is receiving (RX) or transmitting (TX).

8) Odometer

Total distance travelled in kilometers or miles since the delivery from the factory. To change units, refer to *PREFERENCES SCREEN*.

9) Main Screen

The main screen is the area where the most information is displayed. The display will change when navigating through the available gauge functions.

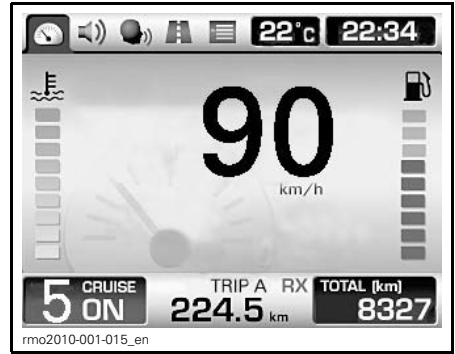

TYPICAL – DEFAULT RIDING SCREEN SHOWN

For a complete description of the screens, refer to *CATEGORY ICON SCREEN DESCRIPTION*.

10) ECO Mode Icon

The ECO (fuel economy mode) setting reduces fuel consumption by limiting throttle response and maximum throttle opening to maintain an optimal cruising setting.

To activate ECO mode press the mode button for 2 seconds when in the main screen.

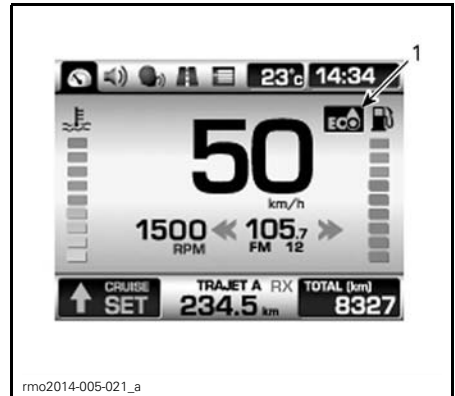

1. ECO mode icon

When ECO mode is activated, a green arrow will alternate with the gearbox position indicator to indicate the optimal timing to shift up transmission.

NOTE: Gearbox position indicator will return when transmission is shifted.

To deactivate ECO mode, press the mode button for 2 seconds when in the main screen.

Navigating in the Digital Display

We recommend you practice selecting some functions on the infotainment center before getting on the road. You will get used to them and they will be easier to use on the road.

Use the RECC (Roadster Electronic Command Center) to control the display functions. Refer to *RECC (ROADSTER ELECTRONIC COMMAND CENTER)* in *SECONDARY CONTROLS* sub-section.



TYPICAL
1. RECC

Pressing the MODE button will move a selection through the category icons, located at the top left area of the screen, in this order: Default riding screen, Audio, CB, Trip meter and Preferences. Each press of the button will move the selection to the next available icon. When an icon is selected, its related screen will appear.

NOTE: The CB icon is skipped when the vehicle is not equipped with this feature. The Preferences Screen is skipped when vehicle is above 5 km/h (3 MPH), .

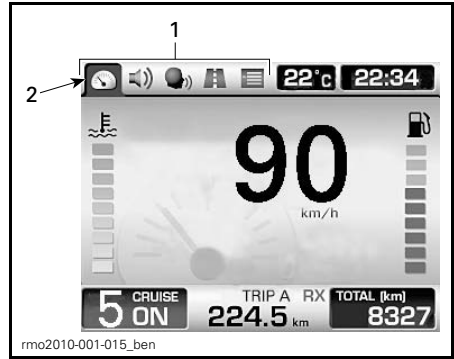

1. Category icons
2. Default riding icon selected

When the selection is on the last icon, it will then move to the first icon when the MODE button will be pressed.

In some screens, vertical or horizontal arrows are visible. This indicates that you have to use the LEFT/RIGHT button to change the setting enclosed by the horizontal arrows and to use the UP/DOWN button to change the setting enclosed by the vertical arrows.

When a double arrow is visible, it indicates the following depending on the displayed screen:

- Holding the DOWN button when the volume bar is displayed will mute the audio system. From the mute condition, pressing the UP button will reset the audio volume to its last setting.
- Holding the related arrow button will scroll the values to the end or to the beginning.
- Using the related arrow button will scroll the list to reveal the remaining items.

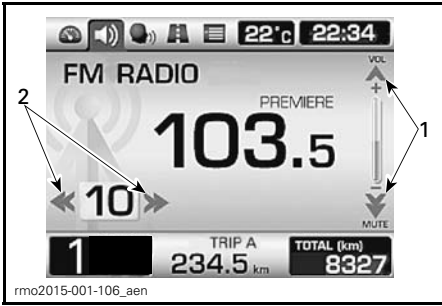

rmo2015-001-106_aen

TYPICAL

1. Use the UP/DOWN button to select the vertical arrows
2. Use the LEFT/RIGHT button to select the horizontal arrows

When an item is selected, this sets the item to the current value.

After acknowledging the initial safety message at gauge startup, or after a few seconds elapsed in any other screen without pressing any RECC button, the display will automatically return to the default riding screen.

Category Icon Screen Description

Default Riding Screen

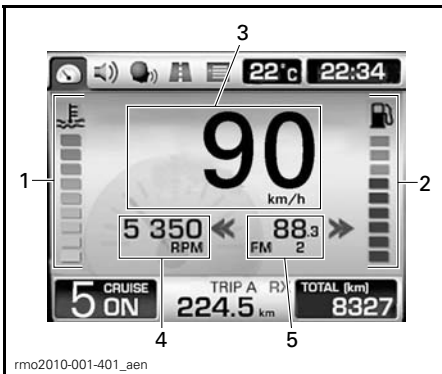

rmo2010-001-401_aen

DEFAULT RIDING SCREEN

1. Engine coolant temperature (option package)
2. Fuel level (option package)
3. Digital speedometer
4. Engine speed (not factory set)
5. Radio preset or radio frequency (not factory set)

1) Engine Coolant Temperature (Except Models with Separate Analog Gauges)

Bar gauge that continuously indicates the engine coolant temperature.

NOTE: On models with a separate analog engine coolant temperature gauge, the bar gauge is not displayed in the digital display.

2) Fuel Level (Except Models with Separate Analog Gauges)

Bar gauge that continuously indicates the amount of fuel left in the fuel tank.

NOTE: On models with a separate analog fuel level gauge, the bar gauge is not displayed in the digital display.

NOTE: Low fuel indicator lamp turns on when quantity of fuel is left for 50 km (31 mi) if riding steady at speed of 100 km/h (62 MPH) in 6th gear.

3) Digital Speedometer

Displays vehicle speed in kilometers (km/h) or miles per hour (MPH). To change units, refer to *PREFERENCES SCREEN*.

4) Engine Speed

Displays engine speed in revolutions per minute (RPM).

NOTE: This is not a default function. To activate this function, refer to *PREFERENCES SCREEN*.

5) Radio Preset or Radio Frequency

Displays the selected radio preset or radio frequency.

NOTE: This is not a default function. To activate this function, refer to *PREFERENCES SCREEN*.

Audio Screen

The audio screen will appear with its last configuration.

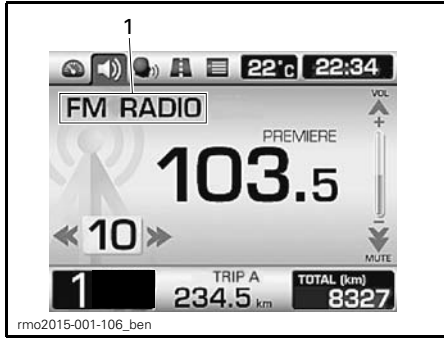

TYPICAL

1. Current selected audio device

For additional information on audio functions, refer to *AUDIO CONTROLS*.

CB Screen (Optional)

This screen is only available when a CB is installed.

NOTE: The CB screen will appear whenever the PTT (Push To Talk) button is pressed whatever the screen that was displayed.

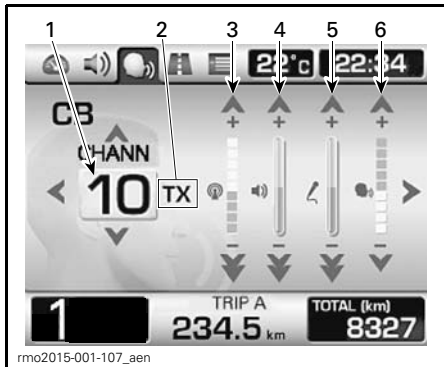

TYPICAL

1. Current channel
2. CB communication status: RX (receiving), TX (transmitting) and OFF
3. Squelch adjustment
4. Volume adjustment
5. Intercom volume adjustment (i-com)
6. Voice activation sensitivity adjustment (vox)

For additional information on audio functions, refer to *AUDIO CONTROLS* subsection.

Trip Meter Screen

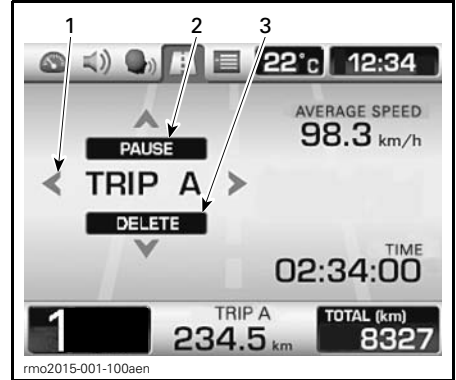

TYPICAL

1. Display selection: Trip A or Trip B
2. Pause or resume the selected trip meter
3. Reset the selected trip meter

Press the LEFT/RIGHT button to select the desired trip meter.

Press the UP button to pause or resume the selected trip meter.

Press the DOWN button to reset the selected trip meter.

Preferences Screen

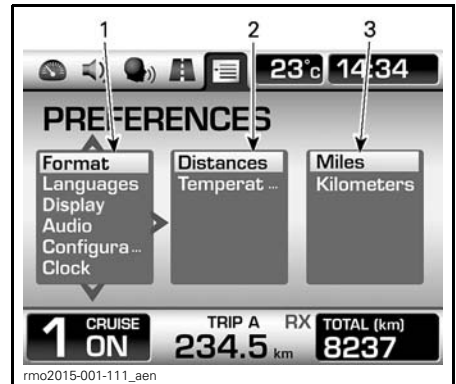

1. 1st column: Main category
2. 2nd column: Secondary category or item
3. 3rd column: Unit or setting

This screen is only available when vehicle is stopped.

Use the LEFT/RIGHT button to select the desired column.

Within a column, use the UP/DOWN button to select the desired item. If more items are available to the next right column, use the RIGHT button to select the column then use again the UP/DOWN button to select the desired item. Continue using this pattern to reach the desired item.

When an item is selected, this sets the item to the current value. You may then go to any screen, the value will be kept.

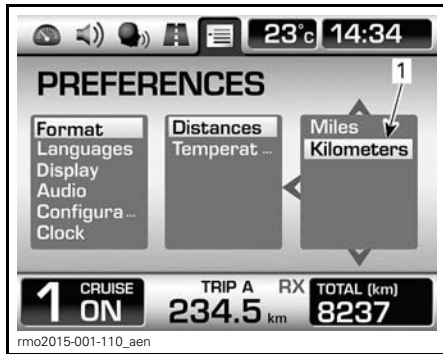

1. The selected value will be set

NOTE: When in the 2nd or 3rd column, you can go back to the column at the left using the LEFT button.

NOTE: When the units are changed they will be changed on both the analog and the digital displays. The units will be used for the odometer and both trip meters.

Setting the Time

To set the hours:

Select CLOCK in main category of Preferences Screen.

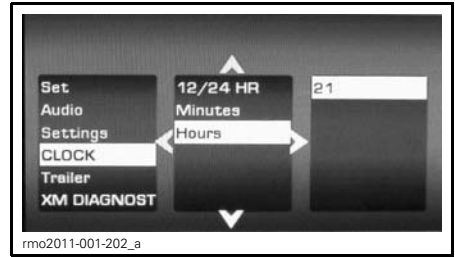

Select HOURS in secondary category.

Adjust the unit value using the UP and DOWN arrow.

To set the minutes:

Select CLOCK in main category of Preferences Screen.

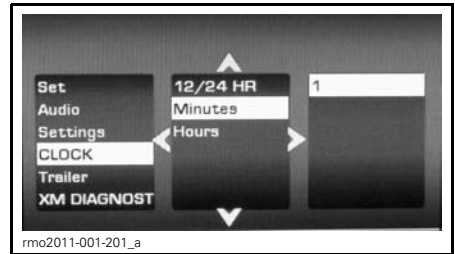

Select MINUTES in secondary category.

Adjust the unit value using the UP and DOWN arrow.

Selecting the Hour Mode

To select the 12/24 hour mode:

Select CLOCK in main category of Preferences Screen.

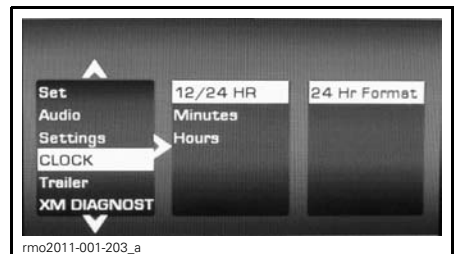

Select 12/24 HOUR in secondary category.

Select the appropriate value in main unit or setting.

Selecting the Region (Audio)

To select the region:

Select AUDIO in main category of Preferences Screen.

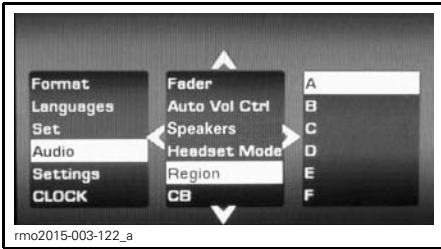

Select REGION in secondary category.

Select the appropriate region according to the table below in main unit or setting.

NOTE: If your country is not listed in the table below, select a region with an identical frequency range.

Restart the vehicle in order for changes to take effect.

REGION	COUNTRIES	LW	AM / MW	FM
A	- USA - Canada - South Africa	---	520 to 1720 kHz	87.9 to 107.9 MHz
B	- Austria - Bulgaria - Denmark - France - Iceland - Israel - Kuwait - Norway - Romania - Slovakia - Slovenia - Spain - Switzerland - Turkey - UAE - UK/Ireland - Ukraine	153 to 279 kHz	531 to 1602 kHz	87.5 to 108 MHz
C	- Benelux - Germany - Greece - Italy - Poland - Portugal - Russia	153 to 279 kHz	531 to 1602 kHz	87.5 to 108 MHz
D	- Japan	---	522 to 1629 kHz	76.1 to 89.9 MHz
E	- Australia - China - Malaysia - New Zealand	---	531 to 1701 kHz	87.5 to 108 MHz
F	- Taiwan	---	531 to 1701 kHz	87.5 to 108 MHz
G	- Argentina - Brazil - Cayman - Chile - Columbia - Costa Rica - Curacao - Dominican Rep. - Guadeloupe - Mexico - Puerto Rico - Venezuela	---	520 to 1720 kHz	87.9 to 107.9 MHz

ANALOG GAUGES (OPTION PACKAGE)

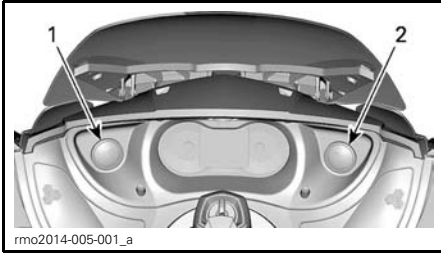

1. Fuel level gauge
2. Engine coolant temperature gauge

Fuel Level Gauge

The needle in gauge continuously indicates the amount of fuel left in the fuel tank.

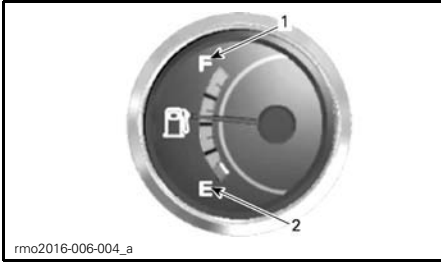

TYPICAL - FUEL LEVEL

1. Full
2. Empty

Engine Coolant Temperature Gauge

The needle in gauge continuously indicates the engine coolant temperature. Under all riding conditions, the needle should stay within this range.

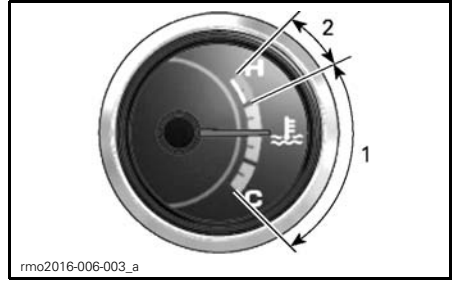

TYPICAL - COOLANT TEMPERATURE

1. Normal operating range
2. Overheat

AUDIO CONTROLS

Audio System Power

Follow one of the following steps below to turn the audio system ON:

- Turn ignition switch to ON.
- Press MODE button for 3 seconds immediately after ignition switch is turned OFF.

Follow one of the following steps below to turn the audio system OFF:

- Turn ignition switch to OFF.
- If the audio was ON with the ignition switch to OFF, press MODE button for 10 seconds.

Audio Volume Control

When in the default riding screen, pressing the UP or DOWN button will increase or decrease the audio volume.

NOTE: On models without a separate analog fuel level gauge, the fuel level bars will be replaced by the volume bars for a few seconds, then the fuel level bars will come back.

Self-Adjusting Audio Volume

The audio volume level can be automatically adjusted based on the vehicle speed. This is controlled by the automatic volume control setting in the Preferences Screen.

Audio Mute

Press the DOWN button and hold it more than one second. The audio volume will mute.

From the mute setting, pressing the UP button will reset the audio volume to its last setting.

Radio Band

For North America (Region A)

When in the audio screen, repeatedly pressing the SET button will display the available audio devices in this order:

- FM
- AM
- WX (NOAA weather radio)
- USB (iPod device or USB)
- AUX (iPod device or MP3 player)
- NAV
- XM.

NOTE: XM is displayed only if so equipped.

For Europe (Regions B and C)

When in the audio screen, repeatedly pressing the SET button will display the available audio devices in this order:

- FM
- MW
- LW
- USB (iPod device or USB)
- AUX (iPod device or MP3 player)
- NAV
- XM.

NOTE: XM is displayed only if so equipped.

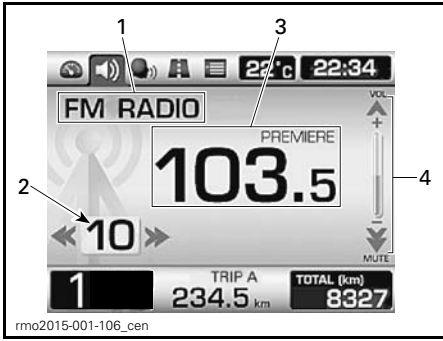

TYPICAL - FM RADIO SHOWN

1. Current selected band
2. Station number preset
3. Current station
4. Volume level

While riding, the available radio functions are:

- Audio volume
- Mute, seek and slew (XM radio) functions
- Radio preset functions (selection and storing).

NOTE: The radio is always ON. Use the MUTE function to cancel the volume.

To listen to the radio while ignition switch is set to OFF, hold the MODE button for 3 seconds immediately after the switch is set to OFF to power up the digital display.

NOTE: To preserve battery charge, radio may shut off automatically after a certain period.

Selecting a Radio Preset Station

Press the LEFT/RIGHT button to decrease or increase the preset number.

Press and hold the LEFT/RIGHT button for more than one second to SEEK the next available radio station. The radio will remain tuned to that station.

Press the SET button and hold for more than one second to enter the setup screen.

In the setup screen, press the LEFT/RIGHT button to tune the radio frequency.

Recording a Radio Preset Station

To record up to 15 station presets:

Press and hold the DOWN button to record the actual frequency to the preset number displayed.

NOTE: While riding, the radio station will be automatically recorded to the next available preset number. If all preset numbers are used, the preset number 15 will be overwritten.



TYPICAL

1. LEFT/RIGHT button to select the frequency
2. UP button to select the preset number
3. DOWN button to record the radio station

AUX (Auxiliary) and USB Port

An audio input jack and a USB port are provided in the top storage compartment.

Compatible audio devices include:

- Supported iPod models
- Supported iPhone models
- Smartphones supporting MTP or MSC
- Flash drives supporting MSC
- MP3 players that support MTP or MSC
- MP3 Players

Compatible music format include:

- MP3
- WAVE
- FLAC
- Ogg

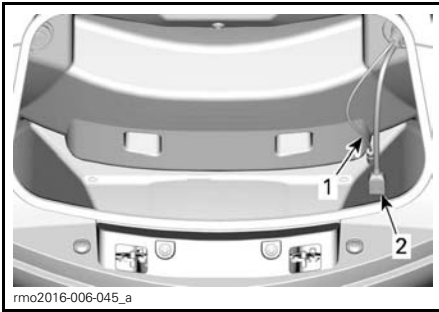
**TYPICAL**

1. Audio in jack
2. USB port

An audio device can be connected in the audio in jack or in the USB port to be played through the audio system.

NOTE: An adapter (optional on some models) is required to connect the audio device to the vehicle audio jack.

MP3 Player, USB Drive or Cellphone

When an MP3 player or Cellphone is connected to the vehicle audio connector or the USB port, it will play as set at the time of the connection. Only the volume control will be available.

USB Drives will resume playback at the song they were last at when connected to vehicle or play the first song.

Track controls are only available to some devices plugged into the USB port.

Audio will be heard through the system if a device is plugged into the AUX connector and the AUX source is selected. Similarly, audio will be heard if a device is plugged into the USB connector and the USB source is selected.

iPod Device

When an iPod device is connected, "iPod" is displayed instead of USB.

**TYPICAL - iPod DEVICE SCREEN**

Press the LEFT/RIGHT button to change the song in the current folder.

Press and hold the SET button to select the playlist item.

Press and hold the LEFT/RIGHT button for more than one second to change the playlist if the playlist item is selected, to change the artist if the artist item is selected and to change the album if the album item is selected.

While riding, the available functions are:

- Audio volume and mute
- Previous or next song selection
- Artist, album or playlist selection.

Compatible iPod Device

Made for:

- iPhone 6 Plus
- iPhone 6
- iPhone 5s
- iPhone 5c
- iPhone 5
- iPod touch (5th generation)

NAV Sound

The NAV system sound when activated overrides the other sources selected when streaming audio. For example the radio will be interrupted for the navigation instructions to be heard by the driver.

If the NAV source is selected then your external navigation device can be used to play MP3 files stored on it or connected to it by Bluetooth. If you switch to another source then you must stop the audio stream coming from the navigation device or it will be interpreted as navigation commands.

CB Screen (Optional)

This screen is only available when a CB is installed.

NOTE: The CB screen will appear whenever the PTT (Push To Talk) button is pressed whatever the screen that was displayed.

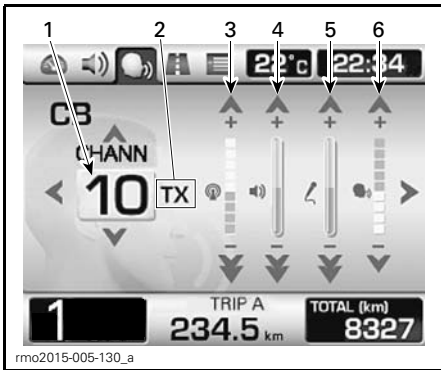

TYPICAL

1. Current channel
2. CB communication status:RX (receiving), TX (transmitting) and OFF
3. Squelch adjustment
4. CB volume adjustment
5. Intercom volume adjustment (i-com)
6. Voice activation sensitivity adjustment (vox)

Use the LEFT/RIGHT buttons to select the item to change (channel, squelch, CB volume, intercom volume and vox detection).

Use the UP/DOWN buttons to set a value.

Press and hold the DOWN button for more than one second to set the item to its lowest value.

GPS (OPTION PACKAGE)

For GPS operation, refer to *GPS MANUAL*.

⚠ WARNING

Reading the GPS receiver can distract from the operation of the vehicle, particularly from constantly scanning the environment. Before reading the GPS receiver, ensure your environment is clear and free from obstacle, and bring the vehicle to a low speed. Additionally, make sure to often double-check for obstacles.

⚠ WARNING

Remember, the data provided by the GPS receiver is for reference only. NEVER rely solely on this information for your safety.

GPS Receiver Installation

To remove the cover plate from the GPS base, press on the push button to release it.

To attach the GPS receiver to its base; insert the lower part of the GPS receiver first into the tab, then push the GPS receiver towards the top of the base.

Push into place until it locks in.



TYPICAL

1. GPS receiver
2. GPS base

GPS Receiver Removal

Press the push button.

Gently pull the top of GPS receiver from the base until it unlocks.

Reposition the cover plate on the base and push into place.

Install rubber boot on receiver.

⚠ CAUTION The rubber boot must be installed at all times except when the GPS is installed onto the vehicle.



TYPICAL

1. GPS base with cover plate installed
2. Cover boot

EQUIPMENT

Mirrors

Adjusting Mirrors

Press the mirror at the points shown below to adjust its position in the four directions.



MIRROR ADJUSTMENT POINTS

Glove Box

Locking the Handlebar/Glove Box

To lock the steering mechanism and the glove box:

1. Insert key in ignition switch.
2. Rotate the handlebar all the way to the right or to the left.
3. Turn the key 1/4 turn counterclockwise to the steering lock position then remove key.

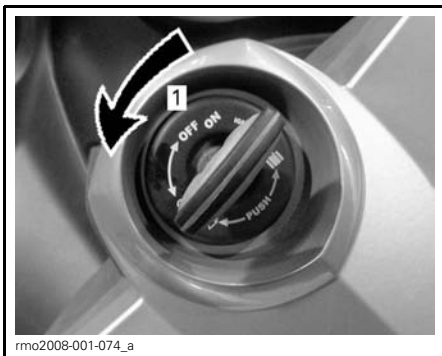

KEY POSITION TO LOCK HANDLEBAR

1. Turn key 1/4 turn

Opening the Glove Box

First ensure steering is not locked to allow glove box opening.

Push on the lower end of glove box to release it.

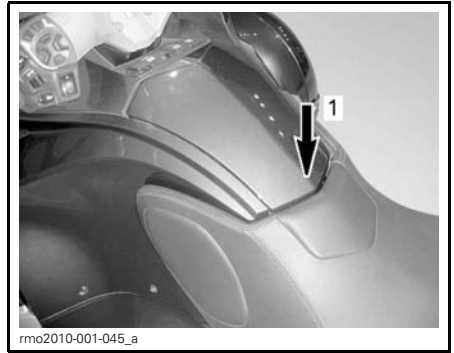

1. Push here to release

Open cover.

When done, close cover then push on the lower end of glove box to latch it.

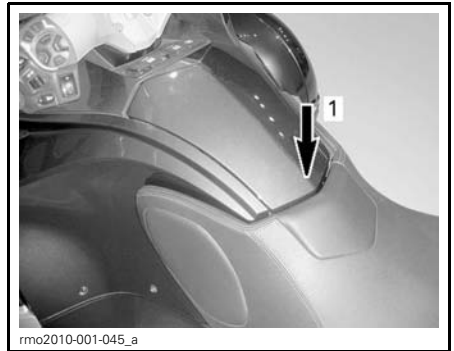

1. Push here to latch

Always latch the glove box after usage.

NOTE: The glove box will be automatically locked when locking the steering.

Front Storage Compartment

Opening the Front Storage Compartment

1. Insert key in ignition switch.
2. Push and turn the key 1/4 turn counterclockwise to the front storage compartment position and hold while lifting cover.

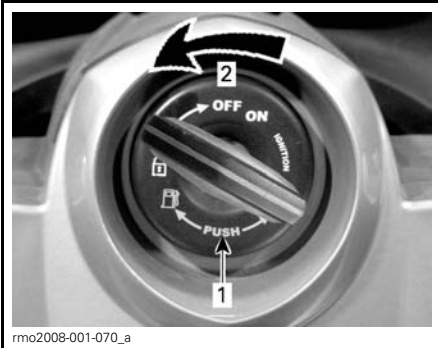

KEY POSITION TO OPEN FRONT STORAGE COMPARTMENT

1. Push key
2. Turn key 1/4 turn

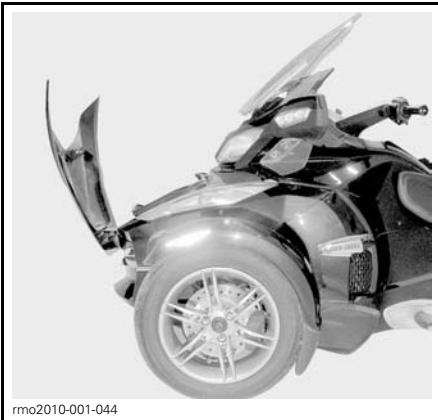

OPENED

Seat

The operator's seat is equipped with a provision to install the operator's seat backrest (available in option).



1. Backrest access cover

NOTE: When backrest is not installed, make sure the five tabs of the access cover are properly engaged.

Opening the Seat

1. Insert key in ignition switch.
2. Push and turn the key 1/4 turn clockwise to the seat opening position and hold while lifting seat.

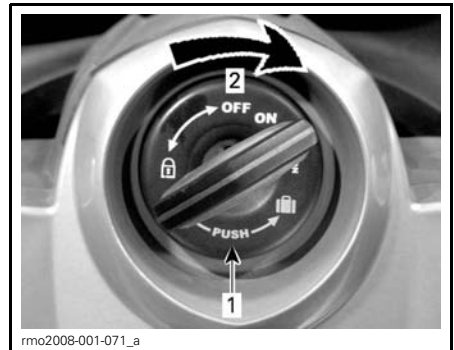

KEY POSITION TO OPEN SEAT

1. Push key
2. Turn key 1/4 turn

NOTICE Do not force the seat past the maximum opening angle or it may break.



1. Maximum opening of seat

Storage Compartments

Opening the Side Storage Compartments

The side storage compartment latches are located at the rear of vehicle.

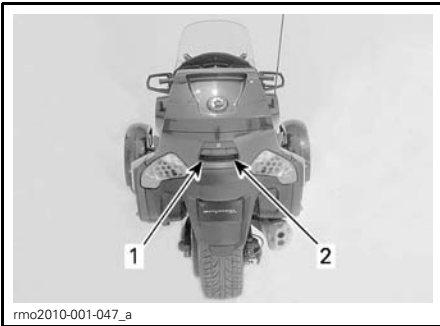

1. Latch for the left side storage compartment
2. Latch for the right side storage compartment

If locked, use the ignition key and unlock all the latches at the same time by turning key counterclockwise.



1. Turn counterclockwise to unlock

Pull the left side latch to open the left side storage compartment cover and pull the right side latch to open the right side cover.



1. Opening the left cover

The chosen storage compartment cover will open.

NOTE: Be aware that objects may have moved while riding. Pay attention not to drop objects while opening the cover.

Always latch the cover after usage.

When finished, lock the latches if desired. Turn key clockwise.



1. Turn clockwise to lock

NOTICE Never ride the vehicle with any cover open.

Closing the Side Storage Compartments

Lift slowly the side storage compartment cover to let air flow out.

Bring the cover at closing position.

Put your hand in the center of the cover then push to lock.

Opening the Top Storage Compartment

The top storage compartment latch is located at the rear of vehicle.



1. Latch for the top storage compartment

If locked, use the ignition key and unlock all the latches at the same time by turning key counterclockwise.



1. Turn counterclockwise to unlock

Pull the latch.



1. Opening the top cover

Open the storage compartment cover.

Always latch the cover after usage.

When finished, lock the latches if desired. Turn key clockwise.



1. Turn clockwise to lock

NOTICE Never ride the vehicle with the cover open.

Helmet

Securing a Helmet

Two helmet hooks are provided under the seat to secure a helmet.

Open seat.



1. RH helmet hook

Secure the helmet strap buckle on the hook.

Gently put down helmet on the vehicle side panel.

Carefully close the seat and latch.

Tool Kit

Tool Kit Location

The tool kit is located in the top storage compartment.

The tool kit contains the tools for the basic maintenance described in this Operator's Guide.

Operator's Guide

The operator's guide is located with the *SAFETYDVD* video inside the front storage compartment.

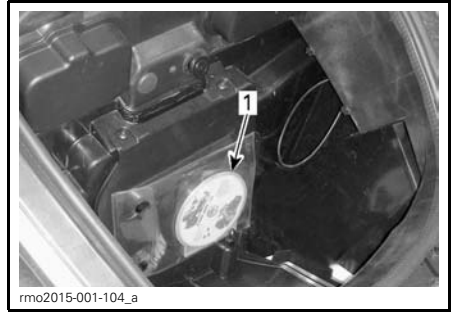

TYPICAL

1. Operator's guide

Body Panels

The body panels on the vehicle can be removed for maintenance.

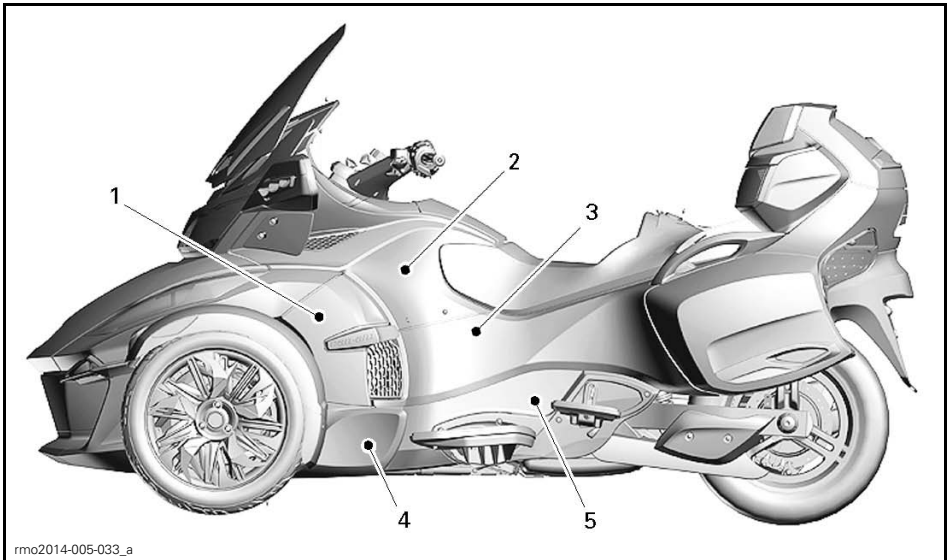

LEFT HAND SIDE PANELS

1. Side panel
2. Top side panel
3. Rear side panel
4. Bottom front side panel
5. Bottom rear side panel

Side Panel

Removal

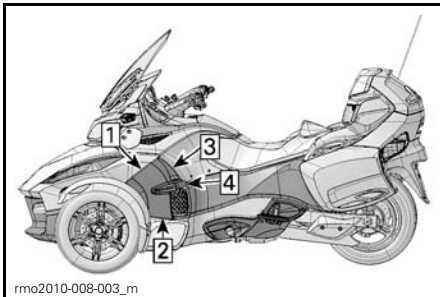

REMOVAL SEQUENCE

1. Pull the top front of the panel out of its grommet.
2. Pull the bottom front of the panel out of its grommet.
3. Unclip the top rear of the panel.
4. Pull the rear of the panel out of its grommet.

Installation

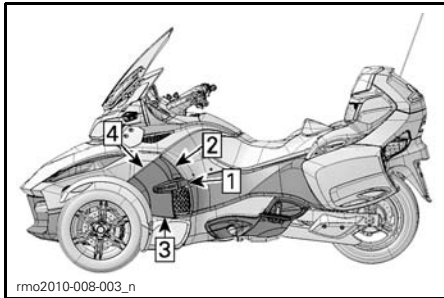

INSTALLATION SEQUENCE

Reinstall side panel in the reverse order of the removal.

Top Side Panel

Removal

1. Open seat.
2. Open front storage compartment.
3. Remove side panel.
4. Remove retaining screws from lower wind deflector.

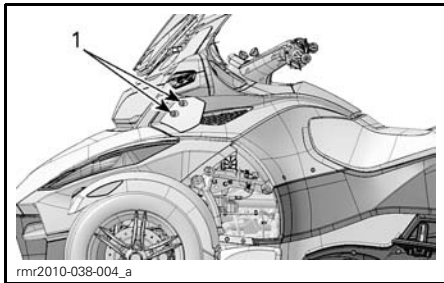

1. Retaining screws of wind deflector

5. Remove mirror:
 - 5.1 Push firmly on the top front of the mirror towards the rear of the vehicle.
 - 5.2 Push up firmly on the outermost part of the mirror.

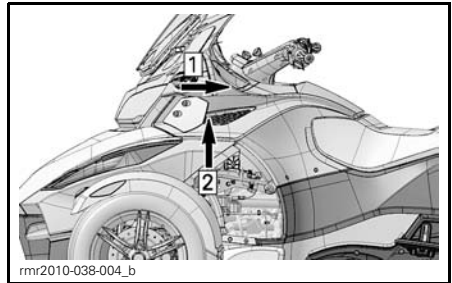

- Step 1: Push towards the rear
- Step 2: Push up

6. Remove upper retaining screws from top side panel.

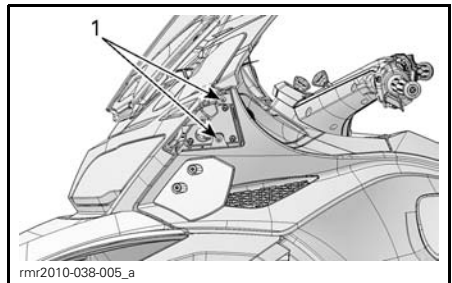

1. Upper retaining screws

7. Remove rear retaining screw from top side panel.

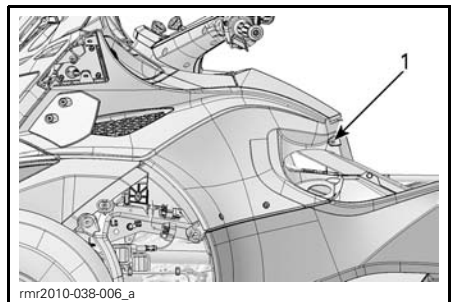

1. Rear retaining screw

8. Remove left service cover by removing plastic rivet.

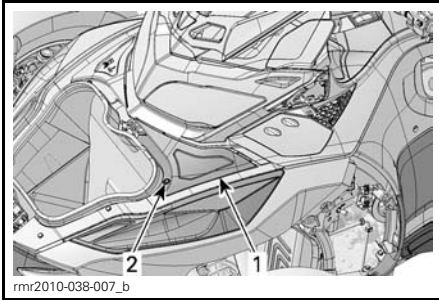

1. Left service cover
2. Plastic rivet

9. Remove front retaining screw from top side panel.

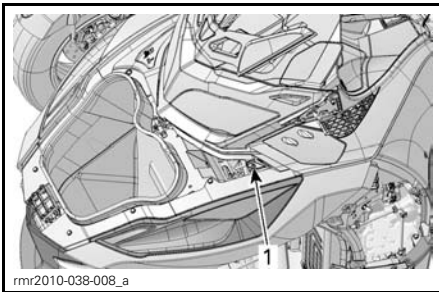

1. Front retaining screw

10. Remove lower retaining screws of top panel.

11. Remove top side panel by lifting it upwards.

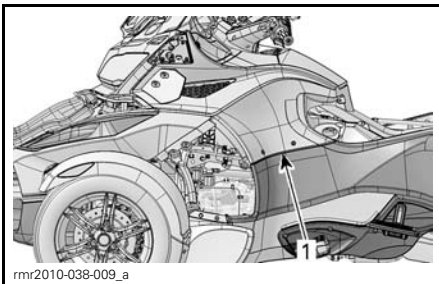

1. Top side panel

12. Remove two screws from the acoustic panel.

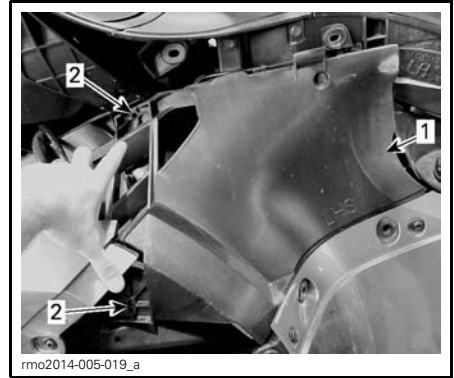

1. Acoustic panel
2. Screws

13. Remove the acoustic panel.

NOTE: There are two esthetic screws on the top side panel which cannot be removed.

Installation

Reinstall top side panel in the reverse order of the removal.

Rear Side Panel

Removal

1. Remove side panel.
2. Remove top side panel.
3. Remove front retaining screw of rear side panel.
4. Remove upper retaining screw and washer from rear side panel.

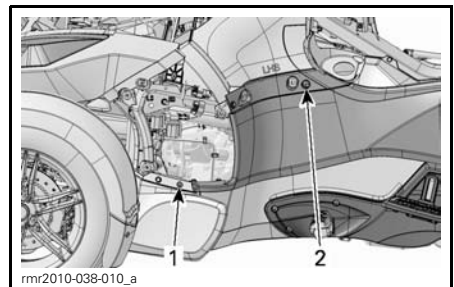

1. Front retaining screw
2. Upper retaining screw

5. Remove front plastic rivet from rear side panel.

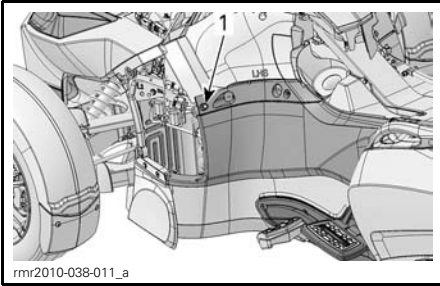

1. Front plastic rivet

6. Open side storage compartment cover.
7. Remove rear retaining screws from rear side panel.

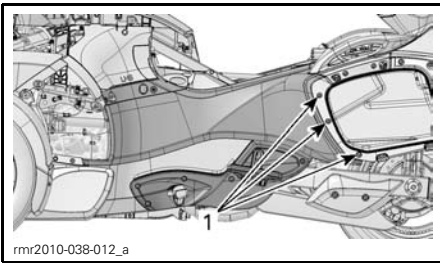

1. Rear retaining screws

8. Remove top retaining screw of rear side panel.

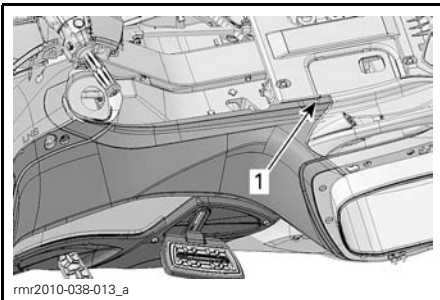

1. Top retaining screw

9. Remove rear side panel from vehicle.

Installation

Reinstall rear side panel in the reverse order of the removal.

Bottom Front Side Panel

Removal

1. Remove side panel.
2. Remove upper retaining screw from panel.
3. Remove upper plastic rivet from panel.

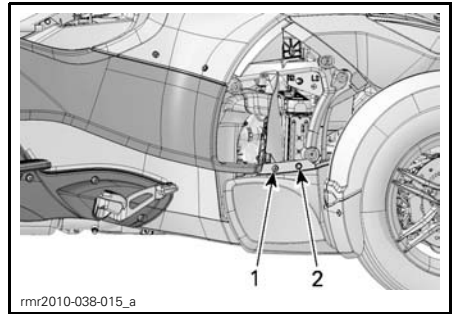

1. Upper retaining screw
2. Upper plastic rivet

4. Remove the 2 bottom plastic rivets from the panel.

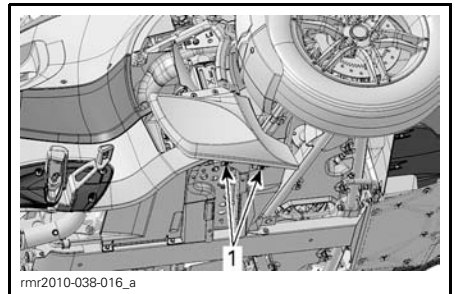

1. Plastic rivets

5. Remove bottom front side panel from vehicle.

Installation

Reinstall bottom front side panel in the reverse order of the removal.

Bottom Rear Side Panels

Removal of Bottom Rear RH Side Panel

1. Remove middle side panel.
2. Remove top side panel.
3. Remove rear RH side panel.
4. Remove bottom front side panel.
5. Remove bolt and nut from bottom rear RH side panel.

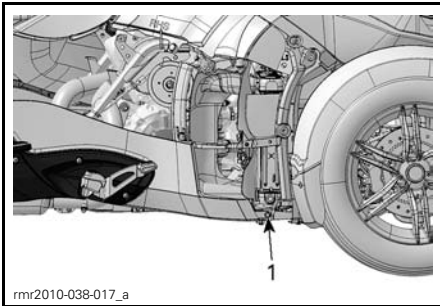

1. *Front retaining nut*

6. Remove retaining screws from bottom rear RH side panel.

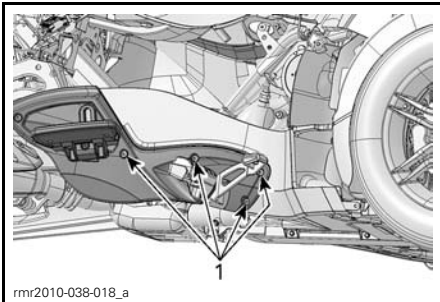

1. *Retaining screws*

7. Remove bottom rear RH side panel from vehicle.

Removal of Bottom Rear LH Side Panel

1. Remove middle side panel.
2. Remove top side panel.
3. Remove rear LH side panel.

4. Remove bottom front side panel.
5. Remove bottom retaining screw from bottom rear LH side panel.

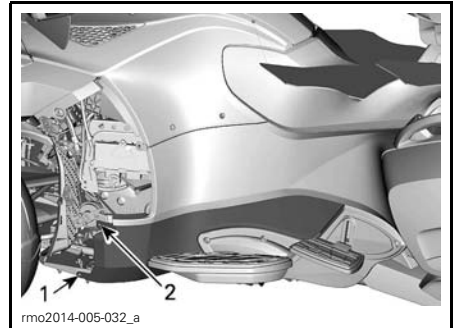

1. *Bottom retaining screw*
2. *Upper retaining screw*

6. Loosen upper retaining screw.

NOTE: Upper retaining screw remains attached to bottom panel.

7. Remove bottom rear side panel from vehicle by pulling forward to release panel from bracket.

NOTE: The back of the panel is inserted between the bracket and aluminium support.

Installation

Reinstall bottom rear side panels in the reverse order of the removal.

BASIC PROCEDURES

Adjusting the Passenger Footrest

For the passenger's comfort, its footrest height can be adjusted.

Flip the footrest upward.

Turn the retaining screw counterclockwise with a wrench (stored in the tool kit) to loosen the screw.

NOTE: Do not completely unscrew the retaining screw to adjust the footrest. Unscrew only until you can disengage the footrest from the slots.

Raise or lower the footrest to your convenience.

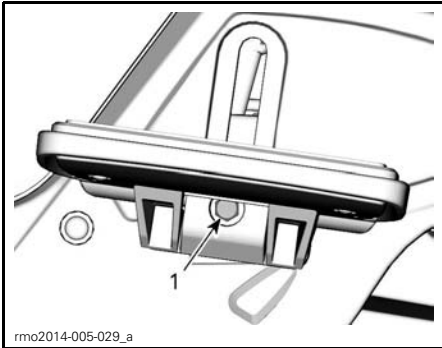

1. Retaining screw

When finished, tighten retaining screw clockwise.

Flip the footrest downward.

Starting and Stopping the Engine

Starting the Engine

⚠ WARNING

Exhaust gas contains poisonous carbon monoxide that can rapidly accumulate in an enclosed or poorly ventilated area. If inhaled, it can cause serious injury or death.

Only run the engine in an unenclosed, well ventilated area. See the *GENERAL PRECAUTIONS* section.

SM6 Model

1. Push down and hold the brake pedal.
2. Turn the key to ON.

NOTICE Do not apply throttle while electrical system is initializing.

3. Refer to the Safety Card as needed to prepare yourself, your passenger and the vehicle, then press the MODE button to allow engine starting.
4. Set the engine stop switch to the RUN/ON position.
5. Pull in and hold the clutch lever.
6. Shift into NEUTRAL. Check the multifunction gauge to be sure you are in neutral.
7. Press and hold the engine start button until the engine starts. Do not hold the start button for more than 15 seconds. If it does not start, release the button and wait 30 seconds to let the starter cool down before trying again.

NOTICE Do not apply throttle while starting the engine.

8. Check the display for problems and to ensure that the oil light turns off.
9. Release the parking brake. Make sure the brake indicator lamp on the multifunction gauge is off.

SE6 Model

NOTE: The SE6 model can be started in any gear with the brake pedal pressed. The transmission automatically shifts to neutral when the engine has been started.

1. Push down and hold the brake pedal.
2. Turn the key to ON.

NOTICE Do not apply throttle while electrical system is initializing.

3. Refer to the Safety Card as needed to prepare yourself, your passenger and the vehicle, then press the MODE button to allow engine starting.
4. Set the engine stop switch to the RUN/ON position.
5. Press and hold the engine start button until the engine starts. Do not hold the start button for more than 15 seconds. If it does not start, release the button and wait 30 seconds to let the starter cool down before trying again.

NOTICE Do not apply throttle while starting the engine.

6. Check the display for problems and to ensure that the oil light turns off.
7. Release the parking brake. Make sure the brake indicator lamp on the multifunction gauge is off.

Stopping the Engine

SM6 Model

1. Shift into first gear.
2. Set the engine stop switch to OFF.

3. Engage the parking brake. The brake indicator lamp will flash.
4. Turn the key to OFF.
5. Before dismounting, check that the parking brake is fully engaged. Hold the clutch and rock the vehicle back and forth.

WARNING

Always engage the parking brake. The vehicle can roll if the parking brake is not engaged and the transmission is in neutral.

SE6 Model

1. Shift into neutral.
2. Set the engine stop switch to OFF.
3. Engage the parking brake. The brake indicator lamp will flash.
4. Turn the key to OFF.

NOTE: If the parking brake is not engaged while the key is OFF, the parking brake indicator lamp will flash and a beeper will sound.

5. Before dismounting, check that the parking brake is fully engaged. Rock the vehicle back and forth.

WARNING

Always engage the parking brake. The vehicle can roll if the parking brake is not engaged, regardless of what gear it is in. The clutch is always disengaged when the vehicle is stopped, so the transmission will not hold the vehicle in place.

All Models

This vehicle is equipped with an Electronic Throttle Control (ETC).

Pushing the Vehicle

NOTE: Before pushing the vehicle, ensure the ignition key is in the ON position.

⚠ CAUTION Avoid pushing the vehicle on a slope. If you must push the vehicle on a slope, take extra care to stay within reach of the brake pedal in case the vehicle starts to roll.

To move the vehicle a short distance without starting the engine:

1. While seated on the vehicle, push down and hold the brake pedal.
2. Shift the transmission into NEUTRAL (SM6 model).
3. Disengage the parking brake.
4. Dismount on the right side of the vehicle, keeping your foot on the brake pedal.
5. Push the vehicle, using the brake as needed.

⚠ CAUTION Only push from the right side, so you can reach the brake pedal. Stay clear of the hot exhaust pipe.

When pulling the vehicle backward, be careful that the front wheel does not roll over your feet.

6. Remount the vehicle and park as specified above.

Operating in Reverse

For safe operation in reverse, refer to *SAFE OPERATING INSTRUCTIONS* section.

Shifting Into Reverse (SM6 Model)

1. With engine running, shift into first gear.
2. Hold in the clutch lever.
3. Press and hold the reverse button.
4. Step down on the shift lever one stroke.
5. Release the reverse button and check that the letter "R" flashes on the multifunction gauge and the backup lights turn on.

Shifting Into Reverse (SE6 Model)

1. With engine running, the roadster stopped, and the brake depressed, shift into first gear or neutral.
2. Press and hold the reverse button.
3. Pull the gearshift selector toward you to downshift to reverse.

Driving in Reverse

Check that the area behind you is clear and continue to look backwards while you operate in reverse. Keep your speed low and do not back up for long distances.

Shifting Out of Reverse

SM6 Model

To shift out of reverse, hold in the clutch and lift the shift lever once to shift into first. You do not need to use the reverse button — it resets automatically.

SE6 Model

To shift out of reverse, stop vehicle and push on upshift selector quickly to shift into neutral and more longer to shift in first gear.

NOTE: To shift out of reverse into 1st gear, press the brake pedal and shift up.

Operation During Break-In

A break-in period of 1 000 km (600 mi) is required for the vehicle.

During the first 300 km (200 mi), avoid hard braking.

⚠ WARNING

New brakes and tires do not operate at their maximum efficiency until their break-in is completed. Braking, steering and VSS performance may be reduced, so use extra caution. Brakes and tires take about 300 km (200 mi) of riding with frequent braking and steering to break-in. For riding with infrequent braking and steering, allow extra time to break-in the brakes and tires.

During the first 1 000 km (600 mi):

- Avoid full throttle acceleration.
- Avoid prolonged riding maintaining constant RPM.
- If the cooling fans operate continuously during stop and go traffic, pull over and shut off the engine to let it cool off or speed up to let air cool off the engine.

After the break-in period, your vehicle should be inspected as per the *MAINTENANCE SCHEDULE* subsection.

Fueling**Fuel Requirements**

NOTICE Always use fresh gasoline. Gasoline will oxidize; the result is loss of octane, volatile compounds, and the production of gum and varnish deposits which can damage the fuel system.

Alcohol fuel blending varies by country and region. Your vehicle has been designed to operate using the recommended fuels, however, be aware of the following:

- Use of fuel containing alcohol above the percentage specified by government regulations is not recommended and can result in the following problems in the fuel system components:
 - Starting and operating difficulties.
 - Deterioration of rubber or plastic parts.
 - Corrosion of metal parts.
 - Damage to internal engine parts.
- Inspect frequently for the presence of fuel leaks or other fuel system abnormalities if you suspect the presence of alcohol in gasoline exceeds the current government regulations.
- Alcohol blended fuels attract and hold moisture which may lead to fuel phase separation and can result in engine performance problems or engine damage.

Recommended Fuel

Use premium unleaded gasoline with an AKI (RON+MON)/2 octane rating of 91, or an RON octane rating of 95.

NOTICE Never experiment with other fuels. Engine or fuel system damages may occur with the use of an inadequate fuel.

NOTICE Do NOT use fuel from fuel pumps labeled E85.

Use of fuel labeled E15 is prohibited by U.S. EPA Regulations.

Refueling Procedure

⚠ WARNING

Gasoline is extremely flammable and highly explosive. Follow the refueling procedure to reduce the risk of fire or explosion. See the **GENERAL PRECAUTIONS** section.

To refuel the vehicle:

1. Park outdoors in a well ventilated area away from flames, sparks, anyone smoking and other sources of ignition.
2. Stop the engine.
3. Unlatch and lift seat (see *EQUIPMENT* subsection). The fuel cap is located on the left side.

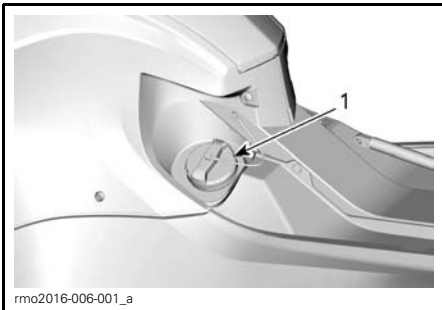

rmo2016-006-001_a

1. Fuel cap
4. Slowly rotate cap counterclockwise and remove it.
5. Fill the tank until the fuel level reaches the higher point of the filler tube.

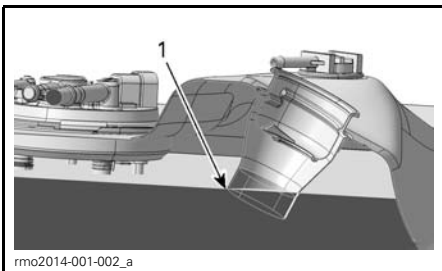

rmo2014-001-002_a

TYPICAL

1. Higher point of the filler tube

NOTE: Do not try to top off the fuel tank. Leave some room for the fuel to expand with temperature changes.

6. Wipe up any spilled fuel. If fuel spills on you, wash with soap and water and change your clothes.
7. Put cap on and fully tighten clockwise until you hear a click. Never start or operate the engine with the fuel cap removed.
8. Close seat.

Adjusting Suspension

ACS Rear Suspension Adjustment (with Manual Adjustment)

The rear air suspension is pressurized for general operation. If the vehicle load changes (adding a passenger, riding with more cargo etc.) or if a softer or a harder setting is desired, the pressure of the rear suspension can be changed to your preferences.

The suspension pressure is adjustable by deflating or inflating the air spring. Use an air compressor (from a gas station) and a pressure gauge.

To soften suspension, reduce the air pressure and to harden suspension, increase air pressure.

NOTE: The following chart is a guideline only. You may adjust the pressure to your riding preference as long as you do not exceed the maximum allowed pressure.

NOTICE Do not exceed the maximum allowed pressure. This might damage the air suspension.

⚠ WARNING						
MINIMUM PRESSURE 70 kPa / 10 Psi / 0.7 bar						
DO NOT EXCEED RECOMMENDED PRESSURE BY 70 kPa / 10 Psi / 0.70 bar						
		(PASSENGER + CARGO) Kg / Lb 704905155				
LOAD		0	45/100	70/150	90/200	115/250
DRIVER	Kg/Lb	kPa/Psi/bar	kPa/Psi/bar	kPa/Psi/bar	kPa/Psi/bar	kPa/Psi/bar
	70/150	310/45/3.10	380/55/3.80	450/65/4.50	480/70/4.80	515/75/5.15
	90/200	345/50/3.45	415/60/4.15	480/70/4.80	515/75/5.15	550/80/5.50
	115/250	380/55/3.80	450/65/4.50	515/75/5.15	550/80/5.50	585/85/5.85

704905155

NOTE: When adjusting the pressure, do not put your weight on the vehicle and do not load cargo in the storage compartment.

The air spring is connected directly to an air hose with a schrader valve located under the seat.

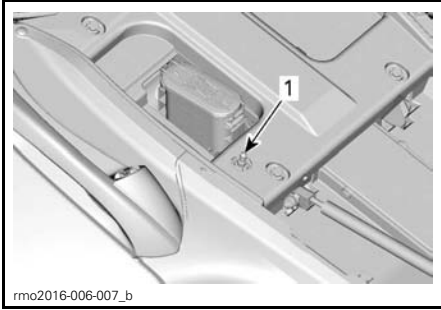

1. Schrader valve

To change the air pressure, proceed the same way as for setting the pressure in a tire.

When finished, ensure to reinstall cap on the valve.

ACS Rear Suspension Adjustment (with Remote Adjustment)

Adjustment Guidelines

The rear suspension is calibrated for a general riding and will adjust automatically, using an integrated compressor, while riding to maintain this preset when the road conditions change or if the vehicle load changes (adding a passenger, riding with more cargo etc.).

NOTE: It is normal to hear pressure release or the air compressor operating while engine is running. It indicates the suspension is self-adjusting.

If the driver desires a softer or a stiffer adjustment than the factory setting, he can adjust the rear suspension by pressing the ACS switch in the switch cluster. By changing the ACS setting, air pressure in the air spring will change to provide a customized suspension adjustment.

The following suspension settings are available.

ACS SUSPENSION SETTINGS	
BAR GRAPH INDICATION IN MULTIFUNCTION GAUGE	
1 (top)	Lowest
2	Low
3	Middle
4	High
5 (bottom)	Highest

To change the actual setting, proceed as follows:

Adjusting Suspension (While Riding)

1. Press the ACS switch once (either UP or DOWN). The digital display will enter the suspension adjustment mode.

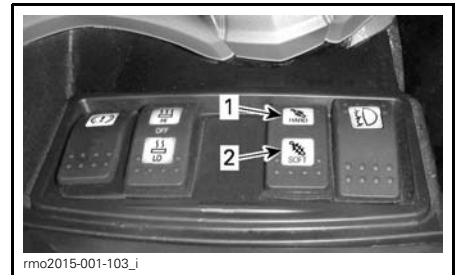

1. Press here to stiffen
2. Press here to soften

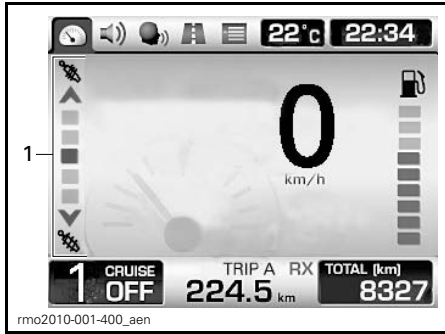

TYPICAL - SUSPENSION ADJUSTMENT MODE

1. Suspension settings
2. The highlighted bar indicates the actual setting.



TYPICAL
1. Actual setting

3. Pressing the switch UP or DOWN will move the highlighted bar accordingly one at a time. Releasing the switch will keep the set point after a few seconds.

Adjusting Suspension (When Vehicle Is Stopped)

Follow the same instructions as for *ADJUSTING SUSPENSION (WHILE RIDING)*.

However the following conditions must be met:

- Engine running
- Parking brake released
- Gearbox not in neutral position.

Using the 12 V Power Outlet

A 12 V power outlet is available on the vehicle. It is located in the top storage compartment.

Limited Model

To access the 12 V power outlet, open the access flap in the top storage compartment.

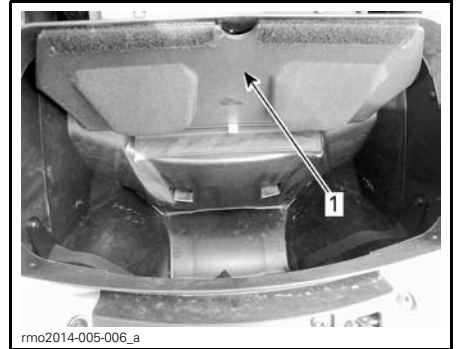

1. Access flap

All Models

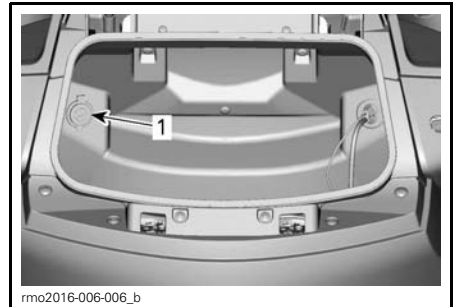

1. Power outlet

A 12-volt electric appliance may be connected to the jack connector. Electric current is supplied all the time.

NOTICE The 12-volt power outlet is not designed to supply current of more than 3 amperes.

NOTE: Leaving an appliance connected while the engine is not running will gradually discharge the battery.

NOTE: When fuse 6 is installed in the RH fuse box, 12 V power outlet is only operational when ignition switch is at ON position. When fuse 7 is installed, 12 V power outlet is always operational.

Using the Audio in Jack

An audio input jack is provided in the top storage compartment.

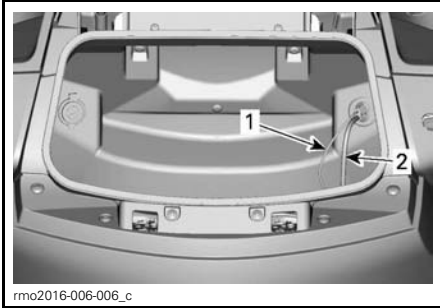

1. Audio in jack
2. USB jack

An audio player such as a CD player, iPod mobile digital device or a MP3 player can be connected in this jack to be played through the audio system. The iPod mobile digital device can be partially controlled through the RECC.

NOTE: An adapter (optional on some models) is required to connect the audio player to the vehicle audio jack.

***This page is
intentionally blank***

SAFE OPERATING INSTRUCTIONS

WHAT'S DIFFERENT ABOUT THE SPYDER ROADSTER

The Spyder roadster is a different type of road vehicle. This section will help you understand some of the vehicle distinctive features and operating characteristics.

Stability

The three-wheeled “Y” configuration provides greater low-speed stability than a motorcycle. However, it is not as stable as a four-wheeled vehicle such as an automobile. Driving aid technologies, like the electronic Vehicle Stability System (VSS), help maintain stability during maneuvers, but you can still lose control, tip or roll the vehicle due to extreme maneuvers (such as hard turns at high speeds) or striking uneven surfaces or objects. In addition, the operator or passenger can fall off due to hard turns, acceleration, braking or impacts.

Response to Road Conditions

The Spyder roadster responds differently than other vehicles to certain road conditions.

- Do not ride off-road or on ice or snow.
- Avoid puddles and running water. The vehicle hydroplanes more easily than a car. If you must go through water, slow down.
- Slow down on gravel, dirt or sand covered roads.

See the *STREET STRATEGIES* subsection for detailed instructions.

Brake Pedal

One pedal brakes all three wheels. There is no hand-operated brake, and there is no way to brake front and rear wheels separately. The Spyder roadster is better able to brake and steer at the same time than a motorcycle. The

vehicle can stop quickly – be aware of vehicles behind you that may not be able to stop as quickly.

Anti-Lock Braking System (ABS)

The vehicle is equipped with an Antilock Braking System (ABS) as part of the Vehicle Stability System (VSS). For hard braking, press and hold the brake pedal. ABS will prevent wheels from locking.

Parking Brake

The parking brake mechanically brakes the rear wheel only, and it locks in place when engaged. It is not controlled by driving aid technologies (e.g., ABS, Electronic Brake Distribution).

Steering

Direct Steering

To steer your Spyder roadster, always steer in the direction of the turn.

Motorcyclists — Do not countersteer as it is done on a motorcycle. Unlike a motorcycle, your Spyder roadster cannot lean while turning. If you are a motorcyclist, you must relearn how to turn. Practice steering in the direction of the turn at all speeds until you are proficient.

Sideways Forces in Turns

Unlike a motorcycle, the Spyder roadster does not lean in turns. You will feel sideways forces pushing you to the outside of the turn. To maintain balance, the operator and passenger must hold on with both hands and keep both feet firmly planted on the footrests. In hard turns, it may help to lean your upper body forward and toward the inside of the turn.

Width

Because the Spyder roadster is wider than a typical motorcycle:

- Keep the front wheels in your lane during turns. Be particularly aware of where your front wheels are in curves and when passing. If you take a path that would put a motorcycle front wheel near the edge of the lane, the Spyder roadster front wheel may be out of the lane.
- Do not share lanes or split lanes (ride between two lanes of traffic). Group riding should proceed in a single file, even with motorcycles.
- Be prepared to swerve farther to avoid obstacles.

Reverse



The Spyder roadster operates in reverse like a car. However, there are some important differences:

- The backup lights turn on when it is in reverse. Be aware that other motorists might not know that you are about to back up.
- If necessary, have the passenger dismount if your visibility is limited.
- Remember that the front is wider than the rear. Do not back up too close to objects or you may hit them with the front tires.
- Keep your speed low and do not back up for long distances.
- When possible, park so that you do not have to back out of the parking space.
- SM6 model: Shift back into first gear before shutting off the engine.

⚠ CAUTION Always keep both feet on the pegs while operating in reverse. Never put your feet on the ground while backing-up.

Driver's License and Local Laws

Driver's license requirements for operating the Spyder roadster vary by location. Depending on local laws, you may need a motorcycle endorsement, three-wheeled vehicle endorsement, or just a standard automobile driver's license.

Check with local authorities to make sure you have the proper license before operating the vehicle on public roads.

DRIVING AID TECHNOLOGIES

Vehicle Stability System (VSS)

The Spyder roadster is equipped with a Vehicle Stability System (VSS). VSS can help you control the direction of the vehicle and reduce the risk of tipping or rolling over in some situations. VSS consists of:

- An **Antilock Braking System (ABS)** that helps maintain steering control during hard braking by preventing the wheels from locking.
- An **Electronic Brake Distribution (EBD)** system that automatically adjusts the brake balance between all three wheels. With the ABS, EBD helps maintain directional control and maximize the braking force depending on the traction available.
- A **Traction Control System (TCS)** that helps prevent the rear wheel from slipping under throttle demand. The TCS will limit rear wheel spin only if you turn the handlebar (steer out of straight line) or if vehicle speed exceeds 50 km/h (31 MPH). When off-throttle (deceleration), the TCS will prevent the rear wheel from blocking.
- A **Stability Control System (SCS)** is designed to limit the power driving the rear tire and to brake individual wheels, which reduces the risk of losing control of the vehicle or rolling over.

NOTE: The VSS light in the gauge will turn on when VSS intervenes and will remain on for 2 seconds after VSS intervention.

Limitations

VSS cannot help you maintain control in all situations.

Surfaces with Poor Traction

The grip of tires on the road surface limits the maximum braking. Even with ABS and EBD, your stopping dis-

tance will be longer on surfaces with poor traction or if you do not maintain tire pressure and tread condition.

If your tires lose traction with the road surface you may lose control of the vehicle, even with VSS.

If the paved road surface is covered or partially covered with ice, snow or slush, there is not enough traction available to maintain control of the vehicle, even with VSS. Do not operate on snow, ice or slush.

Like other on-road vehicles, this vehicle can hydroplane on water (lose traction on a layer of water). If you ride too fast into a layer of water, such as a large puddle or flowing water on the road, the vehicle can lose traction and spin out, and the VSS cannot keep you in control. Avoid large water puddles or water streams, and slow down or pull off the road during heavy rains. If you must pass through water, slow down as much as possible before you reach it.

Reduce speed on surfaces with poor traction, like mud, sand, gravel or wet pavement. The Spyder roadster is not for off-road operation. Always operate the vehicle on maintained roadways. Do not use the vehicle on any other terrain.

Tires

The VSS on the vehicle has been calibrated to perform best with a tire of a specific size, material and tread pattern. Replacing your tires with ones not approved by BRP can cause the VSS to be ineffective.

Use only BRP recommended tires, which can be ordered only from an authorized Can-Am roadster dealer.

Proper tire inflation pressure and tread condition are important for maintaining traction, especially on loose or wet surfaces.

Hard Turns

The VSS does not control or limit steering input — it cannot keep you from turning too sharply. Large and rapid steering handlebar movements can cause the vehicle to go out of control, spin, tip or roll over.

Excess Speed

The VSS does not control the vehicle speed, except when SCS intervenes during a turn. VSS does not prevent the vehicle from entering a turn too fast. If you drive too fast for conditions, you can lose control, even with VSS.

Dynamic Power Steering (DPS)

The DPS (Dynamic Power Steering) provides a computer controlled, variable power assist, achieved by an electric motor to optimize the amount of steering effort required by the rider.

The steering assist level is dependent of the handlebar effort, the steering angle and the vehicle speed.

When vehicle is in the reverse gear, power steering assist will decrease as vehicle speed increases.

UNDERSTANDING RISK ON THE ROAD

Before you operate the Spyder roadster, consider your risk of being hurt or killed in a crash, how you can reduce the risk and whether you are willing to take the risk. There are many factors that contribute to the risk that you face. You can control some of these factors, but others, like the behavior of other drivers, are beyond your control. Here are some of the factors that affect your risk:

Type of Vehicle

Different types of vehicles vary in terms of size, visibility and maneuverability and provide different degrees of protection.

The Spyder roadster is small and maneuverable. Maneuverability can help avoid crashes. However, smaller vehicles are harder to see, which increases the chance that other motorists will cause a crash. In some situations, the Spyder roadster is less likely to be in a crash than a motorcycle. For example, you are less likely to tip over at low speeds while operating the vehicle. However, in other situations, the vehicle is more likely to be in a crash. For example, because the vehicle is wider, it will not fit through as small an opening as many motorcycles.

In cars and trucks, the structure of the vehicle provides protection in crashes and from other road hazards. In addition, passengers can protect themselves by wearing seat belts. You should expect that riding the Spyder roadster is riskier than riding in a car and that the risk of injury is more like riding a motorcycle.

As when riding a motorcycle, you can reduce the risk of injuries by wearing a helmet and riding gear.

Operator Skills and Judgment

Every driver has some control over their own risk on the road. Drivers who develop good skills will have better control of their vehicle. Do not rely on your experience with motorcycles, automobiles, ATVs, snowmobiles or any other kind of vehicle to prepare you to operate the Spyder roadster. Learn how this vehicle is different. Read this Operator's Guide, watch the *SAFETY DVD* video, and if available, take a training course. Become proficient with the controls and be able to do the practice exercises accurately and with confidence before going on the road.

When you begin riding on the road, start with less challenging situations (e.g., light traffic, lower speeds, good weather, no passenger) and gradually move on to more challenging riding situations as you develop your skills. Plan ahead to avoid situations that are too difficult for your skill level, or that present more risk than you want to take on.

Even skilled drivers cause crashes. For example, if you use your skills to do extreme maneuvers or stunts, you increase your risk. The smart driver uses good judgment along with skills to increase the margin of safety and minimize risk. Learn the defensive driving techniques in the *STREET STRATEGIES* subsection.

Rider Condition

A driver needs to be alert, sober, and physically ready to ride. Never use this vehicle with drugs or alcohol. Riding when intoxicated, tired or otherwise impaired increases the risk of a crash.

Alcohol, drugs, medications, fatigue, drowsiness and emotions can all inhibit your ability to ride safely. Like riding a motorcycle, riding the Spyder roadster is a challenging activity – being in good physical and mental condi-

tion is even more important than for a car. The safest policy is to never operate the vehicle unless you are alert and completely sober. Even if your blood alcohol level is not over the legal limit, your judgment and skills are impaired by any alcohol consumption.

You must be physically able to operate all controls, turn the handlebar through the full range of steering, mount and dismount, and monitor your surroundings to operate the vehicle.

Passengers also need to be alert, sober and physically able to maintain their posture, hold on and react appropriately to curves, bumps, acceleration and stops.

Vehicle Condition

Keep your vehicle in good condition.

Do pre-operation checks and perform regular maintenance. Watch for any messages on the multifunction gauge when you start the vehicle, and address any problems before you ride.

Road and Weather Conditions

Roads with heavy traffic, poor visibility or poor traction surfaces increase your risk. Choose routes that are appropriate for your skill level and the level of risk you are willing to accept.

RIDING GEAR

Riding three-wheeled, open-air vehicles like the Spyder roadster requires the same protective gear as motorcycling. Even though the vehicle is more stable at low speeds than a motorcycle, you can still be thrown off.

This section is based on guidance for motorcyclists given by the Motorcycle Safety Foundation (MSF).

In the event of a crash, protective gear may prevent or reduce injuries. Protective gear also helps you stay comfortable and can help provide protection against the elements.

Recommended basic protective gear for riders and passenger includes sturdy over-the-ankle footwear with non-slip soles, long pants, a jacket, full-fingered gloves and, above all, an approved helmet with proper eye protection.

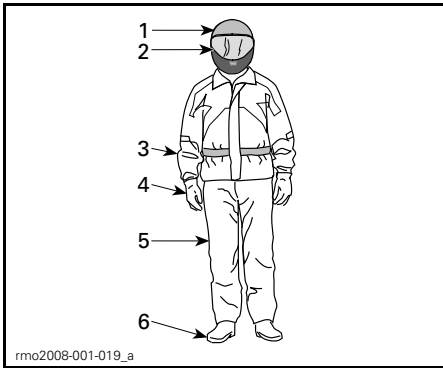

RIDING GEAR

1. Approved helmet
2. Eye and face protection
3. Jacket with long sleeves
4. Gloves
5. Long pants
6. Over-the-ankle footwear

Proper apparel can reduce the severity of injury in case of a crash for both operators and passengers.

Helmets

Helmets protect the head and brain from injury. A helmet can also protect the passenger's face from impact

with the back of the operator's helmet. Even the best helmet is no guarantee against injury, but statistics indicate that helmet use significantly reduces the risk of brain injury. So, be safe and always wear a helmet while riding.

Choosing a Helmet

Helmets should be manufactured to meet the appropriate standard in your state, province or country.

A full-face helmet gives the most protection against impacts since it covers all of the head and face. It can also protect against debris, stones, insects, etc.

A three-quarter or open-face helmet can also offer protection. It is constructed with the same basic components but does not offer the face and chin protection of full-face helmets. If you wear an open-face helmet, you should use a snap-on face shield or a pair of goggles.

NOTE: Ordinary glasses or sunglasses are not sufficient eye protection for a motorcyclist. They can shatter or fly off, and they allow wind and airborne objects to reach the eyes.

Use tinted face shields, goggles or glasses in the daytime only; do not use them at night or in poor illumination. Do not use them if they impair your ability to discern color.

Other Riding Gear

Footwear

Always wear closed toe footwear. Sturdy over-the-ankle boots protect against a variety of riding hazards, such as stones that get thrown up from the roadway and burns from the hot exhaust pipe.

Avoid long shoelaces that can be tangled in the gearshift lever, brake pedal or other parts. Rubber soles and low heels are a good idea to help keep feet on the footrests.

Gloves

Full-fingered gloves protect hands from the wind, sun, heat, cold and flying objects. Gloves that fit snugly will improve grip on the handlebar and help reduce hand fatigue. Sturdy, reinforced motorcycle gloves help protect hands in the event of a fall. Gloves made specifically for motorcyclists have seams on the outside to prevent irritation, and are curved to provide a natural grip when curled around the handgrips. If gloves are too bulky, it may be difficult to operate the controls. Gauntlets keep cold air from going up sleeves and protect the wrists.

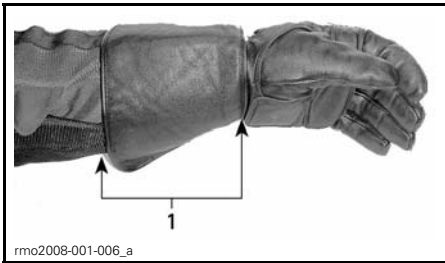

1. *Glove gauntlet*

Jackets, Pants and Riding Suits

Wear a jacket and long pants, or a full riding suit. Quality motorcycle-type protective gear will provide comfort, and it can help you avoid being distracted by adverse environmental elements. In case of a crash, good quality protective gear made of sturdy material may prevent or reduce injury. Some gear includes padding or hard armor that may further reduce the risk of injury in a crash. Pants also help protect against burns from hot parts.

Protective gear sold for motorcycling will often provide the best combination of fit and protection. These garments are designed to fit while sitting in a riding position. They are cut longer in the sleeves and legs and are fuller across the shoulders. Riding suits are available in both one-piece and two-piece sets.

Leather is a good choice because it is durable and wind-resistant and provides protection against injury. Other abrasive-resistant protective gear made of synthetic fabrics are good choices, too. Do not wear loose or long clothing or scarves that can become tangled in the moving parts.

Flaps and fasteners seal out the wind. A jacket with a zippered front will be more wind resistant than a jacket with buttons or snaps. A flap of material over the zipper of a jacket gives additional protection against the wind. Jackets with snug cuffs and waist are recommended to keep wind from blowing in. A large, loose collar can flap when riding and may irritate skin or be a distraction.

In cool-weather riding, protect yourself against hypothermia. Hypothermia, a condition of low body temperature, can cause loss of concentration, slowed reactions and loss of smooth, precise muscle movement. In cool conditions, proper protective gear like a windproof jacket and insulated layers of clothing are essential. Even at moderate temperatures, you can feel very cold due to the wind while riding.

Protective gear that is appropriate for cold-weather riding may be too hot when stopped. Dress in layers so that clothing can be removed as desired. Topping the protective gear with a windproof outer layer can prevent cold air from reaching the skin.

Riding gear can also help a rider be more visible. Wearing bright colors is a wise choice. If a dark jacket is worn, an inexpensive reflective vest can be worn over it. It is a good idea to put extra reflective tape on garments worn regularly while riding.

Rain Gear

If you must ride in wet weather, a rain suit or a waterproof riding suit is recommended. On long rides, it is a good

idea to carry rain gear. A dry rider will be much more comfortable and alert than a rider who is wet and cold.

One or two-piece styles are available, and those designed specifically for motorcycling are best. High-visibility orange or yellow colors are good choices. A feature to look for is elastic in the waist, pant legs and sleeves. The jacket should have a high collar and zip up with wide flaps across the opening. When purchasing a rain suit, consider adding waterproof gloves and footwear.

Remember, if the weather is wet, it is best to avoid riding. If you do ride in wet weather, you may need to stop if water starts to accumulate on the road.

Hearing Protection

Long-term exposure to wind and motor noise when riding can cause permanent hearing loss. Properly worn hearing protective devices such as earplugs can help prevent hearing loss. Check local laws before using any hearing protective devices.

REQUIRED RIDING SKILLS AND PRACTICE EXERCISES

Before you take the Spyder roadster on the road, you need to develop riding skills and strategies for managing risk on the road. The following exercises will familiarize you with the basic operation of the vehicle. If you have experience with motorcycles or other motor vehicles, pay particular attention to how the Spyder roadster operation and performance are different from vehicles you are used to. Practice each exercise until you can perform it proficiently before moving on to the next. If you tow a trailer, practice all the exercises riding with the trailer. This section includes the following exercises:

SM6 Model

1. Revving the engine and using the engine stop switch
2. Learning the friction zone and basic handling
3. Engine stop while in motion
4. Using the throttle and clutch
5. Basic turns
6. Quick stops
7. Weaves
8. Shifting
9. Swerve
10. Operating in reverse.

SE6 Model

1. Revving the engine and using the engine stop switch
2. Starting, stopping, and basic handling
3. Engine stop while in motion
4. Basic turns
5. Quick stops
6. Weaves
7. Shifting
8. Swerve
9. Operating in reverse.

Choosing a Practice Area

Perform these exercises in a paved area at least 76 m - 30 m (250 ft - 100 ft) that is not open to traffic. A closed, well marked parking lot without obstacles (light poles, curbs, etc.) makes a good practice area. Be aware of oil left by parked cars. Look for parking lots that are empty during off hours, such as at schools, churches, community centers or shopping centers. Do not trespass on private property.

Once you have selected a suitable location, get permission to use it from the owner. If there are obstructions, such as light poles or islands, be sure that they do not interfere with the required open paths shown in the diagram below.

Keep this basic parking lot diagram in mind when setting up the exercises. 3 m (10 ft) wide parking lot spaces are indicated in the diagrams for convenience, but the size of the spaces in the lot you use may be different. If the parking lot you choose does not have lines or if the parking spaces are sized much larger or smaller than the ones in the diagrams, use the dimensions shown below. Mark them using a tape measure and chalk or markers such as cones or milk containers weighted with water or sand.

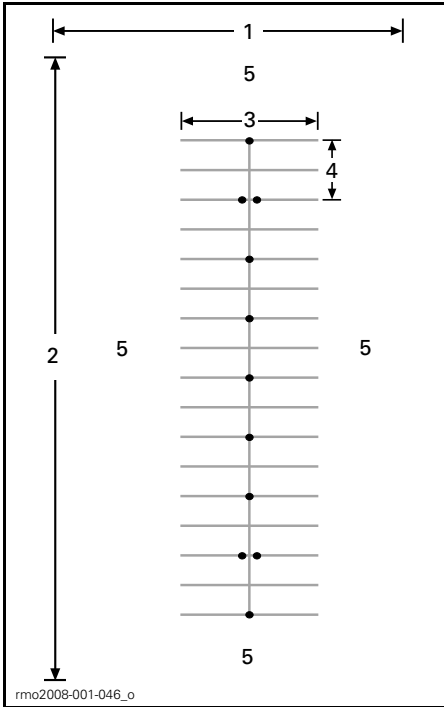

TYPICAL PARKING LOT

1. At least 30 m (100 ft)
2. At least 75 m (250 ft)
3. 12 m (40 ft)
4. 6 m (20 ft)
5. Open area

Even in a closed lot, be aware of potential traffic. Check to the front, sides and rear before doing an exercise. Also, watch out for children and animals.

Preparing to Ride

Know the location and operation of all the vehicle controls.

Perform the pre-ride inspection; see *PRE-RIDE INSPECTION* section.

Always start and stop the engine according to the instructions in *STARTING AND STOPPING THE ENGINE* in *BASIC PROCEDURES* subsection.

Riding Posture

Good posture helps you maneuver the vehicle more easily. Always keep both hands and both feet in position so that you can operate the controls easily. The wrist should typically be aligned straight with the arm (this position helps you apply the amount of throttle you want). Arms should be relaxed and bent. Keep your back straight and your head and eyes up. Keep both feet on the pegs near the controls.

Never operate the vehicle, even for a short distance, unless you are in the proper riding posture.



TYPICAL — RIDING POSTURE

Practice Exercises (SM6 Model)

NOTE: If you are planning to use a BRP trailer we recommend performing these exercises carrying a loaded trailer before getting on the road. You will learn about the new behavior of your vehicle.

1) Revving the Engine and Using the Engine Stop Switch

Purpose

- Become familiar with the sound of the engine revving so you will not be surprised during the exercises.
- Become familiar with using the engine stop switch.

Directions

- With the vehicle in NEUTRAL, the parking brake engaged, and your right foot pressing the brake pedal, pull in and hold the clutch lever. Watch the tachometer and apply throttle (twist by lowering your wrist) a few times to raise the RPM to no more than 4000. As long as the clutch is fully pulled in the power will not transfer to the rear wheel.
- Use the engine stop switch to cut all power to the vehicle. Press the switch with your right thumb while keeping your hand on the handgrip.

Tips for Additional Practice

- Practice pressing the engine stop switch without looking at it.

2) Learning the Friction Zone and Basic Handling

Pulling in the clutch disengages power to the rear wheel – if you feel like you are losing control while doing these exercises, you can pull in the clutch to stop accelerating and apply the brake as needed to slow down. You can also use the engine stop switch to cut power entirely.

The friction zone is the area in the travel of the clutch lever that begins where the clutch starts to transmit power to the rear wheel and ends just before the clutch becomes fully engaged. While the clutch is partially engaged, it allows you to precisely control engine power transmitted to the rear wheel. Proper use of the friction zone helps you get moving smoothly from a stop.

Purpose

- Become familiar with the clutch and operating within the friction zone.
- Become familiar with low speed deceleration and braking.

Directions

For this exercise, do **NOT** use any throttle. You will be controlling your movement using only the clutch in the friction zone and brake.

Begin by stopping every 6 m (20 ft) (every marker/every second line).

- Start the engine and release the parking brake.
- With the brake pedal depressed and the clutch lever pulled in, shift the transmission into first gear by firmly pushing down on the shift lever.
- Release the foot brake.
- **Slowly** let out the clutch lever until the vehicle starts to creep forward. Hold the clutch lever at this point. This is the friction zone. If you release the clutch too quickly, the engine may stall or the vehicle may jump forward. **If the vehicle stalls**, restart the engine and try again, releasing the clutch more gradually.
- As you approach the stopping point, pull the clutch lever all the way in and press the brake pedal to stop. Pulling the clutch in does not have to be gradual – you can do this quickly.
- When you reach the end of the straightaway, stop, turn the handlebar all the way to the right, and turn around. Be careful not to apply throttle as you turn. Stop when you are in line with the straightaway in the opposite direction.
- Repeat this exercise until you feel comfortable.

Tips for Additional Practice

- As you become more comfortable with the friction zone, try stopping every 12 m (40 ft) (every other cone) so that you can fully release the clutch.

3) Engine Stop while in Motion

Purpose

- Become familiar with using the engine stop switch when in motion so you know how the vehicle will react if you need to use it later.

Directions

- Partway down the straightaway, while operating in the friction zone, turn the engine stop switch to OFF and coast to a stop.
- Restart the engine and repeat the exercise. Try releasing the clutch farther and moving a little faster before using the engine stop switch.

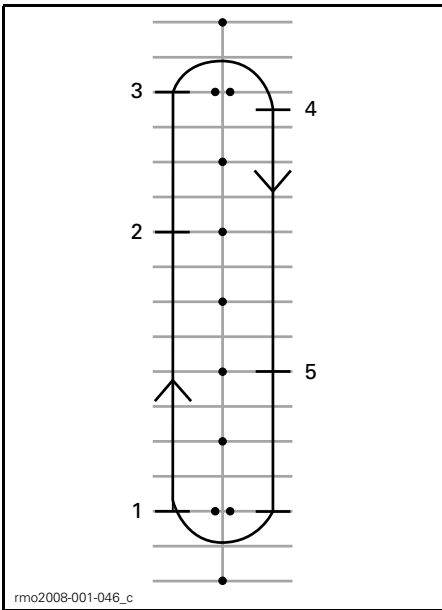

1. Start
2. Press engine stop switch
3. Proceed to end of straightaway, stop and turn as before
4. Stop
5. Press engine stop switch

Restart the engine and proceed to the next exercise.

4) Using the Throttle and Clutch

Purpose

- Become familiar with operating the throttle.
- Learn to balance throttle and clutch.

Directions

This exercise is similar to the friction zone exercise, except this time you will be using some throttle. You will use the entire straightaway, stopping only at the ends.

- Start this exercise stopped in first gear at the beginning of a straightaway.
- With the clutch lever pulled in, gently apply throttle until the tachometer reads between 1500 and 2000 RPM. Practice holding it within this range.
- Hold the throttle at this position while gently releasing the clutch lever as before. Try not to let the RPMs exceed 2500.
- The more quickly you release the clutch lever, the more quickly you will accelerate. If you release the clutch too quickly, the engine may stall or the vehicle may jump forward.
- Applying too much throttle can cause the rear wheel to spin and can result in rapid acceleration.
- When the clutch lever is fully released, the throttle controls your speed.
- As you approach the end of the straightaway, release the throttle, pull in the clutch lever and apply the brakes to come to a stop.
- Without using throttle, turn around and head down the opposite straightaway.

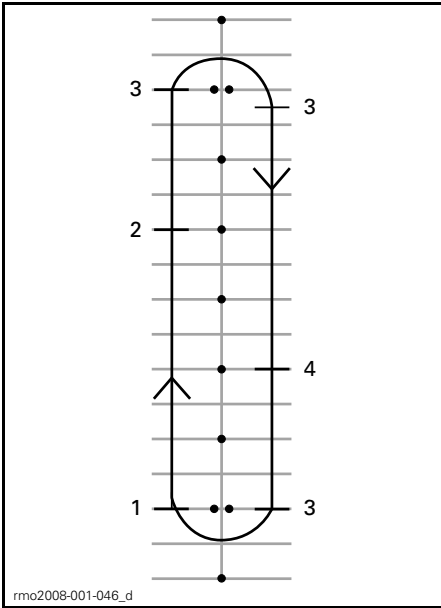

1. Start
2. Release throttle
3. Stop
4. Release throttle

Tips for Additional Practice

- Coordinate releasing the clutch lever and applying the throttle to start smoothly and to control your acceleration.

5) Basic Turns

Purpose

- Get comfortable turning in a controlled manner.

Directions

This exercise is similar to what you did before, except that now instead of stopping for each turn, you will make the turn in the friction zone.

- Proceed down the straight away in first gear. Ride a little farther from the cones so you can make a wide arcing turn at the end of the straight-away.

- As you approach the curve, slow down to no more than 8 km/h (5 MPH) by pulling in the clutch lever and applying brake if needed.
- Hold the clutch lever in the friction zone to maintain your low speed.
- Look in the direction of the curve.
- Turn the handlebar in the direction of the curve, pulling on the inside hand-grip and pushing on the outside. Be careful not to change your hand position on the throttle.
- Leaning forward and into the curve may help you turn the handlebar more easily.
- Straighten your handlebar after the turn and proceed down the straight-away.



TYPICAL — RIDING POSTURE WHEN TURNING

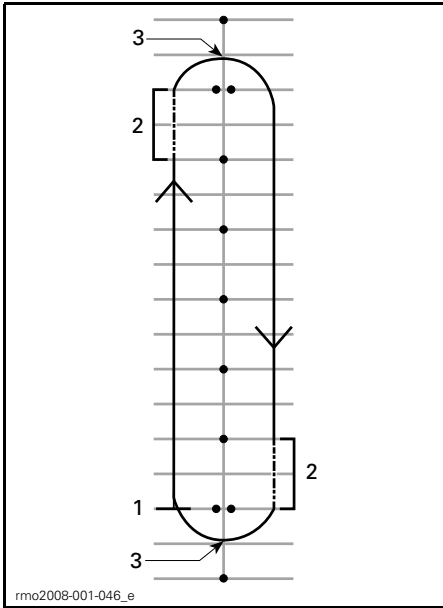

1. Start
2. Friction zone
3. Apex

NOTE: Motorcyclists — Riding through turns and curves with your Spyder roadster is different than on a motorcycle. The vehicle does not lean during a turn, so you may need to shift your body weight to the inside of the turn to keep a comfortable posture on the vehicle. You will need to exert more force to turn the handlebar of your vehicle than is needed to turn a motorcycle. However, it is easier to stop while turning than with a motorcycle.

Tips for Additional Practice

- After you are comfortable turning in one direction, try going around the course the other way. Be careful not to apply more throttle than you intend when turning left.
- Stop at the apex of the turn to see what it is like to use your brakes in a curve or turn.

6) Quick Stops

Purpose

- Become familiar with the vehicle braking ability.
- Learn to apply brakes with maximum force.

Directions

This exercise is similar to what you did before, except you'll be applying the brake more firmly, working up to braking as hard as possible.

- Start at one end of the straight away and accelerate to 8 km/h (5 MPH).
- Partway down the straightaway, release the throttle completely and brake quickly and firmly.
- Keep head and eyes up and keep handlebar straight.
- Repeat, increasing your speed and braking harder.

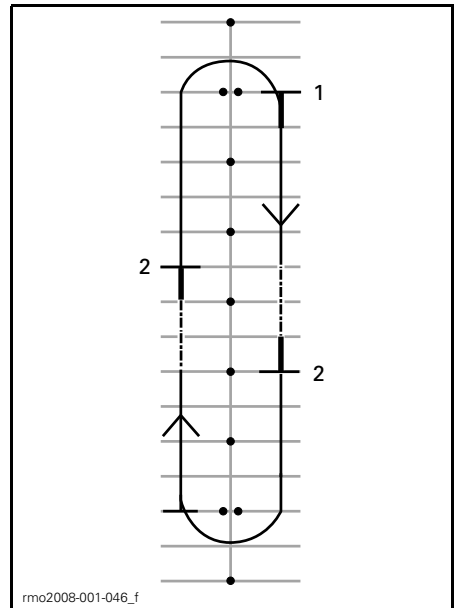

1. Start
2. Stop

Tips for Additional Practice

- Practice checking your mirrors before braking hard.

7) Weaves

Purpose

- Get more experience with the vehicle handling and rider position.

Directions

6 m (20 ft) Weave

1. Weave between every marker/intersection of every other parking spot. Do not use throttle – stay in the friction zone.
2. Lean into each turn and turn the handlebar in the direction you want to go by pulling and pushing the grips.

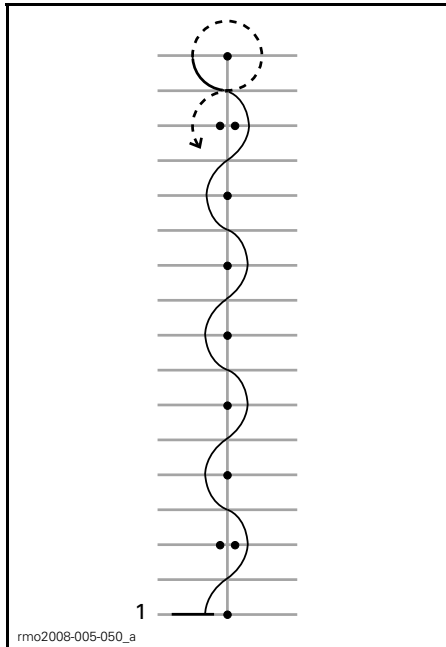

1. Start

12 m (40 ft) Weave

Once you're comfortable, try doing 12 m (40 ft) weaves between every other cone/every fourth parking space.

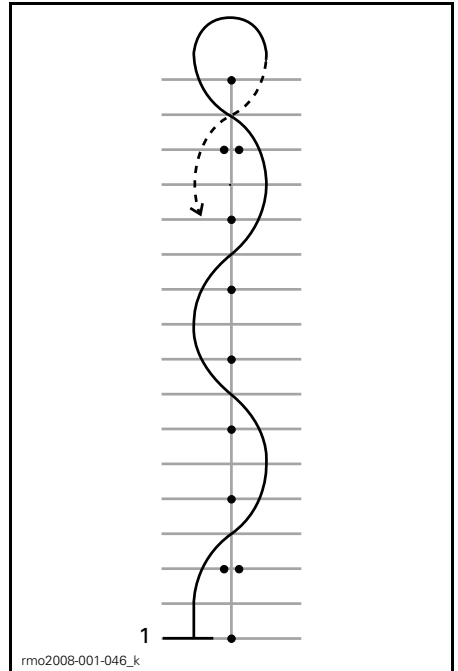

1. Start

Tips for Additional Practice

- You can gradually increase speed as you get comfortable to 16 km/h - 19 km/h (10 MPH - 12 MPH) for the weaves, but slow down for the U-turns at the ends.

8) Shifting

When riding, you must change gears to match the engine speed with road speed.

Purpose

- Become familiar with the foot motions needed to shift gears.
- Learn to upshift and downshift.

Directions

This exercise is similar to what you did before, except now you will be upshifting on the straightaways, then coming to a stop at the end of each straight-

away. You may want to use the parking lot aisles for this exercise rather than riding in the spaces.

8a) Practice Using the Shift Lever at a Stop

First, while stopped, practice the left foot motion for shifting between first and second gears.

- At a stop in first gear, pull in the clutch lever.
- Slide the tip of your left foot under the shift lever and lift it as far as it will go, one firm stroke up to shift into second gear.
- Step on the shift lever and press it as far as it will go, one firm stroke down to shift into first gear.
- Repeat until you are comfortable with the foot motions required.

8b) Upshifting from First into Second Gear

In the straightaway, accelerate to approximately 16 km/h (10 MPH) in first gear.

To upshift:

- Release the throttle.
- Pull in the clutch lever. (If you pull in the clutch before releasing throttle, the engine may rev – just release the throttle if this happens.)
- Slide the tip of your left foot under the shift lever and lift it as far as it will go, one firm stroke up to shift into second gear.
- Smoothly ease out the clutch.
- You do not need to apply throttle, but once you are comfortable, if space allows, you can apply the throttle to increase speed in second gear.

As you approach the end of the straightaway, come to a stop:

- Release the throttle.
- Pull the clutch lever all the way in.

- Apply brake.
- After stopping, downshift into first gear by stepping on the shift lever and pressing it as far as it will go, one firm stroke down. Once you are more comfortable, downshift into first as you come to a stop.

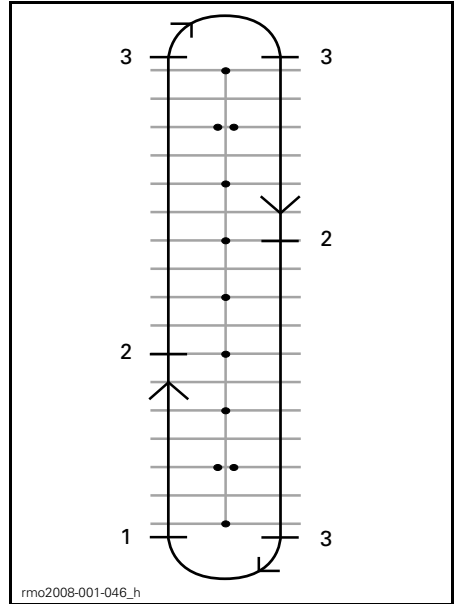

1. Start
2. Shift into second at 16 km/h (10 MPH)
3. Stop

8c) Downshifting from Second to First Gear

If space allows, practice downshifting into from second to first gear.

In the straightaway, slow to approximately 16 km/h (10 MPH).

- Release the throttle and pull in the clutch lever.
- Step on the shift lever to shift into first gear.
- Smoothly ease out the clutch.
- Put your foot back on the footrest.

8d) Other Gears

If space allows, you can try shifting into and out of higher gears as well. Follow the same process and shift UP or DOWN one gear at a time.

Tips for Additional Practice

As you gain more experience, you can refine your shifting skills and use them to better control the vehicle.

- When downshifting, rolling on the throttle slightly while smoothly easing out the clutch can help the engine rev up to match vehicle speed more quickly and make the downshift smoother, preventing skidding of the rear wheel.
- Shifting to a lower gear slows the vehicle if you do not apply throttle. This is known as engine braking. To use engine braking, shift down one gear at a time and ease out the clutch between each downshift. Keep the clutch in the friction zone until the engine speed stabilizes, then ease out the lever fully until ready for the next downshift.
- Usually you shift gears one at a time, but it is possible to shift through more than one gear while the clutch is squeezed by repeating the UP or DOWN stroke as many times as you want gear changes.

Remember that VSS does not control engine braking. If you shift into too low a gear when you are at high speed, the rear tire can skid and you can lose control, spin out, tip or roll over, particularly in a curve.

9) Swerve

Purpose

- Become familiar with the vehicle handling for quick maneuvers.
- Try different variations of braking and swerving.

Directions

Set up your markers as shown in the diagram below. Do not use any fixed or hard, heavy objects as markers for this exercise.

- Enter between the double cones at about 8 km/h (5 MPH) and maintain that speed throughout.
- Steer around the line of cones.
- Exit through the second set of double cones.
- Repeat the exercise multiple times, swerving in both directions.

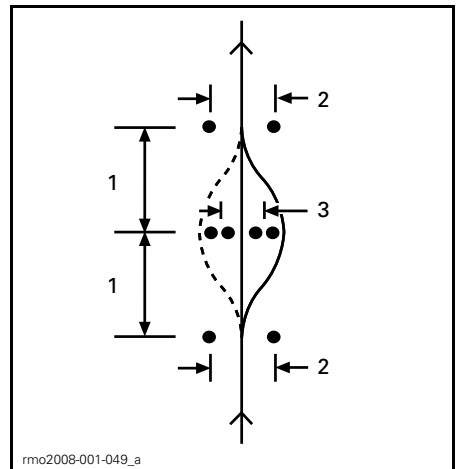

1. 6 m (20 ft)
2. 3 m (10 ft)
3. 2.5 m (8 ft)

Tips for Additional Practice

- You can gradually increase your entry speed (to no more than 13 km/h to 19 km/h (8 MPH to 12 MPH) and try some variations. For example, approach faster and slow before entering the exercise, pull in the clutch and apply brakes during the swerve, etc.

- A helper can add an element of surprise to the exercise by deciding which direction you should swerve, or if you should come to a stop instead. Have your helper stand at a safe distance away (e.g., beyond the end of your practice area). As you reach the first set of cones, the helper can use hand signals to indicate which direction to swerve or for you to stop.
- Practice checking your mirrors and blind spot before you swerve.

10) Operating in Reverse

Purpose

- Become familiar with the vehicle handling and turning radius in reverse.

Directions

Shift into reverse. See *OPERATING IN REVERSE* in *BASIC PROCEDURES* subsection.

Check that the area behind you is clear and continue to look backwards while you ease out the clutch. Be careful not to strike anything with your front wheels as you back up. Slow and stop using clutch and brake, just like when operating normally.

Back for a few feet at time, stopping in between.

Keep your speed low and do not back up for long distances.

After you are comfortable with reverse, back into a parking space as shown in the diagram below.

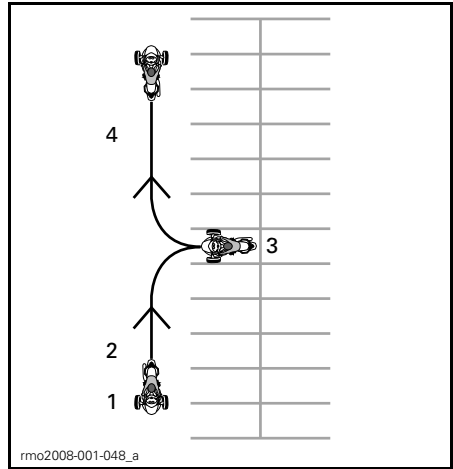

Additional Practice in Controlled Environments

Once you are comfortable with all of the above exercises, you can try a few other things as space and conditions allow. This might be in the parking lot or at a later time in a place where you have the opportunity without putting yourself at risk.

- **Quick starts:** Try quickly getting up to speed and upshifting through the gears.
- **Quick stop from higher speed:** Similar to the quick stop exercise, but performed from higher speeds to get a feel for emergency stops.
- **Starting up an incline:** To do this, keep holding the brake pedal as you release the clutch lever until you are in the friction zone. This will keep you from rolling backwards.

Practice Exercises (SE6 Model)

1) Revving the Engine and Using the Engine Stop Switch

Purpose

- Become familiar with the operation of the twist throttle.
- Become familiar with the sound of the engine at different RPMs. This will help you to know when to up-shift and downshift based on the engine sound.
- Become familiar with using the engine stop switch.

Directions

- Start with the vehicle in NEUTRAL, the parking brake engaged, and your right foot on the brake pedal. Check the multifunction gauge to be sure you are in NEUTRAL – if you are in first gear, the roadster will try to start moving when you apply the throttle.
- Watch the tachometer and apply throttle (twist by lowering your wrist) a few times to raise the RPM to no more than 4000. Practice applying the throttle gently and smoothly, holding it steady at about 3000 RPMs, and releasing it. As long as the transmission is in neutral the power will not transfer to the rear wheel.
- Use the engine stop switch to cut all power to the vehicle. Press the switch with your right thumb while keeping your hand on the handgrip.

Tips for Additional Practice

- Practice pressing the engine stop switch without looking at it.

2) Starting, Stopping and Basic Handling

Purpose

- Learn throttle control and how to get the vehicle moving.
- Become familiar with low speed deceleration and braking.

Directions

If you feel like you are losing control while doing these exercises, release the throttle to stop accelerating and apply the brake as needed to slow down. You can also use the engine stop switch to cut power entirely.

2a) Apply and Immediately Release Throttle

Directions

At first, you will only use the throttle for a moment at a time, then release it and coast.

- Start the engine and release the parking brake.
- With the brake pedal depressed, shift the transmission into first gear by pressing the gear selector forward.
- Release the brake.
- Slowly apply throttle until the vehicle starts to creep forward. As soon as you start moving release the throttle and coast, then press the brake to stop. Repeat to the end of the straightaway.
- To turn around at the end of the straightaway, stop, turn the handlebar all the way to the right, then briefly apply and release the throttle, and coast through the turn. You may need to briefly apply the throttle more than once to complete the turn. Stop when you are in line with the straightaway in the opposite direction.
- Continue with this part of the exercise until you are comfortable with applying and releasing the throttle.

2b) Hold Throttle, Release and Stop Every 12 m (40 ft)

Next, you will be holding the throttle a little longer, then stopping every 12 m (40 ft) (every other marker/every fourth line).

- Again, slowly apply throttle until the vehicle starts to creep forward. This time, hold the throttle at this point.
- As you approach the stopping point, release the throttle and press the brake to stop.
- Turn around at the end of the straightaway as before, except now you do not need to release the throttle during the turn. Pay attention to maintaining a steady throttle position as you turn. Stop when you are in line with the straightaway in the opposite direction.

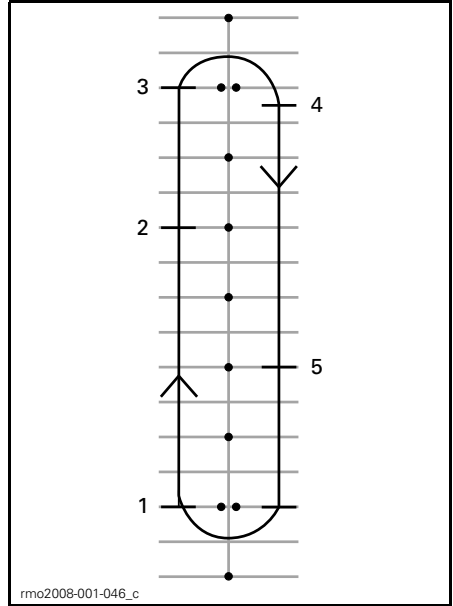

2c) Hold Throttle, Release and Stop at Ends

Next, use the entire straightaway, stopping only at the ends. Keep the throttle moderate.

3) Engine Stop while in Motion

Purpose

- Become familiar with using the engine stop switch when in motion so you know how the vehicle will react if you need to use it later.

Directions

- Partway down the straightaway, while operating at 8 km/h (5 MPH), turn the engine stop switch to OFF and coast to a stop.
- Restart the engine and repeat the exercise. Try increasing your speed (to a maximum of 20 km/h (12 MPH)) before using the engine stop switch.

NOTE: SE6 model will not start in gear without brake pedal depressed.

1. Start
2. Press engine stop switch
3. Proceed to end of straightaway, stop and turn as before
4. Stop
5. Press engine stop switch

Restart the engine and proceed to the next exercise.

4) Basic Turns

Purpose

- Get comfortable turning in a controlled manner.

Directions

This exercise is similar to what you did before, except that now instead of stopping for each turn, you will make the turn at low speed.

- Proceed down the straight away in first gear. Ride a little farther from the cones so you can make a wide arcing turn at the end of the straightaway.
- As you approach the curve, slow down to no more than 8 km/h (5 MPH) by releasing the throttle and apply brake if needed.

- Hold the throttle to maintain your low speed.
- Look in the direction of the curve.
- Turn the handlebar in the direction of the curve, pulling on the inside hand-grip and pushing on the outside, being careful not to apply throttle.
- Leaning forward and into the curve may help you turn the handlebar more easily.
- Straighten your handlebar after the turn and proceed down the straight-away.



TYPICAL — RIDING POSTURE WHEN TURNING

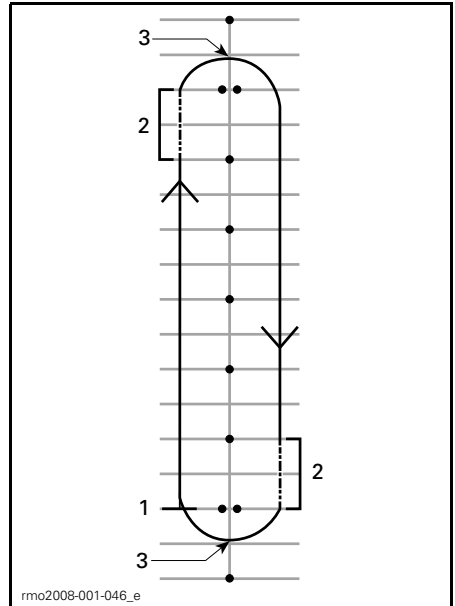

1. Start
2. Friction zone
3. Apex

NOTE: Motorcyclists — Riding through turns and curves with your Spyder roadster is different than on a motorcycle. The vehicle does not lean in during a turn, so you may need to shift your body weight towards the inside of the turn to keep a comfortable posture on the vehicle. You will need to exert more force to turn the handlebar of your vehicle than is needed to turn a motorcycle. However, it is easier to stop while turning than with a motorcycle.

Tips for Additional Practice

- After you are comfortable turning in one direction, try going around the course the other way. Be careful not to apply more throttle than you intend when turning left.
- Stop at the apex of the turn to see what it is like to use your brakes in a curve or turn.

5) Quick Stops

Purpose

- Become familiar with the vehicle braking ability.
- Learn to apply brakes with maximum force.

Directions

This exercise is similar to what you did before, except you'll be applying the brake more firmly, working up to braking as hard as possible. The Antilock Braking System (ABS) will prevent the wheels from locking and help you maintain steering control while applying maximum braking force. Always release the throttle completely for quick stops with the SE6. If you apply throttle and brake at the same time, your stopping distance will be longer.

- Start at one end of the straightaway and accelerate to 8 km/h (5 MPH). Partway down the straightaway, release the throttle completely and brake quickly. Never pump the brake as the ABS will prevent wheel lock.
- Keep head and eyes up, keep handlebar straight, and do not release the brake until fully stopped.
- Repeat, increasing your speed and braking harder.

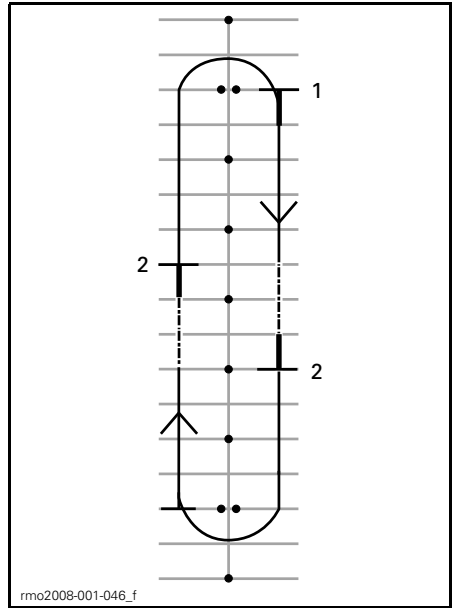

1. Start
2. Stop

Tips for Additional Practice

- Practice checking your mirrors before braking hard.

6) Weaves

Purpose

- Get more experience with the vehicle handling and rider position.

Directions

6 m (20 ft)

1. Weave between every marker/intersection of every other parking spot. Keep your speed low initially as you get used to making the changes of direction.
2. Lean into each turn and turn the handlebar in the direction you want to go by pulling and pushing the grips.

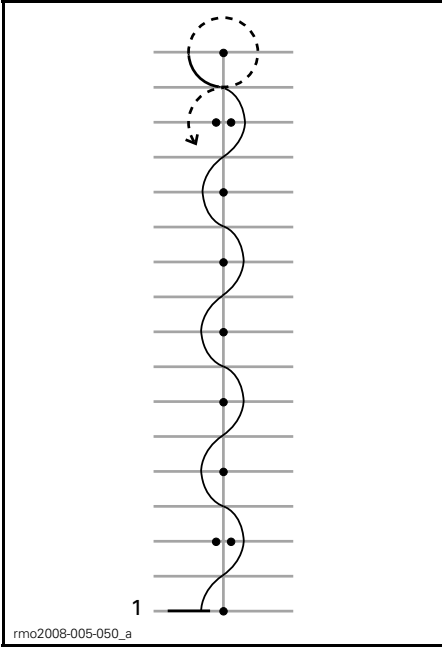

1. Start

12 m (40 ft) Weave

Once you're comfortable, try doing 12 m (40 ft) weaves between every other cone/every fourth parking space.

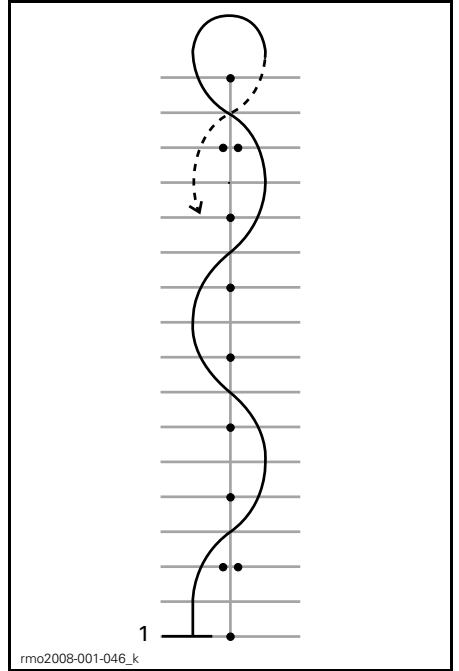

1. Start

Tips for Additional Practice

- You can gradually increase speed as you get comfortable to 16 km/h - 19 km/h (10 MPH - 12 MPH) for the weaves, but slow down for the U-turns at the ends.

7) Shifting

When riding, you must change gears to match the engine speed with road speed. Lower gears are used for lower speeds and higher gears are used for higher speeds, just like on a manual transmission car or truck.

The SE6 will automatically downshift if the engine speed drops under 1800 RPMs.

Purpose

- Learn to upshift and downshift.

Directions

This exercise is similar to what you did before, except now you will be upshifting on the straightaways, then coming to a stop at the end of each straightaway. You may want to use the parking lot aisles for this exercise rather than riding in the spaces.

7a) Practice Using the Gear Selector at a Stop

First, while stopped, practice to single shift between reverse, neutral and first gear. Then practice to:

- Double shift from reverse to first gear
- Double shift from first to reverse gear
- Repeat until you are comfortable.

7b) Upshifting from First into Second Gear

- In the straightaway, accelerate until the engine speed reaches 3000 RPM.
- Press the gear selector forward to shift into second gear. You do not have to release the throttle while shifting with the SE6.
- Once you are comfortable, if space allows, you can adjust the throttle to increase speed in second gear.

As you approach the end of the straightaway, come to a stop:

- Release the throttle.
- Apply brake.
- The SE6 will downshift automatically as the roadster slows. You can also manually downshift by pulling the gear selector towards you.

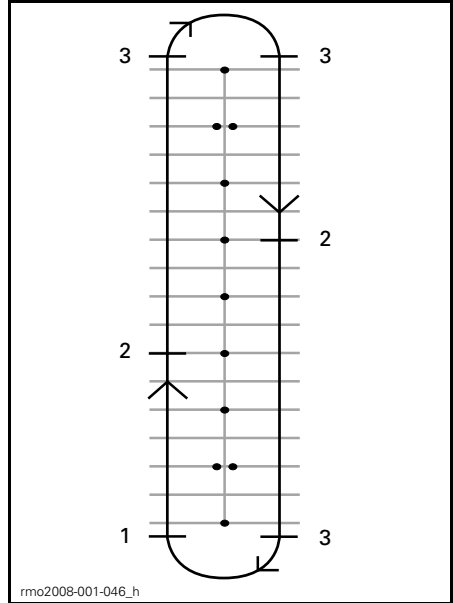

1. Start
2. Shift into second at 25 km/h (16 MPH)
3. Stop

7c) If Space Allows, Practice Downshifting into First While Moving

In the straightaway:

- Pull the gear selector toward you without releasing throttle.
- You will feel more engine braking when you downshift without throttle.

7d) Other Gears

If space allows, you can try shifting into and out of higher gears as well. Follow the same process and shift UP or DOWN one gear at a time.

NOTE: Applying slightly more throttle while downshifting can help the engine rev up to match vehicle speed more quickly and make the downshift smoother. When you do not apply throttle while downshifting, engine braking will slow the vehicle. This can help you decrease speed, but remember that VSS does not control engine braking. If you shift into too low a gear when you are at high speed, the rear tire can skid and you can lose control, spin out, tip or roll over, particularly in a curve.

8) Swerve

Purpose

- Become familiar with the vehicle handling for quick maneuvers.
- Try different variations of braking and swerving.

Directions

At this point you will need to change your course. Set up your markers as shown in the diagram below. Do not use any fixed or hard, heavy objects as markers for this exercise.

- Enter between the double cones at about 8 km/h (5 MPH) and maintain that speed throughout.
- Steer around the line of cones.
- Exit through the second set of double cones.
- Repeat the exercise multiple times, swerving in both directions.

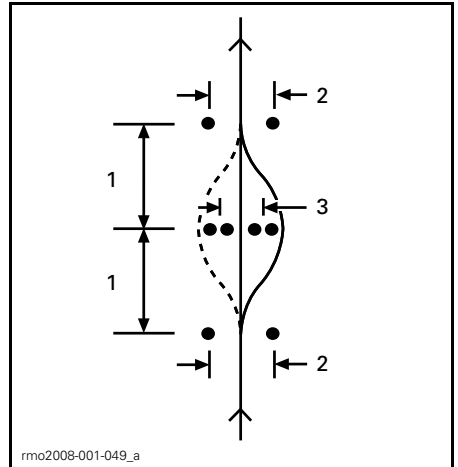

1. 6 m (20 ft)
2. 3 m (10 ft)
3. 2.5 m (8 ft)

Tips for Additional Practice

- You can gradually increase your entry speed (to no more than 13 km/h to 19 km/h (8 MPH to 12 MPH) and try some variations. For example, approach faster and slow before entering the exercise, apply brakes during the swerve, etc.
- A helper can add an element of surprise to the exercise by deciding which direction you should swerve, or if you should come to a stop instead. Have your helper stand at a safe distance away (e.g., beyond the end of your practice area). As you reach the first set of cones, the helper can use hand signals to indicate which direction to swerve or for you to stop.
- Practice checking your mirrors and blind spot before you swerve.

9) Operating in Reverse

Purpose

- Become familiar with the vehicle handling and turning radius in reverse.

Directions

- Shift into reverse. See *BASIC PROCEDURES* subsection.
- Check that the area behind you is clear. Continue to look backwards. Be careful not to strike anything with your front wheels as you back up. Slow and stop by releasing throttle and using brake, just like when operating normally.
- Back for a few feet at a time, stopping in between.
- Keep your speed low and do not back up for long distances.
- After you are comfortable with reverse, back into a parking space as shown in the diagram below.

Start by riding in less challenging situations:

- Short distances
- Good weather
- Low traffic
- Daytime
- Lower speeds
- No passenger.

You can gradually move on to more challenging riding situations as you develop your skills.

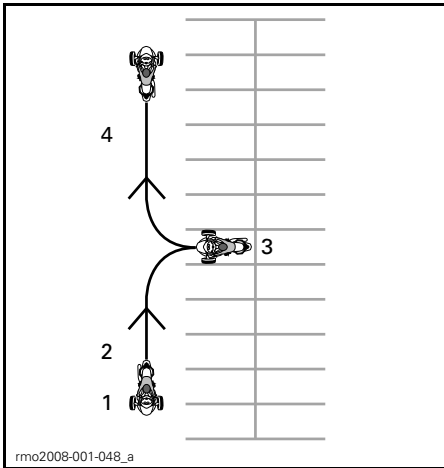

1. Start
2. Reverse
3. Stop
4. Forward

Developing Advanced Riding Skills

Once you have mastered basic riding skills, you can begin developing more advanced skills. First, learn the "Street Strategies" covered in the next section. Then you can take the vehicle on the road in relatively low-risk situations.

STREET STRATEGIES

This section provides some strategies to reduce your risk on the road. Many of these strategies are similar to those used for motorcycles.

This section is based on guidance for motorcyclists given by the Motorcycle Safety Foundation (MSF). However, even experienced motorcyclists should read this section, as some strategies are different for the Spyder roadster.

Plan your Trip

Always check weather conditions before riding the vehicle. Take appropriate gear for any weather you might encounter.

Plan a route and ride in conditions that are appropriate for your skill level.

The vehicle has a 26 L (6.9 U.S. gal.) fuel tank. When the low fuel indicator light flashes, fill fuel tank as soon as possible. Plan your refueling stops, particularly in unpopulated areas.

Defensive Riding

As with a motorcycle, defensive riding can help you avoid crashes. You need to stay alert at all times. Never stop watching your surroundings, including the area behind you. Always scan for potential hazards, plan ahead, and leave space and time to avoid trouble. Do not assume other motorists will see you or follow the rules of the road.

Following Distance

Always leave at least a two-second following distance between you and the vehicle in front of you when operating under ideal riding conditions. This means that you should pass any fixed point on the road at least two full seconds after the vehicle in front of you.

When conditions make braking distance longer, or visibility is limited, use a longer following distance for a greater margin of safety. For example, braking distance is longer on slippery

road surfaces, down hills, or when carrying more weight, and visibility may be limited in fog, in curves or at night.

Scanning Ahead

In addition to leaving adequate following distance to the next vehicle, scan ahead and plan your path even farther in advance.

Plan your immediate path at least four seconds ahead. Watch this path for hazards, such as anything in the road or anything entering the road.

Scan ahead 12 seconds along your anticipated path to identify potential hazardous situations before they happen. For example, look for intersections where other vehicles may appear or places where pedestrians might enter the road. Be prepared to respond if a hazardous situation develops.

Watch Behind and to the Sides

Vehicles and other hazards can approach from all directions. Constantly be aware of your surroundings. Check your mirrors frequently to see directly behind you. Also do frequent head checks (turn your head to look) to monitor your blind spot.

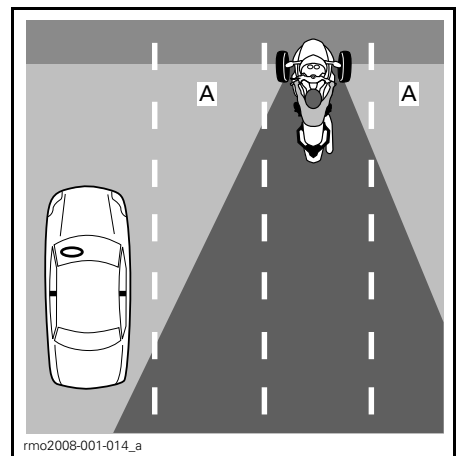

A. Operator's blind spots

When braking, be particularly aware of vehicles behind you that may not be able to stop as quickly as the Spyder roadster.

Keep your Eyes Moving

To stay aware of your surroundings, do not fixate on any one thing. Move your eyes constantly to monitor the road, traffic control markings, devices and other vehicles. Look near and far, in all directions.

Anticipate Trouble

Whenever you notice a potential hazard, plan a way to avoid it. This might mean adjusting your speed or lane position, or changing lanes. You should be ready for evasive maneuvers such as swerving and/or braking if something enters your path. Always leave time and space to react to trouble.

Being Visible

Motorists tend not to see smaller vehicles like motorcycles. Therefore you should use strategies to become more visible.

To Be More Visible to Other Motorists

Lighting and Reflectors

Make sure that the headlights, running lights and taillights on your vehicle work properly. Your vehicle is equipped with reflectors on the fenders, sides, and back. Make sure that all reflectors are clean and not broken or missing.

Use your high beams whenever possible, both day and night. Use low beams to avoid blinding other motorists at night or when too much light reflects back, such as in fog.

Signals

Use your turn signals to inform others of your intentions. The Spyder roadster has automatic canceling turn

signals, but they may not cancel after shallow turns. Make sure turn signals are off after you have completed your maneuver; leaving them on may confuse other motorists.

When possible, flash your brake lights before slowing and when waiting at intersections, to alert motorists behind you.

Use your emergency flashers to make yourself visible when needed.

You can also use your horn to attempt to alert other motorists of your presence.

Do not assume that other motorists will notice your lights, signals or horn.

Blind Spots

Avoid riding in the blind spots of other vehicles. Position yourself so that drivers ahead can see you in their mirrors. In some cases, such as when you are following a truck or a bus, you must be farther behind the vehicle in front of you.

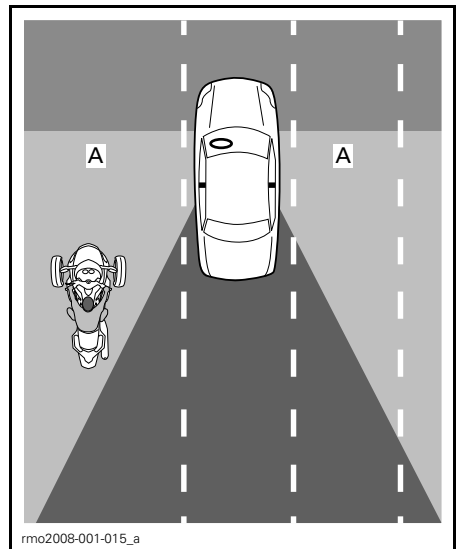

A. Blind spots of other vehicles

Time of Day and Weather

In dim light, such as at night, at dawn or dusk, or in poor weather such as rain or fog, you may be harder to see. Glare at dawn and dusk or very bright sunlight can also make it harder for other motorists to see you.

Clothing

Bright colors or reflective clothing can increase your visibility.

Be Careful Even When Motorists See You

Even when motorists seem to notice you, they may still drive in a way that puts you at risk of a crash. Drive defensively, and do not rely on other motorists to operate their vehicles safely.

Lane Position

Normally, position the Spyder roadster in the center of the lane. This position keeps the front tires in the lane. It also provides distance from vehicles in other lanes, reducing wind from large vehicles and reducing the risk of being struck by vehicles that leave their lane. This position also keeps your front wheels out of the slippery area in the middle of the lane, helping maintain braking and steering ability. If you are used to driving a car, remember that you are centered on the Spyder roadster, rather than seated to the side, so your perspective is different.

You can move to the left or right part of the lane, to avoid hazards, keep distance from other vehicles, or handle curves. You can also move to the left or right part of the lane to get a better view or to be seen by other vehicles. Because of the Spyder roadster center seat position and width, it may be harder to see around traffic, even when you are near the edge of the lane. You may need a greater following distance behind wide or tall vehicles. Avoid putting your wheel outside of the lane to see around traffic. In order

for drivers ahead to see you, you must be able to see their mirrors. When you are being followed by a large vehicle, passing vehicles may not be able to see you easily if you are not in the left part of the lane.

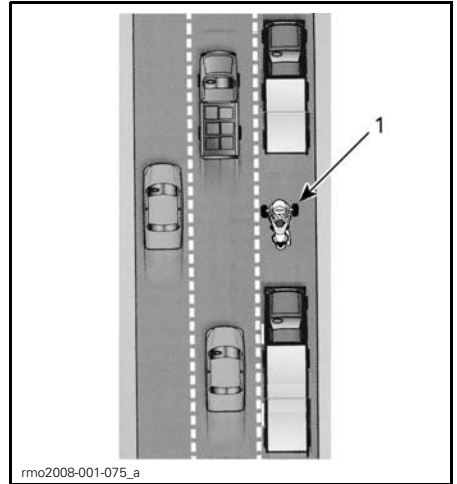

1. Vehicles in left portion of lane

Because the Spyder roadster is wider than a motorcycle, the range of lane positions is smaller. When riding in the left or right part of the lane be sure that the front wheels stay in the lane.

On multilane roads, choose a lane that is appropriate for your speed in the flow of traffic, and also consider your ability to see and be seen, and possible paths for evasive maneuvers (such as swerving into other lanes or onto the shoulder).

Common Riding Situations

Intersections

Intersections, including small intersections with alleys and driveways, present an additional risk due to the cross traffic. Always watch for traffic in all directions: behind, in front and to the left and right.

When stopping at an intersection, stop in the middle of the lane, even if you are preparing to turn. This can make you more visible and discourage other motorists from trying to drive around you. Watch for vehicles approaching from behind. Flash your brake lights as they approach. Be in first gear and be prepared to move if necessary to avoid a collision.

Lane Changes and Passing

Remember that the Spyder roadster is wider than a motorcycle and needs more lateral space to pass another vehicle. Also remember that the vehicle is less visible than a car, so it is particularly important to signal your lane change well in advance and check your mirrors and blind spots. Be sure to turn off your turn signal after changing lanes; a lane change will not turn the handlebar far enough to automatically cancel the signal.

Never drive on the line between two lanes of traffic (split lanes). The vehicle is too wide.

Never drive on the shoulder to pass vehicles. If you put one wheel off the road, you can lose control.

Turns

Remember to slow, look, and steer through turns.

- **Slow:** Reduce speed as needed before entering a turn by rolling off the throttle, using the brakes, and/or downshifting to a lower gear. Enter the turn at a speed that you can maintain throughout the turn.

Although the Spyder roadster is better able to brake while turning than a motorcycle, it is still important to slow down before you enter a turn or curve rather than braking in the turn. Braking and turning both require traction. The more traction you use for braking, the less there is available for turning at the same time.

When you take a turn or curve too fast, you may notice the inside front wheel lifting off the pavement and feel and hear VSS cutting back engine power. While VSS can help you maintain control, it is still possible to spin or roll over if you turn too hard and fast.

- **Look:** Search through the entire turn and keep your eyes moving. Evaluate the entire turn as soon as possible – surface characteristics, sharpness of the turn, and overall traffic conditions – so you have time to make decisions about speed and position. Sometimes turning your head in the direction of the turn helps to keep a good visual picture.
- **Steer:** Turn the handlebar to steer the vehicle in the direction of the turn. The Spyder roadster is not like a motorcycle, so it does not countersteer, and the vehicle does not lean. Remember, you will experience the lateral force generated by turning, so you may need to shift your body weight to the inside of the turn to keep a comfortable posture on the vehicle. You will need to exert more force to turn the handlebar of your vehicle than is needed to turn a motorcycle.

SM6 Model

When shifting gears while turning, be careful not to release the clutch lever too fast. Adjust throttle as you release the clutch lever to match engine and vehicle speed in a smooth shift. Releasing the clutch too quickly or using too much throttle may cause the rear wheel to lose traction and start skidding, potentially causing loss of control. The Traction Control System (TCS) will detect the onset of wheel spin and reduce the power transmitted to the rear wheel. This intervention is intended to allow the rear wheel to regain traction and allow you to correct the unwanted oversteering to keep your vehicle on the intended turning radius.

Curves

Because the Spyder roadster is narrower than a car, you can move from side to side in the lane in curves to straighten your path of travel. But the Spyder roadster is wider than a motorcycle, so less lateral movement is possible, and it is important to make sure that your front tires do not leave the lane.

For typical curves, an outside, inside, outside path is best.

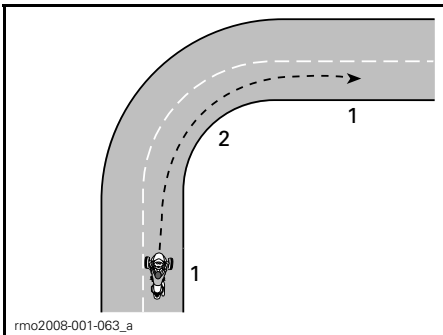

PATH FOR TYPICAL CURVES

1. Outside
2. Inside (at the apex)

Hills

Select an appropriate gear for the incline. Going up hills, a lower gear can help maintain enough power. Going down hills, a lower gear can provide engine braking to control your speed.

SM6 Model

To start while on an incline, hold the vehicle in place with the brake until you move the clutch lever into the friction zone. Then smoothly release the brake as you release the clutch lever and apply throttle.

SE6 Model

When stopped, the SE6 model can roll regardless of what gear it is in. The SE6 model clutch is always disengaged when the vehicle is stopped, so the transmission will not hold the vehicle in place. Hold the brake pedal when stopped on an incline. To start while on an incline, hold the brake pedal as you increase throttle. Release the brake pedal as you feel the clutch engage (at about 1500 RPM).

Night Riding

In addition to using your lights and signals to be seen by other motorists, consider your own ability to see at night. Use high beams when appropriate. Avoid overriding your headlight (riding so fast that you can't see as far as your stopping distance). You can also use other vehicle headlights to see the road ahead.

Do not use tinted or colored visors or lenses at night, and be particularly careful that your visor does not have scratches or smudges.

Group Riding

Ride single file only. Never share lanes, even with a motorcycle.

When riding with motorcycles, maintain proper following distance from the motorcycle in front of you, even if they are riding to one side of the

lane. In curves, do not try to follow the path of motorcycles. Motorcycles can move farther to the edges of the lane in curves – if you follow them exactly, your front wheel can leave the lane. Motorcycles may be able to take curves faster than the Spyder roadster. Do not try to match their speed.

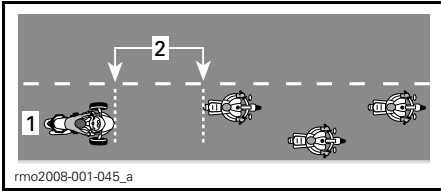

GROUP RIDING POSITION

1. Center of lane
2. Distance of 2 seconds

Particularly on curvy roads, Spyder roadster riders might become tired sooner than motorcyclists. Do not push yourself to keep up with motorcycles; stop if you are tired.

Road Conditions and Hazards

Ice, Snow and Slush

Do not ride on ice, snow or slush. Even with VSS, there will not be enough traction to maintain control on these slippery surfaces. The Spyder roadster is more likely than a car to spin out of control in slippery surfaces.

Gravel, Dirt and Sand

On gravel, dirt, or sand-covered roads, use extra caution and reduce your speed, particularly for curves. These surfaces do not provide as much traction as paved surfaces and you can lose control, even with VSS.

Wet Pavement and Puddles

There is normally enough traction to maintain control on pavement that is moist or wet, as long as there is not a layer of water on top of the pavement (like a puddle or flowing water on

the road). As with other vehicles, the Spyder roadster can hydroplane if you drive too fast over water that has accumulated on the road, but hydroplaning occurs at lower speeds than with most cars or motorcycles. You are more likely to hydroplane in deeper water. Watch for splashing or spraying when other vehicles go through water as an indicator of depth.

When hydroplaning occurs, one or more wheels rise up on a layer of water, losing contact with the road. If this happens to the rear wheel, you may feel it slide sideways. Hydroplaning wheels do not have the traction necessary to control the vehicle. You can lose control and spin out, and the VSS cannot keep you in control.

Avoid large water puddles or water streams, and slow down or pull off the road during heavy rains. If you must pass through water, slow down as much as possible before you reach it.

After passing through water, test your brakes. Apply them several times if necessary to let friction dry the brake pads.

Properly maintained tires reduce the risk of hydroplaning. Always maintain recommended tire pressure:

COLD TIRE PRESSURE	
Front tires	138 kPa ± 14 kPa (20 PSI ± 2 PSI)
Rear tire	193 kPa ± 14 kPa (28 PSI ± 2 PSI)

NOTE: The pressure difference between the left and right side tire should not exceed 3.4 kPa (.03 bar).

Immediately replace any tire that shows the maximum tread wear indicator to minimize risk of hydroplaning.

The middle of a lane can be particularly slick in the first few minutes of rain, as oil and dirt combine with the water. After more rain, water can accumulate in ruts in worn pavement. Avoid both of

these low traction areas. When possible, keep your front tires in areas with the best traction.

Off-Road Use

Do not use the Spyder roadster off road. The vehicle cannot handle the rough, low-traction, uneven surfaces that you may encounter in off-road riding. You could easily get stuck, lose control or roll over. Also, it may be illegal for off-road use in certain areas.

Obstacles, Holes and Bumps

Whenever possible, avoid riding over obstacles, holes and bumps. If you must ride over them, slow down as much as possible before you get there, then release the brake as you go over. For wide obstacles or bumps, approach straight on if possible, so that both front tires go over at the same time. When going over an obstacle, bump or hole with both front wheels, riders should stand up slightly on the pegs and use legs to absorb the shock. Be prepared for the rear wheel to strike the obstacle. For narrower obstacles, bumps or holes, it is better to ride over it with the rear tire. If you ride over them with a front tire, maintain a firm grip on the handlebar, take care not to accidentally applying the throttle and be prepared to correct your trajectory if necessary.

If you strike a large enough obstacle, bump or hole, the impact can make the vehicle jump and strike you, eject riders, make you lose control, spin or roll over.

If you can't come to a complete stop in time to avoid an obstacle, you can swerve to avoid it. You can swerve and brake at the same time if necessary.

If you encounter a large animal in the road, like a deer, it is best to stop before reaching it and wait until the animal leaves, or go past slowly. If a dog chases you, a good strategy is to slow

down and downshift as the dog approaches, then accelerate away as you get closer to where the dog would intercept you.

On-Road Emergencies

A vehicle malfunction or an unexpected situation can occur any time during a ride. A well-maintained vehicle can help reduce the risk of malfunction, but you should still be prepared for an emergency.

- Always have the Operator's Guide and tool kit in the vehicle. Refer to the *ROAD SIDE REPAIRS* section for technical guidelines on problems that could occur during a trip.
- When stopping on the road, follow these precautions:
 - If the road has paved shoulders, signal your intention to pull off the highway, pull off at near traffic speed, then slow down to a complete stop.
 - If the shoulder is unpaved, signal a right turn and slow down to a safe speed before pulling off the paved roadway.
 - To increase your visibility, turn on the hazard warning lights.
- If you have cellular phone or other communication device, fully charge it before long rides.
- If you are involved in a crash, BRP strongly recommends that you have your vehicle transported (see *TRANSPORTING THE VEHICLE* subsection) to the nearest Can-Am roadster dealer to have it thoroughly inspected for safety before riding again.
- Fill in the BRP accident/incident report.

Tire Failure

If a tire failure or a blowout suddenly occurs, firmly grip the handlebar, gradually slow down and carefully steer to a safe place to stop. Avoid hard braking, downshifting, or sharp steering. If a front tire fails, the vehicle may tend to pull in the direction of the failed tire, so you will need to maintain a firm grip on the handlebar to control your direction. Refer to *ROAD SIDE REPAIRS* section for instructions on tire repair.

CARRYING A PASSENGER, CARGO OR TOWING A TRAILER

Weight Limits

Do not exceed the weight limits for riders and cargo.

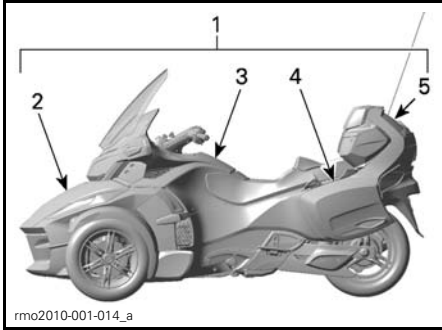

1. 224 kg (494 lb)
2. 16 kg (35 lb)
3. 2 kg (4 lb)
4. 7 kg (15 lb) (each)
5. 9 kg (20 lb)

WEIGHT LIMITS	
Vehicle load limit (including operator, passenger, cargo and added accessories)	224 kg (494 lb)
Front storage compartment	16 kg (35 lb)
Glove box	2 kg (4 lb)
Side storage compartment (each)	6.8 kg (15 lb)
Top storage compartment	9 kg (20 lb)

Excess weight will:

- Reduce your ability to accelerate, brake and turn.
- Reduce the effectiveness of the VSS.
- Increase the risk of rolling over if the weight is high or toward the rear.

- Reduce ground clearance, increasing the risk of striking low obstacles or uneven road surfaces.
- Increase the risk of tire failure.

Operating with Extra Weight

Carrying a passenger or heavy cargo affects the way the vehicle handles because of the greater weight, and because the weight distribution will be different.

1. You will not be able to accelerate as quickly. Allow more time and space for passing.
2. You will not be able to stop as quickly. Use a longer following distance from the vehicle in front of you, at least three seconds. Use an even longer distance if riding conditions are not ideal (e.g., low visibility, poor road surface).
3. You will not be able to turn as sharply or at as high a speed. Slow down more than usual before turning and avoid sharp turns.
4. The Spyder roadster may be less stable. There is a greater risk of tipping or rolling during extreme maneuvers with weight that is higher or farther to the rear (like a passenger).

Carrying a Passenger

The Spyder roadster is designed for only one passenger, seated behind the operator. Never carry multiple passengers.

Do not carry a passenger until you have experience riding alone in a variety of conditions and can proficiently handle the vehicle.

The passenger must be sober, alert, able to reach the passenger footrests and handholds, maintain balance and hold on in sudden maneuvers, and not distract the operator.

The passenger should use its audio control in respect to the rider's directives.

Be sure the passenger is wearing appropriate protective gear. The passenger should wear all of the protective gear recommended for the operator, particularly a helmet. A full-face helmet is recommended; in a sudden stop, the passenger's face can strike the back of the operator's helmet.

Keep the brakes applied and the transmission in neutral until the passenger is in riding position.

Instruct the passenger on how to ride before starting out. Have the passenger follow these rules:

1. Maintain proper riding position. Hold the passenger handholds and keep feet on the passenger footrests at all times. The passenger footrest height is adjustable. Refer to *ADJUSTING THE PASSENGER FOOTREST*.

The passenger should not hold on to the operator as the operator may not be able to withstand the lateral force generated by both.

Different gripping positions on the handholds may be more comfortable for different maneuvers. (e.g., one hand at the front corner of and one hand at the opposite back corner for turns, both hands further forward or back for other situations).

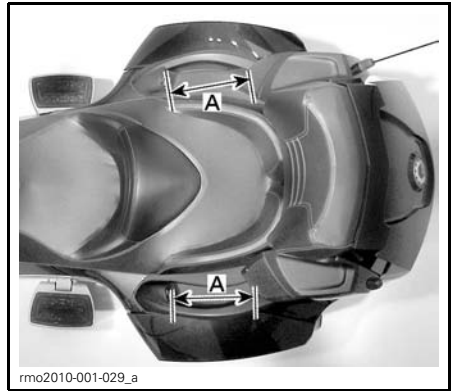

A. Different gripping positions on the handholds

2. Stay clear of the exhaust pipe, the rear wheel and the drive belt.
3. Avoid turning around or leaning except to keep balance in a turn. In an unexpected maneuver, a passenger who is not in the normal riding position is more likely to fall off.
4. Watch the road and respond to upcoming road conditions. Lean into curves as needed to resist any sideways force. When crossing an obstacle, hole or bump, rise slightly off the seat without locking your elbows.

Avoid abrupt acceleration, braking and turns, especially with inexperienced passengers. Sudden, unexpected maneuvers can make the passenger fall off.

Where to Store Cargo

You can carry cargo in the following compartments. Do not carry cargo in any other location unless the vehicle is equipped with approved BRP accessories.

Never store flammable items, such as fuel, in any of these compartments.

Always respect the load limit of each compartment. Refer to *WEIGHT LIMITS* in this section.

Glove Box

The glove box provides room to store small personal articles.

It is very convenient to store items that could be needed quickly during a ride (such as money for pay toll).

NOTE: A key barrel is supplied in the glove box to use with the BRP optional trailer. This allows to use the vehicle key for the trailer.

Front Storage Compartment

The front storage compartment is the most spacious and has room to store two helmets or other items. The front storage compartment includes a designated space for this Operator's Guide.

Make sure the compartment cover is securely latched before riding.

Side Storage Compartments

The side storage compartments have room to store a helmet or other light objects.



rmr2010-001-002

Make sure the storage compartment cover is securely latched before riding.

Top Storage Compartment

The top storage compartment has room to store a helmet or other light items.



rmr2010-001-003

TYPICAL

Make sure the storage compartment cover is securely latched before riding.

Towing a Trailer

The RT series has been designed to be able to tow a BRP optional trailer (with the optional BRP hitch).

The VSS (vehicle stability system) on the roadster RT series incorporates a program that allows to tow a BRP trailer while maintaining appropriate vehicle stability control.

Use only a BRP trailer designed specifically for the Roadster RT series or a BRP approved equivalent. This is important to ensure the trailer and the roadster remain stable during normal operation and it does not interfere with the vehicle stability system.

NOTICE The use of a non-recommended wiring harness may lead to vehicle electrical system failure.

⚠ WARNING

The use of any other trailer could damage the vehicle or interfere with the proper operation of the vehicle stability system. It is not recommended to use the cruise control when towing a trailer.

Towing a trailer affects the way the vehicle handles due to the greater weight and the different weight distribution.

- Allow more time and space for passing.
- Allow a greater distance for braking.
- Use a longer following distance from the vehicle in front of you.
- Reduce your speed and slow down more than usual before turning and avoid sharp turns.
- There is a greater risk of tipping or rolling during extreme maneuvers.

Crosswinds and air turbulence caused when crossing or being passed by others can disrupt the steering and make the trailer to sway. To minimize the effect, keep a constant speed and do not make quick steering or braking corrections.

Reduce your speed before entering in a curve.

When cornering, achieve the turn on a larger radius. It takes more space to turn with a trailer.

Try to anticipate the riding ahead to avoid having to backup with a trailer.

Always move slowly when backing up. Ask someone to guide you when possible. Practice in an open area at the first opportunity. Refer to *REQUIRED RIDING SKILLS AND PRACTICE EXERCISES*.

When possible, avoid swerving, twist and turns, sharp and abrupt turns as well as sudden braking. This could

cause the trailer to jackknife or to turn over. It is easier to unstabilize an empty trailer. When accelerating, it is normal to shift at a higher RPM to avoid loading excessively the engine.

NOTICE Avoid spinning the rear wheel. Rocks or pebbles could be projected on the trailer and damage it.

Hill Particularities

When possible, avoid stopping uphill.

When starting uphill from a stop, more clutch slippage is needed to prevent engine stalling.

When riding uphill, more frequent downshift will be required so that engine has enough power to minimize speed variations.

When riding downhill, downshift one or more gears to use engine braking to slow down vehicle instead of continuously applying the brake. It will take longer to slow down or to stop.

Load Limits

⚠ WARNING

Never add cargo on the trailer cover as it will increase the risk of tipping over. All cargo must be stored and secured inside the trailer.

Load limits must be observed with the appropriate towing equipment.

TOWING SPECIFICATIONS	
Maximum weight on trailer tongue	18 kg (40 lb)
Maximum towed weight (trailer and cargo)	180 kg (400 lb)

NOTE: For information about the maximum cargo that can be loaded in trailer, refer to the *CAN-AM FREEDOM TRAILER OPERATOR'S GUIDE*.

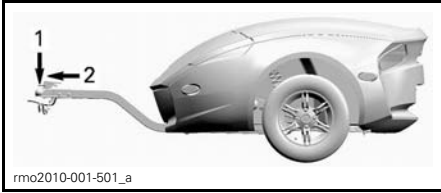

1. 18 kg (40 lb)
2. 180 kg (400 lb)

The weight at the tongue applies when the trailer is loaded. A scale can be used to measure the weight at the tongue when it is not latched to the vehicle. If the trailer is not fully loaded, place cargo in the front part of the trailer then, if the weight at the tongue is reached, place the remaining cargo at the rear in the trailer. The weight distribution in the trailer affects the weight at the tongue. Redistribute the weight in the trailer to meet the weight at the tongue specification. Too much weight at the tongue reduces steering control. Too little weight at the tongue can render the trailer unstable and make it sway.

⚠ WARNING

Exceeding the maximum towed weight can seriously affect handling and performance of the vehicle. The vehicle handling, stability, acceleration and braking distance are affected when towing a trailer. Correct loading and weight distribution are important. Never overload, tow or carry cargo improperly. Always ensure the cargo is safely secured and properly distributed in the trailer before operating the vehicle. Always secure cargo as low as possible in the trailer to reduce the effect of a higher center of gravity. Failure to follow the recommendations here could cause affect the vehicle handling which could lead to the vehicle loss of control.

NOTICE Exceeding the maximum towed weight can damage vehicle or trailer. Avoid transporting heavy parts with sharp edges that could damage the trailer. Place the cargo so that it does not shift while the trailer is being towed.

Hitch

Use only a BRP hitch or a BRP approved equivalent. The BRP hitch properly fits the vehicle swing arm and is securely bolted to the wheel axle.

NOTICE The use of a non-approved hitch may lead to rear swing arm failure.

⚠ WARNING

If the hitch is removed from vehicle, always install a new cotter pin to lock the wheel axle nut.

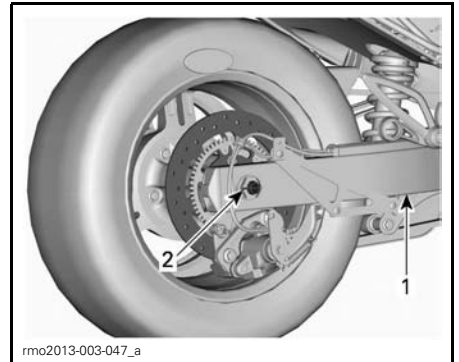

WHEEL AXLE CAP AND MUFFLER REMOVED FOR CLARITY PURPOSE

1. Swing arm
2. New cotter pin here

Safety Cables

Always use safety cables when towing a trailer. Ensure they are secured to the trailer and to the hitch, and that they cross under the tongue. Leave enough slack in cables to allow the trailer to turn corners. When trailer is in straight line with the vehicle, ensure chains will not drag on the ground.

KNOWLEDGE SELF-TEST

The following provides a sample of information that you should have learned by reading this guide. It does not include all of the important information, but should give you an idea of whether you have a general understanding of the vehicle and its operation.

See the *ANSWERS* on the page following the questionnaire.

Questionnaire

1. If you need to stop quickly, press the brake pedal and activate the parking brake.
True False
2. A pre-ride inspection should be performed once a week.
True False
3. VSS allows you to use the vehicle in any kind of weather.
True False
4. You should only replace the tires with those approved by BRP obtained from an authorized Can-Am roadster dealer.
True False
5. It is important for the passenger to be alert and sober.
True False
6. Name six items of protective gear that can reduce your risk of injury.
1) _____
2) _____
3) _____
4) _____
5) _____
6) _____
7. Protective gear is important for preventing and reducing injuries, keeping you comfortable, and providing protection against the elements.
True False
8. Which of the following is not one of the vehicle driving controls?
 - a. Handlebar
 - b. Twist throttle
 - c. Front brake lever
9. You should leave your low beam lights on during the day for added visibility.
True False
10. You should normally position the vehicle in the center of the lane.
True False
11. Unlike a typical motorcycle, you should make it common practice to brake and turn at the same time.
True False

12. Under normal conditions, following distance should be at least _____.

- a. 1 second
- b. 2 seconds
- c. 3 seconds

13. You should not store flammable liquids such as gasoline in any storage compartment, even if they are in approved containers.

True False

14. List 5 ways of being more noticeable to other drivers.

- 1) _____
- 2) _____
- 3) _____
- 4) _____
- 5) _____

15. When braking on surfaces with less than ideal traction, you should pump the brakes to help maintain control of the vehicle.

True False

16. The vehicle maximum load including riders, cargo and accessories is 224 kg (494 lb).

True False

17. The vehicle can safely tow a trailer as long as the total towed weight does not exceed 180 kg (400 lb).

True False

18. A passenger should hold onto the operator.

True False

19. Riding the Spyder roadster is as safe as riding in a car.

True False

20. ABS allows you to press the brake pedal hard without locking the wheels.

True False

Answers

1. **False**
To stop quickly, press the brake pedal only.
2. **False**
You should do a pre-ride inspection every time you ride.
3. **False**
If there is ice, snow, slush or enough water on the road to cause hydroplaning, VSS can not help you maintain control.
4. **True**
5. **True**
6.
 - 1) Helmet
 - 2) Eye and face protection
 - 3) Jacket with long sleeves
 - 4) Gloves
 - 5) Long pants
 - 6) Closed-toe footwear, preferably over the ankle.
7. **True**
8. **c. Front brake lever**
The vehicle does not have a front brake lever.
9. **False**
You should use your high beams during the day.
10. **True**
11. **False**
You can brake and turn at the same time if you need to, but generally it is better to brake before the turn.
12. **b. 2 seconds**
Under normal conditions, following distance should be at least two seconds.
13. **True**
14.
 - 1) Make sure your lights and reflectors are clean.
 - 2) Use your high beams whenever possible.
 - 3) Use your turn signals.
 - 4) Flash your brake lights before slowing.
 - 5) Use your emergency flashers as needed.
 - 6) Use your horn to alert others of your presence.
 - 7) Avoid riding in blind spots.
 - 8) Wear bright colors and reflective clothing.
15. **False**
You should press and hold the brake pedal, not pump. The vehicle is equipped with ABS, which keeps the wheels from locking.
16. **True**
17. **True**
You can tow a trailer with the vehicle as long as all the recommendations are strictly followed.
18. **False**
The passenger should always hold on to the handholds.
19. **False**
In cars and trucks, the structure of the vehicle provides protection. In addition, passengers can protect themselves by wearing seat belts. You should expect that riding the Spyder roadster is much riskier than riding in a car and that the risk of injury is more like the risk of injury when riding a motorcycle.
20. **True**

SAFETY INFORMATION ON THE VEHICLE

This vehicle comes with a hang tag and labels containing important safety information.

Any person who rides this vehicle should read and understand this information on the vehicle before riding.

Hang Tag

 **WARNING**

**The Spyder roadster is a different type of vehicle -
it requires special skills and knowledge.
Learn how the Spyder roadster is different.**

Read the operator's guide (in the front storage compartment) and watch the safety video.

Complete a training course (if available), **practice**, become proficient with the controls, and get a proper license.

Refer to the Safety Card before riding.

Always wear a helmet and riding gear.

With this type of vehicle, riders are exposed to more road risks than in a car. Even skilled operators can be struck by other vehicles or lose control. This vehicle will not protect you in a crash.

Handling limits and road conditions

The Vehicle Stability System (VSS) cannot stop you from losing control, flipping over, or falling off if you exceed this vehicle's limits. Know the limits for different road conditions. Do not ride on ice, snow, or off road. Avoid puddles and running water. This type of vehicle can hydroplane on water and slip on gravel, dirt and sand covered roads. If you must go through these road conditions, slow down.

This hangtag may only be removed by the customer.

704904124

704904124

Safety Card

The Safety Card is found at the top of the multifunction gauge. Pull it out to read it, and be sure to securely put it back before riding.

Use the Safety Card to review key information and when you are teaching new operators and passengers how to ride the vehicle. It also includes frequently referenced information.

NOTE: The following illustration used in this Operator's Guide is a general representation only. Your model may differ.

▲ WARNING

The Can-Am Spyder is a different type of vehicle - it requires special skills and knowledge.

Learn how the Can-Am Spyder is different. Read the operator's guide (in front storage compartment) and watch the safety video.

Complete a training course (if available), **practice**, become proficient with the controls, and get a proper license. **Do** the following procedures before each ride.

<p>Check road conditions. The Vehicle Stability System (VSS) cannot stop you from losing control, flipping over, or falling off if you exceed this vehicle's limits. Know the limits for different road conditions. Do not ride on ice, snow, or off road. Avoid puddles and running water. This type of vehicle can hydroplane on water and slip on gravel, dirt and sand covered roads. If you must go through these road conditions, slow down.</p> <p>Wear a helmet and riding gear. With this type of vehicle, riders are exposed to more road risks than in a car. Even skilled operators can be struck by other vehicles or lose control. This vehicle will not protect you in a crash.</p>	<p>Instruct the passenger.</p> <ul style="list-style-type: none"> • Always hold handholds and keep feet on pegs. • Watch the road. Lean into curves. Brace for bumps. <p>Always keep in mind:</p> <ul style="list-style-type: none"> • Make sure the surrounding is clear and safe before looking at the digital screen. • Brake with the foot pedal. Never apply parking brake while moving, you could lose control and crash. • Steer in the direction of a turn; do not countersteer. • Keep all wheels in your lane, always ride in a single lane, and do not split lanes. <p>Perform Pre-ride Inspection</p> <div style="text-align: center;">  </div>
--	---

704904927

704904927

SAFETY CARD



1. Safety card tab location



TYPICAL - SAFETY CARD PULLED OUT

Safety Labels (All models except European models)

These labels are affixed to the vehicle for the safety of the operator, passenger (2-UP) or bystanders.

The following labels are on your vehicle, and they should be considered permanent parts of the vehicle. If missing or damaged, they can be replaced free of charge. See an authorized Can-Am roadster dealer.

NOTE: In the event of any discrepancy between this guide and the vehicle, the safety labels on the vehicle have precedence over the labels in this guide.

Label 1



**TIRE AND LOADING INFORMATION/
RENSEIGNEMENTS SUR LES PNEUS ET LE CHARGEMENT**

**THIS VEHICLE IS EQUIPPED WITH TUBELESS TIRES/
CE VÉHICULE EST ÉQUIPÉ DE PNEUS SANS CHAMBRE À AIR**

704905125

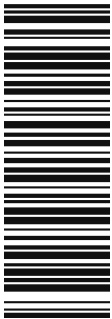

SEATING CAPACITY / NOMBRE DE PLACES	TOTAL 2	FRONT AVANT 1	REAR ARRIÈRE 1		
THE COMBINED WEIGHT OF OCCUPANTS AND CARGO SHOULD NEVER EXCEED					
LE POIDS TOTAL DES OCCUPANTS ET DU CHARGEMENT NE DOIT JAMAIS DÉPASSER					
				224	494
				Kg OR	lbs
				Kg OU	lb

READ OPERATOR'S GUIDE/ VOIR GUIDE DU CONDUCTEUR	TIRE/PNEU	SIZE/ DIMENSION	COLD TIRE PRESSURE/ PRESSION DES PNEUS À FROID	TIRE BRAND MARQUE DE PNEU	RIM SIZE/ DIMENSION DE LA JANTE
	FRONT/AVANT	MC165/55R15 55H	138 ± 14 kPa / 20 ± 2 psi (1.38 ± 0.14 bar)	KENDA KR31	381 x 127mm (15 x 5)in
	REAR/ARRIÈRE	MC225/50R15 76H	193 ± 14 kPa / 28 ± 2 psi (1.93 ± 0.14 bar)	KENDA KR21	381 x 178mm (15 x 7)in
	SPARE/PNEU DE SECOURS	NONE/AUCUN	NONE/AUCUN	NONE/AUCUN	NONE/AUCUN

704905125

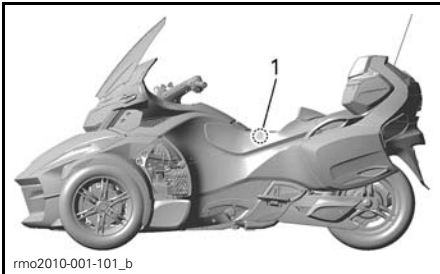

rmo2010-001-101_b

1. Label 1 location

Label 2

NOTICE

- Matt finish paint needs special care to maintain its appearance. See operator's guide
- PVD chrome wheel should be washed with water and a mild soap. Do not polish, use acid based or abrasive chrome cleaner on the PVD chrome wheel.
- Do not clean windshield with alkaline or acid cleaner, gasoline or solvent to avoid windshield damage. See operator's guide.

704904936A

704904936

LOCATED UNDER FRONT STORAGE COVER

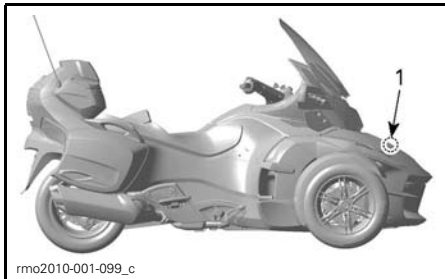

1. Label 2 location

Label 3

WARNING

DO NOT OVERLOAD
16 kg (35 lb)
LOAD LIMIT **5121A**

704905121



1. Label 3 located in the front storage compartment

Label 4

WARNING

DO NOT OVERLOAD
6.8 kg (15 lb)
LOAD LIMIT **5122A**

704905122

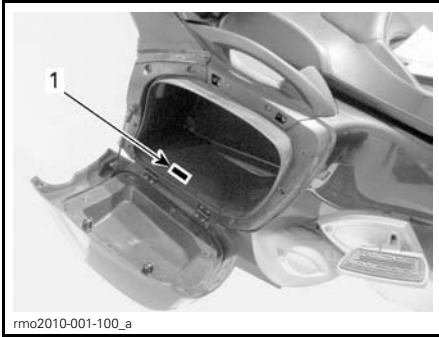

rmo2010-001-100_a

1. Label 4 located in the side storage compartment

Label 5



704905123

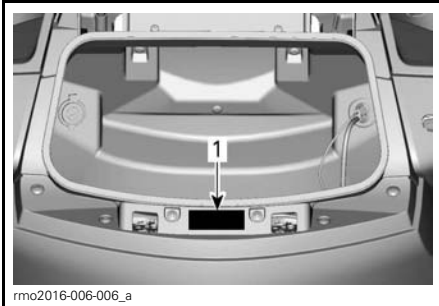

rmo2016-006-006_a

1. Label 5 located in the top storage compartment

Label 6

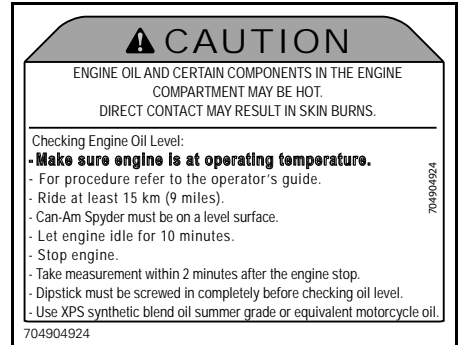

704904924

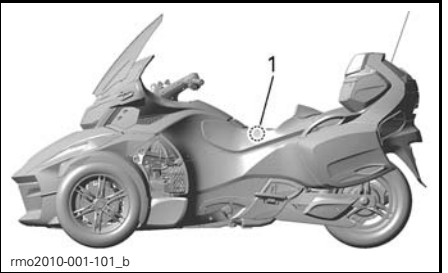

rmo2010-001-101_b

1. Label 6 located under the seat

Label 7



rmo2008-003-003

COOLANT RESERVOIR CAP

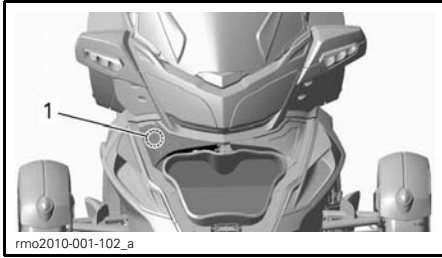

1. Label 7 located underneath service cover

Label 8

⚠ WARNING

Clean filler cap before removing.
Use only DOT 4 brake fluid from a sealed container.

704903119



TYPICAL
1. Label 8 located underneath seat

Label 9

⚠ WARNING

MINIMUM PRESSURE 70 kPa / 10 Psi / 0.7 bar
DO NOT EXCEED RECOMMENDED PRESSURE BY 70 kPa / 10 Psi / 0.70 bar

LOAD	(PASSENGER + CARGO) Kg / Lb 704900155				
	0	45/100	70/150	90/200	115/250
DRIVER					
Kg/Lb	kPa/Psi/bar	kPa/Psi/bar	kPa/Psi/bar	kPa/Psi/bar	kPa/Psi/bar
70/150	310/45/3.10	380/55/3.80	450/65/4.50	480/70/4.80	515/75/5.15
90/200	345/50/3.45	415/60/4.15	480/70/4.80	515/75/5.15	550/80/5.50
115/250	380/55/3.80	450/65/4.50	515/75/5.15	550/80/5.50	585/85/5.85

704905155

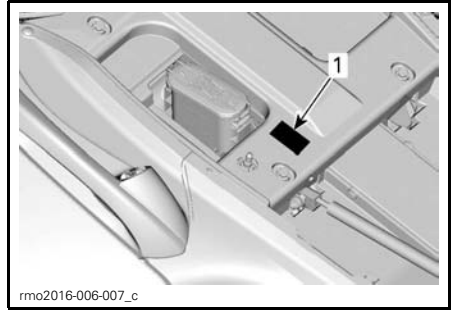

TYPICAL
1. Label 9 located underneath seat

Label 10

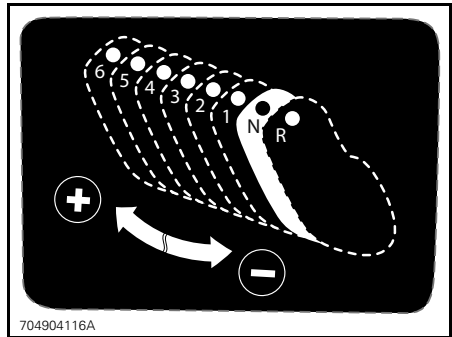

JAPANESE MODELS ONLY - INSTALLED BY DEALER

Label 11

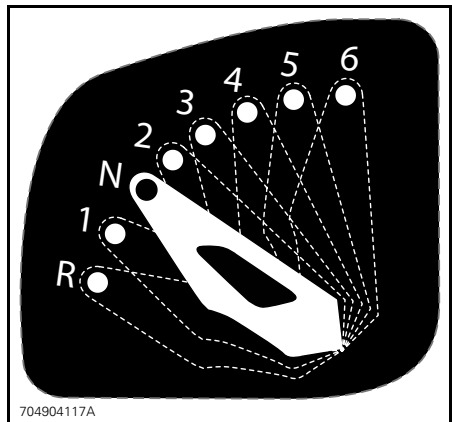

JAPANESE MODELS ONLY - INSTALLED BY DEALER

Safety Labels (European models)

These labels are affixed to the vehicle for the safety of the operator, passenger (2-UP) or bystanders

The following labels are on your vehicle, and they should be considered permanent parts of the vehicle. If missing or damaged, they can be replaced free of charge. See an authorized Can-Am roadster dealer.

NOTE: In the event of any discrepancy between this guide and the vehicle, the safety labels on the vehicle have precedence over the labels in this guide.

Label 1

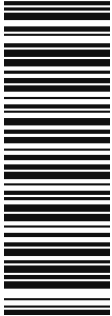
	TIRE AND LOADING INFORMATION/ RENSEIGNEMENTS SUR LES PNEUS ET LE CHARGEMENT				704905125
	THIS VEHICLE IS EQUIPPED WITH TUBELESS TIRES/ CE VÉHICULE EST ÉQUIPÉ DE PNEUS SANS CHAMBRE À AIR				
SEATING CAPACITY / NOMBRE DE PLACES		TOTAL 2	FRONT AVANT 1	REAR ARRIÈRE 1	
THE COMBINED WEIGHT OF OCCUPANTS AND CARGO SHOULD NEVER EXCEED LE POIDS TOTAL DES OCCUPANTS ET DU CHARGEMENT NE DOIT JAMAIS DÉPASSER			224 Kg	OR 494 lbs	
READ OPERATOR'S GUIDE/ VOIR GUIDE DU CONDUCTEUR	TIRE/PNEU	SIZE/ DIMENSION	COLD TIRE PRESSURE/ PRESSION DES PNEUS À FROID	TIRE BRAND MARQUE DE PNEU	RIM SIZE/ DIMENSION DE LA JANTE
	FRONT/AVANT	MC165/55R15 55H	138 ± 14 kPa / 20 ± 2 psi (1.38 ± 0.14 bar)	KENDA KR31	381 x 127mm (15 x 5)in
	REAR/ARRIÈRE	MC225/50R15 76H	193 ± 14 kPa / 28 ± 2 psi (1.93 ± 0.14 bar)	KENDA KR21	381 x 178mm (15 x 7)in
	SPARE/PNEU DE SECOURS	NONE/AUCUN	NONE/AUCUN	NONE/AUCUN	NONE/AUCUN

704905125

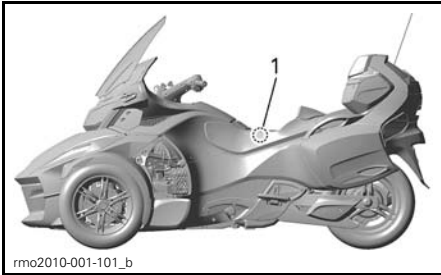

rmo2010-001-101_b

1. Label 1 location

Label 2

NOTICE

- Matt finish paint needs special care to maintain its appearance. See operator's guide
- PVD chrome wheel should be washed with water and a mild soap. Do not polish, use acid based or abrasive chrome cleaner on the PVD chrome wheel.
- Do not clean windshield with alkaline or acid cleaner, gasoline or solvent to avoid windshield damage. See operator's guide.

704904936A

704904936

LOCATED UNDER FRONT STORAGE COVER

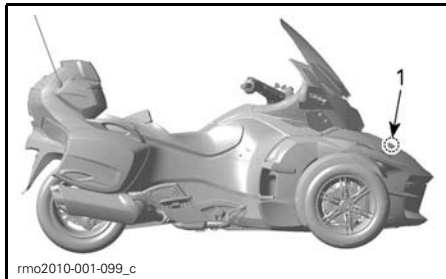

1. Label 2 location

Label 3

WARNING

DO NOT OVERLOAD
16 kg (35 lb)
LOAD LIMIT 5121A

704905121



1. Label 3 located in the front storage compartment

Label 4

WARNING

DO NOT OVERLOAD
6.8 kg (15 lb)
LOAD LIMIT 5122A

704905122

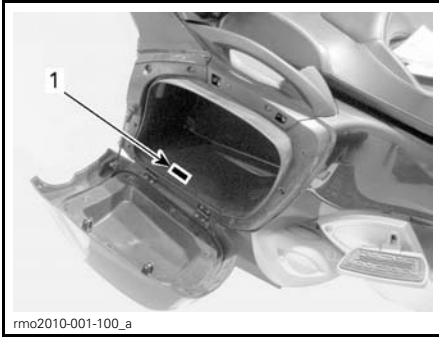

rmo2010-001-100_a

1. Label 4 located in the side storage compartment

Label 5



704905123

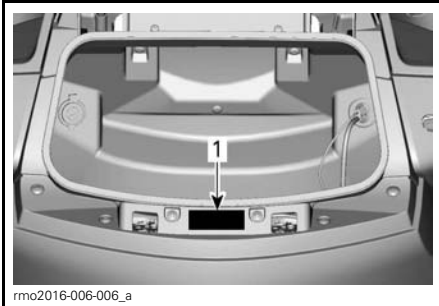

rmo2016-006-006_a

1. Label 5 located in the top storage compartment

Label 6

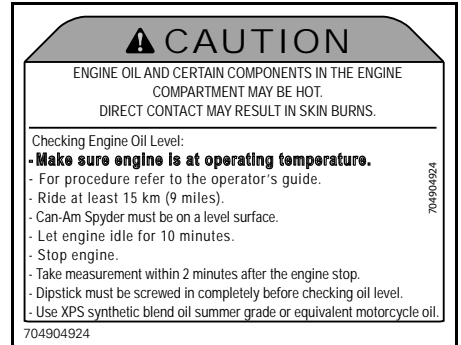

704904924

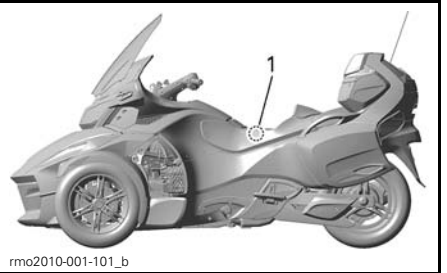

rmo2010-001-101_b

1. Label 6 located under the seat

Label 7



rmo2008-003-003

COOLANT RESERVOIR CAP

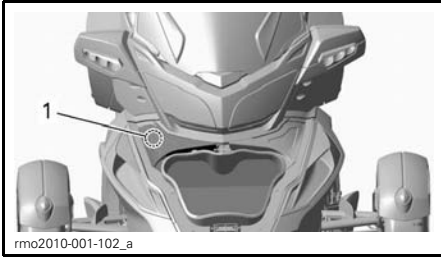

rmo2010-001-102_a

1. Label 7 located underneath service cover

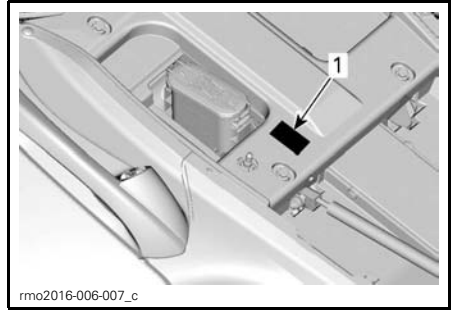

rmo2016-006-007_c

TYPICAL
1. Label 9 located underneath seat

Label 8

⚠ WARNING

Clean filler cap before removing.
Use only DOT 4 brake fluid from a sealed container.

704903119

704903119



rmo2010-001-013_d

TYPICAL
1. Label 8 located underneath seat

Label 9

⚠ WARNING

MINIMUM PRESSURE 70 kPa / 10 Psi / 0.7 bar
DO NOT EXCEED RECOMMENDED PRESSURE BY 70 kPa / 10 Psi / 0.70 bar

LOAD	(PASSENGER + CARGO) Kg / Lb 704905155				
	0	45/100	70/150	90/200	115/250
DRIVER					
Kg/Lb	kPa/Psi/bar	kPa/Psi/bar	kPa/Psi/bar	kPa/Psi/bar	kPa/Psi/bar
70/150	310/45/3.10	380/55/3.80	450/65/4.50	480/70/4.80	515/75/5.15
90/200	345/50/3.45	415/60/4.15	480/70/4.80	515/75/5.15	550/80/5.50
115/250	380/55/3.80	450/65/4.50	515/75/5.15	550/80/5.50	585/85/5.85

704905155

REPORTING SAFETY DEFECTS

Your safety is very important to Bombardier Recreational Products Inc. (BRP). If you have any concerns you should immediately contact BRP customer service.

In the USA, if you believe that your vehicle has a defect which could cause a crash or could cause injury or death, you should immediately inform the National Highway Traffic Safety Administration (NHTSA) in addition to notifying Bombardier Recreational Products Inc.

If NHTSA receives similar complaints, it may open an investigation, and if it finds that a safety defect exists in a group of vehicles, it may order a recall and remedy campaign. However, NHTSA cannot become involved in any individual problems between you, your dealer or Bombardier Recreational Products Inc.

To contact NHTSA you may either call the Safety Hotline toll-free at 1 888-327-4236 (TTY: 1 800-424-9153) or go the website: www.safercar.gov or write to:

Administrator
NHTSA
400 7th Street SW
Washington, DC 20590

You can also obtain other information about motor vehicle safety from the website www.safercar.gov.

***This page is
intentionally blank***

PRE-RIDE INSPECTION

PRE-RIDE CHECKLIST

We encourage you to have an Annual Safety Inspection of your vehicle. Please contact an authorized BRP dealer for further details. Though not required, it is recommended that an authorized BRP dealer performs the preseason preparation of your vehicle. Each visit to your authorized BRP dealer is a great opportunity for your dealer to verify if your vehicle is included in any safety campaign. We also urge you to visit your authorized BRP dealer in a timely manner if you become aware of any safety related campaigns.

WARNING

Perform a pre-ride inspection before each ride to detect potential problems during operation. The pre-ride inspection can help you monitor wear and deterioration before they become a problem. Correct any problems that you discover to reduce the risk of a breakdown or crash. See an authorized Can-Am roadster dealer as necessary.

Before Starting the Vehicle, Inspect the Following:

ITEM	PROCEDURE	
TIRES	Look for damage. Inspect inflation and tread wear. Refer to the <i>MAINTENANCE PROCEDURES</i> subsection.	
WHEELS AND LUG NUTS	Look for damage. Twist each front wheel lug nut by hand to be sure it is not loose. Be sure the rear wheel axle nut is in place.	
DRIVE BELT	Look for fraying, cuts, punctures and missing teeth. Verify alignment. For additional information, refer to the <i>MAINTENANCE PROCEDURES</i> subsection	
LEAKS	Look under the vehicle for any leaks.	
STORAGE COMPARTMENT COVERS AND GLOVE BOX	Pull to check that they are all properly latched.	
ACS REAR SUSPENSION (WITH MANUAL ADJUSTMENT)	Verify inflation. Refer to the <i>BASIC PROCEDURES</i> subsection	
SEAT	Ensure seat is properly latched.	
MIRRORS	Clean and adjust: (see <i>MIRRORS</i> in <i>EQUIPMENT</i> subsection).	
BRAKE PEDAL	Press and make sure you feel firm resistance. Pedal must fully return when released.	
THROTTLE HANDLE	Twist several times. Be sure it operates freely and returns to idle position when released.	

ITEM	PROCEDURE	
CLUTCH LEVER (SM6 MODEL)	Adjust to your convenience (see <i>PRIMARY CONTROLS</i> subsection). Squeeze to be sure it operates normally and fully returns when released.	
GEARSHIFT SELECTOR (SE6 MODEL)	Be sure gearshift selector operates normally in both directions and returns to center when released.	
PASSENGER FOOTREST HEIGHT ADJUSTMENT	Be sure the passenger is comfortable with the footrest height. Adjust as necessary.	
WEIGHT	Ensure that total load on the vehicle (including operator, passenger, cargo and added accessories) does not exceed recommended load as indicate in the <i>TECHNICAL SPECIFICATIONS</i> section.	
TRAILER	If a trailer is towed, be sure its cargo is properly loaded and secured, the covers are latched, the trailer and safety cables are properly latched to vehicle hitch and all the trailer lights work and reflectors are clean. Check trailer tire condition and pressure.	
RADIATOR FAN GRILLS	Remove any debris from the grills. Do not clean with a pressure washer because it can damage the radiator fins. Clean only with compressed air.	

Turn Ignition Key to the ON Position:

ITEM	PROCEDURE	
MULTIFUNCTION GAUGE	Check the gauges, indicators, messages and the fuel level	
LIGHTS	Check operation of headlights, taillight, brake light, turn signals and hazard warning lights.	
HORN	Check operation.	
STEERING	Start engine and verify that steering operates freely.	
ENGINE STOP SWITCH	Check that the engine stop switch is working properly.	
PARKING BRAKE	Start engine, release parking brake and ensure brake indicator lamp is off on the multifunction gauge.	
BRAKE	Drive a short distance forward slowly then apply brake to test.	
SAFETY CARD	Always lock the safety card back into position.	

***This page is
intentionally blank***

MAINTENANCE

MAINTENANCE SCHEDULE

Maintenance is very important for keeping your vehicle in safe operating condition. **A repair shop or person of the owner's choosing may maintain, replace, or repair** emission control devices and systems. These instructions do not require components or service by BRP or authorized Can-Am roadster dealers. Although an authorized Can-Am roadster dealer has an in-depth technical knowledge and tools to service the Can-Am roadster, the emission-related warranty is not conditioned on the use of an authorized Can-Am roadster dealer or any other establishment with which BRP has a commercial relationship. For emission-related warranty claims, BRP is limiting the diagnosis and repair of emission-related parts to the authorized Can-Am roadster dealers. For more information, please refer to the *US EPA EMISSIONS PERFORMANCE WARRANTY* contained herein. Proper maintenance is the owner's responsibility. A warranty claim may be denied if, among other things, the owner or operator caused the problem through improper maintenance or use.

You must follow the instructions for fuel requirements in the fueling section of this manual. Even if gasoline containing greater than ten volume percent ethanol is readily available, the US EPA issued a prohibition against the use of gasoline containing greater than 10 vol% ethanol that applies to this vehicle. The use of gasoline containing greater than 10 vol% ethanol with this engine may harm the emission control system.

Perform periodic checks and follow the maintenance schedule. **The maintenance schedule does not exempt the pre-ride inspection.**

Verifying fault codes, as first maintenance step, is a good practice and is highly recommended.

WARNING

Failure to properly maintain the vehicle according to the maintenance schedule and procedures can make it unsafe to operate.

FIRST INSPECTION - 5 000 KM (3,000 MI)

Perform all items indicated in the *PRE-RIDE INSPECTION*.

Replace engine oil and oil filter.

Check clutch fluid level (**SM6 model only**).

Check brake fluid level.

Check reverse mechanism operation.

Check engine coolant level.

Check operation of control switches and passenger switches.

Check the drive belt condition and its tension.

Check tightening torque of the rear wheel axle nut.

Visually check brake pads and discs condition.

Check passenger handholds looseness.

Check footrests looseness.

Check body panels looseness.

Check operation of storage compartment latches, hinges and key barrels.

EVERY 1 500 KM (1,000 MI)

Check oil level.

EVERY 15 000 KM (9,300 MI) OR 1 YEAR (WHICHEVER COMES FIRST)

Perform all items indicated in the *PRE-RIDE INSPECTION*.

Replace engine oil and oil filter.

Check clutch fluid level (**SM6 model only**).

Check brake fluid level. Replace every 2 years.

Check brake hoses

Check reverse mechanism operation.

Check radiator, hoses and water pump.

Check engine coolant level.

Perform a pressure test of cooling system.

Check operation of control switches and passenger switches.

Check condition of fuel hoses, fuel evaporation lines and canister.

Check battery connections tightening.

EVERY 15 000 KM (9,300 MI) OR 1 YEAR (WHICHEVER COMES FIRST)

Check the drive belt condition and its tension.

Check and retighten exhaust pipe, clamping rings, joints, and gaskets condition.

Check steering for abnormal play.

Check tie-rods condition.

Check shock absorbers for leaks or other damages.

Check tightening torque of the rear wheel axle nut.

Check ball joints condition.

Check front and rear wheel bearings condition.

Check brake pads and discs condition.

Check passenger handholds looseness.

Check footrests looseness.

Check body panels looseness.

Check operation of storage compartment latches, hinges and key barrels.

EVERY 30 000 KM (19,000 MI)

Replace air filter and clean air filter housing.

Replace clutch fluid (**SM6 model only**).

EVERY 45 000 KM (28,000 MI)

Replace the Hydraulic Control Module (HCM) oil filter (**SE6 model only**).

Replace the canister pre-filter.

Replace fuel filter (or every 5 years)

Replace engine coolant (or every 5 years).

Replace the spark plugs.

Check front suspension arms rubber bushings.

FIRST INSPECTION

We recommend that after the first 5 000 km (3,000 mi) of operation, your vehicle be inspected by an authorized Can-Am roadster dealer, repair shop, or person of your own choosing. This maintenance is very important and must not be neglected.

NOTE: The first inspection is at the expense of the vehicle owner.

We recommend that this inspection be signed by the authorized Can-Am dealer, repair shop, or person of your own choosing having performed the first inspection.

Date of inspection

Signature of the Authorized Can-Am dealer, repair shop, or person

Name of the Authorized Can-Am dealer, repair shop, or person

MAINTENANCE PROCEDURES

This section includes instructions for basic maintenance procedures.

⚠ WARNING

Turn off the engine and follow these maintenance procedures when performing maintenance. If you do not follow proper maintenance procedures you can be injured by hot parts, moving parts, electricity, chemicals or other hazards.

Engine Oil

Recommended Engine Oil

The same oil is used for the engine, gearbox, clutch, and the Hydraulic Control Module (HCM) on the SE6 model.

NOTICE Do not use engine oil which is not designed specifically for motorcycle application (wet clutch). Automotive application oils contain friction modifiers which can lead to clutch slippage.

Use the XPS 4-STROKE SYNTH. BLEND OIL (P/N 293 600 121) or a 5W40 semi-synthetic or synthetic oil certified JASO-MA may be used as an alternative to the recommended oil. Always check the API service label on the oil container.

NOTICE Do not add any oil additives to the recommended oil. This may lead to gearbox and clutch malfunctions.

Engine Oil Level Verification

In order to perform the engine oil level verification, the engine must be at normal operating temperature.

1. Take a ride of at least 15 km (9 mi).
2. Park the vehicle on a level surface.
3. Let the engine idle for 10 minutes.

⚠ WARNING

Exhaust gas contains poisonous carbon monoxide that can rapidly accumulate in an enclosed or poorly ventilated area. If inhaled, it can cause serious injury or death. Only run the engine in an unenclosed, well ventilated area.

NOTICE Adjusting the oil level on a cold engine will result in overfilling.

4. Stop engine.

NOTE: Engine oil level verification must be performed within 2 minutes after engine stop.

5. Open the seat. Refer to *OPENING THE SEAT* in the *EQUIPMENT* sub-section.
6. Unscrew and remove the oil dipstick.

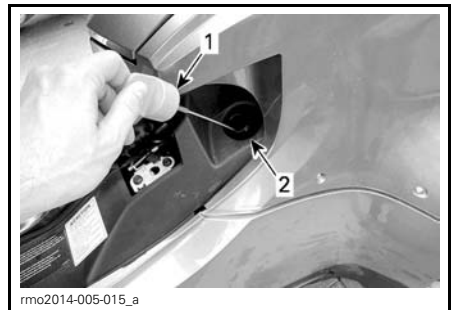

1. Oil dipstick
2. Oil filler tube

7. Wipe off the dipstick.
8. Reinsert and completely screw in the dipstick.
9. Unscrew and remove the dipstick again.
10. Check the oil level on the dipstick.

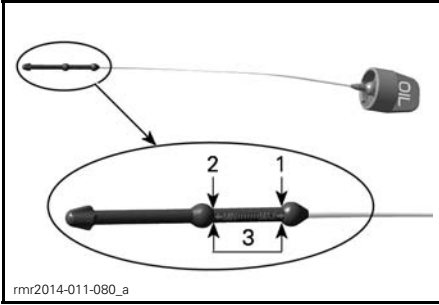

rmr2014-011-080_a

1. MAX
2. MIN
3. Operating range, 0.5 L (.5 qt (U.S. liq.))

Oil Level between Lower (MIN) and Upper (MAX) Marks:

1. Do not add oil.
2. Properly insert and tighten dipstick.
3. Close the seat.

Oil Level under MIN Mark Adjustment:

1. Add approximately 500 ml (17 U.S. oz) of recommended oil.

NOTE: The oil quantity between MIN and MAX marks is 500 ml (17 U.S. oz).

2. Restart the engine and let it idle for 10 minutes.

⚠ WARNING

Exhaust gas contains poisonous carbon monoxide that can rapidly accumulate in an enclosed or poorly ventilated area. If inhaled, it can cause serious injury or death. Only run the engine in an unenclosed, well ventilated area.

NOTICE Adjusting the oil level on a cold engine will result in overfilling.

3. Stop the engine.

NOTE: Engine oil level verification must be performed within 2 minutes after engine stop.

4. Recheck oil level.

5. Repeat the above steps until oil level reaches the dipstick between the lower and upper marks. **Do not overfill.**
6. Properly insert and tighten dipstick.
7. Close seat.

Engine Oil and Oil Filter Change

1. Prior to changing the oil, ensure vehicle is on a level surface.

NOTICE The engine oil and the engine oil filter must be replaced at the same time. The oil change should be carried out with a warm engine.

⚠ CAUTION Engine oil can be very hot.

2. Remove the following RH body panels, refer to *BODY* subsection:
 - Middle side panel
 - Top side panel
 - Acoustic panel.
3. Clean area around drain plug under oil sump cover.
4. Place an appropriate drain pan under oil sump cover.
5. Remove the drain plug and discard the sealing washer and O-rings.

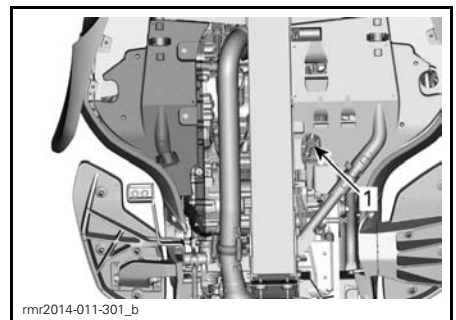

rmr2014-011-301_b

TYPICAL - SE6 MODEL SHOWN

1. Engine oil drain plug

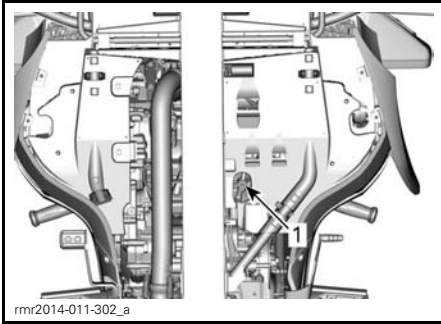

TYPICAL - SM6 MODEL SHOWN

1. Engine oil drain plug

6. Remove the dipstick.
7. Allow sufficient time for oil to completely drain.
8. Clean area around magnetic drain plug in the clutch cover.
9. Place an appropriate drain pan under the clutch cover.
10. Remove the magnetic oil drain plug and discard the sealing ring.

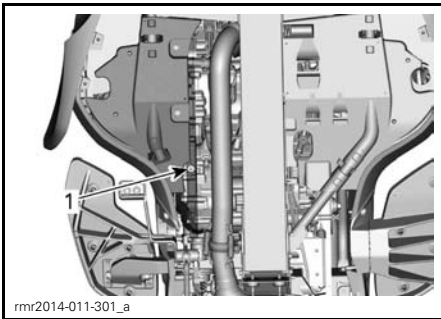

TYPICAL - SE6 MODEL SHOWN

1. Clutch cover magnetic drain plug

11. Remove oil filter cover and discard its O-rings.
12. Remove and discard oil filter.

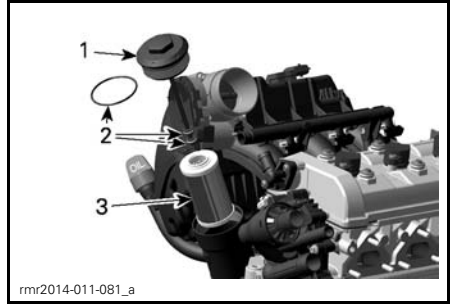

1. Oil filter cover

2. O-rings

3. Oil filter

13. Allow sufficient time for oil to completely drain from clutch cover.
14. Check and clean oil filter cavity for dirt and contamination.
15. Clean the magnet on the magnetic drain plug.
16. Using **NEW** sealing washers and O-rings and install both drain plugs.

NOTICE Never reuse the drain plug sealing washers and O-rings. Always replace it with a new one.

17. Tighten drain plugs as specified.

TIGHTENING TORQUE	
Drain plug (oil sump cover)	28 N•m ± 2 N•m (21 lbf•ft ± 1 lbf•ft)

TIGHTENING TORQUE	
Magnetic drain plug (clutch cover)	20 N•m ± 1 N•m (15 lbf•ft ± 1 lbf•ft)

18. Insert **NEW** engine oil filter.
19. Install **NEW** O-rings on oil filter cover.
20. Install oil filter cover and tighten to specification.

TIGHTENING TORQUE	
Oil filter cover	25 N•m ± 3 N•m (18 lbf•ft ± 2 lbf•ft)

21. Pour following amount of the recommended oil into the oil tank.

OIL QUANTITIES		
MODEL	WHEN DOING...	QUANTITY
SE6	Engine oil and engine oil filter replacement	4.7 L (5 qt (U.S. liq.))
	Engine oil, engine oil filter and HCM surface filter replacement	4.9 L (5.2 qt (U.S. liq.))
SM6	Engine oil and engine oil filter replacement	4.5 L (4.8 qt (U.S. liq.))

22. Reinsert and completely screw in the dipstick.
23. Check engine oil level. Refer to *ENGINE OIL LEVEL VERIFICATION* in this subsection.

NOTICE Ensure oil pressure warning lamp goes out within 5 seconds from engine start. If oil pressure warning lamp stays ON for more than 5 seconds, STOP ENGINE and recheck oil level.

24. Ensure engine oil filter cover, magnetic drain plug (clutch cover) and drain plug (oil sump cover) are not leaking.
25. Stop engine.

NOTE: The oil level dipstick is accurate when the oil temperature is between 80°C and 95°C (176°F and 203°F).

NOTE: The quantity between MIN and MAX marks on oil dip stick is 0.5 L (.5 qt (U.S. liq.)).

26. Check oil level immediately and adjust if required. Refer to *ENGINE OIL LEVEL VERIFICATION* in this subsection

27. Reinstall all removed body panels.
28. Dispose of used oil as per your local environmental regulations.

Air Filter

Air Filter Removal

1. Remove the following body panels to access the air filter. Refer to *BODY PANELS* in the *EQUIPMENT* subsection.
 - LH side panel.
 - LH top side panel.

Remove the 3 screws from the air filter cover.

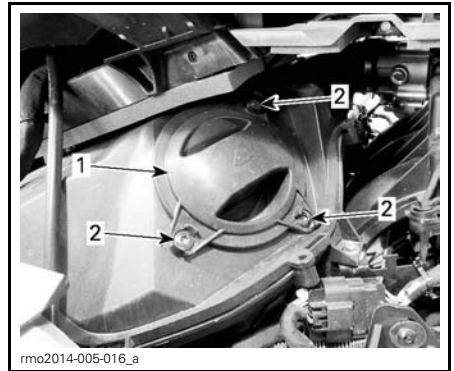

1. Cover
2. Screws

Remove the air filter cover and the filter.



1. Cover
2. Filter

Air Filter Inspection

Inspect air filter for cleanliness and damage.

NOTICE It is not recommended to blow compressed air on the paper filter. This could damage the paper fibers and reduce its filtration ability when used in dusty environments.

NOTICE Do not wash the paper filter with any cleaning solution.

NOTICE Inspect air intake silencer and remove any dust or debris taking care not to blow or move anything inside the clean side of the engine air inlet (passed air filter).

NOTICE Remove any dust or debris that may have moved or shifted inside the clean side of the air intake silencer (passed air filter). Clean by pulling on the dust and not pushing it inside.

Replace air filter as necessary according to recommended maintenance schedule and particular use (especially in dusty environments).

Air Filter Installation

Carefully install air filter into position.

NOTE: The air filter should sit itself correctly. Please make sure the seat/receptacle of the intake hose is not deformed before inserting the air filter.

Properly position air filter cover then secure with all screws.

TIGHTENING TORQUE	
Air filter cover screws	3 N•m ± 0.5 N•m (27 lbf•in ± 4 lbf•in)

Reinstall parts in the reverse order of their removal.

Engine Coolant

Engine Coolant Level Verification

⚠ WARNING

When opening the reservoir, the coolant can be very hot and spray out if the engine is hot. In order to avoid getting burned, check the coolant level when the engine is cold.

The cooling system must be filled with distilled water and antifreeze solution (50% distilled water, 50% antifreeze).

For best performance, use LONG LIFE ANTIFREEZE (P/N 219 702 685) or equivalent.

With the engine cold, check the coolant level as follows:

1. Park the vehicle on a firm, level surface.
2. Open the front storage compartment cover.
3. Remove the plastic rivet from the right service cover.

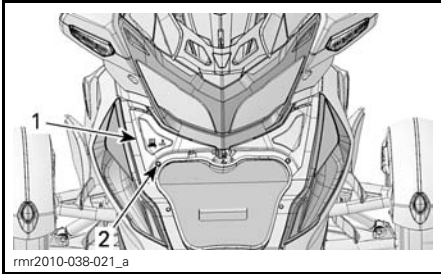

1. Right service cover
2. Plastic rivet

4. Pull down the service cover using the recess to release upper tabs from the front fascia.



5. Pull out the rear tab.
6. Lift service cover to remove it.

NOTICE Pay attention not to damage the FCS switch.

7. Check the coolant level on the right hand side. Coolant must be visible slightly above the COLD level mark.

NOTE: If engine is hot, coolant must be visible without exceeding the HOT level mark.



1. Coolant reservoir cap

8. If required, add coolant until it is visible in the reservoir slightly above the COLD level mark. Use a funnel to avoid spillage. **Do not overfill.**

9. Stop adding coolant once coolant starts to appear in the tube.

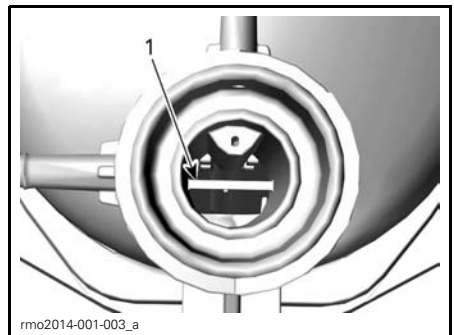

1. HOT coolant level reference line

10. Reinstall the service cover.

NOTE: A coolant system that frequently requires coolant indicates leaks or engine problems. See an authorized Can-Am roadster dealer.

Radiator Fans

Radiator Fans Cleaning

Remove any debris from the grills.

NOTE: Do not clean with a pressure washer because it can damage the radiator fins. Clean only with compressed air from behind (blow the air from the back towards the front).



1. Radiator fan grills

NOTE: When the engine is running and the vehicle is stopped or travelling at low speed, the radiator fans push air towards the front of the vehicle. When the vehicle is travelling at higher speed the fans push the air towards the back of the vehicle.

Clutch Fluid (SM6 Model)

Clutch Fluid Level Verification

Check the clutch fluid level when the clutch does not operate normally or when it is difficult to shift gears with the gearshift lever.

The clutch fluid reservoir is near the reverse button on the left handlebar.

Check the clutch fluid level as follows:

1. Park the vehicle on a firm, level surface.
2. Set the handlebar straight in order to position the top of clutch fluid reservoir horizontally.
3. Wipe clean the cap area.
4. Use the Phillips head screwdriver located in the toolkit.
5. Unscrew cap retaining screws.



6. Carefully remove cap. Pay attention not to drop the cap seal.
7. Look inside the reservoir to see the fluid level.

Check clutch fluid level inside the reservoir:

- The fluid must be flush to the fill level line (protuberance on the reservoir wall).

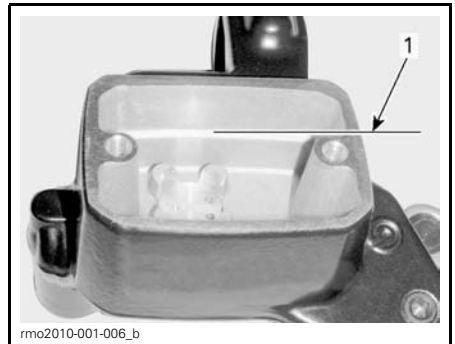

FLUID REMOVED FOR CLARITY PURPOSE

1. Fill level line

Adding Clutch Fluid

1. If the fluid level is lower than specified, add fluid to the reservoir up to the fill level line. Use only DOT 4 brake fluid.
2. Add fluid as required. **Do not over-fill.**

NOTICE Immediately wipe up any spills.

3. Push back the seal located inside the cap.

4. Reinstall the cap to the reservoir.
5. Tighten cap screws.

TIGHTENING TORQUE	
Cap screws	1.35 N•m ± 0.15 N•m (12 lbf•in ± 1 lbf•in)

Battery

Battery Location

The battery is located in the front storage compartment.

To access the battery, open the front storage compartment.



rmo2010-001-044

FRONT STORAGE COMPARTMENT OPENED

- Open the access cover.
Unzip the liner if applicable.



rmo2013-005-002_a

1. Liner

Loosen the screws and open the battery access panel.

Battery Charging

The vehicle is equipped with a maintenance-free type battery and is completely sealed; there is no need to add water to adjust the electrolyte level. The battery may need to be charged if the vehicle has not been ridden for at least one month.

Always have the battery replaced by an authorized Can-Am roadster dealer.

⚠ WARNING

Do not use conventional lead-acid type batteries. Acid may leak out through the battery vent of a conventional lead-acid type battery. Acid may also leak if the battery case is cracked or damaged, which can cause severe burns.

The battery can be charged while it is installed on the vehicle.

NOTICE Follow the instructions provided with your battery charger. Improper charging may damage the battery.

To charge the battery, proceed as follows:

1. Open the front storage compartment.
2. Remove the battery access panel.
3. First connect the RED (+) cable to the corresponding terminal.
4. Connect the BLACK (-) cable to the corresponding terminal.

NOTICE Always connect the RED (+) cable first to avoid damaging the electrical system of the vehicle.

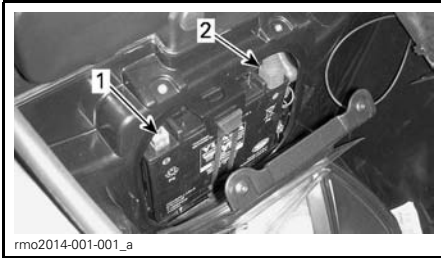

rmo2014-001-001_a

1. BLACK (-) terminal
2. RED (+) terminal

5. Start the battery charger. Charging time will depend on the charging rate.

When the battery is charged:

6. First disconnect the BLACK (-) cable.
7. Disconnect the RED (+) cable.

NOTICE Always disconnect the BLACK (-) cable first to avoid damaging the electrical system of the vehicle.

8. Close the battery access panel and the front storage compartment.

A standard battery charger can be used. The recommended charge rate is 2 A. If the battery is dead, it can be jump started with a car battery (see *ROAD SIDE REPAIRS* section).

For home charging, a “trickle” charger can be used to slowly charge the battery. This type of charger can be left connected for a long period of time without damaging the battery. Always follow the charging time as recommended in the charger instructions.

Drive Belt

Visually inspect belt alignment and condition before each ride.

Belt alignment and deflection adjustment should always be performed by an authorized Can-Am roadster dealer according to the *MAINTENANCE SCHEDULE*.

Drive Belt Alignment

If belt goes beyond the outside edge of sprocket, have the belt properly aligned by an authorized Can-Am roadster dealer as soon as possible.

NOTE: Belt must **NOT** be in contact with flange from **FRONT SPROCKET**.

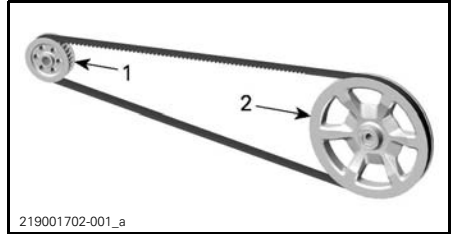

219001702-001_a

- TYPICAL**
1. Front sprocket
 2. Rear sprocket

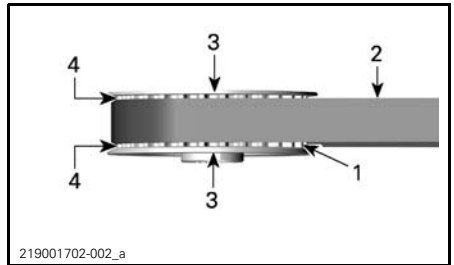

219001702-002_a

- TYPICAL - FRONT SPROCKET**
1. Front sprocket teeth
 2. Belt
 3. Sprocket flange
 4. Gap between flange and belt

Drive Belt Wear



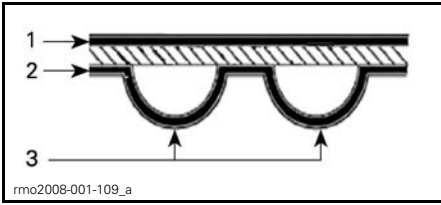



Inspect the drive belt with the vehicle in neutral, engine off, on a level surface with plenty of room — you will have to roll the vehicle forward or backward to see the full length of the belt.





DRIVE BELT SURFACES

1. Outer surface
2. Teeth side surface
3. Tooth

Inspect for the following conditions:

WEAR CONDITION	REQUIRED ACTION
Good condition 	None
Hairline cracks 	Monitor condition
Minor chipping 	Monitor condition
Opened cracks 	Replace belt
Hook wear 	Replace belt
Missing teeth 	Replace belt

WEAR CONDITION	REQUIRED ACTION
Belt fabric worn, exposing internal components 	Replace belt
Stone damage 	Replace belt

NOTE: Hairline cracks do not require the replacement of the belt, but must be monitored closely — they may lead to opened cracks or missing teeth, requiring belt replacement. Damage to the center of the belt will eventually require belt replacement, but when cracks extend to the edge of the belt, belt failure is imminent.

When a drive belt is replaced, also replace the sprockets to increase the longevity of the new drive belt.

Drive Belt Tension

While riding, if you feel vibrations or noise in the belt or if the belt is skipping sprocket teeth, have the belt tension adjusted as soon as possible by an authorized Can-Am roadster dealer. Pay particular attention during break-in period (first 1 000 km (600 mi)).

Wheels and Tires

⚠ WARNING

Tires that are not the recommended type, damaged, worn down below the minimum tread wear limit indicator or not properly inflated can cause loss of control. New tires will not operate at their maximum efficiency until their break-in is completed. Braking, steering and VSS performance may be reduced, so use extra caution. Tires take about 300 km (200 mi) of riding with frequent braking to break-in. For riding with infrequent braking, allow extra time to break-in the tires.

The tires have been specifically designed for the Spyder roadster. Use only the BRP recommended radial tires, which can be ordered only from an authorized Can-Am roadster dealer.

When the rear tire is removed or replaced, perform the following:

- Check and clean the rear sprocket bearing. Replace if damaged or broken.
- Check and clean the rear axle bearings. Replace if damaged or broken.
- Replace and lubricate the bearing seal of the rear axle.
- Replace and lubricate rear axle O-ring.
- Check and clean the rear axle wear sleeves. Replace if damaged or broken.

When the rear wheel is removed or replaced, perform the following:

- Replace rear wheel nut.
- Replace and lubricate the bearing seal of the rear axle.
- Replace and lubricate rear axle O-ring.
- Check rubber damper condition. Replace if damaged or broken.

Tire Pressure

Check pressure when tires are cold before using the vehicle. Tire pressure changes with the air temperature. Recheck pressure if temperature has changed (e.g., significant weather change, driving in the mountains).

COLD TIRE PRESURE	
Front tires	138 kPa ± 14 kPa (20 PSI ± 2 PSI)
Rear tire	193 kPa ± 14 kPa (28 PSI ± 2 PSI)

NOTE: The pressure difference between the left and right side tire should not exceed 3.4 kPa (.03 bar).

Tire Damage

Check all tires for:

- Cuts, slits and cracks in the tires.
- Bumps or bulges in the side of the tire or the tread.
- Nails or other foreign objects in the side of the tire or tread.
- Air leaks (hissing sound) caused by an ill-fitting rim or a faulty tire valve.

If any of the above occurs, have the tire repaired or replaced as soon as possible by an authorized Can-Am roadster dealer.

Tire Tread Wear

Check minimum tread depth by using the tread-wear indicators (hard rubber bars molded at the base of the tread; 1 in figure below). Check in three locations across the tire tread:

- Outer edge
- Center
- Inside edge.

The tread-wear indicators will appear across the treads that have been worn down to the minimum tread depth. When at least one tread-wear indicator appears across the tread, have the tire replaced as soon as possible by an authorized Can-Am roadster dealer.

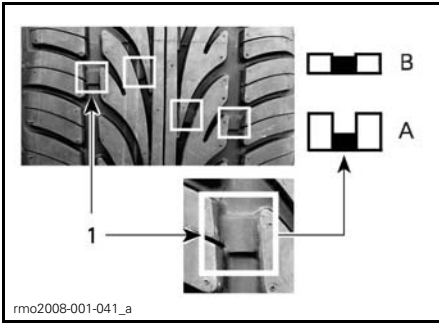
**TIRE TREAD WEAR**

1. Tread-wear limit indicator

A. Appropriate tread depth

B. Minimum tread depth, replace tire

It is normal to see uneven wear on tires depending on how the vehicle is driven and road conditions. The front tires external or internal edges and the rear tire center tread will wear unevenly depending on if the vehicle is driven smoothly or aggressively.

Tire Rotation (Front)

Rotate front tires when tread depth reaches 4 mm (5/32 in). This will maximize tire life.

⚠ WARNING

The tires are designed to rotate only in one direction. Do not switch the left and right front wheels. The tires must be dismounted from the wheels for tire rotation. If a tire is mounted on the incorrect side, you will have less traction and could lose control.

⚠ CAUTION Do not hold the front wheel spoke while attempting to spin the front wheel as your fingers may be caught between the wheel and the brake caliper.

Tire Registration Form

In the event of a tire recall, we can only contact you if we have your name and address. As a vehicle manufacturer, BRP keeps a record of the Tire Identification Number (TIN) associated with

the Vehicle Identification Number (VIN) (see *VEHICLE IDENTIFICATION*) and its current owner information.

If you replace any tire on your vehicle, a "Tire Registration Form" must be completed and sent to the tire manufacturer consumer service group. The "Tire Registration Form" is available at an authorized Can-Am roadster dealer.

Brakes**⚠ WARNING**

New brakes will not operate at their maximum efficiency until their break-in is completed. Braking performance may be reduced, so use extra caution. Brakes take about 300 km (200 mi) of riding with frequent braking to break-in. For riding with infrequent braking, allow extra time to break-in the brakes.

Brake Fluid Level Verification

Use only DOT 4 brake fluid from a sealed container.

Check the brake fluid level as follows:

1. Park the vehicle on a firm, level surface.
2. Unlatch and lift the seat *OPENING THE SEAT*.
3. Check the brake fluid level in both reservoirs, near the back of the seat. They should both be above the MIN. mark.

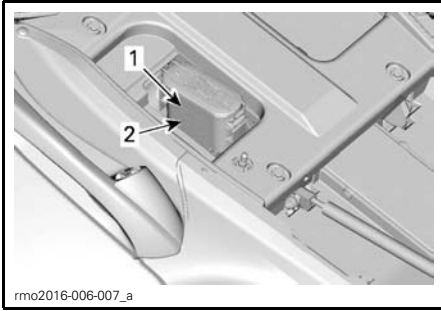

1. Brake fluid MAX. level mark
2. Brake fluid MIN. level mark

4. Add fluid as required. Refer to *ADDING BRAKE FLUID* subsection.

NOTE: Low brake fluid may indicate leaks or worn brake pads. See an authorized Can-Am roadster dealer.

Adding Brake Fluid

1. Remove the filler cap.

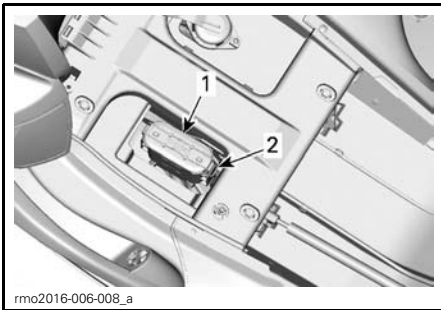

1. Filler cap
2. Filler cap locking mechanism

⚠ WARNING

Clean filler cap before removing. Use only DOT 4 brake fluid from a sealed container.

2. Add fluid to MAX level.

NOTE: Replacing brake pads will increase brake fluid level. If replaced when at MAX level, brake fluid spills may occur.

NOTICE Brake fluid can damage painted surfaces or plastic parts. Wipe up any spills.

3. Reinstall filler cap and lock in place.
4. Close the seat and ensure it is fully latched.

Brake System Verification

The front and rear brakes are hydraulic disc types. These brakes are self-adjusting and do not require adjustment.

The brake pedal also requires no adjustment.

To keep brakes in good condition, check the following as per the *MAINTENANCE SCHEDULE*:

- Entire brake system for fluid leaks
- Brake pedal for spongy feel
- Brake discs for excessive wear and surface condition
- Brake pads for wear, damage or looseness.

RT-S and RT Limited SE6 Models

1. Release the latch underneath the floorboard.
2. Pivot the floorboard by manually pushing down its front part.
3. Flip back the floorboard until it latches. The mechanism must work freely.

See an authorized Can-Am roadster dealer if there are any problems with the brake system.

Headlights

Headlights Aiming Verification (North American Models)

1. Verify tires are correctly inflated. Refer to *SPECIFICATIONS*.
2. Set the rear suspension air pressure to 0 kPa (0 PSI) using the schrader valve located under the seat.

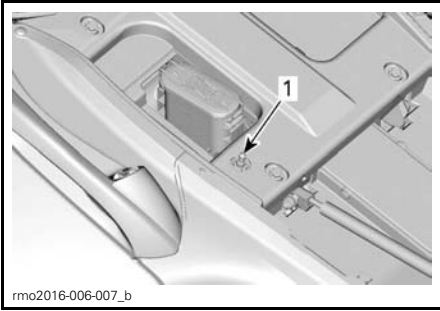

1. Schrader valve

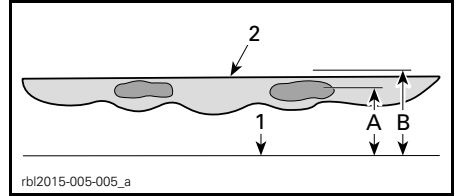

TYPICAL HEADLIGHT REFLECTION ON TEST SURFACE (BOTH HEADLIGHTS)

1. Ground
 2. Top line
- A. 703 mm (27-11/16 in)
 B. 773 mm (30-7/16 in)

3. Position vehicle in front of a test surface as shown. Make sure vehicle is on leveled ground.

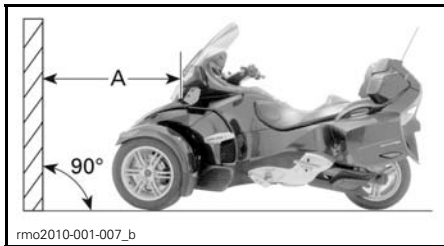

A. 10 m (33 ft)

Headlights Aiming Verification (European, Australian and Japanese Models)

Low Beam

NOTE: This verification is valid for either left-hand or right-hand traffic regulations.

1. Verify that the tires are correctly inflated.
2. Set the rear suspension air pressure to 0 kPa (0 PSI) using the schrader valve located under the seat.

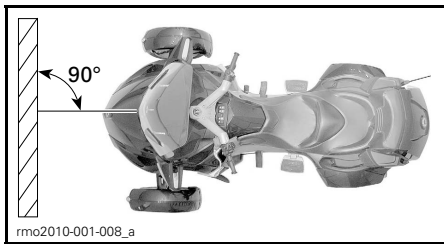

Trace 2 lines parallel to the ground on the test surface as follows:

LINES ON THE TEST SURFACE	
Line A	703 mm (27-11/16 in) above ground
Line B	773 mm (30-7/16 in) above ground

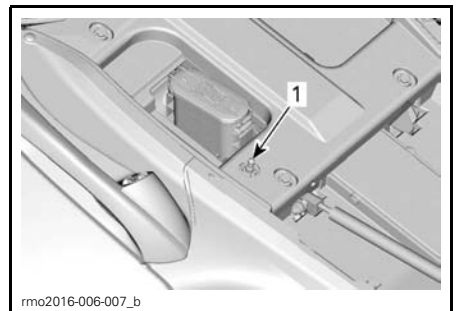

1. Schrader valve

3. Position vehicle in front of a test surface as shown. Make sure vehicle is on leveled ground.

4. Select **low** beam.
5. Beam aiming is correct when the top line of the headlight reflection is between lines A and B.

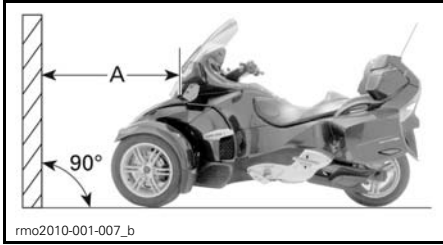

A. 10 m (33 ft)

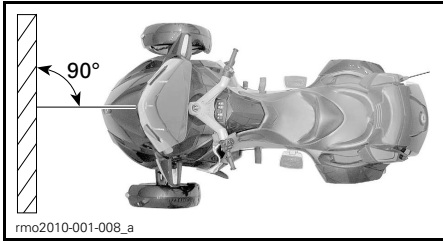

4. Trace 4 lines parallel to the ground on the test surface as follows:

LINES ON THE TEST SURFACE	
Line A	703 mm (27-11/16 in) above ground
Line B	773 mm (30-7/16 in) above ground
Line C	566 mm (2-9/32 in) above ground
Line D	370 mm (14-9/16 in) above ground

5. Select **low beam**.
6. Beam aiming is correct when the top line of the headlight reflection is between lines C and D.

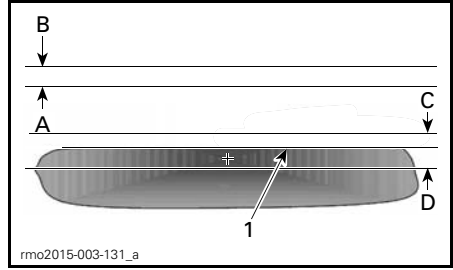

TYPICAL HEADLIGHT REFLECTION ON SURFACE TEST (SINGLE HEADLIGHT)

1. Top line

High Beam

NOTE: As the low beam and high beam are separate units, this verification is valid for either left-hand or right-hand traffic regulations.

1. Follow steps 1 to 4 of the low beam verification procedure.
2. Select **High beam**.

Beam aiming is correct when the focus point (brightest spot) of the headlight reflection is between lines A and B.

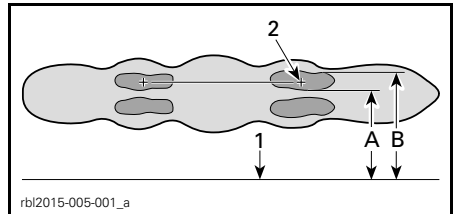

TYPICAL HEADLIGHT REFLECTION ON SURFACE TEST (BOTH HEADLIGHTS)

1. Ground
2. Focus point

Headlights Vertical Aiming Adjustment

1. Remove both middle side panels. Refer to the *BODY PANELS* in the *EQUIPMENT* subsection.

North American Models

To adjust headlight beam, turn the HB_V adjustment knob. Adjust both headlights evenly.

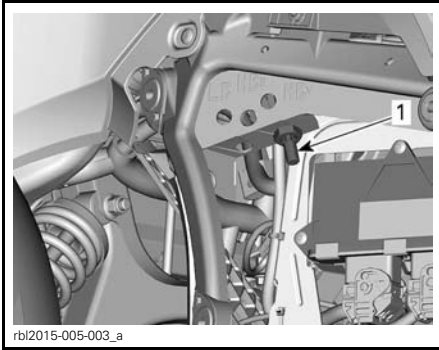

1. HB_V adjustment knob

European and Australian Models

2. To adjust headlight beam, turn the appropriate adjustment knob. Adjust evenly on both sides.

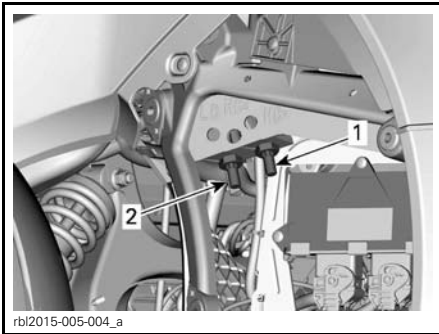

LH SIDE SHOWN (EUROPEAN AND AUSTRALIAN MODELS)

1. High beam adjustment knob (HB_V)
2. Low beam adjustment knob (LB)

Japanese Models

To adjust headlight beam, turn the applicable adjustment knob. Adjust both headlights evenly.

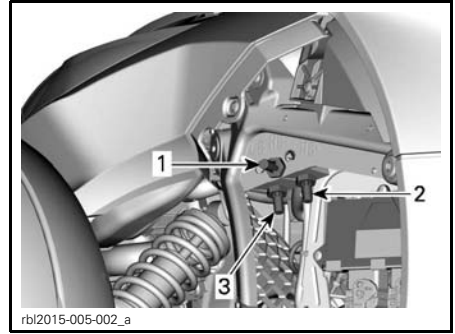

LH SIDE SHOWN

1. High Beam Horizontal Adjustment Knob " HB_H "
2. High Beam Vertical Adjustment Knob " HB_V "
3. Low Beam Vertical Adjustment Knob " LB "

All Models

HEADLIGHT BEAM ADJUSTMENT	
Raise beam	Turn knob clockwise
Lower beam	Turn knob counterclockwise

3. Reinstall side panels. Refer to *BODY PANELS* in *EQUIPMENT* sub-section.

Headlights Horizontal Aiming Adjustment, High Beams (Japanese Models Only)

If high beam headlights are out of adjustment (to far left or right), carry out the following procedure.

1. Remove both middle side panels.
2. To adjust headlight beam, turn the applicable adjustment knob.

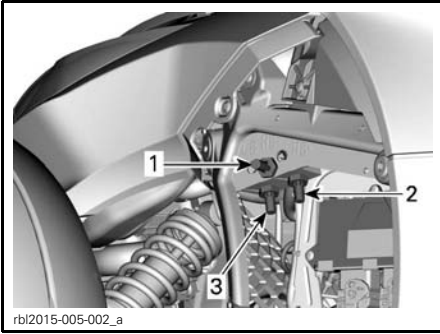

LH SIDE SHOWN

1. High Beam Horizontal Adjustment Knob "HB_H"
2. High Beam Vertical Adjustment Knob "HB_V"
3. Low Beam Vertical Adjustment Knob "LB"

Adjust both high beam headlights so that a line drawn from the center of the focus point (brightest spot on the wall) to the center of the headlight assembly is parallel to the fore and aft center line of the vehicle.

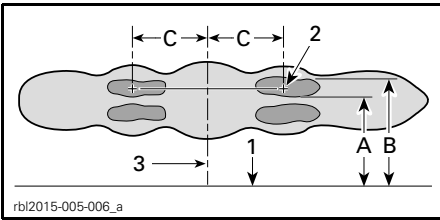

HIGH BEAM HEADLIGHT REFLECTION ON TEST SURFACE (BOTH HEADLIGHTS)

1. Ground
 2. Focus point
 3. Vehicle center line
- A. 703 mm (27-11/16 in) above ground
 B. 773 mm (30-7/16 in) above ground
 C. 122 mm ± 35 mm (4-13/16 in ± 1-3/8 in) from vehicle center line

VEHICLE CARE

Vehicle Cleaning

To clean the vehicle, **do not use high-pressure washers** (like the ones found in car washes) as they may damage certain parts of the vehicle.

NOTICE Chrome wheels should be washed with water and mild soap. Do not polish, use acid based or abrasive chrome cleaner on the chrome wheels.

NOTICE Do not clean the windshield with alkaline or acid cleaner, gasoline or solvent to avoid windshield damage.

NOTICE For Matte finishes, do not use wax, detail spray, or other products used on regular paint. Do not wash with abrasive materials. Do not use mechanical cleaners or polishers, and do not rub the surfaces vigorously.

To clean the vehicle:

1. Rinse the vehicle thoroughly with water to remove loose dirt.
2. Using a soft, clean cloth, wash the vehicle with water mixed with a mild detergent, such as soap specially formulated for motorcycles or automobiles.

NOTE: Using warm water works well to remove bugs in the windshield and front panels.

NOTE: For **Matte finishes**, hand-wash with a soft wash mitt and a mild cleaning product safe for matte paint. To remove foreign substances such as insects, use a soft applicator and a mild solvent. Saturate and soak area before cleaning. Rub lightly.

3. While washing the vehicle, check for grease or oil. You can use XPS ROADSTER WASH (P/N 219 701 703) or a mild automotive degreaser. Thoroughly follow the manufacturer's instructions.

4. Dry the vehicle with a chamois or a soft towel.

Vehicle Protection

Apply non-abrasive wax to plastic parts.

NOTICE Do not wax or polish matte surfaces.

SURFACE	PRODUCT/PRECAUTION
Glossy finishes	Apply only non-abrasive wax, safe for clear coat paints
Matte finishes	Do not apply wax

NOTICE Do not polish windshield with any plastic cleaner/polisher.

WARNING

Do not apply a vinyl or plastic protector on the seat as the surface will become slippery and the operator or the passenger may slip off the vehicle.

STORAGE AND PRESEASON PREPARATION

Storage

If the vehicle will not be ridden for at least four months, such as during the winter, proper storage is necessary to keep the vehicle in good condition.

BRP recommends you have your authorized Can-Am roadster dealer, repair shop, or person of your own choosing fully prepare your vehicle for storage. Or, at your convenience, you can follow the basic procedures below.

To Prepare the Vehicle for Storage:

1. Inspect vehicle and have your authorized Can-Am roadster dealer, repair shop, or person of your own choosing for maintenance, repair, or replacement if necessary. Please refer to the *US EPA EMISSIONS PERFORMANCE WARRANTY* contained herein for information about warranty claims.
2. Change the engine oil and filter. Seek service from an authorized Can-Am roadster dealer, repair shop, or person of your own choosing for maintenance, repair, or replacement.
3. Check engine coolant, brake fluid and clutch fluid levels.
4. Fill the fuel tank, add fuel stabilizer and run the engine to prevent the tank from rusting and the fuel from deteriorating. Strictly follow instructions on fuel stabilizer container.
5. Inflate all tires to their recommended pressure.
6. Clean the vehicle.
7. Lubricate all control cables and latches, pivoting points of all levers and lubrication points of front suspensions.
8. Close and latch all storage compartments.

9. Cover the vehicle with a permeable materials (e.g., tarpaulin). Avoid using plastic or similar non-breathing, coated materials that restrict air flow and allow heat and moisture to accumulate.
10. Store the vehicle in a dry area, away from sunlight, with a small amount of daily temperature variation.
11. Slow charge the battery once a month at the recommended charging rate of 2 A. It is not necessary to remove the battery.

Preseason Preparation

All Models

After a storage period, vehicle must be prepared and inspected.

To Remove the Vehicle from Storage:

1. Uncover and clean the vehicle.
2. Charge the battery if needed.
3. Perform a pre-ride inspection, then test-ride the vehicle at low speed.

RT-S and RT Limited SE6 Models

1. Release the latch underneath the floorboard.
2. Pivot the floorboard by manually pushing down its front part.
3. Flip back the floorboard until it latches. The mechanism must work freely.

ROAD SIDE REPAIRS

DIAGNOSTIC GUIDELINES

NOTICE If the vehicle must be transported, do not have it towed — towing can seriously damage the vehicle. Refer to *TRANSPORTING THE VEHICLE* in this section for detailed instructions.

Will not Shift into First Gear (SM6 Model)

If the gearbox cannot shift into first gear when vehicle is not moving:

1. Slowly release the clutch lever while maintaining a light pressure down on the shift lever.
2. When you feel the shift lever engaging into first gear, pull in the clutch lever.

Will not Shift into Neutral (SE6 Model)

If the gearbox cannot shift into neutral when vehicle is not moving:

1. The engine speed will be automatically increased to approximately 1300 RPM then it will be brought back to idle speed.
2. Up to 3 attempts will be done.
3. If it does not work, retry pressing up-shift or downshift.

Will not Shift (SE6 Model)

Have your vehicle transported to the nearest Can-Am roadster dealer.

Engine Does Not Start

ENGINE DOES NOT TURN OVER

1. Scrolling safety message on the multifunction gauge not acknowledged.
 - Read the safety message then press the *MODE* button.
2. Engine stop switch in the OFF position.
 - Make sure that the engine stop switch is in the *ON* position.

ENGINE DOES NOT TURN OVER (cont'd)

3. Clutch lever not engaged (SM6 model).
 - Pull in and hold the clutch lever.
4. Ignition switch in the OFF position.
 - Turn the ignition to the *ON* position.
5. Battery dead or poor battery connections.
 - Check the battery charge. Recharge if necessary (see *MAINTENANCE PROCEDURES* subsection).
 - Check the battery connections in the front storage compartment (see *MAINTENANCE PROCEDURES* subsection).
6. Blown fuse.
 - Check fuse condition (see the *HOW TO REPLACE FUSES AND LIGHTS* in this section).
7. Transmission is in gear (SE6 model).
 - Depress brake pedal if transmission is in gear.

ENGINE DOES NOT TURN OVER (cont'd)**8. The key is not read.**

If the immobilizer system cannot read the key, the engine will not start. The following conditions can lead to the immobilizer system failing to read the key:

- Damaged computer chip
- Large metallic object near the key
- Electronic device near the key
- Second electronic coded key near the main key
- Other strong electromagnetic field in the key area
- *If the engine does not start and a key error message is displayed in the cluster, make sure that none of the above conditions are present. If the problem is still present without these conditions, see an authorized Can-Am roadster dealer.*

ENGINE TURNS OVER, BUT DOES NOT START**1. Low fuel.**

- *Fill the fuel tank. Refer to BASIC PROCEDURES subsection.*

2. Weak battery.

- *Check battery charge. Recharge if necessary (see MAINTENANCE PROCEDURES subsection).*
- *Check the battery connections in the front storage compartment (see MAINTENANCE PROCEDURES subsection).*

ENGINE TURNS OVER, BUT DOES NOT START (cont'd)**3. Engine management problem.**

- *Check to see whether the engine malfunction indicator lamp is ON while starting. Seek service from an authorized Can-Am roadster dealer, repair shop, or person of your own choosing for maintenance, repair, or replacement. Please refer to the US EPA EMISSIONS PERFORMANCE WARRANTY contained herein for information about warranty claims.*

Manual is Displayed in the Gauge

The manual message will appear on the LH side of the digital display in place of the bar graph indication to inform you that there is a problem with the automatic suspension adjustment.

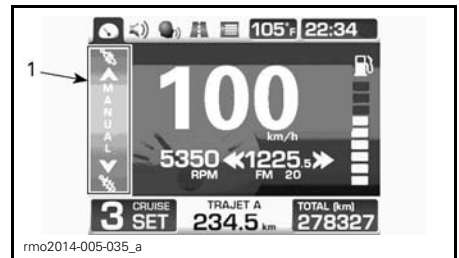





**TYPICAL - DIGITAL DISPLAY WITH MANUAL SETTING****1. Manual setting indication**









The suspension can still be manually adjusted to your preferred setting.



Have your vehicle inspected by a Can-Am dealer as soon as possible.

MESSAGES IN MULTIFUNCTION GAUGE

Important information about vehicle condition is displayed on the multifunction gauge. When starting the engine, always look at the gauge for any indicator lamps or special messages.

INDICATOR LAMPS (MALFUNCTIONS)				
INDICATOR LAMP(S)	DIGITAL INDICATOR	DIGITAL WARNING	CAUSE	WHAT TO DO
 FLASHING	E displayed instead of selected gear	NONE	Gearbox position sensor malfunction	Stop vehicle and allow to reach neutral. Have the vehicle repaired by an authorized Can-Am roadster dealer.
NONE		KEY ERR	Wrong or defective key	Use the right key for the vehicle or contact an authorized Can-Am roadster dealer.
 ON	NONE	NONE	Engine is overheating	<ul style="list-style-type: none"> - Stop and wait for engine to cool off. - Check for leaks. - Check coolant level and adjust (see <i>MAINTENANCE PROCEDURES</i> subsection).
 ON	NONE	NONE	Low or high battery voltage	<ul style="list-style-type: none"> - Recharge battery (see <i>MAINTENANCE PROCEDURES</i> subsection). - Check battery connections Have the vehicle transported to the nearest authorized Can-Am roadster dealer.
 ON	NONE	NONE	ABS malfunction. No ABS operation	Have the vehicle transported to the nearest authorized Can-Am roadster dealer.
 ON	NONE	NONE	VSS malfunction	* Have the vehicle transported to the nearest authorized Can-Am roadster dealer.

INDICATOR LAMPS (MALFUNCTIONS)				
INDICATOR LAMP(S)	DIGITAL INDICATOR	DIGITAL WARNING	CAUSE	WHAT TO DO
NONE		NONE	Air controlled suspension malfunction	<ul style="list-style-type: none"> – Check pressure in the air spring – Check rear suspension position sensor – Have the vehicle transported to the nearest authorized Can-Am Roadster Dealer to verify the Air Controlled Suspension Min/Max values calibration.
 ON	BRAKE FAILURE OR 	BRAKE FAILURE	EBD malfunction	Have the vehicle transported to the nearest authorized Can-Am roadster dealer.
	BRAKE FAILURE OR 	BRAKE FAILURE - LOW BRAKE FLUID	Low brake fluid level or faulty sensor	<ul style="list-style-type: none"> – Check for brake fluid leaks. – Check brake fluid level and adjust (see <i>MAINTENANCE PROCEDURES</i> subsection).
 ON+BEEPING AT KEY OFF	NONE	NONE	Faulty parking brake or component	<ul style="list-style-type: none"> – Make sure battery tension is at least at 11 V. – Check fuse no. 1 on the right fuse box (see <i>MAINTENANCE PROCEDURES</i> subsection). Have the vehicle transported to the nearest authorized Can-Am roadster dealer.
 ON		NONE	Engine management component malfunction	Remove key, wait 20 seconds, and reinsert key.
		NONE	Dynamic power steering component	Have the vehicle repaired by an authorized Can-Am roadster dealer.
		NONE	Transmission Control Module component	<ul style="list-style-type: none"> – Remove key, wait 20 seconds, and reinsert key. – Have the vehicle repaired by an authorized Can-Am roadster dealer.

INDICATOR LAMPS (MALFUNCTIONS)				
INDICATOR LAMP(S)	DIGITAL INDICATOR	DIGITAL WARNING	CAUSE	WHAT TO DO
 FLASHING		LIMP HOME	Important engine management component or VSS malfunction	* Have the vehicle transported to the nearest authorized Can-Am roadster dealer.
 ON	NONE	NONE	Low oil pressure	<ul style="list-style-type: none"> – Check for oil leaks. – Check oil level and adjust (see <i>MAINTENANCE PROCEDURES</i> subsection)

A combination of two different warnings can occur.

* BRP recommends having the vehicle transported when in LIMP HOME. If you operate the vehicle in LIMP HOME, avoid abrupt maneuvers and immediately go to the nearest authorized Can-Am roadster dealer to have your vehicle serviced before riding again. In LIMP HOME, the engine RPM is limited and therefore the vehicle speed.

Important information messages can also be displayed temporarily to assist indicator lamps.



TYPICAL
1. Message

When a digital warning appears, it will show the warning for 6 seconds and then the warning will disappear for 60 seconds. During the 60 seconds, the small digital indicator will flash. This sequence will be repeated three times and then will stop for 15 minutes. During the 15 minutes only the indicator lamps will be activated.



TYPICAL
1. Message/icon

If a fault is displayed, press the MODE button to skip the error message.

NOTE: Skipped error messages will still be displayed in the lower section of the multifunction gauge and will be brought back to the main screen for a period of 60 seconds when the vehicle speed is below 3 km/h (2 MPH).

If a problem persists, go to an authorized Can-Am roadster dealer.

WHAT TO DO IN THE FOLLOWING CIRCUMSTANCES

Lost Keys

Use your spare key to have another one made by an authorized Can-Am roadster dealer as soon as possible. If **both keys are lost**, the ignition switch, the key barrel of the rear storage compartment and the trailer key barrel (if using a BRP trailer) will need to be replaced at the expense of the vehicle owner.

Cannot Open the Side Storage Compartment

Open the seat.

Remove both retaining screws from panel.

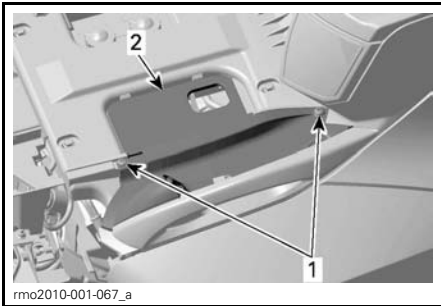

LEFT SIDE PANEL SHOWN
1. Retaining screws
2. Panel

Pull out panel.

Disconnect the switch connector.

Remove panel.

Slide the mechanism as shown to release the latch.

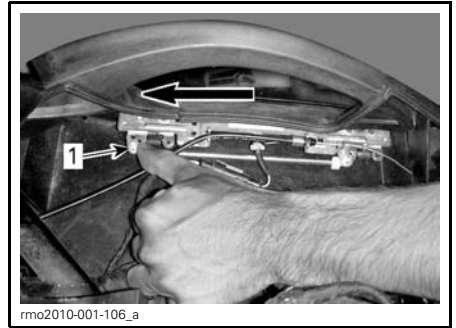

LEFT SIDE PANEL SHOWN
1. Slide mechanism

Reinstall switch and panel when done.

Flat Tire

If a tire has a **major** puncture or cut in the tread and is completely deflated, have the vehicle transported to the nearest Can-Am Spyder dealer. Refer to *TRANSPORTING THE VEHICLE* for transporting instructions.

If a tire has a **minor** nail or stone puncture and is not completely deflated, the tire can be temporarily repaired. To temporarily repair a tire, a self-inflating tire sealer or tire plug repair kit can be used. Follow the manufacturer's instructions that come with the tire sealer or repair kit and have the tire repaired or replaced by an authorized Can-Am roadster dealer **as soon as possible**.

When a tire is temporarily repaired, ride slowly and carefully, and frequently check tire pressure until it is replaced or permanently repaired.

Dead Battery

If the battery is dead or too low to crank the engine, it can be jump started.

⚠ WARNING

Connect the jumper cables as specified in the jump start procedure.

Batteries can emit explosive gas that can ignite if jumper cables are not properly connected.

To jump start the battery, proceed as follows:

1. If using another vehicle to jump start the battery, move the other vehicle as close as possible and preferably to the front of the Spyder roadster. Make sure the vehicles are not touching.

NOTE: If battery voltage is below 11 V, parking brake cannot be activated.

2. Shift the Spyder roadster into NEUTRAL (N) and engage the parking brake.
3. Turn off the engine of the other vehicle and all electrical accessories.
4. Open the hood of the other vehicle.
5. Open the front storage compartment of the Spyder roadster.
6. Make sure the ignition switch is set to OFF.
7. Remove the battery access panel.
8. Connect one end of the RED (+) jumper cable to the POSITIVE (+) terminal of the Spyder roadster.
9. Connect the other end of the RED (+) jumper cable to the POSITIVE (+) terminal of the booster battery.
10. Connect one end of the BLACK (-) jumper cable to the NEGATIVE (-) terminal of the booster battery.
11. Connect the other end of the BLACK (-) jumper cable to the NEGATIVE (-) terminal seat of the Spyder roadster.

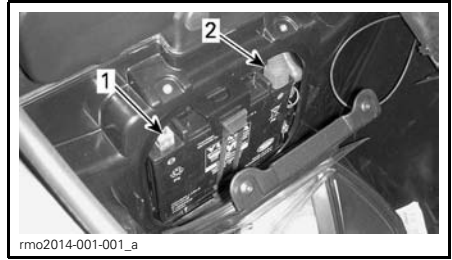

1. BLACK (-) terminal
2. RED (+) terminal

12. Stand on the right side of the Spyder roadster, apply brakes and start the engine. If it does not crank or it cranks slowly, check the jumper cables to make sure they are making good contact and try again.
If it still does not start, there might be a problem with the starting system. Have the vehicle transported (see *TRANSPORTING THE VEHICLE*) and repaired by the nearest authorized Can-Am roadster dealer.
13. As soon the engine starts, disconnect both jumper cables in the reverse connection order, starting with the BLACK (-) cable connected to the Spyder roadster.
14. Run the engine at an idle of 900 RPM for a couple of minutes.
15. Have the battery fully recharged with a battery charger (see *MAINTENANCE PROCEDURES* subsection) or by a qualified service station as soon as possible.

If the engine dies shortly after it has been jump started or when the jumper cables are disconnected, there might be a problem with the charging system. Have the vehicle transported (see *TRANSPORTING THE VEHICLE*) and repaired by the nearest authorized Can-Am roadster dealer.

After recharging battery, have the vehicle inspected by an authorized Can-Am roadster dealer.

HOW TO REPLACE FUSES AND LIGHTS

Fuses

If any electrical accessories stop working on the vehicle, check for blown fuses and replace if necessary.

If an electrical failure still occurs, have the vehicle serviced by an authorized Can-Am roadster dealer.

Fuse Locations

Fuses are located in the front storage compartment.

To access the fuses, open the front storage compartment.



FRONT STORAGE COMPARTMENT OPENED

Open the access cover.

Unzip the liner if applicable.



1. Liner

Push down on the fuse service covers and pull the covers off.

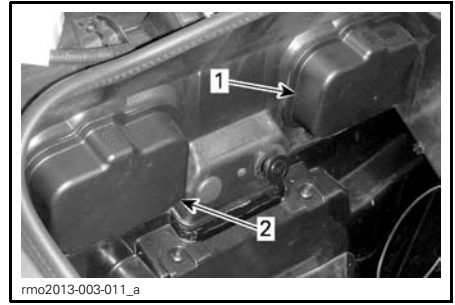

INSIDE FRONT STORAGE COMPARTMENT

1. Left fuse service cover
2. Right fuse service cover

Push down on the tabs and carefully remove the fuse box covers.

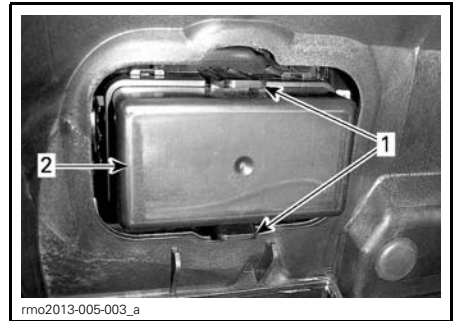

1. Tabs
2. Fuse box cover

Fuse Description

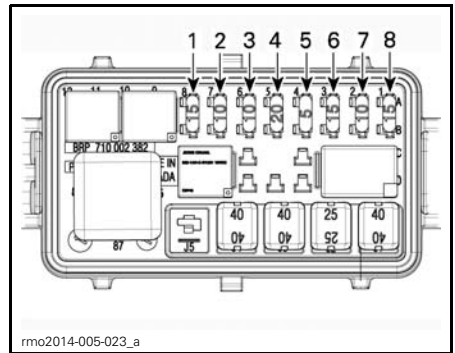

FUSES - LEFT FUSE BOX

NOTE: Refer to decal located between both fuse boxes for correct identification

NOTE: Fuse boxes may differ between models.

Left Fuse Box

FUSE NO.	DESCRIPTION	RATING
1	Cluster / DLC	15 A
2	Wake-up ECM / VCM/ MSR and D.E.S.S. /SAS / YRS / PRS	10 A
3	Alternator	10 A
4	WPM / PBM	20 A
5	ECM	5 A
6	Injectors / Coils	15 A
7	Wake-up TCM, DPS / Cluster, Fuel gauge and Coolant temperature gauge	10 A
8	H02S / CAPS / Fuel pump / EVAP / CSV, PSR	15 A

FUSE NO.	DESCRIPTION	RATING
5	Horn, Load shedding	25 A
6	DC plugs VKEY	5 A
7	DC Plugs VBAT	5 A
8	NOT USED	

NOTE: When fuse 6 is installed, 12 V power outlet is only operational when ignition switch is at ON position. When fuse 7 is installed, 12 V power outlet is always operational.

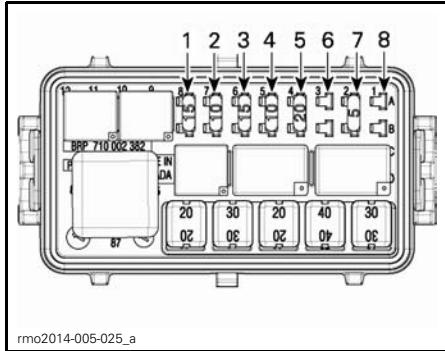

FUSES - RIGHT FUSE BOX

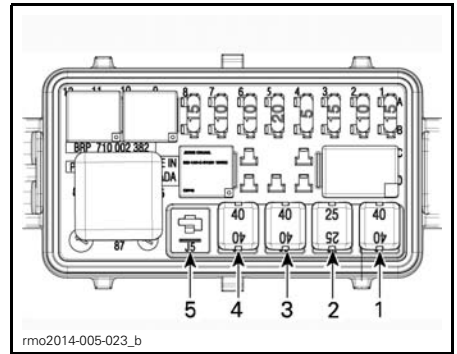

JCASE FUSES - LEFT FUSE BOX

Left JCase Fuse Box

JCASE FUSE NO.	DESCRIPTION	RATING
1	VCM pump	40 A
2	VCM valves	25 A
3	DPS	40 A
4	Main control (F1, F2,R4, R5)	40 A
5	Not used	

Right Fuse Box

FUSE NO.	DESCRIPTION	RATING
1	Days lights / Parking lamps / Plate lights	15 A
2	Brake lights / Hazard	10 A
3	Battery, Radio	15 A
4	Trailer module	10 A

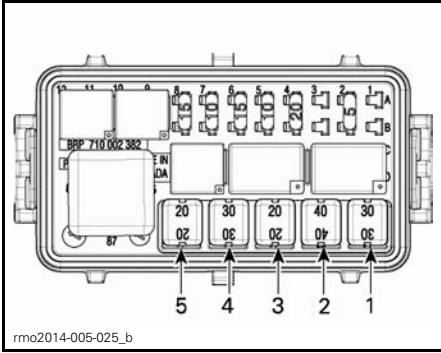

JCASE FUSES - RIGHT FUSE BOX

Right JCase Fuse Box

JCASE FUSE NO.	DESCRIPTION	RATING
1	Cooling fan	30 A
2	Accessories	40 A
3	TCM solenoids	20 A
4	LO headlamps	30 A
5	HI headlamps	20 A

Fuse Replacement

1. To access the fuses, refer to *FUSE LOCATIONS* in the *FUSES* subsection.
2. Set the ignition switch to OFF.
3. Pull the fuse out.
4. Check whether the filament is melted.

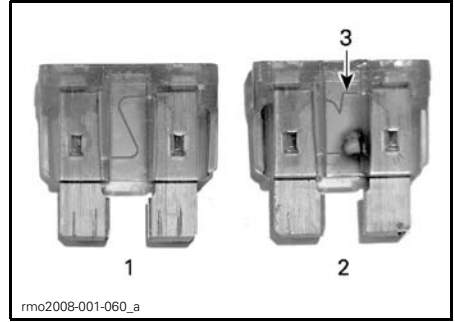

FUSE

1. Good fuse
2. Blown fuse
3. Melted filament

5. Replace the fuse with one with the same rating. Spare fuses are located in the fuse box cover.

⚠ WARNING

Using a higher-rated fuse can cause severe damage and may cause fire.

6. To close the fuse box covers, position covers over fuse boxes and carefully push down until they click.
7. Zip up the liner if applicable.
8. To close the fuse service covers, position covers over fuse boxes and push down carefully until the fuse service covers engage.
9. Close the access cover and then the front storage compartment.

Lights

NOTE: The front turn signal lights and the brake lights are built with LEDs (light emitting diode) and this technology proved to be reliable. In the unlikely event they do not work, have them checked by an authorized Can-Am roadster dealer.

If a light described here stop working on the vehicle, replace bulb of defective light. The lights not described here should be serviced by an authorized Can-Am roadster dealer.

If the light failure still occurs, have the vehicle serviced by an authorized Can-Am roadster dealer.

⚠ CAUTION Always turn the ignition switch to the OFF position before replacing a bulb to avoid electric shock.

Always check light operation after replacement.

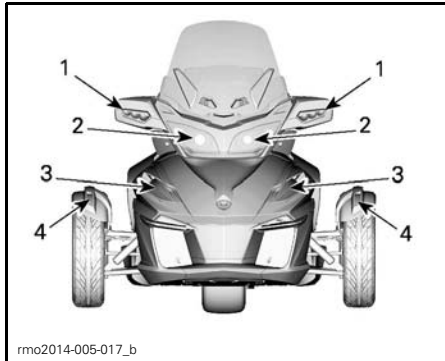

TYPICAL - LIGHTS LOCATION — FRONT OF VEHICLE - ALL MODELS EXCEPT EUROPEAN MODELS

1. Turn signal
2. Headlight
3. Fog light (option package)
4. Position light

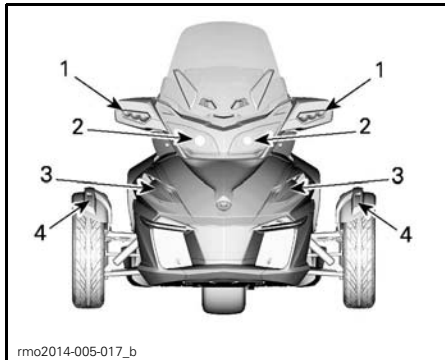

TYPICAL - LIGHTS LOCATION — FRONT OF VEHICLE - EUROPEAN MODELS

1. Turn signal
2. Headlight — high beam
3. Headlight — low beam
4. Position light

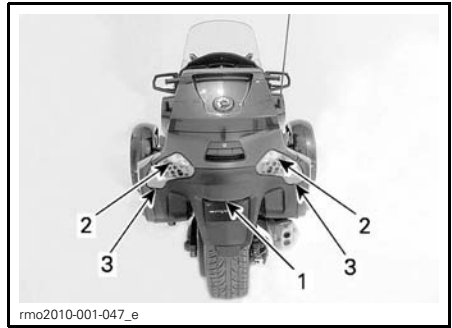

LIGHTS LOCATION – REAR OF VEHICLE

1. License plate light
2. Backup light
3. Turn signal light

Japanese Models Only

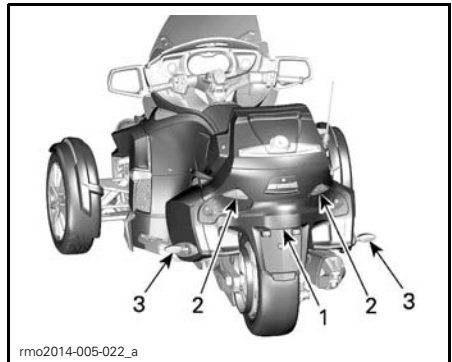

LIGHTS LOCATION – REAR OF VEHICLE

1. License plate light
2. Backup light
3. Turn signal light

Headlight — High Beam

1. Remove the top side panel.
2. Remove the upper retaining screws from front fascia.

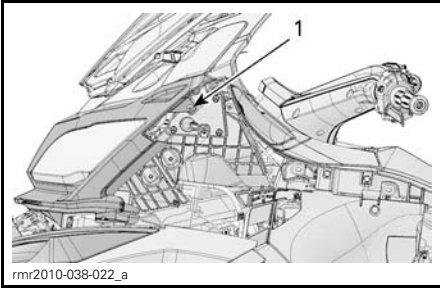

1. Upper retaining screw

3. Remove middle retaining screws from front fascia.



1. Middle retaining screw

4. Remove lower retaining screws and washers from front fascia.

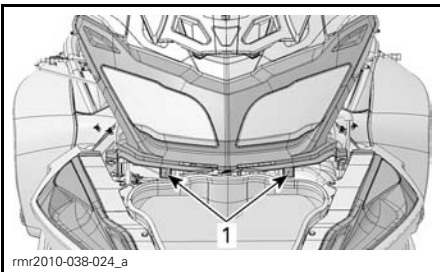

1. Lower retaining screw

5. Remove front fascia from vehicle.
6. Remove adjustment cable retaining nuts.

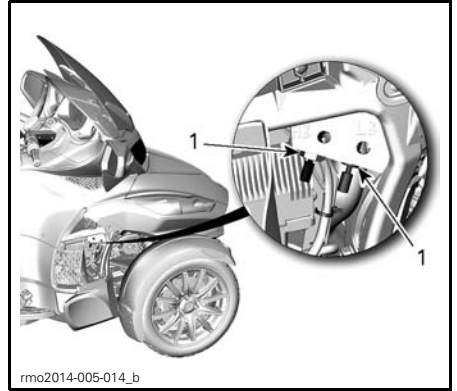

1. Adjustment cable retaining nuts

7. Remove all 4 headlight retaining screws.

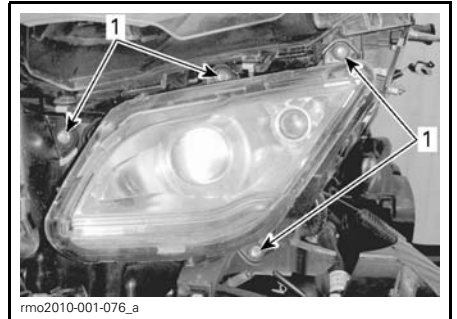

1. Retaining screws

8. Pull tabs apart to unlock cover.

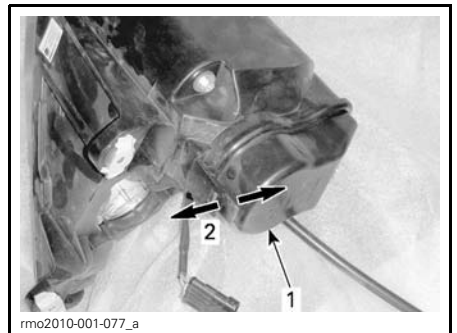

1. Headlight cover
2. Pull tabs apart

9. Pull cover out.

10. Disconnect the bulb connector.

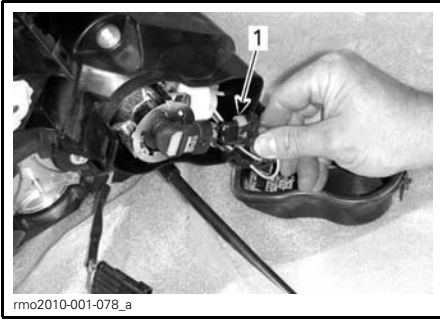

1. Unplug connector

11. Turn the bulb counterclockwise to unlock it.

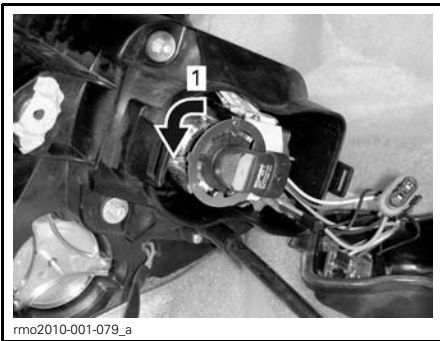

1. Turn counterclockwise

12. Pull bulb out.

13. Insert the new bulb into its socket then turn clockwise to lock it in position.

NOTICE Never put your fingers on a new halogen bulb. This would shorten its life.

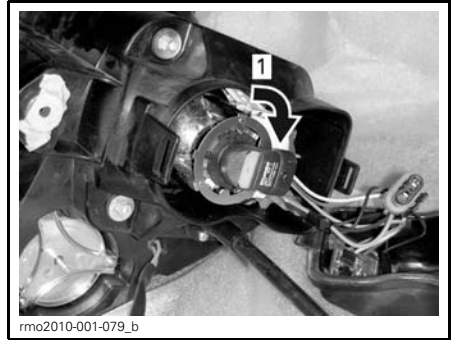

1. Turn clockwise

14. Plug connector to the bulb.

15. Reinstall headlight cover and remaining parts in the reverse order of the removal.

Headlight — Low Beam

Remove the middle side panel.

Clean the back area of headlight.

Insert your hand through the opening above the upper arm of front suspension.

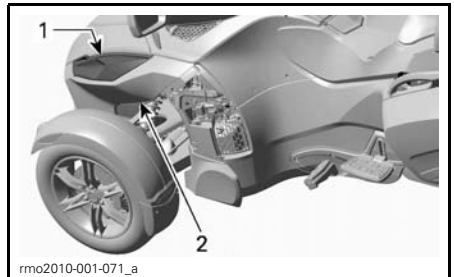

1. Headlight

2. Access to the headlight bulb

Pull tabs apart to unlock cover.

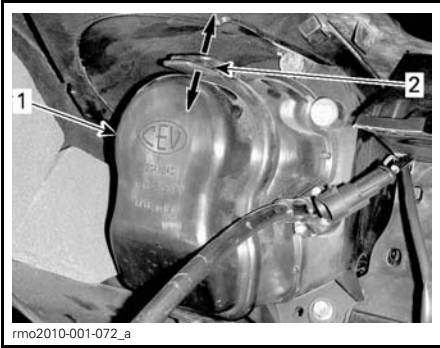

1. Headlight cover
2. Pull tabs apart

Pull cover out.
Disconnect bulb connector.

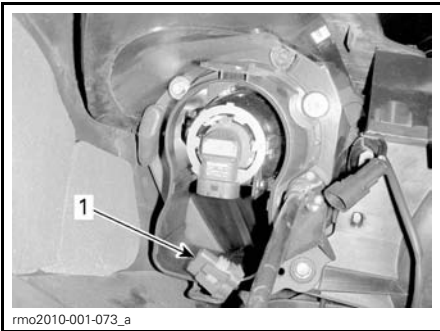

1. Unplugged connector

Turn bulb counterclockwise to unlock it.

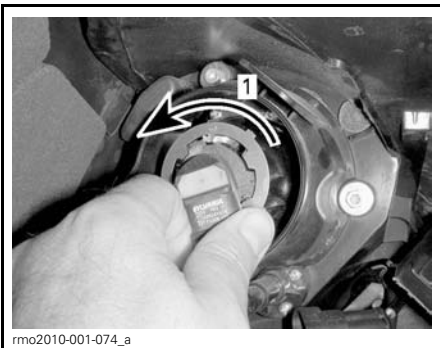

1. Turn counterclockwise

Pull bulb out.

NOTICE Never put your fingers on a new halogen bulb. This would shorten the bulb life.

Insert the new bulb into its socket then turn clockwise to lock it in position.

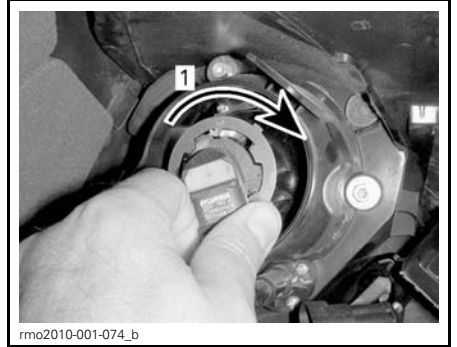

1. Turn clockwise

Plug connector to the bulb.

Reinstall headlight cover and middle side panel in the reverse order of the removal.

Fog Light (Option Package)

All models except European models

See your authorized Can-Am roadster dealer for the bulb replacement procedure.

Position Light

Base Model Only

1. Push then hold lens towards rear of fender.



2. Lift front portion of lens with your thumb or a small screwdriver to release.



3. Turn the bulb holder clockwise and remove it from the connector.

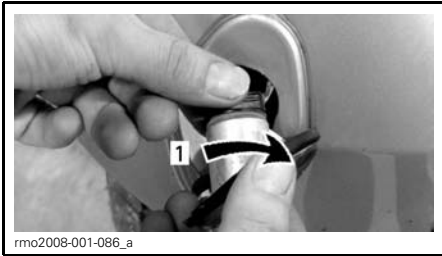

1. Turn clockwise

4. Pull bulb out of the holder as indicated below.

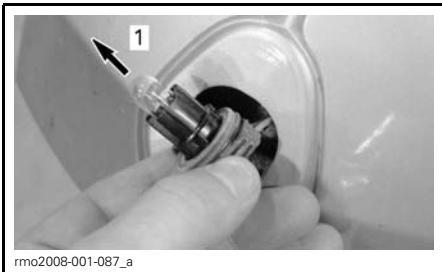

1. Pull out bulb

5. Insert a new bulb in the holder.
6. Properly reinstall the parts in the reverse order of their removal.

RT-S and RT Limited Models

The position lights are built with LEDs (light emitting diode) and this technology proved to be reliable. In the unlikely event they do not work, have them checked by an authorized Can-Am roadster dealer.

License Plate Light

1. Remove the lens screws with a Phillips head screwdriver.

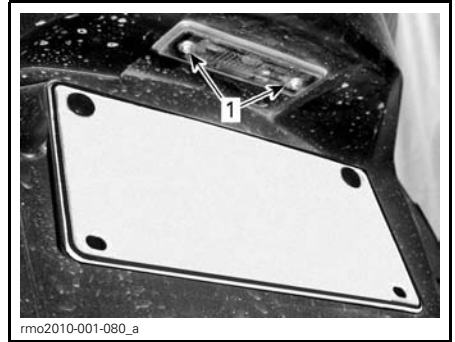

1. License plate lens screws

2. Pull out the lens.
3. Remove the bulb by pulling it out.

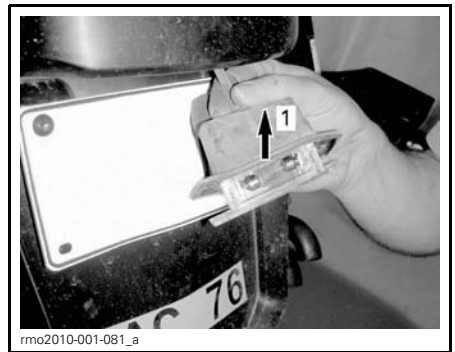

1. Pull out

4. Install the new bulb by pushing it in.
5. Reinstall the lens.

Backup Light

1. Open the top storage compartment.

2. Open the side storage compartments.
3. Remove the 8 retaining screws from the rear panel.

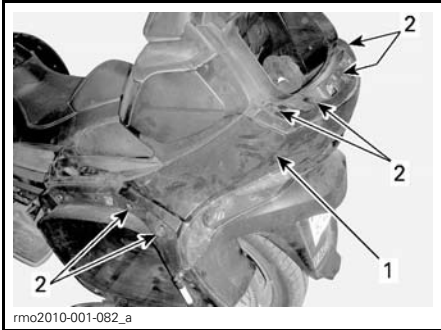

1. Rear panel
2. Retaining screws

4. Pull out panel.

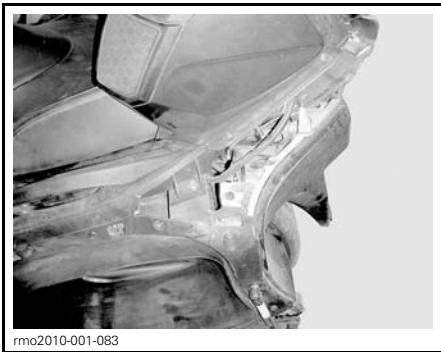

5. Unplug connector.
6. Turn the bulb counterclockwise to unlock it.



1. Turn counterclockwise

7. Pull bulb out.
8. Insert the new bulb into its socket then turn clockwise to lock it in position.



1. Turn clockwise

9. Plug connector to the bulb.
10. Reinstall rear panel in the reverse order of the removal.

Flashers (Japanese Models Only)

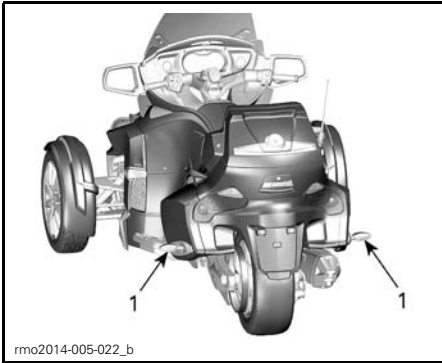

rmo2014-005-022_b

1. *Flashers*

1. Remove screw and lens from flasher to access the bulb.
2. Replace the bulb.

TRANSPORTING THE VEHICLE

If your vehicle needs to be transported, it should be carried on a flatbed trailer of the proper size and capacity.

CAUTION If you need to push the vehicle, do it from the right-hand side to be able to reach the brake pedal.

When pulling the vehicle backwards, be careful that the front wheel does not roll over your feet.

NOTICE Do not tow the Spyder roadster — towing can seriously damage the vehicle drive system.

When contacting a towing or transporting service, be sure to ask if they have a flatbed trailer, loading ramp or power ramp to safely lift the vehicle and tie-down straps. Ensure the vehicle is properly transported as specified in this section.

NOTICE Avoid using chains to tie the vehicle — they may damage the surface finish or plastic components.

To load the vehicle for transport, proceed as follows:

1. Shift the vehicle into NEUTRAL (N).
2. Remove the key from the ignition switch.
3. Put a strap around the lower arm of each front suspension.



1. Lower suspension arm
2. Strap between shock absorber and fin

NOTICE Do not place the strap over the fin. This could break it.

4. Attach the straps to the winch cable. If possible, use chains or additional straps to attach the straps to the winch cable as indicated below to avoid damaging the bumper cover.

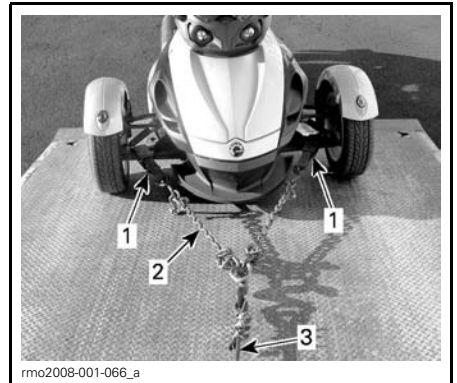

TYPICAL

1. Strap around front suspension lower arms
 2. Chains to avoid damaging the bumper cover
 3. Winch cable
5. Ensure that the parking brake is released.
 6. Pull the vehicle on the flatbed trailer with the winch.
 7. Engage the parking brake.
 8. Ensure that the vehicle gear is in NEUTRAL (N).
 9. Strap the front tires by using one the following methods indicated below.

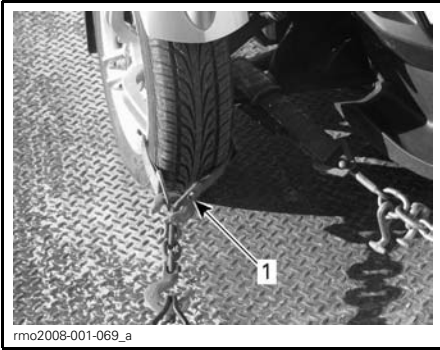

TYPICAL FRONT WHEELS ATTACHMENT — METHOD 1

1. Strap around the rim of each front wheel and attached to the front of trailer



TYPICAL FRONT WHEELS ATTACHMENT — METHOD 2

1. Strap around each wheel and fixed to the front and rear of trailer

10. Pass a tie-down strap inside the rear wheel rim only. Do not pass the tie-down strap inside the rear sprocket.

NOTICE Passing the tie-down strap inside the rear sprocket may seriously damage the drive system.

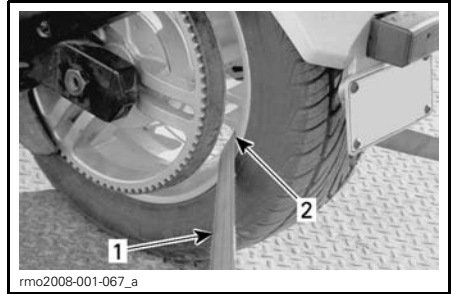

TYPICAL REAR WHEEL ATTACHMENT

1. Tie-down strap
2. Inside rear wheel rim ONLY

11. Firmly attach the rear wheel tie-down strap to the rear of the trailer with a ratchet.
12. Ensure that both the front and rear wheels are firmly attached to the trailer.



TYPICAL

1. Front and rear wheel firmly attached to trailer

TECHNICAL INFORMATION

VEHICLE IDENTIFICATION

The main components of your vehicle (engine and frame) are identified by different serial numbers. It may sometimes become necessary to locate these numbers for warranty purposes or to trace your vehicle in the event of loss. These numbers are required by the authorized Can-Am roadster dealer to complete warranty claims properly. We strongly recommend that you take note of all the serial numbers on your vehicle and supply them to your insurance company.

Vehicle Identification Number

NOTE: VIN (Vehicle Identification Number) label may vary according to country.

North American Models

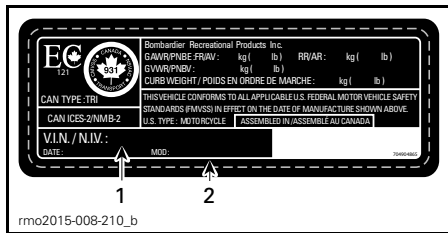

VEHICLE SERIAL NUMBER LABEL

1. VIN (Vehicle Identification Number)
2. Model number

European Models

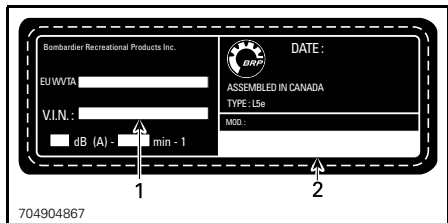

VEHICLE IDENTIFICATION NUMBER LABEL

1. VIN (Vehicle Identification Number)
2. Model number

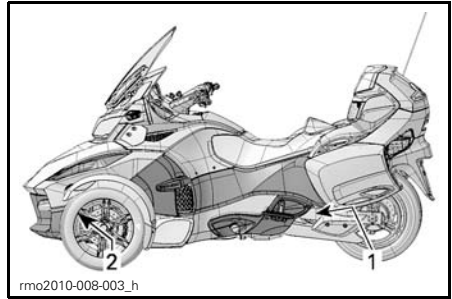

LOCATION OF VIN

1. Swing arm (VIN label)
2. Lower frame (VIN stamped on the right side)

Engine Identification Number

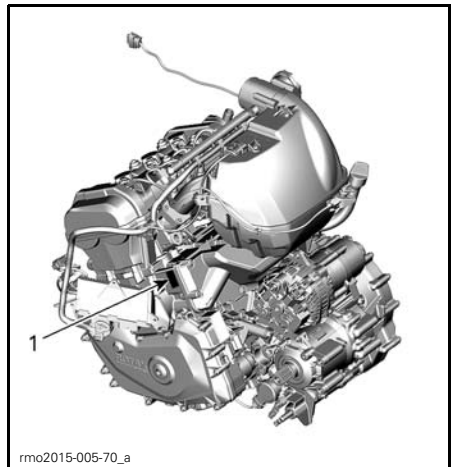

TYPICAL

1. EIN (Engine Identification Number) location

EPA Compliance Label

VEHICLE EMISSION CONTROL INFORMATION

BOMBARDIER RECREATIONAL PRODUCTS INC. 

THIS VEHICLE CONFORMS TO U.S. EPA AND CALIFORNIA REGULATIONS APPLICABLE TO MODEL YEAR NEW MOTORCYCLES AND IS CERTIFIED TO AN HC+NOx EMISSION STANDARD OF _____ GRAM/KILOMETER. See operator's guide for maintenance specifications

RENSEIGNEMENT SUR LE DISPOSITIF ANTIPOLLUTION

BOMBARDIER PRODUITS RECRÉATIFS INC.

CE VÉHICULE EST CONFORME AUX RÈGLEMENTS DE L'ÉPA DES É.U. ET DE LA CALIFORNIE APPLICABLES AUX MOTOCYCLES NEUVES DE L'ANNÉE _____ ET EST CERTIFIÉ À LA NORME D'ÉMISSIONS HC+NOx de _____ GRAMME/KILOMÈTRE. Voir guide du conducteur pour les spécifications de maintenance

Engine Displacement		Cylindrée
Engine Family		Famille de moteur
Permeation Family		Famille de perméation
Evaporation Family		Famille d'évaporation
Exhaust Emission Control System		Système de contrôle des émissions
Idle Speed		Ralentir moteur
Fuel		Essence

704904694

VACUUM HOSE ROUTING

ENGINE FAMILY:	EVAPORATION FAMILY:
-----------------------	----------------------------

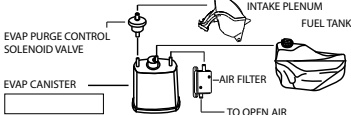

MOTORCYCLE NOISE EMISSION CONTROL INFORMATION

THIS _____, _____, MEETS U.S. EPA NOISE EMISSION REQUIREMENTS OF _____ db (A) AT _____ RPM BY THE FEDERAL TEST PROCEDURE. MODIFICATIONS WHICH CAUSE THIS MOTORCYCLE TO EXCEED FEDERAL NOISE STANDARDS ARE PROHIBITED BY FEDERAL LAW. SEE OPERATOR'S GUIDE.

704904694

TYPICAL - NORTH AMERICAN MODELS - LOCATED UNDER THE SEAT

NOISE EMISSION CONTROL SYSTEM REGULATION

Tampering with Noise Control System Is Prohibited!

U.S. Federal law and Canadian provincial laws may prohibit the following acts or the causing there of:

1. The removal or rendering inoperative by any person other than for purposes of maintenance, repair or replacement of any device or element of design incorporated into any new vehicle for the purpose of noise control prior to its sale or delivery to the ultimate purchaser or while it is in use or
2. The use of the vehicle after such device or element of design has been removed or rendered inoperative by any person.

Among those Acts Presumed to Constitute Tampering Are the Acts Listed Below:

1. Removal or alteration or the puncturing of the muffler or any engine component which conducts removal of engine exhaust gases.
2. Removal or alteration or the puncturing of any part of the intake system.
3. Replacing any moving parts of the vehicle or parts of the exhaust or intake system, with non-compliant part.
4. Lack of proper maintenance.

RADIO FREQUENCY DIGITALLY ENCODED SECURITY SYSTEM (RF D.E.S.S. KEY)

This device complies with FCC Part 15 and Industry Canada license exempt RSS standard(s). Operation is subject to the following two conditions: (1) this device may not cause interference, and (2) this device must accept any interference, including interference that may cause undesired operation of the device.

Changes or modifications not expressly approved by the party responsible for compliance could void the user's authority to operate the equipment.

IC Registration Number: 11538A-246416

FCC ID: 2ABBF-246416

We, the party responsible for compliance, declare under our sole responsibility that the device is in conformity with the provisions of the following Council Directive: 2014/53/EU. To which this declaration relates is in conformity with the essential requirements and other relevant requirements. The product is in conformity with the following directives, harmonized standards and regulations:

Radio Equipment Directive (RED) 2014/53/EU and Harmonized Standards: 301 489-1, EN 301 489-3, EN 60950-1

SPECIFICATIONS

MODEL			SPYDER RT		
ENGINE					
Engine type			ROTAX® 1330 ACE, 4-stroke, Dual Over Head Camshaft (DOHC), liquid cooled		
Number of cylinders			3		
Number of valves			12		
Bore			84 mm (3.31 in)		
Stroke			80 mm (3.15 in)		
Displacement			1 330 cm ³ (81.16 in ³)		
Compression ratio			12:1		
Lubrication	Type		Dry sump with separate oil tank and oil cooler		
	Oil filter	Engine		BRP Rotax microglass fibre type, replaceable	
		Transmission/HCM		BRP Rotax multi-layer surface filter, replaceable	
	Engine oil Capacity	Oil change with new engine filter	SM6	4.5 L (4.8 qt (U.S. liq.))	
		Oil change with new engine filter	SE6	4.7 L (5 qt (U.S. liq.))	
		Oil change with new engine and HCM filters		4.9 L (5.2 qt (U.S. liq.))	
	Recommended engine oil			XPS 4-STROKE SYNTH. BLEND OIL (P/N 293 600 121) or a 5W40 semi-synthetic or synthetic motorcycle oil meeting the requirements for API service SJ, SL, SM or SN classification and JASO MA2	
Clutch	Type	SM6	Wet, multi-plate, manual operation through a hydraulic piston, vacuum assist		
	Fluid		DOT 4		
	Type	SE6	Hydraulic clutch + wet multi-plate clutch automatically controlled by TCM		
	Engagement		1100 RPM		
Exhaust system			3 into 1 manifold, primary muffler with catalytic converter, with secondary muffler		
Air filter			Paper element		

MODEL		SPYDER RT	
GEARBOX			
Type	SM6	Sequential Manual 6-speed (SM6) with remote electronic reverse interlock	
	SE6	Sequential Electronic 6-speed (SE6) with reverse interlock	
COOLING SYSTEM			
Type		Liquid cooled, double radiator with cooling fans	
Coolant	Type	See <i>ENGINE COOLANT</i> in the <i>MAINTENANCE PROCEDURES</i> section of this guide	
	Capacity	4.2 L (1.1 U.S. gal.)	
ELECTRICAL SYSTEM			
Ignition system type		Electronic ignition with dual output coil	
Ignition timing		Electronically controlled, not adjustable	
Spark plug	Quantity	3	
	Make and type	NGK MR7BI-8 (iridium) or equivalent	
	Gap (not adjustable)	0.7 mm to 0.8 mm (.028 in to .031 in)	
Engine RPM limiter setting	Forward	8100 RPM with engaged drivetrain	
		7500 RPM with open clutch or on neutral	
Battery	Type	Maintenance free	
	Voltage	12 volts	
	Nominal rating	21 A•h	
	Recommended charging rate	2 A	
Headlight Hi/Low	C/U	Halogen, 2 x 65 W (type HB3)	
	CE	High Beam: Halogen, 2 x 65 W (type H9) Low Beam: Halogen, 2 x 60 W (type HHB3)	
Taillight/brake light	All models except Japanese	LED 3.1 W total	
	Japanese models only	2 x 21 W + LED 3.1 W	
Turn signal lights	Front	LED 2 x 4.5 W each side	
	Rear	All models except Japanese	2 x 21 W
		Japanese models only	2 x 10 W
Position lights	Base model only	2 x 5 W	
	Japanese models only	2 x 21 W + LED 0.6 W	

SPECIFICATIONS

MODEL		SPYDER RT
ELECTRICAL SYSTEM (cont'd)		
License plate light		5 W
Backup light		2 x 21 W
Day light (Spyder RT-S/Limited)		2 x 0.5 W
Front storage compartment light (Spyder RT-S/Limited)		0.2 W
Fuses		Refer to <i>HOW TO REPLACE FUSES AND LIGHTS</i>
FUEL SYSTEM		
Fuel delivery	Type	Multi-point Electronic Fuel Injection (EFI) with ETC (Electronic Throttle Control). Single throttle body (54 mm) with an actuator
Fuel pump	Type	Electrical module in fuel tank
Idle speed		900 RPM (electronically controlled, not adjustable)
Fuel - Refer to <i>FUEL REQUIREMENTS</i>	Type	Premium unleaded gasoline
	Minimum octane	87 Pump Posted AKI (RON+MON)/2
		92 RON
	Recommended octane	91 Pump Posted AKI (RON+MON)/2
95 RON		
Fuel tank capacity		26 L (6.9 U.S. gal.)
DRIVE SYSTEM		
Final drive type		Carbon reinforced drive belt
Final drive ratio		28/79
STEERING		
Type		Dynamic Power Steering (DPS)
FRONT SUSPENSION		
Suspension type		Double A-arm with anti-roll bar
Suspension travel		174 mm (6.85 in)
Shock absorber	Qty	2
	Type	Oil damper
Spring preload adjustment		Not adjustable
REAR SUSPENSION		
Suspension type	Base	Swing arm with mono shock with a manually adjustable pneumatic preload
	RT-S RT Limited	Swing arm with mono shock. Air Controlled Suspension (ACS). Compressor-controlled with remote adjustment only

MODEL		SPYDER RT
REAR SUSPENSION (cont'd)		
Suspension travel		152 mm (5.98 in)
Shock absorber	Qty	1
	Type	Oil damper
Preload adjustment (ACS with manual adjustment)		Adjustable air pressure: 135 kPa to 625 kPa (20 PSI to 90 PSI)
Preload adjustment (ACS with remote adjustment)		5 positions
BRAKES		
Type	Front	270 mm (11 in) rigid discs, radially mounted Brembo monobloc calipers 4-piston, 2-pad
	Rear	270 mm (11 in) disc, 1-piston floating caliper with integrated parking brake
Front brake		Dual rigid discs 270 mm (10.6 in), radially mounted Brembo monobloc, with 4 piston calipers, 2-pad
Rear brake		Single disc 270 mm (10.6 in) with 1 piston floating caliper with integrated parking brake
Brake fluid	Capacity	530 ml (17.9 U.S. oz)
	Type	DOT 4
Parking brake		Mechanical, electrically actuated to the rear caliper
Minimum brake pad thickness		1 mm (.04 in)
Minimum brake disc thickness		6.4 mm (.25 in)
Maximum brake disc warpage		0.1 mm (.004 in)
TIRES		
Type (use only radial tires recommended by BRP)	Front	KR31 165/55R15
	Rear	KR21 225/50R15
Pressure	Front	Nominal: 138 kPa (20 PSI) Min.: 124 kPa (18 PSI) Max.: 152 kPa (22 PSI)
	Rear	Nominal: 193 kPa (28 PSI) Min.: 179 kPa (26 PSI) Max.: 207 kPa (30 PSI) NOTE: The pressure difference between the left and right side tire should not exceed 3.4 kPa (.03 bar).
Minimum tire tread depth	Front	2.5 mm (3/32 in)
	Rear	4 mm (5/32 in)

SPECIFICATIONS

MODEL		SPYDER RT	
WHEELS			
Size (diameter X width)	Front	381 mm (15 in) x 127 mm (5 in)	
	Rear	381 mm (15 in) x 178 mm (7 in)	
Front wheel nuts torque		105 N•m to 113 N•m (77 lbf•ft to 83 lbf•ft)	
Rear drive axle nut torque		210 N•m to 240 N•m (155 lbf•ft to 177 lbf•ft)	
DIMENSIONS			
Overall length		2 667 mm (105 in)	
Overall width		1 572 mm (61.9 in)	
Overall height		1 510 mm (59.4 in)	
Seat (top) height		772 mm (30.4 in)	
Wheelbase		1 714 mm (67.5 in)	
Front wheel track		1 384 mm (54.5 in)	
Ground clearance, front and under engine		115 mm (4.5 in)	
WEIGHT AND LOADING CAPACITY			
Dry weight	Base	SM6	459 kg (1,012 lb)
		SE6	466 kg (1,027 lb)
	RT-S	SM6	464 kg (1,023 lb)
		SE6	471 kg (1,038 lb)
	Limited	477 kg (1,052 lb)	
Front storage compartment	Capacity	58 L (15.3 U.S. gal.)	
	Maximum load	16 kg (35 lb)	
Glove box	Capacity	2 L (.5 U.S. gal.)	
Side storage compartment	Capacity	52 L (13.7 U.S. gal.)	
	Maximum load	7 kg (15 lb)	
Rear storage compartment	Capacity	43 L (11.4 U.S. gal.)	
	Maximum load	9 kg (20 lb)	
Total vehicle load allowed (including operator, passenger, cargo and added accessories)		224 kg (494 lb)	
Gross vehicle weight rating (GVWR)	All models except Limited	680 kg (1,499 lb)	
	Limited only	750 kg (1,653.5 lb)	
Maximum weight on trailer tongue		18 kg (40 lb)	
Maximum towed weight (trailer and cargo)		180 kg (400 lb)	

Because of our ongoing commitment to product quality and innovation, BRP reserves the right, at any time, to make changes in design and specifications and/or to make additions to, or improvements in its products without imposing any obligation upon itself to install them on its previously manufactured products.

***This page is
intentionally blank***

WARRANTY

BRP LIMITED WARRANTY — USA AND CANADA: 2017 Can-Am® SPYDER® ROADSTER

1. SCOPE OF THE LIMITED WARRANTY

Bombardier Recreational Products Inc. ("BRP")* warrants its 2017 Can-Am Spyder Roadsters ("Roadster") sold by authorized Can-Am Roadster Dealers (as defined below) in the United States of America and in Canada from defects in material or workmanship for the period and under the conditions described below. This limited warranty will become null and void if: (1) Roadster was used for racing or any other competitive activity, at any point, even by a previous owner; (2) the odometer was removed or has been tampered with; (3) the Roadster was used off-road; or (4) the Roadster has been altered or modified in such a way so as to adversely affect its operation, performance or durability, or has been altered or modified to change its intended use.

Non-factory installed parts and accessories are not covered under this limited warranty. Please refer to the applicable parts and accessories limited warranty text.

2. LIMITATIONS OF LIABILITY

THIS WARRANTY IS EXPRESSLY GIVEN AND ACCEPTED IN LIEU OF ANY AND ALL OTHER WARRANTIES, EXPRESSED OR IMPLIED, INCLUDING WITHOUT LIMITATION ANY WARRANTY OF MERCHANTABILITY OR FITNESS FOR A PARTICULAR PURPOSE. TO THE EXTENT THAT THEY CANNOT BE DISCLAIMED, THE IMPLIED WARRANTIES ARE LIMITED IN DURATION TO THE LIFE OF THE EXPRESS WARRANTY. INCIDENTAL AND CONSEQUENTIAL DAMAGES ARE EXCLUDED FROM COVERAGE UNDER THIS WARRANTY. SOME STATES/PROVINCES DO NOT ALLOW FOR THE DISCLAIMERS, LIMITATIONS AND EXCLUSIONS IDENTIFIED ABOVE, AS A RESULT, THEY MAY NOT APPLY TO YOU. THIS WARRANTY GIVES YOU SPECIFIC RIGHTS, AND YOU MAY ALSO HAVE OTHER LEGAL RIGHTS WHICH MAY VARY FROM STATE TO STATE, OR PROVINCE TO PROVINCE.

Neither the distributor, any Dealer nor any other person has been authorized to make any affirmation, representation or warranty regarding the Roadster, other than those contained in this limited warranty, and if made, shall not be enforceable against BRP. BRP reserves the right to modify this limited warranty at any time, being understood that such modification will not alter the warranty conditions applicable to the Roadsters sold while this limited warranty is in effect.

3. EXCLUSIONS — ARE NOT WARRANTED

The following are not warranted under any circumstances:

- Replacement of routine maintenance items such as, without limitation, oil, lubricants, fluids, filters and spark plugs.
- Normal wear and tear, such as, without limitation, wear and tear of the tires, battery, generator brushes, sealed beams and light bulbs, clutch plates and facings, drive belt, brake pads, brake linings and rotors and sprockets.
- Tune ups and adjustments including without limitation adjustments of belt, alignment and wheel balance.
- Damages related to the appearance of the Roadster, including without limitation scratches, dents, fading, flaking, peeling and damages to seat cover material.
- Damage caused by failure to provide proper maintenance or storage, as described in the *OPERATOR'S GUIDE*.

- Damage resulting from removal of parts, improper repairs, improper service or improper maintenance, modifications, alterations that are outside of the original specifications of the Roadster, or damage resulting from repairs done by a person that is not an authorized servicing Dealer.
- Damage resulting from the installation of parts with specifications that differ from the original Roadster parts, such as, without limitation, different tires, exhaust system, wheels or brakes.
- Damage resulting from abuse, abnormal use, neglect or operation of the Roadster in a manner inconsistent with the recommendations of the *OPERATOR'S GUIDE*.
- Damage resulting from water ingestion, accident, road hazards, submersion, fire, theft, vandalism or any act of God.
- Damage resulting from operation with fuels, oils or fluids with specifications different than as recommended in the *OPERATOR'S GUIDE*.
- Damage resulting from corrosion from road salts, battery acid, environmental influences or treatment contrary to the *OPERATOR'S GUIDE*.
- Incidental or consequential damages, including without limitation towing, storage, telephone, rental, taxi, inconvenience, insurance coverage, loan payments, loss of time or loss of income.

4. WARRANTY COVERAGE PERIOD

This limited warranty will be in effect from the date of delivery to the first retail consumer or the date the Roadster is first put into use, whichever occurs first and for the following periods:

1. For private, recreational use, **TWENTY FOUR (24) CONSECUTIVE MONTHS**, except for the items covered in points (2) to (5) below; and for commercial use **TWELVE (12) CONSECUTIVE MONTHS**, except for the items covered in points (2) to (5) below.

A Roadster is used commercially when it is used in connection with any work or employment that generates income during any part of the warranty period.

A Roadster is also used commercially when, at any point during the warranty period, it is licensed for commercial use. This is a minimal warranty period which can be extended by any applicable warranty promotional program, as the case may be.

2. For the battery, **SIX (6) CONSECUTIVE MONTHS**.
3. For the tires, **6 CONSECUTIVE MONTHS** or until tires are worn to the last three thirty-seconds of an inch (3/32 ") (2.38 millimeters) for the front tires and the last five thirty-seconds of an inch (5/32 ") (3.97 millimeters) for the rear tire, whichever occurs first.
4. For emission-related components; please also refer to the *USEPA EMISSIONS PERFORMANCE WARRANTY* contained herein.

5. For Roadsters produced for sale in the state of California, that are originally sold to residents or subsequently warranty registered to residents in the state of California, please also refer to the applicable California Emissions Control Warranty Statement.

The repair or replacement of parts or the performance of service under this warranty does not extend the life of this warranty beyond its original expiration date.

5. CONDITIONS TO HAVE WARRANTY COVERAGE

This warranty coverage is available **only** if **each** of the following conditions has been fulfilled:

- The 2017 Roadster must be purchased as new and unused by its first owner from a Spyder Roadster dealer authorized to distribute Roadsters in the country in which the sale occurred (“Dealer”).
- The BRP-specified pre-delivery inspection process must be completed, documented and signed by the purchaser.
- The Roadster must have undergone proper warranty registration by an authorized Dealer.
- The Roadster must be purchased in the country in which the purchaser resides.
- Routine maintenance must be performed as indicated in the *OPERATOR'S GUIDE*. BRP reserves the right to make warranty coverage contingent upon proof of proper maintenance.

BRP will not honor this limited warranty to any private use owner or commercial use owner if the preceding conditions have not been met. Such limitations are necessary in order to allow BRP to preserve both the safety of its products, and also that of its consumers and the general public.

6. WHAT TO DO TO OBTAIN WARRANTY COVERAGE

The customer must cease using the Roadster upon the appearance of an anomaly. The customer must notify a servicing Dealer within three (3) days of the appearance of a defect, and provide it with reasonable access to the product and reasonable opportunity to repair it. The customer must also present to the authorized Dealer proof of purchase of the product and must sign the repair/work order prior to starting the repair in order to validate the warranty repair. All parts replaced under this limited warranty become the property of BRP.

7. WHAT BRP WILL DO

BRP's obligations under this warranty are limited to, at its sole discretion, repairing parts found defective under normal use, maintenance and service, or replacing such parts with new genuine Roadster parts without charge for parts and labor, at any authorized Dealer during the warranty coverage period. BRP's responsibility is limited to making the required repairs or replacements of parts. No claim of breach of warranty shall be cause for cancellation or rescission of the sale of the Roadster to the owner.

In the event that service is required outside of the country of original sale, the owner will bear responsibility for any additional charges due to local practices and conditions, such as, but not limited to, freight, insurance, taxes, license fees, import duties, and any and all other financial charges, including those levied by governments, states, territories and their respective agencies.

BRP reserves the right to improve or modify products from time to time without assuming any obligation to modify any products manufactured.

8. TRANSFER

If the ownership of a product is transferred during the warranty coverage period, this limited warranty, subject to its terms and conditions, shall also be transferred and be valid for the remaining coverage period provided BRP or an authorized Distributor/Dealer receives a proof that the former owner agreed to the transfer of ownership, in addition to the co-ordinates of the new owner.

9. CONSUMER ASSISTANCE

In the event of a controversy or a dispute in connection with this limited warranty, BRP suggests that you try to resolve the issue at the dealership level. We recommend discussing the issue with the authorized Dealer's service manager or owner.

If the matter still remains unresolved, contact BRP by filling out the customer contact form at www.brp.com or contact BRP by mail at one of the addresses listed under the *CONTACT US* section of this guide.

US EPA EMISSIONS PERFORMANCE WARRANTY

Bombardier Recreational Products Inc. ("BRP")* warrants that if:

1. The vehicle is maintained and operated in accordance with the written instructions for proper maintenance and use, and
2. The vehicle fails to conform at any time during its useful life to the applicable emission standards or family emission limits as determined by an EPA-approved emission test, and
3. Such nonconformity results or will result in the vehicle owner having to bear any penalty or other sanction (including the denial of the right to use the vehicle) under local, State or Federal law, then BRP shall remedy the nonconformity at no cost to the owner; except that, if the vehicle has been in operation for more than 5 years or 30,000 kilometers (18,641 miles). BRP shall be required to remedy only those nonconformities resulting from the failure of components which have been installed in or on the vehicle for the sole or primary purpose of reducing vehicle emissions and that were not in general use prior to model year 1968.

The warranty period begins on the date the vehicle is delivered to its ultimate purchase, or if the vehicle is first placed in service as a "demonstrator" or "company" motorcycle prior to delivery, on the date it is first placed first placed in service.

Items which are covered by the Emissions Performance Warranty for the full useful life of the vehicle:

Fuel System and Air Admission Systems

- Fuel Injectors, Fuel Pump Module, Fuel Filter Ass'y, Throttle Body (Including Throttle Position Sensor), Air Intake Manifold

Ignition Components and Sensors

- Engine Control Module (ECM), Engine Wiring Harness, Ignition Coils, Spark Plugs (covered only up to the first maintenance replacement), Noise Sensor (Knock Sensor), Camshaft Position Sensor, Crankshaft Position Sensor, Temperature Sensor (Coolant), Pressure And Temperature Sensor, Oxygen Sensors

Exhaust System

- Primary Muffler (Containing Catalytic Converter), Exhaust Manifolds
- Clamps, Gaskets and Seals (from Engine up to Primary Muffler)

Crankcase Ventilation System

- Crankcase Vent Breather, Crankcase Vent Hose, Oil Filler Cap

Evaporative Emission Control System

- Fuel Tank, Fuel Cap, Fuel Hose, Vapor Canister, Vapor Canister Mounting Bracket, Bleed Valve (Purge Valve), Check Valve, Filters, Evaporative Components Mounting Brackets
- Clamp, Seal, Gasket and Fitting (associated with fuel system assembly)

See maintenance information section in this operator's guide for proper maintenance. This operator's guide contains information for proper use of the vehicle.

Under the Emissions Performance Warranty, BRP shall be liable for the total cost of the remedy for any vehicle validly presented for repair to any authorized Can-Am roadster dealer, unless for emergency repairs as required by item 2 of the following list. State or local limitations as to the extent of the penalty or sanction imposed upon an owner of a failed vehicle shall have no bearing on this liability.

In no case may BRP deny an emission performance warranty claim on the basis of:

1. Warranty work or pre-delivery service performed by any facility authorized by BRP to perform such work or service; or
2. Work performed in an emergency situation to rectify an unsafe condition, including an unsafe driveability condition, attributable to BRP, provided the vehicle owner has taken steps to put the vehicle back in a conforming condition in a timely manner; or
3. The use of any uncertified part or non-compliance with any written instruction for proper maintenance and use which is not relevant to the reason that the vehicle failed to comply with applicable emission standards; or
4. Any cause attributable to BRP; or
5. The use of any fuel which is commonly available in the geographical area in which the vehicle is located, unless the written instructions for proper maintenance and use specify that the use of that fuel would adversely affect the emission control devices and systems of the vehicle, and there is commonly available information for the owner to identify the proper fuel to be used. See maintenance information section and fuel requirements of fueling section.

Except as stated in the previous items; BRP may deny an emission performance warranty claim on the basis of an uncertified aftermarket part used in the maintenance or repair of a vehicle if the use of the uncertified part caused the vehicle's failure to meet emission standards. The use of parts not equivalent to the original parts or uncertified aftermarket parts may have a negative impact on the effectiveness of the emission control system and results in the vehicle's failure to meet emission standards. The use of certified parts does not affect the emission performance warranty. **Maintenance, replacement, or repair of the emission control devices and systems may be performed by any motorcycle repair establishment or individual using any certified part.**

As soon as you become aware of a defect; you are responsible for presenting your vehicle to an authorized Can-Am roadster dealer. Authorized Can-Am roadster dealer will proceed with the warranty claim.

In the case an authorized Can-Am roadster dealer is unable (for reasons not attributable to the vehicle owner or events beyond the control of BRP or an authorized Can-Am roadster dealer) to repair a vehicle within 30 days after the initial presentation of the vehicle to an authorized Can-Am roadster dealer, then the owner shall be entitled to have the warranty remedy performed, at the expense of BRP, by any repair facility of the owner's choosing.

All defective parts replaced under this warranty become the property of BRP.

Contact the Director, Field Operations and Support Division (6406J), Environmental Protection Agency, 401 "M" Street, SW., Washington, DC 20460 (Attention: Warranty Claim) for further information concerning the Emissions Performance Warranty or to report a violation of the terms of the Emissions Performance Warranty.

Bombardier Recreational Products Inc. ("BRP")* also warrants to the ultimate purchaser and each subsequent purchaser that this new vehicle, including all parts of its exhaust emission-control system and its evaporative emission-control system, meets two conditions:

- It is designed, built, and equipped so it conforms at the time of sale to the ultimate purchaser with the requirements of 40 CFR 86 and with the evaporative emission standards of 40 CFR 1051, as applicable to onroad motorcycles.
- It is free from defects in materials and workmanship that may keep it from meeting the requirements of 40 CFR 86 and with the evaporative emission standards of 40 CFR 1051, as applicable to onroad motorcycles.

Where a warrantable condition exists, BRP will repair or replace, as it elects, any part or component with a defect in materials or workmanship that would increase the engine's emissions of any regulated pollutant within the stated warranty period at no cost to the owner, including expenses related to diagnosing and repairing or replacing emission-related parts.

The emission-related warranty is valid for the following period whichever comes first:

	KILOMETERS/MILES	YEARS
Exhaust and Evaporative emission-related components	30,000/18,641	5

US EPA FEDERAL NOISE EMISSION WARRANTY

Bombardier Recreational Products Inc. ("BRP")* warrants to the ultimate purchaser and each subsequent purchaser that this new vehicle, at time of sale, was designed, built and equipped to meet all applicable US EPA Federal noise control standards and is free from defects in materials and workmanship that may keep it, when properly maintained and used, from meeting the requirements of all applicable US EPA Federal noise standards for the following period whichever comes first:

KILOMETERS/MILES	YEAR
6,000/3,730	1

* In the USA, products are distributed and serviced by BRP US Inc.

CALIFORNIA EMISSION CONTROL WARRANTY STATEMENT

YOUR WARRANTY RIGHTS AND OBLIGATIONS:

The California Air Resources Board and BRP US Inc. ("BRP")*, on behalf of Bombardier Recreational Products Inc., are pleased to explain the emission control system warranty on your 2017 Can-Am Spyder Roadster. In California, new motor vehicles must be designated, built and equipped to meet the State's stringent anti-smog standards. BRP must warrant the emission control system on your Roadster for the periods of time listed below provided there has been no abuse, neglect or improper maintenance of your Roadster.

Your emission control system may include parts such as the fuel-injection system, ignition system, catalytic converter and engine computer. Also included may be hoses, connectors and other emission-related assemblies. Where a warrantable condition exists, BRP will repair your Roadster at no cost to you including diagnosis, parts and labor.

MANUFACTURER'S WARRANTY COVERAGE

– For 5 years or 30 000 kilometers (18,641 miles), whichever occurs first.

OWNER'S WARRANTY RESPONSIBILITIES:

As the Roadster owner, you are responsible for the performance of the required maintenance listed in your *OPERATOR'S GUIDE*. BRP recommends that you retain all receipts covering maintenance on your Roadster, but BRP cannot deny warranty solely for the lack of receipts or for your failure to ensure the performance of all scheduled maintenance.

You are responsible for presenting your Roadster to a Dealer as soon as a problem exists. The warranty repairs should be completed in a reasonable amount of time, not to exceed 30 days.

As the Roadster owner, you should also be aware that BRP may deny you warranty coverage if your Roadster or a part has failed due to abuse, neglect, improper maintenance or unapproved modifications.

If you have any questions regarding your warranty rights and responsibilities, you should contact BRP's customer assistance center at 1 715 848-4957 or the California Air Resource Board at 9528 Telstar Avenue, El Monte, CA 91731.

* In the USA, products are distributed and serviced by BRP US Inc.

© 2016 Bombardier Recreational Products Inc. All rights reserved.

® Registered Trademarks of Bombardier Recreational Products Inc. or its affiliates.

BRP LIMITED WARRANTY OUTSIDE USA AND CANADA: 2017 Can-Am® SPYDER® ROADSTER

1. SCOPE OF THE LIMITED WARRANTY

Bombardier Recreational Products Inc. ("BRP")* warrants its 2017 Can-Am Spyder roadsters (the "Products") sold by authorized Can-Am Spyder roadster distributors or dealers located in the EEA (the "EEA" or "European Economic Area" shall mean the countries member of the European Union plus Norway, Iceland and Liechtenstein) or elsewhere, except in the USA and Canada** (the "Distributors/Dealers") from defects in material or workmanship for the period and under the conditions described below. This limited warranty will become null and void if: (1) the Product was used for racing or any other competitive activity, at any point, even by a previous owner; or (2) the odometer was removed or has been tampered with; (3) the Product was used off-road; or (4) the Product has been altered or modified in such a way so as to adversely affect its operation, performance or durability, or has been altered or modified to change its intended use.

Non-factory installed parts and accessories are not covered under this limited warranty. Please refer to the applicable parts and accessories limited warranty text.

2. LIMITATIONS OF LIABILITY

JURISDICTIONS TO THE EXTENT PERMITTED BY LAW. THIS WARRANTY IS EXPRESSLY GIVEN AND ACCEPTED IN LIEU OF ANY AND ALL OTHER WARRANTIES, EXPRESSED OR IMPLIED, INCLUDING WITHOUT LIMITATION ANY WARRANTY OF MERCHANTABILITY OR FITNESS FOR A PARTICULAR PURPOSE. TO THE EXTENT THAT THEY CANNOT BE DISCLAIMED, THE IMPLIED WARRANTIES ARE LIMITED IN DURATION TO THE LIFE OF THE EXPRESS WARRANTY. ALL INCIDENTAL, CONSEQUENTIAL, DIRECT, INDIRECT OR OTHER DAMAGES OF ANY KIND ARE EXCLUDED FROM COVERAGE UNDER THIS WARRANTY. SOME JURISDICTIONS DO NOT ALLOW FOR THE DISCLAIMERS, LIMITATIONS OF INCIDENTAL OR CONSEQUENTIAL DAMAGES OR OTHER EXCLUSIONS IDENTIFIED ABOVE. AS A RESULT, THEY MAY NOT APPLY TO YOU. THIS WARRANTY GIVES YOU SPECIFIC RIGHTS, AND YOU MAY ALSO HAVE OTHER LEGAL RIGHTS WHICH MAY VARY FROM COUNTRY TO COUNTRY, OR JURISDICTION TO JURISDICTION. (FOR PRODUCTS PURCHASED IN AUSTRALIA SEE CLAUSE 4 BELOW).

Neither the authorized Distributors/Dealers nor any other person has been authorized to make any affirmation, representation or warranty regarding the Product, other than those contained in this limited warranty, and if made, shall not be enforceable against BRP. BRP reserves the right to modify this warranty at any time, being understood that such modification will not alter the warranty conditions applicable to the Products sold while this warranty is in effect.

3. EXCLUSIONS — ARE NOT WARRANTED

The following are not warranted under this limited policy under any circumstances:

- Replacement of routine maintenance items such as, without limitation, oil and lubricants, filters and spark plugs.
- Normal wear and tear, such as, without limitation, wear and tear of the tires, battery, generator brushes, sealed beams and light bulbs, clutch plates and facings, drive belt, brake pads, brake linings and rotors and sprockets.

- Tune ups and adjustments including without limitation adjustments of belt, alignment and wheel balance.
- Damages related to the appearance of the Product, including without limitation scratches, dents, fading, flaking, peeling and damages to seat cover material.
- Damage caused by negligence or failure to provide proper maintenance and/or storage, as described in the *OPERATOR'S GUIDE*.
- Damage resulting from removal of parts, improper repairs, improper service or improper maintenance, modifications, alterations that are outside of the original specifications of the Product, or damage resulting from use of parts or accessories not manufactured or approved by BRP which in its reasonable judgement are either incompatible with the product or adversely affect its operation, performance or durability or resulting from repairs done by a person that is not an authorized servicing Distributor/Dealer.
- Damage resulting from the installation of parts with specifications that differ from the original Product parts, such as, without limitation, different tires, exhaust system, wheels or brakes.
- Damage resulting from abuse, abnormal use, neglect, racing or operation of the Product in a manner inconsistent with the recommendations of the *OPERATOR'S GUIDE*.
- Damage resulting from water ingestion, accident, road hazards, submersion, fire, theft, vandalism or any act of God.
- Damage resulting from operation with fuels, oils or lubricants with specifications different than as recommended in the *OPERATOR'S GUIDE*.
- Damage resulting from corrosion from road salts, battery acid, environmental influences or treatment contrary to the *OPERATOR'S GUIDE*.
- Incidental or consequential damages, including without limitation, expense for gasoline, expense for transporting the Product to and from the authorized Distributor/Dealer, mechanic's travel time, trailering or towing, storage, telephone, cell phone, fax or telegram charges, rental of a like or replacement Product during warranty services or down time, taxi, travel, lodging, loss of or damage to personal property, inconvenience, cost of insurance coverage, loan payments, loss of time, loss of income, revenue or profits, or loss of enjoyment or use of Product.

4. WARRANTY COVERAGE PERIOD

This warranty will be in effect from the date of delivery to the first retail consumer or the date the Product is first put into use, whichever occurs first and for the following periods:

- a. For private, recreational use, **TWENTY-FOUR (24) CONSECUTIVE MONTHS**, except for the items covered in points (2) and 3) below; and for commercial use **TWELVE (12) CONSECUTIVE MONTHS**, except for the items covered in points (2) and (3) below.

The Product is used commercially when it is used in connection with any work or employment that generates income, during any part of the warranty period. The Product is also used commercially when, at any point during the warranty period, it is licensed for commercial use;

- b. For the battery, **SIX (6) CONSECUTIVE MONTHS**;
- c. For the tires, **6 CONSECUTIVE MONTHS** or until tires are worn to the last three thirty-second of an inch (3/32 ") (2.38 millimeters) for the front tires and the last five thirty-second of an inch (5/32 ") (3.97 millimeters) for the rear tire, whichever occurs first.

The repair or replacement of parts or the performance of service under this warranty does not extend the life of this warranty beyond its original expiration date.

Note that the duration and any other modalities of the warranty coverage are subject to the applicable national or local legislation in the customer's country.

FOR PRODUCTS SOLD IN AUSTRALIA ONLY

Nothing in these Warranty terms and conditions should be taken to exclude, restrict or modify the application of any condition, warranty, guarantee, right or remedy conferred or implied under the Competition and Consumer Act 2010 (Cth), including the Australian Consumer Law or any other law, where to do so would contravene that law, or cause any part of these terms and conditions to be void. The benefits given to you under this limited warranty are in addition to other rights and remedies that you have under Australian law.

Our goods come with guarantees that cannot be excluded under the Australian Consumer Law. You are entitled to a replacement or refund for a major failure and for compensation for any other reasonably foreseeable loss or damage. You are also entitled to have the goods repaired or replaced if the goods fail to be of acceptable quality and the failure does not amount to a major failure.

5. CONDITIONS TO HAVE WARRANTY COVERAGE

This warranty coverage is available only if each of the following conditions has been fulfilled:

- The Product must be purchased as new and unused by its first owner from a Distributor/Dealer authorized to distribute the Product in the country or union of countries in which the sale occurred;
- The BRP specified pre-delivery inspection process has been completed and documented by the purchaser and the authorized Distributor/Dealer and signed by the purchaser;
- The Product must have undergone proper warranty registration by an authorized Distributor/Dealer;
- The Product must be purchased in the country or union of countries in which the purchaser resides.
- Routine maintenance as outlined in the *OPERATOR'S GUIDE* must be performed in a timely manner. BRP reserves the right to make warranty coverage contingent upon proof of proper maintenance.

BRP will not honour this limited warranty to any private use owner or commercial use owner if one of the preceding conditions has not been met. Such limitations are necessary in order to allow BRP to preserve both the safety of its products, and also that of its consumers and the general public.

6. WHAT TO DO TO OBTAIN WARRANTY COVERAGE

The customer must cease using the Product upon the appearance of an anomaly. The customer must notify an authorized servicing Distributor/Dealer within two (2) months of the appearance of a defect, and provide it with reasonable access to the Product and reasonable opportunity to repair it. The customer must also present to the authorized Distributor/Dealer, proof of purchase of the Product and must sign the repair/work order prior to starting the repair in order to validate the warranty repair. All parts replaced under this limited warranty become the property of BRP. Note that the notification period is subject to the applicable national or local legislation in customer's country.

7. WHAT BRP WILL DO

To the extent permitted by law, BRP's obligations under this warranty are limited to, at its sole discretion, repairing parts found defective under normal use, maintenance and service, or replacing such parts with new genuine Product parts without charge for parts and labour, at any authorized Distributor/Dealer during the warranty coverage period under the conditions described herein. BRP's responsibility is limited to making the required repairs or replacements of parts. No claim of breach of warranty shall be cause for cancellation or rescission of the sale of the Product to the owner. You may have other legal rights which may vary from country to country.

In the event that service is required outside of the country of original sale, or for EEA residents, if service is required outside of the EEA, the owner will bear responsibility for any additional charges due to local practices and conditions, such as, but not limited to, freight, insurance, taxes, license fees, import duties, and any and all other financial charges, including those levied by governments, states, territories and their respective agencies.

BRP reserves the right to improve or modify products from time to time without assuming any obligation to modify all products previously manufactured.

8. TRANSFER

If the ownership of a Product is transferred during the warranty coverage period, this limited warranty, subject to its terms and conditions, shall also be transferred and be valid for the remaining coverage period provided BRP or an authorized Distributor/Dealer receives a proof that the former owner agreed to the transfer of ownership, in addition to the co-ordinates of the new owner.

9. CONSUMER ASSISTANCE

In the event of a controversy or a dispute in connection with this limited warranty, BRP suggests that you try to resolve the issue at the Distributor/Dealer level. We recommend discussing the issue with the authorized Distributor/Dealer's service manager or owner.

If the matter still remains unresolved, contact BRP by filling out the customer contact form at www.brp.com or contact BRP by mail at one of the addresses listed under the *CONTACT US* section of this guide.

ADDITIONAL TERMS AND CONDITIONS FOR FRANCE ONLY

The following terms and conditions are applicable to products sold in France only:

The seller shall deliver goods that are complying with the contract and shall be responsible for defects existing upon delivery. The seller shall also be responsible for defects resulting from packaging, assembling instructions or the installation when it is its responsibility per the contract or if accomplished under its responsibility. To be compliant with the contract, the good shall:

1. Be fit for normal use for goods similar thereto and, if applicable:
 - 1.1 Correspond to the description provided by the seller and have the qualities presented to the buyer though sample or model;
 - 1.2 Have the qualities that a buyer may legitimately expect considering the public declarations of the seller, the manufacturer of its representative, including in advertising or labeling; or
2. Have the characteristics mutually agreed upon as between the parties or be fit for the specific use intended by the buyer and brought to the attention of the seller and which accepted.

The action for failure to comply is prescribed after two years after delivery of the goods. The seller is responsible for the warranty for hidden defects of the good sold if such hidden defects are rendering the good unfit for the intended use, or if they diminish its use in such a way that the buyer would not have acquired the good or would have given a lesser price, had he known. The action for such hidden defects shall be taken by the buyer within 2 years of the discovery of the defect.

* In the European Economic Area and elsewhere, Products are distributed and serviced by BRP European Distribution S.A. and other subsidiaries of BRP.

** The BRP limited warranty offered on Products sold in the USA and Canada is different than the one offered in the EEA and elsewhere.

© 2016 Bombardier Recreational Products Inc. All rights reserved.

® Registered Trademarks of Bombardier Recreational Products Inc. or its affiliates.

CUSTOMER INFORMATION

PRIVACY INFORMATION

BRP wishes to inform you that your coordinates will be used for safety and warranty related purposes. Furthermore, BRP and its affiliates may use its customer list to distribute marketing and promotional information about BRP and related products.

To exercise your right to consult or correct your data, or to be removed from the addressee-list for direct marketing, please contact BRP.

By E-mail: privacyofficer@brp.com

By mail: BRP
Senior Legal Counsel-Privacy Officer
726 St-Joseph
Valcourt QC
Canada,
J0E 2L0

CONTACT US

www.brp.com

North America

565 de la Montagne Street
Valcourt (Québec) J0E 2L0
Canada

Sturtevant, Wisconsin, U.S.A.
10101 Science Drive
Sturtevant, Wisconsin
53177
U.S.A.

Circuito de la Productividad #111
Parque Industrial Guadalajara
Col. Las Pintas
El Salto, Jalisco, 45690
Mexico

Av. Ferrocarril # 202
Parque Industrial Querétaro
Santa Rosa Jáuregui, Querétaro
Querétaro
C.P. 76220 México

Europe

Skaldenstraat 125
B-9042 Gent
Belgium

Itterpark 11
D-40724 Hilden
Germany

ARTEPARC Bâtiment B
Route de la côte d'Azur, Le Canet
13590 Meyreuil
France

Ingvald Ystgaardsvei 15
N-7484 Trondheim
Norway

Isoaavantie 7
PL 8040
96101 Rovaniemi

Formvägen 16
S-906 21 Umeå
Sweden

Avenue d'Ouchy 4-6
1006 Lausanne
Switzerland

Oceania

6 Lord Street
Lakes Business Park
Botany, NSW 2019
Australia

South America

Rodovia Anhanguera Km 104
Loteamento Techno Park
Condominio Empresarial AZTech
Avenida James Clerck Maxwell, 280 -
Modulo 04
13069-380, Campinas SP
Brazil

Asia

15/F Parale Mitsui Building,8
Higashida-Cho, Kawasaki-ku
Kawasaki 210-0005
Japan

Room Dubai, level 12, Platinum Tower
233 Tai Cang Road
Xintiandi, Lu Wan District
Shanghai 200020
PR China

CHANGE OF ADDRESS/OWNERSHIP

If your address has changed or if you are the new owner of the vehicle, be sure to notify BRP by either:

- Notifying an authorized Can-Am roadster dealer.
- **North America Only:** calling at 1-888-272-9222;
- Mailing one of the change of address cards on the following pages at one of the BRP addresses indicated in the *CONTACT US* section of this guide.

In case of change of ownership, please join a proof that the former owner agreed to the transfer.

Notifying BRP, even after the expiration of the limited warranty, is very important as it enables BRP to reach the vehicle owner if necessary, like when safety recalls are initiated. It is the owner's responsibility to notify BRP.

STOLEN UNITS: If your personal vehicle is stolen, you should notify BRP or an authorized Can-Am roadster dealer. We will ask you to provide your name, address, phone number, the vehicle identification number and the date it was stolen.

***This page is
intentionally blank***

CHANGE OF ADDRESS CHANGE OF OWNERSHIP 

VEHICLE IDENTIFICATION NUMBER

Model Number

Vehicle Identification Number (V.I.N.)

OLD ADDRESS
OR PREVIOUS OWNER: NAME NO. STREET APT CITY STATE/PROVINCE ZIP/POSTAL CODE COUNTRY TELEPHONENEW ADDRESS
OR NEW OWNER: NAME NO. STREET APT CITY STATE/PROVINCE ZIP/POSTAL CODE COUNTRY TELEPHONE E-MAIL ADDRESS

V00A2F

CHANGE OF ADDRESS CHANGE OF OWNERSHIP 

VEHICLE IDENTIFICATION NUMBER

Model Number

Vehicle Identification Number (V.I.N.)

OLD ADDRESS
OR PREVIOUS OWNER: NAME NO. STREET APT CITY STATE/PROVINCE ZIP/POSTAL CODE COUNTRY TELEPHONENEW ADDRESS
OR NEW OWNER: NAME NO. STREET APT CITY STATE/PROVINCE ZIP/POSTAL CODE COUNTRY TELEPHONE E-MAIL ADDRESS

V00A2F

 **WARNING**

The Spyder roadster is a different type of vehicle- it requires special skills and knowledge. Learn how the Spyder roadster is different.

Read this operator's guide and watch the safety DVD.

Complete a training course (if available), **practice**, become proficient with the controls, and get a proper license.

Refer to the Safety Card before riding.

Always wear a helmet and riding gear.

With this type of vehicle, riders are exposed to more road risks than in a car. Even skilled operators can be struck by other vehicles or lose control. This vehicle will not protect you in a crash.

Handling limits and road Conditions.

The Vehicle Stability System (VSS) cannot stop you from losing control, flipping over, or falling off if you exceed this vehicle's limits. Know the limits for different road conditions. Do not ride on ice, snow, or off road. Avoid puddles and running water. This type of vehicle can hydroplane on water and slip on gravel, dirt and sand covered roads. If you must go through these road conditions, slow down.

219 001 702
OPERATOR'S GUIDE, SPYDER RT / ENGLISH
GUIDE DU CONDUCTEUR, SPYDER RT / ANGLAIS

FAIT AU / MADE IN CANADA

U/M:P.C.