

LYNX®



2018

OPERATOR'S GUIDE

Includes
Safety, Vehicle
and Maintenance Information



REX²

Touring / Utility

WARNING

Read this guide thoroughly. It contains important safety information.
Minimum recommended operator's age: 16 years old.
Keep this Operator's Guide in the vehicle.

6 1 9 9 0 0 9 3 8

Original Instructions

OPERATOR'S GUIDE 2018

TOURING

Adventure™ LX 600 ACE

UTILITY

49 RANGER™ 600HO E-TEC

49 RANGER™ 600HO E-TEC Touring

49 RANGER™ 600 ACE

49 RANGER™ 600 ACE Touring

49 RANGER™ ST 900 ACE

! WARNING

Disregarding any of the safety precautions and instructions contained in this Operator's Guide, on-product labels could cause injury including the possibility of death!

! WARNING

This vehicle may exceed the performance of other vehicles you may have ridden in the past. Take time to familiarize yourself with your new vehicle.



Lynx products are manufactured by BRP.

The following are trademarks of Bombardier Recreational Products Inc. or its subsidiaries.

ACE®

ITC™

RAVE™

ROTAX™

D.E.S.S.™

Learning Key™

RER™

SC™

E-TEC®

LYNX®

REX2™

TRA™

HPG™

PPS2™

FOREWORD

Deutsch	Dieses Handbuch ist möglicherweise in Ihrer Landessprache verfügbar. Bitte wenden Sie sich an Ihren Händler oder besuchen Sie: www.operatorsguides.brp.com
English	This guide may be available in your language. Check with your dealer or go to: www.operatorsguides.brp.com
Español	Es posible que este manual esté disponible en su idioma. Consulte a su distribuidor o visite: www.operatorsguides.brp.com
Français	Ce guide peut être disponible dans votre langue. Vérifier avec votre concessionnaire ou aller à: www.operatorsguides.brp.com
中文	本手册可能有您的语种的翻译版本。请向经销商问询，或者登录 www.operatorsguides.brp.com 查询。
日本語	このガイドは、言語によって翻訳版が用意されています。ディーラーに問い合わせるか、次のアドレスでご確認ください： www.operatorsguides.brp.com
Nederlands	Deze handleiding kan beschikbaar zijn in uw taal. Vraag het aan uw dealer of ga naar: www.operatorsguides.brp.com
Norsk	Denne boken kan finnes tilgjengelig på ditt eget språk. Kontakt din forhandler eller gå til: www.operatorsguides.brp.com
Português	Este manual pode estar disponível em seu idioma. Fale com sua concessionária ou visite o site: www.operatorsguides.brp.com
Suomi	Käyttöohjekirja voi olla saatavissa omalla kielelläsi. Tarkista jälleenmyyjältä tai käy osoitteessa: www.operatorsguides.brp.com
Svenska	Denna bok kan finnas tillgänglig på ditt språk. Kontakta din återförsäljare eller gå till: www.operatorsguides.brp.com

Congratulations on your purchase of a new Lynx® snowmobile. Whatever model you have chosen, it is backed by the Bombardier Recreational Products Inc. (BRP) warranty and a network of authorized Lynx snowmobile dealers ready to provide the parts, service or accessories you may require.

Your dealer is committed to your satisfaction. He has taken training to perform the initial set-up and inspection of your snowmobile as well as completed the final adjustment required to suit your specific weight and riding environment before you took possession.

At delivery, you were informed of the warranty coverage and signed the *PREDELIVERY CHECK LIST* to ensure your new vehicle was prepared to your entire satisfaction.

Know Before you Go

To learn how to reduce the risk for you, your passenger or bystanders being injured or killed, read the following sections before you operate the vehicle:

- *SAFETY INFORMATION*
- *VEHICLE INFORMATION.*

Also read all safety labels on your snowmobile.

We highly recommend that you take a safety riding course. Please check with your dealer or local authorities for availability in your area.

Failure to follow the warnings contained in this Operator's Guide can result in **SERIOUS INJURY** or **DEATH**.

The proper functioning of a snowmobile depends in part on the surface on which it is driven.

Driving on very hard or snow-free surfaces compromises the cooling of the engine and the lubrication of rear suspension components. Avoid prolonged driving on such surfaces.

Safety Messages

The types of safety messages, what they look like and how they are used in this guide are explained as follows:

The safety alert symbol  indicates a potential injury hazard.

 WARNING
Indicates a potential hazard, if not avoided, could result in serious injury or death.

 **CAUTION** Indicates a hazard situation which, if not avoided, could result in minor or moderate injury.

NOTICE Indicates an instruction which, if not followed, could severely damage vehicle components or other property.

About this Operator's Guide

This Operator's Guide has been prepared to acquaint the owner/operator and passenger with this snowmobile and its various controls, safe riding and maintenance instructions.

The following terminology in regards to operator, passenger and vehicle configuration is used as follows throughout this guide:

- **Operator:** refers to the person being behind the controls and driving the snowmobile.
- **Passenger:** refers to a person sitting behind the operator.
- **1-UP:** refers to a model designed for an operator only.
- **2-UP:** refers to a model designed to accommodate **one** passenger.

Keep this Operator's Guide in the vehicle as you can refer to it for things such as maintenance, troubleshooting and instructing others.

Note that this guide is available in several languages. In the event of any discrepancy, the English version shall prevail.

If you want to view and/or print an extra copy of your Operator's Guide, simply visit the following website www.operatorsguides.brp.com.

The informations contained in this document are correct at the time of publication. BRP, however, maintains a policy of continuous improvement of its products without imposing upon itself any obligation to install them on products previously manufactured. Due to late changes, some differences between the manufactured product and the descriptions and/or specifications in this guide may occur. BRP reserves the right at any time to discontinue or change specifications, designs, features, models or equipment without incurring any obligation upon itself.

This Operator's Guide should remain with the vehicle when it's sold.

TABLE OF CONTENTS

FOREWORD	1
Know Before you Go	1
Safety Messages	2
About this Operator's Guide	2

SAFETY INFORMATION

GENERAL PRECAUTIONS	8
Avoid Carbon Monoxide Poisoning	8
Avoid Gasoline Fires and Other Hazards	8
Avoid Burns from Hot Parts	8
Accessories and Modifications	8
SPECIAL SAFETY MESSAGES	9
ACTIVE TECHNOLOGIES (iTC) (ACE)	13
Introduction	13
iTC (intelligent Throttle Control)	13
RIDING THE VEHICLE	14
Pre-Ride Inspection	14
How to Ride	15
Carrying a Passenger	17
Terrain/Riding Variations	18
Environment	22
TRACTION ENHANCING PRODUCTS	25
Manoeuvrability	25
Acceleration	26
Braking	26
Important Safety Rules	26
Effects of Having a Studded Track on the Life of the Snowmobile	27
Installation of Studs on BRP Approved Tracks	27
Maintenance/Replacement	28
IMPORTANT ON-PRODUCT LABELS	29
Vehicle Safety Labels	29
Technical Information Labels	33

VEHICLE INFORMATION

CONTROLS, INSTRUMENTS AND EQUIPMENT	38
1) Handlebar	39
2) Throttle Lever	39
3) Brake Lever	41
4) Parking Brake Lever	41
5) Engine Cut-Off Switch	42
6) Emergency Engine Stop Switch	43
7) Multifunction Switch	43
8) Tool Kit	45

CONTROLS, INSTRUMENTS AND EQUIPMENT (cont'd)	
9) Drive Belt Guard	45
10) Gauge	46
11) Analog/Digital Gauge (Standard)	50
12) Multifunction Analog/Digital Gauge	54
13) ECO/Standard/Sport Mode Switch	67
14) Front Storage Compartment	67
15) Shift Lever	68
16) Front and Rear Bumpers	68
17) Upper Body Module (Hood)	68
18) Side Panels	71
19) Passenger Handhold	71
20) Rear Rack	72
21) Seat	72
22) Seat Latch	72
23) Storage/Battery Compartment	74
24) Hitch	74
25) Mountain Strap (49 Ranger)	74
FUEL	75
Fuel Requirements	75
Vehicle Fueling Procedure	75
INJECTION OIL (E-TEC)	77
Recommended Injection Oil	77
BREAK-IN PERIOD	78
Operation During Break-In	78
OPERATING MODES (ACE)	79
ECO Mode (Fuel Economy Mode)	79
Standard Mode	79
Sport Mode	79
Navigating Operating Modes	79
Learning Key Modes	80
BASIC PROCEDURES	82
Engine Starting Procedure	82
Emergency Starting (E-TEC)	82
Vehicle Warm-Up	83
Engaging Reverse (RER) (E-TEC)	84
Shifting in Reverse or Forward (ACE Models)	85
Shutting Off the Engine	85
RIDING CONDITIONS AND YOUR SNOWMOBILE	86
Altitude	86
Temperature	86
Hard Packed Snow	86
SPECIAL OPERATION	87
Towing an Accessory	87
Towing Another Snowmobile	87

TUNE YOUR RIDE	88
Rear Suspension Adjustments.....	88
Front Suspension Adjustments.....	91
Adjustment Tips According to Vehicle Behavior	93
VEHICLE TRANSPORTATION	94

MAINTENANCE

FIRST INSPECTION	96
MAINTENANCE SCHEDULE (E-TEC)	98
MAINTENANCE SCHEDULE (ACE)	100
MAINTENANCE PROCEDURES	102
Air Filter with Dual Air Intake	102
Engine Coolant	102
Engine Oil	103
Engine Oil Filter (ACE)	105
Engine Stopper (E-TEC).....	106
Exhaust System	107
Spark Plugs	108
Brake Fluid	108
Chaincase Oil	109
Drive Chain	110
Drive Belt	111
Drive Pulley (E-TEC).....	113
Track.....	115
Suspension	118
Skis.....	119
Fuses.....	119
Lights.....	120
VEHICLE CARE	122
Post-Operation Care	122
Vehicle Cleaning and Protection	122
STORAGE	123
Storage (E-TEC)	123
PRESEASON PREPARATION	125

TECHNICAL INFORMATION

VEHICLE IDENTIFICATION	128
Vehicle Description Decal	128
Identification Numbers (Serial Numbers)	128
NOISE EMISSION AND VIBRATION VALUES (ALL COUNTRIES EXCEPT CANADA/UNITED STATES)	130
EC DECLARATION OF CONFORMITY	131

RADIO FREQUENCY DIGITALLY ENCODED SECURITY SYSTEM (RF D.E.S.S. KEY) 132
SPECIFICATIONS 133

TROUBLESHOOTING

TROUBLESHOOTING GUIDELINES (E-TEC AND ACE) 144
MONITORING SYSTEM 147
 Pilot Lamps, Messages and Beeper Codes 147
 Fault Codes 150

WARRANTY

BRP FINLAND OY INTERNATIONAL LIMITED WARRANTY: 2018 LYNX® SNOWMOBILES 152
MAINTENANCE RECORDS 157

CUSTOMER INFORMATION

CONTACT US..... 162
 Europe 162
 North America 162
 Oceania 162
 South America..... 162
 Asia..... 162
CHANGE OF ADDRESS/OWNERSHIP..... 163

SAFETY INFORMATION

GENERAL PRECAUTIONS

Avoid Carbon Monoxide Poisoning

All engine exhaust contains carbon monoxide, a deadly gas. Breathing carbon monoxide can cause headaches, dizziness, drowsiness, nausea, confusion and eventually death.

Carbon monoxide is a colorless, odorless, tasteless gas that may be present even if you do not see or smell any engine exhaust. Deadly levels of carbon monoxide can collect rapidly, and you can quickly be overcome and unable to save yourself. Also, deadly levels of carbon monoxide can linger for hours or days in enclosed or poorly ventilated areas. If you experience any symptoms of carbon monoxide poisoning, leave the area immediately, get fresh air and seek medical treatment.

To prevent serious injury or death from carbon monoxide:

- Never run the vehicle in poorly ventilated or partially enclosed areas such as garages, carports or barns. Even if you try to ventilate engine exhaust with fans or open windows and doors, carbon monoxide can rapidly reach dangerous levels.
- Never run the vehicle outdoors where engine exhaust can be drawn into a building through openings such as windows and doors.

Avoid Gasoline Fires and Other Hazards

Gasoline is extremely flammable and highly explosive. Fuel vapors can spread and be ignited by a spark or flame many feet away from the engine. To reduce the risk of fire or explosion, follow these instructions:

- Use only an approved gasoline container to store fuel.
- Strictly adhere to instructions in *FUELING PROCEDURE*.
- Never start or operate the engine if the fuel cap is not properly installed.

Gasoline is poisonous and can cause injury or death.

- Never siphon gasoline by mouth.
- If you swallow gasoline, get any in your eye or inhale gasoline vapor, see your doctor immediately.

If gasoline spills on you, wash with soap and water and change your clothes.

Avoid Burns from Hot Parts

The exhaust system and engine become hot during operation. Avoid contact during and shortly after operation to avoid burns.

Accessories and Modifications

Do not make unauthorized modifications, or use attachments or accessories that are not approved by BRP. Since these changes have not been tested by BRP, they may increase the risk of crashes or injuries, and they can make the vehicle illegal.

Tunnel accessories must be loaded onto vehicle as per instructions provided for each accessories.

Accessory passenger seats approved by BRP and conforming to SSCC standards may be available for certain models. If such a seat is used, you must follow the guidelines and recommendations in regards to a passenger in this guide.

WARNING

Passenger seat must have a strap or handholds and must meet SSCC standards.

See your authorized Lynx dealer for available accessories for your vehicle.

SPECIAL SAFETY MESSAGES

SEVERE INJURY OR DEATH can result if you do not follow these instructions:

- Always make a pre-ride inspection **BEFORE** you start the engine.
- Throttle mechanism should be checked for free movement and return to idle position before starting engine.
- Always attach tether cord eyelet to clothing before starting the engine.
- Never operate the engine without drive belt guard and brake disk guard securely installed or, with hood or side panels opened or removed. Never run the engine without drive belt installed. Running an unloaded engine such as without drive belt or with track raised, can be dangerous.
- Always engage parking brake before starting the engine.
- Everyone is a beginner the first time he sits behind the controls of a snowmobile regardless of previous experience in driving any other type of vehicle. The safe use of your snowmobile depends on many conditions such as visibility, speed, weather, environment, traffic, vehicle condition and the condition of the operator.
- Basic training is required for the safe operation of any snowmobile. Study your Operator's Guide paying particular attention to cautions and warnings. Join your local snowmobile club: its social activities and trail systems are planned for both fun and safety. Obtain basic instructions from your snowmobile dealer, friend, fellow club member or enroll in your state or provincial safety training program.
- Any new operator must read and understand all safety labels on the snowmobile, the Operator's Guide before operating the snowmobile. Only allow a new operator to operate the snowmobile in a restricted flat area, at least until he is completely familiar with its operation. If snowmobile operator's training course is offered in your area, have him enroll.
- The performance of some snowmobiles may significantly exceed that of other snowmobiles you have operated. Therefore, use by novice or inexperienced operators is not recommended.
- Snowmobiles are used in many areas and in many snow conditions. Not all models perform the same in similar conditions. Always consult your snowmobile dealer when selecting the snowmobile model for your particular needs and uses.
- Injury or death may result to the snowmobile operator, passenger or bystander if the snowmobile is used in risky conditions which are beyond the operator's, passenger's or snowmobile's capabilities or intended use.
- BRP recommends the operator has at least 16 years old of age. Verify also your local laws for age and training requirements.
- It is very important to inform any operator, regardless of his experience, of the handling characteristics of this snowmobile. The snowmobile configuration, such as ski stance, ski type, suspension type, track length, width and type vary from a model to another. The snowmobile handling is greatly influenced by these characteristics.
- The novice operator should become familiar with the snowmobile through practice on a level area at slow speeds before venturing far afield.

- Know your local laws. Federal, state, provincial and local government agencies have enacted laws and regulations pertaining to the safe use and operation of snowmobiles. It is your responsibility as a snowmobiler to learn and obey these laws and regulations. Respect and observance will result in safer snowmobiling for all. Be aware of the liability property damages and insurance laws regarding your equipment.
- Speeding can be fatal. In many cases, you cannot react or respond quickly enough to the unexpected. Always ride at a speed which is suitable to the trail, weather conditions and your own ability. Know your local rules. Speed limit may be in effect and meant to be observed.
- Always keep right hand side of the trail.
- Always keep a safe distance from other snowmobiles and bystanders.
- Remember, promotional material may show risky maneuvers performed by professional riders under ideal and/or controlled conditions. You should never attempt any such risky maneuvers if they are beyond your level of riding ability.
- Never use this vehicle with drugs or alcohol. They slow reaction time and impair judgement.
- Your snowmobile is not designed to be operated on public streets, roads or highways.
- Avoid road traveling. If you must do so, and it is permitted, reduce speed. The snowmobile is not designed to operate or turn on paving. When crossing a road, make a full stop, then look carefully in both directions before crossing at a 90° angle. Be wary of parked vehicles.
- Snowmobiling at night can be a delightful experience but because of reduced visibility, be extra cautious. Avoid unfamiliar terrain and be sure your lights are working. Always carry a flashlight and spare light bulbs.
- Never remove any original equipment from your snowmobile. Each vehicle has many built in safety features. Such features include various guards and consoles, plus reflective materials and safety labels.
- Nature is wonderful but don't let it distract your attention from driving. If you want to truly appreciate winter's scenery, stop your snowmobile on the side of the trail so that you don't become a hazard to others.
- Fences represent a very serious threat for both you and your snowmobile. Give a wide berth to telephone poles or posts.
- Hidden wires unseen from a distance can cause serious accidents.
- Always wear an approved safety helmet, eye protection and a face shield. This also applies to your passenger.
- Be aware of inherent risks associated with riding off trails, such as avalanche and other natural or man made hazards or obstacles.
- Tailgating another snowmobile should be avoided. If the snowmobile in front of you slows for any reason, its operator and passenger could be harmed through your neglect. Maintain a safe stopping distance between you and the snowmobile in front of you. Depending on the terrain condition, stopping may require a little more space than you think. Play it safe. Be prepared to use evasive driving.

- Venturing out alone with your snowmobile could also be hazardous. You could run out of fuel, have an accident, or damage your snowmobile. Remember, your snowmobile is capable of traveling further in half an hour than you may be able to walk in a day. Use the “buddy system”. Always ride with a friend or member of your snowmobile club. Even then, tell someone where you are going and the approximate time you plan to return.
- Meadows sometimes have low areas where water accumulate and freezes over in winter. This ice is usually glare ice. Attempting to turn or brake on this surface could cause your vehicle to spin out of control. Never brake or attempt speeding or turning on glare ice. If you do happen to travel over such a condition, reduce speed by carefully releasing the throttle.
- Never “jump” with your snowmobile.
- When riding in a group, do not “gun” the throttle. Snow and ice can be thrown back into the path of a following snowmobile. In addition, when “gunning” the throttle, the vehicle digs into and leaves an irregular snow surface for others.
- Riding in a group is fun and enjoyable but don't show off or overtake others in the group. A less experienced operator might try to do the same as you and fail. When riding with others, limit your abilities to the experience of others.
- In case of an emergency, press down on the engine emergency stop switch, then apply brake.
- Always engage parking brake when vehicle is not in use.
- Never run the engine in a non-ventilated area and/or if vehicle is left unattended.
- **Electric start models only:** Never charge or boost a battery while installed on snowmobile.
- E-TEC engines: Never attempt any fuel system or electrical system maintenance or repair. Any maintenance or repair of these systems must be performed by an authorized Lynx dealer.
- Ensure the path behind is clear of obstacles or bystanders before proceeding in reverse.
- Always remove the tether cord cap from engine cut-off switch when vehicle is not in operation in order to prevent accidental engine starting, to avoid unauthorized use by children or others or theft.
- NEVER stand behind or near a rotating track. Debris could be projected causing severe injuries. To remove packed snow or ice, stop engine, tilt and hold vehicle on its side and use screwdriver from tool kit.
- Do not stud the track unless it has been approved for studs. At speed, a studded track that has not been approved for studs could tear and separate from vehicle. See an authorized Lynx dealer for current specific studding availability and applications.
- You may stud the track on this vehicle model. However, you MUST only use the BRP approved type stud for use on Lynx snowmobiles. DO NOT EVER use conventional studs because the track thickness is thinner than our standard tracks. The stud could tear off of track and separate from vehicle.
- Always wear an approved helmet and follow the same dressing guidelines as those recommended for the operator and described in this guide.
- Make sure that you are able to achieve a stable stance, both feet resting positively on the footboards of footrests with good grip, and that you are able to hold on firmly to the handholds.

- Do not forget, with 2-UP models, the operator is responsible for the safety of the passenger. Always remember that the snowmobile handling, stability and braking distance may be affected when riding with a passenger.
- Before riding the vehicle, ask your passenger to inform you to slowdown or stop immediately if he feels uncomfortable or insecure during the ride. Keep a watchful eye on your passenger while riding.

Introduction

NOTE: Some functions or features described in this section may not apply to every model, or may be available as an option.

The throttle is electronic and provides a command signal to an electronic module whose function is to assure proper operation of its system within set parameters.

It is extremely important for operators to read all information contained in this operator's guide so as to become familiar with this snowmobile, its systems, controls, capabilities and limitations.

iTC (intelligent Throttle Control)

The system uses an electronic throttle control (ETC) that provides command signals to the ECM (Engine Control Module). With this system, there is no need for a traditional throttle cable.

The iTC allows the following operating modes:

- ECO mode
- Standard mode
- Sport mode.

ECO Mode

When ECO mode is selected (fuel economy mode), vehicle torque and speed are limited whereby an optimal cruising speed is maintained in order to reduce fuel consumption.

Refer to *OPERATING MODES* subsection for detailed instructions.

Standard Mode

In standard mode, acceleration is reduced when accelerating from a complete stop and when operating in the low vehicle speed range under certain conditions.

Sport Mode

In sport mode, maximum engine power is available throughout the engine operational range.

Refer to *OPERATING MODES* subsection for detailed instructions.

Learning Key Modes

The Lynx™ learning key limits the torque and speed of the snowmobile therefore enabling first time users and less experienced operators to learn how to operate the snowmobile while gaining the necessary confidence and control.

Limitations

The ability of a novice to operate the snowmobile can be exceeded even when a learning key is used.

Refer to *OPERATING MODES* subsection for details.

RIDING THE VEHICLE

Each operator has a responsibility to ensure the safety of other recreationists or bystanders.

You are responsible for proper operation of your vehicle as well as training those whom you allow to ride or drive. There may be noticeable handling and performance differences from one snowmobile to the other.

A snowmobile is relatively simple to operate but like any other vehicle or mechanical equipment, it can be hazardous if you or a passenger are reckless, thoughtless or inattentive. We encourage you to have an Annual Safety Inspection of your snowmobile. Please contact an authorized Lynx dealer for further details. Though not required, it is recommended that an authorized Lynx dealer performs the pre-season preparation of your snowmobile. Each visit to your authorized Lynx dealer is a great opportunity for your dealer to verify if your snowmobile is included in any safety campaign. We also urge you to visit your authorized Lynx dealer in a timely manner if you become aware of any safety related campaigns.

See an authorized Lynx dealer for available accessories you may require.

Before venturing on the trails, operate the snowmobile in a restricted flat area until you are completely familiar with its operation and feel comfortable that you can safely tackle a more demanding task. Have an enjoyable and safe ride.

Pre-Ride Inspection

WARNING

The pre-operation check is very important prior to operating the vehicle. Always check the proper operation of critical controls, safety features and mechanical components before starting.

Before Starting the Engine

1. Remove snow and ice from body including lights, seat, footrests, controls and instruments.
2. Verify that air silencer prefilter is free of snow.
3. Verify that skis and steering operate freely. Check corresponding action of skis versus handlebar.
4. Check fuel and oil for levels and leaks. Replenish if necessary and in case of any leaks; you should seek service from an authorized Lynx dealer, repair shop, or person of your own choosing for maintenance, repair, or replacement.
5. All storage compartments must be properly latched and they must not contain any heavy or breakable objects. Hood and side panels must be also properly latched.
6. Activate the throttle control lever several times to check that it operates easily and smoothly. It must return to idle position when released.
7. Activate the brake lever and make sure the brake fully applies before the brake control lever touches the handlebar grip. It must fully return when released.
8. Apply parking brake and check if it operates properly. Leave parking brake applied.

After Engine Is Started

For proper engine starting procedure, refer to the appropriate *ENGINE STARTING PROCEDURE* section.

1. Check headlights high beam and low beam, taillight, stop light and pilot lamps operation.

NOTE: You may need to detach tether cord from your clothes to check lights. In such a case, attach cord as soon as you get back at the controls of the snowmobile.

2. Check the engine cut-off switch (by pulling tether cord cap) and emergency engine stop switch operation.
3. Release parking brake.
4. Refer to the *VEHICLE WARM UP* section and follow instructions.

Pre-Ride Check List

ITEM	OPERATION	✓
BODY INCLUDING SEAT, FOOTRESTS, LIGHTS, AIR FILTER, CONTROLS AND INSTRUMENTS	Check condition and remove snow or ice.	
SKIS AND STEERING ACTION	Check for free movement and proper operation.	
FUEL AND INJECTION OIL (IF APPLICABLE)	Check for proper level and no leaks.	
COOLANT	Check for proper level and no leaks.	
BRAKE FLUID	Check for proper level and no leaks.	
STORAGE COMPARTMENT	Check for proper latching and no heavy or breakable objects.	
TRACK	Check condition and remove snow or ice. For studded tracks, see <i>INSPECTION</i> in the <i>TRACTION ENHANCING PRODUCTS</i> subsection.	
THROTTLE LEVER	Check for proper operation.	
BRAKE LEVER	Check for proper operation.	
PARKING BRAKE, BRAKE	Check for proper operation.	
EMERGENCY ENGINE STOP SWITCH AND ENGINE CUT-OFF SWITCH (TETHER CORD CAP)	Check for proper action. Tether cord must be attached to operator clothing eyelet.	
LIGHTS	Check for proper operation.	
SKI RUNNERS	Check for proper operation.	
SLIDER SHOES	Check for proper operation.	
DRIVE BELT	Check for cracks, fraying or abnormal wear.	

How to Ride

Riding Gear

Proper snowmobile clothing should be worn. It should be comfortable and not too tight. Always check the weather forecast before going on a ride. Dress for the coldest weather

expected. Thermal underwear next to the skin also provides a good insulation.

Wear an approved helmet at all times for safety and comfort. They provide both warmth and reduce injury. A stocking type cap, balaclava and

face mask should always be carried or worn. Goggles or a face shield that attach to the helmet are indispensable. Hands should be protected by a pair of snowmobile gloves or mitts which have sufficient insulation and allow use of thumbs and fingers for operation of controls.

Rubber bottom boots with either a nylon or a leather top, with removable felt liners are best suited for snowmobiling.

You should keep yourself as dry as possible when snowmobiling. When you come indoors, take your snowmobile suit and boots off and make certain they dry properly.

Do not wear a long scarf or loose apparel that could get caught in moving parts.

Carry colored lens goggles.

What to Bring

First aid kit	Provided tool kit
Mobile phone	Knife
Spare spark plugs	Flashlight
Friction tape	Trail map
Spare drive belt	Snack

Rider Position (Forward Operation)

Your riding position and balance are the two basic principles of making your snowmobile go where you want it to. When turning on the side of a hill, you and your passenger must be ready to shift body weight to help it turn in the desired direction. Operator and passenger(s) must never attempt this maneuvering by placing feet outside of the vehicle. Experience will teach you how much lean to put into turns at different speeds and how much you will have to lean into a slope to maintain proper balance.

Generally, the riding position for best balance and control is sitting. However, the posting, kneeling or standing positions are also used under certain conditions.

⚠ WARNING
 Do not attempt any maneuvers if they are beyond your abilities.

Sitting

Feet on the running boards, body mid-way back on seat is an ideal position when operating the snowmobile over familiar, smooth terrain. Knees and hips should remain flexible to absorb shocks.



Posting

A semi-sitting position with the body off the seat and the feet under the body in a sort of squatting posture, thus allowing the legs to absorb the shocks when traveling over uneven terrain. Avoid abrupt stops.



Kneeling

This position is achieved by placing one foot firmly on the running board and the opposite knee on the seat. Avoid abrupt stops.



fmo2008-003-003

Standing

Place both feet on the running boards. Knees should be flexed to absorb the shock from surface bumps. This is an effective position to see better and to shift weight as conditions dictate. Avoid abrupt stop.



fmo2008-003-004

Rider Position (Reverse Operation)

We recommend sitting on your snowmobile when operating in reverse.

Avoid standing up. Your weight could shift forward against throttle lever while operating in reverse, causing an unexpected acceleration.

⚠ WARNING

Unexpected acceleration when snowmobile operates in reverse can cause a loss of control.

Carrying a Passenger

Certain snowmobiles are designed for an operator only (1-UP), and others can allow one passenger (2-UP). Make sure to identify and respect the warnings according to your specific models.

Even when a passenger is allowed, this person must be physically fit for snowmobiling.

⚠ WARNING

Any passenger must be able to firmly lay his feet on the footrests and keep his hands on the handholds or seat strap at all times when seated. Respecting those physical criteria is important to ensure that the passenger is stable and to reduce the risks of ejection.

On snowmobiles allowing two passengers, if you have an adult and a child for passenger, BRP recommends that the child sits in the center location. This allows an adult sitting in the rear seat to keep a visual contact with the child and hold him if necessary. In addition, the child is best protected against the wind and cold temperature if seated in the center location.

The operator has a responsibility to ensure the safety of his passenger and should inform the passenger about snowmobiling basics.

⚠ WARNING

- Passenger must only sit on designated passenger seat. Never allow anyone to sit between the handlebar and the operator.
- Passenger and operator must always wear an approved helmets and warm clothing appropriate for snowmobiling. Make sure that no skin is exposed.
- Once underway, if the passenger feels uncomfortable or insecure for any reason, he must right away inform the operator to slowdown or stop.

Riding with a passenger on board is different than riding alone. The operator has the benefit of knowing what will be the next maneuver and is able to prepare himself accordingly. The operator also benefits from the support of his grip on the handlebar. In contrast, the passenger has to rely on the operator's careful and safe operation of the vehicle. In addition, "body english" is limited with a passenger, and the operator can sometimes see more of the trail ahead than the passenger. Therefore, smooth starting and stopping are required with a passenger, and the operator must slow down. The operator must also warn the passenger about side hills, bumps, branches, etc. An unforeseen bump can leave you passenger-less. Remind your passenger to lean into the turn with you, without causing the vehicle to topple. Be extremely careful, go more slowly and check the passenger frequently.

⚠ WARNING

When riding with a passenger:

- Braking ability and steering control are reduced. Decrease speed and allow extra space to maneuver.
- Adjust suspension according to weight.

For complete information on how to adjust the suspension, please refer to the *TUNE YOUR RIDE* subsection.

Riding with a Child

On snowmobiles allowing two passengers (with optional seat), if you have an adult and a child for passenger, BRP recommends that the child sits in the center location. This allows an adult sitting in the rear seat to keep a visual contact with the child and hold him if necessary. In addition, the child is best protected against the wind and cold temperature if seated in the center location.

Use extra caution and go even more slowly with a young passenger. Check frequently to make certain the child has a firm grip and is properly positioned with his feet on the running boards.

Terrain/Riding Variations**Groomed Trail**

On a maintained trail, sitting is the most preferred riding position. Do not race and, above all, keep to the right hand side of the trail. Be prepared for the unexpected. Observe all trail signs. Do not zigzag from one side of the trail to the other.

Ungroomed Trail

Unless there has been a fresh snowfall you can expect "washboard" and snowdrift conditions. Taken at excessive speeds, such conditions can be physically harmful. Slow down. Hold on the handlebar and assume a posting position. Feet should be under the body assuming a crouched position to absorb any jarring effect. On longer stretches of "washboard" trails, the kneeling position of one knee on the seat can be adopted. This provides a certain amount of comfort, while at the same time keeps the body loose and

capable of vehicle control. Beware of hidden rocks or tree stumps partially hidden by a recent snowfall.

Deep Snow

In deep “powder” snow, your vehicle could begin to “bog” down. If this occurs, turn in as wide an arc as possible and look for a firmer base. If you do get “bogged”, and it happens to everyone, do not spin your track as this makes the vehicle sink deeper. Instead, turn the engine off, get off and clear the snow under running boards and bottom pan with your feet or a shovel. If possible tilt your snowmobile on side and pack new snow under the track with your feet and tilt snowmobile back to its skis. Then tramp a clear path ahead of the vehicle. A few feet will generally suffice. Restart the engine. Assume the standing position and rock the vehicle gently as you steadily and slowly apply the throttle. Depending on whether the front or rear end of the vehicle is sinking, your feet should be placed on the opposing end of the running boards. Never place foreign material beneath the track for support. Do not allow anyone to stand in front of, or to the rear of, the snowmobile with the engine running. Stay away from the track. Personal injury will result if contact is made with the revolving track.

Frozen Water

Traveling frozen lakes and rivers can be fatal. Avoid waterways. If you are in an unfamiliar area, ask the local authorities or residents about the ice condition, inlets, outlets, springs, fast moving currents or other hazards. Never attempt to operate your snowmobile on ice that may be too weak to support you and the vehicle. Operating a snowmobile on ice or icy surfaces can be very dangerous if you do not observe certain precautions. The very nature of ice is foreign to good control of a snowmobile or any vehicle. Traction for starting, turning or stop-

ping is much less than that on snow. Thus, these distances can be multiplied manyfold. Steering is minimal, and uncontrolled spins are an ever present danger. When operating on ice, drive slowly with caution. Allow yourself plenty of room for stopping and turning. This is especially true at night.

Hard Packed Snow

Don't underestimate hard packed snow. It can be difficult to negotiate as both skis and track do not have as much traction. Best advice is to slow down and avoid rapid acceleration, turning or braking.

Uphill

There are two types of hills you can encounter — the open hill on which there are few trees, cliffs or other obstacles, and a hill that can only be climbed directly. On an open hill, the approach is to climb it by side hilling or slaloming. Approach at an angle. Adopt a kneeling position. Keep your weight on the uphill side at all times. Maintain a steady, safe speed. Continue as far as you can in this direction, then switch to an opposite hill angle and riding position.

A direct climb could present problems. Choose the standing position, accelerate before you start the climb and then reduce throttle pressure to prevent track slippage.

In either case, vehicle speed should be as fast as the incline demands. Always slow down as you reach the crest. If you cannot proceed further, don't spin your track. Turn the engine off, free the skis by pulling them out and downhill, place the rear of the snowmobile uphill restart the engine and ease it out with slow even throttle pressure. Position yourself to avoid tipping over, then descend.

Downhill

Downhill driving requires that you have full control of your vehicle at all times. On steeper hills, keep your center of gravity low and both hands on the handlebar. Maintain slight throttle pressure and allow the machine to run downhill with the engine operating. If a higher than safe speed is reached, slow down by braking but apply the brake with frequent light pressure. Never jam the brake and lock the track.

Side Hill

When crossing a side hill or traversing up or downhill, certain procedures must be followed. All riders should lean towards the slope as required for stability. The preferred operating positions are the kneeling position, with the knee of the down hill leg on the seat and the foot of the uphill leg on the running board, or the posting position. Be prepared to shift your weight quickly as needed. Side hills and steep slopes are not recommended for a beginner or a novice snowmobiler.

Avalanche Hazard

When riding on mountainous terrain, you should be aware of the risk of avalanches. Avalanches vary in size and shapes and generally occur in steep terrain and on unstable snow.

New snow, animals, people, wind and snowmobiles can all trigger an avalanche. Avoid high marking or traversing steep terrain when avalanche conditions are possible. When in unstable snow conditions, travel should be restricted to lower angle slopes. Wind formed cornices should be avoided. Staying off unstable conditions is the key to safe mountain riding. Probably most important is to be aware of the conditions and dangers on a daily basis when in the mountains. Check local avalanche forecasts and threats each day before heading out to ride and heed forecasters advice.

You should always carry a snow shovel, probe and avalanche beacon while riding on mountains. We recommend that all mountain riders take a local avalanche safety training course to become more familiar with snow conditions and learn how to properly use their equipment.

Here are some web sites that can help you finding important information:

– Europe: www.avalanches.org

Slush

Slush should be avoided at all times. Always check for slush before starting across any lake or river. If dark spots appear in your tracks, get off the ice immediately. Ice and water can be thrown rearward into the path of a following snowmobile. Getting a vehicle out of a slush area is strenuous and in some cases, impossible.

Fog or Whiteout Conditions

On land or water, fog or visibility-limiting snow can form. If you have to proceed into the fog or heavy snow, do so slowly with your lights on and watch intently for hazards. If you are not sure of your way, do not proceed. Keep a safe distance behind other snowmobilers to improve visibility and reaction time.

Unfamiliar Territory

Whenever you enter an area that is new to you, drive with extreme caution. Go slow enough to recognize potential hazards such as fences or fence posts, brooks crossing your path, rocks, sudden dips, guy wires and countless other obstacles which could result in a termination of your snowmobile ride. Even when following existing tracks, be cautious. Travel at a speed so you can see what is around the next bend or over the top of the hill.

Bright Sunshine

Bright sunny days can considerably reduce your vision. The glare from sun and snow may blind you to the extent that you cannot easily distinguish ravines, ditches or other obstacles. Goggles with colored lenses should always be worn under these conditions.

Unseen Obstruction

There may be obstructions hidden beneath the snow. Driving off established trails and in the woods requires reduced speed and increased vigilance. Driving too fast in an area can make even minor obstacles very hazardous. Even hitting a small rock or stump could throw your snowmobile out of control and cause injury to its riders. Stay on established trails to reduce your exposure to hazards. Be safe, slow down and enjoy the scenery.

Hidden Wires

Always be on the lookout for hidden wires, especially in areas that may have been farmed at one time or another. Too many accidents have been caused by running into wires in the fields, guy wires next to poles and roads, and into chains and wires used as road closures. Slow speeds are a must.

Obstacles and Jumping

Unplanned jumps of snowdrifts, snow-plow ridges, culverts or indistinguishable objects can be dangerous. You can avoid them by wearing the proper color lenses or face shields and by operating at a lower speed.

Jumping can be a hazardous situation. Be prepared before landing to absorb the shock and brace yourself for the impact. Knees must be flexed to act as shock absorbers. If the trail does suddenly drop away from you, crouch (stand) towards the rear of the vehicle and keep the skis up and straight

ahead. Apply partial throttle and brace yourself for the impact. Knees must be flexed to act as shock absorbers.

Turning

Depending on terrain conditions, there are two preferred ways to turn or corner a snowmobile. For most snow surfaces, "body english" is the key to turning. Leaning towards the inside of the turn and positioning body weight on the inside foot will create a "banking" condition beneath the track. By adopting this position and positioning yourself as far forward as possible, weight will be transferred to the inside ski.

On occasion, you will find that the only way to turn the vehicle about in deep snow is to pull the snowmobile around. Do not over-exert yourself. Get assistance. Remember to always lift using your legs as opposed to your back.



fmo2008-003-005

Road Crossing

In some cases, you will be approaching the road from a ditch or snowbank. Choose a place where you know you can climb without difficulty. Use the standing position and proceed with only as much speed needed to crest the bank. Stop completely at the top of the bank and wait for all traffic to clear. Judge the drop to the roadway. Cross the road at a 90° angle. If you encounter another snowbank on the opposite side, position your feet near the rear of the vehicle. Remember, your

snowmobile is not designed to operate on bare pavement and steering on this type of surface is more difficult.

Railroad Crossing

Never ride on railroad tracks. It is illegal. Railroad tracks and railroad rights-of-way are private property. A snowmobile is no match for a train. Before crossing a railroad track, stop, look and listen.

Night Rides

The amount of natural and artificial light at a given time can effect your ability to see or to be seen. Nighttime snowmobiling is delightful. It can be a unique experience if you acknowledge your reduced visibility. Before you start, make certain your lights are clean and work properly. Drive at speeds that will allow you to stop in time when you see an unknown or dangerous object ahead. Stay on established trails and never operate in unfamiliar territory. Avoid rivers and lakes. Guy wires, barbed wire fences, cabled road entrances and other objects such as tree limbs are difficult to see at night. Never drive alone. Always carry a flashlight. Keep away from residential areas and respect the right of others to sleep.

Riding in a Group

Before starting out, designate a "trail boss" to lead the party and another person to follow-up at the end of the party. Ensure that all members of the party are aware of the proposed route and destination. Make certain that you are carrying all necessary tools and equipment and that you have sufficient fuel to complete the trip. Never overtake the trail boss or, for that matter, any other snowmobile. Use down-the-line hand signals to indicate hazards or intent of direction change. Assist others whenever necessary.

It is always IMPORTANT to keep a safe distance between each snowmobile. Always maintain a safe interval and allow sufficient stopping distance. Don't be a tailgater. Know the position of the machine ahead.

Signals

If you intend to stop, raise either hand straight above your head. A left turn is indicated by extending your left hand straight out in the proper direction. For right turns, extend the left arm and raise the hand to a vertical position so it forms a right angle at the elbow. Every snowmobiler should relay any signal to the ones behind.

Trail Stops

Whenever possible, pull off the trail when you stop. This will reduce the hazard to other snowmobilers using the trail.

Trails and Signs

Trail signs are used to control, direct or regulate the use of snowmobiles on trails. Become familiar with all signs used in the area where you are snowmobiling.

Environment

Wildlife compliments your snowmobiling day. Snowmobile tracks provide firm ground over which animals can travel from area to area. Do not violate this privilege by chasing or harassing wildlife. Fatigue and exhaustion can lead to animal's death. Avoid areas posted for the protection or feeding of wildlife.

If you happen to be fortunate enough to see an animal, stop your snowmobile and observe quietly.

The guidelines that we support are not designed to limit your snowmobiling fun, but to preserve the beautiful freedom that you can experience only on a snowmobile! These guidelines will keep snowmobilers healthy, happy and

able to introduce others to what they know and enjoy about their favorite winter pastime. So, the next time you hit the trails on a cool, crisp and clear winter day, we ask you to remember that you are paving the way for the future of our sport. Help us lead it down the right path! From all of us at BRP, thank you for doing your share.

There is nothing more exhilarating than snowmobiling. Venturing onto snowmobile trails that cross wild areas is an exciting and healthy winter sport. However, as the number of people using these recreational parks increases, so does the potential for damage to the environment. Abuse of land, facilities and resources inevitably leads to restrictions and closures of both private and public land.

In essence, the greatest threat to our sport, is all around us. Which leaves us with one logical choice. When we snowmobile, we must always ride responsibly.

The vast majority respect the law and the environment. Each of us must set an example for those who are new to the sport, young and old alike.

It is in every one's best interest to tread lightly into our recreational areas. Because, in the long run, to protect the sport we must preserve the environment.

Recognizing the importance of this issue and the need for snowmobilers to do their share in preserving areas that make it possible to enjoy our sport, BRP has developed the "Light Treading Is Smart Sledding" campaign for snowmobilers.

Light Treading refers to more than the thread of our tracks. It's a statement of concern, respect and willingness to take the lead and take action. It applies to the environment in general, its proper care and maintenance, its natural inhabitants and all enthusiasts and the public at large who enjoy the great outdoors. With this theme, we invite

all snowmobilers to remember that respecting the environment is not only critical to the future of our industry but to future generations.

Light Treading in no way suggests you should curb your appetite for snowmobiling fun! It simply means tread with respect!

The fundamental objective of Light Treading is one of respect for where and how you ride a snowmobile. You're a light treader when you follow the principles below.

Become informed. Obtain maps, regulations and other information from the Forest Service or from other public land agencies. Learn the rules and follow them and that goes for speed limits, too!

Avoid running over young trees, shrubs, and grasses and don't cut wood. On flatlands or areas where trail riding is popular, it's important to ride only where authorized. Remember, there is a link between protecting your environment and your own safety.

Respect wildlife and be particularly sensitive of animals that are rearing young or suffering from food shortage. Stress can sap scarce energy reserves. Refrain from riding in areas where only animals are intended to tread!

Obey gate closures and regulatory signs and remember, light treaders don't litter!

Stay out of wilderness areas. They're closed to all vehicles. Know where the boundaries are.

Obtain permission to travel across private land. Respect the rights of landowners and other people's privacy. Remember, snowmobile technology has lowered the noise factor considerably, but you still shouldn't rev your engines where quiet "is the order of the day".

Snowmobilers know all too well the efforts that have been made throughout the sport's history to enjoy access to

areas where people can snowmobile safely and responsibly. This effort continues today, as strong as ever.

Respecting the areas where we ride... wherever they may be... is the only way to ensure their future enjoyment. That's one major reason why we know you'll agree that Light Treading is smart sledding! And there are more.

Enjoying the opportunity to see winter and all its natural majestic wonders, is an experience cherished by snowmobilers. Light Treading will preserve this opportunity and will make it possible for us to expose others to the beauty of winter and the unique thrill of our sport! Light Treading will help our sport to grow!

Finally, Light Treading is the sign of a smart snowmobiler. You don't have to leave big tracks or careen through a virgin forest to show you can ride. So whether you're driving a high performance Lynx, a sporty RS snowmobile or any other make or model, show you know what you're doing. Show you know how to send snow flying and make tracks with a light touch!

TRACTION ENHANCING PRODUCTS

NOTE: This section is applicable to snowmobiles equipped with a factory installed track that has been approved by BRP for special studs installation.

⚠ WARNING

Never stud a track that has not been approved for studs. Installing studs on an unapproved track could increase the risk of the track tearing or severing.

⚠ WARNING

You may stud the track on this vehicle model. However, you **MUST** only use the BRP approved type stud for use on these Lynx snowmobiles. **DO NOT EVER** use conventional studs as the track thickness is thinner than other standard tracks. The stud could tear off of track and separate from vehicle. See an authorized Lynx dealer for current specific studding availability and applications.

Using traction enhancing products such as, adjustable or more aggressive ski carbide runners and/or studs on your snowmobile will change its behavior, particularly in terms of manoeuvrability, acceleration, and braking.

Using traction enhancing products gives a better grip on packed snow and ice, but has no noticeable effect on soft snow. For this reason, driving a snowmobile equipped with traction enhancing products requires a certain adaptation period. If your snowmobile is equipped with traction enhancing products, be sure to take plenty of time to get used to the way it handles when turning, accelerating, and braking.

Also, always check local regulations concerning the use of traction enhancing products on snowmobiles. Always drive your snowmobile in a responsible manner, respecting the environment and other people's property.

Manoeuvrability

Using traction enhancing products such as, more aggressive ski carbide runners and/or studs makes the snowmobile grip the ground better at both the front and at the rear. The use of carbide runners is therefore required to give the skis a better grip, so that the front and rear of the snowmobile are in balance. While off-the-shelf carbide ski runners are adequate, they don't necessarily give you optimal control, since that depends on your personal preferences, your riding style, and how your suspension is adjusted.

⚠ WARNING

If the front and rear of the snowmobile are out of balance due to an incorrect combination of traction enhancing products, the snowmobile may tend to oversteer or understeer, which could lead to a loss of control.

Oversteering

In certain conditions, using more aggressive ski carbide runners without studs on the rear track could make the snowmobile prone to oversteering, see illustration.

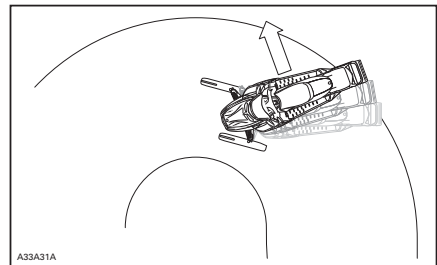

OVERSTEERING

Understeering

In certain conditions, the use of studs on the track could make the snowmobile prone to understeering if the skis are not equipped with more aggressive ski carbide runners, see illustration.

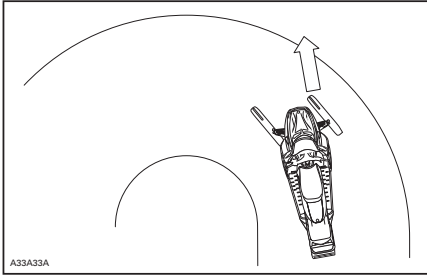

UNDERSTEERING

Controlled Driving

A balanced combination of carbide ski runners and studs on the track ensures adequate control and better handling, see illustration.

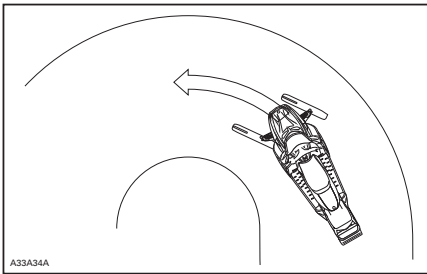

CONTROLLED DRIVING

Acceleration

Using studs on the track will allow your sled to accelerate better on packed snow and ice but will have no noticeable effect on soft snow. This can cause sudden variations in traction under certain conditions.

⚠ WARNING

To prevent surprises that could lead to a loss of control of the snowmobile:

- Always go easy on the throttle.
- NEVER try to spin the track to make the rear of the snowmobile skid.

This could cause debris or ice to be thrown violently backwards, possibly injuring others nearby or on snowmobiles behind you.

Braking

As in the case of acceleration, using studs on the track will give you better braking capacity on packed snow or ice but will have no noticeable effect on soft snow. Braking may thus vary suddenly under certain conditions. Be sure to use restraint in braking to keep from blocking the track in order to avoid surprises that could lead to a loss of control.

Important Safety Rules

⚠ WARNING

To prevent serious injury to individuals near the snowmobile:

- NEVER stand behind or near a moving track.
- Always use a wide-base snowmobile stand with a rear deflector panel if it is necessary to rotate track.
- When the track is raised off the ground, only run it at the lowest possible speed.

Centrifugal force could cause debris, damaged or loose studs, pieces of torn track, or an entire severed track to be violently thrown backwards out of the tunnel with tremendous force.

Effects of Having a Studded Track on the Life of the Snowmobile

The use of traction enhancing products can increase the load and the stress on certain snowmobile components, as well as the vibration level. This can cause premature wear on parts such as belts, brake linings, bearings, chain, chaincase sprocket, and on approved studded tracks, shorten track life. Always proceed with a visual inspection of your track before each use. For more information, refer to the *TRACK* section in *MAINTENANCE*.

Studs on the track can also cause serious damage to your snowmobile if it is not equipped with the tunnel protectors designed for your particular model. Damage to the electrical wiring or perforation of the heat exchangers are potential hazards, that could cause the engine to overheat and be severely damaged.

⚠ WARNING

If tunnel protectors are excessively worn or not installed, the gas tank could be punctured, causing a fire.

NOTICE Ask your dealer for the appropriate tunnel protectors model and kit number required for your snowmobile.

NOTE: Consult the BRP limited warranty to find out what warranty limitations are related to the use of studs.

Installation of Studs on BRP Approved Tracks

⚠ WARNING

Never stud a track that has not been approved for studs. Approved tracks can be identified by a stud symbol (see illustration below) molded into the track surface. Installing studs on an unapproved track could increase the risk of the track tearing or severing.

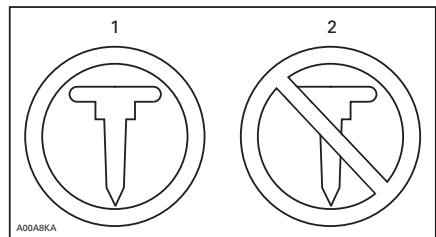

TRACK SYMBOLS

1. Approved
2. NOT Approved

To ensure safe and proper installation, BRP recommends to have the studs installed by your dealer.

- Use only the BRP approved special studs.
- Never use studs that exceed the height of your snowmobile's track profile by more than 9.5 mm (3/8 in).

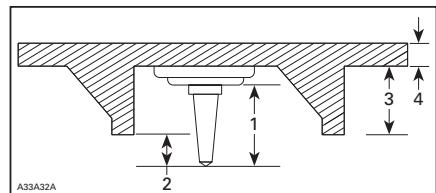

INSTALLATION OF STUDS

1. Stud size
2. Penetration range 6.4 mm to 9.5 mm (1/4 in to 3/8 in)
3. Track lug height
4. Track belt thickness

⚠ WARNING

- See an authorized Lynx dealer for current specific studding availability and applications.
- DO NOT EVER use conventional stud because, the track thickness is thinner than our standard tracks and the stud could tear off of track and separate from vehicle.
- Studs should only be installed in the locations indicated by molded bulges in the track surface. Some track models have two types of molded bulges; triangles and circles. See the warning molded into the track surface to know which one to use.
- Never stud a track with a profile of 35 mm (1-3/8 in) or more.
- The number of studs installed must always perfectly match the pattern of molded bulges in the track.
- Always consult the traction product manufacturer's installation instructions and recommendations before having your dealer install studs and runners. It is very important to follow the torque specifications for the stud bolts.

INSTALLING AN INCORRECT NUMBER OF STUDS OR AN IMPROPER INSTALLATION CAN INCREASE THE RISK OF THE TRACK TEARING OR SEVERING.

Maintenance/Replacement

PROCEED WITH A VISUAL INSPECTION OF YOUR TRACK BEFORE EACH USE.

Look for any defects, such as:

- Perforations in the track
- Tears in the track (particularly around traction holes on studded tracks)
- Lugs that are broken or torn off, exposing portions of rods
- Delamination of the rubber
- Broken rods
- Broken studs (studded tracks)
- Bent studs (studded tracks)
- Missing studs
- Studs that are torn off the track
- Missing track guide(s)
- Also, ensure that studs nut are tighten to the recommended torque.

On approved studded tracks, replace broken or damaged studs immediately. If your track shows signs of deterioration, it must be replaced immediately. When in doubt, ask your dealer. Always proceed with a visual inspection of your track before each use.

⚠ WARNING

Riding with a damaged track or studs could lead to loss of control.

IMPORTANT ON-PRODUCT LABELS

Vehicle Safety Labels

These labels are affixed to the vehicle for the safety of the operator, passenger or bystanders.

The following labels are on your vehicle and they should be considered permanent parts of the vehicle. If missing or damaged, the decals can be replaced free of charge. See an authorized Lynx dealer.

NOTE: In the event of any discrepancy between this guide and the vehicle, the safety labels on the vehicle have precedence over the labels in this guide.

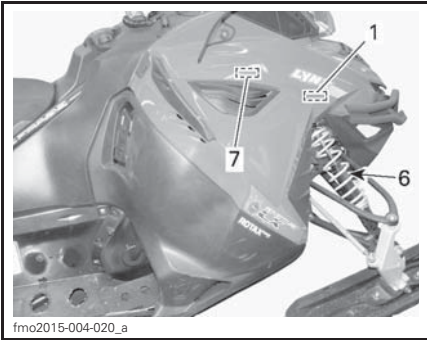

ACE MODELS

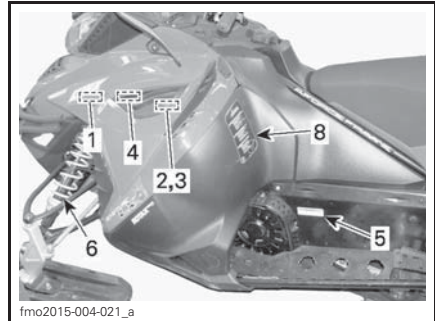

TYPICAL ACE MODELS

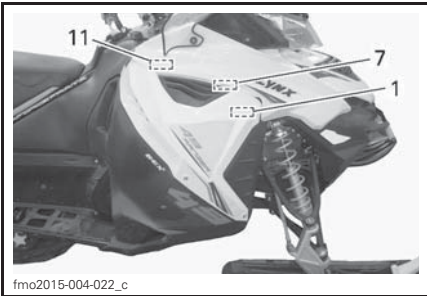

E-TEC MODEL

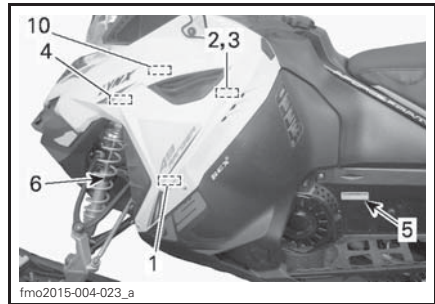

E-TEC MODEL

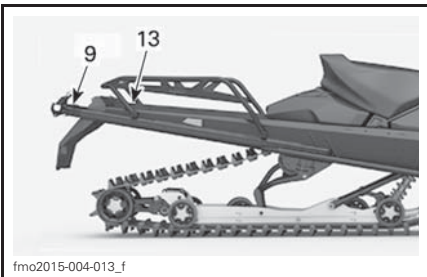

TYPICAL

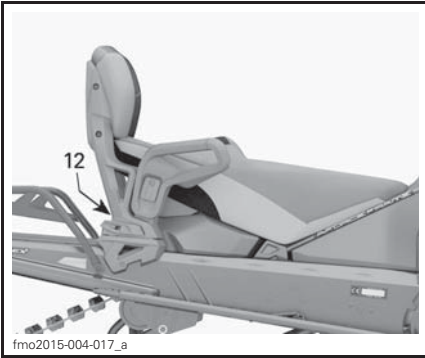

2 UP MODEL

⚠ CAUTION

ENGINE OIL AND CERTAIN COMPONENTS IN THE ENGINE COMPARTMENT MAY BE HOT. DIRECT CONTACT MAY RESULT IN SKIN BURN.

CHECKING ENGINE OIL LEVEL

- Make sure engine is at operating temperature.
- Vehicle must be level to perform verification.
- Let engine running at idle for at least 30 seconds.
- Stop engine and wait at least 30 seconds.
- Check oil level using the dipstick.
- The engine of this snowmobile has been developed and validated using the BRP XPS™ Synthetic 4-stroke oil (293 600 112), BRP strongly recommends the use of its XPS™ Synthetic 4-stroke oil at all times. Damages caused by oil which is not suitable for the engine will not be covered by the BRP limited warranty.

516005521

LABEL 4

⚠ CAUTION

Beware of HOT parts!

516006903

LABEL 1

⚠ WARNING

This guard must ALWAYS be in place when engine is running.

Beware of rotating parts - they could cause injuries or catch your clothing.

516006900 en

LABEL 5

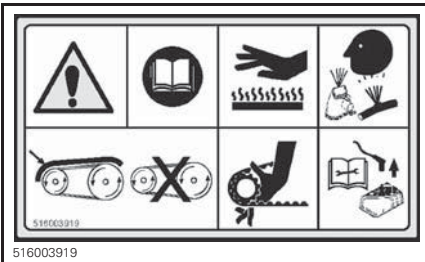

LABEL 2- ON PULLEY GUARD

⚠ WARNING: Under pressure.

Avoid flame or spark.

Do not disassemble.

Do not torch, puncture or unsolderate.

fmo2014-001-017

LABEL 6- SHOCK

⚠ WARNING

This guard must ALWAYS be in place when engine is running.

Beware of rotating parts - they could cause injuries or catch your clothing.

516006900 en

LABEL 3 ON PULLEY GUARD

⚠ WARNING

DO NOT OPEN WHEN HOT

⚠ AVERTISSEMENT

NE PAS OUVRIR A CHAUD

516005904A

LABEL 7



mmo2008-003-007

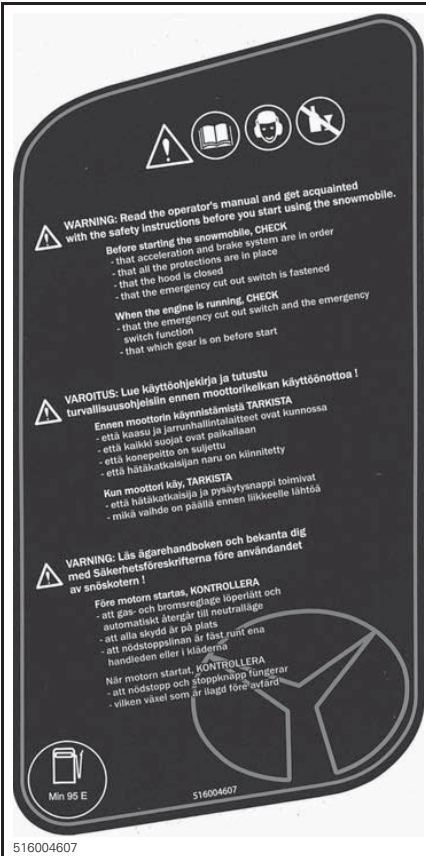

516004607

LABEL 8

Label 9

⚠ WARNING

- Always use a securely fastened rigid tow bar to tow.
- Always reduce your speed when towing.
- NEVER sit nor exceed maximum load capacity in cargo area.
- **MAXIMUM REAR LOAD: 15kg (33lbs)**
- **MAXIMUM towing capacity: 2500N / 250 kg / 562lbs.**
- **MAXIMUM tongue capacity: 100N / 10 kg / 22 lbs.**

⚠ WARNING

516008282

EN-516008282-DEC

LABEL 9 - 49 RANGER - X TRIM SC

⚠ WARNING

-Gasoline vapor may cause fire or explosion. **ALWAYS** refer to service manual before installing or servicing this fuel injector.

-Injectors **MUST** remain located on their original cylinder to avoid a powerhead failure.

Tampering with emissions related parts can result in penalties under federal law and voiding the product warranty.

mmo2013-004-046_a

LABEL 10 - E-TEC

<p style="text-align: center;">⚠ WARNING</p> <p>Capacitor May Spark If Shorted.</p> <ul style="list-style-type: none"> -Spark can ignite fuel vapors. -Keep objects away from poles. -When removing from vehicle, always discharge properly. 	<p>CAPACITOR</p>
---	-------------------------

516006206

LABEL 11 E-TEC

⚠ WARNING

Always electrically disconnect both fuel injectors prior to testing for ignition spark. Otherwise, fuel vapors may ignite in presence of a spark creating a fire hazard.

5583A

516005583A

LABEL 11 E-TEC ONLY

Label 12 - 2 UP MODELS

⚠ WARNING

- Read operator's guide and get acquainted with the instructions before remove seat from the snowmobile.
- Make sure seat is securely latched before riding.



LABEL 12 - 2 UP MODELS

Label 13

⚠ WARNING
Beware of rotating track



LABEL 13

Technical Information Labels

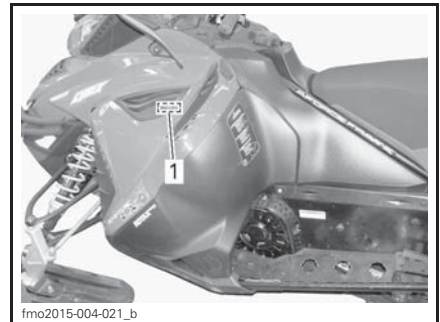

ACE MODELS

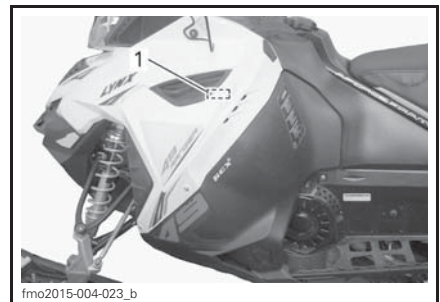

E-TEC MODELS



ACE MODELS

TARKISTA öljypinnan korkeus voimansiirrosta kerran viikossa.
OLJENIVÄ I KRAFTÖVERFÖRING
Kontrolleras varje vecka

Oil level in transmission should be checked once a week.

5447012 5447012

LABEL 2

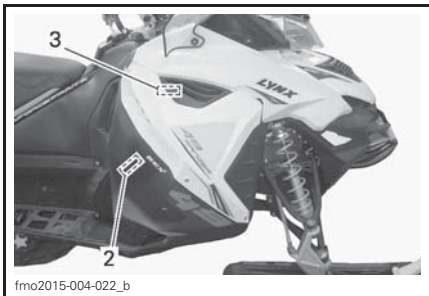

E-TEC MODELS

NOTICE

The engine of this snowmobile has been developed and validated using the BRP XPS™ approved lubricant. BRP strongly recommends the use of its XPS™ approved lubricant at all times. Damages caused by oil which is not suitable for the engine will not be covered by the BRP limited warranty.

516006904 516006904

516006904 en

LABEL 3 - IN ENGINE COMPARTMENT

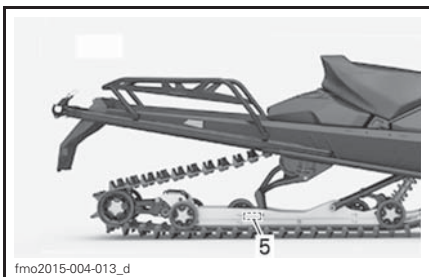

NOTICE

Drive pulley bolt recommended torque
85-92 lbf·ft / 115-125N·m

Not applying the recommended torque may result in a major failure of the drive pulley and the engine. Refer to the shop manual for the complete assembly procedure.

516005503 516005503

LABEL 1

NOTICE

- To comply with noise regulations, this engine is designed to operate with an air intake silencer.
- Operation without air intake silencer or with one not properly installed may cause engine damage.

516004572 516004572

516004572

LABEL 4 E-TEC MODELS

WITHOUT FORCE:
> 35- 45mm

WITH FORCE (7.3kg):
> 50- 60mm

516007588 516007588

LABEL 6- ADVENTURE LX

WITHOUT FORCE:
> 40- 50mm

WITH FORCE (7.3kg):
> 60- 70mm

516007589 516007589

LABEL 6- 49 RANGER

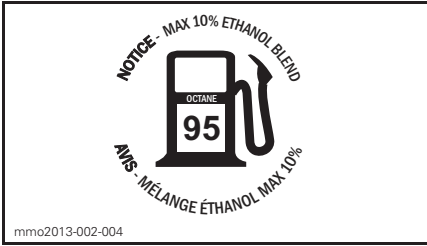

LOCATED ON FUEL CAP

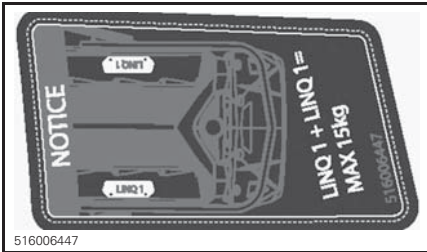

LABEL ON REAR RACK - ADVENTURE LX

***This page is
intentionally blank***

VEHICLE INFORMATION

CONTROLS, INSTRUMENTS AND EQUIPMENT

NOTE: Some features may not apply to your model or could be optional.

NOTE: Some vehicle safety labels are not shown on illustrations. For information on vehicle safety labels, refer to *VEHICLE SAFETY LABELS* subsection.

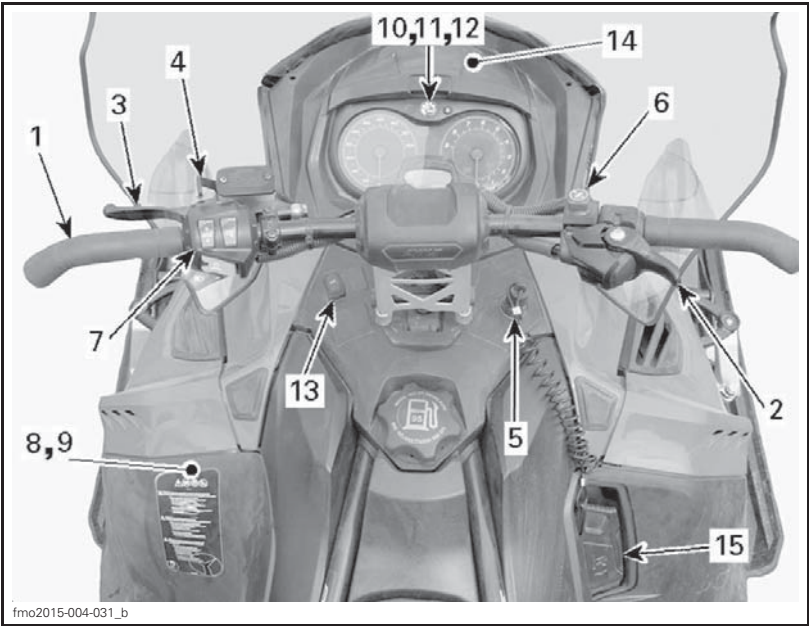

TYPICAL

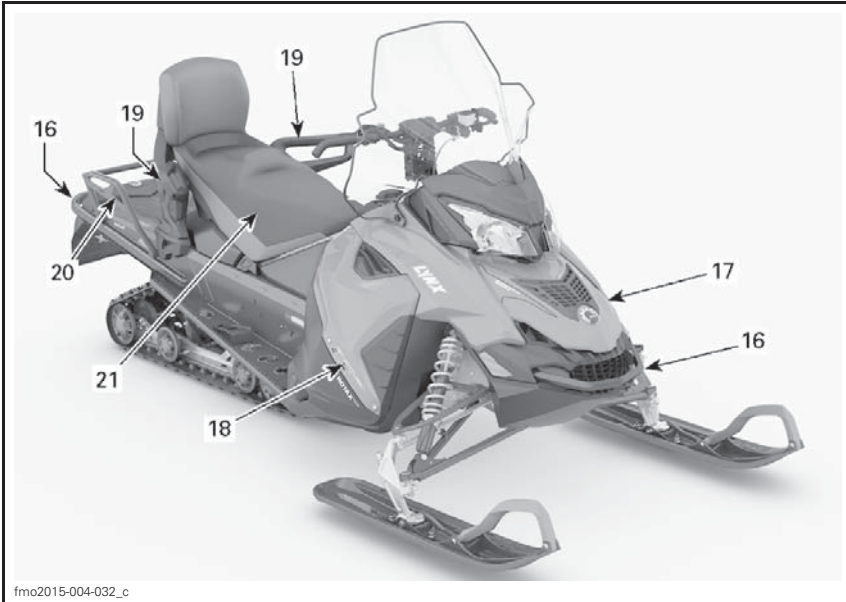

fmo2015-004-032_c

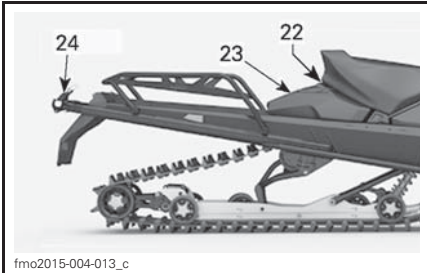

fmo2015-004-013_c

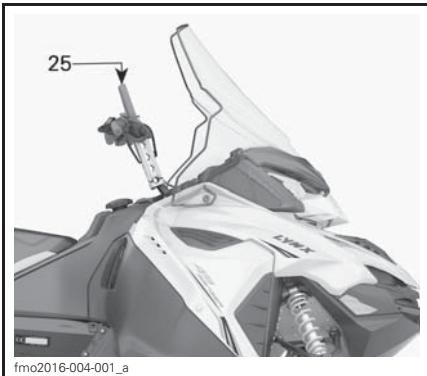

fmo2016-004-001_a

1) Handlebar

The handlebar controls the steering of the snowmobile. As the handlebar is rotated to right or left, the skis are turned right or left to steer the snowmobile.

! WARNING

Fast reverse while turning, could result in loss of stability and control.

2) Throttle Lever

Throttle Lever

E-TEC Models

Throttle lever is located on the RH side of handlebar.

Designed to be thumb activated. When squeezed, it increases the engine speed. When released, engine speed returns automatically to idle.

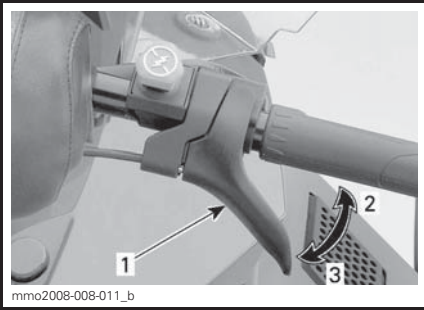

TYPICAL

1. Throttle lever
2. To accelerate
3. To decelerate

⚠ WARNING

Test the throttle lever operation each time before starting the engine. The lever must return to the rest position once released. Otherwise, do not start engine.

Throttle Lever

600 ACE and 900 ACE Models

Throttle lever is located on the RH side of handlebar.

Designed to be either thumb activated or finger activated. When squeezed, it increases the engine speed. When released, engine speed returns automatically to idle.

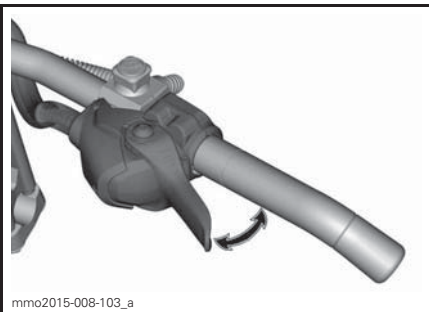

TYPICAL

⚠ WARNING

Test the throttle lever operation each time before starting the engine. The lever must return to its rest position once released. Otherwise, do not start engine.

Switching from Thumb to Finger Throttle Position

⚠ CAUTION It is highly recommended to immobilize the snowmobile before attempting any modification to the throttle position as it could lead to a hazardous situation.

There are mainly three positions to choose from when going from the thumb to the finger throttle position and the best one will be to the rider's preference and in direct relation with the riding style and conditions.

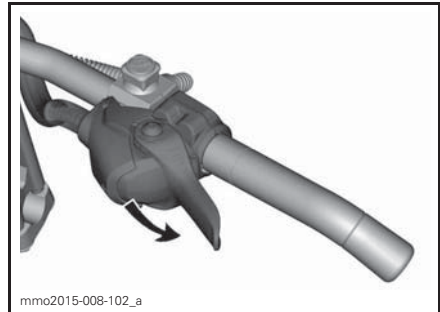

THUMB THROTTLE POSITION : PUSH DOWNWARD TO ROTATE THROTTLE HOUSING

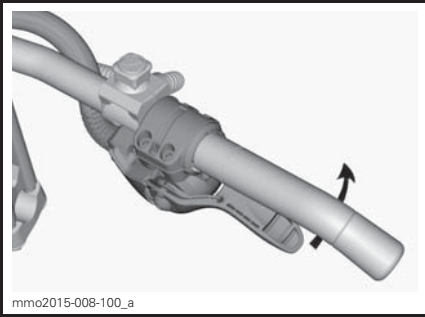

mmo2015-008-100_a

IF WANTED, CONTINUE TO ROTATE THE THROTTLE HOUSING

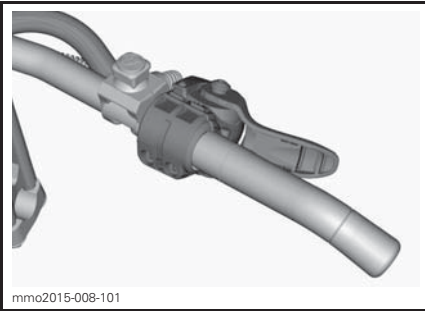

mmo2015-008-101

FINGER THROTTLE POSITION

⚠ CAUTION

- It is **HIGHLY** recommended to use gloves and **NOT** mitts when using the finger throttle position.
- It is not recommended to use the finger throttle position while riding in dense off trail areas.

The procedure to go back to the thumb throttle position is the reverse of the one shown above.

3) Brake Lever

Brake lever is located on the LH side of handlebar.

When squeezed, brake is applied. When released, it automatically returns to the rest. Braking effect is proportional to the pressure applied on the lever and to the type of terrain and its snow coverage.

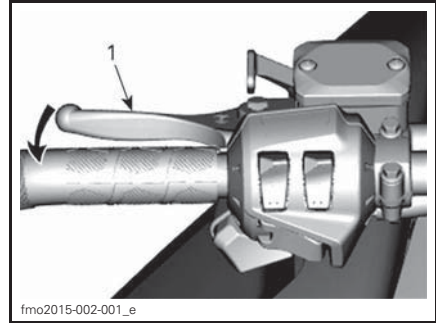

fmo2015-002-001_e

TYPICAL

1. Brake lever
2. To apply brake

4) Parking Brake Lever

Parking brake lever is located on the LH side of handlebar.

Parking brake should be used whenever snowmobile is parked.

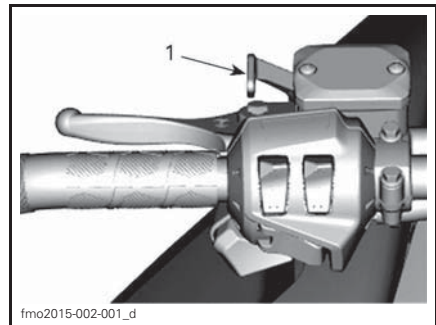

fmo2015-002-001_d

TYPICAL

1. Parking brake lever

⚠ WARNING

Make sure parking brake is fully disengaged before operating the snowmobile. When you ride the vehicle, brake pads that are caused to drag by a continuous pressure on the lever may cause damage to the brake system and cause loss of braking capacity and/or fire.

To Engage Parking Brake

Apply and hold brake, then lock brake lever using the parking brake lever as shown.

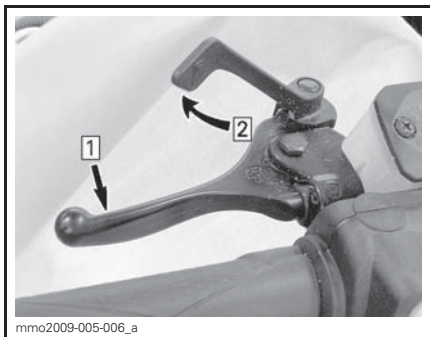

TYPICAL — ENGAGE MECHANISM

Step 1: Apply and hold brake

Step 2: Lock brake lever using parking brake lever

To Release Parking Brake

Squeeze brake lever. Parking brake lever will automatically return to its original position. Always release parking brake before riding.

5) Engine Cut-Off Switch

The engine cut-off switch (tether cord) is located to on the RH side of console.

The tether cord cap must be securely snapped on the engine cut-off switch to allow vehicle operation.

NOTE: After engine starting, 2 short beeps should be heard if a programmed D.E.S.S. key (tether cord cap) is correctly snapped on engine cut-off switch. If another beep code is heard, refer to *MONITORING SYSTEM* for D.E.S.S. malfunction codes information.

Pulling the tether cord cap from the switch shuts the engine off.

WARNING

Always attach the tether cord eyelet to clothing before starting the engine.

D.E.S.S. (Digitally Encoded Security System)

The tether cord cap has an integrated D.E.S.S. key to provide you and your snowmobile with the equivalent security of a conventional lock key.

The D.E.S.S. key contains an electronic chip which features a unique permanently memorized digital code.

Your authorized Lynx dealer has programmed the D.E.S.S. of your snowmobile to recognize the D.E.S.S. key in the tether cord cap to allow vehicle operation.

If another tether cord is used without programming the D.E.S.S., the engine will start but will not reach drive pulley engagement speed to move vehicle.

Make sure the tether cord cap is free of dirt or snow.

D.E.S.S. Flexibility

The D.E.S.S. of your snowmobile can be programmed by your authorized Lynx dealer to accept up to 8 different keys.

We recommend the purchase of additional tether cords from your authorized Lynx dealer. If you have more than one D.E.S.S. equipped Lynx snowmobile, each can be programmed by your authorized Lynx dealer to accept the other vehicles D.E.S.S. keys.

RF D.E.S.S. Key Types

Two types of keys can be used:

- Normal key
- Learning key.

To ease key type recognition, the key comes in different colors.

KEY TYPE	COLOR
Normal	Gray
Learning	Green

The Lynx learning key, limits the speed of the snowmobile and the engine torque, therefore enabling first time users and less experienced operators to learn how to operate the snowmobile while gaining the necessary confidence and control.

NOTE: The initial learning key programming can limit the speed to 40 km/h (25 MPH) or 70 km/h (43 MPH). Refer to your authorized Lynx dealer to modify this setting.

Refer to *OPERATING MODES* subsection for details.

6) Emergency Engine Stop Switch

The emergency engine stop switch is located on the RH side of handlebar.

Use the emergency stop switch to stop engine in a emergency situation.

To stop the engine, push switch down (OFF position).



OFF POSITION

To allow engine starting, the switch must be in the ON position (UP).



ON POSITION

All operators of the snowmobile should familiarize themselves with the function of the emergency engine stop switch by using it several times on first outing and whenever stopping the engine thereafter. This engine stopping procedure will become a reflex and will prepare operators for emergency situations requiring its use.

! WARNING

If the switch has been used in an emergency caused by a suspected malfunction, the source of the malfunction should be determined and corrected before restarting engine. See an authorized Lynx dealer for servicing.

7) Multifunction Switch

Multifunction switch is located on the LH side of handlebar.

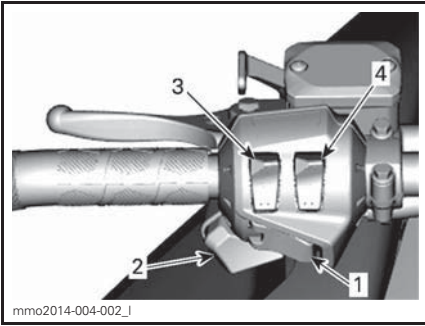

1. Start button
2. Headlights dimmer switch
3. Heated grips
4. Heated throttle lever

Touring Kit Models

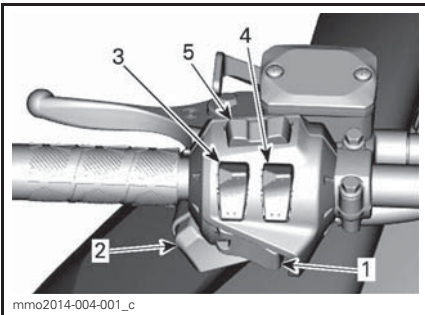

1. Start/Electronic Reverse button
2. Headlights dimmer switch
3. Heated grips
4. Heated throttle lever
5. Mode/set button

Start Button

Press to start engine. Refer to *ENGINE STARTING PROCEDURE* in the *OPERATING INSTRUCTIONS* subsection.

Headlights Dimmer Switch

Press to select HI or LOW beam. Lights are automatically ON when the engine is running.

Heated Grips and Throttle Lever Switch

E-TEC

NOTE: Under 1900 RPM, heated grips or throttle lever will be limited at 50%.

ACE

NOTE: Heated grips or throttle lever are enabled above 1900 engine RPM.

All Models

Depress switch as required to select heating intensity to keep your hands at a comfortable temperature.

Heated Grips Switch

E-TEC and ACE Models

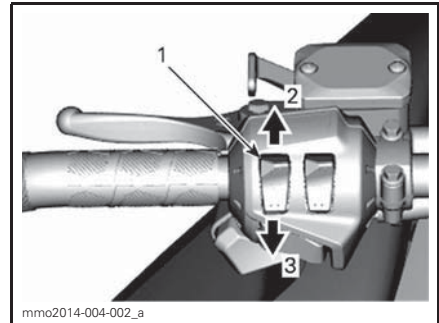

TYPICAL

1. Heated grip switch
2. Increase heat
3. Decrease heat

Heated Throttle Lever Switch

E-TEC and ACE Models

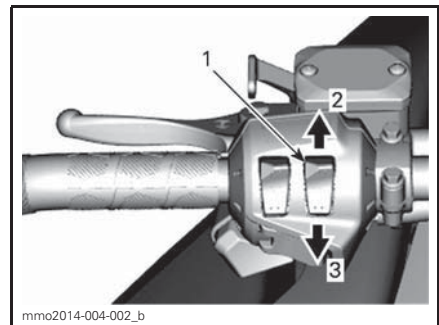

TYPICAL

1. Heated throttle lever switch
2. Increase heat
3. Decrease heat

8) Tool Kit

A tool kit containing tools for basic maintenance is supplied with the vehicle.

The tool kit support is located in engine compartment on pulley guard.

NOTICE Make sure tool kit is secured properly to avoid contact with CVT (continuously variable transmission).

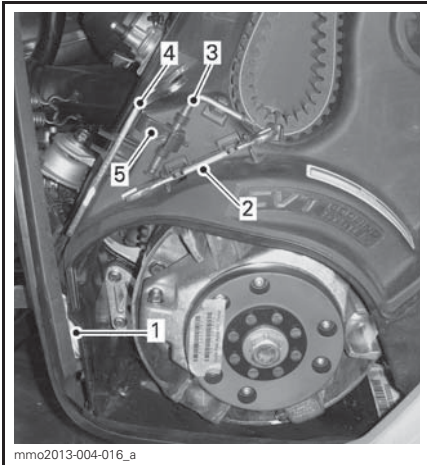

TYPICAL

1. Emergency rope (E-tec Models)
2. Wrench
3. Driven pulley expander
4. Suspension adjustment tool
5. Starter clip

9) Drive Belt Guard

Drive Belt Guard Removal

⚠ WARNING

NEVER operate engine:

- Without shields and drive belt guard securely installed.
- With hood and/or side panels opened or removed.

NEVER attempt to make adjustments to moving parts while engine is running.

NOTE: Belt guard is purposely made slightly oversize to maintain tension on its pins and retainers preventing undue noise and vibration. It is important that this tension be maintained when reinstalling.

Remove tether cord cap from engine cut-off switch.

Open engine compartment LH side panel, see procedure in this subsection.

Remove retaining pin.

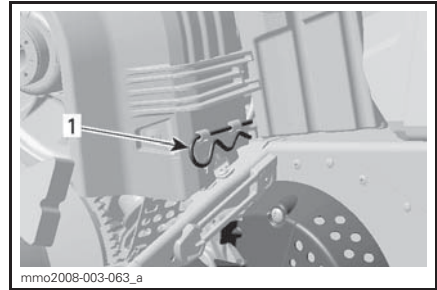

1. Retaining pin

Lift rear portion of guard then release from front tabs by pivoting the guard outwards.

Drive Belt Guard Installation

When reinstalling drive belt guard, position its cutaway toward front of snowmobile.

Insert the tab into the slot and push it into place



TYPICAL

1. Tab

Position the grommet over the retaining rod. It may be necessary to slightly lift the console to make room.

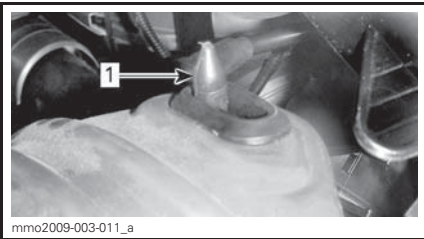

1. Retaining rod

Position rear portion of the drive belt guard over the retainer and secure it using the retaining pin.

NOTE: The drive belt guard is purposely made slightly oversize to maintain tension on its pins and retainers preventing undue noise and vibration. It is important that this tension be maintained when reinstalling.

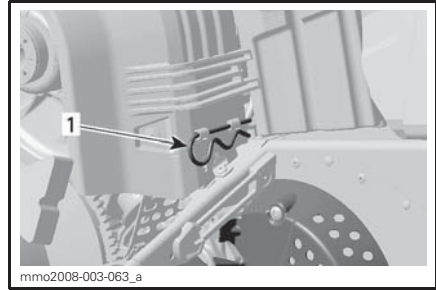

1. Retaining pin

10) Gauge

ACE Models

⚠ WARNING

Reading the gauge digital display can distract from the operation of the vehicle, particularly from constantly scanning the environment.

Gauge Description

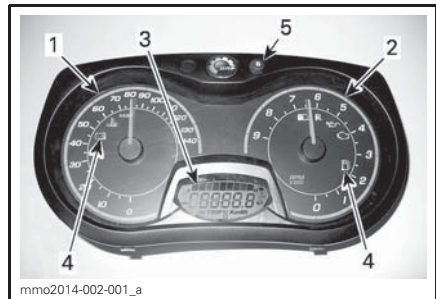

ANALOG/DIGITAL GAUGE (STANDARD)

1. Speedometer
2. Tachometer (RPM)
3. Gauge Digital Display
4. Gauge Pilot Lamps
5. Gauge SET "S" button

NOTE: The gauge is factory preset in metric units but it is possible to change it to Imperial units, contact an authorized Lynx dealer for unit settings.

1) Speedometer

Measures vehicle speed (in miles per hour or kilometers per hour depending on the setting).



mmo2014-001-001

LH PORTION OF GAUGE

2) Tachometer (RPM)

Measures engine revolution per minute (RPM). Multiply by 1000 to obtain the actual revolutions.

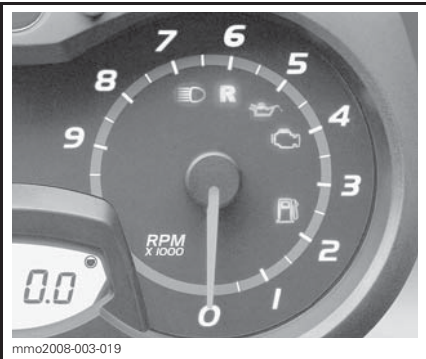

mmo2008-003-019

RH PORTION OF GAUGE

4) Pilot Lamps and Messages



mmo2014-002-003_a

TYPICAL — PILOT LAMPS

3) Digital Display



mmo2014-002-001_b

1. Digital display



The multifunction display is used to:

- Display the WELCOME message on power up
- Display the KEY recognition message
- Provide various indications as selected by the operator
- Activating or changing various functions or modes of operation
- Display scrolling messages of function activation or system faults
- Display fault codes.

⚠ WARNING

Never adjust or set functions on the multifunction gauge while riding the vehicle.

See table below for usual pilot lamps information. Refer to *MONITORING SYSTEM* for details on malfunction pilot lamps.

PILOT LAMP(S) ON	BEEPER	DESCRIPTION
	—	Low fuel level. One (1) bar left in fuel level display. Replenish fuel tank as soon as possible.
	Long beeps repeating slowly	Reverse is selected.
	—	High beam headlights are selected.

5) SET (S) Button

Button used to navigate, adjust or reset gauge multifunction display.

In order to memorize settings, engine must be running.

Gauge Features

AVAILABLE INDICATIONS IN DIGITAL DISPLAY		
FUNCTIONS	ADVENTURE LX	49 RANGER
A) Odometer	X	X
B) Trip meter "A" or "B"	X	X
C) Trip hour meter	X	X
D) Fuel level	X	X

NOTE: The display is factory preset in Metric units but it is possible to change it to Imperial units, contact an authorized Lynx dealer for unit settings.

A) Odometer

Records the total distance travelled.
Press the SET (S) button to select odometer mode.



mmo2014-002-001_d

1. Odometer mode

B) Trip Meter "A" or "B"

Trip meters records distance travelled since it has been reset.
Press the SET (S) button to select trip meter (TRIP A/TRIP B) mode.



mmo2014-002-001_d

1. Trip meter (TRIP A/TRIP B) mode

Press and hold the SET (S) button to re-set.



mmo2014-002-001_c

C) Trip Hour Meter

Records vehicle running time when the electrical system is activated since it has been reset.

Press the SET (S) button to select trip hour meter (HrTRIP) mode.



mmo2014-002-001_d

1. Trip hour meter (HrTRIP) mode

Press and hold the SET (S) button to re-set.



mmo2014-002-001_c

D) Fuel Level

Bar gauge that continuously indicates the amount of fuel left in the fuel tank.

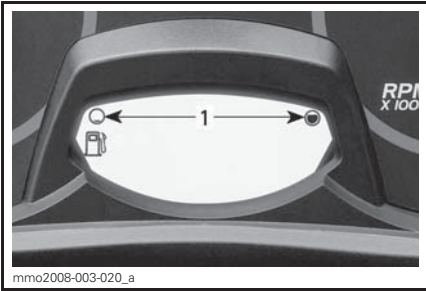

FUEL LEVEL
1. Operating range

E) Heated Grips Heating Intensity

The heating intensity is displayed via the digital display.

NOTE: There are nine intensity settings. When released, display will return to fuel tank level.

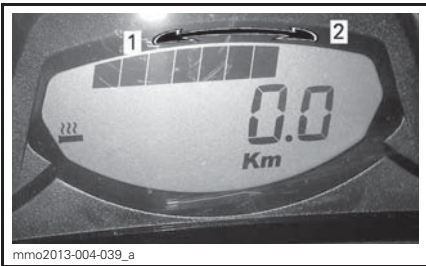

HEATING INTENSITY DISPLAY
1. Less heat
2. More heat

F) Heated Throttle Lever Heating Intensity

NOTE: The heating intensity is displayed via the digital display with the activation of the throttle lever switch. When released, display will return to fuel tank level.

NOTE: There are nine intensity settings.

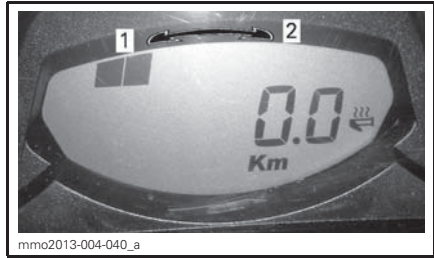

HEATING INTENSITY DISPLAY
1. Less heat
2. More heat

Gauge Setup

Unit Selection (KM/H vs MPH)

The units can be set in metric or imperial. Refer to an authorized Lynx dealer.

11) Analog/Digital Gauge (Standard)

E-TEC Models

! WARNING
Reading the gauge digital display can distract from the operation of the vehicle, particularly from constantly scanning the environment.

Gauge Description

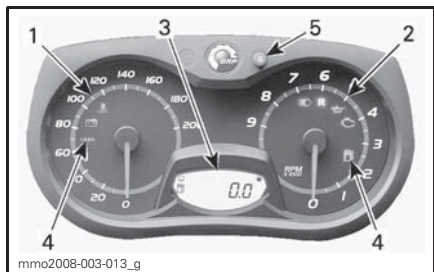

ANALOG/DIGITAL GAUGE (STANDARD)
1. Speedometer
2. Tachometer (RPM)
3. Gauge Digital Display
4. Pilot Lamps
5. Gauge SET "S" button

NOTE: The gauge is factory preset in metric units but it is possible to change it to Imperial units, contact an authorized Lynx dealer for unit settings.

1) Speedometer

Measures vehicle speed (in miles per hour or kilometers per hour depending on the setting).

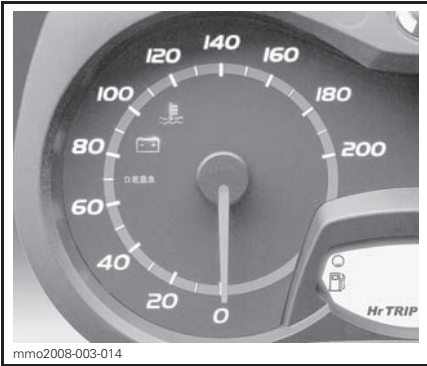

mmo2008-003-014

LH PORTION OF GAUGE

2) Tachometer (RPM)

Measures engine revolution per minute (RPM). Multiply by 1000 to obtain the actual revolutions.

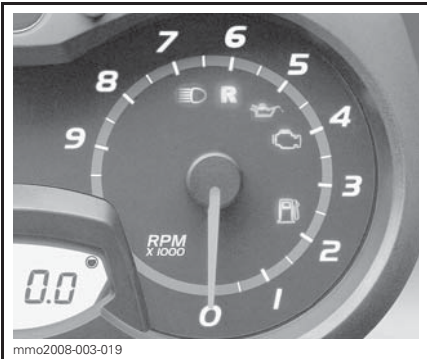

mmo2008-003-019

RH PORTION OF GAUGE

3) Digital Display

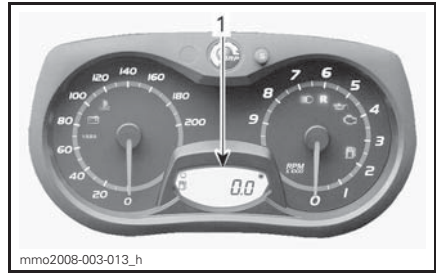

mmo2008-003-013_h

1. Digital display

The multifunction display is used to:

- Display the WELCOME message on power up
- Display the KEY recognition message
- Provide various indications as selected by the operator
- Activating or changing various functions or modes of operation
- Display scrolling messages of function activation or system faults
- Display fault codes.

⚠ WARNING

Never adjust or set functions on the multifunction gauge while riding the vehicle.





4) Pilot Lamps and Messages



mmo2008-003-024_a

TYPICAL — PILOT LAMPS

See table below for usual pilot lamps information. Refer to *MONITORING SYSTEM* for details on malfunction pilot lamps.

PILOT LAMP(S) ON	BEEPER	DESCRIPTION
	4 short beeps every 5 minutes	Injection oil level is low. Stop vehicle in a safe place then, replenish injection oil reservoir.
	—	Low fuel level. One (1) bar left in fuel level display. Replenish fuel tank as soon as possible.
	Long beeps repeating slowly	Reverse is selected.
	3 short beeps	Reverse did not engage, try again.
	—	High beam headlights are selected.
—	—	E-TEC: Engine and/or injection oil need to warm-up before normal operation. The engine's RPM is limited until desired temperature is reached.

5) SET (S) Button

Button used to navigate, adjust or re-set gauge multifunction display.

In order to memorize settings, engine must be running.

NOTE: SET (S) button on the multifunction switch has the same functions and can also be used.

Gauge Features

GAUGE FEATURES	
FUNCTIONS	600 HO E-TEC
A) Odometer	X
B) Trip meter "A" or "B"	X
C) Trip hour meter	X
D) Fuel level	X
E) Engine Coolant Temperature ⁽¹⁾	X
F) Engine Storage Mode	X
X = An X indicates a standard feature Opt = Feature available as an option N.A. = Not available (1) Coolant temperature is an option package. See a Lynx dealer for more information	

NOTE: The display is factory preset in Metric units but it is possible to change it to Imperial units, contact an authorized Lynx dealer for unit settings.

A) Odometer

Records the total distance travelled.
Press the SET (S) button to select odometer mode.

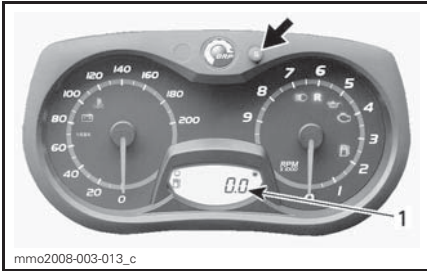

mmo2008-003-013_c

1. Odometer mode

B) Trip Meter A or B

Trip meters records distance travelled since it has been reset.

Press the SET (S) button to select trip meter (TRIP A/TRIP B) mode.

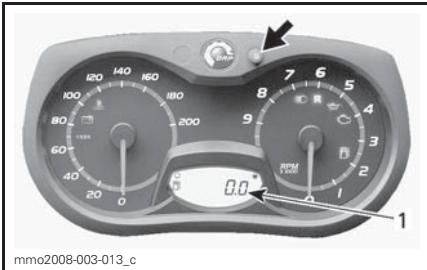

mmo2008-003-013_c

1. Trip meter (TRIP A/TRIP B) mode

Press and hold the SET (S) button to reset.

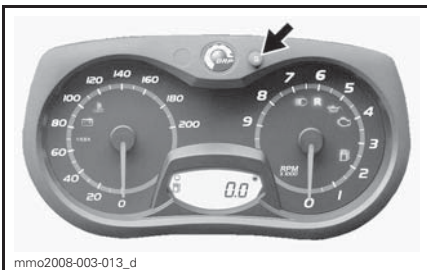

mmo2008-003-013_d

C) Trip Hour Meter

Records vehicle running time when the electrical system is activated since it has been reset.

Press the SET (S) button to select trip hour meter (HrTRIP) mode.

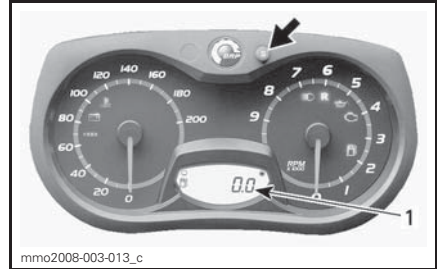

mmo2008-003-013_c

1. Trip hour meter (HrTRIP) mode

Press and hold the SET (S) button to reset.

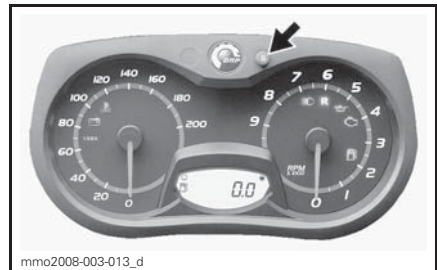

mmo2008-003-013_d

D) Fuel Level

Bar gauge that continuously indicates the amount of fuel left in the fuel tank.

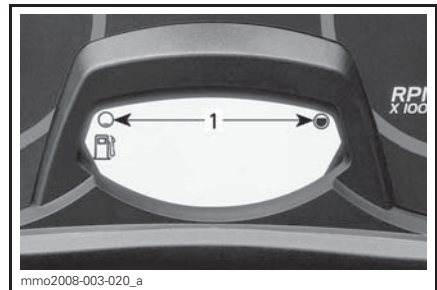

mmo2008-003-020_a

FUEL LEVEL

1. Operating range

Engine Coolant Temperature
(Optional Module)

Overheating indicator.

NOTICE If engine overheats, stop vehicle in a safe place. Refer to TROUBLESHOOTING section.

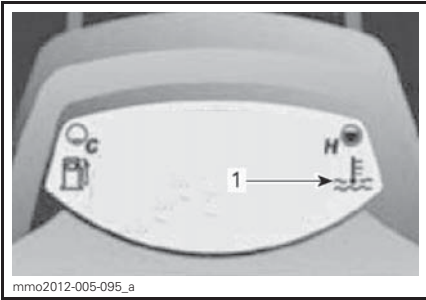

OPTIONAL MODULE INSTALLED
1. Overheating indicator

F) E-TEC Engine Storage Mode

Displays "OIL" when the engine enters the storage procedure.

**12) Multifunction
Analog/Digital Gauge**

E-TEC Touring Kit Models with
Multifunction Analog/Digital Gauge

⚠ WARNING

Reading the gauge digital display can distract from the operation of the vehicle, particularly from constantly scanning the environment.

Gauge Description

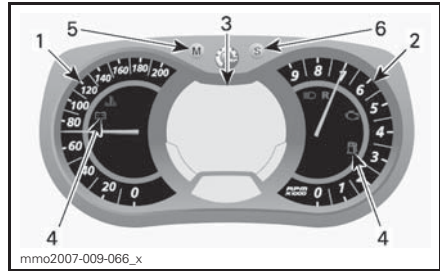

MULTIFUNCTION ANALOG/DIGITAL GAUGE

1. Speedometer
2. Tachometer
3. Multifunction digital display
4. Pilot lamps
5. Mode button
6. Set button

NOTE: The gauge is factory preset in metric units but it is possible to change it to Imperial units, contact an authorized Lynx dealer for unit settings.

1) Speedometer

Measures vehicle speed.



LH PORTION OF GAUGE

2) Tachometer (RPM)

Measures engine revolution per minute (RPM). Multiply by 1000 to obtain the actual revolutions.



RH PORTION OF GAUGE

4) Pilot Lamps and Messages

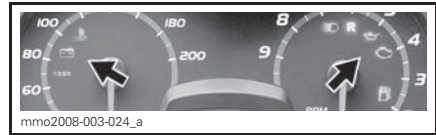

TYPICAL — PILOT LAMPS

3) Multifunction Digital Display

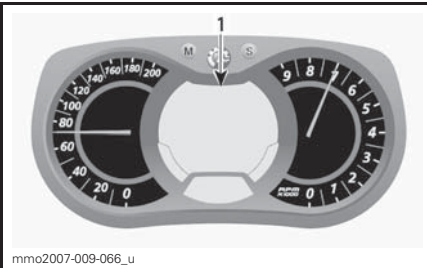

MULTIFUNCTION ANALOG/DIGITAL GAUGE
1. Multifunction display

The multifunction display is used to:







- Display the WELCOME message on power up
- Display the KEY recognition message
- Provide various indications as selected by the operator
- Activating or changing various functions or modes of operation
- Display scrolling messages of function activation or system faults
- Display fault codes.

When the information center is first powered up, the numerical display defaults to the last selected indication.

⚠ WARNING

Never adjust or set functions on the multifunction gauge while riding the vehicle.

See table below for usual pilot lamps information. Refer to *MONITORING SYSTEM* for details on malfunction pilot lamps.

PILOT LAMP(S) ON	BEEPER	MESSAGE DISPLAY	DESCRIPTION
	4 short beeps every 5 minutes	LOW OIL	E-TEC: Injection oil level is low. Stop vehicle in a safe place then, replenish injection oil reservoir.
	—	—	Low fuel level. One (1) bar left in fuel level display. Replenish fuel tank as soon as possible.
	Long beeps repeating slowly	REVERSE	Reverse is selected.
	3 short beeps	REV. FAIL	Reverse did not engage, try again.
	—	—	High beam headlights are selected.
—	—	WARM UP	E-TEC: Engine and/or injection oil need to warm-up before normal operation. The engine's RPM is limited until desired temperature is reached (up to 10 minutes when driving). Warm-up period may occur after a restart in very cold weather.
ACE Models			
	—	—	ECO mode is selected.
	—	—	Standard mode is selected.
	—	—	Sport mode is selected.

5) MODE (M) Button

Button use to navigate in gauge multi-function display.

NOTE: MODE (M) button on the multi-switch housing has the same functions and can also be used.

In order to memorize settings, engine must be running.

NOTE: SET (S) button on the multi-function switch has the same functions and can also be used.

6) SET (S) Button

Button used to navigate, adjust or re-set gauge multifunction display.

Gauge Features

GAUGE FEATURES	
FUNCTIONS	600 HO E-TEC
A) Speedometer	Indication by default
B) Engine RPM	X
C) Odometer	X
D) Trip meter "A" or "B"	X
E) Trip hour meter	X
F) Clock	X
G) Fuel level	X
H) Altitude	X
I) Top speed	X
J) Average speed	X
K) Heated grips heating intensity	X
L) Heated throttle lever heating intensity	X
M) Instant fuel consumption (ACE)	X
N) Total fuel consumption (ACE)	X
O) Message display	X
P) Engine coolant temperature	X
Q) E-TEC engine storage mode	X
R) Lap Record Mode	X
X = An X indicates a standard feature Opt = Feature available as an option N.A. = Not available	

A) Speedometer

In addition of the analog type speedometer, vehicle speed can also be displayed via the multifunction display.

Vehicle speed can be displayed on display 1 or display 2.

Press the MODE (M) button to confirm selection or wait 5 seconds.

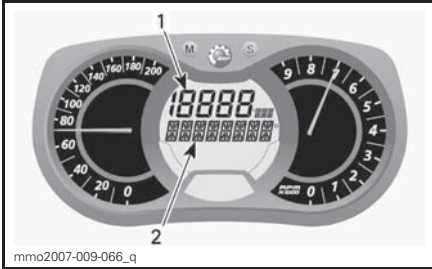

MULTIFUNCTION DISPLAY

1. Display 1
2. Display 2



B) Tachometer (RPM)

In addition of the analog type tachometer, RPM can also be displayed via the multifunction display.

Engine RPM can be displayed on display 1 or display 2.

Use MODE (M) button to select the desired display, then proceed as follows:

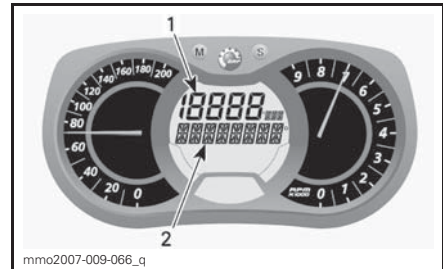
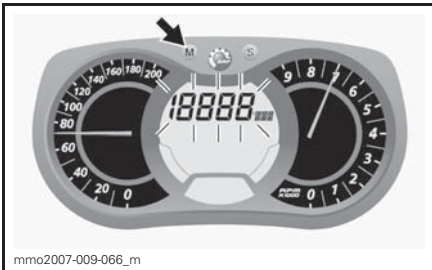

MULTIFUNCTION DISPLAY

1. Display 1
2. Display 2

While display is flashing, press the SET (S) button to select speedometer mode.

Use MODE (M) button to select the desired display, then proceed as follows:

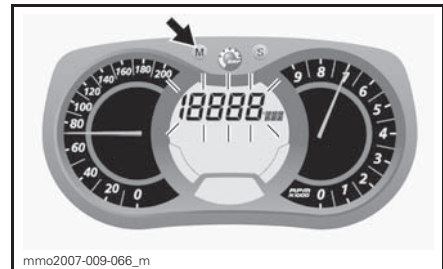
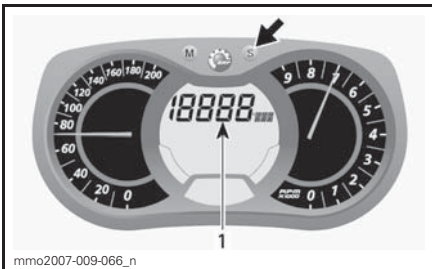

1. Speedometer mode

While display is flashing, press SET (S) button to select RPM mode.

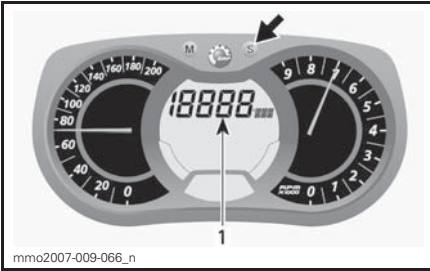

1. RPM mode

Press the MODE (M) button to confirm selection or wait 5 seconds.



C) Odometer

Records the total distance travelled.

Press the SET (S) button to select odometer mode.

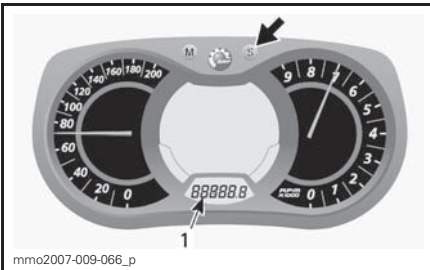

1. Odometer (km/mi) mode

D) Trip Meter A or B

Trip meters records distance travelled since it has been reset.

Press the SET (S) button to select trip meter (TRIP A/TRIP B) mode.

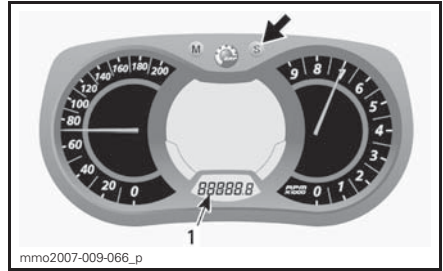

1. Trip meter (TRIP A/TRIP B) mode

Press and hold the SET (S) button to re-set.

NOTE: On E-TEC models, resetting TRIP B mode will also reset TOTAL FUEL CONSUMPTION.

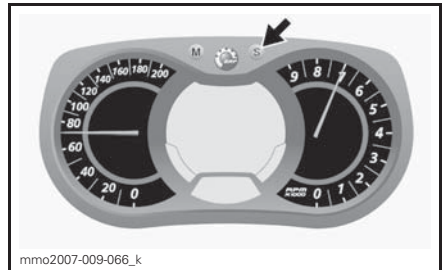

E) Trip Hour Meter

Records vehicle running time when the electrical system is activated since it has been reset.

Press the SET (S) button to select trip hour meter (HrTRIP) mode.

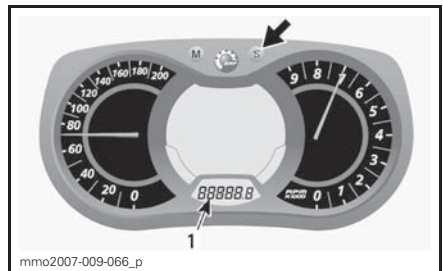

1. Trip hour meter (HrTRIP) mode

Press and hold the SET (S) button to re-set.

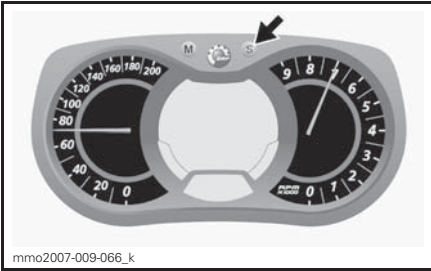

F) Clock

Electric Start Models

NOTE: This clock displays hour in the 24-hour format only.

Press the SET (S) button to select clock mode.

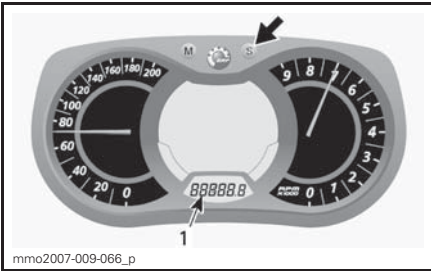

1. Clock mode

Press and hold the SET (S) button to activate clock set-up.

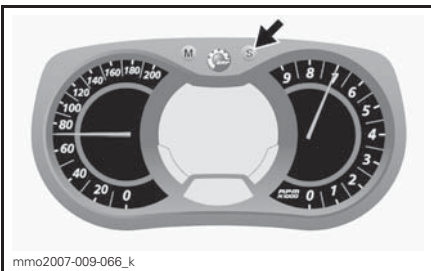

To change HOURS, while the value of HOURS is blinking, use the SET (S) button to change hours.

To change MINUTES, while the value of HOURS is blinking, press the MODE (M) button to switch to minutes. Use the SET (S) button to change minutes.

Press the MODE (M) button to save clock set-up and exit mode.

G) Fuel Level

Bar gauge that continuously indicates the amount of fuel left in the fuel tank.

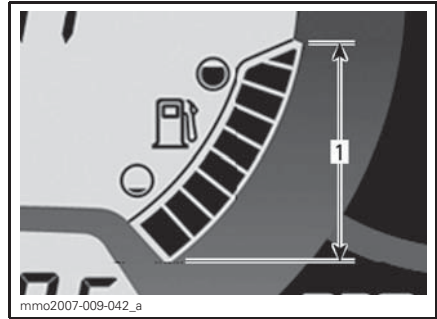

FUEL LEVEL
1. Operating range

H) Altitude

Displays vehicle **approximate** altitude above sea level calculated from the barometric pressure.

NOTE: Altitude displayed is rounded off every 100 meters when set in metric units or 200 feet when set in imperial units.

To display vehicle altitude, proceed as follows.

Press the MODE (M) button to select display 2.



While display is flashing, press the SET (S) button to select altitude mode.

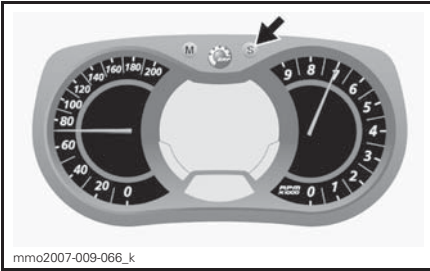

mmo2007-009-066_k

The following symbol appears when altitude mode is selected.



mmo2008-003-023

ALTITUDE MODE

Press the MODE (M) button to confirm selection or wait 5 seconds.

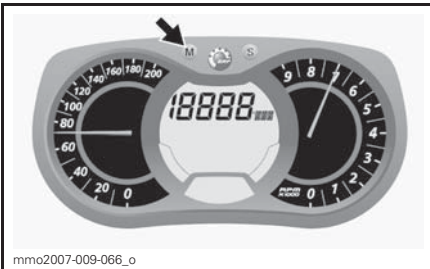

mmo2007-009-066_o

I) Top Speed

Records vehicle top speed since it has been reset.

To display vehicle top speed, proceed as follows.

Press the MODE (M) button to select display 1.



mmo2007-009-066_m

While display flashes, press the SET (S) button to select top speed (TOP_SPD) mode.

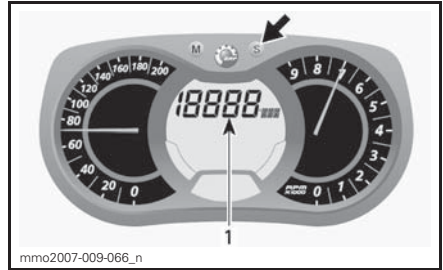

mmo2007-009-066_n

1. Top speed (TOP_SPD) mode

Press the MODE (M) button to confirm selection or wait 5 seconds.

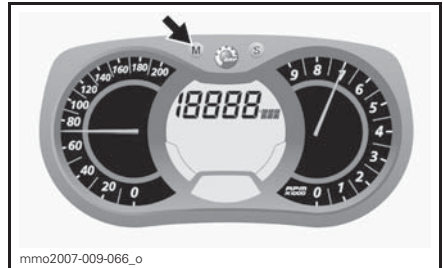

mmo2007-009-066_o

To reset, press the MODE (M) to select mode.

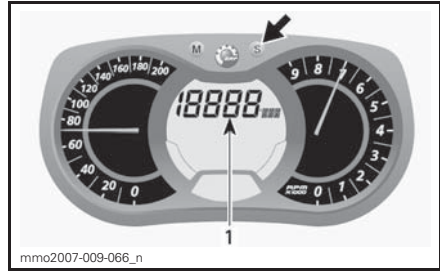
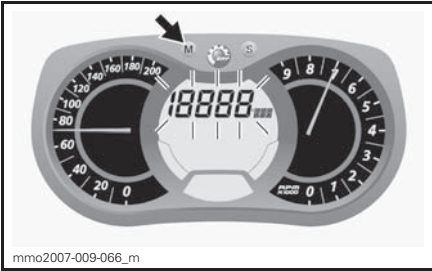

While display flashes, press and hold the SET (S) button within 5 seconds to reset.

1. Vehicle average speed (AVR_SPD) mode

Press the MODE (M) button to confirm selection or wait 5 seconds.

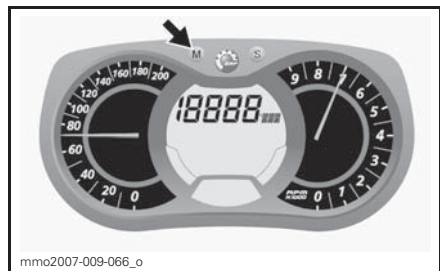
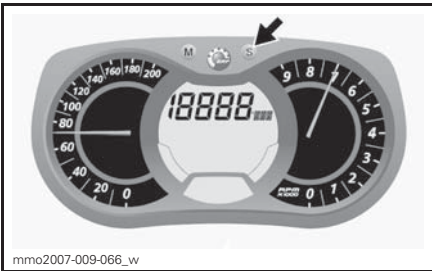

J) Average Speed

Records vehicle average speed since it has been reset.

To display vehicle average speed, proceed as follows.

Press the MODE (M) button to select display 1.

To reset, press the MODE (M) to select mode.

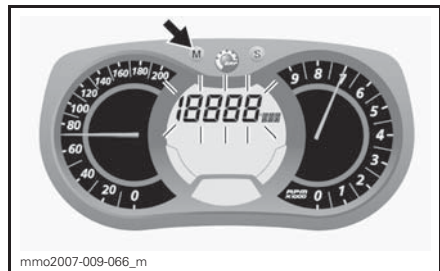

While display flashes, press and hold the SET (S) button within 5 seconds to reset.

While display flashes, press SET (S) button to select vehicle average speed (AVR_SPD) mode.

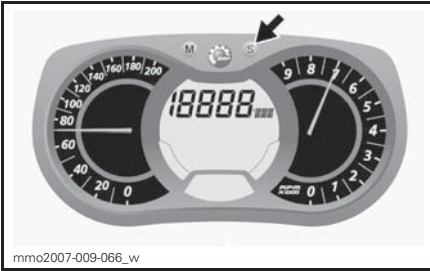

mmo2007-009-066_w

K) Heated Grips Heating Intensity

Bar gauge that indicates heating intensity.

Refer to *HEATED GRIPS SWITCH* for more details.

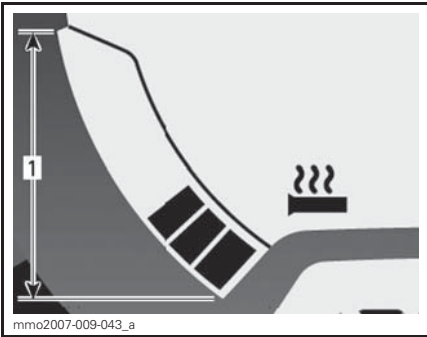

mmo2007-009-043_a

HEATED GRIPS
1. Operating range

L) Heated Throttle Lever Heating Intensity

Bar gauge that indicates heating intensity.

Bar gauge will be displayed instead of the fuel level with the activation of the heated throttle lever switch. When released, display will return to fuel level.

Refer to *HEATED THROTTLE LEVER SWITCH* for more details.

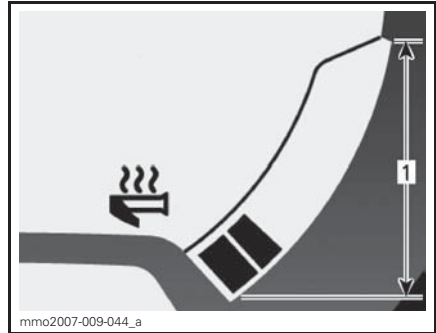

mmo2007-009-044_a

HEATED THROTTLE LEVER

1. Operating range

M) Instant Fuel Consumption

Calculates vehicle average fuel consumption while riding.

To display vehicle average fuel consumption, proceed as follows.

Press the MODE (M) button to select display 1.



mmo2007-009-066_m

While display flashes, press SET (S) button to select instant fuel consumption mode.

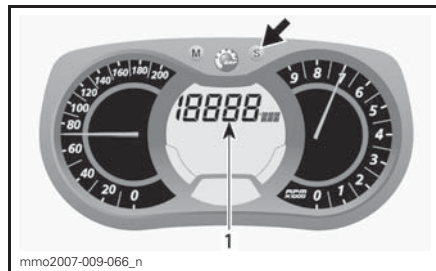

mmo2007-009-066_n

1. Instant fuel consumption mode

Press the MODE (M) button to confirm selection or wait 5 seconds.

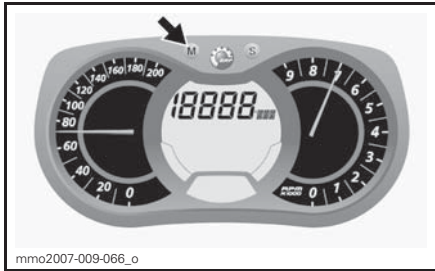

N) Total Fuel Consumption

Records vehicle average fuel consumption since it has been reset.

To display vehicle total fuel consumption, proceed as follows.

Press the MODE (M) button to select display.

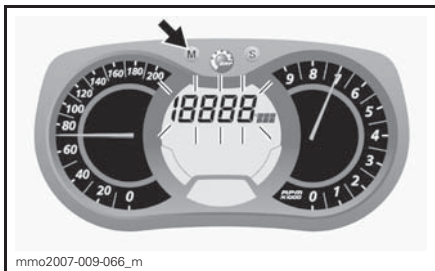

While display flashes, press the SET (S) button to select total fuel consumption (TC) mode.

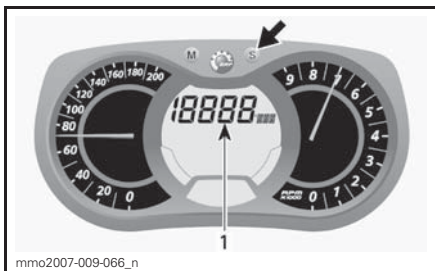

1. Total fuel consumption (TC) mode

TC appears when the mode is selected.

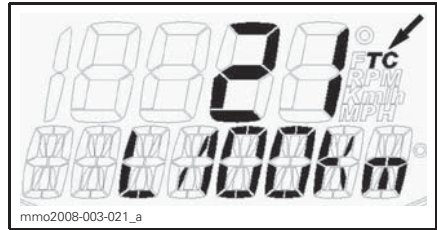

TYPICAL

Press the MODE (M) button to confirm selection or wait 5 seconds.

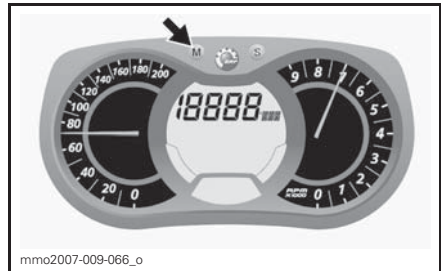

To reset, set the trip meter to TRIP B. Refer to *TRIP METER A OR B* for more details.

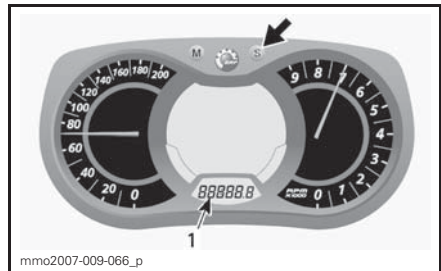

1. Trip meter (TRIP B) mode

Press and hold the SET (S) button to reset.

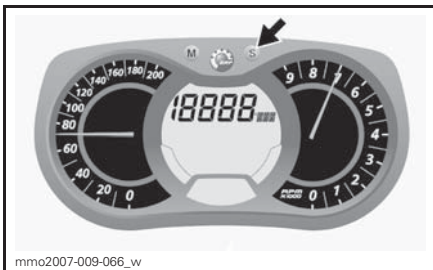

O) Message Display

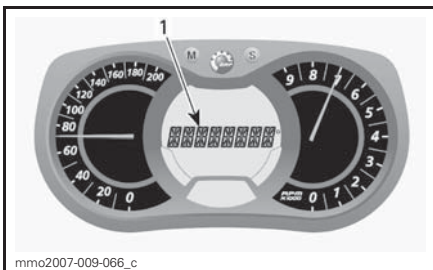

1. Message display

Refer to *PILOT LAMPS AND MESSAGES* in this section for details on usual messages.

Refer to *MONITORING SYSTEM* for details on malfunction and D.E.S.S. related messages.

P) Engine Coolant Temperature

Bar gauge that indicates the engine coolant temperature.

During normal operation, the bars should not exceed approximately the middle of the gauge.

NOTICE If engine overheats, stop vehicle in a safe place. Refer to **TROUBLESHOOTING** section.

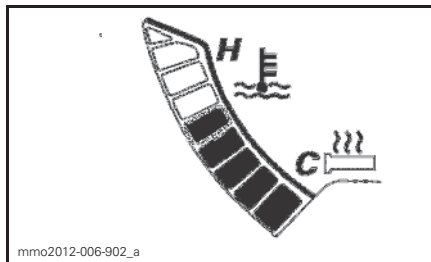

Q) E-TEC Engine Storage Mode

Displays "OIL" when the storage mode procedure is initiated.

R) Lap Record Mode

With this mode, vehicle speed, engine revolutions per minute (RPM) and a preselected function in display 1 can be recorded at the same time during a period of time defined by the operator.

Also, a possibility of nine (9) different sessions (laps) can be recorded for a maximum total of 2.5 minutes.

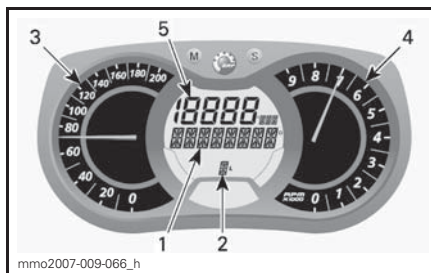

LAP RECORD MODE

1. Lap record mode display
2. Sessions (laps)
3. Vehicle speed
4. Engine revolution per minute (RPM)
5. Preselected function

To Activate Lap Record Mode:

1. Press the SET (S) button to select the odometer mode in display 3.
2. Press and hold SET (S) button for 2 seconds to activate mode, REC will be displayed to indicate that record mode has been selected.



1. Record mode
2. Odometer

3. Press the SET (S) button to scroll between modes.

Available modes are: STOP, REC (record) or PLAY.

To Record:

1. Select REC (record) mode.

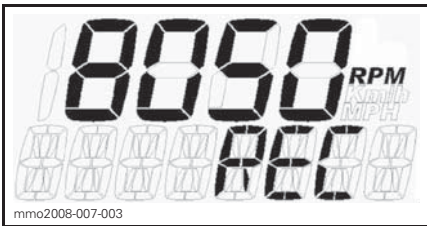

RECORD MODE

2. Press the MODE (M) button to start recording.
3. While recording, press the MODE (M) button again each time you want to record a new lap time (from 1 to 9 laps).

Press the SET (S) button to stop recording.

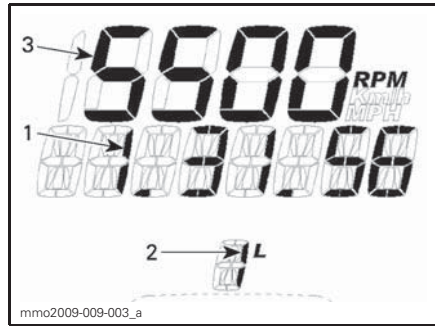

RECORD MODE

1. Recording time
2. Lap/session
3. Selected mode

To record another session, press the SET (S) button until REC (record) mode appears in display. Repeat same procedure previously described to record.

To Review Recorded Data:

Select PLAY mode.

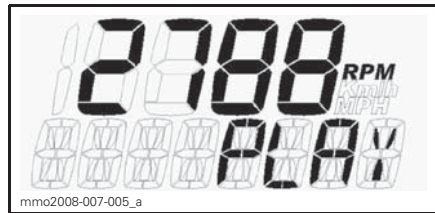

PLAY MODE

1. Press the MODE (M) button to play recorded data.

All recorded data (speedometer, tachometer and the preselected mode in display 1) will be displayed at the same time.

2. Press the SET (S) button to stop recorded lap OR press the MODE (M) button to switch to another recorded lap.

NOTE: Pressing the SET (S) button will stop time of the lap in progress, then the display will show the recorded time length of that lap and will switch automatically to the following recorded lap after 5 seconds.

At the end of all recorded laps, STOP will appear in display.

To review recorded data again, press the SET (S) button to return to PLAY mode. Repeat same procedure previously described to review.

To record other laps, press the SET (S) button to switch to REC (record) mode. Repeat same procedure previously described to record.

Press and hold SET (S) button for 5 seconds to exit the lap record mode, the previously selected mode will be displayed.

Gauge Setup

Clock Setting

NOTE: This clock displays in the 24-hour format only.

Press the SET (S) button to select clock mode.

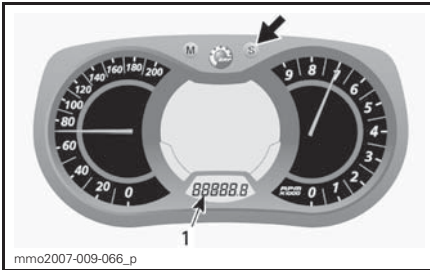

1. Clock mode

Press and hold the SET (S) button to activate clock set-up.

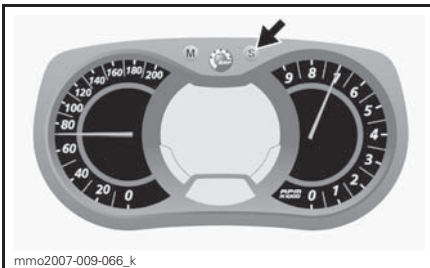

mmo2007-009-066_k

To change HOURS, while the value of HOURS is blinking, use the SET (S) button to change hours.

To change MINUTES, while the value of HOURS is blinking, press the MODE (M) button to switch to minutes. Use the SET (S) button to change minutes.

Press the MODE (M) button to save clock set-up and exit mode.

Unit Selection (KM/H vs MPH)

The units can be set in metric or imperial. Refer to an authorized Lynx dealer.

Language Selection

The gauge display language can be changed. Refer to an authorized Lynx dealer for language availability and setup the gauge to your preference.

13) ECO/Standard/Sport Mode Switch

ACE Models

The Mode switch is located on the LH side of fuel tank.

It is used to activate or deactivate Eco/Standard/Sport modes.

Refer to *OPERATING MODES* subsection for details.

14) Front Storage Compartment

A storage compartment is located at the front of the vehicle, above the gauge.

To open the storage compartment, pull the tab.

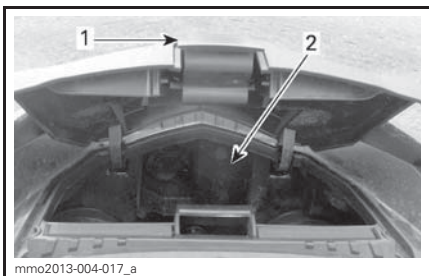

1. Tab
2. Storage compartment

15) Shift Lever

Use this lever to shift in forward or reverse.



PULL TO ENGAGE REVERSE GEAR

Refer to *OPERATING IN REVERSE* in *BASIC PROCEDURES* for details.

16) Front and Rear Bumpers

To be used whenever snowmobile requires manual lifting.

CAUTION Use proper lifting techniques, notably using your legs force. Do not attempt to lift the either end of the vehicle if it is above your limits. Use appropriate lifting device or have assistance to share lifting stress if possible.

NOTICE Do not use skis to pull or lift snowmobile.

17) Upper Body Module (Hood)

Upper Body Module Removal

1. Remove the gauge.

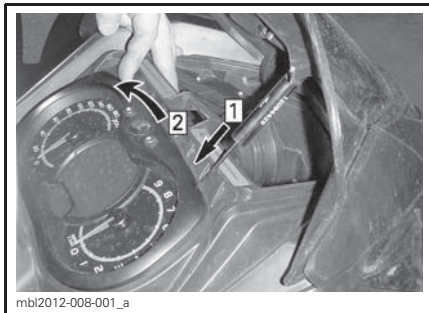

- Step 1: Unlock
- Step 2: Tilt

2. Disconnect the headlights connector.
3. Disconnect the gauge connector.

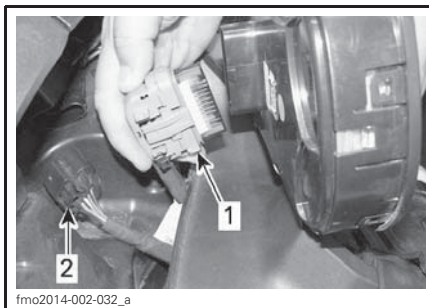

1. Gauge connector
2. Headlights connector

4. Remove LH and RH side panels.
5. Remove the drive belt guard.

E-tec Models

6. Disconnect the air intake connector tube.

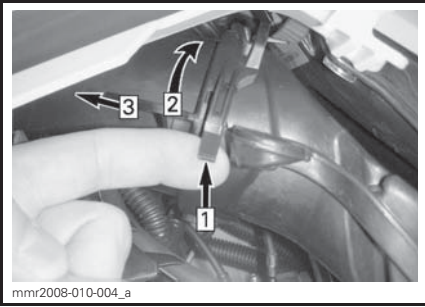

- Step 1: Lift tab
 Step 2: Twist tube
 Step 3: Pull forward

7. Disconnect air temperature sensor (ATS) on top of connector tube.

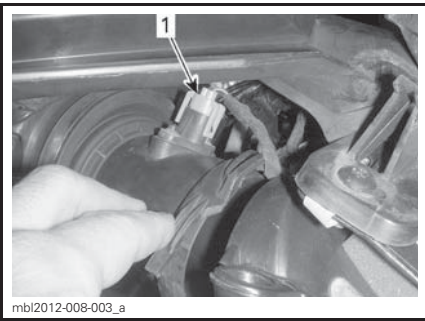

1. ATS connector (Air Temperature Sensor)

8. Disconnect the APS hose at the ECM.

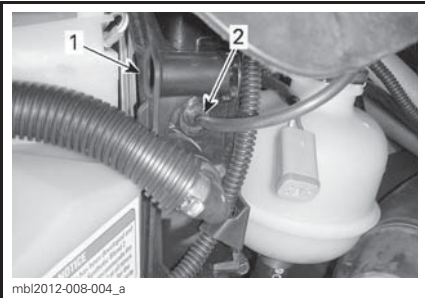

1. ECM
 2. APS hose

ACE Models

9. Pull backward the air intake tube.

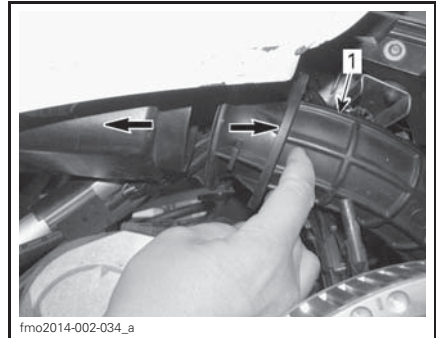

1. Air intake tube

All Models

10. Remove the six upper body module retaining screws, three on each side.

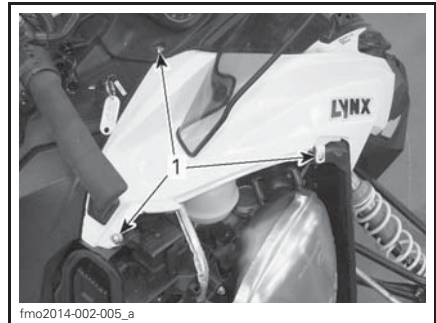

RH SIDE SHOWN

1. Retaining screws

11. Tilt the upper body module 5 degrees up towards the top section and then push it towards the front of the vehicle.

12. Remove the upper body module.

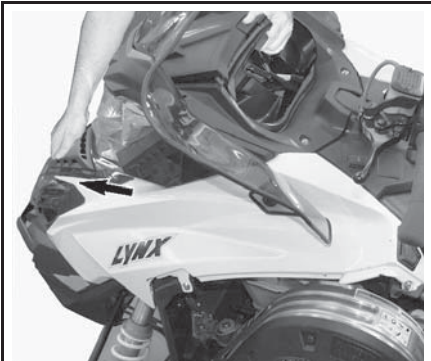

SLIDE TOWARDS FRONT



SLIDE TOWARDS REAR

Upper Body Module Installation

1. Insert the upper body module tabs into the upper bottom pan openings.

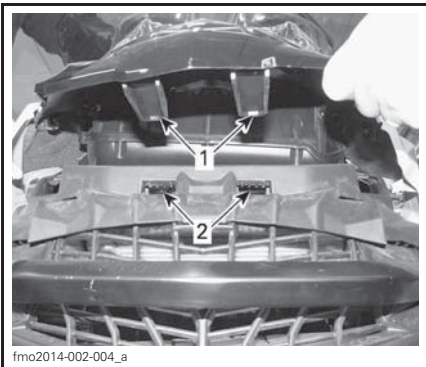

1. Upper body module tab
2. Upper bottom pan opening

2. Slide the module towards rear.

3. On both sides, install the upper body module retaining screws.

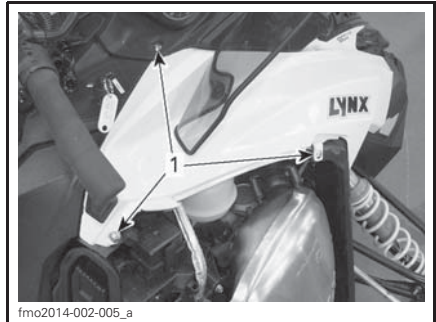

RH SIDE SHOWN

1. Retaining screws

E-TEC Models

4. Connect:
 - APS hose on the ECM
 - Headlights connector
 - Gauge connector
 - Air temperature sensor (ATS)
 - Air intake connector tube.

ACE Models

5. Connect:
 - Headlights connector
 - Gauge connector
 - Air intake connector tube.

All Models

6. Install:

- Gauge
- Drive belt guard.

18) Side Panels

To open a side panel, push the buttons.

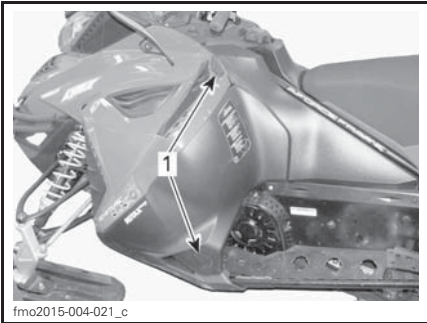
**TYPICAL**

1. Buttons

To close a side panel, set firmly on the stud location and push side panel locks to make sure it is secured.

Make sure lower front edge of the side panel goes to its right place and side panel is align.

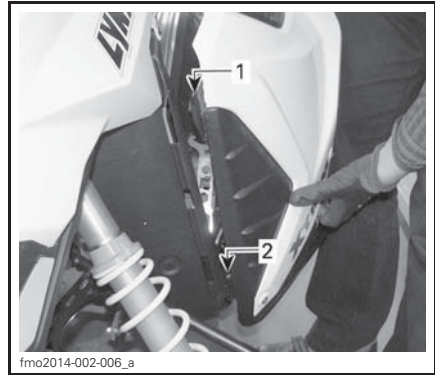
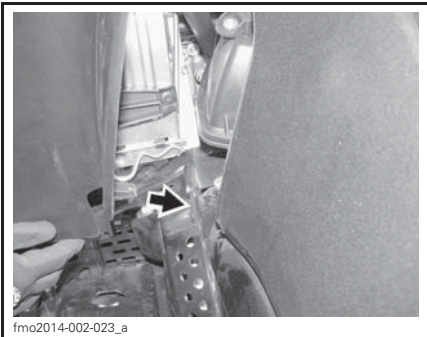

1. Upper hinge
2. Lower hinge

Close the side panel.

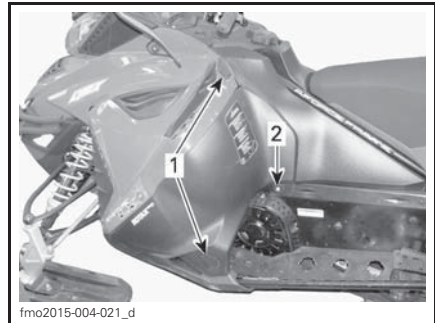
**TYPICAL**

1. Buttons
2. Stud location

! WARNING

Never operate engine with side panels opened or removed from vehicle.

19) Passenger Handhold**2-UP Models**

Seat handholds provides a grip for the passenger.

To remove a side panel, open it then lift it up. Free the lower hinge from its slot, then free the upper hinge by lowering the panel.

To install a side panel, insert the upper hinge and then the lower hinge.

20) Rear Rack

! WARNING

All objects in rear rack must be properly latched. Do not carry any breakable objects. Excessive weight in rack may reduce steering ability. Always readjust suspension according to the load. The capacity of this rack is limited, the **MAXIMUM** cargo load is 15.8 kg (35 lb). Ride at very low speed when loaded. Avoid speed over bumps.

49 Ranger Model

! CAUTION Always readjust suspension according to the load. The capacity of this rack is limited, the **MAXIMUM** cargo load is 25 kg (55.1 lb). Ride at very low speed when loaded. Avoid speed over bumps.

21) Seat

! WARNING

Any passenger must be able to firmly lay his feet on the footrests and keep his hands on the handholds at all times when seated. Respecting those physical criteria is important to ensure that the passenger is stable and to reduce the risks of ejection.

Passenger seat with backrest.

! WARNING

- Read operator's guide and get acquainted with the instructions before remove seat from the snowmobile.
- Make sure seat is securely latched before riding.

1. Pull up the rubber tabs.

2. Open The LINQ Attachments.
3. Lift the backrest.

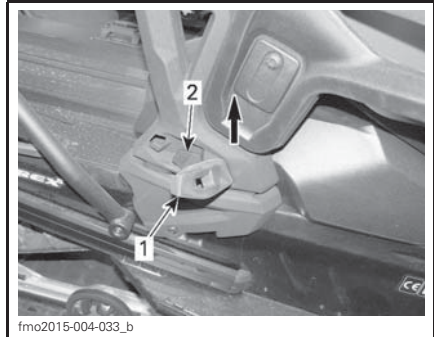

1. Rubber tab
2. LINQ Attachment

4. Refer to the decal located on the RH backrest bracket and locate backrest until it latches in position.

22) Seat Latch

Located under the seat.

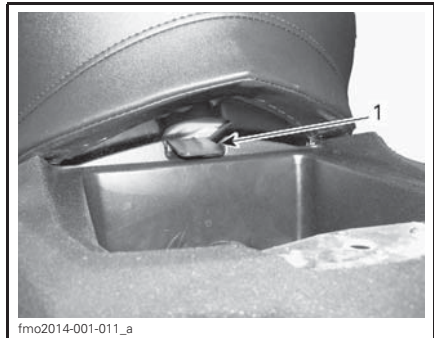

1. Seat Latch

Seat Removal

Adventure LX and Touring kit Models

Remove the backrest.

All

Remove the storage/battery compartment cover.

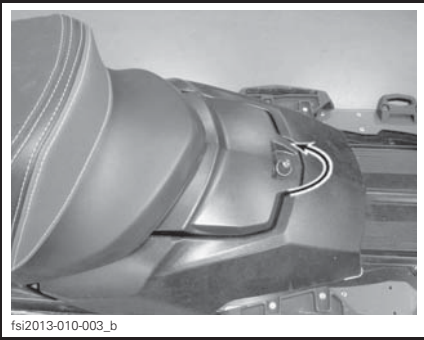

Remove the seat by pulling and lifting at the same time.



Attach the battery cover back to its place.



NOTICE Pull the handle upwards when removing the seat.

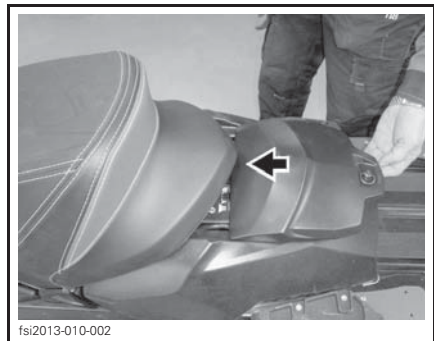

Finish the installation by locking the storage / battery compartment cover.



Seat Installation

Push the seat until you hear a clicking sound.

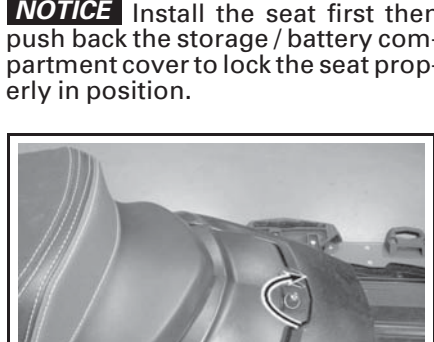

NOTICE Install the seat first then push back the storage / battery compartment cover to lock the seat properly in position.

23) Storage/Battery Compartment

NOTICE MAXIMUM load is 1.8 kg (4 lb) evenly distributed.

Turn quarter-turn fastener counter-clockwise to release it and open cover.

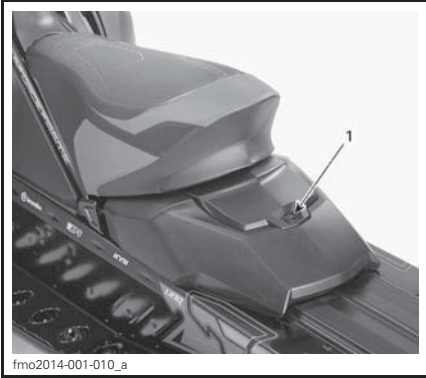

fmo2014-001-010_a

TYPICAL - STORAGE/BATTERY COMPARTMENT

1. Quarter-turn fastener

Close cover and turn quarter-turn fastener clockwise to secure it.

24) Hitch

Use the hitch in conjunction with a tow bar to tow an accessory.

NOTE: Refer to decal on vehicle for towing weight capacities.

⚠ WARNING

Never tow an accessory with a rope. Always use a rigid tow bar. Using a rope would result in a collision between the object and the snowmobile and possibly in a tip over in case of a rapid deceleration or on a downward slope.

Hitch (Tongue Type)

To attach an equipment to the hitch, secure the accessory tow bar to the hitch tongue using a lockable pin.

Hitch ("J" Type)

49 Ranger Models

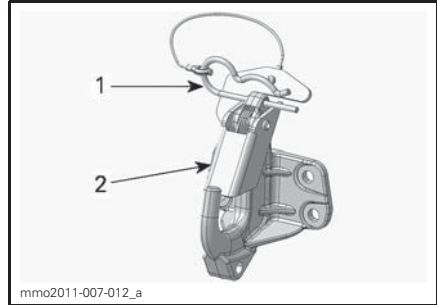

mmo2011-007-012_a

1. Hairpin clip
2. Safety tab

Attaching an Equipment

1. Remove the hairpin clip.
2. Align accessory attachment hole with the hitch hook.
3. Push the accessory attachment passed the safety tab.
4. Secure safety tab using the hairpin clip.

Detaching an Equipment

1. Remove the hairpin clip.
2. Push safety tab forward to free accessory attachment from the hitch.
3. Detach accessory attachment.
4. Install hairpin clip.

25) Mountain Strap (49 Ranger)

Mountain strap provides a grip for operator when a leverage is needed.

⚠ WARNING

This strap is not for towing, lifting or other purpose than temporary use as a grab handle when a leverage is needed at very low speed.

FUEL

Fuel Requirements

NOTICE Always use fresh gasoline. Gasoline will oxidize; the result is loss of octane, volatile compounds, and the production of gum and varnish deposits which can damage the fuel system.

Alcohol fuel blending varies by country and region. Your vehicle has been designed to operate using the recommended fuels, however, be aware of the following:

- Use of fuel containing alcohol above the percentage specified by government regulations is not recommended and can result in the following problems in the fuel system components:
 - Starting and operating difficulties.
 - Deterioration of rubber or plastic parts.
 - Corrosion of metal parts.
 - Damage to internal engine parts.
- Inspect frequently for the presence of fuel leaks or other fuel system abnormalities if you suspect the presence of alcohol in gasoline exceeds the current government regulations.
- Alcohol blended fuels attract and hold moisture which may lead to fuel phase separation and can result in engine performance problems or engine damage.

Recommended Fuel

Use unleaded gasoline containing MAXIMUM 10% ethanol. The gasoline must have the following minimum octane requirements.

FUEL TYPE	ENGINE	MINIMUM OCTANE RATING
Fuel which may contain up to 10% MAX ethanol	600 HO E-TEC ACE	95 E10

NOTICE Never experiment with other fuels. Engine or fuel system damages may occur with the use of an inadequate fuel.

Fuel Antifreeze Additives

When using oxygenated fuel, additional gas line antifreeze or water absorbing additives are not required and should be not used.

When using non-oxygenated fuel, isopropyl base gas line antifreeze can be used in a proportion of 150 ml (5 U.S. oz) of gas line antifreeze added to 40 L (10.6 U.S. gal.) of gas.

This precaution is in order to reduce the risk of frost buildup in fuel system components which may lead, in certain cases, to severe damage to engine.

NOTE: Use only methyl hydrate free gas line antifreeze.

Vehicle Fueling Procedure

WARNING

- Fuel is flammable and explosive under certain conditions.
- Never use an open flame to check fuel level.
- Never smoke or allow flame or spark in vicinity.
- Always work in a well-ventilated area.

1. Stop engine.

⚠ WARNING

Always stop engine before refueling.

2. Have operator and passenger get off vehicle.

⚠ WARNING

Do not allow anyone to remain in the vehicle while fueling. If there is a fire or explosion during fueling, a vehicle occupant could be unable to quickly leave the area.

3. Unscrew slowly the fuel reservoir cap counterclockwise to remove it.

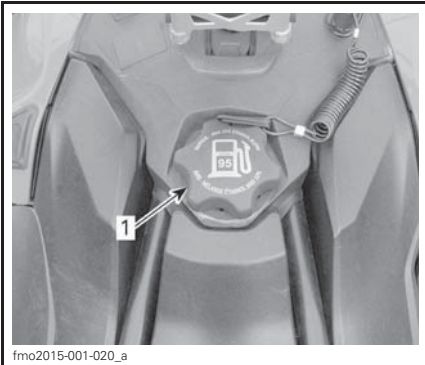

fmo2015-001-020_a

TYPICAL

1. Fuel tank cap

⚠ WARNING

If a differential pressure condition is noticed (whistling sound heard when loosening fuel reservoir cap) have vehicle inspected and/or repaired before further operation.

4. Insert the spout into the filler neck.
5. Pour fuel slowly so that air can escape from the tank and prevent fuel flow back. Be careful not to spill fuel.

6. Stop filling when the fuel reaches the bottom of filler neck. **Do not overfill.**

⚠ WARNING

Never top up the fuel tank before placing the vehicle in a warm area. As temperature increases, fuel expands and may overflow.

7. Fully tighten fuel reservoir cap clockwise.

⚠ WARNING

Always wipe off any fuel spillage from the vehicle.

NOTE: Do not sit or lean on seat when fuel tank cap is not properly installed.

INJECTION OIL (E-TEC)

Recommended Injection Oil

E-TEC Models

RECOMMENDED INJECTION OIL	
ENGINES	XPS SYNTHETIC 2-STROKE OIL(F) (P/N 619 590 106)
600 HO E-TEC	✓

NOTICE The engine of this snowmobile has been developed and validated using the recommended BRP XPS™ oil. BRP recommends the use of its recommended XPS oil or equivalent. Damages caused by oil which is not suitable for this oil injected 2-stroke direct fuel injection engine may not be covered by the BRP limited warranty.

Injection Oil Level Verification

The injection oil reservoir is located behind the RH side panel. See *BODY* in *MAINTENANCE PROCEDURES* for opening procedure.

Always maintain a sufficient amount of recommended injection oil in the injection oil reservoir.

NOTICE Check level and refill every time you refuel.

NOTE: Do not exceed the maximum level tab in the oil tank neck.

Reinstall cap and fully tighten.

NOTICE Do not mismatch oil reservoir cap with fuel tank cap.

⚠ WARNING

Wipe off any oil spills. Oil is highly flammable when heated.

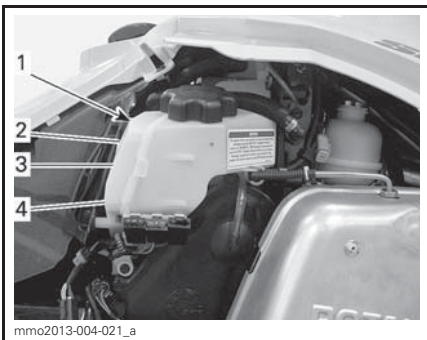

TYPICAL

1. Oil reservoir
2. 3/4 level
3. 1/2 level
4. 1/4 level

To Add Injection Oil

Remove injection oil reservoir cap.

Add injection oil.

BREAK-IN PERIOD

Operation During Break-In

A break-in period of 10 operating hours or 500 km (300 mi) is required for the vehicle.

After the break-in period, the vehicle should be inspected by an authorized Lynx dealer, repair shop or person of your own choosing. Refer to *MAINTENANCE* section.

Engine

During the break-in period:

- Avoid prolonged full throttle operation.
- Avoid sustained accelerations.
- Avoid prolonged cruising speeds.
- Avoid engine overheating.

However, brief accelerations and speed variations contribute to a good break-in.

During the first few hours of break-in, the engine management system controls some engine parameters which will slightly reduce the engine performance.

During break-in period, maximum throttle should not exceed 3/4 opening. However, brief full acceleration and speed variations contribute to a good break-in.

 **CAUTION** Engine overheating, continued wide open throttle runs and prolonged cruising without speed variations should be avoided, this can cause engine damage during the break-in period.

E-TEC Models

During a predetermined period, the engine management system controls some engine parameters.

The duration is based on fuel volume. It will take approximately two fuel tanks to complete the break-in.

During this period:

- The engine performance and behavior will not be optimal.
- The fuel and oil consumption will be higher.

Drive Belt

A new drive belt requires a break in period of 50 km (30 mi).

During the break-in period:

- Avoid strong acceleration and deceleration.
- Avoid pulling a load.
- Avoid high speed cruising.

10-Hour Inspection

NOTE: The 10-hour inspection is at the expense of the snowmobile owner.

As with any precision piece of mechanical equipment, we suggest that after the first 10 hours of operation or 500 km, whichever comes first, your snowmobile be checked by an authorized LYNX dealer. This inspection will also give you the opportunity to discuss the unanswered questions you may have encountered during the first hours of operation.

OPERATING MODES (ACE)

⚠ WARNING

Whenever changing operating mode, make sure to maintain situational awareness while riding.

ECO Mode (Fuel Economy Mode)

When ECO mode is selected (fuel economy mode), vehicle torque and speed are limited whereby an optimal cruising speed is maintained in order to reduce fuel consumption.

Once activated, ECO mode will remain active until it is deactivated by the operator.

Standard Mode

A Standard mode indicator is ON in the multifunction gauge to confirm the active mode of operation.

Sport Mode

⚠ WARNING

Ensure passenger is advised to hold on tightly before activating Sport mode. Sport mode provides increased acceleration.

When selected, Sport mode provides for instant throttle response and more rapid accelerations than Standard or ECO mode.

Once activated, Sport mode will remain active until it is deactivated by the operator.

Navigating Operating Modes

Use ECO/Standard/Sport Mode switch to navigate between power levels, from ECO (reduced power) to Standard (full power) to Sport (increased response).

To increase power, press the switch upwards. To decrease power, press the switch downwards.

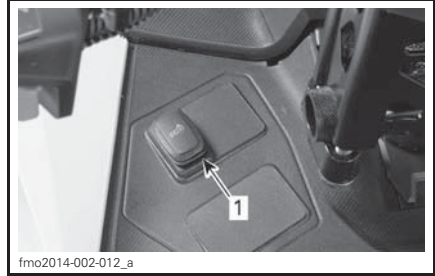

TYPICAL - LH SIDE OF FUEL TANK
1. Mode switch

To activate Standard mode when in Sport mode, press bottom end of switch once.

To activate ECO mode when in Sport mode, press bottom end of switch twice.

To activate ECO mode when in Standard mode, press bottom end of switch once.

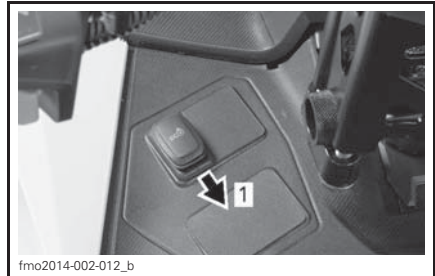

TYPICAL
Step 1: Press bottom end of switch

⚠ WARNING

Ensure passenger is advised to hold on tightly before activating Sport mode. Sport mode provides increased acceleration.

To activate Sport mode when in Standard mode, press top end of switch once.

To activate Sport mode when in ECO mode, press top end of switch twice.

To activate Standard mode when in ECO mode, press top end of switch once.



TYPICAL

Step 1: Press top end of switch

WARNING

When adjusting modes, be sure to maintain situational awareness of other snowmobiles, obstacles, or persons .

Learning Key Modes

The learning key provides a mode of operation whereby engine torque and speed are limited.

NOTE: The initial learning key programming can limit the speed to 40 km/h (25 MPH) or 70 km/h (43 MPH). Refer to your authorized Lynx dealer to modify this setting.

There are 3 levels available for the learning key mode.

Changing Learning Key Settings

To change learning key setting, carry out the following:

1. Press the START/electronic reverse button to wake up the electrical system and install the NORMAL key on the engine cut-off switch.
2. Wait for the information center to complete its self-test and display the key recognition message.

Analog/Digital Gauge

3. Press the SET button until LEARN is visible in the digital screen of the information center.

Multifunction Analog/Digital Gauge

4. Press the MODE button once, then press the SET button until LEARN is visible in the digital center of the gauge.

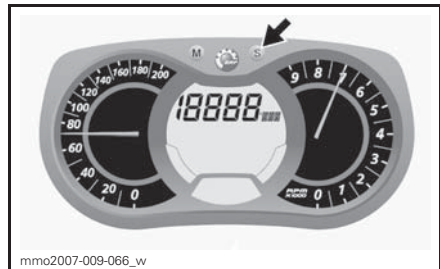

All Models

5. Use the heated grip switch to toggle the key setting between 1 and 3.

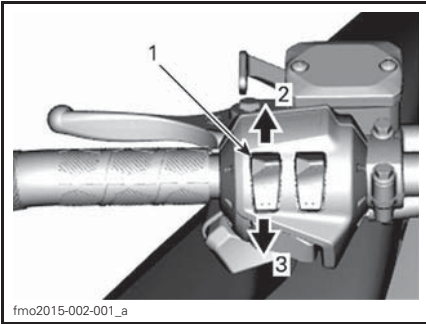
**TYPICAL**

1. Heated grip switch
2. Increase
3. Decrease

NOTE: Setting 1 is the lowest available torque, while setting 3 is the highest available torque for learning key.

6. After a few seconds, the setting is automatically confirmed and saved.

NOTE: The key speed setting is applicable to any key of the same type used on a specific snowmobile. The same key type used on a different snowmobile may therefore have a different key speed setting.

NOTE: Vehicle performance may vary depending on riding conditions.

BASIC PROCEDURES

Engine Starting Procedure

Procedure

1. Apply parking brake.
2. Recheck throttle control lever operation.
3. Put your helmet on.
4. Ensure that the tether cord cap is installed on the engine cut-off switch and that the cord is attached to your clothing eyelet.
5. Ensure that the emergency engine stop switch is in the ON position (up).
6. Depress the START button to engage the electric starter and start the engine. Release button immediately when engine has started.

 **WARNING**

Never depress throttle while starting engine.

Manual Start E-TEC Models

Grab rewind starter handle, pull handle slowly until a resistance is felt, then hold handle firmly and pull vigorously to start engine.

 **WARNING**

Do not apply throttle while starting.

Electric Start E-TEC models

Depress the START/RER button to engage the electric starter and start the engine.

Release button immediately when engine has started.

 **WARNING**

Do not apply throttle while starting.

 **CAUTION** Do not use electric starter for more than 10 seconds. A rest period should be observed between the cranking cycles to let electric starter cool down. Using electric starter when engine has started could damage electric starter mechanism.

NOTE: If for any reason, the engine cannot be cranked electrically, start engine manually using the rewind starter.

7. Release parking brake.

NOTE: For an initial cold start, do not release parking brake. Perform the *VEHICLE WARM-UP* procedure as explained below.

NOTICE Do not engage electric starter for more than 10 seconds at a time. A rest period should be observed between the cranking cycles to allow electric starter to cool down.

NOTE: For an initial cold start, do not release parking brake. Perform the *VEHICLE WARM-UP* procedure as explained below.

Emergency Starting (E-TEC)

ACE Models

Do not attempt an emergency starting procedure. Have the battery charged or replaced.

NOTE: Emergency manual engine start is not provided for ACE models.

E-TEC

The engine can be started with the emergency starter rope supplied with the tool kit.

Remove belt guard.

⚠ WARNING

Do not wind starting rope around your hand. Hold rope by the handle only. Do not start the snowmobile by the drive pulley unless it is a true emergency situation. Have the snowmobile repaired as soon as possible.

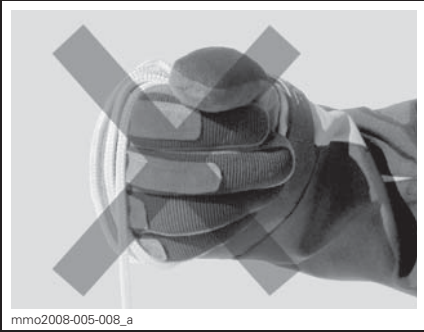

Attach one end of emergency rope to rewind handle.

NOTE: The suspension adjustment tool can be used as an emergency handle.

Attach the other end of emergency rope to the starter clip supplied in the tool kit.

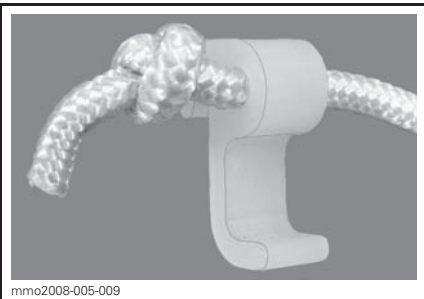

Hook up clip on drive pulley.

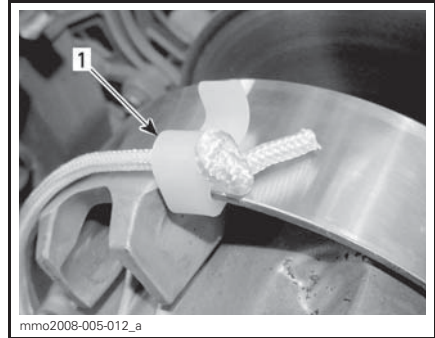

1. Clip installation location

Wind the rope tightly around drive pulley. When pulled, pulley must rotate counterclockwise.

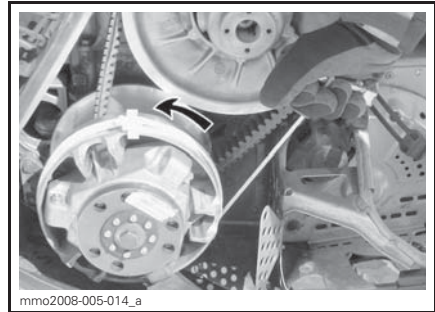

Pull the rope using a sharp, crisp pull so the rope comes free of the drive pulley. Start engine as per usual manual starting.

⚠ WARNING

When starting the snowmobile in an emergency situation, using drive pulley, do not reinstall the belt guard and return slowly to have snowmobile repaired.

Vehicle Warm-Up

Before every ride, vehicle has to be warmed up as follows.

1. Start engine as explained in *ENGINE STARTING PROCEDURE* above.

2. Allow engine to warm up one or two minutes at idle speed.

NOTE: E-TEC engines will shut down after approximately 12 minutes of idling. ACE engines will shut down after 5 minutes of idling when coolant temperature is higher than 70°C (158°F). This delay increase to 12 minutes if a radiator fan is mounted.

3. Disengage parking brake.
4. Apply throttle until drive pulley engages. Drive at low speed the first two or three minutes.

NOTICE If vehicle does not move when throttle is applied, stop engine, remove tether cord cap from the engine cut-off switch, then do the following.

- Check if skis are stuck on the ground. Lift one ski at a time by the handle, then put it down.
- Check if track is stuck on the ground. Lift rear of snowmobile enough to clear track from the ground, then drop.
- Check rear suspension for hard snow or ice accumulation that could interfere with track rotation. Clean the area.

CAUTION Use proper lifting techniques, notably using your legs force. Do not attempt to lift the either end of the vehicle if it is above your limits.

WARNING

Make sure tether cord cap is removed before standing in front of the vehicle, getting close to the track or rear suspension components.

NOTE: On E-TEC models, warm-up is electronically controlled. During this period (up to 10 minutes depending on ambient temperature), engine RPM is limited.

Engaging Reverse (RER) (E-TEC)

When the engine is running, depressing the RER button will slow down engine RPM to almost a stop and advance the ignition timing to invert crankshaft rotation.

- Engine will automatically shift into forward when restarting after stopping or stalling.
- Shifting procedure will take place only when the engine is running.
- If engine is running at a speed above 4300 RPM, the function of the RER button is disabled.
- It is recommended to warm up the engine to its normal operating temperature before shifting.

Shifting in Reverse

1. Bring vehicle to a complete stop.
2. Apply and hold brake. Remain seated, refer to *RIDER POSITION (REVERSE OPERATION)* for posture information.
3. With engine at idle speed, press and release the RER button.
4. Wait until reverse beeper sounds, then gently depress throttle lever.

WARNING

Engaging the reverse mode is done by depressing the RER button when the engine is running. Wait until the reverse alarm sounds and the RER pilot lamp comes on in the analog/digital gauge before operating throttle to proceed in reverse. The reverse speed is not limited. Always proceed with caution as fast reverse could result in loss of vehicle stability. Come to complete stop before depressing RER button. Always remain seated and apply the brake before shifting. Ensure the path behind is clear of obstacles or bystanders before proceeding.

Shifting in Forward

1. Bring vehicle to a complete stop.
2. Apply and hold brake.
3. Press and release the RER button.
4. RER pilot lamp will stop.
5. Apply throttle slowly and evenly. Allow drive pulley to engage then accelerate carefully.

Shifting in Reverse or Forward (ACE Models)

WARNING

When shifting in reverse, wait until the reverse alarm sounds and the pilot lamp comes on in the analog/digital gauge before operating throttle. The reverse speed is not limited. Always proceed with caution as fast reverse could result in loss of vehicle stability. Come to complete stop before depressing engaging the reverse. Always remain seated and apply the brake before shifting. Ensure the path behind is clear of obstacles or bystanders before proceeding.

Reverse (Manual Shift Models)

Shifting in Reverse

To engage reverse gear, proceed as follows:

1. Bring vehicle to a complete stop.
2. Apply and hold brake. Remain seated, refer to *RIDER POSITION (REVERSE OPERATION)* for posture information.
3. With engine at idle speed, pull the reverse shift lever all the way out.
4. Gently depress throttle lever.

Shifting in Forward

To engage forward gear, proceed as follows:

1. Bring vehicle to a complete stop.

2. Apply and hold brake.
3. With engine at idle speed, push the reverse shift lever all the way in.
4. Gently depress throttle lever.

Reverse (Electronic Shift Models)

Shifting in Reverse/Shifting in Forward

To engage reverse or forward, proceed as follows:

1. Bring vehicle to a complete stop.
2. Apply and hold brake.
3. With engine at idle speed, press the START/RER button and release.
4. Gently depress throttle lever.

Shutting Off the Engine

Release throttle lever and wait until engine has returned to idle speed.

Shut off the engine using either the emergency engine stop switch or by pulling off the tether cord cap from the engine cut-off switch.

WARNING

Always remove the tether cord cap from engine cut-off switch when vehicle is not in operation in order to prevent accidental engine starting, theft or use by unauthorized persons.

RIDING CONDITIONS AND YOUR SNOWMOBILE

Altitude

At factory, your snowmobile was calibrated to be used within an altitude range (height above the sea level). For your model's factory calibration, refer to the following table.

MODEL	FACTORY CALIBRATION
All Models	Sea level up to 600 m (2,000 ft)

If your snowmobile is to be used at an altitude outside the specified range, have it calibrated accordingly by an authorized Lynx dealer.

NOTICE An inappropriate altitude calibration would decrease performance and may cause serious damage to the snowmobile.

Temperature

The engine management of these engines provides the optimum air/fuel ratio for all temperatures.

Hard Packed Snow

Models Equipped with Minimum Track Profile of 1.75 in

BRP does **not recommend** to ride a snowmobile equipped with high lug profile track at **high speed** in a trail, on hard packed surfaces or ice for an extended period of time.

In the event that you have to, **reduce your speed**, then minimize the distance you ride on those surfaces.

NOTICE Running those tracks at **high speed** in a trail, on hard packed surfaces or ice put more stress on the lugs, which tend to heat up as a result. To avoid potential degradation or damage to the track, **reduce your speed**, then minimize the distance you ride on those surfaces.

SPECIAL OPERATION

Towing an Accessory

Always use a rigid tow bar to tow an accessory. Any towed accessory should have reflectors on both sides and at the rear. Check local laws for brake light(s) requirements.

WARNING

Never tow an accessory with a rope. Always use a rigid tow bar. Using a rope would result in a collision between the object and the snowmobile and possibly in a tip over in case of a rapid deceleration or on a downward slope.

Towing Another Snowmobile

If a snowmobile is disabled and must be towed use a rigid tow bar. Remove the drive belt from disabled snowmobile, refer to *DRIVE BELT* in the *MAINTENANCE PROCEDURES* subsection and tow at moderate speed.

NOTICE Always remove the drive belt of the snowmobile that is to be towed to prevent damage to its drive belt and drive system.

In an emergency situation only, if a rigid tow bar is not available, a rope. Proceed with extra caution. In some areas, it may be illegal to do so. Check with state or local authorities.

Remove the drive belt, attach the rope to the ski legs (spindles), have someone sit on the towed snowmobile to activate the brake, and tow at low speed.

NOTICE In order to prevent damage to the steering system, never attach the tow rope to the ski handles.

WARNING

Never ride at high speed when towing a disabled snowmobile. Proceed slowly with extra caution.

TUNE YOUR RIDE

Snowmobile handling and comfort depend on multiple adjustments.

⚠ WARNING

Suspension adjustment could affect vehicle handling. Always take time to familiarize yourself with the vehicle's behavior after any suspension adjustment have been made. Always adjust LH and RH suspension components to the same setting.

Choice of suspension adjustments vary with carrying load, operator's weight, personal preference, riding speed and field condition.

NOTE: Some adjustments may not apply to your snowmobile.

⚠ WARNING

Before proceeding with any suspension adjustment, remember:

- Park in a safe place.
- Remove the tether cord cap from the engine cut-off switch.
- Use appropriate lifting device or have assistance to share lifting stress. If a lifting device is not used, use proper lifting techniques, notably using your legs force.
- Do not attempt to lift the front or rear of vehicle if it is above your limits.
- Support front of vehicle off the ground with a suitable device before adjusting suspension.
- Support rear of vehicle off the ground with a wide-base snowmobile stand with a rear deflector panel.
- Make sure support device is stable and secure.

The best way to set up the suspension is to customize each adjustment one at a time. Various adjustments

are interrelated. It may be necessary to readjust center spring after adjusting front springs for instance. Test run the snowmobile under the same conditions; trail, speed, snow, operator riding position, etc. Proceed methodically until you are satisfied.

Following are guidelines to fine-tune suspension. Use suspension adjustment tool provided in the tool kit.

Rear Suspension Adjustments

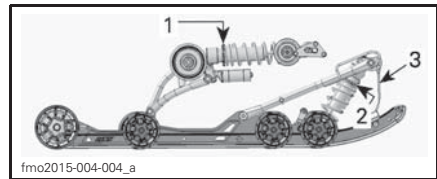

TYPICAL PPS2 - ADJUSTABLE COMPONENTS

1. Rear spring
2. Center spring
3. Stopper strap

NOTICE Whenever adjusting rear suspension, check track tension and adjust if necessary.

Stopper Strap

Stopper strap length has an effect on the amount of weight the center spring has to carry especially during acceleration, therefore on the front end uplift.

Stopper strap length also has an effect on center spring travel.

NOTICE Whenever stopper strap length is changed, track tension must be checked.

ACTION	RESULT
Increasing stopper strap length	Lighter ski pressure under acceleration
	More center spring travel
	More bump absorption capability
Decreasing stopper strap length	Heavier ski pressure under acceleration
	Less center spring travel
	Less bump absorption capability

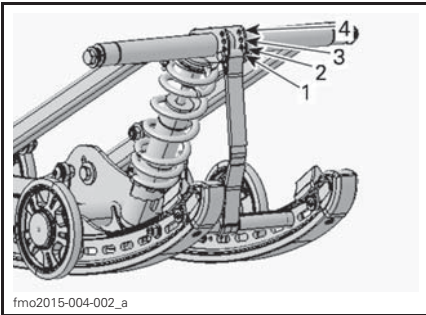

fmo2015-004-002_a

TYPICAL

1. Position 1 (factory setting)
2. Position 2
3. Position 3
4. Position 4

NOTE: Decreasing the stopper strap length may reduce comfort.

When operating the snowmobile in deep snow or hill climbing, it may be necessary to vary stopper strap length and/or riding position, to change the angle at which the track rides on the snow. Operator's familiarity with the various adjustments as well as snow conditions will dictate the most efficient combination.

Generally, a longer stopper strap setting gives better performance in deep snow on a flat landscape and a shorter setting will improve handling in steep hill climbing conditions.

Center Spring

Center spring preload has an effect on steering effort, handling and bump absorption.

Also, since center spring preload adjustment puts more or less pressure on the front of the track, it has an effect on the performance in deep snow.

ACTION	RESULT
Increasing preload	Lighter steering
	More bump absorption capability
	Better deep snow starts
	Better deep snow performance and handling
Decreasing preload	Heavier steering
	Less bump absorption capability
	Better trail handling

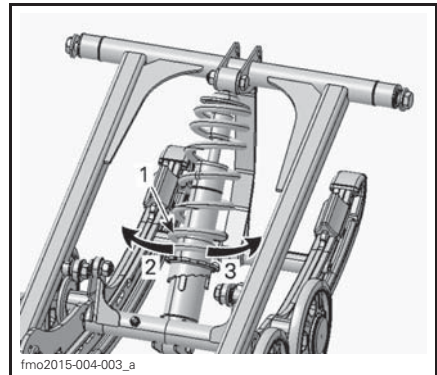

fmo2015-004-003_a

CAM TYPE - TYPICAL

1. Spring preload adjustment cam
2. Decrease preload
3. Increase preload

NOTE: For cam type or ring type preload adjuster, use the suspension adjustment tool provided in the tool kit.

Rear Spring

Rear spring preload has an effect on comfort, ride height and load compensation.

Also, adjusting rear spring preload shifts more or less weight to the snowmobile front end. As a result, more or less weight is applied to the skis. This has an effect on performance in deep snow, steering effort and handling.

Slight suspension bottoming occurring under the worst riding conditions indicates a good choice of spring preload.

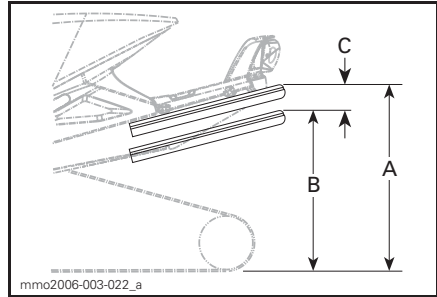

TYPICAL — PROPER ADJUSTMENT

- A. Suspension fully extended
- B. Suspension has collapsed with operator, passenger and load added
- C. Distance between dimension "A" and "B", see table below

ACTION	RESULT
Increasing preload	Firmer rear suspension
	Higher rear end
	More bump absorption capability
	Heavier steering
Decreasing preload	Softer rear suspension
	Lower rear end
	Less bump absorption capability
	Lighter steering
	Better deep snow performance and handling

"C"	WHAT TO DO
50 to 75 mm (2 to 3 in)	No adjustment required
More than 75 mm (3 in)	Adjusted too soft, increase preload
Less than 50 mm (2 in)	Adjusted too firm, decrease preload

Refer to the following to determine if preload is correct.

NOTE: If the specification is unattainable with the original springs, see an authorized Lynx dealer for other available springs.

Rear Suspension Extension Spring Preload

49 Ranger Only

Adjust by turning the preload cam.

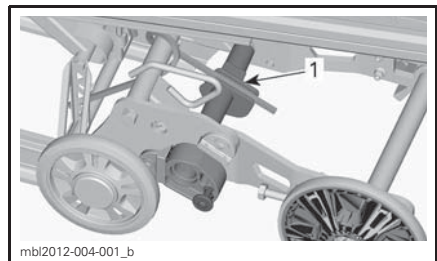

1. Preload cam

ACTION	RESULT
Increasing preload	More track surface on the ground
	Less extension lift
Decreasing preload	Better reverse capability especially in deep snow
	More extension lift

Rear Suspension Extension Stabilizer Cam

49 Ranger Only

To change stabilizer cam setting, pull lock off, then turn cam.

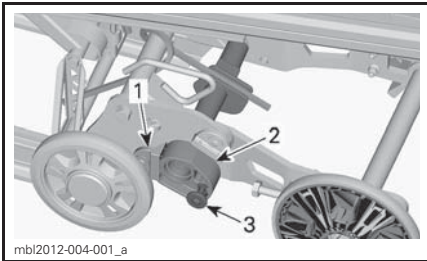

mbl2012-004-001_a

1. Stop block
2. Stabilizer cam
3. Lock

CAM SETTING	RESULT
Away from stop block	Allows free movement of the suspension extension on its entire stroke
	General use
	Good reverse capability

CAM SETTING	RESULT
Leaning on stop block	Locks the suspension extension in line with the suspension rails
	Better traction, full track contact surface
	Better towing capability

Front Suspension Adjustments

Skis

It is possible to set the ski to three different position.

Standard position for Ski is that Ski runner is installed on center holes.

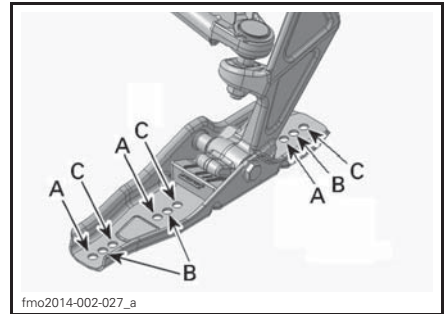

fmo2014-002-027_a

BLADE SKI

- A. Light control -for deep snow riding
- B. Standard - Trail riding
- C. Stable control

49 Ranger Models

On these models, it is possible to set the ski stance to two different width.

When the spacer is installed inside the ski leg, skis are set to the narrower stance.

When the spacer is installed outside the ski leg, skis are set to the wider stance.

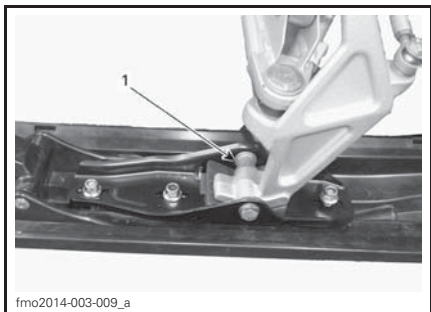

fmo2014-003-009_a

1. Spacer on inside of ski leg

To change the ski stance, proceed as follows on both sides:

1. Lift the front of vehicle.
2. Remove the ski bolt.
3. Place the spacer according to the desired stance, see illustration.

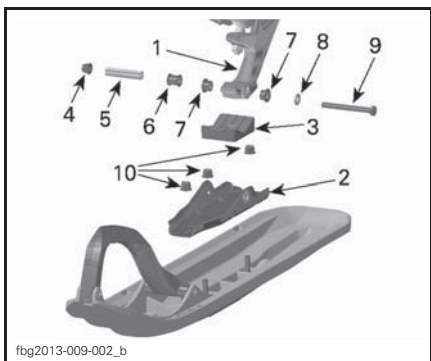

fbg2013-009-002_b

PARTS LAYOUT - RH SIDE SHOWN

1. Ski leg
2. Ski runner
3. Ski stopper
4. Elastic Flanged Nut M10
5. Ski Axle
6. Models with adjustable stance
7. Bushings
8. Washer
9. Ski bolt (Hex. Cap Screw M10 x 100)
10. Flanged Nut M10

4. Install all the other parts and tighten nut to the specified torque.

SKI BOLT TIGHTENING TORQUE
48 N•m ± 6 N•m (35 lbf•ft ± 4 lbf•ft)

NOTE: Make sure your vehicle does not exceed the maximum width allowed for trail riding. Check local regulations.

Front Springs

Front spring preload has an effect on front suspension firmness.

Front spring preload also has an effect on the steering behavior.

ACTION	RESULT
Increasing preload	Firmer front suspension
	Higher front end
	More precise steering
	More bump absorption capability
Decreasing preload	Softer front suspension
	Lower front end
	Lighter steering
	Less bump absorption capability

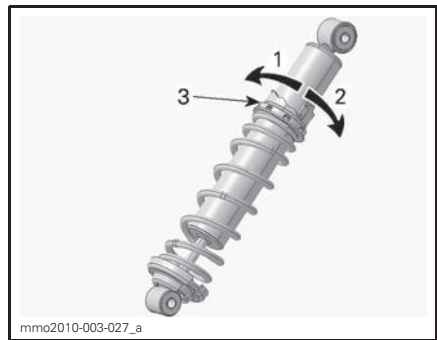

mmo2010-003-027_a

CAM TYPE - TYPICAL

1. Decrease preload
2. Increase preload
3. Spring preload adjustment cam

Adjustment Tips According to Vehicle Behavior

PROBLEM	CORRECTIVE MEASURES
Front suspension darting	Check ski alignment. – Reduce front suspension spring preload. – Increase center spring preload. – Reduce rear spring preload.
Steering feels too heavy at steady speeds	– Reduce front suspension spring preload. – Increase center spring preload.
Steering feels too heavy during acceleration	– Reduce rear spring preload. – Lengthen limiter strap.
Too much ski lift during cornering or acceleration	– Shorten limiter strap. – Increase rear spring preload.
Rear of snowmobile seems too stiff	– Reduce rear spring preload.
Rear of snowmobile seems too soft	– Increase rear spring preload.
Rear suspension is frequently bottoming	– Increase rear spring preload. – Increase center spring preload. – Lengthen limiter strap.
Snowmobile seems to pivot around its center	– Reduce center spring preload. – Increase rear spring preload. – Increase front suspension spring preload. – Shorten limiter strap.
Track spins too much at start	– Lengthen limiter strap.

REAR AND FRONT SUSPENSION SPRING PRELOAD FACTORY SETTINGS

MODEL	SKI	FRONT ARM	REAR ARM
Adventure LX	17 mm Cam position #4	16 mm Cam position #6	13 mm Cam position #4
49 Ranger Series	3 mm Cam position #1	4 mm Cam position #2	5 mm Cam position #1
49 Ranger ST Series	6 mm Cam position #2	4 mm Cam position #2	5 mm Cam position #1

VEHICLE TRANSPORTATION

Make sure the fuel tank cap is properly installed.

Tilt bed trailers can easily be equipped with a winch mechanism to afford maximum safety in loading. Simple as it may seem, never drive your snowmobile onto a tilt bed trailer or any other kind of trailer or vehicle. Many serious accidents have resulted from driving up and over a trailer. Anchor your vehicle securely, front and rear, even on short hauls. Be certain all equipment is securely fastened. Cover your snowmobile when trailering to prevent road grime from causing damage.

Be certain your trailer meets state or provincial requirements. Ensure the hitch and safety chains are secure and the brake, turn indicators and clearance lights all function.

WARNING

Do not tow the vehicle facing backwards. If the vehicle is towed facing backwards, the wind may cause damage to the windshield or even loss of the windshield.

MAINTENANCE

FIRST INSPECTION

After the first 10 hours or 500 km (300 mi) of operation, whichever comes first, your vehicle have to be inspected by an authorized Lynx dealer, repair shop or person of your own choosing. The first inspection is very important and must not be neglected.

NOTE: The first inspection is at the expense of the vehicle owner.

FIRST INSPECTION (2-STROKE) AFTER THE FIRST 500 KM (300 MI) OR 10 HOURS OF OPERATION, WHICHEVER COMES FIRST	
ENGINE	Inspect engine motor mounts
	Inspect exhaust system and check for leaks
	Tighten exhaust manifold screws to specified torque
	Check coolant level
FUEL SYSTEM	Inspect fuel lines and connections
	Inspect throttle cable
DRIVE SYSTEM AND BRAKE	Inspect drive belt
	Visually inspect drive pulley
	Tighten drive pulley retaining screw to specified torque
	Inspect driven pulley
	Adjust and align track
	Change chaincase / gearbox oil
	Adjust drive chain (except models with gearbox)
	Check brake fluid level
Inspect brake hose, pads and disk	
STEERING SYSTEM	Inspect steering mechanism
	Inspect skis and runners
FRAME	Tighten frame pyramid rod screws to 14 N•m (124 lbf•in)
	Retighten rear member screws to frame to specified torque REX2 35 N•m (26 lbf•ft)
SUSPENSION	Inspect front suspension
	Inspect rear suspension (including stopper straps and slider shoes)
	Lubricate front and rear suspension
	Retighten PPS2 rear axle bolt 1/4 turn
BODY	Adjust seat lock plate

FIRST INSPECTION (4-STROKE) AFTER THE FIRST 500 KM (300 MI) OR 10 HOURS OF OPERATION, WHICHEVER COMES FIRST	
ENGINE	Inspect engine seals and gaskets for leaks
	Inspect exhaust system and check for leaks
	Check coolant level
FUEL SYSTEM	Inspect fuel lines and connections
DRIVE SYSTEM AND BRAKE	Inspect drive belt
	Visually inspect drive pulley
	Tighten drive pulley retaining screw to specified torque
	Inspect driven pulley
	Check driven pulley preload
	Adjust and align track
	Change chaincase / gearbox oil
	Adjust drive chain (Not for models equipped with gearbox)
	Check brake fluid level
Inspect brake hose, pads and disk	
STEERING SYSTEM	Inspect steering mechanism
	Inspect skis and runners
FRAME	Tighten frame pyramid rod screws to 14 N•m (124 lbf•in)
	Retighten rear member screws to specified torque REX2 35 N•m (26 lbf•ft)
SUSPENSION	Inspect front suspension
	Inspect rear suspension (including stopper straps and slider shoes)
	Retighten PPS2 rear axle bolt 1/4 turn.
BODY	Adjust seat lock plate
FIRST INSPECTION (4-STROKE) AFTER THE FIRST 3 000 KM (2,000 MI) OR 1 YEAR OF OPERATION, WHICHEVER COMES FIRST	
ENGINE	Change engine oil and filter

MAINTENANCE SCHEDULE (E-TEC)

NOTE: The maintenance schedule does not exempt the pre-ride inspection.

WARNING

Failure to properly maintain the vehicle according to the maintenance schedule and procedures can make it unsafe to operate.

EVERY 1 500 KM (1,000 MI)	
DRIVE SYSTEM	Models with chaincase: Adjust drive chain
	Models with chaincase: Check chaincase oil level
	Models with gearbox: Check oil level
EVERY 3 000 KM (2,000 MI) OR 1 YEAR (WHICHEVER COMES FIRST)	
ENGINE	Inspect heat shields
	Inspect engine rubber mounts
	Inspect exhaust system and check for leaks
	Inspect cooling system cap, hoses and clamps and check for leaks
	Adjust engine stopper
DRIVE SYSTEM AND BRAKE	Visually inspect and clean drive pulley
	Tighten drive pulley retaining screw to specified torque
	Clean driven pulley
	Adjust and align track
	Inspect brake hose, pads and disk
STEERING SYSTEM	Inspect steering mechanism
FRAME	Retighten rear member screws to frame to specified torque (REX2 35 N•m (26 lbf•ft))
SUSPENSION	Inspect front suspension
	Inspect rear suspension and stopper strap. PPS2 Suspension REX2 models: Replace stopper strap.
	Lubricate front and rear suspension whenever the vehicle is used in wet conditions (wet snow, rain, puddles)
	Check ski leg bushing and bearing. Replace if needed.
	All models with T/A shocks, oil change / service.
ELECTRICAL SYSTEM	Replace spark plugs (ACE Models)

EVERY 6 000 KM (4,000 MI) OR 2 YEARS (WHICHEVER COMES FIRST)	
ENGINE	Clean and lubricate rewind starter
FUEL SYSTEM	Inspect fuel pump strainer and replace if necessary
	Inspect throttle cable
DRIVE SYSTEM	Replace brake fluid
	Replace the following drive pulley wear parts: slider shoes, O-rings and sliding sheave bushing (E-TEC)
SUSPENSION	Check PPS2 bushing and bearing. Replace both if either one is worn.

EVERY 10 000 KM (6,000 MI) OR 3 YEARS (WHICHEVER COMES FIRST)	
ENGINE	E-TEC: Inspect oil pump strainer and clean if needed
	Clean 3D rive valves
DRIVE SYSTEM	Replace the following drive pulley wear parts: spring cover bushing and ramps (E-TEC)
ELECTRICAL SYSTEM	E-TEC: Replace spark plugs

EVERY 5 YEARS	
ENGINE	Replace engine coolant
FUEL SYSTEM	Replace in-line fuel filter (E-TEC)

MAINTENANCE SCHEDULE (ACE)

NOTE: The maintenance schedule does not exempt the pre-ride inspection.

WARNING

Failure to properly maintain the vehicle according to the maintenance schedule and procedures can make it unsafe to operate.

EVERY 1 500 KM (1,000 MI)	
DRIVE SYSTEM	Models with chaincase: Adjust drive chain
	Models with chaincase: Check chaincase oil level
	Models with gearbox: Check oil level
EVERY 3 000 KM (2,000 MI) OR 1 YEAR (WHICHEVER COMES FIRST)	
ENGINE	Inspect all heat shields
	Inspect exhaust system and check for leaks (ACE)
DRIVE SYSTEM AND BRAKE	Visually inspect and clean drive pulley
	Tighten drive pulley retaining screw to specified torque
	Check driven pulley preload
	Clean driven pulley
	Adjust and align track
	Inspect brake hose, pads and disk
STEERING SYSTEM	Inspect steering mechanism
FRAME	Retighten rear member screws to frame to specified torque (REX2 35 N•m (26 lbf•ft))
SUSPENSION	Inspect front suspension
	Inspect rear suspension and stopper strap. PPS2 Suspension REX2-models: Replace stopper strap.
	Lubricate front and rear suspension whenever the vehicle is used in wet conditions (wet snow, rain, puddles)
	Check ski leg bushing and bearing. Replace if needed.
	All models with T/A shocks, oil change / service

**EVERY 6 000 KM (4,000 MI) OR AT PRE-SEASON
(WHICHEVER COMES FIRST)**

ENGINE	Change engine oil and filter
--------	------------------------------

**EVERY 6 000 KM (4,000 MI) OR 2 YEARS
(WHICHEVER COMES FIRST)**

FUEL SYSTEM	Replace fuel filter
	Replace fuel pump outlet filter (ACE)
DRIVE SYSTEM AND BRAKE	Replace drive pulley slider shoes, O-ring and rollers and inspect ramps (900 ACE)
	Replace brake fluid
SUSPENSION	Check PPS2 bushing and bearing. Replace both if either one is worn

**EVERY 10 000 KM (6,000 MI) OR 3 YEARS
(WHICHEVER COMES FIRST)**

ELECTRICAL SYSTEM	Replace spark plugs
-------------------	---------------------

EVERY 5 YEARS

ENGINE	Replace engine coolant
--------	------------------------

MAINTENANCE PROCEDURES

This section includes instructions for basic maintenance procedures.

⚠ WARNING

Turn off the engine, remove tether cord cap and follow these maintenance procedures when performing maintenance. If you do not follow proper maintenance procedures you can be injured by hot parts, moving parts, electricity, chemicals or other hazards.

⚠ WARNING

Should removal of a locking device be required (e.g. lock tabs, self-locking fasteners, etc.) when undergoing disassembly/assembly, always replace with a new one.

Air Filter with Dual Air Intake

Air Filter Verification

There are two air intake pre-filters, one on each side of the console.

Ensure the air intake prefilters are properly installed, clean and in good condition.

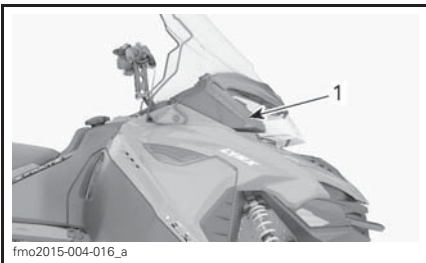

1. RH Air filter

If the air filter has to be cleaned or replaced, see an authorized Lynx dealer, repair shop or person of your own choosing.

Engine Coolant

⚠ WARNING

Never open coolant tank cap when engine is hot.

Engine Coolant level Verification

The engine coolant tank is located under the hood. See *CONTROLS, INSTRUMENTS AND EQUIPMENT* for hood removal procedure.

Check coolant level at room temperature with the cap removed. Liquid should be at cold level line (engine cold) of coolant tank.

NOTE: When checking level at low temperature it may be slightly lower than the mark.

If additional coolant is necessary or if entire system has to be refilled, refer to an authorized Lynx dealer, repair shop or person of your own choosing.

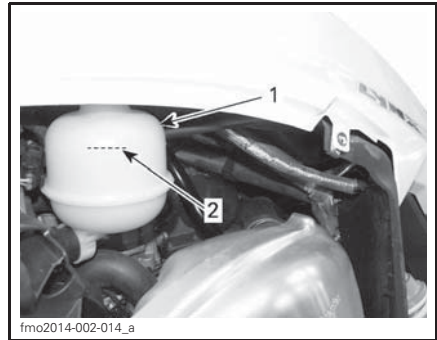

TYPICAL

1. Coolant tank
2. COLD LEVEL line

Recommended Engine Coolant

COOLANT	
BRP recommended product	LONG LIFE ANTIFREEZE(F) (P/N 619 590 204)
Alternative, or if not available	Distilled water and antifreeze solution (50% distilled water, 50% antifreeze)

NOTICE A blend of 50% antifreeze with 50% distilled water will improve the cooling efficiency. Using water tap instead of distilled water, would contribute to make deposits in cooling system and to reduce antifreeze efficiency. This could lead to engine overheating.

To prevent antifreeze deterioration, always use the same brand. Never mix different brands unless cooling system is completely flushed and refilled.

NOTICE To prevent rust formation or freezing condition in cold areas, always replenish the system with 50% antifreeze and 50% distilled water. Pure antifreeze will freeze at a higher temperature than the optimal water/antifreeze mix. Always use ethylene glycol antifreeze containing corrosion inhibitors specifically recommended for aluminum engines.

Engine Oil

Recommended Engine Oil

E-TEC Models

Refer to *INJECTION OIL* subsection for detailed information.

ACE Models

ENGINE	RECOMMENDED ENGINE OIL
600 and 900 ACE	XPS 4-STROKE SYNTHETIC OIL (F) (P/N 619 590 114)

NOTICE The engine of this snowmobile has been developed and validated using the recommended BRP XPS™ oil. BRP recommends the use of its recommended XPS oil or equivalent. Damages caused by oil which is not suitable for this 4-stroke engine will not be covered by the BRP limited warranty.

If the recommended oil is not available, use SAE 0W-40 synthetic-based oil that meets or exceeds the requirements for API service classification SM.

Engine Oil Level Verification

NOTICE Check level every 10 hours of use and refill if necessary. Do not overfill. Operating the engine with an improper level may severely damage engine. Wipe off any spillage.

Make sure the engine is at normal operating temperature.

NOTE: The engine reaches normal temperature when the rear radiator gets warm indicating the thermostat has opened.

Place vehicle on a level surface and proceed as follows to check oil level:

1. Let engine run at idle for approximately 30 seconds.
2. Stop engine.
3. Open the LH side panel, refer to *CONTROLS, INSTRUMENTS AND EQUIPMENT*.
4. Remove the drive belt guard, refer to *CONTROLS, INSTRUMENTS AND EQUIPMENT*.

5. Remove dipstick from the filler tube, then wipe it clean.
6. Completely insert dipstick in the filler tube.
7. Remove dipstick and check the oil level. Oil level should be between the MIN. and MAX. marks as shown, add if necessary.

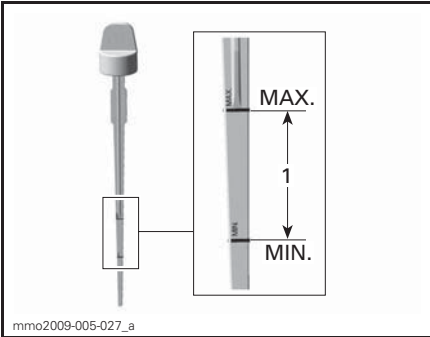

1. Oil level between MIN. and MAX.

⚠ WARNING

Wipe off any oil spills. Oil is highly flammable when heated.

Engine Oil Replacement

⚠ WARNING

The engine oil can be very hot. Wait until engine oil is warm.

NOTICE Engine oil and oil filter must be replaced at the same time.

1. Place vehicle on a level surface.
2. Remove the LH side panel.
3. Remove dipstick.



LH SIDE OF VEHICLE

1. Oil tank dipstick

4. From underneath the vehicle, access the drain plug:
 - 4.1 Remove one access cover retaining screw and loosen the other.
 - 4.2 Pivot the access cover to clear the bottom pan opening.

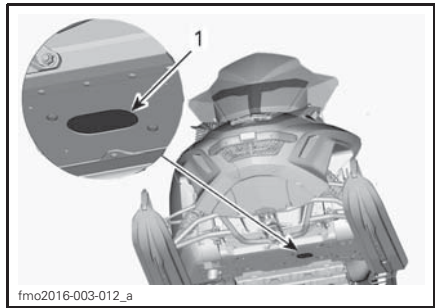

1. Drain plugs access cover

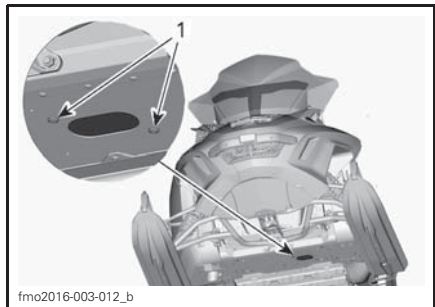

PIVOT THE ACCESS COVER

1. Retaining screws

5. Clean drain plug area.

6. Place a drain pan under the bottom pan opening.
7. Remove engine drain plugs in the following order.
 - 7.1 Main drain plug.
 - 7.2 Secondary drain plug.

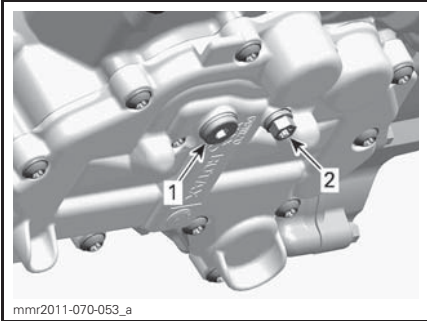

mnr2011-070-053_a

UNDERNEATH THE ENGINE

1. Main drain plug
2. Secondary drain plug

8. Allow oil to drain completely.
9. Install **NEW** sealing washers on oil drain plugs.

NOTICE Never use a sealing washer a second time. Always replace with a new one.

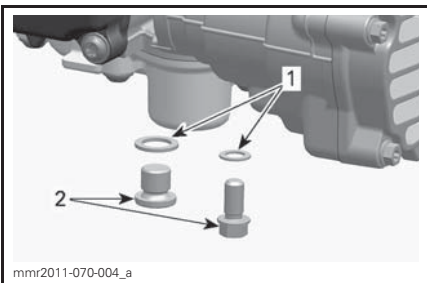

mnr2011-070-004_a

1. Sealing washer
2. Oil drain plug

10. Install drain plugs and tighten to the specified torque.

TIGHTENING TORQUE	
Drain plugs	15 N•m ± 1.8 N•m (133 lbf•in ± 16 lbf•in)

11. Replace *OIL FILTER*, see procedure in this subsection.
12. Refill oil tank at the proper level with the recommended oil.

APPROXIMATE ENGINE OIL CAPACITY (WITH FILTER)	
600 ACE	2.1 L (2.2 qt (U.S. liq.))
900 ACE	3.3 L (3.5 qt (U.S. liq.))

13. Reinstall dipstick in oil tank and properly tighten it.
14. Start engine and let it idle for a few minutes.
15. Ensure there are no leaks.
16. Stop engine and check oil level as explained in this subsection. Refill if necessary.
17. Dispose oil and filter as per your local environmental regulations.

Engine Oil Filter (ACE)

Engine Oil Filter Replacement

Oil Filter Removal

1. Remove the RH side panel.
2. Clean oil filter area.
3. Remove:
 - Oil filter cover screws
 - Oil filter cover with O-ring
 - Oil filter.

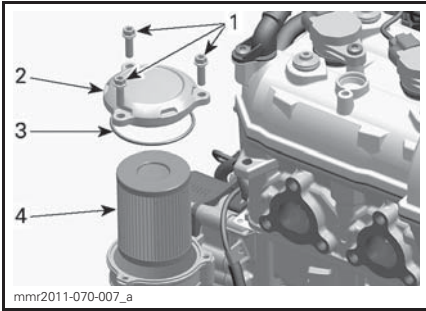

1. Oil filter cover screws
2. Oil filter cover
3. O-ring
4. Oil filter

4. Dispose filter as per your local environmental regulations.

Oil Filter Installation

1. Check the oil filter inlet and outlet orifices inside oil filter receptacle (integrated part of magneto cover) for dirt and contaminations.

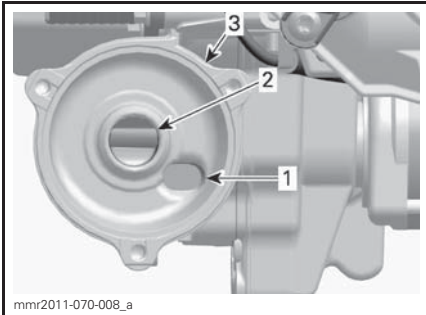

1. Oil inlet orifice from the oil pressure pump
2. Oil outlet orifice to the engine lubrication system
3. Oil filter receptacle

2. Install a O-ring on oil filter cover.
3. Lubricate filter seal and cover O-ring with engine oil.

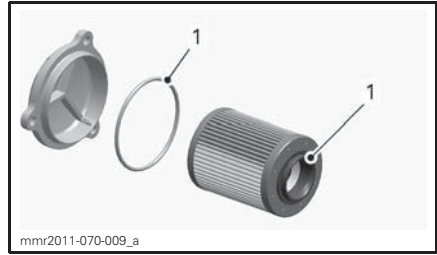

1. Lubricate with engine oil

4. Install the oil filter cover.
5. Tighten oil filter cover screws to the specified torque.

TIGHTENING TORQUE	
Oil Filter Cover	9 N•m ± 1 N•m (80 lbf•in ± 9 lbf•in)

Engine Stopper (E-TEC)

Engine Stopper Adjustment

The engine stopper is located on the LH front engine support, in front of the drive pulley.

1. Remove D.E.S.S. key from post.
2. Remove the LH side panel, refer to *CONTROLS, INSTRUMENTS AND EQUIPMENT*.
3. Remove drive belt guard, refer to *DRIVE BELT GUARD REMOVAL* subsection in *CONTROLS, INSTRUMENTS AND EQUIPMENT*.
4. Loosen the three screws retaining the engine stopper to the engine support just enough to allow a vertical play (1/2 to one turn).

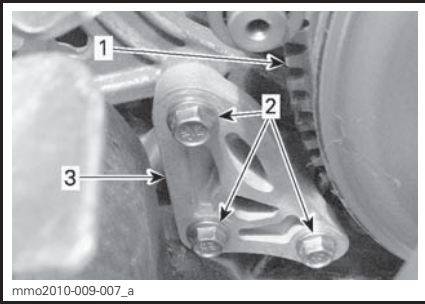

1. Drive pulley
2. Engine stopper screws
3. Engine stopper

5. Insert a 0.5 mm (.02 in) feeler gauge in the engine stopper opening (see illustration).

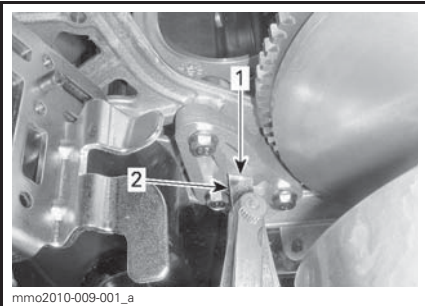

1. Opening
2. Feeler gauge

6. Place feeler gauge between engine stopper and rubber stop block (on engine).

NOTE: Do not insert the feeler gauge too deep, as it will pass over the bump at the surface of the rubber stop block and alter adjustment. See illustration.

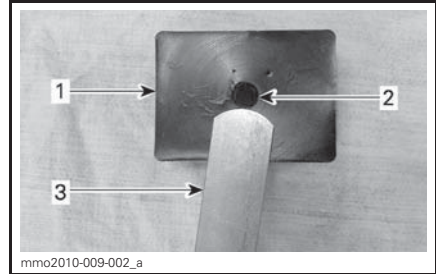

1. Rubber stop block
2. Bump
3. Feeler gauge

7. Tighten screws to $10 \text{ N}\cdot\text{m} \pm 2 \text{ N}\cdot\text{m}$ ($89 \text{ lbf}\cdot\text{in} \pm 18 \text{ lbf}\cdot\text{in}$) following the illustrated sequence, taking care not to pinch the feeler gauge.

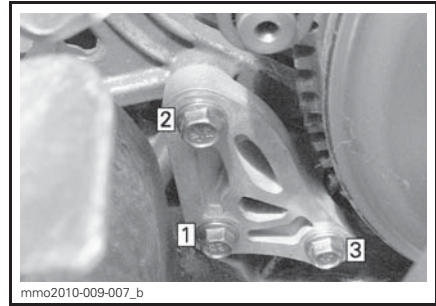

TIGHTENING SEQUENCE

NOTICE Serious pulley damage can occur if the engine stopper and its screws are not properly installed.

Exhaust System

Exhaust System Verification

The muffler tail pipe should be centered with the exit hole in the bottom pan. Exhaust system must be free of rust or leaks. Make sure that all parts are securely in place.

Check retaining springs condition and replace if necessary.

The exhaust system is designed to reduce noise and to improve the total performance of the engine. Modification may be in violation of local laws.

NOTICE If any exhaust system component is removed, modified or damaged, severe engine damage may result.

Muffler Removal and Installation

1. Refer to *CONTROLS, INSTRUMENTS AND EQUIPMENT* subsection and remove:
 - Hood
 - RH side panel.
 - Drive belt guard

600 HO E-TEC

2. Disconnect the EGTS (Exhaust Gas Temperature Sensor).
3. Remove the springs retaining the exhaust pipes to the muffler using the following tool.

SPRING INSTALLER/REMOVER
(P/N 529 035 983)



CAUTION Wear protective eye glasses when removing exhaust components. Beware of sudden spring tension release.

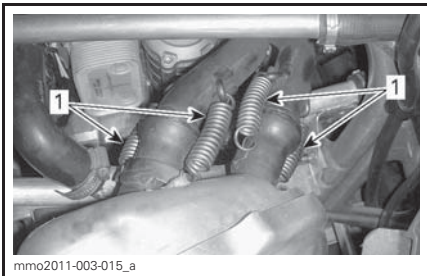

1. Exhaust pipes to muffler retaining springs
4. Remove the two muffler retaining springs.

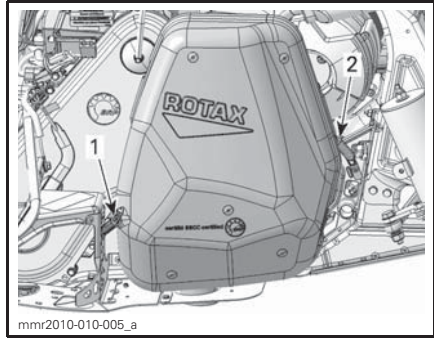

TYPICAL

1. Aft muffler retaining spring
2. Front muffler retaining spring

5. Remove the muffler.

Inspect doughnut shaped muffler gaskets and replace if necessary.

To install muffler, reverse removal procedure.

Spark Plugs

Spark plugs inspection or replacement may be performed by an authorized Lynx dealer, repair shop, or person of your own choosing. Spark plugs inspection or replacement requires an in-depth technical knowledge. Though not required, it is recommended that an authorized Lynx dealer performs spark plugs inspection or replacement.

Brake Fluid

Recommended Brake Fluid

Use only DOT 4 brake fluid from a sealed container. An opened container may be contaminated or may have absorbed moisture from the air.

WARNING

Use only DOT 4 brake fluid from a sealed container. To avoid serious damage to the braking system, do not use fluids other than the recommended one, nor mix different fluids for topping up.

NOTICE Brake fluid can damage painted and plastic parts. Handle with care. Rinse thoroughly in case of spillage.

Brake Fluid Level Verification

Place vehicle on a level surface.

Check brake fluid in reservoir for proper level. Add recommended brake fluid as required.

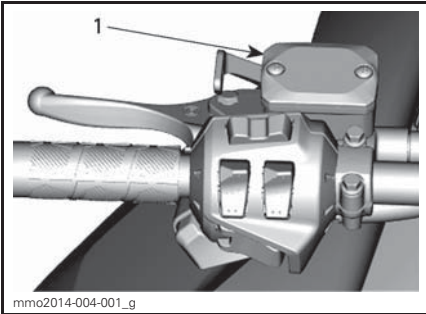

mmo2014-004-001_g

TYPICAL

1. Brake fluid reservoir

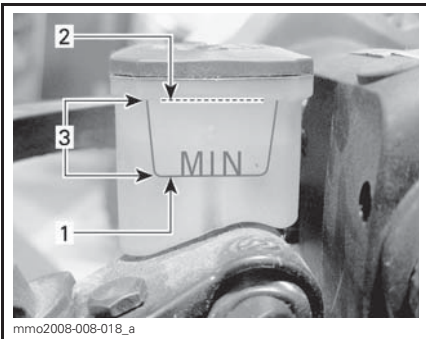

mmo2008-008-018_a

1. Minimum
2. Maximum
3. Operating range

CAUTION Avoid getting brake fluid on skin or eyes - it may cause severe burns. In case of contact skin, wash thoroughly. In case of contact with the eyes, immediately rinse with plenty of water for at least 10 minutes and then consult a doctor immediately.

Chaincase Oil

Recommended Chaincase Oil

RECOMMENDED CHAINCASE OIL
(P/N 619 590 098)

NOTICE The chaincase of this snowmobile has been developed and validated using the XPS™ Synthetic chaincase oil. BRP strongly recommends the use of its XPS Synthetic chaincase oil at all times. Damages caused by oil which is not suitable for the chaincase will not be covered by the BRP limited warranty.

Access to Chaincase

Open RH side panel, refer to *CONTROLS, INSTRUMENTS AND EQUIPMENT*.

Chaincase Oil Level Verification

With the vehicle on a level surface, check the oil level by removing the magnetic check plug.

E-TEC Models

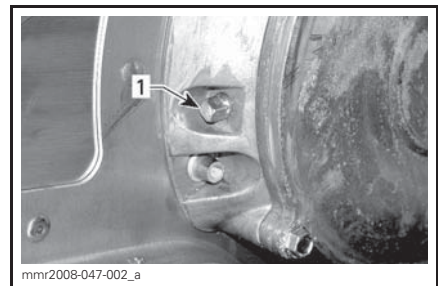

mmt2008-047-002_a

1. Magnetic check plug

NOTE: It is normal to find metallic particles stuck to magnetic check plug. If bigger pieces of metal are found, remove the chaincase cover and inspect the chaincase parts.

Remove metal particles from magnetic check plug.

ACE Models

Oil level must reach the threaded hole.

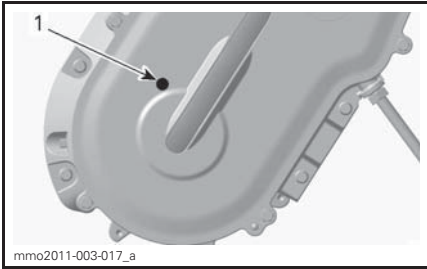

TYPICAL

1. Check plug

All Models

Oil level must reach the threaded hole.

Chaincase Filling Procedure

Remove the check plug.

Remove the filler cap on the chaincase cover.

E-TEC Models

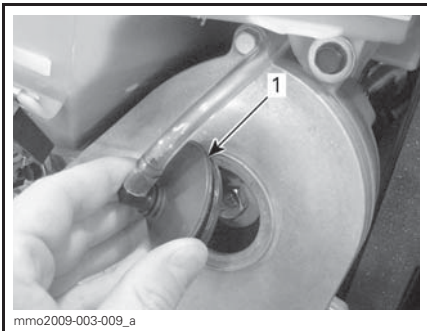

1. Filler cap

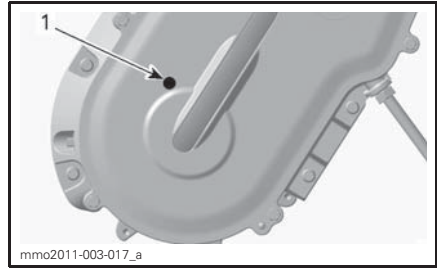

TYPICAL

1. Check plug

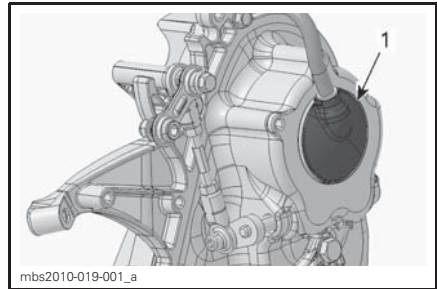

1. Filler cap

All Models

Pour recommended oil in chaincase by the filler hole until oil comes out by the check plug hole.

Reinstall check plug and torque to specification.

TIGHTENING TORQUE	
Check plug	6 N•m ± 1 N•m (53 lbf•in ± 9 lbf•in)

Reinstall the filler cap.

Drive Chain

Access to Chaincase

Open RH side panel, refer to *CONTROLS, INSTRUMENTS AND EQUIPMENT*.

Drive Chain Adjustment

1. Remove muffler, refer to *EXHAUST SYSTEM* in this subsection.

2. Unscrew tensioner lock nut several turns.

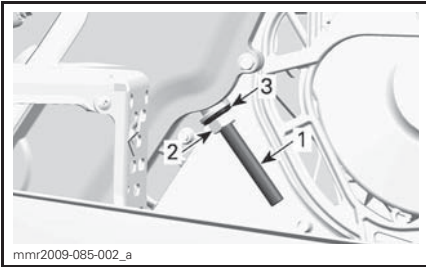

1. Tensioner adjustment screw
2. Lock nut
3. Seal washer

3. Unscrew tensioner adjustment screw a few turns.
4. Pull seal washer back.
5. Clean adjustment screw threads if necessary.

NOTICE Adjustment screw threads must be clean to obtain an accurate adjustment.

6. Tighten tensioner adjustment screw by hand.

NOTE: Turn adjustment screw until resistance is strong enough that it can not be turned by hand.

7. Hold tensioner adjustment screw and tighten lock nut to $36 \text{ N}\cdot\text{m} \pm 3 \text{ N}\cdot\text{m}$ ($27 \text{ lbf}\cdot\text{ft} \pm 2 \text{ lbf}\cdot\text{ft}$).
8. Install muffler.

Drive Belt

Drive Belt Inspection

Inspect drive belt for cracks, fraying or abnormal wear (uneven wear, wear on one side, missing cogs, cracked fabric). If abnormal wear is noted, probable cause could be pulley misalignment, excessive RPM with frozen track, fast starts without warm-up pe-

riod, burred or rusty sheave, oil on drive belt or distorted spare drive belt. Contact an authorized Lynx dealer.

Drive Belt Replacement

Drive Belt Removal

1. Remove tether cord cap from engine cut-off switch.
2. Remove drive belt guard, refer to *CONTROLS, INSTRUMENTS AND EQUIPMENT*.
3. Insert the driven pulley expander provided in the tool kit in the threaded hole on the adjuster hub as shown.

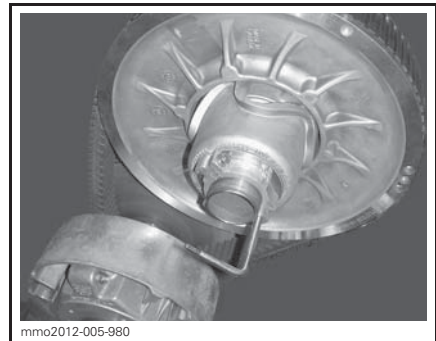

PULLEY EXPANDER INSTALLED ON ADJUSTER HUB

4. Open the driven pulley by screwing the tool in.
5. Remove the belt by slipping it over the top of the driven pulley, then over the drive pulley.

Drive Belt Installation

1. Slip the drive belt over the drive pulley, then over the driven pulley.

NOTICE Do not force or use tools to pry the drive belt into place, as this could cut or break the cords in the drive belt.

NOTE: The maximum drive belt life span is obtained when drive belt is installed with arrows in the direction of rotation.

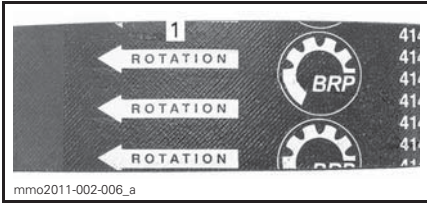

1. To be pointed in the direction of rotation
2. Unscrew and remove the driven pulley expander from the pulley.
3. Rotate the driven pulley several times to properly set the drive belt between the sheaves.
4. Refer to *DRIVE BELT HEIGHT ADJUSTMENT* below.
5. Install drive belt guard and close side panel. Refer to *CONTROLS, INSTRUMENTS AND EQUIPMENT*.

Drive Belt Height Adjustment

The drive belt height must be checked every time a new drive belt is installed.

To adjust the drive belt height, proceed as follows:

1. Remove tether cord cap from engine cut-off switch.
2. Remove drive belt guard.
3. Loosen the clamping bolt.

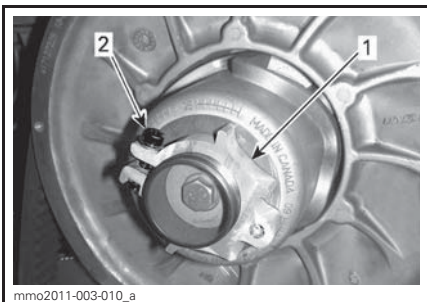

1. Adjuster hub
2. Clamping bolt

4. Using the suspension adjustment tool provided in the tool kit, turn the ring 1/4 turn at a time then rotate the driven pulley to properly set the drive belt between the pulley sheaves.

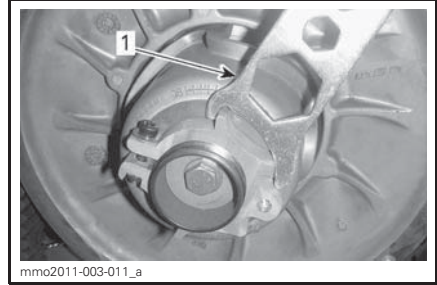

1. Suspension adjustment tool

NOTE: The adjustment ring has left hand threads.

Belt without External Cogs

Repeat step 4 until the drive belt is flush with driven pulley edge.



PRELIMINARY SETTING

1. Drive belt flush with driven pulley edge

Belt with External Cogs

Repeat step 4 until the bottom of grooves on the external side of drive belt are flush with the driven pulley edges.

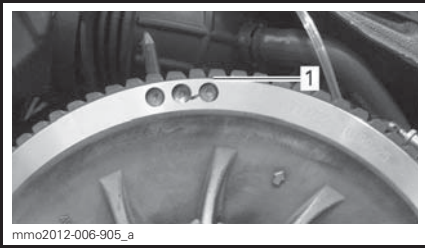

mmo2012-006-905_a

TYPICAL - PRELIMINARY SETTING

1. Lowest portion of cogs even with external surface of drive belt

All Drive Belt Types

NOTE: Turning the ring counterclockwise lowers the drive belt in the pulley. Turning the ring clockwise raises the drive belt in the pulley.

5. Firmly tighten the clamping bolt. If possible, tighten to specified torque using a torque wrench.

TORQUE	
Clamping bolt	5.5 N•m ± 0.5 N•m (49 lbf•in ± 4 lbf•in)

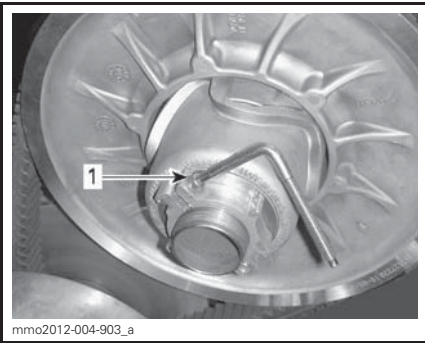

mmo2012-004-903_a

TYPICAL

1. Clamping bolt

6. Install drive belt guard.
7. Install side panel.

NOTE: This setting is correct as a preliminary adjustment for most models. In some cases, when starting the engine, the vehicle could creep, indicating that the drive belt is too tight.

If the vehicle creeps, lower the drive belt height from the preliminary setting. Repeat procedure until creeping stops.

Reverse Activation

NOTE: The reverse may not activate or may be harder to activate if the drive belt is positioned too high in the driven pulley. If reverse activation does not work properly, ensure the drive belt is properly adjusted. Adjust the drive belt lower in the driven pulley if needed.

Drive Pulley (E-TEC)

Drive Pulley Adjustment

⚠ WARNING

Remove tether cord cap from engine cut-off switch before performing any adjustment. Vehicle must be parked in a safe place, away from the trail.

The drive pulley is factory calibrated to transmit maximum engine power at a predefined RPM. Factors such as ambient temperature, altitude or surface condition may vary this critical engine RPM thus affecting snowmobile efficiency.

This adjustable drive pulley allows setting maximum engine RPM to maintain maximum power.

Calibration screws should be adjusted so that actual maximum engine RPM matches the maximum horsepower RPM.

ENGINE	MAXIMUM HORSEPOWER RPM
600 HO E-TEC	8100 RPM (± 100)

NOTE: Use precision digital tachometer for engine RPM adjustment.

NOTE: The adjustment has an effect on high RPM only.

There are 6 positions numbered 1 to 6. The calibration screws have 6 different settings identified by numbers scribed on their head.

The actual setting is the screw head number aligned with the mark on the pulley.

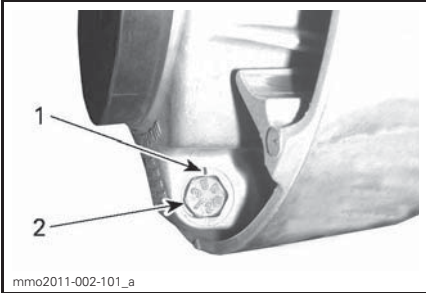

mmo2011-002-101_a

PULLEY SETTING

1. Mark
2. Number

Each position modifies maximum engine RPM by about 200 RPM.

Lower position numbers decrease engine RPM in steps of 200 RPM and higher position numbers increase it in steps of 200 RPM.

Example:

Calibration screws initially set at position 4 and changed to position 6 will increase maximum engine RPM by 400 RPM.

Procedure

Loosen the lock nut just enough to get the calibration screw head out of the pulley and rotate to the desired position. Do not completely remove the lock nut.

Set all 3 calibration screws to the same position.

Tighten lock nuts to 10 N•m ± 2 N•m (89 lbf•in ± 18 lbf•in).

NOTICE Do not completely remove calibration screw otherwise internal washers will fall off. Always adjust all 3 calibration screws and make sure they are all set to the same position.



mmo2015-007-303_a

TYPICAL

1. Loosen just enough to permit rotating of calibrate screw

⚠ WARNING

NEVER disassemble or modify the drive pulley. Improper assembly or modifications could cause the pulley to explode violently under the stress generated by the high rotational speed. See your Lynx dealer to maintain or service the drive pulley. Improper servicing or maintenance may affect performance and reduce belt life. Always respect maintenance schedules.

⚠ WARNING

NEVER operate engine:

- Without shields and belt guard securely installed.
- With hood and/or side panels opened or removed.

NEVER attempt to make adjustments to moving parts while engine is running.

Track

Track Condition

! WARNING

Remove tether cord cap from engine cut-off switch before performing any maintenance or adjustment, unless otherwise specified. Vehicle must be parked in a safe place, away from the trail.

Remove tether cord cap from engine cut-off switch.

Lift the rear of the snowmobile and support it with a wide-base snowmobile mechanical stand with a rear deflector panel. With the engine off, rotate the track by hand, and inspect condition. If worn or cut, or if track fibers are exposed, or if missing or defective inserts or guides are noted; contact an authorized Lynx dealer.

Snowmobiles Equipped with Traction Enhancing Products

If your snowmobile is equipped with a BRP approved studded track, refer to *INSPECTION* in the *TRACTION ENHANCING PRODUCTS* subsection.

! WARNING

Riding with a damaged track or studs could lead to a loss of control.

Track Tension and Alignment

NOTE: Track tension and alignment are interrelated. Do not adjust one without the other.

! WARNING

To prevent serious injury to individuals near the snowmobile:

- NEVER stand behind or near a moving track.
- Always use a wide-base snowmobile stand with a rear deflector panel if it is necessary to rotate track.
- When the track is raised off the ground, only run it at the lowest possible speed.

Centrifugal force could cause debris, damaged or loose studs, pieces of torn track, or an entire severed track to be violently thrown backwards out of the tunnel with tremendous force, possibly resulting in the loss of a leg or other serious injury.

Track Tension Verification

NOTE: Ride the snowmobile in snow about 15 to 20 minutes prior to adjusting track tension.

1. Remove tether cord cap from engine cut-off switch.
2. Lift rear of vehicle and support it off the ground.

! CAUTION Use proper lifting techniques, notably using your legs force. Do not attempt to lift the rear of vehicle if it is above your limits.

3. Allow rear suspension to fully extend.
4. Use the TENSIO METER (P/N 414 348 200).



5. Set deflection using bottom O-ring. Check gap halfway between front and rear idler wheels. Measure between slider shoe bottom and inside of track. The gap should be as given in *SPECI-*

SPECIFICATIONS at the end of this guide. If the track tension is too loose, track will have a tendency to thump.



DEFLECTION SETTING

1. Bottom O-ring set to specification
6. Place upper O-ring to 0 kgf (0 lbf).
7. Position the tensiometer on track, halfway between front and rear idler wheels.
8. Push the tensiometer downwards until bottom O-ring (deflection set earlier) be aligned with the bottom of slider shoe.

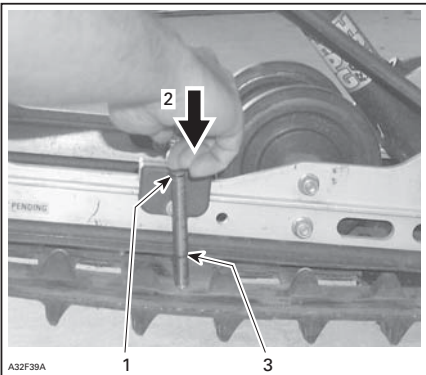

TYPICAL

1. Top tool O-ring positioned at 7.3 kg (16 lb)
2. Push on top portion of tool until it contacts the top O-ring
3. Measured track deflection (See specifications section to find your model track deflection)
9. Read load recorded by the upper O-ring on the tensiometer.



LOAD READING

1. Upper O-ring
10. Load reading must be as per the following table / see *SPECIFICATIONS* at the end of this guide.
11. If load reading is not in accordance with the specification, adjust track tension. Refer to *TRACK TENSION ADJUSTMENT*.

Track Tension Adjustment

1. Remove tether cord cap from engine cut-off switch.
2. Remove rear wheel caps (if so equipped).
3. Loosen the rear idler wheel retaining screws.
4. Tighten or loosen both adjustment screws to increase or decrease track tension.

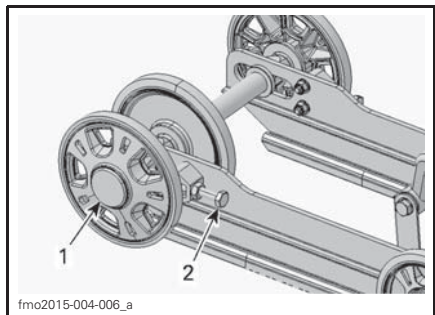

ADVENTURE LX

1. RH rear wheel cap
2. RH adjustment screw

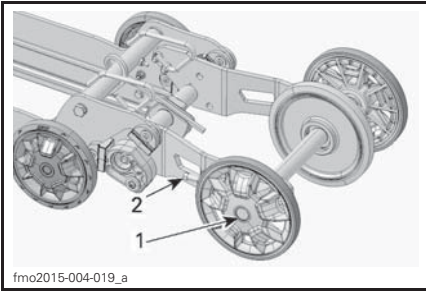

49 RANGER

1. RH rear idler wheel bolt
2. RH adjustment screw

5. If correct tension is unattainable, contact an authorized Lynx dealer.
6. Retighten retaining bolts to specification.

TIGHTENING TORQUE	
Retaining Bolt	48 N•m ± 6 N•m (35 lbf•ft ± 4 lbf•ft)

7. Check track alignment as described below.

Track Alignment

⚠ WARNING

Before checking track alignment, ensure that the track is free of all particles which could be thrown out while track is rotating. Keep hands, tools, feet and clothing clear of track. Always lift the snowmobile on a wide-base stand with a rear deflector panel. Ensure no one is standing in close proximity to the snowmobile, especially at the rear of the track. Never rotate track at high speed.

Centrifugal force could cause debris, damaged or loose studs, pieces of torn track, or an entire severed track to be violently thrown backwards out of the tunnel with tremendous force.

1. Lift rear of vehicle and support it off the ground.

⚠ CAUTION Beware of injuries by using proper lifting techniques, notably using your legs force. Do not attempt to lift the rear of vehicle if it is above your limits.

2. Start engine and accelerate slightly so that track slowly turns. This must be done in a short period of time (15 to 20 seconds).
3. Check that the track is well centered; equal distance on both sides between edges of track guides and slider shoes.

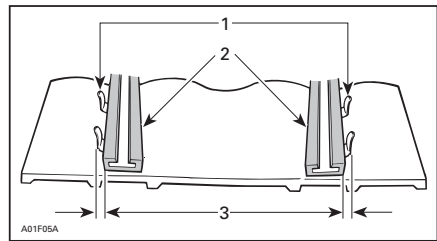

1. Guides
2. Slider shoes
3. Equal distance

4. To correct track alignment:

- 4.1 Stop engine.
- 4.2 Remove tether cord cap from engine cut-off switch.

⚠ WARNING

Remove tether cord cap from engine cut-off switch before performing any maintenance or adjustment, unless otherwise specified. Vehicle must be parked in a safe place, away from the trail.

- 4.3 Loosen rear wheel retaining screws.
- 4.4 Tighten adjustment screw on side where the slider shoe is the farthest from the track insert guides.

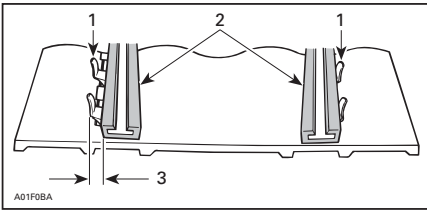

1. Guides
2. Slider shoes
3. Tighten on this side

5. Tighten retaining screws.

⚠ WARNING

Properly tighten wheel retaining bolts, otherwise wheel may come off and cause track to "lock".

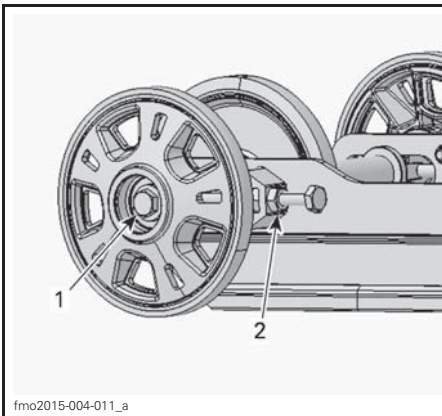

TYPICAL

1. Retaining bolt - Retighten to $48\text{ N}\cdot\text{m} \pm 6\text{ N}\cdot\text{m}$ ($35\text{ lbf}\cdot\text{ft} \pm 4\text{ lbf}\cdot\text{ft}$)
 2. Locknut
6. Restart engine and rotate track slowly to recheck alignment.
7. Reposition snowmobile on the ground.
8. Install rear wheel caps if so equipped.

Suspension

Rear Suspension Condition

Visually inspect all suspension components including slider shoes, springs, wheels, etc.

NOTE: During normal driving, snow will act as a lubricant and coolant for the slider shoes. Extensive riding on ice or sanded snow, will create excessive heat build-up and cause premature slider shoe wear.

Suspension Stopper Strap Condition

Inspect stopper strap for wear and cracks, bolt and nut for tightness. If loose inspect holes for deformation. Replace as required. Torque nut to specification.

TIGHTENING TORQUE	
Nut	11 N•m (97 lbf•in)

Rear Suspension Lubrication

Lubricate rear suspension at grease fittings using SUSPENSION GREASE (P/N 619 590 193.) Refer to *MAINTENANCE SCHEDULE* for maintenance frequency.

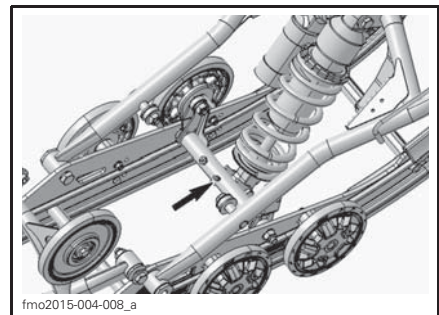

TYPICAL PPS2 GREASE FITTINGS (FRONT)

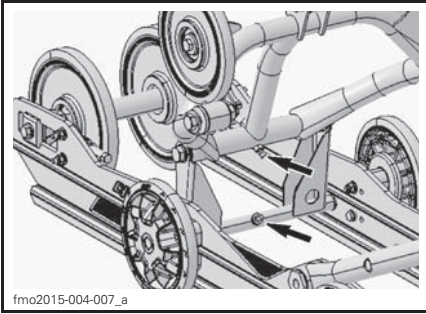

fmo2015-004-007_a

TYPICAL PPS2 GREASE FITTINGS (REAR)

Steering and Front Suspension Condition

Visually inspect steering and front suspension for tightness of components (steering arms, control arms and links, tie rods, ball joints, ski bolts, ski legs, etc.). If necessary, contact an authorized Lynx dealer.

Skis

Wear and Condition of Skis and Runners

Check the condition of the skis and ski runner carbides. If worn, contact an authorized Lynx dealer.

⚠ WARNING

Excessively worn skis and/or ski runners will adversely affect snowmobile control.

Fuses

Fuse Inspection

The electrical system is protected with fuses, the fuse holders are located in the engine compartment.

Check fuse condition and replace it if necessary.

To remove fuse from holder, pull fuse out. Check if filament is melted.

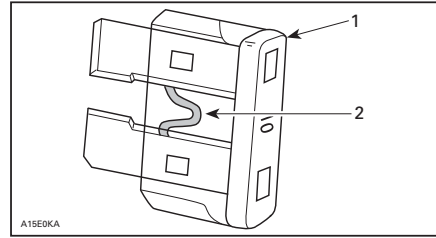

A15E0KA

1. Fuse
2. Check if melted

⚠ CAUTION Do not use a higher rated fuse as this can cause severe damage to electrical components and/or be a potential fire.

⚠ WARNING

If fuse has burnt out, source of malfunction should be determined and corrected before restarting. See an authorized Lynx dealer for servicing.

Fuse Location

E-TEC Manual Start

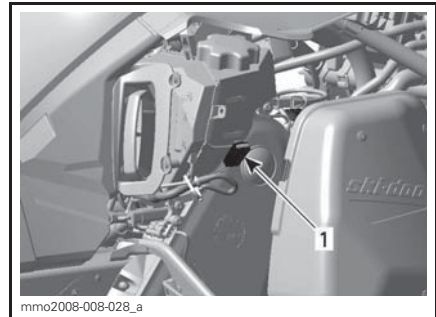

mno2008-008-028_a

TYPICAL — RH SIDE OF ENGINE COMPARTMENT

1. 5 A main fuse

E-TEC Electric Start

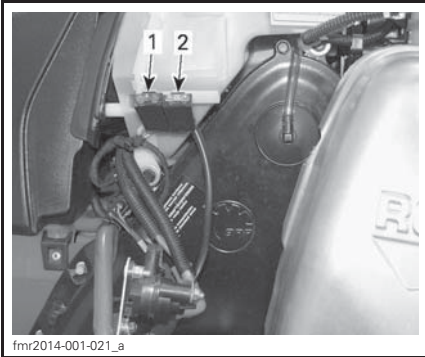

fmr2014-001-021_a

RH SIDE OF ENGINE COMPARTMENT

1. Charging fuse
2. START/RER fuse

600 ACE and 900 ACE

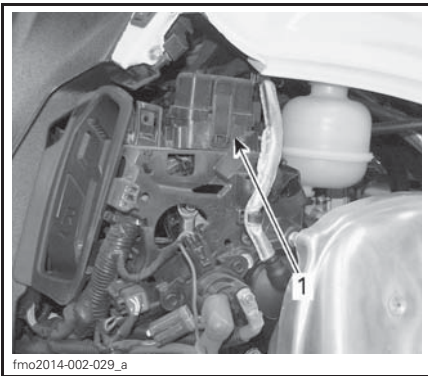

fmo2014-002-029_a

TYPICAL - RH SIDE OF ENGINE COMPARTMENT

1. Fuse Box

Refer to the cover decal or the *SPECIFICATIONS* subsection of this guide for fuses identification.

The electric fuel level sender fuse is located behind the air intake silencer.

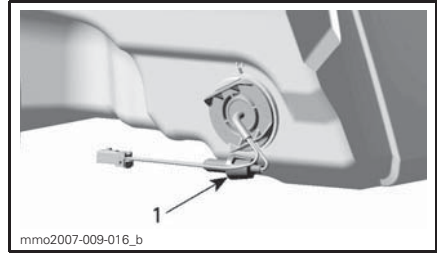

mmo2007-009-016_b

BEHIND AIR INTAKE SILENCER

1. Fuse location - 0.25 A fuse

Lights

Always check light operation after bulb replacement.

Headlights Bulb Replacement

NOTICE Never touch glass portion of an halogen bulb with bare fingers, it shortens its operating life. If glass is touched, clean it with isopropyl alcohol which will not leave a film on the bulb.

1. Open the front storage compartment by pulling the tab.

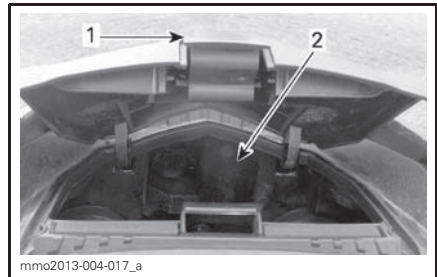

mmo2013-004-017_a

1. Tab
2. Storage compartment

2. Remove the applicable rubber boot.

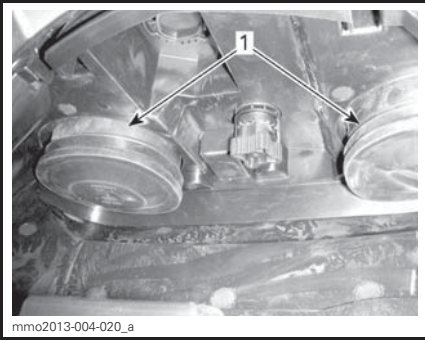

1. Rubber boots

NOTE: Make sure to properly reinstall both rubber boots to ensure that no humidity gets inside the headlamp. Humidity can create fog inside the headlamp.

3. Disconnect electrical connector.

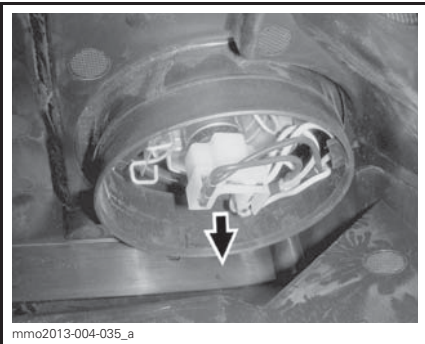

ELECTRICAL CONNECTOR

NOTE: Make sure to properly reconnect the electrical connector.

4. Press and pull both sides of the retaining clip at the same time to release it from bulb support.

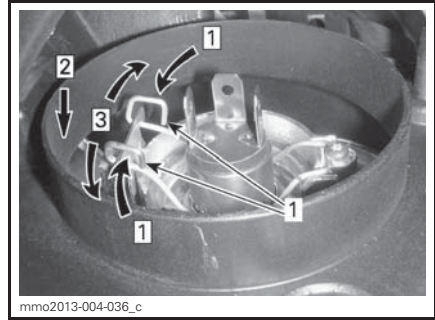

Step 1: Push both sides
Step 2: Push down to release
Step 3: Release both sides

1. Retaining clip

5. Pull bulb and replace. Properly reinstall parts.

Headlights Beam Aiming

Open the front storage compartment.

Turn knob to adjust beam height.

Turn knob clockwise to lower the beam height.

Turn knob counterclockwise to raise the beam height.

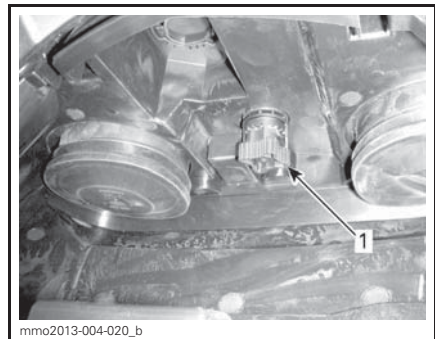

TYPICAL

1. Knob

Taillight

Led taillight leds cannot be replaced. If failed change taillight assy. Fasten new taillight by screws.

VEHICLE CARE

Post-Operation Care

Remove snow and ice from rear suspension, track, front suspension, steering mechanism and skis.

NOTE: Apply wax on glossy finish only.

WARNING

Make sure tether cord cap is away from engine cut-off switch before standing in front the vehicle, getting close to the track or rear suspension components.

Always cover your snowmobile when leaving it outside overnight or during extended periods of inactivity. This will protect it from frost and snow as well as help maintain its appearance.

Vehicle Cleaning and Protection

Wash snowmobile with water mixed with a mild detergent. Use only flannel cloths or an equivalent.

NOTICE It is necessary to use flannel cloths or equivalent on windshield and hood to avoid scratching the surfaces.

To remove grease, oil and grime, use BRP HEAVY DUTY CLEANER (P/N 293 110 001).

NOTICE Do not use Heavy duty cleaner on decals or vinyl.

To remove stubborn dirt from all plastic and vinyl surfaces, use XPS ALL PURPOSE CLEANER (P/N 219 701 709).

To remove scratches on windshield or hood use the (P/N 861 774 800).

NOTICE Never clean plastic parts or hood with strong detergent, degreasing agent, paint thinner, acetone, products containing chlorine, etc.

Wax painted portion of the vehicle for better protection.

STORAGE

During summer, or when a snowmobile is not in use for more than three months, proper storage is a necessity.

STORAGE	
VEHICLE	Clean the vehicle
ENGINE	2-Stroke models: Lubricate engine. See owners guide for instruction.
	Block muffler with rags
	Add fuel stabilizer to fuel following the product manufacturer recommendations
	Run the engine after adding the product to the fuel
DRIVE SYSTEM AND BRAKE	Lubricate brake lever pivot
	Lift rear of vehicle until track is clear of the ground. Do not release track tension
SUSPENSION	Inspect and lubricate rear suspension
	Lubricate front and rear suspension
ELECTRICAL SYSTEM	Charge battery monthly to keep it fully charge during storage

Storage (E-TEC)

Engine Cooling System

E-TEC Engines

Antifreeze should be replaced every 5 years or 6000 km to prevent antifreeze deterioration.

The antifreeze replacement and a density test should be performed by an authorized LYNX dealer.

⚠ CAUTION Improper antifreeze mixture might allow freezing of the liquid in the cooling system if vehicle is stored in area where freezing point is reached. This would seriously damage the engine. Failure to replace the antifreeze for storage may allow its degradation that could result in poor cooling when engine will be used.

⚠ CAUTION Do not run engine during storage period.

Engine Storage Mode (E-TEC)

Like other engines, the E-TEC has to be properly lubricated at storage for internal parts protection. The E-TEC system offers a built-in engine storage lubrication function (summerization) that can be initiated by the operator.

To engage procedure, do the following:

1. Place the vehicle in a well ventilated area.
2. Start the engine and let it run at idle speed until it reaches its operating temperature (watch the coolant temperature on the display or verify the rear heat exchanger becomes warm).
3. Push the SET (S) button to select odometer mode.

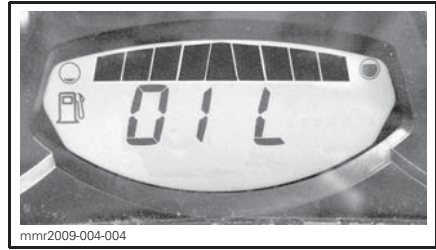
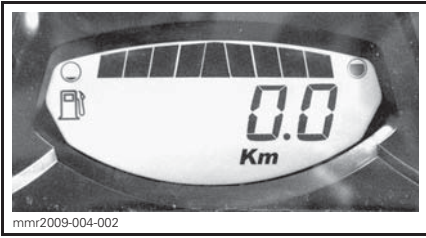

NOTE: The storage mode does not function in other modes (trip A, trip B and hr trip).

4. Repeatedly depress the HI/LOW beam switch rapidly, then, **while doing this**, press and hold the **SET button** until PUSH "S" appears on the display.

NOTE: It is critical for this procedure to depress the HI/LOW beam switch repeatedly **before** holding down the SET button.



5. Release all buttons when gauge displays **PUSH "S"** appears.
6. Again, press and hold the SET (S) button 2 - 3 seconds.

NOTE: The gauge will display OIL when the storage procedure is initiated.

7. When gauge displays **OIL**, release button and wait for the lubrication function to end.

Do not touch anything during engine lubrication cycle.

The engine lubrication function takes approximately 1 minute. During this time the engine RPM will increase slightly to approximately 1600 RPM and the oil pump will "oil flood" the engine.

At the end of engine lubrication procedure, the ECM will turn the engine off.

Remove tether cord.

NOTICE Do not start the engine during storage period.

PRESEASON PREPARATION

PRESEASON PREPARATION (2-STROKE)	
ENGINE	Inspect engine rubber mounts
	Check exhaust system condition and check for leaks
	Tighten exhaust manifold screws or nuts to specified torque
	Inspect cooling system cap, hoses and clamps and check for leaks
	Check coolant density
	Inspect crankshaft PTO seal
FUEL SYSTEM	Inspect fuel lines and connections
	Inspect throttle cable
DRIVE SYSTEM AND BRAKE	Inspect drive belt (adjust at every drive belt replacement)
	Clean and visually inspect drive pulley
	Clean and inspect driven pulley
	Inspect, adjust and align track
	Adjust drive chain (Not for models equipped with gearbox)
	Change chaincase / gearbox oil
	Check brake fluid level
Inspect brake hose, pads and disk	
STEERING SYSTEM	Inspect steering mechanism
	Inspect skis and runners
SUSPENSION	Inspect front suspension
	Inspect rear suspension (including stopper straps and slider shoes)
ELECTRICAL SYSTEM	Inspect spark plugs (All except E-TEC)
	Charge battery (if so equipped)
	Adjust headlight beam aiming

PRESEASON PREPARATION (4-STROKE)	
ENGINE	Visually inspect engine seals and gaskets and check for leaks
	Check exhaust system condition and check for leaks
	Change engine oil and filter
	Check coolant density
FUEL SYSTEM	Inspect fuel lines and connections
	Clean and inspect throttle body
DRIVE SYSTEM AND BRAKE	Inspect drive belt (adjust at every drive belt replacement)
	Clean and visually inspect drive pulley
	Clean and inspect driven pulley
	Inspect, adjust and align track
	Adjust drive chain (Not for models equipped with gearbox)
	Change chaincase / gearbox oil
	Check brake fluid level
	Inspect brake hose, pads and disk
STEERING SYSTEM	Inspect steering mechanism
	Inspect skis and runners
SUSPENSION	Inspect front suspension
	Inspect rear suspension and stopper strap.
ELECTRICAL SYSTEM	Charge battery (if so equipped)
	Adjust headlight beam aiming

TECHNICAL INFORMATION

VEHICLE IDENTIFICATION

Vehicle Description Decal

Vehicle description decal is located on the right hand side of tunnel.

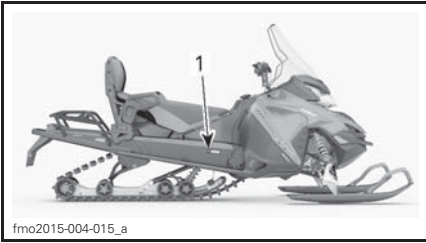

TYPICAL

1. Vehicle description decal

Vehicle Identification Number (V.I.N.)

V.I.N. is scribed on the vehicle description decal. See above. It is also engraved on the tunnel, near the vehicle description decal.

Model number and model year are part of the information found in the V.I.N. See illustration.

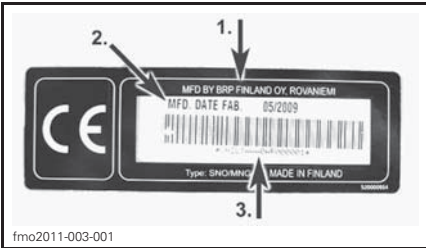
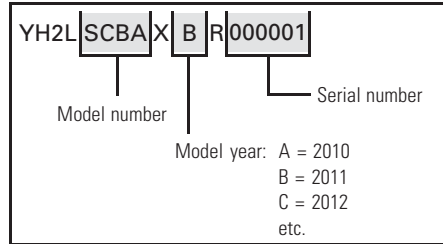

VEHICLE DESCRIPTION DECAL

1. Manufacturer name
2. Manufacturing date
3. Vehicle identification number (VIN)

Identification Numbers (Serial Numbers)

The main components of your snowmobile (engine and frame) are identified by different identification numbers. It may sometimes become necessary to locate these numbers for warranty purposes or to trace your snowmobile in the event of loss. These numbers are required by the authorized Lynx dealer to complete warranty claims properly. We strongly recommend that you take note of all the identification numbers on your snowmobile and supply them to your insurance company.

Engine Identification Number

Refer to the following illustration to locate the engine identification number on the applicable engine.

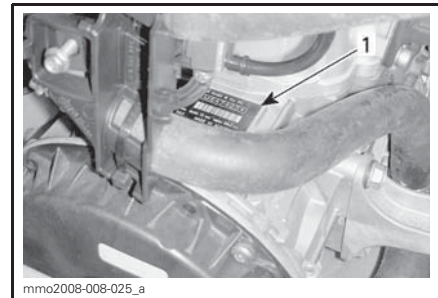

600 HO E-TEC® ENGINE — RH SIDE OF ENGINE COMPARTMENT

1. Engine serial number

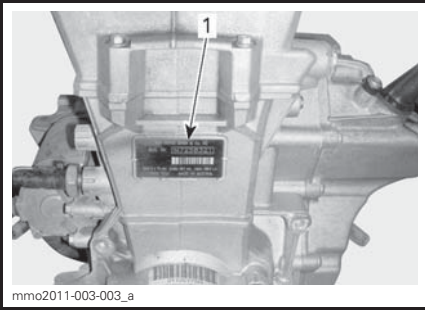

mmo2011-003-003_a

600 ACE ENGINE

1. Engine identification number

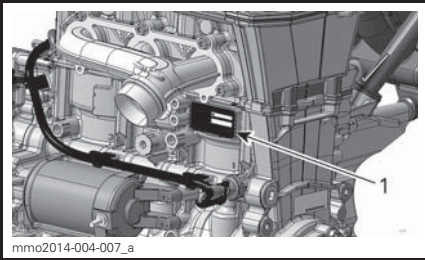

mmo2014-004-007_a

900 ACE ENGINE

1. Engine identification number

NOISE EMISSION AND VIBRATION VALUES (ALL COUNTRIES EXCEPT CANADA/UNITED STATES)

MODEL		600 HO E-TEC	600 ACE	900 ACE
NOISE EMISSION AND VIBRATION VALUES¹				
Noise	Sound power level (L _{WA})	96,7 dB @ 4050 RPM (Uncertainty (K _{wa}) 3 dB)	90,4 dB @ 3625 RPM (Uncertainty (K _{wa}) 3 dB)	92,7 dB @ 3625 RPM (Uncertainty (K _{wa}) 3 dB)
	Sound pressure (L _{pA})	86 dB @ 4050 RPM (Uncertainty (K _{pA}) 3 dB)	80 dB @ 3625 RPM (Uncertainty (K _{pA}) 3 dB)	80 dB @ 3625 RPM (Uncertainty (K _{pA}) 3 dB)
Vibration	Hand-arm system	<2.5m/s ² @ 4050 RPM	<2.5 m/s ² @ 3625 RPM	<2.5m/s ² @ 3625 RPM
	Whole body at seat	<0.5m/s ² @ 4050 RPM	<0.5 m/s ² @ 3625 RPM	<0.5m/s ² @ 3625 RPM
¹ : Noise emission and Vibration values are measured in accordance with Standard ISMA 1:2014 on a paved surface, at neutral or without belt.				

The EC-Declaration of Conformity does not appear in this version of the Operator's Guide.

Please refer to the printed version that was delivered with your vehicle.

RADIO FREQUENCY DIGITALLY ENCODED SECURITY SYSTEM (RF D.E.S.S. KEY)

This device complies with FCC Part 15 and Industry Canada license exempt RSS standard(s).

Operation is subject to the following two conditions: (1) this device may not cause interference, and (2) this device must accept any interference, including interference that may cause undesired operation of the device.

Changes or modifications not expressly approved by the party responsible for compliance could void the user's authority to operate the equipment.

IC Registration Number: 12006A-M01456

FCC ID: 2ACERM01456

We, the party responsible for compliance, declare under our sole responsibility that the device is in conformity with the provisions of the following Council Directive: 2014/53/EU. To which this declaration relates is in conformity with the essential requirements and other relevant requirements. The product is in conformity with the following directives, harmonized standards and regulations:

Radio Equipment Directive (RED) 2014/53/EU and Harmonized Standards:

EN 300 330-2, EN 60950-1

SPECIFICATIONS

MODEL		600 ACE
ENGINE		
Engine type		Rotax 602, liquid cooled, 4-stroke, D.O.H.C., dry sump
Cylinders		2
Displacement		600 cm ³ (36.6 in ³)
Bore		74 mm (2.9 in)
Stroke		69.7 mm (2.74 in)
Maximum horsepower RPM		7250 RPM
Exhaust system		Double front pipe, baffle muffler
Engine oil		XPS 4-STROKE SYNTHETIC OIL (F) (P/N 619 590 114) or SAE 0W 40 API SM synthetic oil
Engine oil capacity		Oil change, 2.1 L (2.2 qt (U.S. liq.))
Engine coolant		Ethyl glycol/water mix (50% coolant, 50% distilled water). Use LONG LIFE ANTIFREEZE(F) (P/N 619 590 204) or coolant specifically designed for aluminum engines
FUEL SYSTEM		
Fuel injection system		Multi point EFI, 46 mm throttle body
Recommended fuel		Regular unleaded (fuel containing MAXIMUM 10% ethanol)
Minimum octane rating	RON	95 E10 (fuel which may contain up to 10% MAX ethanol)
Fuel tank capacity		34 L (8.98 U.S. gal.)
ELECTRICAL SYSTEM		
Lightning system output		650 Watts @ 6000 RPM
Headlights bulb HI/LOW beam	Spark plug	2 x 60/55 Watts (H-4)
Taillight bulb		2 x P 21/5 W
Spark Plug	Type	NGK MR8BI-8
	Gap	.8 mm (.031 in)

MODEL		600 ACE
ELECTRICAL SYSTEM (cont'd)		
Fuses and relays	FA: Main	40 A
	F1: Fuel/engine	10 A
	F2: Accessories	20 A
	F3: Fan	15 A
	F4: Start	15 A
	F5: Lighting	20 A
	F6: Gauge/ECM/CAPS	10 A
	R1: Fuses 1, 6	-
	R2: Fuse 5	-
	R3: Fuse 2	-
DRIVE SYSTEM		
Drive pulley type		eDrive II LC
Driven pulley type		QRS (short shaft)
Engagement		2200 RPM
Chaincase oil	Type	(P/N 619 590 098)
	Capacity	500 ml (16.9 U.S. oz)
Drive Belt Part Number	Adventure LX 49 Ranger	417 300 127 ⁽¹⁾
Small sprocket number of teeth	All models	21
Large sprocket number of teeth	All models	51
Drive sprocket number of teeth	Adventure LX	8/16
	49 Ranger	7
	All others	8

MODEL		600 ACE	
DRIVE SYSTEM (cont'd)			
Track nominal width	Adventure LX with Silent Drive	38 cm (14.961 in)	
	All others	40.6 cm (15.984 in)	
Track nominal length	Adventure LX	348.7 cm (137.283 in)	
	49 Ranger	414.1 cm (163.031 in)	
Track profile height	49 Ranger	39 mm (1.535 in)	
	Adventure LX except Silent Drive	34 mm (1.339 in)	
	Adventure LX with Silent Drive	25 mm (1 in)	
Track tension	Deflection	49 Ranger	40 mm - 50 mm (1.575 in - 1.969 in)
		Adventure LX	35 mm - 45 mm (1.378 in - 1.772 in)
	Force without force		0 kg (0 lb)
	Deflection	49 Ranger	60 mm - 70 mm (2.362 in - 2.756 in)
		Adventure LX	50 mm - 60 mm (1.969 in - 2.362 in)
	Force ⁽¹⁾		7.3 kg (16 lb)
Track alignment		Equal distance between edges of track guides and slider shoes	
BRAKE SYSTEM			
Brake system type		Hydraulic, REX™ brake type	
Brake fluid		DOT 4	
SUSPENSION			
Front suspension	All models	A-LFS+	
Front shock	All models	HPG 36	
Front suspension max. travel	Adventure LX	242 mm (9.528 in)	
	49 Ranger	190 mm (7.48 in)	
	49 Ranger Touring	210 mm (8.27 in)	
Rear suspension	Adventure LX	PPS ² -3500	
	49 Ranger	PPS ² -4100-DS-A	
Center shock	Adventure LX	HPG 25	
	49 Ranger	HPG 36	

MODEL		600 ACE
SUSPENSION (cont'd)		
Rear shock	Adventure LX	HPG 25
	49 Ranger	HPG 36
Rear suspension max. travel	All models	390 mm (15.354 in)
WEIGHT AND DIMENSIONS		
Dry weight	Adventure LX except Silent Drive	250 kg (551 lb)
	Adventure LX with Silent Drive	245 kg (540 lb)
	49 Ranger	262 kg (577.6 lb)
	49 Ranger Touring	272 kg (599.7 lb)
Vehicle overall length	Adventure LX	307 cm (120.87 in)
	49 Ranger	347 cm (136.6 in)
Vehicle overall width	Adventure LX	126.5 cm (49.8 in)
	49 Ranger	110.5 cm (43.5 in)
	49 Ranger Touring	118 cm (46.46 in)
Vehicle overall height	All models	147 cm (57.874 in)
Ski stance	Adventure LX	1 080 mm (42.52 in)
	49 Ranger	921 mm ± 21 mm (36.26 in ± .827 in)
	49 Ranger Touring	996 mm ± 21 mm (39.213 in ± .827 in)
<p>⁽¹⁾ Drive belt height must be adjusted every time a new drive belt is installed. Confirm drive belt part number application with an authorized LYNX dealer.</p>		

600 HO E-TEC Models

MODEL	600 HO E-TEC
ENGINE	
Engine type	Rotax 593, liquid cooled w/Reed valve, 3D-RAVE
Cylinders	2
Displacement	594.4 cm ³ (36.3 in ³)
Bore	72 mm (2.8 in)
Stroke	73 mm (2.9 in)
Maximum engine speed	8100 ± 100 RPM
Fuel injection system	E-TEC Direct injection
Exhaust system	Single tuned pipe, baffle muffler
Engine oil	Refer to <i>RECOMMENDED OIL</i> section ⁽¹⁾
Engine oil tank capacity	3.7 L (3.9 qt (U.S. liq.))
Coolant	Ethyl glycol/water mix (50% coolant, 50% distilled water). Use LONG LIFE ANTIFREEZE(F) (P/N 619 590 204) or coolant specifically designed for aluminum engines
Recommended fuel	Premium unleaded (fuel which may contain up to 10% MAX ethanol)
Minimum octane rating. Refer to <i>FUEL REQUIREMENTS</i>	Regular unleaded
	95 E (RON) E10
Fuel tank capacity	34 L (8.98 U.S. gal.)
DRIVE SYSTEM	
Drive pulley type	TRA III
Driven pulley type	QRS 3 mm
Engagement	3400 ± 100 RPM
Drive belt part number	417 300 383 ⁽³⁾
Chaincase oil	XPS SYNTHETIC CHAINCASE OIL (P/N 413 803 300)
Small sprocket number of teeth	19
Large sprocket number of teeth	49
Drive sprocket number of teeth	8

MODEL		600 HO E-TEC
DRIVE SYSTEM (cont'd)		
Track nominal width		40.6 cm (15.984 in)
Track nominal length		414.1 cm (163.031 in)
Track profile height		59 mm (2.323 in)
Track tension	Deflection	40 mm - 50 mm (1.575 in - 1.969 in)
	Force ⁽²⁾	0 kg (0 lb)
Track tension	Deflection	60 mm - 70 mm (2.362 in - 2.756 in)
	Force ⁽²⁾	7.3 kg (16 lb)
Track alignment		Equal distance between edges of track guides and slider shoes
BRAKE SYSTEM		
Brake system type		Hydraulic, RE-X brake type
Brake fluid		DOT 4
SUSPENSION		
Front suspension		A- LFS+
Front shock		HPG 36
Front suspension max. travel		190 mm (7.48 in)
		210 mm (8.27 in)
Rear suspension		PPS ² -4100-DS-A
Center shock		HPG 36
Rear shock		HPG 36
Rear suspension max. travel		390 mm (15.354 in)
ELECTRICAL SYSTEM		
Lightning system output		12V/55V/1340W
Headlights bulb HI/LOW beam		2 x 60/55 Watts (H-4)
Taillight bulb		Led
Spark plug	Type	NGK PZFR6F ⁽³⁾
	Gap	Not adjustable (0.8 +0/-0.1mm) 0.75 mm ± 0.05 mm (.03 in ± .002 in) (not adjustable)
Fuse		Refer to <i>FUSES</i> in <i>MAINTENANCE</i>

MODEL		600 HO E-TEC
DIMENSIONS AND WEIGHT		
Vehicle overall length		347 cm (136.6 in)
Vehicle overall width	49 Ranger	110.5 cm (43.5 in)
	49 Ranger Touring	118 cm (46.46 in)
Vehicle overall height		147 cm (57.874 in)
Dry weight	49 Ranger	257 kg (566.6 lb)
	49 Ranger Touring	267 kg (588.6 lb)
Ski stance	49 Ranger	921 mm ± 21 mm (36.26 in ± .827 in)
	49 Ranger Touring	996 mm ± 21 mm (39.213 in ± .827 in)
Ski width		188 mm (7.402 in)

- (1) Refer to *INJECTION OIL* subsection for detailed information.
- (2) Measure gap between slider shoe and bottom inside track when exerting a downward pull to the track.
- (3) **NOTICE** Do not attempt to adjust gap on this spark plug.

900 ACE Models

MODEL		49 RANGER 900 ACE
ENGINE		
Engine type		Rotax 903, liquid cooled, 4-stroke, D.O.H.C., dry sump
Cylinders		3
Displacement		899 cm ³ (54.9 in ³)
Bore		74 mm (2.9 in)
Stroke		69.7 mm (2.74 in)
Maximum horsepower RPM		7250 RPM
Exhaust system		Single front pipe, baffle muffler
Engine oil		(P/N) (P/N 619 590 114) or SAE 0W 40 API SM synthetic oil
Engine oil capacity		Oil change, 3.3 L (3.5 qt (U.S. liq.))
Engine coolant		Ethyl glycol/water mix (50% coolant, 50% distilled water). Use BRP LONG LIFE ANTIFREEZE(F) (P/N 619 590 204) or coolant specifically designed for aluminum engines
FUEL SYSTEM		
Fuel injection system		Multi point EFI, 46 mm throttle body
Recommended fuel		Regular unleaded (fuel containing MAXIMUM 10% ethanol)
Minimum octane rating. Refer to <i>FUEL REQUIREMENTS</i>		95 RON (fuel which may contain up to 10% MAX ethanol)
Fuel tank capacity		34 L (8.98 U.S. gal.)
ELECTRICAL SYSTEM		
Lightning system output		644 Watts @ 6000 RPM
Headlights bulb HI/LOW beam	Spark plug	2 x 60/55 Watts (H-4)
Taillight bulb		2.6 W / 139m W LED
Spark Plug	Type	NGK MR8BI-8
	Gap	.8 mm (.031 in)

MODEL		49 RANGER 900 ACE
ELECTRICAL SYSTEM (cont'd)		
Fuses and relays	FA: Main	40 A
	F1: Ignition coils, fuel injectors, fuel pump, starter solenoid	10 A
	F2: Accessories	20 A
	F3: Electro mechanical reverse	20 A
	F4: Start clock, cooling fan	10 A
	F5: Headlights, taillight, brake light	20 A
	F6: ECM, gauge, CAPS	10 A
	R1: Main relay	Fuses F1, F3 and F6
	R2: Lighting relay	Fuse F5
R3: Accessory relay	Fuse F2	
DRIVE SYSTEM		
Drive pulley type		eDrive II
Driven pulley type		QRS (short shaft)
Engagement		2200 RPM
Chaincase oil	Type	(P/N) (P/N 619 590 098)
	Capacity	500 ml (16.9 U.S. oz)
Drive Belt Part Number		417 300 383 ⁽¹⁾
Small sprocket number of teeth		21
Large sprocket number of teeth	49 Ranger with 59mm track profile	51
	49 Ranger with 49mm track profile	49
Drive sprocket number of teeth		8
Track nominal width		40.6 cm (15.984 in)
Track nominal length		414.1 cm (163.031 in)
Track profile height		39 mm (1.535 in) OR 59 mm (2.323 in)
Track tension	Deflection	40 mm - 50 mm (1.575 in - 1.969 in)
	Force without force	0 kg (0 lb)
	Deflection	60 mm - 70 mm (2.362 in - 2.756 in)
	Force ⁽¹⁾	7.3 kg (16 lb)
Track alignment		Equal distance between edges of track guides and slider shoes

MODEL		49 RANGER 900 ACE
BRAKE SYSTEM		
Brake system type		Brembo with braided stainless-steel brake line
Brake fluid		DOT 4
SUSPENSION		
Front suspension		A-LFS+
Front shock		HPG 36
Front suspension max. travel	49 Ranger except 59mm track profile	190 mm (7.48 in)
	49 Ranger with 59mm track profile	210 mm (8.268 in)
Rear suspension		PPS ² -4100-DS-A
Center shock		HPG 36
Rear shock		HPG 36
Rear suspension max. travel		390 mm (15.354 in)
WEIGHT AND DIMENSIONS		
Dry weight	49 Ranger except 59mm track profile	278 kg (613 lb)
	49 Ranger with 59mm track profile	281 kg (619.5 lb)
Vehicle overall length		347 cm (136.6 in)
Vehicle overall width		118 cm (46.46 in)
Vehicle overall height		147 cm (57.874 in)
Ski stance		996 mm ± 21 mm (39.213 in ± .827 in)
⁽¹⁾ Drive belt height must be adjusted every time a new drive belt is installed. Confirm drive belt part number application with an authorized LYNX dealer.		

TROUBLESHOOTING

TROUBLESHOOTING GUIDELINES (E-TEC AND ACE)

ELECTRIC STARTER DOES NOT WORK

1. Emergency engine stop switch in OFF position or tether cord cap not installed on engine cut-off switch.
 - *Place the emergency engine stop switch in the ON position and install tether cord cap (on engine cut-off switch).*
2. Throttle applied while attempting an engine start.
 - *Release throttle while cranking.*

ENGINE IS CRANKED BUT FAILS TO START

1. No fuel to the engine.
 - *Check fuel tank level, add fuel if necessary.*
2. System voltage too low.
 - *Contact an authorized Lynx dealer.*

ENGINE RPM DOES NOT REACH CLUTCH ENGAGEMENT POINT

1. D.E.S.S. did not read D.E.S.S. key code in the tether cord cap. D.E.S.S. pilot lamp blinks (slow short beeps/repetitive).
 - *Properly install tether cord cap.*
2. D.E.S.S. has read a different code than the one programmed. D.E.S.S. pilot lamp blinks rapidly (fast short beeps/repetitive).
 - *Install a tether cord cap for which this snowmobile was programmed.*
3. ECM does not recognize the D.E.S.S. key (ACE).
 - *Refer to an authorized Lynx dealer.*

ENGINE LACKS ACCELERATION OR POWER

1. Learning key used (ACE).
 - *Use a Normal key.*
2. Sport mode not activated (ACE).
 - *Refer to ACTIVATING SPORT MODE in OPERATING MODES.*
3. Engine warm-up in progress.
 - *Drive vehicle at low speeds for a few minutes.*
4. Engine break-in period not completed.
 - *Complete break-in period.*
5. Incorrect drive pulley adjustment (E-TEC).
 - *Adjust drive pulley, refer to MAINTENANCE PROCEDURES.*
6. Drive and driven pulleys require servicing.
 - *Contact an authorized Lynx dealer.*
7. Engine overheats.
 - *Check coolant level, see MAINTENANCE PROCEDURES.*
 - *Check heat exchangers cleanliness. Clean if necessary.*

ENGINE LACKS ACCELERATION OR POWER (cont'd)

8. Drive belt worn too thin.

- *If the drive belt has lost more than 3 mm (1/8 in) of its original width, it will affect vehicle performance.*
- *Replace drive belt.*

9. Incorrect track adjustment.

- *See MAINTENANCE and/or an authorized Lynx dealer for proper alignment and tension adjustments.*

10R.A.V.E. valves problem.

- *Seek service from an authorized Lynx dealer, repair shop, or person of your own choosing for maintenance, repair, or replacement.*

11 Fuel pressure too low.

- *Seek service from an authorized Lynx dealer, repair shop, or person of your own choosing for maintenance, repair, or replacement.*

ENGINE BACKFIRES

1. Engine is running too hot.

- *See item 5 of ENGINE LACKS POWER.*

2. Ignition timing is incorrect or there is an ignition system failure.

- *Seek service from an authorized Lynx dealer, repair shop, or person of your own choosing for maintenance, repair, or replacement.*

3. Exhaust system leak.

- *Seek service from an authorized Lynx dealer, repair shop, or person of your own choosing for maintenance, repair, or replacement.*

4. Fuel pressure too low.

- *Seek service from an authorized Lynx dealer, repair shop, or person of your own choosing for maintenance, repair, or replacement.*

ENGINE MISFIRES

1. Water in fuel.

- *Drain fuel system and refill with fresh fuel.*

2. RAVE valves malfunction.

- *Have RAVE valves system inspected. Seek service from an authorized Lynx dealer, repair shop, or person of your own choosing for maintenance, repair, or replacement.*

NO RESPONSE FROM THE THROTTLE LEVER INPUTS. MESSAGE DISPLAYED: PRESS START TO GO

1. Engine management system has detected a sensor problem.

- *Press and hold the Start/electronic reverse button in order to move vehicle. Seek service from an authorized Lynx dealer, repair shop, or person of your own choosing for maintenance, repair, or replacement.*

HEATED GRIPS/THUMB WARMERS ARE NOT WORKING

1. Engine RPM is too low.

- *Make sure engine RPM is above 2000 (ACE).*

ENGINE HAS SHUT DOWN

1. The engine shuts down after long periods of idling.

- *Do not let engine idle too long. Refer to VEHICLE WARM-UP in OPERATING INSTRUCTION.*

MONITORING SYSTEM

Pilot Lamps, Messages and Beeper Codes

Gauge pilot lamp(s) will inform you if an anomaly occurs or to inform you of a particular condition.



TYPICAL — PILOT LAMPS

Pilot lamp can flash alone or in combination with another lamp.

On the multifunction analog/digital gauge, the display is used as a complement of the pilot lamps to give you a brief description if an anomaly occurs or to inform you of a particular condition.

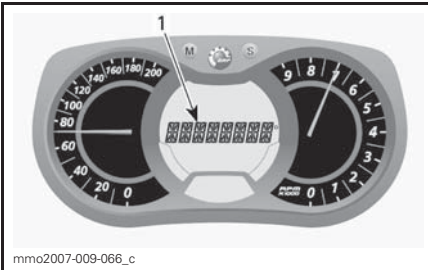





1. Message display

Messages will be displayed with a beep code and pilot lamp(s).

Beeper codes will be emitted to catch your attention.

See table below for details.

NOTE: Some of the listed pilot lamps do not apply to all models. The message display is available only on the multifunction analog/digital gauge.

PILOT LAMP(S) ON	BEEPER	MESSAGE DISPLAY	DESCRIPTION
	4 short beeps every 5 minutes	LOW OIL	E-TEC: Injection oil level is low. Stop vehicle in a safe place then, replenish injection oil reservoir. ACE: Low engine oil pressure. Stop vehicle in a safe place then, check oil level. Fill to proper level. If oil level was correct, discontinue use and contact an authorized Lynx dealer.
	4 short beeps every 30 seconds	ENGINE OVERHEAT	Engine is overheating, reduce snowmobile speed and run in loose snow or stop engine immediately and let engine cool down. Check coolant level, refer to <i>MAINTENANCE</i> . If coolant level is correct and overheating persists, contact an authorized Lynx dealer. Do not run the engine if condition persists.
		MUFFLER	Reduce speed or stop engine. Let engine cool down and restart. If overheating persists, contact an authorized Lynx dealer. Do not run the engine if condition persists.
	Short beeps repeating rapidly	ENGINE OVERHEAT	Critical overheat. Stop engine immediately and let engine cool down. Check coolant level, refer to <i>MAINTENANCE</i> . If coolant level is correct and overheating persists, contact an authorized Lynx dealer. Do not run the engine if condition persists.
		MUFFLER OVERHEAT	E-TEC: Critical overheat. Stop engine immediately and let engine cool down. If overheating persists, contact an authorized Lynx dealer. Do not run the engine if condition persists.
		ECM OVERHEAT	E-TEC: Critical overheat. Stop engine immediately and let engine cool down. If overheating persists, contact an authorized Lynx dealer. Do not run the engine if condition persists.
	4 short beeps every 5 minutes	LOW BAT	Indicate a low or high battery voltage condition. See an authorized Lynx dealer as soon as possible.
		HIGH BAT	
	4 short beeps	CHECK ENGINE	Engine fault, see an authorized Lynx dealer as soon as possible.

PILOT LAMP(S) ON	BEEPER	MESSAGE DISPLAY	DESCRIPTION
	—		Displayed when brake is applied for more than 15 seconds while throttle lever is squeezed and vehicle is moving at more than 5 km/h (3 MPH).
—	4 short beeps every 5 minutes	KNOCK	E-TEC: Engine detonation (RPM is limited when this condition occurs). <ul style="list-style-type: none"> – Ensure recommended fuel is used. – Check fuel quality, replace if necessary. – If fault still occurs, contact an authorized Lynx dealer, repair shop, or person of your own choosing.
—	4 short beeps every 5 minutes	REV LIMIT	Engine RPM limited for protection when certain faults occur.
—	—	OVER REV	On E-TEC engines, indicates that maximum engine RPM is reached. Check clutch calibration.
—	Short beeps repeating rapidly	SHUTDOWN	Shutdown procedure in force due to engine overheating or fuel pump problem, remove tether cord cap from engine cut-off switch and contact an authorized Lynx dealer.
—	—	COMMUNICATION	Communication problem between ECM and gauge. Stop engine, remove tether cord cap. Wait a few minutes, then start engine. If problem persists, contact an authorized Lynx dealer
DESS	2 short beeps	—	Good key, vehicle ready to operate.
	2 short beeps, repeating slowly	CHECK KEY	Unable to read key (bad connection). Make sure the key is clean and correctly snapped on post.
	Short beeps repeating rapidly	BAD KEY	Invalid key or key not programmed. Use the proper key for the vehicle or have the programmed.

PILOT LAMP(S) ON	BEEPER	MESSAGE DISPLAY	DESCRIPTION
	—	 (blinking)	Fuel level sender problem.
—	—	THROTTLE OPEN	ACE: Throttle lever applied while attempting an engine start (engine cranks but won't run). Release throttle lever while starting.
—	—	DROWN MODE	ACE: Throttle wide open while attempting an engine start (engine cranks but won't run). Release throttle while starting.

Fault Codes

Multifunction Analog/Digital Display Only

To read any active fault code, press and hold MODE (M) Button and simultaneously depress the HI/LOW beam switch repeatedly several times.

If two or more codes are registered, use SET (S) or MODE (M) to scroll.

To exit the fault codes mode, press and hold MODE (M) button.

Contact an authorized Lynx dealer for code signification.

WARRANTY

BRP FINLAND OY INTERNATIONAL LIMITED WARRANTY: 2018 LYNX® SNOWMOBILES

1) SCOPE OF THE LIMITED WARRANTY

Bombardier Recreational Products Inc. ("BRP")* warrants its 2018 LYNX snowmobiles sold by distributors or dealers authorized by BRP to distribute LYNX snowmobiles ("LYNX Distributor/Dealer") from defects in material or workmanship for the period and under the conditions described below.

Non-factory installed parts and accessories are not covered under this limited warranty. Please refer to the applicable parts and accessories limited warranty text.

This limited warranty will become null and void if: (1) the snowmobile was used for racing or any other competitive activity, at any point, even by a previous owner; or (2) the snowmobile has been altered or modified in such a way so as to adversely affect its operation, performance or durability, or has been altered or modified to change its intended use.

2) LIMITATIONS OF LIABILITY

TO THE EXTENT PERMITTED BY LAW, THIS WARRANTY IS EXPRESSLY GIVEN AND ACCEPTED IN LIEU OF ANY AND ALL OTHER WARRANTIES, EXPRESSED OR IMPLIED, INCLUDING WITHOUT LIMITATION ANY WARRANTY OF MERCHANTABILITY OR FITNESS FOR A PARTICULAR PURPOSE. TO THE EXTENT THAT THEY CANNOT BE DISCLAIMED, THE IMPLIED WARRANTIES ARE LIMITED IN DURATION TO THE LIFE OF THE EXPRESS WARRANTY. INCIDENTAL AND CONSEQUENTIAL DAMAGES ARE EXCLUDED FROM COVERAGE UNDER THIS WARRANTY. SOME JURISDICTIONS DO NOT ALLOW FOR THE DISCLAIMERS, LIMITATIONS AND EXCLUSIONS IDENTIFIED ABOVE, AS A RESULT, THEY MAY NOT APPLY TO YOU. THIS WARRANTY GIVES YOU SPECIFIC RIGHTS, AND YOU MAY ALSO HAVE OTHER LEGAL RIGHTS WHICH MAY VARY FROM COUNTRY TO COUNTRY. (FOR PRODUCTS PURCHASED IN AUSTRALIA SEE CLAUSE 4 BELOW).

Neither the LYNX Distributor/Dealer nor any other person has been authorized to make any affirmation, representation or warranty regarding the product, other than those contained in this limited warranty, and if made, shall not be enforceable against BRP.

BRP reserves the right to modify this warranty at any time, being understood that such modification will not alter the warranty conditions applicable to the products sold while this warranty is in effect.

3) EXCLUSIONS – ARE NOT WARRANTED

The following are not warranted under this limited warranty under any circumstances:

- Normal wear and tear;
- Routine maintenance items, tune ups, adjustments;
- Damage caused by negligence or failure to provide proper maintenance and/or storage, as described in the Operator's Guide;

- Damage resulting from removal of parts, improper repairs, service, maintenance, modifications or use of parts or accessories not manufactured or approved by BRP which in its reasonable judgement are either incompatible with the product or adversely affect its operation, performance and durability, or resulting from repairs done by a person that is not an authorized servicing LYNX Distributor/Dealer;
- Damage caused by abuse, abnormal use, neglect, racing or operation of the product on surfaces other than snow, or operation of the product in a manner inconsistent with the recommended operation described in the Operator's Guide;
- Damage resulting from accident, submersion, fire, snow or water ingestion, theft, vandalism or any act of God;
- Operation with fuels, oils or lubricants which are not suitable for use with the product (see the Operator's Guide);
- Damage resulting from rust, corrosion or exposure to the elements;
- Incidental or consequential damages, or damages of any kind including without limitation towing, storage, transportation expenses, telephone, rental, taxi, inconvenience, insurance coverage, loan payments, loss of time, loss of income; or time missed for downtime experience due to service work.
- And damage resulting from studs installed on tracks if the installation does not conform to BRP's instructions.

4) WARRANTY COVERAGE PERIOD

This warranty will be in effect from (1) the date of delivery to the first retail consumer or (2) the date the product is first put into use, whichever occurs first and for a period of:

TWELVE (12) CONSECUTIVE MONTHS, for private or commercial use owners. However, the warranty coverage period on a snowmobile delivered between June 1st and December 1st of a given year will expire November 30th of the following year.

The repair or replacement of parts or the performance of service under this warranty does not extend the life of this warranty beyond its original expiration date.

Note that the duration and any other modalities of the warranty coverage are subject to the applicable national or local legislation in the customer's country.

FOR PRODUCTS SOLD IN AUSTRALIA ONLY

Nothing in these Warranty terms and conditions should be taken to exclude, restrict or modify the application of any condition, warranty, guarantee, right or remedy conferred or implied under the Competition and Consumer Act 2010 (Cth), including the Australian Consumer Law or any other law, where to do so would contravene that law, or cause any part of these terms and conditions to be void. The benefits given to you under this limited warranty are in addition to other rights and remedies that you have under Australian law.

Our goods come with guarantees that cannot be excluded under the Australian Consumer Law. You are entitled to a replacement or refund for a major failure and for compensation for any other reasonably foreseeable loss or damage. You are also entitled to have the goods repaired or replaced if the goods fail to be of acceptable quality and the failure does not amount to a major failure.

5) CONDITIONS TO HAVE WARRANTY COVERAGE

This warranty coverage is available **only** if each of the following conditions has been fulfilled:

- The 2018 LYNX snowmobile must be purchased as new and unused by its first owner from a LYNX Distributor/Dealer authorized to distribute LYNX snowmobiles in the country in which the sale occurred;
- The BRP specified pre-delivery inspection process must be completed and documented;
- The product must have undergone proper registration by an authorized LYNX Distributor/Dealer;
- The 2018 LYNX snowmobile must be purchased in the country or union of countries in which the purchaser resides.
- Routine maintenance outlined in the Operator's Guide must be timely performed in order to maintain warranty coverage. BRP reserves the right to make warranty coverage contingent upon proof of proper maintenance.

BRP will not honour this limited warranty to any private use owner or commercial use owner if one of the preceding conditions has not been met. Such limitations are necessary in order to allow BRP to preserve both the safety of its products, and also that of its consumers and the general public.

6) WHAT TO DO TO OBTAIN WARRANTY COVERAGE

The customer must cease using the snowmobile upon the appearance of an anomaly. The customer must notify a servicing LYNX Distributor/Dealer within two (2) days of the appearance of a defect, and provide it with reasonable access to the product and reasonable opportunity to repair it. The customer must also present to the authorized LYNX Distributor/Dealer, proof of purchase of the product and must sign the repair/work order prior to starting the repair in order to validate the warranty repair. All parts replaced under this limited warranty become the property of BRP.

Note that the notification period is subject to the applicable national or local legislation in customer's country.

7) WHAT BRP WILL DO

To the extent permitted by law, BRP's obligations under this warranty are limited to, at its sole discretion, repairing parts found defective under normal use, maintenance and service, or replacing such parts with new genuine LYNX parts without charge for parts and labour, at any authorized LYNX Distributor/Dealer during the warranty coverage period under the conditions described herein. BRP's responsibility is limited to making the required repairs or replacements of parts. No claim of breach of warranty shall be cause for cancellation or rescission of the sale of the snowmobile to the owner. You may have other legal rights which may vary from country to country.

In the event that service is required outside of the country of original sale, the owner will bear responsibility for any additional charges due to local practices and conditions, such as, but not limited to, freight, insurance, taxes, license fees, import duties, and any and all other financial charges, including those levied by governments, states, territories and their respective agencies.

BRP reserves the right to improve or modify products from time to time without assuming any obligation to modify products previously manufactured.

8) TRANSFER

If the ownership of a product is transferred during the warranty coverage period, this limited warranty, subject to its terms and conditions, shall also be transferred and be valid for the remaining coverage period provided BRP or an authorized LYNX Distributor/Dealer receives a proof that the former owner agreed to the transfer of ownership, in addition to the co-ordinates of the new owner.

9) CONSUMER ASSISTANCE

In the event of a controversy or a dispute in connection with this limited warranty, BRP suggests that you try to resolve the issue at the LYNX Distributor/Dealer level. We recommend discussing the issue with the authorized LYNX Distributor/Dealer's service manager or owner.

If the matter still remains unresolved, contact BRP by filling out the customer contact form at www.brp.com or contact BRP by mail at one of the addresses listed under the *CONTACT US* section of this guide.

* For the territory covered by this limited warranty, products are distributed and serviced by Bombardier Recreational Products Inc. or its affiliates.

© 2017 Bombardier Recreational Products Inc. All rights reserved.

® Registered trademark of Bombardier Recreational Products Inc.

ADDITIONAL TERMS AND CONDITIONS FOR FRANCE ONLY

The following terms and conditions are applicable to products sold in France only:

The seller shall deliver goods that are complying with the contract and shall be responsible for defects existing upon delivery. The seller shall also be responsible for defects resulting from packaging, assembling instructions or the installation when it is its responsibility per the contract or if accomplished under its responsibility. To be compliant with the contract, the good shall:

1. Be fit for normal use for goods similar thereto and, if applicable:
 - Correspond to the description provided by the seller and have the qualities presented to the buyer though sample or model;
 - Have the qualities that a buyer may legitimately expect considering the public declarations of the seller, the manufacturer of its representative, including in advertising or labeling; or
2. Have the characteristics mutually agreed upon as between the parties or be fit for the specific use intended by the buyer and brought to the attention of the seller and which accepted

The action for failure to comply is prescribed after two years after delivery of the goods. The seller is responsible for the warranty for hidden defects of the good sold if such hidden defects are rendering the good unfit for the intended use, or if they diminish its use in such a way that the buyer would not have acquired the good or would have given a lesser price, had he known. The action for such hidden defects shall be taken by the buyer within 2 years of the discovery of the defect.

MAINTENANCE RECORDS

Send photocopy of maintenance record to BRP if needed.

PREDELIVERY	
Serial number: _____ Mileage / km: _____ Hours: _____ Date: _____ Dealer no: _____ Notes: _____ _____	Signature/Print: _____
Refer to vehicle Pre-Delivery Bulletin for detailed installation procedures	

FIRST INSPECTION	
Mileage / km: _____ Hours: _____ Date: _____ Dealer no: _____ Notes: _____ _____	Signature/Print: _____
For maintenance schedule refer to Maintenance Information section of this operator's guide	

SERVICE	
Mileage / km: _____ Hours: _____ Date: _____ Dealer no: _____ Notes: _____ _____	Signature/Print: _____
For maintenance schedule refer to Maintenance Information section of this operator's guide	

SERVICE	
Mileage / km: _____ Hours: _____ Date: _____ Dealer no: _____ Notes: _____ _____	Signature/Print: _____
For maintenance schedule refer to Maintenance Information section of this operator's guide	

SERVICE	
Mileage / km: _____	Signature/Print:
Hours: _____	
Date: _____	
Dealer no: _____	
Notes: _____	

For maintenance schedule refer to Maintenance Information section of this operator's guide	

SERVICE	
Mileage / km: _____	Signature/Print:
Hours: _____	
Date: _____	
Dealer no: _____	
Notes: _____	

For maintenance schedule refer to Maintenance Information section of this operator's guide	

SERVICE	
Mileage / km: _____	Signature/Print:
Hours: _____	
Date: _____	
Dealer no: _____	
Notes: _____	

For maintenance schedule refer to Maintenance Information section of this operator's guide	

SERVICE	
Mileage / km: _____	Signature/Print:
Hours: _____	
Date: _____	
Dealer no: _____	
Notes: _____	

For maintenance schedule refer to Maintenance Information section of this operator's guide	

SERVICE	
Mileage / km: _____ Hours: _____ Date: _____ Dealer no: _____ Notes: _____ 	Signature/Print: _____
For maintenance schedule refer to Maintenance Information section of this operator's guide	

SERVICE	
Mileage / km: _____ Hours: _____ Date: _____ Dealer no: _____ Notes: _____ 	Signature/Print: _____
For maintenance schedule refer to Maintenance Information section of this operator's guide	

SERVICE	
Mileage / km: _____ Hours: _____ Date: _____ Dealer no: _____ Notes: _____ 	Signature/Print: _____
For maintenance schedule refer to Maintenance Information section of this operator's guide	

SERVICE	
Mileage / km: _____ Hours: _____ Date: _____ Dealer no: _____ Notes: _____ 	Signature/Print: _____
For maintenance schedule refer to Maintenance Information section of this operator's guide	

***This page is
intentionally blank***

CUSTOMER INFORMATION

CONTACT US

www.brp.com

Europe

Skaldenstraat 125
B-9042 Gent
Belgium

Itterpark 11
D-40724 Hilden
Germany

ARTEPARC Bâtiment B
Route de la côte d'Azur, Le Canet
13590 Meyreuil
France

Ingvald Ystgaardsvei 15
N-7484 Trondeim
Norway

Isoaavantie 7
PL 8040
96101 Rovaniemi

Formvägen 16
S-906 21 Umeå
Sweden

Avenue d'Ouchy 4-6
1006 Lausanne
Switzerland

North America

565 de la Montagne Street
Valcourt (Québec) J0E 2L0
Canada

Sturtevant, Wisconsin, U.S.A.
10101 Science Drive
Sturtevant, Wisconsin
53177
U.S.A.

Sa De Cv, Av. Ferrocarril 202
Parque Ind. Querétaro, Lote2-B
76220
Santa Rosa Jáuregui, Qro., Mexico

Oceania

6 Lord Street
Lakes Business Park
Botany, NSW 2019
Australia

South America

Rua James Clerck Maxwell, 230
TechnoPark Campinas SP 13069-380
Brazil

Asia

15/F Parale Mitsui Building, 8
Higashida-Cho, Kawasaki-ku
Kawasaki 210-0005
Japan

Room Dubai, level 12, Platinum Tower
233 Tai Cang Road
Xintiandi, Lu Wan District
Shanghai 200020
PR China

CHANGE OF ADDRESS/OWNERSHIP

If your address has changed or if you are the new owner of the Snowmobile, be sure to notify BRP by either:

- Mailing one of the change of address cards on the following pages.
- Notifying an authorized Lynx dealer.

In case of change of ownership, please join a proof that the former owner agreed to the transfer.

Notifying BRP, even after the expiration of the limited warranty, is very important as it enables BRP to reach the Snowmobile owner if necessary, like when safety recalls are initiated. It is the owner's responsibility to notify BRP.

STOLEN UNITS: If your personal Snowmobile is stolen, you should notify BRP or an authorized Lynx dealer. We will ask you to provide your name, address, phone number, the vehicle identification number and the date it was stolen.

***This page is
intentionally blank***

CHANGE OF ADDRESS

CHANGE OF OWNERSHIP



VEHICLE IDENTIFICATION NUMBER

Grid for Vehicle Identification Number (VIN) entry

Model Number

Vehicle Identification Number (V.I.N.)

OLD ADDRESS
OR PREVIOUS OWNER:

NAME

NO. STREET APT

CITY STATE/PROVINCE ZIP/POSTAL CODE

COUNTRY TELEPHONE

NEW ADDRESS
OR NEW OWNER:

NAME

NO. STREET APT

CITY STATE/PROVINCE ZIP/POSTAL CODE

COUNTRY TELEPHONE

E-MAIL ADDRESS

V00A2F

CHANGE OF ADDRESS

CHANGE OF OWNERSHIP



VEHICLE IDENTIFICATION NUMBER

Grid for Vehicle Identification Number (VIN) entry

Model Number

Vehicle Identification Number (V.I.N.)

OLD ADDRESS
OR PREVIOUS OWNER:

NAME

NO. STREET APT

CITY STATE/PROVINCE ZIP/POSTAL CODE

COUNTRY TELEPHONE

NEW ADDRESS
OR NEW OWNER:

NAME

NO. STREET APT

CITY STATE/PROVINCE ZIP/POSTAL CODE

COUNTRY TELEPHONE

E-MAIL ADDRESS

V00A2F

***This page is
intentionally blank***

CHANGE OF ADDRESS

CHANGE OF OWNERSHIP



VEHICLE IDENTIFICATION NUMBER

Grid for entering the Vehicle Identification Number (V.I.N.)

Model Number

Vehicle Identification Number (V.I.N.)

OLD ADDRESS
OR PREVIOUS OWNER:

NAME

NO.

STREET

APT

CITY

STATE/PROVINCE

ZIP/POSTAL CODE

COUNTRY

TELEPHONE

NEW ADDRESS
OR NEW OWNER:

NAME

NO.

STREET

APT

CITY

STATE/PROVINCE

ZIP/POSTAL CODE

COUNTRY

TELEPHONE

E-MAIL ADDRESS

V00A2F

CHANGE OF ADDRESS

CHANGE OF OWNERSHIP



VEHICLE IDENTIFICATION NUMBER

Grid for entering the Vehicle Identification Number (V.I.N.)

Model Number

Vehicle Identification Number (V.I.N.)

OLD ADDRESS
OR PREVIOUS OWNER:

NAME

NO.

STREET

APT

CITY

STATE/PROVINCE

ZIP/POSTAL CODE

COUNTRY

TELEPHONE

NEW ADDRESS
OR NEW OWNER:

NAME

NO.

STREET

APT

CITY

STATE/PROVINCE

ZIP/POSTAL CODE

COUNTRY

TELEPHONE

E-MAIL ADDRESS

V00A2F

VEHICLE MODEL No. _____

VEHICLE IDENTIFICATION NUMBER (V.I.N.) _____

ENGINE IDENTIFICATION NUMBER (E.I.N.) _____

Owner: _____
NAME

No. STREET APT

CITY STATE/PROVINCE ZIP/POSTAL CODE

Purchase Date _____
YEAR MONTH DAY

Warranty Expiry Date _____
YEAR MONTH DAY

To be completed by the dealer at the time of the sale.

DEALER IMPRINT AREA



619 900 938

OPERATOR'S GUIDE, REX² TOURING / UTILITY/ ENGLISH
GUIDE DU CONDUCTEUR, REX² TOURING / UTILITY /
ANGLAIS

FAIT AU / MADE IN CANADA

U/M:P.C.