

The Lynx logo is written in a bold, italicized, white sans-serif font with a registered trademark symbol (®) at the end.The year '2015' is displayed in a large, white, sans-serif font, centered on the right side of the page.

OPERATOR'S GUIDE
REX

600 HO E-TEC®
800R E-TEC®

 **WARNING**

Read this guide thoroughly. It contains important safety information.
Minimum recommended operator's age: 16 years old.
Keep this Operator's Guide in the vehicle.

EN 619 900 589

Original instructions

WARNING

This vehicle may exceed the performance of other vehicles you may have ridden. Take time to familiarize yourself with your new vehicle.

OPERATOR'S GUIDE 2015

Rave™ 600 E-TEC
Rave™ RE 600 E-TEC
Rave™ RE 800 E-TEC
Xtrim™ SC 600 E-TEC
BoonDocker® 3700 600 E-TEC
BoonDocker® RE 3700 800R E-TEC
BoonDocker® 3900 600 E-TEC
BoonDocker® DS 3900 800R E-TEC

SAFETY WARNING

Disregarding any of the safety precautions and instructions contained in this Operator's Guide, or on-product warnings may result in injury, including the possibility of death.

This Operator's Guide should remain with the snowmobile at time of resale.



Lynx products are manufactured by BRP .

The following are trademarks of Bombardier Recreational Products Inc. or its subsidiaries.

LYNX®

3-D RAVE™

ROTAX®

DESS™

HPG™

RER™

E-TEC®

TRA™

Radio Frequency Digitally Encoded Security System (RF D.E.S.S.)

FCC Certification:

The following device is in compliance with FCC part 15C.

Warning to the user: Any changes /modifications not approved by the manufacturer could void the user's authority to operate the equipment.

European Conformity

The following device is in compliance with the following standards:

ETSI EN 300 330-2

ETSI EN 60950-1

FOREWORD

Deutsch	Dieses Handbuch ist möglicherweise in Ihrer Landessprache verfügbar. Bitte wenden Sie sich an Ihren Händler oder besuchen Sie: www.operatorsguide.brp.com .
English	This guide may be available in your language. Check with your dealer or go to: www.operatorsguide.brp.com .
Français	Ce guide peut être disponible dans votre langue. Vérifier avec votre concessionnaire ou aller à: www.operatorsguide.brp.com .
Italiano	Questa guida potrebbe essere disponibile nella propria lingua. Contattare il concessionario o consultare: www.operatorsguide.brp.com .
日本語	このガイドは、言語によって翻訳版が用意されています。ディーラーに問い合わせるか、次のアドレスでご確認ください： www.operatorsguide.brp.com .
Norsk	Denne boken kan finnes tilgjengelig på ditt eget språk. Kontakt din forhandler eller gå til: www.operatorsguide.brp.com .
Русский	Воспользуйтесь руководством на вашем языке. Узнайте о его наличии у дилера или на странице по адресу www.operatorsguide.brp.com .
Suomi	Käyttöohjekirja voi olla saatavissa omalla kielelläsi. Tarkista jälleenmyyjältä tai käy osoitteessa: www.operatorsguide.brp.com
Svenska	Denna bok kan finnas tillgänglig på ditt språk. Kontakta din återförsäljare eller gå till: www.operatorsguide.brp.com .

Congratulations on your purchase of a new Lynx snowmobile. Whatever model you have chosen, it is backed by the Bombardier Recreational Products inc. (BRP) warranty and a network of authorized Lynx snowmobile dealers ready to provide the parts, service or accessories you may require.

Your dealer is committed to your satisfaction. He has taken training to perform the initial set-up and inspection of your snowmobile as well as completed the final adjustment required to suit your specific weight and riding environment before you took possession. At delivery, your dealer would have explained the snowmobile controls and provided you with a brief explanation of the various suspension adjustments. We trust you have taken full advantage of this!

At delivery, you were informed of the warranty coverage and signed the *PREDELIVERY CHECK LIST* to ensure your new vehicle was prepared to your entire satisfaction.

If you have any question regarding any topic whether or not it is covered in this Operator's Guide, please send a written letter to BRP to following address:

BRP Finland OY
Service Department
P.O. Box 8039
FIN-96101 ROVANIEMI
FINLAND
Tel +358 16 3208 111

Although the mere reading of such information does not eliminate the hazard, the understanding and application of the information will promote the correct use of the vehicle.

The information and components/system descriptions contained in this guide are correct at time of publica-

tion. BRP, however maintains a policy of continuous improvement of its products without imposing upon itself any obligation to install them on products previously manufactured.

Because of its ongoing commitment to product quality and innovation, BRP reserves the right at any time to discontinue or change specifications, designs, features, models or equipment without incurring obligation.

The illustrations in this document show the typical construction of the different assemblies and, in all cases, may not reproduce the full detail or exact shape of the parts shown, however, they represent parts which have the same or a similar function.

It is understood that this guide may be translated into another language. In the event of any discrepancy, the English version shall prevail.

Specifications are given in the SI metric system with the SAE U.S. equivalent in parentheses. Where precise accuracy is not required, some conversions are rounded off for easier use.

Most components of this snowmobile are built with parts dimensioned in the metric system. Most fasteners are metric and must not be replaced by customary fasteners or vice versa.

We recommend genuine BRP products for replacement parts and accessories. They've been specially designed for your vehicle and manufactured to meet BRP's demanding standards.

For any questions pertaining to the warranty and its application, consult the WARRANTY section in this guide, and/or an authorized Lynx dealer.

Know Before you Go

To learn how to reduce the risk for you, your passenger or bystanders being injured or killed, read the following sections before you operate the vehicle:

- SAFETY INFORMATION
- VEHICLE INFORMATION.

Also read all safety labels on your snowmobile.

We highly recommend that you take a safety riding course. Please check with your dealer or local authorities for availability in your area.

Failure to follow the warnings contained in this Operator's Guide can result in SERIOUS INJURY or DEATH.

Safety Messages

The types of safety messages, what they look like and how they are used in this guide are explained as follows:

The safety alert symbol  indicates a potential injury hazard.

 WARNING
Indicates a potential hazard, if not avoided, could result in serious injury or death.

 **CAUTION** Indicates a hazard situation which, if not avoided, could result in minor or moderate injury.

NOTICE Indicates an instruction which, if not followed, could severely damage vehicle components or other property.

About this Operator's Guide

This Operator's Guide has been prepared to acquaint the owner/operator and passenger with this snowmobile and its various controls, safe riding and maintenance instructions.

The following terminology in regards to operator, passenger and vehicle configuration is used as follows throughout this guide:

- **Operator:** refers to the person being behind the controls and driving the snowmobile.
- **Passenger:** refers to a person sitting behind the operator.
- **1-UP:** refers to a model designed for an operator only.
- **2-UP:** refers to a model designed to accommodate **one** passenger.

Keep this Operator's Guide in the vehicle as you can refer to it for things such as maintenance, troubleshooting and instructing others.

Note that this guide is available in several languages. In the event of any discrepancy, the English version shall prevail.

If you want to view and/or print an extra copy of your Operator's Guide, simply visit the following website www.operatorsguide.brp.com.

The informations contained in this document are correct at the time of publication. BRP, however, maintains a policy of continuous improvement of its products without imposing upon itself any obligation to install them on products previously manufactured. Due to late changes, some differences between the manufactured product and the descriptions and/or specifications in this guide may occur. BRP reserves the right at any time to discontinue or change specifications, designs, features, models or equipment without incurring any obligation upon itself.

This Operator's Guide should remain with the vehicle when it's sold.

TABLE OF CONTENTS

FOREWORD	1
Know Before you Go	2
Safety Messages.....	2
About this Operator's Guide	2

SAFETY INFORMATION

GENERAL PRECAUTIONS	9
Avoid Carbon Monoxide Poisoning	9
Avoid Gasoline Fires and Other Hazards	9
Avoid Burns from Hot Parts	9
Accessories and Modifications	9
SPECIAL SAFETY MESSAGES	10
LAWS AND REGULATIONS	13
RIDING THE VEHICLE	14
Pre-Ride Inspection	14
How to Ride	15
Rider Position (Reverse Operation)	17
Carrying a Passenger	17
Terrain/Riding Variations	18
Environment.....	22
Transporting and Towing.....	24
TRACTION ENHANCING PRODUCTS	25
Manoeuvrability	25
Acceleration	26
Braking	26
Important Safety Rules	26
Effects of Having a Studded Track on the Life of the Snowmobile	27
Installation of Studs on BRP Approved Tracks	27
Maintenance/Replacement	28
IMPORTANT ON-PRODUCT LABELS	29
Hang Tag(s)	29
Vehicle Safety Labels	30
Technical Information Labels.....	33

VEHICLE INFORMATION

CONTROLS/INSTRUMENTS/EQUIPMENT	37
1) Handlebar	39
2) Throttle Lever.....	39
3) Brake Lever	39
4) Parking Brake Lever	40
5) Engine (Tether) Cut-Out Switch	40
6) Emergency Engine Stop (Cut-Out) Switch	42
7) Multifunction Switch (Xtrim SC).....	43

CONTROLS/INSTRUMENTS/EQUIPMENT (cont'd)

8) Start/Electronic Reverse Button and Headlights Dimmer Switch (All except Xtrim SC) 45

9) Rewind Starter Handle (If Applicable)..... 45

10) Tool Kit 45

11) Analog/Digital Gauge (Standard) 46

12) Multifunction Analog/Digital Gauge 51

13) Drive Belt Guard..... 63

14) Heated Grips Switch (BoonDocker and Rave RE Only) 64

15) Heated Throttle Lever Switch (BoonDocker and Rave RE Only) 65

16) Spare Drive Belt Holder..... 65

17) Front Storage Compartment..... 66

18) Rear Rack..... 66

19) Upper Body Module (Hood) 67

20) Holding Strap 69

21) Side Panels 69

22) Fuses 70

23) Seat Latch 70

24) Storage / Battery Compartment 72

25) Front and Rear Bumpers 72

26) Brake disc guard 73

27) Anti-Sway Bar Quick Disconnect Link..... 73

28) Electronic Damping Control (LEDC) 73

29) Ice Scratchers (BoonDocker DS) 74

30) Hitch 74

FUEL..... **76**

Fuel Requirements..... 76

INJECTION OIL..... **78**

Recommended Injection Oil 78

BREAK-IN PERIOD..... **79**

Operation During Break-In..... 79

Engine..... 79

Drive Belt 79

10-Hour Inspection..... 79

BASIC PROCEDURES..... **80**

Engine Starting Procedure 80

Vehicle Warm-Up..... 80

Engaging Reverse (RER) 81

Shutting Off the Engine..... 81

Post-Operation Care 82

SPECIAL OPERATING INSTRUCTIONS..... **83**

Riding at High Altitudes..... 83

Riding in Cold Weather 83

Emergency Starting..... 83

Towing an Accessory 84

Towing Another Snowmobile 84

SPECIAL OPERATING INSTRUCTIONS (cont'd)	
Transporting the Vehicle	84
TUNE YOUR RIDE	85
Rear Suspension Adjustments	85
Front Suspension Adjustments	90
Adjustment Tips According to Vehicle Behavior	94

MAINTENANCE INFORMATION

BREAK-IN INSPECTION	99
PERIODIC MAINTENANCE CHART	100
MAINTENANCE SCHEDULE (2-STROKE)	101
MAINTENANCE PROCEDURES	103
Air Filter with Dual Air Intake (E-TEC models)	103
Engine Coolant	103
Exhaust System	104
Engine Stopper	104
Brake Fluid	105
Chaincase Oil	106
Drive system	107
Rear Suspension	114
Steering and front suspension	116
Electrical System	116
Ice Scratchers (BoonDocker)	119
VEHICLE CARE	120
Post-Operation Care	120
Vehicle Cleaning and Protection	120
PRESEASON PREPARATION	121
STORAGE	122
Storage (E-TEC)	122

TECHNICAL INFORMATION

VEHICLE IDENTIFICATION	125
Vehicle Description Decal	125
Serial Numbers	125
DECLARATION OF CONFORMITY	126
SPECIFICATIONS	127

TROUBLESHOOTING

TROUBLESHOOTING GUIDELINES (600 HO E-TEC AND 800R E-TEC) ...	137
MONITORING SYSTEM	139
Pilot Lamps, Messages and Beeper Codes	139

MONITORING SYSTEM (cont'd)
Fault Codes 141

WARRANTY

**BRP FINLAND OY INTERNATIONAL LIMITED WARRANTY: 2015 LYNX®
SNOWMOBILES** 145
MAINTENANCE RECORDS 148
PRIVACY OBLIGATIONS/DISCLAIMER 151
CHANGE OF ADDRESS/OWNERSHIP..... 152

SAFETY INFORMATION

GENERAL PRECAUTIONS

Avoid Carbon Monoxide Poisoning

All engine exhaust contains carbon monoxide, a deadly gas. Breathing carbon monoxide can cause headaches, dizziness, drowsiness, nausea, confusion and eventually death.

Carbon monoxide is a colorless, odorless, tasteless gas that may be present even if you do not see or smell any engine exhaust. Deadly levels of carbon monoxide can collect rapidly, and you can quickly be overcome and unable to save yourself. Also, deadly levels of carbon monoxide can linger for hours or days in enclosed or poorly ventilated areas. If you experience any symptoms of carbon monoxide poisoning, leave the area immediately, get fresh air and seek medical treatment.

To prevent serious injury or death from carbon monoxide:

- Never run the vehicle in poorly ventilated or partially enclosed areas such as garages, carports or barns. Even if you try to ventilate engine exhaust with fans or open windows and doors, carbon monoxide can rapidly reach dangerous levels.
- Never run the vehicle outdoors where engine exhaust can be drawn into a building through openings such as windows and doors.

Avoid Gasoline Fires and Other Hazards

Gasoline is extremely flammable and highly explosive. Fuel vapors can spread and be ignited by a spark or flame many feet away from the engine. To reduce the risk of fire or explosion, follow these instructions:

- Use only an approved gasoline container to store fuel.
- Strictly adhere to instructions in *FUELING PROCEDURE*.
- Never start or operate the engine if the fuel cap is not properly installed.

Gasoline is poisonous and can cause injury or death.

- Never siphon gasoline by mouth.
- If you swallow gasoline, get any in your eye or inhale gasoline vapor, see your doctor immediately.

If gasoline spills on you, wash with soap and water and change your clothes.

Avoid Burns from Hot Parts

The exhaust system and engine become hot during operation. Avoid contact during and shortly after operation to avoid burns.

Accessories and Modifications

Do not make unauthorized modifications, or use attachments or accessories that are not approved by BRP. Since these changes have not been tested by BRP, they may increase the risk of crashes or injuries, and they can make the vehicle illegal.

Tunnel accessories must be loaded onto vehicle as per instructions provided for each accessories.

Accessory passenger seats approved by BRP and conforming to SSCC standards may be available for certain models. If such a seat is used, you must follow the guidelines and recommendations in regards to a passenger in this guide.

WARNING

Passenger seat must have a strap or handholds and must meet SSCC standards.

See your authorized Lynx dealer for available accessories for your vehicle.

SPECIAL SAFETY MESSAGES

SEVERE INJURY OR DEATH can result if you do not follow these instructions:

- Always make a pre-ride inspection **BEFORE** you start the engine.
- Throttle mechanism should be checked for free movement and return to idle position before starting engine.
- Always attach tether cord eyelet to clothing before starting the engine.
- Never operate the engine without belt guard and brake disk guard securely installed or, with hood or side panels opened or removed. Never run the engine without drive belt installed. Running an unloaded engine such as without drive belt or with track raised, can be dangerous.
- Always engage parking brake before starting the engine.
- Everyone is a beginner the first time he sits behind the controls of a snowmobile regardless of previous experience in driving any other type of vehicle. The safe use of your snowmobile depends on many conditions such as visibility, speed, weather, environment, traffic, vehicle condition and the condition of the operator.
- Basic training is required for the safe operation of any snowmobile. Study your Operator's Guide paying particular attention to cautions and warnings. Join your local snowmobile club: its social activities and trail systems are planned for both fun and safety. Obtain basic instructions from your snowmobile dealer, friend, fellow club member or enroll in your state or provincial safety training program.
- Any new operator must read and understand all safety labels on the snowmobile, the Operator's Guide before operating the snowmobile. Only allow a new operator to operate the snowmobile in a restricted flat area, at least until he is completely familiar with its operation. If snowmobile operator's training course is offered in your area, have him enroll.
- The performance of some snowmobiles may significantly exceed that of other snowmobiles you have operated. Therefore, use by novice or inexperienced operators is not recommended.
- Snowmobiles are used in many areas and in many snow conditions. Not all models perform the same in similar conditions. Always consult your snowmobile dealer when selecting the snowmobile model for your particular needs and uses.
- Injury or death may result to the snowmobile operator, passenger or bystander if the snowmobile is used in risky conditions which are beyond the operator's, passenger's or snowmobile's capabilities or intended use.
- BRP recommends the operator has at least 16 years old of age.
- The novice operator should become familiar with the snowmobile through practice on a level area at slow speeds before venturing far afield.
- It is very important to inform any operator, regardless of his experience, of the handling characteristics of this snowmobile. The snowmobile configuration, such as width, track length and suspension type vary from a model to another and the handling is greatly influenced by these characteristics.
- Know your local laws. Federal, state, provincial and local government agencies have enacted laws and regulations pertaining to the safe use and operation of snowmobiles. It is your responsibility as a snowmobiler to learn and obey these laws and regulations. Respect and observance will result in safer snowmobiling for all. Be aware of the liability property damages and insurance laws regarding your equipment.

- Speeding can be fatal. In many cases, you cannot react or respond quickly enough to the unexpected. Always ride at a speed which is suitable to the trail, weather conditions and your own ability. Know your local rules. Speed limit may be in effect and meant to be observed.
- Always keep right hand side of the trail.
- Always keep a safe distance from other snowmobiles and bystanders.
- Remember, promotional material may show risky maneuvers performed by professional riders under ideal and/or controlled conditions. You should never attempt any such risky maneuvers if they are beyond your level of riding ability.
- Never use this vehicle with drugs or alcohol. They slow reaction time and impair judgement.
- Your snowmobile is not designed to be operated on public streets, roads or highways.
- Avoid road traveling. If you must do so, and it is permitted, reduce speed. The snowmobile is not designed to operate or turn on paving. When crossing a road, make a full stop, then look carefully in both directions before crossing at a 90° angle. Be wary of parked vehicles.
- Snowmobiling at night can be a delightful experience but because of reduced visibility, be extra cautious. Avoid unfamiliar terrain and be sure your lights are working. Always carry a flashlight and spare light bulbs.
- Never remove any original equipment from your snowmobile. Each vehicle has many built in safety features. Such features include various guards and consoles, plus reflective materials and safety labels.
- Nature is wonderful but don't let it distract your attention from driving. If you want to truly appreciate winter's scenery, stop your snowmobile on the side of the trail so that you don't become a hazard to others.
- Fences represent a very serious threat for both you and your snowmobile. Give a wide berth to telephone poles or posts.
- Hidden wires unseen from a distance can cause serious accidents.
- Always wear an approved safety helmet, eye protection and a face shield. This also applies to your passenger.
- Be aware of inherent risks associated with riding off trails, such as avalanche and other natural or man made hazards or obstacles.
- Tailgating another snowmobile should be avoided. If the snowmobile in front of you slows for any reason, its operator and passenger could be harmed through your neglect. Maintain a safe stopping distance between you and the snowmobile in front of you. Depending on the terrain condition, stopping may require a little more space than you think. Play it safe. Be prepared to use evasive driving.
- Venturing out alone with your snowmobile could also be hazardous. You could run out of fuel, have an accident, or damage your snowmobile. Remember, your snowmobile is capable of traveling further in half an hour than you may be able to walk in a day. Use the "buddy system". Always ride with a friend or member of your snowmobile club. Even then, tell someone where you are going and the approximate time you plan to return.
- Meadows sometimes have low areas where water accumulate and freezes over in winter. This ice is usually glare ice. Attempting to turn or brake on this surface could cause your vehicle to spin out of control. Never brake or attempt speeding or turning on glare ice. If you do happen to travel over such a condition, reduce speed by carefully releasing the throttle.

- Never “jump” with your snowmobile.
- While on safari, do not “gun” the throttle. Snow and ice can be thrown back into the path of a following snowmobile. In addition, when “gunning” the throttle, the vehicle digs into and leaves an irregular snow surface for others.
- Safaris are both fun and enjoyable but don't show off or overtake others in the group. A less experienced operator might try to do the same as you and fail. When riding with others, limit your abilities to the experience of others.
- In an emergency, the snowmobile engine can be stopped by pressing down on the emergency engine stop switch or by pulling the tether cord cap from the engine cut-off switch.
- Always engage parking brake when vehicle is not in use.
- Never run the engine in a non-ventilated area and/or if vehicle is left unattended.
- **Electric start models only:** Never charge or boost a battery while installed on snowmobile.
- E-TEC engines: Never attempt any fuel system or electrical system maintenance or repair. Any maintenance or repair of these systems must be performed by an authorized Lynx dealer.
- Never attempt any fuel system or electrical system maintenance or repair. Any maintenance or repair of these systems must be performed by an authorized Lynx dealer.
- Ensure the path behind is clear of obstacles or bystanders before proceeding in reverse.
- Always remove the tether cord cap and key when vehicle is not in operation in order to prevent accidental engine starting, to avoid unauthorized use by children or others or theft.
- NEVER stand behind or near a rotating track. Debris could be projected causing severe injuries. To remove packed snow or ice, stop engine, tilt and hold vehicle on its side and use screwdriver from tool kit.
- Do not stud the track unless it has been approved for studs. At speed, a studded track that has not been approved for studs could tear and separate from vehicle. See an authorized Lynx dealer for current specific studding availability and applications.
- You may stud the track on this vehicle model. However, you MUST only use the BRP approved type stud for use on Lynx snowmobiles. DO NOT EVER use conventional studs because the track thickness is thinner than our standard tracks. The stud could tear off of track and separate from vehicle.
- Always wear an approved helmet and follow the same dressing guidelines as those recommended for the operator and described in this guide.
- Make sure that you are able to achieve a stable stance, both feet resting positively on the footboards of footrests with good grip, and that you are able to hold on firmly to the handholds.
- Do not forget, with 2-UP models, the operator is responsible for the safety of the passenger. Always remember that the snowmobile handling, stability and braking distance may be affected when riding with a passenger.
- Before riding the vehicle, ask your passenger to inform you to slowdown or stop immediately if he feels uncomfortable or insecure during the ride. Keep a watchful eye on your passenger while riding.

LAWS AND REGULATIONS

▲ Know your local laws.

State, provincial and local government agencies have enacted laws and regulations pertaining to the safe use and operation of snowmobiles. It is your responsibility as a snowmobiler to learn and obey these laws and regulations. Respect and observance will result in safer snowmobiling for all.

Be aware of the liability property damages and insurance laws regarding your equipment.

RIDING THE VEHICLE

Each operator has a responsibility to ensure the safety of other recreationists or bystanders.

You are responsible for proper operation of your vehicle as well as training those whom you allow to ride or drive. There may be noticeable handling and performance differences from one snowmobile to the other.

A snowmobile is relatively simple to operate but like any other vehicle or mechanical equipment, it can be hazardous if you or a passenger are reckless, thoughtless or inattentive. We encourage you to have an Annual Safety Inspection of your snowmobile. Please contact an authorized Lynx dealer for further details. Finally, we urge you to visit an authorized Lynx dealer periodically for regular and safety maintenance, as well as snowmobile accessories you may require.

Before venturing on the trails, operate the snowmobile in a restricted flat area until you are completely familiar with its operation and feel comfortable that you can safely tackle a more demanding task. Have an enjoyable and safe ride.

Pre-Ride Inspection

WARNING

The pre-operation check is very important prior to operating the vehicle. Always check the proper operation of critical controls, safety features and mechanical components before starting.

WARNING

Always use a wide base snowmobile mechanical stand to properly support vehicle during any track verification. Slowly accelerate engine in order to rotate track at very low speed when it is not on ground.

Before Starting the Engine

1. Remove snow and ice from body including lights, seat, footrests, controls and instruments.
2. Verify that air filter is free of snow.
3. Verify that skis and steering operate freely. Check corresponding action of skis versus handlebar.
4. Check fuel and injection oil (if applicable) for levels and leaks. Replenish if necessary and see an authorized Lynx dealer in case of any leaks.
5. All storage compartments must be properly latched and they must not contain any heavy or breakable objects. Hood and side panels must be also properly latched.
6. Activate the throttle control lever several times to check that it operates easily and smoothly. It must return to idle position when released.
7. Activate the brake lever and make sure the brake fully applies before the brake control lever touches the handlebar grip. It must fully return when released.
8. Apply parking brake and check if it operates properly. Leave parking brake applied.

After Engine Is Started

For proper engine starting procedure, refer to the appropriate *ENGINE STARTING PROCEDURE* section.

1. Check headlights high beam and low beam, taillight, stop light and pilot lamps operation.

NOTE: You may need to detach tether cord from your clothes to check lights. In such a case, attach cord as soon as you get back at the controls of the snowmobile.

2. Check the engine cut-off switch (by pulling tether cord cap) and emergency engine stop switch operation.

3. Release parking brake.

4. Refer to the *WARM UP* section and follow instructions.

Pre-Ride Check List

ITEM	OPERATION
Body including seat, footrests, lights, air filter, controls and instruments	Check condition and remove snow or ice.
Skis and steering	Check for free movement and proper action.
Fuel and injection oil (if applicable)	Check for proper level and no leaks.
Coolant	Check for proper level and no leaks.
Storage compartment	Check for proper latching and no heavy or breakable objects.
Throttle lever	Check for proper action.
Track	Check condition and remove snow or ice.
Brake lever	Check for proper operation.
Parking brake	Check for proper operation.
Emergency engine stop switch and engine cut-off switch (tether cord cap)	Check for proper action. Tether cord must be attached to operator clothing eyelet.
Lights	Check for proper operation.
Vehicle vicinity	Snowmobile must be pointed away from people or objects. No one is to be standing in front of or in back of the snowmobile.
Clothing	Be warmly dressed with clothing designed for snowmobiling.

How to Ride

Riding Gear

Proper snowmobile clothing should be worn. It should be comfortable and not too tight. Always check the weather forecast before going on a ride. Dress for the coldest weather expected. Thermal underwear next to the skin also provides a good insulation.

Wear an approved helmet at all times for safety and comfort. They provide both warmth and reduce injury. A stocking type cap, balaclava and

face mask should always be carried or worn. Goggles or a face shield that attach to the helmet are indispensable.

Hands should be protected by a pair of snowmobile gloves or mitts which have sufficient insulation and allow use of thumbs and fingers for operation of controls.

Rubber bottom boots with either a nylon or a leather top, with removable felt liners are best suited for snowmobiling.

You should keep yourself as dry as possible when snowmobiling. When you come indoors, take your snowmobile suit and boots off and make certain they dry properly.

Do not wear long scarfs and loose apparel that could get caught in moving parts.

Carry colored lens goggles.

What to Bring

Every snowmobiler should carry at least the following basic parts and tools that can help him and others in an emergency:

First aid kit	Provided tool kit
Mobile phone	Knife
Spare spark plugs	Flashlight
Friction tape	Trail map
Spare drive belt	Snack

Include other items depending on the length and time of your ride.

Riding Position (Forward Operation)

Your riding position and balance are the two basic principles of making your snowmobile go where you want it to. When turning on the side of a hill, you and your passenger must be ready to shift body weight to help it turn in the desired direction. Driver and passenger(s) must never attempt this maneuvering by placing feet outside of the vehicle. Experience will teach you how much lean to put into turns at different speeds and how much you will have to lean into a slope to maintain proper balance.

Generally, the riding position for best balance and control is sitting. However, the posting, kneeling or standing positions are also used under certain conditions.

The novice driver should become familiar with the snowmobile through practice on a level area at slow speeds before venturing afield.

⚠ WARNING

Do not attempt any maneuvers if they are beyond your abilities.

Sitting

Feet on the running boards, body mid-way back on seat is an ideal position when operating the snowmobile over familiar, smooth terrain. Knees and hips should remain flexible to absorb shocks.



fmo2008-003-001

Posting

A semi-sitting position with the body off the seat and the feet under the body in a sort of squatting posture, thus allowing the legs to absorb the shocks when traveling over uneven terrain. Avoid abrupt stops.



fmo2008-003-002

Kneeling

This position is achieved by placing one foot firmly on the running board and the opposite knee on the seat. Avoid abrupt stops.



Standing

Place both feet on the running boards. Knees should be flexed to absorb the shock from surface bumps. This is an effective position to see better and to shift weight as conditions dictate. Avoid abrupt stop.



Rider Position (Reverse Operation)

We recommend sitting on your snowmobile when operating in reverse.

Avoid standing up. Your weight could shift forward against throttle lever while operating in reverse, causing an unexpected acceleration.

⚠ WARNING

Unexpected acceleration when snowmobile operates in reverse can cause a loss of control.

Carrying a Passenger

Certain snowmobiles are designed for an operator (1-UP) only, others can allow one passenger (2-UP). Refer to the registration papers on the vehicles to know if any particular snowmobile can accommodate passengers or not, and if so, how many. Always respect those indications. Overloading is dangerous because snowmobiles are not designed for it.

Even when a passenger is allowed, this person must be physically fit for snowmobiling.

⚠ WARNING

Any passenger must be able to firmly lay his feet on the footrests and keep his hands on the grab handles or seat strap at all times when seated. Respecting those physical criteria is important to ensure that the passenger is stable and to reduce the risks of ejection.

The operator has a responsibility to ensure the safety of his passenger and should inform the passenger about snowmobiling basics.

⚠ WARNING

- Passengers must only sit on designated passenger seats. Never allow anyone to sit between the handlebar and the operator.
- Each passenger seat must have a strap or grab handles and meet SSCC standards.
- Passengers and operators must always wear DOT approved helmets and warm clothing appropriate for snowmobiling. Make sure that no skin is exposed.
- Once underway, if a passenger feels uncomfortable or unsecure for any reason, he must not wait, and tell the driver to slow-down or stop.

Riding with passengers on board is different than riding alone. The operator has the benefit of knowing what will be the next maneuver and is able to prepare himself accordingly. The operator also benefits from the support of his grip on the handlebar. In contrast, the passengers have to rely on the operator's careful and safe operation of the vehicle. In addition, "body english" is limited with passengers, and the operator can sometimes see more of the trail ahead than the passengers. Therefore, smooth starting and stopping are required with passengers, and the operator must slow down. The operator must also warn passengers of side hills, bumps, branches, etc. An unforeseen bump can leave you passenger-less. Remind your passengers to lean into the turn with you, without causing the vehicle to topple. Be extremely careful, go more slowly and check the passengers frequently.

⚠ WARNING

- When riding with a passenger:
- Braking ability and steering control are reduced. Decrease speed and allow extra space to maneuver.
 - Adjust suspension according to weight.

For complete information on how to adjust the suspension, please refer to the section of this Operator's Guide entitled SUSPENSION ADJUSTMENTS under OPERATING INSTRUCTIONS and to the relevant label on the belt guard.

Riding with a Child

On snowmobiles allowing two passengers (with optional seat), if you have an adult and a child for passenger, BRP recommends that the child sits in the center location. This allows an adult sitting in the rear seat to keep a visual contact with the child and hold him if necessary. In addition, the child is best protected against the wind and cold temperature if seated in the center location.

Use extra caution and go even more slowly with a young passenger. Check frequently to make certain the child has a firm grip and is properly positioned with his feet on the running boards.

Terrain/Riding Variations**Groomed Trail**

On a maintained trail, sitting is the most preferred riding position. Do not race and, above all, keep to the right hand side of the trail. Be prepared for the unexpected. Observe all trail signs. Do not zigzag from one side of the trail to the other.

Ungroomed Trail

Unless there has been a fresh snowfall you can expect “washboard” and snowdrift conditions. Taken at excessive speeds, such conditions can be physically harmful. Slow down. Hold on the handlebar and assume a posting position. Feet should be under the body assuming a crouched position to absorb any jarring effect. On longer stretches of “washboard” trails, the kneeling position of one knee on the seat can be adopted. This provides a certain amount of comfort, while at the same time keeps the body loose and capable of vehicle control. Beware of hidden rocks or tree stumps partially hidden by a recent snowfall.

Deep Snow

In deep “powder” snow, your vehicle could begin to “bog” down. If this occurs, turn in as wide an arc as possible and look for a firmer base. If you do get “bogged”, and it happens to everyone, do not spin your track as this makes the vehicle sink deeper. Instead, turn the engine off, get off and clear the snow under running boards and bottom pan with your feet or a shovel. If possible tilt your snowmobile on side and pack new snow under the track with your feet and tilt snowmobile back to its skis. Then tramp a clear path ahead of the vehicle. A few feet will generally suffice. Restart the engine. Assume the standing position and rock the vehicle gently as you steadily and slowly apply the throttle. Depending on whether the front or rear end of the vehicle is sinking, your feet should be placed on the opposing end of the running boards. Never place foreign material beneath the track for support. Do not allow anyone to stand in front of, or to the rear of, the snowmobile with the engine running. Stay away from the track. Personal injury will result if contact is made with the revolving track.

Frozen Water

Traveling frozen lakes and rivers can be fatal. Avoid waterways. If you are in an unfamiliar area, ask the local authorities or residents about the ice condition, inlets, outlets, springs, fast moving currents or other hazards. Never attempt to operate your snowmobile on ice that may be too weak to support you and the vehicle. Operating a snowmobile on ice or icy surfaces can be very dangerous if you do not observe certain precautions. The very nature of ice is foreign to good control of a snowmobile or any vehicle. Traction for starting, turning or stopping is much less than that on snow. Thus, these distances can be multiplied manyfold. Steering is minimal, and uncontrolled spins are an ever present danger. When operating on ice, drive slowly with caution. Allow yourself plenty of room for stopping and turning. This is especially true at night.

Hard Packed Snow

Don't underestimate hard packed snow. It can be difficult to negotiate as both skis and track do not have as much traction. Best advice is to slow down and avoid rapid acceleration, turning or braking.

Uphill

There are two types of hills you can encounter — the open hill on which there are few trees, cliffs or other obstacles, and a hill that can only be climbed directly. On an open hill, the approach is to climb it by side hilling or slaloming. Approach at an angle. Adopt a kneeling position. Keep your weight on the uphill side at all times. Maintain a steady, safe speed. Continue as far as you can in this direction, then switch to an opposite hill angle and riding position.

A direct climb could present problems. Choose the standing position, accelerate before you start the climb and then reduce throttle pressure to prevent track slippage.

In either case, vehicle speed should be as fast as the incline demands. Always slow down as you reach the crest. If you cannot proceed further, don't spin your track. Turn the engine off, free the skis by pulling them out and downhill, place the rear of the snowmobile uphill, restart the engine and ease it out with slow even throttle pressure. Position yourself to avoid tipping over, then descend.

Downhill

Downhill driving requires that you have full control of your vehicle at all times. On steeper hills, keep your center of gravity low and both hands on the handlebar. Maintain slight throttle pressure and allow the machine to run downhill with the engine operating. If a higher than safe speed is reached, slow down by braking but apply the brake with frequent light pressure. Never jam the brake and lock the track.

Side Hill

When crossing a side hill or traversing up or downhill, certain procedures must be followed. All riders should lean towards the slope as required for stability. The preferred operating positions are the kneeling position, with the knee of the down hill leg on the seat and the foot of the uphill leg on the running board, or the posting position. Be prepared to shift your weight quickly as needed. Side hills and steep slopes are not recommended for a beginner or a novice snowmobiler.

Slush

Slush should be avoided at all times. Always check for slush before starting across any lake or river. If dark spots appear in your tracks, get off the ice immediately. Ice and water can be

thrown rearward into the path of a following snowmobile. Getting a vehicle out of a slush area is strenuous and in some cases, impossible.

Fog or Whiteout Conditions

On land or water, fog or visibility-limiting snow can form. If you have to proceed into the fog or heavy snow, do so slowly with your lights on and watch intently for hazards. If you are not sure of your way, do not proceed. Keep a safe distance behind other snowmobilers to improve visibility and reaction time.

Unfamiliar Territory

Whenever you enter an area that is new to you, drive with extreme caution. Go slow enough to recognize potential hazards such as fences or fence posts, brooks crossing your path, rocks, sudden dips, guy wires and countless other obstacles which could result in a termination of your snowmobile ride. Even when following existing tracks, be cautious. Travel at a speed so you can see what is around the next bend or over the top of the hill.

Bright Sunshine

Bright sunny days can considerably reduce your vision. The glare from sun and snow may blind you to the extent that you cannot easily distinguish ravines, ditches or other obstacles. Goggles with colored lenses should always be worn under these conditions.

Unseen Obstruction

There may be obstructions hidden beneath the snow. Driving off established trails and in the woods requires reduced speed and increased vigilance. Driving too fast in an area can make even minor obstacles very hazardous. Even hitting a small rock or stump could throw your snowmobile out of control and cause injury to its riders. Stay on established trails

to reduce your exposure to hazards. Be safe, slow down and enjoy the scenery.

Hidden Wires

Always be on the lookout for hidden wires, especially in areas that may have been farmed at one time or any other. Too many accidents have been caused by running into wires in the fields, guy wires next to poles and roads, and into chains and wires used as road closures. Slow speeds are a must.

Obstacles and Jumping

Unplanned jumps of snowdrifts, snow-plow ridges, culverts or indistinguishable objects can be dangerous. You can avoid them by wearing the proper color lenses or face shields and by operating at a lower speed.

Jumping can be a hazardous situation. Be prepared before landing to absorb the shock and brace yourself for the impact. Knees must be flexed to act as shock absorbers. If the trail does suddenly drop away from you, crouch (stand) towards the rear of the vehicle and keep the skis up and straight ahead. Apply partial throttle and brace yourself for the impact. Knees must be flexed to act as shock absorbers.

Turning

Depending on terrain conditions, there are two preferred ways to turn or corner a snowmobile. For most snow surfaces, "body english" is the key to turning. Leaning towards the inside of the turn and positioning body weight on the inside foot will create a "banking" condition beneath the track. By adopting this position and positioning yourself as far forward as possible, weight will be transferred to the inside ski.

On occasion, you will find that the only way to turn the vehicle about in deep snow is to pull the snowmobile around.

Do not over-exert yourself. Get assistance. Remember to always lift using your legs as opposed to your back.



Road Crossing

In some cases, you will be approaching the road from a ditch or snowbank. Choose a place where you know you can climb without difficulty. Use the standing position and proceed with only as much speed needed to crest the bank. Stop completely at the top of the bank and wait for all traffic to clear. Judge the drop to the roadway. Cross the road at a 90° angle. If you encounter another snowbank on the opposite side, position your feet near the rear of the vehicle. Remember, your snowmobile is not designed to operate on bare pavement and steering on this type of surface is more difficult.

Railroad Crossing

Never ride on railroad tracks. It is illegal. Railroad tracks and railroad rights-of-way are private property. A snowmobile is no match for a train. When crossing a railroad track, stop, look and listen.

Night Rides

The amount of natural and artificial light at a given time can effect your ability to see or to be seen. Nighttime snowmobiling is delightful. It can be a unique experience if you acknowledge your reduced visibility. Before you start, make certain your lights

are clean and work properly. Drive at speeds that will allow you to stop in time when you see an unknown or dangerous object ahead. Stay on established trails and never operate in unfamiliar territory. Avoid rivers and lakes. Guy wires, barbed wire fences, cabled road entrances and other objects such as tree limbs are difficult to see at night. Never drive alone. Always carry a flashlight. Keep away from residential areas and respect the right of others to sleep.

Riding in a Group

Before starting out, designate a "trail boss" to lead the party and another person to follow-up at the end of the party. Ensure that all members of the party are aware of the proposed route and destination. Make certain that you are carrying all necessary tools and equipment and that you have sufficient fuel to complete the trip. Never overtake the trail boss or, for that matter, any other snowmobile. Use down-the-line hand signals to indicate hazards or intent of direction change. Assist others whenever necessary.

It is always IMPORTANT to keep a safe distance between each snowmobile. Always maintain a safe interval and allow sufficient stopping distance. Don't be a tailgater. Know the position of the machine ahead.

Signals

If you intend to stop, raise either hand straight above your head. A left turn is indicated by extending your left hand straight out in the proper direction. For right turns, extend the left arm and raise the hand to a vertical position so it forms a right angle at the elbow. Every snowmobiler should relay any signal to the ones behind.

Trail Stops

Whenever possible, pull off the trail when you stop. This will reduce the hazard to other snowmobilers using the trail.

Trails and Signs

Trail signs are used to control, direct or regulate the use of snowmobiles on trails. Become familiar with all signs used in the area where you are snowmobiling.

Environment

Wildlife compliments your snowmobiling day. Snowmobile tracks provide firm ground over which animals can travel from area to area. Do not violate this privilege by chasing or harassing wildlife. Fatigue and exhaustion can lead to animal's death. Avoid areas posted for the protection or feeding of wildlife.

If you happen to be fortunate enough to see an animal, stop your snowmobile and observe quietly.

The guidelines that we support are not designed to limit your snowmobiling fun, but to preserve the beautiful freedom that you can experience only on a snowmobile! These guidelines will keep snowmobilers healthy, happy and able to introduce others to what they know and enjoy about their favorite winter pastime. So, the next time you hit the trails on a cool, crisp and clear winter day, we ask you to remember that you are paving the way for the future of our sport. Help us lead it down the right path! From all of us at BRP, thank you for doing your share.

There is nothing more exhilarating than snowmobiling. Venturing onto snowmobile trails that cross wild areas is an exciting and healthy winter sport. However, as the number of people using these recreational parks increases, so does the potential for damage to the environment. Abuse of land, facilities

and resources inevitably leads to restrictions and closures of both private and public land.

In essence, the greatest threat to our sport, is all around us. Which leaves us with one logical choice. When we snowmobile, we must always ride responsibly.

The vast majority respect the law and the environment. Each of us must set an example for those who are new to the sport, young and old alike.

It is in every one's best interest to tread lightly into our recreational areas. Because, in the long run, to protect the sport we must preserve the environment.

Recognizing the importance of this issue and the need for snowmobilers to do their share in preserving areas that make it possible to enjoy our sport, BRP has developed the "Light Treading Is Smart Sledding" campaign for snowmobilers.

Light Treading refers to more than the thread of our tracks. It's a statement of concern, respect and willingness to take the lead and take action. It applies to the environment in general, its proper care and maintenance, its natural inhabitants and all enthusiasts and the public at large who enjoy the great outdoors. With this theme, we invite all snowmobilers to remember that respecting the environment is not only critical to the future of our industry but to future generations.

Light Treading in no way suggests you should curb your appetite for snowmobiling fun! It simply means tread with respect!

The fundamental objective of Light Treading is one of respect for where and how you ride a snowmobile. You're a light treader when you follow the principles below.

Become informed. Obtain maps, regulations and other information from the Forest Service or from other pub-

lic land agencies. Learn the rules and follow them and that goes for speed limits, too!

Avoid running over young trees, shrubs, and grasses and don't cut wood. On flatlands or areas where trail riding is popular, it's important to ride only where authorized. Remember, there is a link between protecting your environment and your own safety.

Respect wildlife and be particularly sensitive of animals that are rearing young or suffering from food shortage. Stress can sap scarce energy reserves. Refrain from riding in areas where only animals are intended to tread!

Obey gate closures and regulatory signs and remember, light treaders don't litter!

Stay out of wilderness areas. They're closed to all vehicles. Know where the boundaries are.

Obtain permission to travel across private land. Respect the rights of landowners and other people's privacy. Remember, snowmobile technology has lowered the noise factor considerably, but you still shouldn't rev your engines where quiet "is the order of the day".

Snowmobilers know all too well the efforts that have been made throughout the sport's history to enjoy access to areas where people can snowmobile safely and responsibly. This effort continues today, as strong as ever.

Respecting the areas where we ride... wherever they may be... is the only way to ensure their future enjoyment. That's one major reason why we know you'll agree that Light Treading is smart sledding! And there are more.

Enjoying the opportunity to see winter and all its natural majestic wonders, is an experience cherished by snowmobilers. Light Treading will preserve this opportunity and will make it possible for us to expose others to the

beauty of winter and the unique thrill of our sport! Light Treading will help our sport to grow!

Finally, Light Treading is the sign of a smart snowmobiler. You don't have to leave big tracks or careen through a virgin forest to show you can ride. So whether you're driving a high performance Lynx, a sporty RS™ snowmobile or any other make or model, show you know what you're doing. Show you know how to send snow flying and make tracks with a light touch!

Transporting and Towing

Follow transporting and towing instructions explained further in this guide.

TRACTION ENHANCING PRODUCTS

NOTE: This section is applicable to snowmobiles equipped with a factory installed track that has been approved by BRP for special studs installation.

⚠ WARNING

Never stud a track that has not been approved for studs. Installing studs on an unapproved track could increase the risk of the track tearing or severing.

⚠ WARNING

You may stud the track on this vehicle model. However, you **MUST** only use the BRP approved type stud for use on these Lynx snowmobiles. **DO NOT EVER** use conventional studs as the track thickness is thinner than other standard tracks. The stud could tear off of track and separate from vehicle. See an authorized Lynx dealer for current specific studding availability and applications.

Using traction enhancing products such as, more aggressive ski carbide runners and/or studs on your snowmobile will change its behavior, particularly in terms of manoeuvrability, acceleration, and braking.

Using traction enhancing products gives a better grip on packed snow and ice, but has no noticeable effect on soft snow. For this reason, driving a snowmobile equipped with traction enhancing products requires a certain adaptation period. If your snowmobile is equipped with traction enhancing products, be sure to take plenty of time to get used to the way it handles when turning, accelerating, and braking.

Also, always check local regulations concerning the use of traction enhancing products on snowmobiles. Always drive your snowmobile in a responsible manner, respecting the environment and other people's property.

Manoeuvrability

Using traction enhancing products such as, more aggressive ski carbide runners and/or studs makes the snowmobile grip the ground better at both the front and at the rear. The use of carbide runners is therefore required to give the skis a better grip, so that the front and rear of the snowmobile are in balance. While off-the-shelf carbide ski runners are adequate, they don't necessarily give you optimal control, since that depends on your personal preferences, your riding style, and how your suspension is adjusted.

⚠ WARNING

If the front and rear of the snowmobile are out of balance due to an incorrect combination of traction enhancing products, the snowmobile may tend to oversteer or understeer, which could lead to a loss of control.

Oversteering

In certain conditions, using more aggressive ski carbide runners without studs on the rear track could make the snowmobile prone to oversteering, see illustration.

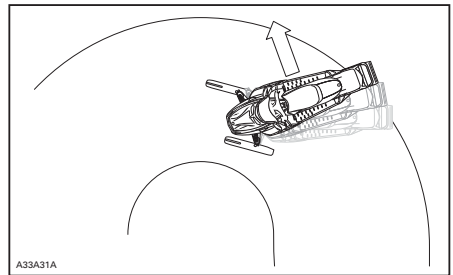

OVERSTEERING

Understeering

In certain conditions, the use of studs on the track could make the snowmobile prone to understeering if the skis are not equipped with more aggressive ski carbide runners, see illustration.

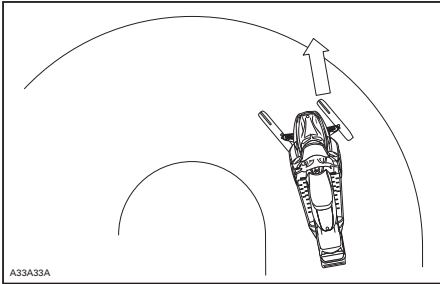

UNDERSTEERING

Controlled Driving

A balanced combination of carbide ski runners and studs on the track ensures adequate control and better handling, see illustration.

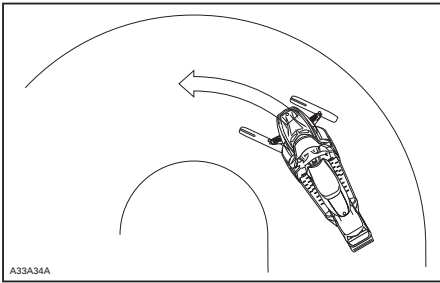

CONTROLLED DRIVING

Acceleration

Using studs on the track will allow your sled to accelerate better on packed snow and ice but will have no noticeable effect on soft snow. This can cause sudden variations in traction under certain conditions.

⚠ WARNING

To prevent surprises that could lead to a loss of control of the snowmobile:

- Always go easy on the throttle.
- NEVER try to spin the track to make the rear of the snowmobile skid.

This could cause debris or ice to be thrown violently backwards, possibly injuring others nearby or on snowmobiles behind you.

Braking

As in the case of acceleration, using studs on the track will give you better braking capacity on packed snow or ice but will have no noticeable effect on soft snow. Braking may thus vary suddenly under certain conditions. Be sure to use restraint in braking to keep from blocking the track in order to avoid surprises that could lead to a loss of control.

Important Safety Rules

⚠ WARNING

To prevent serious injury to individuals near the snowmobile:

- NEVER stand behind or near a moving track.
- Always use a wide-base snowmobile stand with a rear deflector panel if it is necessary to rotate track.
- When the track is raised off the ground, only run it at the lowest possible speed.

Centrifugal force could cause debris, damaged or loose studs, pieces of torn track, or an entire severed track to be violently thrown backwards out of the tunnel with tremendous force.

Effects of Having a Studded Track on the Life of the Snowmobile

The use of traction enhancing products can increase the load and the stress on certain snowmobile components, as well as the vibration level. This can cause premature wear on parts such as belts, brake linings, bearings, chain, chaincase sprocket, and on approved studded tracks, shorten track life. Always proceed with a visual inspection of your track before each use. For more information, refer to the *TRACK* section in *MAINTENANCE*.

Studs on the track can also cause serious damage to your snowmobile if it is not equipped with the tunnel protectors designed for your particular model. Damage to the electrical wiring or perforation of the heat exchangers are potential hazards, that could cause the engine to overheat and be severely damaged.

⚠ WARNING

If tunnel protectors are excessively worn or not installed, the gas tank could be punctured, causing a fire.

NOTICE Ask your dealer for the appropriate tunnel protectors model and kit number required for your snowmobile.

NOTE: Consult the BRP limited warranty to find out what warranty limitations are related to the use of studs.

Installation of Studs on BRP Approved Tracks

⚠ WARNING

Never stud a track that has not been approved for studs. Approved tracks can be identified by a stud symbol (see illustration below) molded into the track surface. Installing studs on an unapproved track could increase the risk of the track tearing or severing.

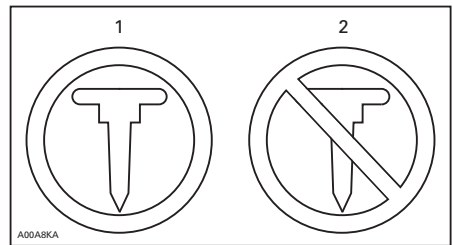

TRACK SYMBOLS

1. *Approved*
2. *NOT Approved*

To ensure safe and proper installation, BRP recommends to have the studs installed by your dealer.

- Use only the BRP approved special studs.
- Never use studs that exceed the height of your snowmobile's track profile by more than 9.5 mm.

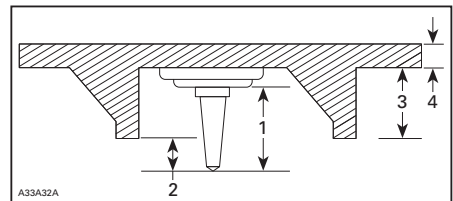

INSTALLATION OF STUDS

1. *Stud size*
2. *Penetration range 6.4 mm to 9.5 mm*
3. *Track lug height*
4. *Track belt thickness*

⚠ WARNING

- See an authorized Lynx dealer for current specific studding availability and applications.
- DO NOT EVER use conventional stud because, the track thickness is thinner than our standard tracks and the stud could tear off of track and separate from vehicle.
- Studs should only be installed in the locations indicated by molded bulges in the track surface. Some track models have two types of molded bulges; triangles and circles. See the warning molded into the track surface to know which one to use.
- Never stud a track with a profile of 35 mm or more.
- The number of studs installed must always perfectly match the pattern of molded bulges in the track.
- Always consult the traction product manufacturer's installation instructions and recommendations before having your dealer install studs and runners. It is very important to follow the torque specifications for the stud bolts.

INSTALLING AN INCORRECT NUMBER OF STUDS OR AN IMPROPER INSTALLATION CAN INCREASE THE RISK OF THE TRACK TEARING OR SEVERING.

Maintenance/Replacement

PROCEED WITH A VISUAL INSPECTION OF YOUR TRACK BEFORE EACH USE.

Look for any defects, such as:

- Perforations in the track
- Tears in the track (particularly around traction holes on studded tracks)
- Lugs that are broken or torn off, exposing portions of rods
- Delamination of the rubber
- Broken rods
- Broken studs (studded tracks)
- Bent studs (studded tracks)
- Missing studs
- Studs that are torn off the track
- Missing track guide(s)
- Also, ensure that studs nut are tighten to the recommended torque.

On approved studded tracks, replace broken or damaged studs immediately. If your track shows signs of deterioration, it must be replaced immediately. When in doubt, ask your dealer. Always proceed with a visual inspection of your track before each use.

⚠ WARNING

Riding with a damaged track or studs could lead to loss of control.

IMPORTANT ON-PRODUCT LABELS

Hang Tag(s)

VEHICLE ENGINE DESCRIPTION:
XXXXXX

EPA CERTIFIED

NER (NORMALIZED EMISSION RATE) =
ON A 0 TO 10 SCALE, 0 BEING THE CLEANEST

***NOT TO BE REMOVED PRIOR TO SALE**



704901107

vmo2006-005-009_en

TYPICAL

Dear consumer,

Your new E-TEC engine technology has an automatic computer-controlled break-in period that ensures you get the most performance, efficiency and reliability for the life. During the break-in, it will consume more oil and fuel than normal. Also, you may feel the engine misfire. This is normal, the computer is protecting the engine components against premature wear and ensure optimal break-in. After this period, which lasts for about the first two tanks of fuel (22 gal./80 l), you'll be able to experience the unmatched performance, fuel and oil economy that only the E-TEC technology delivers.

Cher client,

Votre nouveau moteur à technologie E-TEC a une période de rodage contrôlée automatiquement qui assurera une performance, une efficacité et une fiabilité optimales à long terme. Durant la période de rodage, le moteur consommera plus d'huile et d'essence qu'à la normale. Ainsi, il se peut que le moteur ait des ratés. Cela est normal puisque le module de commande protège le moteur contre l'usure prématurée et assure un rodage optimal. Après cette période, qui dure environ 2 pleins d'essence (80 l), vous serez en mesure de profiter pleinement des performances, ainsi que de la faible consommation d'huile et d'essence, que seule la technologie E-TEC peut offrir.

516004621

516004621

E-TEC MODELS

CAUTION

This snowmobile is calibrated for operating at SEA-LEVEL. Operating above 2000 ft requires calibration parts and adjustment. For more details, REFER to your Operator's Guide that came with your snowmobile or see your authorized Ski-Doo dealer. **INCORRECT ADJUSTMENTS MAY CAUSE PARTS DAMAGE**

mno2008-003-054

Vehicle Safety Labels

These labels are affixed to the vehicle for the safety of the operator, passenger or bystanders.

The following labels are on your vehicle and they should be considered permanent parts of the vehicle. If missing or damaged, the decals can be replaced free of charge. See an authorized Lynx dealer.

NOTE: In the event of any discrepancy between this guide and the vehicle, the safety labels on the vehicle have precedence over the labels in this guide.

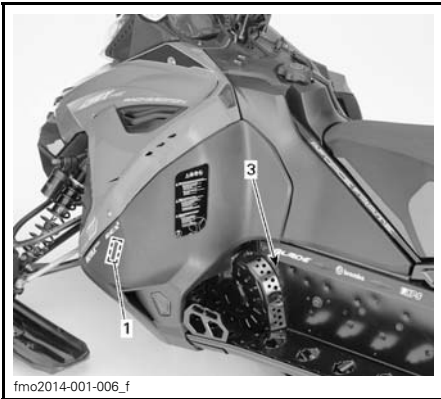
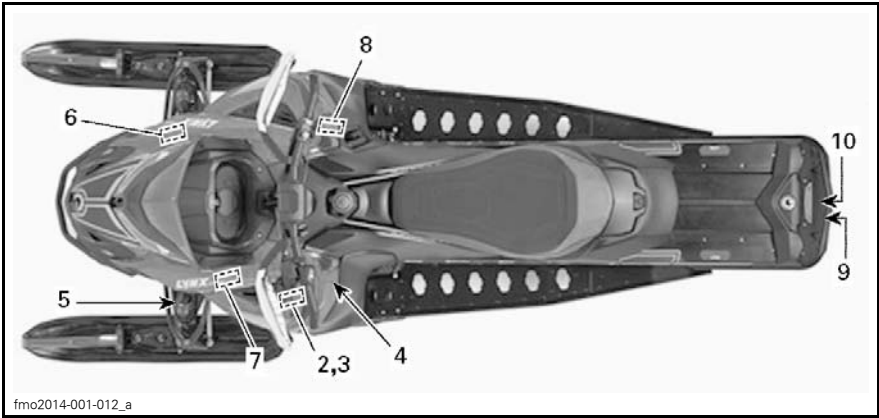

TYPICAL

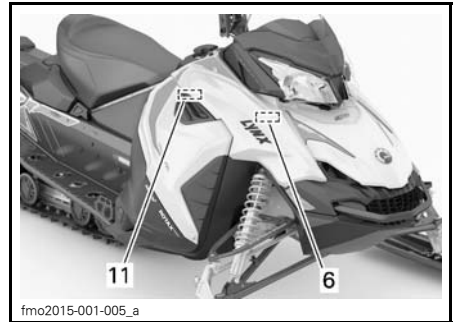

TYPICAL

Label 1



LABEL 1 (ON LEFT/RIGHT SIDE PANEL)

Label 2

⚠ WARNING

- Locate and read operator's guide. Follow all instructions and warnings.
- Beware of hot parts.
- Beware of hot vapors.
- Do not use without pulley guard.
- Beware of drive belt.
- Read instructions before service.

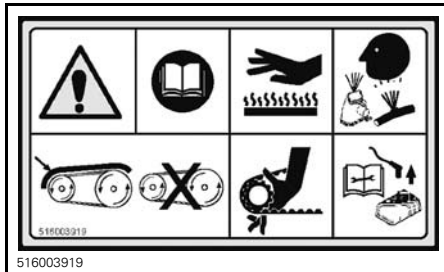

LABEL 2- ON PULLEY GUARD

Label 3

⚠ WARNING

This guard must ALWAYS be in place when engine is running.

Beware of rotating parts - they could cause injuries or catch your clothing.

516006900

LABEL 3- ON PULLEY GUARD AND ON BRAKE DISC GUARD

Label 4

⚠ WARNING: Read the operator's manual and get acquainted with the safety instructions before you start using the snowmobile.

Before starting the snowmobile, CHECK

- that acceleration and brake system are in order
- that all the protections are in place
- that the hood is closed
- that the emergency cut out switch is fastened

When the engine is running, CHECK

- that the emergency cut out switch and the emergency switch function
- that which gear is on before start

VAROITUS: Lue käyttöohjekirja ja tutustu turvallisuusohjeisiin ennen moottorikelkan käyttöönottoa!

Ennen moottorin käyttöönottoa TARKISTA

- että kaasuu ja jarrunhallintalaitteet ovat kunnossa
- että kaikki suojat ovat paikallaan
- että konepeltto on suljettu
- että hätäkatkaisijan naru on kiinnitetty

Kun moottori käy, TARKISTA

- että hätäkatkaisija ja pysäytysnappi toimivat
- mikä vaihde on päällä ennen liikkeelle lähtöä

⚠ WARNING: Läs ägarehandboken och bekanta dig med Säkerhetsföreskrifterna före användandet av snöskotern!

Före motorn startas, KONTROLLERA

- att gas- och bromsreglage löperfritt och automatiskt återgår till neutralläge
- att alla skydd är på plats
- att nödstoppknappen är fäst runt ena handleden eller i kläderna

När motorn startat, KONTROLLERA

- att nödstopp och stoppknapp fungerar
- vilken växel som är lågd före utård

Min 95 E

516004607

LABEL 4 (ON LEFT SIDE PANEL)

Label 5

WARNING: Under pressure.

Avoid flame or spark.

Do not disassemble.

Do not torch, puncture or incinerate.

fmo2014-001-017

LABEL 5- ON SHOCK

Label 6



516005904A

LABEL 6



mmo2008-003-007

LABEL 6

Label 7

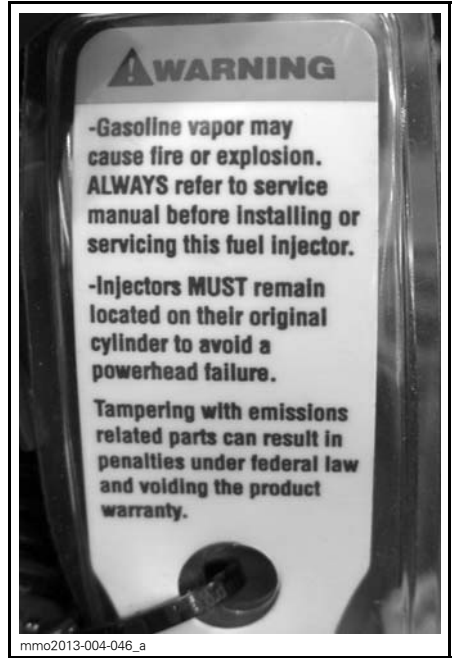

mmo2013-004-046_a

LABEL 7- ON FUEL INJECTORS - E-TEC MODELS

Label 8

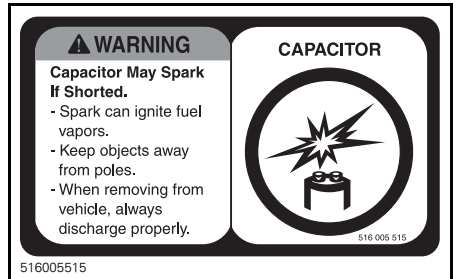

516005515

LABEL 8- E-TEC ONLY

Label 9

⚠ WARNING

- Always use a rigid tow bar to tow.
- MAXIMUM REAR LOAD: 15kg
- MAXIMUM towing capacity: 2500N
- MAXIMUM tongue capacity: 100N

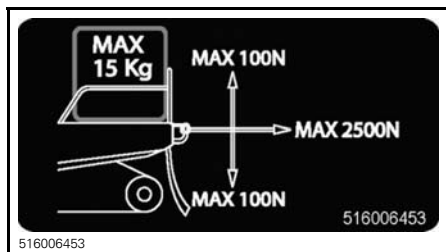

LABEL 9 - ON RAVE RE , XTRIM SC AND BOONDOCKER

Label 10

⚠ WARNING

- Always use a rigid tow bar to tow.

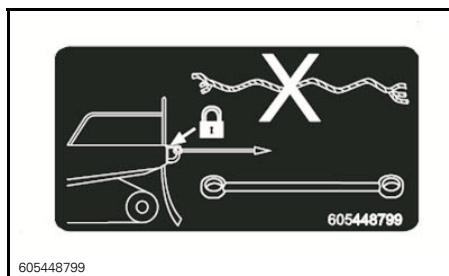

LABEL 10

Label 11

⚠ WARNING

Always electrically disconnect both fuel injectors prior to testing for ignition spark. Otherwise, fuel vapors may ignite in presence of a spark creating a fire hazard.

5583A

516005583

LABEL 11

Technical Information Labels

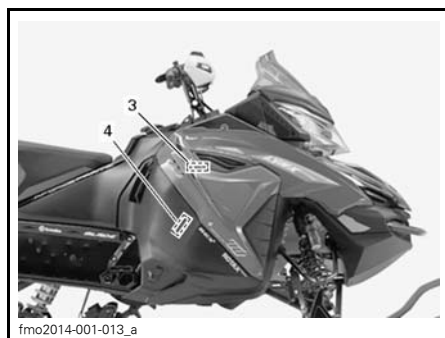
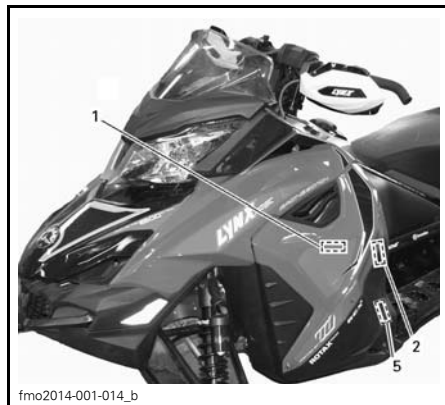

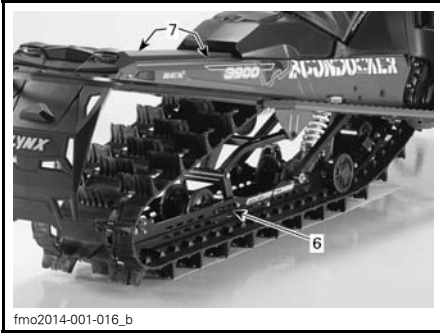

TARKISTA öljypinnan korkeus voimansiirrosta kerran viikossa.

OLJENIVÄ I KRAFTÖVERFÖRING Kontrolleras varje vecka

Oil level in transmission should be checked once a week.

5447012

LABEL 4 - (ON RIGHT SIDE)

NOTICE

The engine of this snowmobile has been developed and validated using the BRP XPS™ approved lubricant. BRP strongly recommends the use of its XPS™ approved lubricant at all times. Damages caused by oil which is not suitable for the engine will not be covered by the BRP limited warranty.

516006904

516006904

LABEL 1

NOTICE

7900 ± 100 RPM

MAXIMUM HORSEPOWER

516005507

LABEL 5

NOTICE

- To comply with noise regulations, this engine is designed to operate with an air intake silencer.
- Operation without air intake silencer or with one not properly installed may cause engine damage.

516004572

516004572

LABEL 2 E-TEC MODELS

WITHOUT FORCE:

- XTRIM > 35- 45mm
- BD 3700 > 50- 60mm
- BD 3900 > 70- 80mm

516006395

516006395

LABEL 6- ON XTRIM, BOONDOCKER 3700 AND BOONDOCKER 3900

NOTICE

The engine of this snowmobile has been developed and validated using the BRP XPS™ Synthetic Blend 2 stroke oil (293 600 101). BRP strongly recommends the use of its XPS™ Synthetic Blend 2 stroke oil at all times. Damages caused by oil which is not suitable for the engine will not be covered by the BRP limited warranty.

516005528

516005528

LABEL 3 ON E-TEC MODELS

LINQ 2 + LINQ 1 = MAX 15kg

- LINQ 2 = MAX 6 kg

NOTICE

516006343

LABEL 7 ON XTRIM AND BOONDOCKER

IMPORTANT ON-PRODUCT LABELS

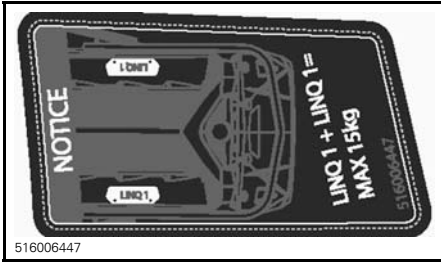

LABEL 7 ON RAVE RE

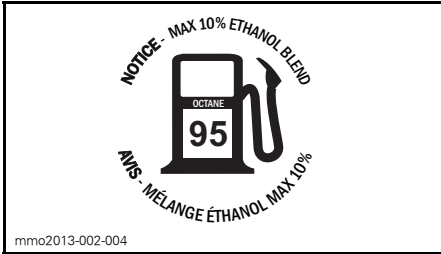

LOCATED ON FUEL CAP

VEHICLE INFORMATION

CONTROLS/INSTRUMENTS/EQUIPMENT

NOTE: Some controls/instruments/equipment do not apply or are optional on some models. In these cases their reference numbers are deliberately missing in the illustrations.

NOTE: Some vehicle safety labels are not shown on illustrations. For information on vehicle safety labels, refer to *VEHICLE SAFETY LABELS* subsection.

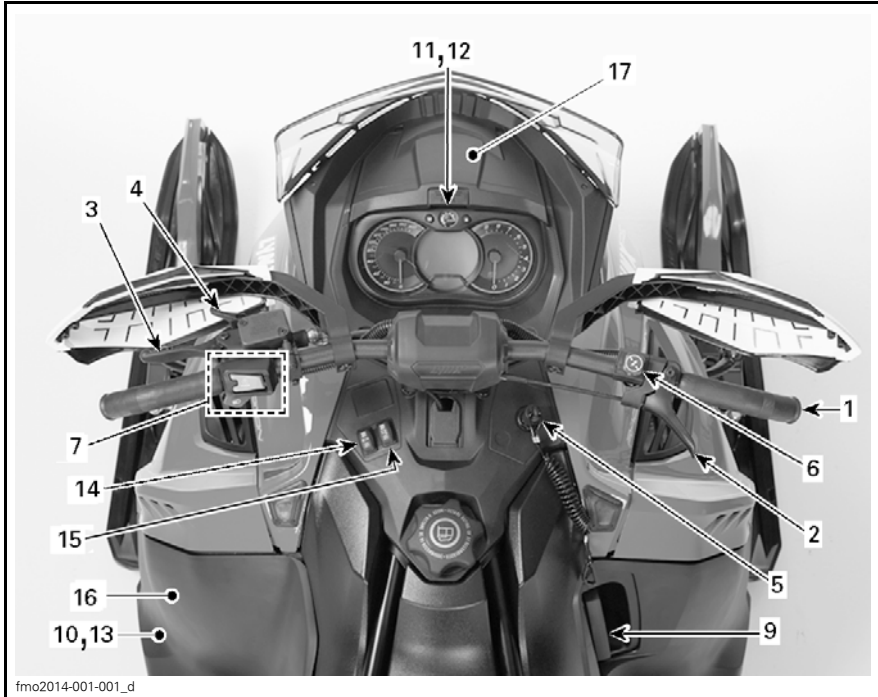

TYPICAL

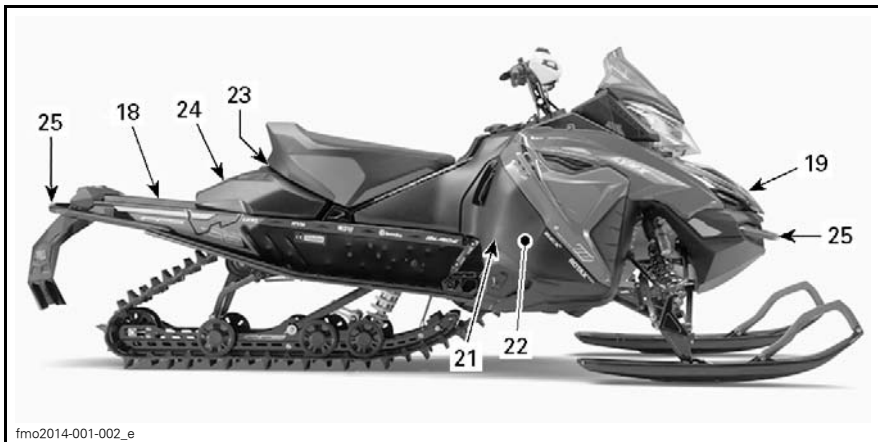

TYPICAL

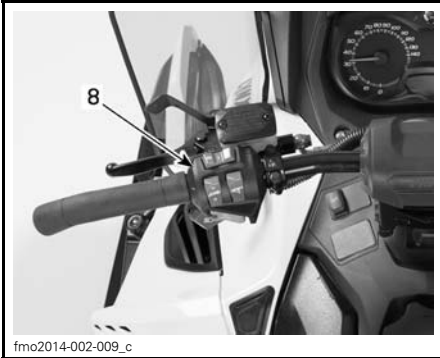

fmo2014-002-009_c

XTRIM SC ONLY

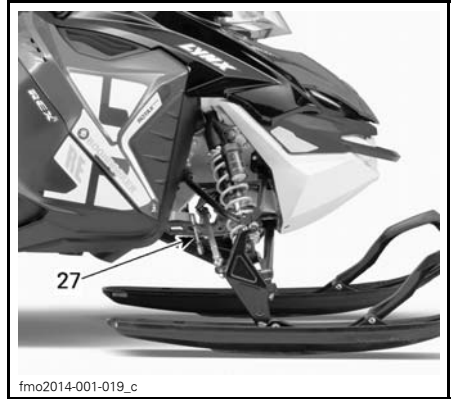

fmo2014-001-019_c

BOONDOCKER



fmo2014-002-007_d

XTRIM SC AND BOONDOCKER

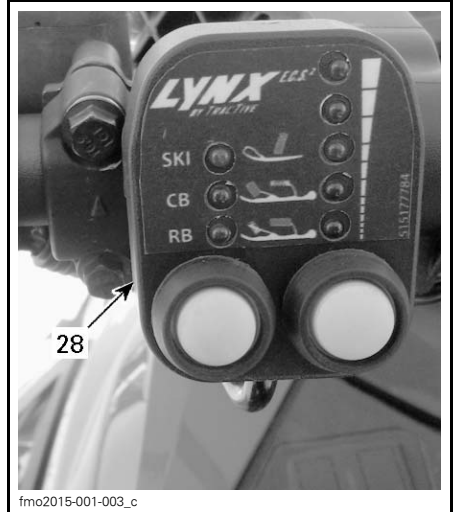

fmo2015-001-003_c

RAVE RE ONLY

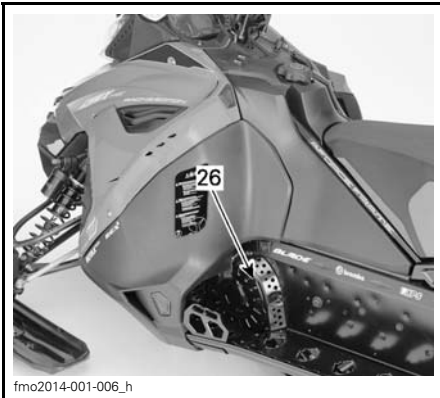

fmo2014-001-006_h

TYPICAL

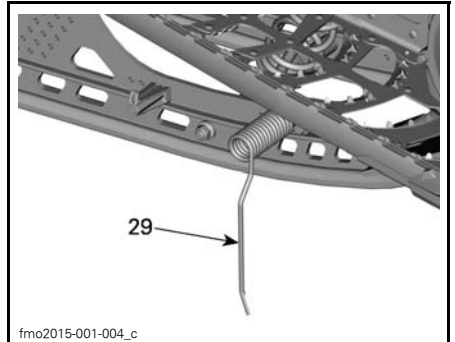

fmo2015-001-004_c

TYPICAL - BOONDOCKER



TYPICAL - XTRIM SC

1) Handlebar

The handlebar controls the steering of the snowmobile. As the handlebar is rotated to right or left, the skis are turned right or left to steer the snowmobile.

⚠ WARNING

Fast reverse while turning, could result in loss of stability and control.

2) Throttle Lever

Throttle lever is located on the RH side of handlebar.

Designed to be thumb activated. When squeezed, it increases the engine speed and engages the transmission. When released, engine speed returns automatically to idle.

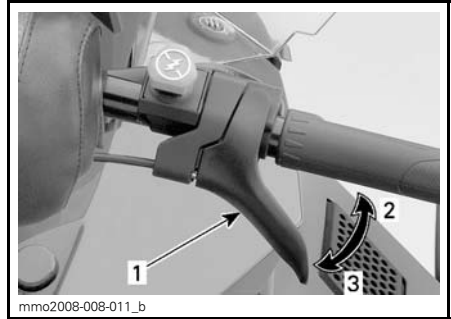

TYPICAL

1. Throttle lever
2. To accelerate
3. To decelerate

⚠ WARNING

Test the throttle lever operation each time before starting the engine. The lever must return to its original position once released. Otherwise, do not start engine.

3) Brake Lever

Brake lever is located on the LH side of handlebar.

When squeezed, brake is applied. When released, it automatically returns to the rest. Braking effect is proportional to the pressure applied on the lever and to the type of terrain and its snow coverage.

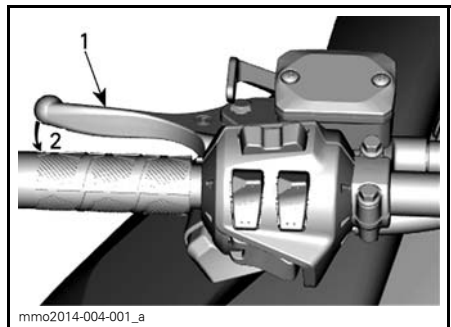

TYPICAL

1. Brake lever
2. To apply brake

4) Parking Brake Lever

Parking brake lever is located on the LH side of handlebar.

Parking brake should be used whenever snowmobile is parked.

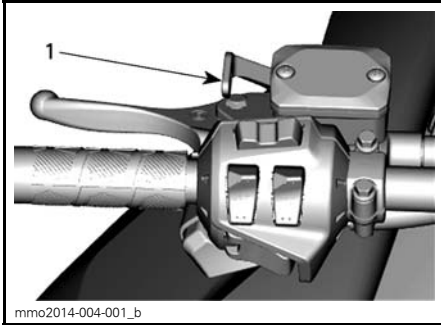

TYPICAL

1. Parking brake lever

⚠ WARNING

Make sure parking brake is fully disengaged before operating the snowmobile. When you ride the vehicle, brake pads that are caused to drag by a continuous pressure on the lever may cause damage to the brake system and cause loss of braking capacity and/or fire.

To Engage Parking Brake

Squeeze brake lever and maintain while pulling locking lever with a finger. When brake lever is held at halfway the parking brake should be fully applied.

⚠ CAUTION Parking brake position can vary depending on brake pads wear. Ensure when the parking brake is applied that the vehicle stays securely in place.

NOTE: Locking lever can be adjusted in two different positions.

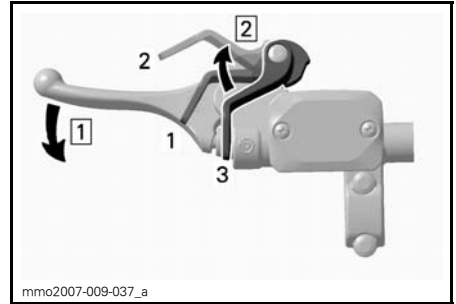

TYPICAL — ENGAGE MECHANISM

Step 1: Step 1: Squeeze and maintain brake lever

Step 2: Step 2: Adjust locking lever

1. Position 1
2. Position 2
3. OFF

To Release Mechanism Parking Brake

Squeeze brake lever. Locking lever will automatically return to its original position. Always release parking brake before riding.

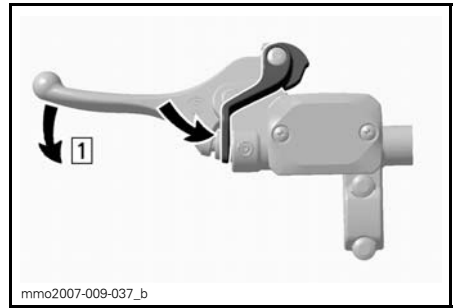

TYPICAL — RELEASE MECHANISM

Step 1: Step 1: Squeeze brake lever

5) Engine (Tether) Cut-Out Switch

Xtrim, Rave RE and BoonDocker Series

The engine cut-off switch (tether cord) is located to on the RH side of console.

The tether cord cap must be securely snapped on the engine cut-off switch to allow vehicle operation.

General

When the tether cord cap (DESS key) is removed, it shuts the engine off preventing snowmobile to runaway if the operator falls off the vehicle accidentally.

⚠ WARNING

Always remove the tether cord cap (DESS key) when vehicle is not in operation in order to prevent accidental engine starting, to avoid unauthorized use by children or others or theft.

Operation

Attach tether cord eyelet to clothing, then snap cap (DESS key) over post before starting engine.

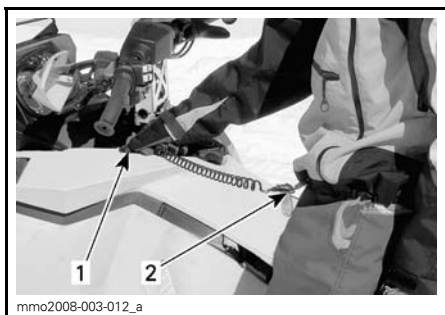

TYPICAL

1. Snap over post
2. Attach to clothing

If emergency engine shut off is required, pull tether cord cap (DESS key) from post completely.

DESS (Digitally Encoded Security System)

The tether cord cap has an integrated D.E.S.S. key to provide you and your snowmobile with the equivalent security of a conventional lock key.

The D.E.S.S. key contains an electronic chip which features a unique permanently memorized digital code.

Your authorized Lynx dealer has programmed the D.E.S.S. of your snowmobile to recognize the D.E.S.S. key in the tether cord cap to allow vehicle operation.

If another tether cord is used without programming the D.E.S.S., the engine will start but will not reach drive pulley engagement speed to move vehicle.

Make sure the tether cord cap is free of dirt or snow.

D.E.S.S. Flexibility

The ECM of your snowmobile can be programmed by your authorized LYNX dealer to accept 8 different keys.

We recommend the purchase of additional tether cords from your authorized LYNX dealer. If you have more than one DESS-equipped LYNX snowmobile, each can be programmed by your authorized LYNX dealer to accept the other vehicles keys.

DESS Pilot Lamp Codes

NOTE: If any code still occurs, contact an authorized LYNX dealer.

WARNING SIGNALS		DESCRIPTION
BEEPER	DISPLAY MESSAGE	
2 shorts	WELCOME...	Personalized welcome message, good key
Slow short beeps/repetitive	CHECK KEY	Unable to read key (bad connection) Make sure the key is free of dirt or snow. Reinstall key and restart engine. Vehicle can not be driven.
Fast short beeps/repetitive	BAD KEY	Invalid key or key not programmed. Vehicle can not be driven.

RFD.E.S.S. Key Types

Two types of keys can be used:

- Normal key
- Learning key.

To ease key type recognition, the tether cord comes in different colors.

KEY TYPE	COLOR
Normal	Black
Learning	Green

The Lynx learning key, limits the speed of the snowmobile and the engine torque, therefore enabling first time users and less experienced operators to learn how to operate the snowmobile while gaining the necessary confidence and control.

NOTE: The initial learning key programming can limit the speed to 40 km/h or 70 km/h. Refer to your authorized Lynx dealer to modify this setting.

Refer to *OPERATING MODES* subsection for details.

6) Emergency Engine Stop (Cut-Out) Switch

The emergency engine stop switch is located on the RH side of handlebar.

Push-pull type switch. To stop the engine in an emergency, select OFF position (down) and simultaneously apply the brake. To restart, button must be at the ON position (up).



OFF POSITION

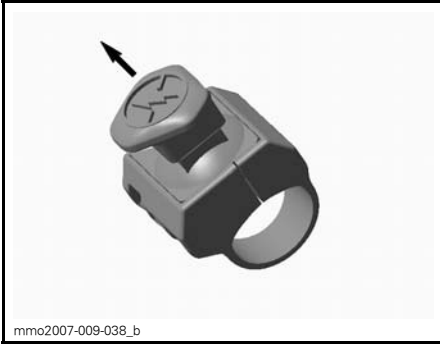

ON POSITION

All operators of the snowmobile should familiarize themselves with the function of this device by using it several times on first outing and whenever stopping the engine thereafter. This engine cut-out procedure will become a reflex and will prepare operators for emergency situations requiring its use.

⚠ WARNING

If the switch has been used in an emergency caused by a suspected malfunction, the source of the malfunction should be determined and corrected before restarting engine. See an authorized LYNX dealer for servicing.

7) Multifunction Switch (Xtrim SC)

Multifunction switch is located on the LH side of handlebar.

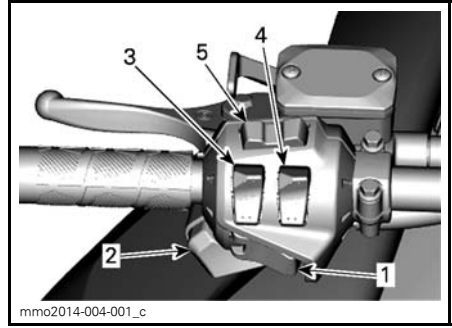

TYPICAL

1. Start/Electronic Reverse button
2. Headlights dimmer switch
3. Heated grips
4. Heated throttle lever
5. Mode/set button

Start/Electronic Reverse Button

On electric start models, press to start engine. Refer to *ENGINE STARTING PROCEDURE* in the *BASIC PROCEDURES* subsection.

Electronic Reverse Models

Once engine is started, press to engage the electronic reverse. Refer to *REVERSE (RER)* in *BASIC PROCEDURES* section for procedure.

Headlights Dimmer Switch

Press to select HI or LOW beam. Lights are automatically ON when the engine is running.

Heated Grips Switch

Models with Multifunction Analog/Digital Gauge

NOTE: Under 2000 RPM, heated grips will be limited at 50%.

Depress switch as required to select heating intensity to keep your hands at a comfortable temperature.

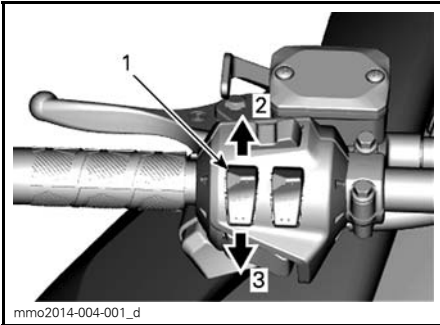

VARIABLE INTENSITY

1. Heated grip switch
2. Increase heat
3. Decrease heat

The heating intensity is displayed via the digital display.

NOTE: There are nine intensity settings. When released, display will return to engine coolant temperature (if equipped).

Depress switch as required to select heating intensity to keep your thumb at a comfortable temperature.

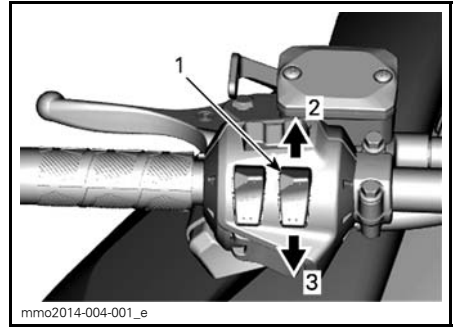

VARIABLE INTENSITY

1. Heated throttle lever switch
2. Increase heat
3. Decrease heat

NOTE: The heating intensity is displayed via the multifunction display with the activation of the throttle display switch. There are nine intensity settings. When released, display will return to fuel tank level.

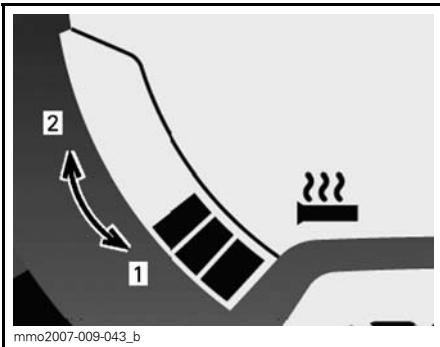

HEATING INTENSITY DISPLAY

1. Less heat
2. More heat

Heated grips will be in OFF position when there are no bars displayed on the gauge.

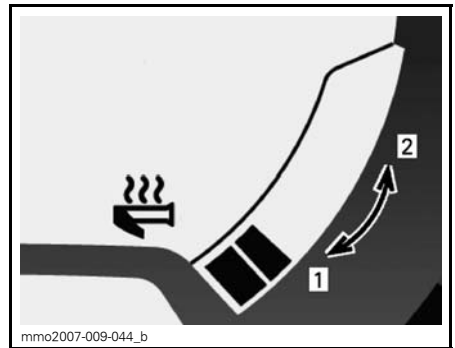

HEATING INTENSITY DISPLAY

1. Less heat
2. More heat

Heated throttle lever will be in OFF position when there are no bars displayed on the gauge.

Heated Throttle Lever Switch

Models with Multifunction Analog/Digital Gauge

NOTE: Under 2000 RPM, heated throttle lever will be limited at 50%.

Mode/Set Button

Models with Multifunction Analog/Digital Gauge

This button can be used instead of the two buttons on top of the analog/digital gauge to facilitate gauge adjustments.

- When pressed left, it has the same functions as the MODE (M) button.
- When pressed right, it has the same functions as the SET (S) button.

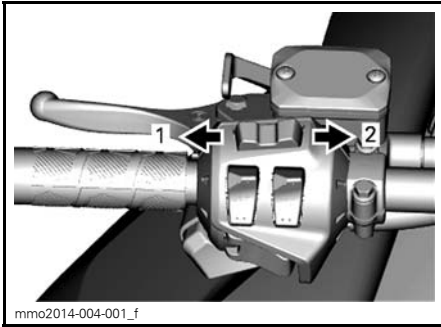

MULTIFUNCTION GAUGE

1. MODE function
2. SET function

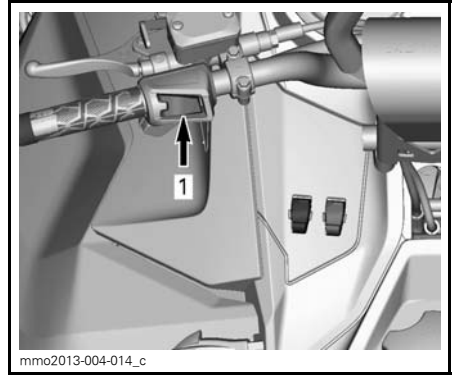

1. Start/electronic reverse button

Press to select HI or LOW beam. Lights are automatically ON when the engine is running.

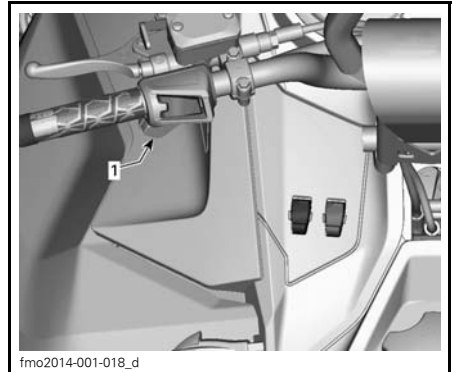

HEADLIGHTS DIMMER SWITCH

1. HI or LOW beam

8) Start/Electronic Reverse Button and Headlights Dimmer Switch (All except Xtrim SC)

On electric start models, press to start engine. Refer to *ENGINE STARTING PROCEDURE* in the *BASIC PROCEDURES* subsection.

Once engine is started, press to engage the electronic reverse. Refer to *REVERSE (RER)* in *BASIC PROCEDURES* section for procedure.

9) Rewind Starter Handle (If Applicable)

Models without Electric Start

Auto-rewind type located on right hand side of snowmobile. To engage mechanism, pull handle slowly until a resistance is felt then pull vigorously. Slowly release handle.

10) Tool Kit

A tool kit containing tools for basic maintenance is supplied with the vehicle.

The tools are located directly on the pulley drive guard.

NOTICE Make sure tools are secured properly to avoid contact with CVT (continuously variable transmission). The driven pulley expander is inserted through the starter clip.

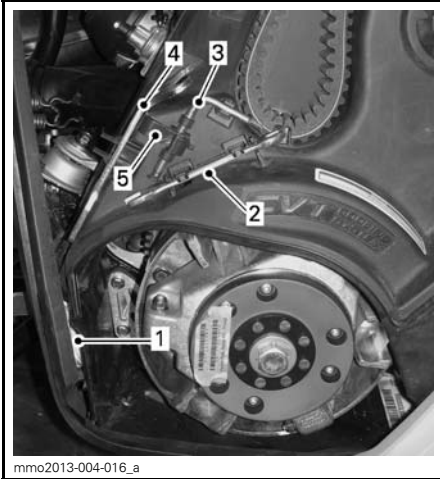

TYPICAL

1. Emergency rope
2. Wrench
3. Driven pulley expander
4. Suspension adjustment tool
5. Starter clip

11) Analog/Digital Gauge (Standard)

Models with Analog/Digital Gauge (Standard)

⚠ WARNING

Reading the gauge digital display can distract from the operation of the vehicle, particularly from constantly scanning the environment.

Gauge Description

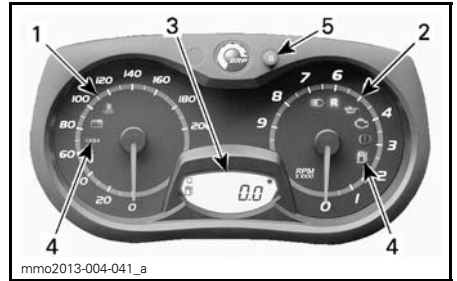

ANALOG/DIGITAL GAUGE (STANDARD)

1. Speedometer
2. Tachometer (RPM)
3. Gauge Digital Display
4. Pilot Lamps
5. Gauge SET "S" button

NOTE: The gauge is factory preset in metric units but it is possible to change it to Imperial units, contact an authorized Lynx dealer for unit settings.

1) Speedometer

Measures vehicle speed (in miles per hour or kilometers per hour depending on the setting).



LH PORTION OF GAUGE

2) Tachometer (RPM)

Measures engine revolution per minute (RPM). Multiply by 1000 to obtain the actual revolutions.



RH PORTION OF GAUGE

3) Digital Display

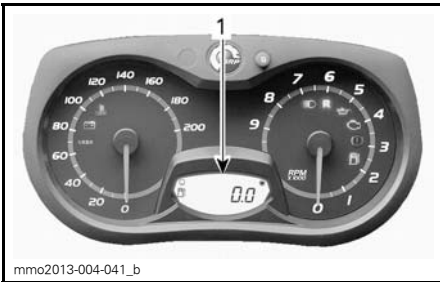

1. Digital display

The multifunction display is used to:

- Display the WELCOME message on power up
- Display the KEY recognition message
- Provide various indications as selected by the operator
- Activating or changing various functions or modes of operation
- Display scrolling messages of function activation or system faults
- Display fault codes.

⚠ WARNING



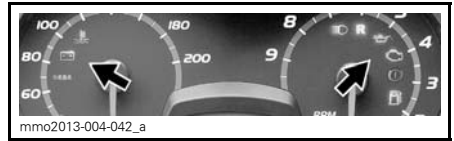

Never adjust or set functions on the multifunction gauge while riding the vehicle.

4) Pilot Lamps and Messages



TYPICAL — PILOT LAMPS

See table below for usual pilot lamps information. Refer to *MONITORING SYSTEM* for details on malfunction pilot lamps.

PILOT LAMP(S) ON	BEEPER	DESCRIPTION
	4 short beeps every 5 minutes	Injection oil level is low. Stop vehicle in a safe place then, replenish injection oil reservoir.
	—	Low fuel level. One (1) bar left in fuel level display. Replenish fuel tank as soon as possible.
	Long beeps repeating slowly	Reverse is selected.
	3 short beeps	Reverse did not engage, try again.
	—	High beam headlights are selected.
—	—	E-TEC: Engine and/or injection oil need to warm-up before normal operation. The engine's RPM is limited until desired temperature is reached.

5) SET (S) Button

Button used to navigate, adjust or re-set gauge multifunction display.

In order to memorize settings, engine must be running.

NOTE: SET (S) button on the multi-function switch has the same functions and can also be used.

Gauge Features

GAUGE FEATURES	
FUNCTIONS	600 HO E-TEC
A) Odometer	X
B) Trip meter "A" or "B"	X
C) Trip hour meter	X
D) Fuel level	X
E) Engine Coolant Temperature ⁽¹⁾	X
F) Engine Storage Mode	X
G) Heated grips heating intensity	X
H) Heated throttle Lever heating intensity	X
X = An X indicates a standard feature Opt = Feature available as an option N.A. = Not available (1) Coolant temperature is an option package. See a Lynx dealer for more information	

NOTE: The display is factory preset in Imperial units but it is possible to change it to Metric units, contact an authorized Lynx dealer for unit settings.

A) Odometer

Records the total distance travelled.
Press the SET (S) button to select odometer mode.

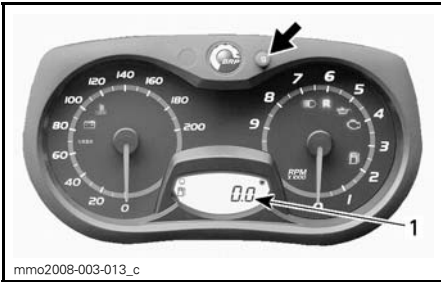

1. Odometer mode

B) Trip Meter A or B

Trip meters records distance travelled since it has been reset.
Press the SET (S) button to select trip meter (TRIP A/TRIP B) mode.

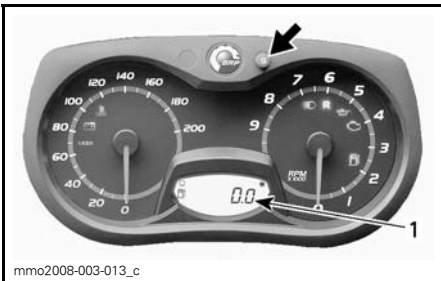

1. Trip meter (TRIP A/TRIP B) mode

Press and hold the SET (S) button to re-set.

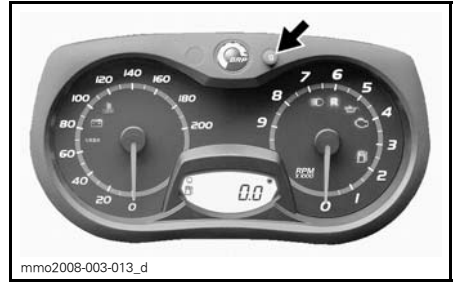

C) Trip Hour Meter

Records vehicle running time when the electrical system is activated since it has been reset.

Press the SET (S) button to select trip hour meter (HrTRIP) mode.

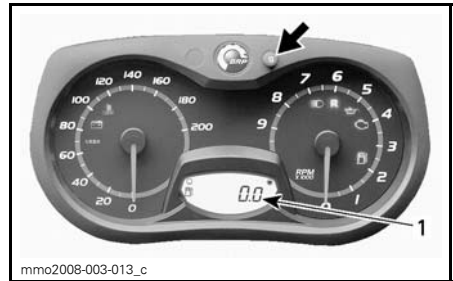

1. Trip hour meter (HrTRIP) mode

Press and hold the SET (S) button to re-set.

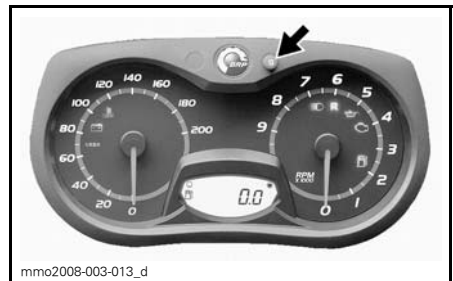

D) Fuel Level

Bar gauge that continuously indicates the amount of fuel left in the fuel tank.

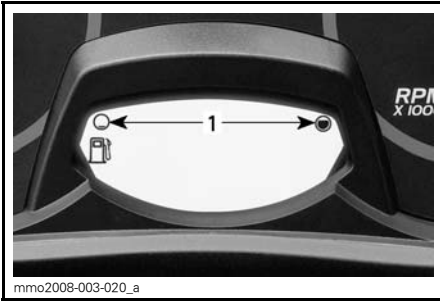
**FUEL LEVEL**

1. Operating range

Engine Coolant Temperature (Optional Module)

Overheating indicator.

NOTICE If engine overheats, stop vehicle in a safe place. Refer to TROUBLESHOOTING section.

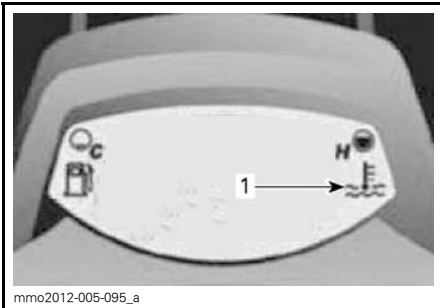
**OPTIONAL MODULE INSTALLED**

1. Overheating indicator

F) E-TEC Engine Storage Mode

Displays "OIL" when the engine enters the storage procedure.

G) Heated Grips Heating Intensity

The heating intensity is displayed via the digital display.

NOTE: There are nine intensity settings. When released, display will return to fuel tank level.

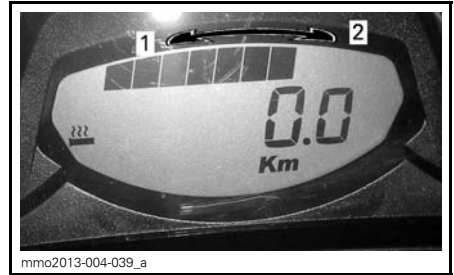
**HEATING INTENSITY DISPLAY**

1. Less heat
2. More heat

H) Heated Throttle Lever Heating Intensity

NOTE: The heating intensity is displayed via the digital display with the activation of the throttle lever switch. When released, display will return to fuel tank level.

NOTE: There are nine intensity settings.

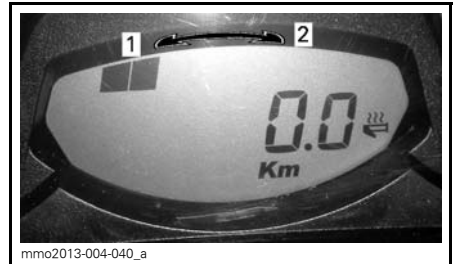
**HEATING INTENSITY DISPLAY**

1. Less heat
2. More heat

12) Multifunction Analog/Digital Gauge

Models with Multifunction Analog/Digital Gauge

⚠ WARNING

Reading the gauge digital display can distract from the operation of the vehicle, particularly from constantly scanning the environment.

Gauge Description

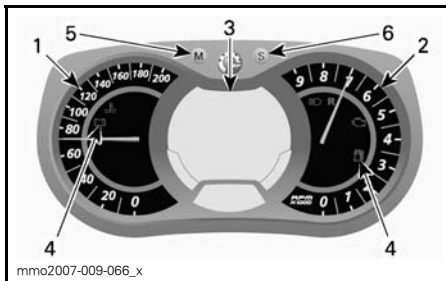

MULTIFUNCTION ANALOG/DIGITAL GAUGE

1. Speedometer
2. Tachometer
3. Multifunction digital display
4. Pilot lamps
5. Mode button
6. Set button

NOTE: The gauge is factory preset in metric units but it is possible to change it to Imperial units, contact an authorized Lynx dealer for unit settings.

1) Speedometer

Measures vehicle speed.



LH PORTION OF GAUGE

2) Tachometer (RPM)

Measures engine revolution per minute (RPM). Multiply by 1000 to obtain the actual revolutions.



RH PORTION OF GAUGE

3) Multifunction Digital Display

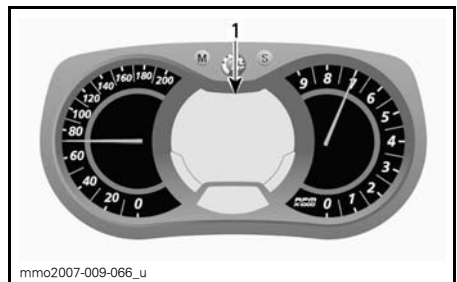

MULTIFUNCTION ANALOG/DIGITAL GAUGE

1. Multifunction display

The multifunction display is used to:

- Display the WELCOME message on power up

- Display the KEY recognition message
- Provide various indications as selected by the operator
- Activating or changing various functions or modes of operation
- Display scrolling messages of function activation or system faults
- Display fault codes.

When the information center is first powered up, the numerical display defaults to the last selected indication.

⚠ WARNING





Never adjust or set functions on the multifunction gauge while riding the vehicle.

4) Pilot Lamps and Messages



TYPICAL — PILOT LAMPS

See table below for usual pilot lamps information. Refer to *MONITORING SYSTEM* for details on malfunction pilot lamps.

PILOT LAMP(S) ON	BEEPER	MESSAGE DISPLAY	DESCRIPTION
	4 short beeps every 5 minutes	LOW OIL	E-TEC: Injection oil level is low. Stop vehicle in a safe place then, replenish injection oil reservoir.
	—	—	Low fuel level. One (1) bar left in fuel level display. Replenish fuel tank as soon as possible.
	Long beeps repeating slowly	REVERSE	Reverse is selected.
	3 short beeps	REV. FAIL	Reverse did not engage, try again.
	—	—	High beam headlights are selected.
—	—	WARM UP	E-TEC: Engine and/or injection oil need to warm-up before normal operation. The engine's RPM is limited until desired temperature is reached (up to 10 minutes when driving). Warm-up period may occur after a restart in very cold weather..

5) MODE (M) Button

Button use to navigate in gauge multifunction display.

NOTE: MODE (M) button on the multi-switch housing has the same functions and can also be used.

6) SET (S) Button

Button used to navigate, adjust or reset gauge multifunction display.

In order to memorize settings, engine must be running.

NOTE: SET (S) button on the multifunction switch has the same functions and can also be used.

Gauge Features**GAUGE FEATURES**

FUNCTIONS	600 HO E-TEC	800R E-TEC
A) Speedometer	Indication by default	
B) Engine RPM	X	X
C) Odometer	X	X
D) Trip meter "A" or "B"	X	X
E) Trip hour meter	X	X
F) Clock	N.A.	N.A.
G) Fuel level	X	X
H) Altitude	X	X
I) Top speed	X	X
J) Average speed	X	X
K) Heated grips heating intensity	X	X
L) Heated throttle lever heating intensity	X	X
M) Instant fuel consumption	X	X
N) Total fuel consumption	X	X
O) Message display	X	X
P) Engine coolant temperature	X	X
Q) E-TEC engine storage mode	X	X
R) Lap Record Mode	X	X
X = An X indicates a standard feature Opt = Feature available as an option N.A. = Not available		

A) Speedometer

In addition of the analog type speedometer, vehicle speed can also be displayed via the multifunction display.

Vehicle speed can be displayed on display 1 or display 2.

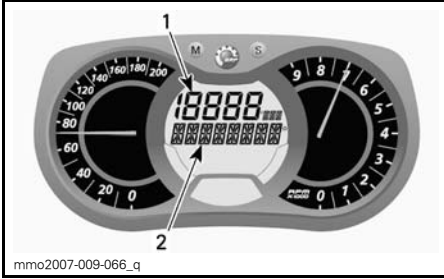

mmo2007-009-066_q

MULTIFUNCTION DISPLAY

1. Display 1
2. Display 2

Use MODE (M) button to select the desired display, then proceed as follows:

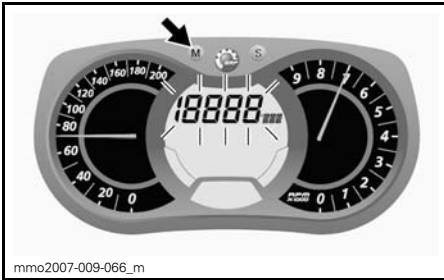

mmo2007-009-066_m

While display is flashing, press the SET (S) button to select speedometer mode.

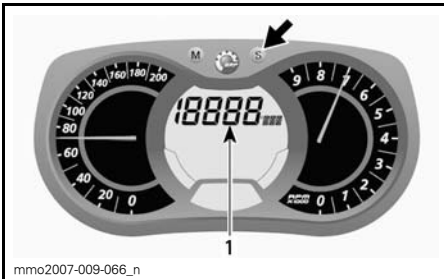

mmo2007-009-066_n

1. Speedometer mode

Press the MODE (M) button to confirm selection or wait 5 seconds.



mmo2007-009-066_o

B) Tachometer (RPM)

In addition of the analog type tachometer, RPM can also be displayed via the multifunction display.

Engine RPM can be displayed on display 1 or display 2.

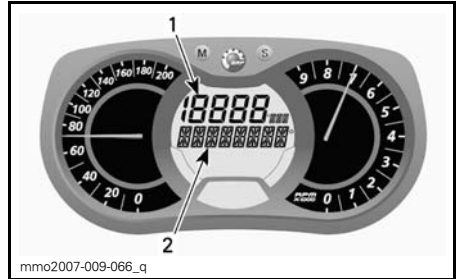

mmo2007-009-066_q

MULTIFUNCTION DISPLAY

1. Display 1
2. Display 2

Use MODE (M) button to select the desired display, then proceed as follows:

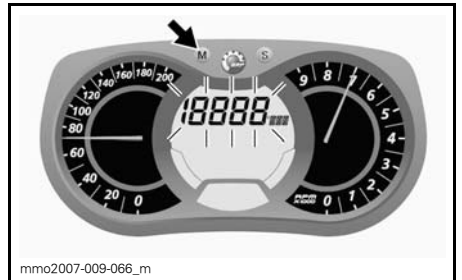

mmo2007-009-066_m

While display is flashing, press SET (S) button to select RPM mode.

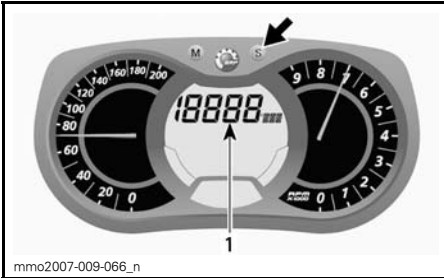

1. RPM mode

Press the MODE (M) button to confirm selection or wait 5 seconds.

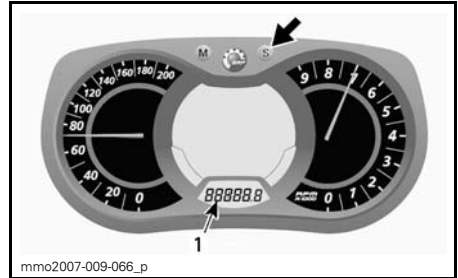

1. Trip meter (TRIP A/TRIP B) mode

Press and hold the SET (S) button to re-set.

NOTE: On E-TEC models, resetting TRIP B mode will also reset TOTAL FUEL CONSUMPTION.

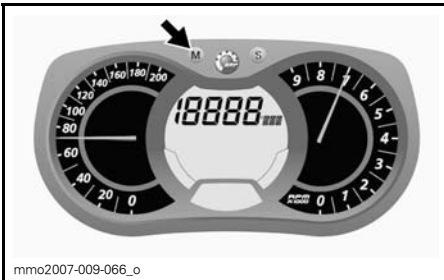

C) Odometer

Records the total distance travelled.

Press the SET (S) button to select odometer mode.

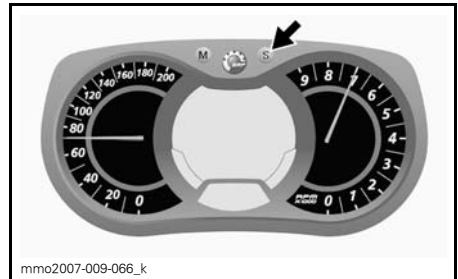

E) Trip Hour Meter

Records vehicle running time when the electrical system is activated since it has been reset.

Press the SET (S) button to select trip hour meter (HrTRIP) mode.

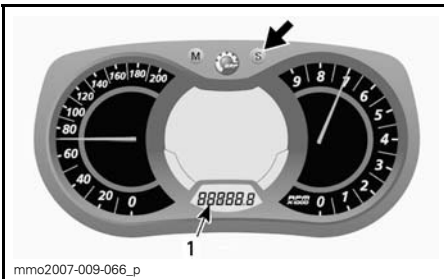

1. Odometer (km/mi) mode

D) Trip Meter A or B

Trip meters records distance travelled since it has been reset.

Press the SET (S) button to select trip meter (TRIP A/TRIP B) mode.

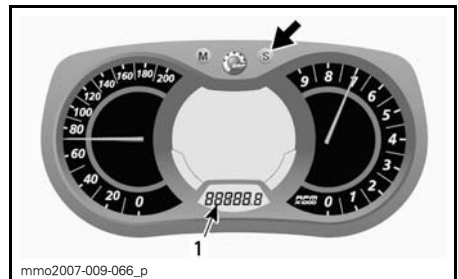

1. Trip hour meter (HrTRIP) mode

Press and hold the SET (S) button to re-set.

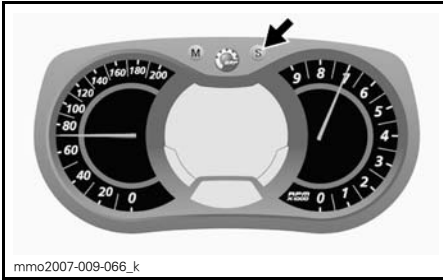

F) Clock (Not available)

G) Fuel Level

Bar gauge that continuously indicates the amount of fuel left in the fuel tank.

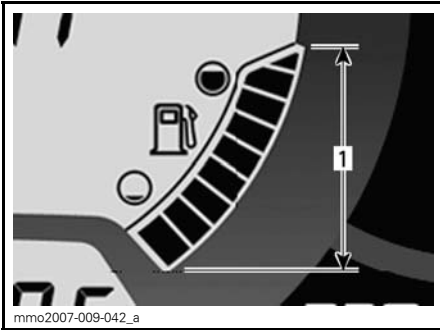

FUEL LEVEL

1. Operating range

H) Altitude

Displays vehicle **approximate** altitude above sea level calculated from the barometric pressure.

NOTE: Altitude displayed is rounded off every 100 meters when set in metric units or 200 feet when set in imperial units.

To display vehicle altitude, proceed as follows.

Press the MODE (M) button to select display 2.



While display is flashing, press the SET (S) button to select altitude mode.

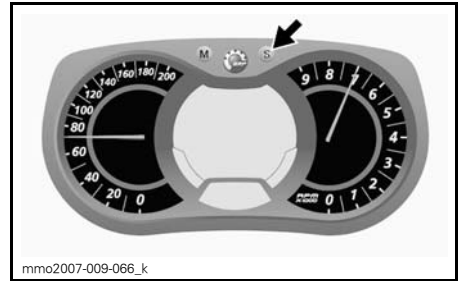

The following symbol appears when altitude mode is selected.



ALTITUDE MODE

Press the MODE (M) button to confirm selection or wait 5 seconds.

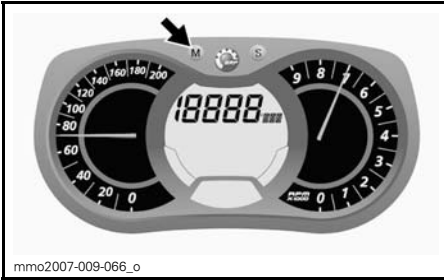

I) Top Speed

Records vehicle top speed since it has been reset.

To display vehicle top speed, proceed as follows.

Press the MODE (M) button to select display 1.

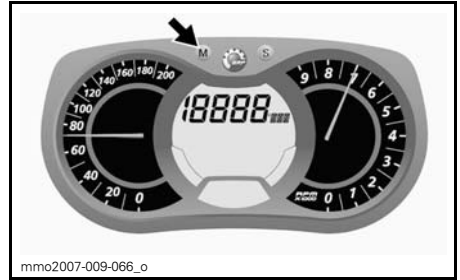

To reset, press the MODE (M) to select mode.

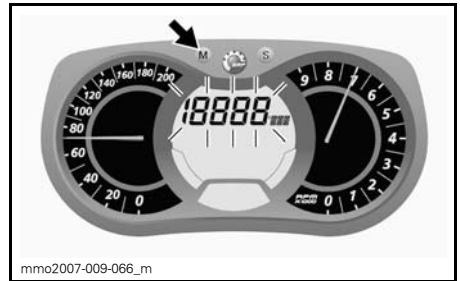
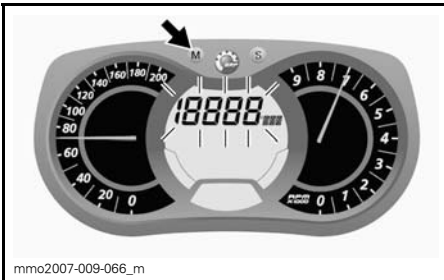

While display flashes, press and hold the SET (S) button within 5 seconds to reset.

While display flashes, press the SET (S) button to select top speed (TOP_SPD) mode.

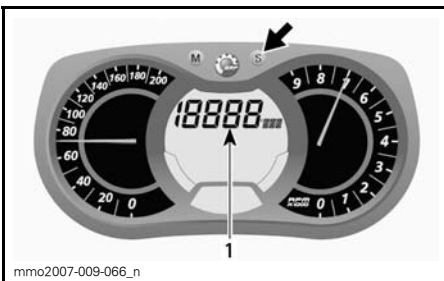
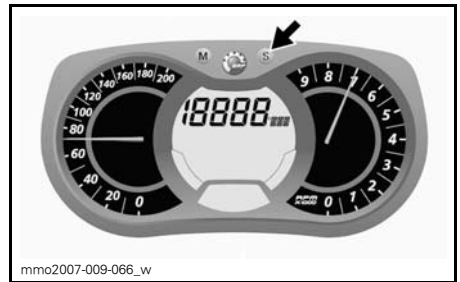

1. Top speed (TOP_SPD) mode

Press the MODE (M) button to confirm selection or wait 5 seconds.

J) Average Speed

Records vehicle average speed since it has been reset.

To display vehicle average speed, proceed as follows.

Press the MODE (M) button to select display 1.



While display flashes, press SET (S) button to select vehicle average speed (AVR_SPD) mode.



While display flashes, press and hold the SET (S) button within 5 seconds to reset.

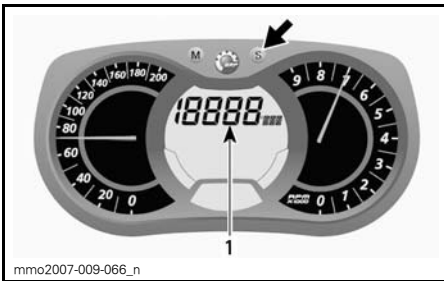

1. Vehicle average speed (AVR_SPD) mode

Press the MODE (M) button to confirm selection or wait 5 seconds.

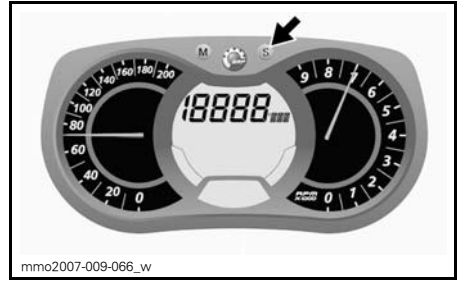

K) Heated Grips Heating Intensity

Bar gauge that indicates heating intensity.

Refer to *HEATED GRIPS SWITCH* for more details.

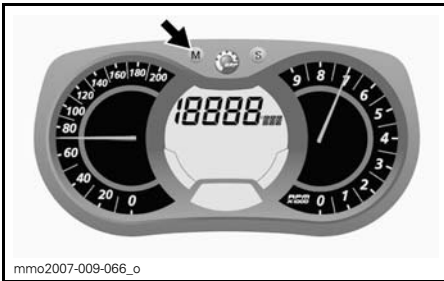

To reset, press the MODE (M) to select mode.

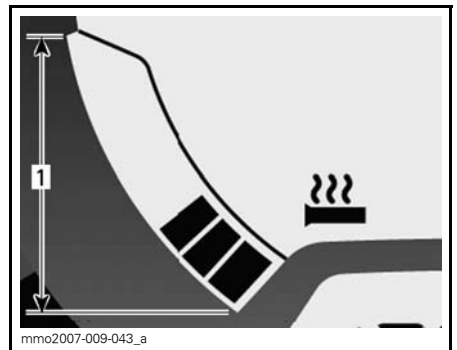

HEATED GRIPS

1. Operating range

L) Heated Throttle Lever Heating Intensity

Bar gauge that indicates heating intensity.

Bar gauge will be displayed instead of the fuel level with the activation of the heated throttle lever switch. When released, display will return to fuel level.

Refer to *HEATED THROTTLE LEVER SWITCH* for more details.

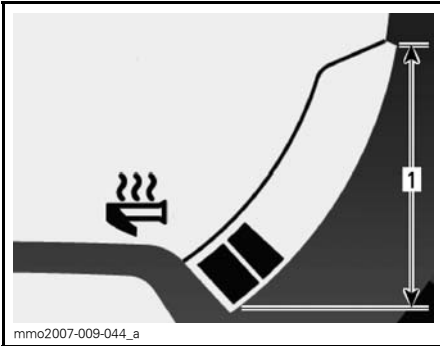

HEATED THROTTLE LEVER
1. Operating range

M) Instant Fuel Consumption

Calculates vehicle average fuel consumption while riding.

To display vehicle average fuel consumption, proceed as follows.

Press the MODE (M) button to select display 1.

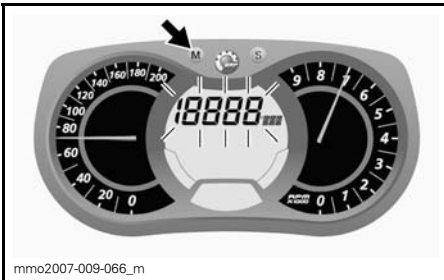

While display flashes, press SET (S) button to select instant fuel consumption mode.

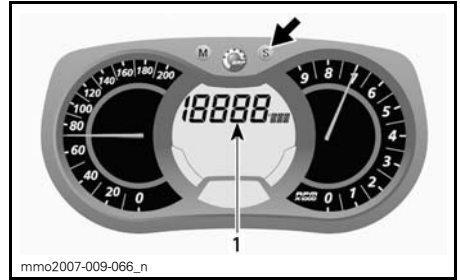

1. Instant fuel consumption mode

Press the MODE (M) button to confirm selection or wait 5 seconds.

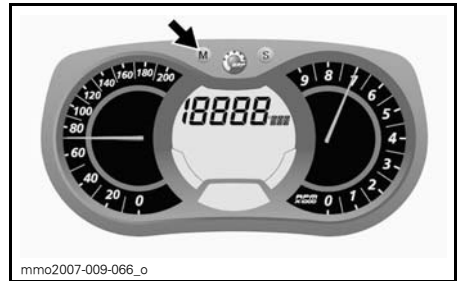

N) Total Fuel Consumption

Records vehicle average fuel consumption since it has been reset.

To display vehicle total fuel consumption, proceed as follows.

Press the MODE (M) button to select display.



While display flashes, press the SET (S) button to select total fuel consumption (TC) mode.

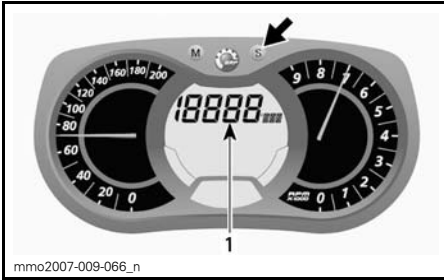

1. Total fuel consumption (TC) mode

TC appears when the mode is selected.

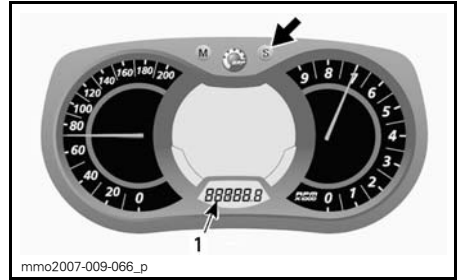

1. Trip meter (TRIP B) mode

Press and hold the SET (S) button to re-set.

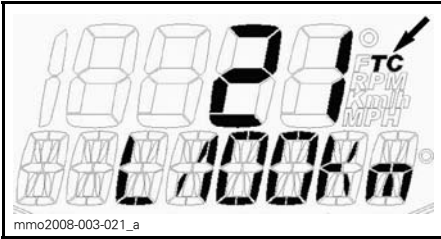

TYPICAL

Press the MODE (M) button to confirm selection or wait 5 seconds.

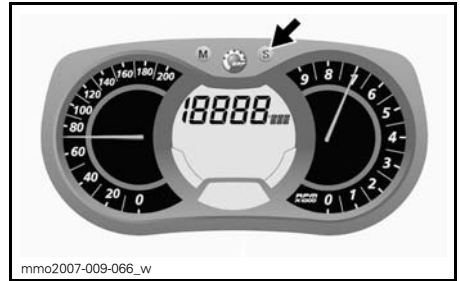

O) Message Display

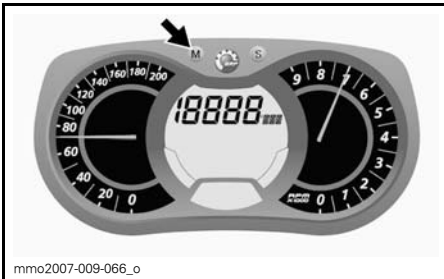

To reset, set the trip meter to TRIP B. Refer to *TRIP METER A OR B* for more details.

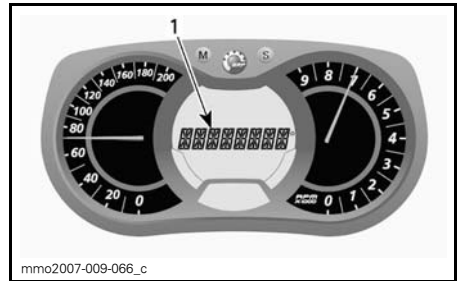

1. Message display

Refer to *PILOT LAMPS AND MESSAGES* in this section for details on usual messages.

Refer to *MONITORING SYSTEM* for details on malfunction and D.E.S.S. related messages.

P) Engine Coolant Temperature

Bar gauge that indicates the engine coolant temperature.

During normal operation, the bars should not exceed approximately the middle of the gauge.

NOTICE If engine overheats, stop vehicle in a safe place. Refer to TROUBLESHOOTING section.

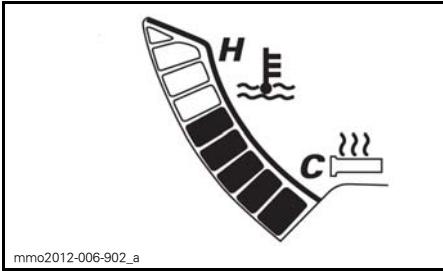

Q) E-TEC Engine Storage Mode

Displays "OIL" when the storage mode procedure is initiated.

R) Lap Record Mode

With this mode, vehicle speed, engine revolutions per minute (RPM) and a preselected function in display 1 can be recorded at the same time during a period of time defined by the operator.

Also, a possibility of nine (9) different sessions (laps) can be recorded for a maximum total of 2.5 minutes.

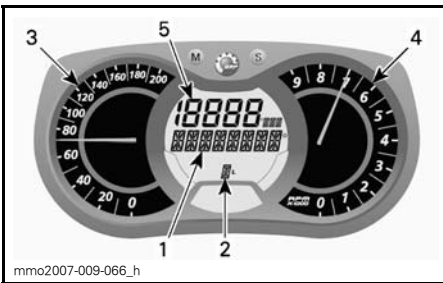

LAP RECORD MODE

1. Lap record mode display
2. Sessions (laps)
3. Vehicle speed
4. Engine revolution per minute (RPM)
5. Preselected function

To Activate Lap Record Mode:

1. Press the SET (S) button to select the odometer mode in display 1.
2. Press and hold SET (S) button for 2 seconds to activate mode, REC will be displayed to indicate that record mode has been selected.



1. Record mode
2. Odometer

3. Press the SET (S) button to scroll between modes.

Available modes are: STOP, REC (record) or PLAY.

To Record:

1. Select REC (record) mode.

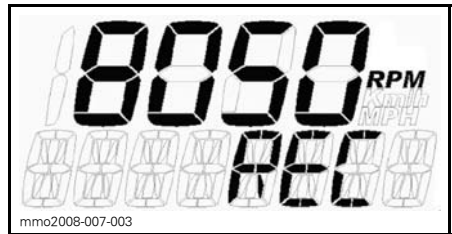

RECORD MODE

2. Press the MODE (M) button to start recording.
3. While recording, press the MODE (M) button again each time you want to record a new lap time (from 1 to 9 laps).

Press the SET (S) button to stop recording.

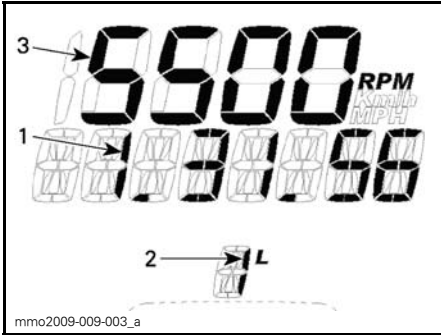
**RECORD MODE**

1. Recording time
2. Lap/session
3. Selected mode

To record another session, press the SET (S) button until REC (record) mode appears in display. Repeat same procedure previously described to record.

To Review Recorded Data:

Select PLAY mode.

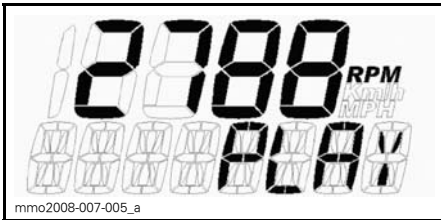
**PLAY MODE**

1. Press the MODE (M) button to play recorded data.

All recorded data (speedometer, tachometer and the preselected mode in display 1) will be displayed at the same time.

2. Press the SET (S) button to stop recorded lap OR press the MODE (M) button to switch to another recorded lap.

NOTE: Pressing the SET (S) button will stop time of the lap in progress, then the display will show the recorded time length of that lap and will switch automatically to the following recorded lap after 5 seconds.

At the end of all recorded laps, STOP will appear in display.

To review recorded data again, press the SET (S) button to return to PLAY mode. Repeat same procedure previously described to review.

To record other laps, press the SET (S) button to switch to REC (record) mode. Repeat same procedure previously described to record.

Press and hold SET (S) button for 5 seconds to exit the lap record mode, the previously selected mode will be displayed.

Gauge Setup**Clock Setting**

NOTE: This clock displays in the 24-hour format only.

Press the SET (S) button to select clock mode.

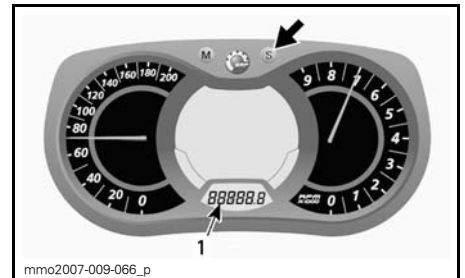

1. Clock mode

Press and hold the SET (S) button to activate clock set-up.

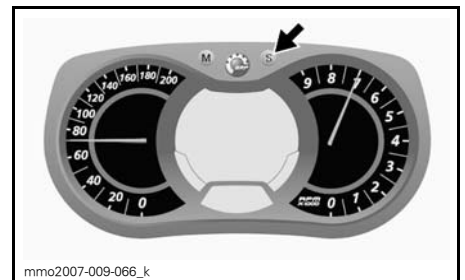

To change HOURS, while the value of HOURS is blinking, use the SET (S) button to change hours.

To change MINUTES, while the value of HOURS is blinking, press the MODE (M) button to switch to minutes. Use the SET (S) button to change minutes.

Press the MODE (M) button to save clock set-up and exit mode.

Unit Selection (KM/H vs MPH)

The units can be set in metric or imperial. Refer to an authorized Lynx dealer.

Language Selection

The gauge display language can be changed. Refer to an authorized Lynx dealer for language availability and setup the gauge to your preference.

13) Drive Belt Guard

Drive Belt Guard Removal

⚠ WARNING

NEVER operate engine:

- Without shields and belt guard securely installed.
- With hood and/or side panels opened or removed.

NEVER attempt to make adjustments to moving parts while engine is running.

NOTE: Belt guard is purposely made slightly oversize to maintain tension on its pins and retainers preventing undue noise and vibration. It is important that this tension be maintained when reinstalling.

Remove tether cord cap from engine cut-off switch.

Open engine compartment LH side panel.

Remove retaining pin.

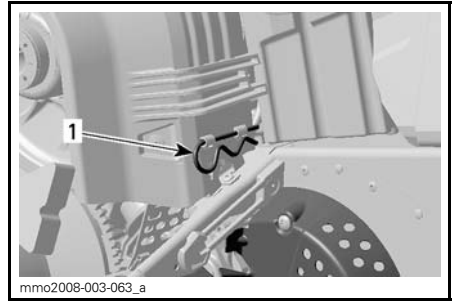

TYPICAL

1. Retaining pin

Lift rear portion of guard then release from front tabs by pivoting the guard outwards.

Drive Belt Guard Installation

When reinstalling belt guard, position its cutaway toward front of snowmobile.

Insert the tab into the slot and push it into place



TYPICAL

1. Tab

Position the grommet over the retaining rod. It may be necessary to slightly lift the console to make room.

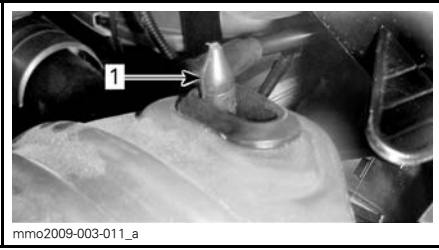

TYPICAL

1. Retaining rod

Position rear portion of the belt guard over the retainer and secure it using the retaining pin.

NOTE: Make sure rear portion of the belt guard is properly positioned on the stopper.



1. Retaining pin

14) Heated Grips Switch (BoonDocker and Rave RE Only)

NOTE: Heated grips are enabled above 2000 engine RPM.

Depress switch as required to select heating intensity to keep your hands at a comfortable temperature.

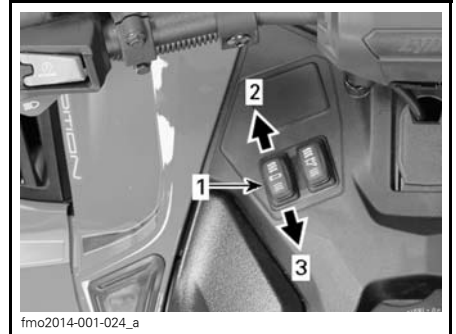

VARIABLE INTENSITY

1. Heated grip switch
2. Increase heat
3. Decrease heat

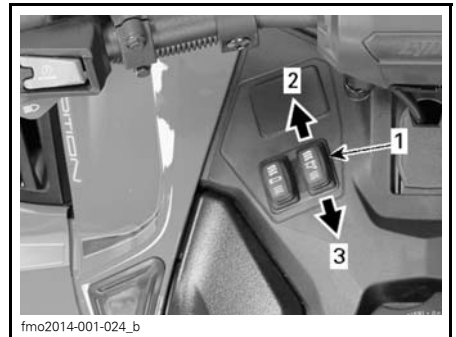

VARIABLE INTENSITY

1. Heated throttle lever switch
2. Increase heat
3. Decrease heat

The heating intensity is displayed via the multifunction display.

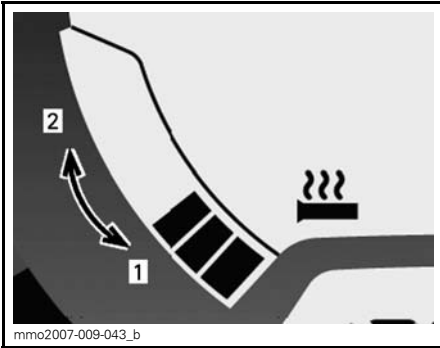

HEATING INTENSITY DISPLAY

1. Less heat
2. More heat

Heated grips will be in OFF position when there are no bars displayed on the gauge.

15) Heated Throttle Lever Switch (BoonDoker and Rave RE Only)

NOTE: Heated throttle lever is enabled above 2000 engine RPM.

Depress switch as required to select heating intensity to keep your thumb at a comfortable temperature.

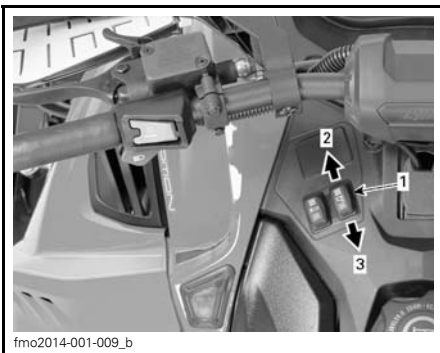

VARIABLE INTENSITY

1. Heated throttle lever switch
2. Increase heat
3. Decrease heat

NOTE: The heating intensity is displayed via the multifunction display with the activation of the throttle lever switch. When released, display will return to fuel tank level.

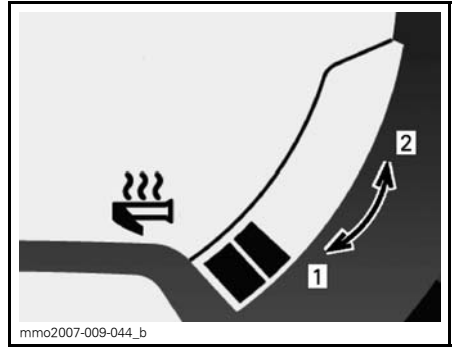

HEATING INTENSITY DISPLAY

1. Less heat
2. More heat

Heated throttle lever will be in OFF position when there are no bars displayed on the gauge.

16) Spare Drive Belt Holder

A spare drive belt can be stored in holder.

NOTE: Spare drive belt is not supplied with the snowmobile.

⚠ CAUTION To avoid damages to the drive belt, ensure that belt does not come in contact with tuned pipe when installed in its support.

Rave RE, Xtrim and BoonDoker models

A spare drive belt can be stored in its holder located on the drive belt guard.

NOTE: The spare drive belt is not supplied with the snowmobile.

Position spare drive belt into drive belt guard slot.

Secure in place by sliding it into the fastener tabs.

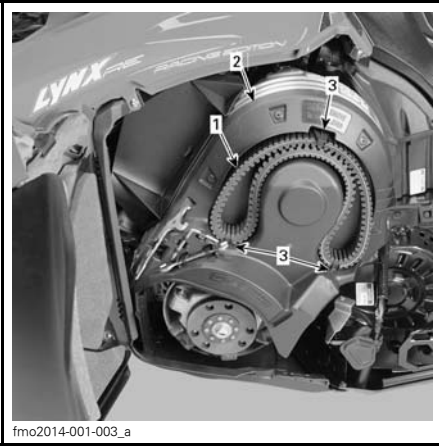

fmo2014-001-003_a

1. Spare drive belt
2. Drive belt guard
3. Fastener tabs

17) Front Storage Compartment

A storage compartment is located at the front of the vehicle, above the gauge.

To open the storage compartment, pull the tab.

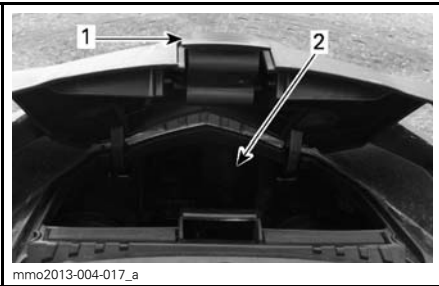

mmo2013-004-017_a

1. Tab
2. Storage compartment

18) Rear Rack

⚠ WARNING

All objects in rear rack must be properly latched. Do not carry any breakable objects. Excessive weight in rack may reduce steering ability.

Rear Rack (LinQ)

Rave RE Model

⚠ CAUTION Always readjust suspension according to the load. The capacity of this rack is limited, the **MAXIMUM** cargo load is 15 kg on LinQ 1. Ride at very low speed when loaded. Avoid speed over bumps.

Xtrim and Boondocker Models

⚠ CAUTION Always readjust suspension according to the load. The capacity of this rack is limited, the **MAXIMUM** cargo load is 15 kg on LinQ 1 + LinQ 2 and the **MAXIMUM** cargo load is 6 kg on LinQ 2. Ride at very low speed when loaded. Avoid speed over bumps.

⚠ WARNING

The **MAXIMUM** cargo load is 15 kg including the storage compartment load. Reduce your speed when carrying a load.



fmo2014-002-007_b

1. Front LinQ
2. Rear LinQ

Total **MAXIMUM** load in both LinQs together is 15 kg. The **MAXIMUM** cargo load is 6 kg on rear LinQ side.

Always load the front LinQ at first if possible. Overloading can cause damage to frame and speed is proportional to the load.

19) Upper Body Module (Hood)

Upper Body Module Removal

1. Remove the gauge.

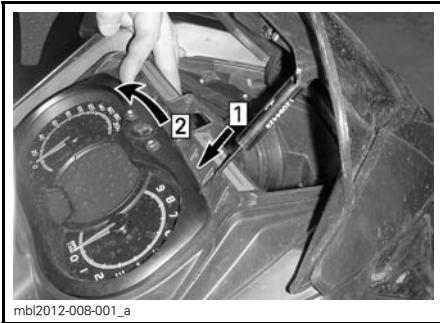

- Step 1: Unlock
Step 2: Tilt

2. Disconnect the gauge connector.
3. Disconnect the headlights connector.

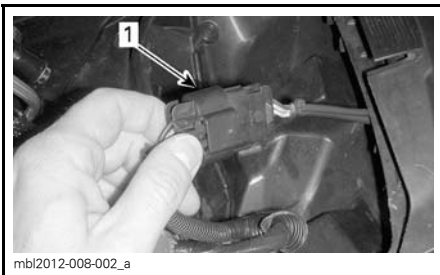

1. Headlights connector

4. Open LH side panel.
5. Remove LH and RH side panels.
6. Remove the drive belt guard.
7. Disconnect the air intake connector tube.

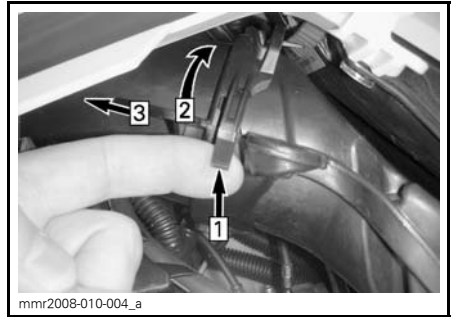

- Step 1: Lift tab
Step 2: Twist tube
Step 3: Pull forward

8. Disconnect air temperature sensor (ATS) on top of connector tube.

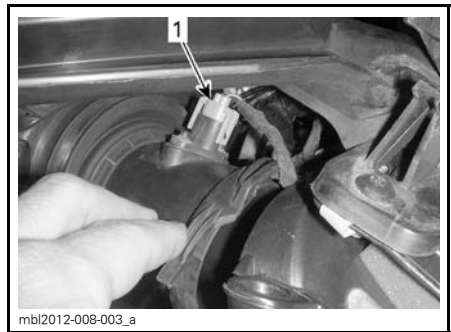

1. ATS connector

9. Open and remove RH side panel.
10. Disconnect the APS hose at the ECM.

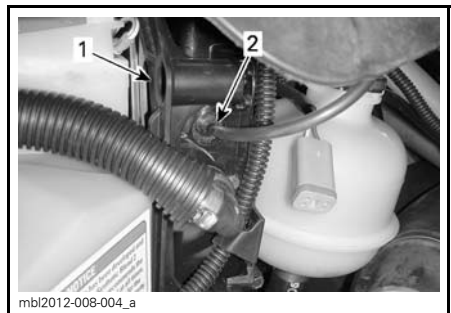

1. ECM
2. APS hose

- Remove the four upper body module retaining screws, three on each side.



RH SIDE SHOWN

- Retaining screws

- Tilt the upper body module 5 degrees up towards the top section and then push it towards the front of the vehicle.

- Remove the upper body module.



SLIDE TOWARDS FRONT

Upper Body Module Installation

- Insert the upper body module tabs into the upper bottom pan openings.



- Upper body module tab
- Upper bottom pan opening

- Slide the module towards rear.



TYPICAL - SLIDE TOWARDS REAR

- On both sides, install the upper body module retaining screws.



RH SIDE SHOWN

- Retaining screws

4. Connect:
 - APS hose on the ECM
 - Headlights connector
 - Gauge connector
 - Air temperature sensor (ATS)
 - Air intake connector tube.
5. Install:
 - Gauge
 - Drive belt guard.

20) Holding Strap

BoonDocker Series

Holding strap provides a grip for operator when side-hilling.

⚠ WARNING

This strap is not for towing, lifting or other purpose than temporary use as a grab handle during side-hilling. Always keep at least one hand on handlebar.

21) Side Panels

To open a side panel, push the buttons.

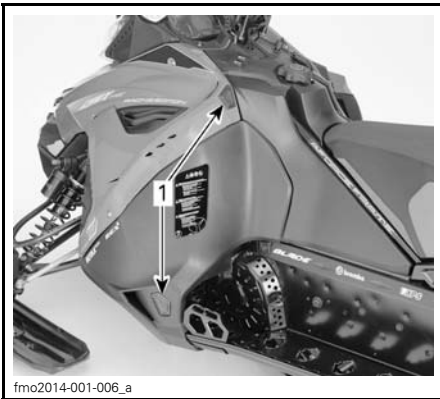

fmo2014-001-006_a

TYPICAL

1. Buttons

To close a side panel, set firmly on the stud location and push side panel locks to make sure it is secured.

Make sure lower front edge of the side panel goes to its right place and side panel is align.



fmo2014-002-023_a

To remove a side panel, open it then lift it up. Free the lower hinge from its slot, then free the upper hinge by lowering the panel.

To install a side panel, insert the upper hinge and then the lower hinge.

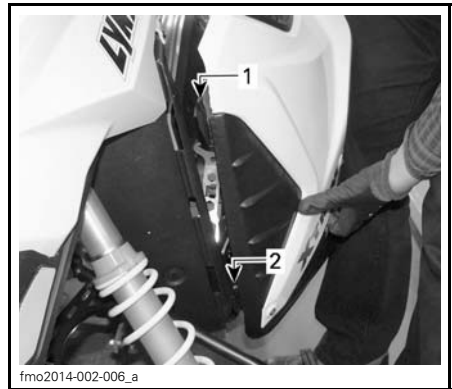

fmo2014-002-006_a

1. Upper hinge
2. Lower hinge

Close the side panel.

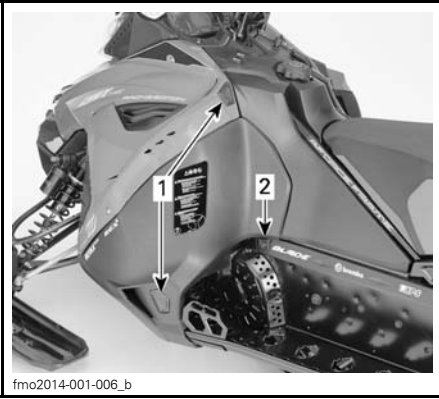

fmo2014-001-006_b

TYPICAL

1. Buttons
2. Stud location

⚠ WARNING

Never operate engine with side panels opened or removed from vehicle.

22) Fuses

The electrical system is protected with fuses, refer to *MAINTENANCE* for details.

The fuse holders are located in the engine compartment.

⚠ CAUTION Do not use a higher rated fuse as this can cause severe damage to electrical components and/or be a potential fire.

⚠ WARNING

If fuse has burnt out, source of malfunction should be determined and corrected before restarting. See an authorized LYNX dealer for servicing.

All Engines

Manual Start



mno2007-009-017_b

RH SIDE OF ENGINE COMPARTMENT

1. Fuse location

Electric Start

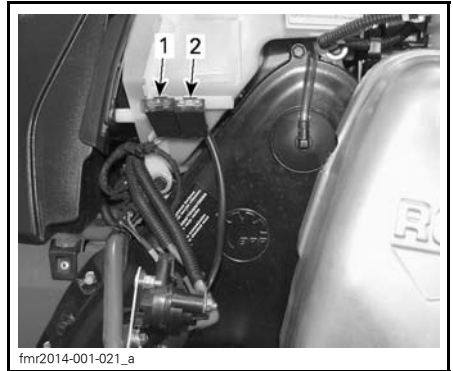

fmr2014-001-021_a

RH SIDE OF ENGINE COMPARTMENT

1. Charging fuse
2. START/RER fuse

23) Seat Latch

Located under the seat.



1. Seat Latch

Seat Removal

Remove the storage/battery compartment cover.



Remove the seat by pulling and lifting at the same time.



NOTICE Pull the handle upwards when removing the seat.



Seat Installation

Push the seat until you hear a clicking sound.



Attach the battery cover back to its place.



Finish the installation by locking the battery cover.



fsl2013-010-003_a

NOTE: Ensure that the seat is secured properly.

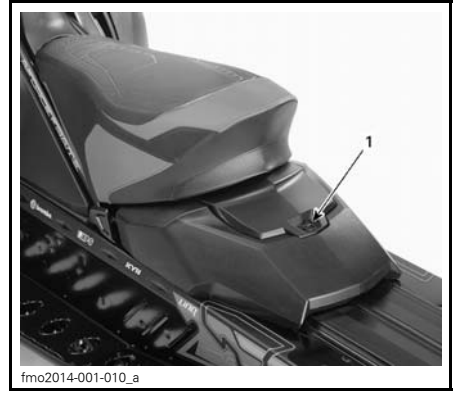

fmo2014-001-010_a

STORAGE COMPARTMENT
1. Quarter-turn fastener

Close cover and turn quarter-turn fastener clockwise to secure it.

Models with Electric Start



fmo2015-001-022_b

24) Storage / Battery Compartment

NOTICE MAXIMUM load is 1.8 kg evenly distributed.

Turn quarter-turn fastener counter-clockwise to release it and open cover.



fmo2014-001-007

BATTERY COMPARTMENT

25) Front and Rear Bumpers

To be used whenever snowmobile requires manual lifting.

CAUTION Beware of injuries by using proper lifting techniques, notably using your legs force. Do not attempt to lift the rear of vehicle if it is above your limits. Use appropriate lifting device or have assistance to share lifting stress if possible.

⚠ WARNING

Do not attempt to lift the vehicle by hand alone. Use appropriate lifting device or have assistance to share lifting stress in order to avoid risk of strain injuries.

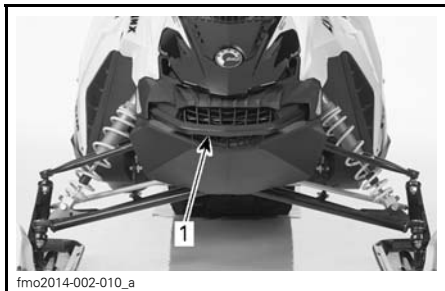

fmo2014-002-010_a

FRONT

1. Front bumper

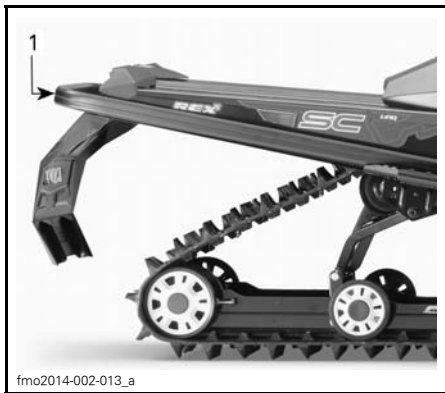

fmo2014-002-013_a

REAR

1. Rear bumper

⚠ CAUTION Do not use ski handles to pull or lift snowmobile.

26) Brake disc guard

⚠ WARNING

This guard must ALWAYS be in place when engine is running.

27) Anti-Sway Bar Quick Disconnect Link

BoonDocker DS/RE 800 E-TEC Series

The quick disconnect link of the anti-sway bar is located on the RH side. Manually remove the quick disconnect link to improve handling for side hilling and deep powder snow.

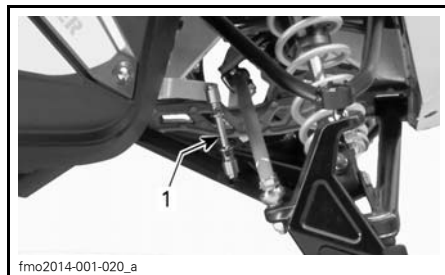

fmo2014-001-020_a

TYPICAL

1. Quick disconnect

⚠ WARNING

Trail riding without this link connected to the anti-sway bar will increase the risk of losing control of the snowmobile. Always reconnect this link to the anti-sway bar when trail riding. To do so, vehicle must be parked in a safe place, away from the trail.

28) Electronic Damping Control (LEDC)

Rave RE

The operator can adjust damping force by Electronic Damping Control (LEDC). Refer to *REAR SUSPENSION ADJUSTMENT* in the *TUNE YOUR RIDE* section

29) Ice Scratchers (BoonDocker DS)

Ice scratchers are equipped on the vehicle to increase cooling efficiency when riding on ice or hard packed snow..

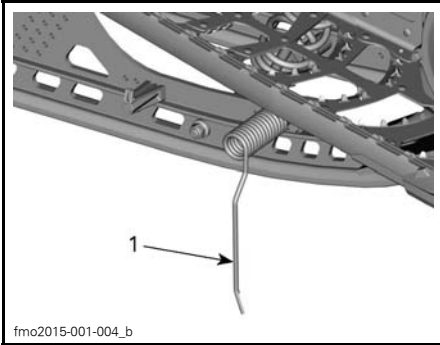

fmo2015-001-004_b

TYPICAL - PARTS REMOVED FOR CLARITY

1. Ice scratcher in active position

When not in use, ice scratchers should be stowed.

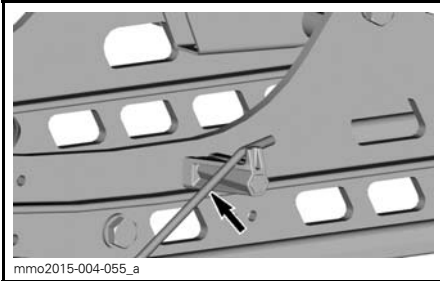

mmo2015-004-055_a

ICE SCRATCHER IN STOWED POSITION

NOTE: When storing vehicle inside, make sure ice scratchers are stowed properly.

⚠ CAUTION When vehicle is stuck, make sure ice scratchers are stowed and secured properly before attempting to free vehicle.

30) Hitch

Xtrim SC Model

Use the hitch in conjunction with a tow bar to tow an accessory.

NOTE: Refer to decal on vehicle for towing weight capacities.

⚠ WARNING

Never tow an accessory with a rope. Always use a rigid tow bar. Using a rope would result in a collision between the object and the snowmobile and possibly in a tip over in case of a rapid deceleration or on a downward slope.

Hitch ("J" Type)

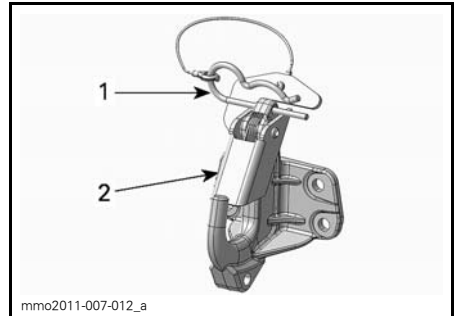

mmo2011-007-012_a

1. Hairpin clip
2. Safety tab

Attaching an Equipment

1. Remove the hairpin clip.
2. Align accessory attachment hole with the hitch hook.
3. Push the accessory attachment passed the safety tab.
4. Secure safety tab using the hairpin clip.

Detaching an Equipment

1. Remove the hairpin clip.
2. Push safety tab forward to free accessory attachment from the hitch.
3. Detach accessory attachment.

4. Install hairpin clip.

Hitch (Tongue Type)

To attach an equipment to the hitch, secure the accessory tow bar to the hitch tongue using a lockable pin.

FUEL

Fuel Requirements

NOTICE Always use fresh gasoline. Gasoline will oxidize; the result is loss of octane, volatile compounds, and the production of gum and varnish deposits which can damage the fuel system.

Alcohol fuel blending varies by country and region. Your vehicle has been designed to operate using the recommended fuels, however, be aware of the following:

- Use of fuel containing alcohol above the percentage specified by government regulations is not recommended and can result in the following problems in the fuel system components:
 - Starting and operating difficulties.
 - Deterioration of rubber or plastic parts.
 - Corrosion of metal parts.
 - Damage to internal engine parts.
- Inspect frequently for the presence of fuel leaks or other fuel system abnormalities if you suspect the presence of alcohol in gasoline exceeds the current government regulations.
- Alcohol blended fuels attract and hold moisture which may lead to fuel phase separation and can result in engine performance problems or engine damage.

Recommended Fuel

Use unleaded gasoline containing MAXIMUM 10% ethanol. The gasoline must have the following minimum octane requirements.

FUEL TYPE	ENGINE	MINIMUM OCTANE RATING
Fuel which may contain up to 10% MAX ethanol	600 HO E-TEC 800R E-TEC	95 E10

NOTICE Use octane rating according to fuel type. Never experiment with other fuels. Engine or fuel system damages may occur with the use of an inadequate fuel.

⚠ WARNING

Always stop the engine before refueling. Fuel is flammable and explosive under certain conditions. Always work in a well ventilated area. Do not smoke or allow open flames or sparks in the vicinity. Open cap slowly. If a differential pressure condition is noticed (whistling sound heard when loosening fuel tank cap) have vehicle inspected and/or repaired before further operation. Do not overfill or top off the fuel tank before placing the vehicle in a warm area. As temperature increases, fuel expands and might overflow. Always wipe off any fuel spillage from the vehicle. Periodically verify fuel system.

Fuel Antifreeze Additives

When using oxygenated fuel, additional gas line antifreeze or water absorbing additives are not required and should be not used.

When using non-oxygenated fuel, isopropyl base gas line antifreeze can be used in a proportion of 150 ml of gas line antifreeze added to 40 L of gas.

This precaution is in order to reduce the risk of frost buildup in carburetors or other fuel system components which may lead, in certain cases, to severe damage to engine.

NOTE: Use only methyl hydrate free gas line antifreeze.

Vehicle Fueling Procedure

⚠ WARNING

- Fuel is flammable and explosive under certain conditions.
- Never use an open flame to check fuel level.
- Never smoke or allow flame or spark in vicinity.
- Always work in a well-ventilated area.

1. Stop engine.

⚠ WARNING

Always stop engine before refueling.

2. Have operator and passenger get off vehicle.

⚠ WARNING

Do not allow anyone seated on the vehicle while fueling.

3. Unscrew slowly the fuel reservoir cap counterclockwise to remove it.

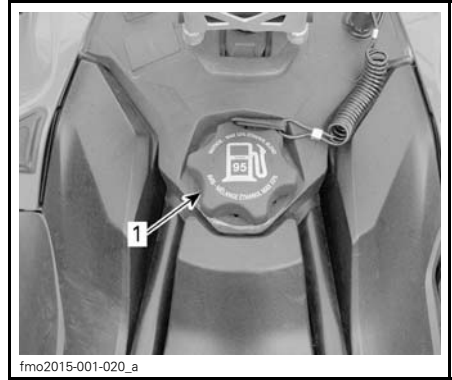

TYPICAL
1. Fuel tank cap

⚠ WARNING

If a differential pressure condition is noticed (whistling sound heard when loosening fuel reservoir cap) have vehicle inspected and/or repaired before further operation.

4. Insert the spout into the filler neck.
5. Pour fuel slowly so that air can escape from the tank and prevent fuel flow back. Be careful not to spill fuel.
6. Stop filling when the fuel reaches the bottom of filler neck. Do not overflow.

⚠ WARNING

Never top up the fuel tank before placing the vehicle in a warm area. As temperature increases, fuel expands and may overflow.

7. Fully tighten fuel reservoir cap clockwise.

⚠ WARNING

Always wipe off any fuel spillage from the vehicle.

NOTE: Do not sit or lean on seat when fuel tank cap is not properly installed.

INJECTION OIL

Recommended Injection Oil

E-TEC Models

RECOMMENDED INJECTION OIL	
ENGINES	XPS SYNTHETIC 2-STROKE OIL (P/N 619 590 106)
600 HO E-TEC	✓
800R E-TEC	✓

NOTICE The engine of this snowmobile has been developed and validated using the recommended BRP XPS™ oil. BRP strongly recommends the use of its recommended XPS oil at all times. Damages caused by oil which is not suitable for the engine will not be covered by the BRP limited warranty.

Injection Oil Level Verification

The injection oil reservoir is located behind the RH side panel. See *BODY* in *MAINTENANCE PROCEDURES* for opening procedure.

Always maintain a sufficient amount of recommended injection oil in the injection oil reservoir.

NOTICE Check level and refill every time you refuel.

NOTE: Do not exceed the maximum level tab in the oil tank neck.

Reinstall cap and fully tighten.

NOTICE Do not mismatch oil reservoir cap with fuel tank cap.

⚠ WARNING

Wipe off any oil spills. Oil is highly flammable when heated.

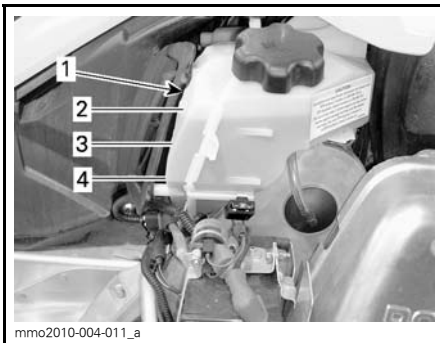

1. Oil reservoir
2. 3/4 level
3. 1/2 level
4. 1/4 level

To Add Injection Oil

Remove injection oil reservoir cap.

Add injection oil.

BREAK-IN PERIOD

Operation During Break-In

⚠ CAUTION A break-in period of 10 operating hours — 500 km (300 miles) — is required before running the snowmobile at full throttle.

After the break-in period, the vehicle should be inspected by an authorized Lynx dealer. Refer to *MAINTENANCE* section.

During break-in period, maximum throttle should not exceed 3/4 opening. However, brief full acceleration and speed variations contribute to a good break-in.

⚠ CAUTION Engine overheating, continued wide open throttle runs and prolonged cruising without speed variations should be avoided, this can cause engine damage during the break-in period.

Engine

During the break-in period:

- Avoid prolonged full throttle operation.
- Avoid sustained accelerations.
- Avoid prolonged cruising speeds.
- Avoid engine overheating.

However, brief accelerations and speed variations contribute to a good break-in.

During the first few hours of break-in, the engine management system controls some engine parameters which will slightly reduce the engine performance.

During a predetermined period, the engine management system controls some engine parameters.

The duration is based on fuel volume. It will take approximately two fuel tanks to complete the break-in.

During this period:

- The engine performance and behavior will not be optimal.
- The fuel and oil consumption will be higher.

Drive Belt

A new drive belt requires a break-in period of 50 km . Avoid strong acceleration/deceleration, pulling a load or high speed cruising.

During the break-in period:

- Avoid strong acceleration and deceleration.
- Avoid pulling a load.
- Avoid high speed cruising.

10-Hour Inspection

NOTE: The 10-hour inspection is at the expense of the snowmobile owner.

As with any precision piece of mechanical equipment, we suggest that after the first 10 hours of operation or 500 km, whichever comes first, your snowmobile be checked by an authorized LYNX dealer. This inspection will also give you the opportunity to discuss the unanswered questions you may have encountered during the first hours of operation.

BASIC PROCEDURES

Engine Starting Procedure

Procedure

1. Apply parking brake.
2. Recheck throttle control lever operation.
3. Put your helmet on.
4. Ensure that the tether cord cap (DESS key) is in position and that the cord is attached to your clothing eyelet.
5. Ensure that the engine cutout switch is in the ON position.
6. Start engine as explained below.

WARNING

Never depress throttle while starting engine.

Manual Start E-TEC Models

Grab rewind starter handle, pull handle slowly until a resistance is felt, then hold handle firmly and pull vigorously to start engine.

WARNING

Do not apply throttle while starting.

Electric Start E-TEC models

Depress the START/RER button to engage the electric starter and start the engine.

Release button immediately when engine has started.

WARNING

Do not apply throttle while starting.

 **CAUTION** Do not use electric starter for more than 10 seconds. A rest period should be observed between the cranking cycles to let electric starter cool down. Using electric starter when engine has started could damage electric starter mechanism.

NOTE: If for any reason, the engine cannot be cranked electrically, start engine manually using the rewind starter.

7. Release parking brake.

NOTE: For an initial cold start, do not release parking brake. Perform the *VEHICLE WARM-UP* procedure as explained below.

Vehicle Warm-Up

Before every ride, vehicle has to be warmed up as follows.

1. Start engine as explained in *ENGINE STARTING PROCEDURE* above.
2. Allow engine to warm up one or two minutes at idle speed.

NOTE: Engine will shut down after approximately 12 minutes of idling.

3. Disengage parking brake.
4. Apply throttle until drive pulley engages. Drive at low speed the first two or three minutes.

NOTICE If vehicle does not move when throttle is applied, stop engine, remove tether cord cap from the engine cut-off switch, then do the following.

- Check if skis are stuck on the ground. Lift one ski at a time by the handle, then put it down.
- Check if track is stuck on the ground. Lift rear of snowmobile enough to clear track from the ground, then drop.
- Check rear suspension for hard snow or ice accumulation that could interfere with track rotation. Clean the area.

⚠ CAUTION Beware of injuries by using proper lifting techniques, notably using your legs force. Do not attempt to lift the rear of vehicle if it is above your limits.

⚠ WARNING
 Make sure tether cord cap is removed before standing in front the vehicle, getting close to the track or rear suspension components.

NOTE: On E-TEC models, warm-up is electronically controlled. During this period (up to 10 minutes depending on ambient temperature), engine RPM is limited.

Engaging Reverse (RER)

When the engine is running, depressing the RER button will slow down engine RPM to almost a stop and advance the ignition timing to cause direction change in crankshaft rotation.

- Engine will automatically shift into forward when re-starting after stopping or stalling.
- Shifting procedure will take place only when the engine is running.
- If engine is running at a speed above 4300 RPM, the reverse function of the RER button is cancelled.
- It is recommended to warm up the engine to its normal operating temperature before shifting.

Shifting in Reverse

1. Bring vehicle to a complete stop.
2. Apply and hold brake. Remain seated, refer to *RIDER POSITION (REVERSE OPERATION)* for posture information.
3. With engine at idle speed, press and release the RER button.
4. Wait until reverse beeper sounds, then gently depress throttle lever.

⚠ WARNING
 Engaging to reverse mode on these snowmobiles is done by depressing the RER button when the engine is running. Wait until the reverse alarm sounds and the RER pilot lamp comes on in the dash before operating throttle to proceed in reverse. The reverse speed of these snowmobiles is not limited. Always proceed with caution as fast reverse could result in loss of vehicle stability. Come to complete stop before depressing RER button. Always remain seated and apply the brake before shifting. Ensure the path behind is clear of obstacles or bystanders before proceeding.

With the snowmobile completely stopped and engine running at idle, press and release the RER button.

The RER pilot lamp will blink when the snowmobile is engaged in reverse.

Apply throttle slowly and evenly. Allow drive pulley to engage then accelerate carefully.

Shifting in Forward

1. Bring vehicle to a complete stop.
2. Apply and hold brake.
3. Press and release the RER button. RER pilot lamp will stop.
4. RER pilot lamp will stop.
5. Apply throttle slowly and evenly. Allow drive pulley to engage then accelerate carefully.

Shutting Off the Engine

Release throttle lever and wait until engine has returned to idle speed.

Shut off the engine using either engine cut-out switch or tether cord cap (DESS key) engine cut-out switch.

 WARNING

Always remove the tether cord cap (DESS key) when vehicle is not in operation in order to prevent accidental engine starting or to avoid unauthorized use by children or others or theft.

Post-Operation Care

Shut off the engine. Install rear of vehicle on a wide-base snowmobile mechanical stand.

Remove snow and ice from rear suspension, track, front suspension, steering mechanism and skis.

Always cover your snowmobile when leaving it outside overnight or during extended periods of inactivity. This will protect it from frost and snow as well as help retain its appearance.

SPECIAL OPERATING INSTRUCTIONS

Riding at High Altitudes

⚠ CAUTION Failure to re-calibrate may cause serious engine damage.

Refer to an authorized LYNX dealer..

Riding in Cold Weather

The engine management of these engines provides the optimum air/fuel ratio for all temperatures.

Refer also to *RIDING AT HIGH ALTITUDES OR SEA LEVEL*.

Emergency Starting

The engine can be started with the emergency starter rope supplied with the tool kit.

Remove belt guard.

⚠ WARNING

Do not wind starting rope around your hand. Hold rope by the handle only. Do not start the snowmobile by the drive pulley unless it is a true emergency situation. Have the snowmobile repaired as soon as possible.

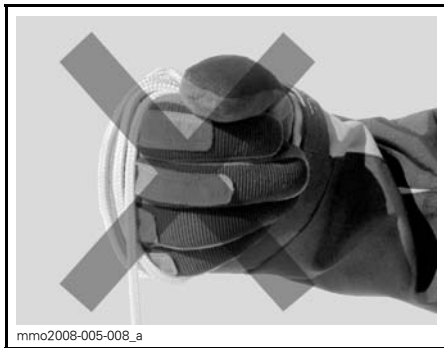

Attach one end of emergency rope to rewind handle.

NOTE: The spark plug socket can be used as an emergency handle.

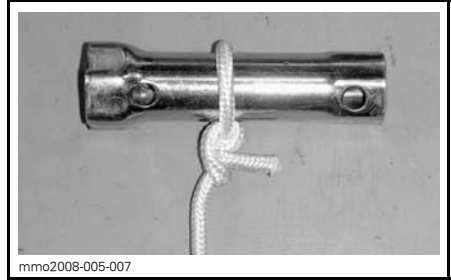

Attach the other end of emergency rope to the starter clip supplied in the tool kit.

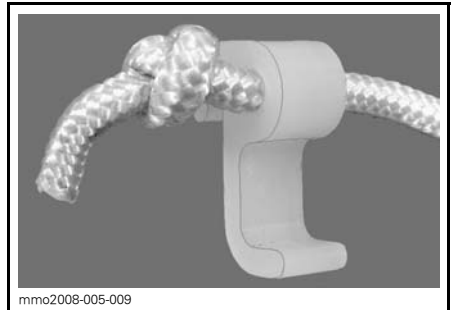

Hook up clip on drive pulley.

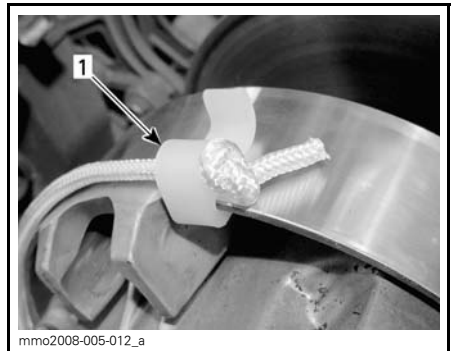

1. Clip installation location

Wind the rope tightly around drive pulley. When pulled, pulley must rotate counterclockwise.

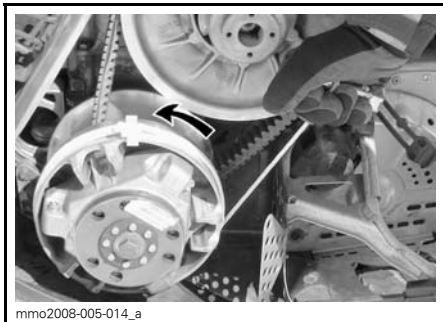

Pull the rope using a sharp, crisp pull so the rope comes free of the drive pulley. Start engine as per usual manual starting.

⚠ WARNING

When starting the snowmobile in an emergency situation, using drive pulley, do not reinstall the belt guard and return slowly to have snowmobile repaired.

Towing an Accessory

Always use a rigid tow bar to tow an accessory. Any towed accessory should have reflectors on both sides and at the rear. Check local laws for brake light(s) requirements.

⚠ WARNING

Never tow an accessory with a rope. Always use a rigid tow bar. Using a rope would result in a collision between the object and the snowmobile and possibly in a tip over in case of a rapid deceleration or on a downward slope.

Towing Another Snowmobile

If a snowmobile is disabled and must be towed use a rigid tow bar, remove the drive belt from disabled snowmobile and tow at moderate speed.

⚠ CAUTION Always remove the drive belt of the snowmobile that is to be towed to prevent damage to its belt and drive system.

In an emergency situation only, if a rigid tow bar is not available, a rope can be used provided you proceed with extra caution. In some areas, it may be illegal to do so. Check with state or local authorities.

Remove the drive belt, attach the rope to the ski legs (spindles), have someone sit on the towed snowmobile to activate the brake, and tow at low speed.

⚠ CAUTION In order to prevent damage to the steering system, never attach the tow rope to the ski loops (handles).

⚠ WARNING

Never ride at high speed when towing a disabled snowmobile. Proceed slowly with extra caution.

Transporting the Vehicle

Make sure that oil reservoir and fuel tank caps are properly installed.

Tilt bed trailers can easily be equipped with a winch mechanism to afford maximum safety in loading. Simple as it may seem, never drive your snowmobile onto a tilt bed trailer or any other kind of trailer or vehicle. Many serious accidents have resulted from driving up and over a trailer. Anchor your vehicle securely, front and rear, even on short hauls. Be certain all equipment is securely fastened. Cover your snowmobile when trailering to prevent road grime from causing damage.

Be certain your trailer meets state or provincial requirements. Ensure the hitch and safety chains are secure and the brake, turn indicators and clearance lights all function.

TUNE YOUR RIDE

Snowmobile handling and comfort depend upon suspension adjustments.

⚠ WARNING

Suspension adjustment could affect vehicle handling. Always take time to familiarize yourself with the vehicle's behavior after any suspension adjustment have been made. Always adjust LH and RH suspension components to the same setting.

Choice of suspension adjustments vary with carrying load, operator's weight, personal preference, riding speed and field condition.

NOTE: Some adjustments may not apply to your snowmobile.

⚠ WARNING

Before proceeding with any suspension adjustment, remember:

- Park in a safe place.
- Remove the tether cord cap from the engine cut-off switch.
- Use appropriate lifting device or have assistance to share lifting stress. If a lifting device is not used, use proper lifting techniques, notably using your legs force.
- Do not attempt to lift the front or rear of vehicle if it is above your limits.
- Support front of vehicle off the ground with a suitable device before adjusting suspension.
- Support rear of vehicle off the ground with a wide-base snowmobile stand with a rear deflector panel.
- Make sure support device is stable and secure.

The best way to set up the suspension is to customize each adjustment one at a time. Various adjustments

are interrelated. It may be necessary to readjust center spring after adjusting front springs for instance. Test run the snowmobile under the same conditions; trail, speed, snow, operator riding position, etc. Proceed methodically until you are satisfied.

Following are guidelines to fine-tune suspension. Use suspension adjustment tool provided in the tool kit.

Rear Suspension Adjustments

Rave std, Xtrim SC

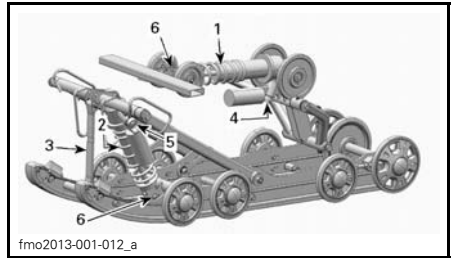

TYPICAL PPS 3300- ADJUSTABLE COMPONENTS

1. Rear spring
2. Center spring
3. Stopper strap
4. Rear shock - Damping strength
5. Center Shock - Damping strength
6. Rebound strength adjustment

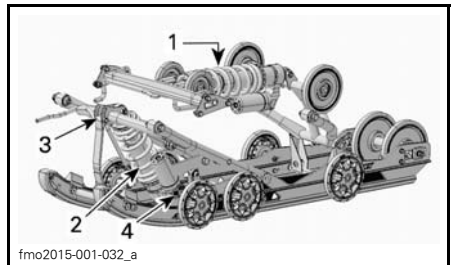

PPS3300 - ADJUSTABLE COMPONENTS

1. Rear spring
2. Center spring
3. Stopper strap
4. Electronic Damping (EDC)

BoonDocker 600R E-TEC Models

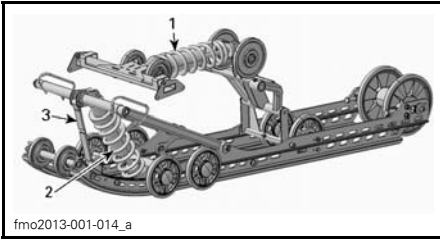

fmo2013-001-014_a

PPS3900 - ADJUSTABLE COMPONENTS

1. Rear spring
2. Center spring
3. Stopper strap

BoonDocker 800R E-TEC Models

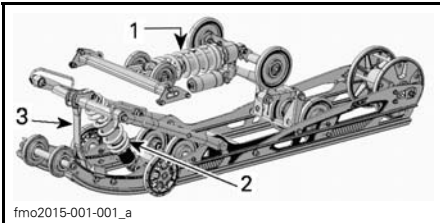

fmo2015-001-001_a

PPS2 3700/3900 - ADJUSTABLE COMPONENTS

1. Rear spring
2. Center spring
3. Stopper strap

NOTICE Whenever adjusting rear suspension, check track tension and adjust if necessary.

Stopper Strap Length

Stopper strap length has an effect on the amount of weight the center spring has to carry especially during acceleration, therefore on the front end uplift.

Stopper strap length also has an effect on center spring travel.

NOTICE Whenever stopper strap length is changed, track tension must be checked.

ACTION	RESULT
Increasing stopper strap length	Lighter ski pressure under acceleration
	More center spring travel
	More bump absorption capability
Decreasing stopper strap length	Heavier ski pressure under acceleration
	Less center spring travel
	Less bump absorption capability

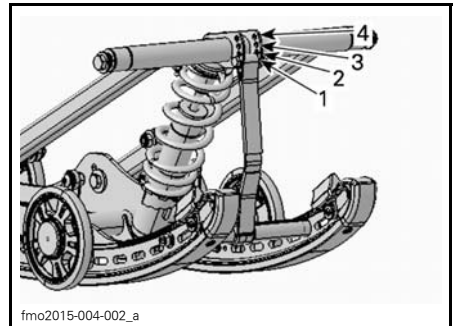

fmo2015-004-002_a

TYPICAL

1. Position 1 (longest)
2. Position 2
3. Position 3
4. Position 4

NOTE: Decreasing the stopper strap length may reduce comfort.

When operating the snowmobile in deep snow or hill climbing, it may be necessary to vary stopper strap length and/or riding position, to change the angle at which the track rides on the snow. Operator's familiarity with the various adjustments as well as snow conditions will dictate the most efficient combination.

Generally, a longer stopper strap setting gives better performance in deep snow on a flat landscape and a shorter setting will improve handling in steep hill climbing conditions.

Center Spring

Center spring preload has an effect on steering effort, handling and bump absorption.

Also, since center spring preload adjustment puts more or less pressure on the front of the track, it has an effect on the performance in deep snow.

ACTION	RESULT
Increasing preload	Lighter steering
	More bump absorption capability
	Better deep snow starts
	Better deep snow performance and handling
Decreasing preload	Heavier steering
	Less bump absorption capability
	Better trail handling

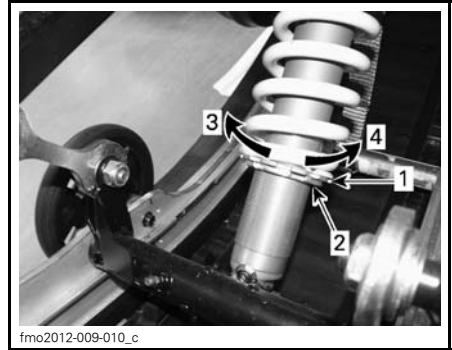

TYPICAL - RING TYPE (INCREASE PRELOAD OR DECREASE PRELOAD)

1. Spring preload adjustment ring
2. Spring preload adjustment lock ring
3. Increase preload
4. Decrease preload

NOTE: For cam type or ring type preload adjuster, use the suspension adjustment tool provided in the tool kit.

Rear Spring

Rear spring preload has an effect on comfort, ride height and load compensation.

Also, adjusting rear spring preload shifts more or less weight to the snowmobile front end. As a result, more or less weight is applied to the skis. This has an effect on performance in deep snow, steering effort and handling.

Slight suspension bottoming occurring under the worst riding conditions indicates a good choice of spring preload.

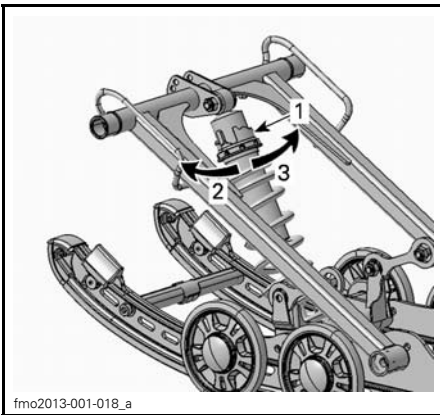

CAM TYPE - HPG™ SHOCK ABSORBER

1. Spring preload adjustment cam
2. Decrease preload
3. Increase preload

ACTION	RESULT
Increasing preload	Firmer rear suspension
	Higher rear end
	More bump absorption capability
	Heavier steering
	(Rear suspension): Better sidehilling on deep snow
Decreasing preload	Softer rear suspension
	Lower rear end
	Less bump absorption capability
	Lighter steering
	Better deep snow performance and handling
	Better deep snow performance and handling for flat land riding

"C"	WHAT TO DO
50 to 75 mm (2 to 3 in)	No adjustment required
More than 75 mm (3 in)	Adjusted too soft, increase preload
Less than 50 mm (2 in)	Adjusted too firm, decrease preload

NOTE: If the specification is unattainable with the original springs, see an authorized Lynx dealer for other available springs.

Refer to the following to determine if preload is correct.

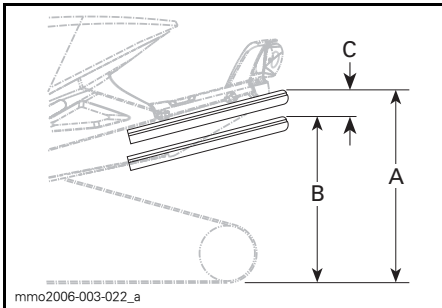

TYPICAL — PROPER ADJUSTMENT

- A. Suspension fully extended
- B. Suspension has collapsed with operator, passenger and load added
- C. Distance between dimension "A" and "B", see table below

Electronic Damping Control (LEDC)

Rave RE

Damping controls the energy absorption when the shock absorber is being increased or extended and controls how fast the shock absorber returns to its normal position. LYNX Electronic Damping Control (by Tractive) allow to adjust separately rear, center or skies shocks.

To increase or decrease the damping choose the shock you want to adjust by pushing the left knob till the led lights up in right position. Push the right knob to set the damping. Upwards is more damping and down is less damping.

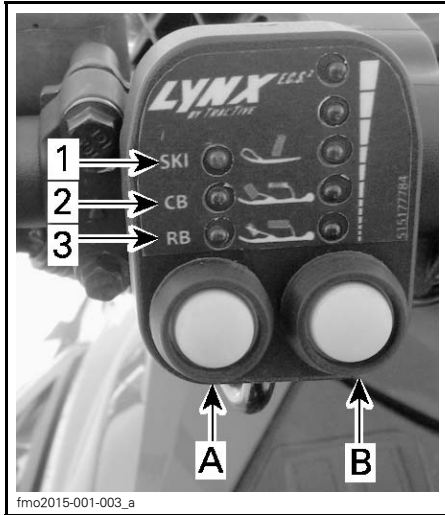

1. SKI - Skies shocks
2. CB - Center shock
3. RB - Rear shock

- A. Left knob
- B. Right knob

In the LEDC system it is also possible to adjust the shape of damping curve by mechanical adjusters. In all shocks there are own adjusters for the low speed (LS) and high speed (HS) dampings. The speed means the velocity of shock piston. If you want more/less

damping for low speed turn LS adjuster. In case you need more/less damping for high speed turn HS adjuster. If you want to return standard calibrations, close the adjuster totally and then open 12 clicks. 12 clicks open is standard setting for all shocks.

NOTE: When one of the LED's starts blinking the controller is reporting an error code. Contact an authorized Lynx dealer and report which LED is blinking.



Rear and Center Shock Absorber

Rear Shock Compression Damping

NOTE: Both low and high speed compression damping are adjusted separately.

Low speed compression damping controls how the shock absorber reacts to a low suspension velocity (slow compression strokes, in most cases when riding at lower speeds).

High speed compression damping controls how the shock absorber reacts to a high suspension velocity (quick compression strokes, in most cases when riding at higher speeds).

(1) The KYB Pro Series is a registered mark of KYB America LLC.

ACTION	RESULT ON BIG AND SMALL BUMPS
Increasing compression damping force	Firmer compression damping
Decreasing compression damping force	Softer compression damping

To adjust, turn the adjuster button located on the oil reservoir on shock clockwise to increase compression damping force and counterclockwise to decrease compression damping force.



1. Rear shock absorber
2. Compression damping adjuster (button)

Front Suspension Adjustments

Skis

It is possible to set the ski to three different position.

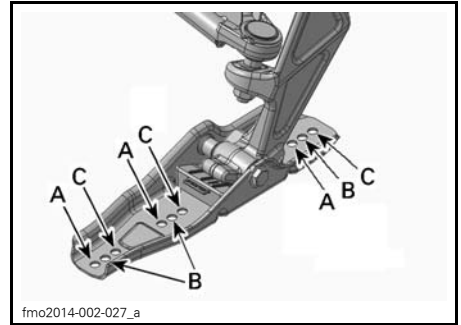

BLADE SKI

- A. Light control -for deep snow riding
- B. Standard - Trail riding
- C. Stable control

Xtrim, BoonDocker Series

On these models, it is possible to set the ski stance to two different width.

Recommend to use narrow ski stance.

When the spacer is installed inside the ski leg, skis are set to the narrower stance.

When the spacer is installed outside the ski leg, skis are set to the wider stance.

To change the ski stance, proceed as follows on both sides:

1. Lift the front of vehicle.
2. Remove the ski bolt.
3. Place the spacer according to the desired stance, see illustration.

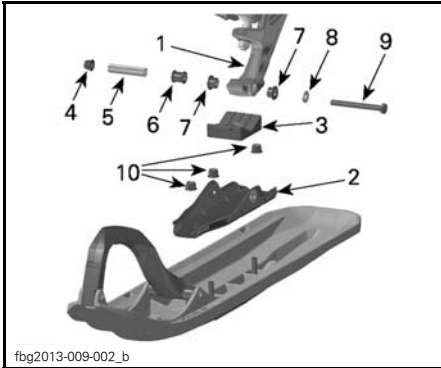

PARTS LAYOUT - RH SIDE SHOWN

1. Ski leg
2. Ski runner
3. Ski stopper
4. Elastic Flanged Nut M10
5. Ski Axle
6. Models with adjustable stance
7. Bushings
8. Washer
9. Ski bolt (Hex. Cap Screw M10 x 100)
10. Flanged Nut M10

4. Install all the other parts and tighten nut to the specified torque.

SKI BOLT TIGHTENING TORQUE
48 N•m ± 6 N•m

NOTE: Make sure your vehicle does not exceed the maximum width allowed for trail riding. Check local regulations.

Front Springs

Front ski spring preload has an effect on front suspension firmness.

Front ski spring preload also has an effect on the steering behavior.

NOTICE In order to have a sufficient preload, the spring free length (with skis off the ground) must not exceed 270 mm. An insufficient preload can cause the spring stopper to fall off the shock absorber.

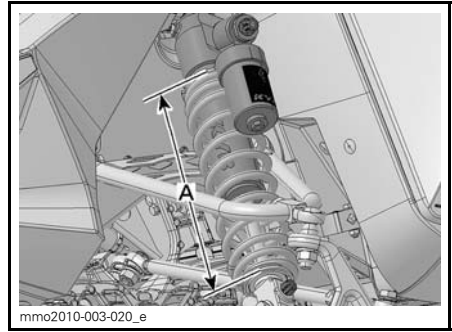

TYPICAL
A. Maximum 270 mm with skis off the ground

ACTION	RESULT
Increasing preload	Firmer front suspension
	Higher front end
	More precise steering
Decreasing preload	More bump absorption capability
	Softer front suspension
	Lower front end
	Lighter steering
	Less bump absorption capability

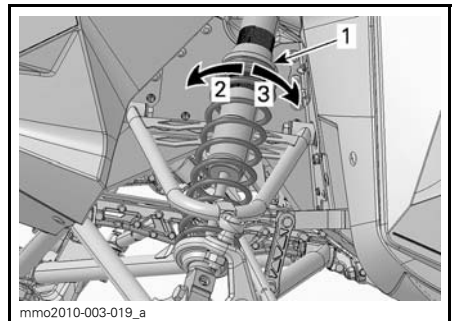

TYPICAL- RING TYPE
1. Spring preload adjustment ring
2. Increase preload
3. Decrease preload

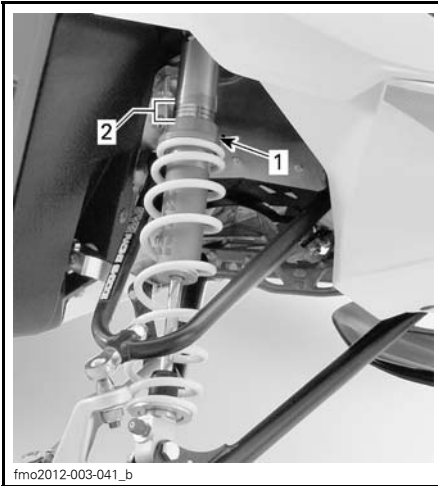
**KYB 36 R SHOWN**

1. Adjustment ring
2. Ring positions

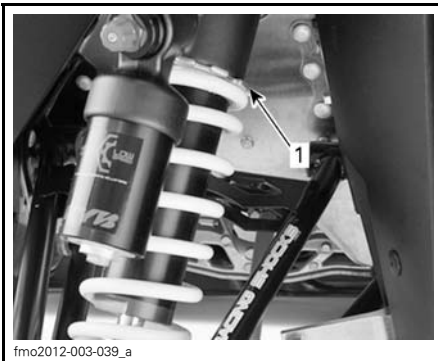
**KYB 40 PB HLCR SHOWN**

1. Adjustment ring

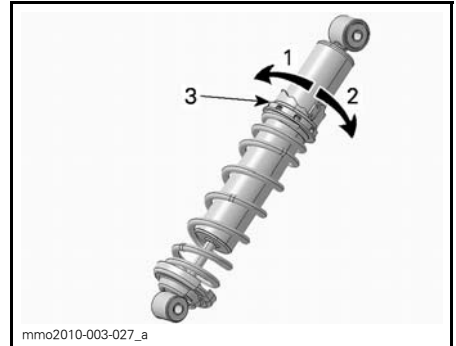
**CAM TYPE - HPG SHOCK ABSORBER**

1. Decrease preload
2. Increase preload
3. Spring preload adjustment cam

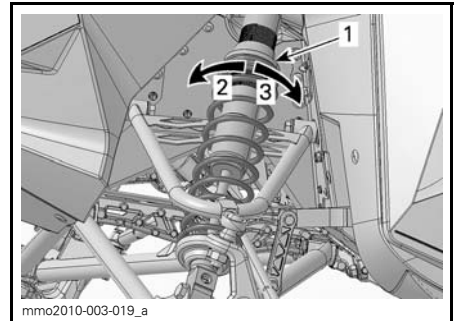
**TYPICAL - RING TYPE**

1. Spring preload adjustment ring
2. Increase preload
3. Decrease preload

Front Shock Absorber**Front Shock Compression Damping**

NOTE: Both low and high speed compression damping are adjusted simultaneously.

Low speed compression damping controls how the shock absorber reacts to a low suspension velocity (slow compression strokes, in most cases when riding at lower speeds).

High speed compression damping controls how the shock absorber reacts to a high suspension velocity (quick compression strokes, in most cases when riding at higher speeds).

ACTION	RESULT
Increasing compression damping force	Firmer compression damping
Decreasing compression damping force	Softer compression damping

To adjust, turn clockwise to increase compression damping force and counterclockwise to decrease compression damping force.

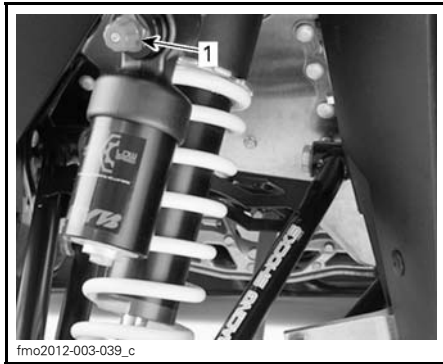

1. Compression damping adjuster knob

NOTE: In repetitive short small bumps (ripple), it is recommended to use a lower rebound damping setting.

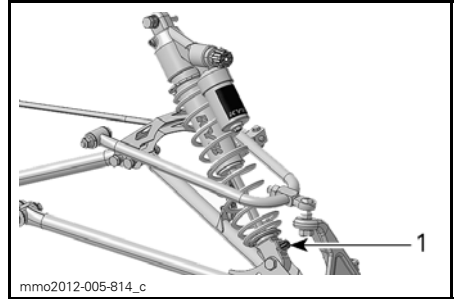

1. Rebound adjuster (knob or slot)

Shock Rebound Damping

KYB 40 PB HLCR

Rebound damping controls how the shock absorber restrains the extension stroke.

Turn the damping adjuster accordingly. Turning it clockwise increases shock damping action (stiffer).

ACTION	RESULT
Increasing rebound damping force	Firmer rebound damping (extension stroke)
Decreasing rebound damping force	Softer rebound damping (extension stroke)

Adjustment Tips According to Vehicle Behavior

PROBLEM	CORRECTIVE MEASURES
Front suspension darting	Check ski alignment. – Reduce front suspension spring preload. – Increase center spring preload. – Reduce rear spring preload.
Steering feels too heavy at steady speeds	– Reduce front suspension spring preload. – Increase center spring preload.
Steering feels too heavy during acceleration	– Reduce rear spring preload. – Lengthen limiter strap.
Too much ski lift during cornering or acceleration	– Shorten limiter strap. – Increase rear spring preload.
Rear of snowmobile seems too stiff	– Reduce rear spring preload. – Reduce compression damping adjustment if equipped
Rear of snowmobile seems too soft	Increase rear spring preload.
Rear suspension is frequently bottoming	– Increase rear spring preload. – Increase center spring preload. – Lengthen limiter strap. – Increase compression damping adjustment if equipped
Snowmobile seems to pivot around its center	– Reduce center spring preload. – Increase rear spring preload. – Increase front suspension spring preload. – Shorten limiter strap.
Track spins too much at start	– Lengthen limiter strap.

REAR AND FRONT SUSPENSION SPRING PRELOAD FACTORY SETTINGS			
MODEL	SKI	FRONT ARM	REAR ARM
Rave RE 600 HO E-TEC	6 mm	5 mm	14 mm
Rave RE 800 E-TEC	6 mm	5 mm	14 mm
Boondocker 3700 600 HO E-TEC	4 mm / cam position #1	4 mm / cam position #1	5 mm
Boondocker RE 3700 800 E-TEC	11 mm	3 mm	5 mm
Boondocker 3900 600 HO E-TEC	11 mm	4 mm	5 mm
Boondocker DS 3900 800 E-TEC	11 mm	3 mm	3 mm

CLICKER FACTORY SETTINGS						
MODEL	SKI SHOCK		CENTER SHOCK		REAR SHOCK	
Rave RE 600 HO E-TEC Rave RE 800 E-TEC	Low Speed	12 Clicks open	Low Speed	12 Clicks open	Low Speed	12 Clicks open
	High Speed	1,5 Turns open	High Speed	1,5 Turns open	High Speed	1,5 Turns open
	Rebound	11 Clicks open	Rebound	2 Clicks open	Rebound	2 Clicks open
Boondocker 3700 800 E-TEC	Low Speed	12 Clicks open	--		Low Speed	12 Clicks open
	High Speed	1,5 Turns open	--		High Speed	1,5 Turns open
	Rebound	11 Clicks open	--		Rebound	2 Clicks open

CLICKER FACTORY SETTINGS						
MODEL	SKI SHOCK		CENTER SHOCK		REAR SHOCK	
Rave RE 600 HO E-TEC Rave RE 800 E-TEC	Low Speed	20 Clicks open	Low Speed	20 Clicks open	Low Speed	20 Clicks open
	High Speed	2,5 Turns open	High Speed	2,0 Turns open	High Speed	2,0 Turns open
	Rebound	15 Clicks open	Rebound	4 Clicks open	Rebound	4 Clicks open
Boondocker 3700 800 E-TEC	Low Speed	12 Clicks open	–		Low Speed	12 Clicks open
	High Speed	1,5 Turns open	–		High Speed	1,5 Turns open
	Rebound	11 Clicks open	–		Rebound	2 Clicks open

MAINTENANCE INFORMATION

BREAK-IN INSPECTION

After the first 10 hours or 500 km of operation, whichever comes first, your vehicle have to be inspected by an authorized Lynx dealer. The break-in inspection is very important and must not be neglected.

NOTE: The break-in inspection is at the expense of the vehicle owner.

BREAK-IN INSPECTION (2-STROKE)	
ENGINE	Inspect engine motor mounts
	Inspect exhaust system and check for leaks
	Tighten exhaust manifold screws to specified torque
	Check coolant level
FUEL SYSTEM	Inspect fuel lines and connections
	Inspect throttle cable
DRIVE SYSTEM AND BRAKE	Inspect drive belt
	Visually inspect drive pulley
	Tighten drive pulley retaining screw to specified torque
	Inspect driven pulley
	Adjust and align track
	Change chaincase / gearbox oil
	Adjust drive chain (except models with gearbox)
	Check brake fluid level
Inspect brake hose, pads and disk	
STEERING SYSTEM	Inspect steering mechanism
	Inspect skis and runners
FRAME	Tighten frame pyramid rod screws to specified torque
	Retighten rear pyramid A-arm screws to specified torque (XU 14 N•m, REX 35 N•m)
SUSPENSION	Inspect front suspension
	Inspect rear suspension (including stopper straps and slider shoes)
	Lubricate front and rear suspension
	Retighten PPS2 rear axle bolt 1/4 turn.
BODY	Adjust seat lock plate (only REX2 models)

PERIODIC MAINTENANCE CHART

WARNING

It is recommended that the assistance of an authorized LYNX dealer be periodically obtained on other components/systems not covered in this guide. Unless otherwise specified, engine must be cold and not running. Remove the tether cord cap (DESS key) before performing any maintenance or adjustment, unless otherwise specified. Vehicle must be parked in a safe place, away from the trail.

WARNING

Observe WARNINGS and CAUTIONS mentioned throughout this guide which are relevant to the item being checked. When component conditions seem less than satisfactory, replace with genuine BRP parts or approved equivalents.

Some items may not apply to your particular model. Contact an authorized Lynx dealer for more details.

MAINTENANCE SCHEDULE (2-STROKE)

NOTE: The maintenance schedule does not exempt the pre-ride inspection.

EVERY 1 500 KM	
DRIVE SYSTEM	Models with chaincase: Adjust drive chain
	Models with chaincase: Check chaincase oil level
	Models with gearbox: Check oil level
EVERY 3 000 KM OR 1 YEAR (WHICHEVER COMES FIRST)	
ENGINE	Inspect heat shields
	Inspect engine rubber mounts
	Inspect exhaust system and check for leaks
	Inspect cooling system cap, hoses and clamps and check for leaks
	Adjust engine stopper
DRIVE SYSTEM AND BRAKE	Visually inspect and clean drive pulley
	Tighten drive pulley retaining screw to specified torque
	Clean driven pulley
	Adjust and align track
	Inspect brake hose, pads and disk
STEERING SYSTEM	Inspect steering mechanism
SUSPENSION	Inspect front suspension
	Inspect rear suspension and stopper strap.
	Lubricate front and rear suspension whenever the vehicle is used in wet conditions (wet snow, rain, puddles)
	Check ski leg bushing and bearing. Replace if needed.
	All models with T/A shocks, oil change / service.
ELECTRICAL SYSTEM	Replace spark plugs (All except of E-TEC)

EVERY 6 000 KM OR 2 YEARS (WHICHEVER COMES FIRST)	
ENGINE	Clean and lubricate rewind starter
FUEL SYSTEM	Inspect fuel pump strainer and replace if necessary
	Inspect throttle cable
DRIVE SYSTEM	Replace brake fluid
	Lubricate the splines of joint between QRS axle and gearbox
SUSPENSION	Check PPS2 bushing and bearing. Replace if needed.

EVERY 10 000 KM OR 3 YEARS (WHICHEVER COMES FIRST)	
ENGINE	E-TEC: Inspect oil pump strainer and clean if needed
ELECTRICAL SYSTEM	E-TEC: Replace spark plugs (must be replaced by an authorized BRP dealer)

EVERY 5 YEARS	
ENGINE	Replace engine coolant
FUEL SYSTEM	Replace in-line fuel filter

MAINTENANCE PROCEDURES

This section includes instructions for basic maintenance procedures. If you have the necessary mechanical skills and the required tools, you can perform these procedures. If not, see your authorized Lynx dealer.

Other important items in the maintenance schedule that are more difficult and require special tools are best performed by your authorized Lynx dealer.

⚠ WARNING

Turn off the engine, remove tether cord cap and follow these maintenance procedures when performing maintenance. If you do not follow proper maintenance procedures you can be injured by hot parts, moving parts, electricity, chemicals or other hazards.

⚠ WARNING

Should removal of a locking device be required (e.g. lock tabs, self-locking fasteners, etc.) when undergoing disassembly/assembly, always replace with a new one.

Air Filter with Dual Air Intake (E-TEC models)

Air Filter Verification

There are two air intake pre-filters, one on each side of the console.

Ensure the air intake prefilters are properly installed, clean and in good condition.

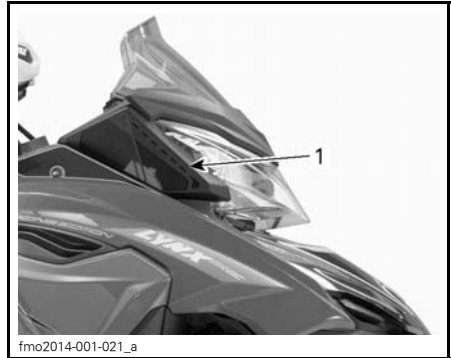

1. RH Air filter

If the air filter has to be cleaned or replaced, see an authorized Lynx dealer.

Engine Coolant

⚠ WARNING

Never open coolant tank cap when engine is hot.

Engine Coolant level Verification

Check coolant level at room temperature. Liquid should be at cold level line (engine cold) of coolant tank.

NOTE: When checking level at low temperature it may be slightly lower than the mark.

If additional a large amount of coolant has to be added or if entire system has to be refilled, refer to an authorized LYNX dealer.

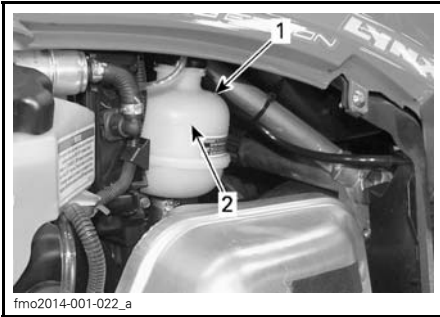

TYPICAL

1. Coolant tank
2. COLD LEVEL line

Recommended Engine Coolant

Always use ethylene-glycol antifreeze containing corrosion inhibitors specifically for internal combustion aluminum engines.

Cooling system must be filled with BRP PREMIXED COOLANT (P/N 619 590 183) or with distilled water and antifreeze solution (50% distilled water, 50% antifreeze).

Exhaust System

The muffler tail pipe should be centered with the exit hole in the bottom pan. Exhaust system must be free of rust or leaks. Make sure that gear clamps are properly tightened.

The exhaust system is designed to reduce noise and to improve the total performance of the engine. Modification may be in violation of local laws.

⚠ CAUTION If any exhaust system component is removed, modified or damaged, severe engine damage may result.

Engine Stopper

Engine Stopper Adjustment

The engine stopper is located on the LH front engine support, in front of the drive pulley.

1. Remove D.E.S.S. key from post.

2. Remove the LH side panel.
3. Remove drive belt guard, refer to *DRIVE BELT GUARD REMOVAL*.
4. Loosen the three screws retaining the engine stopper to the engine support just enough to allow a vertical play (1/2 to one turn).

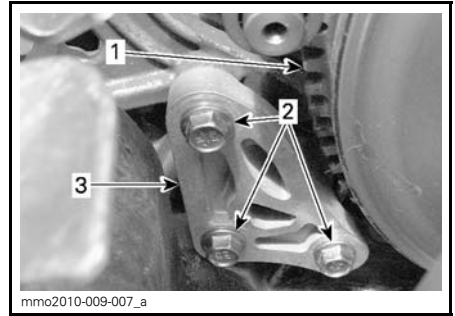

1. Drive pulley
2. Engine stopper screws
3. Engine stopper

5. Insert a 0.5 mm feeler gauge in the engine stopper opening (see illustration).

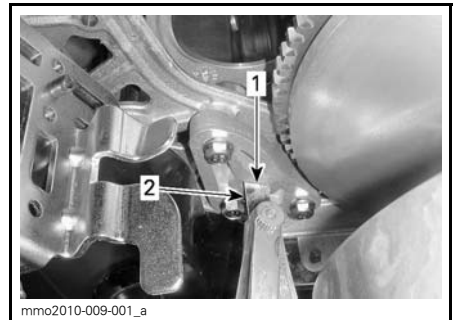

1. Opening
2. Feeler gauge

6. Place feeler gauge between engine stopper and rubber stop block (on engine).

NOTE: Do not insert the feeler gauge too deep, as it will pass over the bump at the surface of the rubber stop block and alter adjustment. See illustration.

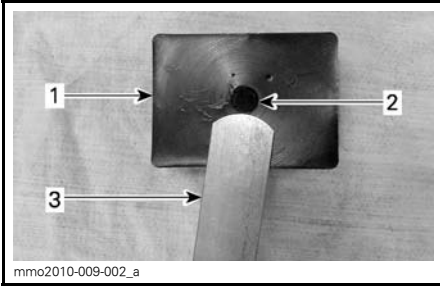

1. Rubber stop block
 2. Bump
 3. Feeler gauge
7. Tighten screws to $10\text{ N}\cdot\text{m} \pm 2\text{ N}\cdot\text{m}$ following the illustrated sequence, taking care not to pinch the feeler gauge.

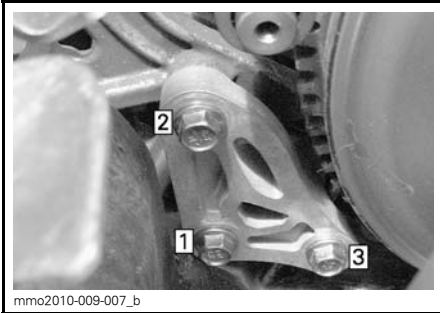

TIGHTENING SEQUENCE

NOTICE Serious pulley damage can occur if the engine stopper and its screws are not properly installed.

Brake Fluid

Use only DOT 4 brake fluid from a sealed container. An opened container may be contaminated or may have absorbed moisture from the air.

⚠ WARNING

Use only DOT 4 brake fluid from a sealed container. To avoid serious damage to the braking system, do not use fluids other than the recommended one, nor mix different fluids for topping up.

NOTICE Brake fluid can damage painted and plastic parts. Handle with care. Rinse thoroughly in case of spillage.

Brake Fluid Level Verification

NOTICE Vehicle must be on a level surface before checking any fluid levels.

Check brake fluid (DOT 4) in reservoir for proper level. Add fluid (DOT 4) as required.

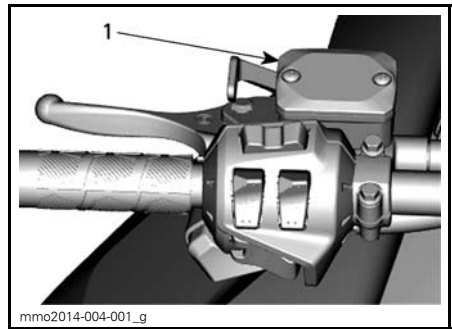

TYPICAL
1. Brake fluid reservoir

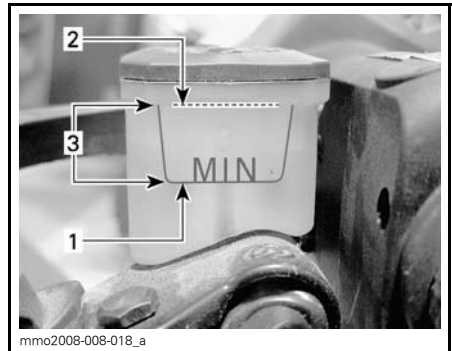

1. Minimum
2. Maximum
3. Operating range

⚠ CAUTION Avoid getting brake fluid on skin or eyes - it may cause severe burns. In case of contact skin, wash thoroughly. In case of contact with the eyes, immediately rinse with plenty of water for at least 10 minutes and then consult a doctor immediately.

Brake Condition

⚠ WARNING

The brake mechanism on your snowmobile is an essential safety device. Keep this mechanism in proper working condition. Above all, do not operate the snowmobile without an effective brake system. Periodically verify the condition/wear of the brake pads.

Brake Adjustment

No adjustment is provided for hydraulic brake. See an authorized LYNX dealer if any problems.

Chaincase Oil

Recommended Chaincase Oil

RECOMMENDED CHAINCASE OIL

XPS SYNTHETIC CHAINCASE OIL (P/N 413 803 300)

NOTICE The chaincase of this snowmobile has been developed and validated using the XPS™ Synthetic chaincase oil. BRP strongly recommends the use of its XPS Synthetic chaincase oil at all times. Damages caused by oil which is not suitable for the chaincase will not be covered by the BRP limited warranty.

Chaincase Oil Level Verification

With the vehicle on a level surface, check the oil level by removing the magnetic check plug on the left side of chaincase. Oil level must be equal with the lower edge.

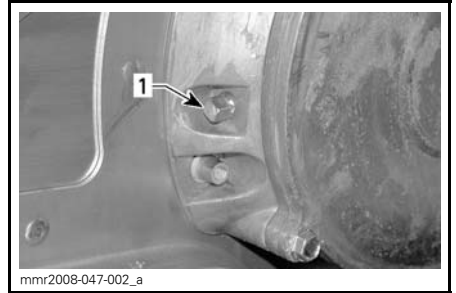

1. Magnetic check plug

NOTE: It is normal to find metallic particles stuck to magnetic check plug. If bigger pieces of metal are found, remove the chaincase cover and inspect the chaincase parts.

Chaincase Filling Procedure

Remove the magnetic check plug.

Remove the filler cap on the chaincase cover.

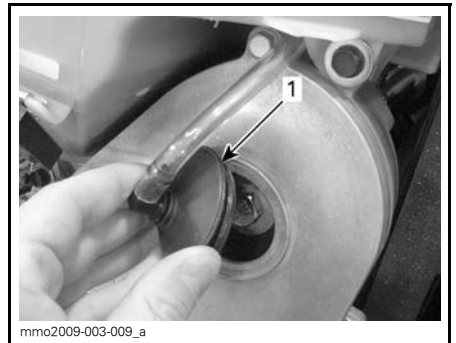

1. Filler cap

Pour recommended oil in chaincase by the filler hole until oil comes out by the check plug hole.

Reinstall check plug and torque to specification.

CHECK PLUG TORQUE

6 N•m ± 1 N•m

Reinstall the filler cap.

Drive system

Drive Chain Tension

Contact an authorized LYNX dealer.

Drive Chain

Access to Chaincase

Open RH side panel, refer to *CONTROLS, INSTRUMENTS AND EQUIPMENT*.

Drive Chain Adjustment

1. Remove muffler, refer to *EXHAUST SYSTEM* in this subsection.
2. Unscrew tensioner lock nut several turns.

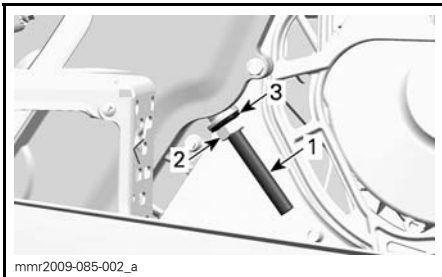

1. Tensioner adjustment screw
2. Lock nut
3. Seal washer

3. Unscrew tensioner adjustment screw a few turns.
4. Pull seal washer back.
5. Clean adjustment screw threads if necessary.

NOTICE Adjustment screw threads must be clean to obtain an accurate adjustment.

6. Tighten tensioner adjustment screw by hand.

NOTE: Turn adjustment screw until resistance is strong enough that it can not be turned by hand.

7. Hold tensioner adjustment screw and tighten lock nut to specification.

CHECK LOCK NUT TORQUE

36 N•m ± 3 N•m

8. Install muffler.

Drive Belt Inspection

Inspect belt for cracks, fraying or abnormal wear (uneven wear, wear on one side, missing cogs, cracked fabric). If abnormal wear is noted, probable cause could be pulley misalignment, excessive RPM with frozen track, fast starts without warm-up period, burred or rusty sheave, oil on belt or distorted spare belt. Contact an authorized LYNX dealer.

Drive Belt Replacement

Drive Belt Removal

1. Remove DESS key from post.
2. Open LH side panel.
3. Remove belt guard, refer to *DRIVE BELT GUARD REMOVAL* section in *CONTROLS, INSTRUMENTS AND EQUIPMENT*.
4. Insert the driven pulley expander provided in the tool kit in the threaded hole on the adjuster hub as shown.



mmo2012-005-980

PULLEY EXPANDER INSTALLED ON ADJUSTER HUB

5. Open the driven pulley by screwing the tool in.
6. Remove the belt by slipping it over the top of the driven pulley, then over the drive pulley.

Drive Belt Installation

1. If necessary, open the driven pulley, refer to *DRIVE BELT REMOVAL*.
2. Slip the belt over the drive pulley, then over the driven pulley.

NOTICE Do not force or use tools to pry the belt into place, as this could cut or break the cords in the belt.

NOTE: The maximum drive belt life span is obtained when belt is installed with arrows in the direction of rotation.

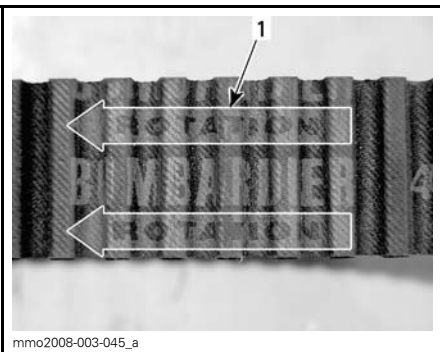

mmo2008-003-045_a

1. To be pointed in the direction of rotation

3. Unscrew and remove the driven pulley expander from the pulley.
4. Rotate the driven pulley several times to properly set the belt between the sheaves.
5. If a new belt was installed, adjust the belt height. Refer to *DRIVE BELT HEIGHT ADJUSTMENT* below.
6. Install belt guard, refer to *DRIVE BELT GUARD INSTALLATION* section in *CONTROLS, INSTRUMENTS AND EQUIPMENT*.
7. Close side panel, refer to *HOOD AND SIDE PANELS* section in *CONTROLS, INSTRUMENTS AND EQUIPMENT*.

Drive Belt Height Adjustment

The drive belt height must be checked every time a new belt is installed.

To adjust the drive belt height, proceed as follows:

1. Remove D.E.S.S. key from post.
2. Open LH side panel, refer to *HOOD AND SIDE PANELS* section in *CONTROLS, INSTRUMENTS AND EQUIPMENT*.
3. Remove belt guard, refer to *DRIVE BELT GUARD REMOVAL* section in *CONTROLS, INSTRUMENTS AND EQUIPMENT*.
4. Loosen the clamping bolt.

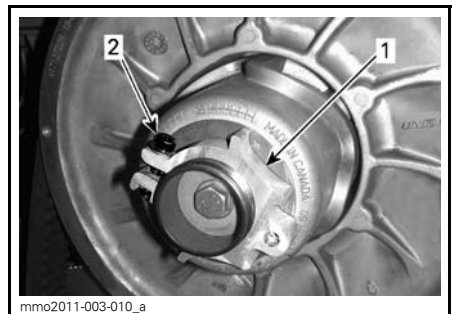

mmo2011-003-010_a

ALUMINUM ADJUSTER HUB

1. Adjuster hub
2. Clamping bolt

- Using the suspension adjustment tool provided in the tool kit, turn the ring 1/4 turn at a time then rotate the driven pulley to properly set the belt between the pulley sheaves.



ALUMINUM ADJUSTER HUB
1. Suspension adjustment tool

NOTE: The adjustment ring has left hand treads

Belt with External Cogs / E-TEC Models

Repeat step 5 until the bottom of grooves on the external side of drive belt are flush with the driven pulley edges.

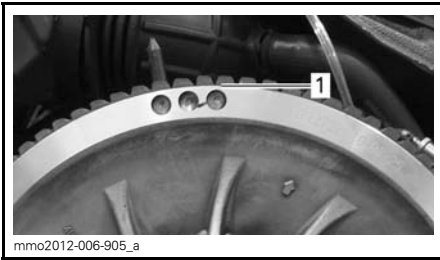

TYPICAL - PRELIMINARY SETTING
1. Lowest portion of cogs even with external surface of drive belt

All Drive Belt Types

NOTE: Turning the ring counterclockwise lowers the belt in the pulley. Turning the ring clockwise raises the belt in the pulley.

- Firmly tighten the clamping bolt. If possible, tighten to specified torque using a torque wrench.

TORQUE	
Clamping Bolt	5.5 N•m ± 0.5 N•m

- Install belt guard, refer to *DRIVE BELT GUARD INSTALLATION*.

- Close side panel, refer to *BODY*.

NOTE: These settings are correct as a preliminary adjustment for most models and belt types. In some cases, when starting the engine, the vehicle could creep, indicating that the belt is too tight.

If the vehicle creeps, lower the drive belt height from the preliminary setting. Repeat procedure until creeping stops.

Reverse Activation

NOTE: The reverse may not activate if the belt is positioned too high in the driven pulley. If reverse activation does not work properly, ensure the drive belt is properly adjusted. Adjust the drive belt lower in the driven pulley if needed.

Drive Pulley Adjustment

⚠ WARNING

Remove the tether cord cap (DESS key) from engine cut-off switch before performing any maintenance or adjustment, unless otherwise specified. Vehicle must be parked in a safe place, away from the trail.

General

The drive pulley is factory calibrated to transmit maximum engine power at a predefined RPM. Factors such as ambient temperature, altitude or surface condition may vary this critical engine RPM thus affecting snowmobile efficiency.

This adjustable drive pulley allows setting maximum engine RPM to maintain maximum power.

Calibration screws should be adjusted so that actual maximum engine RPM matches the maximum horsepower RPM.

ENGINE	MAXIMUM HORSEPOWER RPM
600 HO E-TEC	8100 RPM (± 100)
800 R E-TEC	7900 RPM (± 100)

NOTE: Use precision digital tachometer for engine RPM adjustment.

NOTE: The adjustment has an effect on high RPM only.

There are 6 positions numbered 1 to 6.

The calibration screws have 6 different settings identified by numbers scribed on their head.

The actual setting is the screw head number aligned with the mark on the pulley.

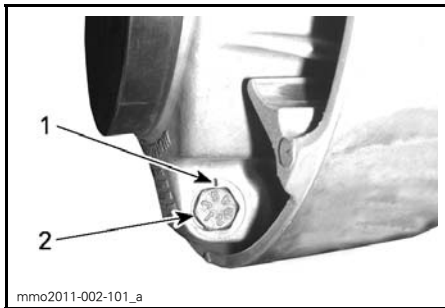

PULLEY SETTING

1. Mark
2. Number

Each position modifies maximum engine RPM by about 200 RPM.

Lower position numbers decrease engine RPM in steps of 200 RPM and higher position numbers increase it in steps of 200 RPM.

Example:

Calibration screws initially set at position 4 and changed to position 6 will increase maximum engine RPM by 400 RPM.

Procedure

Loosen the lock nut just enough to get the calibration screw head out of the pulley and rotate to the desired position. Do not completely remove the lock nut.

Set all 3 calibration screws to the same position.

Tighten lock nuts to 10 N•m ± 2 N•m.

NOTICE Do not completely remove calibration screw otherwise internal washers will fall off. Always adjust all 3 calibration screws and make sure they are all set to the same position.

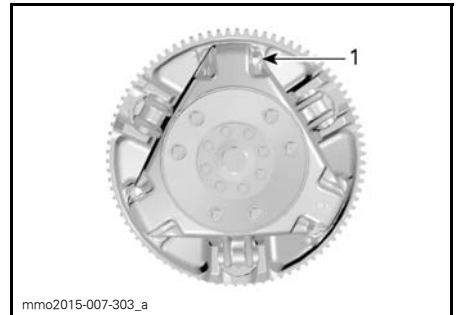

TYPICAL

1. Loosen just enough to permit rotating of calibrate screw

⚠ WARNING

NEVER disassemble or modify the drive pulley. Improper assembly or modifications could cause the pulley to explode violently under the stress generated by the high rotational speed. This could lead to serious injury including the possibility of death.

See your LYNX dealer to maintain or service the drive pulley. Improper servicing or maintenance may affect performance and reduce belt life. Always respect maintenance schedules.

⚠ WARNING

NEVER operate engine:

- without shields and belt guard securely installed
- with hood and/or side panels opened or removed.

NEVER attempt to make adjustments to moving parts while engine is running.

Track

⚠ WARNING

Never stud a track that has not been approved for studs. Installing studs on an unapproved track could increase the risk of the track tearing or severing, possibly resulting in serious injury or death.

Before proceeding with the installation of special studs on tracks you must contact your authorized LYNX snowmobile dealer for current specific studing availability and applications.

BRP does **not** recommend to ride a snowmobile equipped with high lug profile track at **high speed** in a trail, on hard packed surfaces or ice for an extended period of time.

In the event that you have to, **reduce your speed**, then minimize the distance you ride on those surfaces.

⚠ CAUTION Running those tracks at high speed in a trail, on hard packed surfaces or ice put more stress on the lugs, which tend to heat up as a result. To avoid potential degradation or damage to the track, **reduce your speed**, then minimize the distance you ride on those surfaces.

For general instructions on maintenance of tracks, refer to the sections *TRACK CONDITION* and *TRACK TENSION AND ALIGNMENT* in the *MAINTENANCE* section of this guide.

Track Condition

⚠ WARNING

Remove the tether cord cap (DESS key) before performing any maintenance or adjustment, unless otherwise specified. Vehicle must be parked in a safe place, away from the trail.

Remove the tether cord cap (DESS key).

Lift the rear of the snowmobile and support it with a wide-base snowmobile mechanical stand with a rear deflector panel. With the engine off, rotate the track by hand, and inspect condition. If worn or cut, or if track fibers are exposed, or if missing or defective inserts or guides are noted; contact an authorized LYNX dealer.

Look for any defects, such as:

- perforations in the track
- tears in the track
- lugs that are broken or torn off, exposing portions of rods
- delamination of the rubber
- broken rods
- missing track guide(s).

If your track shows signs of deterioration, it must be replaced immediately. When in doubt, ask your dealer.

⚠ WARNING

Riding with a damaged track could lead to a loss of control, resulting in a risk of serious injury or death.

Track Tension and Alignment

NOTE: Track tension and alignment are interrelated. Do not adjust one without the other.

⚠ WARNING

To prevent serious injury to individuals near the snowmobile:

- NEVER stand behind or near a moving track
- always use a wide-base snowmobile stand with a rear deflector panel
- when the track is raised off the ground, only run it at the lowest possible speed.

Centrifugal force could cause debris, damaged or loose studs, pieces of torn track, or an entire severed track to be violently thrown backwards out of the tunnel with tremendous force, possibly resulting in the loss of a leg or other serious injury.

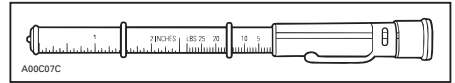

BELT TENSION TESTER

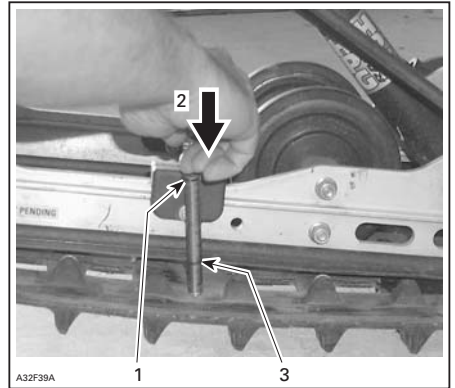

TYPICAL

1. Top tool O-ring positioned at 7.3 kg (16 lb)
2. Push on top portion of tool until it contacts the top O-ring
3. Measured track deflection (See specifications section to find your model track deflection)

Track Tension Verification

NOTE: Ride the snowmobile in snow about 15 to 20 minutes prior to adjusting track tension.

Remove the tether cord cap (DESS key).

Lift rear of snowmobile and support it with a wide-base snowmobile mechanical stand.

⚠ CAUTION Use proper lifting techniques, notably using your legs force. Do not attempt to lift the rear of vehicle if it is above your limits.

Allow the suspension to extend normally and check gap halfway between front and rear idler wheels. Measure between slider shoe bottom and inside of track. The gap should be as given in *SPECIFICATIONS* at the end of this guide. If the track tension is too loose, track will have a tendency to thump.

NOTE: A belt tension tester (P/N 414 348 200) may be used to measure deflection as well as force applied.

⚠ CAUTION Too much tension will result in power loss and excessive stresses on suspension components.

To adjust track tension:

- Remove the tether cord cap (DESS key).
- Remove rear wheel caps (if so equipped).
- Loosen rear axle screws (on each side).
- Turn adjustment bolts to adjust.

If correct tension is unattainable, contact an authorized LYNX dealer.

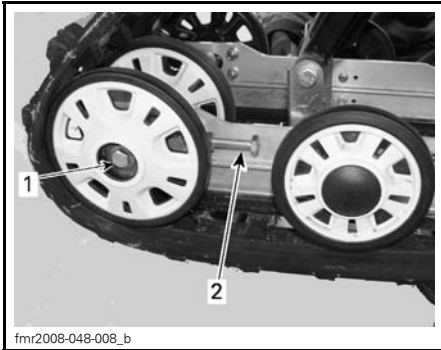

TYPICAL (RH SIDE)

1. Rear axle screw
2. Adjustment bolt

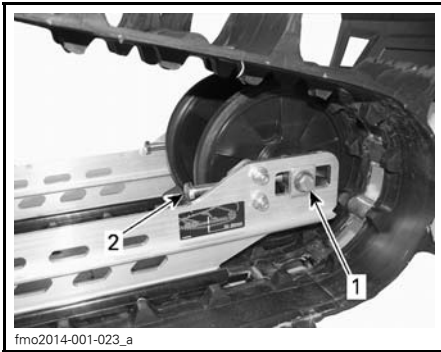

BOONDOKER AND RAVE RE (LH SIDE)

1. Rear axle screw
2. Adjustment bolt

- Retighten retaining bolts.
- Check track alignment as described below.

Track Alignment

⚠ WARNING

Before checking track alignment, ensure that the track is free of all particles which could be thrown out while track is rotating. Keep hands, tools, feet and clothing clear of track. Always lift the snowmobile on a wide-base stand with a rear deflector panel. Ensure no one is standing in close proximity to the snowmobile, especially at the rear of the track. Never rotate track at high speed.

Centrifugal force could cause debris, pieces of torn track, or an entire severed track to be violently thrown backwards out of the tunnel with tremendous force, possibly resulting in the loss of a leg or other serious injury.

⚠ WARNING

Remove the tether cord cap (DESS key) before performing any maintenance or adjustment, unless otherwise specified. Vehicle must be parked in a safe place, away from the trail.

- Remove the tether cord cap (DESS key).
 - Loosen rear idler wheel retaining bolts.
 - Tighten the adjustment bolt on side where the slider shoe is the farthest from the track insert guides.
1. Lift rear of vehicle and support it off the ground.
 2. Start the engine and accelerate slightly so that track barely turns. This must be done in a short period of time (15 to 20 seconds).
 3. Check that the track is well centered; equal distance on both sides between edges of track guides and slider shoes.

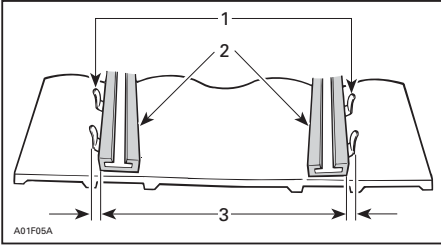

1. Guides
2. Slider shoes
3. Equal distance

4. To correct track alignment:

- 4.1 Stop engine.
- 4.2 Remove tether cord cap from engine cut-off switch.
- 4.3 Loosen rear wheel retaining screws.
- 4.4 Tighten adjustment screw on side where the slider shoe is the farthest from the track insert guides.

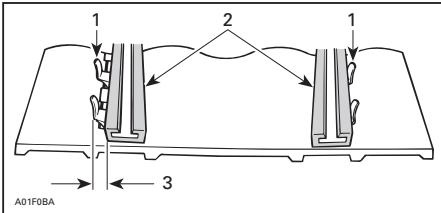

1. Guides
2. Slider shoes
3. Tighten on this side

5. Tighten retaining screws.

⚠ WARNING

Properly tighten wheel retaining bolts, otherwise wheel may come off and cause track to "lock".

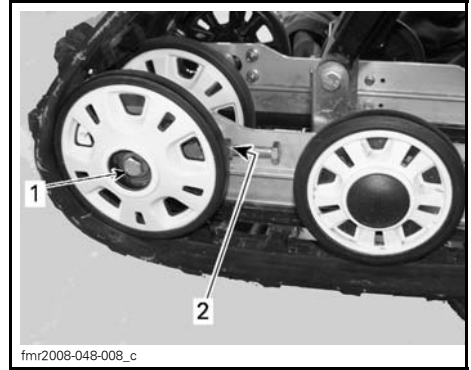

TYPICAL

1. Locknut
2. Retaining bolt - Retighten to 48 N•m ± 6 N•m

6. Restart engine and rotate track slowly to recheck alignment.
7. Reposition snowmobile on the ground.
8. Install rear wheel caps if so equipped.

Rear Suspension

Rear Suspension Condition

Visually inspect all suspension components including slider shoes, springs, wheels, etc.

NOTE: During normal driving, snow will act as a lubricant and coolant for the slider shoes. Extensive riding on ice or sanded snow, will create excessive heat build-up and cause premature slider shoe wear.

Suspension Stopper Strap Condition

Inspect stopper strap for wear and cracks, bolt and nut for tightness. If loose inspect holes for deformation. Replace as required. Torque nut to specification.

TORQUE	
Nut	11 N•m

Rear Suspension Lubrication

Lubricate rear suspension at grease fittings using SUSPENSION GREASE (P/N 619 590 193) Refer to *MAINTENANCE SCHEDULE* for maintenance frequency.

PPS Suspension

Rave, Xtrim SC, Boondocker 3700/3900 600-E-TEC

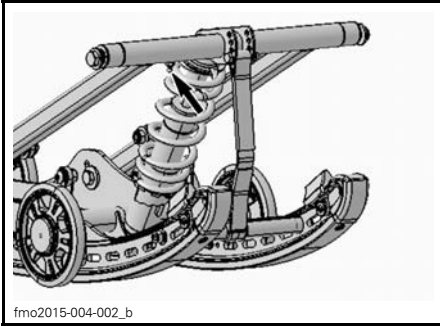

TYPICAL PPS GREASE FITTINGS (FRONT)

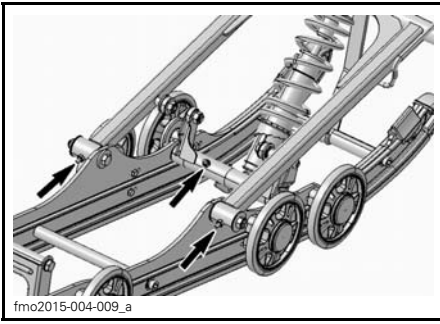

TYPICAL PPS GREASE FITTINGS (FRONT)

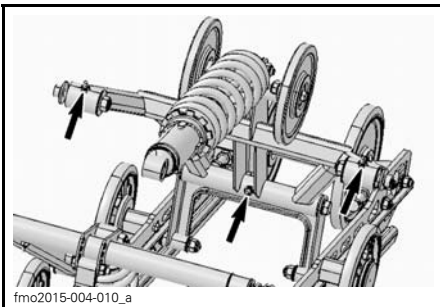

TYPICAL PPS GREASE FITTINGS (REAR)

PPS2 Suspension

Rave RE, BoonDocker 3700/3900 800R E-TEC

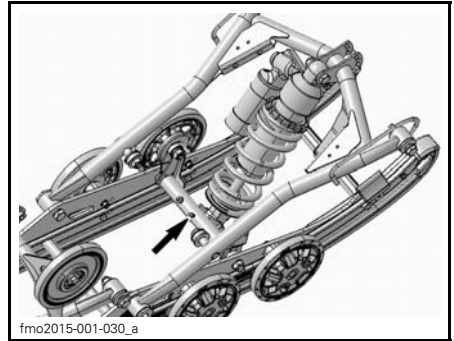

TYPICAL PPS2 3300 GREASE FITTINGS (FRONT)

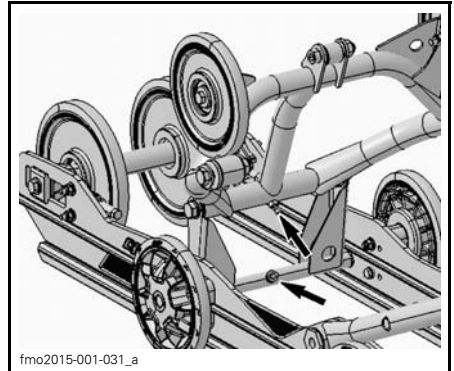

TYPICAL PPS2 3300 GREASE FITTINGS (REAR)

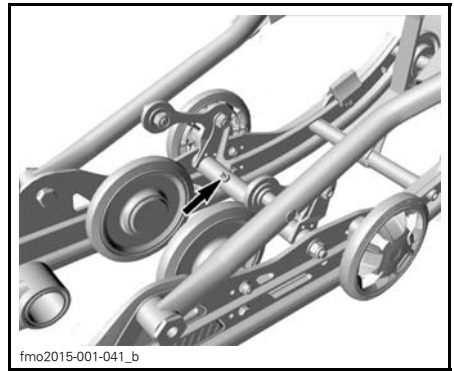

TYPICAL PPS2 3700 GREASE FITTINGS (FRONT)

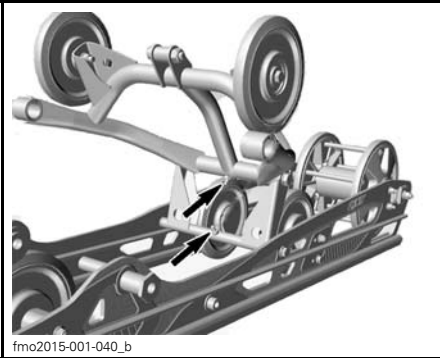

fmo2015-001-040_b
TYPICAL PPS2 3700 AND 3700 GREASE FITTINGS (REAR)

Steering and front suspension

Visually inspect steering and front suspension for tightness of components (steering arms, control arms and links, tie rods, ball joints, ski bolts, ski legs, etc.). If necessary, contact an authorized LYNX dealer.

Wear and Condition of Skis and Runners

Check the condition of the skis and ski runner carbides. If worn, contact an authorized LYNX dealer.

⚠ WARNING

Excessively worn skis and/or ski runners will adversely affect snowmobile control.

Blade Ski

Standard position for Ski is that Ski runner is installed on center holes.

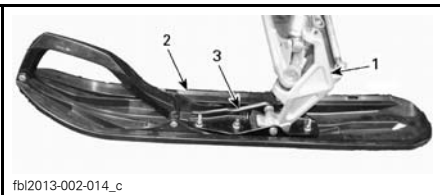

fbl2013-002-014_c
TYPICAL
1. Ski leg
2. Ski
3. Ski Runner

Ski stance can be adjusted by spacer location. It can be installed inside or outside of the ski leg

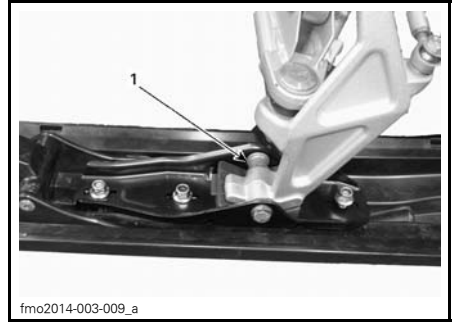

fmo2014-003-009_a
1. Spacer on inside of ski leg

Electrical System

Recommended Spark Plug

⚠ CAUTION Use only spark plug mentioned list below. It must be installed to a specific torque, refer to *SPARK PLUG INSTALLATION* for proper installation procedure.

Spark Plugs (E-TEC)

Spark plugs inspection or replacement must be done by an authorized Lynx dealer.

Fuse Removal/Inspection

The electrical system is protected with fuses, the fuse holders are located in the engine compartment.

Check fuse condition and replace it if necessary.

To remove fuse from holder, pull fuse out. Check if filament is melted.

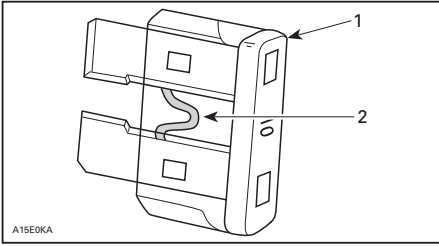

1. Fuse
2. Check if melted

⚠ CAUTION Do not use a higher rated fuse as this can cause severe damage to electrical components and/or be a potential fire.

⚠ WARNING

If fuse has burnt out, source of malfunction should be determined and corrected before restarting. See an authorized LYNX dealer for servicing.

E-TEC Manual Start



TYPICAL — RH SIDE OF ENGINE COMPARTMENT

1. 5 A main fuse

E-TEC Electric Start

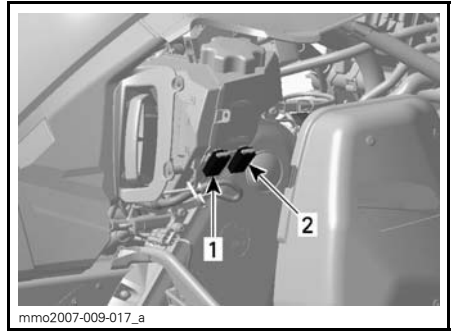

TYPICAL - RH SIDE OF ENGINE COMPARTMENT

1. 30 A charging system fuse
2. 5 A start/RER fuse

Electric Fuel Level Sender

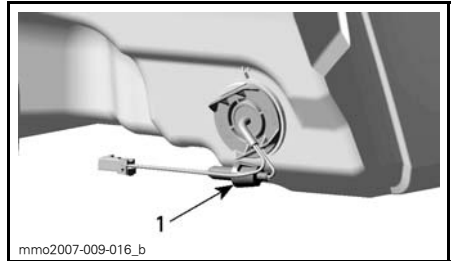

BEHIND AIR INTAKE SILENCER

1. 0.25 A fuse

Headlamp Beam Aiming

Remove multifunction gauge, refer to *BULB REPLACEMENT*. Turn knob to adjust beam height.

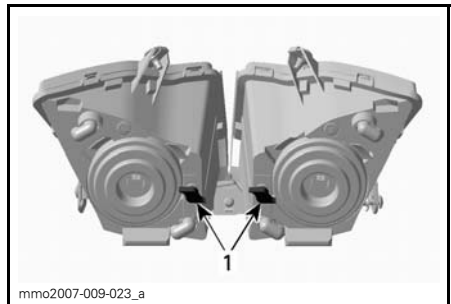

TYPICAL

1. Knob

Lights (Xtrim, Rave RE and BoonDocker series)

Always check light operation after bulb replacement.

Headlights Bulb Replacement

NOTICE Never touch glass portion of an halogen bulb with bare fingers, it shortens its operating life. If glass is touched, clean it with isopropyl alcohol which will not leave a film on the bulb.

1. Open the front storage compartment by pulling the tab.

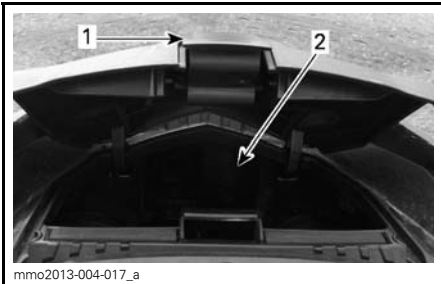

1. Tab
2. Storage compartment

2. Remove the applicable rubber boot.

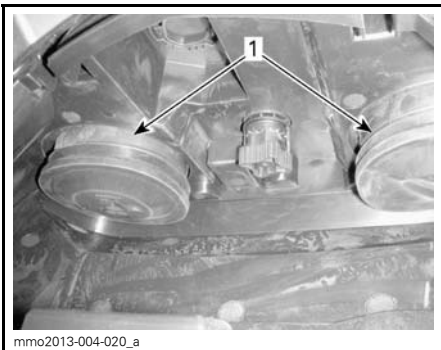

1. Rubber boots

NOTE: Make sure to properly reinstall both rubber boots to ensure that no humidity gets inside the headlamp. Humidity can create fog inside the headlamp.

3. Disconnect electrical connector.

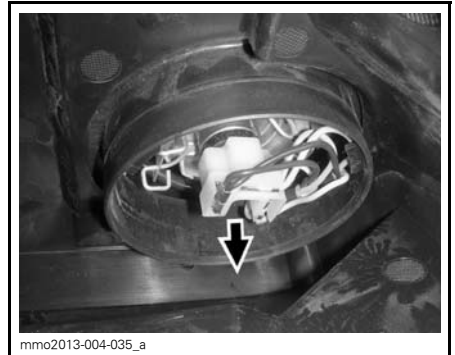

ELECTRICAL CONNECTOR

NOTE: Make sure to properly reconnect the electrical connector.

4. Press and pull both sides of the retaining clip at the same time to release it from bulb support.

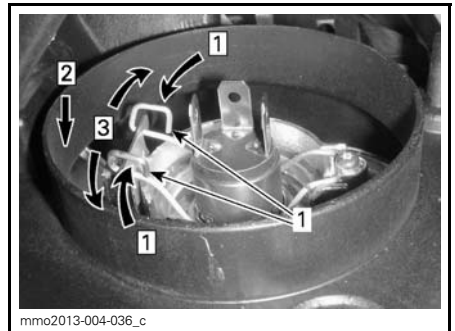

Step 1: Push both sides
Step 2: Push down to release
Step 3: Release both sides

1. Retaining clip

5. Pull bulb and replace. Properly reinstall parts.

Headlights Beam Aiming

Open the front storage compartment.

Turn knob to adjust beam height.

Turn knob clockwise to lower the beam height.

Turn knob counterclockwise to raise the beam height.

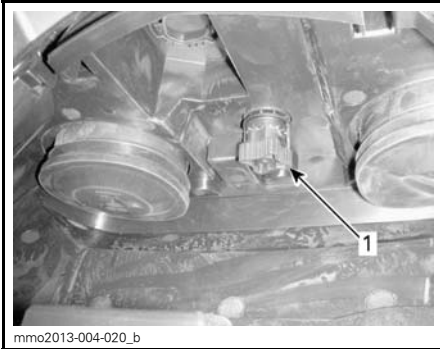

TYPICAL

1. Knob

Ice Scratchers (BoonDocker)

Ice Scratchers Replacement

When the wear limit mark is no longer visible on ice scratcher. Have ice scratchers replaced by a Lynx dealer.



TYPICAL

1. Wear limit

VEHICLE CARE

Post-Operation Care

Remove snow and ice from rear suspension, track, front suspension, steering mechanism and skis.

WARNING

Make sure tether cord cap is away from engine cut-off switch before standing in front the vehicle, getting close to the track or rear suspension components.

Always cover your snowmobile when leaving it outside overnight or during extended periods of inactivity. This will protect it from frost and snow as well as help retain its appearance.

Vehicle Cleaning and Protection

Wash snowmobile with water mixed with a mild detergent. Use only flannel cloths or an equivalent.

 **CAUTION** It is necessary to use flannel cloths or equivalent on windshield and hood to avoid damaging further surfaces to clean.

To remove grease, oil and grime, use Heavy duty cleaner (P/N 293 110 001) (spray can 400 g) and (P/N 293 110 002) (4 L).

 **CAUTION** Do not use Heavy duty cleaner on decals or vinyl.

To remove stubborn dirt from all plastic and vinyl surfaces, use Vinyl & Plastic Cleaner ((P/N 413 711 200) (6 x 1 L)).

To remove scratches on windshield or hood use the Scratch Remover Kit (P/N 861 774 800).

 **CAUTION** Never clean plastic parts or hood with strong detergent, degreasing agent, paint thinner, acetone, products containing chlorine, etc.

Clean sheaves of both pulleys using Pulley flange cleaner (P/N 413 711 809).

Inspect the hood and repair any damage.

Touch up all metal spots where paint has been scratched off. Spray all metal parts including shock chromed rods with XP-S Lube (P/N 293 600 016).

Wax painted portion of the vehicle for better protection.

NOTE: Apply wax on glossy finish only. Protect the vehicle with a cover to prevent dust accumulation during storage.

 **CAUTION** The snowmobile has to be stored in a cool and dry place and covered with an opaque tarpaulin. This will prevent sun rays and grime from affecting plastic components and vehicle finish.

Lift rear of vehicle until track is clear of the ground. Install on a wide-base snowmobile mechanical stand with a rear deflector panel.

WARNING

Do not attempt to lift the vehicle by hand alone. Use appropriate lifting device or have assistance to share lifting stress in order to avoid risk of strain injuries.

NOTE: Do not release track tension.

PRESEASON PREPARATION

PRESEASON PREPARATION (2-STROKE)	
ENGINE	Inspect engine rubber mounts
	Check exhaust system condition and check for leaks
	Tighten exhaust manifold screws or nuts to specified torque
	Inspect cooling system cap, hoses and clamps and check for leaks
	Check coolant density
	Inspect crankshaft PTO seal
FUEL SYSTEM	Inspect fuel lines and connections
	Inspect throttle cable
DRIVE SYSTEM AND BRAKE	Inspect drive belt (adjust at every drive belt replacement)
	Clean and visually inspect drive pulley
	Clean and inspect driven pulley
	Inspect, adjust and align track
	Adjust drive chain (Not for models equipped with gearbox)
	Change chaincase / gearbox oil
	Check brake fluid level
Inspect brake hose, pads and disk	
STEERING SYSTEM	Inspect steering mechanism
	Inspect skis and runners
SUSPENSION	Inspect front suspension
	Inspect rear suspension (including stopper straps and slider shoes)
ELECTRICAL SYSTEM	Inspect spark plugs (All except E-TEC)
	Charge battery (if so equipped)
	Adjust headlight beam aiming

To prepare your snowmobile, refer to an authorized LYNX dealer.

STORAGE

WARNING

Have an authorized LYNX dealer inspect fuel and oil systems integrity as specified in *PERIODIC MAINTENANCE CHART*.

During summer, or when a snowmobile is not in use for more than three months, proper storage is necessary.

STORAGE	
VEHICLE	Clean the vehicle
ENGINE	2-Stroke models: Lubricate engine. See owners guide for instruction.
	Block muffler with rags
	Add fuel stabilizer to fuel following the product manufacturer recommendations Run the engine after adding the product to the fuel
DRIVE SYSTEM AND BRAKE	Lubricate brake lever pivot
	Lift rear of vehicle until track is clear of the ground. Do not release track tension
SUSPENSION	Inspect and lubricate rear suspension
	Lubricate front and rear suspension
ELECTRICAL SYSTEM	Charge battery monthly to keep it fully charge during storage

Storage (E-TEC)

E-TEC Engines

It is during summer, or when a snowmobile is not in use for more than one month that proper storage is a necessity.

To prepare your snowmobile, refer to an authorized LYNX dealer.

Engine Cooling System

E-TEC Engines

Antifreeze should be replaced every 5 years or 6000 km to prevent antifreeze deterioration.

The antifreeze replacement and a density test should be performed by an authorized LYNX dealer.

 **CAUTION** Improper antifreeze mixture might allow freezing of the liquid in the cooling system if vehicle is stored in area where freezing point is reached. This would seriously damage the engine. Failure to replace the antifreeze for storage may allow its degradation that could result in poor cooling when engine will be used.

 **CAUTION** Do not run engine during storage period.

Engine Storage Mode

E-TEC Engines

Like other engines, the E-TEC has to be properly lubricated at storage for internal parts protection. The E-TEC

system offers a built-in engine storage lubrication function (summerization) that can be initiated by the operator.

To engage procedure, do the following:

1. Place the vehicle in a well ventilated area.
2. Start the engine and let it run at idle speed until it reaches its operating temperature (watch the coolant temperature on the display or verify the rear heat exchanger becomes warm.).
3. Push the SET (S) button to select odometer mode.



NOTE: The storage mode does not function in other modes (trip A, trip B and hr trip).

4. Repeatedly depress the HI/LOW beam switch rapidly, then, **while doing this**, press and hold the **SET button** until PUSH "S" appears on the display.

NOTE: It is critical for this procedure to depress the HI/LOW beam switch repeatedly **before** holding down the SET button.



5. Release all buttons when gauge displays **PUSH "S"** appears.

6. Again, press and hold the SET (S) button 2 - 3 seconds.

NOTE: The gauge will display OIL when the storage procedure is initiated.

7. When gauge displays **OIL**, release button and wait for the lubrication function to end.



Do not touch anything during engine lubrication cycle.

The engine lubrication function takes approximately 1 minute. During this time the engine RPM will increase slightly to approximately 1600 RPM and the oil pump will "oil flood" the engine.

At the end of engine lubrication procedure, the ECM will turn the engine off.

Remove tether cord.

NOTICE Do not start the engine during storage period.

TECHNICAL INFORMATION

VEHICLE IDENTIFICATION

Vehicle Description Decal

Vehicle description decal is located on right hand side of tunnel.



TYPICAL

1. Vehicle description decal

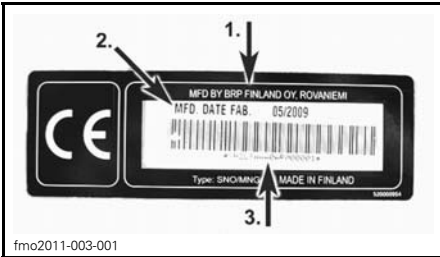

VEHICLE DESCRIPTION DECAL

1. Manufacturer name
2. Manufacturing date
3. Vehicle identification number (VIN)

Serial Numbers

The main components of your snowmobile (engine and frame) are identified by different serial numbers. It may sometimes become necessary to locate these numbers for warranty purposes or to trace your snowmobile in the event of loss. These numbers are required by the authorized Lynx dealer to complete warranty claims properly. No warranty will be allowed by BRP if the engine serial number or vehicle identification number (VIN) is removed or mutilated in any way. We strongly recommend that you take note of all the serial numbers on your snowmobile and supply them to your insurance company.

Vehicle Identification Number (VIN) Location

VIN is scribed on vehicle description decal. See above. It is also engraved on tunnel near vehicle description decal.

Model Number Location

Model number is part of vehicle identification number (VIN).

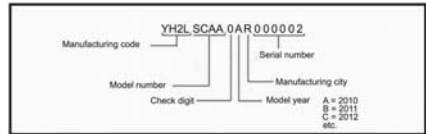

VIN DESCRIPTION

Engine Serial Number Location

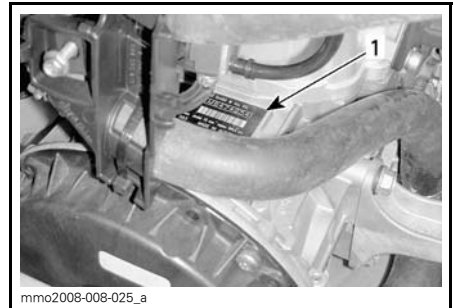

600 HO E-TEC® ENGINE — RH SIDE OF ENGINE COMPARTMENT

1. Engine serial number

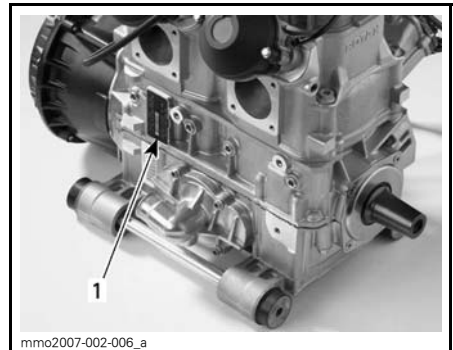

800R E-TEC ENGINE

1. Engine serial number

DECLARATION OF CONFORMITY

The EC-Declaration of Conformity does not appear in this version of the Operator's Guide.

Please refer to the printed version that was delivered with your vehicle.

Vibrations in the seat (EN 1032, ISO 5008), is less than 0,5 m/s².

Vibrations in the handle (EN 1032, ISO 5008), is less than 2,5 m/s².

SPECIFICATIONS

NOTE: Because of its ongoing commitment to product quality and innovation, BRP reserves the right, at any time, to make changes in design and specifications and/or to make additions to, or improvements in its products without imposing any obligation upon itself to install them on its products previously manufactured.

600 HO E-TEC Models

MODEL		600 HO E-TEC
ENGINE		
Engine type		Rotax 593, liquid cooled w/Reed valve, 3D-RAVE
Cylinders		2
Displacement		594.4 cm ³
Bore		72 mm
Stroke		73 mm
Maximum engine speed		8100 ± 100 RPM
Fuel injection system		E-TEC Direct injection
Exhaust system		Single tuned pipe, baffle muffler
Engine oil		Refer to <i>RECOMMENDED OIL</i> section. ⁽¹⁾
Engine oil tank capacity		3.7 L
Coolant		Use BRP PREMIXED COOLANT or coolant specifically designed for aluminum engines (P/N 619 590 183)
Recommended fuel		Premium unleaded (fuel which may contain up to 10% MAX ethanol)
Minimum octane rating. Refer to <i>FUEL REQUIREMENTS</i>		Regular unleaded
		95 E (RON) E10
Fuel tank capacity		38 L
DRIVE SYSTEM		
Drive pulley type		TRA III
Driven pulley type		QRS
Engagement	All models	3400 ± 100 RPM
Drive belt part number	All models	417 300 383 ⁽³⁾
Chaincase oil		XPS SYNTHETIC CHAINCASE OIL (P/N 413 803 300)

MODEL		600 HO E-TEC
DRIVE SYSTEM (cont'd)		
Small sprocket number of teeth	Rave	23 (38 track)
	Rave RE	25 (35 track)
	Xtrim SC	23
	Boondocker 3700	19
	Boondocker 3900	19
Large sprocket number of teeth Rave RE	Rave	45
	Rave RE	
	Xtrim SC	
	Boondocker 3700	49
Boondocker 3900		
Drive sprocket number of teeth		8
Track nominal width	Rave RE	390 mm
	Xtrim SC	406 mm
	Boondocker 3700	
	Boondocker 3900	
Track nominal length	Rave RE	326.9 cm
	Xtrim SC	370.5 cm
	Boondocker 3700	370.5 cm
	Boondocker 3900	392 cm
Track profile height	Rave RE	38 mm/35 mm
	Xtrim SC	39 mm
	Boondocker 3700	59 mm
	Boondocker 3900	
Track tension	Rave RE Deflection	25 mm - 35 mm
	Force ⁽²⁾	0 kg
Track tension	Rave RE Deflection	40 mm - 50 mm
	Force ⁽²⁾	7.3 kg
Track tension	Xtrim SC Deflection	35 mm - 45 mm
	Force ⁽²⁾	0 kg
Track tension	Xtrim SC Deflection	50 mm - 60 mm
	Force ⁽²⁾	7.3 kg

SPECIFICATIONS

MODEL		600 HO E-TEC
DRIVE SYSTEM (cont'd)		
Track tension	Boondocker 3700 Deflection	50 mm - 60 mm
	Force ⁽²⁾	0 kg
Track tension	Boondocker 3700 Deflection	75 mm - 85 mm
	Force ⁽²⁾	7.3 kg
Track tension	Boondocker 3900 Deflection	70 mm - 80 mm
	Force ⁽²⁾	0 kg
Track tension	Boondocker 3900 Deflection	90 mm - 100 mm
	Force ⁽²⁾	7.3 kg
Track alignment		Equal distance between edges of track guides and slider shoes
BRAKE SYSTEM		
Brake system type		Hydraulic, RE-X brake type
Brake fluid		DOT 4
SUSPENSION		
Front suspension	Rave RE	A- LFS +
	All except Rave RE	A- LFS
Front shock	Rave	HPG 36
	Rave RE	KYB 40 PB HLCR
	Xtrim SC	KYB 36 R
	BoonDocker 3700	HPG 36
	BoonDocker 3900	HPG 36
Front suspension max. travel	Rave Rave RE	242 mm
	Xtrim SC	210 mm
	BoonDocker 3700	190 mm
	BoonDocker 3900	190 mm

MODEL		600 HO E-TEC
SUSPENSION (cont'd)		
Rear suspension	Rave	PPS 3300
	Rave RE	PPS2 3300
	Xtrim SC	PPS 3700
	BoonDocker 3700	PPS 3700 DS
	BoonDocker 3900	PPS 3900 DS
Center shock	Rave	HPG 36
	Rave RE	KYB 46 PB HLCR
	Xtrim SC	KYB 36
	BoonDocker 3700	HPG 36
	BoonDocker 3900	HPG 36
Rear shock	Rave	HPG 36
	Rave RE	KYB 46 PB HLCR
	Xtrim SC	KYB 46
	BoonDocker 3700	HPG 36
	BoonDocker 3900	HPG 36
Rear suspension max. travel	All	390 mm
ELECTRICAL SYSTEM		
Lightning system output		12V/55V/1200W
Headlights bulb HI/LOW beam		2 x 60/55 Watts (H-4)
Taillight bulb		Led
Spark plug	Type	NGK PZFR6F ⁽³⁾
	Gap	Not adjustable (0.8 +0/-0.1mm) 0.75 mm ± 0.05 mm (not adjustable)
Fuse		Refer to <i>FUSES</i> in <i>MAINTENANCE</i>

SPECIFICATIONS

MODEL		600 HO E-TEC
DIMENSIONS AND WEIGHT		
Vehicle overall length	Rave Rave RE	300 cm
	Xtrim SC	320 cm
	BoonDocker 3700	320 cm
	BoonDocker 3900	330.5 cm
Vehicle overall width	Rave Rave RE	125.5 cm
	Xtrim SC	116.5 cm + 4.2 cm
	BoonDocker 3700 BoonDocker 3900	111.5 cm + 2.1 cm
Vehicle overall height	Rave Rave RE	119.5 cm
	Xtrim SC	131.5 cm
	BoonDocker 3700	124 cm
	BoonDocker 3900	124 cm
Dry weight	Rave	216 kg
	Rave RE Series	217 kg - 230 kg
	Xtrim SC	233 kg
	BoonDocker 3700 Series	226 kg - 237 kg
	BoonDocker 3900 Series	229 kg - 239 kg
Ski stance	Rave Rave RE	1 070 mm
	Xtrim SC	975 mm +42 mm
	BoonDocker 3700 BoonDocker 3900	930 mm+ 21 mm
Ski width	All	188 mm

(1) Refer to *INJECTION OIL* subsection for detailed information.

(2) Measure gap between slider shoe and bottom inside track when exerting a downward pull to the track.

(3) **NOTICE** Do not attempt to adjust gap on this spark plug.

800R E-TEC Models

MODEL		800R E-TEC
ENGINE		
Engine type		Rotax 797, liquid cooled w/Reed valve, 3D-RAVE
Cylinders		2
Displacement		799.5 cm ³
Bore		82 mm
Stroke		75.7 mm
Maximum engine speed		7900 RPM
Fuel injection system		E-TEC Direct injection
Exhaust system		Single tuned pipe, baffle muffler
Engine oil		Refer to <i>RECOMMENDED OIL</i> section
Engine oil tank capacity		3.7 L
Coolant	Mixture	Ethyl glycol/water mix (50% coolant, 50% distilled water). Use coolant specifically designed for aluminum engines
	Premix	Use BRP PREMIXED COOLANT or coolant specifically designed for aluminum engines (P/N 619 590 183)
Recommended fuel		Premium unleaded (fuel which may contain up to 10% MAX ethanol)
Minimum octane rating. Refer to <i>FUEL REQUIREMENTS</i>		Regular unleaded
		95 E (RON) E10
Fuel tank capacity		38 L
DRIVE SYSTEM		
Drive pulley type		TRA VII
Driven pulley type		QRS
Drive belt part number		417300391 ⁽³⁾
Engagement		3800 ± 100 RPM
Chaincase oil		XPS SYNTHETIC CHAINCASE OIL
Small sprocket number of teeth	Rave RE	23 (44 track)
		25 (38 track)
	Boondocker RE 3700	21
	Boondocker DS 3900	19

SPECIFICATIONS

MODEL		800R E-TEC
DRIVE SYSTEM (cont'd)		
Large sprocket number of teeth	Rave Re	45
	Boondocker RE 3700	49
	Boondocker DS 3900	49
Drive sprocket number of teeth		8
Track nominal width	Rave RE	38 cm
	Boondocker RE 3700 Boondocker DS 3900	40.6 cm
Track nominal length	Rave Re	326.9 cm
	Boondocker RE 3700	370.5 cm
	Boondocker DS 3900	392.3 cm
Track profile height	Rave RE	38 mm
	Boondocker 3700	59 mm
	Boondocker DS 3900	64 mm
Track tension	Rave RE Deflection	25 mm - 35 mm
	Force ⁽²⁾	0 kg
Track tension	Rave RE Deflection	40 mm - 50 mm
	Force ⁽²⁾	7.3 kg
Track tension	Boondocker 3700 Deflection	50 mm - 60 mm
	Force ⁽²⁾	0 kg
Track tension	Boondocker 3700 Deflection	75 mm - 85 mm
	Force ⁽²⁾	7.3 kg
Track tension	Boondocker 3900 Deflection	70 mm - 80 mm
	Force ⁽²⁾	0 kg
Track tension	Boondocker 3900 Deflection	90 mm - 100 mm
	Force ⁽²⁾	7.3 kg
Track alignment		Equal distance between edges of track guides and slider shoes

MODEL		800R E-TEC
BRAKE SYSTEM		
Brake system type		Brembo/ hydraulic caliper, self-adjustable/disk
Brake fluid		DOT 4
SUSPENSION		
Front suspension	Rave RE	A- LFS +
	All except Rave RE	A- LFS
Front shock	Rave RE	KYB 40 PB HLCR
	Boondocker RE 3700	KYB 40 PB HLCR
	Boondocker DS 3900	KYB 36 R
Front suspension max. travel	Rave RE	242 mm
	Boondocker RE 3700	210 mm
	Boondocker DS 3900	190 mm
Rear suspension	Rave RE	PPS2 3300
	Boondocker RE 3700	PPS2 3700 DS
	Boondocker DS 3900	PPS2 3900 DS
Center shock	Rave RE	KYB 46 PB HLCR
	Boondocker RE 3700	KYB 36
	Boondocker DS 3900	KYB 36
Rear shock	Rave RE	KYB 46 PB HLCR
	Boondocker RE 3700	KYB 46 PB HLCR
	Boondocker DS 3900	KYB 46
Rear suspension max. travel	All	390 mm
ELECTRICAL SYSTEM		
Lightning system output		12V / 55V / 1200 W
Headlights bulb HI/LOW beam		2 x 60/55 Watts (H-4)
Taillight bulb		LED
Spark plug	Type	NGK PFR7AB ⁽³⁾
	Gap	Not adjustable (0.80 ± 0.05 mm)
Fuse		Refer to <i>FUSES</i> in <i>MAINTENANCE</i>

SPECIFICATIONS

MODEL		800R E-TEC
DIMENSIONS AND WEIGHT		
Vehicle overall length	Rave RE	300 cm
	Boondocker RE 3700	320 cm
	Boondocker DS 3900	330.5 cm
Vehicle overall width	Rave RE	125.5 cm
	Boondocker RE 3700	119 cm + 2.1 cm
	Boondocker DS 3900	119 cm / 111.5 cm + 2.1 cm
Vehicle overall height	Rave RE	119.5 cm
	Boondocker RE 3700	124 cm
	Boondocker DS 3900	124 cm
Dry weight	Rave RE Series	224 kg - 236 kg
	Boondocker RE 3700 Series	237 kg - 248 kg
	Boondocker DS 3900 Series	231 kg - 241 kg
Ski stance	Rave RE	1 070 mm
	Boondocker RE 3700	1 005 mm + 21 mm
	Boondocker DS 3900	930 mm / 1 005 mm + 21 mm
Ski width	All	188 mm

(1) Refer to *INJECTION OIL* subsection for detailed information.

(2) Measure gap between slider shoe and bottom inside track when exerting a downward pull to the track.

(3) **NOTICE** Do not attempt to adjust gap on this spark plug.

TROUBLESHOOTING

TROUBLESHOOTING GUIDELINES (600 HO E-TEC AND 800R E-TEC)

ELECTRIC STARTER DOES NOT WORK

1. Emergency engine stop switch in OFF position or tether cord cap not installed on engine cut-off switch.
 - *Place the emergency engine stop switch in the ON position and install tether cord cap (on engine cut-off switch).*
2. Throttle applied while attempting an engine start.
 - *Release throttle while cranking.*

ENGINE IS CRANKED BUT FAILS TO START

1. No fuel to the engine.
 - *Check fuel tank level, add fuel if necessary.*
2. System voltage too low.
 - *Contact an authorized Lynx dealer.*

ENGINE RPM DOES NOT REACH CLUTCH ENGAGEMENT POINT

1. D.E.S.S. did not read D.E.S.S. key code in the tether cord cap. D.E.S.S. pilot lamp blinks (slow short beeps/repetitive).
 - *Properly install tether cord cap.*
2. D.E.S.S. has read a different code than the one programmed. D.E.S.S. pilot lamp blinks rapidly (fast short beeps/repetitive).
 - *Install a tether cord cap for which this snowmobile was programmed.*

ENGINE LACKS POWER

1. Engine warm-up in progress.
 - *Drive vehicle at low speeds for a few minutes.*
2. Engine break-in period not completed.
 - *Complete break-in period.*
3. Incorrect drive pulley adjustment.
 - *Adjust drive pulley, refer to MAINTENANCE PROCEDURES.*
4. Drive and driven pulleys require servicing.
 - *Contact an authorized Lynx dealer.*
5. Engine overheats.
 - *Check coolant level, see MAINTENANCE PROCEDURES.*
 - *Check heat exchangers cleanliness. Clean if necessary.*
6. Drive belt worn too thin.
 - *If the drive belt has lost more than 3 mm (1/8 in) of its original width, it will affect vehicle performance.*
 - *Replace drive belt.*
7. Incorrect track adjustment.
 - *See MAINTENANCE and/or an authorized Lynx dealer for proper alignment and tension adjustments.*

ENGINE LACKS POWER (cont'd)

8. **R.A.V.E. valves problem.**
 - *Contact an authorized Lynx dealer.*
9. **Fuel pressure too low.**
 - *Contact an authorized Lynx dealer.*

ENGINE BACKFIRES

1. **Engine is running too hot.**
 - *See item 5 of ENGINE LACKS POWER.*
2. **Ignition timing is incorrect or there is an ignition system failure.**
 - *Contact an authorized Lynx dealer.*
3. **Exhaust system leak.**
 - *Contact an authorized Lynx dealer.*
4. **Fuel pressure too low.**
 - *Contact an authorized Lynx dealer.*

ENGINE MISFIRES

1. **Water in fuel.**
 - *Drain fuel system and refill with fresh fuel.*
2. **RAVE valves malfunction.**
 - *Have RAVE valves system inspected by an authorized Lynx dealer.*

NO RESPONSE FROM THE THROTTLE LEVER INPUTS. MESSAGE DISPLAYED: PRESS START TO GO

1. **Engine management system has detected a sensor problem.**
 - *Press and hold the Start/electronic reverse button in order to move vehicle. Contact an authorized Lynx dealer.*

HEATED GRIPS/THUMB WARMERS ARE NOT WORKING

1. **Engine RPM is too low.**
 - *Make sure engine RPM is above 2000.*

ENGINE HAS SHUT DOWN

1. **The engine shuts down after long periods of idling.**
 - *Do not let engine idle too long. Refer to VEHICLE WARM-UP in OPERATING INSTRUCTION.*

MONITORING SYSTEM

Pilot Lamps, Messages and Beeper Codes

Gauge pilot lamp(s) will inform you if an anomaly occurs or to inform you of a particular condition.



TYPICAL — PILOT LAMPS

Pilot lamp can flash alone or in combination with another lamp.

On the multifunction analog/digital gauge, the display is used as a complement of the pilot lamps to give you a brief description if an anomaly occurs or to inform you of a particular condition.

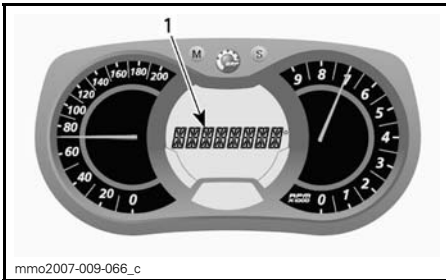

1. Message display

Messages will be displayed with a beep code and pilot lamp(s).

Beeper codes will be heard and messages (depending on gauge model) will be displayed to catch your attention.

See table below for details.

NOTE: Some of the listed pilot lamps and messages do not apply to all models. The message display is available only on the multifunction analog/digital gauge.

PILOT LAMP(S) ON	BEEPER	MESSAGE DISPLAY	DESCRIPTION
	4 short beeps every 5 minutes	LOW OIL	Injection oil level is low. Stop vehicle in a safe place then, replenish injection oil reservoir.
	4 short beeps every 30 seconds	ENGINE OVERHEAT	Engine is overheating, reduce snowmobile speed and run in loose snow or stop engine immediately and let engine cool down. Check coolant level, refer to <i>MAINTENANCE</i> . If coolant level is correct and overheating persists, contact an authorized Lynx dealer. Do not run the engine if condition persists.
		MUFFLER	Reduce speed or stop engine. Let engine cool down and restart. If overheating persists, contact an authorized Lynx dealer. Do not run the engine if condition persists.
	Short beeps repeating rapidly	ENGINE OVERHEAT	Critical overheat. Stop engine immediately and let engine cool down. Check coolant level, refer to <i>MAINTENANCE</i> . If coolant level is correct and overheating persists, contact an authorized Lynx dealer. Do not run the engine if condition persists.
		MUFFLER OVERHEAT	Critical overheat. Stop engine immediately and let engine cool down. If overheating persists, contact an authorized Lynx dealer. Do not run the engine if condition persists. Do not run the engine if condition persists.
		ECM OVERHEAT	
	4 short beeps every 5 minutes	LOW BAT	Indicate a low or high battery voltage condition. See an authorized Lynx dealer as soon as possible.
		HIGH BAT	
	4 short beeps	CHECK ENGINE	Engine fault, see an authorized Lynx dealer as soon as possible.
	—		Displayed when brake is applied for more than 15 seconds while throttle lever is squeezed and vehicle is moving at more than 5 km/h.

PILOT LAMP(S) ON	BEEPER	MESSAGE DISPLAY	DESCRIPTION
—	4 short beeps every 5 minutes	KNOCK	Engine detonation (RPM is limited when this condition occurs). <ul style="list-style-type: none"> – Ensure recommended fuel is used. – Check fuel quality, replace if necessary. – If fault still occurs, contact an authorized Lynx dealer.
—	4 short beeps every 5 minutes	REV LIMIT	Engine RPM limited for protection when certain faults occur.
—	—	OVER REV	On E-TEC engines, indicates that maximum engine RPM is reached. Check clutch calibration.
—	Short beeps repeating rapidly	SHUTDOWN	Shutdown procedure in force due to engine overheating or fuel pump problem, remove tether cord cap from engine cut-off switch and contact an authorized Lynx dealer.
—	—	COMMUNICATION	Communication problem between ECM and gauge. Stop engine, remove tether cord cap. Wait a few minutes, then start engine. If problem persists, contact an authorized Lynx dealer.
DESS	2 short beeps	—	Good key, vehicle ready to operate.
	2 short beeps, repeating slowly	CHECK KEY	Unable to read key (bad connection). Make sure the key is clean and correctly snapped on post.
	Short beeps repeating rapidly	BAD KEY	Invalid key or key not programmed. Use the proper key for the vehicle or have the programmed.
—	—	 (blinking)	Fuel level sensor problem.

Fault Codes

Multifunction Analog/Digital Display Only

To read any active fault code, press and hold MODE (M) Button and simultaneously depress the HI/LOW beam switch repeatedly several times.

If two or more codes are registered, use SET (S) or MODE (M) to scroll.
To exit the fault codes mode, press and hold MODE (M) button.
Contact an authorized Lynx dealer for code signification.

WARRANTY

BRP FINLAND OY INTERNATIONAL LIMITED WARRANTY: 2015 LYNX® SNOWMOBILES

1) SCOPE OF THE LIMITED WARRANTY

BRP Finland Oy ("BRP") warrants its 2015 LYNX snowmobiles from defects in material or workmanship for the period and under the conditions described below.

All genuine LYNX parts and accessories, installed by an authorized BRP distributor/dealer (as hereinafter defined) at the time of delivery of the 2015 LYNX snowmobile, carry the same warranty as that of the snowmobile.

Use of the product for racing or any other competitive activity, at any point, even by a previous owner, will render this warranty null and void.

2) WARRANTY COVERAGE PERIOD

This warranty will be in effect from the date of delivery to the first retail consumer or the date the product is first put into use, whichever occurs first and for a period of:

A) TWELVE (12) CONSECUTIVE MONTHS, for private use owners

B) TWELVE (12) CONSECUTIVE MONTHS, for commercial use owners

C) TWENTY FOUR (24) CONSECUTIVE MONTHS, for private use owners when product was sold in a member state of the European Union and Russia. The repair or replacement of parts or the performance of service under this warranty does not extend the life of this warranty beyond its original expiration date.

3) CONDITIONS TO HAVE WARRANTY COVERAGE

This warranty coverage is available only on 2015 LYNX snowmobile purchased as new and unused by its first owner from a BRP distributor/dealer authorized to distribute LYNX products in the country in which the sale occurred ("BRP distributor/dealer"), and then only after the BRP specified pre-delivery inspection process is completed and documented. Warranty coverage only becomes available upon proper registration of the product by an authorized BRP distributor/dealer. Moreover, this warranty coverage is only available if the LYNX snowmobile is purchased in the country in which the purchaser resides. BRP will not honor this limited warranty to any private use owner or commercial use owner if the preceding conditions have not been met. Such limitations are necessary in order to allow BRP to preserve both the safety of its products, and also that of its consumers and the general public.

Routine maintenance outlined in the Operator's Guide must be timely performed in order to maintain warranty coverage. BRP reserves the right to make warranty coverage contingent upon proof of proper maintenance.

4) WHAT TO DO TO OBTAIN WARRANTY COVERAGE

The customer must notify a servicing BRP distributor/dealer within two (2) months of the appearance of a defect, and provide it with reasonable access to the product and reasonable opportunity to repair it. The customer must also present to the authorized BRP distributor/dealer, proof of purchase of the product and must sign the repair/work order prior to starting the repair in order to validate the warranty repair. All parts replaced under this limited warranty become the property of BRP.

5) WHAT BRP WILL DO

BRP's obligations under this warranty are limited to, at its sole discretion, repairing parts found defective under normal use, maintenance and service, or replacing such parts with new genuine LYNX parts without charge for parts and labor, at any authorized BRP distributor/dealer during the warranty coverage period.

BRP reserves the right to improve or modify products from time to time without assuming any obligation to modify products previously manufactured.

6) EXCLUSIONS

The following are not warranted under any circumstances:

- Normal wear and tear;
- Routine maintenance items, tune ups, adjustments;
- Damage caused by failure to provide proper maintenance and/or storage, as described in the Operator's Guide;
- Damage resulting from removal of parts, improper repairs, service, maintenance, modifications or use of parts not manufactured or approved by BRP or resulting from repairs done by a person that is not an authorized servicing BRP distributor/dealer;
- Damage caused by abuse, abnormal use, neglect, use of the product on surfaces other than snow, or operation of the product in a manner inconsistent with the recommended operation described in the Operator's Guide;
- Damage resulting from accident, submersion, fire, theft, vandalism or any act of God;
- Operation with fuels, oils or lubricants which are not suitable for use with the product (see the Operator's Guide);
- Snow or water ingestion;
- Incidental or consequential damages, or damages of any kind including without limitation towing, storage, telephone, rental, taxi, inconvenience, insurance coverage, loan payments, loss of time, loss of income; and
- Damage resulting from studs installed on tracks if the installation does not conform to BRP's instructions.

7) LIMITATIONS OF LIABILITY

THIS WARRANTY IS EXPRESSLY GIVEN AND ACCEPTED IN LIEU OF ANY AND ALL OTHER WARRANTIES, EXPRESSED OR IMPLIED, INCLUDING WITHOUT LIMITATION ANY WARRANTY OF MERCHANTABILITY OR FITNESS FOR A PARTICULAR PURPOSE. TO THE EXTENT THAT THEY CANNOT BE DISCLAIMED, THE IMPLIED WARRANTIES ARE LIMITED IN DURATION TO THE LIFE OF THE EXPRESS WARRANTY. INCIDENTAL AND CONSEQUENTIAL DAMAGES ARE EXCLUDED FROM COVERAGE UNDER THIS WARRANTY. SOME STATES/ PROVINCES DO NOT ALLOW FOR THE DISCLAIMERS, LIMITATIONS AND EXCLUSIONS IDENTIFIED ABOVE, AS A RESULT, THEY MAY NOT APPLY TO YOU. THIS WARRANTY GIVES YOU SPECIFIC RIGHTS, AND YOU MAY ALSO HAVE OTHER LEGAL RIGHTS WHICH MAY VARY FROM STATE TO STATE, OR PROVINCE TO PROVINCE.

Neither the distributor, any BRP distributor/dealer nor any other person has been authorized to make any affirmation, representation or warranty regarding the product, other than those contained in this limited warranty, and if made, shall not be enforceable against BRP.

BRP reserves the right to modify this warranty at any time, being understood that such modification will not alter the warranty conditions applicable to the products sold while this warranty is in effect.

8) TRANSFER

If the ownership of a product is transferred during the warranty coverage period, this warranty shall also be transferred and be valid for the remaining coverage period provided BRP or an authorized BRP distributor / dealer receives a proof that the former owner agreed to the transfer of ownership, in addition to the co-ordinates of the new owner.

9) CONSUMER ASSISTANCE

1. In the event of a controversy or a dispute in connection with this limited warranty, BRP suggests that you try to resolve the issue at the dealership level. We recommend discussing the issue with the authorized distributor/dealer's service manager or owner.
2. If further assistance is required, the distributor's service department should be contacted in order to resolve the matter.
3. If the matter still remains unresolved then contact BRP by writing to us at the address below.

ADDRESS:

BRP-FINLAND OY
SERVICE DEPARTMENT
P.O. BOX 8039
FIN-96101 ROVANIEMI
FINLAND

© 2014 Bombardier Recreational Products Inc. All rights reserved.

® Registered trademark of Bombardier Recreational Products Inc.

MAINTENANCE RECORDS

Send photocopy of maintenance record to BRP if needed.

PREDELIVERY	
Serial number: _____ Mileage / km: _____ Hours: _____ Date: _____ Dealer no: _____ Notes: _____	Signature/Print: _____
Refer to vehicle Pre-Delivery Bulletin for detailed installation procedures	

10 H SERVICE (BREAK IN INSPECTION)	
Serial number: _____ Mileage / km: _____ Hours: _____ Date: _____ Dealer no: _____ Notes: _____	Signature/Print: _____
For maintenance schedule refer to Maintenance Information section of this operator's guide	

SERVICE	
Serial number: _____ Mileage / km: _____ Hours: _____ Date: _____ Dealer no: _____ Notes: _____	Signature/Print: _____
For maintenance schedule refer to Maintenance Information section of this operator's guide	

SERVICE	
Serial number: _____ Mileage / km: _____ Hours: _____ Date: _____ Dealer no: _____ Notes: _____	Signature/Print: _____
For maintenance schedule refer to Maintenance Information section of this operator's guide	

SERVICE

Serial number: _____
Mileage / km: _____
Hours: _____
Date: _____
Dealer no: _____
Notes: _____

Signature/Print: _____

For maintenance schedule refer to Maintenance Information section of this operator's guide

SERVICE

Serial number: _____
Mileage / km: _____
Hours: _____
Date: _____
Dealer no: _____
Notes: _____

Signature/Print: _____

For maintenance schedule refer to Maintenance Information section of this operator's guide

SERVICE

Serial number: _____
Mileage / km: _____
Hours: _____
Date: _____
Dealer no: _____
Notes: _____

Signature/Print: _____

For maintenance schedule refer to Maintenance Information section of this operator's guide

SERVICE

Serial number: _____
Mileage / km: _____
Hours: _____
Date: _____
Dealer no: _____
Notes: _____

Signature/Print: _____

For maintenance schedule refer to Maintenance Information section of this operator's guide

SERVICE	
Serial number: _____ Mileage / km: _____ Hours: _____ Date: _____ Dealer no: _____ Notes: _____ _____	Signature/Print: _____
For maintenance schedule refer to Maintenance Information section of this operator's guide	

SERVICE	
Serial number: _____ Mileage / km: _____ Hours: _____ Date: _____ Dealer no: _____ Notes: _____ _____	Signature/Print: _____
For maintenance schedule refer to Maintenance Information section of this operator's guide	

SERVICE	
Serial number: _____ Mileage / km: _____ Hours: _____ Date: _____ Dealer no: _____ Notes: _____ _____	Signature/Print: _____
For maintenance schedule refer to Maintenance Information section of this operator's guide	

SERVICE	
Serial number: _____ Mileage / km: _____ Hours: _____ Date: _____ Dealer no: _____ Notes: _____ _____	Signature/Print: _____
For maintenance schedule refer to Maintenance Information section of this operator's guide	

PRIVACY OBLIGATIONS/DISCLAIMER

We wish to inform you that your coordinates will be used for safety and warranty purposes. Sometimes, we also use the coordinates of our clients to inform them about our products and to present them offers. Should you prefer not to receive information on our products, services and offers, please let us know by writing to the address below.

Also note that, from time to time, carefully selected and trustworthy organizations may be permitted to use the coordinates of our clients to promote quality products and services. If you prefer not to have your name and address released, please let us know by writing to the address below:

FOR SCANDINAVIAN AND EUROPEAN COUNTRIES:

BRP FINLAND OY
Service Department
Isoaavantie 7
FIN-96320 Rovaniemi
Finland
Fax +358 16 3420 316

CHANGE OF ADDRESS/OWNERSHIP

If your address has changed or if you are the new owner of the vehicle, be sure to notify BRP by either:

- mailing one of the cards hereinafter using of the following mail address;
- contacting an authorized LYNX dealer or distributor.

Mail address:

FOR SCANDINAVIAN AND EUROPEAN COUNTRIES:

BRP FINLAND OY
Service Department
Isoaavantie 7
FIN-96320 Rovaniemi
Finland
Fax: +358 16 3420 316

In case of change of ownership, please join a proof that the former owner agreed to the transfer.

Notifying BRP, even after the expiration of the limited warranty, is very important as it enables BRP to reach the vehicle owner if necessary, like when safety recalls are initiated. It is the owner's responsibility to notify BRP.

STOLEN UNITS: If your personal vehicle is stolen, you should notify BRP or an authorized LYNX dealer. We will ask you to provide your name, address, phone number, the vehicle identification number and the date it was stolen.

VEHICLE MODEL No. _____

VEHICLE IDENTIFICATION NUMBER (V.I.N.) _____

ENGINE IDENTIFICATION NUMBER (E.I.N.) _____

Owner: _____
NAME

No. STREET APT

CITY STATE/PROVINCE ZIP/POSTAL CODE

Purchase Date _____
YEAR MONTH DAY

Warranty Expiry Date _____
YEAR MONTH DAY

To be completed by the dealer at the time of the sale.

DEALER IMPRINT AREA



brp.com

LYNX



© TM and the BRP logo are trademarks of Bombardier Recreational Products Inc. or its affiliates.