

LYNX®



2006

619 900 019

Operator's manual

OPERATOR'S MANUAL LYNX 2006

Rave 440

Rave 550

Rave 600

Rave RC 600 SDI

Rave RC 800 Power Tek

Adventure 550

Adventure 600

Adventure 600 SDI

XTRIM 550

XTRIM 600 SDI

XTRIM 800 Power Tek

Content

| | |
|---|-----------|
| SAFETY MEASURES | 5 |
| WARRANTY | 6 |
| HOW TO IDENTIFY YOUR SNOWMOBILE | 9 |
| Vehicle serial number | 9 |
| Engine serial number | 9 |
| CONTROLS / INSTRUMENTS | 10 |
| 1. Throttle lever | 13 |
| 2. Brake lever | 13 |
| 3. Parking brake lever | 13 |
| 4. Brake / parking brake / low oil level pilot lamp (Red) | 14 |
| 5. RER button | 14 |
| 6. Handle bar | 16 |
| 7. Ignition switch / START/RER button | 16 |
| 8. Tether cut-out switch | 18 |
| 9. DESS pilot lamp | 20 |
| 10. Engine cut-out switch | 20 |
| 11. Headlamp dimmer switch | 21 |
| 12. High beam pilot lamp (Blue) | 21 |
| 13. Rewind starter handle | 23 |
| 14. Choke lever | 23 |
| 15. Speedometer | 24 |
| 16. Odometer | 24 |
| 17. Trip meter | 24 |
| 18. Trip meter reset button/mode button | 24 |
| 19. Fuel tank cap/gauge | 25 |
| 20. Heated grip | 26 |
| 21. Heated throttle lever switch | 26 |
| 22. Hood opening | 27 |
| 23. Power outlet | 29 |
| 24. Fuse | 29 |
| 25. Front grab handle/Front bumper | 31 |
| 26. Storage compartment | 31 |
| 27. Rear rack | 32 |
| 28. Tool kit | 32 |
| 29. Spark plug holder | 33 |
| 30. Hitch | 33 |
| 31. Adjustable suspension | 34 |
| Suspension troubleshooting | 40 |
| In deep snow | 40 |
| FUEL AND OIL | 40 |
| Recommended fuel | 40 |

| | |
|---|-----------|
| Recommended oil | 41 |
| Cold weather carburetion modifications | 41 |
| BREAK-IN PERIOD | 42 |
| Engine | 42 |
| Drive belt | 42 |
| 10 hour inspection | 42 |
| PRE-OPERATION CHECK | 43 |
| CHECK LIST | 43 |
| OPERATION INSTRUCTIONS | 43 |
| Operations | 43 |
| Starting the engine | 44 |
| Manual starting | 45 |
| Shutting off the engine | 47 |
| Vehicle warm-up | 47 |
| POST-OPERATION CARE | 48 |
| SPECIAL OPERATIONS | 48 |
| Riding at high altitudes | 48 |
| Engine overheating | 48 |
| Fuel flooded engine | 48 |
| Rear suspension slider shoe sticking | 48 |
| FLUID LEVELS | 49 |
| Brake system | 49 |
| Chain case oil level/Gearbox oil level | 49 |
| Oil injection system | 50 |
| Cooling system | 51 |
| Battery | 51 |
| MAINTENANCE | 50 |
| Vehicle cleaning and protection | 52 |
| Belt guard removal and installation | 53 |
| Drive belt removal and installation | 55 |
| Drive chain tension | 56 |
| TRA drive pulley adjustment | 57 |
| Drive belt condition | 58 |
| Brake condition | 58 |
| Brake adjustment | 58 |
| Rear suspension condition | 59 |
| Suspension stopper strap condition | 59 |
| Track condition | 59 |
| Track tension and alignment | 59 |
| Steering and front suspension mechanism | 61 |
| Wear and condition of skis and runners | 61 |

| | |
|--|-----------|
| Exhaust system | 61 |
| Air filter cleaning | 61 |
| Headlight | 62 |
| STORAGE AND PRE-SEASON PREPARATION..... | 65 |
| Storage | 65 |
| Pre-season preparation | 65 |
| TROUBLESHOOTING | 66 |
| SERVICE SCEDULE | 69 |
| TECH DATA | 70 |

Safety measures

- * For vehicle with a parking brake, always engage brake when snowmobile is not in use.**
- * Throttle mechanism should be checked for free movement before starting engine.**
- * The snowmobile can be stopped by activating the emergency cut-out switch or pulling the tether cord.**
- * Engine should be running only when belt guard is secured in place. Never run the engine without drive belt installed. Running an unloaded engine can prove to be dangerous.**
- * Never run the engine when the track is raised off the ground or with the hood opened or removed.**
- * Do not stud the track if not accepted by BRP. At speed it may cause the track to tear and separate from vehicle posing a risk of severe injury or death.**
- * Never start the engine in closed area or indoors.**
- * Maintain your snowmobile in top mechanical condition at all times.**
- * Snowmobile is not designed to be operated on public streets, roads or highways. In most countries it is considered an illegal operation.**
- * Never charge or boost battery while installed on snowmobile.**
- * Do not lubricate throttle and/or brake cables and housings.**

BRP FINLAND OY INTERNATIONAL LIMITED WARRANTY: 2006 LYNX® SNOWMOBILES

1. SCOPE OF THE LIMITED WARRANTY

BRP Finland Oy ("BRP") warrants its 2006 LYNX snowmobiles from defects in material or workmanship for the period and under the conditions described below.

All genuine LYNX parts and accessories, installed by an authorized BRP distributor/dealer (as hereinafter defined) at the time of delivery of the 2006 LYNX snowmobile, carry the same warranty as that of the snowmobile.

Use of the product for racing or any other competitive activity, at any point, even by a previous owner, will render this warranty null and void.

2. WARRANTY COVERAGE PERIOD

This warranty will be in effect from the date of delivery to the first retail consumer or the date the product is first put into use, whichever occurs first and for a period of:

- A) TWELVE (12) CONSECUTIVE MONTHS, for private use owners
- B) TWELVE (12) CONSECUTIVE MONTHS, for commercial use owners
- C) TWENTY FOUR (24) CONSECUTIVE MONTHS, for private use owners when product was sold in a member state of the European Union.

The repair or replacement of parts or the performance of service under this warranty does not extend the life of this warranty beyond its original expiration date.

3. CONDITIONS TO HAVE WARRANTY COVERAGE

This warranty coverage is available only on 2006 LYNX snowmobile purchased as new and unused by its first owner from a BRP distributor/dealer authorized to distribute LYNX products in the country in which the sale occurred ("BRP distributor/dealer"), and then only after the BRP specified pre-delivery inspection process is completed and documented. Warranty coverage only becomes available upon proper registration of the product by an authorized BRP distributor/dealer. Moreover, this warranty coverage is only available if the LYNX snowmobile is purchased in the country or union of countries in which the purchaser resides. BRP will not honor this limited warranty to any private use owner or commercial use owner if the preceding conditions have not been met. Such limitations are necessary in order to allow BRP to preserve both the safety of its products, and also that of its consumers and the general public.

Routine maintenance outlined in the Operator's Guide must be timely performed in order to maintain warranty coverage. BRP reserves the right to make warranty coverage contingent upon proof of proper maintenance.

4. WHAT TO DO TO OBTAIN WARRANTY COVERAGE

The customer must notify a servicing BRP distributor/dealer within two (2) months of the appearance of a defect, and provide it with reasonable access to the product and reasonable opportunity to repair it. The customer must also present to the authorized BRP distributor/dealer, proof of purchase of the product and must sign the repair/work order prior to starting the repair in order to validate the warranty repair. All parts replaced under this limited warranty become the property of BRP.

5. WHAT BRP WILL DO

BRP's obligations under this warranty are limited to, at its sole discretion, repairing parts found defective under normal use, maintenance and service, or replacing such parts with new genuine LYNX parts without charge for parts and labor, at any authorized BRP distributor/dealer during the warranty coverage period.

BRP reserves the right to improve or modify products from time to time without assuming any obligation to modify products previously manufactured.

6. EXCLUSIONS

The following are not warranted under any circumstances:

- Normal wear and tear;
- Routine maintenance items, tune ups, adjustments;
- Damage caused by failure to provide proper maintenance and/or storage, as described in the Operator's Guide;
- Damage resulting from removal of parts, improper repairs, service, maintenance, modifications or use of parts not manufactured or approved by BRP or resulting from repairs done by a person that is not an authorized servicing BRP distributor/dealer;
- Damage caused by abuse, abnormal use, neglect, use of the product on surfaces other than snow, or operation of the product in a manner inconsistent with the recommended operation described in the Operator's Guide;
- Damage resulting from accident, submersion, fire, theft, vandalism or any act of God;
- Operation with fuels, oils or lubricants which are not suitable for use with the product (see the Operator's Guide);
- Snow or water ingestion;
- Incidental or consequential damages, or damages of any kind including without limitation towing, storage, telephone, rental, taxi, inconvenience, insurance coverage, loan payments, loss of time, loss of income; and
- Damage resulting from studs installed on tracks if the installation does not conform to BRP's instructions.

7. LIMITATIONS OF LIABILITY

THIS WARRANTY IS EXPRESSLY GIVEN AND ACCEPTED IN LIEU OF ANY AND ALL OTHER WARRANTIES, EXPRESSED OR IMPLIED, INCLUDING WITHOUT LIMITATION ANY WARRANTY OF MERCHANTABILITY OR FITNESS FOR A PARTICULAR PURPOSE. TO THE EXTENT THAT THEY CANNOT BE DISCLAIMED, THE IMPLIED WARRANTIES ARE LIMITED IN DURATION TO THE LIFE OF THE EXPRESS WARRANTY. INCIDENTAL AND CONSEQUENTIAL DAMAGES ARE EXCLUDED FROM COVERAGE UNDER THIS WARRANTY. SOME STATES/ PROVINCES DO NOT ALLOW FOR THE DISCLAIMERS, LIMITATIONS AND EXCLUSIONS IDENTIFIED ABOVE, AS A RESULT, THEY MAY NOT APPLY TO YOU. THIS WARRANTY GIVES YOU SPECIFIC RIGHTS, AND YOU MAY ALSO HAVE OTHER LEGAL RIGHTS WHICH MAY VARY FROM STATE TO STATE, OR PROVINCE TO PROVINCE.

Neither the distributor, any BRP distributor/dealer nor any other person has been authorized to make any affirmation, representation or warranty regarding the product, other than those contained in this limited warranty, and if made, shall not be enforceable against BRP.

BRP reserves the right to modify this warranty at any time, being understood that such modification will not alter the warranty conditions applicable to the products sold while this warranty is in effect.

8. TRANSFER

If the ownership of a product is transferred during the warranty coverage period, this warranty shall also be transferred and be valid for the remaining coverage period provided BRP or an authorised BRP distributor / dealer receives a proof that the former owner agreed to the transfer of ownership, in addition to the coordinates of the new owner.

9. CONSUMER ASSISTANCE

- (a) In the event of a controversy or a dispute in connection with this limited warranty, BRP suggests that you try to resolve the issue at the dealership level. We recommend discussing the issue with the authorized distributor/dealer's service manager or owner.
- (b) If further assistance is required, the distributor's service department should be contacted in order to resolve the matter.
- (a) If the matter still remains unresolved then contact BRP by writing to us at the address listed below.

BRP FINLAND OY
SERVICE DEPARTMENT
P.O. BOX 8040
FIN-96101 ROVANIEMI
FINLAND

© 2005 Bombardier Recreational Products Inc. All rights reserved.

® Registered trademark of Bombardier Recreational Products Inc.

How to identify your snowmobile

Serial numbers

The main components of your snowmobile (engine and frame) are identified by different serial numbers. It may sometimes become necessary to locate these numbers for warranty purposes or to trace your snowmobile in the event of loss.

These numbers are required by the Lynx dealers to complete warranty claims properly. No warranty will be allowed by Bombardier if the engine serial number or VIN is removed or mutilated in any way. We strongly recommend that you take all the serial numbers on your snowmobile and supply them to your insurance company.

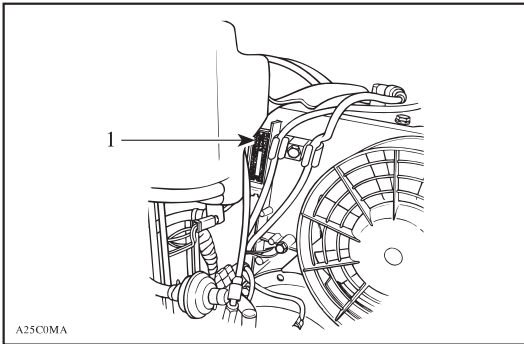
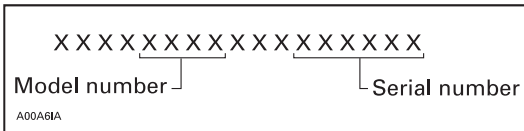

1. Engine serial number

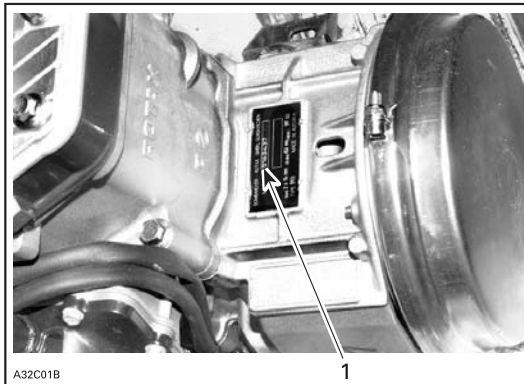

1. Engine serial number

Controls / Instruments

NOTE! Some controls/instruments do not apply to some models.

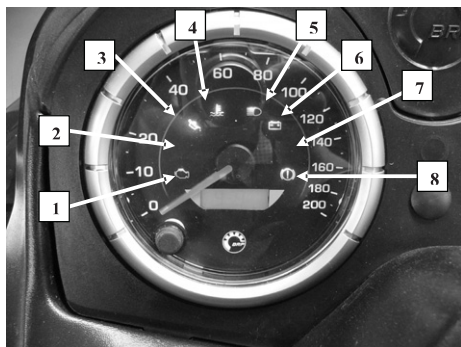
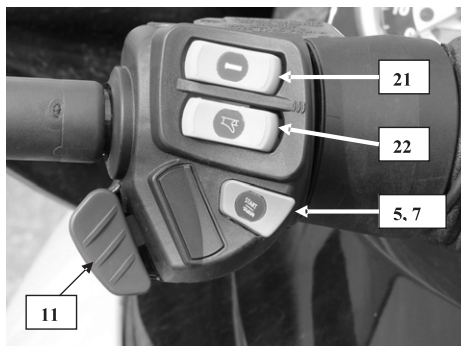

1. Engine Management System (EMS) pilot lamp
2. Air shock pilot lamp (not in use on Lynx)
3. Oil level pilot lamp
4. Cooling liquid temperature pilot lamp
5. High beam pilot lamp
6. Low battery voltage pilot lamp
7. DESS pilot lamp
8. Brake pilot lamp

Multi-display

Note! Multi-display instrument is found only some models.

Operation

When the vehicle is powered up will the multi-display run a short start up test of two second by illuminating all segments of the display. At the end of the test the vertical lines (3.) in the upper part of the display will indicate the fuel level while the clock will show up on the main display.

At this moment it is possible to select the various functions of the instrument with the "MODE" and "SET" keys.

By pressing the "MODE" key, in each pressing you can select following functions: Timer, Calendar, Using hours, Temperature °C or °F.

Clock and calendar operation

NOTE! Before the clock and the calendar is set must the vehicle be power up

YEAR

- Power up the vehicle, press and keep the "SET" key pressed until the indication "YE" shows up on the display which stands for YEAR (please note that you can enter the programming phase only when the display shows date and clock). It is possible to release the "SET" key at this moment and then go back pressing it again several times to change the year, which has been set up in a cyclical way: 02, 03, 04....98, 99, 00, 01, and so on; by keeping the key pressed down it changes faster.

MONTH

- Press the "MODE" key until the indication "MO" shows up on the display which stands for MONTH. It is possible to release the "MODE" key at this moment and then go back pressing the "SET" key several times to change the month, which has been set up in a cyclical way: 12, 11, 02,.. 11 and so on; by keeping the key pressed down it changes faster.

DAY

- Press the "MODE" key until the indication "dY" shows up on the display which stands for DAY. It is possible to release the "MODE" key at this moment and then go back pressing the "SET" key several times to change the hours, which have been set up in a cyclical way: 23, 00, 01, .. 21, 22, 23 and so on; by keeping the key pressed down it changes faster.

HOUR

- Press the "MODE" key until the indication "Ho" shows up on the display which stands for HOUR. It is possible to release the "MODE" key at this moment and then go back pressing the "SET" key several times to change the hours, which have been set up in cyclical way : 23,00, 01,.. 21, 22, 23 and so on ; by keeping the key pressed down it changes faster.

MINUTE

- Press the "MODE" key until the indication "Mn" shows up on the display which stands for MINUTE. It is possible to release the "MODE" key at this moment and then go back pressing the "SET" key several times to change the minutes , which have set up in a cyclical way: 59, 00, 01,..57, 58, 59 and so on; by keeping the key pressed down it changes faster.

After this press the "MODE" key again and the multi-display is released from the programming, the clock starts from "00" and memorizes the new data.

Timer operation

NOTE! Before the timer is set must the vehicle be power up

After having selected the timer by pressing the “MODE” key (power on of the “TIMER” writing on the on the left side of the display) it is possible to start timing the hours, minutes and seconds by pressing the “SET” key; if 23 hours 59 minutes and 59 seconds are reached the timer automatically starts counting again from 00.00.00. the timing can be blocked by pressing the “SET” key while the “MODE” key has a triple function:

- 1) If it is pressed while the timer has been activated, it allows you to visualize the following setting (calendar).
- 2) If it is pressed while the timer has been blocked (with the “SET” key) with a value different from 00:00:00 the timer can be reset.
- 3) If it is pressed while the timer is stopped at 00:00:00 it allows you to visualize the following setting.

Using hours operation

NOTE! Before the using hours operation is set must the vehicle be power up

It is possible to visualize the using hours of the snow mobile with the Multi-display; this setting is adjusted by the following conditions:

- 1) The increase of the hours is directly connected to the powering of the Multi-display.
- 2) The using hours can be voided only if the default procedures are strictly followed (see Default procedure section).
- 3) The using hours are visualized in complete hours (without minutes or seconds)

Thermometer operations

The Multi-display normally indicates the temperature in °C with a resolution of 1°C, however, it is also possible to select the visualization in °F by simply connecting pin no.1 and 5 of the 6-way DEUTSCH connector (NOTE! This operation has to be carried out while the Multi-display is off). No calibration of the thermometer is provided.

Fuel indicator

The fuel level is represented on the upper part of the display by means of 11 vertical lines.

Default procedure

Default procedures aim to reset the using hours of the snow mobile;

- a) Power the Multi-display by pressing the “MODE” and “SET” keys (no indications will show up on the display).
- b) Keep pressing the keys (for about 20 seconds) until the indication “dEF” show up on the display which stands for DEFAULT.
- c) Release the keys: The Multi-display will go back to its normal working.

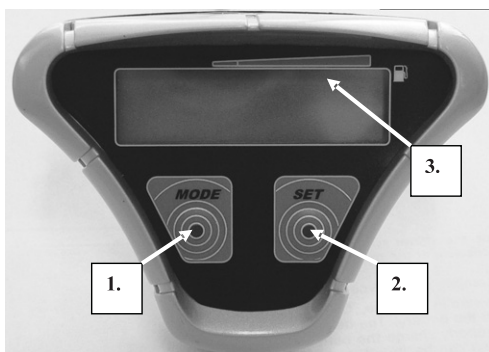

1. Mode
2. Set
3. Vertical line

1. Throttle lever

Located on the right side of handlebar. When compressed, it controls the engine speed and the engagement of the transmission. When released, engine speed returns automatically to idle.

2. Brake lever



Located on the left side of handlebar. When compressed, the brake is applied. When released, it automatically returns to its original position. Braking effect is proportional to the pressure applied on the lever and to the type of terrain and its snow coverage.

3. Parking brake lever

Hydraulic brake

To engage mechanism, squeeze brake lever and maintain while pulling locking lever with a finger. Brake lever in picture 1 is compressed 25% of applying brakes and in picture 2 is compressed 50% of applying brakes.

To release mechanism, squeeze brake lever. Locking lever will automatically return to its original position. Brake lever now returns to rest position. Always release parking brake before riding.

WARNING!

Locking keeps brake lever engaged and keeps pressure against brake disc.

Anyhow, this pressure may decrease so low, that it will not keep vehicle in place. Never leave the snowmobile on hill only with parking brake applied.

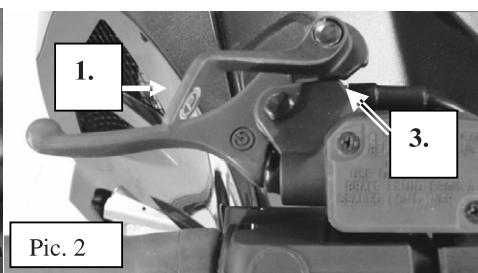
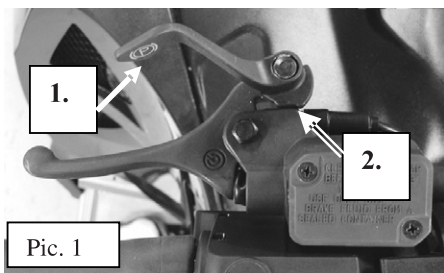

1. Locking lever
2. Position 1
3. Position 2

Located on left side of handlebar. Parking brake should be used whenever snowmobile is parked.

Whenever parking brake is applied and engine is running, injection oil level/parking brake pilot lamp lights up to remind you that it is engaged. Never leave your snowmobile on downhill only with parking brake engaged.

WARNING!

Make sure parking brake is fully disengaged before operating the snowmobile.

4. Brake/Parking brake/Low oil level pilot lamp (Red)

Lights when brake or parking brake is applied (with engine running).

This pilot lamp also lights up when injection oil level is low (with engine running). Check oil level and replenish as soon as possible.

5. RER button

Electric reverse

Some models: These models are equipped with an electronic reverse (RER), which is controlled by a RER button.

Reverse shift can be used when the snowmobile is stopped and engine is running at idle.

Engine is running automatically forward when the snowmobile is started after stalling or stopping.

Shifting in reverse

With the snowmobile completely stopped and engine running at idle, press and release the RER button.



1. RER button

The reverse pilot lamp blink and a reverse alarm will sound once every second with a half a second duration when the snowmobile is engaged in reverse.

Apply throttle slowly and evenly. Allow drive pulley to engage then accelerate carefully.

Shifting in forward

With the snowmobile completely stopped and engine running at idle, press and release the RER button.

Reverse pilot lamp and reverse alarm will stop.

Apply throttle slowly and evenly. Allow drive pulley to engage then accelerate carefully

RER Modification at high altitude

At high altitude, the RER system needs a different engine timing curve to work properly.

Non DPM™ Liquid-Cooled Models

Before using the reverse system, first select the altitude mode that changes engine timing curve.

To do so, push and hold START/RER button with engine running. After 2 seconds, one beep is heard meaning that the low altitude mode can be selected. Releasing START/RER button just after hearing that one beep will select the low altitude

mode. The reverse system is now ready to operate in high altitude regions. Shifting in reverse is achieved as described above in Shifting in Reverse.

To select high altitude mode, push and hold START/RER button until 2 beeps are heard. Release button within one second. The reverse system is now ready to operate in high altitudes. Shifting in reverse is achieved as described above in Shifting in Reverse.

As long as the START/RER button is pushed and held the RER system switches from one mode to the other. One beep then 2 beeps the one beep then 2 beeps and so on are heard with one second interval. The mode to be selected corresponds to the last beep code heard.

The selected altitude mode is kept in memory until a new one is chosen — whether the engine is stopped or not.

DPM Liquid-Cooled Models

These vehicles are equipped with a Digital Performance Management (DPM) system. This system takes care of the altitude mode required by the RER.

No START/RER button operation is needed to select a mode. Just follow Shifting in Reverse above.

6. Handlebar

The handlebar controls the steering of the snowmobile. As the handlebar is rotated to right or left, the skis are turned right or left to steer the snowmobile. Handlebar height is adjustable. See an authorized Lynx dealer.

7. Ignition switch / START/RER button

Ignition switch

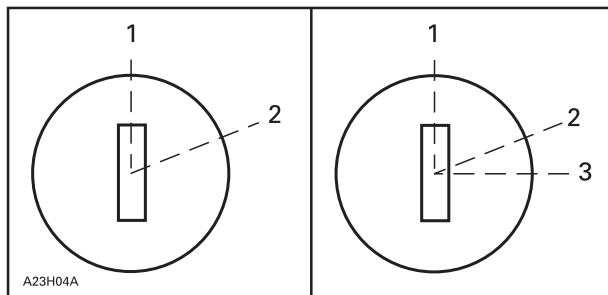

Manual start

1. OFF

2. ON

Electric start models

1. OFF

2. ON

3. START

START / RER button



Electric start models

1. OFF
2. START (PRESS THE BUTTON)

START/RER button has two functions.

When the engine is not running, depressing the START/RER button and hold until engine has started.

When the engine is running, depressing the START/RER button will command the engine to reverse crankshaft rotation as driving the snowmobile is in reverse is achieved by changing the direction of rotation of the engine, not by shifting the chain case in reverse gear.

When depressing the START/RER button, the MPEM will practically slow down the engine RPM to a stop and advance the ignition timing to cause crankshaft rotation reversing.

Engine will automatically shift into forward when starting after stopping or stalling.

Shifting procedure will take place only when the engine is running.

If engine is running at a speed above 3800 RPM, the reverse function of the START/RER button is cancelled.

It is recommended to warm up the engine to its normal operating temperature before shifting.

Start Mode

To start engine, push START/RER button and hold until engine has started.

NOTE! Do not hold START/RER button more than 10 seconds. A rest period should be observed between the cranking cycles to let starter cool down. Holding START/RER button when engine has started could damage starter mechanism.

Manual Starting

To start the engine, pull switch off button to on position, set the safety lanyard on its position, turn key ON position then pull rewind starter grip. To stop the engine, press switch off button down.

Electric Starting

To start engine, pull switch off button to on position, set safety lanyard on its position, turn key to START position (or press start button) until engine has started. To stop the engine, press switch off button down.

NOTE: Do not use electric starter for more than 10 seconds. If start/rer button is pressed when engine has started it could damage electric starter mechanism. Release button as soon as the engine starts.

If engine does not start on first try, wait a few seconds before restarting. To stop the engine, press switch off button down.

NOTE: Engine may be manually started with rewind starter if necessary.

If starter does not operate, check starting system fuse condition. Refer to FUSES.

8. Tether cut-out switch



It shuts off engine preventing snowmobile to runaway if the operator falls off the vehicle accidently.

Operation

Attach to clothing eyelet than snap tether cord cap over post before starting engine.

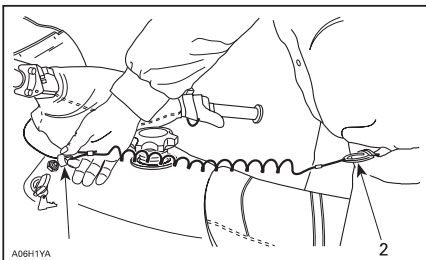

1. Snap over post
2. Attach to eyelet

If emergency engine shut off is required, completely pull tether cord cap from post.

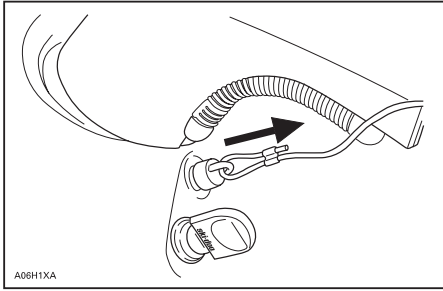

Typical

Liquid-Cooled Models

On these models tether cut-out switch is part of tether cut-out system. This system serves 3 functions. It shuts off engine preventing snowmobile to runaway if the operator falls off the vehicle accidentally.

Through the D.E.S.S.[™] (Digitally Encoded Security System), it acts as a lock by preventing unauthorized use of your snowmobile thus deterring theft.

Finally, it prevents unintentional electric starter operation in vehicles so equipped by disabling the electric starter and ignition circuits in the MPEM or ECU.

DESS (Digitally Encoded Security System) Description; (Liquid Cooled Models)

This system is digitally encoded to provide you and your snowmobile with the equivalent security as a conventional lock key.

The tether cord cap provided with your snowmobile contains an electronic chip in which a unique digital code is permanently memorized. Your authorized Lynx dealer programs this key code in the MPEM or ECU of your snowmobile to allow engine operation above 3000 RPM if and only if this unique code has been read after engine starting.

If a tether cord cap with different code is installed, the engine will start but cannot reach drive pulley engagement speed to move vehicle.

Additional Tether Cord Caps

The MPEM/ECU of your snowmobile can be programmed by your authorized Lynx dealer to accept 8 different key codes (tether cord caps).

DESS Pilot Lamp Codes

DESS pilot lamp blinking slowly (one time per 1,5 second) means that a bad connection has been detected. Vehicle can not be driven.

To check for bad connection, remove tether cord cap. Make sure the tether cord cap is free of dirt or snow. Reinstall cap and restart engine. If a blink still occurs, contact an authorized dealer.

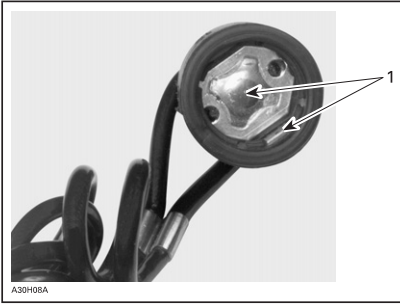

1. Free of dirt and snow

A DESS pilot lamp blinking 3 times per second means that you have installed a cap with a code that MPEM of this snowmobile was not programmed to recognize (wrong key). Vehicle can not be driven.

9. DESS pilot lamp

This lamp will light up to confirm DESS status. Refer to previous paragraphs for description.

10. Engine cut-out switch

This push-pull type switch is located on the right side of the handlebar. To stop the engine in an emergency, select OFF position (DOWN) and simultaneously apply the brake. To restart, button must be at the ON position (UP).

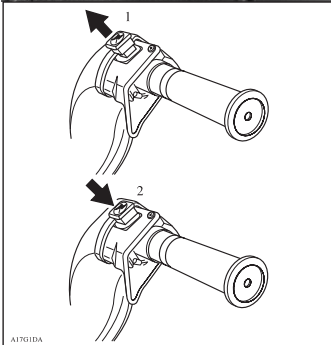

1. ON
2. OFF

All operators of the snowmobile should familiarize themselves with the function of this device by using it several times on first outing and whenever stopping the engine there-after. This engine cut-out procedure will become a reflex and will prepare operators for emergency situations requiring its use

11. Headlamp dimmer switch

Located on left hand side of handlebar, allows selection of headlamp beam. Note that lights are automatically ON whenever the engine is running.

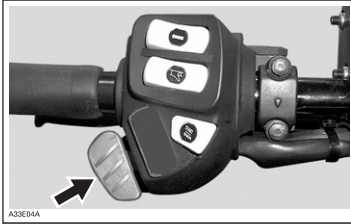

12. Pilot lamps

High beam pilot lamp (Blue)

Lights when headlamp is on HIGH beam.



Oil pilot lamp

2-tec models: This pilot lamp will glow up when injection oil level is too low. Stop vehicle in a safe place, then refill injection oil reservoir.

Restart engine, oil pilot lamp must turn off after few seconds. If oil pilot lamp still glows up, stop engine and have lubrication system inspected by an authorized Lynx dealer.



Low battery voltage pilot lamp

This lamp will light up to indicate a low battery voltage condition. See an authorized Lynx dealer as soon as possible.



Engine Management System (EMS) pilot lamp

This lamp will light up to indicate a trouble. Refer to "TROUBLESHOOTING" for trouble code meaning and remedy.



Engine overheating pilot lamp

If this lamp glows; reduce snowmobile speed and run snowmobile in loose snow or stop engine immediately.



Brake pilot lamp

This lamp will light up to indicate that the brake is on.



13. Rewind starter handle

Auto-rewind type located on right hand side of snowmobile. Pull handle slowly until a resistance is felt then pull vigorously. Slowly release handle.



14. Choke lever



Choke lever on position 0 (=OFF).

See for more information from section "OPERATION INSTRUCTIONS"

15. Speedometer

Electronic speedometer

Direct reading screen shows speed in km/h

Records total distance travelled until it is reset.

Mode button

Depress the mode button to change display. Each time engine is started, display shows odometer. From that point depressing mode button again to return the odometer.

Depressing mode button again will change display for the resettable hourmeter. Push mode button again to return to odometer.

Push and hold mode button for 2 seconds to reset the tripmeter or the resettable hourmeter depending on the one displayed.

Electronic display

16. Odometer

Odometer records the total distance travelled in kilometers.

17. Trip meter

Records the distance travelled. It can be reset when needed.

18. Trip meter reset button

To reset the meter, push the button until all the numbers are zero (0).

Resettable hourmeter

Records engine running time in hours and minutes since it has been reset.

All models: Push and hold mode button for 2 seconds to reset the resettable hourmeter.

Electronic speedometer



1. Odometer, Trip meter
2. Reset button

Electronic display code

If your speedometer shows “**SCALE**” in the display, it means that the display selector button is stuck in the down position or depressed when the electrical system was activated.

Some models: At vehicle speed of 90 km/h and more the mode LCD screen will show speed only instead of the selected mode.

NOTE! At the electronic speedometer display appears “9-9” when you power up the vehicle. This means that the speedometer is calibrated to 9 toothed drive sprocket.

19. Fuel tank cap and fuel gauge



Unscrew to fill up tank then fully tighten.

WARNING!

Stop the engine before refueling. Fuel is inflammable and explosive under certain conditions. Open cap slowly. Do not smoke or allow open flames or sparks in the vicinity. Do not overfill or top off the fuel tank before placing the vehicle in a warm area. As temperature increases, fuel expands and might overflow. Wipe off any fuel spillage from the vehicle.

Fuel gauge

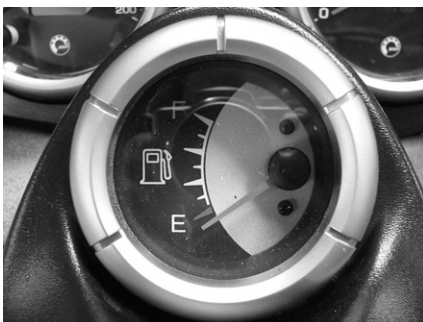

Electronical fuel gauge (in some models)

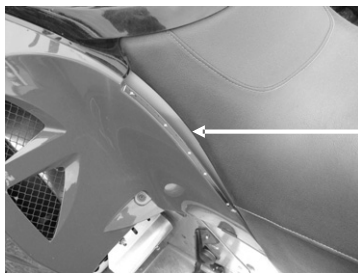

See-through fuel tank

20. Heating grip switch

It is a three –position switch. Select the desired position to keep your hands at a comfortable temperature.

Some models

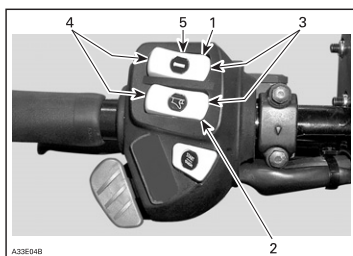

1. *Heated grip switch*
2. *Heated throttle lever switch*
3. *Hot*
4. *Warm*
5. *OFF*

21. Heated throttle lever switch

Three-position switch. Select the desired position to keep your right thumb at a comfortable temperature. See illustration.

Rear passengers heating grip switch

Three-position switch. Select the desired position to keep rear passenger's hands at comfortable temperature.



Passenger heating grip switch on passenger grab handle.

22. Hood opening

Side Hoods

Stretch and unhook the latches to unlock the hood sides from its anchors.



Hood latch

Lift up the fastening pin from the hole and gently open the side hood

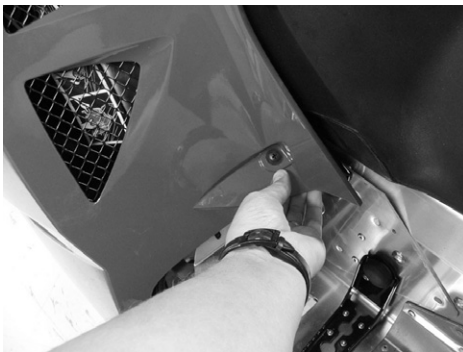

Upper hood

Lift up the pin from the hole (both sides of unit).



Pull the upper hood to forward.



Front hook inside the upper hood.

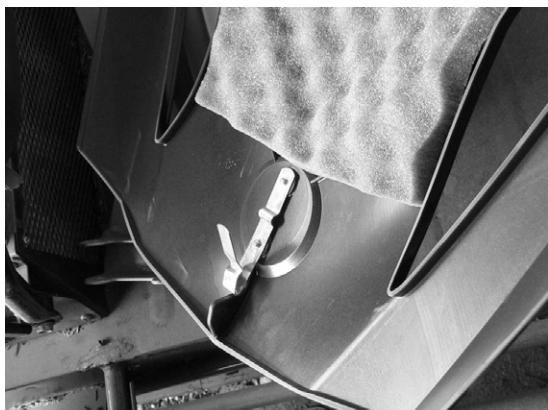

Opening for the hook when installing upper hood.

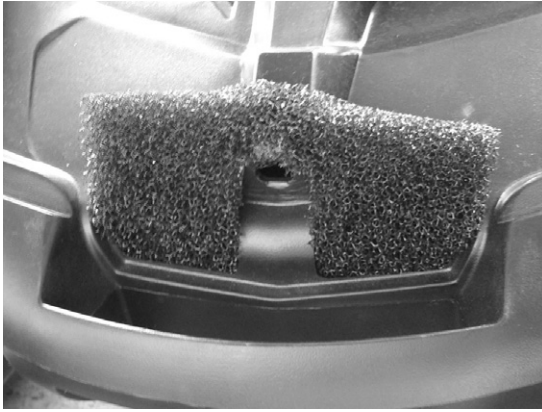

While assembly repeat opposite and assemble side hood lower edge carefully to groove.

23. Power outlet

A 12-volt electric appliance may be connected to that jack connector. Electric current is supplied when ever engine is running. See FUSES for electric power outlet fuse location.



A29104A

24. Fuse

To remove fuse from holder, pull fuse out. Check if filament is melted.

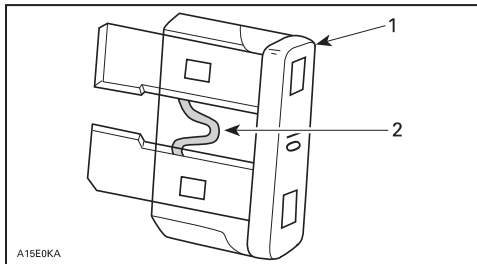

A15E0KA

1. Fuse
2. Check if melted

Fuse for starting system and electric power outlet

Starting system and electric power outlet is protected (if equipped) with 20 amperé fuse. If the starter and electric power outlet is out of function, check the fuse condition and replace if needed.

NOTE: Do not use a higher rated fuse as this can cause severe damage to electric components and/or fire.

SDI models:

Fuse box location (close to oil filling neck).



To open fuse box push on cover tab and tilt cover.



1. Push tab

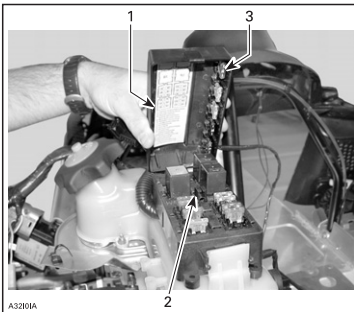

1. Fuse description decal
2. Fuse remover/installer
3. Spare fuses

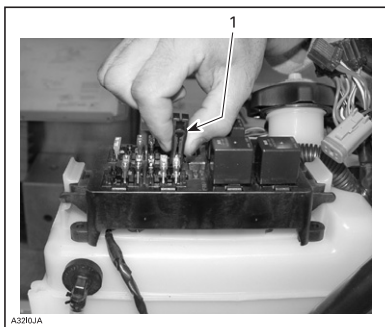

1. Fuse remover/installer

25. Front grab handle/ front bumper

To be used whenever front of snowmobile requires manual lifting.



1. Front grab handle

NOTE: Do not use skis to pull or lift snowmobile.

26. Storage compartment

Situates inside the seat (rear).



27. Rear rack

Always readjust suspension according to the load. The capacity of this rack is limited. Ride at very low speed when loaded. Avoid speed over bumps.

28. Tool kit

A tool kit containing tools for basic maintenance is supplied with the engine. Tool bag is located inside the left side hood.



29. Spark plug holder



Some models: To keep spare spark plugs dry and prevent shocks that might affect the adjustment or break them, a holder is provided in engine compartment.

Firmly tighten them into the holder with spark plug socket (in tool kit) to ensure that they will not be loosened by vibrations.

Spare spark plugs are not supplied with a new snowmobile.

Adjust spare spark plug gap according the TECHNICAL DATA before installation.

CAUTION: Do not attempt to adjust gap on spark plug BR8ECS and BR9ECS; it is not adjustable.

Spark plug change:

Open the side hood.

Remove intake silencer.

Remove sparkplug cable.

Clean carefully cylinder head surface round the sparkplug.

Open the sparkplug by using sparkplug removal tool.

30. Hitch

The hitch can be used to pull most equipment. Use a rigid tow bar.

NOTE! Remember to lock the hitch locking latch with a lock pin.

Check the decal on your own vehicle. There is a description of how much load is allowed to transport and to pull.

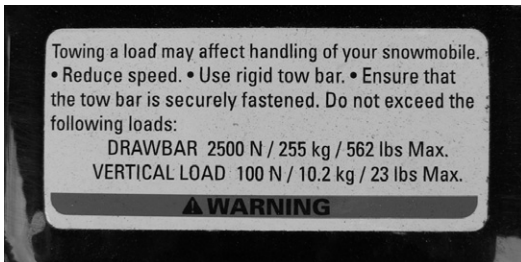

On this decal, max. pulling load 2500N vertical load for hitch is 10.2kg.

31. Adjustable suspension

Snowmobile handling and comfort depend upon suspension adjustments.

Choice of suspension adjustments vary with carrying load, driver's weight, personal preference, riding speed and field condition.

NOTE: Some adjustments may not apply to your snowmobile. Use special keys in tool kit.

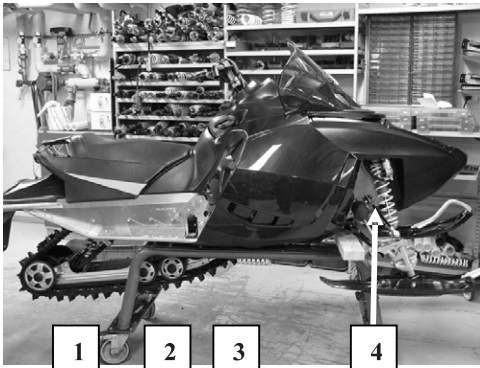

1. Rear springs - comfort and ride height
2. Center spring - handling
3. Stopper strap – snowmobile weight transfer
4. Front shock - handling

Guidelines to adjust suspension

The best way to set up suspension, is to start from factory settings then customize each adjustment one at a time. Adjustments 1 through 4 are interrelated. It may be necessary to readjust center spring after adjusting front springs for instance. Test run the snowmobile under the same conditions; trail, speed, snow, driver riding position, etc. Change one adjustment and retest. Proceed methodically until you are satisfied.

NOTE: Whenever adjusting rear suspension, check track tension and adjust as necessary.

Slight suspension bottoming occurring under the worst riding conditions indicates a good choice of spring preload.

1. Rear Springs — Comfort

IMPORTANT: Make sure that all objects to be transported are in place in rear rack and under the seat.

When driver and passenger (if applicable) take place, rear of snowmobile should collapse by 50 to 75 mm.



Proper adjustment
A. 50 to 75 mm



Too soft of adjustment

To adjust springload, first open lock ring then turn adjust ring to position wanted.

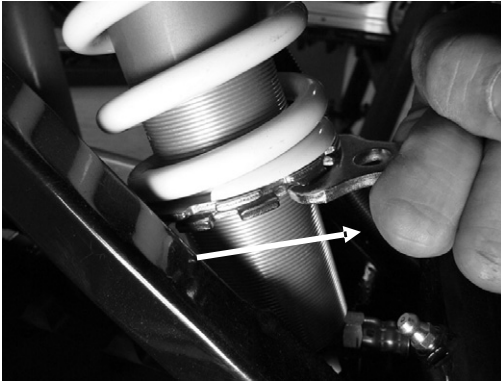

1. Increase spring preload



Too hard of adjustment

2. Center Spring — Steering Behavior

Ride at moderate speed on a trail. If handlebar is felt too hard to turn, adjust centre spring accordingly.

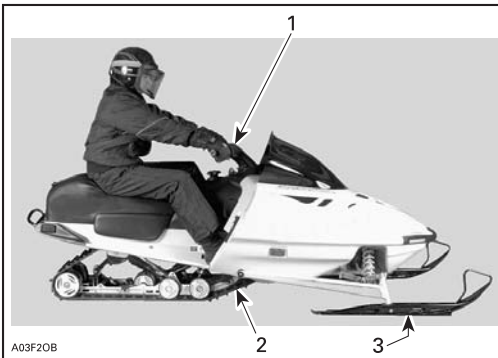

Good adjustment at moderate speed

1. Handlebar easy to turn – neutral steering attitude



A03F2PA

Too soft of adjustment

1. Handlebar harder to turn — oversteering attitude



Use adjuster wrench provided in tool kit to increase preload



A03F2PA

Too hard of adjustment-too much preload

2. Handlebar is very easy to turn – understeering attitude

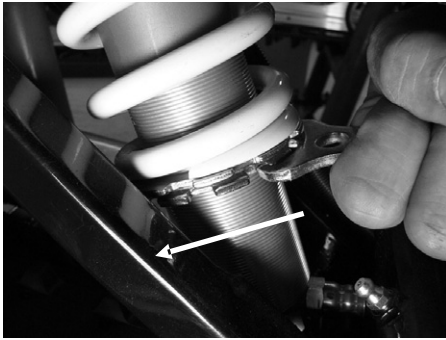

Use adjuster wrench provided in tool kit to decrease preload

3. Stopper Strap — Weight Transfer

Ride at low speed then fully accelerate. Note steering behavior. Adjust stopper strap length accordingly.

NOTE: Whenever stopper strap length is changed, track tension must be readjusted.

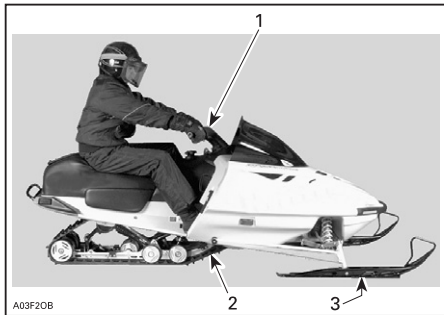

Good adjustment at full acceleration

1. Comfortable steering
2. Good weight transfer to the track
3. Light pressure of skis on the ground



Too long strap

1. Skis lift off the ground

OR



Too short strap

1. Heavy steering

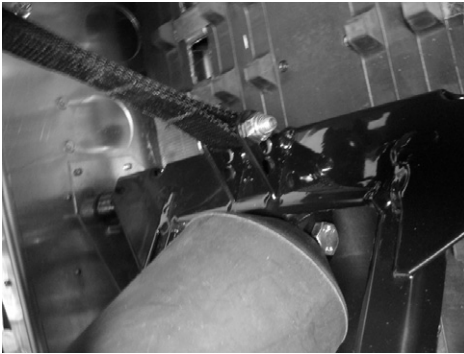

1. Bolt stopper strap to a different hole

4. Front Springs — Handle

Ride at moderate speed and check for proper handling. Adjust front springs accordingly.



Proper adjustment

1. Good handling and comfortable steering

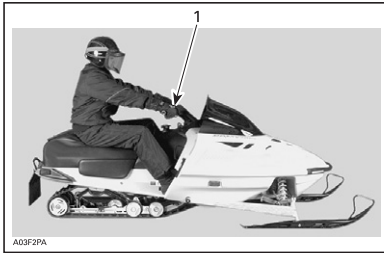

Too soft of adjustment
 1. Bad handling

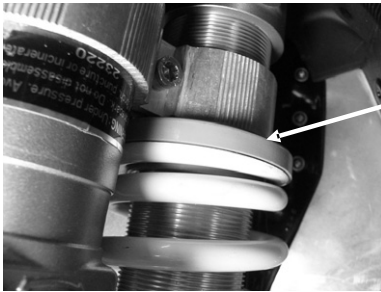

Increase spring preload by turning plastic ring.

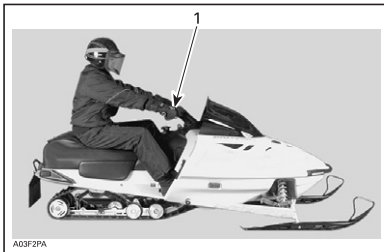

Too hard of adjustment
 1. Steering hard to turn - Decrease spring preload



*Compression stiffness adjusting knob. (Where available).
 Turning the red nut clockwise increases the high-speed compression dampening.
 Turning the small brass screw clockwise increases the low-speed compression dampening.
 These adjustment have no effect on rebound dampening.*

Suspension troubleshoot

| PROBLEM | CORRECTIVE MEASURES |
|---|---|
| Front suspension wandering | -Check ski alignment and camber angle adjustment. See an authorized Lynx dealer. -Reduce ski ground pressure. Reduce front suspension spring preload. Increase center spring preload. Reduce rear spring preload. |
| Snowmobile seems unstable and seems to pivot around its centre. | -Reduce rear suspension front arm pressure. Reduce center spring preload. Increase rear spring preload . Increase front suspension spring preload. |
| Steering feels too heavy. | -Reduce ski ground pressure. Reduce front suspension spring preload. Increase center spring preload. |
| Rear of snowmobile seems too stiff. | -Reduce rear spring preload. |
| Rear of snowmobile seems too soft. | -Increase rear spring preload. |
| Rear suspension front shock absorber is frequently bottoming. | -Lengthen stopper strap. -Increase center shock preload. |
| Track spins too much at start. | -Lengthen stopper strap. -Change driving position. |

In deep snow

When operating the snowmobile in deep snow, it may be necessary to vary extension adjustment, stopper strap and/or riding position, to change the angle at which the track rides on the snow. Operator's familiarity with the various adjustments as well as snow conditions will dictate the most efficient combination.

Fuel and oil

Recommended fuel

Refer to **TECHNICAL DATA** in the end of this manual.

NOTE: Never experiment with other fuels or fuel rations. The use of unrecommended fuel can result in snowmobile performance deterioration and damage to critical parts in the fuel system and engine components.

WARNING!

Do not overfill or top off the fuel tank before placing the vehicle in a warm area. As temperature increases, fuel expands and might overflow. Fuel is inflammable and explosive under certain conditions. Wipe off any fuel spillage from the vehicle.

Fuel System Antifreeze

When using oxygenated fuel, additional gas line antifreeze or water absorbing additives are not required and should not be used.

Recommended oil

Oil reservoir cap is identified "OIL". Use only oil, which flows at -40°.

Oil is in injection oil reservoir. Use Bombardier snowmobile injection oil or synthetic injection oil.

Use only 2-stroke engine injection oil.

MODEL

OIL TYPE

RAVE 440

BRP XP-S Fully Synthetic 2-Stroke injection oil
(P/N 293600045) (NOTE! Mixed with fuel)

2-tec SDI engines

BRP XP-S Synthetic Blend 2-Stroke injection oil
(P/N 293600071) or
BRP XP-S Fully Synthetic 2-Stroke injection oil
(P/N 293600045)

2-tec models (not SDI)

BRP XP-S Synthetic Blend 2-Stroke injection oil
(P/N 293600071) or
BRP XP-S Fully Synthetic 2-Stroke injection oil
(P/N 293600045) or
BRP XP-S Mineral 2-Stroke injection oil (P/N 1472325)

CAUTION: Never use four-stroke mineral or synthetic oil. Do not mix these with outboard motor oil. Do not use NMMA TC-W, TC-W2 or TC-W3 outboard oil. Avoid mixing different brands of API TC oil as resulting chemical reactions may cause severe engine damage.

Always maintain a sufficient amount of recommended oil in the injection oil reservoir.

CAUTION: Check level and refill every time you refuel. Do not mismatch oil reservoir cap with fuel tank cap.

Chaincase oil

Recommendation Bombardier Synthetic Chaincase Oil (P/N 413803300, 12x355 ml).

Cold weather carburetion modifications

All vehicles has been calibrated for - 20°C. They can be operated at warmer winter temperatures without problems.

CAUTION: For colder temperatures than - 20°C, carburetor(s) must be recalibrated to avoid engine damage. Refer to an authorized Lynx dealer.

Heated carburetor valve

The heated carburetor valve should be closed except:

When riding between -5°C and $+5^{\circ}\text{C}$ in a high relative humidity.

When riding in deep powder snow.

When following another snowmobile which makes dust snow.

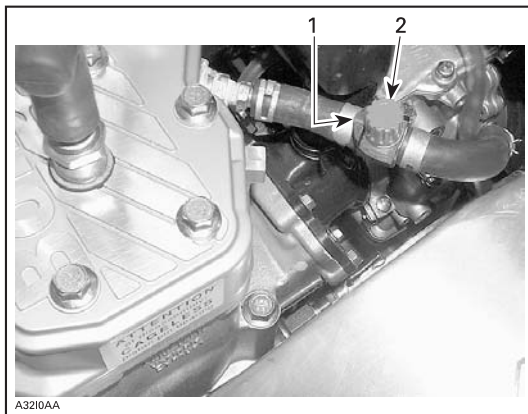

Break-in period

Engine

IMPORTANT

A break-in period of 10-15 hours (about 500 km) is required for Rotax engines before running the snowmobile at full throttle.

During break-in period, maximum throttle should not exceed $\frac{3}{4}$. However, brief full acceleration and speed variations contribute to a good break-in.

All models except 2-tec SDI models: To assure additional protection during the initial engine break-in, 500 ml of recommended injection oil should be added to fuel for the first full filling of fuel tank. Have spark plugs cleaned after engine break-in.

Drive Belt

A new drive belt requires a break-in period of 50 km. Avoid strong acceleration/ deceleration, pulling a load or high speed cruising .

10 Hour Inspection

We suggest that after the first 10 hours of operation— 500 km — or 30 days after the purchase, whichever comes first, your snowmobile be checked by an authorized Lynx dealer.

NOTE! The 10 hour inspection is at expense of the snowmobile owner.

Pre operation check

- * Remove snow and ice from body including seat, footrests, lights, controls and instruments.
- * Verify that track and idler wheels are not frozen and free to turn.
- * Activate the brake control and make sure the brake fully applies before the brake control lever touches the handlebar grip. It must fully return when released.
- * Check the parking device. Apply parking brake and check if it operates easily and smoothly.
- * Activate the throttle control lever several times to check that it operates easily and smoothly.
- * Check operation of ignition switch, headlamp switch, taillight, brake light, pilot lamps and tether/cut-out switches.
- * Verify that skis and steering operate freely. Check corresponding action of skis versus handlebar.
- * Check fuel and injection oil for levels and leaks. Replenish as necessary and see an authorized Lynx dealer in case of any leaks.
- * Verify that air filter(s) is free of snow, if so equipped.
- * Make certain your snowmobile is pointed away from people or objects before you start it.
- * Be warmly dressed with clothing designed for snowmobiling.

Operating instruction

WARNING!

Never use engine on idle speed too long time because snowmobile cooling system does not work on idle. Cooling system works only when driving with unit. When engine is cold it can be used on idle max 1-2 minutes, when engine is warm just few seconds.

Never leave unit on idle without control.

Propulsion

Depressing throttle lever increases engine RPM causing the drive pulley to engage. Depending on models engine RPM must be between 2500 and 4200 before drive pulley engagement will occur.

Outer sheave of drive pulley moves toward inner sheave, forcing drive belt to move upward on the drive pulley and simultaneously forcing the sheaves apart on the driven pulley.

The driven pulley senses the load on the track and limits the belt movement. The result is an optimized speed ratio between engine RPM and the speed of the vehicle at any time.

Power is transferred to the track through the chaincase and drive axle.

Turning

Handlebar controls the steering of the vehicle. As the handlebar is rotated to right or left, the skis are turned right or left to steer the snowmobile.

Stopping

Before riding your snowmobile, you should understand how to stop it. This is done by releasing the throttle and gradually depressing the brake lever on the left side of the handlebar.

In an emergency, you may stop your vehicle by pressing the engine cut-out switch located near the throttle control and applying the brake.

Remember, a snowmobile cannot "stop on a dime". Braking characteristics vary with deep snow, packed snow or ice. If the track is locked during hard braking, skidding may result.

Starting the engine

Check throttle lever operation.

Ensure that the engine cut-out switch is in the ON position.

Ensure that the tether cord cap is in position and that the cord is attached to your clothing eyelet.

Primer equipped vehicles

Starting the engine: To prime, activate button until a pumping resistance is felt. From this point, pump 2 or 3 times to inject fuel in intake manifold.

After priming, ensure that primer button is pushed back.

NOTE: In very cold temperature, it is recommended to rotate primer button 3 - 4 turns prior to pull it. This will eliminate the possibility of sticking.

NOTE: Priming is not necessary when engine is warm.

Choke equipped vehicles

Initial cold starting: Do not operate the throttle lever with the choke lever on.

When temperature is below - 10°C

Move the choke lever to position 2 and start the engine. As soon as the engine starts move the lever to position 1. After a few seconds (max.10 seconds) move the choke lever to OFF position.

NOTE: In severe cold weather, colder than - 20°C you may need to flip choke lever from OFF to position 1 a couple of times once engine is started.

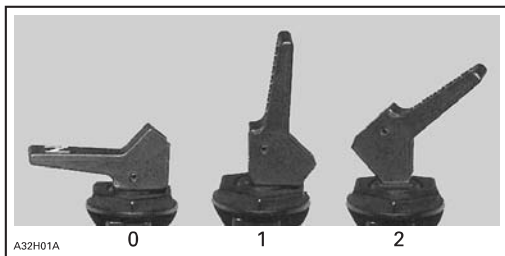

- 0. OFF
- 1. Position 1
- 2. Position 2

When temperature is above - 10°C

Move the choke lever to position 1.

Grab the handle firmly and start the engine or electric starter if it is equipped.

As soon as the engine starts move the choke lever to OFF.

Warm engine starting

Start the engine without any choke. If the engine will not start after two pulls of the rope or two 5 second attempts with the electric starter move choke lever to position 1. Start the engine without activating the throttle lever. As soon as the engine starts move the choke lever to OFF.

Rewind starting

All models: Set the safety lanyard to its post and grab the handle firmly and crank the engine.

WARNING!

Do not activate the throttle lever during starting.

Electric starting

Set the safety lanyard to its post. Press electric starter button until engine starts. Release the button immediately when engine starts.

NOTE: Do not use electric starter longer than 10 seconds.

NOTE: If the vehicle cannot be started in some reasons with electric starter, set safety lanyard to its post and start the engine using rewind starter handle.

Emergency starting

The engine can be started with the emergency starter rope supplied with the tool kit.

Remove belt guard.

Do not wind the starting rope around your hand. Hold rope by the handle only. Do not start the snowmobile by the drive pulley unless it is a true emergency situation. Have the snowmobile repaired as soon as possible.

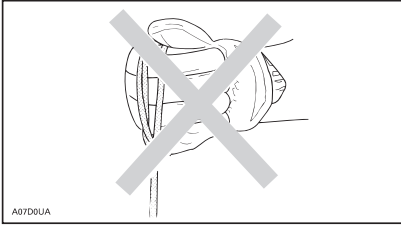

Attach one end of emergency rope to rewind handle.

NOTE: The spark plug socket can be used as an emergency handle.

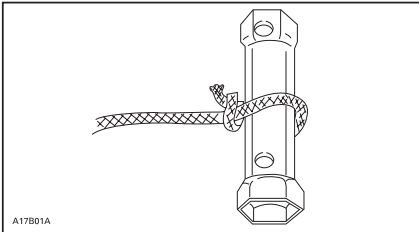

Attach the other end of emergency rope to the starter clip supplied in the tool kit.

Hook up clip on drive pulley.

Wind the rope tightly around drive pulley. When pulled, pulley must rotate counterclockwise.

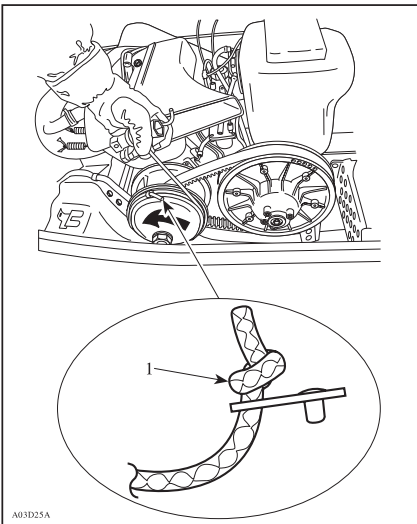

1. *Knot on this side*

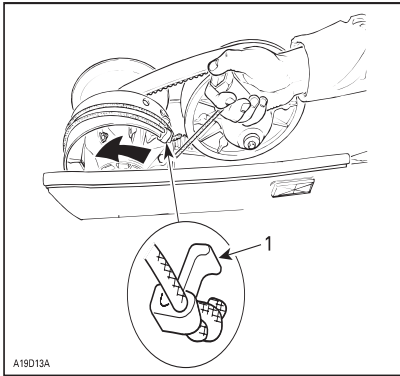

1. Clip

Pull the rope using a sharp, crisp pull so the rope comes free of the drive pulley. Start the engine as per usual manual starting.

When starting the snowmobile in an emergency situation, using drive pulley, do not reinstall the belt guard and return slowly to have snowmobile repaired.

Shutting off the engine

Release throttle lever and wait until engine has returned to idle speed.

Shut off the engine using engine cut-out switch.

WARNING!

Always remove tether cord cap and key when vehicle is not in operation in order to prevent accidental engine starting or to avoid unauthorized use by others or theft.

Vehicle warm-up

Before every ride, vehicle has to be warmed up as follows:

Snowmobile must be securely supported by the rear bumper using a wide-base snowmobile mechanical stand. Track must be 100 mm off the ground.

Start engine and allow it to warm up one or two minutes at idle speed, anyway if needed give some throttle that engine runs smoothly. Never let unit idle without control.

Release parking brake.

WARNING!

Make sure wide-base snowmobile mechanical stand is stable. Stay clear of the front of vehicle and the track. Do not use too much throttle during warm-up or when track is free-hanging.

Apply throttle until drive pulley engages. Let track rotate at low speed for several turns. The lower the vehicle temperature is the longer vehicle warm-up should be.

Shut-off the engine and remove the wide base snowmobile mechanical stand.

Skis may be frozen on the ground. Grab both skis one at a time by their loops and lift their front end slightly off the ground.

After restarting engine, the vehicle can be driven at low speed for the first 2 or 3 minutes of riding. After that, it may be driven up to the legal speed limit as per normal safety practices.

Post operation care

Shut off the engine. Install rear of vehicle on a wide-base snowmobile mechanical stand.

Remove snow and ice from rear suspension, track, front suspension, mechanism and skis.

Protect vehicle with a snowmobile cover.

Engine overheating

IMPORTANT NOTICE!

Fan cooled models: Shut off the engine.

Check for clogged air duct passages. Remove any foreign materials.

Check for proper fan belt condition and tension.

Liquid cooled models: Engine overheating pilot lamp will light up if engine is too hot.

Reduce snowmobile speed and run snowmobile in loose snow or stop engine immediately.

Check for adequate coolant level. See an authorized Lynx dealer.

Fuel flooded engine

Install new spark plugs and restart engine.

Rear suspension slider shoe sticking

Slider shoes are cooled and lubricated by snow. When riding at moderate or high speed on a thin-snow-covered surface, slider shoes may stick on metallic track guides.

Run snowmobile on a surface covered by snow or drive snowmobile at very low speed.

Have slider shoes inspected by an authorized Lynx dealer.

NOTE! This situation comes up the more high profile track is. Avoid driving on hard packed snow, ice surface or other surface, that has not enough snow to ensure the lubrication.

It is noticeable that tracks with 35 mm or more high profile are not meant for the trail ride (hard surface) but only for the deep snow ride. If the vehicle which is equipped with this kind of track, is driven on hard packed snow, slider shoes may stick on track metallic parts or the track can get damaged.

Fluid levels

WARNING!

It is recommended that the assistance of an authorized Lynx dealer be periodically obtained on other components/systems not covered in this guide. Unless otherwise specified, engine must be cold and not running. The tether cord cap must be removed for all maintenance procedures.

CAUTION: Vehicle must be on a level surface before checking any fluid levels.

Brake system

Check brake fluid in reservoir for proper level. Add fluid as required.

CAUTION: Use only DOT 4 brake fluid from a sealed container.

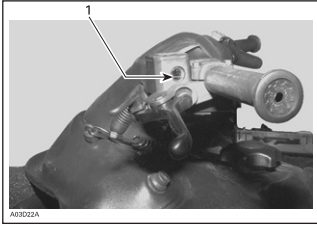

Brake fluid reservoir

1. Minimum

Chain case oil level: Check the oil level by removing dipstick. Oil level must be between lower and upper marks.

NOTE: It is normal to find metallic particles stuck to dipstick magnet. If bigger pieces of metal are found, see an authorized Lynx dealer.

Remove metal particles from magnet.

Refill up to upper mark using recommended oil.

NOTE: Do not use unrecommended other types of oil when servicing. Do not mix synthetic oil with other types of oil.

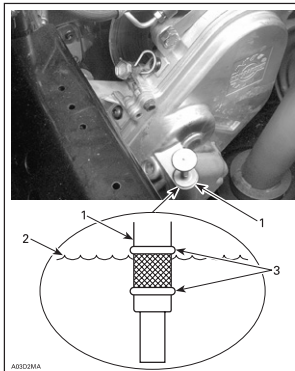

1. Dipstick
2. Oil level
3. Level between marks

Injection oil system

Always maintain a sufficient amount of recommended injection oil in the injection oil reservoir.

NOTE: Never allow oil reservoir to be almost empty.

WARNING!

Check level and refill every time you refuel. Wipe off any spillage. Oil is highly flammable when heated.



Oil tank cap.



See max oil level decal on the side of the oil tank.



1. Max oil level. (Do not overfill).

Cooling system

Check coolant level at room temperature. Liquid should be at COLD LEVEL line (engine cold) of coolant tank.

NOTE: When checking level at low temperature it may be slightly lower than mark.

If additional coolant is necessary often or if entire system has to be refilled, refer to an authorized Lynx dealer.



1. Cold level line

Battery

Removal

WARNING!

Battery BLACK negative cable must always be disconnected first and connected last.

WARNING!

Never charge or boost battery while installed. Battery electrolyte contains sulfuric acid which is corrosive and poisonous. In case of contact with skin, flush with water and call a physician immediately.

WARNING!

Should the battery casing be damaged, wear a suitable pair of non-absorbent gloves when removing the battery by hand.

WARNING!

Battery caps have do not have vent holes. Make sure that vent tube is not obstructed.

Dry battery

These batteries are maintenance-free battery. Electrolyte level can not be checked.

NOTE: During the summer storage the battery (also dry battery) has to be charged at least once a month. Otherwise the battery do not work in the beginning of season.

Maintenance

Vehicle cleaning and protection

Remove any dirt or rust.

To clean the entire vehicle, use only flannel cloths or equivalent.

CAUTION: It is necessary to use flannel cloths or equivalent on windshield and hood to avoid damaging further surfaces to clean.

To clean the entire vehicle, including bottom pan and metallic parts use Bombardier Cleaner (P/N 293 110 001) spray can 400 g and (P/N 293 110 002 (4 L)).

CAUTION: Do not use Bombardier Cleaner on decals or vinyl.

For vinyl and plastic parts use Vinyl & Plastic Cleaner (P/N 413 711 200 (6 x 1 L)).

To remove scratches on windshield or hood use BOMBARDIER Scratch Remover Kit (P/N 861 774 800).

CAUTION: Never clean plastic parts or hood with strong detergent, degreasing agent, paint thinner, acetone, products containing chlorine, etc.

Clean sheaves of both pulleys using BOMBARDIER Pulley flange cleaner (P/N 413 711 809).

Inspect the hood and repair any damage.

Touch up all metal spots where paint has been scratched off. Spray all metal parts including shock chromed rods with BOMBARDIER LUBE (P/N 293 600 016).

Wax the hood and the painted portion of the frame for better protection.

Apply wax on glossy finish only. Protect the vehicle with a cover to prevent dust accumulation during storage.

The snowmobile has to be stored in a cold and dry place and covered with an opaque tarpaulin. This will prevent sun rays from affecting vehicle finish.

Lift rear of vehicle until track is off the ground. Install on a mechanical stand.

Do not release track tension.

Drive belt removal and installation



1. Remove tether cord cap. Open side hood.



Lift up the intake silencer clamp.

Remove intake silencer. First rear part out, pull lower edge and pull to rear to remove intake silencer. Remove cables connected to intake silencer. At reinstallation do not forget to connect air temperature sensor otherwise a trouble code will appear.





Open the drivebelt cover front side.



Lift cover front side up and bend it to out from unit to get it removed.

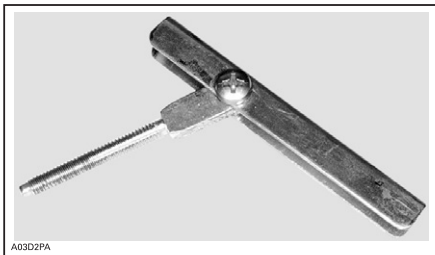

Drive belt installer/ remover

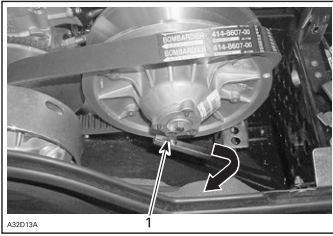

1. Tighten to open pulley

Screw tool in the threaded hole and tighten to open the pulley. Remove belt.

Slip the belt over the top edge of the sliding half, as shown.

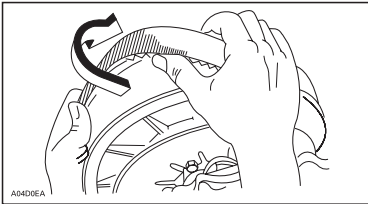

Typical

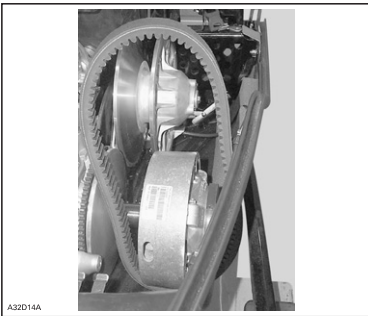

Installation

The maximum drive belt life span is obtained when the belt has the proper rotation direction. Install it so the arrow printed on belt is pointing at front of vehicle.

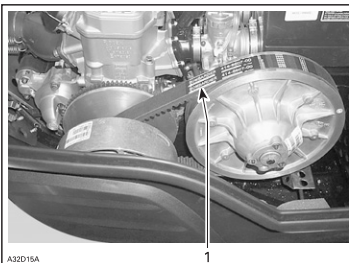

1. Arrow pointing at front of vehicle

CAUTION: Do not force or use tools to pry the belt into place, as this could cut or break the cords in the belt.

Clean sheaves of both pulleys using BOMBARDIER Parts Cleaner (P/N 413 711 809).

To install the drive belt, first place belt between drive pulley sheaves. Then, between driven pulley sheaves, finishing with bottom.

Follow instructions on belt guard.

Reinstall belt guard.

NOTE: Belt guard is purposely made slightly oversize to maintain tension on its retainers preventing undue noise and vibration. It is important that this tension be maintained when reinstalling.

Drive chain tension

Remove hair pin.

Fully tighten tensioner adjustment screw by hand, then back off only far enough for hair pin to engage in locking hole.

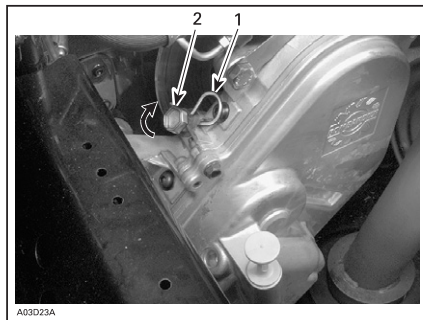

1. Hair pin
2. Adjustment screw

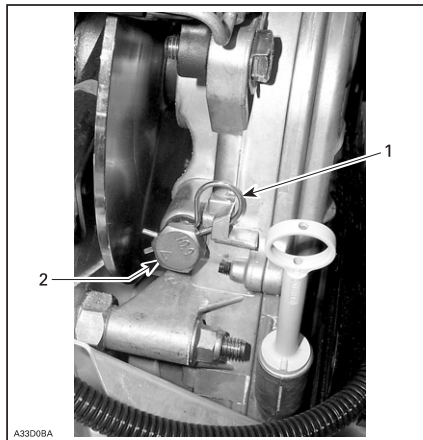

1. Hair pin
2. Adjustment screw

TRA Drive pulley adjustment

The drive pulley is factory calibrated to transmit maximum engine power at a predefined RPM. refer to TECHNICAL DATA at the end of this guide. Factors such as ambient temperature, altitude or surface condition may vary this critical engine RPM thus affecting snowmobile efficiency.

Calibration screws should be adjusted so that actual maximum engine RPM in vehicle matches with the maximum horsepower RPM.

Use precision digital tachometer for engine RPM adjustment.

The adjustment has an effect on high RPM only.

To adjust, turn calibration screws.

CAUTION! Exceeding the engine RPM results to engine damage. Never exceed maximum RPM. Follow the adjustment sets according technical data.

Calibration screw has a notch on top of its head. There are 6 positions numbered 1 to 6.

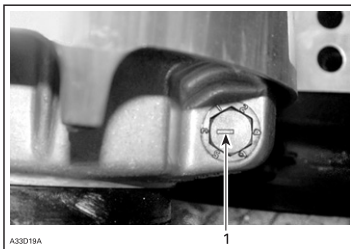

1. Notch

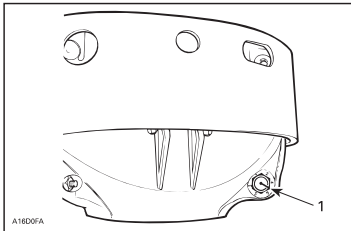

1. Notch

There are 6 positions numbered 1 to 6. Note that in position 1 the number is substituted by a dot (due to its location on casting).

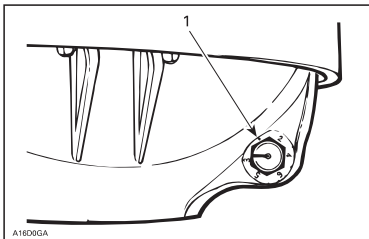

TRA drive pulley

1. Position 1 (not numbered)

Lower position numbers decrease engine RPM in steps of about 200 RPM and higher position numbers increase it in steps of about 200 RPM.

EXAMPLE: Calibration screw is set at position 4 and is changed to position 6: So maximum engine RPM is increased by about 400 RPM.

Adjust as follows: (only if calibrations are changed)

Loosen locking nut enough to pull calibration screw partially out and adjust to desired position. Do not completely remove the locking nut. Torque nut to 10 Nm.

CAUTION: Do not completely remove calibration screw otherwise inside washer will fall off. Always adjust all 3 calibration screws and make sure they are all set at the same number.

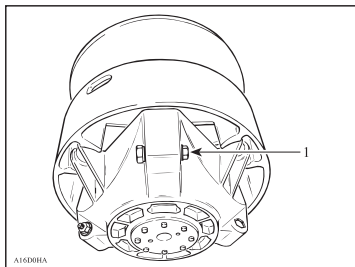

1. Loosen just enough to permit rotating of calibrate screw

WARNING!

Always reinstall belt guard. Do not operate engine with hood open or belt guard removed. Improper servicing, modification or poor adjustment may affect drive pulley performance and belt life. Refer to an authorized Lynx dealer.

Drive belt condition

Inspect belt for cracks, fraying or abnormal wear (uneven wear, wear on one side, missing cogs, cracked fabric). If abnormal wear is noted, probable cause could be pulley misalignment, excessive RPM with frozen track, fast starts without warm-up period, burred or rusty sheave, oil on belt or distorted spare belt. Contact an authorized Lynx dealer.

Check the drive belt width. Replace the drive belt if width is less than the minimum width recommended in TECHNICAL DATA.

Brake condition

WARNING!

The brake mechanism on your snowmobile is an essential safety device. Keep this mechanism in proper working condition. Above all, do not operate the snowmobile without an effective brake system. Periodically verify the condition/wear of the brake pads.

Brake adjustment

Hydraulic brake: No adjustment is provided for hydraulic brake. See an authorized Lynx dealer if any problems.

Rear suspension condition

Visually inspect all suspension components including slider shoes, springs, wheels, etc.

NOTE: During normal driving, snow will act as a lubricant and coolant for the slider shoes. Extensive riding on ice or sanded snow, will create excessive heat build-up and cause premature slide shoe wear

Suspension stopper strap condition

Inspect stopper strap from wear and cracks, bolt and nut for tightness. If loose inspect holes for deformation. Replace as required. Torque nut to 7 Nm.

Track condition

Lift the rear of the snowmobile and support it with a wide-base snowmobile mechanical stand. Rotate the track by hand, and inspect condition. If worn or cut, or if track fibers are exposed, or if missing or defective inserts or guides are noted, contact an authorized Lynx dealer.

WARNING!

Do not operate or rotate track if torn, damaged or excessively worn.

Track tension and alignment

Ride the snowmobile in snow about 15 to 20 minutes prior to adjusting track tension. Lift rear of snowmobile and support it with a wide-base snowmobile mechanical stand. Allow the suspension to extend normally and check the gap half-way between front and rear idler wheels. Measure between slider shoe bottom and inside of track. The gap should be as given in TECHNICAL DATA.

WARNING!

Track tension must be as describe in technical data. Too loose track may cause an accident.

IMPORTANT: Too much tension will result in power loss and excessive stresses on suspension components.

To adjust track tension:

Remove rear idler wheel cover. Loosen rear idler wheel fastening screws. Turn adjustment screws if required. If correct tension is unattainable, contact an authorized Lynx dealer.

WARNING!

Do not try to check the tension with engine on. Push engine cut-out switch to OFF position. Do not touch rotating track, it may cause injuries.

Track Alignment:

WARNING!

Before checking track alignment, ensure that the track is free of all particles which could be thrown out while track is rotating. Keep hands, tools and clothing clear of track.

Start the engine and accelerate slightly so that track barely turns. This must be done in a short period of time (15 to 20 seconds). Check that the track is well centred.

Check that the track is well centred; equal distance on both sides between edges of track guides and slider shoes.

Stop engine prior to adjusting. Loosen rear idler wheel retaining screws. Tighten the adjustment screw on side where the slider shoe is the farthest from the track insert guides.

Tighten lock nuts and retaining screws.

WARNING!

Tighten the nuts properly. If lock nuts or adjustment screws are not tightened properly, the track may become loose and get damaged.

Restart engine and rotate track slowly to recheck alignment.

Reposition snowmobile on ground.

NOTE: A belt tension tester (P/N 414 348 200) may be used to measure deflection as well as force applied.

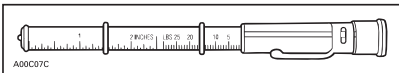

Belt tension tester

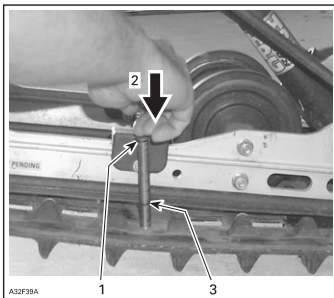

1. Top tool O-ring positioned at 7,3 kg
2. Push on top portion of tool until it contacts the top O-ring
3. Measured track deflection

Steering and front suspension mechanism

Visually inspect steering and front suspension mechanism for tightness of components (steering arms, control arms and links, tie rods, ball joints, ski coupler bolts, etc.)

If necessary, contact an authorized Lynx dealer.

Wear and condition of skis and runners

Check the condition of the skis, ski runners and ski runner carbides. If worn, contact an authorized Lynx dealer.

WARNING!

Excessively worn skis and/or ski runners will affect snowmobile control.

Exhaust system

The exhaust system is designed to reduce noise and to improve the total performance of the engine. If any exhaust system component is removed, modified or damaged, severe engine damage may result.

Air filter cleaning

While riding in deep powder snow, periodically stop then shake the snow from the filter. Check that air silencer is clean and dry and properly reinstall the filter.

Leaving the snowmobile uncovered during a snowfall or riding in deep powder snow may block air filter and choke the engine. Open the sidehood, remove the air filters out of from air silencer and middle hood, shake the snow from filters and properly reinstall the filter.



Check that the air silencer is clean and dry and properly reinstall the filter.

CAUTION: Snowmobile have been calibrated with the filter installed. Operating the snowmobile without it may cause engine damage.

Instruments

Bulb socket is always behind the instrument under a black rubber boot. Pull rubber boot and pull bulb out of socket.

Headlamp beam aiming



Turn knob to adjust beam height.

Bulb replacement

CAUTION: Never touch glass portion of an halogen bulb with bare fingers, it shortens its operating life. If glass is touched, clean it with isopropyl alcohol which will not leave a film on the bulb.

Headlamp bulb change.

If any headlamp bulb is burnt, open the side hoods.

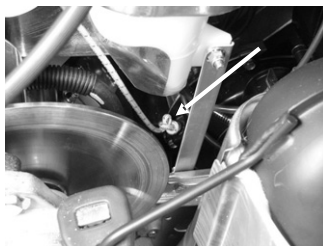

*Pull rewind starter rope out about 40cm and make a knot to get free play for panel.
Open console side screws 2pcs.*



Open console big plastic nut round the fuel tank refill hole.



Lift console front edge up (pin in the rubber ring).



Lift the console rear edge until you have enough space to work with head lamp bulbs.



Unplug burnt bulb connector. Remove the rubber boot.

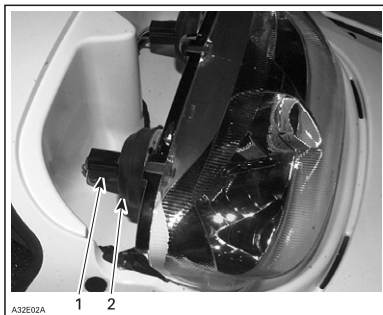

1. Bulb connector
2. Rubber boot

Turn bulb locking ring counterclockwise to remove it. Detach the bulb and replace. Properly reinstall parts.

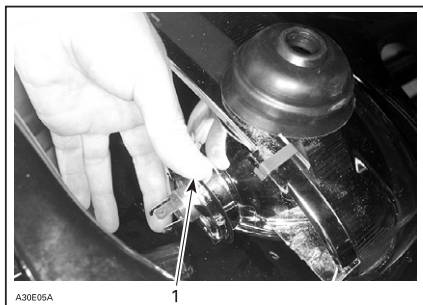

1. *Locking ring*

Unplug burnt bulb connector. Remove the rubber boot.

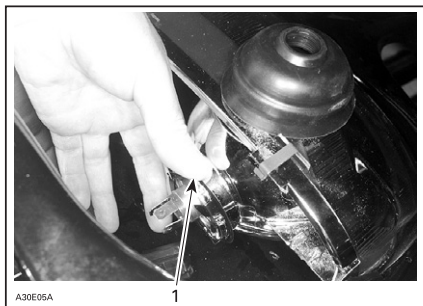

1. *Bulb connector*

2. *Rubber boot*

Turn bulb locking ring counterclockwise to remove it. Detach the bulb and replace. Properly reinstall parts.

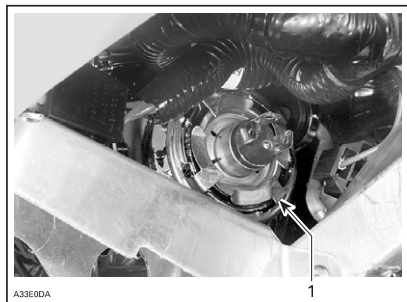

1. *Locking ring*

If taillight bulb is burnt, expose the bulb by removing the red plastic lens. To remove, unscrew the 2 lens screws.

Always check light operation after bulb replacement !

Storage and preseason preparation

WARNING!

Have an authorized LYNX dealer inspect fuel and oil systems integrity as specified in PERIODIC MAINTENANCE CHART.

Storage

It is during summer, or when a snowmobile is not in use for more than one month that proper storage is a necessity.

Engine cooling system

Antifreeze should be replaced for the storage period to prevent antifreeze deterioration. The antifreeze replacement and a density test should be performed by an authorized LYNX dealer.

CAUTION: Improper antifreeze mixture might allow freezing of the liquid in the cooling system if vehicle is stored in area where freezing point is reached. This would seriously damage the engine. Failure to replace the antifreeze for storage may cause its degradation which could result in poor cooling when engine will be used.

CAUTION: Do not run engine during storage period.

Preseason preparation

Refer to an authorized LYNX dealer.

CAUTION: Have carburetor(s) cleaned-up before restarting engine on so equipped models.

Adjustable backrest

The backrest position and support angle may be adjusted to suit driver or passenger convenience.

Troubleshooting

Monitoring beeper coded signals:

| CODED SIGNAL | POSSIBLE CAUSE | REMEDY |
|---|--|--|
| 2 short beeps (when engine is started). DESS/RER pilot lamp also blinks. | Confirms that proper tether cord cap is installed. | Normal condition. |
| 1 short beep every 1,5 seconds (when engine is started). DESS/RER pilot lamp also blinks. Engine cannot reach engagement speed. Vehicle cannot be driven. | Bad DESS system connection. Defective tether cord cap. Dirt or snow in tether cord cap. Defective DESS post. | Reinstall tether cord cap correctly over post. Use another programmed tether cord cap. Clean tether cord cap. Contact an authorized Lynx dealer. |
| 1 long beep per second. SDI 0,5 sec beep every 0,5 sec. | Reverse is selected | Vehicle can be driven in reverse |
| 3 short beeps per second. DESS/RER pilot lamp also blinks. Engine cannot reach pulley engagement. Vehicle cannot be driven. | Wrong tether cord cap is installed | Install proper tether cord cap. |
| 3 short beeps per second. Engine overheating pilot lamp also blinks. SDI 80ms beep every 260ms temp lamp also blinks. | Engine is overheating | Stop engine immediately and allow to cool. If trouble persists, see an authorized Lynx dealer. |
| | | |
| 3 short beeps per second. Battery pilot lamp also lights up blinks. SDI 80ms beep every 260ms batt lamp also blinks. | Low battery voltage | Check battery and charging system, see an authorized Lynx dealer. |
| 4 short beeps every 2 minutes. Oil pilot lamp also lights up. | Low oil level on 2 –tec models. | Check oil level and add oil as soon as possible. |
| 4 short beeps every 2 minutes. Engine pilot lamp also lights every 3 seconds. | Too high battery voltage. DESS system has detected a shorted key installed on DESS post. | Use another programmed tether cord cap. |
| 4 short beeps every 2 minutes. Engine pilot lamp also lights up. SDI 2 sec beep every 58 second lamp, remains on | Defect in engine management system. (EMS) | See an authorized Lynx dealer. |
| 4 short beeps every 2 minutes. Engine pilot lamp blinks every 1 second. SDI 2 sec beep every 15 seconds, lamp remains on. | Defect in engine management system. (EMS) | See an authorized Lynx dealer. |

| TROUBLESHOOTING | |
|--|--|
| SYMPTON: Engine turns over but fails to start | |
| POSSIBLE CAUSES | WHAT TO DO |
| Ignition switch, engine cut-out switch or tether cord is OFF position. | Place all the switches to ON position. |
| Mixture not rich enough to start cold engine. | Check fuel tank and check starting procedure, particularly use of the choke or primer. |
| Flooded engine (spark plug wet when removed). | Do not choke. Remove wet spark plug, turn ignition switch to OFF and crank engine several times. Install clean, dry spark plug. Start engine following usual starting procedure. If engine continues to flood, see an authorized Lynx dealer. SDI opening the throttle fully during cranking will switch off the fuel. |
| No fuel to the engine (spark plug dry when removed). | Check fuel tank level; turn fuel valve on if applicable; check fuel filter; replace if clogged; check condition of fuel and impulse lines and their connections. A failure of the fuel pump or carburetor has occurred; contact an authorized Lynx dealer. |
| Spark plug/ignition (no spark). | Remove spark plug (s) then reconnect to spark cap. Check that engine cut-out switch is at the ON position and the tether cut-out cord cap is snapped over the receptacle. Start engine with spark plug (s) grounded to engine away from spark plug hole. If trouble persists, contact an authorized Lynx dealer. |
| Engine compression. | As the engine is pulled over with the rewind starter, "cycles" of resistance should be felt as piston goes past top dead center (each piston on multi-cylinder engines). If no pulsating resistance is felt, it suggests a major loss of compression. Contact an authorized Lynx dealer. |











| SYMPTON: Engine lacks acceleration or power | |
|--|---|
| POSSIBLE CAUSES | WHAT TO DO |
| Fouled or defective spark plug | Check item " <i>Engine turns over but fails to start</i> " |
| Lack of fuel to engine | See item " <i>Engine turns over but fails to start</i> " |
| Carburetor adjustments | Contact an authorized Lynx dealer. |
| Drive belt worn too thin | If the drive belt has lost more than 3 mm of its original width, it will affect vehicle performance. |
| Drive and driven pulleys require servicing | Contact an authorized Lynx dealer. |
| Engine is overheating | On liquid cooled engines: Check coolant level, pressure cap, thermostat and for air locks in cooling system. On fan cooled engines: Check fan belt and its tension; clean cooling fins of engine; if overheating persists, contact an authorized Lynx dealer. |

| SYMPTON: Engine backfires | |
|---|--|
| POSSIBLE CAUSES | WHAT TO DO |
| Faulty spark plug | See item " <i>Engine turns over but fails to start</i> " |
| Engine is running too hot | See item " <i>Engine lacks acceleration or power</i> " |
| Ignition timing is incorrect or there is an ignition system failure | Contact an authorized Lynx dealer |

| SYMPTON: Engine misfires | |
|----------------------------------|---|
| POSSIBLE CAUSES | WHAT TO DO |
| Fouled/defective/worn spark plug | Clean/verify spark plug gap and identification number. Replace as required. |
| Too much oil supplied in engine | Improper oil pump adjustment, refer to an authorized Lynx dealer. Too rich fuel/oil mixture (only during break-in period). Drain fuel tank and refill with appropriate mixture ratio. |
| Water in fuel | Drain fuel system and refill with fresh fuel. Replace fuel filter if needed. |

| SYMPTOM: Snowmobile cannot reach full speed | |
|--|--|
| POSSIBLE CAUSES | WHAT TO DO |
| Drive belt | Check item " <i>Engine lacks acceleration or power</i> " |
| Incorrect track adjustment | See MAINTENANCE or an authorized Lynx dealer for proper alignment and tension adjustments. |
| Pulleys misaligned | Contact an authorized Lynx dealer. |
| Engine | See item " <i>Engine lacks acceleration or power</i> ". |
| Clutch adjustment required for snow conditions | See TRA drive pulley adjustment in this book |

| | |
|---|---|
| A | Adjust |
| I | Inspect (clean, check, repair, adjust, lubricate) |
| L | Lubricate |
| R | Replace |
| C | Clean |

| SERVICE SCHEDULE | | 10 h or 500 km first service (service shop performs) | every 250 km or weekly | 1000 km or monthly | every 3000 km or once a season | every 6000 km or once a season | Summer storage (service shop performs) | Pre season service (service shop performs) |
|---|---|--|------------------------|--------------------|--------------------------------|--------------------------------|--|--|
|  | | | | | | | | |
|  | Engine mount nuts and screws | I | | | I | | I | |
| | Exhaust system | I | | I | | | I | |
| | Cooling system | I | | | I | | | I |
| | Coolant | I | | | | | R | |
| | Condition of seals | I | | | | | I | I |
|  | Replacement of oil and oil filter / 4-tec | R | | | | R | | |
|  | Fuel stabilizer | | | | | | R | |
| | Fuel filter | | | | | | | I |
| | Fuel lines and connections | I | | | | | I | I |
| | Fuel injection system (visually inspection) | | | | I | | | |
| | Throttle cable | I | | | I | | I | I |
| | Air filter | | | C | | | | C |
|  | Drive belt | I | I | | | | | I |
| | Drive and driven pulleys | I | | I | C | | I | C |
| | Drive pulley screw tightness | I | | | I | | | I |
| | Driven pulley preload | I | | | I | | I | |
|  | Brake fluid | I | I | | | | R | I |
| | Brake | I | I | | | | I | I |
|  | Drive chain tension (3) | A | | A | | | A | |
| | Chaincase oil/gear box oil (6) | R | | I | | | R | I |
| | Drive axle end bearing (2) | L | | L | | | L | |
|  | Steering and front suspension mechanism (2) | A,I,L | | A,I | L | | A,I,L | |
| | Wear and condition of skis and runners | I | I | | | | I | |
| | Suspension (5) | I | | I,L | | | I,L | |
| | Suspension stopper strap | | | | I | | | I |
| | Track | I | | I | | | I | |
| | Track tension and alignment | A | | I | | | | |
|  | Spark plugs (1) | I | | I | | R | | R |
| | Battery (4) | I | | I | | | I | I |
| | Headlight beam aiming | | | | A | | | A |
| | Wiring harnesses and connectors | I | | I | | | I | |
| | Light function | I | I | | | | I | |
|  | Rags in air intake and exhaust system | | | | | | R | C |
| | Engine compartment | C | | C | | | C | |
| | Cleaning and protection of the vehicle | C | | C | | | C | |

- Before installing new spark plugs at pre-season preparation, it is suggested to burn excess storage oil by starting the engine with the old spark plugs. Only perform this operation in a well ventilated area.
- Lubricate whenever the vehicle is used in wet conditions (wet snow, rain, puddles).
- Replace chain and sprockets every 6000 km.
- Battery has to be charged during summer storage at least once a month.
- If your snowmobile is equipped with take a part shock, first oil change have to be performed after 1500 km After that once a season or after 3000 km which ever occur first.
- Change gearbox oil every 3000 km.

| | X-trim 800 PowerTEK | X-trim 600 SDI | X-trim 550 | Adventure 600 | Adventure 550 |
|-----------------------------|--|---|--|--|--|
| Engine | 793 HO PowerTEK | 593 HO SDI | 552 | 593 SS | 552 |
| Max power RPM | 7950 | 8100 | 7000 | 8000 | 7000 |
| Spark plug | | | | | |
| Type NGK | BR9ECS | BR8ECS | BR9ES | BR9ECS | BR9ES |
| Gap mm | 0,8 | 0,8 | 0,45 | 0,5 | 0,45 |
| Track | | | | | |
| Width x length mm | 380x3648 | 380x3648 | 380x3648 | 380x3648 | 380x3648 |
| Tension mm | 20-25 | 20-25 | 20-25 | 20-25 | 20-25 |
| Fluids | | | | | |
| Fuel | 95E | 95E | 95E | 95E | 95E |
| Oil type | BRP XP-S Synthetic Blend 2-stroke injection oil or BRP XP-S Synthetic injection oil or BRP mineral injection | BRP XP-S Synthetic Blend 2-stroke injection oil or BRP XP-S Synthetic injection oil | BRP XP-S Synthetic Blend 2-stroke injection oil or BRP XP-S Synthetic injection oil or BRP mineral injection oil | BRP XP-S Synthetic Blend 2-stroke injection oil or BRP XP-S Synthetic injection oil or BRP mineral injection oil | BRP XP-S Synthetic Blend 2-stroke injection oil or BRP XP-S Synthetic injection oil or BRP mineral injection oil |
| Oil type gearbox | SAE 75W-140 API GL5 HYPOIDI | SAE 75W-140 API GL5 HYPOIDI | SAE 75W-140 API GL5 HYPOIDI | SAE 75W-140 API GL5 HYPOIDI | SAE 75W-140 API GL5 HYPOIDI |
| Antifreeze/Water | 50/50 | 50/50 | - | 50/50 | - |
| Volumes | | | | | |
| Fuel tank | 38 | 38 | 38 | 38 | 38 |
| Oil tank l | 3,5 | 3,5 | 3,5 | 3,5 | 3,5 |
| Oil volume gearbox l | 0,25 | 0,25 | 0,25 | 0,25 | 0,25 |
| Thermostat °C *) | 42 | 42 | - | 42 | - |
| Fan belt P/N | - | - | 420980511 | - | 420980511 |
| Drive belt P/N | 417300166 | 417300197 | 415060600 | 417300197 | 415060600 |
| Headlight W | 2xH4 60/55 | 2xH4 60/55 | 2xH4 60/55 | 2xH4 60/55 | 2xH4 60/55 |
| Taillight W | 5 | 5 | 5 | 5 | 5 |
| Brake light W | 21 | 21 | 21 | 21 | 21 |

*) Opening temperature

| | Rave RC 800 PowerTek | Rave RC 600 SDI | Rave 600 | Rave 550 | Rave 440 | Adventure 600 SDI |
|----------------------|---|---|---|---|---|---|
| Engine | 793 HO Power TEK 7950 | 593 HO SDI 8100 | 593 SS 8000 | 552 7000 | 493 8400 | 593 HO SDI 8100 |
| Max power RPM | | | | | | |
| Spark plug | | | | | | |
| Type NGK | BR9ECS | BR8ECS | BR9ECS | BR9ES | BR9ECS | BR8ECS |
| Gap mm | 0,8 | 0,8 | 0,5 | 0,45 | 0,5 | 0,8 |
| Track | | | | | | |
| Width x length mm | 380x3072 | 380x3072 | 380x3072 | 380x3072 | 380x3072 | 380x3648 |
| Tension mm | 20-25 | 20-25 | 20-25 | 20-25 | 20-25 | 20-25 |
| Fluids | | | | | | |
| Fuel | 95E | 95E | 95E | 95E | 98E + 3,3%inj.oil | 95E |
| Oil type | BRP XP-S Synthetic Blend 2-stroke injection oil or BRP XP-S Synthetic injection oil or BRP mineral injection oil | BRP XP-S Synthetic Blend 2-stroke injection oil or BRP XP-S Synthetic injection oil | BRP XP-S Synthetic Blend 2-stroke injection oil or BRP XP-S Synthetic injection oil or BRP mineral injection oil | BRP XP-S Synthetic Blend 2-stroke injection oil or BRP XP-S Synthetic injection oil or BRP mineral injection oil | BRP XP-S Synthetic 2-stroke injection oil | BRP XP-S Synthetic Blend 2- stroke injection oil or BRP XP-S Synthetic injection oil |
| Oil type gearbox | SAE 75W-140 API GL5 Hypoidi S | | | | | |
| Antifreeze/Water | 50/50 | 50/50 | 50/50 | - | 50/50 | 50/50 |
| Volumes | | | | | | |
| Fuel tank | 38 | 38 | 38 | 38 | 20 | 38 |
| Oil tank I | 3,5 | 3,5 | 3,5 | 3,5 | - | 3,5 |
| Oil volume gearbox I | 0,25 | 0,25 | 0,25 | 0,25 | 0,25 | 0,25 |
| Thermostat (°C *) | 42 | 42 | 42 | - | 42 | 42 |
| Fan belt P/N | - | - | - | 420980511 | - | - |
| Dive belt P/N | 417300166 | 417300197 | 417300197 | 415060600 | 417300288 | 417300197 |
| Headlight W | 2xH4 60/55 | 2xH4 60/55 | 2xH4 60/55 | 2xH4 60/55 | 2xH4 60/55 | 2xH4 60/55 |
| Tailight W | 5 | 5 | 5 | 5 | 5 | 5 |
| Brake light W | 21 | 21 | 21 | 21 | 21 | 21 |

*) Opening temperature

NOTES
