

**can-am**  
OUTLANDER™ T Series

**NOV**

# OPERATOR'S GUIDE

**Includes**  
Safety, Vehicle and  
Maintenance Information

## **⚠ WARNING**

Read this guide thoroughly.  
It contains important safety information.  
Minimum recommended age: Operator: 16 years old.  
Keep this Operator's Guide in the vehicle.

---

**2 1 9 0 0 2 1 6 0**

**Original Instructions**

## **WARNING**

**YOUR VEHICLE CAN BE HAZARDOUS TO OPERATE.** A collision or rollover can occur quickly, if you fail to take proper precautions, even during routine maneuvers such as turning and driving on hills or over obstacles. For your safety, understand and follow all the warnings contained in this Operator's Guide and on the labels on your vehicle. **Failure to follow these warnings can result in SEVERE INJURY OR DEATH!** Keep this Operator's Guide with the vehicle at all times.

## **WARNING**

Disregarding any of the safety precautions and instructions contained in this Operator's Guide, *SAFETY VIDEO* and on-product safety labels could result in an injury including the possibility of death!

## **WARNING**

This vehicle may exceed the performance of other vehicles you may have ridden in the past. Take time to familiarize yourself with your new vehicle.

The following trademarks are the property of Bombardier Recreational Products Inc.:

In Finland, products are distributed by BRP Finland Oy.

Can-Am® DPS™ Outlander™ Rotax® TTI™ XPS™

This document contains the trademark of the following company:

– Visco-lok is a trademark of GKN Viscodrive GmbH.

# I VEHICLE IDENTIFICATION

The main components of your vehicle (engine and frame) are identified using different serial numbers. It may sometimes become necessary to locate these numbers for warranty purposes or to trace your vehicle in the event of loss. These numbers are also required by the authorized Can-Am dealer to complete warranty claims properly. No warranty will be allowed by BRP if the engine identification number (EIN) or vehicle identification number (VIN) is removed, mutilated or altered in any way. We strongly recommend that you take note of all the serial numbers on your vehicle and supply them to your insurance company.



VIN LABEL

## 1) Vehicle Identification Number

The VIN is on the statutory plate located under the seat.

Bombardier Recreational Products Inc. 

1 → TXX  
 2 → eXXXXXXXXXXXXXXXXXX  
 3 → XXXXXXXXXXXXXXXXXXXX  
 4 → XXXX kg  
 5 → A-1: XXX kg  
 6 → A-2: XXX kg  
 7 → A-3: XXX kg

	T-1	T-2	T-3
B-1	XXX kg	XXX kg	XXX kg
B-2	XXX kg	XXX kg	XXX kg

EN-704908168-DEC

### STATUTORY PLATE

- 1: Category
- 2: Type-approval number
- 3: VIN
- 4: Permissible maximum laden mass(es) of the vehicle
- 5-7: Permissible maximum mass(es) per axle
- B-1: Permissible towable mass on rear coupling point; unbraked trailer
- B-2: Permissible towable mass on rear coupling point; inertia-braked trailer

## 2) Vehicle Identification Form

Please verify with your dealer to ensure your vehicle has been registered with BRP.

MODEL No. _____			
<b>VEHICLE IDENTIFICATION NUMBER (V.I.N.)</b> _____			
<b>ENGINE IDENTIFICATION NUMBER (E.I.N.)</b> _____			
<b>Owner:</b> _____			
NAME			
_____	_____	_____	_____
No.	STREET	APT	
_____	_____	_____	_____
CITY	STATE/PROVINCE	ZIP/POSTAL CODE	
<b>Purchase Date</b> _____			
	YEAR	MONTH	DAY
<b>Warranty Expiry Date</b> _____			
	YEAR	MONTH	DAY
To be completed by the dealer at the time of the sale.			

DEALER IMPRINT AREA
---------------------

V00A2IL



### 3) Engine Identification Number (EIN)

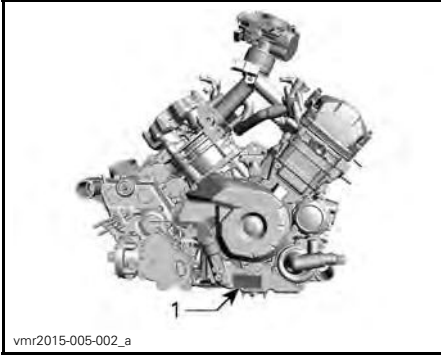

vmr2015-005-002\_a

**RH SIDE OF ENGINE**

1. EIN (Engine Identification Number)

### 4) Compliance Label

**Regulation (EU) 2016/1628 applicable for Non-Road Mobile Machineries**

Vehicles who comply to Regulation (EU) 2016/1628 (NRMM) are identified on the engine valve cover as well as on the frame under the seat.

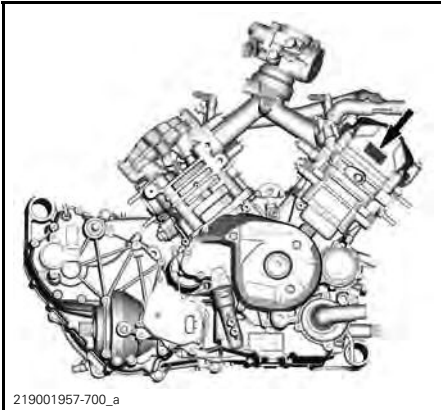

219001957-700\_a

**TYPICAL**



219002028-001

**TYPICAL**

1. NRMM Label - On the frame under the seat

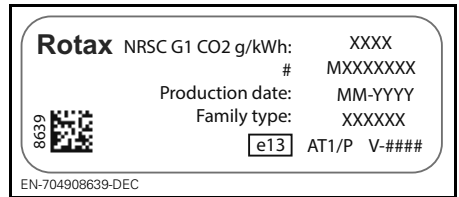

**TYPICAL - NRMM IDENTIFICATION LABEL**

**NOTE:** Any tampering with the engine or its components will void the EU type-approval of the vehicle.

### 5) Intended use

Agricultural tractor that can be used to carry materials. Check the maximum allowable load of the vehicle indicated on the statutory plate and vehicle maximum load label, refer to **IMPORTANT ON-PRODUCT LABELS**. The Can-Am T Category tractor can tow a trailer on the road. Check the maximum allowable load of the trailer. Check the regulations for your area regarding the use of a tractor and trailer on the road. Connect the trailer lights on the vehicle.

## II FOREWORD

### OPERATOR'S GUIDE 2021

T Category (EU) Reg.167/2013

Outlander 450 T Category

Outlander 570 T Category

Outlander 450 T Category DPS ABS

Outlander 570 T Category DPS ABS

Outlander XU 450 T Category ABS

Outlander XU 570 T Category ABS

Outlander XU+ 450 T Category

Outlander MAX 450 T Category DPS ABS

Outlander MAX 570 T Category DPS ABS

Outlander MAX 570 T Category XT ABS

Deutsch	Dieses Handbuch ist möglicherweise in Ihrer Landessprache verfügbar. Bitte wenden Sie sich an Ihren Händler oder besuchen Sie: <a href="http://www.operatorsguides.brp.com">www.operatorsguides.brp.com</a>
English	This guide may be available in your language. Check with your dealer or go to: <a href="http://www.operatorsguides.brp.com">www.operatorsguides.brp.com</a>
Español	Es posible que este manual esté disponible en su idioma. Consulte a su distribuidor o visite: <a href="http://www.operatorsguides.brp.com">www.operatorsguides.brp.com</a>
Français	Ce guide peut être disponible dans votre langue. Vérifier avec votre concessionnaire ou aller à: <a href="http://www.operatorsguides.brp.com">www.operatorsguides.brp.com</a>
Italiano	Questa guida potrebbe essere disponibile nella propria lingua. Contattare il concessionario o consultare: <a href="http://www.operatorsguides.brp.com">www.operatorsguides.brp.com</a>
中文	本手册可能有您的语种的翻译版本。请向经销商询问，或者登录 <a href="http://www.operatorsguides.brp.com">www.operatorsguides.brp.com</a> 查询。
日本語	このガイドは、言語によって翻訳版が用意されています。ディーラーに問い合わせるか、次のアドレスでご確認ください： <a href="http://www.operatorsguides.brp.com">www.operatorsguides.brp.com</a>
Nederlands	Deze handleiding kan beschikbaar zijn in uw taal. Vraag het aan uw dealer of ga naar: <a href="http://www.operatorsguides.brp.com">www.operatorsguides.brp.com</a>
Norsk	Denne boken kan finnes tilgjengelig på ditt eget språk. Kontakt din forhandler eller gå til: <a href="http://www.operatorsguides.brp.com">www.operatorsguides.brp.com</a>
Português	Este manual pode estar disponível em seu idioma. Fale com sua concessionária ou visite o site: <a href="http://www.operatorsguides.brp.com">www.operatorsguides.brp.com</a>
Русский	Воспользуйтесь руководством на вашем языке. Узнайте о его наличии у дилера или на странице по адресу <a href="http://www.operatorsguides.brp.com">www.operatorsguides.brp.com</a>
Suomi	Käyttöohjekirja voi olla saatavissa omalla kielelläsi. Tarkista jälleenmyyjältä tai käy osoitteessa: <a href="http://www.operatorsguides.brp.com">www.operatorsguides.brp.com</a>
Svenska	Denna bok kan finnas tillgänglig på ditt språk. Kontakta din återförsäljare eller gå till: <a href="http://www.operatorsguides.brp.com">www.operatorsguides.brp.com</a>

This operator's guide is regarded as part of the vehicle and should be remain with the vehicle when it is sold.

Congratulations on your purchase of a new Can-Am® ATV. It is backed by the BRP warranty and a network of authorized Can-Am dealers ready to provide the parts, service or accessories you may require.

Your dealer is committed to your satisfaction. He has taken training to perform the initial setup and inspection of your vehicle as well as completed the final adjustment before you took possession. If you need more complete servicing information, please ask your dealer.

At delivery, you were also informed of the warranty coverage and signed the *PREDELIVERY CHECK LIST* to ensure your new vehicle was prepared to your entire satisfaction.

## 1) Know Before you Go

To learn how to reduce the risk for you or bystanders being injured or killed, read this Operator's Guide before you operate the vehicle.

Also, read all safety labels on your ATV and watch attentively the *SAFETY VIDEO* located at <https://can-am.brp.com/off-road/safety>.



This vehicle is mainly for general recreational use but it may also be used for utility purposes.

Failure to follow the warnings contained in this Operator's Guide can result in **SERIOUS INJURY** or **DEATH**.

### Training Course

Never operate this vehicle without proper instruction. **Take a training course.** All operators should receive training from a certified instructor.

For more information about ATV safety, contact an authorized Can-Am dealer to find out about available training courses nearest you.

## 2) Safety Messages

The types of safety messages, what they look like and how they are used in this guide are explained as follows:

The safety alert symbol  indicates a potential injury hazard.

### WARNING

Indicates a potential hazard, if not avoided, could result in serious injury or death.

 **CAUTION** Indicates a hazard situation which, if not avoided, could result in minor or moderate injury.

**NOTICE** Indicates an instruction which, if not followed, could severely damage vehicle components or other property.

## 3) About this Operator's Guide

This Operator's Guide has been prepared to acquaint the owner/operator of a new vehicle with the various vehicle controls, maintenance and safe operating instructions. It is indispensable for the proper use of the product.

After reading, please keep this Operator's Guide with the vehicle. If the vehicle is resold, please give the guide to the new owner for his awareness.

If you have any question regarding any topic whether or not it is covered in this Operator's Guide, refer to *CONTACT US*.

### WARNING

Throughout this Operator's Guide, the term "1-UP" refers to vehicles designed to carry the operator only while the term "2-UP" refers to vehicles designed to carry also a passenger.

**Make sure to identify and follow the warnings and instructions that are applicable to your specific model.**

Note that this guide is available in several languages. In the event of any discrepancy, the English version shall prevail.



Keep this Operator's Guide in the vehicle as you can refer to it for things such as maintenance, troubleshooting and instructing others.

If you want to view and/or print an extra copy of your Operator's Guide, simply visit the following website **[www.operatorsguides.brp.com](http://www.operatorsguides.brp.com)**.

The information contained in this document are correct at the time of publication. However, BRP maintains a policy of continuous improvement of its products without imposing upon itself any obligation to install them on products previously manufactured. Due to late changes, some differences between the manufactured product and the descriptions and/or specifications in this guide may occur. BRP reserves the right at any time to discontinue or change specifications, designs, features, models or equipment without incurring any obligation upon itself.

This Operator's Guide should remain with the vehicle when it is sold.

While reading this Operator's Guide, remember that:

 **WARNING**

Indicates a potential hazard that, if not avoided, could result in serious injury or death.

---

# TABLE OF CONTENTS

<b>I VEHICLE IDENTIFICATION</b> .....	<b>1</b>
1) Vehicle Identification Number .....	1
2) Vehicle Identification Form .....	2
3) Engine Identification Number (EIN) .....	3
4) Compliance Label .....	3
5) Intended use .....	3
<b>II FOREWORD</b> .....	<b>4</b>
1) Know Before you Go .....	6
2) Safety Messages .....	6
3) About this Operator's Guide .....	6
<b>A) SAFETY INFORMATION</b>	
<b>I GENERAL PRECAUTIONS</b> .....	<b>14</b>
1) Avoid Carbon Monoxide Poisoning .....	14
2) Avoid Gasoline Fires and Other Hazards .....	14
3) Avoid Burns from Hot Parts .....	14
4) Accessories and Modifications .....	14
<b>II SPECIAL SAFETY MESSAGES</b> .....	<b>15</b>
European Community .....	18
<b>III OPERATION WARNINGS</b> .....	<b>19</b>
<b>IV RIDING THE VEHICLE</b> .....	<b>47</b>
1) Pre-Ride Inspection .....	48
2) Riding Gear .....	50
3) Carrying a Passenger .....	51
4) Recreational Riding .....	52
5) Environment .....	52
6) Design Limitation .....	53
7) Off-Road Operation .....	53
8) Riding Techniques .....	53
<b>V MOVING LOADS AND DOING WORK</b> .....	<b>65</b>
1) Working with your Vehicle .....	65
2) Carrying Loads .....	65
3) Loading the Cargo Racks .....	66
4) Hauling a Load .....	67
5) Pulling a Trailer .....	67
<b>VI IMPORTANT ON-PRODUCT LABELS</b> .....	<b>69</b>
1) Vehicle Safety Labels .....	69
2) Compliance Labels .....	78
3) Technical Information Labels .....	78

## **B) VEHICLE INFORMATION**

<b>I CONTROLS</b> .....	<b>82</b>
1) Throttle Lever .....	82

<b>I CONTROLS (cont'd)</b>	
2) Brake Lever .....	83
3) Brake Lock .....	83
4) Brake Pedal .....	84
5) Ignition Switch (Key) .....	84
6) Multifunction Switch .....	85
7) Shift Lever .....	87
8) Winch Control Switch (If Equipped) .....	88
9) 2WD/4WD and Driving Modes (if equipped) Selector Switch .....	88
<b>MULTIFUNCTION GAUGE (LCD) .....</b>	<b>91</b>
1) Multifunction Gauge Description .....	91
2) Multifunction Gauge Modes .....	92
3) Navigating in the LCD Gauge .....	94
4) Gauge Setup .....	95
5) Setting the Speed Limit .....	95
<b>4.5" DIGITAL DISPLAY .....</b>	<b>97</b>
Multifunction Display .....	97
Warning Lamps and Indicators .....	99
Settings .....	100
<b>DRIVING AID TECHNOLOGIES (IF EQUIPPED) .....</b>	<b>102</b>
ABS (Anti-lock Brake System) .....	102
eCBS (Electronic Combined Brake System) .....	102
BTC (Brake Traction Control) .....	102
DTC (Drag Torque Control) .....	102
<b>III EQUIPMENT .....</b>	<b>103</b>
1) Operator's Seat .....	103
2) Passenger's Seat (2-UP Models) .....	104
3) Grab Handles (2-UP Models) .....	105
4) Footpegs .....	106
5) 12-Volt Power Outlet .....	106
6) Rear Storage Compartment .....	107
7) Cargo Racks .....	107
8) Trailer Hitch .....	107
9) Trailer Connector .....	108
10) Tool Kit .....	108
11) Recovery Hooks .....	108
12) Winch .....	109
13) License Plate Light .....	110
<b>IV FUEL .....</b>	<b>111</b>
1) Fuel Requirements .....	111
2) Vehicle Fueling Procedure .....	111
<b>V BREAK-IN PERIOD .....</b>	<b>113</b>
1) Operation During Break-In .....	113
<b>VI BASIC PROCEDURES .....</b>	<b>114</b>
1) Starting the Engine .....	114
2) Changing Gear Selection .....	114

<b>VI BASIC PROCEDURES (cont'd)</b>	
3) Stopping the Engine and Parking the Vehicle .....	114
<b>VII SPECIAL PROCEDURES .....</b>	<b>115</b>
1) What to Do if Water Entered the CVT .....	115
2) What to Do if Water Entered the Air Filter Housing .....	115
3) What to Do if Vehicle is Turned Over .....	116
4) What to Do if Vehicle is Immersed in Water .....	116
<b>VIII TUNE YOUR RIDE .....</b>	<b>117</b>
1) Suspension Adjustment .....	117
2) Dynamic Power Steering (DPS) Assist Level Adjustment .....	117
<b>IX TRANSPORTING THE VEHICLE .....</b>	<b>119</b>
Using vehicle power to climb onto trailering equipment .....	119
Using a winch to pull vehicle onto trailering equipment .....	120
Securing vehicle for transport .....	120
Getting vehicle out of trailer .....	121
<b>INSTRUCTIONS FOR VEHICLE LIFTING .....</b>	<b>122</b>
General Safety Information for Lifting .....	122
Lifting the Front of the Vehicle .....	122
Lifting the Rear of the Vehicle .....	122
Lifting the Entire Vehicle .....	123

**C) MAINTENANCE**

<b>I MAINTENANCE SCHEDULE .....</b>	<b>126</b>
1) SEVERE DUSTY CONDITIONS .....	126
2) MAINTENANCE SCHEDULE LEGEND .....	126
3) MAINTENANCE SCHEDULE .....	127
<b>II MAINTENANCE PROCEDURES .....</b>	<b>129</b>
1) Air Filter .....	129
2) Engine Oil .....	132
3) Oil Filter .....	134
4) Radiator .....	135
5) Engine Coolant .....	136
6) Muffler Spark Arrester .....	139
7) CVT Air Filter .....	139
8) Gearbox Oil (570 Models) .....	140
9) Spark Plugs .....	142
10) CVT Cover .....	143
11) Installing the CVT Cover (450 models) .....	144
12) Installing the CVT Cover (all other models) .....	144
13) Drive Belt .....	145
14) Drive and Driven Pulleys .....	146
15) Battery .....	146
16) Fuses .....	147
17) Lights .....	149
18) Drive Shaft Boot and Protector .....	151

<b>II MAINTENANCE PROCEDURES (cont'd)</b>	
19) Wheel Bearing .....	151
20) Wheels and Tires .....	152
21) Steering .....	153
22) Suspension .....	153
23) Brakes .....	154
<b>III VEHICLE CARE .....</b>	<b>156</b>
Post-Operation Care .....	156
Vehicle Cleaning .....	156
<b>IV STORAGE AND PRESEASON PREPARATION.....</b>	<b>158</b>

### ***D) TECHNICAL INFORMATION***

<b>EC-DECLARATION OF CONFORMITY .....</b>	<b>160</b>
<b>EAC DECLARATION OF CONFORMITY.....</b>	<b>161</b>
<b>I SPECIFICATIONS.....</b>	<b>162</b>

### ***E) TROUBLESHOOTING***

<b>I TROUBLESHOOTING GUIDELINES .....</b>	<b>178</b>
<b>II MULTIFUNCTION GAUGE MESSAGES.....</b>	<b>182</b>

### ***F) SPARE PARTS***

<b>I CATALOGS .....</b>	<b>186</b>
-------------------------	------------

### ***G) WARRANTY***

<b>BRP LIMITED WARRANTY USA AND CANADA: 2021 CAN-AM® ATV....</b>	<b>188</b>
<b>US EPA EMISSION-RELATED WARRANTY .....</b>	<b>191</b>
<b>BRP INTERNATIONAL LIMITED WARRANTY: 2021 CAN-AM® ATV .....</b>	<b>194</b>
<b>BRP LIMITED WARRANTY FOR THE EUROPEAN ECONOMIC AREA, THE COMMONWEALTH OF THE INDEPENDENT STATES AND TURKEY: 2021 CAN-AM® ATV .....</b>	<b>198</b>

### ***H) CUSTOMER INFORMATION***

<b>I PRIVACY INFORMATION.....</b>	<b>204</b>
<b>II CONTACT US.....</b>	<b>205</b>
Asia .....	205
Europe .....	205
North America .....	205
Oceania .....	205
South America.....	205

<b>III CHANGE OF ADDRESS/OWNERSHIP .....</b>	<b>206</b>
<b>IV MAINTENANCE RECORDS .....</b>	<b>214</b>

# ***A) SAFETY INFORMATION***

---

# I GENERAL PRECAUTIONS

## 1) Avoid Carbon Monoxide Poisoning

All engine exhaust contains carbon monoxide, a deadly gas. Breathing carbon monoxide can cause headaches, dizziness, drowsiness, nausea, confusion and eventually death.

Carbon monoxide is a colorless, odorless, tasteless gas that may be present even if you do not see or smell any engine exhaust. Deadly levels of carbon monoxide can collect rapidly, and you can quickly be overcome and unable to save yourself. Also, deadly levels of carbon monoxide can linger for hours or days in enclosed or poorly ventilated areas. If you experience any symptoms of carbon monoxide poisoning, leave the area immediately, get fresh air and seek medical treatment.

To prevent serious injury or death from carbon monoxide:

- Never run the vehicle in poorly ventilated or partially enclosed areas such as garages, carports or barns. Even if you try to ventilate engine exhaust with fans or open windows and doors, carbon monoxide can rapidly reach dangerous levels.
- Never run the vehicle outdoors where engine exhaust can be drawn into a building through openings such as windows and doors.

## 2) Avoid Gasoline Fires and Other Hazards

Gasoline is extremely flammable and highly explosive. Fuel vapors can spread and be ignited by a spark or flame many feet away from the engine. To reduce the risk of fire or explosion, follow these instructions:

- Use only an approved red gasoline container to store fuel.
- Never fill a gasoline container on the vehicle. An electrical static discharge may ignite the fuel.

- For refueling, strictly adhere to instructions in *FUEL*.
- Never start or operate the engine if the fuel cap is not properly installed.

Gasoline is poisonous and can cause injury or death.

- Never siphon gasoline by mouth.
- If you swallow gasoline, get any in your eye(s), or inhale gasoline vapor, see your doctor immediately.

If gasoline spills on you, wash with soap and water and change your clothes.

## 3) Avoid Burns from Hot Parts

Certain components become hot during operation. Avoid contact with those parts during and shortly after operation to avoid burns.

## 4) Accessories and Modifications

Any modifications or addition of accessories may affect the handling of your vehicle. It is important to take the time to get familiar with the vehicle once modifications are made to understand how to adapt your driving behavior accordingly.

Do not tamper with unauthorized modifications or install equipment not specifically certified by BRP for the vehicle. These modifications have not been tested by BRP and they may increase the risk of injury or loss of control, or render the vehicle illegal to ride. As an example, tampering with tire specifications may affect the behavior of the vehicle and increase the risk of a loss of control.

Ask your authorized BRP dealer for suitable available accessories for your vehicle.



---

## II SPECIAL SAFETY MESSAGES

### **THIS VEHICLE IS NOT A TOY AND CAN BE HAZARDOUS TO OPERATE.**

- This vehicle handles differently from other vehicles including motorcycles and cars. A collision or rollover can occur quickly, if you fail to take proper precautions, even during routine maneuvers such as turning and driving on hills or over obstacles.

**SEVERE INJURY OR DEATH** can result if you do not comply with the following instructions:

- Read this Operator's Guide and all on-product safety labels carefully and follow the operating procedures described. Watch and pay attention to the *SAFETY VIDEO* before operating the vehicle.
- Always follow this age recommendation: A person under 16 years old should never operate this vehicle.
- Never take place on this vehicle without wearing an approved helmet of the proper size and other required riding gears. Refer to *RIDING GEAR* in *RIDING THE VEHICLE* for detailed information.
- Never carry a passenger on this vehicle unless you are operating a 2-UP model. Passenger(s) affect balance and steering and increase risk of losing control.
- On 1-UP models, do not make any modifications to accommodate a passenger or use racks to carry a passenger.
- Never use this vehicle if you are tired, ill or under the influence of drugs or alcohol. Your reaction time and judgement is greatly affected under these conditions.
- Never attempt wheelies, jumps, or other stunts.
- Never operate at excessive speeds. Always go at a speed that is proper for the terrain, visibility, and operating conditions, and your experience.
- Always go slowly and be extra careful when operating on unfamiliar terrain. Always be alert to changing terrain conditions when operating this vehicle.
- Never operate on excessively rough, slippery or loose terrain until you have learned and practiced the skills necessary to control this vehicle on such terrain. Always be especially cautious on these kinds of terrain.
- Always follow proper procedures for turning. Refer to *RIDING TECHNIQUES* in *RIDING THE VEHICLE*.
- Never operate this vehicle on hills too steep for the vehicle or for your abilities.
- Always follow proper procedures for climbing hills as described in *RIDING TECHNIQUES*. Check the terrain carefully before you start up any hill. Never climb hills with excessively slippery or loose surfaces.
- Always follow proper procedures for going down hills and for braking on hills as described in *RIDING TECHNIQUES*. Check the terrain carefully before you start down any hill.
- Always follow proper procedures for crossing the side of a hill as described in *RIDING TECHNIQUES*. Avoid hills with excessively slippery or loose surfaces.
- Always use proper procedures if you stall or roll backwards when climbing a hill. To avoid stalling, use low gear and maintain a steady speed when climbing a hill. If you stall or roll backwards, follow the driving technique procedures as described in *RIDING TECHNIQUES*.

- Always check for obstacles before operating in a new area. Never attempt to operate over large obstacles, such as large rocks or fallen trees. Always follow proper procedures when operating over obstacles as described in *RIDING TECHNIQUES*.
- Always be careful when skidding or sliding. Learn to safely control skidding or sliding by practicing at low speeds and on level smooth terrain. On extremely slippery surfaces, such as ice, go slowly and be very cautious in order to reduce the chance of skidding out of control. If you are operating a 2-UP model and have a passenger on-board, never attempt skidding or sliding; overturn or passenger ejection may occur.
- Never operate this vehicle through deep or fast flowing water. Water should never exceed footrests. Remember that wet brakes may have reduced stopping ability. Test your brakes after leaving water, mud or snow. If necessary, apply them several times to let friction dry out the pads.
- Always keep in mind that braking distance is readily affected by but not limited to; weather and terrain conditions, braking system and tire conditions, vehicle speed and attitude, and vehicle load including towing. Remember to adjust your driving accordingly.
- Always be sure there are no obstacles or people behind the vehicle when you operate in reverse. When it is safe to proceed in reverse, go slowly. Take into account that on a 2-UP model the passenger can obstruct your view.
- BRP recommends sitting on your ATV when operating in reverse. Avoid standing up. Your weight could shift forward against throttle lever, causing an unexpected acceleration and may lead to a loss of control.
- Never exceed the stated load limits for this vehicle including operator, passenger (2-UP models), all other loads and added accessories. Cargo should be properly distributed and securely attached. Reduce speed and follow instructions in this guide for carrying cargo or pulling a trailer. Allow greater distance for braking.
- Always inspect and confirm the safe operating condition of your vehicle prior to ride. Refer to *PRE-RIDE INSPECTION* in *RIDING THE VEHICLE*. Always follow the maintenance schedules as described in this Operator's Guide. Refer to *MAINTENANCE*.
- Never operate the vehicle if the controls do not function normally.
- Always maintain proper tire pressure. When replacing tires, use only the recommended tire size and type. For tire information, refer to *SPECIFICATIONS*.
- Riding your vehicle too fast for your skills or the conditions may result in injury. Apply only enough throttle to proceed safely. Statistics show that mishaps and injury usually result from high speed turns. Always remember that this vehicle is heavy! Its pure weight alone may entrap you should it fall resulting in injury.
- This vehicle is not designed for jumping, nor can it fully absorb the high impact energy generated during manoeuvres such as jumping which, can be passed on to you, the operator. Performing wheelies can cause the vehicle to flip over onto you. Both practices have a high risk for you and your passenger (2-UP models) and should be avoided at all times.

## 2-UP Models

### Driver must:

- Not forget he is responsible for the safety of the passenger.
- Inform the passenger concerning the basic rules for a safe ride.
- Instruct the passenger to read the vehicle's safety labels and to watch the *SAFETY VIDEO*.
- Always practice the maneuvers described in this Operator's Guide without and with a passenger. Greater skills are required with a passenger.
- Always remember that the vehicle handling and stability may be affected when riding with a passenger. Safely reduce speed. Use proper judgement. If in doubt, do not attempt and disembark the passenger before executing any maneuver.
- Always remember that the vehicle braking distance may be longer when riding with a passenger. Allow greater distance for braking.
- Never carry passenger on a 2-UP model if the passenger seat is not installed.
- Never carry more than one (1) passenger. Do not allow passenger to sit anywhere else than the designated passenger seat.
- Never carry a passenger if you judge his ability or judgement insufficient to concentrate on the terrain conditions and adapt accordingly.
- Never carry a passenger who has used drugs or alcohol, or is tired or ill. These slow reaction time and impair judgment.

### Passenger must:

- Be capable of resting his feet on the footrests and his hands on grab handles when seated on this vehicle.
- Never take place on this vehicle without wearing an approved helmet (including a chin guard) that fits properly. The passenger should also wear eye protection (goggles or face shield), gloves, boots, long sleeved shirt or jacket, and long pants.
- Be seated on the designated passenger's seat.
- Always keep hands on grab handles and feet on the footrests during operation. Never hold on to the operator.
- Never get up during vehicle operation. An excessive movement could cause loss of control.
- Pay attention to vehicle and operator movements.
- Not wait and tell the driver to slow down or stop if you feel uncomfortable or insecure for any reason.

## European Community

### On Road Use

The following warnings apply only in the European Countries where on road usage is allowed. **SEVERE INJURY OR DEATH** can result if you do not comply with the following instructions.

#### **WARNING**

- This vehicle is built for OFF-ROAD purposes only. It may be used for short distances on paved surfaces at reduced speed, in order to move the vehicle from an off-road location to another.
- Always refrain from speeding and substantially reduce vehicle speed when turning.
- Always respect the road traffic laws, even on a dirt or gravel road.
- Always use any other equipment as required by traffic law for slow moving vehicle.

## III OPERATION WARNINGS

The following warning and their format have been requested by the United States Consumer Product Safety Commission and are required to be in the Operator's Guide for all ATVs.

The following list is not exhaustive.

**NOTE:** The illustrations are general representations only. Your model may differ.

### **WARNING**



#### **POTENTIAL HAZARD**

Operating this vehicle without proper instruction.

#### **WHAT CAN HAPPEN**

The risk of an accident is greatly increased if the operator does not know how to operate this vehicle properly in different situations and on different types of terrain.

#### **HOW TO AVOID THE HAZARD**

Beginners and inexperienced operators should complete a training course. They should then regularly practice the skills learned during the course as well as the operating techniques described in this Operator's Guide.

For more information about a training course, contact an authorized Can-Am dealer.

**⚠ WARNING**



V00A1AQ

**POTENTIAL HAZARD**

Failure to follow the age recommendations for this vehicle.

**WHAT CAN HAPPEN**

A lack of respect for this age recommendation can lead to severe injury or death of the child.

Even though a child may be within the age group for which this vehicle is recommended, he may not have the skills, abilities, or judgment needed to operate this vehicle safely and may be involved in a serious accident.

**HOW TO AVOID THE HAZARD**

No one under 16 should operate this vehicle.

*2-UP Models Only***⚠ WARNING**

vmo2014-005-100

**POTENTIAL HAZARD**

Failure to respect the physical limitations of the passenger on 2-UP models.

**WHAT CAN HAPPEN**

A passenger that cannot completely lean his feet on footrests can be ejected when riding on uneven terrain.

**HOW TO AVOID THE HAZARD**

The passenger must be capable of keeping his feet on the footrests and his hands on grab handles at all times when he is seated on the vehicle.

1-UP Models Only

**⚠ WARNING**



V00A02Q

**POTENTIAL HAZARD**

Carrying a passenger on this vehicle.

**WHAT CAN HAPPEN**

Greatly reduces your ability to balance and control this vehicle.

Could cause an accident, resulting in harm to you and/or your passenger.

**HOW TO AVOID THE HAZARD**

Never carry passenger. Even with a long seat that provides unrestricted operator movement, it is not designed nor intended to carry passenger(s).



*2-UP Models Only***⚠ WARNING**

V00A1CQ

**POTENTIAL HAZARD**

Carrying more than one (1) passenger on this vehicle.

**WHAT CAN HAPPEN**

Carrying more than one (1) passenger reduces your ability to balance and control this vehicle.

Could cause an accident, resulting in harm to you and/or your passengers.

**HOW TO AVOID THE HAZARD**

Never carry more than one (1) passenger. Even with a long seat that provides unrestricted operator movement, the vehicle is not designed nor intended to carry more than one (1) operator and one (1) passenger. The passenger must use the designated passenger's seat when he is seated on the vehicle with feet firmly planted on footrests and always hold on to the grab handles.

**⚠ WARNING**



V00A2DQ

**POTENTIAL HAZARD**

Allowing passenger(s) to sit on front or rear racks on this vehicle.

**WHAT CAN HAPPEN**

Allowing a passenger could:

- Impair vehicle stability which could lead to a loss of control.
- Result in injury to passenger(s) from impact on hard surfaces.
- Cause an accident, resulting in harm to you and/or your passenger.

**HOW TO AVOID THE HAZARD**

Never allow any passenger to sit on front or rear racks on this vehicle.

**⚠ WARNING****POTENTIAL HAZARD**

Operating this vehicle on paved surfaces.

**WHAT CAN HAPPEN**

Paved surfaces may seriously affect handling and control of the vehicle, and may cause the vehicle to go out of control.

**HOW TO AVOID THE HAZARD**

If a road usage is allowed in your area, operate your vehicle on paved surfaces only for short distance and for the only purpose of moving the vehicle from an off-road usage to another.

Always operate your vehicle at low speed (never exceed 40 km/h (25 MPH)) and reduce the speed before making a turn.

Always respect all road traffic laws when operating your vehicle on public roads or streets.

**⚠ WARNING**



**POTENTIAL HAZARD**

Riding this vehicle without wearing an approved helmet, eye protection and protective gear. On 2-UP models, passenger should also have an approved helmet with a rigid chin guard.

**WHAT CAN HAPPEN**

- Riding without an approved helmet increases the chances of a severe head injury or death in the event of an accident.
- Riding without eye protection can result in an accident and increases the chances of a severe injury in the event of an accident.
- Riding without protective gear increases the chances of severe injury in the event of an accident.

**HOW TO AVOID THE HAZARD**

Always wear an approved helmet that fits properly. You should also wear:

- Eye protection (goggles or face shield)
- Rigid chin guard
- Gloves and boots
- Long sleeved shirt or jacket
- Long pants.

**! WARNING**

V00A07Q

**POTENTIAL HAZARD**

Using this vehicle with drugs or alcohol.

**WHAT CAN HAPPEN**

Could cause the passenger to fall off (2-UP models).

Could seriously affect your judgment.

Could cause you to react more slowly.

Could affect your balance and perception.

Could result in an accident or death.

**HOW TO AVOID THE HAZARD**

The operator and the passenger (2-UP models) should never use this vehicle with drugs or alcohol.

**⚠ WARNING**

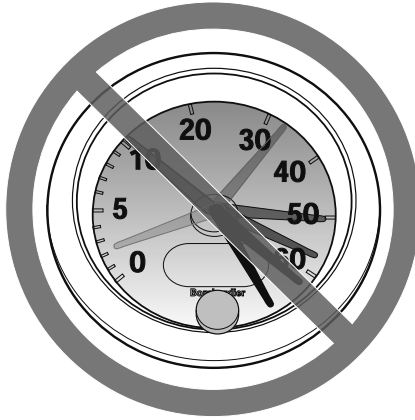

V00A08Q

**POTENTIAL HAZARD**

Operating this vehicle at excessive speeds.

**WHAT CAN HAPPEN**

Increases your chances of losing control of the vehicle, which can result in an accident.

**HOW TO AVOID THE HAZARD**

Always travel at a speed which is appropriate for the terrain, visibility and operating conditions, and your experience.

On 2-UP models, the vehicle handling, stability and braking distance may be affected when riding with a passenger. Safely reduce speed when riding with a passenger. Allow greater distance for braking.

**⚠ WARNING****POTENTIAL HAZARD**

Attempting wheelies, jumps and other stunts.

**WHAT CAN HAPPEN**

Increases the chance of an accident, for the operator and the passenger (2-UP models), including an overturn.

**HOW TO AVOID THE HAZARD**

Never attempt stunts, such as wheelies or jumps. Do not try to show off.

**⚠ WARNING****POTENTIAL HAZARD**

Failure to inspect the vehicle before operating.

Failure to properly maintain the vehicle.

**WHAT CAN HAPPEN**

Increases the possibility of an accident or equipment damage.

**HOW TO AVOID THE HAZARD**

Always inspect your vehicle prior to ride to make sure the vehicle is in safe operating condition.

Always follow the maintenance schedule described in this Operator's Guide.

**⚠ WARNING**

**POTENTIAL HAZARD**

Riding on frozen waterways.

**WHAT CAN HAPPEN**

Breaking through the ice can lead to severe injury or death.

**HOW TO AVOID THE HAZARD**

Never ride this vehicle on a frozen surface before you are sure the ice is thick enough and sound enough to support the vehicle and its load, as well as the force that is created by a moving vehicle.

**⚠ WARNING**



**POTENTIAL HAZARD**

Removing hands from handlebars for the operator and from grab handles for the passenger (2-UP models), or feet from the footrests during operation.

**WHAT CAN HAPPEN**

Removing even one hand or foot can reduce your ability to control the vehicle or could cause you to lose your balance and fall off the vehicle. If you remove a foot from the footrests, your foot or leg may come into contact with the rear wheels, which could injure you or cause an accident.

**HOW TO AVOID THE HAZARD**

Operator must always keep both hands on the handlebars and passenger (2-UP models) on grab handles. Both feet (operator and passenger on 2-UP models) must rest on the footrests during vehicle operation.



**⚠ WARNING****POTENTIAL HAZARD**

Failure to use extra care when operating this vehicle on unfamiliar terrain.

**WHAT CAN HAPPEN**

You can come upon hidden rocks, bumps, or holes, without enough time to react.

Could result in the vehicle overturning, passenger ejection (2-UP models) or loss of control.

**HOW TO AVOID THE HAZARD**

Go slowly and be extra careful when operating on unfamiliar terrain.

Always be alert to changing terrain conditions when operating the vehicle.

Do not forget, on 2-UP models, the operator is responsible for the safety of his passenger. Safely reduce speed when riding with a passenger.

**⚠ WARNING**



**POTENTIAL HAZARD**

Failure to use extra care when operating on excessively rough, slippery or loose terrain.

**WHAT CAN HAPPEN**

Could cause loss of traction or vehicle control, which could result in an accident, including an overturn or passenger ejection (2-UP models).

**HOW TO AVOID THE HAZARD**

Do not operate on excessively rough, slippery or loose terrain until you have learned and practiced the skills necessary to control this vehicle on such terrain.

Always be especially cautious on these kinds of terrain.

Do not forget, on 2-UP models, the operator is responsible for the safety of the passenger. In doubt, disembark him before operating on these terrains.

**⚠ WARNING****POTENTIAL HAZARD**

Turning improperly.

**WHAT CAN HAPPEN**

Vehicle could go out of control, causing a collision or an overturn or a passenger ejection (2-UP models).

**HOW TO AVOID THE HAZARD**

Always follow proper procedures for turning as described in this Operator's Guide. Practice turning at low speeds before attempting to turn at faster speeds.

Do not forget, on 2-UP models, the operator is responsible for the safety of the passenger. Never perform this maneuver with a passenger. Always remember that the vehicle handling, stability and braking distance may be affected when riding with a passenger.

Do not turn at excessive speed.

**⚠ WARNING**



**POTENTIAL HAZARD**

Operating on excessively steep hills.

**WHAT CAN HAPPEN**

The vehicle can overturn more easily on extremely steep hills than on level surfaces or small hills.

**HOW TO AVOID THE HAZARD**

Never operate this vehicle on hills too steep for the vehicle or for your abilities.

Practice, without and with passenger (2-UP models), on smaller hills before attempting larger hills.

Always remember that, on 2-UP models, even if this vehicle can climb some steep hills, it is not recommended to climb such hills with a passenger; always disembark him before attempting this maneuver. Show good judgment.

**⚠ WARNING****POTENTIAL HAZARD**

Climbing hills improperly.

**WHAT CAN HAPPEN**

Could cause loss of control, passenger ejection (2-UP models) or cause vehicle to overturn.

**HOW TO AVOID THE HAZARD**

Always follow proper procedures for climbing hills as described in this Operator's Guide.

Always check the terrain carefully before you start up any hill. Do not forget, on 2-UP models, the operator is responsible for the safety of the passenger. In doubt, disembark him before climbing hill. Always remember that the vehicle handling, stability and braking distance may be affected when riding with a passenger.

Never climb hills with excessively slippery or loose surfaces.

Shift your weight forward (operator and passenger on (2-UP models)).

Never open the throttle suddenly or make sudden gear changes. The vehicle could flip over backwards.

Never go over the top of any hill at high speed. An obstacle, a sharp drop, or another vehicle or person could be on the other side of the hill.

**⚠ WARNING**



**POTENTIAL HAZARD**

Going down a hill improperly.

**WHAT CAN HAPPEN**

Could cause loss of control, passenger ejection (2-UP models) or cause vehicle to overturn.

**HOW TO AVOID THE HAZARD**

Always follow proper procedures for going down hills as described in this Operator's Guide.

NOTE: A special technique is required when braking as you go down a hill.

Always check the terrain carefully before you start down any hill. Do not forget, on 2-UP models, the operator is responsible for the safety of the passenger. In doubt, disembark him before going down hill. Always remember that the vehicle handling, stability and braking distance may be affected when riding with a passenger.

Shift your weight backward (operator and passenger on 2-UP models).

Never go down a hill at high speed.

Avoid going down a hill at an angle which would cause the vehicle to lean sharply to one side. Go straight down the hill where possible.

## WARNING



### **POTENTIAL HAZARD**

Improperly crossing hills or turning on hills.

### **WHAT CAN HAPPEN**

Could cause loss of control, passenger ejection (2-UP models) or cause vehicle to overturn.

### **HOW TO AVOID THE HAZARD**

Never attempt this maneuver on 2-UP models when the passenger is on board. Always disembark him before executing.

Never attempt to turn the vehicle around on any hill until you have mastered the turning technique as described in this Operator's Guide on level ground. Be very careful when turning on any hill.

Avoid crossing the side of a steep hill if possible.

#### ***When crossing the side of a hill:***

Always follow proper procedures as described further in this Operator's Guide.

Avoid hills with excessively slippery or loose surfaces.

Operator and passenger (2-UP models) must shift weight to the uphill side of the vehicle.

**! WARNING**



V00A1PQ

**POTENTIAL HAZARD**

Stalling, rolling backwards or improperly dismounting while climbing a hill.

**WHAT CAN HAPPEN**

Could result in vehicle overturning.

**HOW TO AVOID THE HAZARD**

Use low gear and maintain steady speed when climbing a hill.

***If you lose all forward speed:***

Operator and passenger (2-UP models) must keep their weight uphill. Never open the throttle suddenly or make sudden gear changes. The vehicle could flip over backwards.

Apply the brakes.

Lock brake lock after you have stopped.

Disembark on uphill side, or to a side if pointed straight uphill (passenger first on 2-UP models).

***If you begin rolling backwards:***

Operator and passenger (2-UP models) must keep their weight uphill. Never open the throttle suddenly or make sudden gear changes. The vehicle could flip over backwards.

Never apply the rear brake while rolling backwards.

Apply the front brake gradually.

When fully stopped, apply rear brake as well and lock brake lock.

Disembark on uphill side, or to a side if pointed straight uphill (passenger first on 2-UP models).

Turn the vehicle around and remount, following the procedure described further in this Operator's Guide.



**⚠ WARNING****POTENTIAL HAZARD**

Improperly operating over obstacles.

**WHAT CAN HAPPEN**

Could cause loss of control (passenger ejection on 2-UP models), or a collision.

Could cause the vehicle to overturn.

**HOW TO AVOID THE HAZARD**

Before operating in a new area, check for obstacles.

Never attempt to ride over large obstacles, such as large rocks or fallen trees.

On 2-UP models, the operator is responsible for the safety of his passenger. In doubt, disembark him before riding over obstacles. Always remember that the vehicle handling and stability may be affected when riding with a passenger.

When you go over obstacles, always follow proper procedures as described in this Operator's Guide.

**⚠ WARNING**



**POTENTIAL HAZARD**

Skidding or sliding improperly.

**WHAT CAN HAPPEN**

You may lose control of this vehicle.

You may also regain traction unexpectedly, which may cause the vehicle to overturn or passenger ejection (2-UP models).

**HOW TO AVOID THE HAZARD**

Learn to safely control skidding or sliding by practicing at low speeds and on level smooth terrain.

On 2-UP models, never slide or skid with passenger. Always remember that the vehicle handling and stability may be affected when riding with a passenger.

On extremely slippery surfaces, such as ice, go slowly and be very cautious in order to reduce the chance of skidding or sliding out of control.

**⚠ WARNING****POTENTIAL HAZARD**

Operating this vehicle through deep or fast flowing water.

**WHAT CAN HAPPEN**

Tires may float, causing loss of traction and loss of control, which could lead to an accident.

**HOW TO AVOID THE HAZARD**

Never operate this vehicle in fast flowing water or in deep water.

Check water depth and current before you attempt to cross any water. Water should not go above footrests.

Remember that wet brakes may have reduced stopping ability. Test your brakes after leaving water. If necessary, apply them several times to let friction dry out the pads.

**⚠ WARNING**



**POTENTIAL HAZARD**

Improperly operating in reverse.

**WHAT CAN HAPPEN**

You could hit an obstacle or person behind the vehicle, resulting in serious injury.

**HOW TO AVOID THE HAZARD**

When you select reverse gear, make sure there are no obstacles or people behind the vehicle. When it is safe to proceed, go slowly. On 2-UP models, take account that the passenger can obstruct your view.

**⚠ WARNING****POTENTIAL HAZARD**

Operating this vehicle with improper tires, or with improper or uneven tire pressure.

**WHAT CAN HAPPEN**

Use of improper tires on this vehicle, or operation of this vehicle with improper or uneven tire pressure, may cause loss of control, tire blow outs, tire to move around on its rim, and increases the risk of an accident.

**HOW TO AVOID THE HAZARD**

Always use the size and type of tires specified in this Operator's Guide for this vehicle.

Always maintain proper tire pressure as described in this Operator's Guide.

Always replace wheels or tires that are damaged.

**⚠ WARNING**



**POTENTIAL HAZARD**

Operating this vehicle with improper modifications.

**WHAT CAN HAPPEN**

Improper installation of accessories or modification of this vehicle may cause changes in handling which in some situations could lead to an accident.

**HOW TO AVOID THE HAZARD**

Never modify this vehicle through improper installation or use of accessories. All parts and accessories added to this vehicle should be approved by BRP and should be installed and used according to instructions. If you have questions, consult an authorized Can-Am dealer.

**NEVER** install a passenger seat (1-UP models) or use the racks to carry a passenger.

Modification of the vehicle to increase speed and performance may violate the terms and conditions of your vehicle limited warranty. In addition, certain modifications including the removal of engine or exhaust components are illegal under most laws.

**⚠ WARNING****POTENTIAL HAZARD**

Overloading this vehicle, carrying or towing cargo improperly.

**WHAT CAN HAPPEN**

Could cause changes in vehicle handling which could lead to an accident.

**HOW TO AVOID THE HAZARD**

Never exceed the stated load capacity for this vehicle including operator and passenger (2-UP models) as well as other loads and added accessories.

Cargo should be properly distributed and securely attached.

Reduce speed when carrying cargo or pulling a trailer. Allow greater distance for braking.

Always follow the instructions in this Operator's Guide for carrying cargo or pulling a trailer.

**⚠ WARNING**



V03M01Q

**POTENTIAL HAZARD**

Transporting flammable or dangerous material can lead to explosions.

**WHAT CAN HAPPEN**

This can cause serious injury or death.

**HOW TO AVOID THE HAZARD**

Never transport flammable or dangerous material.



---

## IV RIDING THE VEHICLE

To fully appreciate the pleasures and excitement of riding this vehicle, there are some basic rules and tips that you **MUST** follow. Some may be new to you while others may be common sense or obvious.

Please take the time to study this Operator's Guide and all on-product safety labels as well as the *SAFETY VIDEO* located at <https://can-am.brp.com/off-road/safety>. They more completely describe what you should know about this vehicle before riding it.

Whether you are a new user or an experienced rider, it is important for your personal safety that you know the controls and features of this vehicle. Equally important is knowing how to properly ride.

This is a high performance ATV for off-road use only. Inexperienced riders may overlook risks and be surprised by the specific behavior of this ATV in any terrain condition.

We recommend following the age recommendation indicated on the safety label affixed on the unit. Even though a person may be within the age group for which this vehicle is recommended, he may not have the skills, abilities, or judgment needed to operate this vehicle safely and may be involved in a serious accident.

Individuals with cognitive or physical impairments or who are high risk takers have an increased exposure to overturns or collisions which may result in injury including death.

Not all vehicles are the same. Each has its own unique performance characteristics, controls and features. Each will ride and handle differently.

Become completely familiar with the operational controls and the general operation of the vehicle before venturing into off road conditions. Practice driving in a suitable area free of hazards and feel the response of each control. Drive at low speeds. Higher speeds require greater experience, knowledge and suitable riding conditions.

Riding conditions vary from place to place. Each is subject to weather conditions which may radically change from time to time and from season to season.

Riding on sand is different than riding on snow or through forests or marshes. Each location may require a greater degree of awareness and skill. Show good judgement. Always proceed with caution. Please do not take any unnecessary risks that could leave you stranded or possibly injured.

Never assume that the vehicle will go everywhere safely. Sudden changes in terrain caused by holes, depressions, banks, softer or harder "ground" or other irregularities may cause the vehicle to topple or become unstable. To avoid this, slow down and always observe the terrain ahead. If the vehicle does begin to topple or tip over, the best advice is to immediately get off **AWAY** from the direction of the tip over!

If a road usage is allowed in your area, operate your vehicle on paved surface only for short distance and for the only purpose of moving the vehicle from an off-road usage to another. Always operate your vehicle at low speed (never exceed 40 km/h (25 MPH)) and reduce the speed before making a turn. This vehicle is not equipped with a rear differential (rear wheels are always turning at the same speed). For this reasons, pavement may seriously affect the handling and control of the vehicle.

Always respect all road traffic laws when operating your vehicle on public roads or streets. If you have to cross a road, the lead driver should get off his vehicle the observe and give direction to the other riders. The last person after crossing then assists the lead driver to cross. Do not travel on sidewalks. They are designated for pedestrian use.

We encourage you to have an Annual Safety Inspection of your vehicle. Please contact an authorized BRP dealer for further details. Though not required, it is recommended that an authorized BRP dealer performs the preseason preparation of your vehicle. Each visit to your authorized BRP dealer is a great opportunity for your dealer to verify if your vehicle is included in any safety campaign. We also urge you to visit your authorized BRP dealer in a timely manner if you become aware of any safety related campaigns.

See an authorized BRP dealer for available accessories you may require.

## 1) Pre-Ride Inspection

### WARNING

Perform a pre-ride inspection before each ride to detect any potential problem that could occur during operation. The pre-ride inspection can help you monitor component wear and deterioration before they become a problem. Correct any problem that you discover to reduce the risk of a breakdown or crash. See an authorized Can-Am dealer as necessary.

Before using this vehicle, the operator should always perform the following pre-ride inspection check list.

Correct any problem found before riding the vehicle. See an authorized Can-Am dealer if necessary.

### Pre-Ride Inspection Check List

#### What to Do Before Starting the Engine (Key OFF)

ITEMS TO BE INSPECTED	INSPECTION TO PERFORM	✓
Engine oil	Check engine oil level.	
Coolant	Check coolant level.	
Fluids	Check fuel, engine oil and coolant levels	
Brake fluid	Check brake fluid level.	
Leaks	Check for any leaks under vehicle	
Throttle lever	Activate throttle lever several times to ensure it operates freely. It must return to idle position when released	
Brake lock	Apply brake lock and check if it operates properly	
Tires	Check tire pressure and condition. Refer to <i>SPECIFICATIONS</i> and adjust according to load.	

ITEMS TO BE INSPECTED	INSPECTION TO PERFORM	✓
Wheels	Check wheels for damage and for abnormal play, and make sure that lug nuts are tightened. Tighten wheel beadlock bolts (if equipped). Refer to <i>WHEELS AND TIRES</i> in <i>MAINTENANCE PROCEDURES</i> for torque specification.	
Radiator	Check cleanliness of the radiator	
Drive shaft boots	Check drive shaft boots and protectors condition	
Seat(s)	Check if operator seat is in place and properly latched	
	Check if passenger seat is in place and properly latched (2-UP Models)	
	Check the passenger backrest and grab handles condition (2-UP Models)	
Cargo	If you transport a cargo, respect the load capacity. Refer to <i>LOADING THE CARGO RACKS</i> Ensure cargo is properly secured to the racks	
	If you are pulling a trailer or another equipment: – Check hitch and trailer ball condition – Respect the tongue capacity and towing capacity as indicated on the label affixed to the hitch or refer to <i>SPECIFICATIONS</i> – Ensure trailer is properly secured to hitch.	
Storage compartment	Check if rear storage compartment is properly latched	
Chassis and suspension	Check underneath vehicle for any debris on chassis or suspension and clean them properly	
Engine air filter	Inspect and clean engine air filter	
CVT air filter	Inspect and clean CVT air filter	

**What to Do Before Starting the Engine (Key ON)**

ITEMS TO BE INSPECTED	INSPECTION TO PERFORM	✓
Multifunction gauge	Check operation of indicator lamps in multifunction gauge (during first few seconds of key ON)	
	Check for messages on multifunction gauge	
Lights	Check operation and cleanliness of headlights and taillight	
	Check operation of low and high beams	
	Check operation of brake light	
	Check operation and cleanliness of turn signal lights	
	Check operation of hazard lights	
Horn	Check operation of the horn	
Fuel level	Check the fuel level.	

**What to Do After the Engine is Started**

ITEMS TO BE INSPECTED	INSPECTION TO PERFORM	✓
Steering	Check if steering operates freely by completely turning it from side to side	
Shift lever	Check operation of shift lever (P, R, N, H and L)	
2WD/4WD selector	Check operation of 2WD/4WD selector	
Brakes	Drive forward slowly a few feet and apply brake lever and brake pedal individually. The brakes must fully apply. Lever and pedal must fully return when released	
Engine stop switch	Check that the engine stop switch is working properly	
Ignition switch	Check if ignition switch is working properly by restarting and stopping the engine	

**2) Riding Gear**

Actual weather conditions should help you decide how to dress. Dress for the coldest weather expected. Thermal underwear next to the skin also provides a good insulation. It is important that the operator always wears the appropriate protective riding gear and apparel, including an approved helmet, eye protection, boots, gloves, a long sleeved shirt and pants. This type of clothing will provide you protection from some of the minor hazards you may encounter en route. The operator must never wear loose clothing such as a scarf that may get entangled in the vehicle or on tree branches and shrubs. Depending on conditions, anti-fogging

goggles or sunglasses may be required. Different colored lenses available for goggles or sunglasses help you distinguish terrain variations. Sunglasses should only be worn during the daytime.

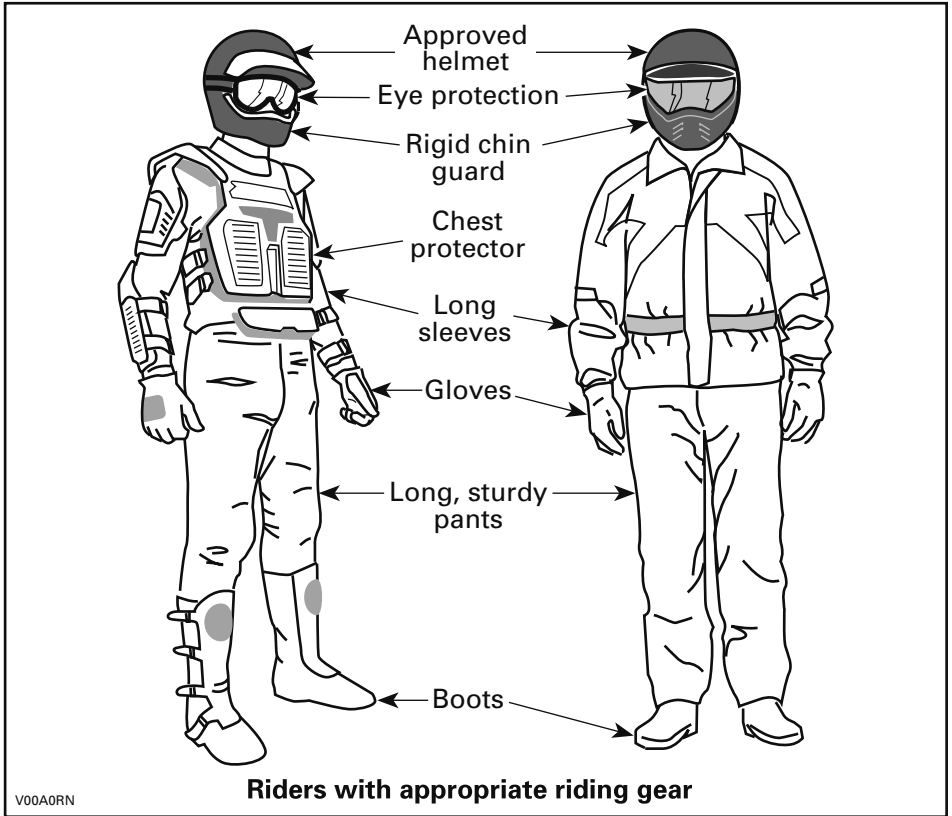

### 3) Carrying a Passenger

#### *1-UP Models*

This vehicle is designed to carry ONE (1) operator only. Do not install passenger seat or use the racks to carry a passenger.

#### *2-UP Models*

This vehicle is designed specifically to carry an operator and ONE (1) passenger only. The passenger must be seated on the designated passenger's seat and hold on to the grab handles at all times. NEVER install other passenger's seat other than the one recommended by BRP. Do not use the racks or their location to carry passenger(s). Carrying more than one (1) passenger may affect the stability and your control of the vehicle. When the passenger seat is not installed, the vehicle becomes a ONE-RIDER vehicle (1-UP model) and NO PASSENGER must be allowed on it.

## 4) Recreational Riding

Respect the rights and limitations of others. Stay away from areas designated for other types of off road use. This includes snowmobile trails, equestrian trails, cross country ski trails, mountain bike trails, etc. Never assume there are no other users on the trail. Do not drive to the center of the trail and do not zigzag to one side of the trail then the other. Be prepared to stop or pull off to the side if another trail user appears in front of you.

Join a local ATV club. It will provide you with a map and advice or inform you where you can ride. If a club does not exist in your area, help to start one. Group riding and club activities provide a pleasurable, social experience.

Always keep a safe distance from other riders. Your judgment of speed, terrain conditions, weather, mechanical condition of your vehicle and the "trust in judgment" you have in others around you will help you make a better choice of appropriate safe distance. This vehicle, like any other motorized vehicle, cannot stop "on a dime". Allow greater distance for braking. On 2-UP models, the vehicle handling, stability and braking distance may be affected when riding with a passenger. Safely reduce speed when riding with a passenger.

Before you ride, tell someone where you are planning to travel and your expected time of return.

Depending on the length of your ride, carry additional tools , drinking water, food and emergency equipment. Find out where you can get additional gasoline and oil. Be prepared for the possible conditions you may encounter.

First aid kit	Adjustable wrench
Mobile phone	Knife
Friction tape	Flashlight
A rope	Colored lens goggles
Spare light bulbs	Trail map
Provided tool kit	Snack

## 5) Environment

One of the benefits of this vehicle is that it can take you off the beaten path away from most communities. However, you should always respect nature and the rights of others to enjoy it. Do not ride in environmentally sensitive areas. Do not drive over forest crops or shrubs nor cut down trees or take down fencing nor spin your wheels and destroy the terrain. "Tread Lightly".

This vehicle can cause OHV wildfires if debris builds up near the exhaust or other engine hot spots and ignites then falls off into dry grass. Avoid riding in wet areas, through muskeg or tall grass, where debris can build up. Should you ride in those areas, inspect and remove all debris from your engine and hot spots.

Chasing wildlife is in many areas illegal. Wildlife can die of exhaustion after being chased by a motorized vehicle. If you encounter animals on the trail, stop and observe quietly and with caution. It will be one of the better memories of your life.

Observe the rule “what you take in, carry out”. Do not litter. Do not start campfires unless you have permission to do so and then only away from dry areas. The hazards you may create on the trail may cause injury to others or yourself, even at a later date.

Respect farm lands. Always obtain the permission of the landowner before riding on private land. Respect crops, farm animals and property lines. If you come to a closed gate, close it again behind you.

Finally, do not pollute streams, lakes or rivers and do not modify the engine or exhaust system, or remove any of its components.

## **6) Design Limitation**

Although the vehicle is exceptionally rugged for its class, it is still a light vehicle by definition and its operation must be restricted to its proper purpose.

The addition of weight to any part of the vehicle changes its center of gravity and modifies its performance.

## **7) Off-Road Operation**

The very nature of off-road operation is dangerous. Any terrain, which has not been specially prepared to carry vehicles, presents an inherent danger where angularity, terrain substance and exact steepness are unpredictable. The terrain itself presents a continual element of danger, which must be knowingly accepted by anyone venturing over it.

An operator who takes a vehicle off-road should always exercise the utmost care in selecting the safest path and keeping close watch on the terrain ahead of him. On no account should the vehicle be operated by anyone who is not completely familiar with the driving instructions applicable to the vehicle, nor should it be operated on steep or treacherous terrain.

## **8) Riding Techniques**

Information in this guide is limited. Increase your knowledge and improve your skills by following a certified training course.

Care, caution, experience and driving skill are the best precautions against the hazards of vehicle operation.

Respect and follow all posted trail signs. They are there to help you and others.

In off-road operation, power and traction, not speed, are important. Never drive faster than visibility and your own ability to select a safe route permits.

Constantly watch the terrain ahead for sudden changes in slopes or obstacles, such as rocks or stumps, that may cause loss of stability, resulting in tip over or rollover.

It is also wise to know the terrain condition on the other side of a hill or bank. All too often there exists a sharp drop-off that is impossible to negotiate or descend.

Whenever there is the slightest doubt that the vehicle can safely negotiate an obstacle or a particular piece of terrain, always choose an alternate route.

Always use proper riding techniques to avoid vehicle overturns on hills and rough terrain and in turns.

## Body Position

To maintain proper control, it is strongly advised that you keep your hands on the handlebar and within easy reach of all controls. The same holds true for your feet on the foot pegs. To minimize the possibility of a leg or foot injury, keep your feet on the foot pegs at all times. Do not direct your toes outwards nor extend your feet out to assist in turning as they can be hit or be snagged on passing obstacles, or may come into contact with the wheels.

Even though there is a suspension on this vehicle, there are “washboard” or rough terrain conditions that will make you feel uncomfortable and can even cause a back injury. “Posting” or riding in a crouched position will often be required. Slow down and allow your flexed legs to absorb part of the impact energy.

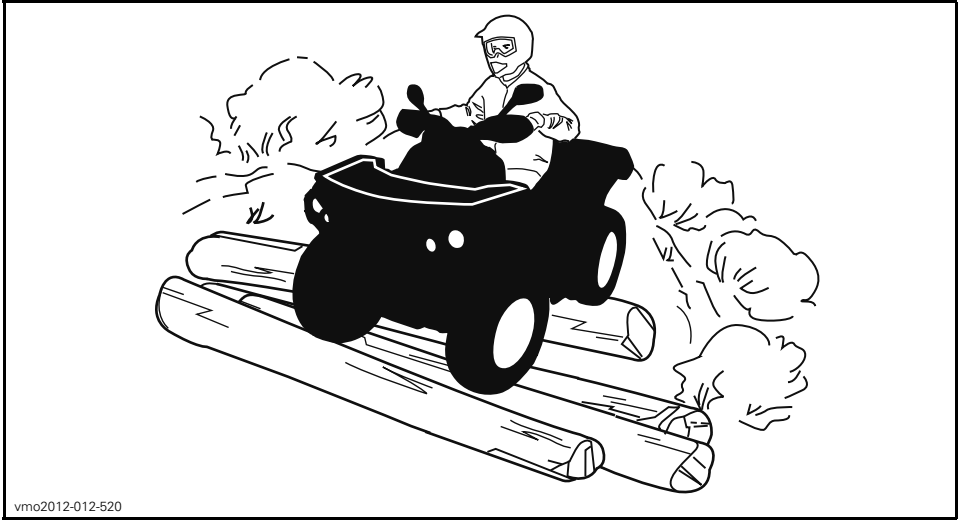

vmo2012-012-520

## 2-UP Models

The passenger must keep his hands on the grab handles and his feet on footrests at all times.

The passenger must synchronize his movements with the operator.

## Crossing Roads

If you have to cross a road, the lead driver should get off his vehicle, then observe and give directions to the other riders. The last person, after crossing, assists the lead driver to cross. Do not use sidewalks. They are designated for pedestrian use.

If road usage is allowed in your area, operate your vehicle on paved surface only for short distance and for the only purpose of moving the vehicle from an off-road usage to another. Always operate your vehicle at low speed (never exceed 40 km/h) and reduce the speed before making a turn. This vehicle is not equipped with a rear differential (rear wheels are always turning at the same speed). For this reasons, pavement may seriously affect the handling and control of the vehicle.



## Riding on Roads

Always respect all road traffic laws when operating your vehicle on public roads or streets. Do not travel on sidewalks. They are designated for pedestrian use.

## Turning

Practice turning at low speeds before attempting to turn at faster speeds.

Keep both hands on handlebars and feet on foot pegs.

Maintain a constant speed or a slight acceleration during turn.

To reduce the risk of rollovers:

- Use care when turning.
  - Do not turn the handlebar too far or too fast for your speed and environment. Adjust steering inputs accordingly.
  - Slow down before entering a turn. Avoid hard braking during a turn.
  - Avoid sudden or hard acceleration when turning, even from a stop or low speed.
- Never attempt donuts, skids, slides, fishtails, jumps, or other stunts. If vehicle starts to skid or slide, steer in the direction of the skid or slide. Never slam the brakes and lock the wheels.
- Avoid paved surfaces. This vehicle is not designed to operate on paved surfaces and is more likely to roll over. If you must drive on pavement, turn gradually, go slowly, and avoid abrupt acceleration and braking.

Avoid sudden inputs to steering, throttle or brakes while turning.

### **⚠ WARNING**

**Do not attempt turns at excessive speed.**

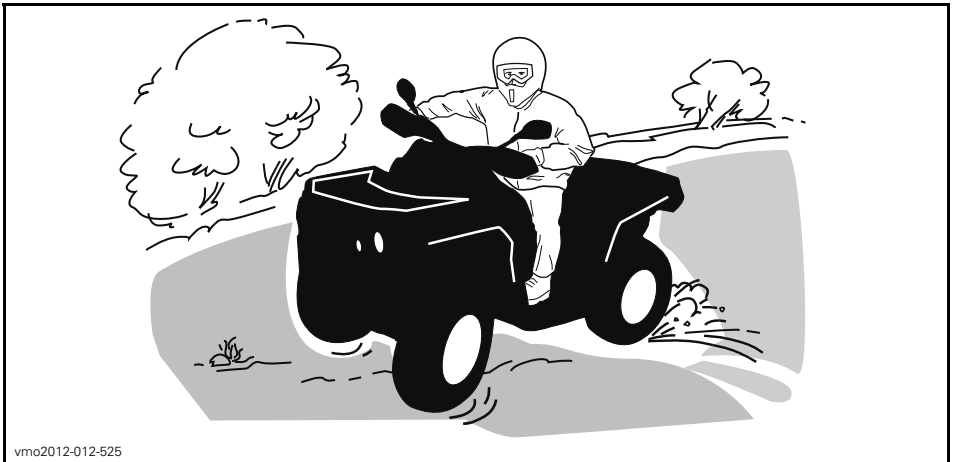

vmo2012-012-525

If you do get into a slide or skid, it may help to turn the handlebar in the direction of the skid until you regain control. Never jam the brakes and lock the wheels.

## Braking

Always keep both hands on handlebars and feet on foot pegs when braking.

Practice braking to get familiar with the brake response.

- Do it at low speed first, then increase the speed.
- Practice braking in straight line at different speeds and different braking force.
- Practice emergency braking; optimal braking is obtained in straight line, with high force applied, without locking the wheels.

Remember, braking distance depends on vehicle speed, load and the type of surface. Also, the tires and brakes conditions play a major role.

**NOTE:** If going forward the vehicle weight is transferred to the front wheels when braking. To obtain greater stopping efficiency, the brake system distributes more braking force to the front wheels. This will affect vehicle handling and steering control when braking vigorously. Take it into account when braking.

## Reverse Operation

When operating in reverse, check that the path behind the vehicle is free of people or obstacles. Proceed slowly and avoid sharp turns.

When riding on a 2-UP model, take into account that the passenger can obstruct your view. Disembark the passenger if necessary.

We recommend sitting on your ATV when operating in reverse. Avoid standing up. Your weight could shift forward against throttle lever, causing an unexpected acceleration.

### **WARNING**

**Unexpected acceleration when the ATV is operated in reverse can cause a loss of control.**

## Obstacles

Obstacles in the “trail” should be traversed with caution. This includes loose rocks, fallen trees, slippery surfaces, fences, posts, and embankments and depressions. You should avoid them whenever possible. Remember that some obstacles are too large or dangerous to cross and should be avoided. Small rocks or fallen trees may be safely crossed approach at a 90° angle. Stand on the footrests while keeping your knees flexed. Adjust speed without losing momentum and operate the throttle lever smoothly. Hold handlebar (operator) or grab handles (passenger on 2-UP models) firmly. Place body weight rearwards (operator and passenger 2-UP models) and proceed. Do not try to lift the vehicle front wheels off the ground. Be aware that the object may be slippery or may move while crossing.

When riding on 2-UP models, the operator is responsible for the safety of the passenger; in doubt, disembark the passenger before proceeding.

## Uphill Driving

### 1-UP Models

Before trying to climb a hill, keep these things in mind. Hill Climbing should only be attempted by experienced operators. Start on shallow slopes. Always drive straight uphill and keep your body weight forward towards the top of the hill. Keep your feet on the footrests, shift your ATV into a lower gear and accelerate before you start to climb. Try to keep a steady speed and go easy on the throttle to avoid acceleration. Abrupt slope or terrain variation or rolling one wheel over an obstacle could have a big impact on the stability as it will lift the front of the vehicle increasing the risk of tipping over. Some hills are too steep to safely stop or recover from after an unsuccessful climbing attempt. Try to avoid steep inclines. If you're not careful, you could tip over when going up hills. If the hill is too steep and you cannot proceed or the vehicle begins to roll backwards, apply the brake, being careful not to slide, put the parking brake. Dismount on the left side then use the "K" turn (while walking back, next to the vehicle on the up hill side and with a hand on the brake lever, slowly back the rear of the vehicle toward the top of the hill then drive downhill). Always walk or dismount on the upside of the slope while keeping clear of the vehicle and its rotating wheels. Do not try to hold on to the vehicle if it begins to topple. Stay clear. Do not ride over the crest of the hill at high speed. Obstacles, including sharp drop-offs, may exist.

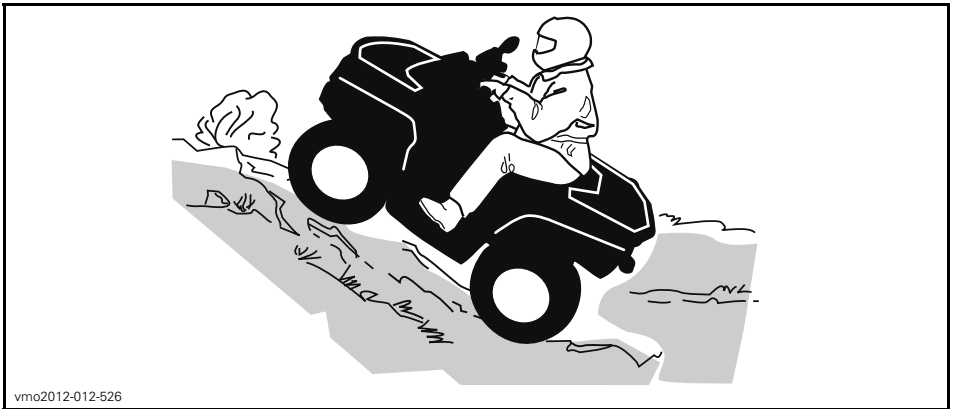

vmo2012-012-526

### 2-UP Models

The passenger must synchronize his movements with the operator. The passenger must remain seated at all times.

Do not forget, the operator is responsible for the safety of the passenger. In doubt, disembark the passenger before climbing a hill.

Before trying to climb a hill, keep these things in mind. Hill Climbing should only be attempted by experienced operators. Start on shallow slopes. Always drive straight uphill. Operator and passenger must keep their body weight forward, towards the top of the hill. Keep feet on the footrests, shift the ATV into a lower gear and accelerate before you start to climb. Try to keep a steady speed and go easy on the throttle to avoid acceleration. Abrupt slope or terrain variation or rolling one wheel over an obstacle could have a big impact on the stability as it will lift the front of the vehicle increasing the risk of tipping over. Some hills are

too steep to safely stop or recover from after an unsuccessful climbing attempt. Try to avoid steep inclines. If you're not careful, you could tip over when going up hills. If the hill is too steep and you cannot proceed or the vehicle begins to roll backwards, apply parking the brake, being careful not to slide. Ask the passenger to dismount first, dismount on the left side then use the "K" turn (while walking back, next to the vehicle on the up hill side and with a hand on the brake lever, slowly back the rear of the vehicle toward the top of the hill then drive downhill). Always walk or dismount on the upside of the slope while keeping clear of the vehicle and its rotating wheels. Do not try to hold on to the vehicle if it begins to topple. Stay clear. Do not ride over the crest of the hill at high speed. Obstacles, including sharp drop-offs, may exist. The passenger should get on the vehicle only when the vehicle has returned to a safe location.

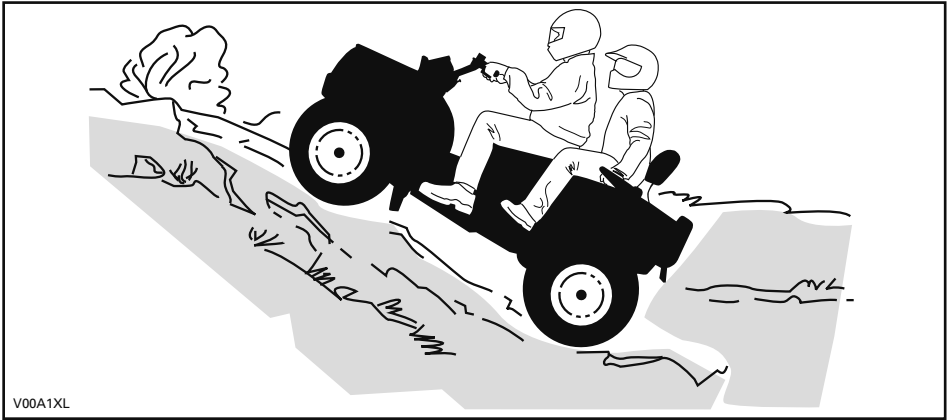

### Vehicle Behaviors

Due to configuration, this vehicle has excellent climbing ability, so much so that it is possible to tip over before traction is lost. For example, it is common to encounter terrain situations where the top of the hill has eroded to a point that the hill peak rises very sharply. The vehicle can readily negotiate such a condition, however, in doing so, when the front of the vehicle is driven to a point that the vehicle's balance moves rearward, a tip over can occur.

The same situation may apply if an embedded object causes the front of the vehicle to climb more than desired. If such a situation occurs take an alternate route. Be aware of side hilling dangers when doing so. Refer to *SIDE HILLING* below.



vmo2012-012-526

## Downhill Driving

### *1-UP Models*

Keep your body weight rearwards. Stay seated. Apply the brake gradually to prevent skidding. Do not “coast” down the slope using solely engine compression or in neutral gear.

Decelerating while negotiating a slippery downhill slope could “toboggan” the vehicle. Maintain steady speed and/or accelerate slightly to regain control. Try to avoid steep inclines. If you're not careful, you could tip over when going down hills.

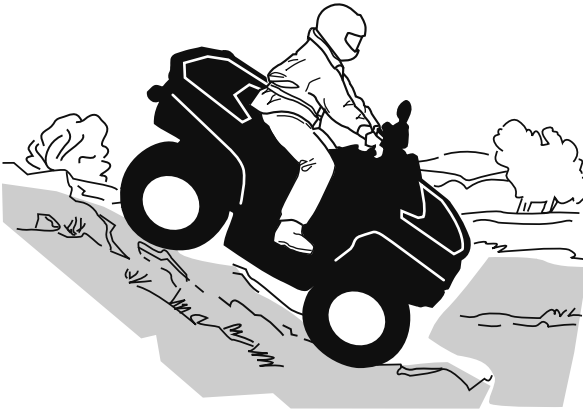

vmo2012-012-523

### *2-UP Models*

The operator is responsible for the safety of the passenger; in doubt, disembark the passenger before proceeding.

Always remember that the vehicle handling, stability and braking distance may be affected when riding with a passenger.

The passenger must synchronize his movements with the operator. The passenger must remain seated at all times.

Operator and passenger must keep their body weight rearwards. Apply the brake gradually to prevent skidding. Do not "coast" down the slope using solely engine compression or in neutral gear. Try to avoid steep inclines. If you're not careful, you could tip over when going down hills.

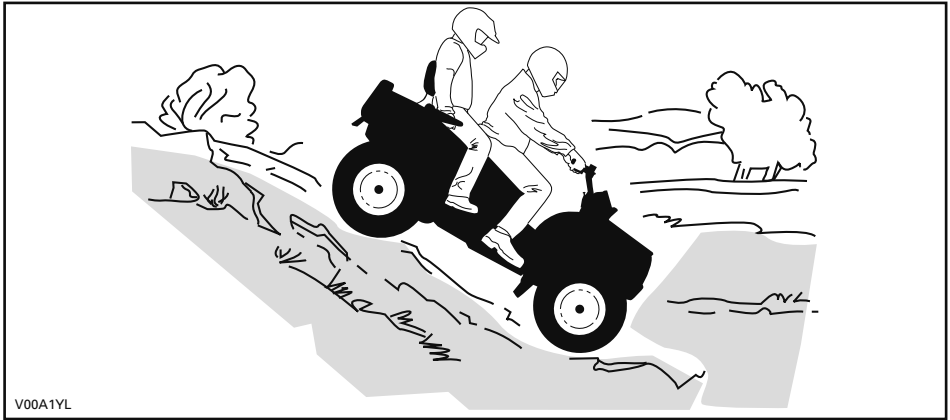

### Vehicle Behaviors

This vehicle can climb slopes that are steeper than it can safely descend. Therefore, it is essential to ensure that a safe route exists to descend a slope before you climb it.

### Side Hilling

This is one of the **most risky** types of riding since it may drastically change the balance of the vehicle. It should be avoided whenever possible. However, if it is necessary to do so, it is important that you **ALWAYS** keep your body weight on the up-side of the slope and be prepared to dismount on that side should the vehicle begin to topple.

Avoid all objects or depressions that will intensify the raising of one side of the vehicle higher than the other, thus causing rollover.

#### **⚠ WARNING**

Do not try to stop or save the vehicle from damage.

#### **⚠ WARNING**

Be careful when loading and transporting liquid reservoirs. They can affect vehicle stability when side hilling by pulling downhill and increasing the risk of a roll over.

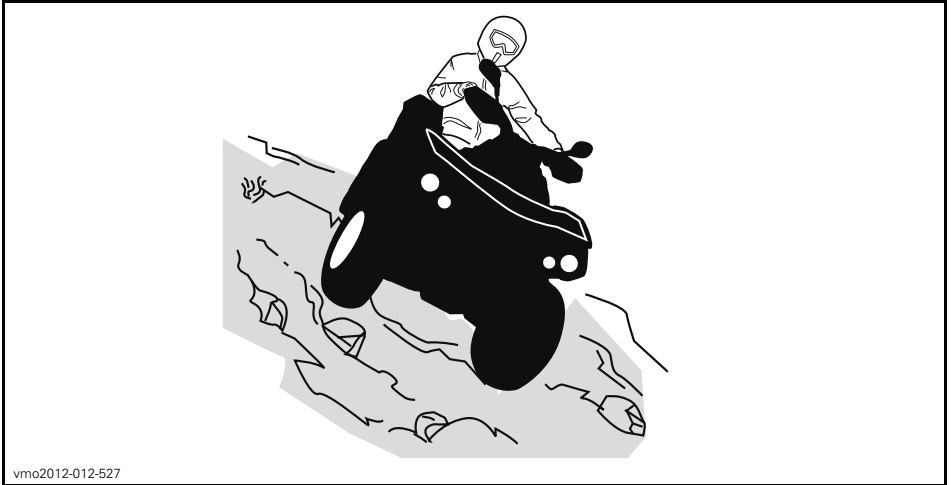

### **2-UP Models**

The passenger must synchronize his movements with the operator. The passenger must remain seated at all times.

The operator is responsible for the safety of the passenger; in doubt, disembark the passenger before proceeding.

### **Drop-Offs**

This vehicle will “bottom-out” and usually stop if either the front or rear wheels are driven over a drop-off. If the drop is sharp or deep, the vehicle will nose dive and tip over.

When riding on a 2-UP model, the operator is responsible for the safety of the passenger; in doubt, disembark the passenger before proceeding.

## **⚠ WARNING**

**Avoid negotiating drop-offs. Reverse and select an alternate route.**

### **Crossing Water**

Water can be a unique hazard. If it is too deep the vehicle may “float” and topple. Check the water depth and current before you attempt to cross any water. Water should not go above the footrest. Be wary of slippery surfaces such as rocks, grass, logs, etc., both in the water and on its banks. A loss of traction may occur. Do not attempt to enter the water at high speed. The water will act as a brake and could throw you off the vehicle, on the ground.

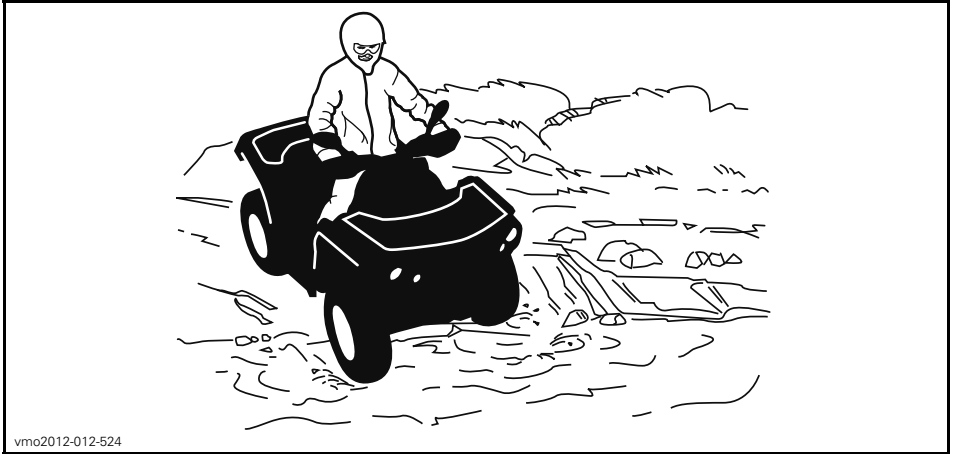

Wet brakes will affect the braking ability of your vehicle. Make sure you dry the brakes by applying them several times after the vehicle leaves the water, mud or snow. Allow greater distance for braking.

Mud or marsh lands may be encountered near water. Be prepared for sudden "holes" or changes in depth. Similarly so, be watchful of hazards such as rocks, logs, etc., partially covered by vegetation.

### **Riding on Ice**

If your route crosses frozen waterways, make sure the ice is thick enough and sound enough to support the total weight of yourself, your passenger (2-UP models), the vehicle and its load. Be ever watchful of open water it is a sure indication that the ice thickness will vary.

On 2-UP models, the operator is responsible for the safety of the passenger; in doubt, do not attempt to cross.

Ice will also affect the control of the vehicle. Slow down and do not "gun" the throttle. This will only result in spinning of the tires and possible tip over of the vehicle or passenger ejection (2-UP models). Avoid rapid braking. This again will possibly result in an uncontrolled slide and tip over of the vehicle. Slush should be avoided at all times since it could block the operation or controls of the vehicle.

### **Riding on Snow Covered Surfaces**

When performing the pre-ride inspection, pay special attention to locations on the vehicle where snow and/or ice accumulations may obstruct visibility of the taillight and reflectors, clog ventilation openings, block the radiator and fan, and interfere with the movement of control levers, switches and brake pedal. Before starting with your ATV check the steering, throttle and brake lever and pedal controls for interference free operation.

Whenever an ATV is ridden on a snow covered drive path the tire grip is generally reduced causing the vehicle to react differently to control inputs from the operator. On low grip surfaces, the steering responses are not as crisp and precise, stopping distances are lengthened and acceleration becomes sluggish. Slow down and do not "gun" the throttle. This will only result in spinning of the tires and possibly in an over steering slide of the vehicle. Avoid hard braking. This will possibly result in a



straight line slide of the vehicle. Again, the best advice is to safely reduce speed in anticipation of a maneuver so to give yourself time and distance to regain total vehicle control before it spins out of your control.

As you drive your ATV over a loose snow covered surface, snow dust will be picked up in the wake turbulence of the moving vehicle and transported to contact and accumulate or melt on some exposed components including rotating parts like brake discs. Water, snow or ice may affect the response time of the brake system of your ATV. Even when not required to reduce vehicle speed apply brakes frequently to prevent ice or snow accumulation and to dry brake pads and discs. While doing so in low risk driving situations you will test for grip level and keep yourself alerted to how the vehicle reacts to your control inputs. Always keep brake pedal, footrests, floor boards, brake and throttle levers free of snow and ice. Frequently wipe snow off seat, hand grips, headlights, taillights and reflectors.

The depth of the snow cover may hide rocks, tree stumps or other objects and if it is wet may totally impede the driveability as the vehicle becomes bogged down or completely loses traction in slushy snow. Look far ahead and always be watchful of any visible clues that might indicate the presence of such obstacles. In doubt steer clear. Avoid driving on any frozen body of water before checking that the ice will safely support the ATV, its riders and its load of cargo. Remember that a given thickness of ice may be sufficient to support a snowmobile but not an ATV of an identical weight because of the smaller load bearing surface of the four tire contact patches as compared to that of a snowmobile track and skis.

To maximize comfort and avoid frostbite, always wear clothing and ATV protective equipment appropriate for the weather conditions you will be exposed to during your ride.

At the end of each ride it is a good practice to clean the vehicle body and all moving components (brakes, steering components, drivelines, controls, radiator fan etc.) from any snow or ice accumulations. Wet snow will turn to ice during the shut down period and become more difficult to remove at the next pre-ride inspection.

Riding in snow may reduce the brakes stopping capability. Safely reduce speed and allow greater distance for braking. Snow projection may cause ice build up or snow accumulation on brake components and controls. Apply brakes frequently to prevent ice or snow accumulation.

## **Riding on Sand**

Riding on sand, sand dunes or on snow is another unique experience, but there are some basic precautions that should be observed. Wet, deep or fine sand/snow may create a loss of traction and cause the vehicle to slide, drop off or become "bogged" down. If this occurs look for a firmer base. Again, the best advice is to slow down and be watchful of the conditions. When you ride with a passenger (2-UP models), slow down even more.

When riding in sand dunes it is advisable to equip the vehicle with an antenna type safety flag. This will help make your location more visible to others over the next sand dune. Proceed carefully should you see another safety flag ahead. Since the antenna type safety flag can snag and rebound on your body if caught, do not use it in areas where there are low hanging branches or obstacles. Always remember when riding on a 2-UP model that the vehicle handling and stability may be affected when riding with a passenger.

### **Riding on Loose Stones**

Riding on loose stones or gravel is very similar to riding on ice. They will affect the steering of vehicle possibly causing it to slide or tip over especially at high speeds (resulting in operator and passenger ejection (2-UP models)).

Again, the best advice is to slow down and be watchful of the conditions. When you ride with a passenger (2-UP models), slow down even more.

In addition, braking distance may be affected. Remember that “gunning” the throttle or sliding may cause loose stones to be ejected rearwards into the path of another rider. Never do it deliberately.

# V MOVING LOADS AND DOING WORK

## 1) Working with your Vehicle

Your vehicle can help you perform a number of different LIGHT tasks ranging from snow removal to pulling wood or carrying cargo. A variety of accessories are available from your authorized Can-Am dealer. To prevent possible injury, follow the instructions and warnings that accompany the accessory. Always respect the load limits of the vehicle. Overloading the vehicle can overstress the components and cause failure. Avoid overexerting yourself if you lift or pull heavy loads or manually push the vehicle.

### **⚠ WARNING**

Mounted machinery must be lowered on the ground before leaving the tractor.

## 2) Carrying Loads

Any load carried on the vehicle including a passenger (2-UP models) and/or the carrying rack(s) will affect the handling, stability and braking distance of the vehicle. Do not exceed the total load allowed for this vehicle, including the weight of operator and passenger cargo, accessories and trailer tongue weight. Always make sure the load is secured, properly distributed (1/3 of cargo weight in front and 2/3 of cargo weight in back) and cannot interfere with your proper control. Always be aware that the cargo may slide or fall off and create an accident. Avoid cargo that may protrude sideways and get snagged or caught in brush or other obstacles. Avoid covering and obstructing the headlights or taillight with the cargo.

Always be aware that the "load" may slide or fall off and cause an accident.

### **⚠ WARNING**

The vehicle handling, stability and braking distance are affected when driving with loaded cargo racks. Correct loading and weight distribution are therefore important. Never overload, tow or carry cargo improperly. Always ensure the cargo is safely secured and properly distributed on the rack(s) before operating the vehicle. Safely reduce speed according to terrain conditions when carrying cargo or pulling a trailer, and avoid hills and rough terrain. Allow greater distance for braking, especially on inclined surfaces and when a passenger (2-UP models) is on board. Be careful not to skid or slide. Always secure cargo as low as possible on the rack(s) to reduce the effect of a higher center of gravity. Failure to follow the recommendations could cause changes in vehicle handling which could lead to an accident.

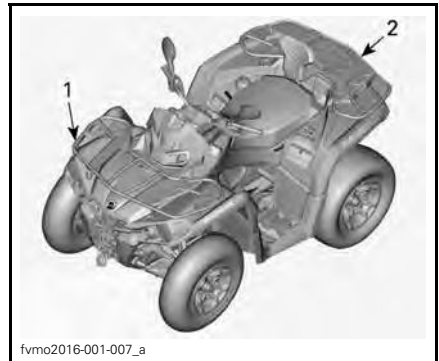

1. 1/3 of cargo weight
2. 2/3 of cargo weight

MAXIMUM LOAD TABLE			
TOTAL LOAD ALLOWED	1-UP MODELS	235 kg (517 lb)	Includes weight of operator, cargo, accessories and trailer tongue weight.
	2-UP MODELS	272 kg (598 lb)	Includes weight of operator, passenger, cargo, accessories and trailer tongue weight.
FRONT LOAD		54 kg (120 lb)	Evenly distributed.
REAR LOAD		109 kg (240 lb)	Evenly distributed. Includes rear rack, rear storage compartment (if so equipped) and tongue load.

The following is an example of suitable load distribution:

EXAMPLE OF LOAD DISTRIBUTION (VEHICLE WITH A TOTAL LOAD ALLOWED OF 235 KG (517 LB))				
TOTAL VEHICLE LOAD	OPERATOR AND PASSENGER	CARGO LOAD	ACCESSORIES	TONGUE WEIGHT
235 kg (517 lb)	100 kg (220 lb)	105 kg (231 lb)	10 kg (22 lb)	20 kg (44 lb)

### 3) Loading the Cargo Racks

Load cargo as low as possible – a higher load can raise the vehicle’s center of gravity, which can reduce stability. Position cargo on the rack as evenly distributed as possible.

Secure the load on the cargo rack. Do not secure cargo to parts of the vehicle. If it is not properly secured, a load may slide or fall off, possibly striking occupants or bystanders; or it may shift during riding, affecting the handling of the vehicle.

Objects that are high may affect visibility for the driver and may act as projectiles in case of an accident. Loads that protrude sideways can get snagged or caught in bush, branches or other obstacles. Avoid covering and obstructing the brake lights with the cargo. Ensure no cargo protrudes outside the

cargo rack and that cargo will not interfere with your visibility or control of the vehicle.

**NOTICE** Do not exceed the cargo racks capacity. Refer to *SPECIFICATIONS*.

Never carry gasoline container(s) or any dangerous liquids on the cargo rack.

** WARNING**

Never overload, tow or carry cargo improperly. Safely reduce speed according to terrain conditions when carrying cargo or pulling a trailer, and avoid hills and rough terrain. Allow greater distance for braking. Always secure cargo as low as possible to reduce the effect of a higher center of gravity. Failure to follow the recommendations here could cause changes in vehicle handling which could lead to an accident.

## 4) Hauling a Load

Never pull a load by attaching it to the bumper or luggage racks; this can cause the vehicle to tip over. Use only the trailer hitch to pull a load.

In an emergency situation, use the recovery hooks to recover a stuck vehicle. Refer to *RECOVERY HOOKS* in *EQUIPMENT*.

When pulling loads with a chain or cable, ensure that there is no slack before starting and maintain tension while pulling.

When pulling loads with a chain or cable, be sure to brake progressively. The inertia of the load could lead to an impact.

When hauling a load, respect the maximum hauling capacity. See *PULLING A TRAILER* in this section.

### WARNING

A slack in the chain or cable can cause it to break and snap back.

When pulling another vehicle, be sure that someone is controlling the pulled vehicle. They must brake and steer to prevent the vehicle from going out of control.

Reduce your speed when hauling a load and turn gradually. Avoid hills and rough terrain. Never attempt steep hills. Allow more distance for braking, especially on inclined surfaces and when a passenger (2-up models) is on board. Be careful not to skid or slide.

## 5) Pulling a Trailer

Check the maximum axle loads of the vehicle identification plate (statutory plate). Can-am T Category tractor can tow a trailer on the road. Check the trailer maximum load on its identification plate. Check the regulations for your area regarding the use of a tractor and trailer on the road. Connect the trailer lights.

**NOTICE** A BRP approved rear hitch must be properly installed on the vehicle for hauling trailers.

Riding this vehicle with a trailer substantially increases the risk of toppling, especially on inclined slopes. If a trailer is attached to the vehicle make sure that its hitch is compatible with the one on the vehicle. Make sure the trailer is horizontal with the vehicle. (In some instances a special extension may have to be installed on the vehicle hitch). Use security chains or cables to secure the trailer with the vehicle.

Reduce your speed when pulling a trailer and turn gradually. Avoid hills and rough terrain. Never attempt steep hills. Allow more distance for braking, especially on inclined surfaces and when a passenger (2-up models) is on board. Be careful not to skid or slide. This vehicle may require additional stopping distance if hauling heavy loads, especially on inclined surfaces and when a passenger (2-UP models) is on board.

Improperly loading a trailer may cause loss of control. Respect the recommended maximum towing capacity and maximum tongue capacity (Refer to *CARRYING LOADS*). Make sure there is at least some weight on the tongue.

Always make sure load is evenly distributed and safely secured on the trailer; an evenly balanced trailer is easier to control.

Always put the shift lever to L (low range) for hauling a trailer – in addition to providing more torque, operating in low range helps account for the increased load on the rear tires.

When stopped or parked, block the vehicle and trailer wheels from possible movement.

Use caution when disconnecting a loaded trailer; it or its load may topple on you or others.

When hauling a trailer, respect the maximum hauling capacity indicated on the label on the hitch.

Do not exceed the towing capacity and tongue capacity. Refer to *SPECIFICATIONS* or label affixed to the hitch.

**NOTE:** The towing capacity includes the trailer weight.

 **WARNING**

Stay clear from the area between tractor and trailed vehicle.

 **WARNING**

Strictly follow the instructions outlined in the operator's manual of the mounted or trailed machinery or trailer, and not to operate the combination tractor - machine or tractor - trailer unless all instructions have been followed.

# VI IMPORTANT ON-PRODUCT LABELS

## 1) Vehicle Safety Labels

Read and understand all the safety labels on your vehicle.

These labels are affixed to the vehicle for the safety of the operator, passenger (2-UP) or bystanders.

The safety labels on your vehicle should be considered permanent parts of the vehicle. If missing or damaged, they can be replaced free of charge. See an authorized Can-Am dealer.

The following labels are on your vehicle, and they should be considered permanent parts of the vehicle. They need to be clean, visible and legible at all times. If missing or damaged, they need to be replaced. Safety labels are free of charge. See an authorized Can-Am dealer.

Also, upon replacement of parts that have safety labels on them, make sure to order (free of charge) the applicable safety warnings if not already installed on the replacement part.

**NOTE:** In the event of any discrepancy between this guide and the vehicle, the safety labels on the vehicle have precedence over the labels in this guide.

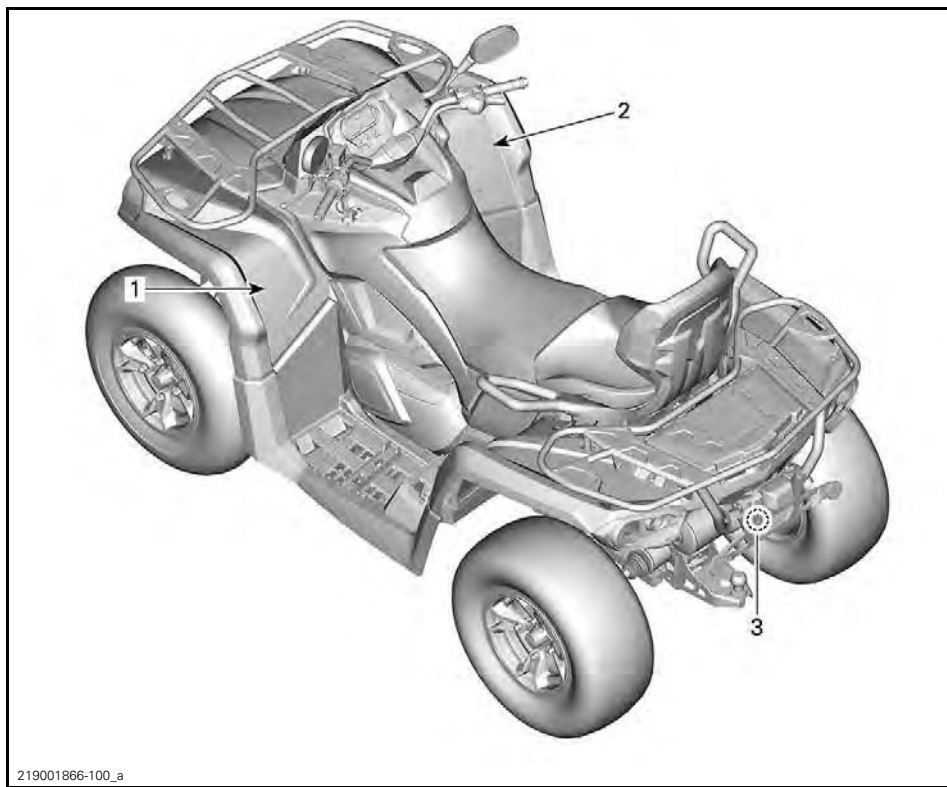

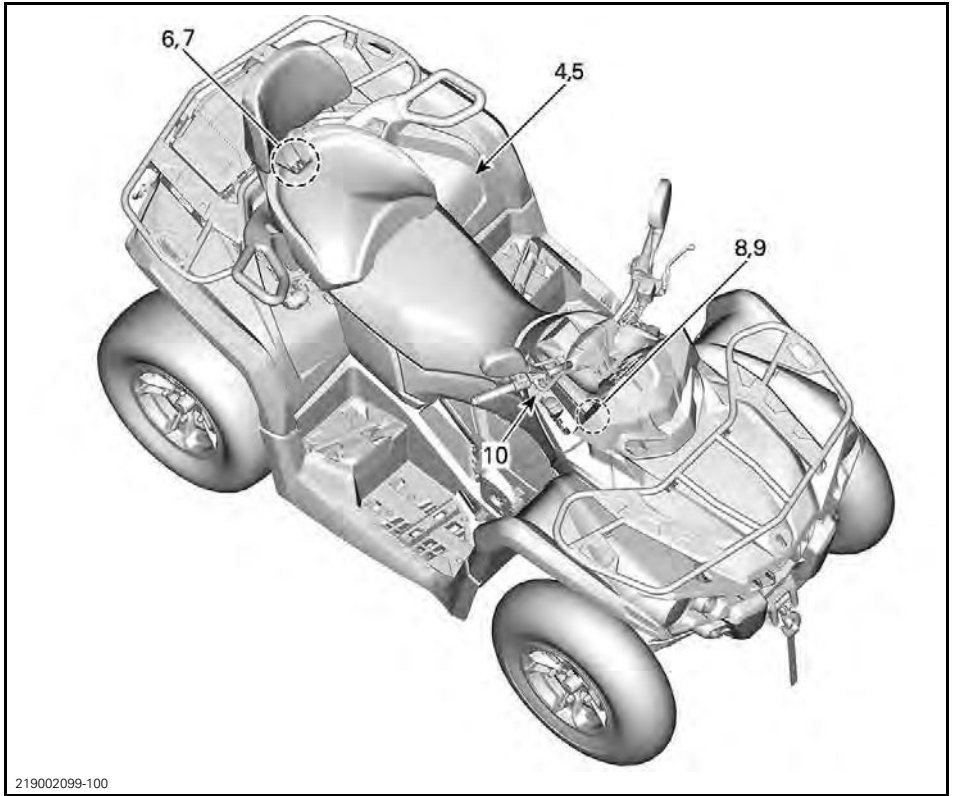

219002099-100





## Label 1

**⚠ WARNING**

- Always use an approved helmet and protective gear.
- Always wear ear protection.
- Locate and read operator's guide. Improper ATV use can result in SEVERE INJURY or DEATH. Follow all instructions and warnings.
- Reduce your speed if you must use paved roads.
- Never carry a passenger on 1-up models and NEVER carry more than one passenger on 2-up models.
- Never use with drugs or alcohol.

**⚠**









Safety Video

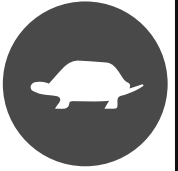

[https://  
can-am.brp.com  
/off-road/safety](https://can-am.brp.com/off-road/safety)

+







Patent : [www.brp.com/en/about-brp/patents.html](http://www.brp.com/en/about-brp/patents.html)





EN-704908380-DEC

LABEL 1 - 1-UP MODELS













Safety Video

  
[https://  
can-am.brp.com  
/off-road/safety](https://can-am.brp.com/off-road/safety)

+







Patent : [www.brp.com/en/about-brp/patents.html](http://www.brp.com/en/about-brp/patents.html)



EN-704908399-DEC

**LABEL 1 - 2-UP MODELS**

*Label 2*



**WARNING**

Operating this ATV if you are under the age of 16 increases the chance of SEVERE INJURY or DEATH to the operator, and to both the operator and passenger on 2-up models. NEVER operate this ATV if you are under age 16.





704905679

EN-704905679-DEC

**LABEL 2**

Label 3

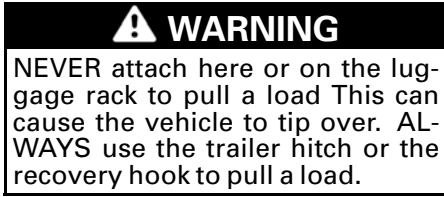

EN-704905699-DEC

LABEL 3

Label 4

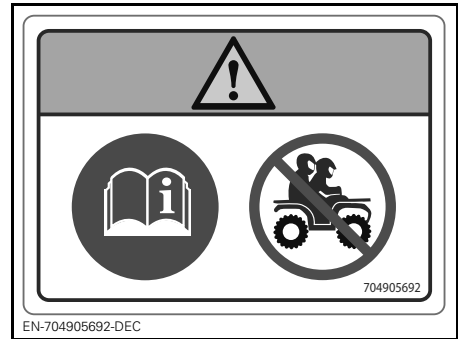
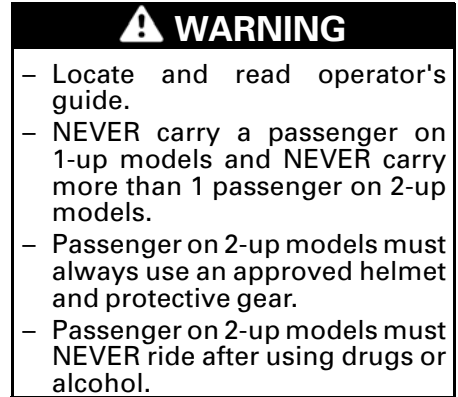

EN-704905692-DEC

LABEL 4 - 1-UP MODELS



EN-704905694-DEC

LABEL 4 - 2-UP MODELS

Label 5

**⚠ WARNING**

- Locate and read operator's guide. Improper tire pressure or overloading can cause loss of control, resulting in SEVERE INJURY or DEATH.
- ALWAYS maintain proper tire pressure as shown.
- On 1-up models, NEVER exceed the load capacity of 235 kg (517 lb) including weight of operator, cargo, accessories, and trailer tongue weight.
- On 2-up models, NEVER exceed the load capacity of 272 kg (600 lb) including weight of operator, passenger, cargo, accessories, and trailer tongue weight.
- ALWAYS pull a load using the trailer hitch or recovery hook.

**⚠**

**!**

**i**

+ +

< 155 kg (341 lb)

+ +

> 155 kg (341 lb)  
< 235 kg (517 lb)

=

<u>kPa(psi)</u>		<u>kPa(psi)</u>	
48.3 (7)	48.3 (7)	62.1 (9)	68.9 (10)

704907515

EN-704907515-DEC

ABS

LABEL 5 - 1-UP MODELS WITH ABS

<235 kg (517 lb)

=

kPa(psi)	kPa(psi)
41.4 (6)	41.4 (6)

704907516

NOABS

EN-704907516-DEC

LABEL 5 - 1-UP MODELS WITHOUT ABS

< 125 kg (275 lb)

>125 kg (275 lb)  
<272 kg (598 lb)

=

=

kPa(psi)	kPa(psi)
48.3 (7)	48.3 (7)

kPa(psi)	kPa(psi)
62.1 (9)	68.9 (10)

704907517

ABS

EN-704907517-DEC

LABEL 5 - 2-UP MODELS WITH ABS





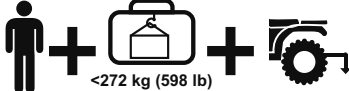

<272 kg (598 lb)

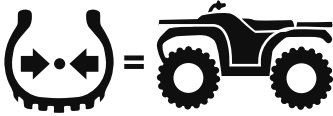

kPa(psi)	kPa(psi)
41.4 (6)	41.4 (6)

NOABS



704907518

EN-704907518-DEC

LABEL 5 - 2-UP MODELS WITHOUT ABS

**Label 6**



**WARNING**

- NEVER carry a passenger on this carrier.
- MAXIMUM FRONT LOAD: 54 kg (120 lb) evenly distributed.
- MAXIMUM REAR LOAD: 109 kg (240 lb) evenly distributed (including trailer tongue weight if applicable).







< 109 kg (240 lb)

< 54 kg (120 lb)

704905703

EN-704905703-DEC

LABEL 6

Label 7

**⚠ WARNING**

- 1) Ensure the latch lever is in the open position by pulling it towards the front of seat.
- 2) Using a forward motion, insert both front tabs of the seat into the vehicle anchor housings.
- 3) Rotate downwards to engage the rear latch.
- 4) Close the latch lever by pushing it rearwards to secure seat in position.

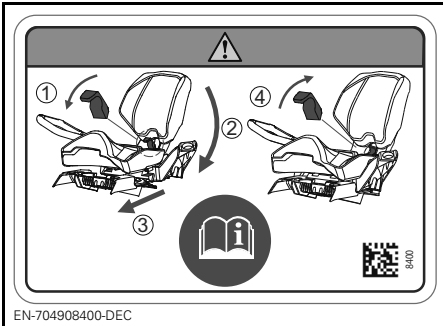

LABEL 7- 2-UP MODELS

Label 8



LABEL 8

Label 9

**⚠ WARNING**

Do not open when hot.



LABEL 9

**NOTICE** This vehicle must be stopped before shifting lever. ALWAYS apply foot brake to shift from Park (P) and Neutral (N).

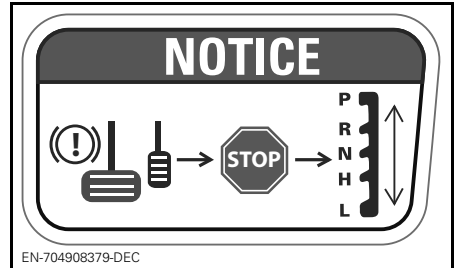

LABEL 10

## 2) Compliance Labels

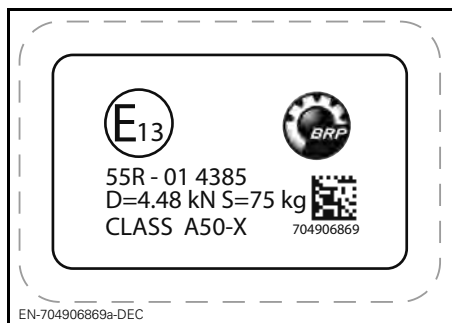

ON TRAILER HITCH

Category 1 - The cab does not offer any protection against substances which are harmful to health.



NEAR GAS CAP

## 3) Technical Information Labels

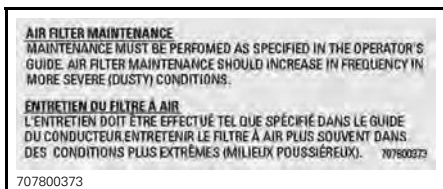

UNDER SEAT



ON SHIFT LEVER GRILL (PARK POSITION)



ON BRAKE FLUID RESERVOIRS



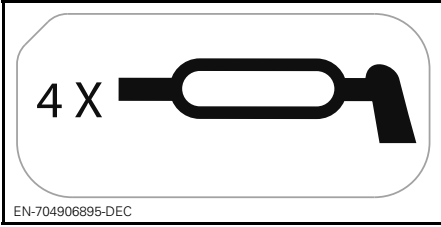

**ON FRONT SUSPENSION ARMS**

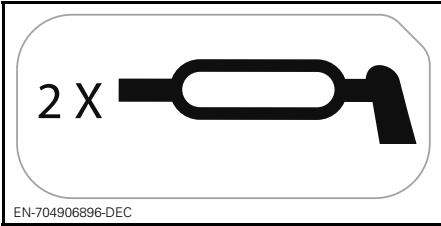

**ON REAR SUSPENSION ARMS**

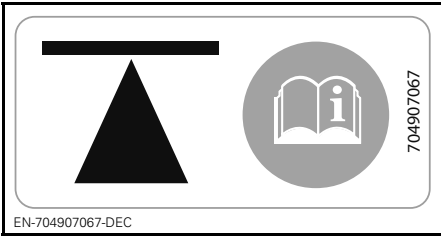

**ON SIDE OF CHASSIS - FRONT AND REAR**  
Refer to **INSTRUCTIONS FOR VEHICLE LIFTING** section in your **OPERATOR'S GUIDE** for lifting points locations and procedure.

***This page is  
intentionally blank***

# ***B) VEHICLE INFORMATION***

# I CONTROLS

**NOTE:** Some vehicle safety labels are not shown on illustrations. For information on vehicle safety labels, refer to *IMPORTANT ON-PRODUCT LABELS*.

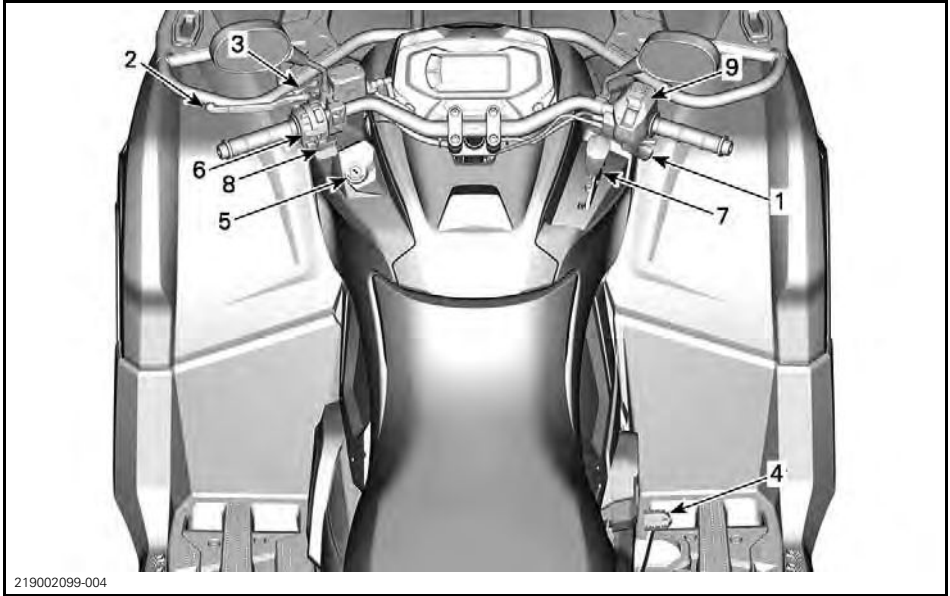

## 1) Throttle Lever

The throttle lever is located on the RH side of the handlebar. It can be positioned to be activated with the thumb or finger.

The throttle lever controls the engine speed.

To increase or maintain vehicle speed, press the throttle lever.

To decrease vehicle speed, release the throttle lever.

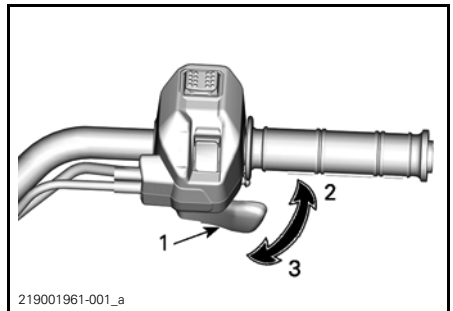

- TYPICAL**
1. Throttle lever
  2. To accelerate
  3. To decelerate

### Engine Stop Switch

This switch can be used to stop the engine and as an emergency control.

To stop engine, set the engine stop switch to the STOP position.



### Override/DPS Button

Depending on the vehicle model, this button can have 3 functions.



### Override Function

The override switch main function is to bypass the engine speed limiter in reverse operation by allowing maximum engine torque.

While reading this Operator's Guide, remember that:

## ⚠ WARNING

Use the "override" mode only if the vehicle is caught in mud or other soft terrain and the "low range" is not enough. Make sure the area is secure before using the "override" mode. Do not use the "override" mode when driving normally in reverse, this would result in excessive speed.

To engage the override function, proceed as follows:

While the shift lever is set to REVERSE position.

1. Ensure that the vehicle is stopped.
2. Press and hold the override/DPS button then press the throttle lever gradually.

**NOTE:** When using the override function, the gauge will scroll an **OVER-RIDE** message to confirm that the function is activated.

3. To disengage the override function, simply release the override button.

### DPS Function (Models with DPS)

This button is also used to change the DPS mode.

To change DPS mode, refer to *TUNE YOUR RIDE*.

### Emergency Throttle Operation in Limp Home Mode

In case of a throttle lever sensor or throttle position sensor failure, the override/DPS button can be used to increase the engine speed in order to drive the vehicle at a low speed.

If such a failure occurs, a message will be displayed on the gauge.

## ⚠ WARNING

Indicates a potential hazard that, if not avoided, could result in serious injury or death.

## 2) Brake Lever

The brake lever is located on the LH side of the handlebar.

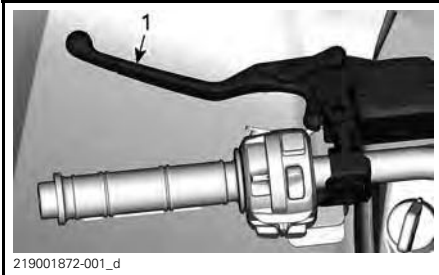

1. Brake lever

The brake lever function is to slow down or stop the vehicle.

When the brake lever is compressed, the front and rear brakes are applied.

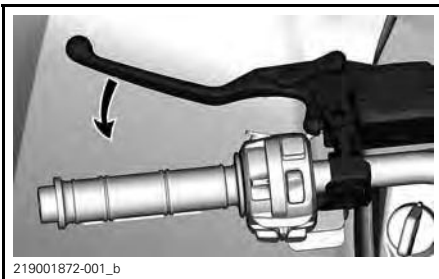

Braking effect is proportional to the force applied on the lever.

## 3) Brake Lock

The brake lock lever is located on the LH side of the handlebar.

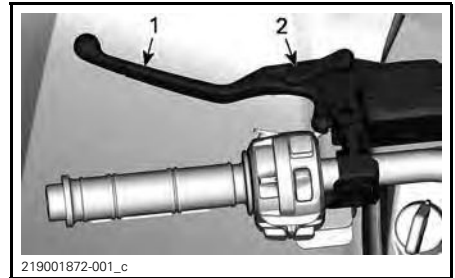

1. Brake lever  
2. Lock lever

Engage the brake lock whenever the vehicle is parked.

**Models without ABS:** The brake lock maintains the brakes on the front and rear wheels to prevent the vehicle from moving.

**Models with ABS:** The brake lock maintains the brakes on front wheels to prevent the vehicle from moving.

### **⚠ WARNING**

Always use the brake lock **and** engage the PARK position on the shift lever when the vehicle is not in operation.

To engage the brake lock proceed as shown:

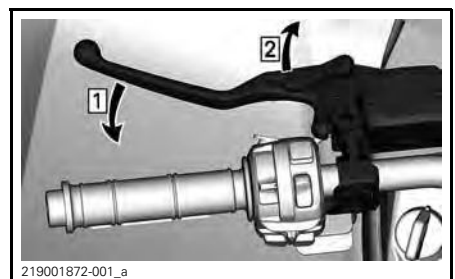

Step 1: Apply brakes  
Step 2: Lock brakes

**NOTE:** The lock lever can be set to several positions.

**NOTICE** Ensure when the brake lock is applied that the vehicle stays securely in place.

To unlock the brakes, simply squeeze the brake lever. It should return to the rest position.

**⚠ WARNING**

Make sure brake lock is released before operating the vehicle. If brake lock is left ON while riding, it may cause damage to the brake system and cause loss of braking capacity and/or fire.

### 4) Brake Pedal

The brake pedal is located on the RH side footrest.

**Models without ABS:** When pressed down, the rear brakes are applied.

**Models with ABS:** When pressed down, the front and rear brakes are applied.



vmo2015-005-003\_a

1. Brake pedal

When released, the brake pedal should return to its original position.

Braking effect is proportional to the force applied on the pedal.

**NOTE:** As on other wheeled vehicles, the vehicle weight is transferred to the front wheels when braking. To obtain greater stopping efficiency, the brake system distributes more braking force to the front wheels. This will affect vehicle handling and steering control when braking vigorously. Take it into account when braking.

Should the brake lever system fail, the rear brake can be used by depressing the brake pedal.

### 5) Ignition Switch (Key)

The ignition switch is located on the LH side of the central panel below the handlebar.

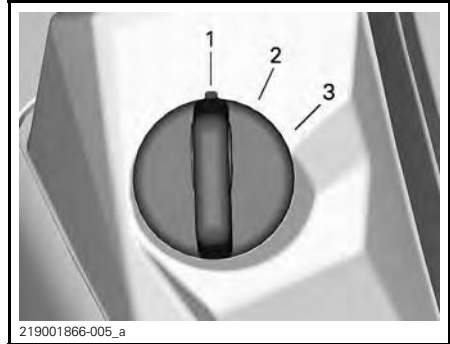

219001866-005\_a

**TYPICAL IGNITION SWITCH**

- 1. OFF
- 2. ON with light
- 3. ON

#### OFF

The key can be inserted or removed in this position only.

When turning the key in OFF position, the engine will shut down and the electrical system will shut down a few seconds afterwards.

**NOTE:** While the engine can be stopped by turning the ignition key to OFF position, we recommend to stop the engine using the engine stop switch.

#### ON with Lights

When the key is turned in this position, the electrical system of the vehicle is activated, including the gauge and lights.

With the key in the "ON with lights" position, and the engine stop switch pulled up, the engine can be started.

## ON

This position offers the same functions as "ON with lights" position, except the vehicle lights are turned off.

### Digitally Encoded Security System (D.E.S.S.)

The ignition keys contain an electronic circuit that gives it a unique electronic serial number.

The D.E.S.S. system reads the key code and allows engine starting for keys it recognizes.

### D.E.S.S. Flexibility

The D.E.S.S. of your vehicle can be programmed by your authorized Can-Am dealer to accept up to 8 different keys.

If you have more than one D.E.S.S. equipped Can-Am vehicle, each can be programmed by your authorized Can-Am dealer to accept the other vehicle D.E.S.S. keys.

## 6) Multifunction Switch

The multifunction switch is located on the LH side of the handlebar.



1. Engine start button
2. Engine stop switch
3. Hazard lights switch
4. Override button (and DPS modes if equipped)
5. Headlight dimmer switch
6. Turn signal switch
7. Horn button

## Engine Start Button



Press and hold the button to start the engine.

Release the button as soon as the engine has started.

**NOTE:** To allow engine starting, the ignition switch must be in the "ON with lights" or "ON" position and the engine stop button set to ON (up).



Press the override/DPS button. If the engine speed rises, drive the vehicle safely. If not, hold the button and press the throttle lever.

### Headlight Dimmer Switch

Move the switch forward to select the high beam and rearward to select the low beam.



### Turn Signal Switch

Move the switch to the left to activate LH turn signals and to the right to activate RH turn signals.

To stop the turn signals, move the switch back to the middle position.



### Horn Button

Push the button to use the horn. It will stop when the button is released.



## 7) Shift Lever

The shift lever is located on the RH side of the console.



### SHIFT LEVER LOCATION

The shift lever is used to change the gearbox position.

The shift lever has 5 positions:

SHIFT LEVER POSITIONS	
POSITION	GEAR
P	Park
R	Reverse
N	Neutral
H	High range (forward)
L	Low range (forward)



vmo2012-012-036

TYPICAL - SHIFT PATTERN

The vehicle must be stopped and brakes applied prior to selecting any gear.

**NOTICE** This gearbox is not designed to shift while vehicle is moving.

### P: Park

The park position locks the gearbox to help prevent vehicle movement.

## ⚠ WARNING

Always use the PARK (P) position when the vehicle is not in operation. The vehicle can roll if the shift lever is not set to P (PARK).

### R: Reverse

The reverse position allows the vehicle to go backwards.

**NOTE:** In reverse operation, the engine's RPM is limited, thus limiting the vehicle reverse speed.

## ⚠ WARNING

When driving downhill in reverse, gravity can increase the vehicle speed above the set limited reverse speed.

### Neutral

The neutral position disengages the gearbox.

## ⚠ WARNING

Always use the PARK (P) position when the vehicle is not in operation. The vehicle can roll if the shift lever is set to N (NEUTRAL).

### High Range (Forward)

This position selects the high speed range of the gearbox. It is the normal driving speed range. It allows the vehicle to reach its maximum speed.

### Low Range (Forward)

This position selects the low speed range of the gearbox. It allows the vehicle to move slowly with maximum torque at the wheels.

**NOTICE** Use the low speed range to pull a trailer, carry heavy cargo, go over obstacles or drive uphill and downhill.

## 8) Winch Control Switch (If Equipped)

Refer to *WINCH* in *EQUIPMENT* for details.

## 9) 2WD/4WD and Driving Modes (if equipped) Selector Switch

The 2WD/4WD and Driving Modes selector is located on the RH side of the handlebar.

This switch is used to select the 2WD or 4WD modes.



219001961-004\_a

**4WD MODE - TYPICAL****TYPICAL**

1. 2WD/4WD Selector
2. 2WD position
3. 4WD position
4. Driving modes selector

Bring the vehicle to a complete stop with the engine idling before changing between 2WD and 4WD modes or the opposite.

**NOTICE** Mechanical damage may occur if the 2WD/4WD selector switch is used while vehicle is moving.

To engage the 4WD mode, press the switch down.



219001961-004\_b

**4WD MODE - TYPICAL**

To engage the 2WD mode, press the switch up.



219001961-004\_c

**2WD MODE - TYPICAL**

This switch is used to select the driving modes. (If equipped)



219001961-004\_d

**1. Driving modes selector**

Activate SPORT or WORK by pushing the selector on the left or right.



219001961-004\_e

The SPORT mode provides a crisper throttle response. Press LEFT to activate, RIGHT to deactivate.

The WORK mode provides a smoother throttle response and is limited to a maximum speed of 70 km/h (43 MPH). Press LEFT to activate, RIGHT to deactivate.

**NOTE:** For a smoother ride on bumpy trails, do not activate Sport mode.

While reading this Operator's Guide, remember that:

 **WARNING**

Indicates a potential hazard that, if not avoided, could result in serious injury or death.

# MULTIFUNCTION GAUGE (LCD)

The multifunction gauge is located in the gauge support.

## **⚠ WARNING**

Reading the multifunction gauge display can distract from the operation of the vehicle, particularly from constantly scanning the environment.

## 1) Multifunction Gauge Description

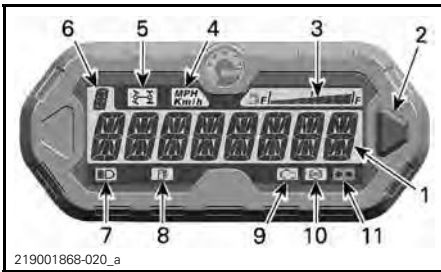

1. Main display
2. Selector button
3. Fuel level display
4. km/h mph, indicator
5. 4WD telltale
6. Gearbox position display
7. High beam telltale
8. Low fuel level telltale
9. Check engine telltale
10. Anti-lock brake system (ABS) telltale (if equipped)
11. Turn signal/hazard lights telltale (if equipped)

### 1) Main Display

The main display is used to display numerous functions of the multifunction gauge.

Refer to *MULTIFUNCTION GAUGE MODES* for available modes:

### 2) Selector Button

The selector button is used to navigate or change settings in the multifunction gauge.

### 3) Fuel Level Display

Bar gauge continuously indicating the level of fuel in the fuel tank while riding.

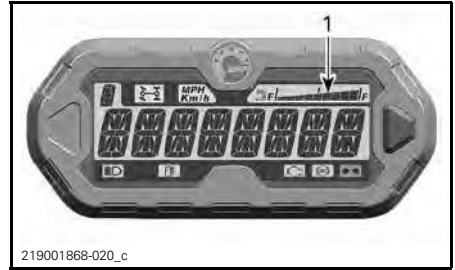

1. Fuel level display

### 4) KM/H or MPH Telltale

*mph*  
*Km/h*

Indicates the unit of measure displayed.

### 5) 4WD Telltale



When this telltale is ON, it indicates the 4WD mode is selected.

### 6) Gearbox Position Display

This display shows the gearbox position.



1. Transmission position

DISPLAY	FUNCTION
P	Park
R	Reverse
N	Neutral
H	High range
L	Low range

### 7) High Beam Telltale



When this telltale is ON, it indicates that **high beam** is selected on the headlights are ON.

### 8) Low Fuel Level Telltale



When this telltale is ON, it indicates that there is approximately 5 L (1.3 U.S. gal.) of fuel left in fuel tank.

### 9) Check Engine Telltale



When this telltale is ON, it indicates an engine fault code, look for a message at the LCD display.

When this telltale blinks, it indicates that the **LIMP HOME** mode is activated.

Refer to *TROUBLESHOOTING* for more details.

### 10) Anti-Lock Brake System (ABS) Telltale (if equipped)

When this telltale is ON, it indicates an ABS fault.

**⚠ CAUTION** Even if the brakes fully operate in the event of an ABS failure, the wheels can lock up during a sudden braking. Beware of changes in brake behavior in the event of ABS failure.

### 11) Turn Signal/Hazard Lights Telltale (if equipped)



When this telltale is blinking, it indicates the turn signals or hazard lights are in function.

**NOTE:** When the hazard lights are in function, an additional indicator lamp located below the gauge, blinks. Refer to *INDICATOR LAMPS* in *EQUIPMENT*.

## 2) Multifunction Gauge Modes

### Speedometer Mode

In this mode, the main screen shows the speed of the vehicle either in km/h or in mph.



### Tachometer (RPM) Mode

In this mode, the main screen shows the engine speed in revolutions per minute (RPM).



### Combined Mode

In this mode, the main screen shows the speed of the vehicle and the engine speed (RPM).

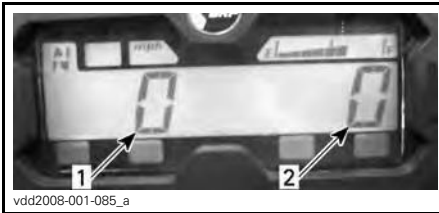

1. Vehicle speed
2. Engine RPM

### Odometer (OD)

Odometer records the total distance travelled either in miles or kilometers.



### Clock

Shows current time.



Refer to *GAUGE SETUP* to set current time.

### Trip Meter (TP)

The trip meter records the travelled distance since it has been reset. Distance travelled is displayed either in kilometers or miles.



It can be used to establish a fuel tank range or distance between 2 way points for instance.

Press and HOLD the selector button for 2 seconds to reset the trip meter.

### Trip Hour Meter (TH)

The trip hour meter records vehicle running time when the electrical system is activated. It can be used to establish traveling time between 2 way points for instance.



Press and HOLD the selector button for 2 seconds to reset the hour meter.

### Engine Hour Meter (EH)

The engine hour meter records total engine running time.



vsi2009-018-033

### Message Mode

If an abnormal engine condition occurs, a message can be combined with a pilot lamp. Refer to *TROUBLESHOOTING* for details.

### Fault Code Mode

Switch to HI beam and select engine hour meter display mode. Press and hold mode button while switching high and low beam (three cycles) to access diagnostic fault codes display.

### Speed Limit Mode

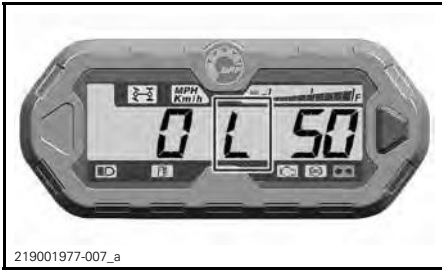

219001977-007\_a

**L FLASHING**

Switch to a maximum vehicle speed limitation mode.

Press and hold mode button.

The speed limitation increases by increments of 10 km/h (5 MPH).

The speed limit mode will remain active until it is cancelled by using the mode button, or when vehicle is stopped and key to off position.

## 3) Navigating in the LCD Gauge

### Default Display Mode

After vehicle startup, the default display mode is either:

- Vehicle speed
- Engine revolutions per minute (RPM)
- Both parameters simultaneously (combined mode).

To change from one display to the other, proceed as follows.

1. Turn ignition key to ON to power the system up.
2. Wait until the “greeting message” has been displayed.
3. Press and release selector button once to display OD (odometer).
4. Press the selector button again, this time for 2 seconds.

This will change the Mode to either Speed, RPM or Combined.



vdd2008-001-083

5. To select another mode, repeat steps 3 and 4 until the desired mode is displayed.

### Temporary Display Mode

In the temporary display mode, the following functions are available:

- Speed Limit (programmable)
- Odometer
- Clock
- Trip meter (resettable)
- Trip Hour meter (resettable)
- Engine hour meter.



Press and release selector button to change the default display mode to the temporary mode. When the selection is made, it becomes the default display.



vmr2007-050-002\_c

1. Selector button

The gauge will display the selected mode for 10 seconds then will return to the normal display mode.

While in a resettable mode, push and HOLD selector button for 2 seconds to reset it.

## 4) Gauge Setup

### Clock Setting Using Gauge Selector Button

To set current time, proceed as follows:

1. Select the clock display.

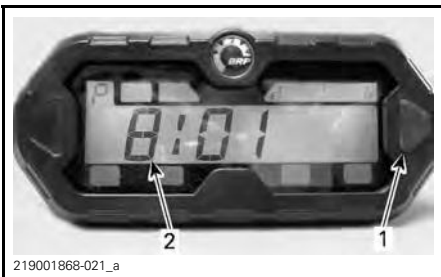

219001868-021\_a

1. Selector button  
2. Time

2. Press and HOLD selector button.

**NOTE:** The display will flash.

3. Choose the 12-hour (12H) or 24-hour (24H) format by pressing button.

4. If the 12-hour format was selected, choose Am (A) or Pm (P) by pressing button.
5. Choose hour first digit by pressing button.
6. Choose hour second digit by pressing button.
7. Choose minutes first digit by pressing button.
8. Choose minutes second digit by pressing button.

**NOTE:** The gauge will display the current time for 10 seconds then will return to the normal display mode.

### Unit Selection (km/h vs MPH)

The speedometer, odometer and trip meter are factory preset in **miles** but it is possible to change them to **kilometer** reading. Contact an authorized Can-Am dealer.

### Language Selection

The gauge display language can be changed. Refer to an authorized Can-Am dealer for language availability and setup the gauge to your preference.

## 5) Setting the Speed Limit

To set speed limit, proceed as follows:

1. Select the speed limit display.
2. Press and HOLD selector button.

**NOTE:** The display letter L will flash.



219001977-007\_a

L FLASHING

3. Increase the speed limit in increments of 10 km/h (5 MPH) by pressing button.
4. Once the desired speed limit is displayed, confirm by pressing and holding button.

**NOTE:** If no activity is detected the gauge will display the current speed limit setting for 10 seconds then will return to the normal display mode without modifications.

If the vehicle speed limitation was set while the vehicle was going at a faster speed than the speed limit setting, the speed limitation will not be in function until the vehicle is slowed down to a speed below the set limit.

**NOTE:** The display letter L and the speed limit set value will flash every time the speed limitation is exceeded. This also occurs when vehicle speed increases above set speed limit while going downhill.



**NO FLASHING**

6. To cancel the speed limit, set the speed limit to no limit.



**NO SPEED LIMIT**

**NOTE:** The speed limit can be temporarily deactivated by applying full throttle. The speed limitation will not be in function until the vehicle is slowed down to a speed below the set limit. Every time the vehicle speed is above the set speed limit, the display letter L and the speed limit set value will flash.



**L AND SPEED LIMIT FLASHING**

5. Once vehicle speed is below the set value, the speed limit will activate and the display will not flash.

## **⚠ WARNING**

When applying full throttle, a sudden power surge and acceleration will occur. Drive carefully and ensure no obstacles are in your surroundings when applying full throttle. Do not apply full throttle when entering or when negotiating a turn or when going uphill.

**NOTE:** By default, when key is set to OFF, speed limit will be deactivated.

# 4.5" DIGITAL DISPLAY

## Multifunction Display

### Lower Display

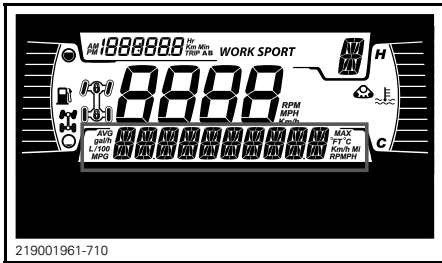

May display the following:

- RPM
- Speed
- Engine Temperature
- Battery Voltage
- Settings
- Messages

Use LOWER (MENU) button to change the displayed information.

The SPEED display shows the Maximum and the averaged speed. Hold LOWER (MENU) button for 1 second to reset.

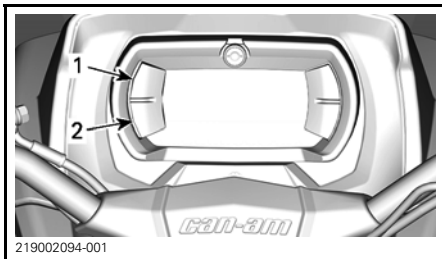

1. Upper button
2. Lower button

### Left Lateral Display

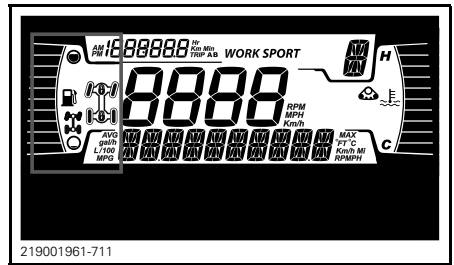

The left lateral display includes:

- Fuel level indicator
- 2X4 / 4X4 telltale



4X4 ICON FOR EUROPEAN COMMUNITY

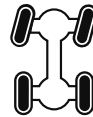

4X4 ICON FOR ALL OTHER COUNTRIES

### Right Lateral Display

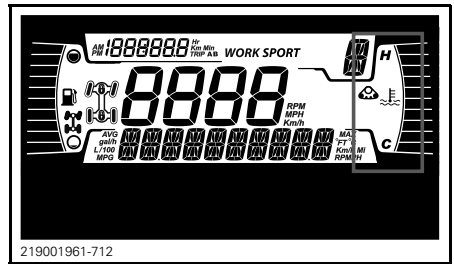

The right lateral display includes:

- Engine Temperature
- Track Kit active

When a track kit is installed, a message will scroll in the lower display.

### Central Display

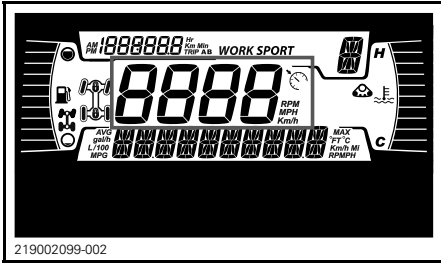

May display the following:

- Vehicle speed in Km/h or MPH
- Speed limiter (ABS models only)

Display the vehicle speed in Km/h or MPH.

### Transmission Position Display

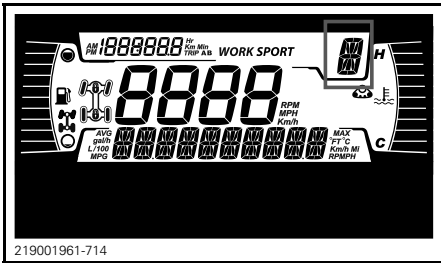

This display shows gear position of gearbox:

- P (Park)
- R (Reverse)
- N (Neutral)
- H (High Range)
- L (Low Range)
- -- (Invalid Range)

### MODE Display

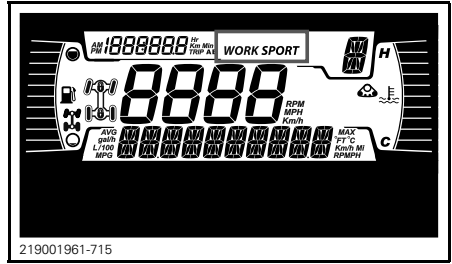

The MODE display indicates the selected mode of operation:

- SPORT
- WORK

A message of the selected mode will be displayed on the lower display at activation and deactivation as follow:

DRIVE MODE	MESSAGE AT ACTIVATION	MESSAGE AT DEACTIVATION
Sport	Sport	Sport OFF
Work	Work	Work OFF

### Trip Display

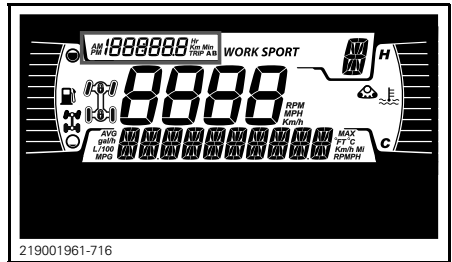

This display shows trip informations:

- Cumulative distance odometer
- Trip A
- Trip B
- Cumulative hours
- Clock

Use UPPER (TRIP) button to change the displayed information.

Hold UPPER (TRIP) button to reset Trip A/B meters.











## Warning Lamps and Indicators

The following indicator lamps will alert you to a vehicle condition that may become serious. Some lamps will illuminate when starting the vehicle to make sure they work. If any lamps remain on after starting the vehicle, refer to the respective system warning lamp for further information.

**NOTE:** Some warning indicators appear in the display of the multifunction gauge and function the same as an indicator lamp but do not display when starting the vehicle.



### Telltale Lights - Lower Bar



WARNING AND TELLTALE LIGHTS	
	RED - The engine temperature is too high.
	RED - Low battery.
	RED - Low oil pressure Normally ON when engine is OFF
	ORANGE - Low fuel level
	ORANGE - Check engine
	ORANGE - Vehicle Malfunction
	ORANGE - ABS*
	RED - (Steady ON) Low Brake Fluid
	BLUE - High Beam
	GREEN - Neutral
	GREEN - Flashers (T Category models only)

**NOTE:** \* On every vehicle key ON, the orange ABS tell-tale (ABS) and the symbol will be ON until the ABS system has found steering angle center (0 degree). During that time, you can drive the vehicle normally, however TCS mode will be unavailable if in 4WD, TCS performance will be reduced in 2WD and BTC performance will be reduced. Driving above 12 km/h in a straight line for about 2-3 seconds will be enough to clear both symbol and tell-tale at start up.

## Icons and Indicators - Multifunction Display

ICONS AND INDICATORS	
<b>SPORT</b>	Denotes SPORT mode is selected.
<b>WORK</b>	Denotes WORK mode is selected.
	Track kit active (If equipped)
	Denotes Speed limiter is selected (T Category models only)

## Settings

The buttons to navigate through menus are located on the left side of the LCD display.

### Setup

Using LOWER (MENU) button, Select **SETTINGS** and hold to enter setting menu.

### Maintenance Reset

**NOTE:** Only when the maintenance icon is displayed.

Using LOWER (MENU) button, Select **RES MAINT** and hold to reset maintenance.

### Fault Codes

**NOTE:** Only when codes are actives.

Using LOWER (MENU) button, Select **CODES** and hold to see actives and occurred fault codes. Fault codes will be scrolled on the Lower Display.

### Speed Limiter Mode

Speed limiter mode allows the operator to set the desired maximum speed.

This is useful when operating in limited speed zones.

The operator must keep the throttle depressed to maintain forward speed.

Once the maximum speed is set, the operator can vary the from stopped to the set speed using the throttle. The set speed will be exceeded when the throttle is fully depressed, at that time, the speed limiter will be temporary deactivated (the icon will be blinking) until vehicle speed is under or equal the speed limiter's set point.

As you proceed under a constant speed setting, keep your attention level up to maintain good situational awareness.

Slowing down is a matter of releasing the throttle.

### Activating Speed Limiter Mode

1. Press the Gauge Switch to go to the *SETTINGS* menu.
2. Select *SPEED LIM*, then you will have a choice of
  - 2.1 in km/h:
    - -- (Unlimited)
    - 30 km/h
    - 40 km/h
    - 50 km/h
    - 60 km/h
    - 70 km/h
    - 80 km/h
    - 90 km/h
    - 100 km/h
  - 2.2 in MPH:
    - -- (Unlimited)
    - 20 MPH
    - 25 MPH
    - 30 MPH
    - 35 MPH
    - 45 MPH
    - 50 MPH
    - 55 MPH
    - 60 MPH
    - 65 MPH

Speed limiter indicator will be lit.

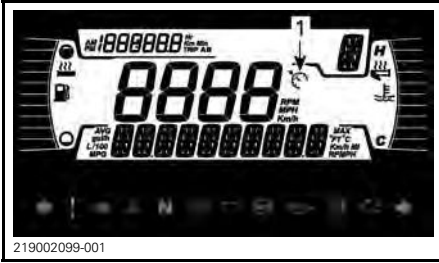
**TYPICAL****1. Speed limiter INDICATOR**

Hold menu button to confirm selected speed limit.

**NOTE:** Activating speed limiter mode of operation only limits the maximum speed available when depressing the throttle. The throttle must be held in to maintain forward speed. Speed can be varied from idle up to the set speed using the throttle once the speed limiter function is activated.

**Deactivating Speed Limiter Mode**

To deactivate speed limiter mode, in *SETTINGS*, select *SPEED LIM* and then select the -- (unlimited) limit.

**Unit Selection**

This multifunction gauge is factory preset in Imperial units but it is possible to change it to Metric units.

Using LOWER (MENU) button, Select **UNITS** and hold button to change units.

**Reset Stats**

Using LOWER (MENU) button, select **RESET STAT** and hold to reset.

**Setting Brightness**

The brightness of the LCD display can be adjusted.

Using LOWER (MENU) button, select **BRIGHTNESS** and hold button to change brightness.

Using LOWER (MENU) button, adjust brightness then push and hold LOWER (MENU) button to acknowledge selection.

**Setting Clock**

Using LOWER (MENU) button, Select **CLOCK** and hold to change units.

1. Press LOWER (MENU) button to select clock display.
2. Push and hold LOWER (MENU) button for 1 second.
3. Press LOWER (MENU) button to select 12:00 AM PM or 24:00 time base (time flash).
4. Push and hold LOWER (MENU) button to acknowledge selection.
5. Press LOWER (MENU) button to change hours (hours flash).
6. Press LOWER (MENU) to acknowledge hour selection.
7. Press LOWER (MENU) button to change minutes (minutes flash).
8. Press LOWER (MENU) button to acknowledge minutes.

**Setting Language**

The gauge display language can be changed. Refer to an authorized Can-Am dealer for language availability and to setup the gauge to your preference.

**DPS Modes (if equipped)**

The lower display can show which DPS mode is active. Refer to *TUNE YOUR RIDE*.

---

## DRIVING AID TECHNOLOGIES (IF EQUIPPED)

These systems actively manage braking and traction.

Under certain conditions, the driver may feel the actions taken by the systems in the form of reduced engine braking, vibrations or slight jerks in the handlebar, brake pedal or brake lever, which is normal.

### **ABS (Anti-lock Brake System)**

This system prevents the wheels from locking during braking, which improves the stability of the vehicle and the contact of the tires on the ground.

**Limitations:** Low tire adhesion to the surface limits the braking ability. Even with ABS, the braking distance will be longer under the conditions of low adhesion.

### **eCBS (Electronic Combined Brake System)**

This system actively manages the balance of the braking force between the front and rear axles.

### **BTC (Brake Traction Control)**

This system actively manages the traction between the front wheels during the acceleration in order to prevent them from slipping.

This system is active only on the 4WD mode.

### **DTC (Drag Torque Control)**

During deceleration, this system prevents the wheels from slipping due to the engine brake by requesting a light and limited engine torque request. When in 4WD mode, the DTC will be more noticeable eliminating most engine braking. This ensures proper ABS system operation.

## **WARNING**

Unit modification such as fitting different tire model and/or size may cause unwanted system behavior such as under or over reaction of the above system.



# III EQUIPMENT

NOTE: Some vehicle safety labels are not shown on illustrations. For information on vehicle safety labels, refer to *IMPORTANT ON-PRODUCT LABELS*.

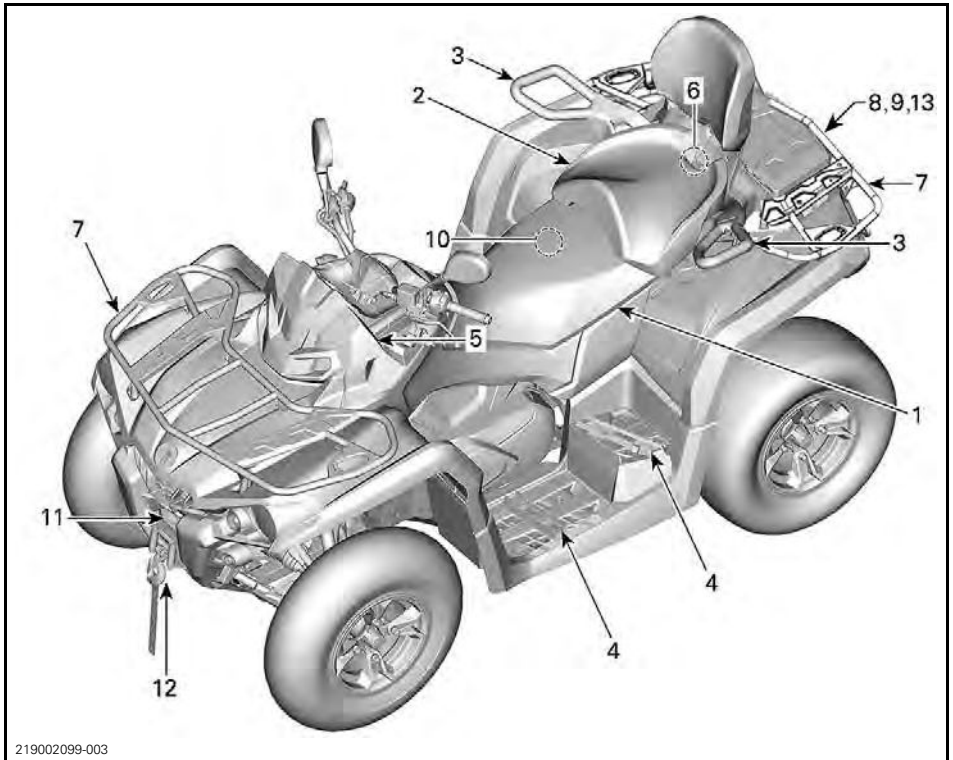

219002099-003

TYPICAL - 2-UP MODEL SHOWN

## 1) Operator's Seat

The seat is designed for an operator only.

### **WARNING**

Never allow anyone to seat as a passenger on the operator's seat.

### Seat Removal

To remove the operator's seat, push its latch upward. This latch is located underneath the rear of seat.



1. Seat latch

Pull seat upward then rearward. Continue lifting movement until you can release the front retaining device then completely remove seat.

### Seat Installation

Insert front tabs of seat ion U-rod welded to frame. When seat rests in its position, firmly push seat down to latch.

**NOTE:** A distinctive snap will be felt. Double check that the seat is secure by giving it a tug to confirm proper latching.

#### **⚠ WARNING**

Confirm that the operator's seat is properly locked in position by pulling back and up several times.

### 2) Passenger's Seat (2-UP Models)

#### **⚠ WARNING**

Never operate the vehicle without passenger's seat.

The passenger's seat is designed for a passenger only. The integrated backrest supports his back during the ride.

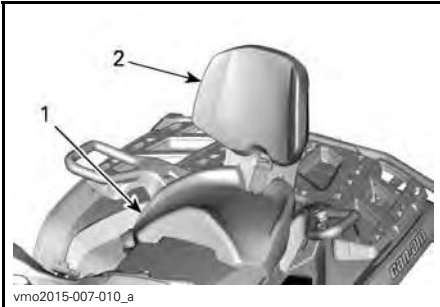

**TYPICAL**

1. Passenger's seat
2. Integrated backrest

When riding without a passenger, the passenger seat can be removed to allow the use of a storage compartment.



**TYPICAL**

1. Storage compartment

#### **⚠ WARNING**

Without its passenger's seat, the vehicle becomes a ONE RIDER vehicle (1-UP model) and NO PASSENGER is allowed on vehicle. NEVER carry passenger on storage compartment.

### Passenger's Seat Removal

1. To unlock latch, pull the passenger's seat latch lever toward the front of the seat.

While reading this Operator's Guide, remember that:

#### **⚠ WARNING**

Indicates a potential hazard that, if not avoided, could result in serious injury or death.

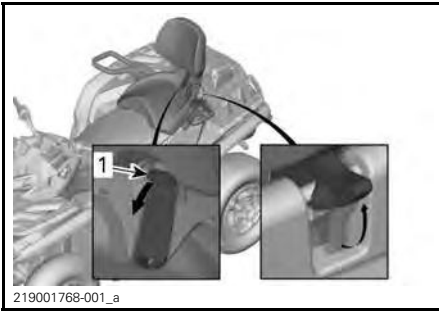

219001768-001\_a

**TYPICAL**

## 1. Lever

2. Apply downwards pressure on the back of latch lever to clear rear latch from pin and turn seat towards front using backrest.
3. While maintaining latch lever pulled towards the front, apply downward pressure on the back of latch lever to clear rear latch from pin and toggle seat towards front using backrest.
4. Pull seat rearward and up out of location to clear the front tabs.

**Passenger's Seat Installation**

1. Ensure the latch lever is in the open position by pulling it towards the front of seat.
2. Using a forward motion, insert both front tabs of the seat into the vehicle anchor housings.
3. Rotate downwards to engage the rear latch.
4. Close the latch lever by pushing it rearwards to secure seat in position.
5. Check if the seat is firmly secured in position before using it.

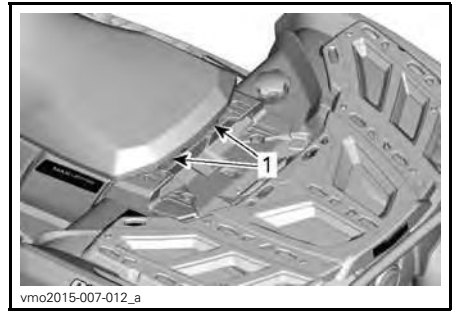

vmo2015-007-012\_a

## 1. Front pins

**⚠ WARNING**

It is of the utmost importance for the passenger's safety that you confirm that the passenger's seat is properly locked in position by pulling back and up several times.

**3) Grab Handles (2-UP Models)**

The grab handles are located on the RH and LH side of the passenger's seat.

The grab handles must be used by the passenger to hold on firmly during vehicle operation.

**⚠ WARNING**

The passenger must always hold on to the passenger grab handles, not the operator. He must also have both feet resting firmly against the footrests.

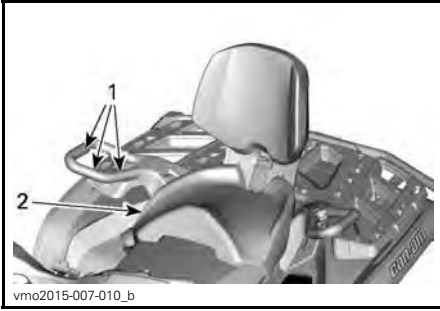

**TYPICAL**

1. Grab handles
2. Passenger's seat

### 4) Footpegs

The footpegs are located on the RH and LH footrests.



**TYPICAL**

1. Operator's LH footpeg

### **⚠ WARNING**

Operator must have both feet on footpegs at all time during vehicle operation.

### 2-UP Models

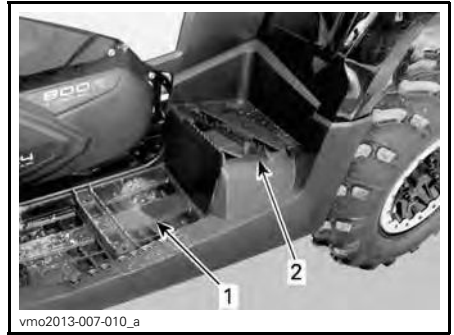

**TYPICAL**

1. Operator's LH footpeg
2. Passenger's LH footpeg

### **⚠ WARNING**

Passenger must have both feet on footpegs at all time during vehicle operation.

### 5) 12-Volt Power Outlet

Convenient for handheld spotlight or other portable equipment.



1. 12 V power outlet

Remove protective cap to use. Always reinstall it after use to protect against weather.

## 6) Rear Storage Compartment

Convenient location to carry personal articles.



fvmo2016-001-008\_a

1. Rear storage compartment cover

### **⚠ WARNING**

Always engage the PARK position on the shift lever before opening cover. Never leave any heavy or loose breakable objects in the storage area. Always latch cover before riding.

### To Open Rear Storage Compartment

Unlatch cover and gently lift cover.



vmo2015-005-009\_b

1. Rear storage compartment latch

### To Close Rear Storage Compartment

Gently lower and latch cover.

## 7) Cargo Racks

Cargo racks are convenient for carrying equipment and various other cargo. They must never be used to carry a passenger.

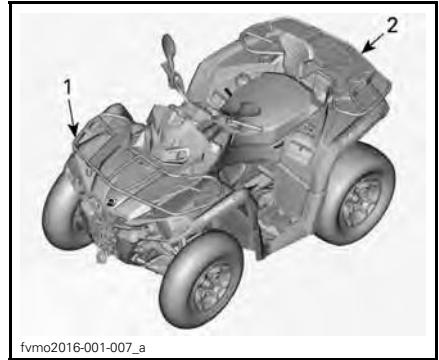

fvmo2016-001-007\_a

### TYPICAL

1. Front cargo rack
2. Rear cargo rack

### **⚠ WARNING**

- Never carry a passenger on a cargo rack.
- Cargo must never interfere with the drivers line of sight or affect his ability to properly steer the vehicle.
- Do not overload the vehicle.
- Always ensure all cargo is properly secured and does not extend out pass the racks.

Refer to *SPECIFICATIONS* for cargo racks capacity.

## 8) Trailer Hitch

Convenient trailer hitch to tow a trailer or other equipment. Install the proper ball size as per trailer manufacturer recommendations. Refer to *SPECIFICATIONS* or the safety label for tongue weight and towing capacity.

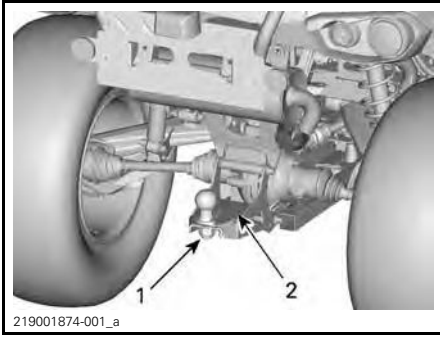

1. Trailer hitch
2. Safety label

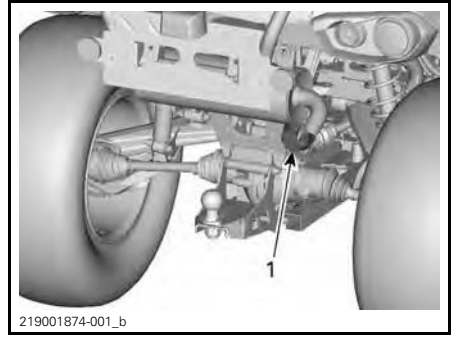

- TYPICAL**
1. Trailer connector

**⚠ WARNING**

Ensure to install the proper ball size that matches the equipment you will tow.

**NOTE:** Follow manufacturer's instructions for proper attachment.

### 9) Trailer Connector

Trailer connector to be used if trailer is equipped with lights.

For towing refer to towing instructions label located at trailer hitch.

When a trailer is connected and the turn signals or hazard lights are in function, an indicator lamp located on the handlebar cover, blinks. Refer to *INDICATOR LAMPS*.

**NOTE:** The Trailer Flasher Module is designed for trailer lights of a total of 40W. If the trailer lights have a different power, the blink frequency will be affected.

### 10) Tool Kit

The tool kit is located under the operator's seat. It contains tools for basic maintenance.

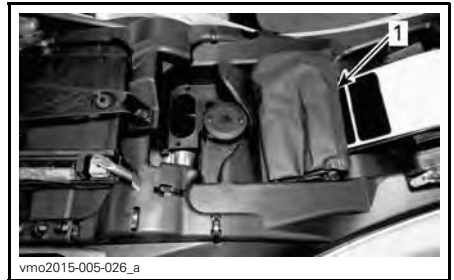

1. Tool kit

### 11) Recovery Hooks

Convenient hook that can be use to recover a stuck ATV.

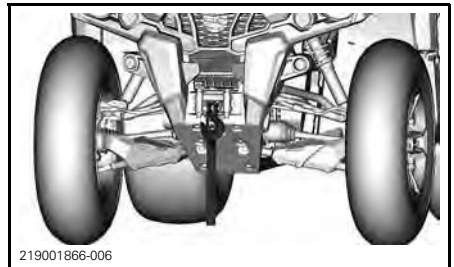

**MODELS WITH WINCH**

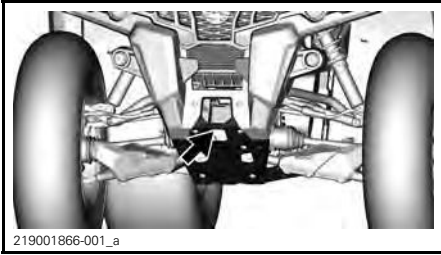

MODELS WITHOUT WINCH



TYPICAL - REAR TIE-DOWN POINT LOCATION

1. Rear tie-down point location

## 12) Winch

The winch can be actuated using the winch control switch or with the remote control (sold separately).

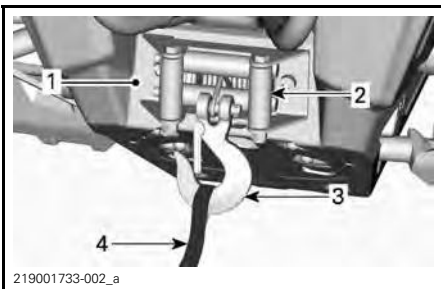

1. Winch
2. Roller fairlead
3. Winch hook
4. Hook strap

**NOTE:** Using the winch intensively over a long period of time may discharge the battery.

The following tips will help to reduce the risk of discharging the battery:

Unwind manually: Unlock the cable using the handle then pull on the hook strap to unreel.

It is recommended to let the engine run while winching or rewinding. After using the winch, let the engine run for a few minutes to help recharge the battery.

Also, when winching for more than 30 seconds, it is recommended to increase engine speed in the range of 3000 RPM to increase charging power to the battery.

**NOTE:** Make sure vehicle is in NEUTRAL (N) before increasing engine speed.

Refer to winch the *GUIDE* provided with the vehicle for more information about the winch.

### Winch Control Switch

The control switch is located on the LH side of handlebar.

To let out the cable, press the left side of switch.

To reel in the cable, press the right side of switch.

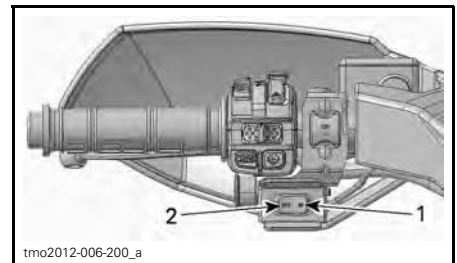

- TYPICAL
1. In
  2. Out

### 13) License Plate Light

Provides lighting for the license plate.

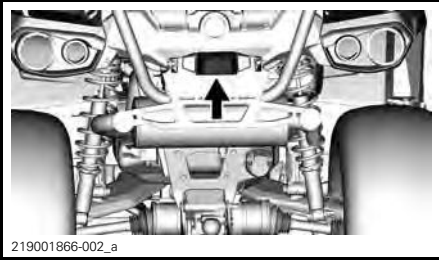



# IV FUEL

## 1) Fuel Requirements

**NOTICE** Always use fresh gasoline. Gasoline will oxidize; the result is loss of octane, volatile compounds, and the production of gum and varnish deposits which can damage the fuel system.

Alcohol fuel blending varies by country and region. Your vehicle has been designed to operate using the recommended fuels, however, be aware of the following:

- Use of fuel containing alcohol above the percentage specified by government regulations is not recommended and can result in the following problems in the fuel system components:
  - Starting and operating difficulties.
  - Deterioration of rubber or plastic parts.
  - Corrosion of metal parts.
  - Damage to internal engine parts.
- Inspect frequently for the presence of fuel leaks or other fuel system abnormalities if you suspect the presence of alcohol in gasoline exceeds the current government regulations.
- Alcohol blended fuels attract and hold moisture which may lead to fuel phase separation and can result in engine performance problems or engine damage.

### Recommended Fuel

Use regular unleaded gasoline containing MAXIMUM 10% ethanol. The gasoline must have the following minimum octane requirements.

MINIMUM OCTANE RATING	
Outside North America	92 RON

**NOTICE** Never experiment with other fuels. Engine or fuel system damages may occur with the use of an inadequate fuel.

## 2) Vehicle Fueling Procedure

**⚠ WARNING**

- Fuel is flammable and explosive under certain conditions.
- Never use an open flame to check fuel level.
- Never smoke or allow flame or spark in vicinity.
- Always work in a well-ventilated area.

1. Stop engine.

**⚠ WARNING**

Always stop engine before refueling.

2. Have operator get off vehicle.

**⚠ WARNING**

Do not allow anyone to remain on the vehicle while fueling. If there is a fire or explosion during fueling, a vehicle occupant could be unable to quickly leave the area.

3. Unscrew slowly the fuel reservoir cap counterclockwise to remove it.

**⚠ WARNING**

If a differential pressure condition is noticed (whistling sound heard when loosening fuel reservoir cap) have vehicle inspected and/or repaired before further operation.



4. Insert the spout into the filler neck.
5. Pour fuel slowly so that air can escape from the tank and prevent fuel flow back. Be careful not to spill fuel.
6. Stop filling when the fuel reaches the bottom of filler neck. **Do not overfill.**

 **WARNING**

Never top up the fuel tank before placing the vehicle in a warm area. As temperature increases, fuel expands and may overflow.

7. Fully tighten fuel reservoir cap clockwise.

 **WARNING**

Always wipe off any fuel spillage from the vehicle.

---

# V BREAK-IN PERIOD

## 1) Operation During Break-In

A break-in period of 300 km (200 mi) or 10 operating hours is required for the vehicle.

### Engine

During the break-in period:

- Avoid full throttle operation.
- Maximum throttle should not exceed 3/4.
- Avoid sustained accelerations.
- Avoid prolonged cruising speeds.
- Avoid engine overheating.

However, brief accelerations and speed variations contribute to a good break-in.

**NOTE:** It is normal that the engine will not operate at its maximum efficiency until the break-in period is completed.

### Brakes

**WARNING**

New brakes will not operate at their maximum efficiency until their break-in is completed. Use extra caution.

### Drive Belt

A new drive belt requires a break in period of 50 km (30 mi).

During the break-in period:

- Avoid strong acceleration and deceleration.
- Avoid pulling a load.
- Avoid high speed cruising.

# VI BASIC PROCEDURES

## 1) Starting the Engine

The shift lever must be set to PARK or NEUTRAL.

**NOTE:** For your convenience, an over-ride mode allows the engine to be started with the shift lever in any position. Press and hold the brake lever or the brake pedal while pressing the engine start button.

Insert key in ignition switch and turn to ON position.

Set the engine stop switch to RUN.

Press the engine start button and hold until the engine starts.

Release the engine start button immediately when the engine has started.

**NOTICE** If engine does not start after a few seconds, do not hold the engine start button more than 10 seconds. Refer to *TROUBLESHOOTING*.

## 2) Changing Gear Selection

Apply brakes and immobilize vehicle, then select the desired shift lever position.

Release brakes.

**NOTICE** When changing gear selection, always completely stop the vehicle and apply the brakes prior to moving the shift lever. Otherwise, damage to the gearbox may occur.

Gradually press the throttle lever to increase engine speed and thus engaging the continuously variable transmission (CVT).

At the opposite, when the throttle lever is released, the engine speed decreases.

## 3) Stopping the Engine and Parking the Vehicle

### WARNING

Avoid parking on steep slope as the vehicle may roll away.

### WARNING

Always put the vehicle in PARK when stopped or parked to prevent rolling.

### WARNING

Avoid parking in places where hot parts can start a fire.

When stopped or parked always bring shift lever to park position. This is especially important when parking on a slope. On very steep inclines or if the vehicle is carrying a cargo, the wheels should be blocked using rocks or bricks.

Select the flattest terrain available for parking.

Release throttle and use brakes to completely stop the vehicle.

Set shift lever in PARK position.

Turn key in ignition switch to OFF position.

Remove key from ignition switch.

If you must park on a steep incline or if the vehicle is carrying cargo, block the wheels using rocks or bricks.

# VII SPECIAL PROCEDURES

## 1) What to Do if Water Entered the CVT

The CVT drain plug is located on the CVT cover. It is accessible from the rear LH fender.

### 450 Models

Remove the CVT drain plug to validate if water is present.

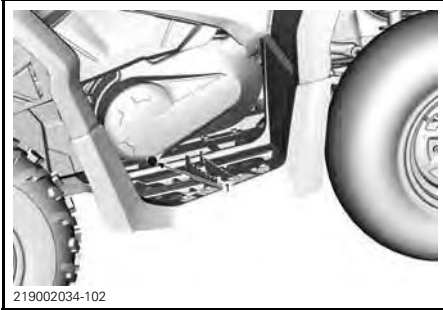

### 450 MODELS

1. CVT drain plug

Inspect the CVT drain plug to validate if water is present.

If water is present, remove CVT drain plug to expel water.

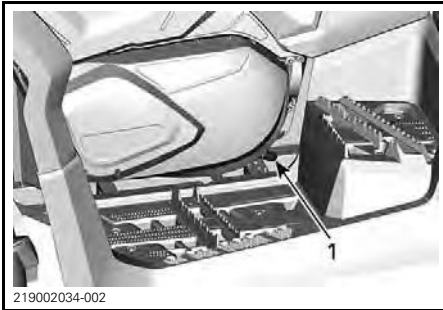

### 570 MODELS

1. CVT drain plug

### All Models

**NOTICE** If water is present in the CVT, it could result in belt slippage. The engine will accelerate but the vehicle will remain still.

Reinstall the drain plug and secure it using the spring clamp.

**NOTE:** Make sure hose is properly inserted on CVT cover nipple.

**NOTICE** See an authorized Can-Am dealer to have the CVT inspected and cleaned.

## 2) What to Do if Water Entered the Air Filter Housing

Remove the LH side panel.

Check if there is water in the translucent drain plug (underneath the air filter housing).

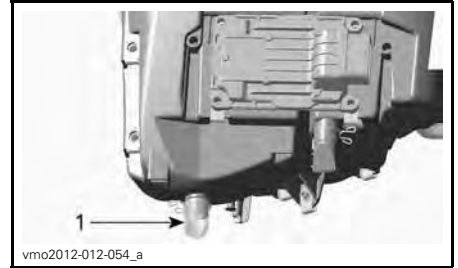

### TYPICAL - AIR FILTER HOUSING

1. Drain plug

If water is present, press clamp and remove the drain plug water from air filter housing.

If one of the following conditions is met, bring the vehicle to your nearest authorized Can-Am dealer to have the vehicle serviced:

- If more than 50 ml (2 U.S. oz) of water (approximately 5 drain reservoirs) is found in the air filter housing.
- If any deposits are present in the drain reservoir.

In such a case, the vehicle must be serviced for:

- Vents
- CVT cleaning

- Fuel tank breather replacement
- Lubricant inspection and replacement as required (engine, gearbox and rear final drive).

**NOTICE** Failure to have vehicle serviced may lead to permanent damage to the following components but not limited to:

- Engine and gearbox
- Fuel pump
- CVT
- Front differential
- Rear final drive.

### 3) What to Do if Vehicle is Turned Over

When vehicle is turned over or stays tilted on the side, put the vehicle back on its wheel. Inspect vehicle for damages.

#### **WARNING**

Never operate the vehicle if damaged. Refer to an authorized Can-Am dealer.

If vehicle has no damage, refer to *MAINTENANCE PROCEDURES* and inspect the following.

- Inspect air filter housing for oil accumulation, if any oil is found, clean air filter and air filter housing.
- Check engine oil level and refill if necessary.
- Check engine coolant level and refill if necessary.
- Check gearbox oil level and refill if necessary.
- Check rear final drive oil level and refill if necessary.
- Start engine. If the oil pressure light stays on, stop engine immediately. See an authorized Can-Am dealer.

Whenever the vehicle is turned over, it should be inspected by an authorized Can-Am dealer.

### 4) What to Do if Vehicle is Immersed in Water

Should the vehicle become immersed, immediately stop the engine. Do not use:

- Any electrical equipments
- Winch (if equipped)

It will be necessary to take the vehicle to an authorized Can-Am dealer as soon as possible. **NEVER ATTEMPT TO START THE ENGINE!**

**NOTICE** Immersion of the vehicle can cause serious damage if the correct restart procedure is not followed.

As soon as vehicle is pulled out of water, carry out the following:

- Drain CVT. See procedure in *WHAT TO DO IF WATER ENTERED THE CVT*.
- Drain air filter housing. Refer to *WHAT TO DO IF WATER ENTERED THE AIR FILTER HOUSING* in this section.

**NOTICE** The vehicle should be serviced as soon as possible by an authorized Can-Am dealer.

## VIII TUNE YOUR RIDE

### **⚠ WARNING**

Suspension adjustment could affect vehicle handling. Always take time to familiarize yourself with the vehicle's behavior after any suspension adjustment have been made.

Following are guidelines to fine-tune suspension. Use suspension adjustment tool provided in the tool kit.

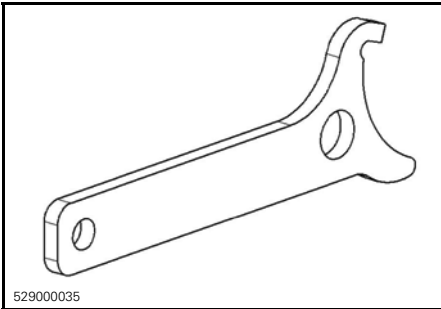

SUSPENSION ADJUSTMENT TOOL

### 1) Suspension Adjustment

Suspension adjustment and loading can have an effect on your vehicle handling and comfort.

Choice of suspension adjustments vary with driver's weight, personal preference, riding speed and field condition.

#### Spring Preload Adjustment

### **⚠ WARNING**

The left and right shock adjustment on front or rear suspension must always be set to the same position. Never adjust one only. Uneven adjustment can cause poor handling and loss of stability, which could lead to an accident.

Shorten the springs for a firmer ride and rough conditions.

Lengthen the springs for a softer ride and smooth conditions.

Adjust spring preload by turning adjustment cam. Use tool from vehicle tool kit.

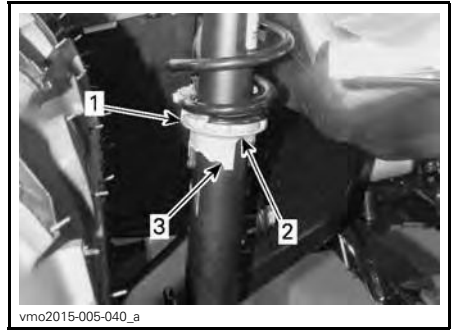

1. Adjustment cam
2. Softer adjustment
3. Firmer adjustment

### 2) Dynamic Power Steering (DPS) Assist Level Adjustment

The Tri-Mode Dynamic Power Steering (DPS) offers easy steering assistance to the rider. The level of assistance will automatically adapt according to the vehicle's speed and rider's demand, in order to provide maximum steering power at lower speed where the demand is normally higher. As speed increases, the assistance is progressively reduced to keep maximum steering feel and precision to the rider.

It is possible to choose between three modes of assistance: Minimum, Medium and Maximum. Each mode will continue to automatically adapt to the vehicle's speed and rider's demand, so it does not require to be changed when riding. These modes are used to set the level of assistance to match each rider's preferences.

The following DPS modes are preset in the vehicle.

DPS MODE	
DPS MAX.	Maximum steering assist
DPS MED.	Medium steering assist
DPS MIN.	Minimum steering assist

**NOTE:** The DPS adjustment will not be possible if the vehicle transmission is in REVERSE.

To show the active DPS mode, proceed as follows:

1. Press and release Override/DPS button.



2. Check the multifunction gauge to confirm the active DPS mode.

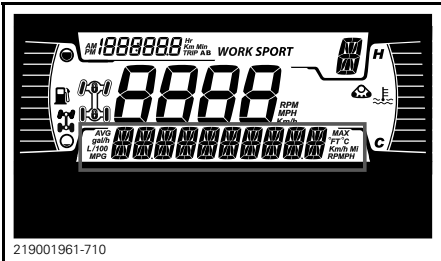

To change the DPS mode, proceed as follows:

1. Press and hold Override/DPS button for 2 seconds to go to the next setting.
2. Release Override/DPS button.
3. Repeat until desired setting is selected.



# IX TRANSPORTING THE VEHICLE

When contacting a towing or transporting service, be sure to ask if they have a flatbed trailer, loading ramp or power ramp to safely lift the vehicle and tie-down straps. Ensure the vehicle is properly transported as specified in this section.

**NOTICE** Do not tow this vehicle — towing can seriously damage the vehicle's drive system.

**NOTICE** Avoid using chains to tie the vehicle — they may damage the surface finish or plastic components.

**⚠ WARNING**  
 Make sure no loose objects are present inside vehicle during vehicle transportation.

**⚠ WARNING**  
 Always transport the vehicle facing forward to avoid damaging the windshield or other components. Parts may detach during transport.

**⚠ WARNING**  
 Before attempting to mount vehicle onto a platform or a trailer, make sure to respect the following safety precautions.

SAFETY PRECAUTIONS	
Carrying equipment	The carrying item (platform or trailer or flat bed) must be of appropriate dimensions and capacity to safely support and transport the vehicle.
Hauling vehicle	Do not exceed vehicle hauling capacity and specifications. Ensure the trailer or platform is properly secured to the hauling vehicle hitch.

SAFETY PRECAUTIONS	
Visibility	Ensure you have a good visibility during the entire maneuver.
Terrain	The hauling vehicle and trailer must be on a leveled surface. Use wheel chocks on trailer and hauling vehicle to avoid any movement.
Ramps	Use ramps with proper rating and secure ramps to the trailer or platform. Avoid steep ramps.
Bystanders	Always make sure bystanders are not close to the vehicle or the trailering equipment while climbing up.

## Using vehicle power to climb onto trailering equipment

*When vehicle can climb on its own power, proceed as follows;*

- Wear protective gear.
- Use low gear only (if equipped).
- If vehicle has 4wd (or 6wd) option, use it.
- When driving remain seated at all times.

Ensure proper alignment on rails or platform.

1. Start from a sufficient distance from the trailer to align the vehicle in a straight line with the ramps. Never attempt to turn while getting closer to the ramp. Rear wheels might not be aligned once you get to the ramp and vehicle may fall off.
2. Slowly climb the front wheels onto the ramp to verify alignment.

3. Back off the vehicle, verify ramps are still secure, then proceed at proper speed.
4. Carefully drive vehicle onto platform or trailer. Use sufficient speed to climb without spinning or abruptly accelerating. Avoid acceleration while on ramps to prevent ramps movement.
5. If trailer is inclined towards front, simply let vehicle roll in without acceleration.
6. Once vehicle is climbed, put shift lever to Park. Apply parking brake.

*When vehicle cannot move on its own power, or in case overshooting is a risk or if any dangerous condition prevents for embarking on its own power, proceed using a winch;*

### Using a winch to pull vehicle onto trailering equipment

*When vehicle cannot climb on its own power, proceed as follows;*

#### **⚠ WARNING**

Have the help of an assistant. One person should be in vehicle to have access to vehicle steering, brakes and winch switch, while the other person controls the environment and safety of the maneuver.

#### **⚠ WARNING**

Ensure the winch hook can be safely attached to a proper anchoring point. Use proper rigging.

**NOTE:** If vehicle can be started safely, let engine idle during winching to avoid draining the battery.

1. Place shift lever to NEUTRAL (N).
2. If the vehicle is equipped with a winch, use the winch to roll the vehicle on the platform.

3. If the vehicle is not equipped with a winch, proceed as follows:
  - 3.1 Attach strap to lower front bumper anchor.
  - 3.2 Attach the strap to the winch cable of the towing vehicle.
  - 3.3 Pull the vehicle on the flatbed trailer with the winch.
4. Put shift lever to Park. Apply parking brake.

### Securing vehicle for transport

When transporting this vehicle, secure it to a trailer or in pickup box with suitable tie-downs. Use of ordinary ropes is not recommended.

#### **⚠ WARNING**

Do not tow this vehicle behind a car or other vehicle. Use a trailer. Never tip this vehicle on end for transporting. The vehicle must be in its normal operating position (on all wheels).

Remember to:

- Unload vehicle racks before transportation.
- Set shift lever to PARK position.
- Set the parking brake.
- Secure the vehicle by the front and rear tie-down points.

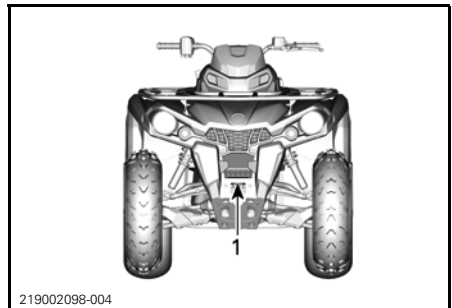

**TYPICAL**  
1. Front tie-down point location

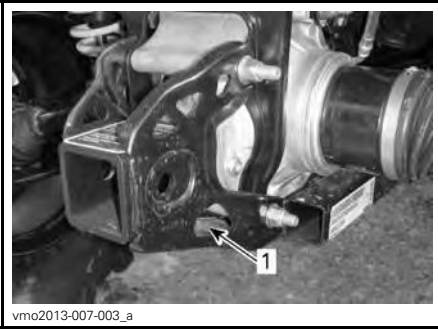

vmo2013-007-003\_a

**TYPICAL**

1. Rear tie-down point location

**NOTICE** Securing vehicle at other locations may damage the vehicle.

## Getting vehicle out of trailer

### **⚠ WARNING**

Vehicle may have moved during transport. Ensure vehicle is properly aligned with ramps before proceeding.

### **⚠ WARNING**

Visibility will be greatly reduced when backing off from the trailer. Have the help of an assistant to ensure proper alignment and safe environment.

# INSTRUCTIONS FOR VEHICLE LIFTING

## General Safety Information for Lifting

1. Engage the 4WD mode.

**NOTE:** 4WD mode is engaged when engine is running and vehicle has moved about one meter.

2. Place the shift lever in PARK.

**NOTE:** Make sure the gearbox is engaged in PARK.

3. Lock the brakes.

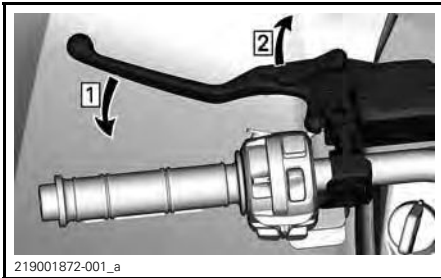

Step 1: Apply brakes  
Step 2: Lock brakes

The following label will be near the lifting points.

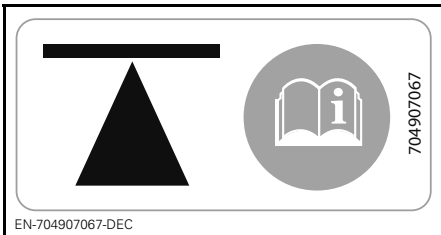

ON SIDE OF CHASSIS - FRONT AND REAR

Lift the vehicle using a suitable lifting device.

## ⚠ WARNING

Ensure all wheels are locked before lifting the vehicle. Do not exceed the lifting device capacity. Use only a device approved for lifting this type of vehicle. Do not move the vehicle using a lifting device. Refer to the manufacturer warnings and instructions prior to use.

## Lifting the Front of the Vehicle



TYPICAL — FRONT LIFTING POINT

## Lifting the Rear of the Vehicle



TYPICAL — REAR LIFTING POINT

## Lifting the Entire Vehicle

1. Use a suitable lifting device and lift the front of the vehicle.
2. Secure the vehicle laterally using jack stands on the stabilization points.

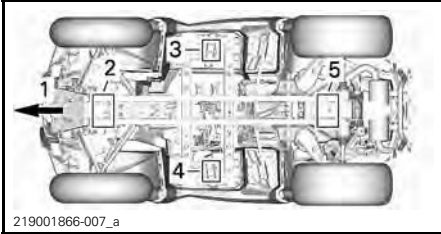

1. *Front of vehicle*
  2. *Front lifting point*
  3. *LH stabilization point*
  4. *RH stabilization point*
  5. *Rear lifting point*
3. Lift the rear of the vehicle.
  4. Adjust the height of the jack stands.

### **WARNING**

Never lift the front AND rear of the vehicle without securing the stabilization points. Never lift the vehicle only by the stabilization points.

***This page is  
intentionally blank***

# ***C) MAINTENANCE***

---

# I MAINTENANCE SCHEDULE

Maintenance is very important for keeping your vehicle in safe operating condition. The maintenance schedule does not exempt the pre-ride inspection.

## WARNING

Failure to properly maintain the vehicle according to the maintenance schedule and procedures can make it unsafe to operate.

### *EPA Regulation - Canadian and USA Vehicles*

A repair shop or person of the owner's choosing may maintain, replace, or repair emission control devices and systems. These instructions do not require components or service by BRP or authorized Can-Am Off-Road dealers.

Although an authorized Can-Am Off-Road dealer has an in-depth technical knowledge and tools to service your vehicle, the emission-related warranty is not conditioned on the use of an authorized Can-Am Off-Road dealer or any other establishment with which BRP has a commercial relationship.

Proper maintenance is the owner's responsibility. A warranty claim may be denied if, among other things, the owner or operator caused the problem through improper maintenance or use.

For emission-related warranty claims, BRP is limiting the diagnosis and repair of emission-related parts to the authorized Can-Am Off-Road dealers. For more information, please refer to the *US EPA EMISSION-RELATED WARRANTY* contained in the *WARRANTY* section.

You must follow the instructions for fuel requirements in the fueling section of this manual. Even if gasoline containing greater than ten volume percent ethanol is readily available, the US EPA issued a prohibition against the use of gasoline containing greater than 10 vol% ethanol that applies to this vehicle. The use of gasoline containing greater than 10 vol% ethanol with this engine may harm the emission control system.

## 1) SEVERE DUSTY CONDITIONS

### **Engine Air Filter Maintenance Guideline**

Air filter maintenance should be adjusted according to riding conditions.

Air filter maintenance must be increased in frequency in the following dusty conditions:

- Riding on dry sand
- Riding on dry dirt covered surfaces
- Riding on dry gravel roads or similar conditions.

**NOTE:** Riding in a group in these conditions would increase even more the air filter maintenance.

## 2) MAINTENANCE SCHEDULE LEGEND

Operation in trail riding conditions

Operation in severe riding conditions (dusty or muddy) or carrying heavy loads condition



### 3) MAINTENANCE SCHEDULE

Make sure to perform proper maintenance at recommended intervals as indicated in the tables. Some items of the maintenance schedule must be performed in function of the calendar, regardless of the distance or time of operation.

<b>EVERY 1 500 KM (1,000 MI) OR 50 HOURS (whichever comes first)</b>
<b>EVERY 750 KM (500 MI) OR 25 HOURS (whichever comes first)</b>
Verify and clean engine air filter. Replace as needed
Verify battery connections
Lubricate rear propeller shaft joint
Inspect tie rod ends and ball joints for play and boots condition
Lubricate front suspension arm bushings
Lubricate rear stabilizer bar bushings
Inspect the drive shaft boots and protectors
Inspect brake pads. Replace as needed
Inspect wheel bearings for abnormal play
Inspect and clean CVT air filter. Replace as needed. (If equipped)
<b>EVERY 3 000 KM (2,000 MI) OR 100 HOURS (whichever comes first)</b>
<b>EVERY 1 500 KM (1,000 MI) OR 50 HOURS (whichever comes first)</b>
Adjust valve clearance
Clean muffler spark arrester
Verify and clean throttle body
Replace fuel vent breather filter
Verify CVT drive belt and clean CVT pulleys
Lubricate the one way bearing of the drive pulley
<b>The following must be performed at least once a year:</b>
Change engine oil and filter
Inspect and clean brake system
Inspect battery condition
Verify steering system for abnormal play
Verify front differential and rear final drive oil level and look for contamination
Verify gearbox oil level and look for contamination (570)

**PERFORM AT THE FIRST 3 000 KM (2,000 MI) AND AT 6 000 KM (4,000 MI)  
THEN FOLLOW THE REGULAR SCHEDULE**

**PERFORM AT THE FIRST 1 500 KM (1,000 MI) AND AT 3 000 KM (2,000 MI)  
THEN FOLLOW THE REGULAR SCHEDULE**

Replace gearbox oil (570)

Clean the vehicle speed sensor (VSS) (570)

**EVERY 6 000 KM (4,000 MI) OR 200 HOURS (whichever comes first)**

**EVERY 3 000 KM (2,000 MI) OR 100 HOURS (whichever comes first)**

Verify the cooling system

Test engine coolant strength

Verify fuel system for leaks

Verify fuel pump pressure

Replace spark plugs

Replace front differential oil

Replace rear final drive oil

Replace gearbox oil (570)

Inspect input and output shaft seals (gearbox, differential and final drive)

Clean vehicle speed sensor

Clean and lubricate lower and upper steering column half bushings

**The following must be performed every 2 years:**

Replace the brake fluid

**EVERY 12 000 KM (8,000 MI) OR 5 YEARS (whichever comes first)**

**EVERY 6 000 KM (4,000 MI) OR 5 YEARS (whichever comes first)**

Replace engine coolant

# II MAINTENANCE PROCEDURES

This section includes instructions for basic maintenance procedures. If you have the necessary mechanical skills and the required tools, you can perform these procedures. If not, see your authorized Can-Am dealer.

Other important items in the maintenance schedule that are more difficult and require in-depth technical knowledge or special tools are best performed by your authorized Can-Am dealer.

## **⚠ WARNING**

Unless otherwise indicated, always turn ignition switch to OFF position and remove key before performing any maintenance.

## **⚠ WARNING**

Should removal of a locking device be required (e.g. lock tab, self-locking fastener, etc.), always replace it with a new one.

## 1) Air Filter

### Air Filter Maintenance Guideline

As with any ATV, air filter maintenance is critical to ensure proper engine performance and life span.

Air filter maintenance should be adjusted according to riding conditions.

Air filter maintenance must be increased in frequency and oil must be added to the foam filter for the following dusty conditions:

- Riding on dry sand.
- Riding on dry dirt covered surfaces.
- Riding on dry gravel trails or similar conditions.

**NOTE:** Riding in a group in these conditions would increase even more the air filter maintenance. Refer to *AIR FILTER CLEANING AND OILING* in this section for maintenance procedure.

**NOTE:** An accessory pre-filter for "dusty conditions" may be used. Contact an authorized Can-Am dealer for details.

### Air Filter Removal

**NOTICE** Never remove or modify any component in the air filter housing. Otherwise, engine performance degradation or damage can occur. The engine is calibrated to operate specifically with these components.

Remove seat.

Lift rear portion of console upwards until the studs are released from the grommets.

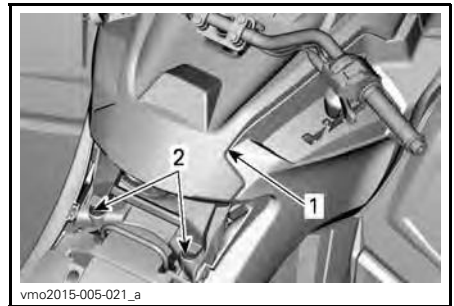

#### TYPICAL

1. Console
2. Studs and grommets

Pull console rearwards.

Rotate air filter cover counterclockwise to remove.

**NOTE:** A socket wrench may be used to ease removal.

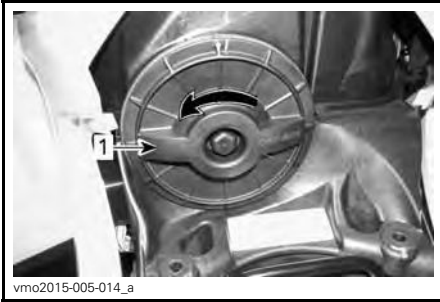

1. Air filter cover

Remove air filter.



#### AIR FILTER REMOVAL

### Engine Air Filter Housing Inspection and Draining

1. Remove LH side panel.
2. Drain air filter housing inlet drain tube.

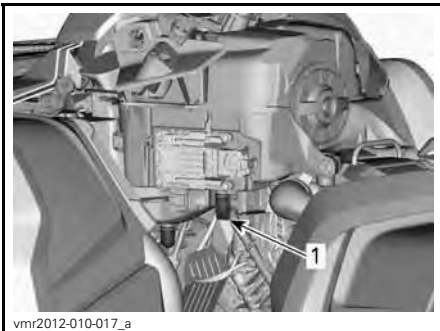

TYPICAL - SOME PARTS REMOVED FOR CLARITY

1. Air filter housing inlet drain tube

3. Check air filter dirty chamber for cleanliness.
  - If any debris or water are found, clean air filter chamber using a vacuum cleaner.

**NOTICE** Do not blow compressed air into air filter chamber.

4. Check air filter drain tube (clean chamber).
  - If any debris or water are found, refer to *SPECIAL PROCEDURES*.
  - Investigate for contamination source.

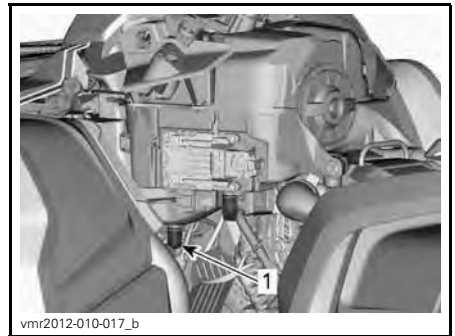

TYPICAL - SOME PARTS REMOVED FOR CLARITY

1. Air filter drain tube

### Air Filter Cleaning and Oiling

**CAUTION** Always wear appropriate skin and eye protection. Chemicals can cause a skin rash and eye injury.

#### Paper Filter Cleaning

1. Ensure that the foam filter is removed from paper filter.
2. Tap out heavy dust from the paper filter.

This will allow dirt and dust to get out of the paper filter.

**NOTE:** Paper filter have a limited life span; replace filter if too dirty or clogged.

**NOTICE** It is not recommended to blow compressed air on the paper filter; this could damage the paper fibers and reduce its filtration ability when used in dusty environments.

**NOTICE** Do not wash the paper filter with any cleaning solution.

**Foam Filter Cleaning**

1. Spray the foam filter inside and out with a good air filter cleaner and follow manufacturer's instructions.



vbs2009-012-015\_a

TYPICAL - SPRAY THE FOAM FILTER

2. Dry the foam filter completely.

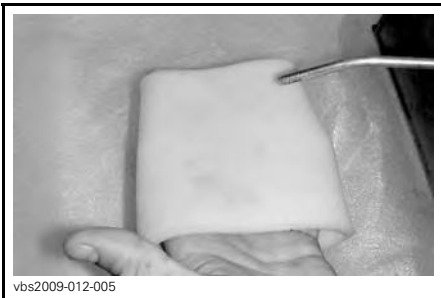

vbs2009-012-005

TYPICAL - DRY

**NOTE:** A second application may be necessary for heavily soiled elements.

**Foam Filter Oiling**

1. Make sure filter is clean. Refer to *FOAM FILTER CLEANING*.
2. Spray air filter oil on the foam filter previously dried.

SERVICE PRODUCT	
AIR FILTER OIL (P/N 219 700 340)	



vbs2009-012-014

TYPICAL - OIL THE FOAM FILTER

3. Let stand for 3 to 5 minutes.
4. Remove any excess of oil that could transfer to the paper filter by wrapping the foam filter into an absorbent cloth and squeezing gently. This will also ensure a full oil coverage on foam filter.
5. Reinstall the foam filter over the paper filter.

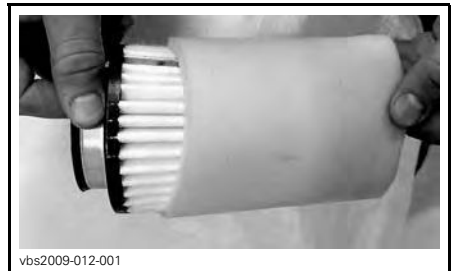

vbs2009-012-001

TYPICAL

**Air Filter Installation**

Slightly grease O-ring seal and plastic body of air filter.

Install air filter as the reverse of removal.

Ensure air filter cover is properly locked onto the air filter housing. See indications on filter cover and housing.

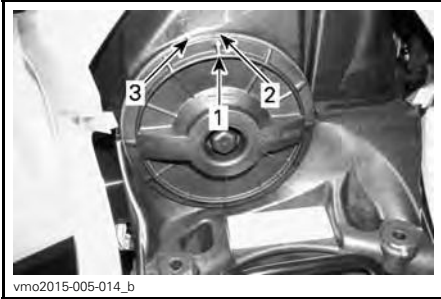

1. Cover position arrow
2. Locked
3. Unlocked

Install console as the reverse of removal. However, pay attention to the following.

Align console front tabs with slots, then push console forward.

Then align and insert studs with grommets on rear portion of console until studs engage with grommets.

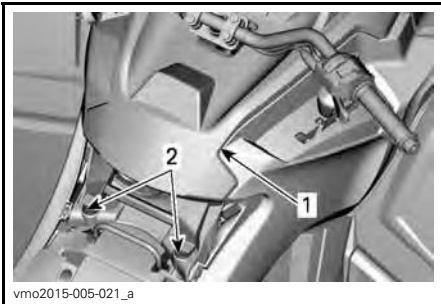

**TYPICAL**

1. Console
2. Studs and grommets

## 2) Engine Oil

### Engine Oil Level

**NOTICE** Check level frequently and refill if necessary. **Do not overfill.** Operating the engine/gearbox with an improper level may severely damage engine/gearbox. Wipe off any spillage.

**NOTE:** While checking the oil level, visually inspect engine area for leaks.

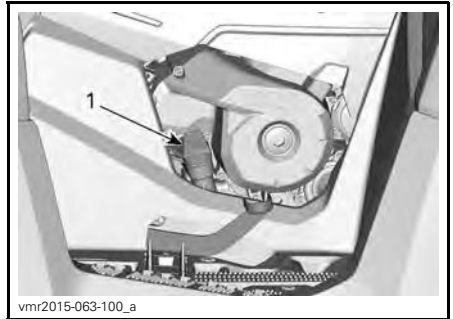

**RH SIDE OF ENGINE**

1. Dipstick

**NOTE:** Do not lose the O-ring placed on the dipstick.

With vehicle on a level surface and engine cold, not running, check the oil level as follows:

1. Unscrew dipstick then remove it and wipe clean.
2. Reinstall dipstick, screw in it completely.
3. Remove and check oil level. It should be near or equal to the upper mark.

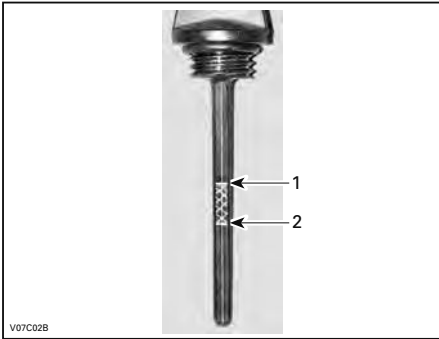

**TYPICAL**

1. Full
2. Add

To add oil, remove dipstick. Place a funnel into the dipstick tube to avoid spillage.

Add a small amount of recommended oil and recheck oil level.

Repeat the above procedures until oil level reaches the dipstick's upper mark. **Do not overfill.**

Properly tighten dipstick.

**Recommended Engine Oil**

Rotax® engines were developed and validated using the XPS™ oil. BRP recommends the use of its XPS engine oil or an equivalent at all time. Damages caused by the use of an oil not suitable for the engine may not be covered by the BRP Limited Warranty.

XPS RECOMMENDED ENGINE OIL	
General purpose	<p><b>Scandinavia:</b> 4T 5W40 SYNTHETIC BLEND OIL (EUR) (P/N 779290)</p> <p><b>Other Countries:</b> 4T 5W40 SYNTHETIC BLEND OIL (P/N 779133)</p>
Cold temperature	<p><b>Scandinavia:</b> 4T 0W40 SYNTHETIC OIL (EUR) (P/N 779286)</p> <p><b>Other Countries:</b> 4T 0W40 SYNTHETIC OIL (P/N 779139)</p>
Warm temperature	<p><b>Scandinavia:</b> 4T 10W50 SYNTHETIC OIL (EUR) (P/N 779240)</p> <p><b>Other Countries:</b> 4T 10W50 SYNTHETIC OIL (P/N 779234)</p>
IF THE RECOMMENDED XPS ENGINE OIL IS NOT AVAILABLE	
<p>Use a 4-stroke SAE engine oil meeting or exceeding the following lubricant industry specifications. Always check the API service label certification on the oil container, it must contain at least one of the indicated standards.</p> <ul style="list-style-type: none"> <li>– API service classification SJ, SL, SM or SN</li> </ul>	

**NOTICE** Damages caused by the use of oil not suitable for this engine may not be covered by the BRP limited warranty.

## Engine Oil Change

**CAUTION** The engine oil can be very hot. Wait until engine oil is warm.

**NOTICE** Engine oil and oil filter must be replaced at the same time.

Bring engine to its normal operating temperature.

Ensure vehicle is on a level surface.

Remove dipstick.

Clean the oil drain plug area.

Place a drain pan under the oil drain plug area.

Unscrew oil drain plug.

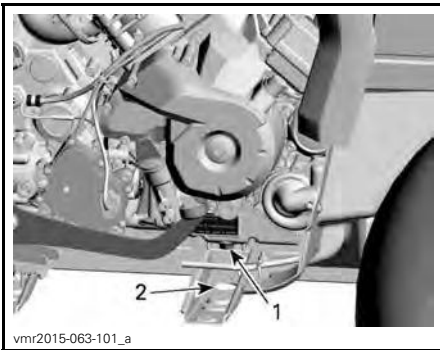

**TYPICAL - SOME PARTS REMOVED FOR CLARITY**

1. Drain plug
2. Access through frame

Allow enough time for oil to flow out of oil filter.

Replace the oil filter. Refer to *OIL FILTER* in this section.

Change gasket on oil drain plug.

Clean gasket area on engine and oil drain plug then reinstall plug.

Refill engine at the proper level with the recommended oil.

Refer to *SPECIFICATIONS* for oil capacity.

Start engine and let idle for a few minutes.

Ensure oil filter area and oil drain plug areas are not leaking.

Stop engine.

Wait a while to allow oil to flow down to crankcase then check oil level.

Refill as necessary.

Dispose of oil as per your local environmental regulations.

## 3) Oil Filter

### Oil Filter Removal

To reach oil filter, remove the following parts:

- Seat
- Console
- RH side panel and extension(s)
- RH footrest panel.

1. Clean oil filter area.
2. Remove oil filter cover.
3. Remove oil filter.

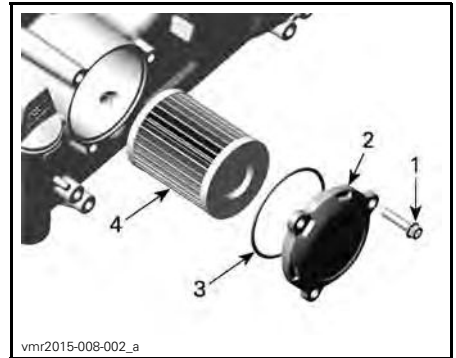

1. Oil filter screw
2. Oil filter cover
3. O-ring
4. Oil filter

### Oil Filter Installation

1. Check and clean the oil filter inlet and outlet area of dirt and other contaminations.



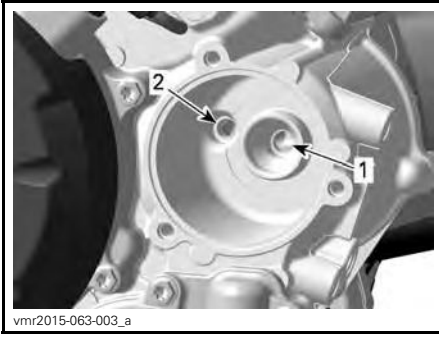

1. Inlet bore from the oil pump to the oil filter
2. Outlet bore to the engine oil providing system

2. Install a **NEW** O-ring on oil filter cover.
3. Install the new filter into the cover.
4. Apply engine oil on O-ring and on end of filter.

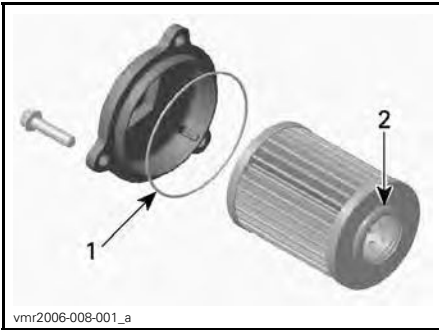

1. O-ring - slightly oil
2. End of filter - slightly oil

**NOTICE** Pay attention to avoid pinching the O-ring during filter and cover installation.

5. Install the cover on the engine.
6. Tighten oil filter cover screws to recommended specification.

TIGHTENING TORQUE	
Oil filter cover screws	10 N•m ± 1 N•m (89 lbf•in ± 9 lbf•in)

7. Wipe off any oil spillage on engine.

8. Reinstall remaining parts if applicable.

## 4) Radiator

### Radiator Inspection

Periodically check the radiator area for cleanliness.



TYPICAL - PARTS REMOVED FOR CLARITY

Inspect radiator and hoses for leaks or any damage.

Inspect radiating fins. They must be clean, free of mud, dirt, leaves and any other deposit that would prevent the radiator to cool properly.

Remove as much deposits as you can with your hands. If water is available in proximity, try rinsing the radiating fins.

If available, use a garden hose to rinse the radiating fins.

**CAUTION** Never clean radiator with your hands when it is hot. Let the radiator cool down before cleaning.

**NOTICE** Be careful not to damage the radiating fins when cleaning. Do not use any object/tool that could damage the fins. The fins are purposely thin parts to allow efficient cooling. **WHEN RINSING, USE LOW PRESSURE ONLY, NEVER USE A HIGH PRESSURE WASHER.**

See an authorized Can-Am dealer to check the performance of the cooling system.

## 5) Engine Coolant

### Engine Coolant Level Verification

#### **⚠ WARNING**

Check coolant level with engine cold. Never add coolant in cooling system when engine is hot.

Place vehicle on a level surface.  
Remove the gauge support.

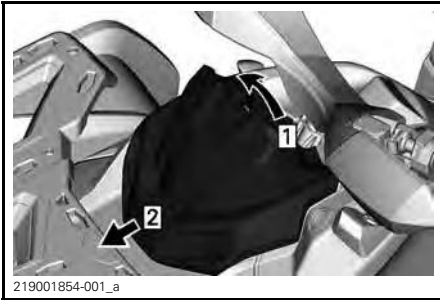

#### TYPICAL

Step 1: Pull up  
Step 2: Slide

Remove the coolant reservoir cap.

#### **⚠ WARNING**

Warning: Do not remove the coolant reservoir cap if engine is hot.

With vehicle on a level surface, liquid should be between MIN. and MAX. level marks of coolant reservoir.



1. Engine coolant reservoir

**NOTE:** When checking level at temperature lower than 20°C (68°F), it may be slightly lower than MIN. mark.

Add coolant if required.

Use a funnel to avoid spillage. **Do not overflow.**

Properly reinstall and tighten reservoir cap.

Reinstall gauge support.

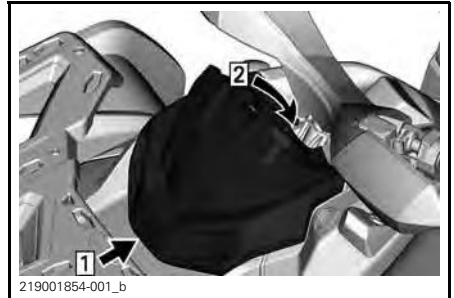

#### TYPICAL

Step 1: Hook  
Step 2: Engage retaining tab

**NOTE:** A cooling system that frequently requires coolant is the indication of leaks or engine problems. See an authorized Can-Am dealer.

### Recommended Engine Coolant

COUNTRY	RECOMMENDED COOLANT
Scandinavia	EXTENDED LIFE PRE-MIXED COOLANT (EUR) (P/N 779223)
All other countries	EXTENDED LIFE PRE-MIXED COOLANT (P/N 779150)
Alternative, or if not available	Distilled water and antifreeze solution (50% distilled water, 50% antifreeze)

**NOTICE** Always use ethylene-glycol antifreeze containing corrosion inhibitors specifically for internal combustion aluminum engines.

### Engine Coolant Replacement

#### Cooling System Draining

Remove the gauge support.

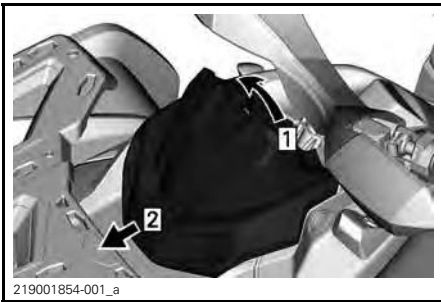

TYPICAL  
Step 1: Pull up  
Step 2: Slide

Remove the coolant reservoir cap.

### **⚠ WARNING**

To avoid potential burns, do not remove the pressure cap if the engine is hot.



1. Engine coolant reservoir cap

Unscrew the coolant drain plug and drain the coolant into a suitable container.

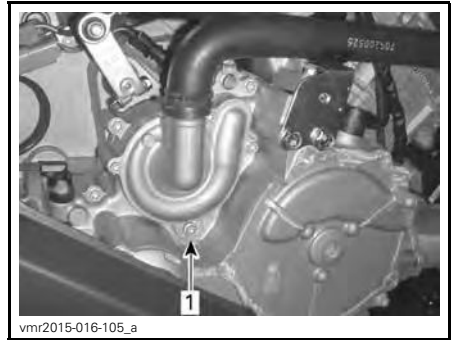

TYPICAL - SOME PARTS REMOVED FOR CLARITY

1. Coolant drain plug

**NOTE:** Do not unscrew the coolant drain plug completely.

Disconnect the lower radiator hose and drain the remaining coolant into a suitable container.

**NOTE:** Take note of hose clamp position on the lower radiator hose.

Reinstall lower radiator hose.

Position the radiator hose clamp as noted during removal.

Tighten radiator hose clamp to specification.

Reinstall cooling system drain plug with a new gasket ring.

Tighten the coolant drain plug to specification.

TIGHTENING TORQUE	
Cooling drain plug	9 N•m to 11 N•m (80 lbf•in to 97 lbf•in)

Bleed cooling system, refer to *COOLING SYSTEM FILLING AND BLEEDING*.

### Cooling System Filling and Bleeding

1. Unscrew bleed screws on both front and rear cylinders.

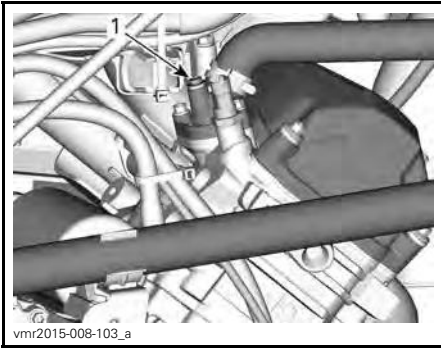

TYPICAL

1. Front cylinder bleed screw



TYPICAL - 570 MODELS ONLY

1. Rear cylinder bleed screw

2. Fill the cooling system until coolant comes out of the bleed screw(s).

3. Squeeze the top of the coolant hose between the radiator and coolant pump several times until all air is bled from the highest point of the hose.
4. Install the bleed screw using **NEW** gasket ring and tighten to specification.

TIGHTENING TORQUE	
Bleed screws	5.0 N•m ± 0.6 N•m (44 lbf•in ± 5 lbf•in)

5. Add coolant until system is full up to the pressure cap seat.

6. Refill coolant tank up to MAX level mark.

7. Start engine.

**NOTE:** Do not install pressure cap.

8. Run engine at idle until coolant fan turns ON.

**NOTE:** Monitor coolant level during engine warm-up and add coolant as required.

9. Depress the throttle lever two or three times; check coolant level.

10. Stop the engine and let it cool down.

11. Inspect cooling system for leaks.

12. Check coolant level in the reservoir. Add coolant as required.

13. Install pressure cap.

14. Install the gauge support.

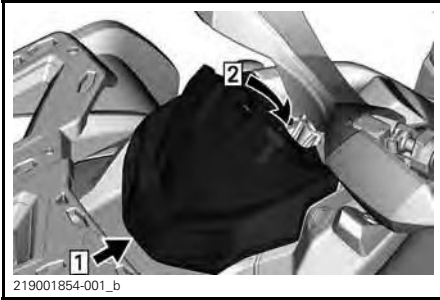

TYPICAL

Step 1: Hook

Step 2: Engage retaining tab

## 6) Muffler Spark Arrester

The muffler must be periodically purged of accumulated carbon.

### ⚠ WARNING

Never run engine in an enclosed area. Never perform this operation immediately after the engine has been run because exhaust system is very hot. Make sure that there are no combustible materials in the area. Wear eye protection and gloves. Never stand behind the vehicle while purging exhaust system. Respect all applicable laws and regulations.

Select a well-ventilated area and make sure the muffler is cool.

Place transmission on PARK position.

Remove the clean out plug of the muffler.

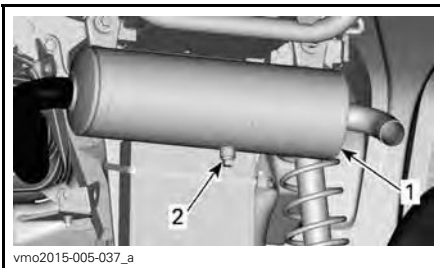

TYPICAL

1. Muffler

2. Clean out plug

Block the end of the muffler with a shop rag and start engine.

Momentarily increase engine RPM several times to purge accumulated carbon out of the muffler.

Stop engine and allow muffler to cool.

Reinstall the clean out plug.

## 7) CVT Air Filter

### CVT Air Filter Removal

1. Remove the gauge support.

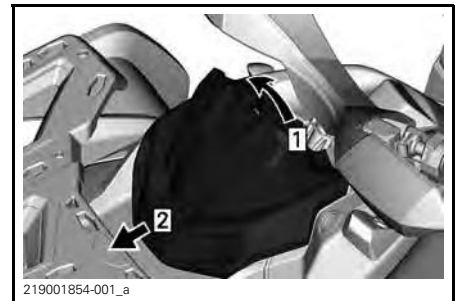

TYPICAL

Step 1: Pull up

Step 2: Slide

2. Push on three tabs and remove air filter.

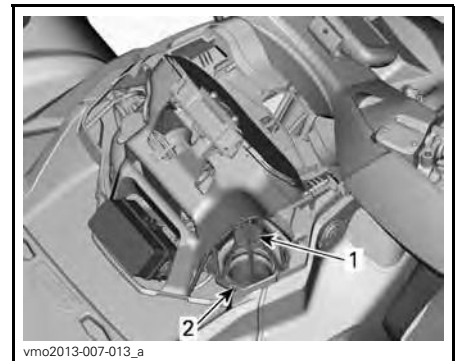

1. CVT air filter

2. Tab

### CVT Air Filter Cleaning

1. Spray filter inside and out with a good air filter cleaner and follow manufacturer's instructions.
2. Dry filter completely.



1. CVT air filter

3. Clean inside the CVT air inlet end.

### CVT Air Filter Installation

1. Install air filter on CVT inlet by inserting tabs in their slots and push on air filter until it clicks.
2. Reinstall gauge support.

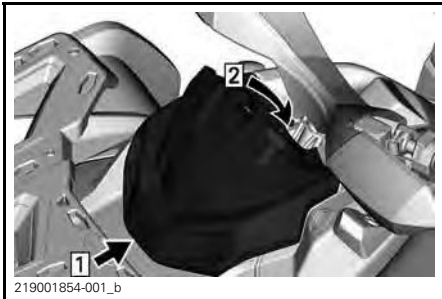

**TYPICAL**

Step 1: Hook

Step 2: Engage retaining tab

## 8) Gearbox Oil (570 Models)

### Recommended Gearbox Oil

RECOMMENDED GEARBOX OIL	
Scandinavia	75W140 SYNTHETIC GEAR OIL (EUR) (P/N 779215)
All other countries	75W140 SYNTHETIC GEAR OIL (P/N 779160)

**NOTE:** The XPS oil is specially formulated to meet the lubrication requirements of this gearbox. BRP strongly recommends the use of its XPS oil. However, if the XPS synthetic gear oil is not available, use the following lubricant:

GEARBOX OIL REQUIREMENT
75W 140 API GL-5 synthetic gear oil

### Gearbox Oil Level Verification

**NOTE:** Prior checking the gearbox oil level, ensure vehicle is on a level surface.

1. To access gearbox oil level plug, remove the following parts:
  - Seat
  - Console
  - RH side panel and extension(s)
  - RH footrest panel

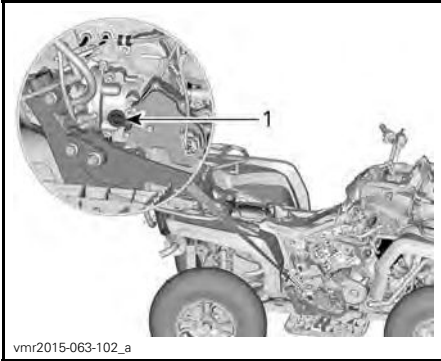

1. Oil level plug

2. Remove the gearbox oil level plug.

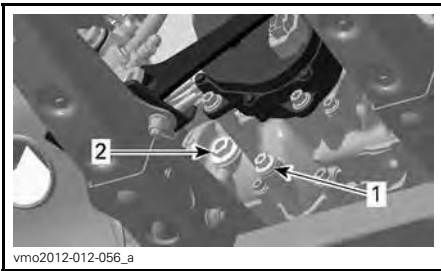

1. Drain plug  
2. Oil level plug

3. Check oil level.

The oil should be level with the bottom of the oil level hole.

**NOTICE** Operating the gearbox with an improper oil level may severely damage gearbox.

### Gearbox Oil Replacement

#### Gearbox Oil Draining Procedure

1. Start engine and operate vehicle to warm-up the gearbox oil.

**NOTE:** Running engine at idle is not sufficient, vehicle transmission must be operated.

2. Position vehicle on a level surface.
3. Place a drain pan under the gearbox drain plug area.
4. Clean drain plug area.

5. Remove magnetic drain plug and sealing ring. Discard sealing ring.

**⚠ WARNING**

**The gearbox oil can be very hot.**

6. Remove oil level plug and its O-ring.  
**NOTE:** Allow oil to completely flow out of gearbox.

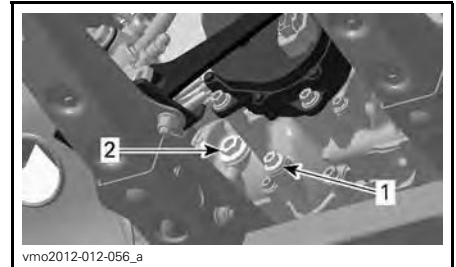

1. Magnetic drain plug  
2. Oil level plug

7. Clean magnetic drain plug and pay attention to any debris present on drain plug.

**NOTE:** Presence of excessive debris provides an indication of a gearbox problem.

8. Reinstall magnetic drain plug with a **NEW** sealing ring.

TIGHTENING TORQUE	
Drain plug	20 N•m ± 2 N•m (15 lbf•ft ± 1 lbf•ft)

9. Dispose gearbox oil as per your local environmental regulations.

#### Gearbox Oil Filling Procedure

1. Fill the gearbox through the oil level hole until the oil reaches the bottom of the oil level hole.
2. Install the oil level plug with its O-ring. Tighten plug to specification.

TIGHTENING TORQUE	
Oil level plug	5 N•m ± 0.6 N•m (44 lbf•in ± 5 lbf•in)

Wipe off any spillage.

## 9) Spark Plugs

### Spark Plug Access

Remove side panels.

Unplug spark plug cable(s).

### Spark Plug Removal

Unscrew spark plugs one turn.

**⚠ CAUTION** Always wear safety goggles when using pressurized air.

Clean spark plugs and cylinder heads with pressurized air if possible.

Unscrew spark plugs completely using a spark plug socket, then remove them.

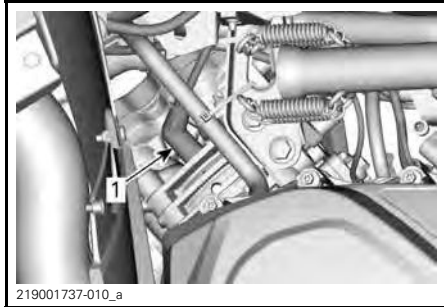

LH SIDE — FRONT CYLINDER  
1. Spark plug

## 570 models

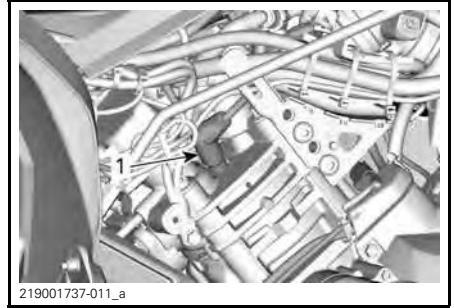

RH SIDE — REAR CYLINDER  
1. Spark plug

### Spark Plug Installation

Prior to installation, make sure that contact surfaces of cylinder heads and spark plugs are free of grime.

Using a feeler gauge, set the spark plug gap.

SPARK PLUG GAP	
450	0.7 mm - 0.9 mm (.028 in - .035 in)
570	0.8 mm to 0.9 mm (.031 in to .035 in)

Apply a small amount of copper-based anti-seize lubricant over spark plug threads to prevent a possible seizure.

Screw spark plugs into cylinder heads by hand and tighten with a torque wrench and a proper socket.

**NOTICE** Do not overtighten spark plugs, engine damage can occur.

TIGHTENING TORQUE	
Spark plug (450)	11 N•m ± 1 N•m (97 lbf•in ± 9 lbf•in)
Spark plug (570)	20 N•m ± 2.4 N•m (15 lbf•ft ± 2 lbf•ft)



## 10) CVT Cover

This CVT is lubrication free. Never lubricate any components except drive pulley bearing.

### **⚠ WARNING**

Never touch CVT while engine is running. Never drive vehicle when CVT cover is removed.

### **⚠ WARNING**

Engine must be cool before cover is removed. Always wear protective gloves when removing cover.

Place the vehicle on a level surface. Select PARK position.

### Accessing the CVT Cover

The CVT cover is located on the LH side of the vehicle.

Remove the following:

- LH side and extension panels
- LH footboard panel.

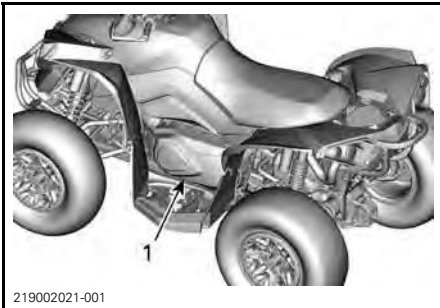

TYPICAL

1. CVT cover

### Removing the CVT Cover (450 models)

Disconnect CVT cooling air ducts.

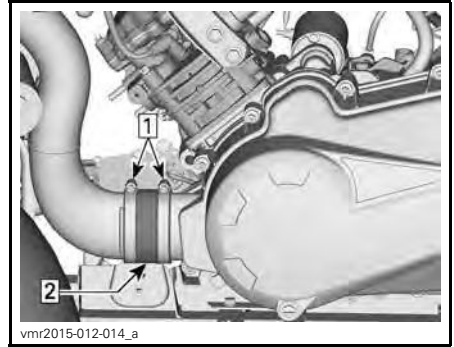

#### CVT AIR INLET DUCT DISCONNECT

1. Loosen clamps
2. Remove CVT air inlet adapter

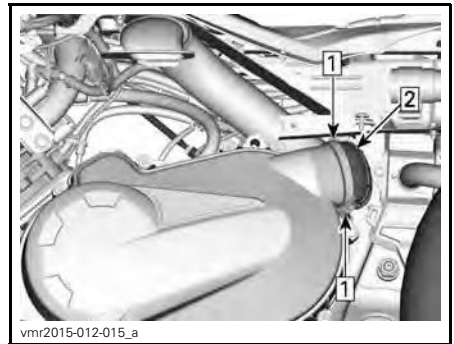

#### CVT AIR OUTLET DUCT DISCONNECT

- Step 1: Loosen clamps
- Step 2: Remove CVT air outlet adapter

Remove:

- Retaining screws
- CVT cover
- Gasket.

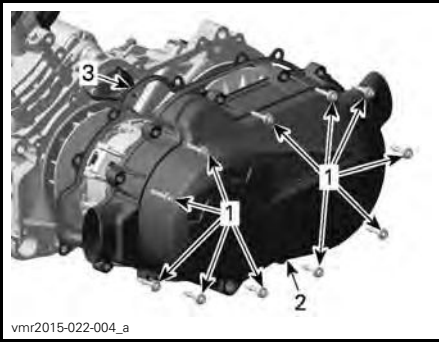

1. Retaining screws
2. CVT cover
3. Gasket

**NOTE:** To support the cover remove the center top screw last.

### Removing the CVT Cover (all other models)

Remove all CVT cover retaining screws.

Remove the center top screw last to support the cover during removal.

**NOTICE** Do not use an impact tool to remove CVT cover screws.

Remove the CVT cover and its gasket.

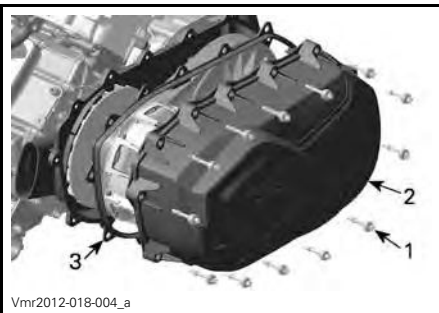

1. CVT cover screw
2. CVT cover
3. Gasket

### 11) Installing the CVT Cover (450 models)

Install the center top screw of first.

Install the other screws then torque them in a crisscross sequence.

Tighten the CVT cover screws as per following sequence.

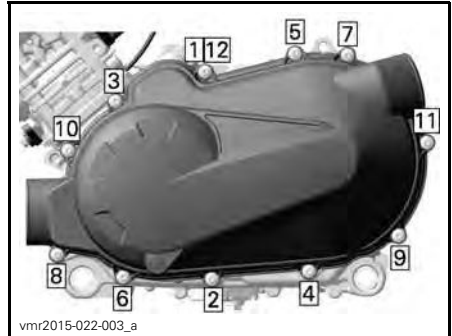

CVT COVER TIGHTENING SEQUENCE

TIGHTENING TORQUE	
CVT cover screws	7 N•m ± 0.8 N•m (62 lbf•in ± 7 lbf•in)

### 12) Installing the CVT Cover (all other models)

Install the center top screw of first.

**NOTE:** Do not use and impact tool to install CVT cover screws.

Tighten the CVT cover screws as per following sequence.

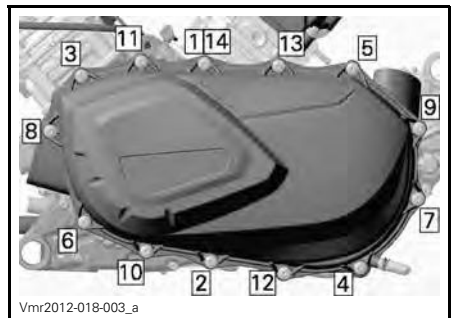

CVT COVER TIGHTENING SEQUENCE

TIGHTENING TORQUE	
CVT cover screws	7 N•m ± 0.8 N•m (62 lbf•in ± 7 lbf•in)

### 13) Drive Belt

#### Removing the Drive Belt

**NOTICE** In case of a drive belt failure, the CVT, cover, drain reservoir and air outlet must be cleaned and inspected for obstruction.

Remove *CVT COVER*.  
Open driven pulley.

REQUIRED TOOL	
PULLER/LOCKING TOOL (P/N 529 036 098)	

Screw tool in the threaded hole of driven pulley and tighten to open the pulley.

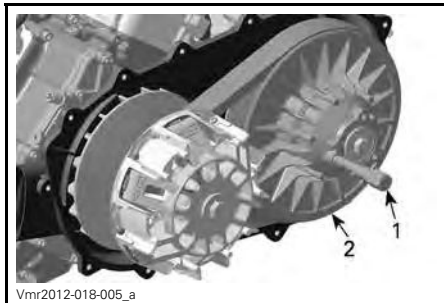

1. Puller/locking tool
2. Fixed sheave of driven pulley

Slide the belt over the top edge of fixed sheave to remove it.

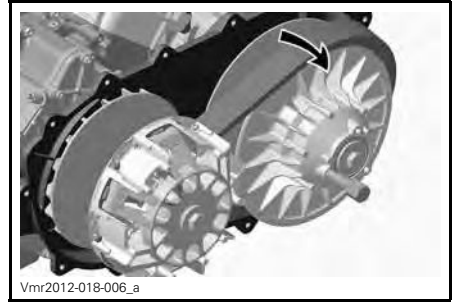

#### Installing the Drive Belt (450 models)

For installation, reverse the removal procedure. Pay attention to the following details.

The maximum drive belt life span is obtained when the drive belt has the proper rotation direction. Install it so that the arrow printed on belt is pointing towards front of the vehicle, viewed from top.

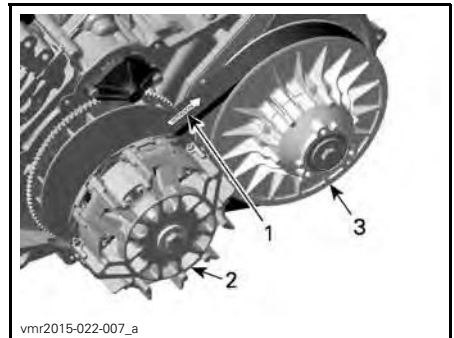

1. Arrow towards the back of the vehicle
2. Drive pulley (front)
3. Driven pulley (rear)

#### Installing the Drive Belt (all other models)

For installation, reverse the removal procedure. Pay attention to the following details.

The maximum drive belt life span is obtained when the drive belt has the proper rotation direction. Install it so that the arrow printed on belt is pointing towards front of the vehicle, viewed from top.

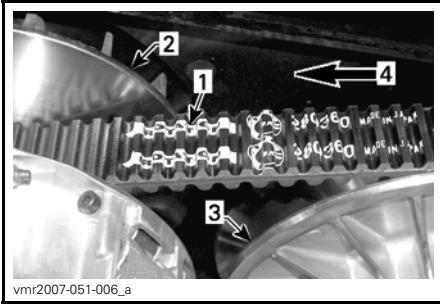

1. Arrow printed on belt
2. Drive pulley (front)
3. Driven pulley (rear)
4. Rotation direction

Turn the driven pulley until the lowest portion of the cogs on the external surface of drive belt is even with the driven pulley edge.



1. Lowest portion of cogs even with external surface of drive belt

## 14) Drive and Driven Pulleys

### Drive and Driven Pulleys Inspection

This inspection must be performed by an authorized Can-Am dealer, repair shop, or person of your own choosing for maintenance, repair, or replacement.

### Drive Pulley

Inspect the bushings of the sliding sheave of the drive pulley, replace worn parts.

### Driven Pulley

Inspect the bushings of the cam and of the sliding sheave of the driven pulley, replace worn parts.

## 15) Battery

**CAUTION** Never charge a battery while installed in vehicle.

These vehicles are equipped with a VRLA battery (Valve Regulated Lead Acid). It is a maintenance-free type battery, there is no need to add water to adjust electrolyte level.

**NOTICE** Never remove the battery sealing cap.

### Battery Isolation

Disconnect BLACK (-) cable from the battery.

**NOTICE** Make sure the connector does not accidentally contact the battery post.

### Battery Removal

Disconnect BLACK (-) cable first then RED (+) cable.

**NOTICE** Always disconnect BLACK (-) battery cable first.

Remove retaining screws, battery holder then pull the battery out of frame.

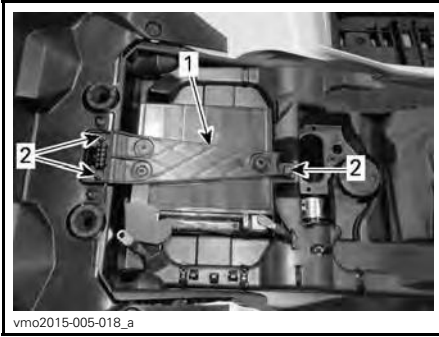

vmo2015-005-018\_a

1. Battery holder
2. Retaining screws

### Battery Cleaning

Clean battery, battery casing and battery posts using a solution of baking soda and water.

Remove corrosion from battery cable terminals and battery posts using a firm wire brush.

### Battery Installation

Battery installation is the reverse of the removal procedure.

**NOTICE** Always connect RED (+) battery cable first.

## 16) Fuses

**CAUTION** Always turn the ignition switch to OFF position before replacing a defective fuse.

### Fuse Inspection

Check if filament is melted.

If filament is melted, replace damaged fuse, refer to *FRONT FUSE* or *REAR FUSE HOLDER AND FUSIBLE LINKS* below for proper rating.

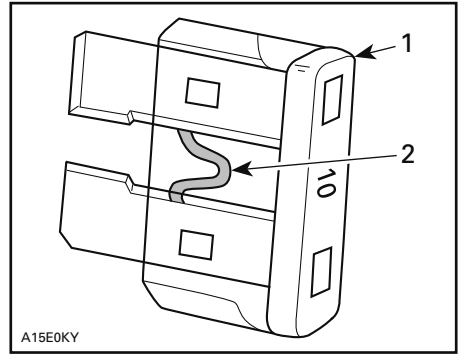

A15E0KY

TYPICAL

1. Fuse
2. Check if melted

**NOTICE** Do not use a higher rated fuse as this can cause severe damage.

### Front Fuse Box

Remove the gauge support.

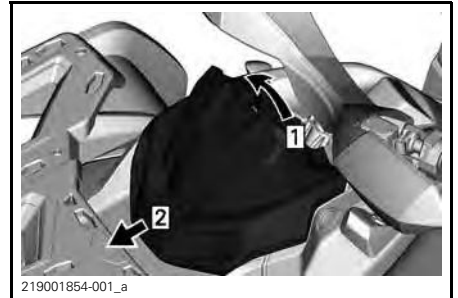

219001854-001\_a

TYPICAL

- Step 1: Pull up
- Step 2: Slide



vmo2015-005-022\_a

1. Front fuse box
2. Front fuse box cover

**NOTE:** Check inside fuse box cover to know fuses location.

**NOTICE** Do not store any objects in the front service compartment.

**Front Fuse Box Description**

FRONT FUSE BOX		
NO.	DESCRIPTION	RATING
RY1	Cooling fan relay	-
RY2	Main relay	-
RY3	Lights relay	-
RY4	Trailer Flasher relay	
RY5	Accessories relay	-
RY6	Brake relay	-
F1	Ignition switch Clock	10 A
F2	Lights	30 A
F3	Accessory connectors 1 DC1 / DC3	20 A
F4	Accessory connectors 2 DC5 / DC6	20 A
F5	Fuel pump Injectors Ignition coils	10 A
F6	Gauge Relays	10 A
F7	Tail Lights	10 A
F8	ECM	10 A
F9	4WD actuator	10 A
F10	Flashers	10 A
F11	ABS valves	25 A
F12	Cooling fan	25 A

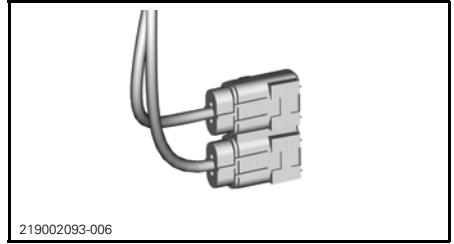

219002093-006  
**FUSE BOX 2 - TYPICAL**

FUSE HOLDERS	
DESCRIPTION	RATING
ABS (Anti-lock Brake System)	40 A

FUSE IN FUSE BOX 2 IDENTIFICATION			
Fuse	1	Main	40 A
	2	DPS (dynamic power steering)	40 A

**Rear Fuse Holder and Fusible Links**

*450 engines only*

The rear fuse holder is located under seat near battery.



vnr2016-132-004\_a  
1. Fusible links

**Rear Fuse Holder(s)**

*570 engines only*

The rear fuse holder is located under seat near battery.



vmr2015-044-004\_a

**FUSE BOX 2**

**Rear Fuse Identification**

FUSE LINK IDENTIFICATION			
Fusible links	1	Main	16 awg
	2	Fan/accessories	16 awg
FUSE IN FUSE BOX 2 IDENTIFICATION			
Fuse	3	DPS (dynamic power steering)	40 A

**17) Lights**

Always check light operation after replacement.

**Headlight Bulb Replacement**

**NOTICE** Never touch glass portion of a halogen bulb with bare fingers, it shortens its operating life. If glass is touched, clean it with isopropyl alcohol which will not leave a film on the bulb.

1. Remove cover.
2. Unplug connector.
3. Remove bulb.

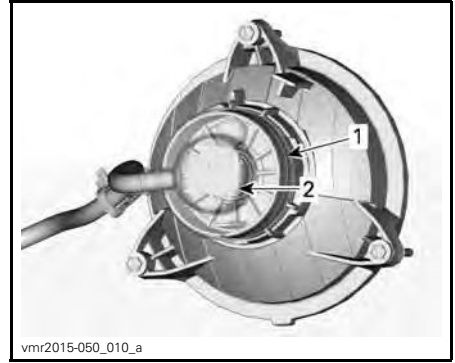

vmr2015-050\_010\_a

1. Cover
2. Connector
3. Remove bulb.
4. Properly reinstall removed parts in the reverse order of their removal.
5. Validate headlight operation.

**Headlight Beam Aiming**

Turn adjustment knobs to adjust beam height and side orientation to specification.

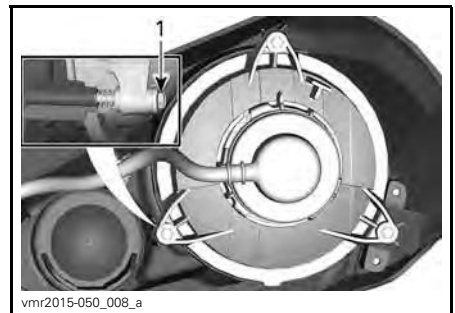

vmr2015-050\_008\_a

**LOW BEAM**

1. Adjustment knobs

**Taillight/Brake Light Bulb Replacement**

1. Remove screws retaining the connector bulb.
2. Unplug connector from bulb.
3. Rotate light bulb counterclockwise to remove it from taillight.



4. Remove bulb socket from taillight. Installation is the reverse of the removal procedure.

### Turn Signal Light Bulb Replacement

1. Remove the light bulb socket.

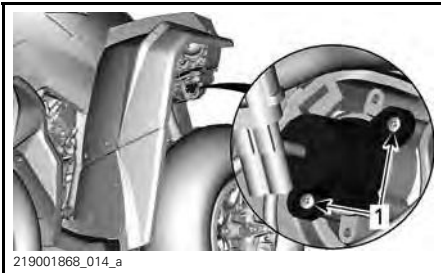

**TYPICAL - FRONT TURN SIGNAL LIGHT**

1. Retaining screws

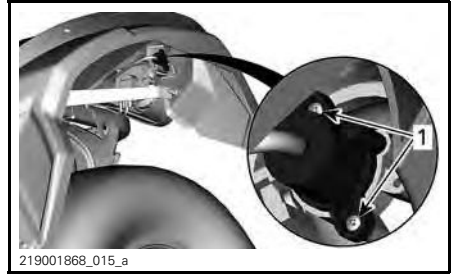

**TYPICAL - REAR TURN SIGNAL LIGHT**

1. Retaining screws

2. Replace the light bulb.

3. Reinstall the socket.

### Front Position Light Replacement

**NOTE:** The front position lights cannot be disassembled. They have to be replaced as a whole.

1. Disconnect the electrical connector.

2. Unscrew the retaining nut.

3. Remove the position light.

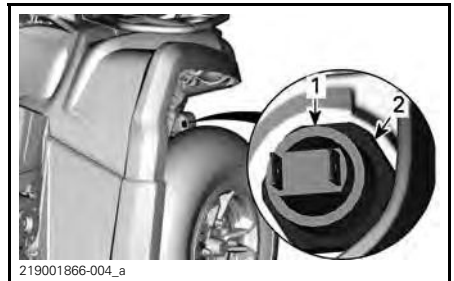

1. Position light

2. Retaining nut

4. Install the new position light in the reverse order.

### Licence Plate Bulb Replacement

1. Remove the licence plate bulb cover.



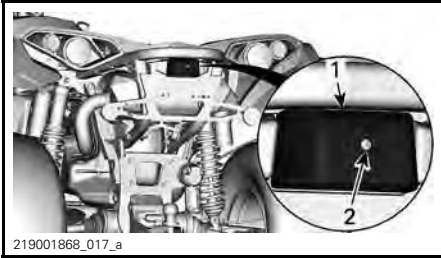

219001868\_017\_a

**TYPICAL**

1. Licence plate bulb cover
2. Retaining screw

2. Replace the bulb.
3. Reinstall the cover.

## 18) Drive Shaft Boot and Protector

### Drive Shaft Boot and Protector Inspection

Visually inspect drive shaft protectors and boots conditions.

Check protectors for damage or rubbing against shafts.

Check boots for cracks, tears, leaking grease etc.

Repair or replace damaged parts as necessary.

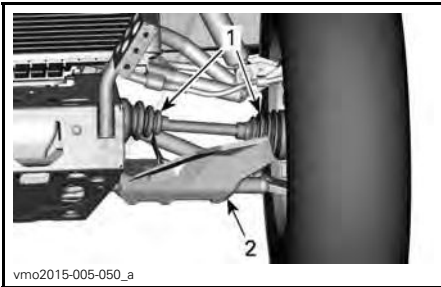

vmo2015-005-050\_a

**TYPICAL — FRONT OF VEHICLE**

1. Drive shaft boots
2. Drive shaft protector

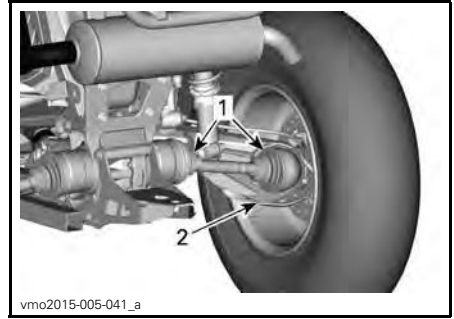

vmo2015-005-041\_a

**TYPICAL — REAR OF VEHICLE**

1. Drive shaft boots
2. Drive shaft protector

## 19) Wheel Bearing

### Wheel Bearing Inspection

Place vehicle on a level surface.

Apply brake lock.

Lift and support vehicle.

Secure vehicle on jack stands.

Push and pull the wheels from the upper edge to feel the play.

See an authorized Can-Am dealer if there is any play.



1mo2011-001-131\_a

**TYPICAL**

## 20) Wheels and Tires

### Tire Pressure

#### WARNING

Tire pressure greatly affects vehicle handling and stability. Insufficient pressure may cause tire to deflate and rotate on wheel. Overpressure may burst the tire. Always follow recommended pressure. NEVER set tire pressure below minimum. It could cause the tire to dislodge from the rim. Since tires are low-pressure types, a manual pump should be used.

Check pressure when tires are cold before using the vehicle. Tire pressure changes with temperature and altitude. Recheck pressure if one of these conditions has changed.

For your convenience, a pressure gauge is supplied in tool kit.

Although the tires are specifically designed for off-road use, a flat may still occur. Therefore, it is recommended to carry a tire pump and a repair kit.

Refer to *SPECIFICATIONS* for recommended pressure.

### Tire Inspection

Check tire for damage and wear. Replace if necessary.

Do not rotate tires. The front and rear tires have a different size. The tires are directional and their rotation must be kept in a specific direction for proper operation.

### Tire Replacement

Tires replacement should be performed by an authorized Can-Am dealer.

#### WARNING

- Replace tires only with the same type and size as original tires.
- For unidirectional tread pattern, ensure that the tires are installed in the correct direction of rotation.
- Tires should be replaced, by an experienced person, in accordance with tire industry standards and tools.

### Wheel Removal

Place vehicle on a level surface.

Engage 4WD mode.

Place shift lever in PARK.

Apply brake lock.

Loosen lug nuts then lift vehicle.

Secure vehicle on jack stands.

Remove lug nuts then remove wheel.

### Wheel Installation

At installation, it is recommended to apply anti-seize lubricant on threads.

If tires are unidirectional, make sure to install wheel according to tire rotation.

Carefully tighten lug nuts in a criss-cross sequence then apply final torque.

TIGHTENING TORQUE	
Wheel lug nuts	80 N•m ± 5 N•m (59 lbf•ft ± 4 lbf•ft)

While reading this Operator's Guide, remember that:

#### WARNING

Indicates a potential hazard that, if not avoided, could result in serious injury or death.

**NOTICE** Always use the recommended wheel lug nuts according to the type of wheel. Using a different nut could cause damage to the rim or studs.

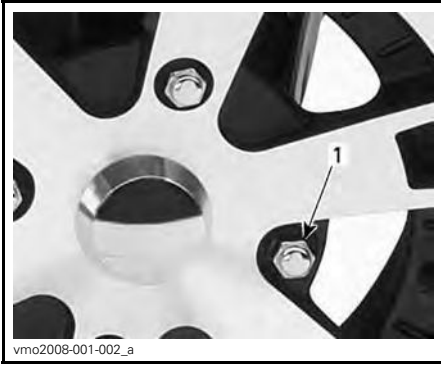

TYPICAL — ALUMINUM WHEEL  
1. Wheel lug nut (closed end type)

## 21) Steering

### Steering Inspection

**⚠ WARNING**  
The steering components inspection and repair should be performed by an authorized Can-Am dealer.

### Tie-Rods

Visually inspect tie-rods.

The tie-rods must be replaced if warpage or any other damage is detected.

**⚠ WARNING**  
The tie-rod must be replaced if damaged.

### Tie-Rod Ends

Place vehicle on a level surface.

Apply brake lock.

Lift vehicle.

Secure vehicle on jack stands.

Inspect inner and outer tie-rod boots for cracks.

Push and pull the wheels from the front or rear edge to feel the play.

The tie-rod ends must be replaced if there is an abnormal play or a boot is cracked.

**⚠ WARNING**  
The tie-rod end must be replaced if the boot is cracked or shows an abnormal play.

## 22) Suspension

### Front Suspension Lubrication

Lubricate front suspension arms at grease fittings.

SUSPENSION GREASE	
Scandinavia	SYNTHETIC SUSPENSION GREASE (EUR) (P/N 779226)
All other countries	SYNTHETIC SUSPENSION GREASE (P/N 779163)

### Rear Suspension Lubrication

Lubricate rear stabilizer bar links and pivot bushing at grease fittings.

SUSPENSION GREASE	
Scandinavia	SYNTHETIC SUSPENSION GREASE (EUR) (P/N 779226)
All other countries	SYNTHETIC SUSPENSION GREASE (P/N 779163)

## Suspension Inspection

### Shock Absorbers

Inspect shock absorber for oil leaks or other damage.

Check tightness of fasteners.

See an authorized Can-Am dealer as necessary.

### Ball Joints

Place vehicle on a level surface.

Apply brake lock.

Lift vehicle.

Secure vehicle on jack stands.

Inspect ball joint boots for cracks.

Push and pull the wheels from the upper and lower edge to feel the play.

The ball joints must be replaced if there is an abnormal play or a boot is cracked.



TYPICAL

## **⚠ WARNING**

The ball joint must be replaced if the boot is cracked or shows an abnormal play.

### Front Suspension Arms

Check suspension arms for cracks, bending or other damage.

See an authorized Can-Am dealer as necessary.

### Rear Trailing Arms

Check trailing arms for distortion, cracks or bending.

See an authorized Can-Am dealer if any problem is detected.

## 23) Brakes

### Brake Fluid Reservoir Level Verification

With vehicle on a level surface, check brake fluid in reservoirs for proper level.

**NOTE:** A low level may indicate leaks or worn brake pads.

### Front Brake Reservoir

Turn steering in the straight-ahead position to ensure reservoir is level.

Check the brake fluid level, the reservoir is full when the fluid reaches of the top of window.

Visually inspect lever boot condition.

Check for cracks, tears, etc. Replace if damaged.



TYPICAL

### Rear Brake Reservoir

Remove the seat.

With vehicle on a level surface, liquid should be between MIN. and MAX. level marks of brake pedal fluid reservoir.

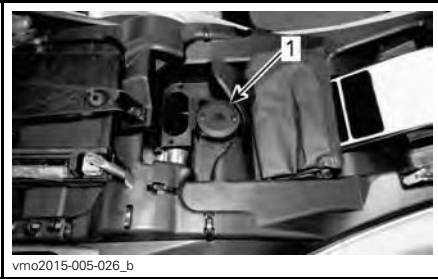

1. Rear brake fluid reservoir

### Adding Brake Fluid

Clean filler cap.

#### **⚠ WARNING**

Clean filler cap before removing.

Remove screws retaining the reservoir cap.

Remove reservoir cap.

Add fluid as required using a clean funnel. Do not overfill.

**NOTICE** Brake fluid can damage plastic and painted surface. Wipe off and clean any spillage.

Reinstall reservoir cap and tighten screws.

**NOTE:** Ensure filler cap diaphragm is pushed inside the cap before closing the brake fluid reservoir.

### Recommended Brake Fluid

Always use DOT 4 brake fluid from a sealed container.

#### **⚠ WARNING**

To avoid damage to the braking system, do not use other brake fluid types.

### Brake Inspection

**⚠ CAUTION** The brakes can be very hot after prolonged use of the vehicle and can cause burns. Wait for the brakes to cool down.

The brake inspection, maintenance and repair should be performed by an authorized Can-Am dealer.

However, verify the following between visits to your dealer:

- Brake fluid level
- Brake system for fluid leaks
- Brake cleanliness.

#### **⚠ WARNING**

The brake fluid replacement or brake system maintenance and repairs should be performed by an authorized Can-Am dealer.

## III VEHICLE CARE

### Post-Operation Care

When vehicle is used in salt-water environment (beach area, launching and loading boats etc.), rinsing the vehicle with fresh water is necessary to preserve vehicle and its components. Metallic parts lubrication is highly recommended. Use anti-corrosive lubricant or an equivalent. This must be performed at the end of each operating day.

When vehicle is operated in muddy conditions, rinsing the vehicle is recommended to preserve vehicle and its components and to keep lights clean.

SERVICE PRODUCT
LUBRICANT AND ANTI-CORROSIVE (P/N 779168)

### Vehicle Cleaning

**NOTICE** Never use a high pressure washer to clean the vehicle. USE LOW PRESSURE ONLY (like a garden hose).

Pay attention to certain areas where mud or debris can accumulate and potentially cause wear, interferences or promote corrosion.

Wash the vehicle with a soapy water solution.

**NOTICE** Never clean polypropylene body parts with any petroleum base cleaning products, as it will alter the glossy finish.

### Non Compatible Cleaning Products

MATERIAL TYPE	NON-COMPATIBLE CLEANING PRODUCTS
Polypropylene	ANY PETROLEUM BASE CLEANING PRODUCTS
	XPS ATV FINISHING SPRAY (P/N 219 701 704)
	XPS ATV CLEANING KIT (P/N 219 701 713) (it contains the above XP-S ATV Finishing Spray)



**DO NOT USE ON POLYPROPYLENE**

## Compatible Cleaning Products

MATERIAL TYPE	COMPATIBLE CLEANING PRODUCT
Polypropylene	XPS ATV WASH (P/N 219 701 702)
	Soapy water



vbs2012-006-001

**SAFE FOR POLYPROPYLENE**

---

## **IV STORAGE AND PRESEASON PREPARATION**

When a vehicle is not in use for more than 4 months, proper storage is a necessity.

When using your vehicle after storage, a preparation is required.

See an authorized Can-Am dealer to have your vehicle prepared for either storage or the preseason.



# ***D) TECHNICAL INFORMATION***

# EC-DECLARATION OF CONFORMITY



555 de la Montagne Street  
Valcourt (Québec) J9E 2L9  
Canada  
www.brp.com

## EU Declaration of Conformity

**Authorized Representative:** BRP Europe N.V., Skaldenstraat 125, Gent, Belgium, 9042

This declaration of conformity is issued under the sole responsibility of the manufacturer.

The undersigned, representing the manufacturer, hereby declares that model year **2021 All Terrain Vehicles (ATVs)** marked with the **CE** mark and a 17-character vehicle identification number (VIN) structured as **3JBxxxxxxMxxxxxxx** under commercial names **Can-am Outlander** and **Can-am Renegade** comply with all the relevant provisions of the following Directives and Regulations:

Machinery Directive 2006/42/EC as amended up to and including Reg. 2019/1243/EU	ISO 12100:2010
Non-Road Mobile Machinery (NRMM) Regulation (EU) 2016/1628 on gaseous pollutants	Category ATS, Stage V emissions limits.
Electromagnetic Compatibility (EMC) Directive 2014/30/EU as amended up to and including Reg. (EU) 2018/1139	CISPR 12:2007/A1:2009 & IEC 61000-6-1:2005 or UN R10.04 or later version
Battery Directive 2006/66/EC as amended up to and including Dir. (EU) 2018/849	
Radio Equipment (RED) Directive 2014/53/EU as amended up to and including Reg. 2018/1139 (If fitted with radio frequency (RF) D.E.S.S. key)	EN 300 330-2 & EN 60950-1

Renald Plante, Eng.  
Director, Product Development, Can-Am ATV & Spyder  
Bombardier Recreational Products Inc.

Valcourt, QC, Canada

January 29<sup>th</sup> 2020

**skifando LYNX SEAWOOD EVTRAUDE ROTAX CAN-AM**

---

# EAC DECLARATION OF CONFORMITY

*Left blank for Eurasian Conformity  
mark where applicable*

# I SPECIFICATIONS

## 450 Models

ENGINE		450
Engine type		ROTAX 450, 4-stroke, Single Over Head Camshaft (SOHC), liquid cooled
Number of cylinder		1
Number of valves		4 valves (mechanical adjustment)
Valve clearance	Intake	0.06 mm to 0.14 mm (.0024 in to .0055 in)
	Exhaust	0.11 mm to 0.19 mm (.0043 in to .0075 in)
Bore		94 mm (3.7 in)
Stroke		61.5 mm (2.42 in)
Displacement		426.8 cm <sup>3</sup> (26.04 in <sup>3</sup> )
Exhaust system		Spark arrester approved by USDA Forest Service Catalyst
Engine air filter		Synthetic paper filter with foam

LUBRICATION SYSTEM			450	
Lubrication	Type	Wet sump with replaceable oil filter		
	Oil filter	Replaceable cartridge		
	Engine oil	Capacity (oil change with filter)	3 L (3.2 qt (U.S. liq.)) (engine/transmission)	
		Recommended oil	XPS 4T 10W50 Synthetic oil or XPS 4T 5W40 Synthetic blend oil or XPS 4T 0W40 Synthetic oil	
Alternate oil if XPS products are not available		5W40 or 10W50 motor oil that meets the requirements for API service classification SJ, SL, SM or SN		

COOLING SYSTEM		450
Coolant	Type	XPS Extended life pre-mixed coolant or coolant specifically designed for aluminum engines
	Capacity	2.9L (3.1 qt (U.S. liq.))

TRANSMISSION		450
Type	CVT (Continuously Variable Transmission)	
Engagement RPM	2000 RPM	

GEARBOX		450
Type	Dual range (HI-LO) with park, neutral and reverse	

ELECTRICAL SYSTEM		450
Magneto generator output	500 W @ 6000 RPM	
Ignition system type	IDI (Inductive Discharge Ignition)	
Ignition timing	Not adjustable	
Spark plug	Quantity	1
	Make and type	NGK LMAR8D-J or equivalent
	Gap	0.7 mm to 0.9 mm (.028 in to .035 in)
Engine RPM limiter setting	Forward	8000 RPM
	Reverse	15 km/h (9 MPH) without Override)
Battery	Type	Maintenance free
	Voltage	12 Vdc
	Nominal rating	18 A•h
	Power starter output	0.7 KW
Headlights	High	HS1 35 W
	Low	HS1 35 W
Taillights	P21/5W	
Fuses	Refer to <i>FUSES</i> in the <i>MAINTENANCE</i> section	

FUEL SYSTEM		450
Fuel delivery	Type	Electronic Fuel Injection (EFI), 46 mm throttle body, 1 injector per cylinder
Fuel pump	Type	Electrical (in fuel tank)
Idle speed	1250 RPM (not adjustable)	

**I SPECIFICATIONS**

FUEL SYSTEM		450
Fuel	Type	Regular unleaded gasoline Refer to <i>FUEL REQUIREMENTS</i>
	Minimum octane rating	92 RON or higher (E10)
Fuel tank capacity		20.5 L (5.4 U.S. gal.)
Fuel remaining when low fuel light turns ON		± 5 L (1.3 U.S. gal.)

DRIVE SYSTEM		450	
Drive system type		Selectable 2WD/4WD	
Front differential oil/ rear final drive oil	Capacity	Front	500 ml (17 U.S. oz)
		Rear	250 ml (8.5 U.S. oz)
	Type	Front	XPS 75W90 Synthetic gear oil or synthetic gear oil 75W90 API GL-5
		Rear	XPS 75W140 Synthetic gear oil or synthetic gear oil 75W140 API GL-5
Front drive	Base	Straight gear Visco-Lok <sup>†</sup> auto-locking front differential	
	All models except Base and ABS equipped	Straight gear Visco-lok <sup>†</sup> OE auto-locking front differential	
	Models with ABS	Open differential with BTC (Brake Traction Control)	
Front drive ratio		3.6:1	
Rear drive		Bevel Straight gear / final drive	
Rear drive ratio		3.6:1	
CV joint grease		CV joint grease or an equivalent	
Propeller shaft grease		Propeller shaft grease or an equivalent	

STEERING	450
Camber angle (vehicle on ground)	0°

FRONT SUSPENSION	450
Suspension type	Double A-arm with dive-control geometry
Suspension travel	229 mm (9 in)

FRONT SUSPENSION		450
Shock absorber	Quantity	2
	Type	Oil
Preload adjustment type		5 positions cam
REAR SUSPENSION		450
Suspension type		Trailing arm Independent (TTI) with external stabilizer bar
Suspension travel		220 mm (8.8 in)
Shock absorber	Quantity	2
	Type	Oil
Preload adjustment type		5 positions cam
BRAKES		450
Front brakes	Type	Dual 214 mm cross drilled disc brakes with hydraulic twin-piston calipers
Rear brake	Type	Single 214 mm cross drilled disc brake with hydraulic twin-piston caliper
Brake fluid	Capacity	260 ml (8.8 U.S. oz)
	Type	DOT 4
Caliper		Floating twin pistons (2 x 26 mm)
Brake pad material		Organic
Minimum brake pad thickness		1 mm (.039 in)
Minimum brake disc thickness		4.0 mm (.157 in)
Maximum brake disc warpage		0.2 mm (.008 in)

**I SPECIFICATIONS**

TIRES			450
Pressure	Front	1-UP with ABS and load less than 155 kg (341 lb)	48.3 kPa (7 PSI)
		1-UP with ABS and load less than 235 kg (517 lb)	62.1 kPa (9 PSI)
		1-UP with no ABS	41.4 kPa (6 PSI)
		2-UP with ABS and load less than 125 kg (275 lb)	48.3 kPa (7 PSI)
		2-UP with ABS and load less than 272 kg (598 lb)	62.1 kPa (9 PSI)
		2-UP with no ABS	41.4 kPa (6 PSI)
	Rear	1-UP with ABS and load less than 155 kg (341 lb)	48.3 kPa (7 PSI)
		1-UP with ABS and load less than 235 kg (517 lb)	68.9 kPa (10 PSI)
		1-UP with no ABS	41.4 kPa (6 PSI)
		2-UP with ABS and load less than 125 kg (275 lb)	48.3 kPa (7 PSI)
		2-UP with ABS and load less than 272 kg (598 lb)	68.9 kPa (10 PSI)
		2-UP with no ABS	41.4 kPa (6 PSI)
Minimum tire thread depth			3 mm (.118 in)
Tire size	Standard DPS	Front	205/80-12 MST (25 x 8 - 12 (in))
		Rear	255/65-12 MST (25 x 10 - 12 (in))
	XU	Front	205/90-12 MST (26 x 8 - 12 (in))
		Rear	255/70-12 MST (26 x 10 - 12 (in))
WHEELS			450
Type		Base and XU	Steel
		All other models	Cast Aluminum
Rim size		Front	30.5 x 15.2 cm (12 x 6 in)
		Rear	30.5 x 19.1 cm (12 x 7.5 in)
Wheel offset		Front	41.2 mm (1.62 in)
		Rear	50.7 mm (2 in)
Wheel lug nut torque			80 N•m ± 5 N•m (59 lbf•ft ± 4 lbf•ft)



DIMENSIONS		450
Overall length	1-UP	211 cm (83 in)
	2-UP	231 cm (91 in)
Overall width		116.8 cm (46 in)
Overall height	1-UP	124 cm (49 in)
	2-UP	133 cm (52.5 in)
Wheelbase	1-UP	129.5 cm (51 in)
	2-UP	149.9 cm (59 in)
Wheel track	Front	97.4 cm (38.3 in)
	Rear	94.3 cm (37.1 in)
Ground clearance	All models except XU and XU+	26.7 cm (10.5 in)
	XU and XU+	29.2 cm (11.5 in)

LOADING CAPACITY AND WEIGHT		450
Dry weight	1-UP	308 kg (678 lb)
	2-UP	324 kg (715 lb)
Front rack capacity		54 kg (120 lb)
Rear rack capacity		109 kg (240 lb)
Rear storage compartment loading capacity		10 kg (22 lb)
Total vehicle load allowed (including driver, all other loads and added accessories)	1-UP	235 kg (517 lb)
	2-UP	272 kg (598 lb)
Towing capacity	Trailer without brakes	395 kg (870 lb)
	Trailer with brakes	750 kg (1,650 lb)
Tongue capacity		75 kg (165 lb)

### 570 Models

ENGINE	570
Engine type	ROTAX® 570, 4-stroke, 2 cylinders (V-twin), liquid cooled
Valve train	4 valves/cylinder (mechanical adjustment), single over head camshaft (SOHC) with timing chain

**I SPECIFICATIONS**

<b>ENGINE</b>		<b>570</b>
Valve clearance	Intake	0.06 mm to 0.14 mm (.0024 in to .0055 in)
	Exhaust	0.11 mm to 0.19 mm (.0043 in to .0075 in)
Bore		82 mm (3.23 in)
Stroke		61.5 mm (2.42 in)
Displacement		650 cm <sup>3</sup> (39.7 in <sup>3</sup> )
Exhaust system		Spark arrestor approved by USDA Forest Service
Engine air filter		Synthetic paper filter with foam

<b>LUBRICATION SYSTEM</b>		<b>570</b>
Type		Wet sump. Replaceable cartridge oil filter
Oil filter		Replaceable cartridge
Engine oil	Capacity (oil change with filter)	2.0 L (2.1 qt (U.S. liq.))
	Recommended oil	XPS 4T 10W50 Synthetic oil or XPS 4T 5W40 Synthetic blend oil or XPS 4T 0W40 Synthetic oil
	Alternate oil if XPS products are not available	5W40 or 10W50 motor oil that meets the requirements for API service classification SJ, SL, SM or SN

<b>COOLING SYSTEM</b>		<b>570</b>
Coolant	Type	XPS Extended life pre-mixed coolant or coolant specifically designed for aluminum engines
	Capacity	3.4 L (.9 U.S. gal.)

<b>TRANSMISSION</b>		<b>570</b>
Type		CVT (Continuously Variable Transmission)
Engagement RPM		1800 RPM ± 100 RPM

GEARBOX		570
Type		Dual range (HI-LO) with park, neutral and reverse
Gearbox oil	Capacity	450 ml (15.2 U.S. oz)
	Recommended oil	75W140 Synthetic gear oil or a 75W140 API GL-5 synthetic gear oil

ELECTRICAL SYSTEM		570
Magneto generator output		500 W @ 6000 RPM
Ignition system type		IDI (Inductive Discharge Ignition)
Ignition timing		Not adjustable
Spark plug	Quantity	2
	Make and type	NGK DCPR8E or equivalent
	Gap	0.8 mm to 0.9 mm (.031 in to .035 in)
Engine RPM limiter setting	Forward	8000 RPM
	Reverse	15 km/h (9 MPH) without Override)
Battery	Type	Maintenance free
	Voltage	12 Vdc
	Nominal rating	18 A•h
	Power starter output	0.7 KW
Headlights	High	HS1 35 W
	Low	HS1 35 W
Taillights		P21/5W
Turn signal lights		R10W
Position light		W5W
Licence plate light		R10W
Fuses		Refer to <i>FUSES</i> in <i>MAINTENANCE</i>

FUEL SYSTEM		570
Fuel delivery	Type	Electronic Fuel Injection (EFI), 46 mm throttle body, 1 injector per cylinder
Fuel pump	Type	Electrical (in fuel tank)
Idle speed		1250 ± 100 RPM (not adjustable)

**I SPECIFICATIONS**

FUEL SYSTEM		570
Fuel	Type	Regular unleaded gasoline Refer to <i>FUEL REQUIREMENTS</i>
	Minimum octane rating	92 RON or higher
Fuel tank capacity		20.5 L (5.4 U.S. gal.)
Fuel remaining when low fuel light turns ON		± 5 L (1.3 U.S. gal.)

DRIVE SYSTEM			570
Drive system type			Selectable 2WD/4WD
Front differential oil/ rear final drive oil	Capacity	Front	500 ml (17 U.S. oz)
		Rear	250 ml (8.5 U.S. oz)
	Type	Front	75W90 Synthetic gear oil or synthetic gear oil 75W90 API GL-5
		Rear	75W140 Synthetic gear oil or synthetic gear oil 75W140 API GL-5
Front drive		Models without DPS	Visco-lok auto-locking front differential
		Models WITH DPS / without ABS	Visco-lok QE auto-locking front differential
		Models with ABS	Open differential with BTC (Brake Traction Control)
Front drive ratio			3.6:1
Rear drive			Spiral bevel gear / final drive
Rear drive ratio			3.6:1
CV joint grease			CV joint grease or an equivalent or an equivalent
Propeller shaft grease			Propeller shaft grease or an equivalent or an equivalent

FRONT SUSPENSION		570
Suspension type		Double suspension arm with dive-control geometry
Suspension travel		229 mm (9 in)
Shock absorber	Quantity	2
	Type	Oil
Preload adjustment type		5 positions cam

REAR SUSPENSION		570
Suspension type		Trailing arm Independent (TTI) with external stabilizer bar
Suspension travel		220 mm (8.8 in)
Shock absorber	Quantity	2
	Type	Oil
Preload adjustment type		5 positions cam
BRAKES		570
Type	Models without ABS	Hydraulic disc brakes
	Models with ABS	Hydraulic disc brakes with ABS
Front brakes		Dual 214 mm cross drilled discs with twin-piston floating calipers
Rear brake		Single 214 mm cross drilled disc with twin-piston floating caliper
Brake fluid	Capacity	260 ml (8.8 U.S. oz)
	Type	DOT 4
Caliper piston diameter		2 x 26 mm
Brake pad material		Organic
Minimum brake pad thickness		1 mm (.039 in)
Minimum brake disc thickness		4.0 mm (.157 in)
Maximum brake disc warpage		0.2 mm (.008 in)

TIRES			570
Pressure	Front	1-UP with ABS and load less than 155 kg (341 lb)	48.3 kPa (7 PSI)
		1-UP with ABS and load from 155 kg (342 lb) to 235 kg (518 lb)	62.1 kPa (9 PSI)
		1-UP with no ABS	41.4 kPa (6 PSI)
		2-UP with ABS and load less than 125 kg (275 lb)	48.3 kPa (7 PSI)
		2-UP with ABS and load from 125 kg (276 lb) to 272 kg (600 lb)	62.1 kPa (9 PSI)
		2-UP with no ABS	41.4 kPa (6 PSI)
	Rear	1-UP with ABS and load less than 155 kg (341 lb)	48.3 kPa (7 PSI)
		1-UP with ABS and load from 155 kg (342 lb) to 235 kg (518 lb)	68.9 kPa (10 PSI)
		1-UP with no ABS	41.4 kPa (6 PSI)
		2-UP with ABS and load less than 125 kg (275 lb)	48.3 kPa (7 PSI)
		2-UP with ABS and load less from 125 kg (276 lb) to 272 kg (600 lb)	68.9 kPa (10 PSI)
		2-UP with no ABS	41.4 kPa (6 PSI)
Minimum tire thread depth			3 mm (.118 in)
Size	Front	XU and XU+	205/90-12 MST (26 x 8 - 12 (in))
		Except XU and XU+	205/80-12 MST (25 x 8 - 12 (in))
	Rear	XU and XU+	255/70-12 MST (26 x 10 - 12 (in))
		Except XU and XU+	255/65-12 MST (25 x 10 - 12 (in))

WHEELS		570
Type	Base and XU	Steel
	All other models	Cast Aluminum
Rim size	Front	30,5 x 15,2 cm (12 x 6 in)
	Rear	30,5 x 19,1 cm (12 x 7.5 in)
Wheel offset	Front	41.2 mm (1.62 in)
	Rear	51 mm (2.01 in)
Wheel lug nut torque		80 N•m ± 5 N•m (59 lbf•ft ± 4 lbf•ft)

DIMENSIONS		570
Overall length	1-UP	211 cm (83 in)
	2-UP	231 cm (91 in)
Overall width		117 cm (46 in)
Overall height	1-UP	124 cm (49 in)
	2-UP	133 cm (52.5 in)
Wheelbase	1-UP	129.5 cm (51 in)
	2-UP	149.9 cm (59 in)
Wheel track	Front	97.4 cm (38 in)
	Rear	92.3 cm (36 in)
Ground clearance		26.7 cm (10.5 in)

LOADING CAPACITY AND WEIGHT		570	
Dry weight	Base, DPS and XU	319 kg (703 lb)	
	DPS MAX and XT MAX	336 kg (741 lb)	
Front rack capacity		54 kg (120 lb)	
Rear rack capacity		109 kg (240 lb)	
Rear storage compartment loading capacity		10 kg (22 lb) or 11 L (11.6 qt (U.S. liq.))	
Load per tire	Front	XU	195 kg (430 lb)
		Except XU	145 kg (320 lb)
	Rear	XU	236 kg (520 lb)
		Except XU	218 kg (481 lb)
Weight distribution per axle Front/Rear (%)		1-UP	48/52
		2-UP	48/52
Total vehicle load allowed (including driver, all other loads and added accessories)		1-UP	235 kg (517 lb)
		2-UP	272 kg (598 lb)
Towing capacity		Trailer without brakes	395 kg (870 lb)
		Trailer with brakes	750 kg (1,650 lb)
Tongue weight		Trailer without brakes	75 kg (165 lb)
		Trailer with brakes	75 kg (165 lb)



NOISE AND VIBRATION			570
Exterior sound level (dB (A)) According to Annex II (EU) 2018/985	Stationary	450	80 dB (A)
		570	78 dB (A)
	Moving (Without ABS)	450	83 dB (A)
		570	81 dB (A)
	Moving (With ABS)	450	83 dB (A)
		570	83 dB (A)
Driver perceived sound level (dB (A)) According to Annex XIII (EU) 1322/2014		450	80 dB (A)
		570	78 dB (A)
Seat vibration According to Annex XIV (EU) 1322/2014			0.81 m/s <sup>2</sup>



***E)***  
***TROUBLESHOOTING***

---

# I TROUBLESHOOTING GUIDELINES

---

## ENGINE DOES NOT TURN

---

1. Ignition switch is in the OFF position.
  - Place switch to the ON position.
2. Engine stop switch.
  - Make sure that engine stop switch is in ON position.
3. Transmission is not set on PARK.
  - Set transmission in PARK or press the brake lever.
4. Burnt fuse.
  - Check main, ignition or ECM fuse condition.
5. Weak battery or loose connections.
  - Check charging system.
  - Check connections and terminals condition.
  - Have the battery checked.
  - Contact an authorized Can-Am dealer.
6. Weak starter or loose connections.
  - Check starter connections.
  - Check starter relay.

---

## ENGINE TURNS OVER BUT FAILS TO START

---

1. Flooded engine (spark plug wet when removed).
  - (Drowned mode) If the engine does not start and it is fuel-flooded, this special mode can be activated to prevent fuel injection and to cut ignition while cranking. Proceed as follows:
    - Insert key in ignition switch and turn to ON position.
    - Move shift lever in park position.
    - Press completely and HOLD throttle lever.
    - Press the engine START button.
  - The engine should be cranked for 20 seconds. Release engine START button.
  - Release throttle lever and start/crank engine again to allow starting.
  - If it does not work:**
    - Clean the spark plug caps area then remove them.
    - Remove the spark plugs.
    - Unplug injector electrical connector.
    - Crank engine several times.
    - Install new spark plugs if possible or clean and dry spark plugs.
    - Start engine as explained above.
  - If engine continues to flood, see an authorized Can-Am dealer.
  - NOTE:** Make sure to verify that there is no fuel in engine oil, if so, replace engine oil.
2. No fuel to the engine (spark plug dry when removed).
  - Check fuel tank level.
  - A failure of the fuel pump may have occurred.
  - Check fuel pump fuse and relay.
  - Contact an authorized Can-Am dealer.

---

**ENGINE TURNS OVER BUT FAILS TO START (cont'd)**

---

**3. Spark plug/ignition (no spark).**

- Remove spark plug then reconnect to ignition coil.
- Start engine with spark plug grounded to the engine away from spark plug hole. If no spark appears, replace spark plug.
- If trouble persists, contact an authorized Can-Am dealer.

**4. Multifunction gauge CHECK ENGINE indicator lamp is on and display shows CHECK ENGINE.**

- Contact an authorized Can-Am dealer.

**5. Engine is under a protection (limp home) mode.**

- Multifunction gauge CHECK ENGINE indicator lamp is on and display shows CHECK ENGINE, contact an authorized Can-Am dealer.

---

**ENGINE LACKS ACCELERATION OR POWER**

---

**1. Fouled or defective spark plug.**

- Refer to ENGINE TURNS OVER BUT FAILS TO START.

**2. Lack of fuel to engine.**

- Refer to ENGINE TURNS OVER BUT FAILS TO START.

**3. Engine is overheating. (CHECK ENGINE indicator light will turn on and HI TEMP will appear in the multifunction display.)**

- Refer to ENGINE OVERHEATS.

**4. Air filter/housing clogged or dirty.**

- Check air filter and clean if necessary.
- Check deposits in air filter housing drain.
- Check the position of the air intake tube.

**5. CVT dirty or worn-out.**

- Contact an authorized Can-Am dealer.

**6. Engine is under a protection (limp home) mode.**

- Check multifunction gauge display for messages.
- Multifunction gauge CHECK ENGINE indicator lamp is on and display shows CHECK ENGINE or LIMP HOME, contact an authorized Can-Am dealer.

---

**ENGINE OVERHEATS**

---

**1. Low coolant in cooling system.**

- Check engine coolant, refer to ENGINE COOLANT in MAINTENANCE PROCEDURES.

**2. Dirty radiator fins.**

- Clean radiator fins, refer to RADIATOR in MAINTENANCE PROCEDURES.

**3. Cooling fan inoperative.**

- Check cooling fan fuse or relay, refer to FUSES in MAINTENANCE PROCEDURES. If the fuse is good, contact an authorized Can-Am dealer.

## **ENGINE BACKFIRE**

---

- 1. Exhaust system leakage.**
  - *Contact an authorized Can-Am dealer.*
- 2. Engine is running too hot.**
  - *Refer to ENGINE LACKS ACCELERATION OR POWER.*
- 3. Ignition timing is incorrect or there is an ignition system failure.**
  - *Contact an authorized Can-Am dealer.*

## **ENGINE MISFIRE**

---

- 1. Fouled/defective/worn spark plug.**
  - *Clean/verify spark plug and heat range. Replace as required.*
- 2. Water in fuel.**
  - *Drain fuel system and refill with fresh fuel.*

## **VEHICLE CANNOT REACH FULL SPEED**

---

- 1. Engine.**
  - *Refer to ENGINE LACKS ACCELERATION OR POWER.*
- 2. Brake lock.**
  - *Ensure brake lock is completely removed.*
- 3. Air filter/housing plugged or dirty.**
  - *Check air filter and clean if necessary.*
  - *Check deposits in air filter housing drain.*
  - *Check the position of the air intake tube.*
- 4. CVT dirty or worn-out.**
  - *Contact an authorized Can-Am dealer.*
- 5. Engine is under a protection (limp home) mode.**
  - *Check multifunction gauge display for messages.*
  - *Multifunction gauge CHECK ENGINE indicator lamp is on and display shows CHECK ENGINE or LIMP HOME, contact an authorized Can-Am dealer.*

## **SHIFT LEVER IS HARD TO MOVE**

---

- 1. Transmission gears are in a position that prevents the shift lever to work.**
  - *Rock the vehicle back and forth to move the gears in the transmission and allow the shift lever to be set.*
- 2. CVT dirty or worn-out.**
  - *Contact an authorized Can-Am dealer.*

## **THE RPM INCREASES BUT THE VEHICLE DOES NOT MOVE**

---

- 1. The transmission is on PARK or NEUTRAL position.**
  - *Select the R, HI or LO position.*
- 2. CVT dirty or worn-out.**
  - *Contact an authorized Can-Am dealer.*

---

**THE RPM INCREASES BUT THE VEHICLE DOES NOT MOVE (cont'd)**

---

**3. Water in the CVT housing.**

- *Contact an authorized Can-Am dealer.*

---

**REDUCED POWER STEERING ASSIST**

---

1. When DPS is subjected to sustained severe steering conditions, the assistance provided by the DPS motor may be reduced to protect the system.
  - *Once the load is reduced, the normal steering assistance will return.*
2. **CHECK ENGINE INDICATOR LAMP is ON and display shows CHECK DPS**
  - *Seek service from an authorized Can-Am dealer, repair shop or person of your own choosing for maintenance, repair or replacement.*

---

**NO RESPONSE FROM THE THROTTLE LEVER (CHECK ENGINE IS ON AND A PPS FAULT OR TPS FAULT MESSAGE IS DISPLAYED)**

---

1. Failure of the throttle lever sensor(s) (PPS) or throttle position sensor (TPS).
  - *Refer to OVERRIDE/DPS BUTTON in CONTROLS. It may be possible to drive the vehicle in the limp home mode.*
  - *Contact an authorized Can-Am dealer.*

---

**ABS INDICATOR LIGHT ON IN THE MULTIFUNCTION GAUGE**

---

1. **Burnt fuse.**
  - *Check fuses condition.*
2. **ABS unit failure**
  - *Contact an authorized Can-Am dealer.*

**⚠ CAUTION** Even if the brakes fully operate in the event of an ABS failure, the wheels can lock up during a sudden braking. Beware of changes in brake behavior in the event of ABS failure.

## II MULTIFUNCTION GAUGE MESSAGES

MESSAGE	PILOT LAMP(S) ON	DESCRIPTION
BRAKE	None	Displayed when brake is applied for more than 15 seconds (while riding).
LO BATT VOLT	Check engine	Low battery voltage, check battery voltage and charging system.
HIGH BATT VOLT	Check engine	High battery voltage, check battery voltage and charging system.
LOW OIL <sup>(1)</sup>	Check engine	Engine low oil pressure, stop engine immediately.
HI TEMP	Check engine	Engine is overheating, refer to <i>ENGINE OVERHEATS</i> in <i>TROUBLESHOOTING</i> .
LIMP HOME	Check engine	Serious fault on the engine that can change the normal operation of the engine, CHECK ENGINE indicator lamp will also blink, refer to <i>TROUBLESHOOTING</i> .
CHECK ENGINE	Check engine	Engine fault, CHECK ENGINE indicator lamp will also be ON, refer to <i>TROUBLESHOOTING</i> .
ECM NOT RECOGNIZED	Check engine	Communication error between speedometer and engine control module (ECM), contact an authorized Can-Am dealer.
CHECK DPS (models with DPS)	Check engine	Indicates that the DPS (Dynamic Power Steering) does not work properly. See an authorized Can-Am dealer.
MAINTENANCE REQUIRED <sup>(2)</sup>	None	Displayed in gauge when vehicle is due for a maintenance
TPS FAULT PRESS OVERRIDE BUTTON TO LIMP HOME	Check engine	Faulty throttle position sensor. Refer <i>VERRIDE/DPS BUTTON</i> in <i>CONTROLS</i> . It may be possible to drive the vehicle in the limp home mode. See an authorized Can-Am dealer.
PPS FAULT PRESS OVERRIDE BUTTON TO LIMP HOME	Check engine	Faulty throttle lever sensor(s). Refer to <i>VERRIDE/DPS BUTTON</i> in <i>CONTROLS</i> . It may be possible to drive the vehicle in the limp home mode. See an authorized Can-Am dealer.
None	ABS	Indicates that the ABS (Anti-lock Brake System) and other related functions do not work properly. Refer to <i>TROUBLESHOOTING</i> .

**NOTICE** <sup>(1)</sup> If the message and the check engine light stay on after engine starting, stop engine. Check engine oil level. Refill if necessary. If the oil level is good, see an authorized Can-Am dealer. Do not use the vehicle until repaired.

<sup>(2)</sup> To erase the MAINTENANCE REQUIRED message, proceed as follows:

1. From main display (vehicle speed), press SET and HOLD.



2. Alternate between LOW beam and HIGH beam 3 times.

**NOTE:** Step 2 must be completed within **2 seconds**.

3. Release SET button.

***This page is  
intentionally blank***

# ***F) SPARE PARTS***

---

## I CATALOGS

You will find your Can-Am ATV spare parts on our website at [www.epc.brp.com](http://www.epc.brp.com).

# ***G) WARRANTY***

---

# **BRP LIMITED WARRANTY USA AND CANADA: 2021 CAN-AM® ATV**

## **SCOPE OF THE LIMITED WARRANTY**

Bombardier Recreational Products Inc. ("BRP")\* warrants its 2021 Can-Am ATV sold by authorized Can-Am ATV dealers (as hereinafter defined) in the United States of America ("USA") and in Canada from defects in material or workmanship for the period and under the conditions described below. This limited warranty will become null and void if: (1) the ATV was used for racing or any other competitive activity, at any point, even by a previous owner; or (2) the ATV has been altered or modified in such a way so as to adversely affect its operation, performance or durability, or has been altered or modified to change its intended use.

Non-factory installed parts and accessories are not covered under this limited warranty. Please refer to the applicable parts and accessories limited warranty text.

## **LIMITATIONS OF LIABILITY**

THIS WARRANTY IS EXPRESSLY GIVEN AND ACCEPTED IN LIEU OF ANY AND ALL OTHER WARRANTIES, EXPRESSED OR IMPLIED, INCLUDING WITHOUT LIMITATION ANY WARRANTY OF MERCHANTABILITY OR FITNESS FOR A PARTICULAR PURPOSE TO THE EXTENT THAT THEY CANNOT BE DISCLAIMED, THE IMPLIED WARRANTIES ARE LIMITED IN DURATION TO THE LIFE OF THE EXPRESS WARRANTY. INCIDENTAL AND CONSEQUENTIAL DAMAGES ARE EXCLUDED FROM COVERAGE UNDER THIS WARRANTY SOME STATES/PROVINCES DO NOT ALLOW FOR THE DISCLAIMERS, LIMITATIONS AND EXCLUSIONS IDENTIFIED ABOVE, AS A RESULT, THEY MAY NOT APPLY TO YOU. THIS WARRANTY GIVES YOU SPECIFIC RIGHTS, AND YOU MAY ALSO HAVE OTHER LEGAL RIGHTS WHICH MAY VARY FROM STATE TO STATE, OR PROVINCE TO PROVINCE.

Neither the distributor, any BRP dealer nor any other person has been authorized to make any affirmation, representation or warranty regarding the product, other than those contained in this limited warranty, and if made, shall not be enforceable against BRP. BRP reserves the right to modify this limited warranty at any time, being understood that such modification will not alter the warranty conditions applicable to the products sold while this warranty is in effect.

## **EXCLUSIONS – ARE NOT WARRANTED**

The following are not warranted under any circumstances:

- Normal wear and tear;
- Routine maintenance items, tune ups, adjustments;
- Damage caused by failure to provide proper maintenance and/or storage, as described in the Operator's Guide;
- Damage resulting from removal of parts, improper repairs, service, maintenance, modifications or use of parts not manufactured or approved by BRP or resulting from repairs done by a person that is not an authorized servicing Can-Am ATV dealer;
- Damage caused by abuse, abnormal use, neglect or operation of the product in a manner inconsistent with the recommended operation described in the Can-Am ATV Operator's Guide;
- Damage resulting from accident, submersion, fire, theft, vandalism or any act of God;

- Operation with fuels, oils or lubricants which are not suitable for use with the product (see the Operator’s Guide);
- Damages from rust, corrosion or exposure to the elements;
- Damage resulting from water or snow ingestion;
- Incidental or consequential damages, or damages of any kind including without limitation towing, storage, telephone, rental, taxi, inconvenience, insurance coverage, loan payments, loss of time, loss of income.

## **WARRANTY COVERAGE PERIOD**

This limited warranty will be in effect from (1) the date of delivery to the first retail consumer or (2) the date the product is first put into use, whichever occurs first and for the applicable period below:

SIX (6) CONSECUTIVE MONTHS, for private use or commercial use owners. For emission-related components; please also refer to the *US EPA EMISSION-RELATED WARRANTY* contained herein.

The repair or replacement of parts or the performance of service under this warranty does not extend the life of this warranty beyond its original expiration date.

## **CONDITIONS TO HAVE WARRANTY COVERAGE**

This warranty coverage is available **only** if **each** of the following conditions has been fulfilled:

- The 2021 Can-Am ATV must be purchased as new and unused by its first owner from a Can-Am ATV dealer authorized to distribute Can-Am ATVs in the country in which the sale occurred (“Can-Am ATV dealer”);
- The BRP specified pre-delivery inspection process must be completed and documented and signed by the purchaser;
- The 2021 Can-Am ATV must have undergone proper registration by an authorized Can-Am ATV dealer;
- The 2021 Can-Am ATV must be purchased in the country in which the purchaser resides;
- Routine maintenance outlined in the Operator’s Guide must be timely performed in order to maintain warranty coverage. BRP reserves the right to make warranty coverage contingent upon proof of proper maintenance.

BRP will not honor this limited warranty to any private use owner or commercial use owner if one of the preceding conditions has not been met. Such limitations are necessary in order to allow BRP to preserve both the safety of its products, and also that of its consumers and the general public.

## **WHAT TO DO TO OBTAIN WARRANTY COVERAGE**

The customer must cease using the Can-Am ATV upon the appearance of an anomaly. The customer must notify a servicing BRP dealer within three (3) days of the appearance of a defect, and provide it with reasonable access to the product and reasonable opportunity to repair it. The customer must also present to the authorized BRP dealer, proof of purchase of the product and must sign the repair/work order prior to starting the repair in order to validate the warranty repair. All parts replaced under this limited warranty become the property of BRP.

## **WHAT BRP WILL DO**

BRP's obligations under this warranty are limited to, at its sole discretion, repairing parts found defective under normal use, maintenance and service, or replacing such parts with new genuine Can-Am ATV parts without charge for parts and labor, at any authorized BRP dealer during the warranty coverage period under the conditions described herein. No claim of breach of warranty shall be cause for cancellation or rescission of the sale of the Can-Am ATV to the owner.

In the event that service is required outside of the country of original sale, the owner will bear responsibility for any additional charges due to local practices and conditions, such as, but not limited to, freight, insurance, taxes, license fees, import duties, and any and all other financial charges, including those levied by governments, states, territories and their respective agencies.

BRP reserves the right to improve or modify products from time to time without assuming any obligation to modify products previously manufactured.

## **ADDITIONAL SUPPLIER WARRANTIES**

A GPS receiver may be supplied by BRP as standard equipment on certain 2021 Can-Am ATV's. The GPS receiver is covered under BRP's limited warranty policy. Additional warranty coverage if offered by the GPS receiver "supplier" that is longer than BRP's limited warranty is to be dealt by the dealer or consumer directly with the GPS receiver "supplier".

## **TRANSFER**

If the ownership of a product is transferred during the warranty coverage period, this limited warranty, subject to its terms and conditions, shall also be transferred and be valid for the remaining coverage period provided BRP or an authorized Can-Am ATV Distributor/Dealer receives a proof that the former owner agreed to the transfer of ownership, in addition to the co-ordinates of the new owner.

## **CONSUMER ASSISTANCE**

In the event of a controversy or a dispute in connection with this limited warranty, BRP suggests that you try to resolve the issue at the dealership level. We recommend discussing the issue with the authorized dealer's service manager or owner.

If the matter still remains unresolved, contact BRP by filling out the customer contact form at [www.brp.com](http://www.brp.com) or contact BRP by mail at one of the addresses listed under the *CONTACT US* section of this guide.

\* In the USA, products are distributed and serviced by BRP US Inc.

© 2020 Bombardier Recreational Products Inc. All rights reserved.

™ trademark of Bombardier Recreational Products Inc. or its affiliates.

® Registered trademark of Bombardier Recreational Products Inc.



---

# US EPA EMISSION-RELATED WARRANTY

Bombardier Recreational Products Inc. (“BRP”)\* warrants to the ultimate purchaser and each subsequent purchaser that this new vehicle, including all parts of its exhaust emission control system and its evaporative emission control system, meets two conditions:

1. It is designed, built, and equipped so it conforms at the time of sale to the ultimate purchaser with the requirements of 40 CFR 1051 and 40 CFR 1060.
2. It is free from defects in materials and workmanship that may keep it from meeting the requirements of 40 CFR 1051 and 40 CFR 1060.

Where a warrantable condition exists, BRP will repair or replace, as it elects, any part or component with a defect in materials or workmanship that would increase the engine’s emissions of any regulated pollutant within the stated warranty period at no cost to the owner, including expenses related to diagnosing and repairing or replacing emission-related parts. All defective parts replaced under this warranty become the property of BRP.

For all emission-related warranty claims, BRP is limiting the diagnosis and repair of emission-related parts to the authorized Can-Am dealers, unless for emergency repairs as required by item 2 of the following list.

As a certifying manufacturer, BRP will not deny emission-related warranty claims based on any of the following:

1. Maintenance or other service BRP or BRP’s authorized facilities performed.
2. Engine/equipment repair work that an operator performed to correct an unsafe, emergency condition attributable to BRP as long as the operator tries to restore the engine/equipment to its proper configuration as soon as possible.
3. Any action or inaction by the operator unrelated to the warranty claim.
4. Maintenance that was performed more frequently than BRP specify.
5. Anything that is BRP fault or responsibility.
6. The use of any fuel that is commonly available where the equipment operates unless BRP written maintenance instructions state that this fuel would harm the equipment’s emission control system and operators can readily find the proper fuel. See maintenance information section and fuel requirements of fueling section.

## Emission-Related Warranty Period

The emission-related warranty is valid for the following period whichever comes first:

	HOURS	MONTHS	KILOMETERS
Exhaust emission-related components	500	30	5000
Evaporative emission-related components	N/A	24	N/A

## Components Covered

The emission-related warranty covers all components whose failure would increase an engine's emissions of any regulated pollutant, including the following listed components:

1. For exhaust emissions, emission-related components include any engine parts related to the following systems:
  - Air-induction system
  - Fuel system
  - Ignition system
  - Exhaust gas recirculation systems
2. The following parts are also considered emission-related components for exhaust emissions:
  - Aftertreatment devices
  - Crankcase ventilation valves
  - Sensors
  - Electronic control units
3. The following parts are considered emission-related components for evaporative emissions:
  - Fuel tank
  - Fuel cap
  - Fuel line
  - Fuel line fittings
  - Clamps\*
  - Pressure relief valves\*
  - Control valves\*
  - Control solenoids\*
  - Electronic controls\*
  - Vacuum control diaphragms\*
  - Control cables\*
  - Control linkages\*
  - Purge valves
  - Vapor hoses
  - Liquid/vapor separator
  - Carbon canister
  - Canister mounting brackets
  - Carburetor purge port connector
4. Emission-related components also include any other part whose only purpose is to reduce emissions or whose failure will increase emissions without significantly degrading engine/equipment performance.

\*As related to the evaporative emission control system

## **Limited Applicability**

As a certifying manufacturer, BRP may deny emission-related warranty claims for failures that have been caused by the owner's or operator's improper maintenance or use, by accidents for which the manufacturer has no responsibility, or by acts of God. For example, an emission-related warranty claim need not be honored for failures that have been directly caused by the operator's abuse of the engine/equipment or the operator's use of the engine/equipment in a manner for which it was not designed and are not attributable to the manufacturer in any way.

If you have any question regarding your warranty rights and responsibility, you should contact Bombardier Recreational Products at 1-888-272-9222.

\* In the USA, products are distributed and serviced by BRP US Inc.

---

# **BRP INTERNATIONAL LIMITED WARRANTY: 2021 CAN-AM® ATV**

## **1) SCOPE OF THE LIMITED WARRANTY**

Bombardier Recreational Products Inc. ("BRP")\* warrants its 2021 Can-Am ATV sold by Can-Am ATV distributors or dealers authorized by BRP to distribute Can-Am ATVs ("Can-Am ATV Distributor/Dealer") outside of the United States of America ("USA"), Canada, member states of the European Economic Area (which is comprised of the member states of the European Union the United Kingdom, plus Norway, Iceland and Liechtenstein) ("EEA"), Turkey, member states of the Commonwealth of the Independent States (including Ukraine and Turkmenistan) ("CIS") and Turkey, from defects in material or workmanship for the period and under the conditions described below.

Non-factory installed parts and accessories are not covered under this limited warranty. Please refer to the applicable parts and accessories limited warranty text.

This limited warranty will become null and void if: (1) The ATV was used for racing or any other competitive activity, at any point, even by a previous owner; or (2) the ATV has been altered or modified in such a way so as to adversely affect its operation, performance or durability, or has been altered or modified to change its intended use.

## **2) LIMITATIONS OF LIABILITY**

TO THE EXTENT PERMITTED BY LAW, THIS WARRANTY IS EXPRESSLY GIVEN AND ACCEPTED IN LIEU OF ANY AND ALL OTHER WARRANTIES, EXPRESSED OR IMPLIED, INCLUDING WITHOUT LIMITATION ANY WARRANTY OF MERCHANTABILITY OR FITNESS FOR A PARTICULAR PURPOSE. TO THE EXTENT THAT THEY CANNOT BE DISCLAIMED, THE IMPLIED WARRANTIES ARE LIMITED IN DURATION TO THE LIFE OF THE EXPRESS WARRANTY. INCIDENTAL AND CONSEQUENTIAL DAMAGES ARE EXCLUDED FROM COVERAGE UNDER THIS WARRANTY. SOME JURISDICTIONS DO NOT ALLOW FOR THE DISCLAIMERS, LIMITATIONS AND EXCLUSIONS IDENTIFIED ABOVE, AS A RESULT, THEY MAY NOT APPLY TO YOU. THIS WARRANTY GIVES YOU SPECIFIC RIGHTS AND YOU MAY ALSO HAVE OTHER LEGAL RIGHTS WHICH MAY VARY FROM COUNTRY TO COUNTRY. (FOR PRODUCTS PURCHASED IN AUSTRALIA SEE CLAUSE 4 BELOW).

Neither the Can-Am ATV Distributor/Dealer nor any other person has been authorized to make any affirmation, representation or warranty regarding the product, other than those contained in this limited warranty, and if made, shall not be enforceable against BRP.

BRP reserves the right to modify this warranty at any time, being understood that such modification will not alter the warranty conditions applicable to the products sold while this warranty is in effect.

### **3) EXCLUSIONS – ARE NOT WARRANTED**

The following are not warranted under this limited warranty under any circumstances:

- Normal wear and tear;
- Routine maintenance items, tune ups, adjustments;
- Damage caused by negligence or failure to provide proper maintenance and/or storage, as described in the Operator's Guide;
- Damage resulting from removal of parts, improper repairs, service, maintenance, modifications or use of parts or accessories not manufactured or approved by BRP which in its reasonable judgement are either incompatible with the product or adversely affect its operation, performance and durability, or resulting from repairs done by a person that is not an authorized servicing Can-Am ATV Distributor/Dealer;
- Damage caused by abuse, abnormal use, neglect, racing or operation of the product in a manner inconsistent with the recommended operation described in the Operator's Guide;
- Damage resulting from accident, submersion, fire, snow or water ingestion, theft, vandalism or any act of God;
- Operation with fuels, oils or lubricants which are not suitable for use with the product (see the Operator's Guide);
- Damage resulting from rust, corrosion or exposure to the elements;
- Incidental or consequential damages, or damages of any kind including without limitation towing, storage, transportation expenses, telephone, rental, taxi, inconvenience, insurance coverage, loan payments, loss of time, loss of income; or time missed for downtime experience due to service work.

### **4) WARRANTY COVERAGE PERIOD**

This warranty will be in effect from (1) the date of delivery to the first retail consumer or (2) the date the product is first put into use, whichever occurs first and for a period of:

SIX (6) CONSECUTIVE MONTHS for private use or commercial use.

In AUSTRALIA and NEW-ZEALAND only, this warranty will be in effect from (1) the date of delivery to the first retail consumer or (2) the date the product is first put into use, whichever occurs first, and for a period of (1) TWENTY-FOUR (24) CONSECUTIVE MONTHS or (2) a total use of FIFTEEN THOUSAND (15 000) kilometers, whichever occurs first, for private use or commercial use.

The repair or replacement of parts or the performance of service under this warranty does not extend the life of this warranty beyond its original expiration date.

Note that the duration and any other modalities of the warranty coverage are subject to the applicable national or local legislation in the customer's country.

## **FOR PRODUCTS SOLD IN AUSTRALIA ONLY**

Nothing in these Warranty terms and conditions should be taken to exclude, restrict or modify the application of any condition, warranty, guarantee, right or remedy conferred or implied under the Competition and Consumer Act 2010 (Cth), including the Australian Consumer Law or any other law, where to do so would contravene that law, or cause any part of these terms and conditions to be void. The benefits given to you under this limited warranty are in addition to other rights and remedies that you have under Australian law.

Our goods come with guarantees that cannot be excluded under the Australian Consumer Law. You are entitled to a replacement or refund for a major failure and for compensation for any other reasonably foreseeable loss or damage. You are also entitled to have the goods repaired or replaced if the goods fail to be of acceptable quality and the failure does not amount to a major failure.

## **5) CONDITIONS TO HAVE WARRANTY COVERAGE**

This warranty coverage is available **only** if **each** of the following conditions has been fulfilled:

- The 2021 Can-Am ATV must be purchased as new and unused by its first owner from a Can-Am ATV Distributor/Dealer authorized to distribute Can-Am ATVs in the country in which the sale occurred;
- The BRP specified pre-delivery inspection process must be completed and documented;
- The product must have undergone proper registration by an authorized Can-Am ATV Distributor/Dealer;
- The 2021 Can-Am ATV must be purchased in the country or union of countries in which the purchaser resides; and
- Routine maintenance outlined in the Operator's Guide must be timely performed in order to maintain warranty coverage. BRP reserves the right to make warranty coverage contingent upon proof of proper maintenance.

BRP will not honour this limited warranty to any private use owner or commercial use owner if one of the preceding conditions has not been met. Such limitations are necessary in order to allow BRP to preserve both the safety of its products, and also that of its consumers and the general public.

## **6) WHAT TO DO TO OBTAIN WARRANTY COVERAGE**

The customer must cease using the ATV upon the appearance of an anomaly. The customer must notify a servicing Can-Am ATV Distributor/Dealer within two (2) days of the appearance of a defect, and provide it with reasonable access to the product and reasonable opportunity to repair it. The customer must also present to the authorized Can-Am ATV Distributor/Dealer proof of purchase of the product and must sign the repair/work order prior to starting the repair in order to validate the warranty repair. All parts replaced under this limited warranty become the property of BRP.

Note that the notification period is subject to the applicable national or local legislation in customer's country.

## **7) WHAT BRP WILL DO**

To the extent permitted by law, BRP's obligations under this warranty are limited to, at its sole discretion, repairing parts found defective under normal use, maintenance and service, or replacing such parts with new genuine Can-Am ATV parts without charge for parts and labour, at any authorized Can-Am ATV Distributor/Dealer during the warranty coverage period under the conditions described herein. BRP's responsibility is limited to making the required repairs or replacements of parts. No claim of breach of warranty shall be cause for cancellation or rescission of the sale of the Can-Am ATV to the owner. You may have other legal rights which may vary from country to country.

In the event that service is required outside of the country of original sale, the owner will bear responsibility for any additional charges due to local practices and conditions, such as, but not limited to, freight, insurance, taxes, license fees, import duties, and any and all other financial charges, including those levied by governments, states, territories and their respective agencies.

BRP reserves the right to improve or modify products from time to time without assuming any obligation to modify products previously manufactured.

## **8) TRANSFER**

If the ownership of a product is transferred during the warranty coverage period, this warranty shall also be transferred and be valid for the remaining coverage period provided BRP or an authorized Can-Am ATV Distributor/Dealer receives a proof that the former owner agreed to the transfer of ownership, in addition to the coordinates of the new owner.

## **9) CONSUMER ASSISTANCE**

In the event of a controversy or a dispute in connection with this limited warranty, BRP suggests that you try to resolve the issue at the Can-Am ATV Distributor/Dealer level. We recommend discussing the issue with the authorized Can-Am ATV Distributor/Dealer's service manager or owner.

If the matter still remains unresolved, contact BRP by filling out the customer contact form at [www.brp.com](http://www.brp.com) or contact BRP by mail at one of the addresses listed under the *CONTACT US* section of this guide.

\* For the territory covered by this limited warranty, products are distributed and serviced by Bombardier Recreational Products Inc. or its affiliates.

© 2020 Bombardier Recreational Products Inc. All rights reserved.

™ Trademark of Bombardier Recreational Products Inc. or its affiliates.

® Registered trademark of Bombardier Recreational Products Inc.

---

# **BRP LIMITED WARRANTY FOR THE EUROPEAN ECONOMIC AREA, THE COMMONWEALTH OF THE INDEPENDENT STATES AND TURKEY: 2021 CAN-AM® ATV**

## **1) SCOPE OF THE LIMITED WARRANTY**

Bombardier Recreational Products Inc. ("BRP")\* warrants its 2021 Can-Am ATVs sold by distributors or dealers authorized by BRP to distribute Can-Am ATVs ("Can-Am ATV Distributor/Dealer") in member states of the European Economic Area (which is comprised of the member states of the European Union plus the United Kingdom, Norway, Iceland and Liechtenstein) ("EEA"), in member states of the Commonwealth of the Independent States (including Ukraine and Turkmenistan) ("CIS") and Turkey from defects in material or workmanship for the period and under the conditions described below.

Non-factory installed parts and accessories are not covered under this limited warranty. Please refer to the applicable parts and accessories limited warranty text.

This limited warranty will become null and void if: (1) The ATV was used for racing or any other competitive activity, at any point, even by a previous owner; or (2) the ATV has been altered or modified in such a way so as to adversely affect its operation, performance or durability, or has been altered or modified to change its intended use.

## **2) LIMITATIONS OF LIABILITY**

TO THE EXTENT PERMITTED BY LAW, THIS WARRANTY IS EXPRESSLY GIVEN AND ACCEPTED IN LIEU OF ANY AND ALL OTHER WARRANTIES, EXPRESSED OR IMPLIED, INCLUDING WITHOUT LIMITATION ANY WARRANTY OF MERCHANTABILITY OR FITNESS FOR A PARTICULAR PURPOSE. TO THE EXTENT THAT THEY CANNOT BE DISCLAIMED, THE IMPLIED WARRANTIES ARE LIMITED IN DURATION TO THE LIFE OF THE EXPRESS WARRANTY. INCIDENTAL AND CONSEQUENTIAL DAMAGES ARE EXCLUDED FROM COVERAGE UNDER THIS WARRANTY. SOME JURISDICTIONS DO NOT ALLOW FOR THE DISCLAIMERS, LIMITATIONS AND EXCLUSIONS IDENTIFIED ABOVE, AS A RESULT, THEY MAY NOT APPLY TO YOU. THIS WARRANTY GIVES YOU SPECIFIC RIGHTS AND YOU MAY ALSO HAVE OTHER LEGAL RIGHTS WHICH MAY VARY FROM COUNTRY TO COUNTRY.

Neither the Can-Am ATV Distributor/Dealer nor any other person has been authorized to make any affirmation, representation or warranty regarding the product, other than those contained in this limited warranty, and if made, shall not be enforceable against BRP.

BRP reserves the right to modify this warranty at any time, being understood that such modification will not alter the warranty conditions applicable to the products sold while this warranty is in effect.



### **3) EXCLUSIONS – ARE NOT WARRANTED**

The following are not warranted under this limited warranty under any circumstances:

- Normal wear and tear;
- Routine maintenance items, tune ups, adjustments;
- Damage caused by negligence or failure to provide proper maintenance and/or storage, as described in the Operator's Guide;
- Damage resulting from removal of parts, improper repairs, service, maintenance, modifications or use of parts or accessories not manufactured or approved by BRP which in its reasonable judgement are either incompatible with the product or adversely affect its operation, performance and durability, or resulting from repairs done by a person that is not an authorized servicing Can-Am/Can-Am ATV Distributor/Dealer;
- Damage caused by abuse, abnormal use, neglect, racing or operation of the product in a manner inconsistent with the recommended operation described in the Operator's Guide;
- Damage resulting from accident, submersion, fire, snow or water ingestion, theft, vandalism or any act of God;
- Operation with fuels, oils or lubricants which are not suitable for use with the product (see the Operator's Guide);
- Damage resulting from rust, corrosion or exposure to the elements;
- Incidental or consequential damages, or damages of any kind including without limitation towing, transportation expenses, storage, telephone, rental, taxi, inconvenience, insurance coverage, loan payments, loss of time, loss of income or time missed for downtime experience due to service work.

### **4) WARRANTY COVERAGE PERIOD**

This warranty will be in effect from (1) the date of delivery to the first retail consumer or (2) the date the product is first put into use, whichever occurs first and for a period of:

TWENTY-FOUR (24) CONSECUTIVE MONTHS for private use.

SIX (6) CONSECUTIVE MONTHS for commercial use or rental use.

The product is used commercially when it is used in connection with any work or employment that generates income during any part of the warranty period. The product is also used commercially when, at any point during the warranty period, it is licensed for commercial use.

The repair or replacement of parts or the performance of service under this warranty does not extend the life of this warranty beyond its original expiration date.

Note that the duration and any other modalities of the warranty coverage are subject to the applicable national or local legislation in the customer's country.

## **5) CONDITIONS TO HAVE WARRANTY COVERAGE**

This warranty coverage is available **only** if **each** of the following conditions has been fulfilled:

- The 2021 Can-Am ATV must be purchased as new and unused by its first owner from a Can-Am ATV Distributor/Dealer authorized to distribute Can-Am ATVs in the country in which the sale occurred;
- The BRP specified pre-delivery inspection process must be completed and documented;
- The product must have undergone proper registration by an authorized Can-Am ATV Distributor/Dealer;
- The 2021 Can-Am ATV must be purchased within the EEA by an EEA resident, in the CIS for residents of the countries comprised in such area and in Turkey for residents of Turkey; and
- Routine maintenance outlined in the Operator's Guide must be timely performed in order to maintain warranty coverage. BRP reserves the right to make warranty coverage contingent upon proof of proper maintenance.

BRP will not honour this limited warranty to any private use owner or commercial use owner if one of the preceding conditions has not been met. Such limitations are necessary in order to allow BRP to preserve both the safety of its products, and also that of its consumers and the general public.

## **6) WHAT TO DO TO OBTAIN WARRANTY COVERAGE**

The customer must cease using the ATV upon the appearance of an anomaly. The customer must notify a servicing Can-Am ATV Distributor/Dealer within two (2) months of the appearance of a defect and provide it with reasonable access to the product and reasonable opportunity to repair it. The customer must also present to the authorized Can-Am ATV Distributor/Dealer, proof of purchase of the product and must sign the repair/work order prior to starting the repair in order to validate the warranty repair. All parts replaced under this limited warranty become the property of BRP.

Note that the notification period is subject to the applicable national or local legislation in customer's country.

## **7) WHAT BRP WILL DO**

To the extent permitted by law, BRP's obligations under this warranty are limited to, at its sole discretion, repairing parts found defective under normal use, maintenance and service, or replacing such parts with new genuine Can-Am ATV parts without charge for parts and labour, at any authorized Can-Am ATV Distributor/Dealer during the warranty coverage period under the conditions described herein. BRP's responsibility is limited to making the required repairs or replacements of parts. No claim of breach of warranty shall be cause for cancellation or rescission of the sale of the Can-Am ATV to the owner. You may have other legal rights which may vary from country to country.

In the event that service is required outside of the EEA, CIS or Turkey, the owner will bear responsibility for any additional charges due to local practices and conditions, such as, but not limited to, freight, insurance, taxes, license fees, import duties, and any and all other financial charges, including those levied by governments, states, territories and their respective agencies.

BRP reserves the right to improve or modify products from time to time without assuming any obligation to modify products previously manufactured.

## **8) TRANSFER**

If the ownership of a product is transferred during the warranty coverage period, this warranty shall also be transferred and be valid for the remaining coverage period provided BRP or an authorized Can-Am ATV Distributor/Dealer receives a proof that the former owner agreed to the transfer of ownership, in addition to the coordinates of the new owner.

## **9) CONSUMER ASSISTANCE**

In the event of a controversy or a dispute in connection with this limited warranty, BRP suggests that you try to resolve the issue at the Can-Am ATV Distributor/Dealer level. We recommend discussing the issue with the authorized Can-Am ATV Distributor/Dealer's service manager or owner.

If the matter still remains unresolved, contact BRP by filling out the customer contact form at [www.brp.com](http://www.brp.com) or contact BRP by mail at one of the addresses listed under the *CONTACT US* section of this guide.

\* In the EEA, products are distributed and serviced by BRP European Distribution S.A. and other affiliates or subsidiaries of BRP.

© 2020 Bombardier Recreational Products Inc. All rights reserved.

™ Trademark of Bombardier Recreational Products Inc. or its affiliates.

® Registered trademark of Bombardier Recreational Products Inc.

## **ADDITIONAL TERMS AND CONDITIONS FOR FRANCE ONLY**

The following terms and conditions are applicable to products sold in France only:

The seller shall deliver goods that are complying with the contract and shall be responsible for defects existing upon delivery. The seller shall also be responsible for defects resulting from packaging, assembling instructions or the installation when it is its responsibility per the contract or if accomplished under its responsibility. To be compliant with the contract, the good shall:

1. Be fit for normal use for goods similar thereto and, if applicable:
  - Correspond to the description provided by the seller and have the qualities presented to the buyer through sample or model;
  - Have the qualities that a buyer may legitimately expect considering the public declarations of the seller, the manufacturer of its representative, including in advertising or labeling; or
2. Have the characteristics mutually agreed upon as between the parties or be fit for the specific use intended by the buyer and brought to the attention of the seller and which accepted by the seller.

The action for failure to comply is prescribed after two years after delivery of the goods. The seller is responsible for the warranty for hidden defects of the good sold if such hidden defects are rendering the good unfit for the intended use, or if they diminish its use in such a way that the buyer would not have acquired the good or would have given a lesser price, had he known. The action for such hidden defects shall be taken by the buyer within 2 years of the discovery of the defect.

# ***H) CUSTOMER INFORMATION***

---

## I PRIVACY INFORMATION

BRP wishes to inform you that your coordinates will be used for safety and warranty related purposes. Furthermore, BRP and its affiliates may use its customer list to distribute marketing and promotional information about BRP and related products.

To exercise your right to consult or correct your data, or to be removed from the addressee-list for direct marketing, please contact BRP.

By E-mail: [privacyofficer@brp.com](mailto:privacyofficer@brp.com)

By mail:

BRP  
Senior Legal Counsel-Privacy Officer  
726 St-Joseph  
Valcourt QC  
Canada  
J0E 2L0

---

## II CONTACT US

www.brp.com

### Asia

Room 4609, Tower 2,  
Grand Gateway 3 Hong Qiao  
Road Shanghai,  
China 200020

21F Shinagawa East One Tower  
2-16-1 Konan, Minatoku-ku,  
Tokyo 108-0075  
Japan

### Europe

Skaldenstraat 125  
B-9042 Gent  
Belgium

Itterpark 11  
D-40724 Hilden  
Germany

ARTEPARC Bâtiment B  
Route de la côte d'Azur, Le Canet  
13590 Meyreuil  
France

Ingvald Ystgaardsvei 15  
N-7484 Trondeim  
Norway

Isoaavantie 7  
PL 8040  
96101 Rovaniemi

Spinnvägen 15  
903 61 Umeå  
Sweden

Avenue d'Ouchy 4-6  
1006 Lausanne  
Switzerland

### North America

565 de la Montagne Street  
Valcourt (Québec) J0E 2L0  
Canada

Sa De Cv, Av. Ferrocarril 202  
Parque Ind. Querétaro, Lote2-B  
76220

Santa Rosa Jáuregui, Qro., Mexico

Sturtevant, Wisconsin, U.S.A.

10101 Science Drive  
Sturtevant, Wisconsin

53177  
U.S.A.

### Oceania

6 Lord Street  
Lakes Business Park  
Botany, NSW 2019  
Australia

3B Echelon Place, East Tamaki,  
Auckland 2013,  
New Zealand

### South America

Rua James Clerck Maxwell, 230  
TechnoPark Campinas SP 13069-380  
Brazil

---

## III CHANGE OF ADDRESS/OWNERSHIP

If your address has changed or if you are the new owner of the ATV, be sure to notify BRP by either:

- Notifying an authorized Can-Am dealer.
- Mailing one of the change of address cards on the following pages at one of the BRP addresses indicated in the *CONTACT US* section of this guide.

In case of change of ownership, please join a proof that the former owner agreed to the transfer.

Notifying BRP, even after the expiration of the limited warranty, is very important as it enables BRP to reach the ATV owner if necessary, like when safety recalls are initiated. It is the owner's responsibility to notify BRP.

**STOLEN UNITS:** If your personal ATV is stolen, you should notify BRP or an authorized Can-Am dealer. We will ask you to provide your name, address, phone number, the vehicle identification number and the date it was stolen.





***This page is  
intentionally blank***



## NOTES



## NOTES

# IV MAINTENANCE RECORDS

Send photocopy of maintenance record to BRP if needed.

<b>PREDELIVERY</b>	
Serial number: _____ Mileage / km: _____ Hours: _____ Date: _____ Dealer no: _____ Notes: _____	Signature/Print: _____
Refer to vehicle Pre-Delivery Bulletin for detailed installation procedures	

<b>FIRST INSPECTION</b>	
Serial number: _____ Mileage / km: _____ Hours: _____ Date: _____ Dealer no: _____ Notes: _____	Signature/Print: _____
For maintenance schedule refer to Maintenance Information section of this operator's guide	

<b>SERVICE</b>	
Serial number: _____ Mileage / km: _____ Hours: _____ Date: _____ Dealer no: _____ Notes: _____	Signature/Print: _____
For maintenance schedule refer to Maintenance Information section of this operator's guide	

<b>SERVICE</b>	
Serial number: _____ Mileage / km: _____ Hours: _____ Date: _____ Dealer no: _____ Notes: _____	Signature/Print: _____
For maintenance schedule refer to Maintenance Information section of this operator's guide	

<b>SERVICE</b>	
Serial number: _____ Mileage / km: _____ Hours: _____ Date: _____ Dealer no: _____ Notes: _____ _____ _____	Signature/Print: _____      
For maintenance schedule refer to Maintenance Information section of this operator's guide	

<b>SERVICE</b>	
Serial number: _____ Mileage / km: _____ Hours: _____ Date: _____ Dealer no: _____ Notes: _____ _____ _____	Signature/Print: _____      
For maintenance schedule refer to Maintenance Information section of this operator's guide	

<b>SERVICE</b>	
Serial number: _____ Mileage / km: _____ Hours: _____ Date: _____ Dealer no: _____ Notes: _____ _____ _____	Signature/Print: _____      
For maintenance schedule refer to Maintenance Information section of this operator's guide	

<b>SERVICE</b>	
Serial number: _____ Mileage / km: _____ Hours: _____ Date: _____ Dealer no: _____ Notes: _____ _____ _____	Signature/Print: _____      
For maintenance schedule refer to Maintenance Information section of this operator's guide	





## **WARNING**

### **THIS VEHICLE CAN BE HAZARDOUS TO OPERATE.**

A collision or rollover can occur quickly, even during routine maneuvers such as turning and driving on hills or over obstacles, if you fail to take proper precautions.

### **SEVERE INJURY OR DEATH**

can result if you do not follow these instructions:

- **BEFORE YOU OPERATE THIS VEHICLE, READ THIS OPERATOR'S GUIDE, ALL ON PRODUCT SAFETY LABELS AND WATCH THE SAFETY VIDEO.**



- **NEVER OPERATE THIS VEHICLE WITHOUT PROPER INSTRUCTIONS.**  
Complete a certified training course.
- **DO NOT EXCEED VEHICLE SEATING CAPACITY**
- **FOR 1UP MODELS, NEVER CARRY A PASSENGER.**  
You increase your risk of losing control if you carry a passenger.

- **NEVER OPERATE THIS VEHICLE ON A PAVED SURFACE.**

You increase your risk of losing control if you operate this vehicle on pavement.

- **NEVER OPERATE THIS VEHICLE ON PUBLIC ROADS.**

You can collide with another vehicle if you operate this vehicle on a public road.

- **OPERATOR AND PASSENGER (MAX models) SHOULD ALWAYS WEAR AN APPROVED HELMET,** eye protection, and protective clothing.

- **NEVER USE WITH DRUGS OR ALCOHOL.**

They slow reaction time and impair judgment.

- **NEVER OPERATE THIS VEHICLE AT EXCESSIVE SPEEDS.**

You increase your risk of losing control if you operate this vehicle at speeds too fast for the terrain, visibility conditions, or your experience.

- **NEVER ATTEMPT WHEELIES, JUMPS, OR OTHER STUNTS.**

219 002 160

OPERATOR'S GUIDE OUTLANDER T Series / ENGLISH  
GUIDE DU CONDUCTEUR Series OUTLANDER T / ANGLAIS

FAIT AU / MADE IN CANADA

®TM AND THE BRP LOGO ARE TRADEMARKS OF BOMBARDIER RECREATIONAL PRODUCTS INC. OR ITS AFFILIATES.  
©2020 BOMBARDIER RECREATIONAL PRODUCTS INC. ALL RIGHTS RESERVED. PRINTED IN CANADA.

