

can-am™



2014

**Operator's
Guide**

**Includes
Safety, Vehicle
and Maintenance Information**

OUTLANDER™ 400 EFI
OUTLANDER™ MAX 400 EFI

⚠ WARNING

Read this guide thoroughly. It contains important safety information.
Minimum recommended age: Operator: 16 years old. Keep this Operator's Guide in the vehicle.

2 1 9 0 0 1 1 8 0



WARNING

YOUR VEHICLE CAN BE HAZARDOUS TO OPERATE. A collision or rollover can occur quickly, if you fail to take proper precautions, even during routine maneuvers such as turning and driving on hills or over obstacles. For your safety, understand and follow all the warnings contained in this Operator's Guide and on the labels on your vehicle. **Failure to follow these warnings can result in SEVERE INJURY OR DEATH!** Keep this Operator's Guide with the vehicle at all times.

WARNING

Disregarding any of the safety precautions and instructions contained in this Operator's Guide, *SAFETY DVD* video and on-product safety labels could result in an injury including the possibility of death!

WARNING

This vehicle may exceed the performance of other vehicles you may have ridden in the past. Take time to familiarize yourself with your new vehicle.

The following trademarks are the property of Bombardier Recreational Products Inc.:

Can-Am™

TTI™

Outlander™

XPS™

Rotax®

D.E.S.S.™

FOREWORD

Deutsch	Dieses Handbuch ist möglicherweise in Ihrer Landessprache verfügbar. Bitte wenden Sie sich an Ihren Händler oder besuchen Sie: www.operatorsguide.brp.com .
English	This guide may be available in your language. Check with your dealer or go to: www.operatorsguide.brp.com .
Español	Es posible que este manual esté disponible en su idioma. Consulte a su distribuidor o visite: www.operatorsguide.brp.com .
Français	Ce guide peut être disponible dans votre langue. Vérifier avec votre concessionnaire ou aller à: www.operatorsguide.brp.com .
Nederlands	Deze handleiding kan beschikbaar zijn in uw taal. Vraag het aan uw dealer of ga naar: www.operatorsguide.brp.com .
Norsk	Denne boken kan finnes tilgjengelig på ditt eget språk. Kontakt din forhandler eller gå til: www.operatorsguide.brp.com .
Português	Este manual pode estar disponível em seu idioma. Fale com sua concessionária ou visite o site: www.operatorsguide.brp.com .
Suomi	Käyttöohjekirja voi olla saatavissa omalla kielelläsi. Tarkista jälleenmyyjältä tai käy osoitteessa: www.operatorsguide.brp.com
Svenska	Denna bok kan finnas tillgänglig på ditt språk. Kontakta din återförsäljare eller gå till: www.operatorsguide.brp.com .

Congratulations on your purchase of a new Can-Am™ ATV. It is backed by the BRP warranty and a network of authorized Can-Am dealers ready to provide the parts, service or accessories you may require.

Your dealer is committed to your satisfaction. He has taken training to perform the initial setup and inspection of your vehicle as well as completed the final adjustment before you took possession. If you need more complete servicing information, please ask your dealer.

At delivery, you were also informed of the warranty coverage and signed the *PREDELIVERY CHECK LIST* to ensure your new vehicle was prepared to your entire satisfaction.

Know Before you Go

To learn how to reduce the risk for you or bystanders being injured or killed, read this Operator's Guide before you operate the vehicle.

Also, read all safety labels on your ATV and watch attentively your *SAFETY DVD* video.

Failure to follow the warnings contained in this Operator's Guide can result in **SERIOUS INJURY** or **DEATH**.

Age Recommendation

This vehicle is a category G, always follow this age recommendation: A person under 16 years old should never operate this vehicle.

This vehicle is for recreational use by experienced operator's only.

Passenger on 2-UP models must be capable of keeping his feet on the footrests and his hands on grab handles at all times when seated on this vehicle.

Training Course

Never operate this vehicle without proper instruction. **Take a training course.** All operators should receive training from a certified instructor.

FOR MORE INFORMATION ABOUT ATV SAFETY, contact an authorized Can-Am dealer to find out about available training courses nearest you.

Safety Messages

The types of safety messages, what they look like and how they are used in this guide are explained as follows:

The safety alert symbol  indicates a potential injury hazard.

WARNING

Indicates a potential hazard, if not avoided, could result in serious injury or death.

 **CAUTION** Indicates a hazard situation which, if not avoided, could result in minor or moderate injury.

NOTICE Indicates an instruction which, if not followed, could severely damage vehicle components or other property.

About this Operator's Guide

This Operator's Guide has been prepared to acquaint the owner/operator of a new vehicle with the various vehicle controls, maintenance and safe operating instructions. It is indispensable for the proper use of the product.

While reading this Operator's Guide, remember that:

WARNING

Indicates a potential hazard that, if not avoided, could result in serious injury or death.

WARNING

Throughout this Operator's Guide, the term "1-UP" refers to vehicles designed to carry the operator only while the term "2-UP" refers to vehicles designed to carry also a passenger.

Make sure to identify and follow the warnings and instructions that are applicable to your specific model.

Note that this guide is available in several languages. In the event of any discrepancy, the English version shall prevail.

Keep this Operator's Guide in the vehicle as you can refer to it for things such as maintenance, troubleshooting and instructing others.

If you want to view and/or print an extra copy of your Operator's Guide, simply visit the following website www.operatorsguide.brp.com.

The information contained in this document are correct at the time of publication. However, BRP maintains a policy of continuous improvement of its products without imposing upon itself any obligation to install them on products previously manufactured. Due to late changes, some differences between the manufactured product and the descriptions and/or specifications in this guide may occur. BRP reserves the right at any time to discontinue or change specifications, designs, features, models or equipment without incurring any obligation upon itself.

This Operator's Guide and the *SAFETY DVD* video should remain with the vehicle when it is sold.

TABLE OF CONTENTS

FOREWORD	1
Know Before you Go	1
Safety Messages	2
About this Operator's Guide	2

SAFETY INFORMATION

GENERAL PRECAUTIONS	8
Avoid Carbon Monoxide Poisoning	8
Avoid Gasoline Fires and Other Hazards	8
Avoid Burns from Hot Parts	8
Accessories and Modifications	8
SPECIAL SAFETY MESSAGES	9
European Community	12
OPERATION WARNINGS	13
RIDING THE VEHICLE	42
Pre-Ride Inspection	43
Clothing	45
Carrying a Passenger	46
Carrying Loads	47
Hauling a Trailer	47
Working with your Vehicle	48
Recreational Riding	48
Environment	49
Design Limitation	49
Off-Road Operation	49
General Operating and Safety Precautions	50
Riding Techniques	52
IMPORTANT ON-PRODUCT LABELS	61
Hang Tag	61
Vehicle Safety Labels	63
Compliance Labels	69
Technical Information Labels	69

VEHICLE INFORMATION

CONTROLS/INSTRUMENTS/EQUIPMENT	72
1) Throttle Lever	75
2) 2WD/4WD Selector	75
3) LH Brake Lever	76
4) Brake Lock	76
5) Shift Lever	77
6) Headlight Dimmer Switch	78
7) Emergency Engine Stop Switch	78
8) Engine Start Button	78

CONTROLS/INSTRUMENTS/EQUIPMENT (cont'd)	
9) Override Button	79
10) Multifunction Gauge	79
11) 12-Volt Power Outlet	84
12) Ignition Switch	84
13) Brake Pedal	85
14) Footpegs	85
15) Grab Handles	86
16) Passenger's Seat	86
17) Glove Box	87
18) Operator's Seat Latch	88
19) Rear Storage Compartment	89
20) Cargo Racks	89
21) Trailer Hitch	90
22) Tool Kit	90
23) Winch (XT Models)	90
24) Winch Control Switch (XT Models)	90
25) Vehicle Lock	91
26) Turn Signal Switch	91
27) Horn Button	91
28) Hazard Warning Button	91
29) Front Service Compartment	92
30) Winch Remote Control (XT Models)	92
FUEL	94
Fuel Requirements	94
Fueling Procedure	94
BREAK-IN PERIOD	96
Operation During Break-In	96
BASIC PROCEDURES	97
Starting the Engine	97
Changing Gear Selection	97
Stopping the Engine	97
SPECIAL PROCEDURES	98
What to Do if Water is in the CVT	98
What to Do if Water is in the Air Filter Housing	98
What to Do if Vehicle is Turned Over	98
What to Do if Vehicle is Immersed in Water	98
TUNE YOUR RIDE	100
Suspension Adjustments	100
VEHICLE TRANSPORTATION	101

MAINTENANCE

BREAK-IN INSPECTION	104
----------------------------------	------------

MAINTENANCE SCHEDULE 107

MAINTENANCE PROCEDURES 111

 Air Filter 111

 Air Filter Housing 113

 Fuel Tank Breather Filter 114

 Engine Oil 115

 Oil Filter 117

 Radiator 118

 Engine Coolant 118

 Muffler Spark Arrester 122

 Throttle Cable 122

 Spark Plug 124

 Battery 125

 Fuses 125

 Lights 126

 Drive Shaft Boot and Protector 129

 Wheels and Tires 129

 Suspension 131

 Steering 131

 Brakes 132

VEHICLE CARE 134

 Post-Operation Care 134

 Vehicle Cleaning and Protection 134

STORAGE AND PRESEASON PREPARATION 135

TECHNICAL INFORMATION

VEHICLE IDENTIFICATION 138

 Vehicle Identification Number 138

 Engine Identification Number 138

SPECIFICATIONS 139

TROUBLESHOOTING

TROUBLESHOOTING GUIDELINES 146

MULTIFUNCTION GAUGE MESSAGES 150

WARRANTY

BRP INTERNATIONAL LIMITED WARRANTY: 2014 CAN-AM™ ATV 152

BRP LIMITED WARRANTY FOR THE EUROPEAN ECONOMIC AREA, THE COMMONWEALTH OF THE INDEPENDENT STATES AND TURKEY: 2014 CAN-AM™ ATV 156

CUSTOMER INFORMATION

PRIVACY INFORMATION 162
CHANGE OF ADDRESS/OWNERSHIP 163

SAFETY INFORMATION

GENERAL PRECAUTIONS

Avoid Carbon Monoxide Poisoning

All engine exhaust contains carbon monoxide, a deadly gas. Breathing carbon monoxide can cause headaches, dizziness, drowsiness, nausea, confusion and eventually death.

Carbon monoxide is a colorless, odorless, tasteless gas that may be present even if you do not see or smell any engine exhaust. Deadly levels of carbon monoxide can collect rapidly, and you can quickly be overcome and unable to save yourself. Also, deadly levels of carbon monoxide can linger for hours or days in enclosed or poorly ventilated areas. If you experience any symptoms of carbon monoxide poisoning, leave the area immediately, get fresh air and seek medical treatment.

To prevent serious injury or death from carbon monoxide:

- Never run the vehicle in poorly ventilated or partially enclosed areas such as garages, carports or barns. Even if you try to ventilate engine exhaust with fans or open windows and doors, carbon monoxide can rapidly reach dangerous levels.
- Never run the vehicle outdoors where engine exhaust can be drawn into a building through openings such as windows and doors.

Avoid Gasoline Fires and Other Hazards

Gasoline is extremely flammable and highly explosive. Fuel vapors can spread and be ignited by a spark or flame many feet away from the engine. To reduce the risk of fire or explosion, follow these instructions:

- Use only an approved red gasoline container to store fuel.
- Strictly adhere to instructions in *FUEL* subsection.
- Never start or operate the engine if the fuel cap is not properly installed.

Gasoline is poisonous and can cause injury or death.

- Never siphon gasoline by mouth.
- If you swallow gasoline, get any in your eye or inhale gasoline vapor, see your doctor immediately.

If gasoline spills on you, wash with soap and water and change your clothes.

Avoid Burns from Hot Parts

Certain components become hot during operation. Avoid contact with those parts during and shortly after operation to avoid burns.

Accessories and Modifications

Do not make unauthorized modifications, or use attachments or accessories that are not approved by BRP. Since these changes have not been tested by BRP, they may increase the risk of crashes or injury, and can render the vehicle illegal.

See your authorized Can-Am dealer for available accessories for your vehicle.

SPECIAL SAFETY MESSAGES

THIS VEHICLE IS NOT A TOY AND CAN BE HAZARDOUS TO OPERATE.

- This vehicle handles differently from other vehicles including motorcycles and cars. A collision or rollover can occur quickly if you fail to take proper precautions, even during routine maneuvers such as turning and driving on hills or over obstacles.

SEVERE INJURY OR DEATH can result if you do not follow these instructions:

- Read this Operator's Guide and all on-product safety labels carefully and follow the operating procedures described. Watch and pay attention to the *SAFETY DVD* video before operating the vehicle.
- Always follow this age recommendation: A person under 16 years old should never operate this vehicle.
- Passenger on 2-UP models must be capable of keeping his feet on the footrests and his hands on grab handles at all times when seated on this vehicle.
- Never carry a passenger on this vehicle unless you are operating a 2-UP model. Passenger(s) affect balance and steering and increase risk of losing control.
- Never carry more than one (1) passenger on a 2-UP model.
- Never operate this vehicle on any paved surfaces unless it is for short distances, at reduced speed and in order to move the vehicle from an off-road location to another.
- Never take place on this vehicle without wearing an approved helmet that fits properly. The operator and the passenger (2-UP models) should also wear eye protection (goggles or face shield), gloves, boots, long sleeved shirt or jacket, and long pants. The passenger on 2-UP models should have an approved helmet including a rigid chin guard.
- Never use this vehicle if you are tired, ill or with drugs or alcohol. Your reaction time and judgement is greatly affected under these conditions.
- Never attempt wheelies, jumps, or other stunts.
- Always go slowly and be extra careful when operating on unfamiliar terrain. Always be alert to changing terrain conditions when operating this vehicle. If you are operating a 2-UP model, always keep in mind that you are carrying a passenger.
- Never operate on excessively rough, slippery or loose terrain until you have learned and practiced the skills necessary to control this vehicle on such terrain. Always be especially cautious on these kinds of terrain. If you are operating a 2-UP model, always keep in mind that you are carrying a passenger.
- Always follow proper procedures for turning as described further in this Operator's Guide. Practice turning at low speeds before attempting to turn at faster speeds. Do not turn at excessive speed. Carrying a passenger with 2-UP models may affect the stability and the handling of the vehicle.
- Never operate this vehicle on hills too steep for the vehicle or for your abilities. Do not forget, with 2-UP models, the operator is responsible for the safety of the passenger. In doubt, disembark him before climbing hill. Always remember that the vehicle handling, stability and braking distance may be affected when riding with a passenger.

- Always follow proper procedures for climbing hills as described further in this Operator's Guide. Check the terrain carefully before you start up any hill. Never climb hills with excessively slippery or loose surfaces. Shift operator and passenger (2-UP models) weight forward. Never open the throttle suddenly or make sudden gear changes. Never go over the top of any hill at high speed. If you are operating a 2-UP model, always keep in mind that you are carrying a passenger.
- Always follow proper procedures for going down hills and for braking on hills as described further in this Operator's Guide. Check the terrain carefully before you start down any hill. Shift operator and passenger (2-UP models) weight backward. Never go down a hill at high speed. Avoid going down a hill at an angle that would cause the vehicle to lean sharply to one side. Go straight down the hill where possible. If you are operating a 2-UP model, always keep in mind that you are carrying a passenger.
- Always follow proper procedures for crossing the side of a hill as described further in this Operator's Guide. Avoid hills with excessively slippery or loose surfaces. Shift operator and passenger weight (2-UP models) to the uphill side of the vehicle. Never attempt to turn the vehicle around on any hill until you have mastered the turning technique described in this Operator's Guide on level ground. Avoid crossing the side of a steep hill if possible. If you are operating a 2-UP model, always keep in mind that you are carrying a passenger.
- Always use proper procedures if you stall or roll backwards when climbing a hill. To avoid stalling, use proper gear and maintain a steady speed when climbing a hill. If you stall or roll backwards, follow the special procedure for braking described in this Operator's Guide. First, disembark the passenger (2-UP models) then the operator. Dismount on the uphill side or to a side if pointed straight uphill. Turn the vehicle around and remount, following the procedure described further in this Operator's Guide.
- Always check for obstacles before operating in a new area. Never attempt to operate over large obstacles, such as large rocks or fallen trees. Always follow proper procedures when operating over obstacles as described further in this Operator's Guide. Do not forget, with 2-UP models, the operator is responsible for the safety of the passenger. In doubt, disembark him to get through the obstacles.
- Always be careful when skidding or sliding. If you are operating a 2-UP model and have a passenger onboard, never attempt skidding or sliding; overturn or passenger ejection may occur. Learn to safely control skidding or sliding by practicing at low speeds and on level smooth terrain. On extremely slippery surfaces, such as ice, go slowly and be very cautious in order to reduce the chance of skidding out of control.
- Never operate this vehicle in fast flowing water or in water deeper than that specified in this Operator's Guide. Remember that wet brakes may have reduced stopping ability. Test your brakes after leaving water, mud or snow. If necessary, apply them several times to let friction dry out the pads. With 2-UP models, the vehicle braking distance may be affected when riding with a passenger. Safely reduce speed when riding with a passenger. Allow greater distance for braking.
- Always keep in mind that braking distance is readily affected by but not limited to; weather and terrain conditions, braking system and tire conditions, vehicle speed and attitude, and vehicle load including towing. Remember to adjust your driving accordingly.

- Never exceed the stated load limits for this vehicle including operator and passenger (2-UP models), all other loads and added accessories. Cargo should be properly distributed and securely attached. Reduce speed and follow instructions in this guide for carrying cargo or pulling a trailer. Allow greater distance for braking.
- Always inspect and confirm the safe operating condition of your vehicle prior to ride. Always follow the inspection and maintenance procedures and schedules described in this Operator's Guide.
- Always use the tire size and type specified further in this Operator's Guide. Always maintain proper tire pressure as described further in this Operator's Guide.
- Never modify this vehicle through improper installation or use of accessories. Only use BRP's approved accessories. NEVER install a passenger seat on a 1-UP model or use the racks to carry a passenger.

2-UP Models only

Driver must:

- Inform the passenger concerning the basic rules for a safe ride.
- Instruct the passenger to read the vehicle's safety labels and to watch the *SAFETY DVD* video.
- Not forget, the operator is responsible for the safety of the passenger. If in doubt, disembark him before executing any maneuver. Always practice the maneuvers described in this Operator's Guide without and with passenger. Always remember that the vehicle handling, stability and braking distance may be affected when riding with a passenger. Safely reduce speed when riding with a passenger. Allow greater distance for braking. In some situations, this vehicle can be used easily with the operator alone but not necessarily with a passenger. Use your common sense.
- Never carry passenger on a 2-UP model if the glove box is installed (in place of rear seat).
- Always keep both hands on the handlebars and both feet on the footrests of the vehicle during operation.
- Never operate a 2-UP model without the passenger's seat or the glove box properly installed.

Passenger must:

- Never take place on this vehicle without wearing an approved helmet (including a chin guard) that fits properly. You should also wear eye protection (goggles or face shield), gloves, boots, long sleeved shirt or jacket, and long pants.
- Be seated on the designated passenger's seat and hold on to the grab handles at all times. Never hold on to the operator.
- Always keep hands and feet in the proper place during operation.
- Never get up during vehicle operation. An excessive movement could cause loss of control.
- Pay attention to vehicle and operator movements.
- Not wait and tell the driver to slow down or stop if you feel uncomfortable or insecure for any reason.

European Community

On Road Use

The following warnings apply only in the European Countries where on road usage is allowed. **SEVERE INJURY OR DEATH** can result if you do not comply with the following instructions.

WARNING

- This vehicle is built for OFF-ROAD purposes only. It may be used for short distances on paved surfaces at reduced speed, in order to move the vehicle from an off-road location to another.
- Always refrain from speeding and substantially reduce vehicle speed when turning.
- Always respect the road traffic laws, even on a dirt or gravel road.
- The front winch hook (if applicable) must be removed and stored.

OPERATION WARNINGS

NOTE: The following illustrations are general representations only. Your model may differ.

WARNING



POTENTIAL HAZARD

Operating this vehicle without proper instruction.

WHAT CAN HAPPEN

The risk of an accident is greatly increased if the operator does not know how to operate this vehicle properly in different situations and on different types of terrain with or without passenger (2-UP models).

HOW TO AVOID THE HAZARD

Beginners and inexperienced operators should complete a training course. They should then regularly practice the skills learned during the course as well the operating techniques described in this Operator's Guide.

For more information about a training course, contact an authorized Can-Am dealer.

⚠ WARNING



V00A1AQ

POTENTIAL HAZARD

Failure to follow the age recommendations for this vehicle.

WHAT CAN HAPPEN

A lack of respect for this age recommendation can lead to severe injury or death of the child.

Even though a child may be within the age group for which this vehicle is recommended, he may not have the skills, abilities, or judgment needed to operate this vehicle safely and may be involved in a serious accident.

HOW TO AVOID THE HAZARD

No one under 16 should operate this vehicle.

2-UP Models only

⚠ WARNING



vmo2013-005-100

POTENTIAL HAZARD

Failure to respect the physical limitations of the passenger on 2-UP models.

WHAT CAN HAPPEN

A passenger that cannot completely lean his feet on footrests can be ejected when riding on uneven terrain.

HOW TO AVOID THE HAZARD

The passenger must be capable of keeping his feet on the footrests and his hands on grab handles at all times when he is seated on the vehicle.

1-UP Models only

⚠ WARNING



POTENTIAL HAZARD

Carrying a passenger on this vehicle.

WHAT CAN HAPPEN

Greatly reduces your ability to balance and control this vehicle.

Could cause an accident, resulting in harm to you and/or your passenger.

HOW TO AVOID THE HAZARD

Never carry passenger. Even with a long seat that provides unrestricted operator movement, it is not designed nor intended to carry passenger(s).

2-UP Models only

⚠ WARNING



V00A1CQ

POTENTIAL HAZARD

Carrying more than one (1) passenger on this vehicle.

WHAT CAN HAPPEN

Carrying more than one (1) passenger reduces your ability to balance and control this vehicle.

Could cause an accident, resulting in harm to you and/or your passengers.

HOW TO AVOID THE HAZARD

Never carry more than one (1) passenger. Even with a long seat that provides unrestricted operator movement, the vehicle is not designed nor intended to carry more than one (1) operator and one (1) passenger. The passenger must be used the designated passenger's seat when he is seated on the vehicle.

When the glove box is installed (in place of rear seat), the vehicle becomes a ONE-RIDER vehicle (1-UP model) and NO PASSENGER must be allowed on it.

2-UP Models only

⚠ WARNING



V00A2DQ

POTENTIAL HAZARD

Allowing passenger to sit in a location other than the designated passenger's seat.

WHAT CAN HAPPEN

Passenger seated in a location other than the designated passenger's seat could:

- Impair vehicle stability which could lead to a loss of control.
- Suffer injury from impact on hard surfaces.

Could cause an accident, resulting in harm to you and/or your passenger.

HOW TO AVOID THE HAZARD

Passenger must always remain seated on designated passenger's seat with feet firmly planted on footrests and always hold on to the grab handles.

⚠ WARNING**POTENTIAL HAZARD**

Operating this vehicle on paved surfaces.

WHAT CAN HAPPEN

Paved surfaces may seriously affect handling and control of the vehicle, and may cause the vehicle to go out of control.

HOW TO AVOID THE HAZARD

If a road usage is allowed in your area, operate your vehicle on paved surfaces only for short distance and for the only purpose of moving the vehicle from an off-road usage to another.

Always operate your vehicle at low speed (never exceed 65 km/h (40 MPH) and reduce the speed before making a turn.

Always respect all road traffic laws when operating your vehicle on public roads or streets.

⚠ WARNING**POTENTIAL HAZARD**

Riding this vehicle without wearing an approved helmet, eye protection and protective clothing. On 2-UP models, passenger should also have an approved helmet with a rigid chin guard.

WHAT CAN HAPPEN

The following items concern the operator and the passenger (2-UP models):

- Riding without an approved helmet increases the chances of a severe head injury or death in the event of an accident.
- Riding without eye protection can result in an accident and increases the chances of a severe injury in the event of an accident.
- Riding without protective clothing increases the chances of severe injury in the event of an accident.

HOW TO AVOID THE HAZARD

Always wear an approved helmet that fits properly. You should also wear:

- Eye protection (goggles or face shield)
- Rigid chin guard (recommended for the passenger)
- Gloves and boots
- Long sleeved shirt or jacket
- Long pants.

⚠ WARNING

V00A07Q

POTENTIAL HAZARD

Using this vehicle with drugs or alcohol.

WHAT CAN HAPPEN

Could cause the passenger to fall off (2-UP models).

Could seriously affect your judgment.

Could cause you to react more slowly.

Could affect your balance and perception.

Could result in an accident or death of passenger (2-UP models) and/or operator.

HOW TO AVOID THE HAZARD

The operator and the passenger (2-UP models) should never use this vehicle with drugs or alcohol.

⚠ WARNING

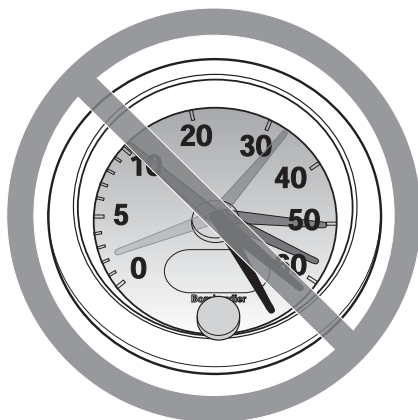

V00A08Q

POTENTIAL HAZARD

Operating this vehicle at excessive speeds.

WHAT CAN HAPPEN

Increases your chances of losing control of the vehicle, which can result in an accident.

HOW TO AVOID THE HAZARD

Always travel at a speed which is appropriate for the terrain, visibility and operating conditions, and your experience. The maximum speed authorized with this vehicle is 65 km/h (40 MPH). Always reduce speed before making a turn.

On 2-UP models, the vehicle handling, stability and braking distance may be affected when riding with a passenger. Safely reduce speed when riding with a passenger. Allow greater distance for braking.

⚠ WARNING**POTENTIAL HAZARD**

Attempting wheelies, jumps and other stunts.

WHAT CAN HAPPEN

Increases the chance of an accident, for the operator and the passenger (2-UP models), including an overturn.

HOW TO AVOID THE HAZARD

Never attempt stunts, such as wheelies or jumps. Do not try to show off.

⚠ WARNING**POTENTIAL HAZARD**

Failure to inspect the vehicle before operating.

Failure to properly maintain the vehicle.

WHAT CAN HAPPEN

Increases the possibility of an accident or equipment damage.

HOW TO AVOID THE HAZARD

Always inspect your vehicle prior to every time you use it to make sure the vehicle is in safe operating condition.

Always follow the inspection and maintenance procedures and schedules described further in this Operator's Guide.

⚠ WARNING

POTENTIAL HAZARD

Riding on frozen waterways.

WHAT CAN HAPPEN

Breaking through the ice can lead to severe injury or death.

HOW TO AVOID THE HAZARD

Never ride this vehicle on a frozen surface before you are sure the ice is thick enough and sound enough to support the vehicle and its load, as well as the force that is created by a moving vehicle.

⚠ WARNING



POTENTIAL HAZARD

Removing hands from handlebars for the operator and from grab handles for the passenger (2-UP models), or feet from the footrests during operation.

WHAT CAN HAPPEN

Removing even one hand or foot can reduce your ability to control the vehicle or could cause you to lose your balance and fall off the vehicle. If you remove a foot from the footrests, your foot or leg may come into contact with the rear wheels, which could injure you or cause an accident.

HOW TO AVOID THE HAZARD

Operator and passenger (2-UP models) must always keep both hands on the handlebars or on grab handles and both feet on the footrests during vehicle operation.

⚠ WARNING**POTENTIAL HAZARD**

Failure to use extra care when operating this vehicle on unfamiliar terrain.

WHAT CAN HAPPEN

You can come upon hidden rocks, bumps, or holes, without enough time to react.

Could result in the vehicle overturning, passenger ejection (2-UP models) or loss of control.

HOW TO AVOID THE HAZARD

Go slowly and be extra careful when operating on unfamiliar terrain.

Always be alert to changing terrain conditions when operating the vehicle.

Do not forget, on 2-UP models, the operator is responsible for the safety of his passenger. Safely reduce speed when riding with a passenger.

⚠ WARNING



POTENTIAL HAZARD

Failure to use extra care when operating on excessively rough, slippery or loose terrain.

WHAT CAN HAPPEN

Could cause loss of traction or vehicle control, which could result in an accident, including an overturn or passenger ejection (2-UP models).

HOW TO AVOID THE HAZARD

Do not operate on excessively rough, slippery or loose terrain until you have learned and practiced the skills necessary to control this vehicle on such terrain.

Always be especially cautious on these kinds of terrain.

Do not forget, on 2-UP models, the operator is responsible for the safety of the passenger. In doubt, disembark him before operating on these terrains.

! WARNING**POTENTIAL HAZARD**

Turning improperly.

WHAT CAN HAPPEN

Vehicle could go out of control, causing a collision, an overturn or a passenger ejection (2-UP models).

HOW TO AVOID THE HAZARD

Always follow proper procedures for turning as described further in this Operator's Guide. Practice turning at low speeds before attempting to turn at faster speeds.

Do not forget, on 2-UP models, the operator is responsible for the safety of the passenger. Never perform this maneuver with a passenger. Always remember that the vehicle handling, stability and braking distance may be affected when riding with a passenger.

Do not turn at excessive speed.

⚠ WARNING



POTENTIAL HAZARD

Operating on excessively steep hills.

WHAT CAN HAPPEN

The vehicle can overturn more easily on extremely steep hills than on level surfaces or small hills.

HOW TO AVOID THE HAZARD

Never operate this vehicle on hills too steep for the vehicle or for your abilities.

Practice, without and with passenger (2-UP models), on smaller hills before attempting larger hills.

Always remember that, on 2-UP models, even if this vehicle can climb some steep hills, it is not recommended to climb such hills with a passenger; always disembark him before attempting this maneuver. Show good judgment.

⚠ WARNING**POTENTIAL HAZARD**

Climbing hills improperly.

WHAT CAN HAPPEN

Could cause loss of control, passenger ejection (2-UP models) or cause vehicle to overturn.

HOW TO AVOID THE HAZARD

Always follow proper procedures for climbing hills as described further in this Operator's Guide.

Always check the terrain carefully before you start up any hill. Do not forget, on 2-UP models, the operator is responsible for the safety of the passenger. In doubt, disembark him before climbing hill. Always remember that the vehicle handling, stability and braking distance may be affected when riding with a passenger.

Never climb hills with excessively slippery or loose surfaces.

Shift operator and passenger (2-UP models) weight forward.

Never open the throttle suddenly or make sudden gear changes. The vehicle could flip over backwards.

Never go over the top of any hill at high speed. An obstacle, a sharp drop, or another vehicle or person could be on the other side of the hill.

⚠ WARNING



POTENTIAL HAZARD

Going down a hill improperly.

WHAT CAN HAPPEN

Could cause loss of control, passenger ejection (2-UP models) or cause vehicle to overturn.

HOW TO AVOID THE HAZARD

Always follow proper procedures for going down hills as described further in this Operator's Guide.

NOTE: A special technique is required when braking as you go down a hill.

Always check the terrain carefully before you start down any hill. Do not forget, on 2-UP models, the operator is responsible for the safety of the passenger. In doubt, disembark him before going down hill. Always remember that the vehicle handling, stability and braking distance may be affected when riding with a passenger.

Shift operator and passenger (2-UP models) weight backward. On 2-UP models, passenger must hold the grab handles firmly.

Never go down a hill at high speed.

Avoid going down a hill at an angle which would cause the vehicle to lean sharply to one side. Go straight down the hill where possible.

⚠ WARNING**POTENTIAL HAZARD**

Improperly crossing hills or turning on hills.

WHAT CAN HAPPEN

Could cause loss of control, passenger ejection (2-UP models) or cause vehicle to overturn.

HOW TO AVOID THE HAZARD

Never attempt this maneuver on 2-UP models when the passenger is on board. Always disembark him before executing.

Never attempt to turn the vehicle around on any hill until you have mastered the turning technique as described further in this Operator's Guide on level ground. Be very careful when turning on any hill.

Avoid crossing the side of a steep hill if possible.

When crossing the side of a hill:

Always follow proper procedures as described further in this Operator's Guide.

Avoid hills with excessively slippery or loose surfaces.

Operator and passenger (2-UP models) must shift their weight to the uphill side of the vehicle.

1-UP Models only

⚠ WARNING

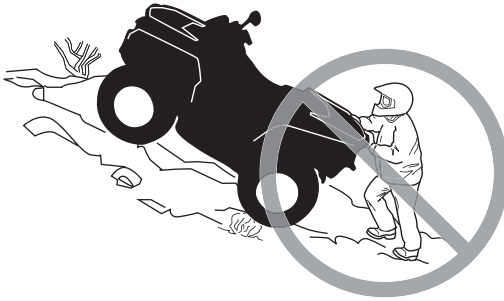

POTENTIAL HAZARD

Stalling, rolling backwards or improperly dismounting while climbing a hill.

WHAT CAN HAPPEN

Could result in vehicle overturning.

HOW TO AVOID THE HAZARD

Use proper gear and maintain steady speed when climbing a hill.

If you lose all forward speed:

Keep your weight uphill. Never open the throttle suddenly or make sudden gear changes. The vehicle could flip over backwards.

Apply the brakes.

Apply brake lock after you have stopped.

Dismount on uphill side, or to a side if pointed straight uphill.

If you begin rolling backwards:

Keep your weight uphill. Never open the throttle suddenly or make sudden gear changes. The vehicle could flip over backwards.

Never apply the rear brake while rolling backwards.

Apply the front brake gradually.

When fully stopped, apply rear brake as well and apply brake lock.

Dismount on uphill side, or to a side if pointed straight uphill.

Turn the vehicle around and remount, following the procedure described further in this Operator's Guide.

2-UP Models only

WARNING



V00A1PQ

POTENTIAL HAZARD

Stalling, rolling backwards or improperly dismounting while climbing a hill.

WHAT CAN HAPPEN

Could result in vehicle overturning.

HOW TO AVOID THE HAZARD

Use proper gear and maintain steady speed when climbing a hill.

If you lose all forward speed:

Operator and passenger must keep their weight uphill. Never open the throttle suddenly or make sudden gear changes. The vehicle could flip over backwards.

Apply the brakes.

Apply brake lock after you have stopped.

First, disembark the passenger, then dismount on uphill side, or to a side if pointed straight uphill.

If you begin rolling backwards:

Operator and passenger must keep their weight uphill. Never open the throttle suddenly or make sudden gear changes. The vehicle could flip over backwards.

Never apply the rear brake while rolling backwards.

Apply the front brake gradually.

When fully stopped, apply rear brake as well and apply brake lock.

First, disembark the passenger, then dismount on uphill side, or to a side if pointed straight uphill.

Turn the vehicle around and remount, following the procedure described further in this Operator's Guide.

⚠ WARNING



POTENTIAL HAZARD

Improperly operating over obstacles.

WHAT CAN HAPPEN

Could cause loss of control, passenger ejection (2-UP models) or a collision.

Could cause the vehicle to overturn.

HOW TO AVOID THE HAZARD

On 2-UP models, the operator is responsible for the safety of his passenger. In doubt, disembark him before riding over obstacles. Always remember that the vehicle handling and stability may be affected when riding with a passenger.

Before operating in a new area, check for obstacles.

Never attempt to ride over large obstacles, such as large rocks or fallen trees.

When you go over obstacles, always follow proper procedures as described further in this Operator's Guide.

⚠ WARNING**POTENTIAL HAZARD**

Skidding or sliding improperly.

WHAT CAN HAPPEN

You may lose control of this vehicle.

You may also regain traction unexpectedly, which may cause the vehicle to overturn or passenger ejection (2-UP models).

HOW TO AVOID THE HAZARD

On 2-UP models, never slide or skid with passenger. Always remember that the vehicle handling and stability may be affected when riding with a passenger.

Learn to safely control skidding or sliding by practicing at low speeds and on level smooth terrain.

On extremely slippery surfaces, such as ice, go slowly and be very cautious in order to reduce the chance of skidding or sliding out of control.

⚠ WARNING



POTENTIAL HAZARD

Operating this vehicle through deep or fast flowing water.

WHAT CAN HAPPEN

Tires may float, causing loss of traction and loss of control, which could lead to an accident.

HOW TO AVOID THE HAZARD

Never operate this vehicle in fast flowing water or in water deeper than that specified further in this Operator's Guide.

Check water depth and current before you attempt to cross any water. Water should not go above footrests.

Remember that wet brakes may have reduced stopping ability. Test your brakes after leaving water. If necessary, apply them several times to let friction dry out the pads. Do not forget, on 2-UP models, allow greater distance for braking when you ride with a passenger.

⚠ WARNING**POTENTIAL HAZARD**

Improperly operating in reverse.

WHAT CAN HAPPEN

You could hit an obstacle or person behind the vehicle, resulting in serious injury.

HOW TO AVOID THE HAZARD

When you select reverse gear, make sure there are no obstacles or people behind the vehicle. When it is safe to proceed, go slowly. On 2-UP models, take account that the passenger can obstruct your view.

⚠ WARNING



POTENTIAL HAZARD

Operating this vehicle with improper tires, or with improper or uneven tire pressure.

WHAT CAN HAPPEN

Use of improper tires on this vehicle, or operation of this vehicle with improper or uneven tire pressure, may cause loss of control, tire blow outs, tire to move around on its rim, and increases the risk of an accident.

HOW TO AVOID THE HAZARD

Always use the size and type of tires specified further in this Operator's Guide for this vehicle.

Always maintain proper tire pressure as described further in this Operator's Guide.

Always replace wheels or tires that are damaged.

⚠ WARNING**POTENTIAL HAZARD**

Operating this vehicle with improper modifications.

WHAT CAN HAPPEN

Improper installation of accessories or modification of this vehicle may cause changes in handling which in some situations could lead to an accident.

HOW TO AVOID THE HAZARD

Never modify this vehicle through improper installation or use of accessories. All parts and accessories added to this vehicle should be approved by BRP and should be installed and used according to instructions. If you have questions, consult an authorized Can-Am dealer.

NEVER install passenger seat (1-UP models) or use the racks to carry a passenger.

Modification of the vehicle to increase speed and performance may violate the terms and conditions of your vehicle limited warranty. In addition, certain modifications including the removal of engine or exhaust components are illegal under most laws.

⚠ WARNING



POTENTIAL HAZARD

Overloading this vehicle, carrying or towing cargo improperly.

WHAT CAN HAPPEN

Could cause changes in vehicle handling which could lead to an accident.

HOW TO AVOID THE HAZARD

Never exceed the stated load capacity for this vehicle including operator and passenger (2-UP models), as well as other loads and added accessories.

Cargo should be properly distributed and securely attached.

Reduce speed when carrying cargo or pulling a trailer. Allow greater distance for braking.

Always follow the instructions in this Operator's Guide for carrying cargo or pulling a trailer.

⚠ WARNING

V03M01Q

POTENTIAL HAZARD

Transporting flammable or dangerous material can lead to explosions.

WHAT CAN HAPPEN

This can cause serious injury or death.

HOW TO AVOID THE HAZARD

Never transport flammable or dangerous material.

RIDING THE VEHICLE

While reading this Operator's Guide, remember that:

WARNING

Indicates a potential hazard that, if not avoided, could result in serious injury or death.

To fully appreciate the pleasures and excitement of riding this vehicle, there are some basic rules and tips that you **MUST** follow. Some may be new to you while others may be common sense or obvious.

Please take the time to study this Operator's Guide and all on-product safety labels as well as the *SAFETY DVD* video that came with this vehicle. They more completely describe what you should know about this vehicle before riding it.

Whether you are a new user or an experienced rider, it is important for your personal safety as well as passenger safety that you know the controls and features of this vehicle. Equally important is knowing how to properly ride.

Even though a person may be within the age group for which this vehicle is recommended, he may not have the skills, abilities, or judgment needed to operate this vehicle safely and may be involved in a serious accident.

2-UP models: The passenger must be capable of keeping his feet on the footrests and his hands on grab handles at all times when he is seated on the vehicle.

Individuals with cognitive or physical impairments or who are high risk takers have an increased exposure to overturns or collisions which may result in injury including death.

Not all vehicles are the same. Each has its own unique performance characteristics, controls and features. Each will ride and handle differently.

Become completely familiar with the operational controls and the general operation of the vehicle before venturing into off road conditions. Practice driving in a suitable area free of hazards and feel the response of each control. Drive at low speeds. Higher speeds require greater experience, knowledge and suitable riding conditions.

Riding conditions vary from place to place. Each is subject to weather conditions which may radically change from time to time and from season to season.

The vehicle handling, stability and braking distance may be affected when riding with a passenger. Safely reduce speed when riding with a passenger. Allow greater distance for braking.

Riding on sand is different than riding on snow or through forests or marshes. Each location may require a greater degree of awareness and skill may not be suitable with a passenger. Show good judgement. Always proceed with caution. Please do not take any unnecessary risks that could leave you or your passenger stranded or possibly injured.

Never assume that the vehicle will go everywhere safely. Sudden changes in terrain caused by holes, depressions, banks, softer or harder "ground" or other irregularities may cause the vehicle to topple or become unstable. To avoid this, slow down and always observe the terrain ahead. If the vehicle does begin to topple or tip-over, the best advice is to immediately get off, **AWAY** from the direction of the tip-over!

Pre-Ride Inspection

WARNING

Perform a pre-ride inspection before each ride to detect any potential problem that could occur during operation. The pre-ride inspection can help you monitor component wear and deterioration before they become a problem. Correct any problems that you discover before riding to reduce the risk of a breakdown or crash. See an authorized Can-Am dealer as necessary.

Before using this vehicle, the operator should always perform the following pre-ride inspection check list.

Correct any problem you may have found before riding. See an authorized Can-Am dealer if necessary.

Pre-Ride Inspection Check List

What to Do Before Starting the Engine (Key OFF)

ITEMS TO BE INSPECTED	INSPECTION TO PERFORM	✓
FLUIDS	Check fuel, engine oil and coolant levels.	
LEAKS	Check for any leaks under vehicle.	
THROTTLE LEVER	Activate throttle lever several times to ensure it operates freely. It must return to idle position when released.	
BRAKE LOCK	Apply brake lock and check if it operates properly.	
TIRES	Check tire pressure and condition.	
WHEELS	Check wheels for damage, and check lug nuts are tightened.	
RADIATOR	Check cleanliness of the radiator.	
DRIVE SHAFT BOOTS	Check drive shaft boots and protectors condition.	
SEAT(S)	Check if operator seat is in place and properly latched.	
	Check if passenger seat or the glove box are in place and properly latched (2-UP models).	
	Check the passenger backrest and grab handles condition (2-UP models).	

ITEMS TO BE INSPECTED	INSPECTION TO PERFORM	✓
CARGO	If you transport a cargo, respect the load capacity. Ensure cargo is properly secured to the racks.	
	If you are pulling a trailer or an other equipment: <ul style="list-style-type: none"> – Check hitch and trailer ball condition. – Respect the tongue capacity and towing capacity. – Ensure trailer is properly secured to hitch. 	
SERVICE AND STORAGE COMPARTMENTS	Check if front service compartment and rear storage compartment are properly latched.	
CHASSIS AND SUSPENSION	Check underneath vehicle for any debris on chassis or suspension and clean them properly.	

What to Do Before Starting the Engine (Key ON)

ITEMS TO BE INSPECTED	INSPECTION TO PERFORM	✓
MULTIFUNCTION GAUGE	Check operation of indicator lamps in multifunction gauge (during first few seconds of key ON).	
	Check for messages on multifunction gauge.	
LIGHTS	Check operation and cleanliness of headlights and taillight.	
	Check operation of high and low beam.	
	Check operation and cleanliness of brake light.	
	Check operation and cleanliness of turn signal lights.	

What to Do After the Engine Is Started

ITEMS TO BE INSPECTED	INSPECTION TO PERFORM	✓
STEERING	Check if steering operates freely by completely turning it from side to side.	
SHIFT LEVER	Check operation of shift lever (P, R, N, H and L).	
2WD/4WD SELECTOR	Check operation of 2WD/4WD selector.	
BRAKES	Drive forward slowly a few feet and apply all brakes individually to test them. The brakes must fully apply. Lever and pedal must fully return when released.	
EMERGENCY ENGINE STOP SWITCH	Check that the emergency engine stop switch is working properly.	
IGNITION SWITCH	Check if ignition switch is working properly by restarting and stopping the engine.	

Clothing

Actual weather conditions should help you decide how to dress. Dress for the coldest weather expected. Thermal underwear next to the skin also provides a good insulation. It is important that the operator and the passenger always wears the appropriate protective clothing and apparel, including an approved helmet, eye protection, boots, gloves, a long sleeved shirt and pants. The passenger should have an approved helmet including a rigid chin guard. This type of clothing will provide you protection from some of the minor hazards you may encounter en route. The operator and passenger must never wear loose clothing such as a scarf that may get entangled in the vehicle or on tree branches and shrubs. Depending on conditions, anti-fogging goggles or sunglasses may be required. Different colored lenses available for goggles or sunglasses help you distinguish terrain variations. Sunglasses should only be worn during the daytime.

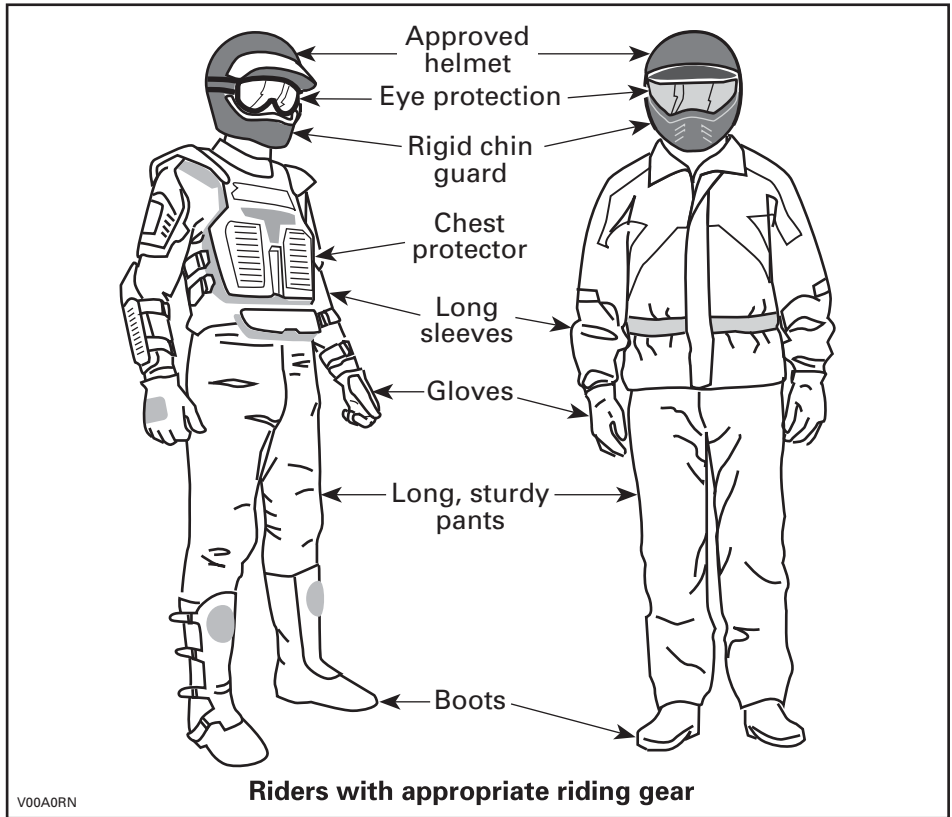

Carrying a Passenger

1-UP Models

This vehicle is designed to carry ONE (1) operator only. Do not install passenger seat or use the racks to carry a passenger.

2-UP Models

This vehicle is designed specifically to carry an operator and ONE (1) passenger only. The passenger must be seated on the designated passenger's seat and hold on to the grab handles at all times. NEVER install other passenger's seat other than the one recommended by BRP. Do not use the racks or their location to carry passenger(s). Carrying more than ONE (1) passenger may affect the stability and your control of the vehicle. When the glove box is installed (in place of rear seat), the vehicle becomes a ONE-RIDER vehicle (1-UP model) and NO PASSENGER must be allowed on it.

Carrying Loads

Any load carried on the vehicle and/or the carrying rack(s) will affect the stability and control of the vehicle. For this reason, do not exceed the load limits of the vehicle manufacturer. Refer to table below. Always make sure the load is secured and cannot interfere with your proper control. Always be aware that the "load" may slide or fall off and create an accident. Avoid loads that may protrude sideways and get snagged or caught in brush or other obstacles. Avoid covering and obstructing the headlight or brake light with the cargo.

Safely reduce speed according to terrain conditions when carrying cargo or pulling a trailer. Allow greater distance for braking. Always secure cargo as low as possible on the rack(s) to reduce the effect of a higher center of gravity.

WARNING

The vehicle handling, stability and braking distance are affected when loading racks and using the vehicle. Correct loading and weight distribution are therefore important. Never overload, tow or carry cargo improperly. Always ensure the cargo is safely secured and properly distributed on the rack(s) before operating the vehicle. Safely reduce speed according to terrain conditions when carrying cargo or pulling a trailer. Allow greater distance for braking. Always secure cargo as low as possible on the rack(s) to reduce the effect of a higher center of gravity. Failure to follow the recommendations here could cause changes in vehicle handling which could lead to an accident.

When transporting cargo on the vehicle, respect these maximum loads.

MAXIMUM LOAD TABLE			
TOTAL LOAD ALLOWED	1-UP Models	227 kg (500 lb)	Includes driver, all other loads and added accessories.
	2-UP Models	235 kg (517 lb)	
FRONT LOAD		45 kg (100 lb)	Evenly distributed.
REAR LOAD		90 kg (200 lb)	Evenly distributed. Includes rear rack, rear glove box and tongue load.

Hauling a Trailer

Riding this vehicle with a trailer substantially increases the risk of toppling, especially on inclined slopes. If a trailer is used make sure that its hitch is compatible with the one on the vehicle. Make sure the trailer is horizontal with the vehicle. (In some instances a special extension may have to be installed on the vehicle hitch). Use security chains to secure the trailer with the vehicle. This vehicle may require additional stopping distance if hauling heavy loads, especially on inclined surfaces and when a passenger (2-UP models) is on board. Be careful not to skid or slide. When stopped or parked, block the vehicle and trailer wheels from possible movement. Always make sure load is evenly distributed on the trailer.

Use caution when disconnecting a loaded trailer; it or its load may topple on you or others. Do not turn at high speeds. Always use low gear range and slow down a lot.

Working with your Vehicle

Your vehicle can help you perform a number of different LIGHT tasks ranging from snow removal to pulling wood or carrying cargo. A variety of accessories are available from your authorized Can-Am dealer. However, always respect the load and capacities of the vehicle. Overloading of the vehicle can overstress the components and cause failure. To prevent possible injury, it is equally important to follow the instructions and warnings that accompany the accessory. Avoid any physical exertion through lifting or pulling of heavy loads or manpowering the vehicle. (Continue to read *RECREATIONAL RIDING* below.)

Recreational Riding

Respect the rights and limitations of others. Stay away from areas designated for other types of off road use. This includes snowmobile trails, equestrian trails, cross country ski trails, mountain bike trails, etc. Never assume there are no other users on the trail. Always stay to the complete right of the trail and do not zig zag to one side of the trail then the other. Be prepared to stop or pull off to the side if another trail user appears in front of you.

Join a local ATV club. It will provide you with a map and advice or inform you where you can ride. If a club does not exist in your area, help to start one. Group riding and club activities provide a pleasurable, social experience.

Always keep a safe distance from other riders. Your judgment of speed, terrain conditions, weather, mechanical condition of your vehicle and the "trust in judgment" you have in others around you will help you make a better choice of appropriate safe distance. This vehicle, like any other motorized vehicle, cannot stop "on a dime". On 2-UP models, the vehicle handling, stability and braking distance may be affected when riding with a passenger. Safely reduce speed when riding with a passenger. Allow greater distance for braking.

Always operate this vehicle at low speed, do not exceed 65 km/h (40 MPH), and reduce the speed before making a turn when the vehicle is operated on the roadway.

Before you ride, tell someone where you are planning to travel and your expected time of return.

Depending on the length of your ride, carry additional tools, drinking water, food and emergency equipment. Find out where you can get additional gasoline and oil. Be prepared for the possible conditions you may encounter.

First aid kit	Adjustable wrench
Mobile phone	Knife
Friction tape	Flashlight
A rope	Colored lens goggles
Spare light bulbs	Trail map
Provided tool kit	Snack

Environment

One of the benefits of this vehicle is that it can take you off the beaten path away from most communities. However, you should always respect nature and the rights of others to enjoy it. Do not ride in environmentally sensitive areas. Do not drive over forest crops or shrubs, nor cut down trees or take down fencing, nor spin your wheels and destroy the terrain. "Tread Lightly".

This vehicle can cause OHV wildfires if debris builds up near the exhaust or other engine hot spots and ignites then falls off into dry grass. Avoid riding in wet areas, through muskeg or tall grass, where debris can build up. Should you ride in those areas, inspect and remove all debris from your engine and hot spots.

Chasing wildlife is in many areas illegal. Wildlife can die of exhaustion after being chased by a motorized vehicle. If you encounter animals on the trail, stop and observe quietly and with caution. It will be one of the better memories of your life.

Observe the rule, "what you take in, carry out". Do not litter. Do not start campfires unless you have permission to do so, and then only, away from dry areas. The hazards you may create on the trail may cause injury to others or yourself, even at a later date.

Respect farm lands. Always obtain the permission of the landowner before riding on private land. Respect crops, farm animals and property lines. If you come to a closed a gate, close it again behind you.

Finally, do not pollute streams, lakes or rivers and do not modify the engine or exhaust system, or remove any of its components.

Design Limitation

Although the vehicle is exceptionally rugged for its class, it is still a light vehicle by definition and its operation must be restricted to its proper purpose.

The addition of weight to any part of the vehicle changes its gravitational stability and modifies its performance.

Off-Road Operation

The very nature of off-Road operation is dangerous. Any terrain, which has not been specially prepared to carry vehicles, presents an inherent danger where angularity, terrain substance and exact steepness are unpredictable. The terrain itself presents a continual element of danger, which must be knowingly accepted by anyone venturing over it.

An operator who takes a vehicle off-road should always exercise the utmost care in selecting the safest path and keeping close watch on the terrain ahead of him. On no account should the vehicle be operated by anyone who is not completely familiar with the driving instructions applicable to the vehicle, nor should it be operated on steep or treacherous terrain.

General Operating and Safety Precautions

Care, caution, experience and driving skill are the best precautions against the hazards of vehicle operation.

Whenever there is the slightest doubt that the vehicle can safely negotiate an obstacle or a particular piece of terrain, always choose an alternate route.

In off-road operation, power and traction, not speed, are important. Never drive faster than visibility and your own ability to select a safe route permit.

Constantly watch the terrain ahead for sudden changes in slopes or obstacles, such as rocks or stumps, that may cause loss of stability, resulting in tip-over or rollover.

On 2-UP models, the vehicle handling, stability and braking distance may be affected when riding with a passenger. Safely reduce speed when riding with a passenger. Allow greater distance for braking.

Never operate the vehicle if the controls do not function normally.

When stopped or parked, always apply the brake lock and place shift lever to the PARK position. This is especially important when parking on a slope. On very steep inclines or if the vehicle is carrying cargo, the wheels should be blocked using rocks or bricks.

For the users in the European Community, it is mandatory to remove the winch hook (if so equipped) to operate the vehicle on the roadway. Failure to follow this requirement could cause additional injuries including the possibility of death if an accident occurs.

Reverse Operation

When operating in reverse, check that the path behind the vehicle is free of people or obstacles. Proceed slowly and avoid sharp turns. When riding on a 2-UP models, take into account that the passenger can obstruct your view. Disembark him if necessary.

We recommend sitting on your ATV when operating in reverse. Avoid standing up. Your weight could shift forward against throttle lever, causing an unexpected acceleration.

Uphill Driving

Due to configuration, this vehicle has excellent climbing ability, so much so that it is possible to tip over before traction is lost. For example, it is common to encounter terrain situations where the top of the hill has eroded to a point that the hill peak rises very sharply. The vehicle can readily negotiate such a condition, however, in doing so, when the front of the vehicle is driven to a point that the vehicle's balance moves rearward, a tip over can occur.

The same situation may apply if an embedded object causes the front of the vehicle to climb more than desired. If such a situation occurs take an alternate route. Be aware of side hilling dangers when doing so.

It is also wise to know the terrain condition on the other side of the hill or bank. All too often there exists a sharp drop-off that is impossible to negotiate or descend.

Downhill Driving

This vehicle can climb slopes that are steeper than it can safely descend. Therefore, it is essential to ensure that a safe route exists to descend a slope before you climb it.

Decelerating while negotiating a slippery downhill slope could “toboggan” the vehicle. Maintain steady speed and/or accelerate slightly to regain control.

Side Hilling

Whenever possible, such operation should be avoided. If necessary, do so with extreme caution. Always disembark the passenger before performing this operation. Side hilling on steep inclines could result in rollover. In addition, slippery or loose surfaces could result in uncontrollable side sliding. Do not attempt to turn the vehicle downhill with the slide. Avoid all objects or depressions that will intensify the raising of one side of the vehicle higher than the other, thus causing rollover.

WARNING

Be careful when loading and transporting liquid reservoirs. They can affect vehicle stability when side hilling by pulling downhill and increasing the risk of a roll over.

Drop-Offs

This vehicle will “bottom-out” and usually stop if either the front or rear wheels are driven over a drop-off. If the drop is sharp or deep, the vehicle will nose dive and tip-over.

WARNING

Avoid negotiating drop-offs. Reverse and select an alternate route.

Riding on Snow Covered Surfaces

When performing the pre-ride inspection, pay special attention to locations on the vehicle where snow and/or ice accumulations may obstruct visibility of the taillight and reflectors, clog ventilation openings, or interfere with the movement of the control levers and switches. Before starting with your ATV check the steering, throttle and brake lever and pedal controls for interference free operation.

Whenever an ATV is ridden on a snow covered drive path the tire grip is generally reduced causing the vehicle to react differently to control inputs from the operator. On low grip surfaces, the steering responses are not as crisp and precise, stopping distances are lengthened and acceleration becomes sluggish. Slow down and do not “gun” the throttle. This will only result in spinning of the tires and possibly in an over steering slide of the vehicle. Avoid hard braking. This will possibly result in a straight line slide of the vehicle. Again, the best advice is to safely reduce speed in anticipation of a maneuver so to give yourself time and distance to regain total vehicle control before it spins out of your control.

As you drive your ATV over a loose snow covered surface, snow dust will be picked up in the wake turbulence of the moving vehicle and transported to contact and accumulate or melt on some exposed components including rotating parts like brake discs. Water, snow or ice may affect the response time of the brake

system of your ATV. Even when not required to reduce vehicle speed apply brakes frequently to prevent ice or snow accumulation and to dry brake pads and discs. While doing so in low risk driving situations you will test for grip level and keep yourself alerted to how the vehicle reacts to your control inputs. Always keep brake pedal, footrests, foot boards, brake and throttle levers free of snow and ice. Frequently wipe snow off seat, handgrips, headlights and taillight.

The depth of the snow cover may hide rocks, tree stumps or other objects and if it is wet may totally impede the drivability as the vehicle becomes bogged down or completely loses traction in slushy snow. Look far ahead and always be watchful of any visible clues that might indicate the presence of such obstacles. In doubt steer clear. Avoid driving on any frozen body of water before checking that the ice will safely support the ATV, its riders and its load of cargo. Remember that a given thickness of ice may be sufficient to support a snowmobile but not an ATV of an identical weight because of the smaller load bearing surface of the four tire contact patches as compared to that of a snowmobile track and skis.

Always remember that the vehicle handling and stability is affected when riding with a passenger. Never attempt maneuvers with a passenger that may cause the vehicle to enter into a slide that if halted abruptly will result in the ejection of the passenger and/or a vehicle roll or tip-over.

To maximize comfort and avoid frostbite, always wear clothing and ATV protective equipment appropriate for the weather conditions you will be exposed to during your ride.

At the end of each ride it is a good practice to clean the vehicle body and all moving components (brakes, steering components, drivelines, controls, etc.) from any snow or ice accumulations. Wet snow will turn to ice during the shut down period and become more difficult to remove at the next pre-ride inspection.

Riding Techniques

Riding your vehicle too fast for the conditions may result in injury. Apply only enough throttle to proceed safely. Statistics show that high speed turns usually result in mishaps and injury. Always remember that this vehicle is heavy! Its pure weight alone may entrap you should it fall and pin you down.

This vehicle is not designed for jumping nor can it fully absorb the high impact energy during manoeuvres such as jumping which, can be passed on to you, the operator. Performing "wheelies" can cause the vehicle to flip over onto you. Both practices have a high risk for you and your passenger (2-UP models) and should be avoided at all times.

To maintain proper control, it is strongly advised that you keep your hands on the handlebar and within easy reach of all controls. The same holds true for your feet. To minimize the possibility of a leg or foot injury, keep your feet on the footrests at all times. Do not direct your toes outwards nor extend your feet out to assist in turning as they can be hit or be snagged on passing obstacles, or may come into contact with wheels. When riding on a 2-UP models, your passenger must keep his hands on grab handles and his feet on footrests at all times.

Always use proper riding techniques to avoid vehicle overturns on hills and rough terrain and in turns.

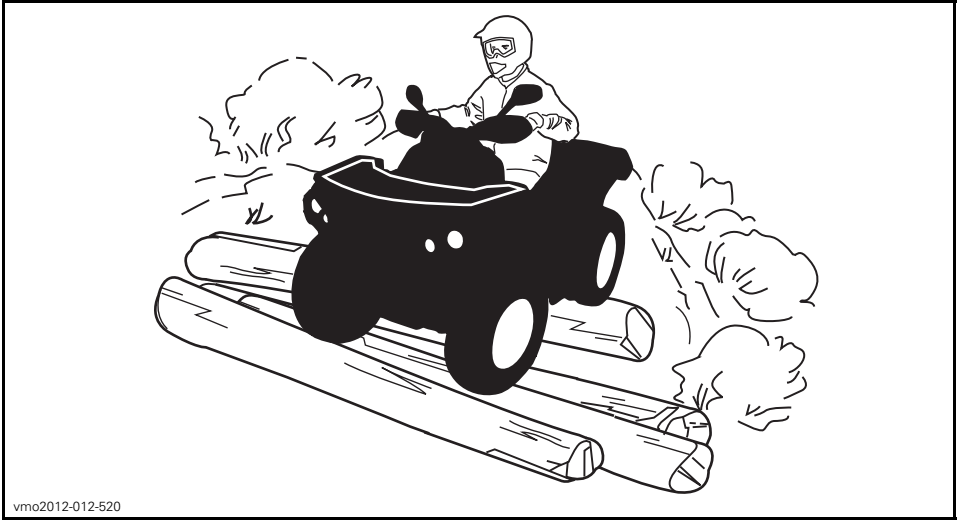

vmo2012-012-520

Even though there is an adequate suspension system on this vehicle, there are “washboard” or rough terrain conditions that will make you feel uncomfortable and can even cause a back injury. “Posting” or riding in a crouched position will often be required. Slow down and allow your flexed legs to absorb part of the impact energy.

If a road usage is allowed in your area, operate your vehicle on paved surface only for short distance and for the only purpose of moving the vehicle from an off-road usage to another. Always operate your vehicle at low speed (never exceed 65 km/h (40 MPH)) and reduce the speed before making a turn.

Always respect all road traffic laws when operating your vehicle on public roads or streets. If you have to cross a road, the lead driver should get off his vehicle the observe and give direction to the other riders. The last person after crossing then assists the lead driver to cross. Do not travel on sidewalks. They are designated for pedestrian use.

Water can be a unique hazard. If it is too deep the vehicle may “float” and topple. Check the water depth and current before you attempt to cross any water. Water should not go above the footrest. Be wary of slippery surfaces such as rocks, grass, logs, etc., both in the water and on its banks. A loss of traction may occur. Do not attempt to enter the water at high speed. The water will act as a brake and could throw you off the vehicle, on the ground.

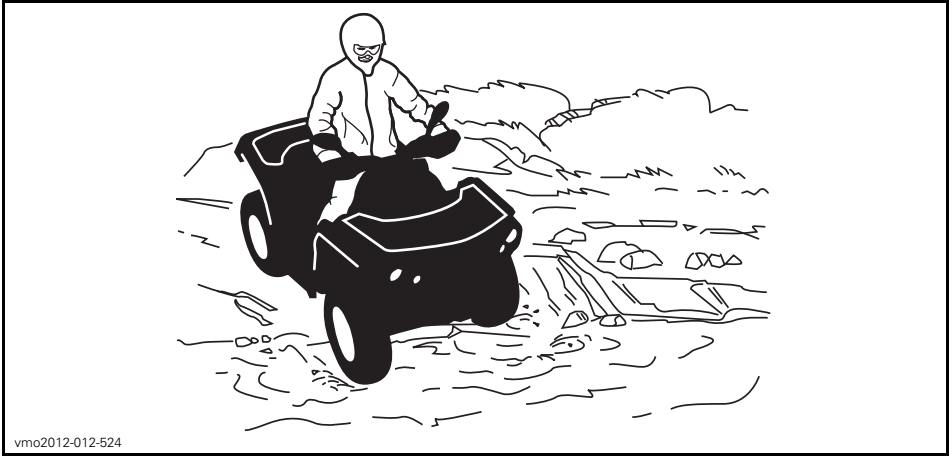

Wet brakes will affect the braking ability of your vehicle. Make sure you dry the brakes by applying them several times after the vehicle leaves the water, mud or snow. On 2-UP models, the vehicle braking distance may be affected when riding with a passenger. Safely reduce speed when riding with a passenger. Allow greater distance for braking.

Mud or marsh lands may be encountered near water. Be prepared for sudden “holes” or changes in depth. Similarly so, be watchful of hazards such as rocks, logs, etc., partially covered by vegetation.

If your route crosses frozen waterways, make sure the ice is thick enough and sound enough to support the total weight of yourself, your passenger (2-UP models), the vehicle and its load. Be ever watchful of open water, it is a sure indication that the ice thickness will vary. On 2-UP models, the operator is responsible for the safety of the passenger. If in doubt, do not attempt to cross.

Ice will also affect the control of the vehicle. Slow down and do not “gun” the throttle. This will only result in spinning of the tires and the vehicle may possibly tip over. Avoid rapid braking. This again can result in an uncontrolled slide and the vehicle may possibly tip over or eject the passenger (2-UP models). Slush should be avoided at all times since it could block the operation or controls of the vehicle. When riding on a 2-UP models, never attempt this maneuver with a passenger. Always remember that the vehicle handling and stability may be affected when riding with a passenger.

Riding in snow may reduce the brakes stopping capability. Safely reduce speed and allow greater distance for braking. Snow projection may cause ice build up or snow accumulation on brake components and controls. Apply brakes frequently to prevent ice or snow accumulation. Refer to *GENERAL OPERATING AND SAFETY PRECAUTIONS* in this subsection for more detailed information regarding riding on snow covered surfaces.

Riding on sand dunes or on snow is another unique experience but there are some basic precautions that should be observed. Wet, deep or fine sand/snow may create a loss of traction and cause the vehicle to slide, drop off or become “bogged” down. If this occurs look for a firmer base. Again, the best advice is to slow down and be watchful of the conditions. When you ride with a passenger (2-UP models), drive slowly.

When riding in sand dunes it is advisable to equip the vehicle with an antenna type safety flag. This will help make your location more visible to others over the next sand dune. Proceed carefully should you see another safety flag ahead. Since the antenna type safety flag can snag and rebound on your body if caught, do not use it in areas where there are low hanging branches or obstacles. Always remember when riding on a 2-UP model that the vehicle handling and stability may be affected when riding with a passenger.

Riding on loose stones or gravel is very similar to riding on ice. They will affect the steering of vehicle, possibly causing it to slide or cause passenger ejection (2-UP models) and tip-over especially at high speeds. In addition, braking distance may be affected. Remember that "gunning" the throttle or sliding may cause loose stones to be ejected rearwards into the path of another rider. Never do it deliberately. Always remember on a 2-UP models that vehicle handling, stability and braking distance may be affected when riding with a passenger.

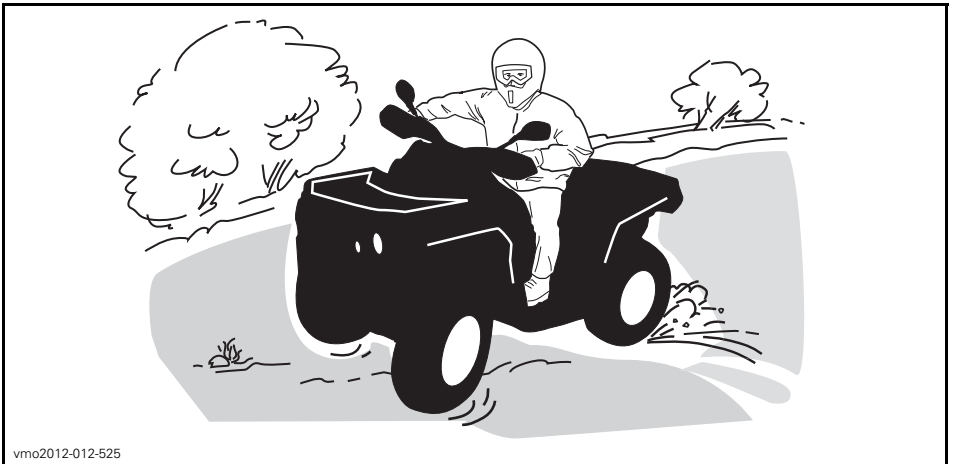

If you do get into a slide or skid, it may help to turn the handlebar in the direction of the skid until you regain control. Never jam the brakes and lock the wheels.

Respect and follow all posted trail signs. They are there to help you and others.

Obstacles in the "trail" should be traversed with caution. This includes loose rocks, fallen trees, slippery surfaces, fences, posts, and embankments and depressions. You should avoid them whenever possible. Remember that some obstacles are too large or dangerous to cross and should be avoided. When riding on 2-UP models, the operator is responsible for the safety of the passenger and in doubt, disembark him before getting through the obstacles. Small rocks or fallen trees may be safely crossed, approach at a 90° angle. Stand on the footrests while keeping your knees flexed. Adjust speed without losing momentum and do not "gun" the throttle. Hold handlebar or grab handles firmly. Place operator and passenger (2-UP models) body weight rearwards and proceed. Do not try to lift the vehicle front wheels off the ground. Be aware that the object may be slippery or may move while crossing.

When driving on hills or slopes two things are highly important, be prepared for slippery surfaces or terrain variations and obstacles and, use proper body positioning. When riding on 2-UP models, the operator is responsible for the safety of the passenger and in doubt, disembark him before getting through the obstacles.

When stopped or parked always apply the brake lock and place the shift lever in PARK position. This is especially important when parking on a slope. On very steep inclines or if the ATV is carrying a cargo, the wheels should be blocked using rocks or bricks.

Uphill

1-UP Models

Before trying to climb a hill, keep these things in mind. Hill Climbing should only be attempted by experienced operators. Start on shallow slopes. Always drive straight uphill and keep your body weight forward towards the top of the hill. Keep your feet on the footrests, shift your ATV into a lower gear and accelerate before you start to climb. Try to keep a steady speed and go easy on the throttle to avoid acceleration. Abrupt slope or terrain variation or rolling one wheel over an obstacle could have a big impact on the stability as it will lift the front of the vehicle increasing the risk of tipping over. Some hills are too steep to safely stop or recover from after an unsuccessful climbing attempt. Try to avoid steep inclines. If you're not careful, you could tip over when going up hills. If the hill is too steep and you cannot proceed or the vehicle begins to roll backwards, apply the brake, being careful not to slide. Dismount then use the "K" turn (while walking back, next to the vehicle on the up hill side and with a hand on the brake lever, slowly back the rear of the vehicle toward the top of the hill then drive downhill). Always walk or dismount on the upside of the slope while keeping clear of the vehicle and its rotating wheels. Do not try to hold on to the vehicle if it begins to topple. Stay clear. Do not ride over the crest of the hill at high speed. Obstacles, including sharp drop-offs, may exist.

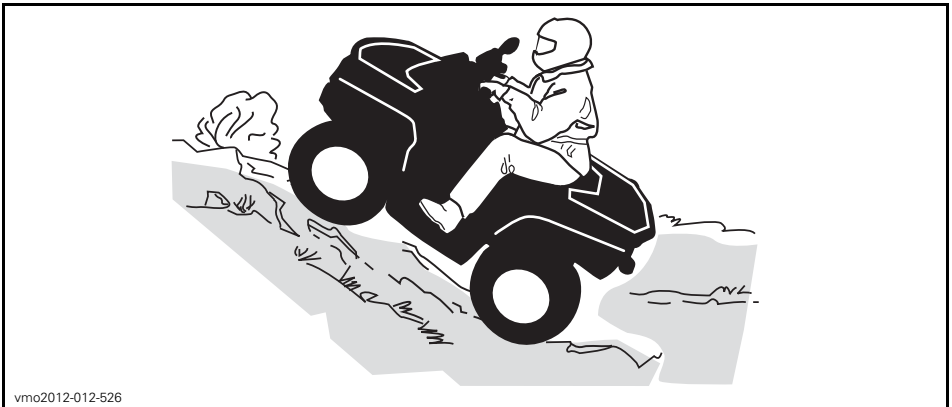

vmo2012-012-526

2-UP Models

Do not forget, the operator is responsible for the safety of the passenger. In doubt, disembark him before climbing hill. Always remember that the vehicle handling, stability and braking distance may be affected when riding with a passenger.

If you decide to keep your passenger, he must synchronize his movements with yours.

Before trying to climb a hill, keep these things in mind. Hill Climbing should only be attempted by experienced operators. Start on shallow slopes. Always drive straight uphill. Operator and passenger must keep their body weight forward, towards the top of the hill. Keep feet on the footrests, shift the ATV into a lower gear and accelerate before you start to climb. Try to keep a steady speed and go easy on the throttle to avoid acceleration. Abrupt slope or terrain variation or rolling one wheel over an obstacle could have a big impact on the stability as it will lift the front of the vehicle increasing the risk of tipping over. Some hills are too steep to safely stop or recover from after an unsuccessful climbing attempt. Try to avoid steep inclines. If you're not careful, you could tip over when going up hills. If the hill is too steep and you cannot proceed or the vehicle begins to roll backwards, apply the brake, being careful not to slide. Dismount, passenger first, then use the "K" turn (while walking back, next to the vehicle on the up hill side and with a hand on the brake lever, slowly back the rear of the vehicle toward the top of the hill then drive downhill). Always walk or dismount on the upside of the slope while keeping clear of the vehicle and its rotating wheels. Do not try to hold on to the vehicle if it begins to topple. Stay clear. Do not ride over the crest of the hill at high speed. Obstacles, including sharp drop-offs, may exist. The passenger should get on the vehicle only when the vehicle has returned to a safe location.

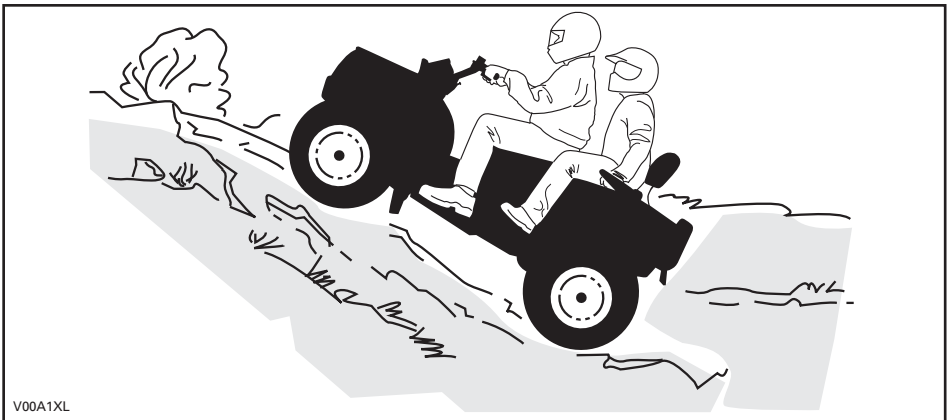

Downhill

1-UP Models

Keep your body weight rearwards. Apply the brake gradually to prevent skidding. Do not "coast" down the slope using solely engine compression or in neutral gear. Try to avoid steep inclines. If you're not careful, you could tip over when going down hills.

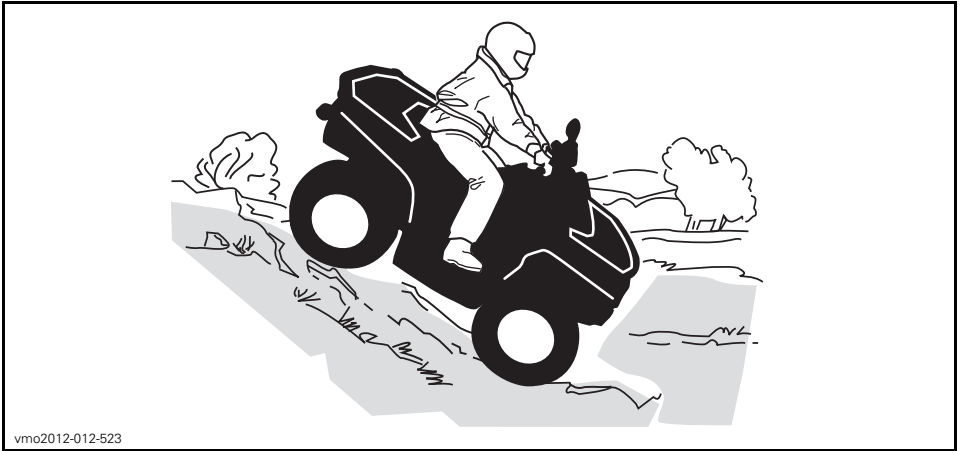

2-UP Models

Do not forget, the operator is responsible for the safety of the passenger. In doubt, disembark him before going down the hill. Always remember that the vehicle handling, stability and braking distance may be affected when riding with a passenger.

If you decide to keep your passenger, he must synchronize his movements with yours.

Operator and passenger must keep their body weight rearwards. Apply the brake gradually to prevent skidding. Do not "coast" down the slope using solely engine compression or in neutral gear. Try to avoid steep inclines. If you're not careful, you could tip over when going down hills.

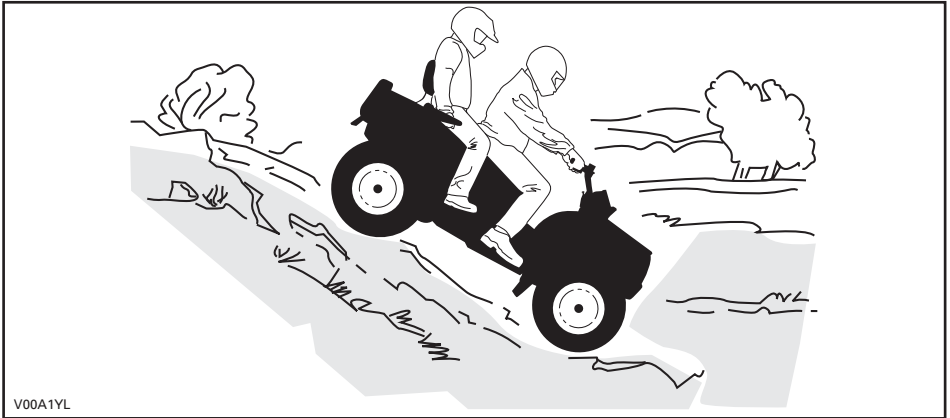

Side Hilling

1-UP Models

This is one of the **most risky** types of riding since it may drastically change the balance of the vehicle. It should be avoided wherever possible. However, if it is necessary to do so, it is important that you **ALWAYS** keep your body weight on the up-side of the slope, and be prepared to dismount on that side should the vehicle begin to topple.

⚠ WARNING

Do not try to stop or save the vehicle from damage.

⚠ WARNING

Be careful when loading and transporting liquid reservoirs. They can affect vehicle stability when side hilling by pulling downhill and increasing the risk of a roll over.



vmo2012-012-527

2-UP Models

Do not forget, the operator is responsible for the safety of the passenger. In doubt, disembark him before proceeding. Always remember that the vehicle handling, stability and braking distance may be affected when riding with a passenger.

If you decide to keep your passenger, he must synchronize his movements with yours.

This is one of the **most risky** types of riding since it may drastically change the balance of the vehicle. It should be avoided wherever possible. If it is necessary to do so however, it is important that you **ALWAYS** keep your body weight on the upside of the slope, and be prepared to dismount on that side should the vehicle begin to topple. **Do not try to stop or save the vehicle from damage.**

IMPORTANT ON-PRODUCT LABELS

Hang Tag







This vehicle comes with hang tags and labels containing important safety information.

Any person who rides this vehicle should read and understand this information before riding.

WARNING







- Locate and read operator's guide. Improper ATV use can result in SEVERE INJURY or DEATH. Follow all instructions and warnings.
- Always wear ear protection.
- Always use an approved helmet and protective gear.
- Never carry passengers on 1-up models and NEVER carry more than one passenger on 2-up models.
- Never use with drugs or alcohol.

1-UP Models

<p>G GENERAL USE MODEL</p> <p>THIS ATV IS FOR RECREATIONAL USE OR UTILITY USE</p> <p>OPERATOR ONLY-NO PASSENGERS</p> <p>NO OPERATOR UNDER AGE 16</p> <hr/> <p>TRAINING COURSES TO TEACH ATV RIDING SKILLS ARE AVAILABLE. FOR INFORMATION CONTACT YOUR DEALER.</p> <hr/> <p>CHECK WITH YOUR DEALER TO FIND OUT ABOUT STATE OR LOCAL LAWS REGARDING ATV OPERATION.</p> <p>THIS HANGTAG IS NOT TO BE REMOVED BEFORE SALE.</p> <p>704903931</p>	<p></p> <p> </p> <p>  </p>
--	---

704903931A

2-UP Models

<p>G GENERAL USE MODEL</p> <p>THIS ATV IS FOR RECREATIONAL USE OR UTILITY USE.</p> <p>NO OPERATOR UNDER AGE 16</p> <hr/> <p>TRAINING COURSES TO TEACH ATV RIDING SKILLS ARE AVAILABLE. FOR INFORMATION CONTACT YOUR DEALER. MAKE SURE TO WATCH SAFETY VIDEO.</p> <hr/> <p>CHECK WITH YOUR DEALER TO FIND OUT ABOUT STATE OR LOCAL LAWS REGARDING ATV OPERATION.</p> <p>THIS HANGTAG IS NOT TO BE REMOVED BEFORE SALE.</p> <p>704903947</p>	<p></p> <p></p> <p></p>
---	---

704903947

Vehicle Safety Labels

Read and understand all the safety labels on your vehicle.

These labels are affixed to the vehicle for the safety of the operator, passenger or bystanders.

The safety labels on your vehicle should be considered permanent parts of the vehicle. If missing or damaged, they can be replaced free of charge. See an authorized Can-Am dealer.

NOTE: In the event of any discrepancy between this guide and the vehicle, the safety labels on the vehicle have precedence over the labels in this guide.

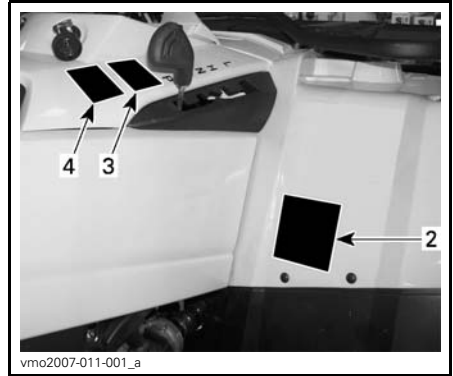

vmo2007-011-001_a

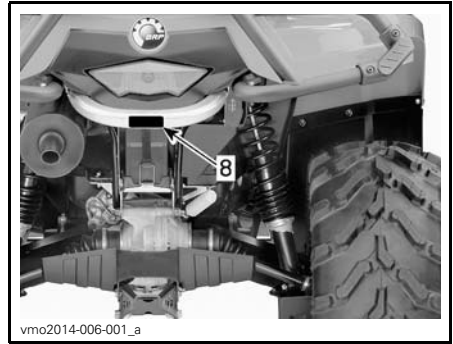

vmo2014-006-001_a

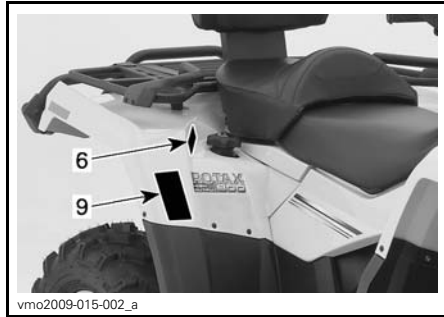

vmo2009-015-002_a



vmo2008-019-055_b

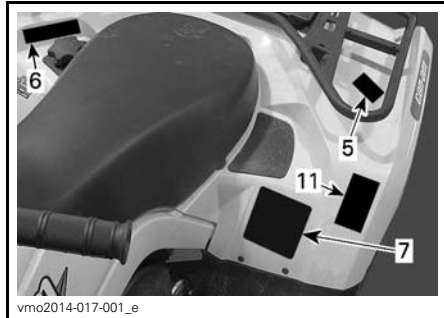

vmo2014-017-001_e

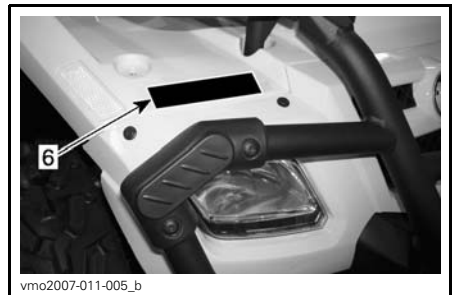

vmo2007-011-005_b



Label 1

⚠ WARNING

- Locate and read operator's guide. Improper ATV use can result in SEVERE INJURY or DEATH. Follow all instructions and warnings.
- Always wear ear protection.
- Always use an approved helmet and protective gear.
- Never carry a passenger on 1-up models and NEVER carry more than one passenger on 2-up models.
- Never use with drugs or alcohol.

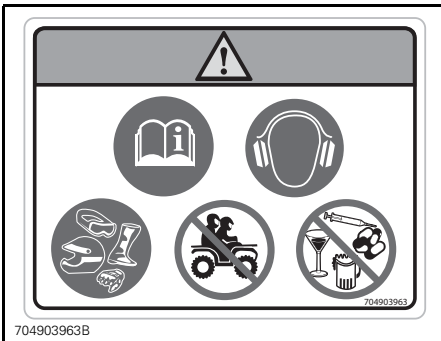

LABEL 1: 1-UP MODELS



LABEL 1: 2-UP MODELS

Label 2

⚠ WARNING

Operating this ATV if you are under the age of 16 increases the chance of SEVERE INJURY or DEATH to the operator, and to both the operator and passenger on 2-up models. NEVER operate this ATV if you are under age 16.

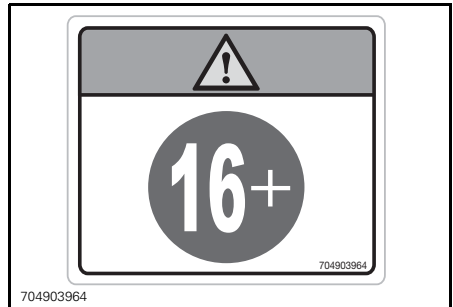

LABEL 2

Label 3

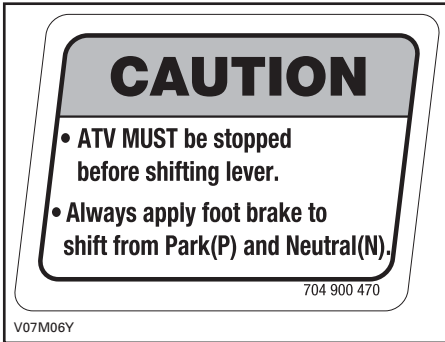

LABEL 3

Label 4

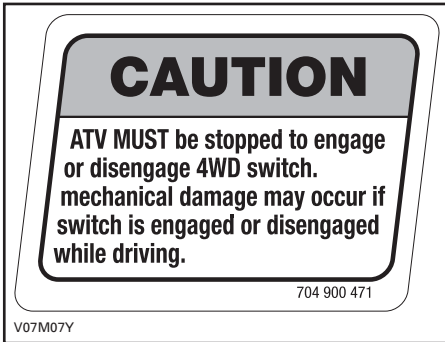

LABEL 4

Label 5

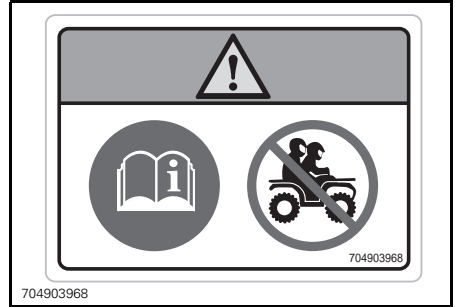
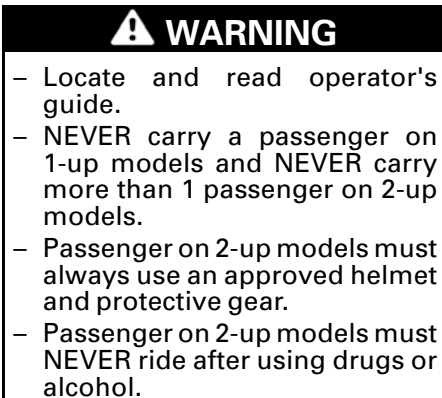

LABEL 5: 1-UP MODELS

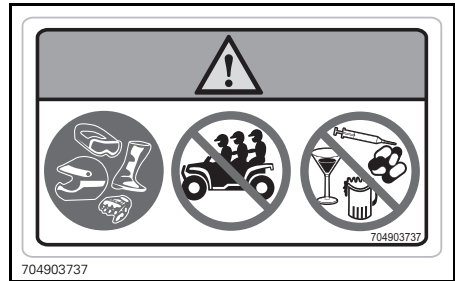

LABEL 5: 2-UP MODELS

Label 6

⚠ WARNING

- NEVER carry a passenger on this carrier.
- MAXIMUM FRONT LOAD: 45 kg (100 lb) evenly distributed.
- MAXIMUM REAR LOAD: 90 kg (200 lb) evenly distributed (including trailer tongue weight if applicable).



704903960

LABEL 6 - NOTE: REFER TO SPECIFICATIONS FOR APPLICABLE VALUES

Label 7

⚠ WARNING

- Locate and read operator's guide. Improper overloading or tire pressure can cause loss of control, resulting in SEVERE INJURY or DEATH.
- ALWAYS maintain proper tire pressure as shown.
- On 1-up models, NEVER exceed the load capacity of 227 kg (500 lb) including weight of operator, cargo, accessories, and trailer tongue weight.
- On 2-up models, NEVER exceed the load capacity of 235 kg (517 lb), and trailer tongue weight.
- ALWAYS pull a load using the trailer hitch or recovery hook.
- NEVER exceed the maximum towing weight of 135 kg (297 lb).
- NEVER exceed the maximum tongue weight of 13 kg (28 lb).

!

+ + + < 227 kg (500 lb)

i

kPa

MAX: 48.3 kPa (7 psi)	MAX: 48.3 kPa (7 psi)
MIN: 34.5 kPa (5 psi)	MIN: 34.5 kPa (5 psi)

135 kg (297 lb) 13 kg (28 lb)

704903979

704903979

LABEL 7

!

+ + + < 235 kg (517 lb)

i

kPa

MAX: 48.3 kPa (7 psi)	MAX: 48.3 kPa (7 psi)
MIN: 34.5 kPa (5 psi)	MIN: 34.5 kPa (5 psi)

135 kg (297 lb) 13 kg (28 lb)

704903944

704903944

LABEL 7 - 2-UP MODELS - NOTE: REFER TO SPECIFICATIONS CHART FOR TIRES APPLICABLE VALUES

Label 8

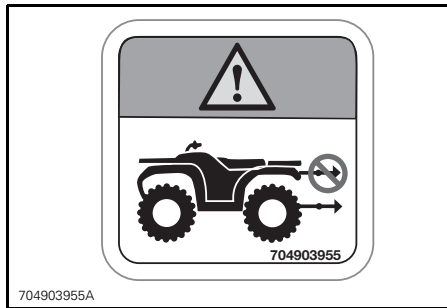
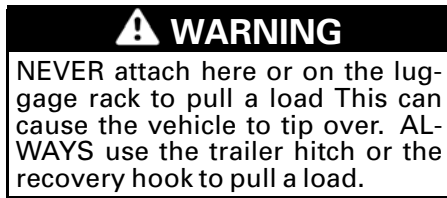

LABEL 8

Label 9



LABEL 9

Label 10



LABEL 10

Label 11



LABEL 11

Compliance Labels

These labels indicate vehicle's compliance.



UNDER SEAT, ON THE UPPER BAR OF FRAME

Technical Information Labels

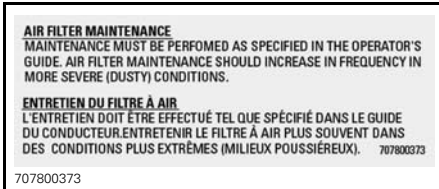

AIR FILTER HOUSING

***This page is
intentionally blank***

VEHICLE INFORMATION

CONTROLS/INSTRUMENTS/EQUIPMENT

NOTE: Some controls/instruments/equipment are optional.

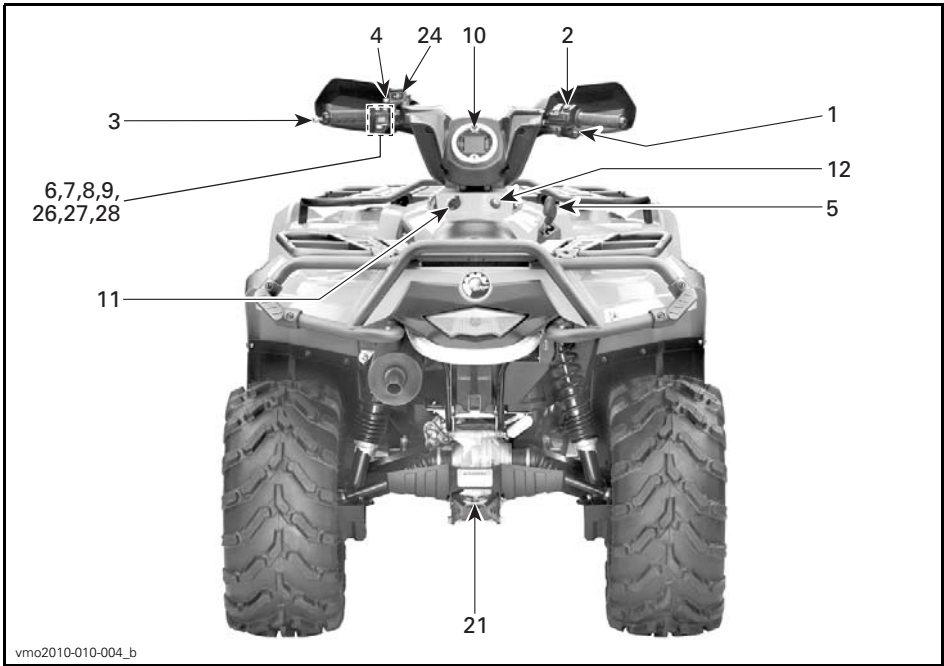

vmo2010-010-004_b

TYPICAL - ALL MODELS

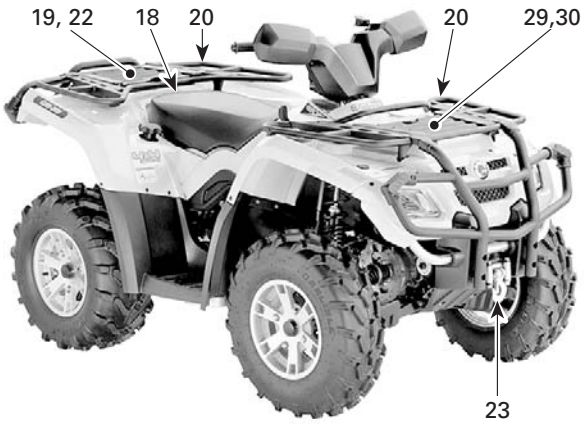

vmo2010-010-002_d

TYPICAL - 1-UP MODELS



vmo2008-019-052_g

TYPICAL - 1-UP MODELS

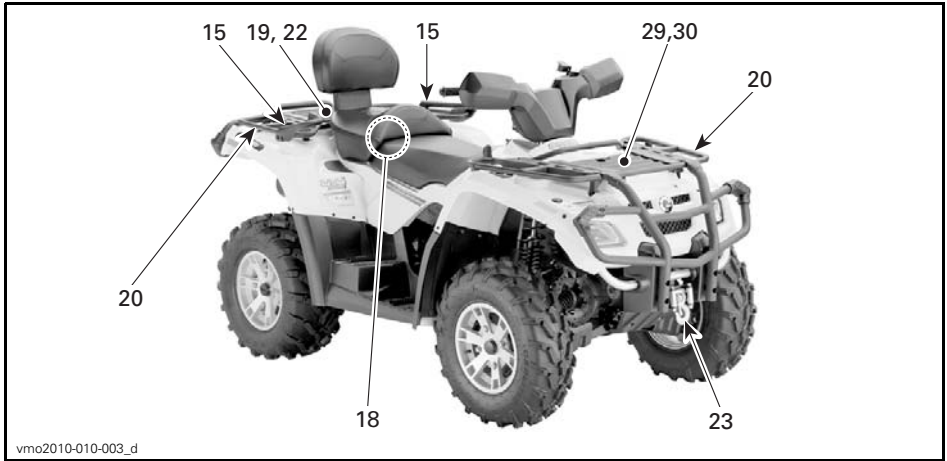

TYPICAL - 2-UP MODELS

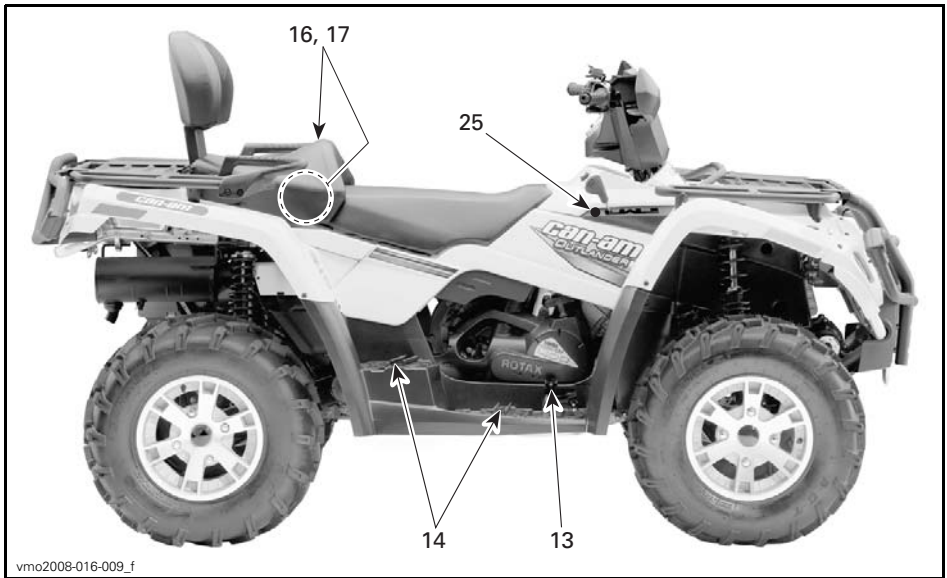

TYPICAL - 2-UP MODELS

1) Throttle Lever

The throttle lever is located on the RH side of the handlebar.

When pushed forward, it increases the engine speed and allows the engagement of the transmission on the selected gear.

When released, the engine speed should automatically return to idle and the vehicle will gradually slow down.

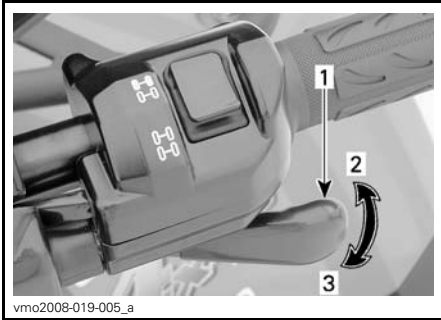

vmo2008-019-005_a

TYPICAL

1. Throttle lever
2. To accelerate
3. To decelerate

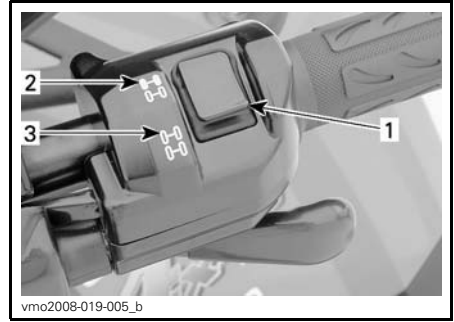

vmo2008-019-005_b

TYPICAL

1. Selector
2. 2WD position
3. 4WD position

NOTICE The vehicle must be stopped to engage or disengage 2WD/4WD selector. Mechanical damage may occur if selector is engaged or disengaged while driving.

NOTICE If the rear wheels are spinning, release the throttle and wait engine return to the idle before selecting the 4WD mode.

The 4WD mode is engaged when the selector is pushed downwards.

2) 2WD/4WD Selector

The 2WD/4WD selector is located on the RH side of the handlebar.

This selector allows to choose between 2WD and 4WD when the vehicle is stopped.

While reading this Operator's Guide, remember that:

WARNING

Indicates a potential hazard that, if not avoided, could result in serious injury or death.



V0710DY

4WD MODE

To deselect the 4WD mode, press the selector on 2WD.



V0710EY

2WD MODE

When the selector is located on the 2WD, the vehicle is in 2 wheel drive at all time.

3) LH Brake Lever

The LH brake lever is located on the LH side of the handlebar.

When the brake lever is pressed, the front and rear brakes are applied.

When released, the brake lever should automatically return to its original position.

Braking effect is proportional to the force applied on the lever.

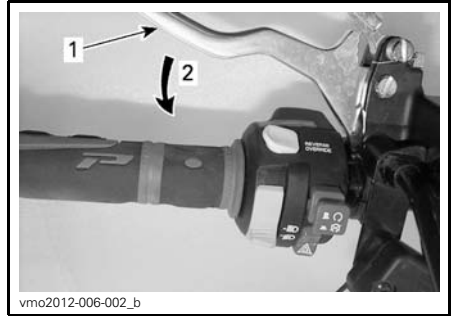

vmc2012-006-002_b

TYPICAL

1. Brake lever
2. To apply brakes

NOTE: As on other wheeled vehicles, the vehicle weight is transferred to the front wheels when braking. To obtain greater stopping efficiency, the brake system distributes more braking force to the front wheels. This will affect vehicle handling and steering control when braking vigorously. Take it into account when braking.

4) Brake Lock

The brake lock device is located on the LH side of the handlebar.

When applied, it prevents the vehicle from moving. Useful when the brake needs to be locked for example when doing a K-turn, during transportation or when the vehicle is not in operation.

⚠ WARNING

Always use the brake lock and engage the **PARK** position on the shift lever when the vehicle is not in operation.

NOTICE Make sure brake lock is fully disengaged before operating the vehicle. When you ride the vehicle, brakes that are caused to drag by a continuous pressure on the lever may cause damage to the brake system and cause loss of braking capacity and/or fire.

To engage mechanism: Squeeze brake lever and maintain while moving locking lever. Brake lever is now compressed and applying brakes.

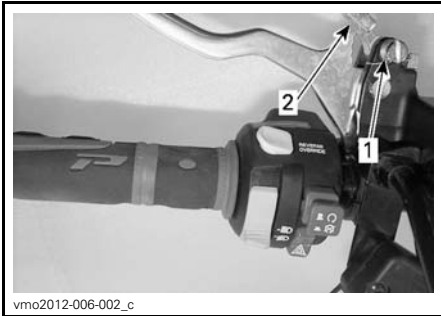

TYPICAL

1. Brake locking lever
2. Press to apply brake lock

NOTE: Locking lever can be adjusted in several positions.

NOTICE Ensure when the brake lock is applied that the vehicle stays securely in place.

To release mechanism: Squeeze brake lever. Locking lever should automatically return to its original position. Brake lever should return to rest position. Always release brake lock before riding.

5) Shift Lever

The shift lever is located on the RH side of the vehicle near steering column.

A 5-position lever: P, R, N, H and L.

To change the transmission position, completely stop vehicle, apply and hold brakes, then move lever to the

desired position. Do not force lever. If unable to shift, rock the vehicle back and forth and try again.



SHIFT PATTERN

NOTICE Always completely stop the vehicle and apply the brake prior to moving the shift lever.

P: Park

This position locks the transmission to help prevent vehicle movement. Always use when the vehicle is not in operation. In some circumstances, it may be necessary to rock the vehicle back and forth to move the gears in the transmission to allow the park to be engaged.

NOTE: The PARK position is used as a mechanical parking brake.

R: Reverse

This allows the vehicle to go backward. The vehicle speed is limited.

⚠ WARNING

Before moving vehicle in reverse, ensure the path behind is clear of obstacles or bystanders. We recommend sitting on your ATV when operating in reverse. Avoid standing up. Your weight could shift forward against throttle lever, causing an unexpected acceleration.

N: Neutral

This position disengages the transmission to allow manual vehicle movement.

H: High Gear

This selects the high speed range of the transmission in the gear box. It is the normal driving speed range. It allows the vehicle to reach its maximum speed.

L: Low Gear

This selects the low speed range of the transmission in the gear box. It is the working position. It allows the vehicle to move slowly with the maximum traction and power.

NOTE: Use the low speed range to pull any load or to climb a steep incline.

6) Headlight Dimmer Switch

The headlight switch is located on the LH side of the handlebar.

This switch is used to select headlight high beam or low beam.

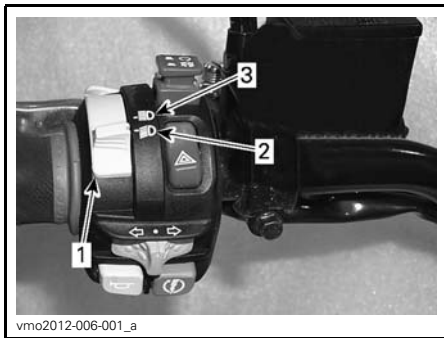

TYPICAL

- 1. Headlight dimmer switch
- 2. High beam
- 3. Low beam

7) Emergency Engine Stop Switch

The emergency engine stop switch is located on the LH side of the handlebar.

This switch is used to stop engine and as an emergency control.

To stop engine, fully release throttle lever then set the emergency engine stop switch to the STOP position.

NOTE: While the engine can be stopped by turning the ignition key to OFF position, we recommend the engine be stopped by setting the emergency engine stop switch to the STOP position.

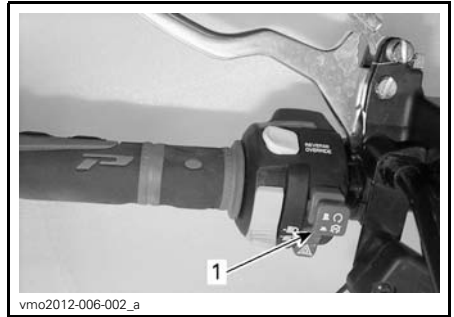

TYPICAL

- 1. Emergency engine stop switch

8) Engine Start Button

The engine start button is located on the LH side of the handlebar.

Button used to start the engine.

To start engine, place the emergency engine stop switch to RUN.

Press and hold to start engine. Release immediately after engine is started.

Refer to *STARTING THE ENGINE* in the *OPERATING INSTRUCTIONS* section for complete procedure on how to start the engine.



vmo2012-006-001_c

TYPICAL

1. Engine start button

9) Override Button

The override button is located on the LH side of the handlebar.

This button is used to override the engine RPM limiter system while power backing up.

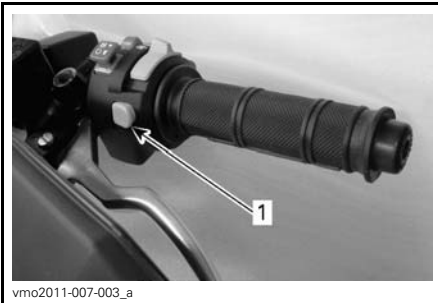

vmo2011-007-003_a

1. Override button

Press and hold the override button then depress throttle lever gradually.

NOTE: When using the override function, the multifunction gauge will scroll an **VERRIDE** message to confirm that the function is properly activated.

⚠ WARNING

Never activate the override button if the throttle is applied as a loss of control may result.

⚠ WARNING

If driving downhill in reverse, gravity can increase the vehicle speed above the set limited reverse speed.

10) Multifunction Gauge

The multifunction gauge is located in the middle of the handlebar.

⚠ WARNING

Selecting various numerical displays, system modes of operation or changing settings should only be carried out with the vehicle stopped. Selecting these various functions while operating the vehicle at speed is not recommended as it deters your attention from situational awareness.

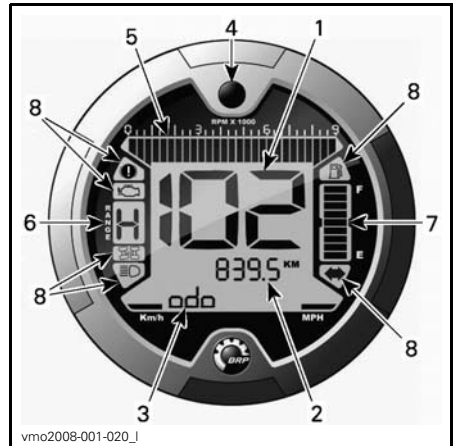

vmo2008-001-020_1

TYPICAL

1. Display 1 (speedometer)
2. Display 2 (mode)
3. Display 3 (mode/message)
4. Display selector button
5. Tachometer
6. Transmission position display
7. Fuel level display
8. Indicator lamps

Unit Selection (mph vs km/h)

This multifunction gauge is factory pre-set in metric units but it is possible to change it to Imperial units, contact an authorized Can-Am dealer for unit settings.

NOTE: All features will have their units changed all together.



1. Unit selection

Language Selection

The gauge display language can be changed. Refer to an authorized Can-Am dealer for language availability and set up the gauge to your preference.

Display 1 (Speedometer)

This display will show vehicle speed.

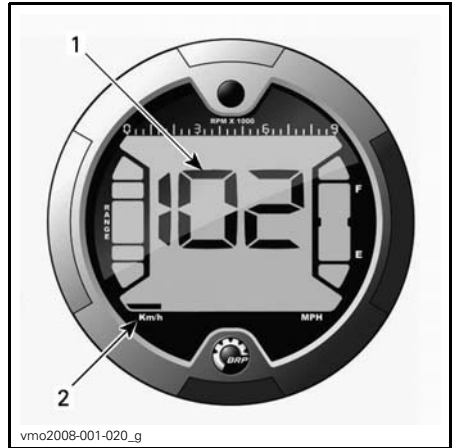

1. Vehicle speed
2. Unit selection

Display 2 (Mode)

By pressing the selector button, the following modes can be displayed:

- Odometer (ODO)
- Trip meter (TRIP)
- Hour meter (TRIP TIME)
- Vehicle hour meter (ENGINE HOURS)
- Engine revolutions per minute (RPM)
- Clock (CLOCK).

NOTE: An abbreviation of the mode selected will also be displayed in display 3 (see abbreviations in parenthesis).

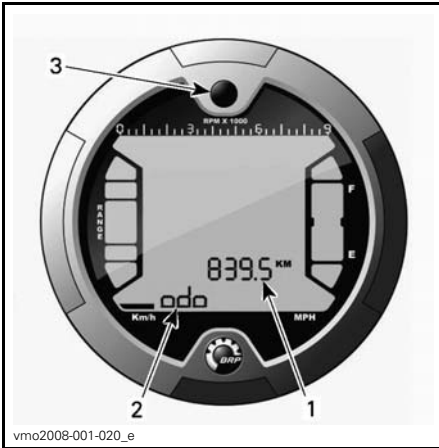

1. Display 2 (mode)
2. Display 3 (mode/message)
3. Selector button

Odometer

Records the total travelled distance.

Trip Meter

Records the travelled distance since it has been reset.

Press and HOLD display selection button to reset.

Hour Meter

Records the vehicle running time when the electrical system is activated since it has been reset.

Press and HOLD display selection button to reset.

Engine Hour Meter

Records engine running time.

Engine RPM

Measures engine revolutions per minute (RPM).

Clock

Shows current time.

To set current time, proceed as follows:

Once clock display as been selected, use the display selector button to set clock as follows:



1. Display selector button
2. Time (Display 2)
3. Am/Pm (12-hour format)
4. Message (Display 3)

1. Press and HOLD button (SET TIME will appear on display 3).
2. Choose the 12-hour (12H) or 24-hour (24H) format by pressing button.
3. If the 12-hour format was selected, choose Am ("A") or Pm ("P") by pressing button.
4. Press and HOLD button.
5. Choose hour first digit by pressing button.
6. Press and HOLD button.
7. Choose hour second digit by pressing button.
8. Press and HOLD button.
9. Choose minutes first digit by pressing button.
10. Press and HOLD button.
11. Choose minutes second digit by pressing button.
12. Press button to enter settings (CLOCK will appear on display 3).

Display 3 (Mode/Message)

This display will show either an abbreviation of the mode selected in display 2 or will communicate important messages to the operator if an anomaly occurs.



1. Display 3 (mode/message)
2. Display 2 (mode)

Mode Abbreviation

- ODO (odometer)
- TRIP (trip meter)
- TRIP TIME (hour meter)
- ENGINE HOURS (vehicle hour meter)
- RPM (engine revolutions per minute)
- CLOCK (Clock).

Display Selector Button

Button used to navigate between modes or to reset data depending on the feature selected.

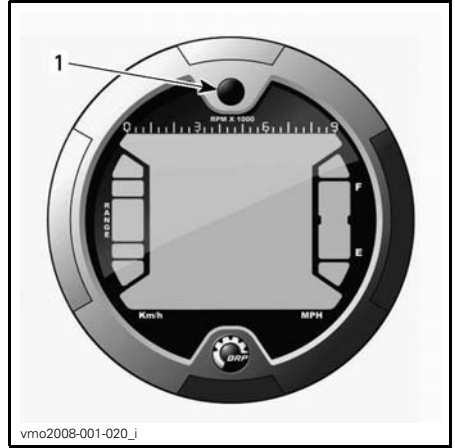

1. Selector button

Tachometer

Measures engine revolutions per minute (RPM). Multiply by 1000 to obtain the actual revolutions.

NOTE: RPM can also be displayed via Display 2 (mode) display. Refer to *DISPLAY 2 (MODE)* in this subsection.

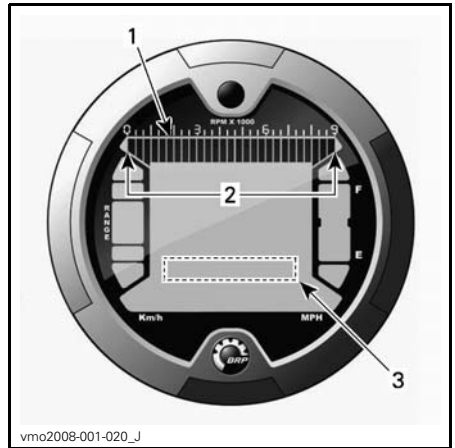

1. Tachometer
2. Operating range
3. Tachometer via display 2 (mode)

Transmission Position Display

This display will show transmission position.

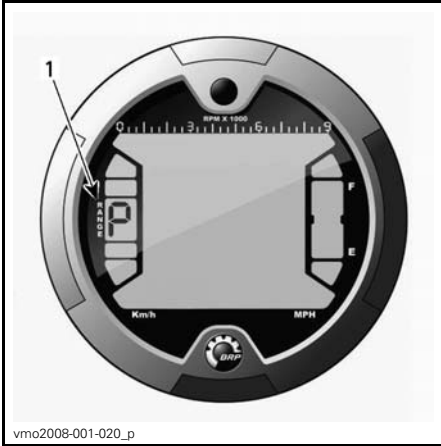

vmo2008-001-020_p

1. Transmission position

DISPLAY	FUNCTION
P	Park
R	Reverse
N	Neutral

NOTE: There is no message when a forward gear is selected. If the letter “E” is displayed in the transmission position display, it means that there is a electrical communication error. Contact an authorized Can-Am dealer.

Fuel Level Display

Bar gauge that continuously indicates the amount of fuel left in the fuel tank.

Also, an indicator lamp will indicate a low-fuel condition as only one bar is displayed.

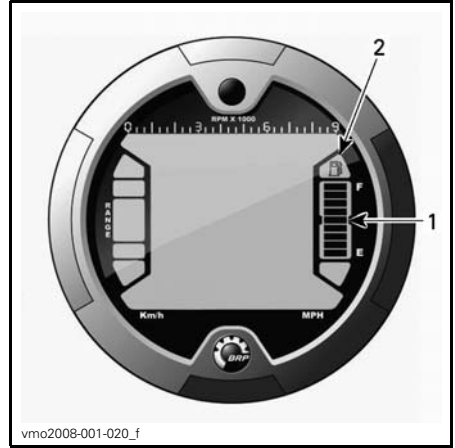

vmo2008-001-020_f

1. Fuel level display
2. Low fuel indicator lamp

Indicator Lamps

NOTE: Use in conjunction with *DISPLAY 3 (MODE/MESSAGE) MESSAGES TABLE* for additional information regarding messages.

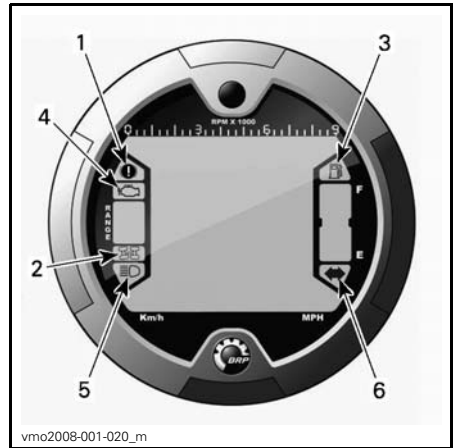

vmo2008-001-020_m

1. Brake indicator lamp
2. 4WD indicator lamp
3. Low fuel level indicator lamp
4. Check engine indicator lamp
5. High beam indicator lamp
6. Flasher/hazard signal indicator lamp

Description:



Brake lock is activated.



4WD system is activated.



Low fuel level. When this indicator is ON, it indicates that there is approximately 2 L (.5 U.S. gal.) of fuel left in fuel tank.



Check engine and D.E.S.S. system operation.



High headlight beam position selected.



Turn signal are in operation.

11) 12-Volt Power Outlet

Convenient for handheld spotlight or other portable equipment.

Remove protective cap to use. Always reinstall it after use to protect against weather.

Do not exceed the rating capacity. Refer to *SPECIFICATIONS* subsection.

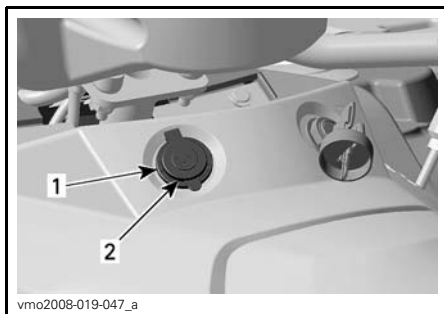

1. 12-volt power outlet
2. Protective cap

12) Ignition Switch

The ignition switch is located on the central panel near steering column.

Key-operated, 3-position switch.

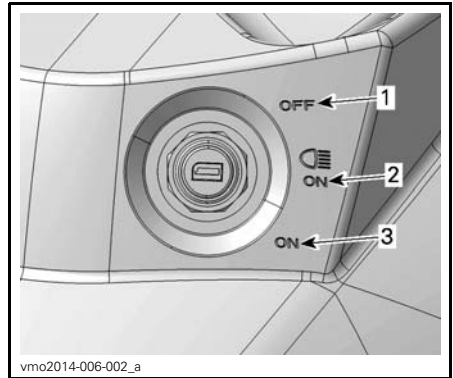

IGNITION SWITCH POSITIONS

1. OFF
2. ON with lights
3. ON without lights

NOTE: The emergency engine stop switch will override the ignition switch. Make sure the emergency engine stop switch is in RUN position to allow electrical system activation.

Insert key in switch and turn to the desired position.

To remove key, turn key to OFF position then pull it out.

The ON with lights position, turns on all lights with either the engine running or not. Remember that having the lights on without the engine running discharges the battery. Always turn the ignition key to OFF position after engine has been stopped.

NOTE: While engine can be stopped by turning ignition key to OFF position, we recommend the engine be stopped by the emergency engine stop switch.

Digitally Encoded Security System (D.E.S.S.)

The ignition key specifically contains an electronic circuit that gives it a unique electronic serial number.

This ignition key cannot be used on another vehicle and conversely, the one from another vehicle cannot be used on your vehicle except if it was programmed this way.

However, the D.E.S.S. brings a great flexibility. You can buy additional ignition keys and have them programmed for your vehicle.

To have additional ignition keys, refer to an authorized Can-Am dealer.

13) Brake Pedal

The brake pedal is located on the RH side of the vehicle near engine.

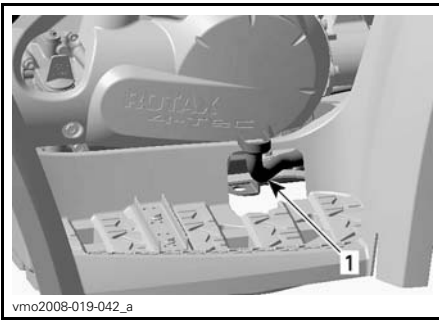

TYPICAL

1. Brake pedal

When the brake pedal is pressed down, the front and rear brakes are applied.

When released, the brake pedal should return to its original position.

Braking effect is proportional to the force applied on the pedal.

NOTE: As on other wheeled vehicles, the vehicle weight is transferred to the front wheels when braking. To obtain greater stopping efficiency, the brake system distributes more braking force to the front wheels. This will affect vehicle handling and steering control when braking vigorously. Take it into account when braking.

14) Footpegs

The footpegs are located on the RH and LH side of the vehicle.

Use this area to keep your feet and the passenger's (2-UP models) feet stable.

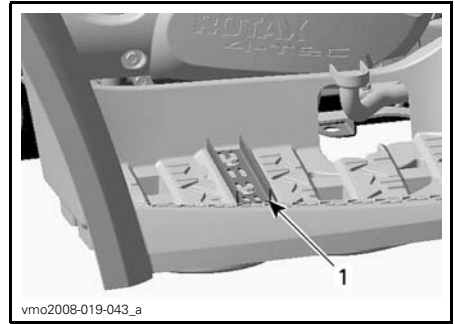

1-UP MODELS

1. Footpeg

⚠ WARNING

Operator must have both feet on footpegs at all time during vehicle operation.

While reading this Operator's Guide, remember that:

⚠ WARNING

Indicates a potential hazard that, if not avoided, could result in serious injury or death.

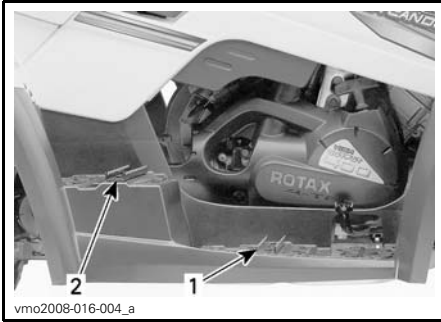

2-UP MODELS

1. Operator's footpeg
2. Passenger's footpeg

⚠ WARNING

Passenger must have both feet on footpegs at all time during vehicle operation.

15) Grab Handles

2-UP Models

The grab handles are located on the RH and LH side of the passenger's seat.

The grab handles must be used by the passenger to hold on firmly during vehicle operation.

⚠ WARNING

The passenger must always hold on to the passenger grab handles, not the operator. He must also have both feet resting firmly against the footrests.

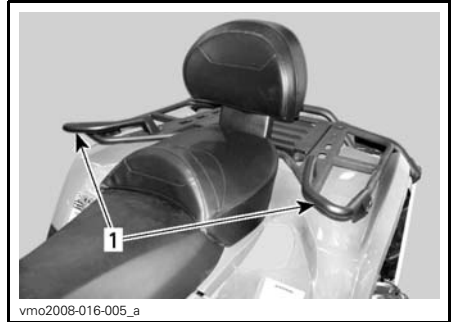

1. Grab handles

16) Passenger's Seat

2-UP Models

⚠ WARNING

Never operate the vehicle without passenger's seat properly installed.

The passenger's seat is designed specially to allow a secure and pleasant ride to ONE (1) passenger.

The integrated backrest supports his back during the ride.

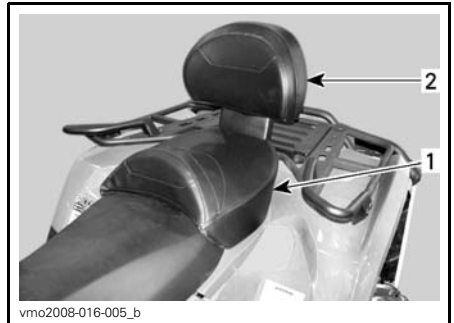

1. Passenger's seat
2. Integrated backrest

Passenger's Seat Removal

Pull one of the passenger's seat latch handles. Those latch handles are located underneath the RH and LH rear end of seat.



vmo2006-008-009_a

LH SIDE SHOWN

1. Seat latch handle

Gently lift seat rearwards.

Continue lifting movement until you can release the retaining device then completely remove passenger's seat.

Passenger's Seat Installation

Insert passenger's seat positioning tubes into rear fender provided holes.

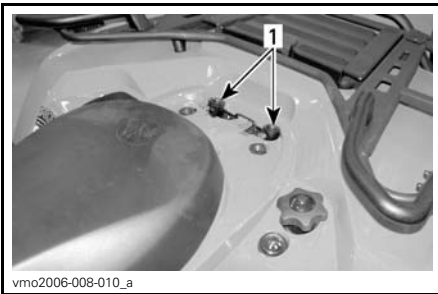

vmo2006-008-010_a

TYPICAL

1. Holes for passenger's seat positioning tubes

When seat rests in its position, firmly push seat down to latch.

NOTE: A distinctive snap will be felt. Double check that the seat is secure by giving it a tug to confirm proper latching.

⚠ WARNING

It is of the upmost importance for the passenger's safety that you confirm that the passenger's seat is properly locked in position by pulling back and up several times.

17) Glove Box

2-UP Models

⚠ WARNING

Never operate the vehicle without glove box properly installed.

The glove box is used to convert a two-rider vehicle (2-UP model) to a one-rider vehicle (1-UP model) with extra cargo capacity.

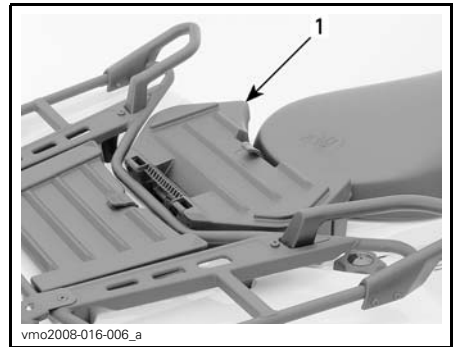

vmo2008-016-006_a

1. glove box

The conversion of the vehicle is easy, remove the passenger's seat then install the glove box.

⚠ WARNING

Without its passenger's seat, the vehicle becomes a ONE RIDER vehicle (1-UP model) and NO PASSENGER must be allowed on vehicle. NEVER carry passenger on glove box.

Glove Box Installation

Remove passenger's seat, refer to *PASSENGER'S SEAT REMOVAL*.

Position glove box onto rear fender.

When glove box rests in its position, firmly push down to latch.

To open glove box, unhook the rubber latch.

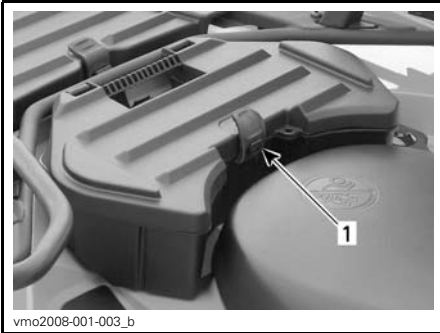

vmo2008-001-003_b

1. Rubber latch

Glove Box Removal

Pull glove box strap to release from vehicle.

Remove glove box.

Reinstall passenger's seat, refer to *PASSENGER'S SEAT INSTALLATION*.



vmo2008-001-003_a

1. Strap

18) Operator's Seat Latch

It allows the removal of operator's seat to give access to engine compartment.

NOTE: To remove the operator's seat on 2-UP models, the passenger's seat removal is necessary.

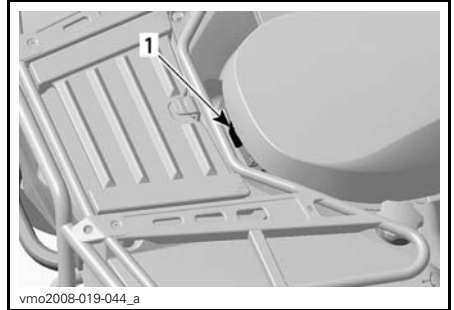

vmo2008-019-044_a

1-UP MODELS

1. Seat latch



vmo2006-008-011_a

2-UP MODELS

1. Seat latch

Seat Removal

Push latch forward while gently lifting rear of seat. Pull seat rearward. Continue lifting movement until you can release the front retaining device then completely remove seat.

Seat Installation

Insert front tabs of seat into frame hooks. When seat rests in its position, firmly push seat down to latch.

NOTE: A distinctive snap will be felt. Double check that the seat is secure by giving it a tug to confirm proper latching.

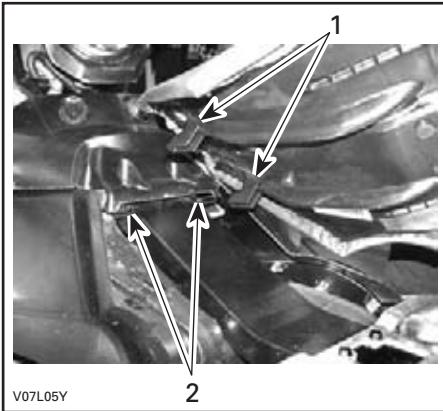

V07L05Y

1. Insert these tabs in hooks
2. Hooks

⚠ WARNING

It is of the utmost importance for the operator's safety that you confirm that the operator's seat is properly locked in position by pulling back and up several times.

19) Rear Storage Compartment

Convenient location to carry personal articles such as a spare spark plugs, first aid kit, etc.

To open the panel, unlatch, lift then remove it completely if necessary.

The compartment is equipped with a drain plug. Remove plug to allow draining when necessary. Reinstall plug when finished.

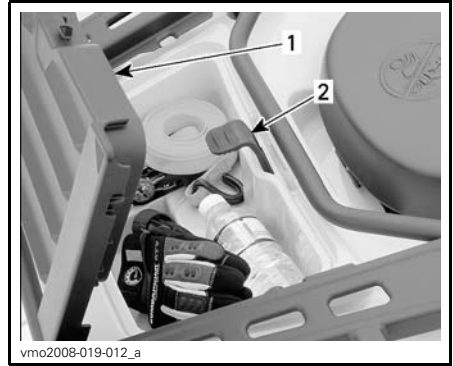

vmo2008-019-012_a

TYPICAL - 1-UP MODELS

1. Rear storage compartment cover
2. Latch

⚠ WARNING

When engine is running, always engage the PARK position on the shift lever before opening cover. Never leave any heavy or loose breakable objects in the storage basket. Always latch cover before riding. If storage cover is removed to provide greater carrying area, ensure that cargo is secured and will not "fly out" when riding at speed on rough terrain. Slow down.

20) Cargo Racks

Cargo racks are convenient for carrying equipment and various other cargo. They must never be used to carry a passenger.

⚠ WARNING

- Never carry a passenger on a cargo rack.
- Cargo must never interfere with the drivers line of sight or affect his ability to properly steer the vehicle.
- Do not overload the vehicle.
- Always ensure all cargo is properly secured and does not extend out pass the racks.

Refer to *SPECIFICATIONS* for cargo weight recommendations.

21) Trailer Hitch

Convenient hitch to install a ball to tow a trailer or other equipment. Install the proper ball size as per trailer manufacturer recommendations. Refer to *SPECIFICATIONS* for carrying loads and towing recommendations.

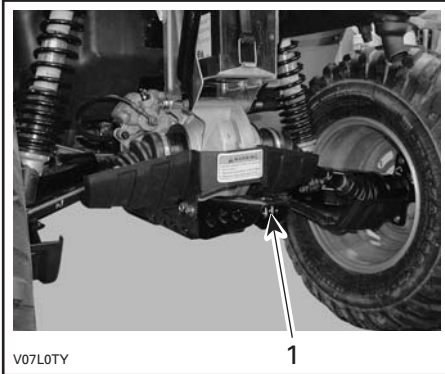

1. Trailer hitch

⚠ WARNING

Ensure to install the proper ball size that matches the equipment you will tow.

NOTE: Follow manufacturer's instructions for proper attachment.

22) Tool Kit

The tool kit is located in the rear storage compartment. It contains tools for basic maintenance, this Operator's Guide and the *BASIC GUIDE TO WINCHING TECHNIQUES* with the XT models.

While reading this Operator's Guide, remember that:

⚠ WARNING

Indicates a potential hazard that, if not avoided, could result in serious injury or death.

23) Winch (XT Models)

For proper winch operating instructions, refer to the *BASIC GUIDE TO WINCHING TECHNIQUES* included with the vehicle.

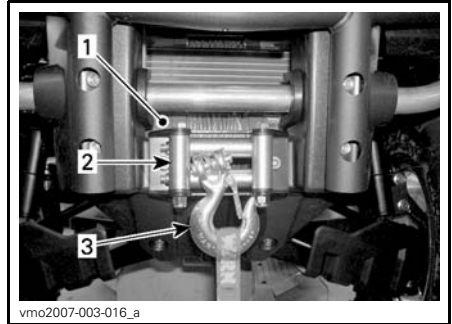

1. Winch
2. Roller fairlead
3. Winch hook

⚠ WARNING

The front winch hook of the so equipped vehicles must be removed and stored when riding the vehicle on public trails and/or roads. Failure to do so can increase the risk of injury to bystanders.

24) Winch Control Switch (XT Models)

Use this switch to roll in or out wire from winch.

To let out the cable, press the left side of switch.

To reel out the cable, press the right side of switch.

Refer to *BASIC GUIDE TO WINCHING TECHNIQUES* for proper operating instructions.

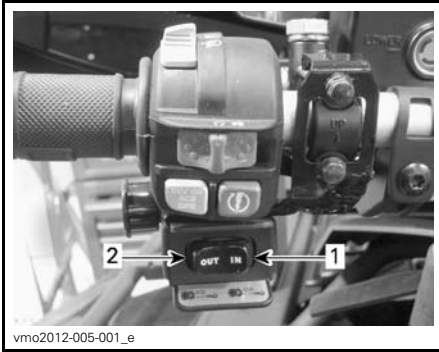

1. Roll in
2. Roll out

25) Vehicle Lock

The vehicle lock is located next to the park position of the shift lever, on the right hand side of the vehicle.

Its purpose is to lock the shift lever in park position.

NOTE: The vehicle will not be lock if the transmission is not placed in park position when the mechanism is engaged.

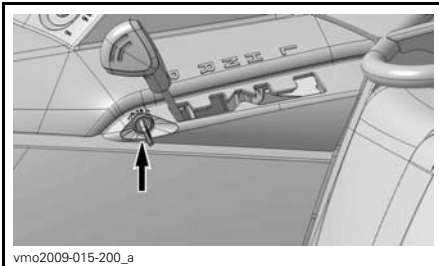

26) Turn Signal Switch

The turn signal switch is located on the LH side of handlebar.

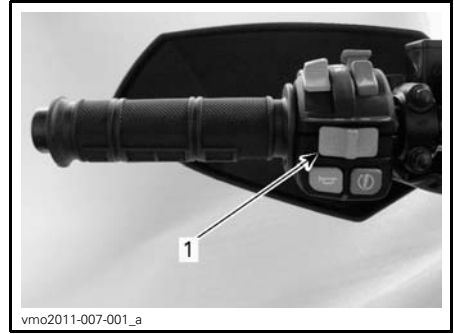

1. Turn signal switch

To activate the turn signals, move the switch button to the right or left side, depending which direction you picked. Reposition the switch in the middle when the maneuver is completed.

27) Horn Button

The horn button is located on the LH side of handlebar.

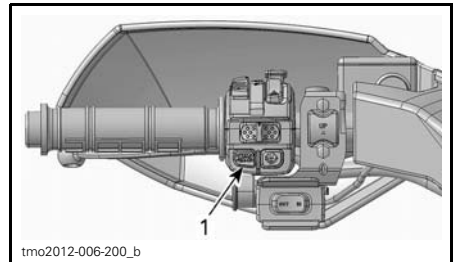

1. Horn button

28) Hazard Warning Button

The hazard warning button is located on the LH side of handlebar.



1. Hazard warning button

Device fitted to the vehicle that operates a simultaneous flashing of all the turn signals, used when the vehicle is stationary to indicate that the vehicle is temporarily obstructing traffic.

Press the hazard warning button once to activate the device.

NOTE: Hazard warning lights can be activated even when the vehicle electrical system is shut down.

29) Front Service Compartment

The front service compartment gives access to:

- Radiator cap
- Brake fluid reservoir
- Fuse box
- Winch remote control (inside cover)

Remove panel to access the compartment.

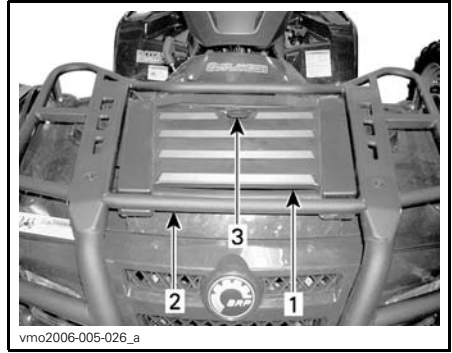

1. Access panel
2. Front racks
3. Latch

NOTICE Never store any objects in the front service compartment.

30) Winch Remote Control (XT Models)

A winch remote control is provided with the vehicle to ease winch operation.

The winch remote control is located underneath front service compartment panel.



FRONT SERVICE COMPARTMENT
1. Winch remote control

To use the winch remote control instead of the handlebar control switch, connect the remote control into the provided connection.



1. Remote control connection

Refer to *BASIC GUIDE TO WINCHING TECHNIQUES* for more informations about the winch.

NOTICE Always disconnect and store the remote control when not in use.

FUEL

Fuel Requirements

NOTICE Always use fresh gasoline. Gasoline will oxidize; the result is loss of octane, volatile compounds, and the production of gum and varnish deposits which can damage the fuel system.

Alcohol fuel blending varies by country and region. Your vehicle has been designed to operate using the recommended fuels, however, be aware of the following:

- Use of fuel containing alcohol above the percentage specified by government regulations is not recommended and can result in the following problems in the fuel system components:
 - Starting and operating difficulties.
 - Deterioration of rubber or plastic parts.
 - Corrosion of metal parts.
 - Damage to internal engine parts.
- Inspect frequently for the presence of fuel leaks or other fuel system abnormalities if you suspect the presence of alcohol in gasoline exceeds the current government regulations.
- Alcohol blended fuels attract and hold moisture which may lead to fuel phase separation and can result in engine performance problems or engine damage.

Recommended Fuel

Use common unleaded gasoline with an AKI (R+M)/2 octane rating of 87, or an RON octane rating of 92.

NOTICE Never experiment with other fuels. Engine or fuel system damages may occur with the use of an inadequate fuel.

Fueling Procedure

WARNING

- Always stop engine before refueling. Open cap slowly.
- If a differential pressure condition is noticed (whistling sound heard when loosening fuel tank cap) have vehicle inspected and/or repaired before further operation.
- Fuel is flammable and explosive under certain conditions.
- Never use an open flame to check fuel level.
- Never smoke or allow flame or spark in vicinity.
- Always work in a well-ventilated area.
- Never top up the fuel tank before placing the vehicle in a warm area. As temperature increases, fuel expands and may overflow.
- Always wipe off any fuel spillage from the vehicle.

NOTICE Never place anything over fuel tank cap because the vent hole on the top of fuel tank cap can be blocked and the engine could misfire.

1. Stop engine.
2. Do not allow anyone to remain seated on the vehicle while filling.
3. Unlock fuel tank cap using provided key.
4. Unscrew fuel tank cap counterclockwise to remove it.
5. Insert the spout into the filler neck.
6. Pour fuel slowly to allow time for the air in the tank to escape from the tank and prevent fuel flow back. Be careful not to spill fuel.

7. Stop fueling when the fuel reaches the bottom of filler neck. **Do not overfill.**
8. Fully tighten fuel tank cap clockwise.
9. Lock fuel tank cap.

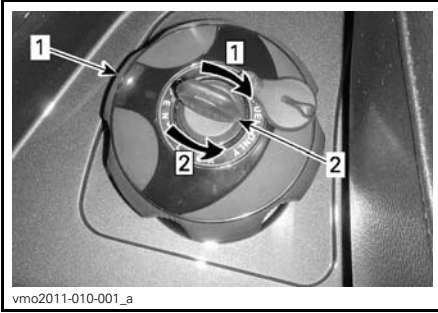
**RH REAR FENDER**

1. Fuel tank cap
2. Key

Step 1: Unlock to fill up
Step 2: Lock

BREAK-IN PERIOD

Operation During Break-In

A break-in period of 10 operating hours or 300 km (200 mi) is required for the vehicle.

After the break-in period, the vehicle should be inspected by an authorized Can-Am dealer. Refer to *MAINTENANCE INFORMATION* section.

Engine

During the break-in period:

- Avoid full throttle operation.
- Maximum throttle should not exceed 3/4.
- Avoid sustained accelerations.
- Avoid prolonged cruising speeds.
- Avoid engine overheating.

However, brief accelerations and speed variations contribute to a good break-in.

Brakes

WARNING

New brakes will not operate at their maximum efficiency until their break-in is completed. Use extra caution.

 **CAUTION** The brakes can be very hot after prolonged use of the vehicle and can cause burns. Wait for the brakes to cool down.

Belt

A new belt requires a break in period of 50 km (30 mi).

During the break-in period:

- Avoid strong acceleration and deceleration.
- Avoid pulling a load.
- Avoid high speed cruising.

BASIC PROCEDURES

Starting the Engine

The shift lever must be set to PARK or NEUTRAL.

NOTE: For your convenience, an override mode allows the engine to be started with the shift lever in any position. Press and hold the brake lever or the brake pedal while pressing the engine start button.

Insert key in ignition switch and turn to ON position.

Set the emergency engine stop switch to RUN.

Press the engine start button and hold until the engine starts.

NOTICE Do not hold the engine start button more than 10 seconds. A rest period should be observed between the cranking cycles to let the starter cool down. Pay attention not to discharge the battery.

Release the engine start button immediately when the engine has started.

NOTE: If the battery is dead, engine cannot be started. Have the battery recharged or replaced.

Changing Gear Selection

Apply brakes and select the desired shift lever position using the shift lever.

Release brakes.

Using Reverse Override Function

When the shift lever is in the REVERSE position, engine RPM is limited thus limiting the reverse speed that can normally be commanded using the throttle lever.

NOTICE When changing gear selection, always completely stop the vehicle and apply the brakes prior to moving the shift lever. Damage to the transmission may occur.

WARNING

If driving downhill in reverse, gravity can increase the vehicle speed above the set limited reverse speed.

To engage the override function, press and hold the override button, then gradually press the throttle lever to increase engine power.

To disengage the override function, release the throttle lever then the override button.

WARNING

Never activate the override button if the throttle lever is not fully released as a loss of control may result.

Stopping the Engine

WARNING

Avoid parking on slope.

Release throttle and completely stop the vehicle.

Apply the brake lock.

Set shift lever in PARK position.

Push the emergency engine stop switch in STOP position.

Turn key in ignition switch to OFF position.

Remove key from ignition switch.

SPECIAL PROCEDURES

What to Do if Water is in the CVT

Any time you suspect that water has entered the CVT cover, drain the CVT housing by removing the drain screw.

NOTE: The drain screw is the screw located at the bottom rear end of the CVT cover.

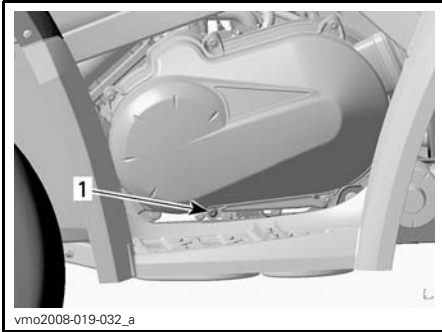

LH SIDE
1. Drain plug

NOTICE If water entered your CVT while in a muddy environment, limit vehicle usage and bring your vehicle to your nearest authorized Can-Am dealer for a proper CVT cleaning procedure.

What to Do if Water is in the Air Filter Housing

In such a case, the vehicle must be serviced for:

- CVT air filter cleaning
- CVT cleaning
- Fuel tank breather replacement
- Lubricant inspection and replacement as required (engine, gearbox and rear final drive).

NOTICE Failure to have vehicle serviced may lead to permanent damage to the following components but not limited to:

- Engine and gearbox
- Fuel pump
- CVT
- Rear final drive.

What to Do if Vehicle is Turned Over

When vehicle is turned over or stays tilted on the side, put the vehicle back on its wheels, then wait 3 to 5 minutes. Refer to *MAINTENANCE* section and inspect the following.

- Inspect air filter housing for oil accumulation, if any oil is found, clean air filter and air filter housing.
- Check engine oil level and refill if necessary.
- Check engine coolant level and refill if necessary.
- Check gearbox oil level and refill if necessary.
- Check rear final drive oil level and refill if necessary.
- Start engine. If the oil pressure light stays on, stop engine immediately. See an authorized Can-Am dealer.

NOTICE When reinstalling dashboard over air filter housing, ensure that all vent hose are routed up above the gauge cluster.

What to Do if Vehicle is Immersed in Water

Should the vehicle become immersed, immediately stop the engine. Do not use winch or any electrical equipment while vehicle is immersed. It will be necessary to take the vehicle to an authorized Can-Am dealer as soon as possible. **NEVER ATTEMPT TO START THE ENGINE!**

NOTICE Immersion of the vehicle can cause serious damage if the correct restart procedure is not followed.

As soon as vehicle is pulled out of water, carry out the following:

- Drain CVT. See procedure in this subsection.

NOTICE The vehicle should be serviced as soon as possible by an authorized Can-Am dealer.

TUNE YOUR RIDE

⚠ WARNING

Suspension adjustment could affect vehicle handling. Always take time to familiarize yourself with the vehicle's behavior after any suspension adjustment have been made.

⚠ WARNING

The left and right shock adjustment cams must always be set to the same position. Never adjust one adjusting cam only. Uneven adjustment can cause poor handling and loss of stability.

Suspension Adjustments

Your vehicle handling and comfort depend upon suspension adjustments.

Choice of suspension adjustments vary with driver's weight, personal preference, riding speed and field condition.

Rear Spring Preload

Adjust spring preload by turning adjusting cam accordingly, with the adjusting wrench in vehicle tool kit.

Turn the adjustment cams clockwise for a firmer ride and rough trail condition or when carrying cargo or pulling a trailer.

Turn the adjustment cams counter-clockwise for a light trail and a smooth trail condition.

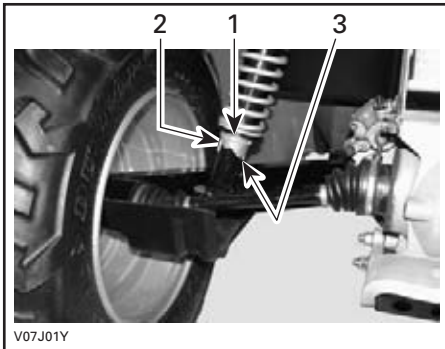

1. *Adjusting cams*
2. *Smooth adjustment*
3. *Hard adjustment*

VEHICLE TRANSPORTATION

When transporting this vehicle, secure it to a trailer or in pickup box using suitable tie-downs. Use of ordinary ropes is not recommended.

⚠ WARNING

Do not tow this vehicle behind a car or other vehicle. Use a trailer. Never tip this vehicle on end for transporting. The vehicle must be in its normal operating position (on all four wheels).

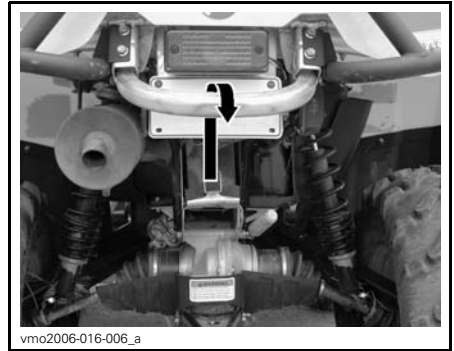

TYPICAL — REAR TIE-DOWN POINT LOCATION

NOTICE Securing vehicle at other locations may damage the vehicle.

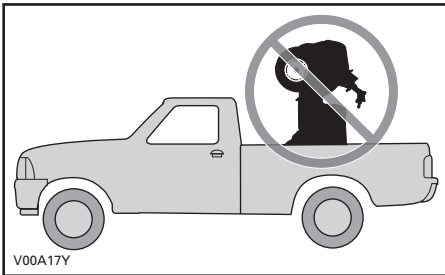

Remember to:

- Unload vehicle racks before transportation.
- Set shift lever to PARK position.
- Set the brake lock.
- Secure the front of the vehicle by the front bumper and the rear of the vehicle by the rear bumper.



TYPICAL — FRONT TIE-DOWN POINT LOCATION

***This page is
intentionally blank***

MAINTENANCE

BREAK-IN INSPECTION

BRP suggests that after the first 10 hours or 300 km (200 mi) of operation, whichever comes first, your vehicle be inspected by an authorized Can-Am dealer. The break-in inspection is very important and must not be neglected.

NOTE: The break-in inspection is at the expense of the vehicle owner.

We recommend that this inspection be signed by an authorized Can-Am dealer.

Date of inspection

Authorized dealer signature

Dealer name

BREAK-IN INSPECTION CHART	REPLACE					
	ADJUST					
	TIGHTEN					
	LUBRICATE					
	CLEAN					
	INSPECT					
ENGINE						
Engine oil and filter						X
Valve clearance	X				X	
Engine seals	X					
Engine mounting fasteners	X					
Exhaust system	X					
COOLING SYSTEM						
Radiator cap/cooling system pressure test	X					
Radiator	X					
ENGINE MANAGEMENT SYSTEM						
EMS sensors	X					
EMS fault codes	X					
FUEL SYSTEM						
Throttle body	X					
Throttle lever	X					
Throttle cable	X		X		X	
Fuel lines, fuel rails, connections, check valves and fuel tank leak test	X					
ELECTRICAL SYSTEM						
Spark plug gap and condition	X					
Battery connections	X					
Electrical connections and fastening (ignition system, starting system, fuel injectors etc.)	X					
Headlights beam aiming	X					

BREAK-IN INSPECTION CHART	REPLACE					
	ADJUST					
	TIGHTEN					
	LUBRICATE					
	CLEAN					
	INSPECT					
CVT TRANSMISSION						
CVT air inlet	X					
DRIVE SYSTEM						
4 x 4 coupling unit	X					
Drive shaft boots and protectors	X					
Front/rear differentials (oil level, seals and vents)	X					
Rear propeller shaft joint	X					
WHEEL/TIRES						
Wheel nuts/studs	X					
STEERING SYSTEM						
Steering system (column, bearing, etc.)	X					
Front wheel alignment	X					
BRAKES						
Brake fluid	X					

MAINTENANCE SCHEDULE

Maintenance is very important for keeping your vehicle in safe operating condition. Proper maintenance is the owner's responsibility. The vehicle should be serviced as per the maintenance schedule.

The maintenance schedule does not exempt the pre-ride inspection.

WARNING

Failure to properly maintain the vehicle according to the maintenance schedule and procedures can make it unsafe to operate.

MAINTENANCE SCHEDULE						
A: Adjust C: Clean I: Inspect L: Lubricate R: Replace	25 h or 750 km (500 mi)					
	50 h or 1 500 km (1,000 mi)					
	100 h or 1 year or 3 000 km (2,000 mi)					
	200 h or 2 years or 6 000 km (4,000 mi)					
	To be performed by					
PART/TASK						LEGEND
ENGINE						
Engine oil and filter		R			Customer	(1) More often under dusty conditions. Refer to <i>AIR FILTER</i> in <i>MAINTENANCE PROCEDURES</i> . (2) Oil must be added to the foam filter element of the air filter.
Valve clearance			I, A		Dealer	
Air filter	I, C (1) L (2)		R		Customer	
Engine seals			I		Dealer	
Engine mounting fasteners			I		Dealer	
Rewind starter rope			I		Dealer	
Exhaust system			I		Dealer	
Muffler spark arrester			C		Customer	
COOLING SYSTEM						
Engine coolant			I (3)	R	Customer	(3) Every 100 hours, check coolant strength.
Radiator cap/cooling system pressure test				I	Dealer	
ENGINE MANAGEMENT SYSTEM						
EMS sensors			I		Dealer	—
EMS fault codes			I		Dealer	

MAINTENANCE SCHEDULE						
A: Adjust C: Clean I: Inspect L: Lubricate R: Replace	25 h or 750 km (500 mi)					
	50 h or 1 500 km (1,000 mi)					
	100 h or 1 year or 3 000 km (2,000 mi)					
	200 h or 2 years or 6 000 km (4,000 mi)					
	To be performed by					
PART/TASK						LEGEND
FUEL SYSTEM						
Throttle body			I, L		Dealer	(5) More often under severe use such as dusty area, sand, snow, wet or muddy conditions.
Throttle cable		I, A, L			Dealer/ Customer	
Fuel lines, connections and fuel tank pressure test			I		Dealer	
fuel pump pre-filter				I (5)	Dealer	
Fuel pump pressure test			I (5)		Dealer	
Fuel tank breather filter			R (5)		Customer	
ELECTRICAL SYSTEM						
Spark plug			R (4)		Customer	(4) Make sure the spark plug is correctly gapped.
Battery connections		I			Customer	
ECM connectors (visual inspection without disconnecting)			I		Dealer	
Electrical connections and fastening (ignition system, starting system, fuel injectors etc.)			I		Dealer	
Headlights beam aiming			I		Customer	
CVT TRANSMISSION						
Drive belt			I		Dealer	—
Drive and driven pulleys (including one-way bearing)			I, C, L		Dealer	
CVT air inlet/outlet duct condition/cleanliness		I, C			Dealer	

MAINTENANCE SCHEDULE						
A: Adjust C: Clean I: Inspect L: Lubricate R: Replace	25 h or 750 km (500 mi)					
	50 h or 1 500 km (1,000 mi)					
	100 h or 1 year or 3 000 km (2,000 mi)					
	200 h or 2 years or 6 000 km (4,000 mi)					
	To be performed by					
PART/TASK						LEGEND
DRIVE SYSTEM						
4 x 4 coupling unit			I		Dealer	(5) More often under severe use such dusty area, sand, snow, wet or muddy conditions.
Drive shaft joints		I			Dealer	
Rear propeller shaft joint		I, L (5)			Dealer	
Front/rear differentials (oil level, seals and vents)		I			Dealer	
Front/rear differential oil				R	Dealer	
WHEELS/TIRES						
Wheel nuts/studs		I			Customer	—
Wheel bearings			I		Customer	
STEERING SYSTEM						
Handlebar fasteners			I		Dealer	(5) More often under severe use such dusty area, sand, snow, wet or muddy conditions.
Steering system (column, bearing, etc.)			I (5)		Dealer	
Tie rod ends		I			Dealer	
Front wheel alignment			I, A		Dealer	
SUSPENSION						
Rear trailing arms			I		Dealer	—
Rear trailing arm bearings				I	Dealer	
Shock absorbers		I			Dealer	
Front A-arms		I, L			Customer	
Ball joints	I				Dealer	

MAINTENANCE SCHEDULE						
A: Adjust C: Clean I: Inspect L: Lubricate R: Replace	25 h or 750 km (500 mi)					
	50 h or 1 500 km (1,000 mi)					
	100 h or 1 year or 3 000 km (2,000 mi)					
	200 h or 2 years or 6 000 km (4,000 mi)					
	To be performed by					
PART/TASK						LEGEND
BRAKES						
Brake fluid	I			R ⁽⁶⁾	Dealer/ Customer	(5) More often under severe use such dusty area, sand, snow, wet or muddy conditions. (6) Brake fluid replacement or any brake system repairs must be performed by an authorized Can-Am distributor/dealer.
Brake pads	I ⁽⁵⁾				Dealer	
Brake system (discs, hoses, etc.)			I ⁽⁵⁾		Customer	
BODY/CHASSIS						
Body/frame fasteners		I			Customer	—
Frame			I		Dealer	

MAINTENANCE PROCEDURES

This section includes instructions for basic maintenance procedures. If you have the necessary mechanical skills and the required tools, you can perform these procedures. If not, see your authorized Can-Am dealer.

Other important items in the maintenance schedule that are more difficult and require special tools are best performed by your authorized Can-Am dealer.

⚠ WARNING

Turn off the engine and follow these maintenance procedures when performing maintenance. If you do not follow proper maintenance procedures you can be injured by hot parts, moving parts, electricity, chemicals or other hazards.

⚠ WARNING

Should removal of a locking device be required (e.g. lock tabs, self-locking fasteners, etc.) when undergoing disassembly/assembly, always replace with a new one.

Air Filter

Air Filter Maintenance Guideline

As with any ATV, air filter maintenance is critical to ensure proper engine performance and life span.

Air filter maintenance should be adjusted according to riding conditions.

Air filter maintenance must be increased in frequency and oil must be added to the foam filter element for the following dusty conditions:

- Riding on dry sand
- Riding on dry dirt covered surfaces
- Riding on dry gravel roads or similar conditions.

NOTE: Riding in a group in these conditions would increase even more the air filter maintenance. Refer to *AIR FILTER CLEANING AND OILING* subsection for maintenance procedure.

NOTE: An accessory pre-filter for "dusty conditions" may be used. Contact an authorized Can-Am dealer for details.

Air Filter Removal

NOTICE Never remove or modify any component in the air filter housing. Otherwise, engine performance degradation or damage can occur. The engine is calibrated to operate specifically with these components.

Remove seat.

On the right side of vehicle, remove side panels.

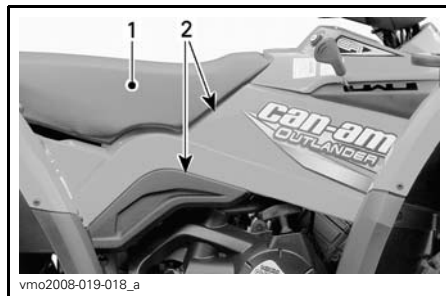

1. Seat
2. Side panels

Release clamps and remove air filter housing cover.

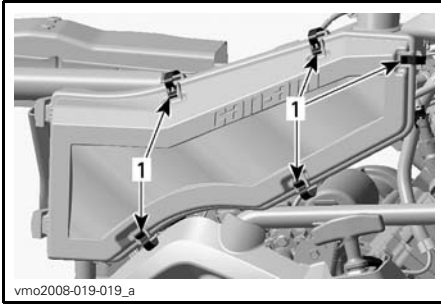

1. Release clamps

Loosen clamp and remove air filter.

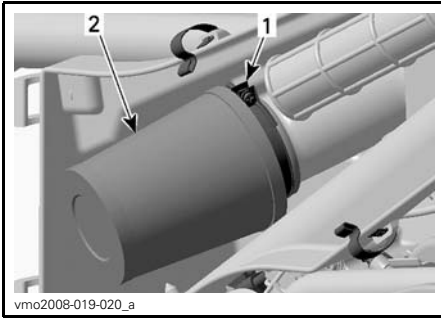

1. Clamp
2. Air filter

Air Filter Cleaning and Oiling

CAUTION Always wear appropriate skin and eye protection. Chemicals can cause a skin rash and severe eye injury.

Paper Filter Cleaning

1. Ensure that the foam filter element is removed from paper filter.
2. Tap out heavy dust from the paper element.

This will allow dirt and dust to get out of the paper filter.

NOTE: Paper filter have a limited life span; replace filter if too dirty or clogged.

NOTICE It is not recommended to blow compressed air on the paper filter; this could damage the paper fibers and reduce its filtration ability when used in dusty environments.

NOTICE Do not wash the paper filter with any cleaning solution.

Foam Filter Element Cleaning

1. Spray the foam filter element inside and out with AIR FILTER CLEANER (P/N 219 700 341).



AIR FILTER CLEANER (P/N 219 700 341)



TYPICAL - SPRAY THE FOAM ELEMENT

2. Let stand for 3 minutes.
3. As stated on air filter cleaner (UNI) container, rinse with plain water.
4. Dry the foam element completely.

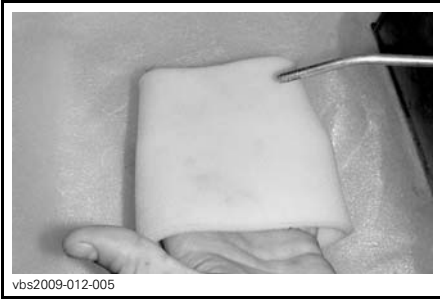

TYPICAL - DRY

NOTE: A second application may be necessary for heavily soiled elements.

Foam Filter Element Oiling

1. Carefully remove foam filter from air paper filter.
2. Spray AIR FILTER OIL (P/N 219 700 340) on the foam filter element previously dried.



AIR FILTER OIL (P/N 219 700 340)



TYPICAL - OIL THE FOAM FILTER ELEMENT

3. Let stand for 3 to 5 minutes.

4. Remove any excess of oil that could transfer to the paper filter by wrapping the foam filter element into an absorbent cloth and squeezing gently. This will also ensure a full oil coverage on foam filter.
5. Reinstall the foam filter element over the paper filter.

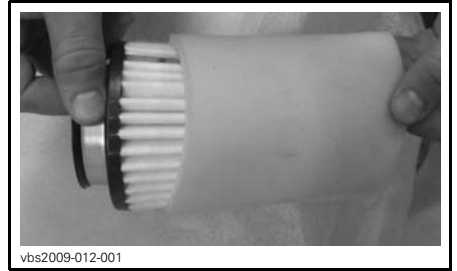

TYPICAL

Air Filter Installation

Properly reinstall removed parts in the reverse order of their removal.

Air Filter Housing

Air Filter Housing Draining

Periodically inspect air filter housing drain tube for liquids or deposits.

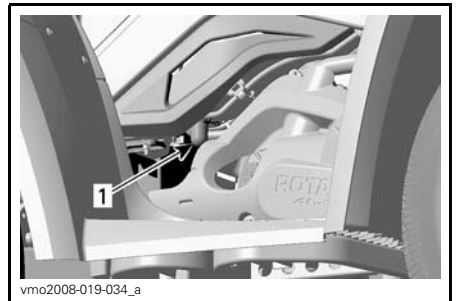

RH SIDE OF VEHICLE

1. Drain tube

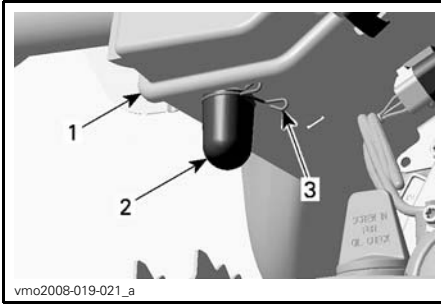

- vmo2008-019-021_a
1. Air filter housing
 2. Drain tube
 3. Clamp

NOTE: If vehicle is used in dusty area, inspect more frequently than specified in *MAINTENANCE SCHEDULE*.

If liquids/deposits are found, squeeze and remove the clamp. Pull drain tube out and empty it.

NOTICE Do not start engine when liquids/deposits are found in the drain tube.

When liquids/deposits are found, the air filter must be inspected/dried/replaced depending on its condition.

Remove air filter as explained in *AIR FILTER REMOVAL*.

Fuel Tank Breather Filter

Fuel Tank Breather Filter Replacement

1. Remove seat.
2. Locate fuel tank breather filter.

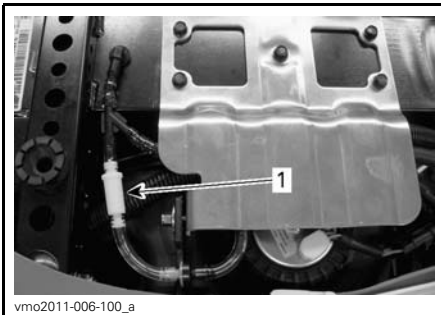

- vmo2011-006-100_a
1. Fuel tank breather filter

3. Remove filter by carefully cutting hoses at both ends.

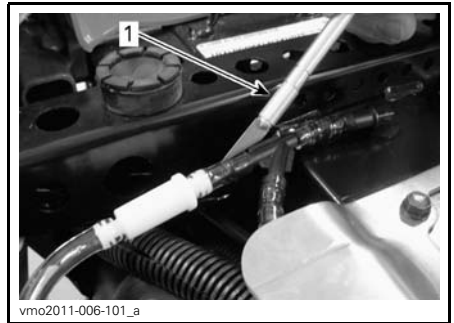

vmo2011-006-101_a

TYPICAL - CAREFULLY CUT HOSE

1. Cutting tool

4. Replace both hoses on fuel tank breather line.
5. Install a **new** filter with the arrow pointing towards the outside of vehicle.

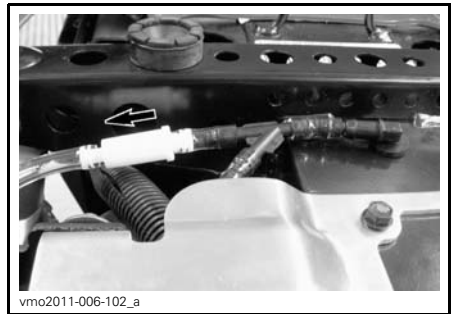

vmo2011-006-102_a

ARROW POINTING TOWARDS OUTSIDE

NOTICE Ensure that all hoses are properly pushed into fittings in order to avoid disconnecting.

6. Reinstall seat.

Engine Oil

Engine Oil Level

NOTICE Check level frequently and refill if necessary. **Do not overfill.** Operating the engine/transmission with an improper level may severely damage engine/transmission. Wipe off any spillage.

NOTE: While checking the oil level, visually inspect engine area for leaks.



RH SIDE OF ENGINE

1. Dipstick

With vehicle on a level surface and engine cold, not running, check the oil level as follows:

1. Unscrew dipstick then remove it and wipe clean.
2. Reinstall dipstick, screw in it completely.
3. Remove dipstick again and check oil level. It should be near or equal to the upper mark.

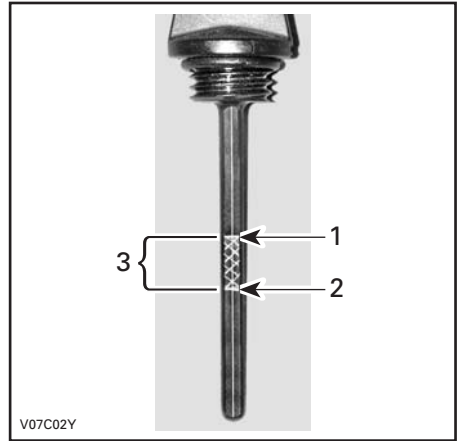

1. Full
2. Add
3. Operating range

To add oil, remove dipstick. Place a funnel into the dipstick tube to avoid spillage.

Add a small amount of recommended oil and recheck oil level.

Repeat the above procedures until oil level reaches the dipstick's upper mark. **Do not overfill.**

Properly tighten dipstick.

Recommended Engine Oil

For the summer season, use XPS 4-STROKE SYNTH. BLEND OIL (SUMMER) (P/N 293 600 121).

For the winter season, use XPS 4-STROKE SYNTHETIC OIL (ALL CLIMATE) (P/N 293 600 112).

NOTE: The XPS oil is specially formulated and tested for the severe requirements of this engine.

If not available, use 4-stroke SAE engine oil that meets or exceeds the requirements for API service classification SM, SL or SJ. Always check the API service label certification on the oil container it must contain at least one of the above standards. Refer to the viscosity chart for details.

Engine Oil Viscosity Chart

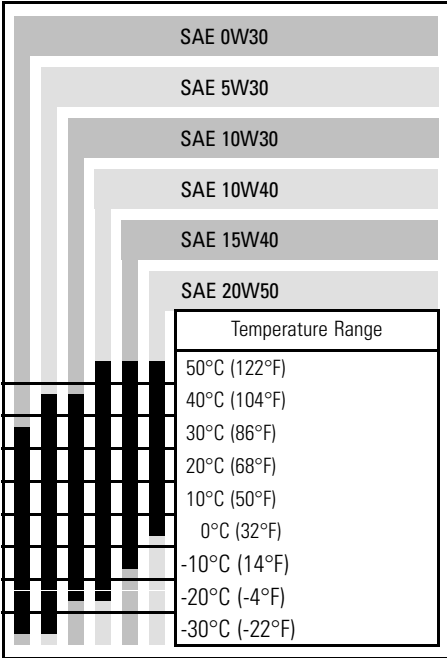

Engine Oil Change

Oil and filter are to be replaced at the same time. Oil change should be done with a warm engine.

CAUTION The engine oil can be very hot. In order to avoid potential burns, do not remove the engine drain plug or the filter cover if the engine is hot. Wait until engine oil is warm.

Ensure vehicle is on a level surface.

Remove dipstick.

NOTICE Pay attention not to lose the O-ring on dipstick.

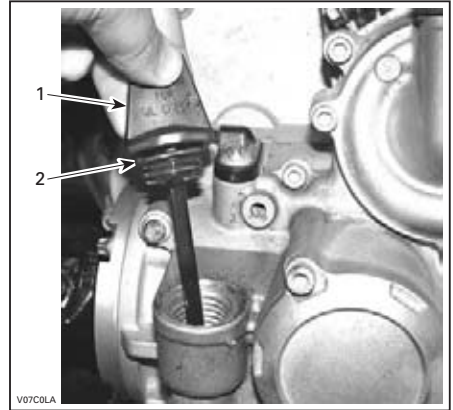

RH SIDE OF ENGINE

1. Dipstick
2. O-ring

Clean the oil drain plug area.

Place a drain pan under the oil drain plug area.

Unscrew oil drain plug.

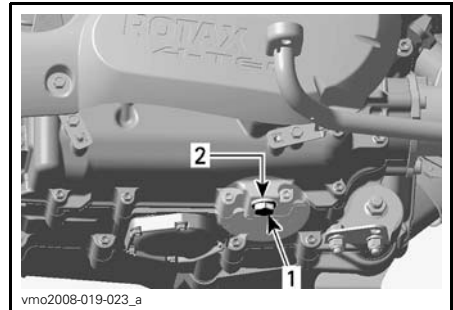

RH SIDE OF ENGINE

1. Oil drain plug
2. Gasket ring

Allow oil to drain completely from crankcase.

Change gasket ring on oil drain plug.

Clean gasket ring area on engine and oil drain plug then reinstall plug.

Torque plug to $30\text{ N}\cdot\text{m} \pm 3.6\text{ N}\cdot\text{m}$ ($22\text{ lb}\cdot\text{ft} \pm 3\text{ lb}\cdot\text{ft}$).

Replace the oil filter.

Refill engine at the proper level with the recommended oil. Engine oil capacity with filter replacement is 3 L (3.2 qt (U.S. liq.)).

Start engine and let idle for a few minutes. Ensure oil filter and oil drain plug areas are not leaking.

Stop engine.

Wait a while to allow oil to flow down to crankcase then check oil level. Refill as necessary.

Dispose of oil as per your local environmental regulations.

Oil Filter

Oil Filter Replacement

On the right side of vehicle, remove engine cover.

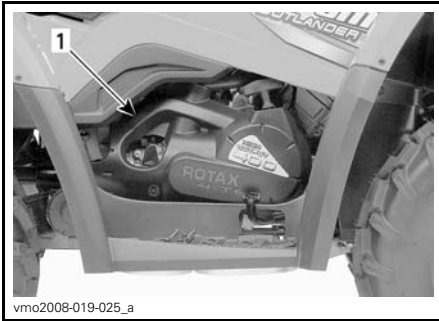

RH SIDE OF VEHICLE

1. Engine cover

Unscrew the oil filter cover.

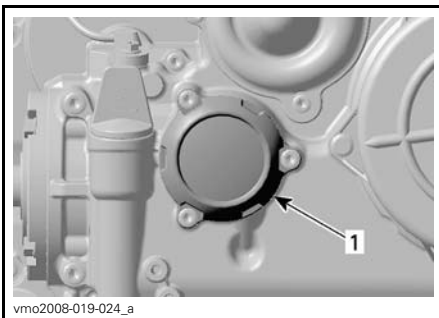

1. Oil filter cover

Remove the oil filter screws, cover with O-ring and oil filter.

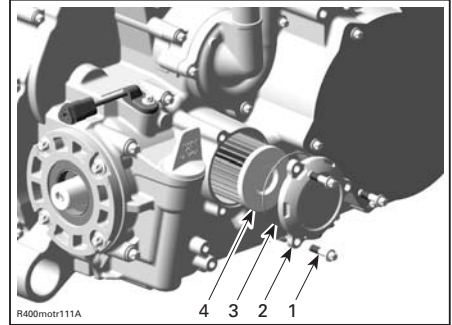

1. Oil filter screws
2. Oil filter cover
3. O-ring
4. Oil filter

Check the cover O-ring and change it if necessary.

Check and clean the oil filter inlet and outlet area for dirt and other contaminations.

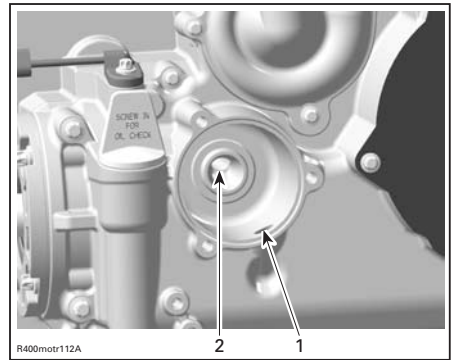

1. Inlet bore from the oil pump to the oil filter
2. Outlet bore to the engine oil providing system

Wipe out any oil spillage on engine.

Apply engine oil on rubber seal of new oil filter to ensure proper installation.

Install oil filter.

Install O-ring on oil filter cover.

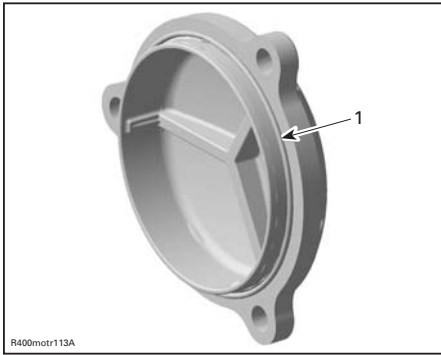

1. O-ring in place

Screw oil filter cover in place.

Torque screws to $10 \text{ N}\cdot\text{m} \pm 1.2 \text{ N}\cdot\text{m}$ ($89 \text{ lbf}\cdot\text{in} \pm 11 \text{ lbf}\cdot\text{in}$).

Reinstall the engine cover.

Radiator

Radiator Inspection

Periodically check the radiator area for cleanliness.



TYPICAL

1. Radiator

Inspect radiator and hoses for leaks or any damage.

Inspect radiating fins. They must be clean, free of mud, dirt, leaves and any other deposit that would prevent the radiator to cool properly.

Remove as much deposits as you can with your hands. If water is available in proximity, try rinsing the radiating fins.

If available, use a garden hose to rinse the radiating fins.

⚠ CAUTION Never clean radiator with your hands when it is hot. Let the radiator cool down before cleaning.

NOTICE Be careful not to damage the radiating fins when cleaning. Do not use any object/tool that could damage the fins. The fins are purposely thin parts to allow efficient cooling. **WHEN HOSING, USE LOW PRESSURE ONLY, NEVER USE A HIGH PRESSURE WASHER.**

See an authorized Can-Am dealer to check the performance of the cooling system.

Engine Coolant

Engine Coolant Level

⚠ WARNING
Check coolant level with engine cold. Never add coolant in cooling system when engine is hot.

NOTE: While checking the coolant level, visually inspect engine area for leaks.

Remove front service compartment panel.

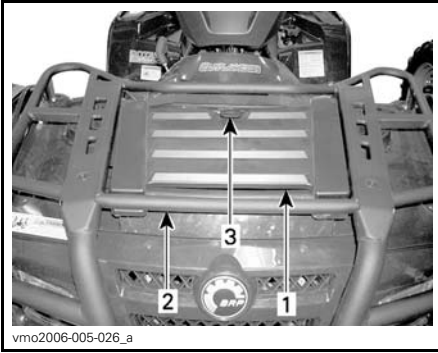

1. Front service compartment panel
2. Front rack
3. Latch

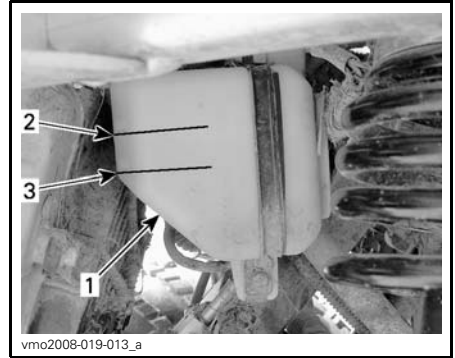

UNDERNEATH LH FRONT FENDER

1. Reservoir
2. MAX. level mark
3. MIN. level mark

Add coolant up to MAX. mark if required.

Use a funnel to avoid spillage. **Do not overfill.**

Properly reinstall and tighten filler cap.

If coolant was added to the coolant reservoir, check coolant level in the radiator too.

Reinstall service compartment panel.

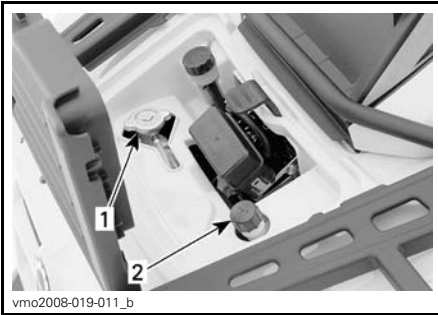

SERVICE COMPARTMENT

1. Radiator cap
2. Coolant reservoir cap

With vehicle on a level surface, liquid should be between MIN. and MAX. level marks of coolant reservoir.

NOTE: When checking level at temperature lower than 20°C (68°F), it may be slightly lower than MIN. mark.

⚠ WARNING

In order to avoid getting burned, do not remove the radiator cap if the engine is hot.

NOTE: A cooling system that frequently requires coolant is the indication of leaks or engine problems. See an authorized Can-Am dealer.

NOTICE Do not store any objects in the front service compartment.

Recommended Engine Coolant

Always use ethylene-glycol antifreeze containing corrosion inhibitors specifically for internal combustion aluminum engines.

Cooling system must be filled with BRP premixed coolant (P/N 219 700 362) or with distilled water and antifreeze solution (50% distilled water, 50% antifreeze).

Engine Coolant Replacement

⚠ WARNING

In order to avoid potential burns, do not remove the radiator cap or loosen the coolant drain plug if the engine is hot.

Remove the front service compartment panel and remove the radiator cap.

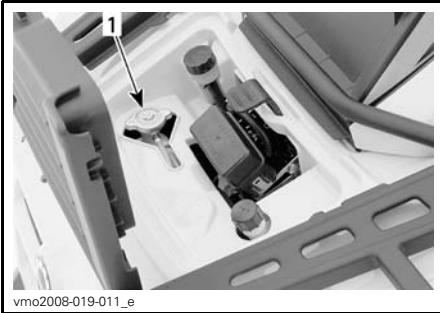

1. Radiator cap

Remove seat and RH side panels.

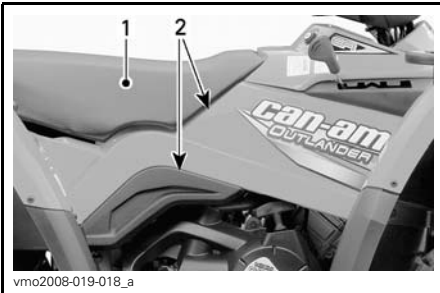

1. Seat
2. Side panels

Remove RH engine cover.

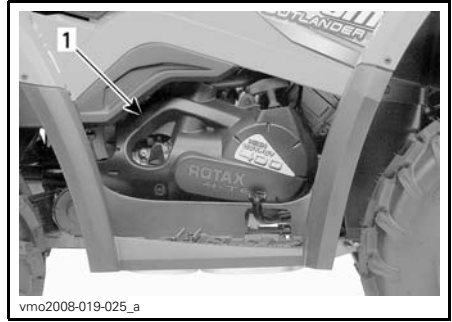

1. Engine cover

Unscrew the coolant drain plug and drain the coolant into a suitable container.

NOTE: Do not unscrew the coolant drain plug completely.

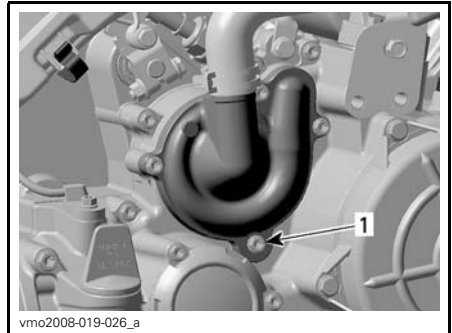

1. Coolant drain plug

Disconnect the engine temperature sensor connector.

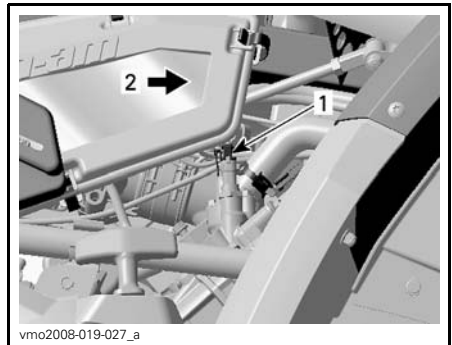

1. Temperature sensor
2. Front of vehicle

Unscrew the bleeding screw on the top of thermostat housing.

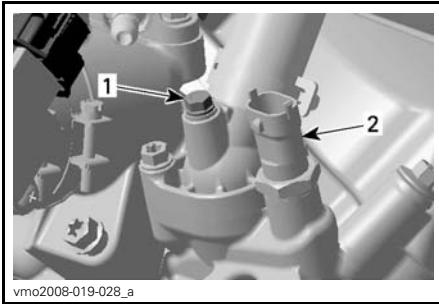

1. Bleeding screw
2. Engine temperature sensor

Drain the system completely.
Reinstall the coolant drain plug.

Torque to $10\text{ N}\cdot\text{m} \pm 1.2\text{ N}\cdot\text{m}$
($89\text{ lbf}\cdot\text{in} \pm 11\text{ lbf}\cdot\text{in}$).

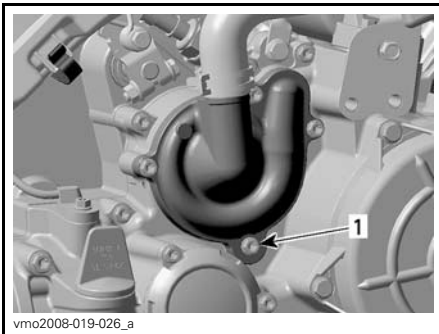

1. Coolant drain plug

Pinch hose between radiator and thermostat housing with a large hose pincher or an equivalent.

NOTICE Do not use vise-grip pliers to pinch hose.

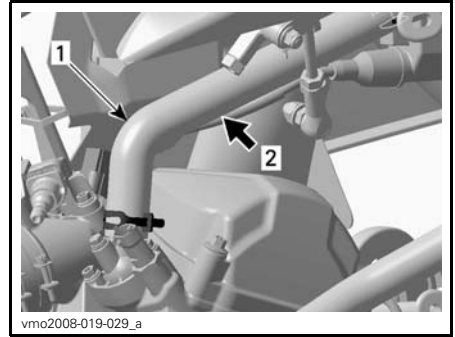

1. Coolant hose
2. Install hose pincher here

Fill the radiator until the coolant comes out by the thermostat housing hole.

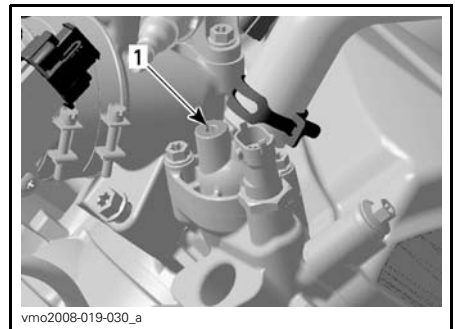

1. Thermostat housing hole

Install the bleeding screw then remove the hose pincher.

Torque bleeding screw to $5\text{ N}\cdot\text{m} \pm 0.6\text{ N}\cdot\text{m}$
($44\text{ lbf}\cdot\text{in} \pm 5\text{ lbf}\cdot\text{in}$).

Complete the radiator filling.

Check the level in the coolant reservoir and refill if necessary.

Run engine at idle with the radiator cap off. Slowly add coolant if necessary.

While reading this Operator's Guide, remember that:

⚠ WARNING

Indicates a potential hazard that, if not avoided, could result in serious injury or death.

At this point, wait until engine reaches normal operating temperature.

Depress the throttle lever two or three times; then add coolant if required.

Install radiator cap.

Inspect all connections for leaks and check coolant level in the reservoir.

Wipe out any coolant spillage on engine.

Dispose of coolant as per your local environmental regulations.

Muffler Spark Arrester

Muffler Spark Arrester Cleaning

The muffler must be periodically purged of accumulated carbon.

⚠ WARNING

Never run engine in an enclosed area. Never perform this operation immediately after the engine has been run because exhaust system is very hot. Make sure that there are no combustible materials in the area. Wear eye protection and gloves. Never stand behind the vehicle while purging exhaust system. Respect all applicable laws and regulations.

Select a well-ventilated area and make sure the muffler is cool.

Place transmission on PARK position.

Remove the clean out plug of the muffler.

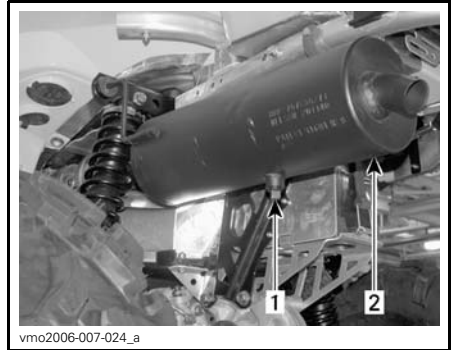

TYPICAL

1. Clean out plug
2. Muffler

Block the end of the muffler with a shop rag and start engine.

Momentarily increase engine RPM several times to purge accumulated carbon out of the muffler.

Stop engine and allow muffler to cool.

Reinstall the clean out plug.

Throttle Cable

Throttle Cable Lubrication

The throttle cable must be lubricated with silicone lubricant (P/N 293 600 041) or an equivalent.

⚠ WARNING

Always use a silicone-based lubricant. Using another lubricant (like a water-based lubricant) could cause the throttle lever/cable to become sticky and stiff.

Open the throttle lever housing.

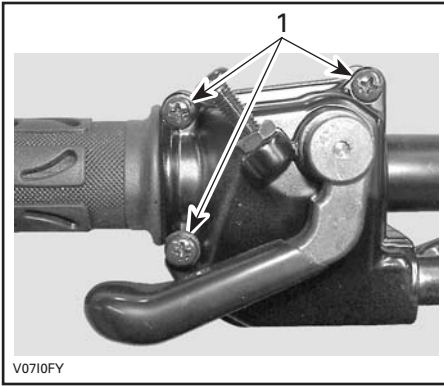

1. Remove these screws

Separate the housing.
Slide rubber protector back to expose throttle cable adjuster.

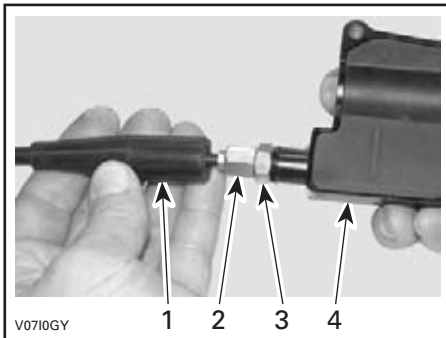

1. Cable protector
2. Throttle cable adjuster
3. Lock nut
4. Throttle lever housing

Screw in the throttle cable adjuster.
Remove inner housing protector.

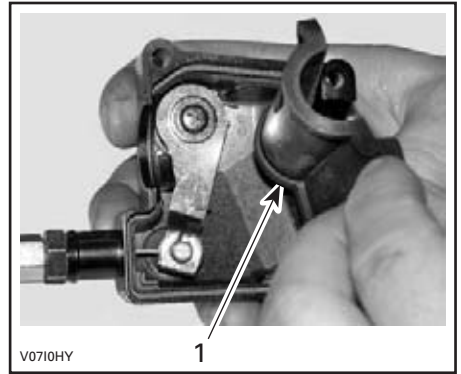

1. Inner housing protector

Remove the cable from the throttle lever housing.

NOTE: Slide cable in clip slot and remove the end of cable from clip.

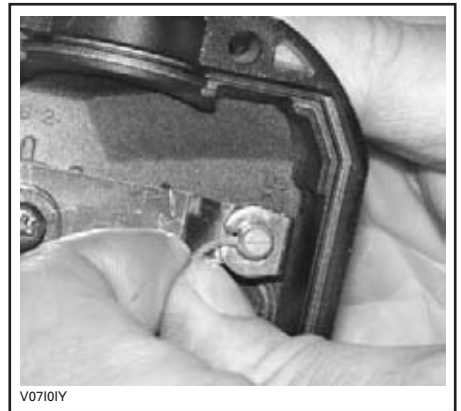

Detach throttle body side cover from throttle body.

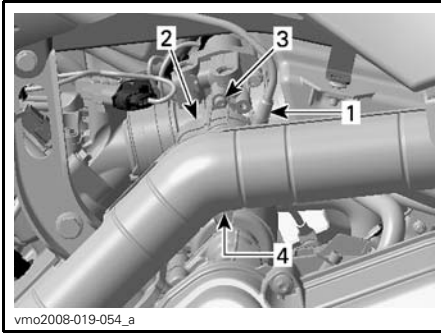

LH SIDE OF ENGINE

1. Throttle cable
2. Side cover
3. Remove screw
4. Release cover clip

Insert the needle of the lubricant can in the end of throttle cable adjuster.

⚠ CAUTION Always wear appropriate skin and eye protection. Chemicals can cause a skin rash and severe eye injury.



TYPICAL

NOTE: Place a rag around the throttle cable adjuster to prevent the lubricant from splashing.

Add lubricant until it runs out at throttle body end of the throttle cable.

Reinstall and adjust the cable.

Throttle Cable Adjustment

Slide rubber protector back to expose throttle cable adjuster.

Loosen lock nut then turn the adjuster to obtain correct throttle lever free play.

NOTE: Measure throttle free play at the tip of throttle lever.

Tighten lock nut and reinstall protector.



1. Throttle lever
- A. 3mm to 6mm (1/8 in to 1/4 in)

With the shift lever on PARK position, start the engine.

Check if the throttle cable is adjusted correctly by turning handlebar fully right then fully left. If the engine RPM increases, readjust the throttle lever free play.

Spark Plug

Spark Plug Removal

⚠ WARNING

Unless otherwise indicated, always turn ignition switch to the OFF position before performing any maintenance or repair on electrical system.

⚠ CAUTION Always wear safety goggles when using pressurized air.

Remove LH side panel.

Unplug the spark plug cable.

Clean the spark plug and cylinder head with pressurized air if possible.

Unscrew spark plug completely then remove it.

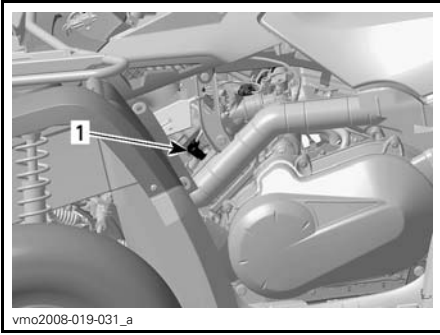

1. Spark plug cable

Spark Plug Installation

Prior to installation make sure that contact surfaces of cylinder head and spark plug are free of grime.

Using a feeler gauge, set the spark plug gap between 0.6 to 0.7 mm.

Apply a small amount of anti-seize lubricant over spark plug threads to prevent a possible seizure.

Screw spark plug into cylinder head by hand and tighten with a torque wrench and a proper socket.

Torque spark plug to $20\text{ N}\cdot\text{m} \pm 2.4\text{ N}\cdot\text{m}$ ($15\text{ lbf}\cdot\text{ft} \pm 2\text{ lbf}\cdot\text{ft}$).

Battery

⚠ WARNING

Unless otherwise indicated, always turn ignition switch to the OFF position before performing any maintenance or repair on electrical system.

⚠ CAUTION Never charge a battery while installed in vehicle.

These vehicles are equipped with a VRLA battery (Valve Regulated Lead Acid). It is a maintenance-free type battery, there is no need to add water to adjust electrolyte level.

NOTICE Never remove the battery sealing cap.

Battery Removal

Disconnect BLACK (-) battery cable.

NOTICE Always disconnect the BLACK (-) battery cable first.

Disconnect RED (+) battery cable.

Remove the holding strap then pull the battery out of frame.

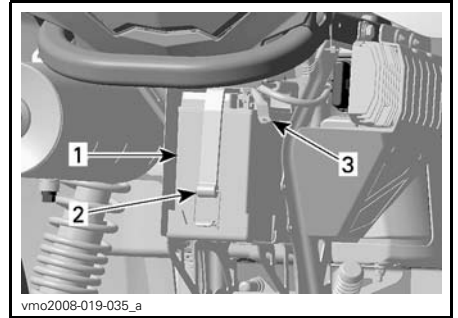

1. Battery
2. Holding strap
3. BLACK (-) cable

Battery Cleaning

Clean battery, battery casing and battery posts using a solution of baking soda and water.

Remove corrosion from battery cable terminals and battery posts using a firm wire brush.

Battery casing should be cleaned by soft brush and baking soda solution.

Battery Installation

Reinstall battery in vehicle.

NOTICE Always connect RED (+) cable first then the BLACK (-) cable.

Fuses

Fuse Inspection

⚠ CAUTION Always turn the ignition switch to OFF position before replacing a defective fuse.

If a fuse is damaged, replace it by one of the same rating.

Check if filament is melted.

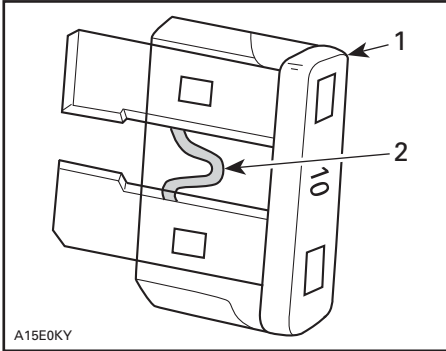

A15E0KY

TYPICAL

1. Fuse
2. Check if melted

NOTICE Do not use a higher rated fuse as this can cause severe damage.

Fuses Location

Fuses are located in the front service compartment and at the rear near battery.

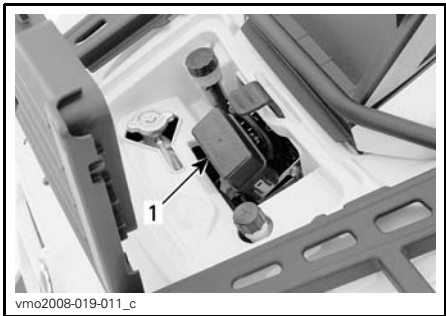

vmo2008-019-011_c

1. Front fuse box

- F1: ECM (5 A)
- F2: Fan (20 A)
- F3: ECM (7.5 A)
- F4: Gauge, taillight, diagnostic (7.5 A)
- F5: Fuel pump (7.5 A)
- F6: Accessories (20 A)

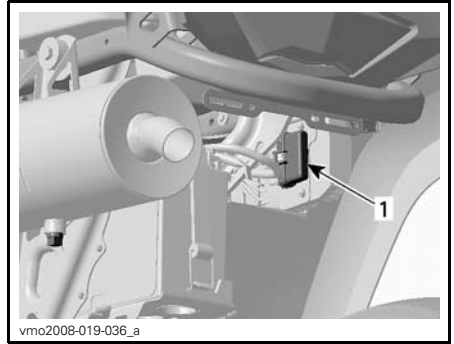

vmo2008-019-036_a

REAR FUSE HOLDER

1. Main (30 A) (RED/GRAY wire) and Accessories (30 A) (RED/GREEN wire)

Lights

CAUTION Always turn the ignition switch to OFF position before replacing a defective bulb.

Always check light operation after replacement.

Headlight Bulb Replacement

NOTICE Never touch glass portion of a halogen bulb with bare fingers, it shortens its operating life. If glass is touched, clean it with isopropyl alcohol which will not leave a film on the bulb.

To replace the headlight bulb, proceed as follows.

Remove rubber holder screws.

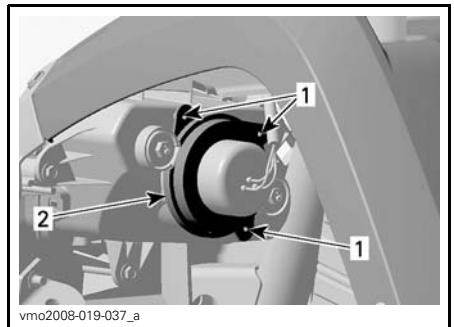

vmo2008-019-037_a

1. Screws
2. Holder

Remove rubber protector from headlight housing.

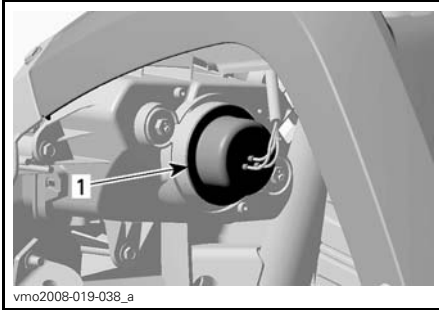

1. Rubber protector

Unplug connector from headlight.

NOTE: Use small locking tab to unlock connector then pull on connector.

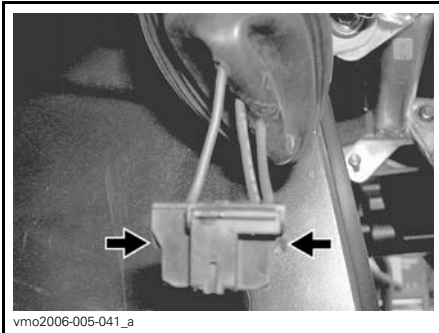

PUSH ON LOCKING TAB TO UNLOCK CONNECTOR

NOTE: Concerning the following illustrations, the front fascia has been removed from the vehicle for a better comprehension.

Press the spindle then push it on the side to unlock headlight bulb.

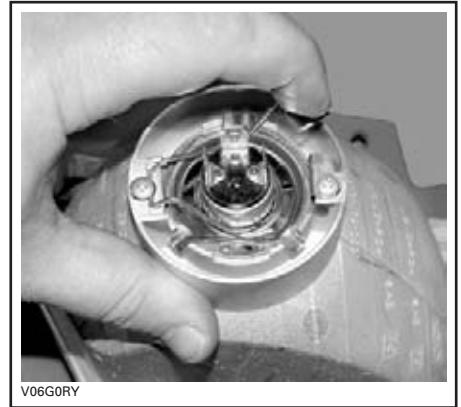

TYPICAL

Lift and hold the spindle then remove the bulb.



TYPICAL

Properly reinstall removed parts in the reverse order of their removal.

Headlight Beam Aiming

Adjust beam aiming as follows:

Turn adjustment screws to adjust beam height and side orientation to your convenience. Adjust both headlights evenly.

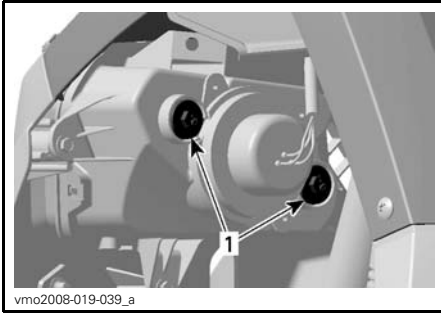

1. Adjustment screws

Front Position Light

To replace the front position lamp bulb located in the headlight housing, proceed as follows.

Push and turn counterclockwise lamp socket out of headlight housing.

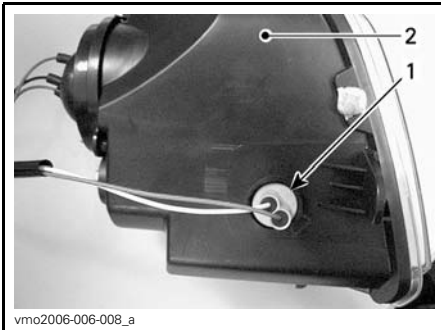

1. Position lamp socket
2. Headlamp housing

Push bulb in and hold while turning counterclockwise to release.

Install the new bulb by first pushing in while turning clockwise.

Put back the position lamp socket in the headlight housing, turn clockwise to lock in place and connect the connectors.

Brake Light and Rear Position Light

To have access to bulb, pull on taillight to release it from its rubber grommets.

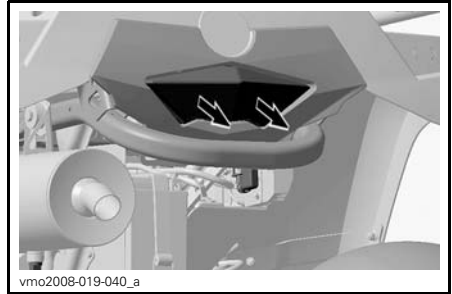

vmo2008-019-040_a

Turn and pull lamp socket to expose bulb.



vmo2008-001-006

Push the bulb in and hold while turning counterclockwise to release.

Install the new bulb by first pushing in while turning clockwise.

Reinstall all removed parts.

Turn Signal Lights

Remove the screw retaining the lens to the housing. To do this, pull the housing to reach an access to the screw.

Push and turn the bulb counterclockwise. Pull the bulb to remove it.

Install the new bulb by first pushing in while turning clockwise.

Reinstall the lens.

Drive Shaft Boot and Protector

Drive Shaft Boot and Protector Inspection

Visually inspect drive shaft protectors and boots conditions.

Check protectors for damage or rubbing against shafts.

Check boots for cracks, tears, leaking grease etc.

Repair or replace damaged parts as necessary.

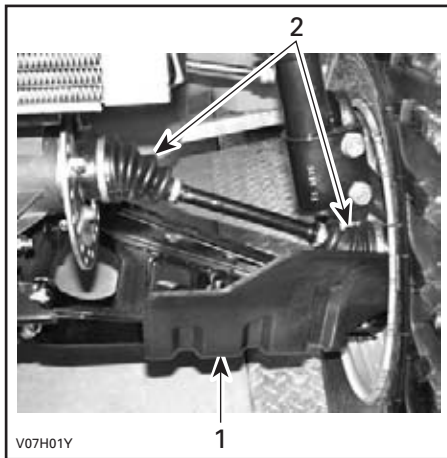

FRONT OF VEHICLE
 1. Drive shaft protector
 2. Drive shaft boots

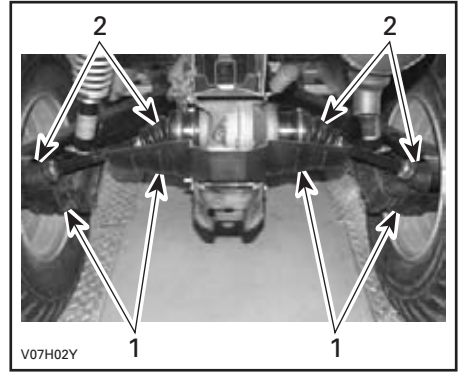

REAR OF VEHICLE
 1. Drive shaft protector
 2. Drive shaft boots

Wheels and Tires

Tire Pressure

⚠ WARNING

Tire pressure greatly affects vehicle handling and stability. Under pressure may cause tire to deflate and rotate on wheel. Overpressure may burst the tire. Always follow recommended pressure. NEVER set tire pressure below minimum. It could cause the tire to dislodge from the rim. Since tires are low-pressure types, a manual pump should be used.

Check pressure when tires are cold before using the vehicle. Tire pressure changes with temperature and altitude. Recheck pressure if one of these conditions has changed.

For your convenience, a pressure gauge is supplied in tool kit.

TIRE PRESSURE			
1-UP MODELS		FRONT	REAR
UP to 227 kg (500 lb)	Max.	48 kPa (7 PSI)	48 kPa (7 PSI)
	Min.	34.5 kPa (5 PSI)	34.5 kPa (5 PSI)

TIRE PRESSURE			
2-UP MODELS		FRONT	REAR
UP to 235 kg (517 lb)	Max.	48 kPa (7 PSI)	48 kPa (7 PSI)
	Min.	34.5 kPa (5 PSI)	34.5 kPa (5 PSI)

Although the tires are specifically designed for off-road use, a flat may still occur. Therefore, it is recommended to carry a tire pump and a repair kit.

Tire Inspection

Check tires and rims for damage.

Also, check tires for wear. Replace if necessary.

Do not rotate tires. The front and rear tires have a different size. The tires are directional and their rotation must be kept in a specific direction for proper operation.

Tire Replacement

⚠ WARNING

- When the tires are replaced, never install a bias tire with a radial tire. Such a combination could create handling and/or stability problems.
- Do not mix tires of different size and/or design on the same axle.
- Front and rear tire pairs must have an identical model and manufacturer.
- For unidirectional tread pattern, ensure that the tires are installed in the correct direction of rotation.
- The radial tires must be installed as a complete set.

Wheel Bearing Inspection

Push and pull the wheels from the upper edge to feel the play.

See an authorized Can-Am dealer if there is any play.

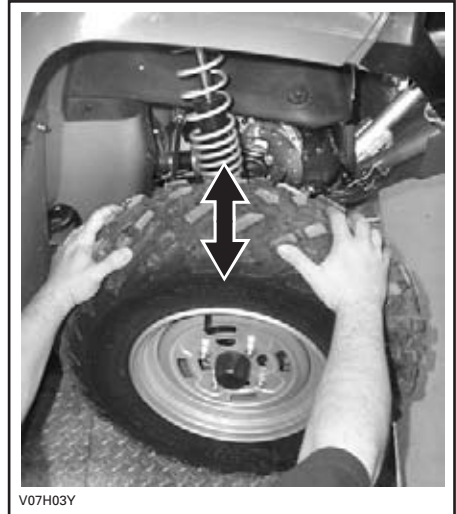

Wheel Removal and Installation

Loosen nuts then lift vehicle.

Place a support under vehicle.

Remove nuts then remove wheel.

At installation, it is recommended to apply anti-seize lubricant on threads.

Carefully tighten nuts in a criss-cross sequence then apply final torque.

WHEEL NUT TORQUE
100 N•M (74 LBF•FT)

NOTE: Occasionally, wheel nuts should be removed to apply anti-seize lubricant on studs to ease future removal. This is particularly important when vehicle is used in salt-water environment or in mud. Remove one nut at a time, lubricate then re-torque.

NOTICE Always use the recommended wheel nuts according to the type of wheel. Using a different nut could cause damage to the rim.

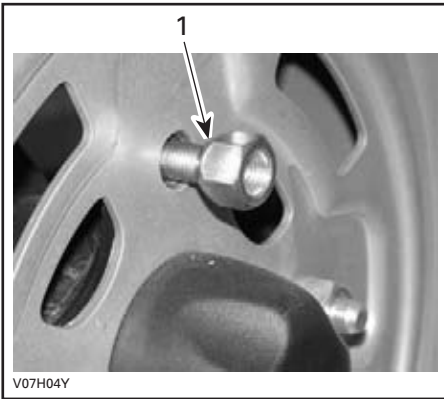

TYPICAL - STEEL WHEEL
 1. Taper side of nut (opened end type)

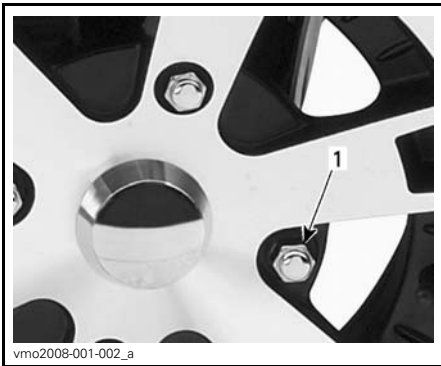

TYPICAL - ALUMINUM WHEEL
 1. Wheel nut (closed end type)

Suspension

Front Suspension Lubrication

Lubricate front A-arms at grease fittings.

SUSPENSION GREASE	
BRP recommended product	SUSPENSION GREASE (P/N 293 550 033)

Rear Suspension Lubrication

Lubricate rear sway bar links and pivot bushing at grease fittings.

SUSPENSION GREASE

BRP recommended product	SUSPENSION GREASE (P/N 293 550 033)
-------------------------	-------------------------------------

Suspension Inspection

Shock Absorbers

Inspect shock absorbers for oil leaks or other damage.

Check tightness of fasteners. See an authorized Can-Am dealer as necessary.

Ball Joints

Inspect ball joint boots for cracks.

⚠ WARNING

The ball joint must be replaced if the boot is cracked.

Front A-Arms

Check A-arms for cracks, bending or other damage.

See an authorized Can-Am dealer as necessary.

Rear Trailing Arms

Check trailing arms for distortion, cracks or bending.

See an authorized Can-Am dealer if any problem is detected.

Steering

Steering Inspection

Tie Rods

Inspect tie rod boots for cracks.

⚠ WARNING

The tie rod must be replaced if the boot is cracked.

Brakes

⚠ WARNING

New brakes will not operate at their maximum efficiency until their break-in is completed. Use extra caution.

Brake Fluid Level

With vehicle on a level surface, check brake fluid in reservoirs for proper level.

Add fluid as required. Do not overfill.

⚠ WARNING

To avoid serious damage to the brake system:

- Clean filler cap before removing.
- Use only DOT 4 brake fluid from a sealed container.
- Use only a clean funnel when filling brake fluid reservoir.
- Do not use brake fluid taken from old or already opened containers.
- Do not mix different fluids for topping off.

NOTE: A low level may indicate leaks or worn brake pads. See an authorized Can-Am dealer.

Brake Lever Fluid Reservoir

Turn steering in the straight-ahead position to ensure reservoir is level.

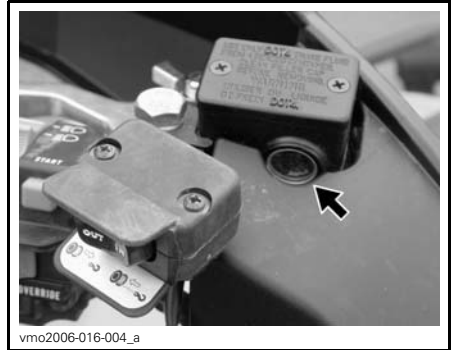

TYPICAL - ON HANDLEBAR

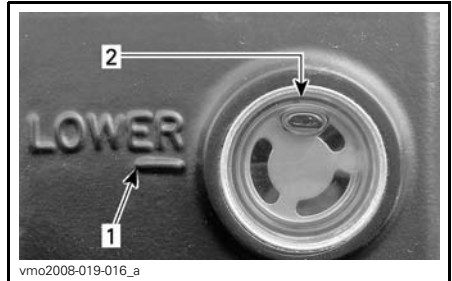

1. MIN. mark
2. MAX. mark

Visually inspect lever boot condition. Check for cracks, tears, etc. Replace if damaged.

Brake Pedal Fluid Reservoir

Remove front service compartment panel.

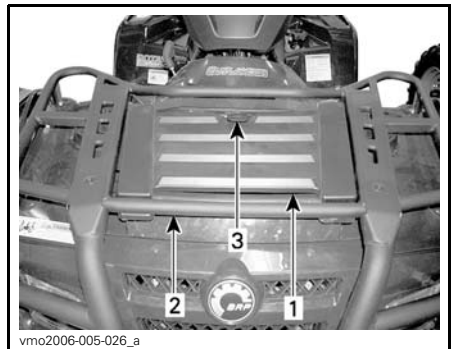

1. Front service compartment panel
2. Front rack
3. Latch

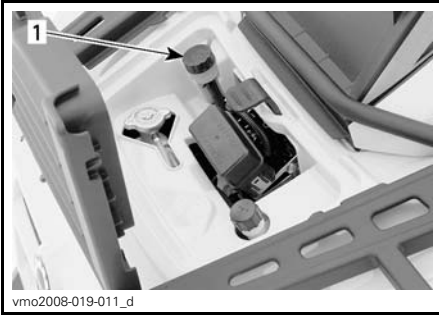

TYPICAL - SERVICE COMPARTMENT
1. Reservoir

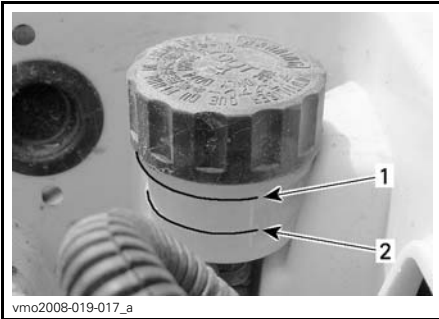

1. MIN. mark
2. MAX. mark

- Brake for spongy feel
- Brake discs for excessive wear and surface condition
- Brake pads for wear, damage or looseness.

SERVICE LIMITS	
BRAKE PADS THICKNESS	1 mm (.039 in)
FRONT DISCS THICKNESS	3.5 mm (.138 in)
REAR DISC THICKNESS	4.3 mm (.169 in)
MAXIMUM DISCS WARPAGE	0.3 mm (.012 in)

See your authorized Can-Am dealer if a problem is detected concerning the brake system.

⚠ WARNING

The brake fluid replacement or brake system maintenance and repairs should be performed by an authorized Can-Am dealer.

Recommended Brake Fluid

NOTICE To avoid serious damage to the braking system, do not use fluids other than the recommended one, nor mix different fluids for topping up.

Always use brake fluid meeting the specification DOT 4 only.

Brake Inspection

⚠ CAUTION The brakes can be very hot after prolonged use of the vehicle and can cause burns. Wait for the brakes to cool down.

Check the following to keep the brakes in a good operating condition:

- Brake fluid level
- Brake system for fluid leaks
- Brake cleanliness

VEHICLE CARE

Post-Operation Care

When vehicle is used in salt-water environment (beach area, launching and loading boats etc.), rinsing the vehicle with fresh water is necessary to preserve vehicle and its components. Metallic parts lubrication is highly recommended. Use XPS Lube (P/N 293 600 016) or an equivalent. This must be performed at the end of each operating day.

When vehicle is operated in muddy conditions, rinsing the vehicle is recommended to preserve vehicle and its components and to keep lights clean.

NOTE: Never use a high pressure washer to clean the vehicle. **USE LOW PRESSURE ONLY (like a garden hose).** High pressure can cause electrical or mechanical damage.

Vehicle Cleaning and Protection

Never use a high pressure washer to clean the vehicle. **USE LOW PRESSURE ONLY (like a garden hose).** High pressure can cause electrical or mechanical damage.

Painted parts which are damaged should be properly repainted to prevent rust.

When required, wash the body with warm water and soap (only use mild detergent). Apply non-abrasive wax.

NOTICE Never clean plastic parts with strong detergent, degreasing agent, paint thinner, acetone, etc.

STORAGE AND PRESEASON PREPARATION

WARNING

Have an authorized Can-Am dealer inspect the fuel system integrity as specified in *MAINTENANCE SCHEDULE*.

When a vehicle is not in use for a period of 4 months, proper storage is a necessity.

See an authorized Can-Am dealer for proper procedures.

When using your vehicle after storage, a post storage preparation is required.

See an authorized Can-Am dealer for proper procedures.

While reading this Operator's Guide, remember that:

WARNING

Indicates a potential hazard that, if not avoided, could result in serious injury or death.

***This page is
intentionally blank***

TECHNICAL INFORMATION

VEHICLE IDENTIFICATION

The main components of your vehicle (engine and frame) are identified using different serial numbers. It may sometimes become necessary to locate these numbers for warranty purposes or to trace your vehicle in the event of loss. These numbers are also required by the authorized Can-Am distributor/dealer to complete warranty claims properly. No warranty will be allowed by BRP if the engine identification number (EIN) or vehicle identification number (VIN) is removed or mutilated or altered in any way. We strongly recommend that you take note of all the serial numbers on your vehicle and supply them to your insurance company.

Vehicle Identification Number

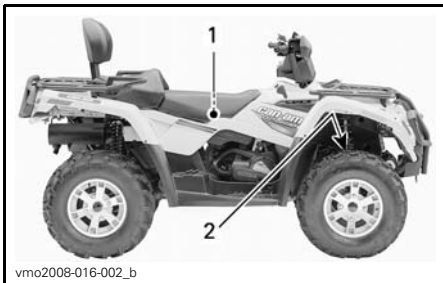

TYPICAL - ALL MODELS

1. Label 1 (on the frame under the seat in the middle)
2. Label 2 (stamped onto frame behind RH front wheel)



LABEL 1

1. VIN (Vehicle Identification Number)
2. Model number



LABEL 2

1. VIN (Vehicle Identification Number)
2. Model number

Engine Identification Number

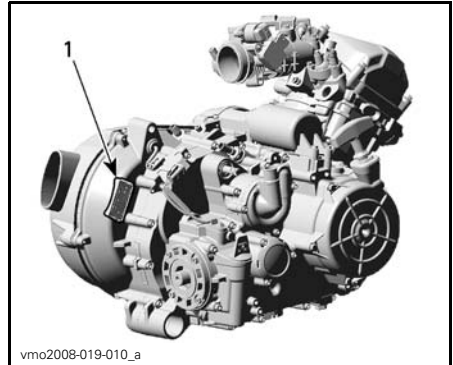

TYPICAL — ENGINE SERIAL NUMBER LABEL

1. EIN (Engine Identification Number)

SPECIFICATIONS

MODEL		OUTLANDER™ 400 EFI / OUTLANDER MAX 400 EFI	
ENGINE			
Engine type		ROTAX 400, 4-stroke, Single Over Head Camshaft (SOHC), liquid cooled	
Number of cylinder		1	
Number of valves		4 valves (mechanical adjustment)	
Bore		91 mm (3.58 in)	
Stroke		61.5 mm (2.42 in)	
Displacement		400 cm ³ (24 in ³)	
Compression ratio		10.3:1	
Decompressor type		Automatic	
Maximum HP RPM		7500 RPM	
Lubrication	Type	Wet sump with replaceable oil filter	
	Oil filter	BRP ROTAX paper type, replaceable	
	Engine oil	Capacity (oil change with filter)	3 L (3.2 qt (U.S. liq.)) (engine/transmission)
		Recommended	For the summer season, use XPS 4-STROKE SYNTH. BLEND OIL (SUMMER) (P/N 293 600 121). For the winter season, use XPS 4-STROKE SYNTHETIC OIL (ALL CLIMATE) (P/N 293 600 112) see <i>OIL VISCOSITY CHART</i>
Exhaust system		Spark arrestor approved by USDA Forest Service	
Air filter		Synthetic paper filter with foam	
GEARBOX			
Type		Dual range (HI-LO) with park, neutral and reverse	
COOLING SYSTEM			
Coolant	Type	Ethyl glycol/water mix (50% coolant, 50% water). Use premixed coolant sold by BRP (P/N 219 700 362) or coolant specifically designed for aluminum engines	
	Capacity	2.5 L (2.6 qt (U.S. liq.))	

SPECIFICATIONS

MODEL		OUTLANDER™ 400 EFI / OUTLANDER MAX 400 EFI		
ELECTRICAL SYSTEM				
Magneto generator output		400 W		
Ignition system type		CDI (Capacity Discharge ignition)		
Ignition timing		Not adjustable		
Spark plug	Quantity	1		
	Make and type	NGK DCPR8E		
	Gap	0.7 mm to 0.8 mm (.028 in to .031 in)		
Engine RPM limiter setting	Forward	8000 RPM		
	Reverse	4000 ± 100 RPM		
Battery	Type	Dry battery type		
	Voltage	12 volts		
	Nominal rating	18 A•h		
	Power starter output	0.7 KW		
Headlight		2 x 35 W		
Taillight/brake light		5/21 W		
Turn signal lights		10 W		
Fuses	Fuse box	Accessories	Aux. supply	20 A
			Diagnostic	
			Headlight	
			Power outlet	
			Winch (XT)	
			4 x 4	
	ECM		5 A and 7.5 A	
	Fuel pump		7.5 A	
	Gauge		7.5 A	
	Tail lamp			
	Diagnostic			
	Fan		20 A	

MODEL			OUTLANDER™ 400 EFI / OUTLANDER MAX 400 EFI	
ELECTRICAL SYSTEM (cont'd)				
Fuses (cont'd)	Rear fuse holder	Main		30 A
		Accessories	Fan	30 A
			Acc. items in fuse box	
FUEL SYSTEM				
Fuel delivery	Type		Electronic Fuel Injection (EFI), Dell'Orto 46 mm throttle body	
Fuel pump	Type		In-tank electric fuel pump	
Idle speed			1300 ± 50 RPM	
Fuel	Type		Regular unleaded gasoline	
	Minimum Octane		87 Pump Posted AKI (92 RON) - Refer to <i>FUEL REQUIREMENTS</i>	
Fuel tank capacity			16.3 L (4 U.S. gal.)	
Fuel tank reserve			± 2 L (.5 U.S. gal.)	
DRIVE SYSTEM				
Front differential			Straight Bevel gear Visco-Lok	
Front differential ratio			3.6:1	
Rear axle			Straight Bevel gear / final drive	
Rear axle ratio			3.6:1	
Differential oil	Capacity	Front	500 ml (17 U.S. oz)	
		Rear	300 ml (10.1 U.S. oz)	
	Recommended	Front/rear	XPS SYNTHETIC GEAR OIL (75W 90) (P/N 293 600 043) or synthetic oil 75W 90 API GL5)	
CV joint grease			CV joint grease (P/N 293 550 019)	
Propeller shaft grease			Propeller shaft grease (P/N 293 550 063)	
TRANSMISSION				
Type			CVT (Continuously Variable Transmission)	
Engagement RPM			2000 ± 100 RPM	

SPECIFICATIONS

MODEL		OUTLANDER™ 400 EFI / OUTLANDER MAX 400 EFI
STEERING		
Turning radius	1-UP	1 800 mm (71 in)
	2-UP	2 000 mm (79 in)
Total toe (vehicle on ground)		0 mm ± 4 mm (0 in ± .157 in)
Camber angle		0°
FRONT SUSPENSION		
Suspension type		MacPherson
Suspension travel		178 mm (7 in)
Preload adjustment		N.A.
REAR SUSPENSION		
Suspension type		TTI™ independent
Suspension travel		203 mm (8 in)
Shock absorber	Qty	2
	Type	Oil
Preload adjustment		5 settings
BRAKES		
Front brake	Type	Hydraulic, 2 discs
Rear brake	Type	Hydraulic, single disc
Brake fluid	Capacity	180 ml (6.1 U.S. oz)
	Type	DOT 4
Brake lock		Hydraulic lock-4 wheels
Brake pad material	Front	Metallic
	Rear	Metallic
Minimum pad thickness		1 mm (.039 in)
Minimum brake disc thickness	Front	3.5 mm (.138 in)
	Rear	4.3 mm (.169 in)
Maximum brake disc warpage		0.2 mm (.008 in)

MODEL			OUTLANDER™ 400 EFI / OUTLANDER MAX 400 EFI	
TIRES				
Pressure	1-UP AND 2-UP models	Front	Max.	48 kPa (7 PSI)
			Min.	34.5 kPa (5 PSI)
		Rear	Max.	48 kPa (7 PSI)
			Min.	34.5 kPa (5 PSI)
Minimum tire thread depth			3 mm (.118 in)	
Size		Front	25 x 8 x 12 (in)	
		Rear	25 x 11 x 12 (in)	
WHEELS				
Size		Front	12 x 6 (in)	
		Rear	12 x 7.5 (in)	
Wheel nuts torque			100 N•m (74 lbf•ft)	
DIMENSIONS				
Overall length		1-UP	218 cm (86 in)	
		2-UP	239 cm (94 in)	
Overall width			117 cm (46 in)	
Overall height			114 cm (45 in)	
Wheelbase		1-UP	124 cm (49 in)	
		2-UP	145 cm (57 in)	
Wheel track		Front	96.5 cm (38 in)	
		Rear	91.4 cm (36 in)	
Ground clearance			23.6 cm (9 in)	

SPECIFICATIONS

MODEL		OUTLANDER™ 400 EFI / OUTLANDER MAX 400 EFI
WEIGHT AND LOADING CAPACITY		
Dry weight		1-UP: 280 kg (617 lb) 2-UP: 303 kg (668 lb)
Weight distribution (Front/rear)		1-UP: 49/51 2-UP: 46/54
Rear storage box (included with rear rack weight)		10 kg (22 lb)
Rack	Front	45 kg (100 lb)
	Rear (including rear glove box and tongue weight)	90 kg (200 lb)
Total vehicle load allowed (including driver, all other loads and added accessories)	1-UP	227 kg (500 lb)
	2-UP	235 kg (517 lb)
Gross vehicle weight rating	1-UP	460 kg (1,014 lb)
	2-UP	554 kg (1,221 lb)
Towing capacity		135 kg (297 lb)
Tongue capacity (included with rear rack weight)		13 kg (28 lb)

TROUBLESHOOTING

TROUBLESHOOTING GUIDELINES

ENGINE DOES NOT TURN

1. Ignition switch is in the OFF position.
 - Place switch to the ON position.
2. Emergency engine stop switch.
 - Make sure that emergency engine stop switch is in RUN position.
3. Transmission is not set on PARK or NEUTRAL.
 - Set transmission either in PARK or in NEUTRAL or press the brake lever.
4. Burnt fuse.
 - Check main fuse condition.
5. Weak battery or loose connections.
 - Check charging system fuse.
 - Check connections and terminals condition.
 - Have the battery checked.
 - Contact an authorized Can-Am dealer.
6. Wrong ignition key, multifunction gauge display shows INVALID KEY.
 - Use the proper key for this vehicle.

ENGINE TURNS OVER BUT FAILS TO START

1. Flooded engine (spark plug wet when removed).
 - (Drowned mode) If the engine does not start and it is fuel-flooded, this special mode can be activated to prevent fuel injection and to cut ignition while cranking. Proceed as follows:
 - Insert key in ignition switch and turn to ON position.
 - Press completely and HOLD throttle lever.
 - Press the engine START button.The engine should be cranked for 20 seconds. Release engine START button.
Release throttle lever and start/crank engine again to allow starting.
If it does not work:
 - Clean the spark plug caps area then remove them.
 - Remove the spark plugs (tools are supplied in tool kit).
 - Crank engine several times.
 - Install new spark plugs if possible or clean and dry spark plugs.
 - Start engine as explained above.If engine continues to flood, see an authorized Can-Am dealer.
NOTE: Make sure to verify that there is no fuel in engine oil, if so, replace engine oil.
2. No fuel to the engine (spark plug dry when removed).
 - Check fuel tank level.
 - A failure of the fuel pump may have occurred.
 - Contact an authorized Can-Am dealer.

ENGINE TURNS OVER BUT FAILS TO START (cont'd)

3. Spark plug/ignition (no spark).

- *Check main fuse condition.*
- *Remove spark plug then reconnect to ignition coil.*
- *Check that ignition switch and/or emergency engine stop switch is/are at the ON position.*
- *Start engine with spark plug grounded to the engine away from spark plug hole. If no spark appears, replace spark plug.*
- *If trouble persists, contact an authorized Can-Am dealer.*

4. Multifunction gauge CHECK ENGINE indicator lamp is on and display shows CHECK ENGINE.

- *Contact an authorized Can-Am dealer.*

5. Engine is in limp home mode.

- *Multifunction gauge CHECK ENGINE indicator lamp is on and display shows CHECK ENGINE, contact an authorized Can-Am dealer.*

ENGINE LACKS ACCELERATION OR POWER

1. Fouled or defective spark plug.

- *Check item ENGINE TURNS OVER BUT FAILS TO START.*

2. Lack of fuel to engine.

- *Check item ENGINE TURNS OVER BUT FAILS TO START.*

3. Engine is overheating.

- *Check ENGINE OVERHEATS.*

4. Air filter/housing plugged or dirty.

- *Check air filter and clean if necessary.*
- *Check deposits in air filter housing drain.*
- *Check the position of the air intake tube.*

5. CVT dirty or worn-out.

- *Contact an authorized Can-Am dealer.*

6. Engine is in limp home mode.

- *Check multifunction gauge display for messages.*
- *Multifunction gauge CHECK ENGINE indicator lamp is on and display shows CHECK ENGINE or LIMP HOME, contact an authorized Can-Am dealer.*

ENGINE OVERHEATS

1. Low coolant in cooling system.

- *Check engine coolant, refer to MAINTENANCE.*

2. Dirty radiator fins.

- *Clean radiator fins, refer to RADIATOR in MAINTENANCE.*

3. Cooling fan inoperative.

- *Check cooling fan fuse, refer to MAINTENANCE. If the fuse is good, contact an authorized Can-Am dealer.*

ENGINE BACKFIRE

- 1. Exhaust system leakage.**
 - *Contact an authorized Can-Am dealer.*
- 2. Engine is running too hot.**
 - *See ENGINE LACKS ACCELERATION OR POWER.*
- 3. Ignition timing is incorrect or there is an ignition system failure.**
 - *Contact an authorized Can-Am dealer.*

ENGINE MISFIRE

- 1. Fouled/defective/worn spark plug.**
 - *Clean/verify spark plug and heat range. Replace as required.*
- 2. Water in fuel.**
 - *Drain fuel system and refill with fresh fuel.*

VEHICLE CANNOT REACH FULL SPEED

- 1. Engine.**
 - *See ENGINE LACKS ACCELERATION OR POWER.*
- 2. Brake lock.**
 - *Ensure brake lock is completely removed.*
- 3. Air filter/housing plugged or dirty.**
 - *Check air filter and clean if necessary.*
 - *Check deposits in air filter housing drain.*
 - *Check the position of the air intake tube.*
- 4. CVT dirty or worn-out.**
 - *Contact an authorized Can-Am dealer.*
- 5. Engine is in limp home mode.**
 - *Check multifunction gauge display for messages.*
 - *Multifunction gauge CHECK ENGINE indicator lamp is on and display shows CHECK ENGINE or LIMP HOME, contact an authorized Can-Am dealer.*

SHIFT LEVER IS HARD TO MOVE

- 1. Transmission gears are in a position that prevents the shift lever to work.**
 - *Rock the vehicle back and forth to move the gears in the transmission and allow the shift lever to be set.*
- 2. CVT dirty or worn-out.**
 - *Contact an authorized Can-Am dealer.*

THE RPM INCREASES BUT THE VEHICLE DOES NOT MOVE

- 1. The transmission is on PARK or NEUTRAL position.**
 - *Select the R, HI or LO position.*
- 2. CVT dirty or worn-out.**
 - *Contact an authorized Can-Am dealer.*

THE RPM INCREASES BUT THE VEHICLE DOES NOT MOVE (cont'd)

3. Water in the CVT housing.
 - *Contact an authorized Can-Am dealer.*

MULTIFUNCTION GAUGE MESSAGES

MESSAGE	PILOT LAMP(S) ON	DESCRIPTION
INVALID KEY	Check engine	Indicates that you have used the wrong ignition key, use the proper key for this vehicle. It is also possible that the ignition key has a bad contact, remove and clean key.
PARK BRAKE	Brake lock	Is displayed when brake lock is applied for more than 15 seconds (while riding).
LO BATT	Check engine	Low battery voltage, check battery voltage and charging system.
HI BATT	Check engine	High battery voltage, check battery voltage and charging system.
LOW OIL ⁽¹⁾	Check engine	Engine low oil pressure, stop engine immediately.
HI TEMP	Check engine	Engine is overheating, refer to <i>ENGINE OVERHEATS</i> in <i>TROUBLESHOOTING</i> .
LIMP HOME	Check engine	Serious fault on the engine that can change the normal operation of the engine, check engine indicator lamp will also blink, refer to <i>TROUBLESHOOTING</i> .
CHECK ENGINE	Check engine	Engine fault, check engine indicator lamp will also be ON, refer to <i>TROUBLESHOOTING</i> .
MAINTENANCE SOON	Check engine	Periodic maintenance required. See an authorized Can-Am dealer.
NO ECM COMMUNICATION	Check engine	Communication error between speedometer and engine control module (ECM), contact an authorized Can-Am dealer.

NOTICE ⁽¹⁾ If the message and the check engine light stay on after engine starting, stop engine. Check engine oil level. Refill if necessary. If the oil level is good, see an authorized Can-Am dealer. Do not use the vehicle until repaired.

WARRANTY

BRP INTERNATIONAL LIMITED WARRANTY: 2014 CAN-AM™ ATV

1) SCOPE OF THE LIMITED WARRANTY

Bombardier Recreational Products Inc. ("BRP")* warrants its 2014 Can-Am ATV sold by Can-Am ATV distributors or dealers authorized by BRP to distribute Can-Am ATVs ("Can-Am ATV Distributor/Dealer") outside of the United States of America ("USA"), Canada, member states of the European Economic Area (which is comprised of the states of the European Union plus Norway, Iceland and Liechtenstein) ("EEA"), Turkey, member states of the Commonwealth of the Independent States (including Ukraine and Turkmenistan) ("CIS") and Turkey, from defects in material or workmanship for the period and under the conditions described below.

All genuine Can-Am ATV parts and accessories, installed by an authorized Can-Am ATV Distributor/Dealer at the time of delivery of the 2014 Can-Am ATV, carry the same warranty as that of the Can-Am ATV.

This limited warranty will become null and void if: (1) The ATV was used for racing or any other competitive activity, at any point, even by a previous owner; or (2) the ATV has been altered or modified in such a way so as to adversely affect its operation, performance or durability, or has been altered or modified to change its intended use.

2) LIMITATIONS OF LIABILITY

TO THE EXTENT PERMITTED BY LAW, THIS WARRANTY IS EXPRESSLY GIVEN AND ACCEPTED IN LIEU OF ANY AND ALL OTHER WARRANTIES, EXPRESSED OR IMPLIED, INCLUDING WITHOUT LIMITATION ANY WARRANTY OF MERCHANTABILITY OR FITNESS FOR A PARTICULAR PURPOSE. TO THE EXTENT THAT THEY CANNOT BE DISCLAIMED, THE IMPLIED WARRANTIES ARE LIMITED IN DURATION TO THE LIFE OF THE EXPRESS WARRANTY. INCIDENTAL AND CONSEQUENTIAL DAMAGES ARE EXCLUDED FROM COVERAGE UNDER THIS WARRANTY. SOME JURISDICTIONS DO NOT ALLOW FOR THE DISCLAIMERS, LIMITATIONS AND EXCLUSIONS IDENTIFIED ABOVE, AS A RESULT, THEY MAY NOT APPLY TO YOU. THIS WARRANTY GIVES YOU SPECIFIC RIGHTS AND YOU MAY ALSO HAVE OTHER LEGAL RIGHTS WHICH MAY VARY FROM COUNTRY TO COUNTRY. (FOR PRODUCTS PURCHASED IN AUSTRALIA SEE CLAUSE 4 BELOW).

Neither the Can-Am ATV Distributor/Dealer nor any other person has been authorized to make any affirmation, representation or warranty regarding the product, other than those contained in this limited warranty, and if made, shall not be enforceable against BRP.

BRP reserves the right to modify this warranty at any time, being understood that such modification will not alter the warranty conditions applicable to the products sold while this warranty is in effect.

3) EXCLUSIONS – ARE NOT WARRANTED

The following are not warranted under this limited warranty under any circumstances:

- Normal wear and tear;
- Routine maintenance items, tune ups, adjustments;

- Damage caused by negligence or failure to provide proper maintenance and/or storage, as described in the Operator's Guide;
- Damage resulting from removal of parts, improper repairs, service, maintenance, modifications or use of parts or accessories not manufactured or approved by BRP which in its reasonable judgement are either incompatible with the product or adversely affect its operation, performance and durability, or resulting from repairs done by a person that is not an authorized servicing Can-Am ATV Distributor/Dealer;
- Damage caused by abuse, abnormal use, neglect, racing or operation of the product in a manner inconsistent with the recommended operation described in the Operator's Guide;
- Damage resulting from accident, submersion, fire, snow or water ingestion, theft, vandalism or any act of God;
- Operation with fuels, oils or lubricants which are not suitable for use with the product (see the Operator's Guide);
- Damage resulting from rust, corrosion or exposure to the elements;
- Incidental or consequential damages, or damages of any kind including without limitation towing, storage, transportation expenses, telephone, rental, taxi, inconvenience, insurance coverage, loan payments, loss of time, loss of income; or time missed for downtime experience due to service work.

4) WARRANTY COVERAGE PERIOD

This warranty will be in effect from (1) the date of delivery to the first retail consumer or (2) the date the product is first put into use, whichever occurs first and for a period of:

SIX (6) CONSECUTIVE MONTHS for private use or commercial use.

The repair or replacement of parts or the performance of service under this warranty does not extend the life of this warranty beyond its original expiration date.

Note that the duration and any other modalities of the warranty coverage are subject to the applicable national or local legislation in the customer's country.

FOR PRODUCTS SOLD IN AUSTRALIA ONLY

Nothing in these Warranty terms and conditions should be taken to exclude, restrict or modify the application of any condition, warranty, guarantee, right or remedy conferred or implied under the Competition and Consumer Act 2010 (Cth), including the Australian Consumer Law or any other law, where to do so would contravene that law, or cause any part of these terms and conditions to be void. The benefits given to you under this limited warranty are in addition to other rights and remedies that you have under Australian law.

Our goods come with guarantees that cannot be excluded under the Australian Consumer Law. You are entitled to a replacement or refund for a major failure and for compensation for any other reasonably foreseeable loss or damage. You are also entitled to have the goods repaired or replaced if the goods fail to be of acceptable quality and the failure does not amount to a major failure.

5) CONDITIONS TO HAVE WARRANTY COVERAGE

This warranty coverage is available **only** if each of the following conditions has been fulfilled:

- The 2014 Can-Am ATV must be purchased as new and unused by its first owner from a Can-Am ATV Distributor/Dealer authorized to distribute Can-Am ATVs in the country in which the sale occurred;
- The BRP specified pre-delivery inspection process must be completed and documented;
- The product must have undergone proper registration by an authorized Can-Am ATV Distributor/Dealer;
- The 2014 Can-Am ATV must be purchased in the country or union of countries in which the purchaser resides; and
- Routine maintenance outlined in the Operator's Guide must be timely performed in order to maintain warranty coverage. BRP reserves the right to make warranty coverage contingent upon proof of proper maintenance.

BRP will not honour this limited warranty to any private use owner or commercial use owner if one of the preceding conditions has not been met. Such limitations are necessary in order to allow BRP to preserve both the safety of its products, and also that of its consumers and the general public.

6) WHAT TO DO TO OBTAIN WARRANTY COVERAGE UNDER THIS WARRANTY

The customer must cease using the ATV upon the appearance of an anomaly. The customer must notify a servicing Can-Am ATV Distributor/Dealer within two (2) days of the appearance of a defect, and provide it with reasonable access to the product and reasonable opportunity to repair it. The customer must also present to the authorized Can-Am ATV Distributor/Dealer proof of purchase of the product and must sign the repair/work order prior to starting the repair in order to validate the warranty repair. All parts replaced under this limited warranty become the property of BRP.

Note that the notification period is subject to the applicable national or local legislation in customer's country.

7) WHAT BRP WILL DO

To the extent permitted by law, BRP's obligations under this warranty are limited to, at its sole discretion, repairing parts found defective under normal use, maintenance and service, or replacing such parts with new genuine Can-Am ATV parts without charge for parts and labour, at any authorized Can-Am ATV Distributor/Dealer during the warranty coverage period under the conditions described herein. BRP's responsibility is limited to making the required repairs or replacements of parts. No claim of breach of warranty shall be cause for cancellation or rescission of the sale of the Can-Am ATV to the owner. You may have other legal rights which may vary from country to country.

In the event that service is required outside of the country of original sale, the owner will bear responsibility for any additional charges due to local practices and conditions, such as, but not limited to, freight, insurance, taxes, license fees, import duties, and any and all other financial charges, including those levied by governments, states, territories and their respective agencies.

BRP reserves the right to improve or modify products from time to time without assuming any obligation to modify products previously manufactured.

8) TRANSFER

If the ownership of a product is transferred during the warranty coverage period, this warranty shall also be transferred and be valid for the remaining coverage period provided BRP or an authorized Can-Am ATV Distributor/Dealer receives a proof that the former owner agreed to the transfer of ownership, in addition to the co-ordinates of the new owner.

9) CONSUMER ASSISTANCE

1. In the event of a controversy or a dispute in connection with this limited warranty, BRP suggests that you try to resolve the issue at the Can-Am ATV Distributor/Dealer level. We recommend discussing the issue with the authorized Can-Am ATV Distributor/Dealer's service manager or owner.
2. If further assistance is required, the Can-Am ATV Distributor/Dealer service department should be contacted in order to resolve the matter.
3. If the matter still remains unresolved then contact BRP by writing at the address listed below.

For countries within Middle East and Africa please contact our European office:

BRP EUROPE N.V.

Customer Assistance Center
Skaldenstraat 125
9042 Gent
Belgium
Tel.: + 32 9 218 26 00

For all other countries, please contact your local Can-Am ATV Distributor/Dealer (visit our website at www.brp.com for contact information), or contact our North American office at:

BOMBARDIER RECREATIONAL PRODUCTS INC.

Customer Assistance Center
75, J.-A. Bombardier Street
Sherbrooke QC J1L 1W3
Canada
Tel.: + 1 819 566-3366

* For the territory covered by this limited warranty, products are distributed and serviced by Bombardier Recreational Products Inc. or its affiliates.

© 2013 Bombardier Recreational Products Inc. All rights reserved.

™ Trademark of Bombardier Recreational Products Inc. or its affiliates.

BRP LIMITED WARRANTY FOR THE EUROPEAN ECONOMIC AREA, THE COMMONWEALTH OF THE INDEPENDENT STATES AND TURKEY: 2014 CAN-AM™ ATV

1) SCOPE OF THE LIMITED WARRANTY

Bombardier Recreational Products Inc. ("BRP")* warrants its 2014 Can-Am ATVs sold by distributors or dealers authorized by BRP to distribute Can-Am ATVs ("Can-Am ATV Distributor/Dealer") in member states of the European Economic Area (which is comprised of the member states of the European Union plus Norway, Iceland and Liechtenstein) ("EEA"), in member states of the Commonwealth of the Independent States (including Ukraine and Turkmenistan) ("CIS") and Turkey from defects in material or workmanship for the period and under the conditions described below.

All genuine Can-Am ATV parts and accessories, installed by an authorized Can-Am ATV Distributor/Dealer at the time of delivery of the 2014 Can-Am ATV, carry the same warranty as that of the ATV.

This limited warranty will become null and void if: (1) The ATV was used for racing or any other competitive activity, at any point, even by a previous owner; or (2) the ATV has been altered or modified in such a way so as to adversely affect its operation, performance or durability, or has been altered or modified to change its intended use.

2) LIMITATIONS OF LIABILITY

TO THE EXTENT PERMITTED BY LAW, THIS WARRANTY IS EXPRESSLY GIVEN AND ACCEPTED IN LIEU OF ANY AND ALL OTHER WARRANTIES, EXPRESSED OR IMPLIED, INCLUDING WITHOUT LIMITATION ANY WARRANTY OF MERCHANTABILITY OR FITNESS FOR A PARTICULAR PURPOSE. TO THE EXTENT THAT THEY CANNOT BE DISCLAIMED, THE IMPLIED WARRANTIES ARE LIMITED IN DURATION TO THE LIFE OF THE EXPRESS WARRANTY. INCIDENTAL AND CONSEQUENTIAL DAMAGES ARE EXCLUDED FROM COVERAGE UNDER THIS WARRANTY. SOME JURISDICTIONS DO NOT ALLOW FOR THE DISCLAIMERS, LIMITATIONS AND EXCLUSIONS IDENTIFIED ABOVE, AS A RESULT, THEY MAY NOT APPLY TO YOU. THIS WARRANTY GIVES YOU SPECIFIC RIGHTS AND YOU MAY ALSO HAVE OTHER LEGAL RIGHTS WHICH MAY VARY FROM COUNTRY TO COUNTRY.

Neither the Can-Am ATV Distributor/Dealer nor any other person has been authorized to make any affirmation, representation or warranty regarding the product, other than those contained in this limited warranty, and if made, shall not be enforceable against BRP.

BRP reserves the right to modify this warranty at any time, being understood that such modification will not alter the warranty conditions applicable to the products sold while this warranty is in effect.

3) EXCLUSIONS – ARE NOT WARRANTED

The following are not warranted under this limited warranty under any circumstances:

- Normal wear and tear;
- Routine maintenance items, tune ups, adjustments;

- Damage caused by negligence or failure to provide proper maintenance and/or storage, as described in the Operator's Guide;
- Damage resulting from removal of parts, improper repairs, service, maintenance, modifications or use of parts or accessories not manufactured or approved by BRP which in its reasonable judgement are either incompatible with the product or adversely affect its operation, performance and durability, or resulting from repairs done by a person that is not an authorized servicing Can-Am ATV Distributor/Dealer;
- Damage caused by abuse, abnormal use, neglect, racing or operation of the product in a manner inconsistent with the recommended operation described in the Operator's Guide;
- Damage resulting from accident, submersion, fire, snow or water ingestion, theft, vandalism or any act of God;
- Operation with fuels, oils or lubricants which are not suitable for use with the product (see the Operator's Guide);
- Damage resulting from rust, corrosion or exposure to the elements;
- Incidental or consequential damages, or damages of any kind including without limitation towing, transportation expenses, storage, telephone, rental, taxi, inconvenience, insurance coverage, loan payments, loss of time, loss of income or time missed for downtime experience due to service work.

4) WARRANTY COVERAGE PERIOD

This warranty will be in effect from (1) the date of delivery to the first retail consumer or (2) the date the product is first put into use, whichever occurs first and for a period of:

TWENTY-FOUR (24) CONSECUTIVE MONTHS for private use.

SIX (6) CONSECUTIVE MONTHS for commercial use or rental use.

The product is used commercially when it is used in connection with any work or employment that generates income during any part of the warranty period. The product is also used commercially when, at any point during the warranty period, it is licensed for commercial use.

The repair or replacement of parts or the performance of service under this warranty does not extend the life of this warranty beyond its original expiration date.

Note that the duration and any other modalities of the warranty coverage are subject to the applicable national or local legislation in the customer's country.

5) CONDITIONS TO HAVE WARRANTY COVERAGE

This warranty coverage is available **only** if **each** of the following conditions has been fulfilled:

- The 2014 Can-Am ATV must be purchased as new and unused by its first owner from a Can-Am ATV Distributor/Dealer authorized to distribute Can-Am ATVs in the country in which the sale occurred;
- The BRP specified pre-delivery inspection process must be completed and documented;
- The product must have undergone proper registration by an authorized Can-Am ATV Distributor/Dealer;

- The 2014 Can-Am ATV must be purchased within the EEA by an EEA resident, in the CIS for residents of the countries comprised in such area and in Turkey for residents of Turkey; and
- Routine maintenance outlined in the Operator's Guide must be timely performed in order to maintain warranty coverage. BRP reserves the right to make warranty coverage contingent upon proof of proper maintenance.

BRP will not honour this limited warranty to any private use owner or commercial use owner if one of the preceding conditions has not been met. Such limitations are necessary in order to allow BRP to preserve both the safety of its products, and also that of its consumers and the general public.

6) WHAT TO DO TO OBTAIN WARRANTY COVERAGE UNDER THIS WARRANTY

The customer must cease using the ATV upon the appearance of an anomaly. The customer must notify a servicing Can-Am ATV Distributor/Dealer within two (2) months of the appearance of a defect and provide it with reasonable access to the product and reasonable opportunity to repair it. The customer must also present to the authorized Can-Am ATV Distributor/Dealer, proof of purchase of the product and must sign the repair/work order prior to starting the repair in order to validate the warranty repair. All parts replaced under this limited warranty become the property of BRP.

Note that the notification period is subject to the applicable national or local legislation in customer's country.

7) WHAT BRP WILL DO

To the extent permitted by law, BRP's obligations under this warranty are limited to, at its sole discretion, repairing parts found defective under normal use, maintenance and service, or replacing such parts with new genuine Can-Am ATV parts without charge for parts and labour, at any authorized Can-Am ATV Distributor/Dealer during the warranty coverage period under the conditions described herein. BRP's responsibility is limited to making the required repairs or replacements of parts. No claim of breach of warranty shall be cause for cancellation or rescission of the sale of the Can-Am ATV to the owner. You may have other legal rights which may vary from country to country.

In the event that service is required outside of the EEA, CIS or Turkey, the owner will bear responsibility for any additional charges due to local practices and conditions, such as, but not limited to, freight, insurance, taxes, license fees, import duties, and any and all other financial charges, including those levied by governments, states, territories and their respective agencies.

BRP reserves the right to improve or modify products from time to time without assuming any obligation to modify products previously manufactured.

8) TRANSFER

If the ownership of a product is transferred during the warranty coverage period, this warranty shall also be transferred and be valid for the remaining coverage period provided BRP or an authorized Can-Am ATV Distributor/Dealer receives a proof that the former owner agreed to the transfer of ownership, in addition to the co-ordinates of the new owner.

9) CONSUMER ASSISTANCE

1. In the event of a controversy or a dispute in connection with this limited warranty, BRP suggests that you try to resolve the issue at the Can-Am ATV Distributor/Dealer level. We recommend discussing the issue with the authorized Can-Am ATV Distributor/Dealer's service manager or owner.
2. If further assistance is required, the Can-Am ATV Distributor/Dealer service department should be contacted in order to resolve the matter.
3. If the matter still remains unresolved then contact BRP at the address listed below:

For countries within EEA, CIS or Turkey, except Scandinavian countries, please contact our European office:

BRP EUROPE N.V.

Customer Assistance Center
Skaldenstraat 125
9042 Gent
Belgium
Tel.: + 32 9 218 26 00

For Scandinavian countries, please contact our Finland office:

BRP FINLAND OY

Service Department
Isoaavantie 7
FIN-96320 Rovaniemi
Finland
Tel.: + 358 16 3208 111

You can find your Can-Am Distributor/Dealer's coordinates on www.brp.com.

* In the EEA, products are distributed and serviced by BRP European Distribution S.A. and other affiliates or subsidiaries of BRP.

© 2013 Bombardier Recreational Products Inc. All rights reserved.

™ Trademark of Bombardier Recreational Products Inc. or its affiliates.

ADDITIONAL TERMS AND CONDITIONS FOR FRANCE ONLY

The following terms and conditions are applicable to products sold in France only:

The seller shall deliver goods that are complying with the contract and shall be responsible for defects existing upon delivery. The seller shall also be responsible for defects resulting from packaging, assembling instructions or the installation when it is its responsibility per the contract or if accomplished under its responsibility. To be compliant with the contract, the good shall:

1. Be fit for normal use for goods similar thereto and, if applicable:
 - Correspond to the description provided by the seller and have the qualities presented to the buyer through sample or model;
 - Have the qualities that a buyer may legitimately expect considering the public declarations of the seller, the manufacturer of its representative, including in advertising or labeling; or
2. Have the characteristics mutually agreed upon as between the parties or be fit for the specific use intended by the buyer and brought to the attention of the seller and which accepted.

The action for failure to comply is prescribed after two years after delivery of the goods. The seller is responsible for the warranty for hidden defects of the good sold if such hidden defects are rendering the good unfit for the intended use, or if they diminish its use in such a way that the buyer would not have acquired the good or would have given a lesser price, had he known. The action for such hidden defects shall be taken by the buyer within 2 years of the discovery of the defect.

CUSTOMER INFORMATION

PRIVACY INFORMATION

BRP wishes to inform you that your coordinates will be used for safety and warranty related purposes. Furthermore, BRP and its affiliates may use its customer list to distribute marketing and promotional information about BRP and related products.

To exercise your right to consult or correct your data, or to be removed from the addressee-list for direct marketing, please contact BRP.

By E-mail: privacyofficer@brp.com

By mail: BRP
Senior Legal Counsel-Privacy Officer
726 St-Joseph
Valcourt QC
Canada
J0E 2L0

CHANGE OF ADDRESS/OWNERSHIP

If your address has changed or if you are the new owner of the ATV, be sure to notify BRP by either:

- Mailing one of the following cards below

In case of change of ownership, please join a proof that the former owner agreed to the transfer.

Notifying BRP, even after the expiration of the limited warranty, is very important as it enables BRP to reach the ATV owner if necessary, like when safety recalls are initiated. It is the owner's responsibility to notify BRP.

STOLEN UNITS: If your personal ATV is stolen, you should notify BRP or an authorized Can-Am dealer. We will ask you to provide your name, address, phone number, the vehicle identification number and the date it was stolen.

Scandinavian countries

BRP FINLAND OY
Service Department
Isoaavantie 7
FIN-96320 Rovaniemi

Other countries in the world

BRP EUROPEAN DISTRIBUTION
Warranty Department
Chemin de Messidor 5-7
1006 Lausanne
Switzerland

***This page is
intentionally blank***

CHANGE OF ADDRESS

CHANGE OF OWNERSHIP



VEHICLE IDENTIFICATION NUMBER

Model Number

Vehicle Identification Number (V.I.N.)

OLD ADDRESS
OR PREVIOUS OWNER:

NAME

NO.

STREET

APT

CITY

STATE/PROVINCE

ZIP/POSTAL CODE

COUNTRY

TELEPHONE

NEW ADDRESS
OR NEW OWNER:

NAME

NO.

STREET

APT

CITY

STATE/PROVINCE

ZIP/POSTAL CODE

COUNTRY

TELEPHONE

E-MAIL ADDRESS

V00A2F

CHANGE OF ADDRESS

CHANGE OF OWNERSHIP



VEHICLE IDENTIFICATION NUMBER

Model Number

Vehicle Identification Number (V.I.N.)

OLD ADDRESS
OR PREVIOUS OWNER:

NAME

NO.

STREET

APT

CITY

STATE/PROVINCE

ZIP/POSTAL CODE

COUNTRY

TELEPHONE

NEW ADDRESS
OR NEW OWNER:

NAME

NO.

STREET

APT

CITY

STATE/PROVINCE

ZIP/POSTAL CODE

COUNTRY

TELEPHONE

E-MAIL ADDRESS

V00A2F

ATV MODEL No. _____

VEHICLE IDENTIFICATION NUMBER (V.I.N.) _____

ENGINE IDENTIFICATION NUMBER (E.I.N.) _____

Owner: _____
NAME

No. STREET APT

CITY STATE/PROVINCE ZIP/POSTAL CODE

Purchase Date _____
YEAR MONTH DAY

Warranty Expiry Date _____
YEAR MONTH DAY

To be completed by the dealer at the time of the sale.

DEALER IMPRINT AREA

V00A2IL

Please verify with your dealer to ensure your vehicle has been registered with BRP.

While reading this Operator's Guide, remember that:

 **WARNING**

Indicates a potential hazard that, if not avoided, could result in serious injury or death.

THIS VEHICLE CAN BE HAZARDOUS TO OPERATE.

A collision or rollover can occur quickly, even during routine maneuvers such as turning and driving on hills or over obstacles, if you fail to take proper precautions.

SEVERE INJURY OR DEATH can result if you do not follow these instructions:

- **BEFORE YOU OPERATE THIS VEHICLE, READ THIS OPERATOR'S GUIDE AND ALL ON-PRODUCT SAFETY LABELS.**
- **NEVER OPERATE THIS VEHICLE WITHOUT PROPER INSTRUCTIONS.** Complete a certified training course.
- **FOR MAX MODELS, NEVER CARRY MORE THAN ONE PASSENGER.** You increase your risk of losing control if you carry more than one passenger.
- **FOR 1 PASSENGER MODELS, NEVER CARRY A PASSENGER.** You increase your risk of losing control if you carry a passenger.
- **NEVER OPERATE THIS VEHICLE ON ANY PAVED SURFACE** unless it is for short distances, at reduced speed and in order to move the vehicle from an off-road location to another.
- **ALWAYS RESPECT THE ROAD TRAFFIC LAWS** when you operate this vehicle on the roadway, even a dirt or gravel road.
- **OPERATOR AND PASSENGER (MAX Models) SHOULD ALWAYS WEAR AN APPROVED HELMET,** eye protection, and protective clothing.
- **NEVER USE WITH DRUGS OR ALCOHOL.** They slow reaction time and impair judgment.
- **NEVER OPERATE THIS VEHICLE AT EXCESSIVE SPEEDS.** You increase your risk of losing control if you operate this vehicle at speeds too fast for the terrain, visibility conditions, or your experience. The maximum speed authorized with this vehicle is 65 km/h.
- **NEVER ATTEMPT WHEELIES, JUMPS, OR OTHER STUNTS.**

219 001 180

CA

OPERATOR'S GUIDE, OUTLANDER 400 EFI / MAX 400 EFI CE/ ENGLISH
GUIDE DU COND., OUTLANDER 400 EFI / MAX 400 EFI CE/ ANGLAIS

FAIT AU / MADE IN CANADA

U/M:P.C.