

**can-am**<sup>TM</sup>



# 2014 Operator's Guide

Includes  
Safety, Vehicle  
and Maintenance Information  
(Canada/United States)

## DS 450<sup>TM</sup> Series

**⚠ WARNING**

Read this guide thoroughly. It contains important safety information. Minimum recommended operator's age: 16 years old. Experienced operator only. Keep this Operator's Guide in the vehicle.

2 1 9 0 0 1 1 5 3

## WARNING

**YOUR VEHICLE CAN BE HAZARDOUS TO OPERATE.** A collision or rollover can occur quickly, even during routine maneuvers such as turning and driving on hills or over obstacles, if you fail to take proper precautions. For your safety, understand and follow all the warnings contained in this Operator's Guide and the labels on your vehicle. **Failure to follow these warnings can result in SEVERE INJURY OR DEATH!** Keep this Operator's Guide with the vehicle at all times.

## WARNING

Disregarding any of the safety precautions and instructions contained in this Operator's Guide, *SAFETY DVD* and on-product labels could cause injury including the possibility of death!

### CALIFORNIA PROPOSITION 65 WARNING

## WARNING

This product contains or emits chemicals known to the state of California to cause cancer and birth defects or other reproductive harm.

In Canada, products are distributed by Bombardier Recreational Products Inc. (BRP). In USA, products are distributed by BRP US Inc.

The following trademarks are the property of Bombardier Recreational Products Inc.:

Can-Am™

DS 450™

DS 450™ X™ xc

DS 450™ X™ mx

Rotax®

XPS™

This document contains the trademarks of the following companies:

- Fox is a trademark of Fox Racing Shox
- Fox Float® X Evol™ and Podium® are trademarks of Fox Racing Shox

# FOREWORD

Deutsch	Dieses Handbuch ist möglicherweise in Ihrer Landessprache verfügbar. Bitte wenden Sie sich an Ihren Händler oder besuchen Sie: <a href="http://www.operatorsguide.brp.com">www.operatorsguide.brp.com</a> .
English	This guide may be available in your language. Check with your dealer or go to: <a href="http://www.operatorsguide.brp.com">www.operatorsguide.brp.com</a> .
Español	Es posible que este manual esté disponible en su idioma. Consulte a su distribuidor o visite: <a href="http://www.operatorsguide.brp.com">www.operatorsguide.brp.com</a> .
Français	Ce guide peut être disponible dans votre langue. Vérifier avec votre concessionnaire ou aller à: <a href="http://www.operatorsguide.brp.com">www.operatorsguide.brp.com</a> .
Nederlands	Deze handleiding kan beschikbaar zijn in uw taal. Vraag het aan uw dealer of ga naar: <a href="http://www.operatorsguide.brp.com">www.operatorsguide.brp.com</a> .
Norsk	Denne boken kan finnes tilgjengelig på ditt eget språk. Kontakt din forhandler eller gå til: <a href="http://www.operatorsguide.brp.com">www.operatorsguide.brp.com</a> .
Português	Este manual pode estar disponível em seu idioma. Fale com sua concessionária ou visite o site: <a href="http://www.operatorsguide.brp.com">www.operatorsguide.brp.com</a> .
Suomi	Käyttöohjekirja voi olla saatavissa omalla kielelläsi. Tarkista jälleenmyyjältä tai käy osoitteessa: <a href="http://www.operatorsguide.brp.com">www.operatorsguide.brp.com</a>
Svenska	Denna bok kan finnas tillgänglig på ditt språk. Kontakta din återförsäljare eller gå till: <a href="http://www.operatorsguide.brp.com">www.operatorsguide.brp.com</a> .

Congratulations on your purchase of a new Can-Am™ ATV. It is backed by the BRP warranty and a network of authorized Can-Am dealers ready to provide the parts, service or accessories you may require.

Your dealer is committed to your satisfaction. He has taken training to perform the initial setup and inspection of your vehicle as well as completed the final adjustment before you took possession. If you need more complete servicing information, please ask your dealer.

At delivery, you were also informed of the warranty coverage and signed the *PREDELIVERY CHECK LIST* to ensure your new vehicle was prepared to your entire satisfaction.

## Know Before you Go

To learn how to reduce the risk for you or bystanders being injured or killed, read this Operator's Guide before you operate the vehicle:

- SAFETY INFORMATION
- VEHICLE INFORMATION.

Also, read all safety labels on your ATV and watch attentively your *SAFETY DVD* video.

Failure to follow the warnings contained in this Operator's Guide can result in **SERIOUS INJURY** or **DEATH**.

## Age Recommendation

This vehicle is a category S, always follow this age recommendation: A person under 16 years old should never operate this vehicle.

This vehicle is for recreational use by experienced operators only.

**⚠ WARNING**

This is a high performance ATV. Inexperienced riders may overlook risks and be surprised by the specific behavior of this ATV in any riding conditions.

**Training Course**

Never operate this vehicle without proper instruction. **Take a training course.** All operators should receive training from a certified instructor.

**FOR MORE INFORMATION ABOUT ATV SAFETY,** contact an authorized Can-Am dealer to find out about available training courses nearest you.

Call the Specialty Vehicle Institute of America (SVIA) at 1 800 887-2887 or in Canada, the Canada Safety Council (CSC) at 1 613 739-1535.

**Safety Messages**

The types of safety messages, what they look like and how they are used in this guide are explained as follows:

The safety alert symbol **⚠** indicates a potential injury hazard.

**⚠ WARNING**

Indicates a potential hazard, if not avoided, could result in serious injury or death.

**⚠ CAUTION** Indicates a hazard situation which, if not avoided, could result in minor or moderate injury.

**NOTICE** Indicates an instruction which, if not followed, could severely damage vehicle components or other property.

**About this Operator's Guide**

This Operator's Guide has been prepared to acquaint the owner/operator of a new vehicle with the various vehicle controls, maintenance and safe operating instructions. It is indispensable for the proper use of the product.

Keep this Operator's Guide in the vehicle as you can refer to it for things such as maintenance, troubleshooting and instructing others.

Note that this guide is available in several languages. In the event of any discrepancy, the english version shall prevail.

If you want to view and/or print an extra copy of your Operator's Guide, simply visit the following website **www.operatorsguide.brp.com**.

The informations contained in this document are correct at the time of publication. BRP, however, maintains a policy of continuous improvement of its products without imposing upon itself any obligation to install them on products previously manufactured. Due to late changes, some differences between the manufactured product and the descriptions and/or specifications in this guide may occur. BRP reserves the right at any time to discontinue or change specifications, designs, features, models or equipment without incurring any obligation upon itself.

This Operator's Guide and the *SAFETY DVD* should remain with the vehicle when it's sold.

While reading this Operator's Guide, remember that:

**⚠ WARNING**

Indicates a potential hazard that, if not avoided, could result in serious injury or death.

---

# TABLE OF CONTENTS

<b>FOREWORD</b> .....	<b>1</b>
Know Before you Go .....	1
Safety Messages.....	2
About this Operator's Guide .....	2

## ***SAFETY INFORMATION***

<b>GENERAL PRECAUTIONS</b> .....	<b>8</b>
Avoid Carbon Monoxide Poisoning .....	8
Avoid Gasoline Fires and Other Hazards .....	8
Avoid Burns from Hot Parts .....	8
Accessories and Modifications .....	8
<b>SPECIAL SAFETY MESSAGES</b> .....	<b>9</b>
<b>OPERATION WARNINGS</b> .....	<b>11</b>
<b>RIDING THE VEHICLE</b> .....	<b>36</b>
Pre-Ride Inspection .....	37
Clothing .....	38
Carrying Passenger .....	38
Carrying Loads .....	38
Recreational Riding .....	39
Environment.....	39
Design Limitation .....	40
Off-Highway Operation.....	40
General Operating and Safety Precautions .....	40
Riding Techniques.....	42
<b>IMPORTANT ON-PRODUCT LABELS</b> .....	<b>49</b>
Hang Tag .....	49
Vehicle Safety Labels .....	50
Compliance Labels.....	53
Technical Information Label .....	53

## ***VEHICLE INFORMATION***

<b>CONTROLS/INSTRUMENT/EQUIPMENTS</b> .....	<b>56</b>
1) Throttle Lever.....	57
2) Front Brake Lever .....	57
3) Clutch Lever .....	58
4) Parking Brake .....	58
5) Multifunction Switch.....	59
6) Ignition Switch.....	60
7) Indicator Lamps .....	60
8) Rear Brake Pedal .....	61
9) Transmission Lever.....	61
10) Tool Kit .....	61
11) Seat .....	62

<b>FUEL</b> .....	<b>63</b>
Fuel Requirements.....	63
Fueling Procedure.....	63
<b>OPERATING INSTRUCTIONS</b> .....	<b>65</b>
Operation During Break-In Period.....	65
Starting the Engine.....	65
Shifting the Transmission.....	66
Stopping the Engine.....	66
<b>SPECIAL PROCEDURES</b> .....	<b>68</b>
What to Do if Vehicle Is Turned Over.....	68
What to Do if Vehicle Is Immersed in Water.....	68
<b>TUNE YOUR RIDE</b> .....	<b>69</b>
Steering Alignment (Toe).....	69
Rear Track Width Adjustment (X xc and X mx).....	70
Caster Adjustment (X xc and X mx).....	71
Camber Adjustment (X mx).....	72
Suspension Adjustments Guideline.....	74
Front Suspension (DS 450/DS450 X xc).....	74
Front Suspension (DS 450 X mx).....	75
Rear Suspension (DS 450/DS450 X xc).....	78
Rear Suspension (DS 450 X mx).....	79
Suspension Factory Settings.....	81
<b>VEHICLE TRANSPORTATION</b> .....	<b>83</b>

## **MAINTENANCE INFORMATION**

<b>5-HOUR AND 10-HOUR INITIAL SERVICES</b> .....	<b>86</b>
5-Hour Engine Oil and Filter Replacement.....	86
Initial Inspection.....	86
<b>MAINTENANCE SCHEDULE</b> .....	<b>87</b>
<b>MAINTENANCE PROCEDURES</b> .....	<b>91</b>
Engine Oil.....	91
Engine Coolant.....	94
Air Filter.....	97
Air Filter Housing.....	98
Muffler Spark Arrester.....	99
Radiator.....	100
Transmission Lever.....	100
Clutch.....	100
Throttle Cable.....	104
Throttle Lever.....	105
Spark Plugs.....	105
Battery.....	106
Fuses.....	107
Lights.....	108
Indicator Lamps.....	109

**MAINTENANCE PROCEDURES (cont'd)**

Drive Chain ..... 109

Drive Chain Slider ..... 110

Drive Chain Sprockets ..... 111

Tires/Wheels ..... 111

Front Wheel Bearings..... 114

Rear Axle..... 114

Suspensions..... 115

Brakes..... 116

Body..... 118

Frame ..... 118

**VEHICLE CARE ..... 119**

Post-Operation Care ..... 119

Vehicle Cleaning and Protection ..... 119

**STORAGE AND PRESEASON PREPARATION ..... 120**

***TECHNICAL INFORMATION***

**VEHICLE IDENTIFICATION ..... 122**

Vehicle Identification Number..... 122

Engine Identification Number ..... 122

**NOISE EMISSION CONTROL SYSTEM REGULATION ..... 123**

Tampering with Noise Control System Is Prohibited! ..... 123

Among those Acts Presumed to Constitute Tampering are the Acts Listed Below:..... 123

**SPECIFICATIONS ..... 124**

***TROUBLESHOOTING***

**TROUBLESHOOTING GUIDELINES ..... 132**

***WARRANTY***

**BRP LIMITED WARRANTY USA AND CANADA: 2014 CAN-AM™ ATV .. 138**

***CUSTOMER INFORMATION***

**PRIVACY INFORMATION ..... 144**

**CHANGE OF ADDRESS/OWNERSHIP..... 145**





# ***SAFETY INFORMATION***

---

# GENERAL PRECAUTIONS

## **Avoid Carbon Monoxide Poisoning**

All engine exhaust contains carbon monoxide, a deadly gas. Breathing carbon monoxide can cause headaches, dizziness, drowsiness, nausea, confusion and eventually death.

Carbon monoxide is a colorless, odorless, tasteless gas that may be present even if you do not see or smell any engine exhaust. Deadly levels of carbon monoxide can collect rapidly, and you can quickly be overcome and unable to save yourself. Also, deadly levels of carbon monoxide can linger for hours or days in enclosed or poorly ventilated areas. If you experience any symptoms of carbon monoxide poisoning, leave the area immediately, get fresh air and seek medical treatment.

To prevent serious injury or death from carbon monoxide:

- Never run the vehicle in poorly ventilated or partially enclosed areas such as garages, carports or barns. Even if you try to ventilate engine exhaust with fans or open windows and doors, carbon monoxide can rapidly reach dangerous levels.
- Never run the vehicle outdoors where engine exhaust can be drawn into a building through openings such as windows and doors.

## **Avoid Gasoline Fires and Other Hazards**

Gasoline is extremely flammable and highly explosive. Fuel vapors can spread and be ignited by a spark or flame many feet away from the engine. To reduce the risk of fire or explosion, follow these instructions:

- Never start or operate the engine with the fuel cap removed.
- Use only an approved red gasoline container to store fuel.
- Strictly adhere to instructions in *FUEL* subsection.

Gasoline is poisonous and can cause injury or death.

- Never siphon gasoline by mouth.
- If you swallow gasoline, get any in your eye or inhale gasoline vapor, see your doctor immediately.

If gasoline spills on you, wash with soap and water and change your clothes.

## **Avoid Burns from Hot Parts**

Certain components become hot during operation. Avoid contact with those parts during and shortly after operation to avoid burns.

## **Accessories and Modifications**

Do not make unauthorized modifications, or use attachments or accessories that are not approved by BRP. Since these changes have not been tested by BRP, they may increase the risk of crashes injuries, and they can make the vehicle illegal.

See your authorized Can-Am dealer for available accessories for your vehicle.

---

## SPECIAL SAFETY MESSAGES

### **THIS VEHICLE IS NOT A TOY AND CAN BE HAZARDOUS TO OPERATE.**

- This vehicle handles differently from other vehicles including motorcycles and cars.
- A collision or rollover can occur quickly, even during routine maneuvers such as turning and driving on hills or over obstacles, if you fail to take proper precautions.

### **SEVERE INJURY OR DEATH** can result if you do not follow these instructions:

- Read this Operator's Guide and all on-product safety labels carefully and follow the operating procedures described. Watch and pay attention to the *SAFETY DVD* video before operation.
- This is a high performance ATV for off-road use only. Inexperienced riders may overlook risks and be surprised by the specific behavior of this ATV in any terrain condition.
- Always follow this age recommendation: A person under 16 years old should never operate this vehicle. For experienced operators only.
- Never carry a passenger on this vehicle. Passenger(s) affect balance and steering and increase risk of losing control.
- Never operate this vehicle on any paved surfaces, including sidewalks, driveways, parking lots and streets.
- Never operate this vehicle on any public street, road or highway, even a dirt or gravel one.
- Never take place on this vehicle without wearing an approved helmet that fits properly. You should also wear eye protection (goggles or face shield), gloves, boots, long sleeved shirt or jacket, and long pants.
- Never use this vehicle with drugs or alcohol. They slow reaction time and impair judgement.
- Never operate at excessive speeds. Always go at a speed that is proper for the terrain, visibility, and operating conditions, and your experience.
- Never attempt wheelies, jumps, or other stunts.
- Always inspect and confirm the safe operating condition of your vehicle prior to ride. Always follow the inspection and maintenance procedures and schedules described in this Operator's Guide.
- Always keep both hands on the handlebars and both feet on the footpegs of the vehicle during operation.
- Always go slowly and be extra careful when operating on unfamiliar terrain. Always be alert to changing terrain conditions when operating this vehicle.
- Never operate on excessively rough, slippery or loose terrain until you have learned and practiced the skills necessary to control this vehicle on such terrain. Always be especially cautious on these kinds of terrain.
- Always follow proper procedures for turning as described further in this Operator's Guide. Practice turning at low speeds before attempting to turn at faster speeds. Do not turn at excessive speed.
- Never operate this vehicle on hills too steep for the vehicle or for your abilities. Practice on smaller hills before attempting larger hills.

- Always follow proper procedures for climbing hills as described further in this Operator's Guide. Check the terrain carefully before you start up any hill. Never climb hills with excessively slippery or loose surfaces. Shift your weight forward. Never open the throttle suddenly or make sudden gear changes. Never go over the top of any hill at high speed.
- Always follow proper procedures for going down hills and for braking on hills as described further in this Operator's Guide. Check the terrain carefully before you start down any hill. Shift your weight backward. Never go down a hill at high speed. Avoid going down a hill at an angle that would cause the vehicle to lean sharply to one side. Go straight down the hill where possible.
- Always follow proper procedures for crossing the side of a hill as described further in this Operator's Guide. Avoid hills with excessively slippery or loose surfaces. Shift your weight to the uphill side of the vehicle. Never attempt to turn the vehicle around on any hill until you have mastered the turning technique described in this Operator's Guide on level ground. Avoid crossing the side of a steep hill if possible.
- Always use proper procedures if you stall or roll backwards when climbing a hill. To avoid stalling, use proper gear and maintain a steady speed when climbing a hill. If you stall or roll backwards, follow the special procedure for braking described in this Operator's Guide. Dismount on the uphill side or to a side if pointed straight uphill. Turn the vehicle around and remount, following the procedure described further in this Operator's Guide.
- Always check for obstacles before operating in a new area. Never attempt to operate over large obstacles, such as large rocks or fallen trees. Always follow proper procedures when operating over obstacles as described further in this Operator's Guide.
- Always be careful when skidding or sliding. Learn to safely control skidding or sliding by practicing at low speeds and on level smooth terrain. On extremely slippery surfaces, such as ice, go slowly and be very cautious in order to reduce the chance of skidding out of control.
- Never operate this vehicle in fast flowing water or in water deeper than that specified in this Operator's Guide. Remember that wet brakes may have reduced stopping ability. Test your brakes after leaving water, mud or snow. If necessary, apply them several times to let friction dry out the pads.
- Always use the size and type of tires specified further in this Operator's Guide. Always maintain proper tire pressure as described further in this Operator's Guide.
- Never modify this vehicle through improper installation or use of accessories. Only use BRP's approved accessories.
- Never exceed the stated load limits for this vehicle including the operator and all other added accessories.
- Never operate this vehicle without proper instruction. **Take a training course.** All operators should receive training from a certified instructor.

**FOR MORE INFORMATION ABOUT ATV SAFETY,** contact an authorized Can-Am dealer to find out about available training courses nearest you.

**USA and Canada only:** call the Specialty Vehicle Institute of America (SVIA) at 1 800 887-2887 or in Canada, the Canada Safety Council (CSC) at 1 613 739-1535.

## OPERATION WARNINGS

The following warning and their format have been requested by the United States Consumer Product Safety Commission and are required to be in the Operator's Guide for all ATVs.

**NOTE:** The following illustrations are general representations only. Your model may differ.

### **WARNING**



#### **POTENTIAL HAZARD**

Operating this vehicle without proper instruction.

#### **WHAT CAN HAPPEN**

The risk of an accident is greatly increased if the operator does not know how to operate this vehicle properly in different situations and on different types of terrain.

#### **HOW TO AVOID THE HAZARD**

Beginning and inexperienced operators should complete a training course. They should then regularly practice the skills learned in the course and the operating techniques described in this Operator's Guide.

For more information about the training course, contact an authorized Can-Am dealer.

**⚠ WARNING**



V00A01Q

**POTENTIAL HAZARD**

Failure to follow the age recommendations for this vehicle.

**WHAT CAN HAPPEN**

A lack of respect for this age recommendation can lead to severe injury or death of the child.

Even though a child may be within the age group for which this vehicle is recommended, he may not have the skills, abilities, or judgment needed to operate this vehicle safely and may be involved in a serious accident.

**HOW TO AVOID THE HAZARD**

No one under 16 should operate this vehicle.

**⚠ WARNING****POTENTIAL HAZARD**

Carrying a passenger on this vehicle.

**WHAT CAN HAPPEN**

Greatly reduces your ability to balance and control this vehicle.

Could cause an accident, resulting in harm to you and/or your passenger.

**HOW TO AVOID THE HAZARD**

Never carry a passenger. Even with a long seat that provides unrestricted operator movement, it is not designed nor intended to carry passenger(s).

**⚠ WARNING**



**POTENTIAL HAZARD**

Operating this vehicle on paved surfaces.

**WHAT CAN HAPPEN**

The tires are designed for off-road use only, not for use on pavement. Paved surfaces may seriously affect handling and control of this vehicle, and may cause the vehicle to go out of control.

**HOW TO AVOID THE HAZARD**

Never operate this vehicle on any paved surfaces, including sidewalks, driveways, parking lots and streets.



**⚠ WARNING****POTENTIAL HAZARD**

Operating this vehicle on public streets, roads or highways.

**WHAT CAN HAPPEN**

You can collide with another vehicle.

**HOW TO AVOID THE HAZARD**

Never operate this vehicle on any public street, road or highway, even a dirt or gravel one. In many states or provinces it is illegal to operate this vehicle on public streets, roads or highways.

**⚠ WARNING**



**POTENTIAL HAZARD**

Riding this vehicle without wearing an approved helmet, eye protection and protective clothing.

**WHAT CAN HAPPEN**

The following items concern all ATV's operator:

- Riding without an approved helmet increases the chances of a severe head injury or death in the event of an accident.
- Riding without eye protection can result in an accident and increases the chances of a severe injury in the event of an accident.
- Riding without protective clothing increases the chances of severe injury in the event of an accident.

**HOW TO AVOID THE HAZARD**

Always wear an approved helmet that fits properly. You should also wear:

- Eye protection (goggles or face shield)
- Gloves and boots
- Long sleeved shirt or jacket
- Long pants.

**⚠ WARNING**

V00A07Q

**POTENTIAL HAZARD**

Using this vehicle with drugs or alcohol.

**WHAT CAN HAPPEN**

- Could seriously affect your judgment.
- Could cause you to react more slowly.
- Could affect your balance and perception.
- Could result in an accident or death.

**HOW TO AVOID THE HAZARD**

Never use this vehicle with drugs or alcohol.

**⚠ WARNING**

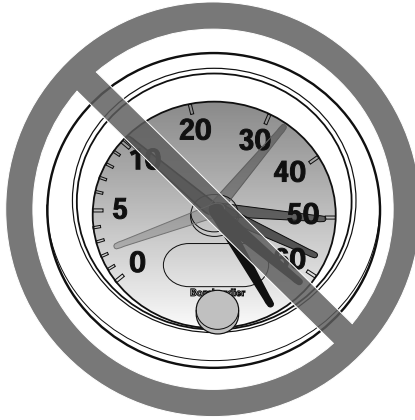

V00A08Q

**POTENTIAL HAZARD**

Operating this vehicle at excessive speeds.

**WHAT CAN HAPPEN**

Increases your chances of losing control of the vehicle, which can result in an accident.

**HOW TO AVOID THE HAZARD**

Always travel at a speed which is proper for the terrain, visibility and operating conditions, and your experience.

**⚠ WARNING****POTENTIAL HAZARD**

Attempting wheelies, jumps and other stunts.

**WHAT CAN HAPPEN**

Increases the chance of an accident, including an overturn.

**HOW TO AVOID THE HAZARD**

Never attempt stunts, such as wheelies or jumps. Do not try to show off.

**⚠ WARNING****POTENTIAL HAZARD**

Failure to inspect the vehicle before operating.

Failure to properly maintain the vehicle.

**WHAT CAN HAPPEN**

Increases the possibility of an accident or equipment damage.

**HOW TO AVOID THE HAZARD**

Always inspect your vehicle every time prior to use it to make sure the vehicle is in safe operating condition.

Always follow the inspection and maintenance procedures and schedules described further in this Operator's Guide.

**⚠ WARNING**

**POTENTIAL HAZARD**

Riding on frozen waterways.

**WHAT CAN HAPPEN**

Breaking through the ice can lead to severe injury or death.

**HOW TO AVOID THE HAZARD**

Never ride this vehicle on a frozen surface before you are sure the ice is thick enough and sound enough to support the vehicle and its load, as well as the force that is created by a moving vehicle.

**⚠ WARNING**



**POTENTIAL HAZARD**

Removing hands from handlebar or feet from the footrests during operation.

**WHAT CAN HAPPEN**

Removing even one hand or foot can reduce your ability to control the vehicle or could cause you to lose your balance and fall off the vehicle. If you remove a foot from the footrests, your foot or leg may come into contact with the rear wheels, which could injure you or cause an accident.

**HOW TO AVOID THE HAZARD**

Always keep both hands on the handlebar and both feet on the footrests during vehicle operation.

**⚠ WARNING****POTENTIAL HAZARD**

Failure to use extra care when operating this vehicle on unfamiliar terrain.

**WHAT CAN HAPPEN**

You can come upon hidden rocks, bumps, or holes, without enough time to react.

Could result in the vehicle overturning or loss of control.

**HOW TO AVOID THE HAZARD**

Go slowly and be extra careful when operating on unfamiliar terrain.

Always be alert to changing terrain conditions when operating the vehicle.

**⚠ WARNING**



**POTENTIAL HAZARD**

Failure to use extra care when operating on excessively rough, slippery or loose terrain.

**WHAT CAN HAPPEN**

Could cause loss of traction or vehicle control, which could result in an accident, including an overturn.

**HOW TO AVOID THE HAZARD**

Do not operate on excessively rough, slippery or loose terrain until you have learned and practiced the skills necessary to control this vehicle on such terrain.

Always be especially cautious on these kinds of terrain.



**⚠ WARNING****POTENTIAL HAZARD**

Turning improperly.

**WHAT CAN HAPPEN**

Vehicle could go out of control, causing a collision or overturn.

**HOW TO AVOID THE HAZARD**

Always follow proper procedures for turning as described further in this Operator's Guide. Practice turning at low speeds before attempting to turn at faster speeds.

Do not turn at excessive speed.

**⚠ WARNING**



**POTENTIAL HAZARD**

Operating on excessively steep hills.

**WHAT CAN HAPPEN**

The vehicle can overturn more easily on extremely steep hills than on level surfaces or small hills.

**HOW TO AVOID THE HAZARD**

Never operate this vehicle on hills too steep for the vehicle or for your abilities.

Practice on smaller hills before attempting larger hills.

**⚠ WARNING****POTENTIAL HAZARD**

Climbing hills improperly.

**WHAT CAN HAPPEN**

Could cause loss of control or cause vehicle to overturn.

**HOW TO AVOID THE HAZARD**

Always follow proper procedures for climbing hills as described further in this Operator's Guide.

Always check the terrain carefully before you start up any hill.

Never climb hills with excessively slippery or loose surfaces.

Shift your weight forward.

Never open the throttle suddenly or make sudden gear changes. The vehicle could flip over backwards.

Never go over the top of any hill at high speed. An obstacle, a sharp drop, or another vehicle or person could be on the other side of the hill.

**⚠ WARNING**



**POTENTIAL HAZARD**

Going down a hill improperly.

**WHAT CAN HAPPEN**

Could cause loss of control or cause vehicle to overturn.

**HOW TO AVOID THE HAZARD**

Always follow proper procedures for going down hills as described further in this Operator's Guide.

**NOTE:** A special technique is required when braking as you go down a hill.

Always check the terrain carefully before you start down any hill.

Shift your weight backward.

Never go down a hill at high speed.

Avoid going down a hill at an angle which would cause the vehicle to lean sharply to one side. Go straight down the hill where possible.

**⚠ WARNING****POTENTIAL HAZARD**

Improperly crossing hills or turning on hills.

**WHAT CAN HAPPEN**

Could cause loss of control or cause vehicle to overturn.

**HOW TO AVOID THE HAZARD**

Never attempt to turn the vehicle around on any hill until you have mastered the turning technique as described further in this Operator's Guide on level ground. Be very careful when turning on any hill.

Avoid crossing the side of a steep hill if possible.

***When crossing the side of a hill:***

Always follow proper procedures as described further in this Operator's Guide.

Avoid hills with excessively slippery or loose surfaces.

Shift your weight to the uphill side of the vehicle.

**⚠ WARNING**

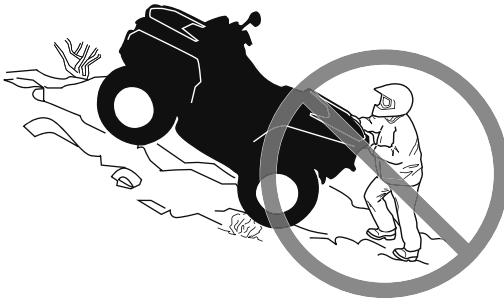

**POTENTIAL HAZARD**

Stalling, rolling backwards or improperly dismounting while climbing a hill.

**WHAT CAN HAPPEN**

Could result in vehicle overturning.

**HOW TO AVOID THE HAZARD**

Use proper gear and maintain steady speed when climbing a hill.

***If you lose all forward speed:***

Keep your weight uphill. Never open the throttle suddenly or make sudden gear changes. The vehicle could flip over backwards.

Apply the brakes.

Lock parking brake after you have stopped.

Dismount on uphill side, or to a side if pointed straight uphill.

***If you begin rolling backwards:***

Keep your weight uphill. Never open the throttle suddenly or make sudden gear changes. The vehicle could flip over backwards.

Never apply the rear brake while rolling backwards.

Apply the front brake gradually.

When fully stopped, apply rear brake as well and lock parking brake.

Dismount on uphill side, or to a side if pointed straight uphill.

Turn the vehicle around and remount, following the procedure described further in this Operator's Guide.

**⚠ WARNING****POTENTIAL HAZARD**

Improperly operating over obstacles.

**WHAT CAN HAPPEN**

Could cause loss of control or a collision.

Could cause the vehicle to overturn.

**HOW TO AVOID THE HAZARD**

Before operating in a new area, check for obstacles.

Never attempt to ride over large obstacles, such as large rocks or fallen trees.

When you go over obstacles, always follow proper procedures as described further in this Operator's Guide.

**⚠ WARNING**



**POTENTIAL HAZARD**

Skidding or sliding improperly.

**WHAT CAN HAPPEN**

You may lose control of this vehicle.

You may also regain traction unexpectedly, which may cause the vehicle to overturn.

**HOW TO AVOID THE HAZARD**

Learn to safely control skidding or sliding by practicing at low speeds and on level smooth terrain.

On extremely slippery surfaces, such as ice, go slowly and be very cautious in order to reduce the chance of skidding or sliding out of control.



**⚠ WARNING****POTENTIAL HAZARD**

Operating this vehicle through deep or fast flowing water.

**WHAT CAN HAPPEN**

Tires may float, causing loss of traction and loss of control, which could lead to an accident.

**HOW TO AVOID THE HAZARD**

Never operate this vehicle in fast flowing water or in water deeper than that specified further in this Operator's Guide.

Check water depth and current before you attempt to cross any water. Water should not go above footrests.

Remember that wet brakes may have reduced stopping ability. Test your brakes after leaving water. If necessary, apply them several times to let friction dry out the pads.

**⚠ WARNING**



**POTENTIAL HAZARD**

Operating this vehicle with improper tires, or with improper or uneven tire pressure.

**WHAT CAN HAPPEN**

Use of improper tires on this vehicle, or operation of this vehicle with improper or uneven tire pressure, may cause loss of control, tire blow outs, tire to move around on its rim, and increases the risk of an accident.

**HOW TO AVOID THE HAZARD**

Always use the size and type of tires specified further in this Operator's Guide for this vehicle.

Always maintain proper tire pressure as described further in this Operator's Guide.

Always replace wheels or tires that are damaged.

**⚠ WARNING****POTENTIAL HAZARD**

Operating this vehicle with improper modifications.

**WHAT CAN HAPPEN**

Improper installation of accessories or modification of this vehicle may cause changes in handling which in some situations could lead to an accident.

**HOW TO AVOID THE HAZARD**

Never modify this vehicle through improper installation or use of accessories. All parts and accessories added to this vehicle should be approved by BRP and should be installed and used according to instructions. If you have questions, consult an authorized Can-Am dealer.

Modification of the vehicle to increase speed and performance may violate the terms and conditions of your vehicle's limited warranty. In addition, certain modifications including the removal of engine or exhaust components are illegal under most laws.

**⚠ WARNING**



**POTENTIAL HAZARD**

Overloading this vehicle or carrying or towing cargo improperly.

**WHAT CAN HAPPEN**

Could cause changes in vehicle handling which could lead to an accident.

**HOW TO AVOID THE HAZARD**

Never exceed the stated load capacity for this vehicle including operator as well as other loads and added accessories.

Cargo should be properly distributed and securely attached.

Reduce speed when carrying cargo. Allow greater distance for braking.

Always follow the instructions in this Operator's Guide for carrying cargo.

**⚠ WARNING**

V03M01Q

**POTENTIAL HAZARD**

Transporting flammable or dangerous material can lead to explosions.

**WHAT CAN HAPPEN**

This can cause serious injury or death.

**HOW TO AVOID THE HAZARD**

Never transport flammable or dangerous material.

---

## RIDING THE VEHICLE

To fully appreciate the pleasures and excitement of riding this vehicle, there are some basic rules and tips that you **MUST** follow. Some may be new to you while others may be common sense or obvious.

Please take the time to study this Operator's Guide and all on-product safety labels as well as the *SAFETY DVD* video that came with this vehicle. They more completely describe what you should know about this vehicle before riding it.

Whether you are a new user or an experienced rider, it is important for your personal safety that you know the controls and features of this vehicle. Equally important is knowing how to properly ride.

This is a high performance ATV for off-road use only. Inexperienced riders may overlook risks and be surprised by the specific behavior of this ATV in any terrain condition.

Persons with cognitive or physical impairments or who are high risk takers have an increased exposure to overturns or collisions which may result in injury including death.

Not all vehicles are the same. Each has its own unique performance characteristics, controls and features. Each will ride and handle differently.

Become completely familiar with the operational controls and the general operation of the vehicle before venturing into off road conditions. Practice driving in a suitable area free of hazards and feel the response of each control. Drive at low speeds. Higher speeds require greater experience, knowledge and suitable riding conditions.

Riding conditions vary from place to place. Each is subject to weather conditions which may radically change from time to time and from season to season.

Riding on sand is different than riding on snow or through forests or marshes. Each location may require a greater degree of awareness and skills. Show good judgement. Always proceed with caution. Please do not take any unnecessary risks that could leave you stranded or possibly injured.

Never assume that the vehicle will go everywhere safely. Sudden changes in terrain caused by holes, depressions, banks, softer or harder "ground" or other irregularities may cause the vehicle to topple or become unstable. To avoid this, slow down and always observe the terrain ahead. If the vehicle does begin to topple or tip over, the best advice is to immediately get off... **AWAY** from the direction of the tip over!

While reading this Operator's Guide, remember that:

### **WARNING**

Indicates a potential hazard that, if not avoided, could result in serious injury or death.

## Pre-Ride Inspection

### **WARNING**

Perform a pre-ride inspection before each ride to detect potential problems during operation. The pre-ride inspection can help you monitor wear and deterioration before they become a problem. Correct any problems that you discover to reduce the risk of a breakdown or crash. See an authorized Can-Am dealer if necessary.

Before using this vehicle, the operator should always:

- Apply parking brake and check if it operates properly.
- Check tire pressure and condition.
- Check wheels and bearings for wear and damage.
- Check location of controls and ensure they work properly.
- Verify if steering operates freely.
- Activate throttle control lever several times to ensure it operates freely. It must return to idle position when released.
- Activate the brake lever and brake pedal to make sure the brakes fully apply. They must fully return when released.
- Ensure front brake lever position is adjusted to suit drivers hand.
- Check all brake line fittings for tightness and against leaks.
- With parking brake correctly applied, activate the clutch lever. It must fully return when released.
- Check drive chain for adjustment and lubrication.
- Check sprockets for wear and damages.
- Check tightening of rear axle fasteners.
- Check swing arm, if any lateral play is detected **DO NOT USE THE VEHICLE**.
- Check fuel, oil and coolant levels.
- Check for oil leaks on the engine, oil tank and transmission.
- Check radiator cleanliness.
- Clean headlights and taillight.
- Ensure seat is properly latched.
- Look and feel for loose parts while engine is off. Check fasteners.
- Ensure the path of travel is free of persons and obstacles.
- Check operation of ignition switch, engine start button, emergency engine stop switch, headlights, taillight and indicator lights.
- Start engine, remove parking brake and drive forward slowly a few feet then apply all brakes individually to test them.

**Correct any problem you may have found before riding. See an authorized Can-Am dealer if necessary.**

## Clothing

Actual weather conditions should help you decide how to dress. However, it is important that the operator always wears the appropriate protective clothing and apparel, including an approved helmet, eye protection, boots, gloves, a long sleeved shirt and pants. This type of clothing will provide you protection from some of the minor hazards you may encounter en route. The operator must never wear loose clothing such as a scarf that may get entangled in the vehicle or on tree branches and shrubs. Depending on conditions, antifogging goggles or sunglasses may be required. Different colored lenses available for goggles or sun glasses help you distinguish terrain variations. Sunglasses should only be worn during the daytime.

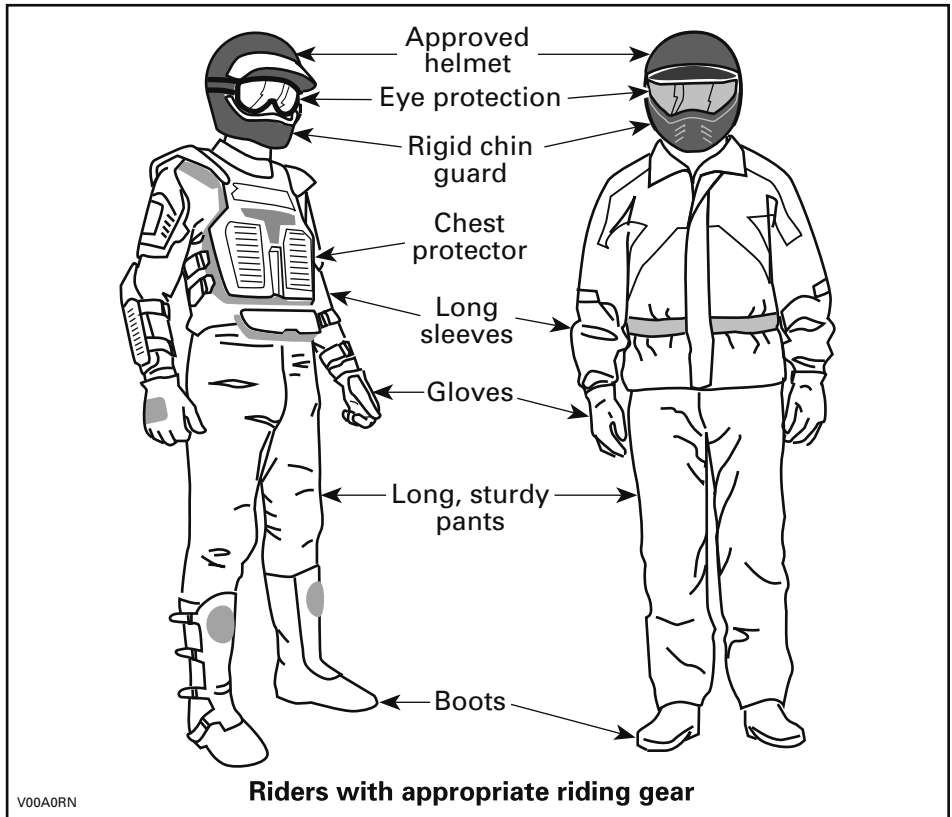

## Carrying Passenger

This vehicle is designed specifically to carry an operator only. This vehicle is not designed nor intended to carry passenger(s). Carrying passenger(s) may affect the stability and your control of the vehicle.

## Carrying Loads

Never load cargo on this vehicle.



## Recreational Riding

Respect the rights and limitations of others. Stay away from areas designated for other types of off road use. This includes snowmobile trails, equestrian trails, cross country ski trails, mountain bike trails etc. Never assume there are no other users on the trail. Always stay to the complete right of the trail and do not zig zag to one side of the trail then the other. Be prepared to stop or pull off to the side if another trail user appears in front of you.

Join a local ATV club. It will provide you with a map and advice or inform you where you can ride. If a club does not exist in your area, help to start one. Group riding and club activities provide a pleasurable, social experience.

Always keep a safe distance from other riders. Your judgment of speed, terrain conditions, weather, mechanical condition of your vehicle and the "trust in judgment" you have in others around you will help you make a better choice of appropriate safe distance. This vehicle, like any other motorized vehicle, cannot stop "on a dime".

Before you ride, tell someone where you are planning to travel and your expected time of return. Never consume alcohol or drugs before or while riding!

Depending on the length of your ride, carry additional tools or emergency equipment. Find out where you can get additional gasoline and oil. Be prepared for the possible conditions you may encounter. An emergency first aid kit should always be a consideration.

## Environment

One of the benefits of this vehicle is that it can take you off the beaten path away from most communities. However, you should always respect nature and the rights of others to enjoy it. Do not ride in environmentally sensitive areas. Do not drive over forest crops or shrubs... nor cut down trees or take down fencing... nor spin your wheels and destroy the terrain. "Tread Lightly".

This vehicle can cause OHV wildfires if debris builds up near the exhaust or other engine hot spots and ignites then falls off into dry grass. Avoid riding in wet areas, through muskeg or tall grass, where debris can build up. Should you ride in those areas, inspect and remove all debris from your engine and hot spots.

Chasing wildlife is in many areas illegal. Wildlife can die of exhaustion after being chased by a motorized vehicle. If you encounter animals on the trail, stop and observe quietly and with caution. It will be one of the better memories of your life.

Observe the rule... "what you take in, carry out". Do not litter. Do not start campfires unless you have permission to do so... and then only... away from dry areas. The hazards you may create on the trail may cause injury to others or yourself, even at a later date.

Respect farm lands. Always obtain the permission of the landowner before riding on private land. Respect crops, farm animals and property lines. If you come to a closed a gate, close it again behind you.

Finally, do not pollute streams, lakes or rivers and do not modify the engine or muffling system, or remove any of its components.

## **Design Limitation**

Although the vehicle is exceptionally rugged for its class, it is still a light vehicle by definition and its operation must be restricted to its proper purpose.

The addition of weight to any part of the vehicle changes its gravitational stability and modifies its performance.

## **Off-Highway Operation**

The very nature of off-highway operation is dangerous. Any terrain, which has not been specially prepared to carry vehicles, presents an inherent danger where angularity, terrain substance and exact steepness are unpredictable. The terrain itself presents a continual element of danger, which must be knowingly accepted by anyone venturing over it.

An operator who takes a vehicle off-road should always exercise the utmost care in selecting the safest path and keeping close watch on the terrain ahead of him. On no account should the vehicle be operated by anyone who is not completely familiar with the driving instructions applicable to the vehicle, nor should it be operated on steep or treacherous terrain.

## **General Operating and Safety Precautions**

Care, caution, experience and driving skill are the best precautions against the hazards of vehicle operation.

Whenever there is the slightest doubt that the vehicle can safely negotiate an obstacle or a particular piece of terrain, always choose an alternate route.

In off-road operation, power and traction, not speed, are important. Never drive faster than visibility and your own ability to select a safe route permit.

Constantly watch the terrain ahead for sudden changes in slopes or obstacles, such as rocks or stumps, that may cause loss of stability, resulting in tip over or rollover.

Never operate the vehicle if the controls do not function normally.

When stopped or parked, always apply the parking brake. This is especially important when parking on a slope. On very steep inclines or if the vehicle is carrying cargo, the wheels should be blocked using rocks or bricks. Remember to turn the fuel valve to the closed position.

## **Uphill Driving**

Due to configuration, this vehicle has excellent climbing ability, so much so that tip over is possible before traction is lost. For example, its common to encounter terrain situations where the top of the hill has eroded to a point that the hill peak rises very sharply. The vehicle can readily negotiate such a condition, however, in doing so, when the front of the vehicle is driven to a point that the vehicle's balance changes rearward tip over can occur.

The same situation may apply if an embedded object causes the front of the vehicle to climb more than desired. If such a situation occurs take an alternate route. Be aware of side hilling dangers when doing so.

It is also wise to know the terrain condition on the other side of the hill or bank. All too often there exists a sharp drop-off that is impossible to negotiate or descend.

## Downhill Driving

This vehicle can climb steeper slopes that it can descend safely. Therefore, it is essential to assure that a safe route exists to descend a slope before you climb it.

Decelerating while negotiating a slippery downhill slope could "toboggan" the vehicle. Maintain steady speed and/or accelerate slightly to regain control.

## Side Hilling

Whenever possible, such operation should be avoided. If necessary, do so with extreme caution. Side hilling on steep inclines could result in rollover. In addition, slippery or unfirm surfaces could result in uncontrollable side sliding. Do not attempt to turn the vehicle downhill with the slide. Avoid all objects or depressions that will intensify the raising of one side of the vehicle higher than the other, thus causing rollover.

### **WARNING**

Do not try to stop or save the vehicle from damage.

### **WARNING**

Be careful when loading and transporting liquid reservoirs. They can affect vehicle stability when side hilling by pulling downhill and increasing the risk of a roll over.

## Drop-Offs

This vehicle will "bottom-out" and usually stop if either the front or rear wheels are driven over a drop-off. If the drop is sharp or deep, the vehicle will nose dive and tip over.

### **WARNING**

Avoid negotiating drop-offs. Reverse and select an alternate route.

## Riding on Snow Covered Surfaces

When performing the pre-ride inspection, pay special attention to locations on the vehicle where snow and/or ice accumulations may obstruct visibility of the tail lamp, clog ventilation openings, block the radiator and fan, and interfere with the movement of control levers, switches and brake pedal. Before starting with your ATV check the steering, throttle and brake lever and pedal controls for interference free operation.

Whenever an ATV is ridden on a snow covered drive path the tire grip is generally reduced causing the vehicle to react differently to control inputs from the operator. On low grip surfaces, the steering responses are not as crisp and precise, stopping distances are lengthened and acceleration becomes sluggish. Slow down and do not "gun" the throttle. This will only result in spinning of the tires and possibly in an over steering slide of the vehicle. Avoid hard braking. This will possibly result in a straight line slide of the vehicle. Again, the best advice is to safely reduce speed in anticipation of a maneuver so to give yourself time and distance to regain total vehicle control before it spins out of your control.

As you drive your ATV over a loose snow covered surface, snow dust will be picked up in the wake turbulence of the moving vehicle and transported to contact and accumulate or melt on some exposed components including rotating parts like brake discs. Water, snow or ice may affect the response time of the brake system of your ATV. Even when not required to reduce vehicle speed apply brakes frequently to prevent ice or snow accumulation and to dry brake pads and discs. While doing so in low risk driving situations you will test for grip level and keep yourself alerted to how the vehicle reacts to your control inputs. Always keep brake pedal, footrests, floor boards, brake and throttle levers free of snow and ice. Frequently wipe snow off seat, handgrips, head and tail lamps.

The depth of the snow cover may hide rocks, tree stumps or other objects and if it is wet may totally impede the drivability as the vehicle becomes bogged down or completely loses traction in slushy snow. Look far ahead and always be watchful of any visible clues that might indicate the presence of such obstacles. In doubt steer clear. Avoid driving on any frozen body of water before checking that the ice will safely support the ATV, its riders and its load of cargo. Remember that a given thickness of ice may be sufficient to support a snowmobile but not an ATV of an identical weight because of the smaller load bearing surface of the four tire contact patches as compared to that of a snowmobile track and skis.

Always remember that the vehicle handling and stability is affected when riding with a passenger. So never attempt maneuvers with a passenger that may cause the vehicle to enter into a slide that if halted abruptly will result in the ejection of the passenger and/or a vehicle roll or tipover.

To maximize comfort and avoid frostbite, always wear clothing and ATV protective equipment appropriate for the weather conditions you will be exposed to during your ride.

At the end of each ride it is a good practice to clean the vehicle body and all moving components (brakes, steering components, drivelines, controls, radiator fan etc.) from any snow or ice accumulations. Wet snow will turn to ice during the shut down period and become more difficult to remove at the next pre-ride inspection.

## **Riding Techniques**

Riding your vehicle too fast for the conditions may result in injury. Apply only enough throttle to proceed safely. Statistics show that high speed turns usually result in mishaps and injury. Always remember that this vehicle is heavy! Its pure weight alone may entrap you should it fall and pin you down.

This vehicle is not designed for jumping nor can it, or you, absorb the energy of high impacts such as jumping. Performing "wheelies" can cause the vehicle to flip over onto you. Both practices have a high risk for you and should be avoided at all times.

To maintain proper control it is strongly advised that you keep your hands on the handlebar and within easy reach of all controls. The same holds true for your feet. To minimize the possibility of any leg or foot injury, keep your feet on the footrests at all times. Do not direct your toes outwards nor place your foot out to assist turning as they can be hit or snagged by passing obstacles or may contact the wheels.

Always use proper riding techniques to avoid vehicle overturns on hills and rough terrain and in turns.

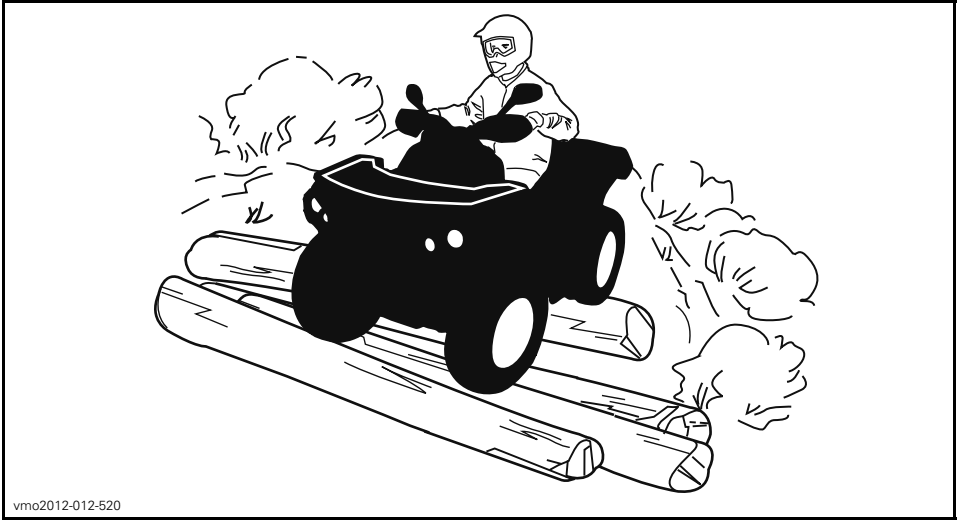

vmo2012-012-520

Even though there is an adequate suspensions system on this vehicle there are "washboard" or rough terrain conditions that will make you feel uncomfortable and even cause back injury. "Posting" or riding in a crouched position will often be required. Slow down and allow your flexed legs to absorb impact.

This vehicle is not designed for riding on roads or highways. In most places it is an illegal practice. Riding your vehicle on roads or highways could cause a collision to occur with another vehicle.

The tires of this vehicle are not suited for paved road use. Also this vehicle is not equipped with a rear differential (rear wheels are always turning at the same speed). For these reasons, pavement may seriously affect the handling and control of the vehicle.

Riding on roads or soft shoulders may confuse other road users, especially if your lights are on.

If you have to cross a road, the lead driver should get off his vehicle, then observe and give directions to the other riders. The last person after crossing then assists the lead driver to cross. Do not travel on sidewalks. They are designated for pedestrian use.

Water can be a unique hazard. If it is too deep the vehicle may "float" and topple. Check the water depth and current before you attempt to cross any water. Water should not go above the footrest. Be wary of slippery surfaces such as rocks, grass, logs, etc., both in the water and on its banks. A loss of traction may occur. Do not attempt to enter the water at high speed. The water will act as a brake and could throw you off the vehicle.

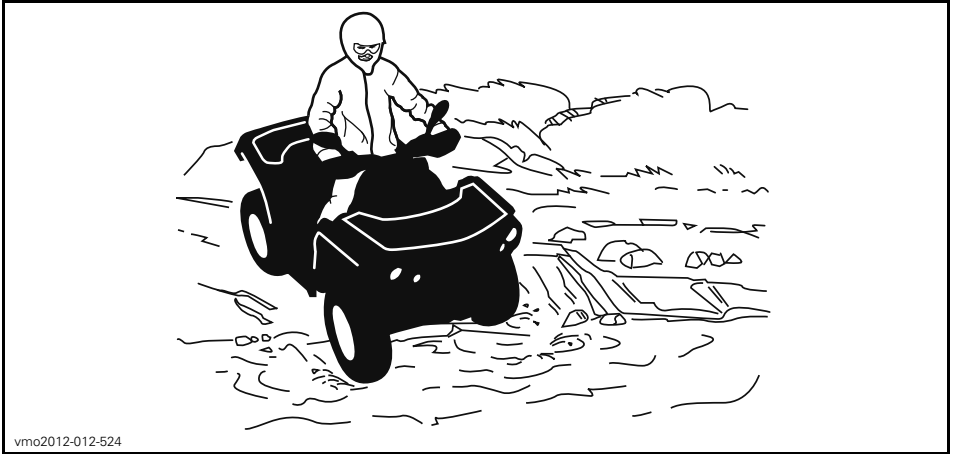

Wet brakes will affect the braking ability of your vehicle. Make sure you dry the brakes by applying them several times after the vehicle leaves the water, mud or snow.

Mud or marsh lands may be encountered near water. Be prepared for sudden "holes" or changes in depth. Similarly so, be watchful of hazards such as rocks, logs, etc., partially covered by vegetation.

If your trip crosses frozen waterways, make sure that the ice is thick enough and sound enough to support the total weight of yourself, the vehicle and its load. Be ever watchful of open water... it is a sure indication that the ice thickness will vary. If in doubt, do not attempt to cross.

Ice will also affect the control of the vehicle. Slow down and do not "gun" the throttle. This will only result in spinning of the tires and possible tip over of the vehicle. Avoid rapid braking. This again will possibly result in an uncontrolled slide and tip over of the vehicle. Slush should be avoided at all times since it could block the operation or controls of the vehicle.

Riding in snow may affect the brakes stopping ability. Safely reduce speed and allow greater distance for braking. Snow projection may cause ice build up or snow accumulation on brake components and controls. Apply brakes frequently to prevent ice or snow accumulation. Carefully inspect the brake system before each ride and always keep brake pedal, footrests, floor boards and brake levers free of snow and ice.

Sand and riding on sand dunes or on snow is another unique experience but there are some basic precautions that should be observed. Wet, deep or fine sand/snow may create a loss of traction and cause the vehicle to slide, drop off or become "bogged" down. If this occurs look for a firmer base. Again, the best advice is to slow down and be watchful of the conditions.

When riding in sand dunes it is advisable to equip the vehicle with an antenna type safety flag. This will help make your location more visible to others over the next sand dune. Proceed carefully should you see another safety flag ahead. Since the antenna type safety flag can snag and rebound on your body if caught, do not use it in areas where there are low hanging branches or obstacles.

Riding on loose stones or gravel is very similar to riding on ice. They will affect the steering of vehicle... possibly causing it to slide and tip over especially at high speeds. In addition, braking distance may be affected. Remember that "gunning" the throttle or sliding may cause loose stones to be ejected rearwards into the path of another rider's way. Never do it deliberately.

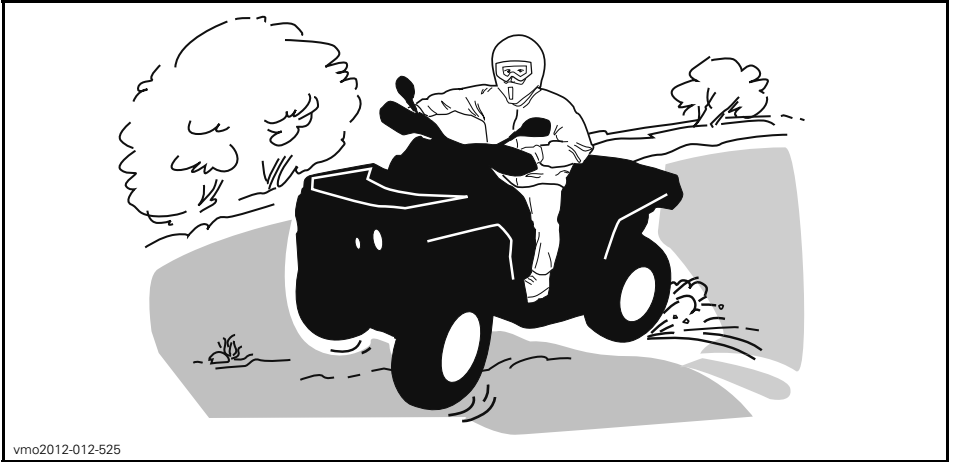

vmo2012-012-525

If you do get into a slide or skid, it may help to turn the handlebar into the direction of the skid until you regain control. Never jam the brakes and lock the wheels.

Respect and follow all posted trail signs. They are there to help you and others.

Obstacles in the "trail" should be traversed with caution. This includes loose rocks, fallen trees, slippery surfaces, fences, posts, and embankments and depressions. You should avoid them whenever possible. Remember that some obstacles are too large or dangerous to cross and should be avoided. Small rocks or fallen trees may be safely crossed... approach at a 90° angle. Stand on the footrests while keeping your knees flexed. Adjust speed without losing momentum and do not "gun" the throttle. Hold handlebar firmly. Place your body weight rearwards and proceed. Do not try to lift the vehicle front wheels off the ground. Be aware that the object may be slippery or may move while crossing.

When driving on hills or slopes two things are highly important... be prepared for slippery surfaces or terrain variations and obstacles and... use proper body positioning.

When stopped or parked always apply the parking device. This is especially important when parking on a slope. On very steep inclines or if the ATV is carrying a cargo, the wheels should be blocked using rocks or bricks.

## Uphill

Before trying to climb a hill, keep these things in mind. Hill Climbing should only be attempted by experienced operators. Start on shallow slopes. Always drive straight uphill and keep your body weight forward towards the top of the hill. Keep your feet on the footrests, shift your ATV into a lower gear and accelerate before you start to climb. Try to keep a steady speed and go easy on the throttle to avoid acceleration. Abrupt slope or terrain variation or rolling one wheel over an obstacle could have a big impact on the stability as it will lift the front of the vehicle increasing the risk of tipping over. Some hills are too steep to safely stop or recover from after an unsuccessful climbing attempt. Try to avoid steep inclines. If you're not careful, you could tip over when going up hills. If the hill is too steep and you cannot proceed or the vehicle begins to roll backwards, apply the brake, being careful not to slide. Dismount then use the "K" turn (while walking back, next to the vehicle on the up hill side and with a hand on the brake lever, slowly back the rear of the vehicle toward the top of the hill then drive downhill). Always walk or dismount on the upside of the slope while keeping clear of the vehicle and its rotating wheels. Do not try to hold on to the vehicle if it begins to topple. Stay clear. Do not ride over the crest of the hill at high speed. Obstacles, including sharp drop-offs, may exist.



vmo2012-012-526



## Downhill

Keep your body weight rearwards. Stay seated. Apply the brake gradually to prevent skidding. Do not "coast" down the slope using solely engine compression or in neutral gear.

Decelerating while negotiating a slippery downhill slope could "toboggan" the vehicle. Maintain steady speed and/or accelerate slightly to regain control. Try to avoid steep inclines. If you're not careful, you could tip over when going down hills.

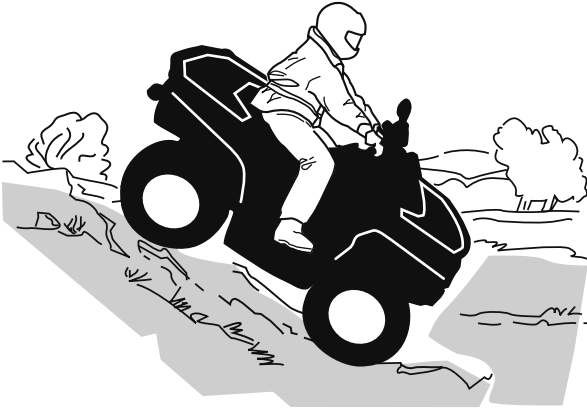

vmo2012-012-523

## Side Hilling

This is one of the **most risky** types of riding since it may drastically change the balance of the vehicle. It should be avoided wherever possible. If it is necessary to do so however, it is important that you **ALWAYS** keep your body weight on the upside of the slope... and be prepared to dismount on that side should the vehicle begin to topple.

### **⚠ WARNING**

Do not try to stop or save the vehicle from damage.

### **⚠ WARNING**

Be careful when loading and transporting liquid reservoirs. They can affect vehicle stability when side hilling by pulling downhill and increasing the risk of a roll over.



vmo2012-012-527

While reading this Operator's Guide, remember that:

### **⚠ WARNING**













Indicates a potential hazard that, if not avoided, could result in serious injury or death.

# IMPORTANT ON-PRODUCT LABELS

## Hang Tag

This vehicle comes with a hang tag and labels containing important safety information.

Any person who rides this vehicle should read and understand this information before riding.

<p><b>S</b> <b>SPORT MODEL</b></p> <p><b>THIS ATV IS FOR RECREATIONAL USE BY EXPERIENCED OPERATORS ONLY.</b></p> <p><b>OPERATOR ONLY-NO PASSENGERS</b></p> <p><b>NO OPERATOR UNDER AGE 16</b></p> <hr/> <p>THIS CATEGORY S (SPORT) ATV IS A HIGH PERFORMANCE ATV FOR OFF ROAD USE ONLY. IT IS FOR SPORT TYPE RECREATIONAL AND COMPETITIVE USE BY OPERATORS WITH ADVANCED SKILLS AND SUBSTANTIAL EXPERIENCE.</p> <hr/> <p>TRAINING COURSES TO TEACH ATV RIDING SKILLS ARE AVAILABLE. FOR INFORMATION CONTACT YOUR DEALER.</p> <hr/> <p>CHECK WITH YOUR DEALER TO FIND OUT ABOUT STATE OR LOCAL LAWS REGARDING ATV OPERATION.</p> <p><b>THIS HANGTAG IS NOT TO BE REMOVED BEFORE SALE.</b></p>	<p><b>! WARNING</b></p> <p>Improper ATV use can result in SEVERE INJURY or DEATH.</p> <table border="0"><tr><td></td><td></td><td></td><td></td></tr><tr><td>ALWAYS USE AN APPROVED HELMET AND PROTECTIVE GEAR.</td><td>NEVER USE ON PUBLIC ROADS.</td><td>NEVER CARRY PASSENGERS.</td><td>NEVER USE UNDER THE INFLUENCE OF DRUGS OR ALCOHOL.</td></tr></table> <p><b>NEVER operate:</b></p> <ul style="list-style-type: none"><li>• without proper training or instructions.</li><li>• at speeds too fast for your skills or the conditions.</li><li>• on public roads - a collision can occur with another vehicle.</li><li>• with a passenger - passengers affect balance and steering and increase risk of losing control.</li></ul> <p><b>ALWAYS:</b></p> <ul style="list-style-type: none"><li>• use proper riding techniques to avoid vehicle overturns on hills and rough terrain and in turns.</li><li>• avoid paved surfaces - pavement may seriously affect handling and control.</li></ul> <p>LOCATE AND READ OPERATOR'S GUIDE. FOLLOW ALL INSTRUCTIONS &amp; WARNINGS.</p>					ALWAYS USE AN APPROVED HELMET AND PROTECTIVE GEAR.	NEVER USE ON PUBLIC ROADS.	NEVER CARRY PASSENGERS.	NEVER USE UNDER THE INFLUENCE OF DRUGS OR ALCOHOL.
									
ALWAYS USE AN APPROVED HELMET AND PROTECTIVE GEAR.	NEVER USE ON PUBLIC ROADS.	NEVER CARRY PASSENGERS.	NEVER USE UNDER THE INFLUENCE OF DRUGS OR ALCOHOL.						

vmo2009-005-003\_en

**VEHICLE ENGINE DESCRIPTION:**

**XXXXX**

**EPA CERTIFIED**

NER (NORMALIZED EMISSION RATE) =

ON A 0 TO 10 SCALE, 0 BEING THE CLEANEST

**\*NOT TO BE REMOVED PRIOR TO SALE**



704901107

vmo2006-005-009\_en

## Vehicle Safety Labels

Read and understand all the safety labels on your vehicle.

These labels are affixed to the vehicle for the safety of the operator or bystanders.

The following labels are on your vehicle and they should be considered permanent parts of the vehicle. If missing or damaged, they can be replaced free of charge. See an authorized Can-Am dealer.

**NOTE:** In the event of any discrepancy between this guide and the vehicle, the safety labels on the vehicle have precedence over the labels in this guide.

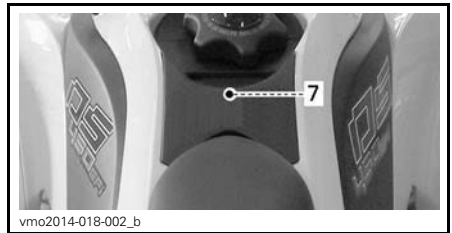
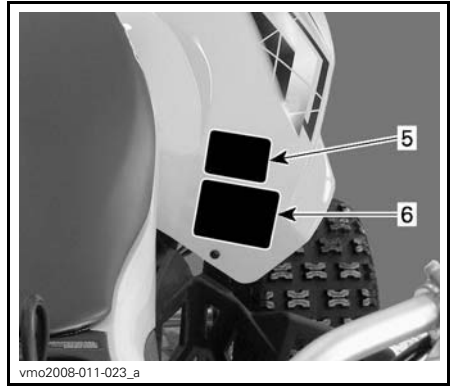
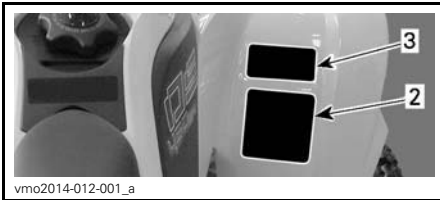
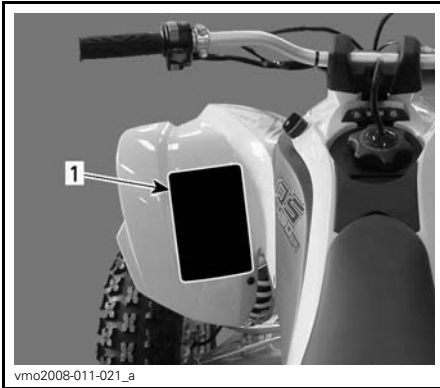

UNDERNEATH ACCESS COVER

**⚠ WARNING**

Improper ATV use can result in SEVERE INJURY or DEATH.

ALWAYS USE AN APPROVED HELMET AND PROTECTIVE GEAR. NEVER USE ON PUBLIC ROADS. NEVER CARRY PASSENGERS. NEVER USE UNDER THE INFLUENCE OF DRUGS OR ALCOHOL.

NEVER operate:

- without proper training or instructions.
- at speeds too fast for your skills or the conditions.
- on public roads - a collision can occur with another vehicle.
- with a passenger - passengers affect balance and steering and increase risk of losing control.

ALWAYS:

- use proper riding techniques to avoid vehicle overturns on hills and rough terrain and in turns.
- avoid paved surfaces - pavement may seriously affect handling and control.

LOCATE AND READ OPERATOR'S GUIDE. FOLLOW ALL INSTRUCTIONS & WARNINGS.

vmo2009-003-004\_en

LABEL 1

**⚠ WARNING**

**UNDER 16**

Operating this ATV if you are under the age of 16 increases your chance of SEVERE INJURY or DEATH. NEVER operate this ATV if you are under age 16.

V01M02Z 704 900 011

LABEL 2

**⚠ WARNING**

This ATV may exceed the performance of other ATVs you may have ridden in the past.

This category S (sport) is a high performance ATV for off road use only. It is for sport type recreational and competitive use by operators with advanced skills and substantial experience.

V02M05Y 704 900 055

LABEL 3

**⚠ WARNING**

NEVER attach here or on the luggage rack to pull a load.

This can cause the vehicle to tip over.

ALWAYS use the trailer hitch or the recovery hook to pull a load.

704902777

704902777A

LABEL 4

**⚠ WARNING**

NEVER ride as a passenger. Passengers can cause a loss of control, resulting in SEVERE INJURY or DEATH.

V01M07Z 704 900 005

LABEL 5

**⚠ WARNING**

Improper tire pressure or overloading can cause loss of control, resulting in SEVERE INJURY or DEATH.

LOAD	COLD TIRE PRESSURE
UP TO 100 kg (220 lb)	FRONT MAX: 48.3 kPa (7 PSI) MIN: 34.5 kPa (5 PSI)
	REAR MAX: 48.3 kPa (9 PSI) MIN: 34.5 kPa (7 PSI)

ALWAYS maintain proper tire pressure as shown.

NEVER set tire pressure below minimum. It could cause the tire to dislodge from the rim.

NEVER exceed the vehicle load capacity of 100 kg (220 lb) including weight of operator and accessories.

704901365

LABEL 6 - DS 450™/DS 450™ X™ XC

<b>⚠ WARNING</b>						
<p>Improper tire pressure or overloading can cause loss of control, resulting in <b>SEVERE INJURY</b> or <b>DEATH</b>.</p> <p>ALWAYS maintain proper tire pressure as shown.</p> <p>NEVER set tire pressure below minimum. It could cause the tire to dislodge from the rim.</p> <p>NEVER exceed the vehicle load capacity of 100 kg (220 lb) including weight of operator and accessories.</p>	<table border="1"> <thead> <tr> <th>LOAD</th> <th>COLD TIRE PRESSURE</th> </tr> </thead> <tbody> <tr> <td rowspan="2"> <p>UP TO 100 kg (220 lb)</p> </td> <td> <p>FRONT MAX: 68.9 kPa (10 PSI) MIN: 55.2 kPa (8 PSI)</p> </td> </tr> <tr> <td> <p>REAR MAX: 62.1 kPa (9 PSI) MIN: 48.3 kPa (7 PSI)</p> </td> </tr> </tbody> </table>	LOAD	COLD TIRE PRESSURE	<p>UP TO 100 kg (220 lb)</p>	<p>FRONT MAX: 68.9 kPa (10 PSI) MIN: 55.2 kPa (8 PSI)</p>	<p>REAR MAX: 62.1 kPa (9 PSI) MIN: 48.3 kPa (7 PSI)</p>
	LOAD	COLD TIRE PRESSURE				
<p>UP TO 100 kg (220 lb)</p>	<p>FRONT MAX: 68.9 kPa (10 PSI) MIN: 55.2 kPa (8 PSI)</p>					
	<p>REAR MAX: 62.1 kPa (9 PSI) MIN: 48.3 kPa (7 PSI)</p>					
<p>704902001</p>						

LABEL 6 - DS 450™ X™ MX

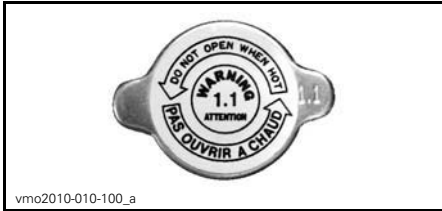

vmo2010-010-100\_a

LABEL 7

## Compliance Labels

	Bombardier Recreational Products Inc. certifies that this ATV complies with the American National Standard for Four Wheel All-Terrain Vehicles, ANSI/SVIA-1-2010 Standard.
	Bombardier Produits Récréatifs inc. certifie que ce VTT est conforme à la norme "American National Standard for Four Wheel All-Terrain Vehicles" ANSI/SVIA-1-2010.



704903327

LOCATED ON RIGHT FRONT FENDER

THIS VEHICLE IS AN ALL TERRAIN VEHICLE AND IS NOT INTENDED FOR USE ON PUBLIC ROADS.
CE VÉHICULE EST UN VÉHICULE TOUT TERRAIN QUI N'EST PAS DESTINÉ À ÊTRE UTILISÉ SUR LES VOIES PUBLIQUES.

704901438

LOCATED ON BOTTOM OF RH FRONT FENDER

ENGINE FAMILY PERMATION FAMILY CERTIFICATION STANDARD (FEL) ENGINE DISPLACEMENT EXHAUST EMISSION CONTROL SYSTEM	FAMILLE DE MOTEUR FAMILLE DE PERMEATION LIMITE DES ÉMISSIONS DE LA FAMILLE CYLINDRÉE SYSTÈME DE CONTRÔLE DES ÉMISSIONS	<b>RENSEIGNEMENTS SUR LE DISPOSITIF ANTIPOLLUTION</b> CE VÉHICULE EST CERTIFIÉ POUR FONCTIONNER À L'ESSENCE SANS PLOMB ET IL EST CONFORME AUX NORMES [ ] DE L'EPA ET DE LA CALIFORNIE AU NIVEAU DES RÉGLEMENTATIONS DE L'ÉCHAPPEMENT ET DE L'ÉVAPORATION POUR LES VTT. <b>EMISSION CONTROL INFORMATION</b> THIS VEHICLE IS CERTIFIED TO OPERATE ON UNLEADED GASOLINE AND CONFORMS TO [ ] U.S. EPA AND CALIFORNIA EMISSION /EVAP REGULATIONS FOR ATV. SEE OPERATOR'S GUIDE FOR MAINTENANCE SCHEDULE VOIR LE PROGRAMME D'ENTRETIEN DANS LE GUIDE DU CONDUCTEUR	 
<b>BOMBARDIER RECREATIONAL PRODUCTS INC.</b>			

704903984

TYPICAL - LOCATED ON LEFT SIDE MEMBER OF FRAME

## Technical Information Label

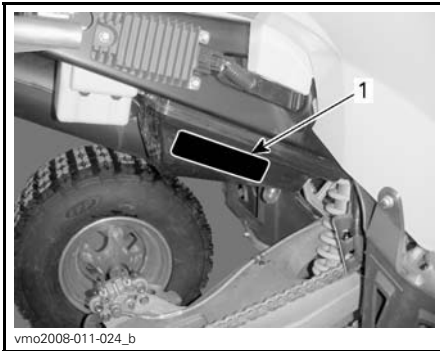

TYPICAL

1. Drive chain label

<b>DRIVE CHAIN</b> DRIVE CHAIN MUST BE WELL ADJUSTED AND LUBRICATED. FREE PLAY IS xx mm (x/x") WITH DRIVER ON VEHICLE. SEE OWNERS MANUAL FOR COMPLETE INSTRUCTIONS.	
--	---

vmo2008-011-088\_en

While reading this Operator's Guide, remember that:

### WARNING

Indicates a potential hazard that, if not avoided, could result in serious injury or death.

***This page is  
intentionally blank***



# ***VEHICLE INFORMATION***

# CONTROLS/INSTRUMENT/EQUIPMENTS

**NOTE:** Some vehicle safety labels are not shown on illustrations. For information on vehicle safety labels, refer to *VEHICLE SAFETY LABELS* subsection.

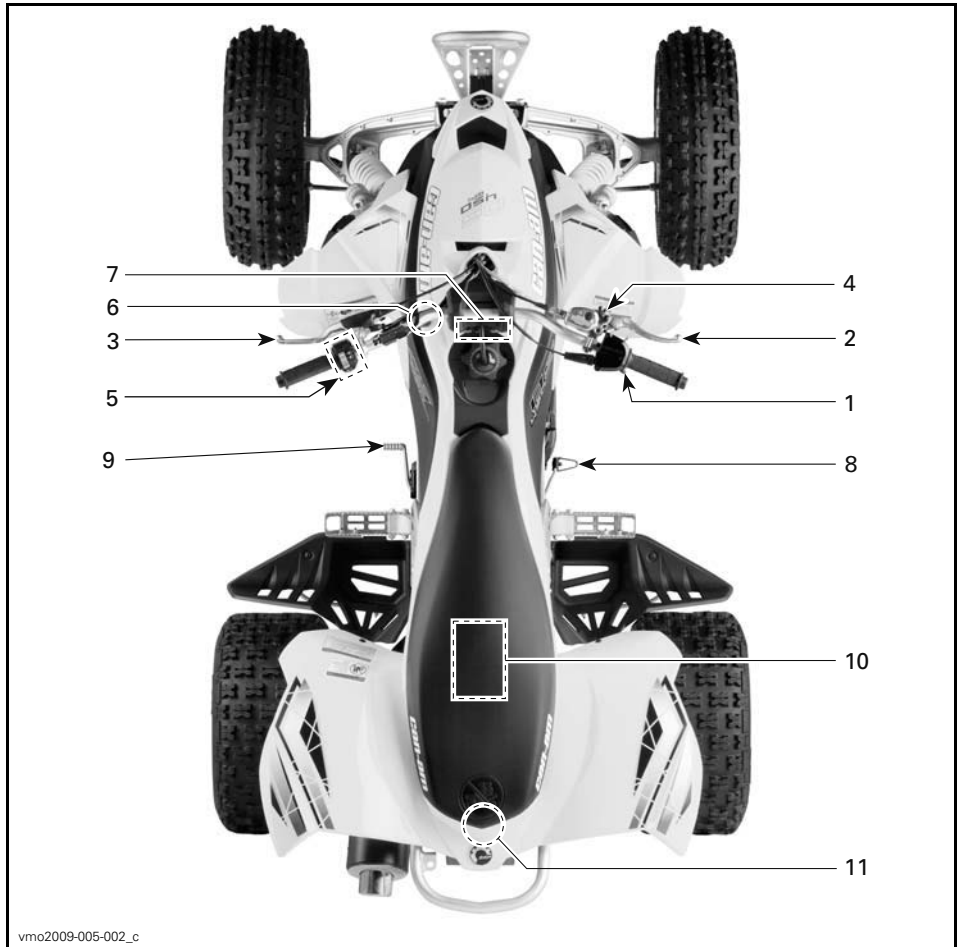

TYPICAL

While reading this Operator's Guide, remember that:

## **⚠ WARNING**

Indicates a potential hazard that, if not avoided, could result in serious injury or death.

## 1) Throttle Lever

The throttle lever is located on the RH side of the handlebar.

When pushed, it increases the engine speed that allows the engagement of the transmission on the selected gear when clutch is engaged.

When released, the engine speed should return automatically to idle and the vehicle will gradually slow down.

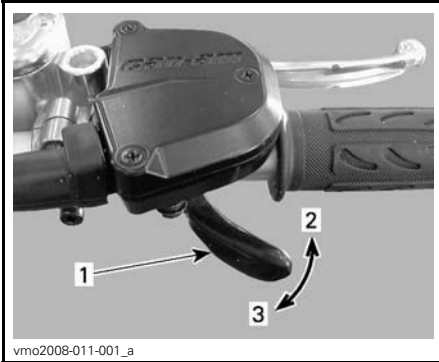

1. Throttle lever
2. To accelerate
3. To decelerate

### **⚠ WARNING**

Always release the throttle when shifting gears. Shifting gears without releasing the throttle, could cause loss of control including the vehicle to overturn and mechanical damages.

## 2) Front Brake Lever

The front brake lever is located on the RH side of the handlebar.

When compressed, the front brakes are applied. When released, it should automatically return to its original position. Braking effect is proportional to the force applied on the lever and to the type and condition of the terrain.

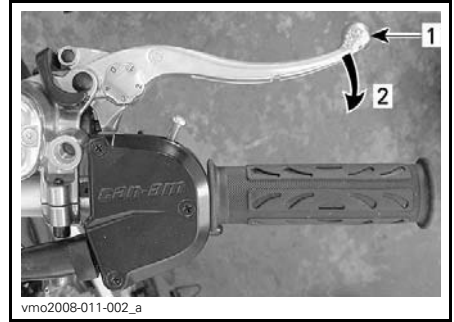

1. Brake lever
2. To apply brake

## Front Brake Lever Adjustment

The brake lever can be adjusted to suit operator preferences. Turn adjustment cam from position 0 to 4, position 0 being the position with the brake lever farther from the handlebar.

Validate brake lever adjustment position when seated on the vehicle by using the lower number on the adjustment cam.

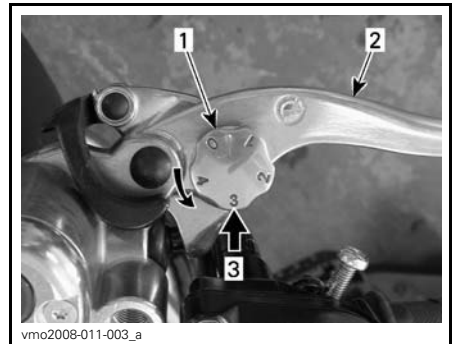

1. Adjustment cam
2. Brake lever
3. Adjustment position, when seated on the vehicle

### 3) Clutch Lever

The clutch lever is located on the LH side of the handlebar.

When compressed, the clutch is disengaged. When released, the clutch is engaged.

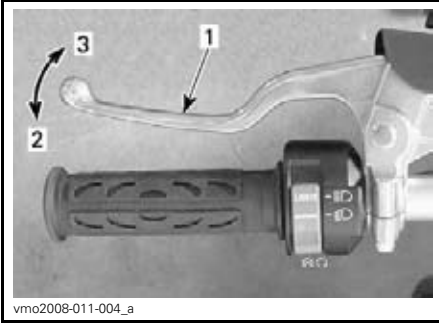

1. Clutch lever
2. To disengage
3. To engage

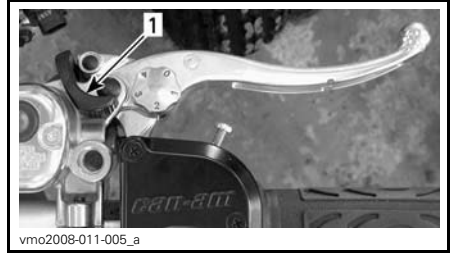

1. Parking brake

#### **⚠ WARNING**

Always use the parking brake when the vehicle is not in operation.

#### **⚠ WARNING**

Make sure parking brake is fully disengaged before operating the vehicle. When you ride the vehicle, brakes that are caused to drag by a continuous pressure on the lever may cause damage to the brake system and cause loss of braking capacity and/or fire.

#### **⚠ WARNING**

Always release the throttle when shifting gears. Shifting gears without releasing the throttle, could cause loss of control including the vehicle to overturn and mechanical damages.

### 4) Parking Brake

The parking brake is located on the RH side of the handlebar.

When applied, it temporarily prevents the vehicle from moving. Useful when the brake needs to be locked for example such as doing a K-turn, during transportation or when the vehicle is not in operation.

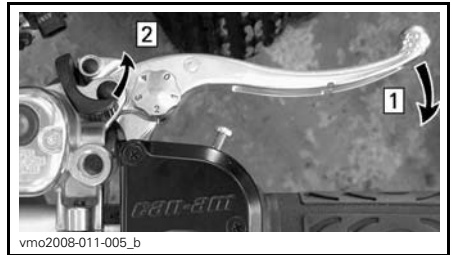

Step 1: Squeeze front brake lever and maintain  
Step 2: Move parking brake lever to desired position

**NOTE:** Parking brake can be adjusted in four (4) different positions.



PARKING BRAKE POSITIONS

**NOTICE** Parking brake position can vary depending on brake pads wear. Ensure when the parking brake is applied that the vehicle stays securely in place.

**To release mechanism:** Squeeze front brake lever. Lever lock should automatically return to its original position. Front brake lever should return to rest position. Always release parking brake before riding.

## 5) Multifunction Switch

The multifunction switch is located on the LH side of the handlebar.

The controls located on this multifunction switch housing are:

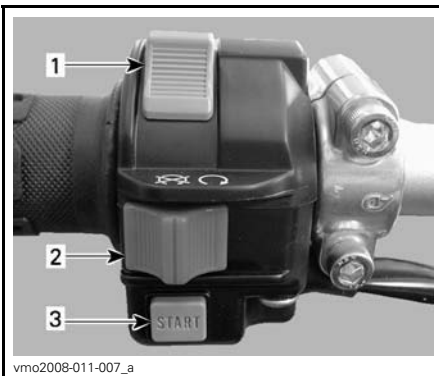

1. Headlights switch
2. Emergency engine stop switch
3. Engine start button

## Headlights Switch

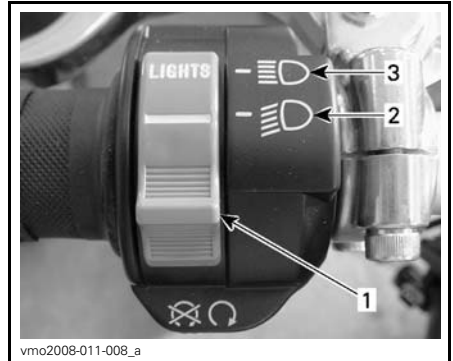

### HEADLIGHTS SWITCH FUNCTIONS

1. Headlights switch
2. Low beam
3. High beam

**NOTE:** Place ignition switch to ON "without headlights" position to turn off the headlights.

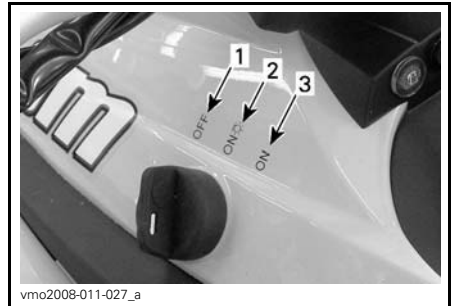

### IGNITION SWITCH POSITIONS

1. OFF
2. ON "with light"
3. ON "without light"

## Emergency Engine Stop Switch

This switch is used to stop the engine and as an emergency control.

To stop engine, fully release throttle lever then use the emergency engine stop switch.

**NOTE:** While engine can be stopped by turning ignition key OFF, we recommend the engine be stopped by the emergency engine stop switch.

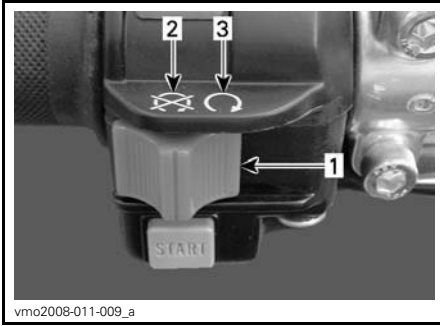

vmo2008-011-009\_a

1. Emergency engine stop switch
2. OFF
3. RUN

### Engine Start Button

The start button is used to start the engine. When the start button is pushed, the starter motor will crank the engine. Refer to *STARTING THE ENGINE* in *OPERATING INSTRUCTIONS* section for proper starting procedure.

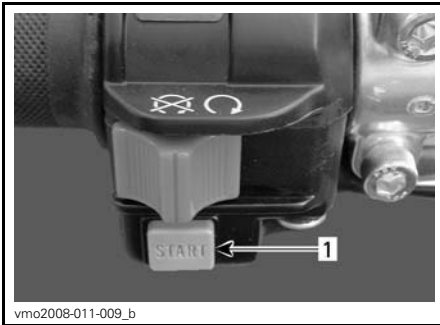

vmo2008-011-009\_b

1. Engine start button

### 6) Ignition Switch

The ignition switch is located on the left side of the vehicle, on top of the body panel.

it is a key-operated 3 position switch.

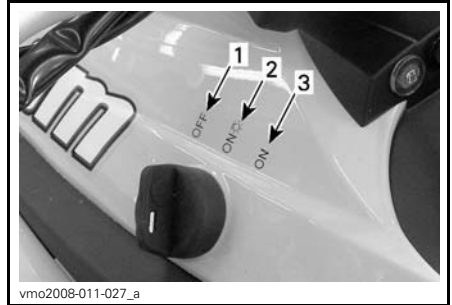

vmo2008-011-027\_a

### IGNITION SWITCH POSITIONS

1. OFF
2. ON "with headlights"
3. ON "without headlights"

Insert key in switch and turn to the desired position. To remove key, turn key to OFF position then pull it out.

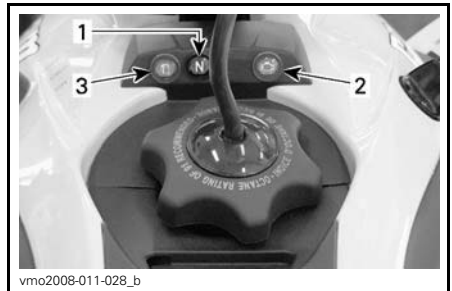

**NOTE:** When selecting either ON with headlights or ON without headlights, the taillight will be on. On both ON positions, the lights will be on with the engine running or not. Always turn the ignition key to OFF position after engine has been stopped.

### 7) Indicator Lamps



vmo2008-011-028\_b

1. Neutral (N) indicator lamp
2. Check engine indicator lamp
3. Low fuel level indicator lamp

	<p>Transmission is in neutral position.</p>
	<p><b>Lamp ON</b> <sup>(1)</sup>: Engine fault, refer to <i>TROUBLESHOOTING</i> section or contact an authorized Can-Am dealer. <b>Lamp blinks</b>: Engine is under a protection mode (limp home), contact an authorized Can-Am dealer.</p>
	<p>Low fuel level. There is approximately 1.5 L (3.2 pt (U.S. liq.)) of fuel left in fuel tank.</p>
<p><sup>(1)</sup> The lamp stays ON when the ignition switch key and emergency engine stop switch are in running position and the engine is not running.</p>	

## 8) Rear Brake Pedal

The rear brake pedal is located on the RH side of the vehicle, in front of the footpeg.

When pressed down, the rear brake is applied. When released, it should return to its original position.

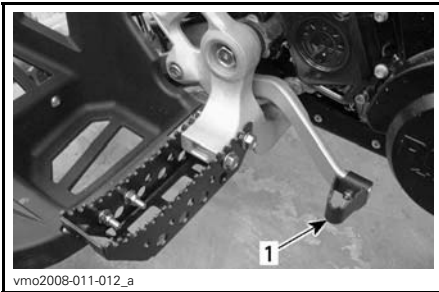

1. Rear brake pedal

**NOTE:** Braking effect is proportional to the force applied on the lever and to the type and condition of the terrain.

## 9) Transmission Lever

The transmission lever is located on the LH side of the vehicle, in front of the footpeg.

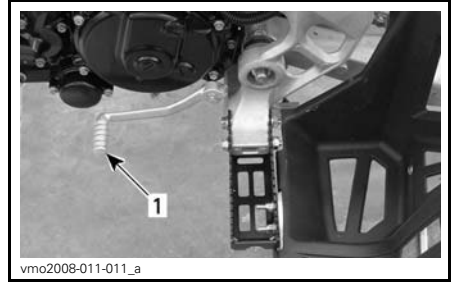

LH SIDE OF VEHICLE

1. Transmission lever

Refer to *SHIFTING THE TRANSMISSION* in *OPERATING INSTRUCTIONS* section for more details.

## 10) Tool Kit

The tool kit is located in the service compartment underneath seat.

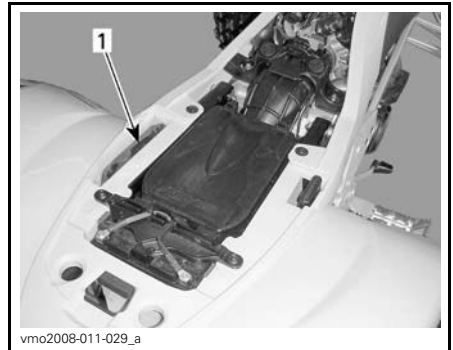

1. Tool kit

The tool kit contains tools for basic maintenance.

## 11) Seat

### Seat Removal

Pull latch rearward while gently lifting rear of seat.



1. Seat latch

Continue lifting movement until you can release seat retaining devices, then completely remove seat.

### Seat Installation

Insert seat front upper slot into coolant tank hook, then make sure seat middle tab is well engaged. When seat rests in its position, firmly push seat down to latch.

**NOTE:** A distinctive snap will be felt. Double check that the seat is secure by giving it a tug to confirm proper latching.

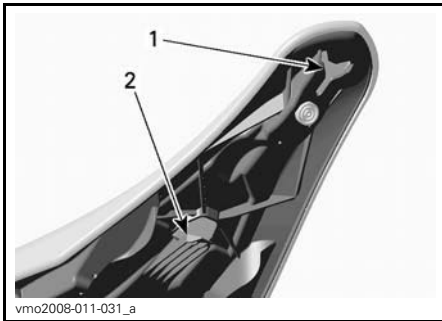

1. Upper slot  
2. Middle tab

## **⚠** WARNING

Make sure seat is securely latched before riding.

### Operator's Guide Location

A convenient location under the seat is provided to stow the *OPERATOR'S GUIDE*. Secure it with the rubber bands.

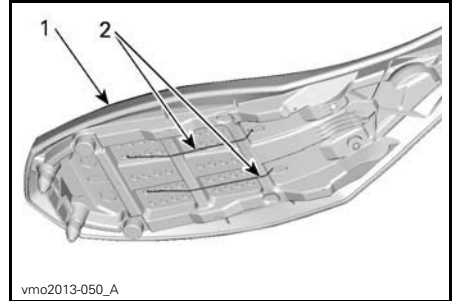

1. Seat  
2. Rubber bands



# FUEL

## Fuel Requirements

**NOTICE** Always use fresh gasoline. Gasoline will oxidize; the result is loss of octane, volatile compounds, and the production of gum and varnish deposits which can damage the fuel system.

Alcohol fuel blending varies by country and region. Your vehicle has been designed to operate using the recommended fuels, however, be aware of the following:

- Use of fuel containing alcohol above the percentage specified by government regulations is not recommended and can result in the following problems in the fuel system components:
  - Starting and operating difficulties.
  - Deterioration of rubber or plastic parts.
  - Corrosion of metal parts.
  - Damage to internal engine parts.
- Inspect frequently for the presence of fuel leaks or other fuel system abnormalities if you suspect the presence of alcohol in gasoline exceeds the current government regulations.
- Alcohol blended fuels attract and hold moisture which may lead to fuel phase separation and can result in engine performance problems or engine damage.

## Recommended Fuel

Use premium unleaded gasoline with an AKI (RON+MON)/2 octane rating of 91, or an RON octane rating of 95.

**NOTICE** Never experiment with other fuels. Engine or fuel system damages may occur with the use of an inadequate fuel.

**NOTICE** Do NOT use fuel from fuel pumps labeled E85.

Use of fuel labeled E15 is prohibited by U.S. EPA Regulations.

## Fueling Procedure

### WARNING

- Always stop engine before refueling. Open cap slowly.
- If a differential pressure condition is noticed (whistling sound heard when loosening fuel tank cap) have vehicle inspected and/or repaired before further operation.
- Fuel is flammable and explosive under certain conditions.
- Never use an open flame to check fuel level.
- Never smoke or allow flame or spark in vicinity.
- Always work in a well-ventilated area.
- Never top up the fuel tank before placing the vehicle in a warm area. As temperature increases, fuel expands and may overflow.
- Always wipe off any fuel spillage from the vehicle.

**NOTICE** Never place anything over fuel tank cap because the vent hole on the top of fuel tank cap can be blocked and the engine could misfire.

1. Stop engine.
2. Do not allow anyone to remain seated on the vehicle while filling.
3. Unscrew fuel tank cap counterclockwise to remove it.
4. Insert the spout into the filler neck.
5. Pour fuel slowly so that air can escape from the tank and prevent fuel flow back. Be careful not to spill fuel.

6. Stop filling when the fuel reaches the bottom of filler neck. **Do not overfill.**
7. Fully tighten fuel tank cap clockwise.
8. Position vent tube in steering column.

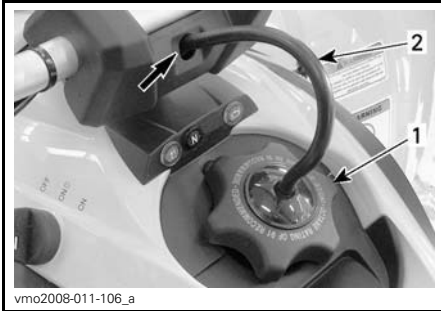

1. Fuel tank cap
2. Vent tube

While reading this Operator's Guide, remember that:

**⚠ WARNING**

Indicates a potential hazard that, if not avoided, could result in serious injury or death.

# OPERATING INSTRUCTIONS

## Operation During Break-In Period

### Engine

A break-in period of 10 operating hours is required before running the vehicle at sustained full throttle.

During this period, maximum throttle should not exceed 1/2 to 3/4 opening. However, brief full acceleration and speed variations contribute to a good break-in. Continued wide open throttle accelerations, prolonged cruising speeds and engine overheating are detrimental during the break-in period.

## Starting the Engine

Insert key in ignition switch and turn to ON position.

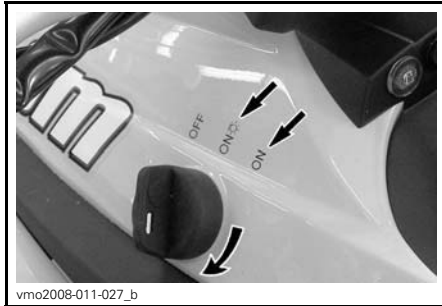

Place the emergency engine stop switch to RUN position.



Shift transmission to NEUTRAL position or press and hold clutch lever.

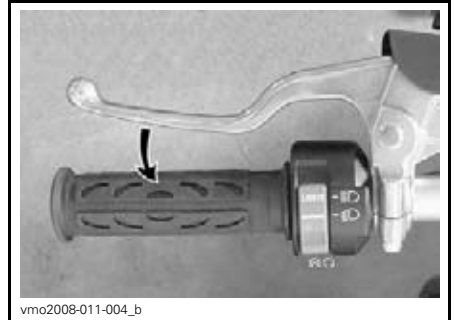
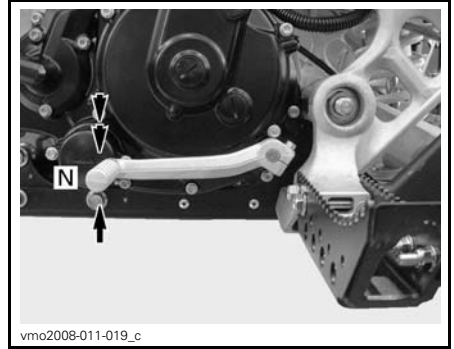

Press and hold engine start button until engine starts.



Release button immediately when engine has started.



**⚠ WARNING**

Do not apply throttle while starting.

## Shifting the Transmission

### Gearshift Control

To shift the transmission, pull in the clutch lever, then operate transmission lever as follows.

**⚠ WARNING**

Always use the clutch lever to up-shift or downshift.

One full stroke of the pedal shifts the transmission to the next higher or lower gear in the shifting sequence. The pedal should automatically return to its original position.

To upshift to a higher gear, put the end of your boot under gearshift lever and lift up the pedal one full stroke. To downshift, lean the tip of the gearshift pedal and depress pedal one full stroke.

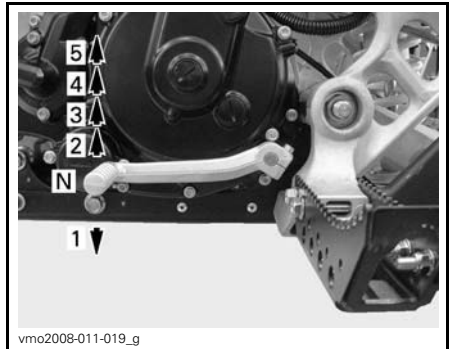

**⚠ WARNING**

Always release the throttle when shifting gears. Shifting gears without releasing the throttle, could cause loss of control or cause the vehicle to overturn.

**NOTICE** Make sure parking brake is fully disengaged before operating vehicle.

## Stopping the Engine

**⚠ WARNING**

Avoid parking vehicle on slope.

Release throttle and completely stop the vehicle.

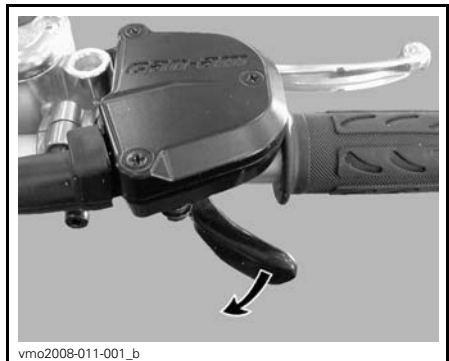

Apply the parking brake.



Depress and hold clutch lever.

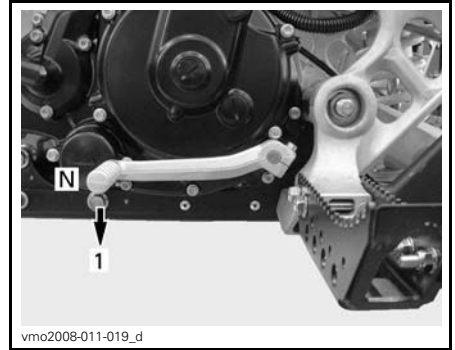

Set the emergency engine stop switch to OFF position.

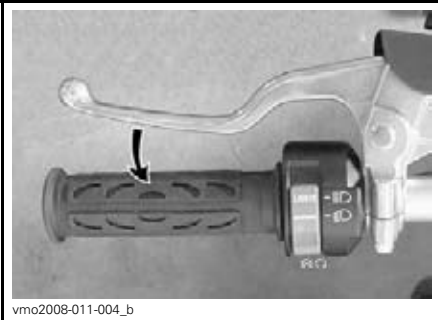

Shift to 1<sup>st</sup> gear.

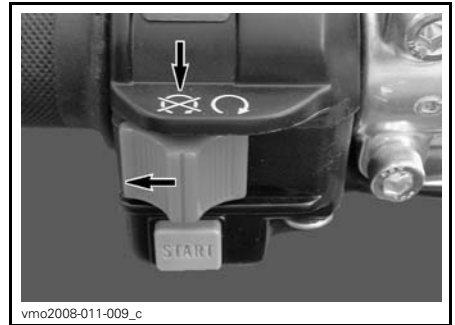

Turn ignition key to OFF position and remove key.

**⚠ WARNING**  
Always use the clutch lever when shifting gears.

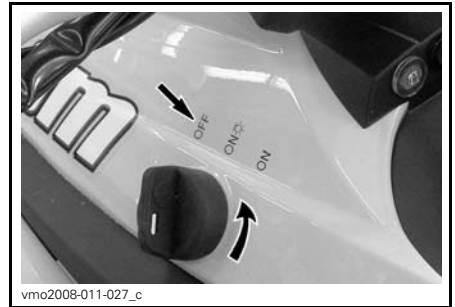

While reading this Operator's Guide, remember that:

**⚠ WARNING**  
Indicates a potential hazard that, if not avoided, could result in serious injury or death.

---

## SPECIAL PROCEDURES

### **What to Do if Vehicle Is Turned Over**

When vehicle is turned over or stays tilted on the side, put the vehicle back on its wheels, then wait 3 to 5 minutes before starting the engine.

Refer to *MAINTENANCE INFORMATION* and inspect the following.

- Inspect air filter housing drain tube for oil accumulation, if any oil is found, clean air filter and air filter housing.
- Check engine oil level and refill if necessary.
- Check engine coolant level and refill if necessary.

### **What to Do if Vehicle Is Immersed in Water**

Should the vehicle become immersed, it will be necessary to take it to an authorized Can-Am dealer as soon as possible. **NEVER START THE ENGINE!**

**NOTICE** Immersion of the vehicle can cause serious damage if the correct restart procedure is not followed.

# TUNE YOUR RIDE

## **⚠ WARNING**

Suspension, steering angle and track width adjustment could affect vehicle handling and are inter-related. Always take time to familiarize yourself with the vehicle's behavior after any suspension, steering angle or track width adjustment have been made.

## Steering Alignment (Toe)

To align handlebar and adjust toe, proceed as follows:

1. Place vehicle on level surface.
2. Position handlebar so that it is in straight ahead position by measuring from the extremities of the handlebar to a rear fixed point.

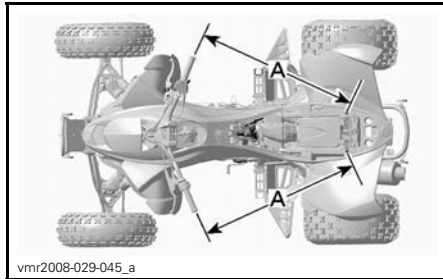

A. Same length

**NOTE:** The reference point must be the same to each side.

3. Tie handlebar to prevent movements during alignment.
4. Measure the distance between front wheels — center to center.

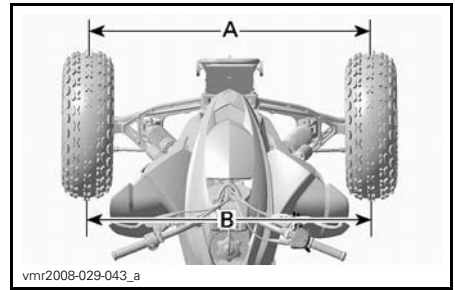

A. Front distance  
B. Rear distance

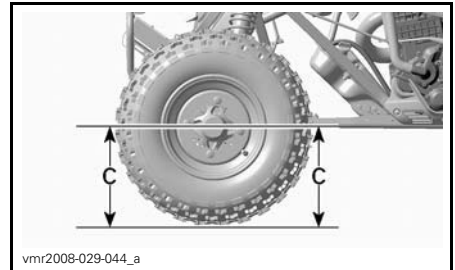

C. Same height

Refer to the following chart for alignment specification.

MODEL	TOTAL TOE-IN (MM)
All Models	0 mm to 6.35 mm (0 in to .25 in)
Toe-in = Rear distance (B) – Front distance (A)	

5. Set alignment of wheel by adjusting tie-rod.

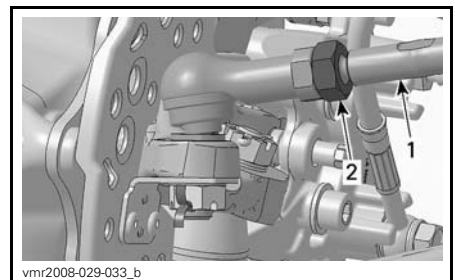

### WHEEL SIDE SHOWN

1. Tie-rod
2. Tie-rod lock nut (one per tie-rod end)

- Recheck the measurement after torquing tie-rod lock nuts.

## Rear Track Width Adjustment (X xc and X mx)

The rear track width, measured outside the wheels, can be adjusted from 117 cm to 127 cm (46 in to 50 in) by moving spacers inside or outside rear wheel hubs.

To adjust, proceed as follows on **both sides**:

- Remove wheel, see procedure in the *MAINTENANCE PROCEDURES* section.
- Remove and discard the cotter pin.
- Unscrew the rear wheel hub nut using a 41 mm socket and a pry bar as shown.

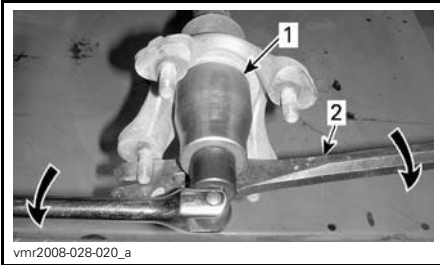

- 41 mm socket
- Pry bar

- Adjust track width by putting the desired amount of spacers between rear axle flange and wheel hub (inner side of wheel hub). Refer to the *TRACK WIDTH SPACER ARRANGEMENT* table below to properly adjust track width.
- Apply CV GREASE (P/N 293 550 019) on drive axle splines.
- Install wheel hub. Align a wheel hub opening with a cotter pin hole.

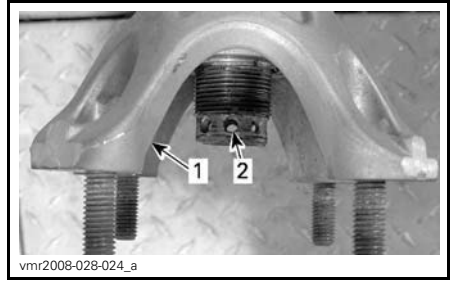

- Wheel hub opening
- Cotter pin hole

- Install the unused spacers on the outer side of hub.

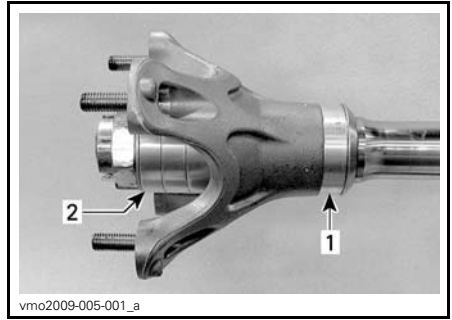

- Spacer on inner side
- Unused spacers on outer side

### **⚠ WARNING**

Always install all 4 spacers on each axle side. The spacers not installed on inner side of wheel hub must be installed on outer side.

- Install flat washer and nut then torque nut to  $260 \text{ N}\cdot\text{m} \pm 15 \text{ N}\cdot\text{m}$  ( $192 \text{ lb}\cdot\text{ft} \pm 11 \text{ lb}\cdot\text{ft}$ ). If necessary, tighten nut further until one of its grooves is aligned with the cotter pin hole and hub opening.

### **⚠ WARNING**

Never unscrew wheel hub nut to align one of its grooves with a cotter pin hole.

- Install a NEW cotter pin.



## Track Width Spacer Arrangement

INNER SIDE OF HUB	OUTER SIDE OF HUB	TOTAL TRACK WIDTH
0	4	117 cm (46 in)
1	3	119.5 cm (47 in)
2	2	122 cm (48 in)
3	1	124.5 cm (49 in)
4	0	127 cm (50 in)

## Caster Adjustment (X xc and X mx)

The caster angle is the angle between the vertical and the steering knuckle pivot axis in a the longitudinal axis.

A higher caster angle improves directional stability but increases steering effort. For best controls in bumpy trails, select a high caster angle.

A lower caster angle gives a quicker steering response but less directional stability. For best maneuverability on trails with low speed tight turns, select a low caster angle.

The caster angle is factory preset at 8°. It is possible to adjust it from 4° to 8° on the X xc model and from 3° to 10° on the X mx model.

The caster angle variation is obtained by moving shims in front or behind the upper suspension arms bearing housings.

### WARNING

Adjust LH and RH caster angles to the same value.

**NOTE:** The caster, camber and steering alignment (toe) are interrelated. Start from the factory settings and customize each adjustment one at a time. Correct the other adjustments if needed.

To adjust, proceed as follows on both sides:

1. Remove wheel, see procedure in the *MAINTENANCE INFORMATION* section.
2. Keeping the vehicle on jack stands, remove the bolts retaining the upper suspension arm to the frame.

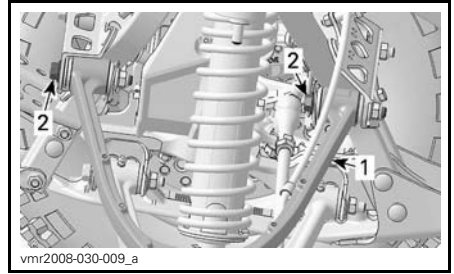

#### TYPICAL

1. Upper suspension arm
2. Upper suspension arm bolts
3. Pull the upper suspension arm just enough to be able to add or remove shims.
4. Adjust the desired amount of shims, from side to side of the upper suspension arm bearing housings, Refer to the following illustration and the *CASTER ADJUSTMENT GUIDE* below. Keep the total amount of shims across each bearing housing.

**NOTE:** Always move the same amount of shims in front or behind both of the upper suspension arm bearing housings. Use the following illustration and table to place shims correctly in all four positions across the suspension arm bearing housings.

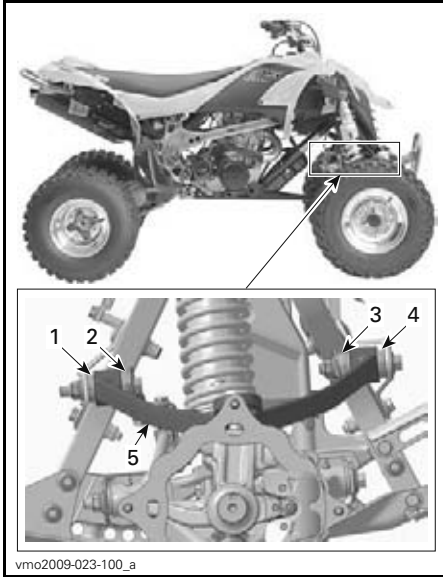

**DS 450 X mx**

CASTER ANGLE	SHIM POSITION			
	1	2	3	4
3°	7	0	7	0
4°	6	1	6	1
5°	5	2	5	2
6°	4	3	4	3
7°	3	4	3	4
8°	2	5	2	5
9°	1	6	1	6
10°	0	7	0	7

**Camber Adjustment (X mx)**

The camber angle is the angle between the vertical and the steering knuckle pivot axis in a the transversal axis.

Adjusting the camber angle changes the front wheels inclination and has an effect on the steering stability an feed-back.

On these models, the camber angle is negative.

The front knuckles camber angle is pre-set at 12° but it is possible to adjust it degree by degree from 11° to 15°.

The camber angle variation is obtained by moving shims from side to side of the upper ball joint mounting sleeve on the suspension arm.

**TYPICAL - SHIM POSITION RH**

1. Position 1
2. Position 2
3. Position 3
4. Position 4
5. Suspension arm

5. Install the suspension arm bolts with NEW elastic nuts and torque to 42 N•m - 54 N•m (31 lbf•ft - 40 lbf•ft).

**Caster Adjustment Guide**

**DS 450 X xc**

CASTER ANGLE	SHIM POSITION			
	1	2	3	4
4°	4	0	6	0
5°	3	1	5	1
6°	2	2	4	2
7°	1	3	3	3
8°	0	4	2	4

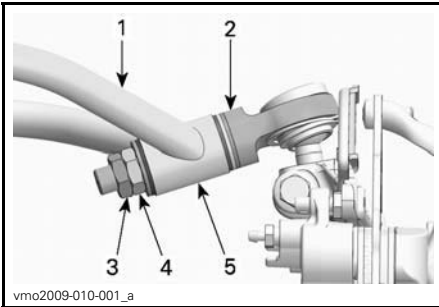

vmo2009-010-001\_a

1. Suspension arm
2. Ball joint assembly
3. Lock nut
4. Retaining nut
5. Mounting sleeve

**NOTE:** The caster, camber and steering alignment (toe) are interrelated. Start from the factory settings and customize each adjustment one at a time. Correct the other adjustments if needed.

To adjust the camber angle, proceed as follows on each side:

1. Support vehicle securely using jack stands.
2. Loosen the lock nut several turns, then loosen the retaining nut.
3. Remove the nuts and the spacer(s).
4. Pull the top of the wheel outwards enough to free the upper ball joint from the suspension arm. Prevent the spacers from falling off.
5. Install the desired amount of spacers on the ball joint threaded rod against the ball joint. Refer to the following illustration and the *CAMBER ADJUSTMENT GUIDE* below.
6. Install the ball joint through the suspension arm sleeve.
7. Install the remaining shims in the ball joint threaded rod against the sleeve.

**NOTICE** Never install the ball joint retaining nut directly on the suspension arm sleeve. Always install at least one spacer between the nut and the sleeve.

8. Install the retaining nut and torque to specification.

<b>TIGHTENING TORQUE</b>
--------------------------

48 N•m ± 6 N•m (35 lbf•ft ± 4 lbf•ft)
---------------------------------------

9. Install the lock nut and torque to specification.

<b>TIGHTENING TORQUE</b>
--------------------------

48 N•m ± 6 N•m (35 lbf•ft ± 4 lbf•ft)
---------------------------------------

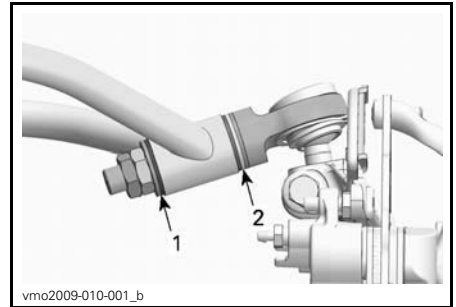

vmo2009-010-001\_b

**SHIM POSITION**

1. Position 1
2. Position 2

**NOTE:** The angle set up refers to the steering knuckles pivot axis.

**Camber Adjustment Guide**

**NOTE:** For both LH and RH, position 1 refers to the nuts side and position 2 refers to the ball joint side.

CAMBER ANGLE	SHIM POSITION	
	1	2
11°	1	4
12°	2	3
13°	3	2
14°	4	1
15°	5	0

## Suspension Adjustments Guideline

Your vehicle handling and comfort depend upon suspension adjustments.

Choice of suspension adjustments vary with driver's weight, personal preference, riding speed and field condition.

Starting from the factory settings, customize each adjustment one at a time.

Test run the vehicle under the same conditions; trail, speed, driver riding position, etc. Change one adjustment and retest. Proceed methodically until you are satisfied. Basic adjustments are covered in this guide. Owner's manuals (English only) from FOX are available at [www.foxracingshox.com](http://www.foxracingshox.com) with detailed information on shock absorber operation and tuning.

### **⚠ WARNING**

Always adjust LH and RH sides at the same setting. Uneven suspension adjustment can cause poor handling and loss of stability, and/or control, and increase the risk of an accident.

## Front Suspension (DS 450/DS450 X xc)

### Spring Preload

Shorten the spring for a firmer ride and rough trail condition.

Lengthen the spring for a softer ride and smooth trail condition.



### TYPICAL - PRELOAD ADJUSTMENT

- Step 1: Loosen top locking ring
- Step 2: Turn adjusting ring accordingly
- Step 3: Tighten top locking ring

Lift the front of the vehicle. Spring length should be measured without load on the wheels.

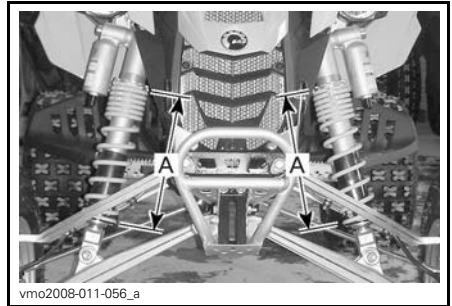

### TYPICAL - PRELOAD ADJUSTMENT

- A. Same length

## Compression Damping Adjustments

### Low Speed Compression Damping

Use a flat screwdriver to adjust it.



1. Low speed compression adjuster (flat screwdriver)

Turning it clockwise (H) **increases** shock damping action (stiffer).

Turning it counterclockwise (S) **decreases** shock damping action (softer).

### High Speed Compression Damping

Use a 17 mm wrench to adjust it.



#### TYPICAL — X xc

1. High speed compression adjuster (17 mm wrench)

Turning it clockwise (H) **increases** shock damping action (stiffer).

Turning it counterclockwise (S) **decreases** shock damping action (softer).

### Rebound Damping

Use a flat screwdriver to adjust it.

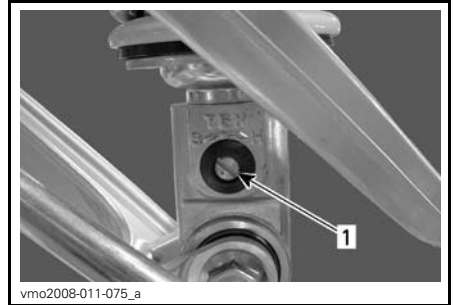

1. Rebound adjuster (flat screwdriver)

Turning it clockwise (H) **increases** shock damping action (stiffer).

Turning it counterclockwise (S) **decreases** shock damping action (softer).

## Front Suspension (DS 450 X mx)

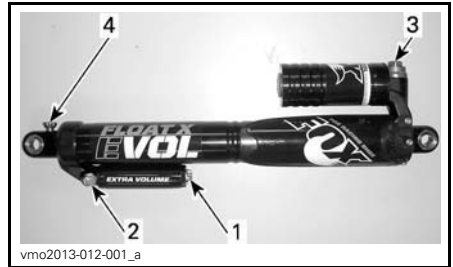

### SHOCK ABSORBER ADJUSTMENTS

1. EVOL air chamber valve
2. Main air chamber valve
3. Dual speed compression damping adjuster
4. Rebound damping adjuster

EVOL air pressures must be adjusted with the shock absorbers at full extension, placed on a stand. This is critical to ensure consistent measurement and performance.

### Spring Force

#### EVOL Air Chamber Pressure

EVOL air chamber regulates spring rate in the final portion of the stroke and controls the bottom-out characteristics of the shock absorber.

Install FOX air pump to the EVOL air chamber valve as follows.

1. Remove cap from EVOL air chamber valve.



1. EVOL air chamber cap

2. Thread the pump chuck valve until pressure registers on pump.

**NOTE:** Approximately 6 turns are required.

**NOTICE** Do not overtighten.

**NOTE:** Air from EVOL air chamber will fill the pump hose. Therefore, the pressure reading may be as much as 69 kPa to 138 kPa (10 PSI to 20 PSI) lower than previously set.

3. Set EVOL air chamber pressure using the HIGH pressure gauge.

**NOTICE** Do not exceed 2 070 kPa (300 PSI). Internal shock absorber damage could occur.

4. Reinstall cap on EVOL air chamber valve.

### Main Air Chamber Pressure

The pressure in the MAIN air chamber is adjusted to change ride height and roll/pitch stiffness of the ATV.

## **⚠ WARNING**

Set the EVOL air chamber pressure before setting the MAIN air chamber pressure. This allows proper location of the floating piston in the EVOL air chamber. Otherwise, poor shock performance and a potentially unsafe vehicle behavior may occur.

Install FOX air pump to the MAIN air chamber valve as follows.

1. Remove cap from MAIN air chamber valve.



1. MAIN air chamber cap

2. Set MAIN air chamber pressure using the LOW pressure gauge.

**NOTICE** Do not exceed 690 kPa (100 PSI). Internal shock absorber damage could occur.

3. Reinstall cap on MAIN air chamber valve.

## Compression Damping Adjustments

### NOTES

- The change in damping from one click to the next is fairly small. Therefore, a one click change is hard to notice. It is recommended making a change 2 clicks at a time then to test it. If it then feels right, that's it. Otherwise, go back 1 click and retest or go 2 clicks farther.
- To know the current setting, turn adjuster clockwise while counting the number of clicks until it bottoms. Do not overtighten. Then, click back to the setting.

## Low Speed Compression Damping

The LSC (low speed compression) adjuster affects the slow suspension movements.

Use a flat screwdriver to adjust.

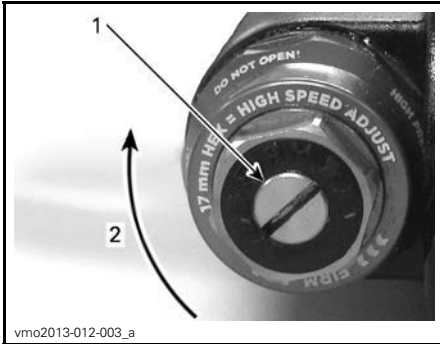

1. Low speed compression damping adjuster
2. Firmer

For more compression damping (firmer): Turn adjuster clockwise.

For less compression damping (softer): Turn adjuster counterclockwise.

## High Speed Compression Damping

The HSC (high speed compression) adjuster mainly affects the compression damping during medium to fast suspension movements.

Use a 17 mm wrench to adjust.

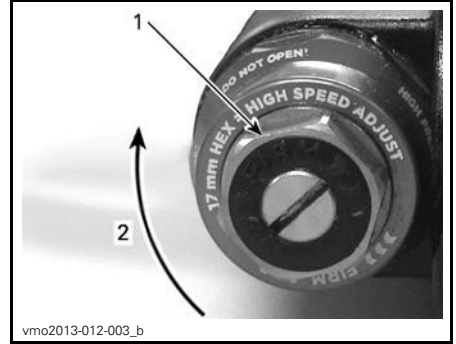

1. High speed compression damping adjuster
2. Firmer

For more compression (firmer): Turn adjuster clockwise.

For less compression (softer): Turn adjuster counterclockwise.

## Rebound Damping

Rebound damping controls the rate at which the shock absorber returns after it has been compressed.

**NOTE:** Too much rebound damping prevents the suspension from extending quickly enough before hitting the next bump. After 5-6 bumps, only minimal stroke is available.

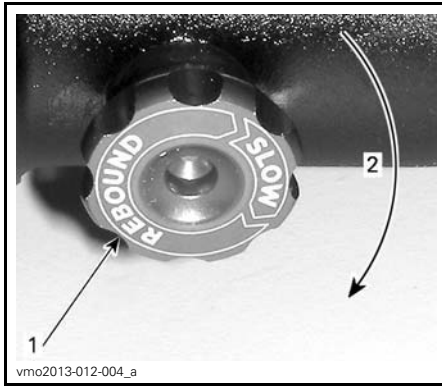

1. Adjuster
2. Slower rebound

For slower rebound (firmer): Turn adjuster clockwise.

For faster rebound (softer): Turn adjuster counterclockwise.

## Rear Suspension (DS 450/DS450 X xc)

### Spring Preload

Adjust as follows.

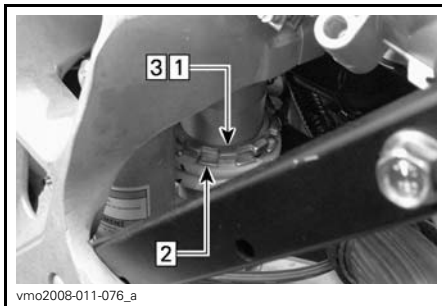

#### PRELOAD ADJUSTMENT

- Step 1: Loosen top locking ring
- Step 2: Turn adjusting ring accordingly
- Step 3: Tighten top locking ring

Lift the rear of the vehicle. Spring length should be measured without load on the wheels.

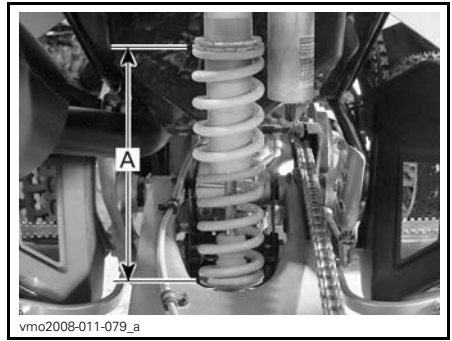

TYPICAL  
A. Spring length

### Compression Damping Adjustments

#### Low Speed Compression Damping

Use a flat screwdriver to adjust it.



TYPICAL - DS 450/DS 450 X xc  
1. Low speed compression adjuster (flat screwdriver)

Turning it clockwise (H) increases shock damping action (stiffer).

Turning it counterclockwise (S) decreases shock damping action (softer).

#### High Speed Compression Damping

The adjuster is located at rear beneath the RH fender.

Use a 17 mm wrench to adjust it.



**NOTE:** On the X xc model, the adjuster is located on the RH side near the rear brake fluid reservoir. On the X mx model, the adjuster is located at rear beneath the RH fender.



vmo2013-012-020\_b

#### TYPICAL

1. High speed compression adjuster (17 mm wrench)

Turning it clockwise (H) **increases** shock damping action (stiffer).

Turning it counterclockwise (S) **decreases** shock damping action (softer).

#### Rebound Damping

Use a flat screwdriver to adjust it.



vmo2008-011-077\_a

1. Rebound adjuster (flat screwdriver)

Turning it clockwise (H) **increases** shock damping action (stiffer).

Turning it counterclockwise (S) **decreases** shock damping action (softer).

## Rear Suspension (DS 450 X mx)

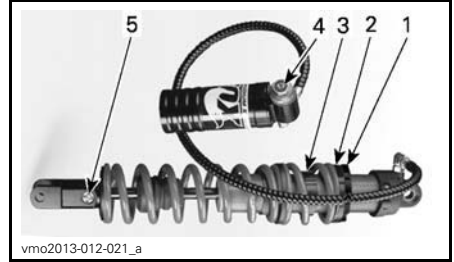

vmo2013-012-021\_a

#### SHOCK ABSORBER ADJUSTMENTS

1. Preload adjuster lock ring
2. Preload adjuster ring
3. Crossover adjuster ring
4. Dual speed compression damping adjuster
5. Rebound damping adjuster

#### Spring Preload

Adjust preload as follows.

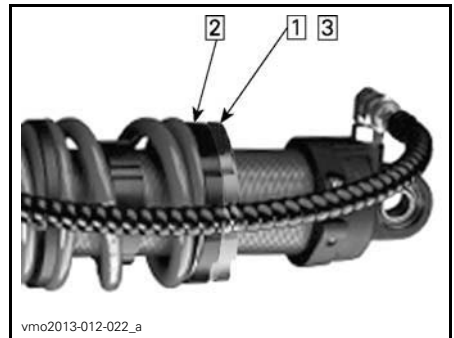

vmo2013-012-022\_a

#### PRELOAD ADJUSTMENT

- Step 1: Loosen lock ring
- Step 2: Turn adjuster ring as required
- Step 3: Tighten lock ring

Lift the rear of the vehicle and safely support vehicle. Spring length should be measured without load on the wheels.

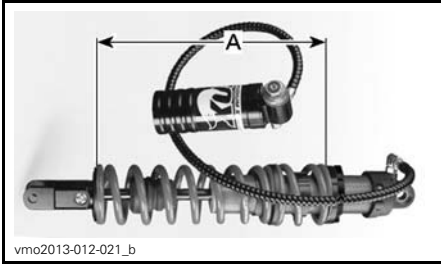

A. Spring length

To increase spring preload (firmer):  
Turn adjuster clockwise (as seen from top).

To decrease spring preload (softer):  
Turn adjuster counterclockwise (as seen from top).

**NOTICE** Do not add more than 13mm (.5in) of preload to the spring. Excessive preload may result in coil-bind, which could potentially be damaging to the shock absorber and spring(s). If more preload is required to reach the desired sag point, replace the spring(s) with a higher spring rate. Contact an authorized BRP ATV dealer.

When finished, set the spring crossover ring position.

### Spring Crossover Ring Position

**NOTE:** Set spring preload before spring crossover ring position.

Set spring crossover ring position when changing:

- Spring preload
- Spring free-length
- Spring rate.

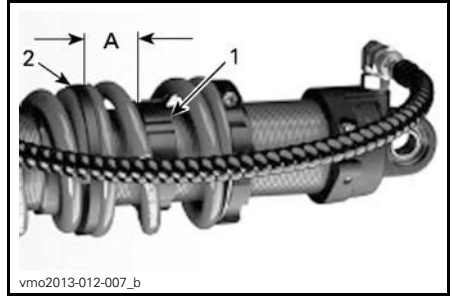

### CROSSOVER RING POSITION

1. Crossover ring
  2. Interspring spacer
- A. 6 mm (.24 in)  
between interspring spacer and crossover ring at ride height with rider seated on ATV

To adjust the crossover ring position:

1. Have ride height set.
2. Have rider seated on ATV.
3. Loosen set screw of crossover ring.
4. Turn ring to set distance.
5. Tighten set screw of crossover ring.

**NOTICE** Do not overtighten the crossover ring set screw.

### Compression Damping Adjustments

#### Low Speed Compression Damping

The LSC (low speed compression) adjuster affects the slow suspension movements.

Use a flat screwdriver to adjust.

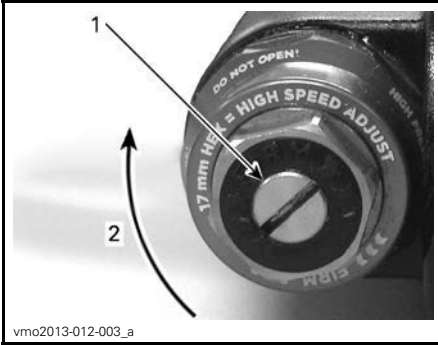

1. Low speed compression damping adjuster
2. Firmer

For more compression (firmer): Turn adjuster clockwise.

For less compression (softer): Turn adjuster counterclockwise.

### High Speed Compression Damping

The HSC (high speed compression) adjuster mainly affects the compression damping during medium to fast suspension movements.

Use a 17 mm wrench to adjust.

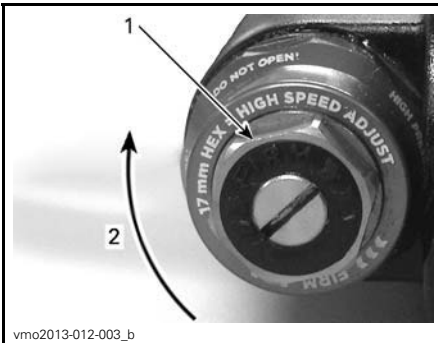

1. High speed compression damping adjuster
2. Firmer

For more compression (firmer): Turn adjuster clockwise.

For less compression (softer): Turn adjuster counterclockwise.

### Rebound Damping

Rebound damping controls the rate at which the shock absorber returns after it has been compressed

**NOTE:** Too much rebound damping prevents the suspension from extending quickly enough before hitting the next bump.

Use a flat screwdriver to adjust.

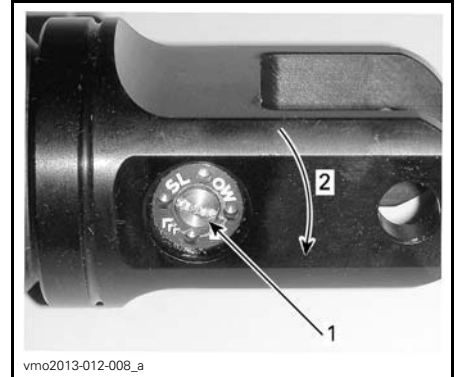

1. Rebound adjuster (flat screwdriver)
2. Slower rebound

For slower rebound (firmer): Turn adjuster clockwise.

For faster rebound (softer): Turn adjuster counterclockwise.

### Suspension Factory Settings

To adjust compression and rebound damping to factory settings, proceed as follows:

1. Turn adjuster clockwise until it stops.
2. Turn adjuster counter clockwise by the specified amount, see table below.

FRONT SUSPENSION FACTORY SETTINGS (DS 450/DS 450 X xc)		
Spring preload	DS 450	282 mm (11.1 in)
	DS 450 X xc	269 mm (10.6 in)
Compression damping (low speed)	DS 450	9 clicks
	DS 450 X xc	10 clicks
Compression damping (high speed)	DS 450 X xc	1/2 of a turn
Rebound damping	DS 450	9 clicks
	DS 450 X xc	12 clicks

FRONT SUSPENSION FACTORY SETTINGS (DS 450 X mx)		
Spring force	EVOL air chamber pressure	1 380 kPa (200 PSI)
	Main air chamber pressure	275 kPa (40 PSI)
Compression damping (low speed)		12 clicks (center)
Compression damping (high speed)		12 clicks (center)
Rebound damping		12 clicks (center)

REAR SUSPENSION FACTORY SETTINGS		
Spring preload	DS 450	262 mm (10.3 in)
	DS 450 X xc	262 mm (10.3 in)
	DS 450 X mx	275 mm (10.8 in)

REAR SUSPENSION FACTORY SETTINGS		
Crossover ring position	DS 450 X mx	6 mm (.24 in) between interspring spacer and crossover ring at ride height with rider seated on ATV
Compression damping (low speed)	DS 450	9 clicks
	DS 450 X xc	7 clicks
	DS 450 X mx	12 clicks (center)
Compression damping (high speed)	DS 450 X xc	1/2 of a turn
	DS 450 X mx	12 clicks (center)
Rebound damping	DS 450	9 clicks
	DS 450 X xc	6 clicks
	DS 450 X mx	12 clicks (center)

# VEHICLE TRANSPORTATION

When transporting this vehicle, secure it to trailer or pickup box with suitable tie-downs. Using ordinary ropes is not recommended.

**⚠ WARNING**

Do not tow this vehicle behind a car or other vehicle. Use a trailer or pickup. Never tip this vehicle on end for transporting. The vehicle must be in its normal operating position (on all 4 wheels).

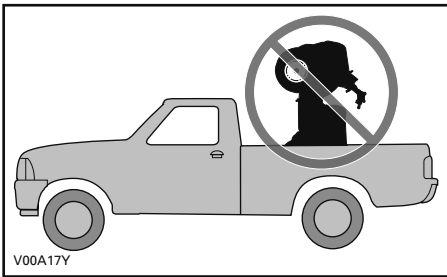

Remember to:

- Apply the parking brake and place the transmission in 1<sup>st</sup> gear.
- Secure the vehicle, using the appropriate areas. See the following illustration.

**NOTICE** Attaching vehicle at other locations may damage the vehicle.

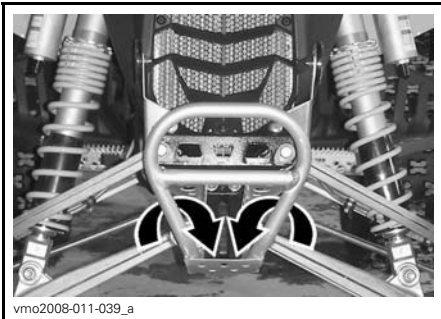

TYPICAL - DS 450 (FRONT LOCATION)

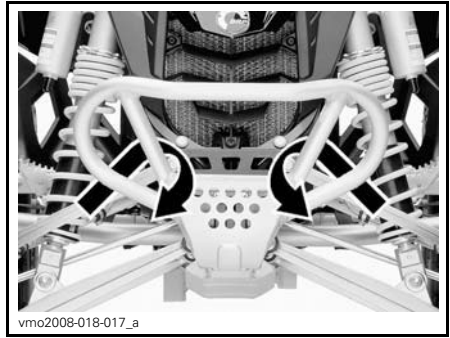

TYPICAL - DS 450 X xc/X mx (FRONT LOCATION)

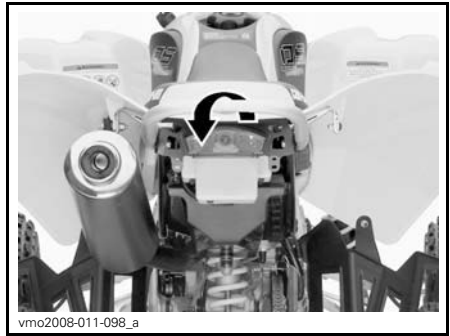

REAR LOCATION

**NOTICE** Attaching vehicle at other locations may damage the vehicle.

***This page is  
intentionally blank***

# ***MAINTENANCE INFORMATION***

---

## 5-HOUR AND 10-HOUR INITIAL SERVICES

### 5-Hour Engine Oil and Filter Replacement

The Can-Am DS 450 series is the most advanced sport ATV and it has been designed using the latest technology all the way down to its synthetic multi-layer oil filter and break-in oil. To maintain your DS 450 ATV at the highest level of performance, change the engine break-in oil and filter after using **3 fuel tanks or 5 hours of riding (whichever comes first)**. Contact an authorized Can-Am dealer for more details.

### Initial Inspection

We suggest that after the first 10 hours or 400 km (250 mi) of operation, whichever comes first, your vehicle be inspected by an authorized Can-Am dealer. This inspection is very important and must not be neglected.

Refer to the *MAINTENANCE SCHEDULE* for the details of the initial inspection.

**NOTE:** The initial inspection is at the expense of the vehicle owner.

We recommend that this inspection be signed by an authorized Can-Am dealer.

---

Date of initial inspection

---

Authorized dealer signature

---

Dealer name



# MAINTENANCE SCHEDULE

Maintenance is very important for keeping your vehicle in safe operating condition. Proper maintenance is the owner's responsibility. Perform periodic checks and follow the maintenance schedule.

The maintenance schedule does not exempt the pre-ride inspection.

## WARNING

Failure to properly maintain the vehicle according to the maintenance schedule and procedures can make it unsafe to operate.

MAINTENANCE SCHEDULE						
A: Adjust C: Clean I: Inspect L: Lubricate R: Replace	Initial inspection 10 h or 400 km					
	25 h or 1250 km					
	50 h or 2500 km					
	100 h or 1 year or 5000 km					
	200 h or 2 years or 10000 km					
	To be performed by					
PART/TASK						LEGEND
<b>ENGINE</b>						
Oil and filter <sup>(1)</sup>		R				Customer
Oil reservoir strainer				C		Customer
Engine valves	I, A			I, A		Dealer
Engine mounting fasteners	I			I		Dealer
Air filter		I, C, L (2)	R (2)			Customer
Exhaust system	I			I		Dealer
Muffler spark arrester				C		Customer
Engine coolant	I		I (3)		R	Customer
Radiator cap/cooling system pressure test	I				I	Dealer
Clutch	(4)					Dealer/ Customer
<b>ENGINE MANAGEMENT SYSTEM</b>						
EMS sensors	I			I		Dealer
EMS fault codes	I			I		Dealer

(1) FIRST engine oil/filter replacement must be performed after 3 fuel tanks OR 5 hours of riding (whichever comes first).  
 (2) More often under dusty conditions. Refer to *AIR FILTER* in *MAINTENANCE PROCEDURES*.  
 (3) Every 50 hours, check coolant strength.  
 (4) Inspect adjustment at every ride.

MAINTENANCE SCHEDULE						
A: Adjust C: Clean I: Inspect L: Lubricate R: Replace	Initial inspection 10 h or 400 km					
	25 h or 1250 km					
	50 h or 2500 km					
	100 h or 1 year or 5000 km					
	200 h or 2 years or 10000 km					
To be performed by						
PART/TASK						LEGEND
<b>FUEL SYSTEM</b>						
Throttle body	I			I, L		Dealer
Throttle cable	I, A		I, A, L			Dealer/ Customer
Fuel lines, fuel rails, connections, check valves and fuel tank pressure test	I				I	Dealer
Fuel pump pressure					I	Dealer
<b>ELECTRICAL SYSTEM</b>						
Spark plugs <sup>(5)</sup>	I	I		R		Customer
Battery connections	I			I		Customer
ECM connectors (visual inspection without disconnecting)				I		Dealer
Electrical connections and fastening (ignition system, starting system, fuel injectors etc.)	I			I		Dealer
Emergency engine stop switch	I			I		Customer
Lighting system (headlights and taillight)	I			I		Customer
<b>DRIVE SYSTEM</b>						
Drive chain and slider	<sup>(6)</sup>					Customer
Drive chain sprockets <sup>(7)</sup>	I		I	R		Customer
Drive chain tensioner <sup>(8)</sup>	I	I				Customer
Rear axle bearings	I		I			Customer
Rear axle and rear axle nut <sup>(8)</sup>	I	I				Customer
						(5) Apply HEAT-SINK PASTE P12 (P/N 420 897 186) on spark plugs threads before installation.  (6) Inspect, adjust and lubricate at every ride. (7) More often under severe use such as dusty area, sand, snow, wet or muddy conditions. (8) Check tightness.

MAINTENANCE SCHEDULE						
A: Adjust C: Clean I: Inspect L: Lubricate R: Replace	Initial inspection 10 h or 400 km					
	25 h or 1250 km					
	50 h or 2500 km					
	100 h or 1 year or 5000 km					
	200 h or 2 years or 10000 km					
To be performed by						
PART/TASK						LEGEND
<b>WHEELS/TIRES</b>						
Wheel nuts/studs	I		I			Customer
Front wheel bearings	I		I			Customer
Rear wheel hub				L		Dealer
<b>STEERING SYSTEM</b>						
Handlebar fasteners	I			I		Dealer
Steering column and bearing <sup>(7)</sup>	I			I		Dealer
Tie rod ends	I		I			Customer
Front wheel alignment	I, A			I, A		Dealer
<b>REAR SUSPENSION</b>						
Swing arm	I	I	L			Dealer
Suspension linkage	I, L	I, L				Dealer/ Customer
Shock absorber			I			Customer
Shock absorber lower pivot			L			Dealer
<b>FRONT SUSPENSION</b>						
Suspension arms	I	I, L				Customer
Ball joint boots	I	I				Customer
Ball joints <sup>(7)</sup>	I	I				Dealer
Shock absorbers			I			Customer

(7) More often under severe use such dusty as area, sand, snow, wet or muddy conditions.

(7) More often under severe use such dusty as area, sand, snow, wet or muddy conditions.

MAINTENANCE SCHEDULE							
A: Adjust C: Clean I: Inspect L: Lubricate R: Replace	Initial inspection 10 h or 400 km						
	25 h or 1250 km						
	50 h or 2500 km						
	100 h or 1 year or 5000 km						
	200 h or 2 years or 10000 km						
To be performed by						LEGEND	
PART/TASK							
BRAKES							
Brake fluid	I	I			R <sup>(10)</sup>	Customer	(9) Brake fluid replacement or any brake system repairs must be performed by an authorized Can-Am dealer.
Brake pads <sup>(9)</sup>		I				Dealer	
Brake discs				I		Customer	
Brake hoses				I		Customer	
CHASSIS							
Chassis				I		Dealer	—
Chassis fasteners	I		I			Customer	

# MAINTENANCE PROCEDURES

This section includes instructions for basic maintenance procedures. If you have the necessary mechanical skills and the required tools, you can perform these procedures. If not, see your authorized Can-Am dealer.

Other important items in the maintenance schedule that are more difficult and require special tools are best performed by your authorized Can-Am dealer.

## **⚠ WARNING**

Turn off the engine and follow these maintenance procedures when performing maintenance. If you do not follow proper maintenance procedures you can be injured by hot parts, moving parts, electricity, chemicals or other hazards.

## **⚠ WARNING**

Should removal of a locking device (e.g. lock tabs, self-locking fasteners, etc.) be required when undergoing disassembly/assembly, always replace with a new one.

**NOTE:** Some vehicle safety labels are not shown on illustrations. For information on vehicle safety labels, refer to *VEHICLE SAFETY LABELS* subsection.

## Engine Oil

### Engine Oil Level

The engine oil tank is located in front of engine.

**NOTICE** Check level frequently and refill if necessary. Do not overfill. Operating the engine with an improper level may severely damage engine/transmission. Wipe off any spillage.

**NOTE:** While checking the oil level, visually inspect oil tank and engine area for leaks.

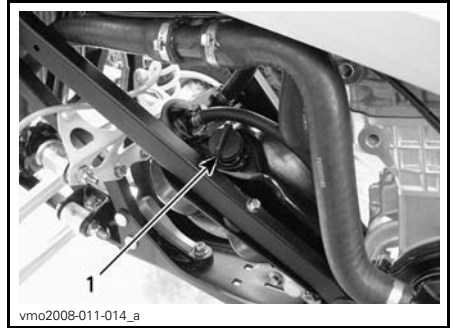

LH SIDE OF VEHICLE

1. Oil tank dipstick

With vehicle on a level surface, start engine and let it running at idle, around 1 minute, then stop engine. Check oil level as follows:

1. Unscrew dipstick and wipe clean.
2. Screw dipstick until it bottoms.
3. Remove dipstick and check oil level. It should be near or equal to the upper mark.

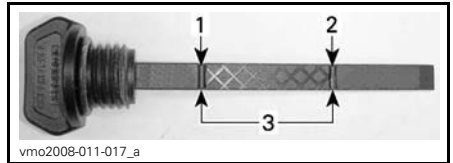

1. Full
2. Add
3. Operating range

To add oil, remove the dipstick. Place a funnel into the oil tank fill hole to avoid spillage.

Add a small amount of oil and recheck oil level.

Repeat the operation until oil level reaches the dipstick's upper mark. Do not overfill.

Properly tighten dipstick.

## Recommended Oil

**NOTE:** The same oil lubricates both engine and transmission.

Use only XPS 4-STROKE SYNTH. BLEND OIL (SUMMER) (P/N 293 600 121). This is a special synthetic oil formulated for wet clutch type gearbox.

**NOTICE** The XPS™ synthetic blend oil is specially formulated and tested for the severe requirements of this engine. Do not use other synthetic oil, synthetic blend oil or oil additives in Can-Am ATV wet clutch equipped vehicles. There is no known equivalent on the market for the moment. If a high quality equivalent were available, it could be used.

## Oil Change and Oil Filter Replacement

Oil and filter are to be replaced at the same time. Oil change should be done with a warm engine.

**CAUTION** The engine oil can be very hot. Wait until engine oil is warm.

## Oil Drainage

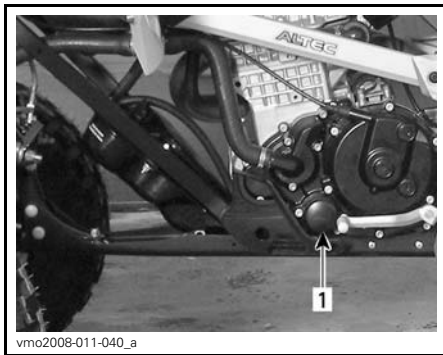

LH SIDE OF VEHICLE  
1. Oil filter

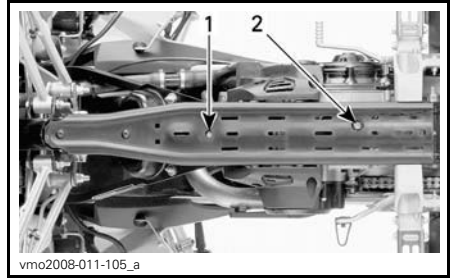

1. Oil tank drain plug  
2. Engine drain plug

Ensure vehicle is on a level surface.  
Remove oil tank cap.

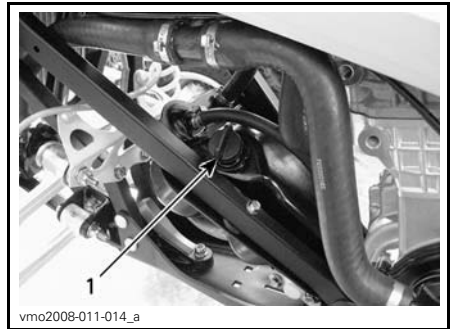

1. Engine oil tank cap

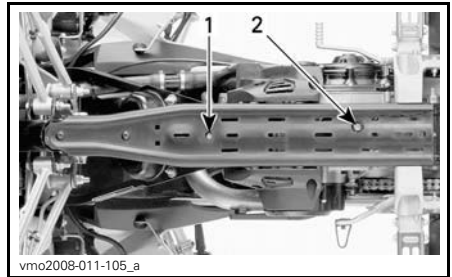

1. Oil tank drain plug  
2. Engine drain plug

Clean drain plugs area.

Place a drain pan under the oil tank drain plug area.

Remove drain plug and drain all oil from oil tank.

Place a drain pan under the engine drain plug area.

Remove drain plug and drain all oil from engine.

Wipe off any oil spillage on frame.

**NOTE:** Allow enough time for oil to flow out of oil filter.

### Oil Tank Strainer Cleaning

**NOTE:** Refer to *MAINTENANCE SCHEDULE* for oil tank strainer cleaning frequency.

Remove bolts retaining oil tank outlet fitting.

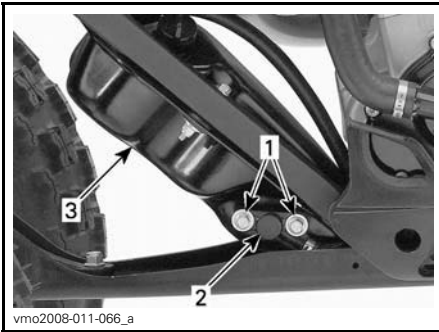

#### LH SIDE OF VEHICLE

1. Retaining bolts
2. Tank outlet fitting
3. Oil tank

Discard O-ring.

Remove oil tank strainer behind outlet fitting.

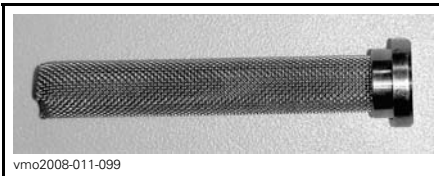

#### STRAINER

To clean oil strainer, use a solvent then dry with compressed air.

## ⚠ WARNING

Always wear eye protection. Chemicals can cause a rash break out and an injury to your eyes.

Wipe off any oil spillage on oil tank.

Install a **NEW** O-ring on the oil tank outlet fitting.

Install the oil tank outlet fitting on the oil tank.

Carefully reinstall all previously removed parts.

**NOTICE** Take care not to damage O-ring while inserting outlet fitting into oil tank. Apply oil on O-ring to ease installation.

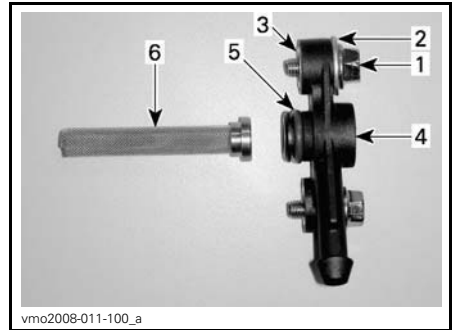

#### OIL OUTLET ASSEMBLY

1. Hexagonal bolt
2. Washer
3. Insert
4. Outlet fitting
5. O-ring
6. Strainer

### Oil Filter Replacement

Unscrew oil filter cover.

**NOTE:** Remember screws location.

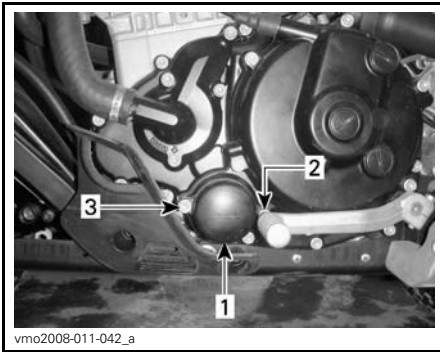

LH SIDE OF ENGINE

1. Oil filter cover
2. Screw (M6 x 25)
3. Screw (M6 x 55)

Remove the oil filter and replace by a new one.

**NOTE:** Check and change the O-ring, if necessary.

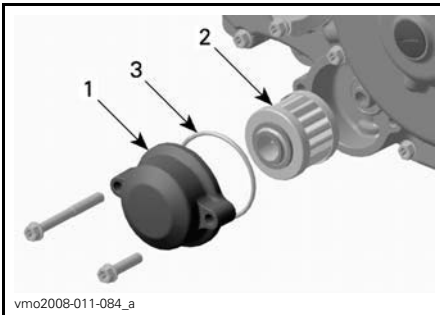

LH SIDE OF ENGINE

1. Oil filter cover
2. Oil filter
3. O-ring

Wipe off any oil spillage on engine.

Change gasket on drain plugs. Clean gasket area on engine, oil tank and drain plugs then reinstall plugs.

Refill oil tank with 1.8 L (1.9 qt (U.S. liq.)) of the recommended oil. Refer to *RECOMMENDED ENGINE OIL* in this section for more details.

Start engine and let idle for a few minutes.

Ensure there are no leaks.

Stop engine and check oil level. Refill if necessary.

Dispose oil as per your local environmental regulations.

## Engine Coolant

### Engine Coolant Level

#### **⚠ WARNING**

Check coolant level with engine cold. Never add coolant in cooling system when engine is hot.

**NOTE:** While checking the coolant level, visually inspect engine area for leaks.

The engine coolant tank cap is located underneath access cover near fuel tank cap.

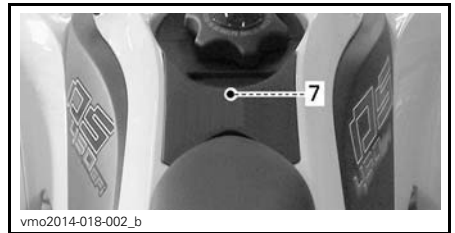

UNDERNEATH ACCESS COVER

1. Coolant tank cap location



COOLANT TANK CAP

To remove access cover, proceed as follows.

Remove seat.





1. *Seat latch*

Remove fuel tank cap.

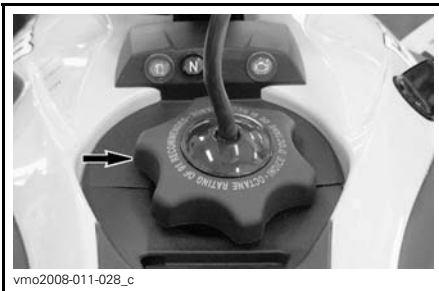

Release cover tabs from fascia.

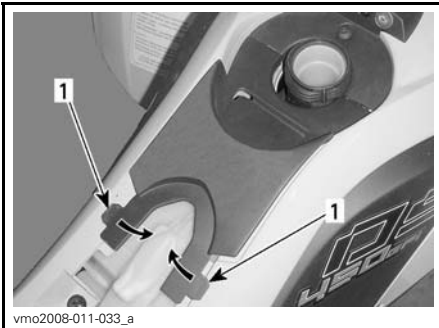

1. *Tabs*

Gently pull cover rearward to remove.



Remove filler cap.

With vehicle on a level surface, liquid is at a proper level when seen through reservoir cap hole.

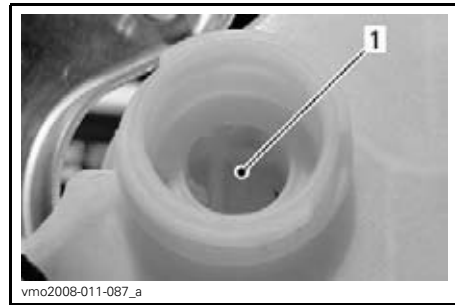

**COOLANT RESERVOIR**

1. *Coolant here*

Fluid level can also be validated using reservoir level marks (small ribs).

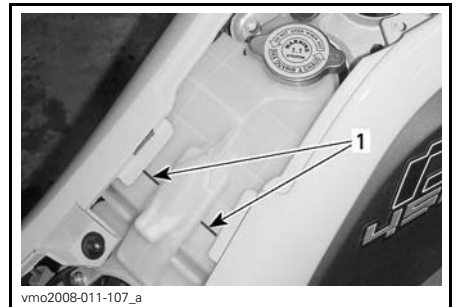

**COOLANT RESERVOIR**

1. *Level marks*

**NOTE:** Coolant may be slightly lower when checking level at temperature lower than 20°C (68°F).

Add coolant if necessary. Use a funnel to avoid spillage. **Do not overfill.**

**⚠ WARNING**

**In order to avoid potential burns, do not remove the coolant tank cap if the engine is hot.**

Properly reinstall and tighten filler cap. Properly reinstall all removed parts in reverse order of their removal.

**NOTE:** A cooling system that frequently requires coolant is the indication of leaks or engine problems. See an authorized Can-Am dealer.

**Recommended Engine Coolant**

Always use ethylene-glycol antifreeze containing corrosion inhibitors specifically for internal combustion aluminum engines.

Cooling system must be filled with BRP premixed coolant (P/N 219 700 362) or with distilled water and antifreeze solution (50% water, 50% antifreeze).

**Engine Coolant Replacement**

**⚠ WARNING**

**In order to avoid potential burns, do not remove the coolant tank cap or loosen the engine drain plug if the engine is hot.**

Remove access cover, refer to *ENGINE COOLANT LEVEL* in this section. Turn the coolant tank cap counterclockwise and remove it.

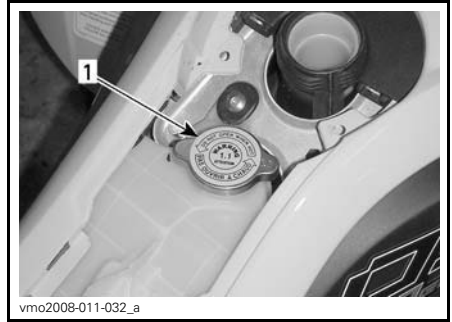

*UNDERNEATH ACCESS COVER*

1. Coolant tank cap

Unscrew the drain plug slowly and drain the coolant into a suitable container.

**NOTE:** It is not necessary to remove drain plug.

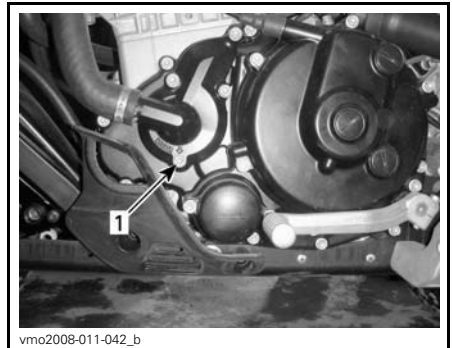

*LH SIDE OF ENGINE*

1. Coolant drain plug

Drain completely and retighten the drain plug.

Loosen gear clamp from radiator outlet hose.

Remove outlet hose from radiator to drain the system completely.

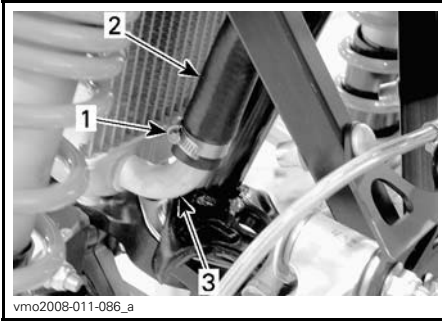

1. Gear clamp
2. Outlet hose
3. Radiator

Reinstall hose and secure with gear clamp.

Wipe off any coolant spillage on frame and engine.

Refill coolant tank with 1.8L (1.9 qt (U.S. liq.)) of recommended coolant. Refer to *SPECIFICATIONS* for more details.

Run engine at idle with the coolant tank cap off. Slowly add additional coolant if necessary. **Do not overfill.**

With vehicle on a level surface, liquid is at a proper level when seen through reservoir cap hole.

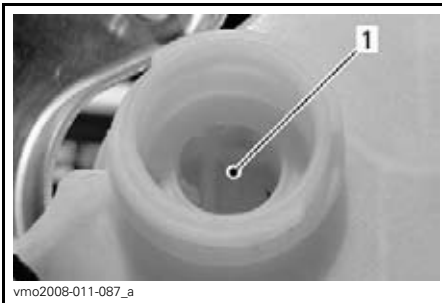

**COOLANT RESERVOIR**

1. Coolant here

Liquid can also be validated using reservoir level marks (small ribs).

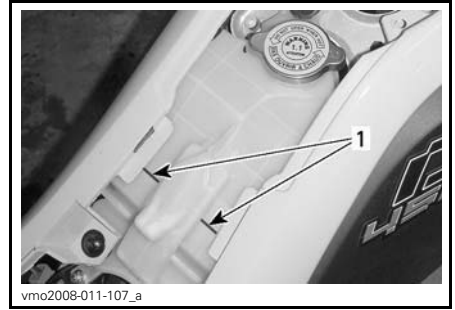

**COOLANT RESERVOIR**

1. Level marks

At this point, wait until engine reaches normal operating temperature. Depress the throttle lever two or three times; then add coolant if necessary.

Install coolant tank cap. Inspect all connections for leaks.

Properly reinstall all previously removed parts.

**Air Filter**

**Air Filter Maintenance Guideline**

As with any ATV, air filter maintenance is critical to ensure proper engine performance and life span.

Air filter maintenance should be adjusted according to riding conditions.

Air filter maintenance must be increased in frequency for the following dusty conditions:

- Riding on dry sand
- Riding on dry dirt covered surfaces
- Riding on dry gravel roads or similar conditions.

**NOTE:** Riding in a group in these conditions would increase even more the air filter maintenance and replacement.

## Air Filter Removal

**NOTICE** Never remove or modify any component in the air filter housing. Always use genuine parts or suitable equivalents when replacing air filter. The engine is calibrated to operate specifically with these components. Otherwise, engine performance degradation or damage can occur.

Remove seat.

Release clamps and remove air filter housing cover.

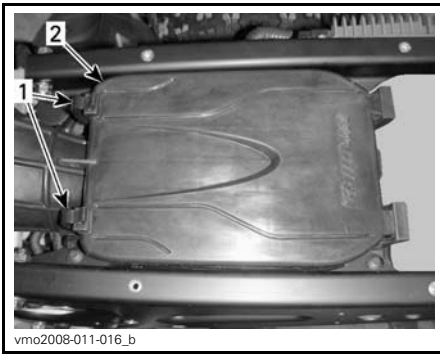

1. Clamps
2. Air filter housing cover

Loosen clamp and remove filter.

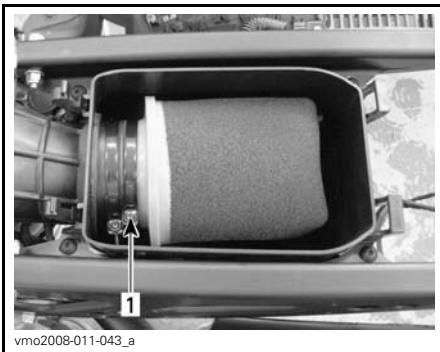

1. Clamp

## Air Filter Cleaning

1. Spray the foam filter element inside and out with AIR FILTER CLEANER (P/N 219 700 341).



AIR FILTER CLEANER (P/N 219 700 341)

2. Let stand for 3 minutes.
3. As stated on air filter cleaner (UNI) container, rinse with plain water.
4. Dry the foam element completely.

**NOTE:** A second application may be necessary for heavily soiled elements.

When the filter is dried, re-oiled with air filter oil (P/N 219 700 340) or an equivalent.

**NOTICE** Engine performance degradation or severe damages can occur if the air filter is not properly maintained and/or if it not well oiled.

## Air Filter Installation

Properly reinstall removed parts in the reverse order of their removal.

## Air Filter Housing

### Air Filter Housing Inspection

Periodically inspect air filter housing drain tube for liquid or deposits.

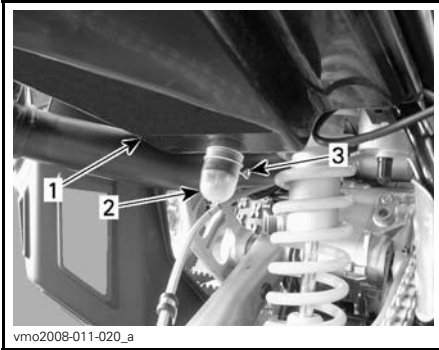

1. Air filter housing
2. Drain tube
3. Clamp

**NOTE:** If vehicle is used in dusty areas, inspect more frequently than specified in *MAINTENANCE SCHEDULE*.

If liquid or deposits are found, squeeze and remove the clamp. Pull drain tube out then empty it.

**NOTICE** Do not start engine when liquid or deposits are found in the drain tube.

When liquid or deposits are found, the air filter must be inspected/dried/replaced depending on its condition.

Remove air filter as explained in this section.

## Muffler Spark Arrester

### Muffler Spark Arrester Cleaning

The muffler spark arrester must be periodically cleaned from accumulated carbon. Refer to *MAINTENANCE SCHEDULE*.

The entire exhaust system should also be visually inspected for cracks, leaks or any damage.

**⚠ CAUTION** Never perform this operation immediately after the engine has been running because exhaust system is very hot.

Remove the spark arrester from the muffler.

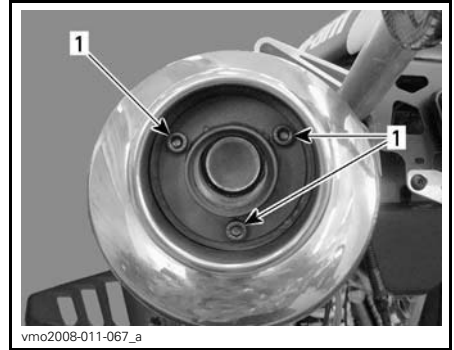

- REMOVE**
1. Screws

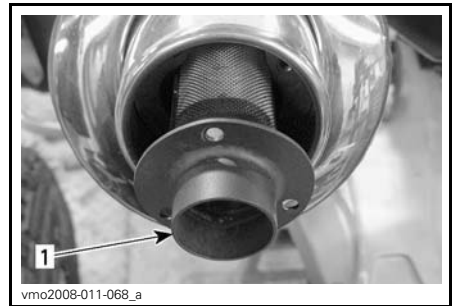

- REMOVE**
1. Spark arrester

Remove carbon deposits from the spark arrester using a brush.

**NOTE:** Use a soft brush and be careful to avoid damaging spark arrester.

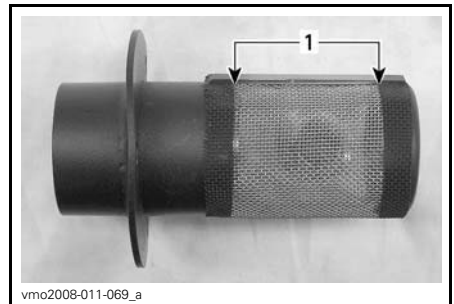

- CLEAN**
1. Clean this portion

For installation, reverse the removal procedure.

## Radiator

### Radiator Cleaning

Inspect radiating fins. They must be clean, free of mud, dirt, leaves and any other deposit that would prevent the radiator to cool properly.

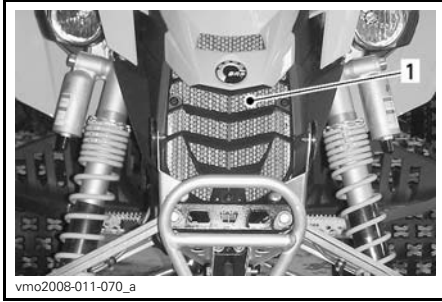

TYPICAL  
1. Radiator

Remove as much deposits as you can with your hands. If water is available in proximity, try rinsing the radiating fins. If available, use a garden hose to rinse the radiator fins.

**CAUTION** Never clean radiator with your hands when it is hot. Let the radiator cool down before cleaning.

**NOTICE** Be careful not to damage the radiator fins when cleaning. Do not use any object/tool that could damage the fins. The fins are purposely thin parts to allow efficient cooling. **WHEN HOSING, USE LOW PRESSURE ONLY, DO NOT USE A HIGH PRESSURE WASHER.**

### Radiator Inspection

Inspect radiator and hoses for leaks or any damage.

See an authorized Can-Am dealer to check the performance of the cooling system.

## Transmission Lever

### Transmission Lever Adjustment

Unfasten socket screw near selector shaft end then remove the transmission lever.

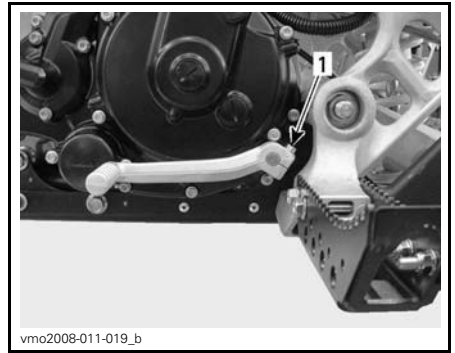

1. Socket screw

Install transmission lever at your convenience then torque socket screw.

## Clutch

### Clutch Adjustment Guidelines

The clutch lever nominal free play is 10 mm to 15 mm (3/8 in to 5/8 in).

While reading this Operator's Guide, remember that:

## **WARNING**

Indicates a potential hazard that, if not avoided, could result in serious injury or death.

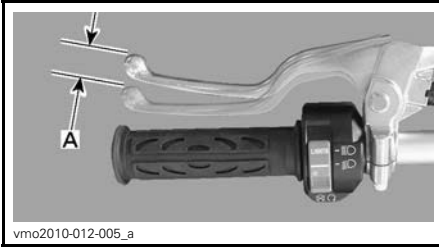

**CLUTCH LEVER — NOMINAL FREE PLAY**  
 A. 10 mm to 15 mm (3/8 in to 5/8 in)

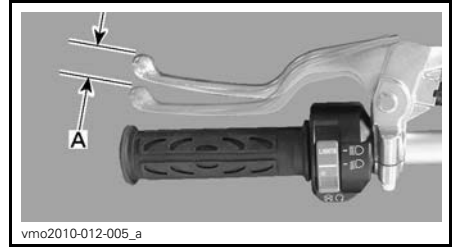

**CLUTCH LEVER — PROPER ADJUSTMENT**  
 A. 10 mm to 15 mm (3/8 in to 5/8 in)

Perform adjustments if required according to the following conditions.

**NOTICE** If recommended adjustments are unattainable, contact an authorized Can-Am Dealer.

**Free Play Is Below Specification**

If free play is less than specification, refer to *ADJUSTMENT AT CLUTCH COVER* further.

**Free Play Is Above Specification**

If free play is more than specification, refer to *ADJUSTMENT AT CLUTCH LEVER* below.

**Adjustment at Clutch Lever**

Turn cable adjuster until proper dimension is obtained.

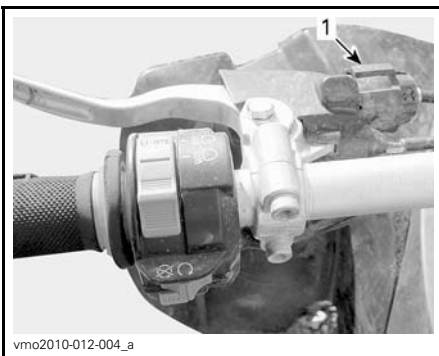

1. Cable adjuster

**Adjustment at Clutch Cover**

**NOTICE** When adjustment of the clutch release cover screw is needed, it means that the clutch plates have worn. Therefore, it is strongly recommended to take the vehicle to an authorized Can-Am dealer for clutch plates inspection.

Loosen clutch cable adjuster to provide maximum free play.

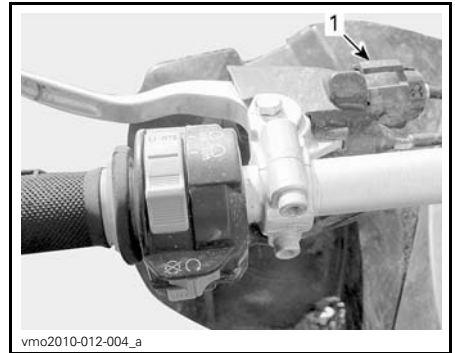

**TYPICAL**

1. Cable adjuster

Remove clutch cover access plugs.

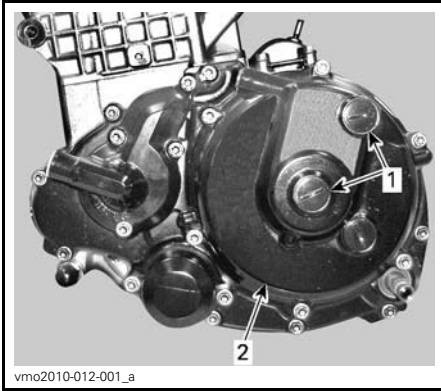

vmo2010-012-001\_a

**LH SIDE OF ENGINE**

1. Access plugs
2. Clutch cover

Verify through clutch cover upper window if clutch cable and clutch release cam are fully released.

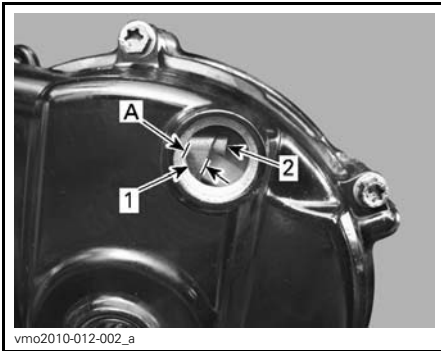

vmo2010-012-002\_a

1. Clutch cable
2. Clutch release cam

A. 4 mm to 5 mm (.16 in to .2 in)

Install CLUTCH ADJUSTMENT WRENCH 11 MM (P/N 529 036 076) provided in tool kit onto lock nut.

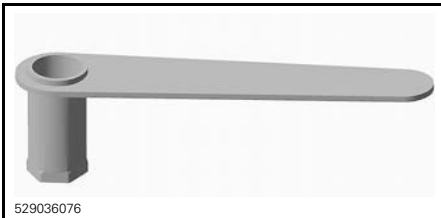

529036076

**CLUTCH ADJUSTMENT WRENCH**

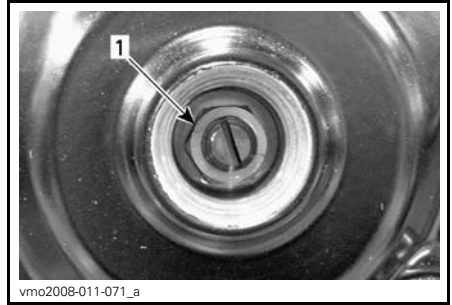

vmo2008-011-071\_a

1. Lock nut

Hold adjustment screw using a flat screwdriver, then loosen lock nut counterclockwise.

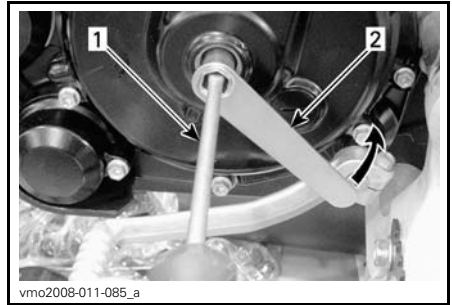

vmo2008-011-085\_a

1. Screwdriver
2. Clutch adjustment wrench

By using the screwdriver, gently turn clutch adjuster screw clockwise to locate the point of contact with release bearing, then turn screw out (counterclockwise) 3/8 to 1/2 turn from contact point.

Hold adjustment screw using the flat screwdriver, then tighten lock nut clockwise using the clutch adjustment wrench.



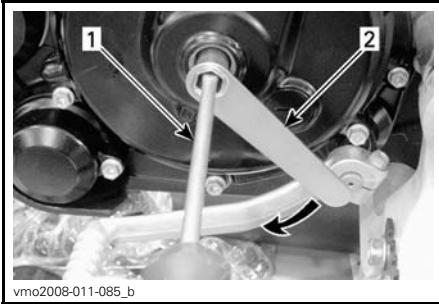

vmo2008-011-085\_b

1. Screwdriver
2. Clutch adjustment wrench

To confirm proper adjustment, gently push on adjustment screw using a screwdriver. A small axial play of approximately 0.5 mm (.02 in) should be felt. If not, perform adjustment again.

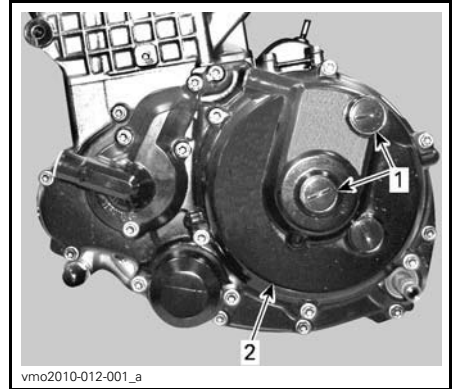

vmo2010-012-001\_a

1. Access plugs
2. Clutch cover

Properly adjust clutch lever. Refer to *ADJUSTMENT AT CLUTCH LEVER* above.

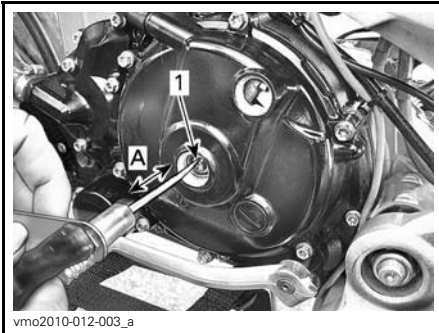

vmo2010-012-003\_a

1. Adjustment screw
- A. 0.5 mm (.02 in)

**NOTICE** A premature clutch disk wear may occur if adjustment is too tight.

Reinstall access plugs.

**NOTICE** Do not overtighten.

## Throttle Cable

### Throttle Cable Lubrication

The throttle cable must be lubricated with CABLE LUBRICANT (P/N 293 600 041) or an equivalent.

#### **⚠ WARNING**

Always use a silicone-based lubricant. Using another lubricant (like water-based lubricant) could cause the throttle lever/cable to become sticky or stiff.

Remove the throttle lever housing cover.

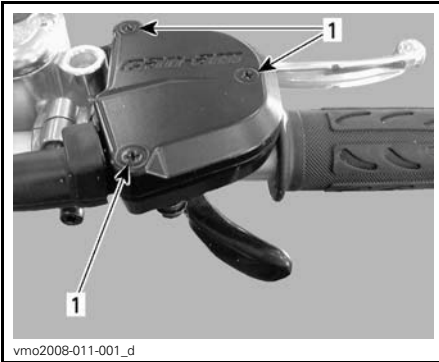

1. Remove screws

Remove cable from throttle lever.

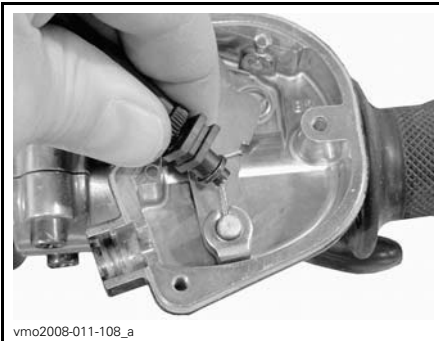

Remove the throttle body side cover.

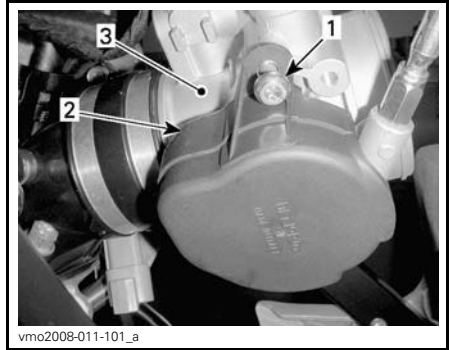

#### LH SIDE OF ENGINE

1. Remove screw
2. Cover
3. Throttle body

Install the CABLE LUBER (P/N 529 035 738) or an equivalent on the cable.



#### TYPICAL

Insert the needle of the spray can in the cable luber hole.

#### **⚠ WARNING**

Always wear eye protection and gloves when you lubricate a cable.

**NOTE:** Place a rag around the cable lube-  
ber to prevent the lubricant to splash.  
Put the lubricant until it passes through  
the cable.

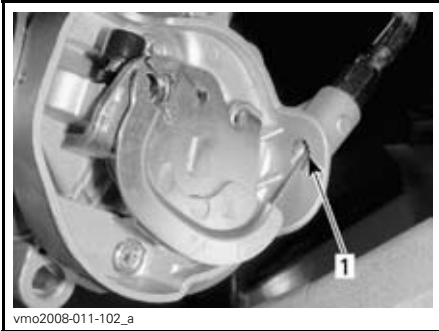

1. Look for lubricant here

Reinstall the cable.

Spray a little quantity of lubricant on the  
throttle lever mechanism then close  
the housing.

Adjust the throttle lever.

## Throttle Lever

### Throttle Lever Adjustment

Slide rubber protector back to expose  
throttle cable adjuster.



1. Rubber protector

Loosen lock nut then turn the adjuster  
to obtain correct throttle lever free play.

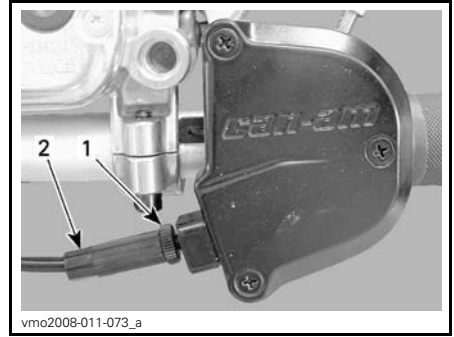

1. Lock nut  
2. Adjuster

**NOTE:** Measure throttle free play at  
the tip of throttle lever.

Tighten lock nut and reinstall protector.

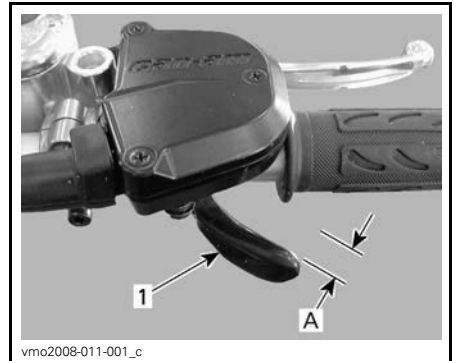

1. Throttle lever  
A. 2 to 4 mm (5/64 to 5/32 in)

## Spark Plugs

### Spark Plugs Removal

Unplug spark plug cables.

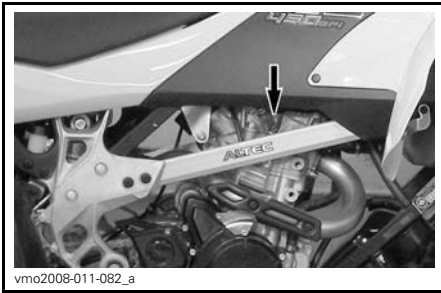

CABLES LOCATION

Clean spark plugs and cylinder head with pressurized air if possible.

**⚠ WARNING**

Always wear safety goggles when using pressurized air.

Unscrew and remove spark plugs.



1. Spark plugs

**Spark Plugs Installation**

Prior to installation, make sure that contact surfaces of cylinder head and spark plugs are free of grime.

Using a feeler gauge, set spark plugs gap between 0.7 to 0.8 mm (0.028 to 0.032 in).

Apply a small amount of HEAT-SINK PASTE P12 (P/N 420 897 186) on spark plugs threads to prevent a possible seizure and to increase heat transfer from spark plugs to cylinder head.

Screw spark plugs into cylinder head by hand and tighten using a torque wrench and a proper socket.

Torque spark plugs to 19 N•m (168 lbf•in).

**Battery**

**⚠ WARNING**

Never charge a battery while installed in vehicle.

**Battery Removal**

Remove seat.

Disconnect BLACK (-) cable first then RED (+) cable.

**NOTICE** Always respect this order for disassembly; disconnect BLACK (-) cable first.

Remove bolts retaining battery holder and rack.



TYPICAL  
1. RED (+)  
2. BLACK (-)  
3. Battery holder

Remove battery.

**Battery Cleaning**

Clean battery post and cable ends with a wire brush.

**Battery Installation**

Reinstall battery in vehicle. Fasten battery holder.

**NOTICE** Connect RED (+) cable first then BLACK (-) cable. Always connect RED (+) cable first.

Apply DIELECTRIC GREASE (P/N 293 550 004) or an equivalent on post to protect against oxidation.

## Fuses

### Fuse Inspection

The electrical system is protected with fuses. If a fuse is damaged, replace it by one of the same rating.

**NOTICE** Do not use a higher rated fuse as this can cause severe damage.

To remove fuse from box, pull fuse out. Check if filament is melted.

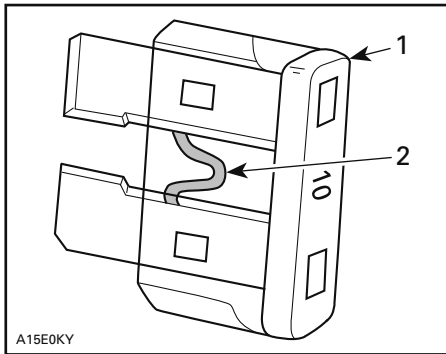

#### TYPICAL

1. Fuse
2. Check if melted

### Fuse Location

The fuse box is located on the RH front frame member.

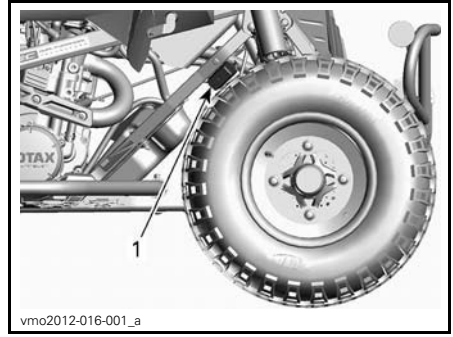

- RH SIDE**  
1. Fuse box

### Fuse and Relay Identification

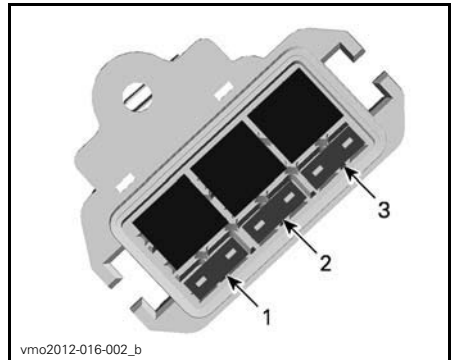

#### FUSES

1. F1: Main (20A)
2. F2: Cooling fan (10A)
3. F3: Accessories (10A)

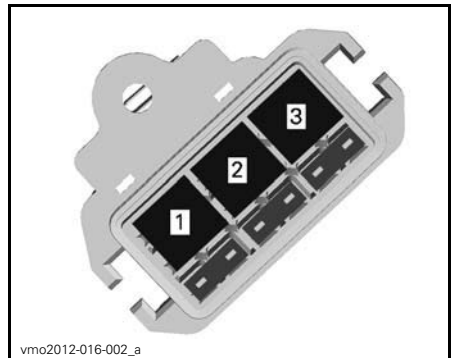

#### RELAYS

1. R1: Main
2. R2: Fuel system
3. R3: Cooling fan

## Lights

### Beam Aiming Adjustment

To adjust beam, proceed as follows.

1. Loosen the bolts shown on the following illustrations but do not remove them.

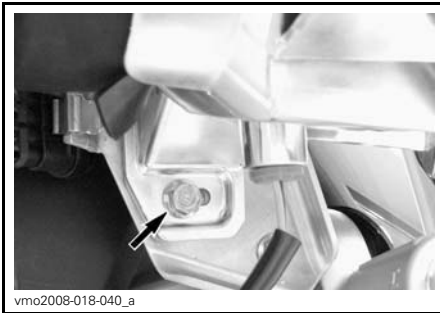

2. Adjust headlight housing angle by hand.
3. Adjust both headlights evenly.
4. Tighten screw when proper adjustment is reached.

### Headlights Bulbs Replacement

**NOTICE** Never touch glass portion of a halogen bulb with bare fingers, it shortens its operating life. If glass is touched, clean it with isopropyl alcohol which will not leave a film on the bulb.

**NOTE:** Concerning the following illustrations, the headlight housing has been removed from the vehicle for a better comprehension.

To replace the headlight bulb, proceed as follows.

Turn the ignition switch to OFF position.

Remove rubber protector from headlight housing.

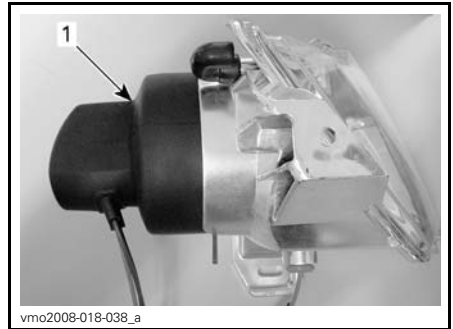

**TYPICAL**

1. Rubber protector

Unplug connector from headlight.

Push the retaining clip round ends forward then set them on the sides to unlock headlight bulb.

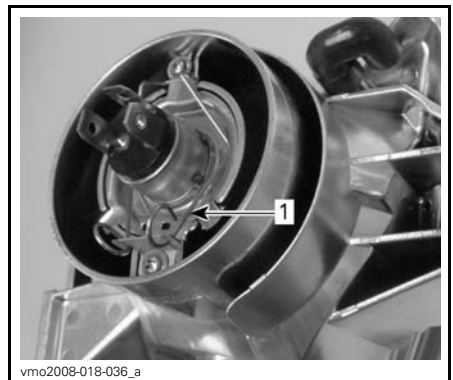

**TYPICAL**

1. Retaining clip

Lift and hold the retaining clip then remove the bulb.



TYPICAL

Replace defective bulb.  
Properly reinstall removed parts in the reverse order of their removal.

### Taillight Bulb Replacement

Turn the ignition switch to OFF position.

Unscrew lens screws to expose bulb.

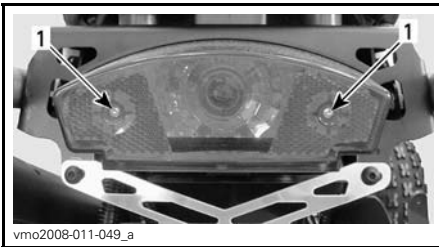

1. Screws

Push bulb in and hold while turning counterclockwise to release.

Install the new bulb by pushing it in while turning clockwise.

### Indicator Lamps

#### Indicator Lamps Bulbs replacement

Remove fuel tank cap.

Remove console.

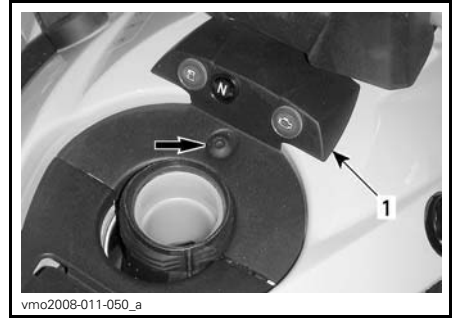

1. Console

Unplug wires on defective indicator lamp.

Press both tabs then pull indicator lamp out of hole.

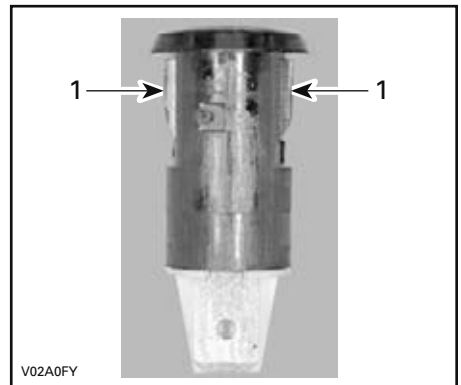

1. Tabs

For installation, reverse the removal procedure.

### Drive Chain

#### ⚠ WARNING

Always turn ignition switch to the OFF position before you check, adjust or lubricate the drive chain.

#### Drive Chain Inspection

This vehicle is equipped with O-ring sealed permanently greased pins and rollers. Before operating the vehicle, always inspect the drive chain.

Check for damage or missing O-ring, rollers and correct slack adjustment.

### Drive Chain Lubrication and Cleaning

**NOTICE** Never wash the chain with a high pressure washer or gas-line. This will result in damage to the O-ring, causing premature wear and drive chain failure.

Clean the side surfaces of the chain with a dry cloth.

**NOTE:** Do not brush chain.

Lubricate only with an approved O-ring chain lubricant. Other commercial chain lubricants may contain solvent which could damage the O-rings.

### Drive Chain Adjustment

Adjust the drive chain before every ride.

**NOTE:** Always adjust drive chain with the driver, or equivalent weight, seated on the vehicle.

1. Select a level surface and set transmission to NEUTRAL.

Loosen rear axle lock bolts.

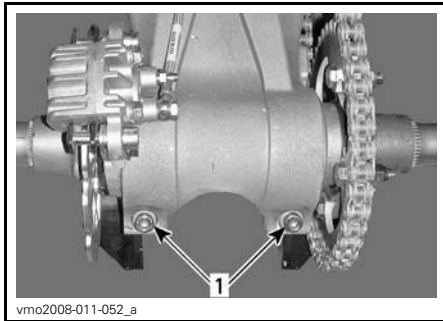

1. Rear axle lock bolts

2. Insert screw driver pin (tool kit) through sprocket hub and into eccentric axle housing.

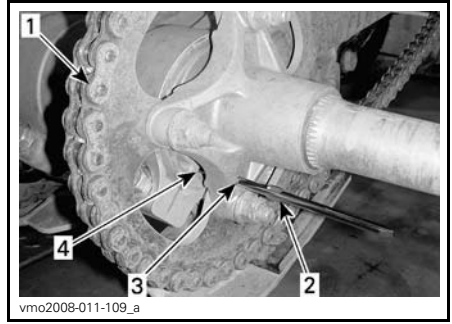

1. Drive chain  
2. Screw driver pin (tool kit)  
3. Sprocket hub  
4. Eccentric axle housing

3. With the screw driver pin properly in place, push or pull the vehicle forward to increase or backwards to decrease chain free play. Refer to the following table for proper adjustment.

MODEL	ADJUSTMENT METHOD	CHAIN FREE PLAY
DS 450 DS 450 X xc	To decrease free play: <b>PULL</b> vehicle backwards	22 mm (7/8 in) at midpoint between sprockets
DS 450 X mx	To decrease free play: <b>PUSH</b> vehicle forward	

**NOTICE** Always use the right drive chain adjustment method according to the your model. Damage to the vehicle can occur if the drive chain is adjusted using a wrong method.

4. Tighten the rear axle lock bolts to 42 N•m - 54 N•m (31 lbf•ft - 40 lbf•ft).

### Drive Chain Slider

#### Drive Chain Slider Inspection

Check the drive chain slider frequently, see the *MAINTENANCE SCHEDULE*.

Replace the drive chain slider when it is worn.



See an authorized Can-Am dealer for replacement.

## Drive Chain Sprockets

### Drive Chain Sprockets Inspection

Check the sprockets for distortion.

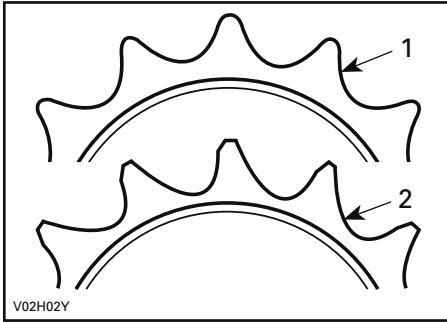

1. Good
2. Replace

**NOTICE** Replace chain and sprockets together to prevent rapid chain and sprocket wear. Install a new retaining ring each time the engine sprocket is removed.

## Tires/Wheels

### Tire Pressure

#### **⚠ WARNING**

Tire pressure greatly affects vehicle handling and stability. Insufficient pressure may cause tire to deflate and rotate on wheel. Excessive pressure may burst the tire. Always follow recommended pressure. NEVER set tire pressure below minimum. It could cause the tire to dislodge from the rim. Since tires are low-pressure types, a manual pump should be used.

Check pressure when tires are COLD before using the vehicle. Tire pressure changes with temperature and altitude. Recheck pressure if one of these conditions has changed.

For your convenience, a pressure gauge is supplied in tool box.

### DS 450/DS 450 X xc

TIRE PRESSURE		FRONT	REAR
Up to 100 kg (220 lb)	MAXIMUM	48.3 kPa (7 PSI)	
	MINIMUM	34.5 kPa (5 PSI)	

### DS 450 X mx

TIRE PRESSURE		FRONT	REAR
Up to 100 kg (220 lb)	MAXIMUM	69 kPa (10 PSI)	62 kPa (9 PSI)
	MINIMUM	55 kPa (8 PSI)	48 kPa (7 PSI)

Although the tires are specifically designed for off-road use, a flat may still occur. Therefore, it is recommended to carry a tire pump and a repair kit.

### Tire/Wheel Condition

Check tire for damage and wear. Replace if necessary. Do not make a tire rotation. The front and rear tires have a different size.

**⚠ WARNING**

When the tires are replaced, never install a bias tire with a radial tire. This combined application may create handling and/or stability problems.

Do not mix tires of different size and/or design on the same axle. Front tire pairs or rear tire pairs must be the identical model and manufacturer.

For unidirectional tread pattern, ensure that the tires are installed in the correct direction of rotation. The radial tires must be installed as a complete set.

**Wheel Removal**

Loosen nuts then lift vehicle. Support vehicle securely using jack stands. Remove nuts, washers then remove wheel.

**NOTE:** X xc and X mx models are equipped with tapered nuts and do not have washers.

**NOTICE** To avoid any damage to front brake discs, never remove or ride vehicle without front discs protectors properly installed.

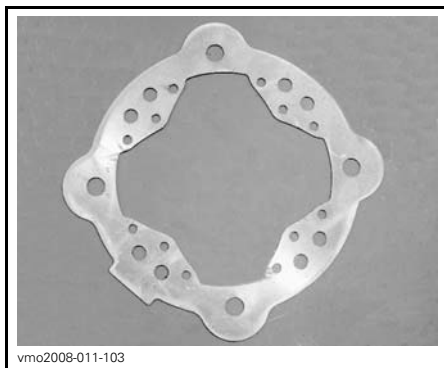

vmo2008-011-103

**DISC PROTECTOR**

**Wheel Installation**

At front, ensure that brake discs protectors are properly installed.

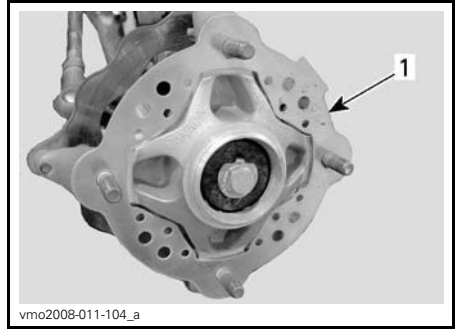

vmo2008-011-104\_a

**FRONT WHEEL**

1. Disc protector

Install nuts and washers (where applicable).

**⚠ WARNING**

On X xc and X mx models, install the tapered side on the nuts towards rim.

Gently tighten nuts in a criss-cross sequence then apply a final torque of 52 N•m (38 lbf•ft).

**NOTICE** Always use the recommended wheel nuts and washers (if applicable). Using a different nut and washer could cause damages to the rim.

**Tire Replacement (Wheels Without Beadlocks)**

Use an automotive tire changer to replace tires.

Adjust tire pressure. Refer to *TIRE PRESSURE* in this section.

**⚠ WARNING**

- Replace tires only with the same size as original tires.

**Tire Removal (Beadlock Wheels)**

1. Remove wheel from the vehicle.
2. Completely deflate tire.

3. Loosen all beadlock bolts a few turns at a time in a criss-cross pattern.
4. Remove beadlock bolts.
5. Remove beadlock clamp ring.

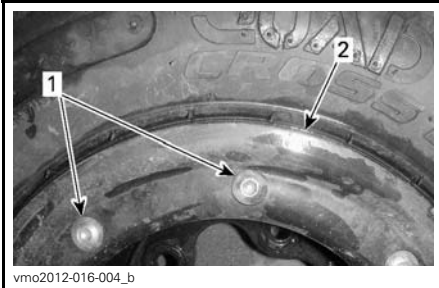

1. Beadlock bolts
2. Beadlock clamp ring

6. Remove tire from the beadlock side.

**Tire Installation (Beadlock Wheels)**

1. Apply the tire mounting lube on the inner tire bead.

**NOTICE** Mount tire from beadlock side only.

2. Pass the inner bead on the wheel.
3. Seat the outer bead on the wheel outer shoulder.
4. Center the tire outer bead over the beadlock inner ring.
5. Apply LOCTITE 767 (ANTISEIZE LUBRICANT) (P/N 293 800 070) or an equivalent on beadlock screw threads.
6. Place and hold the beadlock clamp ring against the tire.
7. Hand tighten ALL beadlock bolts.
8. Tighten beadlock bolts as per following procedure.

**NOTE:** To ensure even pressure on the beadlock clamp ring, tighten screws a few turns at a time.

During tightening, the beadlock clamp ring will flex slightly and should pull down to meet the inner ring.

STEP	FRONT WHEEL BEADLOCK TIGHTENING TORQUE
First step	3 N•m ± 1 N•m (27 lbf•in ± 9 lbf•in)
Second step	8 N•m ± 1 N•m (71 lbf•in ± 9 lbf•in)

STEP	REAR WHEELS BEADLOCK TIGHTENING TORQUE
First step	3 N•m ± 1 N•m (27 lbf•in ± 9 lbf•in)
Second step	10.5 N•m ± 1 N•m (93 lbf•in ± 9 lbf•in)



8-BOLT BEADLOCK WHEELS — FIRST AND SECOND STEPS TIGHTENING SEQUENCE



10-BOLT BEADLOCK WHEELS — FIRST AND SECOND STEPS TIGHTENING SEQUENCE

STEP	FRONT WHEELS BEADLOCK TIGHTENING TORQUE
Final step	8 N•m ± 1 N•m (71 lbf•in ± 9 lbf•in)

STEP	REAR WHEELS BEADLOCK TIGHTENING TORQUE
Final step	10.5 N•m ± 1 N•m (93 lbf•in ± 9 lbf•in)



A. Gap (must be equal all around the wheel)

If the gap is uneven:

- Loosen all bolts a few turns at a time in a criss-cross pattern.
- Reposition tire.
- Restart the tightening procedure from the beginning.

9. Inflate tire to seat the inner bead on the wheel.

**⚠ WARNING**

Always use safe practices, such as a tire safety cage. Never exceed tire's maximum pressure for seating beads.

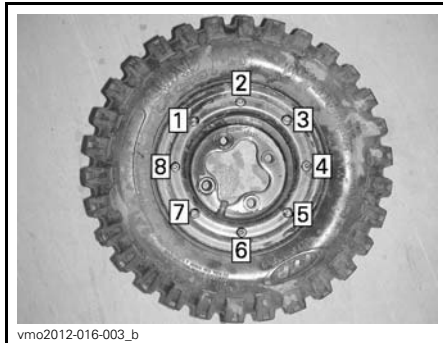

8-BOLT BEADLOCK WHEELS — FINAL STEP TIGHTENING SEQUENCE



10-BOLT BEADLOCK WHEELS — FINAL STEP TIGHTENING SEQUENCE

The gap between tire and beadlock clamp ring should be equal all around the wheel.

10. Adjust air pressure to specification. Refer to *TIRE PRESSURE* in this section.

## Front Wheel Bearings

### Front Wheel Bearings Inspection

Push and pull the wheels from the upper edge to feel the play. See an authorized Can-Am dealer if there is any play.

## Rear Axle

### Rear Axle Inspection

Lift rear of vehicle high enough to have wheels off the ground.

Push and pull rear axle to feel the play.

Look for axle bending or runout.

See an authorized Can-Am dealer if there is any play or damage.

## Suspensions

### Suspension Inspection

#### Shock Absorbers

Inspect shock absorber for oil leaks and fasteners for tightness. See an authorized Can-Am dealer if necessary.

#### **⚠ WARNING**

- Shock absorbers are pressurized.
- An explosion may occur if heated or punctured.
- Do not disassemble.

#### Suspension Arms, Swing Arm and Linkage Inspection

Check these parts for damages (cracks, dents, excessive play or corrosion pin-holes). If one of these damages is detected **DO NOT USE THE VEHICLE AND SEE AN AUTHORIZED CAN-AM DEALER.**

#### **⚠ WARNING**

Never ride a vehicle with a defective suspension parts.

### Front Suspension

#### Front Suspension Lubrication

Lubricate front suspension arms with a grease gun. Use SUSPENSION GREASE (P/N 293 550 033) or an equivalent.

**NOTE:** On the DS 450 X mx, only the lower suspension arms have grease fittings.

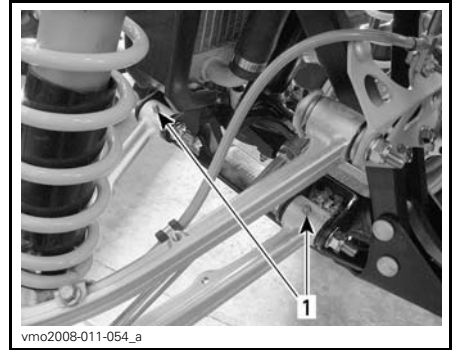

**TYPICAL — LOWER SUSPENSION ARM**  
1. Grease fittings

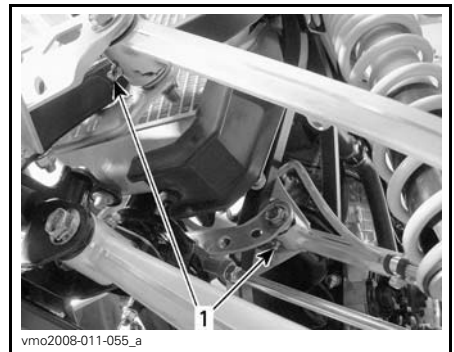

**TYPICAL — UPPER SUSPENSION ARM (DS 450/DS 450 X XC)**  
1. Grease fittings

### Rear Suspension

#### Rear Suspension Lubrication

Lubricate with SUSPENSION GREASE (P/N 293 550 033) at grease fittings as shown.

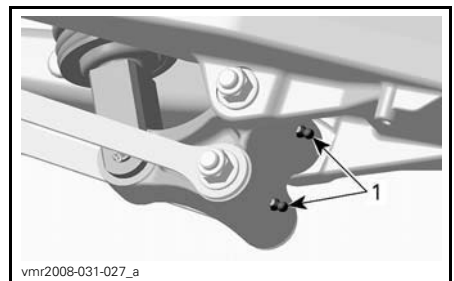

**BELL CRANK LEVER**  
1. Grease fittings



**REAR PIVOT ARM**  
1. Grease fitting

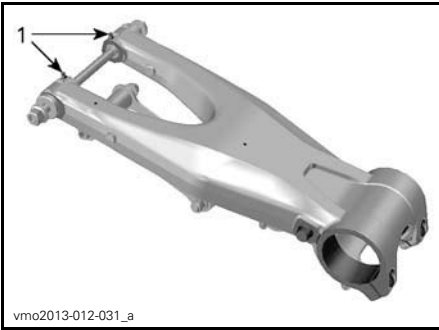

**FRONT PIVOT ARM**  
1. Grease fittings

## Brakes

### Brake Fluid Level

**NOTE:** A low level may indicate leaks or worn brake pads. See an authorized Can-Am dealer.

### Front Brake Fluid Reservoir

Turn steering in the straight-ahead position to ensure reservoir is level.

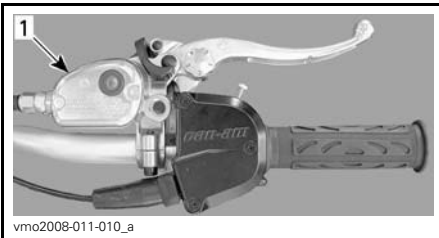

**TYPICAL**  
1. Front brake fluid reservoir

Check brake fluid level through reservoir cover sight window.

A **DARK** color indicates a proper fluid level.

A **LIGHT** color indicates a low fluid level.



**TYPICAL**  
1. Proper fluid level  
2. Low fluid level

Clean and remove the filler cover then add fluid as required. **Do not overfill.**

Visually inspect lever boot condition. Check for cracks, tears etc. Replace if damaged.

### Rear Brake Fluid Reservoir

With vehicle on a level surface, check brake fluid in reservoir for proper level.



**LOCATED NEAR THE RIGHT REAR FENDER**  
1. Rear brake fluid reservoir

It should be above MIN. mark.

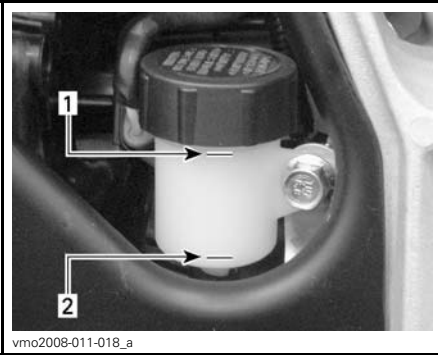

vmo2008-011-018\_a

**RH SIDE OF VEHICLE**

1. Maximum level (MAX.)
2. Minimum level (MIN.)

Clean and remove the filler cap then add fluid as required. **Do not overfill.**

**⚠ WARNING**

When installing the rear brake fluid reservoir filler cap, make sure to return the rubber diaphragm to its original position.



vmo2009-005-009

**RIGHT POSITION**

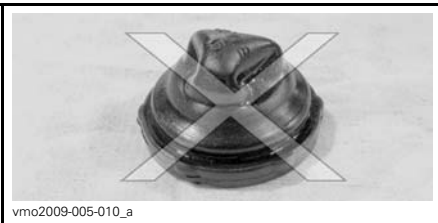

vmo2009-005-010\_a

**WRONG POSITION**

**Recommended Brake Fluid**

Always use brake fluid meeting the specification DOT 4 only.

**NOTICE** To avoid serious damage to the braking system, do not use fluids other than the recommended one, nor mix different fluids for topping up.

**NOTICE** Use only DOT 4 brake fluid from a sealed container. Do not use brake fluid taken from old or already opened containers.

**Brakes Inspection**

**⚠ CAUTION** The brakes can be very hot after prolonged use of the vehicle. Wait for the brakes to cool down.

The braking system is a hydraulic type and no adjustment is required.

Check the following to keep the brakes in a good operating condition:

- Brake fluid level
- Brake system for fluid leaks
- Brake for spongy feel
- Brake cleanliness
- Brake discs for excessive wear and surface condition
- Brake pads for wear, damage or looseness
- Front brake disc protector for damage, replace if necessary.

SERVICE LIMITS	
Brake pads thickness	1 mm (.04 in)
Discs thickness	3.5 mm (.138 in)
Maximum discs warpage	0.2 mm (.008 in)

See your authorized Can-Am dealer if a problem is detected concerning the brake system.

 **WARNING**

The brake fluid replacement or brake system maintenance and repairs should be performed by an authorized Can-Am dealer.

## **Body**

### **Seat Latch**

Remove seat and check latch mechanism. See an authorized Can-Am dealer for parts replacement if damaged.

## **Frame**

### **Frame Inspection**

Check frame for cracks or other damage. See an authorized Can-Am dealer for replace or repair.

Check fastener condition and tightness on the vehicle. See an authorized Can-Am dealer for torque specifications, parts replacement or repairs.

While reading this Operator's Guide, remember that:

 **WARNING**

Indicates a potential hazard that, if not avoided, could result in serious injury or death.



---

## VEHICLE CARE

### Post-Operation Care

When vehicle is used in salt-water environment, rinsing the vehicle with fresh water is necessary to preserve vehicle and its components. Metallic parts lubrication is highly recommended. Use XPS LUBE (P/N 293 600 016) or an equivalent. This must be performed at the end of each operating day.

When vehicle is operated in muddy conditions, rinsing the vehicle is recommended to preserve vehicle and its components and to keep lights clean.

### Vehicle Cleaning and Protection

Never use a high pressure washer to clean the vehicle. **USE LOW PRESSURE ONLY (like a garden hose).** High pressure can cause electrical or mechanical damages. Wrap-up muffler tip to avoid water infiltration in the exhaust system.

Painted parts which are damaged should be properly repainted to prevent rust.

When required, wash the body with warm water and soap (only use mild detergent). Apply non-abrasive wax.

**NOTICE** Never clean plastic parts with strong detergent, degreasing agent, paint thinner, acetone, etc.

---

## STORAGE AND PRESEASON PREPARATION

### **WARNING**

Have an authorized Can-Am dealer to inspect fuel system integrity as specified in *MAINTENANCE SCHEDULE*.

When a vehicle is not in use for more than four months, proper storage is a necessity.

See an authorized Can-Am dealer for proper procedures.

When using your vehicle after storage, a preparation is required. See an authorized Can-Am dealer for proper procedures.

# ***TECHNICAL INFORMATION***

# VEHICLE IDENTIFICATION

The main components of your vehicle (engine and frame) are identified by different serial numbers. It may sometimes become necessary to locate these numbers for warranty purposes or to trace your vehicle in the event of loss. These numbers are required by the authorized Can-Am dealer to complete warranty claims properly. No warranty will be allowed by BRP if the engine identification number (EIN) or vehicle identification number (VIN) is removed or mutilated in any way. We strongly recommend that you take note of all the serial numbers on your vehicle and supply them to your insurance company.

## Vehicle Identification Number



### TYPICAL — VEHICLE SERIAL NUMBER LABEL

1. VIN (Vehicle Identification Number)
2. Model number



1. Vehicle serial number location

## Engine Identification Number



### TYPICAL

1. EIN (Engine Identification Number)

---

# NOISE EMISSION CONTROL SYSTEM REGULATION

## **Tampering with Noise Control System Is Prohibited!**

U.S. Federal law and Canadian provincial laws may prohibit the following acts or the causing there of:

1. The removal or rendering inoperative by any person other than for purposes of maintenance, repair or replacement of any device or element of design incorporated into any new vehicle for the purpose of noise control prior to its sale or delivery to the ultimate purchaser or while it is in use or,
2. The use of the vehicle after such device or element of design has been removed or rendered inoperative by any person.

## **Among those Acts Presumed to Constitute Tampering are the Acts Listed Below:**

1. Removal or alteration or the puncturing of the muffler or any engine component which conducts removal of engine exhaust gases.
2. Removal or alteration or the puncturing of any part of the intake system.
3. Replacing any moving parts of the vehicle or parts of the exhaust or intake system, with parts other than those specified by the manufacturer.
4. Lack of proper maintenance.

While reading this Operator's Guide, remember that:

### **WARNING**

Indicates a potential hazard that, if not avoided, could result in serious injury or death.

# SPECIFICATIONS

<b>MODEL</b>		<b>DS 450/DS 450 X xc/ DS 450 X mx</b>
<b>ENGINE</b>		
Type		BRP Rotax®, 4-stroke. Double overhead camshaft engine, chain drive
Number of cylinder		1
Number of valves		4
Displacement		449.3 cm <sup>3</sup> (27.4 in <sup>3</sup> )
Bore		97 mm (3.82 in)
Stroke		60.8 mm (2.4 in)
Compression ratio		11.8:1
Lubrication	Type	Dry sump lubrication (lubrication of engine and transmission simultaneously)
	Oil filter	Synthetic multi-layer oil filter
Decompressor		Automatic
Exhaust system		BRP, stainless steel
Air filter		2 stage foam filter
<b>TRANSMISSION</b>		
Clutch		Wet-clutch, multi-disc
Transmission		Integrated 5 speeds constant mesh transmission
<b>COOLING</b>		
Type		Liquid cooled with integrated water pump
Radiator		Front mounted with thermostatic fan
<b>FUEL SYSTEM</b>		
Type		Electronic fuel injection with a 46 mm single throttle body
Idle speed		1800 ± 50 RPM (not adjustable)
Fuel pump	Make	Bosch
	Type	Electrical (in fuel tank)

<b>MODEL</b>		<b>DS 450/DS 450 X xc/ DS 450 X mx</b>
<b>ELECTRICAL</b>		
Magneto generator	Make	Denso
	Type	250 W @ 6000 RPM
Ignition type		IDI (Inductive Digital Ignition)
Ignition timing		Not adjustable
Engine RPM limiter		10200 RPM
Spark plug	Make	NGK (apply HEAT-SINK PASTE P12 (P/N 420 897 186) on spark plug threads)
	Type	DCPR9E
	Gap	0.7 mm to 0.8 mm (.028 in to .031 in)
Number of spark plug		2
Battery	Type	Maintenance free battery type
	Volt	12 volts, 7 A•h
Starting system		Electric start. Start in any gear (with clutch applied or on NEUTRAL)
Headlight bulb		2 x 35 W
Taillight and brake light bulb		8/27 W, 1157
Fuses	F1: Main	20 A
	F2: Cooling fan	10 A
	F3: Accessories	10 A
<b>DRIVE TRAIN</b>		
Rear axle		Chain driven/solid axle

**SPECIFICATIONS**

<b>MODEL</b>			<b>DS 450/DS 450 X xc/ DS 450 X mx</b>
<b>SUSPENSION</b>			
Front	Type		Independent suspension - double A-arm
	Shock absorbers	DS 450	HPG
		DS 450 X c	HPG (fully adjustable)
		DS 450 Xmx	Fox Float® X Evol™
	Travel	DS 450 DS 450 X xc	241 mm (9.5 in)
DS 450 X mx		271.8 mm (10.7 in)	
Rear	Type		Rigid swing arm
	Shock absorbers	DS 450	HPG
		DS 450 X xc	HPG (fully adjustable)
		DS 450 X mx	Fox Podium® X
	Travel	DS 450 DS 450 X xc	267 mm (10.5 in) 267 mm (10.5 in)
DS 450 X mx		282 mm (11.1 in)	
<b>TIRES</b>			
Pressure (up to 100 kg (220 lb))	Front	DS 450 DS 450 X xc	48.3 kPa (7 PSI) maximum 34.5 kPa (5 PSI) minimum
		DS 450 X mx	68.9 kPa (10 PSI) maximum 55.2 kPa (8 PSI) minimum
	Rear	DS 450 DS 450 X xc	48 kPa (7 PSI) maximum 34.5 kPa (5 PSI) minimum
		DS 450 X mx	62.1 kPa (9 PSI) maximum 48.3 kPa (7 PSI) minimum
Size	Front	DS 450 DS 450 X xc	21 x 7 x 10
		DS 450 X mx	20 x 6 x 10
	Rear	DS 450 DS 450 X xc	20 x 10 x 9
		DS 450 X mx	18 x 10 x 8



MODEL		DS 450/DS 450 X xc/ DS 450 X mx	
<b>WHEELS</b>			
Size	Front	10 x 5.5	
	Rear	DS 450 DS 450 X xc	9 x 8.5
		DS 450 X mx	8 x 8
Wheel nuts torque		52 N•m (38 lbf•ft)	
<b>BRAKES</b>			
Front		Hydraulic, 2 discs	
Rear		Hydraulic, single disc	
Parking device		RH brake lever includes a parking brake on front wheels	
<b>STEERING</b>			
Toe-in (vehicle on ground and measure on the center of tire tread)		0 mm to 6.35 mm (0 in to .25 in)	
Caster (adjustable on X xc and X mx)		Factory setting: 8°	
Camber (adjustable on X mx)		Factory setting: 12°	
<b>LOADING CAPACITY</b>			
Total vehicle load allowed		100 kg (220 lb) includes operator, all other loads and added accessories	
GVWR (Gross Vehicle Weight Rating)	DS 450	281 kg (620 lb)	
	DS 450 X xc	292 kg (645 lb)	
	DS 450 X mx	283 kg (625 lb)	

**SPECIFICATIONS**

<b>MODEL</b>			<b>DS 450/DS 450 X xc/ DS 450 X mx</b>
<b>DIMENSIONS</b>			
Overall length			1.839 m (72.4 in)
Overall width	DS 450		1.168 m (46 in)
	DS 450 X xc/DS 450 X mx		1.17 m to 1.27 m (46 in to 50 in)
Overall height	DS 450		1.064 m (41.9 in)
	DS 450 X xc		1.05 m (41.5 in)
	DS 450 X mx		1.10 m (43.3 in)
Wheelbase			1.27 m (50 in)
Wheel track (measured at center of tread)	Front	DS 450	1 m (39.5 in)
		DS 450 X xc	1.04 m (40.9 in)
		DS 450 X mx	1.08 m (42.5 in)
	Rear	DS 450	909 mm (35.8 in)
		DS 450 X xc	932 mm (36.7 in)
		DS 450 X mx	997 mm (39.3 in)
Ground clearance	Under frame	DS 450	229 mm (9 in)
		DS 450 X xc	190 mm (7.5 in)
		DS 450 X mx	180 mm (7 in)
	Rear axle	DS 450	124 mm (4.9 in)
		DS 450 X xc	103 mm (4.1 in)
		DS 450 X mx	86 mm (3.4 in)

MODEL		DS 450/DS 450 X xc/ DS 450 X mx
FLUIDS		
Engine oil type		XPS 4-STROKE SYNTH. BLEND OIL (SUMMER) (P/N 293 600 121). <b>Do not use other synthetic oil, synthetic blend oil or additive in Can-Am ATV wet clutch equipped vehicles</b>
Coolant		Ethylene-glycol/water mix (50% coolant, 50% distilled water). Use BRP premixed coolant or a coolant specially designed for aluminum engines
Fuel	Type	Premium unleaded gasoline
	Minimum octane - Refer to <i>FUEL REQUIREMENTS</i>	91 Pump Posted AKI (RON+MON)/2
		95 RON
Hydraulic brake		Brake fluid, DOT 4
CAPACITIES		
Fuel tank		11.5 L (3 U.S. gal.) including an approximate reserve of 1.5 L (3.2 pt (U.S. liq.))
Engine oil		1.8 L (1.9 qt (U.S. liq.))
Coolant		1.8 L (1.9 qt (U.S. liq.))

While reading this Operator's Guide, remember that:

### **WARNING**

Indicates a potential hazard that, if not avoided, could result in serious injury or death.

***This page is  
intentionally blank***

# ***TROUBLESHOOTING***

---

# TROUBLESHOOTING GUIDELINES

---

## ENGINE DOES NOT TURN

---

1. Ignition switch is in the OFF position.
  - Place switch to the ON position.
2. Emergency engine stop switch is in the OFF position.
  - Place switch to the ON position.
3. Transmission is not set on NEUTRAL.
  - Set transmission either in NEUTRAL or depress the clutch lever.
4. Weak battery or loose connections.
  - Check connections and terminals condition.
  - Have the battery checked.
  - Contact an authorized Can-Am dealer.

---

## ENGINE TURNS OVER BUT FAILS TO START

---

1. Blown fuse.
  - Check fuel system fuse.
2. Flooded engine (spark plugs wet when removed).
  - (Drowned mode) If the engine does not start and it is fuel-flooded, this special mode can be activated to prevent fuel injection while cranking. Proceed as follows:
    - Insert key in ignition switch and turn to ON position.
    - Press completely and HOLD throttle lever.
    - Press the engine START button.The engine should be cranked for 20 seconds. Release engine START button.  
Release throttle lever and start/crank engine again to allow starting.  
**If it does not work:**
    - Clean the spark plug caps area then remove them.
    - Remove the spark plugs, refer to MAINTENANCE INFORMATION section.
    - Crank engine several times.
    - Install new spark plugs if possible or clean and dry spark plugs.
    - Start engine as explained above.If engine continues to flood, see an authorized Can-Am dealer.  
**NOTE:** Make sure to verify that there is no fuel in engine oil, if so, replace engine oil.
3. No fuel to the engine (spark plugs dry when removed).
  - Check fuel tank level.
  - A failure of the fuel pump may have occurred.
  - Check fuel system fuse.
  - Contact an authorized Can-Am dealer.

---

**ENGINE TURNS OVER BUT FAILS TO START (cont'd)**

---

**4. Spark plug/ignition (no spark).**

- Check ignition fuse condition.
- Remove spark plugs then reconnect to spark plug caps.
- Check that ignition switch and emergency engine stop switch are at the ON position.
- Start engine with spark plugs grounded to the engine away from spark plug holes. If no spark appears, replace spark plugs.
- If trouble persists, contact an authorized Can-Am dealer.

**5. Engine compression.**

- If no pulsating resistance is felt, it suggests a major loss of compression.
- Contact an authorized Can-Am dealer.

---

**ENGINE LACKS ACCELERATION OR POWER**

---

**1. Fouled or damaged spark plugs.**

- Refer to ENGINE TURNS OVER BUT FAILS TO START.

**2. Lack of fuel to engine.**

- Refer to ENGINE TURNS OVER BUT FAILS TO START.

**3. Engine is overheating (check engine indicator lamp comes ON or flashes).**

- Refer to ENGINE OVERHEATS.

**4. Air filter/housing clogged or dirty.**

- Check air filter and clean if necessary.
- Check liquid/deposits in air filter housing drain tube.

**5. Ignition coil disconnected.**

- Check ignition coils connection.

---

**ENGINE OVERHEATS**

---

**1. Low coolant in cooling system.**

- Check engine coolant refer to MAINTENANCE INFORMATION.
- Ensure cooling fan is working properly.

**2. Dirty radiator fins.**

- Clean radiator fins, Refer to RADIATOR in MAINTENANCE INFORMATION.

**3. Cooling fan inoperative.**

- Check cooling fan fuse, refer to MAINTENANCE INFORMATION. If fan does not work and fuse is good, contact an authorized Can-Am dealer.

---

**ENGINE BACKFIRE**

---

**1. Faulty spark plugs (carbon accumulation).**

- See Refer to ENGINE LACKS ACCELERATION OR POWER.

**2. Exhaust system leakage.**

- Contact an authorized Can-Am dealer.

**3. Engine is running too hot.**

- Refer to ENGINE LACKS ACCELERATION OR POWER.

## ENGINE MISFIRE

---

1. **Fouled/damaged/worn spark plugs.**
  - *Clean/verify spark plugs and heat range. Replace as required.*
2. **Water in fuel.**
  - *Drain fuel system and refill with fresh fuel.*

## UNUSUAL ENGINE NOISE

---

1. **Valve adjustment.**
  - *Contact an authorized Can-Am dealer.*
2. **Chain tensioner.**
  - *Contact an authorized Can-Am dealer.*
3. **Timing chain wear.**
  - *Contact an authorized Can-Am dealer.*

## VEHICLE CANNOT REACH FULL SPEED

---

1. **Engine.**
  - *Refer to ENGINE LACKS ACCELERATION OR POWER.*
2. **Parking brake.**
  - *Ensure parking brake is completely removed.*
3. **Air filter/housing clogged or dirty.**
  - *Check air filter and clean if necessary.*
  - *Check liquid/deposits in air filter housing drain tube.*

## TRANSMISSION DOES NOT SHIFT SMOOTHLY

---

1. **Engine oil level is low.**
  - *Refill oil tank with recommended oil at the proper level.*
2. **Transmission shifting system.**
  - *Try depressing the throttle lever more while up shifting.*
  - *Compress clutch lever longer while down shifting.*
3. **Improper oil type.**
  - *Drain oil in engine and use recommended oil only.*
4. **Transmission.**
  - *See an authorized Can-Am dealer.*

## CHECK ENGINE INDICATOR LAMP STAYS ON

---

1. **Engine is overheating.**
  - *Refer to ENGINE OVERHEATS.*
2. **Low or high battery voltage.**
  - *Check battery voltage and charging system.*
  - *Contact an authorized Can-Am dealer.*



**CHECK ENGINE INDICATOR LAMP FLASHES**

---

1. Engine is under a protection mode (limp home).
  - *Contact an authorized Can-Am dealer.*



# ***WARRANTY***

---

# **BRP LIMITED WARRANTY USA AND CANADA: 2014 CAN-AM™ ATV**

## **1) SCOPE OF THE LIMITED WARRANTY**

Bombardier Recreational Products Inc. ("BRP")\* warrants its 2014 Can-Am ATV sold by authorized Can-Am ATV dealers (as hereinafter defined) in the United States of America ("USA") and in Canada from defects in material or workmanship for the period and under the conditions described below. This limited warranty will become null and void if: (1) the ATV was used for racing or any other competitive activity, at any point, even by a previous owner; or (2) the ATV has been altered or modified in such a way so as to adversely affect its operation, performance or durability, or has been altered or modified to change its intended use.

Except if otherwise specified, all genuine Can-Am ATV parts and accessories installed by an authorized BRP dealer on a 2014 Can-Am ATV at the time of delivery are covered under this limited warranty. Without limiting the generality of the foregoing, the Apache™ and Apache 360™ are not covered under this limited warranty.

## **2) LIMITATIONS OF LIABILITY**

THIS WARRANTY IS EXPRESSLY GIVEN AND ACCEPTED IN LIEU OF ANY AND ALL OTHER WARRANTIES, EXPRESSED OR IMPLIED, INCLUDING WITHOUT LIMITATION ANY WARRANTY OF MERCHANTABILITY OR FITNESS FOR A PARTICULAR PURPOSE TO THE EXTENT THAT THEY CANNOT BE DISCLAIMED, THE IMPLIED WARRANTIES ARE LIMITED IN DURATION TO THE LIFE OF THE EXPRESS WARRANTY. INCIDENTAL AND CONSEQUENTIAL DAMAGES ARE EXCLUDED FROM COVERAGE UNDER THIS WARRANTY SOME STATES/PROVINCES DO NOT ALLOW FOR THE DISCLAIMERS, LIMITATIONS AND EXCLUSIONS IDENTIFIED ABOVE, AS A RESULT, THEY MAY NOT APPLY TO YOU. THIS WARRANTY GIVES YOU SPECIFIC RIGHTS, AND YOU MAY ALSO HAVE OTHER LEGAL RIGHTS WHICH MAY VARY FROM STATE TO STATE, OR PROVINCE TO PROVINCE.

Neither the distributor, any BRP dealer nor any other person has been authorized to make any affirmation, representation or warranty regarding the product, other than those contained in this limited warranty, and if made, shall not be enforceable against BRP. BRP reserves the right to modify this warranty at any time, being understood that such modification will not alter the warranty conditions applicable to the products sold while this warranty is in effect.

## **3) EXCLUSIONS – ARE NOT WARRANTED**

The following are not warranted under any circumstances:

- Normal wear and tear;
- Routine maintenance items, tune ups, adjustments;
- Damage caused by failure to provide proper maintenance and/or storage, as described in the Operator's Guide;
- Damage resulting from removal of parts, improper repairs, service, maintenance, modifications or use of parts not manufactured or approved by BRP or resulting from repairs done by a person that is not an authorized servicing Can-Am ATV dealer;

- Damage caused by abuse, abnormal use, neglect or operation of the product in a manner inconsistent with the recommended operation described in the Can-Am ATV Operator’s Guide;
- Damage resulting from accident, submersion, fire, theft, vandalism or any act of God;
- Operation with fuels, oils or lubricants which are not suitable for use with the product (see the Operator’s Guide);
- Damages from rust, corrosion or exposure to the elements;
- Damage resulting from water or snow ingestion;
- Incidental or consequential damages, or damages of any kind including without limitation towing, storage, telephone, rental, taxi, inconvenience, insurance coverage, loan payments, loss of time, loss of income.

#### **4) WARRANTY COVERAGE PERIOD**

This warranty will be in effect from (1) the date of delivery to the first retail consumer or (2) the date the product is first put into use, whichever occurs first and for the applicable period below:

SIX (6) CONSECUTIVE MONTHS, for private use or commercial use owners, except that emission-related components installed on EPA certified ATVs registered in the USA are covered for 5000 km or thirty (30) consecutive months whichever comes first; and evaporative emission related components are warranted for twenty-four (24) consecutive months. To obtain a list of the current warranted emission-related components, please see an authorized Can-Am ATV dealer.

The repair or replacement of parts or the performance of service under this warranty does not extend the life of this warranty beyond its original expiration date.

#### **5) CONDITIONS TO HAVE WARRANTY COVERAGE**

This warranty coverage is available **only** if **each** of the following conditions has been fulfilled:

- The 2014 Can-Am ATV must be purchased as new and unused by its first owner from a Can-Am ATV dealer authorized to distribute Can-Am ATVs in the country in which the sale occurred (“Can-Am ATV dealer”);
- The BRP specified pre-delivery inspection process must be completed and documented and signed by the purchaser;
- The 2014 Can-Am ATV must have undergone proper registration by an authorized Can-Am ATV dealer;
- The 2014 Can-Am ATV must be purchased in the country in which the purchaser resides;
- Routine maintenance outlined in the Operator’s Guide must be timely performed in order to maintain warranty coverage. BRP reserves the right to make warranty coverage contingent upon proof of proper maintenance.

BRP will not honor this limited warranty to any private use owner or commercial use owner if one of the preceding conditions has not been met. Such limitations are necessary in order to allow BRP to preserve both the safety of its products, and also that of its consumers and the general public.

## **6) WHAT TO DO TO OBTAIN WARRANTY COVERAGE**

The customer must cease using the Can-Am ATV upon the appearance of an anomaly. The customer must notify a servicing BRP dealer within three (3) days of the appearance of a defect, and provide it with reasonable access to the product and reasonable opportunity to repair it. The customer must also present to the authorized BRP dealer, proof of purchase of the product and must sign the repair/work order prior to starting the repair in order to validate the warranty repair. All parts replaced under this limited warranty become the property of BRP.

## **7) WHAT BRP WILL DO**

BRP's obligations under this warranty are limited to, at its sole discretion, repairing parts found defective under normal use, maintenance and service, or replacing such parts with new genuine Can-Am ATV parts without charge for parts and labor, at any authorized BRP dealer during the warranty coverage period under the conditions described herein. No claim of breach of warranty shall be cause for cancellation or rescission of the sale of the Can-Am ATV to the owner.

In the event that service is required outside of the country of original sale, the owner will bear responsibility for any additional charges due to local practices and conditions, such as, but not limited to, freight, insurance, taxes, license fees, import duties, and any and all other financial charges, including those levied by governments, states, territories and their respective agencies.

BRP reserves the right to improve or modify products from time to time without assuming any obligation to modify products previously manufactured.

## 8) SUPPLIER WARRANTIES

A GPS receiver may be supplied by BRP as standard equipment on certain 2014 Can-Am ATV's. The GPS receiver is covered under the limited warranty issued by the GPS receiver's manufacturer and is not covered under this limited warranty. Please contact the following distributors if in Canada or the manufacturer if in the USA:

### In the USA:

Garmin International Inc.  
U.S.: 913 397-8200  
U.S. Toll Free: 1 800 800-1020

Website: [www.garmin.com](http://www.garmin.com)

### In Canada (one or the other):

Raytech Électronique  
Tel.: 450 975-1015  
Fax: 800 975-0025 / 450 975-0817  
Contact: [raytech@raytech.qc.ca](mailto:raytech@raytech.qc.ca)  
Web Site: [www.raytech.qc.ca](http://www.raytech.qc.ca)  
Coord. GPS: N45o35.25' - W73o42.95'

Naviclub Ltd  
Tel.: 418 835-9279  
Fax: 418 835-6681  
Contact: [naviclub@naviclub.com](mailto:naviclub@naviclub.com)  
Web Site: [www.naviclub.com](http://www.naviclub.com)

## 9) TRANSFER

If the ownership of a product is transferred during the warranty coverage period, this warranty shall also be transferred and be valid for the remaining coverage period provided that BRP is notified of such transfer of ownership in the following way:

1. The former owner contacts BRP (at the phone number provided below) or an authorized BRP dealer and gives the coordinates of the new owner; or
2. BRP or an authorized BRP dealer receives a proof that the former owner agreed to the transfer of ownership, in addition to the coordinates of the new owner.

## **10) CONSUMER ASSISTANCE**

In the event of a controversy or a dispute in connection with this limited warranty, BRP suggests that you try to resolve the issue at the dealership level. We recommend discussing the issue with the authorized dealer's service manager or owner.

If the issue has not yet been resolved, please submit your complaint in writing or call the appropriate number below:

### **In Canada**

#### **BOMBARDIER RECREATIONAL PRODUCTS INC.**

CAN-AM ATV

CUSTOMER ASSISTANCE CENTER

75 J.-A. Bombardier Street

Sherbrooke QC J1L 1W3

Tel.: 819 566-3366

### **In USA**

#### **BRP US INC.**

CAN-AM ATV

CUSTOMER ASSISTANCE CENTER

7575 Bombardier Court

Wausau WI 54401

Tel.: 715 848-4957

\* In the USA, products are distributed and serviced by BRP US Inc.

© 2013 Bombardier Recreational Products Inc. All rights reserved.

™ trademark of Bombardier Recreational Products Inc. or its affiliates.

† Carlisle and ITP are trademarks owned by or licensed to Carlisle Tire & Wheel Company.



# ***CUSTOMER INFORMATION***

---

## **PRIVACY INFORMATION**

BRP wishes to inform you that your coordinates will be used for safety and warranty related purposes. Furthermore, BRP and its affiliates may use its customer list to distribute marketing and promotional information about BRP and related products.

To exercise your right to consult or correct your data, or to be removed from the addressee-list for direct marketing, please contact BRP.

**By E-mail:**    [privacyofficer@brp.com](mailto:privacyofficer@brp.com)

**By mail:**        BRP  
Senior Legal Counsel-Privacy Officer  
726 St-Joseph  
Valcourt QC  
Canada  
J0E 2L0

---

## CHANGE OF ADDRESS/OWNERSHIP

If your address has changed or if you are the new owner of the ATV, be sure to notify BRP by either:

- Mailing one of the change of address cards on the following pages.
- Calling at 715 848-4957 (USA) or 819 566-3366 (Canada).
- Notifying an authorized Can-Am dealer.

In case of change of ownership, please join a proof that the former owner agreed to the transfer.

Notifying BRP, even after the expiration of the limited warranty, is very important as it enables BRP to reach the ATV owner if necessary, like when safety recalls are initiated. It is the owner's responsibility to notify BRP.

**STOLEN UNITS:** If your personal ATV is stolen, you should notify BRP or an authorized Can-Am dealer. We will ask you to provide your name, address, phone number, the vehicle identification number and the date it was stolen.

### BOMBARDIER RECREATIONAL PRODUCTS INC.

Warranty Department  
75 J.-A. Bombardier Street  
Sherbrooke QC J1L 1W3  
Canada

***This page is  
intentionally blank***

CHANGE OF ADDRESS CHANGE OF OWNERSHIP 

VEHICLE IDENTIFICATION NUMBER

Model Number

Vehicle Identification Number (V.I.N.)

OLD ADDRESS  
OR PREVIOUS OWNER:

NAME

NO.

STREET

APT

CITY

STATE/PROVINCE

ZIP/POSTAL CODE

COUNTRY

TELEPHONE

NEW ADDRESS  
OR NEW OWNER:

NAME

NO.

STREET

APT

CITY

STATE/PROVINCE

ZIP/POSTAL CODE

COUNTRY

TELEPHONE

E-MAIL ADDRESS

V00A2F

CHANGE OF ADDRESS CHANGE OF OWNERSHIP 

VEHICLE IDENTIFICATION NUMBER

Model Number

Vehicle Identification Number (V.I.N.)

OLD ADDRESS  
OR PREVIOUS OWNER:

NAME

NO.

STREET

APT

CITY

STATE/PROVINCE

ZIP/POSTAL CODE

COUNTRY

TELEPHONE

NEW ADDRESS  
OR NEW OWNER:

NAME

NO.

STREET

APT

CITY

STATE/PROVINCE

ZIP/POSTAL CODE

COUNTRY

TELEPHONE

E-MAIL ADDRESS

V00A2F



CHANGE OF ADDRESS CHANGE OF OWNERSHIP 

VEHICLE IDENTIFICATION NUMBER

Model Number

Vehicle Identification Number (V.I.N.)

OLD ADDRESS  
OR PREVIOUS OWNER:

NAME

NO.

STREET

APT

CITY

STATE/PROVINCE

ZIP/POSTAL CODE

COUNTRY

TELEPHONE

NEW ADDRESS  
OR NEW OWNER:

NAME

NO.

STREET

APT

CITY

STATE/PROVINCE

ZIP/POSTAL CODE

COUNTRY

TELEPHONE

E-MAIL ADDRESS

V00A2F

CHANGE OF ADDRESS CHANGE OF OWNERSHIP 

VEHICLE IDENTIFICATION NUMBER

Model Number

Vehicle Identification Number (V.I.N.)

OLD ADDRESS  
OR PREVIOUS OWNER:

NAME

NO.

STREET

APT

CITY

STATE/PROVINCE

ZIP/POSTAL CODE

COUNTRY

TELEPHONE

NEW ADDRESS  
OR NEW OWNER:

NAME

NO.

STREET

APT

CITY

STATE/PROVINCE

ZIP/POSTAL CODE

COUNTRY

TELEPHONE

E-MAIL ADDRESS

V00A2F









**ATV MODEL No.** \_\_\_\_\_

**VEHICLE IDENTIFICATION NUMBER (V.I.N.)** \_\_\_\_\_

**ENGINE IDENTIFICATION NUMBER (E.I.N.)** \_\_\_\_\_

**Owner:** \_\_\_\_\_  
NAME

\_\_\_\_\_  
No. STREET APT

\_\_\_\_\_  
CITY STATE/PROVINCE ZIP/POSTAL CODE

**Purchase Date** \_\_\_\_\_  
YEAR MONTH DAY

**Warranty Expiry Date** \_\_\_\_\_  
YEAR MONTH DAY

To be completed by the dealer at the time of the sale.

DEALER IMPRINT AREA

V00A2IL

**Please verify with your dealer to ensure your vehicle has been registered with BRP.**

While reading this Operator's Guide, remember that:

** WARNING**

Indicates a potential hazard that, if not avoided, could result in serious injury or death.

 **WARNING****THIS VEHICLE CAN BE HAZARDOUS TO OPERATE.**

A collision or rollover can occur quickly, even during routine maneuvers such as turning and driving on hills or over obstacles, if you fail to take proper precautions.

**SEVERE INJURY OR DEATH** can result if you do not follow these instructions:

- **BEFORE YOU OPERATE THIS VEHICLE, READ THIS OPERATOR'S GUIDE AND ALL ON-PRODUCT PRODUCT LABELS.**
- **NEVER OPERATE THIS VEHICLE WITHOUT PROPER INSTRUCTIONS.**  
Complete a certified training course.
- **NEVER CARRY A PASSENGER.** You increase your risk of losing control if you carry a passenger.
- **NEVER OPERATE THIS VEHICLE ON A PAVED SURFACE.** You increase your risk of losing control if you operate this vehicle on pavement.
- **NEVER OPERATE THIS VEHICLE ON PUBLIC ROADS.** You can collide with another vehicle if you operate this vehicle on a public road.
- **ALWAYS WEAR AN APPROVED HELMET,** eye protection, and protective clothing.
- **NEVER USE WITH DRUGS OR ALCOHOL.** They slow reaction time and impair judgment.
- **NEVER OPERATE THIS VEHICLE AT EXCESSIVE SPEEDS.** You increase your risk of losing control if you operate this vehicle at speeds too fast for the terrain, visibility conditions, or your experience.
- **NEVER ATTEMPT WHEELIES, JUMPS, OR OTHER STUNTS.**

219 001 153

CA

OPERATOR'S GUIDE, DS 450 Series / ENGLISH  
GUIDE DU CONDUCTEUR, Série DS 450 / ANGLAIS

FAIT AU / MADE IN CANADA

U/M:P.C.