

**SEA-DOO**



**SWITCH COMPACT SERIES**

# OPERATOR'S GUIDE

Includes Safety, Use and Maintenance Information

**2025**



## **⚠ WARNING**

Read this guide thoroughly. It contains important safety information.  
Minimum recommended operators age: 16 years old.  
Keep this operator's guide with the watercraft at all times.

**⚠ WARNING**

Disregarding any of the safety precautions and instructions contained in the Operator's Guide, SAFETY VIDEO and on-product safety labels could cause injury including the possibility of death.

## CALIFORNIA PROPOSITION 65 WARNING

**⚠ WARNING**

Operating, servicing and maintaining a recreational marine vessel can expose you to chemicals including engine exhaust, carbon monoxide, phthalates, and lead, which are known to the State of California to cause cancer and birth defects or other reproductive harm. To minimize exposure, avoid breathing exhaust, service your vessel in a well-ventilated area and wear gloves or wash your hands frequently when servicing this vessel. For more information go to:  
[www.p65warnings.ca.gov/marine](http://www.p65warnings.ca.gov/marine)

In Canada, products are distributed and serviced by Bombardier Recreational Products Inc. (BRP).

In the USA, products are distributed and serviced by BRP US Inc.

In the European Economic Area (which is comprised of the member states of the European Union plus the United Kingdom, Norway, Iceland and Liechtenstein), the Commonwealth of the Independent States (including Ukraine and Turkmenistan) and Turkey, products are distributed and serviced by BRP European Distribution S.A. and other affiliates or subsidiaries of BRP.

For all other countries, products are distributed and serviced by Bombardier Recreational Products Inc. (BRP) or its affiliates.

™® Trademarks of BRP or its affiliates.

This is a non-exhaustive list of trademarks that are the property of Bombardier Recreational Products Inc. or its affiliates.

Trademarks may not be registered in every jurisdictions:

ACETM	D.E.S.S.TM	ECOTM	iBR®
iControlTM	iTCM	LinQ®	ROTAX®
SEA-DOO®	Sea-Doo LKTM	SWITCH®	VTSTM
XPS®			

All rights reserved. No parts of this Manual may be reproduced in any form without the prior written permission of Bombardier Recreational Products Inc.

©Bombardier Recreational Products Inc. (BRP) 2024

## Available Languages

Deutsch	Dieses Handbuch ist möglicherweise in Ihrer Landessprache verfügbar. Bitte wenden Sie sich an Ihren Händler oder besuchen Sie: <a href="http://www.operatorsguides.brp.com">www.operatorsguides.brp.com</a>
English	This guide may be available in your language. Check with your dealer or go to: <a href="http://www.operatorsguides.brp.com">www.operatorsguides.brp.com</a>
Español	Es posible que este manual esté disponible en su idioma. Consulte a su distribuidor o visite: <a href="http://www.operatorsguides.brp.com">www.operatorsguides.brp.com</a>
Français	Ce guide peut être disponible dans votre langue. Vérifier avec votre concessionnaire ou aller à: <a href="http://www.operatorsguides.brp.com">www.operatorsguides.brp.com</a>
Italiano	Questa guida potrebbe essere disponibile nella propria lingua. Contattare il concessionario o consultare: <a href="http://www.operatorsguides.brp.com">www.operatorsguides.brp.com</a>
中文	本手册可能有您的语种的翻译版本。请向经销商询问，或者登录 <a href="http://www.operatorsguides.brp.com">www.operatorsguides.brp.com</a> 查询。
日本語	このガイドは、言語によって翻訳版が用意されています。ディーラーに問い合わせるか、次のアドレスでご確認ください： <a href="http://www.operatorsguides.brp.com">www.operatorsguides.brp.com</a>
Nederlands	Deze handleiding kan beschikbaar zijn in uw taal. Vraag het aan uw dealer of ga naar: <a href="http://www.operatorsguides.brp.com">www.operatorsguides.brp.com</a>
Norsk	Denne boken kan finnes tilgjengelig på ditt eget språk. Kontakt din forhandler eller gå til: <a href="http://www.operatorsguides.brp.com">www.operatorsguides.brp.com</a>
Português	Este manual pode estar disponível em seu idioma. Fale com sua concessionária ou visite o site: <a href="http://www.operatorsguides.brp.com">www.operatorsguides.brp.com</a>
Русский	Воспользуйтесь руководством на вашем языке. Узнайте о его наличии у дилера или на странице по адресу <a href="http://www.operatorsguides.brp.com">www.operatorsguides.brp.com</a>
Suomi	Käyttöohjekirja voi olla saatavissa omalla kielelläsi. Tarkista jälleenmyyjältä tai käy osoitteessa: <a href="http://www.operatorsguides.brp.com">www.operatorsguides.brp.com</a>
Svenska	Denna bok kan finnas tillgänglig på ditt språk. Kontakta din återförsäljare eller gå till: <a href="http://www.operatorsguides.brp.com">www.operatorsguides.brp.com</a>

### Covered Models

SWITCH Compact - 130

SWITCH Sport Compact - 170

# TABLE OF CONTENTS

## GENERAL INFORMATION

<b>FOREWORD</b> .....	<b>8</b>
Know Before You Go .....	8
Safety Messages .....	8
About this Operator's Guide .....	8
<b>BE A RESPONSIBLE RIDER</b> .....	<b>9</b>

## SAFETY INFORMATION

<b>BEFORE YOU GO</b> .....	<b>12</b>
Operating Age and Ability .....	12
Drugs and Alcohol .....	12
Safe Boating Courses .....	12
Applicable Boating Laws .....	12
Protective Gear .....	12
Required Equipment .....	13
<b>GET FAMILIAR WITH THE WATERCRAFT</b> .....	<b>14</b>
Jet Thrust .....	14
Steering .....	14
Tether Cord (Safety Lanyard) .....	14
Braking .....	14
Learning Key (available as accessory) .....	15
Cargo and Storage .....	15
Accessories and Modifications .....	15
<b>RIDE SAFELY</b> .....	<b>17</b>
Riding with Passenger(s) .....	17
Avoiding Collisions .....	17
Riding Behaviors .....	18
Speeding .....	18
Reboarding .....	18
Moving Parts .....	19
Know the Waters .....	19
Navigation Rules .....	19
Night-Time Operation .....	20
Carbon Monoxide (CO) Poisoning .....	21
Gasoline Fires and Other Hazards .....	22
Burns From Hot Parts .....	22
Watersports (Towing with the Watercraft) .....	23
<b>PRACTICE EXERCISES</b> .....	<b>26</b>
Where to Practice Exercises .....	26
Practice Exercises .....	26
<b>FUELING</b> .....	<b>28</b>
Fuel Requirements .....	28
Recommended Fuel .....	28
Fueling Procedure .....	29
<b>TRANSPORTING THE WATERCRAFT</b> .....	<b>30</b>
<b>IMPORTANT ON-PRODUCT LABELS</b> .....	<b>32</b>
Watercraft Safety Labels .....	32



Compliance and Capacity labels ..... 63  
 Technical Information Labels ..... 68  
 Hang Tag ..... 71  
**PRE-RIDE INSPECTION ..... 73**  
 What to Do Before Launching the Watercraft ..... 73  
 What to Do After Launching the Watercraft ..... 79  
 What to Do After Leaving the Water ..... 80  
**ANNUAL SAFETY MAINTENANCE ..... 82**

**WATERCRAFT INFORMATION**

**PRIMARY CONTROLS ..... 84**  
 Handlebar ..... 84  
 iTC Lever ..... 84  
 intelligent Brake and Reverse (iBR) Lever ..... 84  
 Master Switch ..... 85  
 Engine Cut-Off Switch ..... 86  
 Engine START/STOP Button ..... 86  
**SECONDARY CONTROLS ..... 88**  
 Right Controller ..... 88  
 Left Controller ..... 88  
 Console Switches ..... 89  
**EQUIPMENT ..... 91**  
 Front and Rear Eyelets ..... 91  
 Horn ..... 91  
 Navigation Lights ..... 91  
 Anchor Storage Compartment ..... 92  
 Front Door ..... 92  
 Single Rear Door (If Equipped) ..... 93  
 Mooring Cleats ..... 93  
 Flooring System Tiles ..... 93  
 Deck Mats and Sun Pads (If Equipped) ..... 94  
 LinQ Attachments ..... 94  
 Front Storage Compartment ..... 94  
 Glove Box ..... 95  
 Rearview Mirror (If Equipped) ..... 95  
 Courtesy Lights (If Equipped) ..... 96  
 BRP Audio System (if equipped) ..... 96  
 Operator's Seat ..... 98  
 Latching System ..... 99  
 Passenger Seats ..... 100  
 Lounge Backrest (If Equipped) ..... 102  
 Corner Table ..... 102  
 USB Port ..... 103  
 12-Volt Power Outlet ..... 103  
 Adjustable Table (If Equipped) ..... 103  
 Inflatable Holder (If Equipped) ..... 105  
 Tow Point ..... 106  
 Ski/Wakeboard Pylon (if equipped) ..... 106  
 Rear Navigation Light Pole ..... 106  
 Boarding Ladder ..... 107  
 Boarding Handle ..... 108

Pontoon Floats Rinsing System .....	108
Bilge Drain Plugs .....	108
Bilge Pump .....	109
Bilge Blower .....	109
Trim Tabs .....	109
<b>4.5" DIGITAL DISPLAY .....</b>	<b>111</b>
Multifunction Gauge Description .....	111
Warning Lamps and Indicators .....	114
Settings .....	116
<b>BREAK-IN PERIOD.....</b>	<b>118</b>
Operation During Break-In Period .....	118
<b>OPERATING INSTRUCTIONS.....</b>	<b>119</b>
Boarding the Watercraft .....	119
Starting the Engine .....	120
Shutting Off the Engine .....	121
Steering the Watercraft .....	121
Shifting into Neutral .....	122
Shifting into Forward .....	122
Shifting into Reverse .....	123
Braking .....	124
Variable Trim System (VTS) .....	125
Activating the Intelligent Debris Free Pump System (iDF System) (if equipped).....	127
General Operating Recommendations .....	128
<b>OPERATING MODES .....</b>	<b>130</b>
Touring Mode .....	130
Sport Mode .....	130
ECO Mode (Fuel Economy Mode).....	130
Cruise Control Mode .....	130
Ski Mode (If Equipped).....	131
<b>SPECIAL PROCEDURES .....</b>	<b>133</b>
Jet Pump Water Intake and Impeller Cleaning.....	133
Capsized Watercraft .....	134
Submerged Watercraft .....	134
Water-Flooded Engine .....	135
Towing the Watercraft in Water .....	135

## **MAINTENANCE**

<b>MAINTENANCE SCHEDULE .....</b>	<b>138</b>
Automatic Fire Extinguisher (If equipped) .....	139
EPA Regulation - Canadian and USA Watercrafts .....	139
Salt Water/ Dirty Water Usage .....	140
Maintenance Schedule.....	140
<b>MAINTENANCE PROCEDURES .....</b>	<b>143</b>
Fuel System Components and Functions.....	143
Engine Access Panels .....	143
Engine Oil .....	144
Engine Coolant.....	146
Ignition Coils .....	147
Spark Plugs.....	147
Exhaust System .....	148

Ride Plate and Water Intake Grate .....	149
Sacrificial Anodes .....	150
Fuses .....	150
Rinsing the Pontoon Floats .....	151
Bimini Top .....	152
<b>WATERCRAFT CARE .....</b>	<b>153</b>
Post-Operation Care .....	153
Deck and Hull .....	153
<b>STORAGE AND PRESEASON PREPARATION .....</b>	<b>155</b>
Storage .....	155
Preseason Preparation .....	158
<b>MAINTENANCE RECORDS .....</b>	<b>159</b>

### **TECHNICAL INFORMATION**

<b>IDENTIFICATION NUMBERS .....</b>	<b>168</b>
Hull Identification Number .....	168
Engine Identification Number .....	168
<b>COMPLIANCE .....</b>	<b>169</b>
Emission Control Hang Tag – 3 Stars .....	169
Emission Control Label .....	170
Emission Control System Information (EPA) Label .....	171
Fuel System Exemption Label .....	172
BRP European Distribution SA .....	173
REP France - TRIMAN Signage .....	173
<b>BRP RF DESS POST GEN3 (CAN) .....</b>	<b>174</b>
USA and Canada .....	174
Mexico .....	175
Brazil .....	175
Japan .....	176
Europe .....	176
<b>BRP AUDIO SYSTEM .....</b>	<b>180</b>
USA and Canada : .....	180
.....	180
Mexico : .....	180
Brazil : .....	181
Japan .....	181
Europe : .....	181
<b>ENGINE EMISSIONS INFORMATION .....</b>	<b>186</b>
Manufacturer's Responsibility .....	186
Dealer's Responsibility .....	186
Owner's Responsibility .....	186
EPA Emission Regulations .....	186
Evaporative Emission Control System .....	186

**TECHNICAL SPECIFICATIONS**

ROTAX 1630 ACE .....188  
 SWITCH COMPACT .....190

**WARRANTY**

BRP LIMITED WARRANTY USA AND CANADA: 2025 SEA-DOO®  
 WATERCRAFT .....196  
 US EPA EMISSION-RELATED WARRANTY .....200  
 CALIFORNIA EVAPORATIVE EMISSIONS CONTROL SYSTEM WAR-  
 RANTY STATEMENT .....203  
 CALIFORNIA AND NEW YORK EMISSION CONTROL WARRANTY  
 STATEMENT FOR MODEL YEAR 2025 SEA-DOO PERSONAL  
 WATERCRAFT .....205  
 BRP INTERNATIONAL LIMITED WARRANTY: 2025 SEA-DOO®  
 WATERCRAFT .....209  
 BRP LIMITED WARRANTY FOR THE EUROPEAN ECONOMIC AREA,  
 THE COMMONWEALTH OF THE INDEPENDENT STATES AND TURKEY:  
 2025 SEA-DOO® WATERCRAFT .....213

**TROUBLESHOOTING**

TROUBLESHOOTING GUIDELINES .....220  
 MONITORING SYSTEM .....226  
     Fault Codes .....226  
     Indicator Lamps Description (4.5" Digital Display) .....227  
     Beeper Code Information .....229

**CUSTOMER INFORMATION**

DATA PRIVACY INFORMATION .....232  
 CONTACT US .....234  
     Asia Pacific .....234  
     Europe, Middle East and Africa .....234  
     Latin America .....235  
     North America .....235  
 CHANGE OF ADDRESS/OWNERSHIP .....236

# GENERAL INFORMATION

# FOREWORD

Congratulations on your purchase of a new Sea-Doo® Switch pontoon (hereinafter referred to as “watercraft”). It is backed by the BRP warranty and a network of authorized Sea-Doo watercraft dealers ready to provide the parts, service or accessories you may require.

Your dealer is committed to your satisfaction. He has taken training to perform the initial setup and inspection of your watercraft as well as completed the final adjustment before you took possession. If you need more complete servicing information, please ask your dealer.

At delivery, you were also informed of the warranty coverage and signed the *Pre-Delivery Check List* to ensure your new watercraft was prepared to your entire satisfaction.

## Know Before You Go

To learn how to reduce the risk for you or other persons being injured or killed, read the following sections before you operate the watercraft:

- *Safety Information*
- *Watercraft Information.*

Read and understand all safety labels on your watercraft and watch attentively the *Safety Video* located at:

<https://www.sea-doo.com/safety>

Or, use the following QR code.



## Safety Messages

This operator’s guide utilizes the following symbols and words to emphasize particular information:

The safety alert symbol  indicates a potential injury hazard.

### DANGER

Indicates a potential hazard which, if not avoided, will result in serious injury or death.

### WARNING

Indicates a potential hazard which, if not avoided, could result in serious injury or death.

### CAUTION

Indicates a potentially hazardous situation which, if not avoided, could result in minor or moderate injury.

### NOTICE

Indicates an instruction which, if not followed, could severely damage watercraft components or other property.

## About this Operator’s Guide

This operator’s guide has been prepared to acquaint the owner / operator or passenger with this watercraft and its various controls, maintenance and safe riding instructions.

Keep this Operator’s Guide in the watercraft as you can refer to it for the operation, instructing others, maintenance and troubleshooting. This operator’s guide needs to remain with the watercraft at all time.

This guide is available in several languages. In the event of any discrepancy, the English version shall prevail.

If you want to view and/or print an extra copy of your operator’s guide, simply visit the following website:

[www.operatorsguides.brp.com](http://www.operatorsguides.brp.com)

The information contained in this document are correct at the time of publication. However, BRP maintains a policy of continuous improvement of its products without imposing upon itself any obligation to install them on products previously manufactured. Due to late changes, some differences between the manufactured product and the descriptions and / or specifications in this guide may occur. BRP reserves the right at any time to discontinue or change specifications, designs, features, models or equipment without incurring any obligation upon itself.



## BE A RESPONSIBLE RIDER

At BRP, we believe there's an opportunity for everyone in the powersports and marine communities to come together and rethink how we approach safety, riding etiquette, and the environment. We believe that when we empower all riders to ride responsibly—to look out for each other and safeguard our trails and playgrounds—we inspire an industry to welcome newcomers, build a more caring community and generate positive experiences.

Whether you ride on trails, roads, water or snow, BRP is committed to driving positive change. That's why we're making the Responsible Rider program a key part of our Corporate Social Responsibility initiative through action, education and community empowerment.

To learn more about Responsible Rider, including tips and tricks on safety, riding etiquette and the environment, visit [sea-doo.com/responsible-rider](https://www.sea-doo.com/responsible-rider)

This page is intentionally blank



# **SAFETY INFORMATION**

---

# BEFORE YOU GO

## WARNING

**Disregarding any of the safety precautions and instructions included in this section could cause injury including the possibility of death. Any potential operator should read and understand this guide before operating the watercraft.**

### Operating Age and Ability

Operators must be qualified. Make sure the operator is 16 or older and has taken a boater safety course. Your state (or province) may have additional requirements. Laws regarding the minimum age and licensing requirements vary from one jurisdiction to another. Be sure to contact the local boating authorities for information regarding the legal operation of a watercraft in the intended jurisdiction of use.

Operation of this watercraft with a disability that impairs vision, reaction time, judgment, or operation of the controls is not recommended.

Remember that sun, wind, fatigue or illness may impair your judgment and reaction time.

Each passenger should be able to use the handhold under the seat when properly seated. They should also be instructed to grab the handrail if needed.

### Drugs and Alcohol

Never ride after consuming alcohol or drugs. Riding on a watercraft requires the operator and passenger(s) to be sober, attentive and alert. The use of drugs and alcohol, singly or in combination, decreases reaction time, impedes judgment, impairs vision, and inhibits your ability to safely ride on a watercraft.

### Safe Boating Courses

Many countries recommend or require a boating safety course. Check with your local competent authorities.

### Applicable Boating Laws

Check boating laws applicable to the waterways where you intend to use your watercraft. Learn the local navigation rules.

### Protective Gear

Watercraft occupants (except children below 12 years old) should wear a properly fitted Personal Flotation Device (PFD) meeting local regulations especially when boating conditions are hazardous.

If not required by law, and when the water conditions are good, occupants (except children below 12 years old) may decide not to wear it, but they **MUST** have quick access to their approved PFD

All children below 12 years old **MUST** wear a properly fitted Personal Flotation Device (PFD) meeting local regulations at all times.

Footwear, gloves, safety goggles or glasses can be worn. Wind, water spray, bugs and speed may cause a person's eyes to water and create blurred vision.

If you are planning a ride in cold weather or water, consider adding appropriate warm clothing. Not only will it make your ride more comfortable, but it may delay or protect you from hypothermia if you fall into cold water. Be prepared for changing conditions.

## Required Equipment

As the owner of the watercraft, you are responsible for ensuring that all required safety equipment is aboard. Check your local regulations about requirements.

This could include:

- Fire extinguisher. Maintenance, repair and refilling must be carried out in accordance with the manufacturer's instructions.
- Watertight flashlight or approved flares
- Sound-producing device (horn, whistle or bell etc.)
- Visual Distress Signal
- Phone in a watertight compartment designed for this application
- Current local map
- First aid kit
- Throw rope
- Paddle.

---

# GET FAMILIAR WITH THE WATERCRAFT

The performance of this watercraft may exceed the performance of other watercrafts you may have operated. Do not assume that all watercrafts handle identically.

Make sure you read and understand the content of this operator's guide to become completely familiar with the controls and operation of the watercraft before embarking on your first trip, or taking on a passenger(s). If you have not had the opportunity to do so, practice in a suitable traffic-free area to become accustomed to the feel and response of each control. Be fully familiar with all controls before accelerating above idle speed.

## Jet Thrust

Your watercraft features a jet drive propulsion system. The water is drawn up from underneath the watercraft from the intake grate and is accelerated by the venturi to produce thrust. This accelerated water is expelled at the rear of the craft.

The jet pump may pick up debris and throw it rearward causing a risk of injuring people, damaging the jet pump, or other property.

Do not start the engine or operate the watercraft if anyone is in the water nearby, or near the rear of the watercraft.

## Steering

Your watercraft has a steerable nozzle at the rear of the boat controlled by the handlebars which direct the stream of water from left to right. To turn the watercraft, both steering and power are necessary.

Do not release the throttle when trying to steer away from objects — as with other powerboats, you need power to steer.

If the engine is shut off, steering is lost.

## Tether Cord (Safety Lanyard)

Keep the tether cord clip attached to the operator's PFD or wrist (wrist strap required) at all times and keep it free from snagging on the handlebars to help ensure the engine stops should the operator fall off.

If the operator falls off the watercraft and the tether cord is not attached as recommended, the engine will not stop and the watercraft will keep running without a driver. The operator may not be able to swim back to it.

After riding, always remove the tether cord from the engine cut-off switch to avoid unauthorized use by children or others and to prevent starting in a closed environment (e.g.: garage).

To prevent accidental starting, always detach the tether cord from the engine cut-off switch when swimmers are boarding, nearby, or during removal of any weeds or debris from the intake grate.

## Braking

Most watercraft have no means of braking.

This watercraft is equipped with a braking system called the iBR (intelligent Brake and Reverse). Practice braking maneuvers in a safe traffic-free area to become familiar with handling under braking and with stopping distances under various operating conditions.

Stopping distance will vary depending on initial speed, load, wind, number of passengers and water conditions. The amount of braking power commanded by the operator using the iBR lever will also affect stopping distance.

When braking, passengers must brace themselves against the deceleration force to prevent from moving forward on the watercraft and losing balance.

When operating an iBR equipped watercraft, be aware that other boats following or operating in close proximity may not be able to stop as quickly. Inform the operator of a watercraft who intends to follow you in a convoy formation of the braking capability of your watercraft and the need of keeping a greater distance between watercraft.

The brake feature of the iBR system cannot prevent your watercraft from drifting due to current or wind. It has no braking effect on rearward velocity. Also note that your engine must be running to be able to use the brake.

## Learning Key (available as accessory)

The Sea-Doo LK™ learning key limits the speed of the watercraft. It could be an option for first time users and less experienced operators to learn how to operate the watercraft.

Visit your BRP authorized Sea-Doo dealer to see if this accessory is available for your model.

## Cargo and Storage

Do not store any objects in areas that are not designed specifically for storage.

When carrying loads, make sure to distribute the cargo in the watercraft and secure the items properly.

Do not exceed the payload or passenger capacities for your watercraft. Overloading can affect manoeuvrability, stability and performance. Also, heavy seas reduce capacity.

Refer to *Technical Specifications* for the maximum loading capacity.

## Accessories and Modifications

Any modifications or addition of accessories approved by BRP may affect the handling of your vehicle. It is important to take the time to get familiar with the vehicle once modifications are made to understand how to adapt your driving behavior accordingly.

Avoid installing equipment not specifically approved by BRP for the vehicle and avoid unauthorized modifications. These modifications and equipment have not been tested by BRP and may create hazards. For example, they could:

- Create a loss of control and increase risk of crash
- Cause overheating or short circuits increasing the risk of fire or burn injuries

- Affect the protection features provided by the vehicle.

Your vehicle may also become illegal to ride.

As an example, installing an additional GPS or cell phone support may prevent the driving capabilities of the vehicle and increase the risk of a loss of control.

**Ask your authorized BRP dealer for suitable available accessories for your vehicle.**

For safety reasons, some BRP accessories must be installed by a BRP dealer but if you decide to install the accessory by yourself, when not required to be done by the dealer, it is important to follow the instructions carefully and, if applicable, understand all the information on how to use the product or for servicing.

If the accessory has been installed on your vehicle by another person than you, BRP strongly recommends you to read the corresponding instruction sheet as there may be more information on how to use it safely or for servicing.

The instruction sheets can be found at:

***INSTRUCTIONS.BRP.COM***

---

# RIDE SAFELY

## Riding with Passenger(s)

The operator is responsible for the safety of the crew. He must inform and protect the passenger(s) invited to ride.

Load the watercraft evenly and under the maximum capacity. When possible, secure things so they do not shift. Passengers should be evenly distributed on the watercraft. Refer to Compliance and Capacity labels to check the maximum passenger capacity and the correct underway seating position for your watercraft.

Instruct all passenger(s) to be properly seated when the engine is running. When the watercraft is moving, each passenger should hold on to the handhold under the seat cushion or to the handrail. Remind your passengers to avoid sudden movements.

Avoid aggressive operation, sharp turns, and unexpected acceleration or deceleration. Passengers can fall or can be thrown off the watercraft during unexpected acceleration or aggressive operation.

When braking or decelerating, passengers must brace themselves against the deceleration force to prevent from moving forward on the watercraft and losing balance

Riding with passenger (s) makes the watercraft handle differently and requires greater skill.

Make sure that every passenger has a seat properly installed. Refer to Passenger Seat in Equipment.

### WARNING

**Do not stand on seats or folded backrest at any given time. Falling and/or getting stuck might occur which can result in severe injury or death.**

If swimming is part of the trip, prepare this activity before boarding.

### WARNING

**Avoid severe injury or death:**

- **Never swim alone near the watercraft or leave it unattended. If you are separated from the watercraft, wind and current may carry the watercraft faster than you can swim.**
- **Make sure at least one qualified operator stays aboard when others are in the water.**
- **Never attempt to swim underneath the watercraft or between the pontoons. You could get caught under the watercraft or in the engine intake grate and drown.**
- **Turn OFF the engine when around swimmers.**
- **Always supervise children in water.**

## Avoiding Collisions

Scan your surroundings constantly for people, objects and other watercraft.

Stay far enough away from others so you can always safely coast to a stop. Do not release throttle when trying to steer away from objects – as with other powerboats, you need throttle to steer.

Be alert for conditions that may limit your visibility or block your vision of others.

Do not go near others to spray or splash them with water, go too close to other boats, or go too fast for traffic conditions. You may misjudge the ability of the watercraft or your own riding skills and strike a boat or person.

If your watercraft is equipped with a braking system, be aware that other boats following or operating in close proximity may not be able to stop as quickly.

Stopping distance will vary depending on initial speed, load, wind and water conditions. The amount of braking power commanded by the operator using the iBR lever will also affect stopping distance.

Although the preferable manoeuvre to avoid an obstacle is to steer away while applying throttle, the iBR can also be used by fully braking and turning in the direction to avoid the obstacle.

## **Riding Behaviors**

Ride within your limits and level of riding ability.

Scan constantly for people, objects and other watercraft. Stay far enough away from others so you can always safely coast to a stop.

Avoid aggressive operation, sharp turns, and unexpected acceleration that can cause riders to be thrown off.

Avoid riding in very rough waters or practicing extreme manoeuvres like jumping wakes or waves - jumping can cause injuries such as back or spinal injuries (paralysis).

## **Speeding**

While your watercraft has the capacity of operating at high speeds, it is strongly recommended that high-speed operation only be applied when ideal conditions exist and are permitted. Higher speed operation requires a higher degree of skill and increases the risk of severe injuries.

The forces generated on the body of riders while turning, negotiating waves or wakes, operating in choppy waters, or falling off the watercraft, especially at higher speeds, may cause injury including the possibility of broken bones or more serious bodily injuries.

## **Reboarding**

Operator and passenger(s) need to know how to swim and how to reboard the watercraft from the water. Boarding in deep water can be strenuous.

Also, make sure you and all passengers know how to reboard with the boarding ladder:

1. Cut off the engine.



2. Deploy the ladder completely.
3. While climbing up, stay on the center of the ladder and keep fingers clear of the pinching points. Always face the ladder when using it.
4. Store the ladder properly before starting the engine.

Ask inexperienced riders to practice this boarding procedure close to shore before venturing into deep water.

To prevent accidental starting, always detach the tether cord from the engine cut-off switch when passenger(s) swimmers are boarding.

## Moving Parts

Never turn handlebar while someone is near the rear of watercraft. Keep away from steering moving parts (nozzle, iBR gate, linkages, etc.).

Keep away from the intake grate while the engine is running. Items such as long hair, loose clothing, or PFD straps can become entangled in moving parts.

Be aware of the iBR gate movement when starting the engine, shutting down the engine or using the iBR lever. Automatic movement of the gate may squeeze fingers or toes of people taking a hold on the back of your watercraft.

## Know the Waters

Know the waters in which the watercraft is to be operated.

Plan your route and avoid shallow waters or hidden rocks, rapids, as well as other possible risks. When leaving dock always inform someone you trust on land of your planned route, and estimated time of arrival. They can then contact rescue if you are late and did not reach them.

Current, tides, rapids, hidden obstacles, wakes and waves, etc., can affect safe operation. It is not advisable to operate the watercraft in rough waters or inclement weather. Keep an eye on the weather. Check local weather broadcasts before departure. Be alert to changing conditions.

Keep accurate and up-to-date charts of the boating area on board. Before getting underway, check water conditions in the planned boating area.

Ensure there is enough fuel on board for the planned trip. Always verify fuel level before use and during the ride. Apply the principle of 1/3 of the fuel to reach your destination, 1/3 to return, and keep 1/3 in reserve. Allow for changes due to adverse weather or other delays.

In shallow water, proceed with caution and at very low speeds. Grounding or abrupt stops may result in injury and watercraft damage. The two floats and the hull increase the risk of impact. Always be alert for debris and objects in the water. They could be picked up and thrown rearward by the jet pump onto people.

## Navigation Rules

Always ride responsibly and safely. Use common sense and courtesy.

Operating a watercraft can be compared with driving on unmarked highways and roads. To prevent collisions or avoid other boaters, a system of operating rules must be followed. Generally keep to your right and safely avoid collisions by keeping a safe distance from other watercrafts, boats, people and objects.

Make sure you know and understand the navigation system applicable to the waterways where you intend to use the watercraft.

Navigational aids on shore or on waters, such as signs or buoys, can assist you in identifying safe waters. They can indicate:

- whether you should keep to the right (starboard) or to the left (port) of the buoy
- which channel you can continue
- whether you are entering a restricted or controlled area such as a no wake or low speed zone
- hazards
- speed limits, no power craft or boating, anchorage and other useful information.

Respect no wake zones, the environment, and the rights of other users of the waterways.

## Night-Time Operation

This watercraft is equipped with navigation lights.

**NOTE:** It is important to know and follow all laws related to the use of the navigation lights.

### Rear Navigation Light (White)

The rear navigation light is mounted on a removable pole. Refer to *Equipment* for installation procedure and storing location.

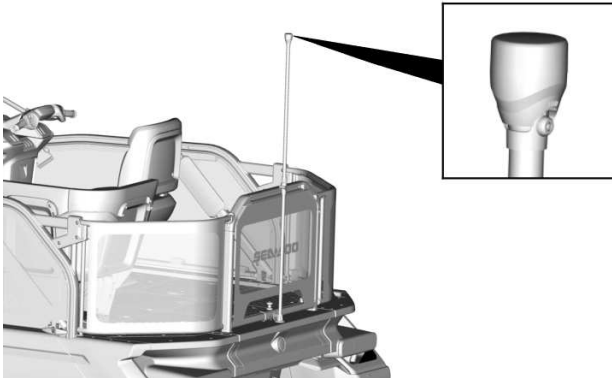

**REAR NAVIGATION LIGHT**

Use this light while your watercraft is anchored on the water after dark so that other boaters can see your watercraft.

While at rest, with the anchor down, set the switch on the console to the anchor position.

Once underway again, return the switch to the navigation position.

### Front Navigation Lights (Red and Green)

The front navigation lights are a set of one red light and one green light at the front of the watercraft.

The red navigation light is always on the port (left) side of the watercraft.

The green navigation light is always on the starboard (right) side of the watercraft.

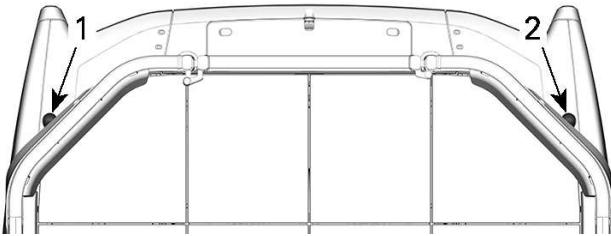

#### FRONT NAVIGATION LIGHTS

1. Red Navigation Light
2. Green Navigation Light

**NOTE:** Keep this information in mind as you watch other boats navigating in the area.

Watercrafts must display navigation lights when they are being operated between sunset and sunrise and during periods of poor visibility, including rain and fog.

These lights help to alert other boaters of your presence and course.

### Carbon Monoxide (CO) Poisoning

All engine exhaust contains carbon monoxide (CO), a deadly gas. Breathing carbon monoxide can cause headaches, dizziness, drowsiness, nausea, confusion and eventually death.

Carbon monoxide is a colorless, odorless, tasteless gas that may be present even if you do not see or smell any engine exhaust. Deadly levels of carbon monoxide can collect rapidly, and you can quickly be overcome and unable to save yourself. Also, deadly levels of carbon monoxide can linger for hours or days in enclosed or poorly ventilated areas. If you experience any symptoms of carbon monoxide poisoning, leave the area immediately, get fresh air and seek medical treatment.

To prevent serious injury or death from carbon monoxide:

- Never run the watercraft in poorly ventilated or partially enclosed areas such as boat houses, garage, seawalls or other boats in close proximity. Even if

- you try to ventilate engine exhaust, carbon monoxide can rapidly reach dangerous levels.
- Never run the watercraft outdoors where engine exhaust can be drawn into a building through openings such as windows and doors.
  - Never stand behind the watercraft while the engine is running. A person standing behind a running engine may inhale high concentrations of exhaust fumes.
  - Never run the engine at idle for a long period of time. Depending of the wind speed and orientation, it may push the exhaust fumes into the boat and increase the risk of carbon monoxide poisoning to occupants.
  - Never ride the watercraft for a long period of time in the transition zone where the boat is dragging water before getting on plane. In this transition zone the exhaust gases can be drawn into the boat and increase the risk of carbon monoxide poisoning to occupants.

After riding, always remove the tether cord from the engine cut-off switch to avoid unauthorized use by children or others and to prevent starting in a closed environment (ex: garage).

## Gasoline Fires and Other Hazards

Gasoline is extremely flammable and highly explosive. Fuel vapors can spread and be ignited by a spark or flame many feet away from the engine. To reduce the risk of fire or explosion, follow these instructions:

- Never attempt to service the fuel system yourself. Servicing the engine installed in this watercraft require special tools, training and identical replacement parts. The fuel system should be serviced only by BRP trained technician.
- Use only an approved red gasoline container to store fuel.
- Strictly adhere to the instructions in *Fueling* section.
- Never start watercraft if gasoline or gasoline vapor odors is present in the engine compartment.
- Never start or operate the engine if the fuel cap is not properly secured.
- Do not carry gasoline containers in ANY of the storage compartments.
- Use only a BRP approved LinQ fuel caddy, which shall be properly installed and secured.
- Never refill the fuel caddy on the watercraft, refill on the dock or shore.

Gasoline is poisonous and can cause injury or death.

- Never siphon gasoline with your mouth.
- If you swallow gasoline, get any in your eyes, or inhale gasoline vapors, see a doctor immediately.

If gasoline is spilled on you, wash thoroughly with soap and water and change your clothes.

## Burns From Hot Parts

Certain components may become hot during operation. Avoid contact during and shortly after operation to avoid burns.

---

## **Watersports (Towing with the Watercraft)**

### ***Attachment and Towing Devices***

This watercraft comes equipped with a tow point suitable for a ski, wakeboard or tube tow rope.

It is recommended not to tow more than one device (ski, wakeboard, tube, etc.) at the same time.

Do not use these attachment points or any other portion of the watercraft to tow a parasail, kites, gliders or any devices which can become airborne or for pulling any other craft. Personal injury or severe damage may occur.

### ***Watercraft Capacity When Towing***

Always carry an observer to observe the person being towed and inform the operator about the participant's hand signals. The operator must focus his attention on operating the watercraft and the waters ahead.

You need to have seats for everyone: operator, observer, towed person. Therefore, if you are the only vessel, your watercraft must have a seating capacity of 3 or more and you can tow only one person.

### ***Towing and Observing***

If you have never towed someone behind your watercraft before, it is a good idea to spend some hours as an observer, working with and learning from an experienced operator. It is also important to be aware of the skill and experience of the person being towed.

Pulling a tube, skier or wakeboarder makes the watercraft handle differently and requires greater skill.









Always respect the safety and comfort of the person being towed.

Proceed with only as much speed as required and follow the observers' instructions.

Never make sharp turns while towing skier or rider(s). Sharp turns may result in sudden acceleration or the skier's/ rider's speed. Do not use the braking system unless absolutely necessary. Remember that although this watercraft is manoeuvrable and has stopping capabilities, the person in tow may not be able to avoid an obstacle, or your watercraft.

The driver, the observer and the person being towed, skier or rider(s), need to learn the hand signals before departure.

**Hand Signals**

<p><b>1. Speed up</b> Thumbs up</p>		<p><b>5. Cut motor</b> Slashing hand across throat</p>	
<p><b>2. Slow down</b> Thumbs down</p>		<p><b>6. OK after fall</b> Hands clasped over the head</p>	
<p><b>3. Turn</b> Circling motion above head followed by pointing in the direction of the turn</p>		<p><b>7. Stop</b> Hand raised with fingers outstretched</p>	
<p><b>4. Back to shore</b> Pat top of head</p>		<p><b>8. All OK</b> An "0" made with the thumb and index finger</p>	

The best seat as an observer should be one where the observer can see both the operator and the skier, wakeboarder or rider(s). Make sure the operator can see and hear the observer for instructions.

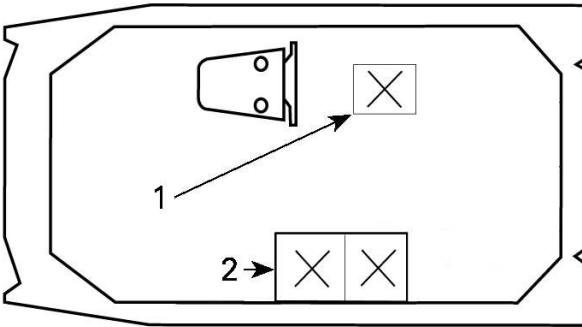

**TYPICAL**

1. Operator
2. Observer

**⚠ CAUTION**

**Make sure the rear view is clear at all times when someone is practicing watersports. The Observer must be able to see the person(s) being towed.**

Participate in watersports only in safe areas. Stay away from other watercrafts, channels, beaches, restricted areas, swimmers, and heavily travelled waterways and underwater obstructions.

 **WARNING**

**Never participate in watersports in the dark or with low visibility weather.**

***Fallen Skier or Rider***

Any fall may result in injury: Give immediate attention to a person who has fallen. He or she is vulnerable in the water alone and may not be seen by other boaters.

Always keep the fallen skier or rider in view and on the driver's side of the watercraft. Circle fallen skier or rider slowly to return the tow rope handle or pick up the fallen skier/ rider. Always turn engine OFF when a skier/ rider is getting into or out of the watercraft or is near the watercraft.

***Tow Rope***

Never wrap the tow rope around your wrist, hand, or any body part. The rope may suddenly lose its slack and cause serious injuries, such as amputation.

Both the operator and observer shall monitor the location of the tow rope when participating in water sports. A slack tow rope can become entangled with a person(s) or objects on the watercraft or in the water, particularly when making a tight turn or circling, and cause serious personal injury.

Do not pull the tow rope in front of other boats and be careful not to run over the rope with the watercraft because it could get trapped in the jet pump.

Do not tow a person in any water sport on a short tow rope such that the person inhales exhaust fumes in concentration. Inhalation of concentrated exhaust fumes, which contain carbon monoxide, can result in CO poisoning, personal injury and death.

Always use a tow rope of proper tensile strength and of sufficient length. Inspect the rope and connectors before each use. Do not use if damaged. Make sure that the tow rope is adequately secured to your watercraft.

Always disconnect and safely stow the tow rope in the watercraft when not in use. While some watercraft are equipped or can be fitted with a specially designed towing mechanism, avoid installing a tow pole on a watercraft. It can become a hazard should someone fall on it.

---

# PRACTICE EXERCISES

It is always a good idea to practice and get familiar with all controls, functions and handling characteristics of your watercraft before venturing on the water.

## Where to Practice Exercises

Find a suitable area to practice the exercises. Ensure that the area meets the following requirements:

- No traffic
- No obstacles
- No swimmers
- No current
- Ample space to maneuver
- Adequate water depth

## Practice Exercises

Practice the following exercises.

### *Turning*

Practice turning in circles in both directions at slow speed.

When comfortable with the exercise, increase difficulty by making some figure 8.

When this is mastered, repeat the above exercises but at increased speed.

### *Stopping Distances*

Practice stopping the watercraft in a straight line at various speeds and braking force. Remember that watercraft speed, load, water conditions, current and wind also affect stopping distances.

Practice releasing the throttle while going at speed and feel the deceleration rate with different speed.

Repeat exercise, but this time while applying iBR lever (if equipped). Note that the iBR system takes control of the throttle.

### *Steering and Avoiding an Obstacle*

Practice obstacle avoidance (choose a virtual point on the water) by steering watercraft and maintaining throttle.

Repeat exercise, but this time release throttle while turning.

Repeat exercise, but this time while applying iBR lever (if equipped). Note that the iBR system takes control of the throttle.

### **NOTE:**

With this exercise, you will learn that you need throttle to steer the watercraft in a different direction.

### *Reverse*

Practice reverse operation to learn how the watercraft operates in reverse and reacts with steering inputs.



**NOTE:**

Remember that steering direction is reversed when backing.

***Docking***

Practice docking using the throttle, the steering and the iBR to become familiar with the response of the watercraft and to develop good control skills.

***Slow Speed Mode, Ski Mode and Speed Limiter Mode (if equipped)***

If your watercraft has any of these modes, it is also important to understand their operation and to become familiar with these features prior to using them on a ride with other people.

** WARNING**

**The ski and the speed limiter modes are not an automatic pilot; they will not drive the watercraft for you.**

# FUELING

## Fuel Requirements

### NOTICE

**Always use fresh gasoline.**

Gasoline will oxidize; the result is loss of octane, volatile compounds, and the production of gum and varnish deposits which can damage the fuel system.

Alcohol fuel blending varies by country and region. Your vehicle has been designed to operate using the recommended fuels, however, be aware of the following:

- Use of fuel containing alcohol above the percentage specified by government regulations is not recommended and can result in the following problems in the fuel system components:
  - Starting and operating difficulties.
  - Deterioration of rubber or plastic parts.
  - Corrosion of metal parts.
  - Damage to internal engine parts.
- Inspect frequently for the presence of fuel leaks or other fuel system abnormalities if you suspect the presence of alcohol in gasoline exceeds the current government regulations.
- Alcohol blended fuels attract and hold moisture which may lead to fuel phase separation and can result in engine performance problems or engine damage.

## Recommended Fuel

The gasoline must have the following minimum octane requirements:

### Recommended Fuel

Use common gasoline with an AKI (RON+MON)/2 octane rating of 87 or an RON octane rating of 91.

Use unleaded gasoline containing MAXIMUM 10% ethanol.



NEAR FUEL CAP

### NOTICE

**Never experiment with other fuels. Engine or fuel system damages may occur with the use of an inadequate fuel.**

### NOTICE

**Do NOT use fuel from fuel pumps labeled E85.**

Use of fuel labeled E15 is prohibited by U.S. EPA Regulations.

## Fueling Procedure

### WARNING

**Gasoline is extremely flammable and highly explosive under certain conditions. Follow the instructions in this section explicitly. Improper handling of fuel could result in property damage, serious injury or death. Leaking fuel is a fire and explosion hazard. Inspect system for leaks frequently.**

Fuel is flammable and explosive under certain conditions. Do not smoke or allow open flames or sparks in the vicinity.

If the watercraft is equipped with a full enclosure, it is recommended to open a section to ventilate adequately while fueling the gas tank.

1. Stop the engine.
2. If on the water, moor the watercraft securely to the dock.
3. The operator and passenger(s) must get off of the watercraft.
4. Unzip the canvas to get access to the fuel tank cap.
5. Open the fuel cap slowly in a well ventilated area to stabilize pressure.

### NOTE:

A short whistling sound is normal.

6. Insert the spout into the filler neck.
7. Pour fuel slowly so the air can escape from the tank and prevent fuel flow back. Be careful not to spill fuel.
8. Stop filling after the release of the gas pump nozzle handle and wait a moment before removing the spout. Do not retract the gas pump nozzle to put more fuel into the fuel tank. Do not overfill.
9. Reinstall the fuel tank cap and tighten it clockwise until you hear a ratchet sound.
10. Always wipe off any fuel spillage from the watercraft.
11. Zip the canvas opening.

---

# TRANSPORTING THE WATERCRAFT

**NOTE:** For complete information about the trailer, refer to the appropriate *User's Guide*.

Ensure the weight is properly distributed and the tongue weight is roughly 7-12% of the total weight of the trailer and watercraft. Move or remove items if necessary.

Carry the watercraft in its normal operating position.

Check the applicable laws and regulations in your area concerning towing a trailer, especially for the following items:

- Brake system
- Tow vehicle weight
- Mirrors.

Respect tow vehicle maximum weight capacity and the tongue weight capacity as recommended by the manufacturer.

Tie the watercraft to both front and rear (bow / stern) eyelets so that it is firmly secured on the trailer. Use additional tie-downs if necessary.

Ensure fuel tank cap and all accessories are properly latched.

Make sure all cargo on the watercraft is properly secured, or remove it to prevent from falling on the road and create a hazard for following vehicles.

**⚠ WARNING**

**Make sure to lower the bimini roof if equipped before departure.**

Observe trailering safety precautions.

Do not route ropes or tie-downs over the seat or attach them to the hand rails to avoid these parts permanently damaged. Wrap ropes or tie-downs with rags or similar protectors where they can come into contact with the watercraft body.

When trailering, it is recommended to use a cover to protect the watercraft from the elements and debris.

**⚠ WARNING**

**Make sure all seats, accessories and cargo are properly secured, or remove it to prevent from falling on the road and creating a hazard for following vehicles.**

For more information, see the following video:

<https://www.youtube.com/watch?v=mXtHWIdt7yl>

Or, use the following QR code.



---

# IMPORTANT ON-PRODUCT LABELS

## Watercraft Safety Labels

These labels are affixed to the vehicle for the safety of the operator, passengers or bystanders.

The operator and when applicable, the passenger, shall read and understand this information before riding.

The labels illustrated on the following pages are on your watercraft. If missing or damaged, they can be replaced free of charge. See an authorized Sea-Doo dealer.

### **NOTE:**

In the event of any discrepancy between this guide and the vehicle, the safety labels on the vehicle have precedence over the labels in this guide.

## Fueling Procedure – Warning Label

### NOTICE

For optimal performance with the 300 engine, use premium unleaded gasoline with an AKI (RON+MON)/2 octane rating of 91, or a RON octane rating of 95.

### ⚠ WARNING / AVERTISSEMENT

**AVOID SERIOUS INJURY OR DEATH FROM FIRE OR EXPLOSION RESULTING FROM LEAKING FUEL**

Inspect system for leaks frequently.

**ÉVITER LES BLESSURES GRAVES OU LA MORT RÉSULTANT D'UNE EXPLOSION OU D'UN INCENDIE PROVOQUÉ PAR UNE FUITE DE CARBURANT**

Inspecter le système régulièrement pour s'assurer qu'il n'y a aucune fuite.

E10

### ⚠ WARNING

- Before fueling, turn off engine, with no one aboard and boat level.
- Keep craft away from open flames and sparks, no smoking.
- Open slowly in well ventilated area, contents can be under pressure.
- Use regular unleaded gasoline.
- Never use gasoline with ethanol content higher than 10%.
- Do not overfill.
- Wipe up spilled gasoline.

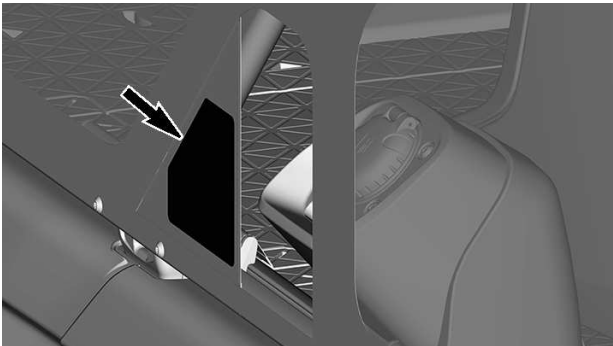

# General Information – Warning Label

## ⚠ WARNING

### CARBON MONOXIDE (CO) EXPOSURE CAN CAUSE BRAIN DAMAGE OR DEATH.

Engine and generator exhaust contains odorless and colorless carbon monoxide gas.

Signs of carbon monoxide poisoning include nausea, headache, dizziness, drowsiness and lack of consciousness.

**MOVE TO FRESH AIR** if anyone shows signs of carbon monoxide poisoning.

See Operator's Guide for additional information regarding carbon monoxide poisoning.



## ⚠ WARNING

### GASOLINE VAPOR CAN EXPLODE RESULTING IN INJURY OR DEATH. BEFORE STARTING THE ENGINE:

- verify engine space for gas leaks or vapors
- operate blower for 4 minutes
- verify blower operation



## ⚠ AVERTISSEMENT

### LES VAPEURS D'ESSENCE PEUVENT EXPLOSER CAUSANT DES BLESSURES OU LA MORT.

- AVANT DE DÉMARRER LE MOTEUR:**
- vérifier le compartiment moteur pour les fuites ou les vapeurs d'essence
  - faire fonctionner le ventilateur pendant 4 minutes
  - vérifier l'opération du ventilateur

## ⚠ WARNING

Failure to follow these warnings could cause SEVERE INJURY or DEATH.

- **VISIBILITY FROM THE SEATED POSITION AT THIS HELM STATION IS LIMITED.** Operation from a standing position may be necessary.
- **OPERATE BLOWER** to clear gasoline vapors from engine compartment when engine is a idle, while below cruising speed and after stopping engine.
- **CHECK WEATHER FORECAST BEFORE DEPARTING DOCK** and heed all weather advisories.
- **WEAR SAFETY LANYARD** at all times while operating boat to prevent unmanned boat operation.
- **NEVER OPERATE WHILE UNDER THE INFLUENCE** of drugs or alcohol.
- **DO NOT OVERLOAD THE BOAT. ENSURE THAT WEIGHT IS PROPERLY AND EVENLY DISTRIBUTED** fore and aft and on both sides of the boat to avoid poor handling, sudden loss of control, swamping and/or capsizing.
- **OCCUPANTS SHOULD WEAR A PERSONAL FLOTATION DEVICE THAT IS COMPLIANT WITH LOCAL REGULATIONS.**
- **MAKE SURE THAT ALL PASSENGERS ARE PROPERLY SEATED WHILE UNDERWAY.** To avoid passengers falling overboard or being ejected from the boat, do not allow passengers to sit on seat backs, gunwales or outermost deck edges while boat is moving.
- **REDUCE SPEED BEFORE ATTEMPTING SUDDEN OR SHARP TURNS, AND MAINTAIN SAFE SPEEDS** for water conditions and environment at all times. Maneuverability at high speeds is limited, and sudden turn may cause loss of boat control. This could cause occupants to fall on the deck or overboard.
- **KEEP PROPER LOOKOUT AND SAFE DISTANCE** for the conditions at all times to avoid collisions. Do not splash others or jump waves or wakes. Directional control is reduced with decreasing speed and lost when engine is off.
- **DO NOT APPLY THROTTLE WHEN ANYONE IS AT THE REAR OF THE BOAT.** Turn the engine off before someone is boarding from the rear and when swimmers are at the rear of the boat. Water and/or debris exiting the jet thrust nozzle can cause severe injury.
- **OBEY APPLICABLE NAVIGATION RULES AND BOATING LAWS.**
- **USE CAUTION AND PROPER LIGHTING** during nighttime boating and boating in adverse weather.

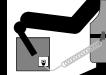

Read and follow safety labels and operator's guide before operation.



Patents - www.tbp.com/en/about/tbp/patents.html



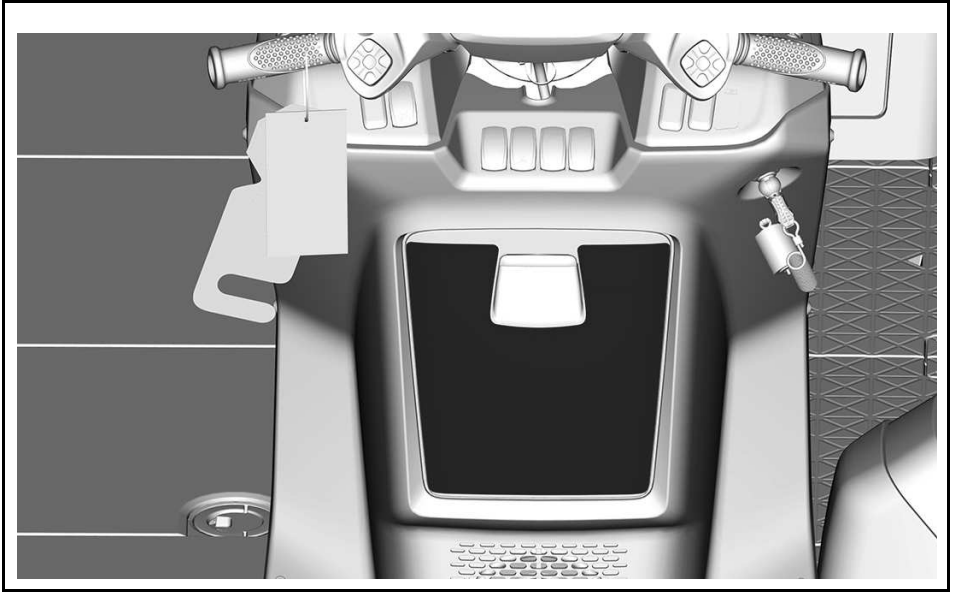

# Engine Safety Label

SERVICE OF THE ENGINE INSTALLED IN THIS BOAT REQUIRES SPECIAL TOOLS, TRAINING AND IDENTICAL REPLACEMENT PARTS. THE FUEL SYSTEM SHOULD BE SERVICED ONLY BY A BOMBARDIER RECREATIONAL PRODUCTS TRAINED TECHNICIAN. DO NOT ATTEMPT TO SERVICE THE SYSTEM YOURSELF.



**NOTICE**  
CHECKING ENGINE OIL LEVEL

- Make sure the engine is at operating temperature. Never let engine run out of water when the flush kit is connected as it may damage the engine.
- Vehicle must be level to perform verification.
- Let engine running at idle for at least 30 seconds.
- Stop engine and wait at least 30 seconds.

Check oil using the dipstick.

**CAUTION**

Engine oil and certain component in the engine compartment may be hot. Direct contact may result in skin burn.

SERVICE OF THE ENGINE INSTALLED IN THIS BOAT REQUIRES SPECIAL TOOLS, TRAINING AND IDENTICAL REPLACEMENT PARTS. THE FUEL SYSTEM SHOULD BE SERVICED ONLY BY A BOMBARDIER RECREATIONAL PRODUCTS TRAINED TECHNICIAN. DO NOT ATTEMPT TO SERVICE THE SYSTEM YOURSELF.



**NOTICE**

**CHECKING ENGINE OIL LEVEL**

- Make sure engine is at operating temperature. Never let engine run out of water without the flush kit connected as it may damage the engine.
- Vehicle must be level to perform verification.
- Let engine running at idle for at least 30 seconds.
- Stop engine and wait at least 30 seconds.
- Check oil using the dipstick.

**CAUTION**

Engine oil and certain component in the engine compartment may be hot. Direct contact may result in skin burn.

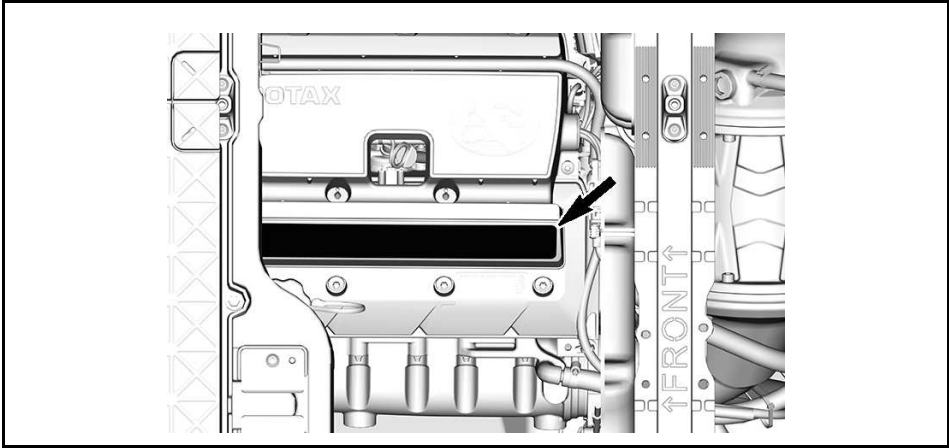

## Front Door – Warning Label



## Accessory Anchorage – Warning Label

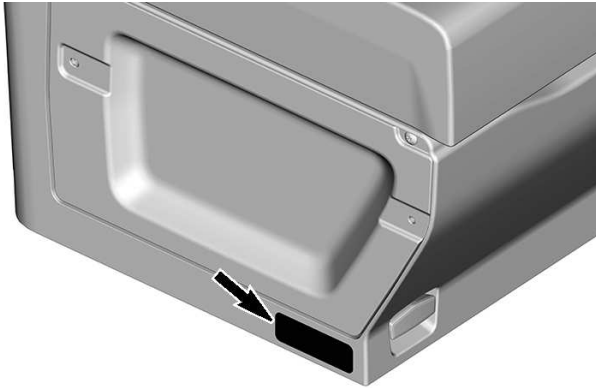

## Front Storage Compartment – Warning Label

**⚠ WARNING**  
Not for gasoline tank storage

**⚠ AVERTISSEMENT**  
Ne pas entreposer de réservoir à essence dans cet espace



**⚠ WARNING**  
Never carry loose, fragile or sharp-edged objects inside the storage compartment

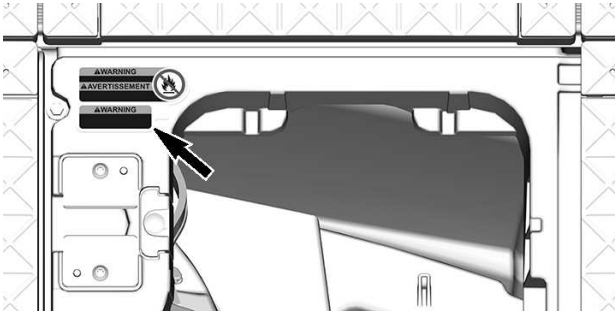

## Fuel System Maintenance Label

SERVICE OF THE ENGINE INSTALLED  
 IN THIS BOAT REQUIRES SPECIAL  
 TOOLS, TRAINING AND IDENTICAL  
 REPLACEMENT PARTS. THE FUEL  
 SYSTEM SHOULD BE SERVICED ONLY  
 BY A BOMBARDIER RECREATIONAL  
 PRODUCTS-TRAINED TECHNICIAN.  
 DO NOT ATTEMPT TO SERVICE  
 THE SYSTEM YOURSELF.



6071

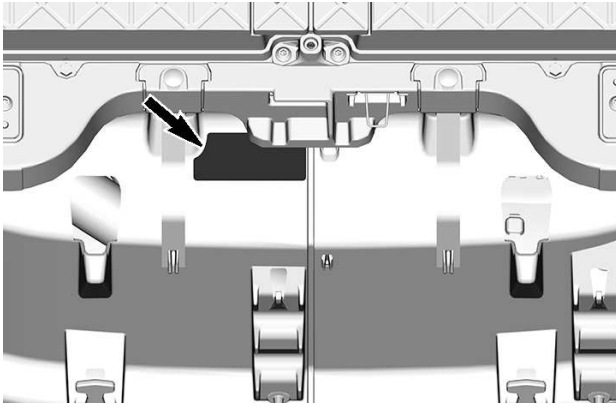

## Battery - Warning Label

### **⚠ Avertissement**

- Enlever la batterie du bateau avant de la charger.
- Ne pas trop charger la batterie.
- Un chargement excessif pourrait faire exploser la batterie.

### **⚠ WARNING**

- Remove battery from boat before charging.
- Do not overcharge battery.
- Improper charging of battery can cause explosion.



219905305

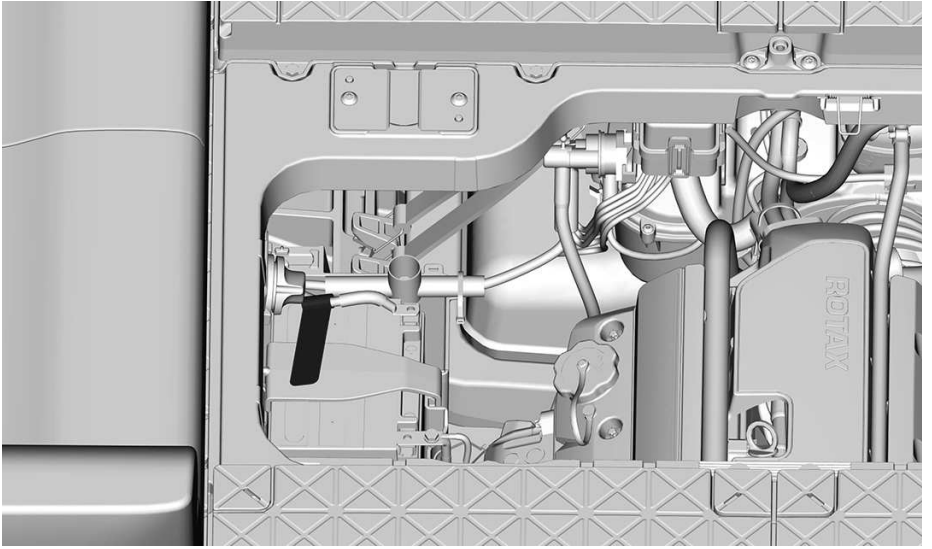



## Fire Extinguisher Position Label

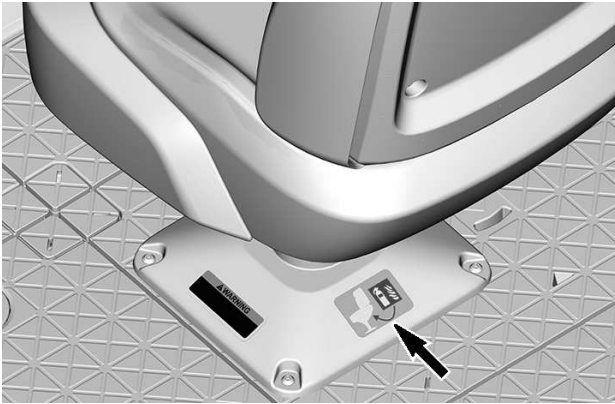

## Swivel Lock – Warning Label



## Latch Lever – Warning Label

**NOTE:**

This label can be found on multiple equipment including seats, backrests and tables.

**⚠ WARNING**

Completely push the tab forward to lock in place.

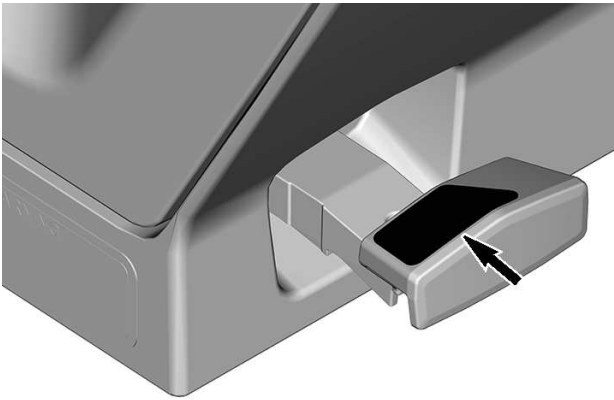
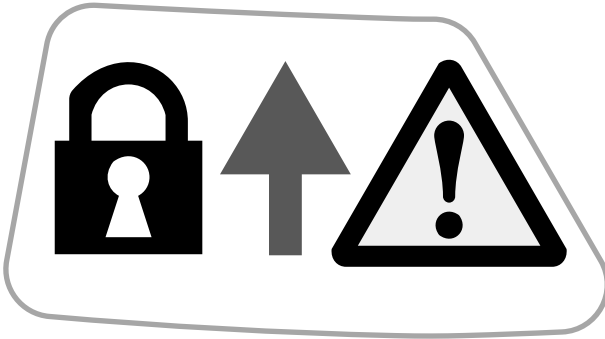

## Bimini Top – Warning Label

### ⚠ WARNING

#### To reduce the risk of severe injury or death

NEVER exceed 70 km/h (45 mph) when trailering this boat with the top raised. Top could break away and become a road hazard.

ALWAYS lower top and secure it using the provided straps when trailering at speeds above 70 km/h (45 mph).

NEVER store items in the top pouch when riding at speeds above 8 km/h (5 mph) as they could fall and strike occupants.

ALWAYS store soft & light items and remove them when riding at speeds above 8 km/h (5 mph).

Manipulate with caution and be aware of pinch points when lifting or lowering the structure.

When the top is raised, make sure it is properly secured. Structure is heavy and could strike occupants.

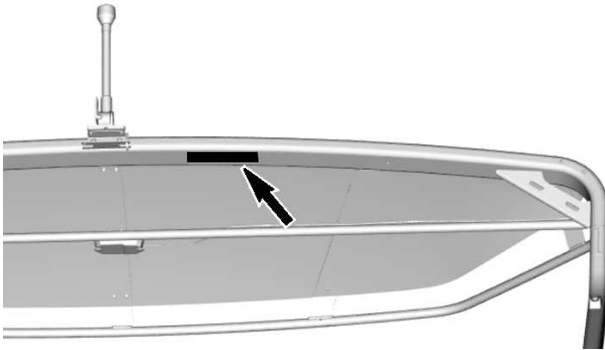
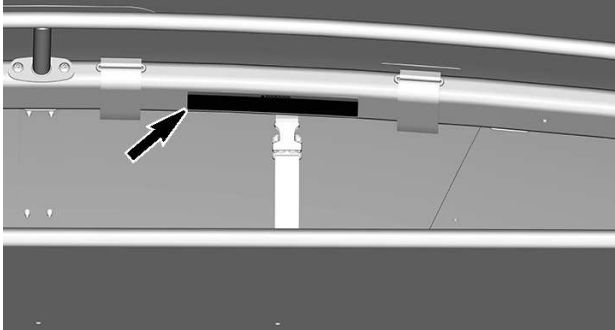

**Table – Warning Label**

**⚠ WARNING**

**To avoid serious injuries**

- Do not sit on or lean against table top
- Never leave post without the table
- Always install table when post is in place
- Store table and post when riding at speed above 8 km/h (5 mph), or when trailering
- Load limit not to exceed 6,8 kg (15 lb).



6083

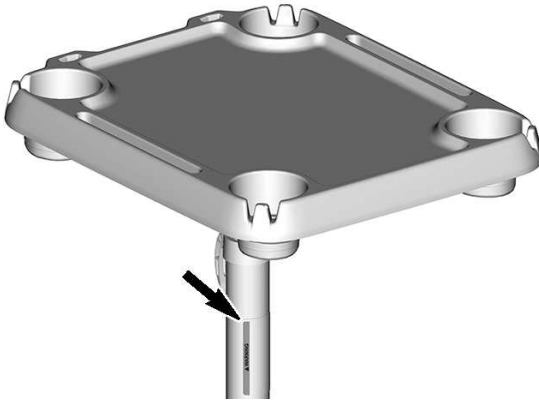

## Table – Caution Pictogram

 **CAUTION**

Do not sit on or lean against table top.

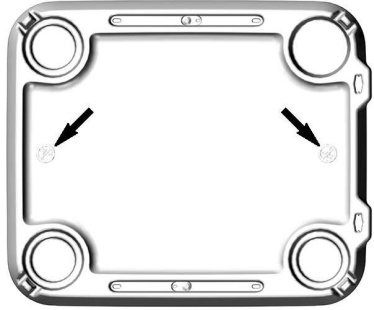
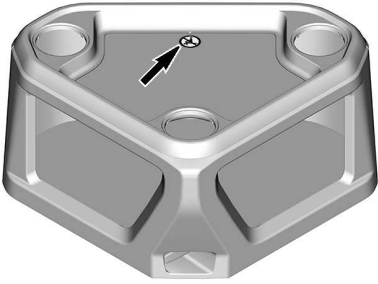

## Stern Bench – Warning Label



**Avoid serious injuries or death from falling overboard.**

- Lift the backrest before getting underway.
- Never sit on cushioned corner table while underway.
- Stay inside gates and rails and remain seated while underway.

6061



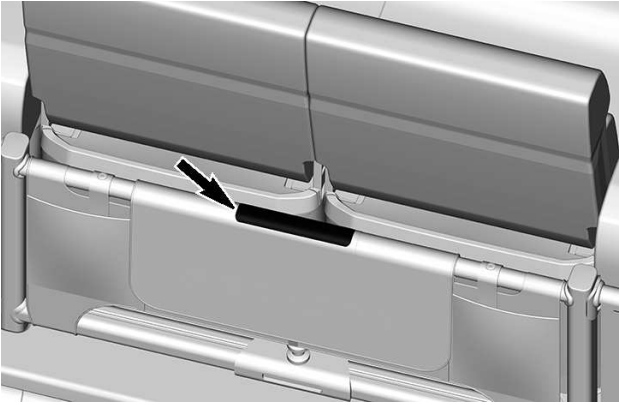

## Rear Hand Rail – Warning Label

### **⚠ WARNING**

Avoid serious injuries or death from falling overboard.  
Close and latch the door before getting underway.  
Stay inside gates and rails and remain seated while underway.

5988

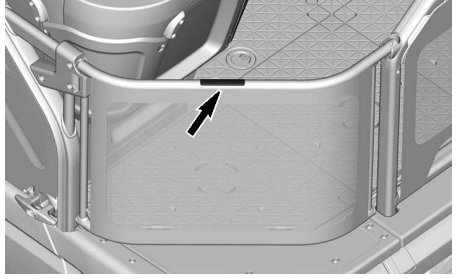
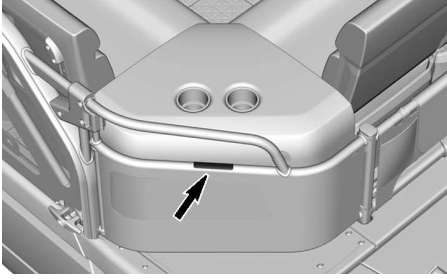

### **⚠ WARNING**

Avoid serious injuries or death from falling overboard.  
Close and latch the door before getting underway.  
Stay inside gates and rails and remain seated while underway.

5988

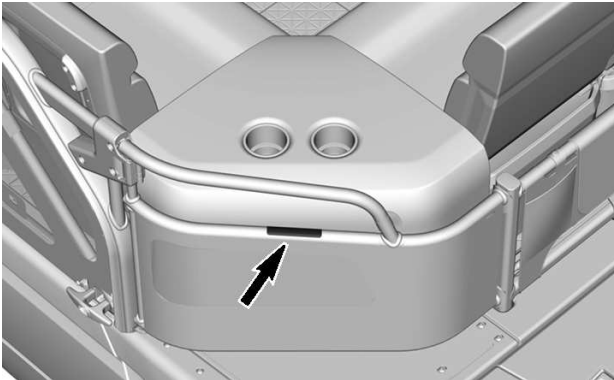



## Ski Post – Warning Label

**⚠ WARNING**

- Use only with a skier or wakeboarder lighter than 114 kg (250 lb).
- Never attach a water tube here.

6073

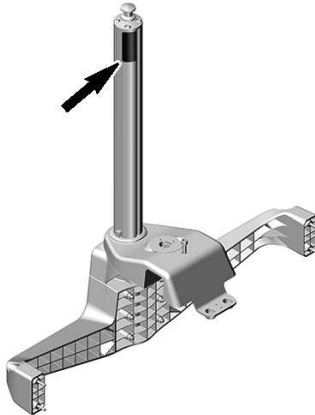

## Carbon Monoxide (CO) – Danger Label (rear bumper)

**⚠ DANGER**



A stylized illustration of a person sitting on a boat. The person is surrounded by several 'CO' gas molecules, indicating the presence of carbon monoxide. The boat is shown in profile, and the background is a simple horizon line.

**CARBON MONOXIDE (CO) CAN CAUSE BRAIN DAMAGE OR DEATH.**

- Engine and generator exhaust contains odorless and colorless carbon monoxide gas.
- Carbon monoxide will be around the back of the boat when engine or generator are running.

**MOVE TO FRESH AIR** if you feel nausea, headache, dizziness, or drowsiness.

5720



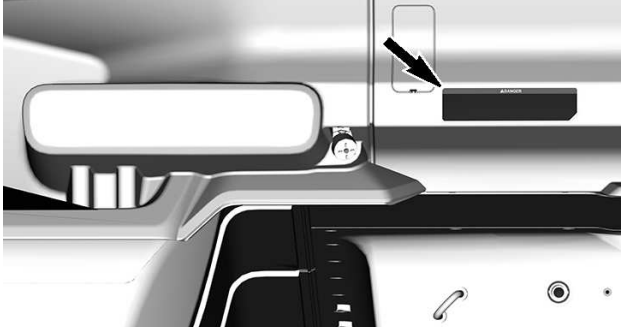



A black and white photograph showing the interior of a boat's dashboard. A rectangular warning label is mounted on the dashboard, indicated by a white arrow. The label is partially obscured by the dashboard's structure. The dashboard features various controls, including a steering wheel, a throttle lever, and several buttons and switches.

## Carbon Monoxide (CO) – Danger Label (Swim platform)

**⚠ DANGER**



**CARBON MONOXIDE (CO) CAN CAUSE BRAIN DAMAGE OR DEATH.**

- Engine and generator exhaust contains odorless and colorless carbon monoxide gas.
- Carbon monoxide will be around the back of the boat when engine or generator are running.

**MOVE TO FRESH AIR** if you feel nausea, headache, dizziness, or drowsiness.

  
6093

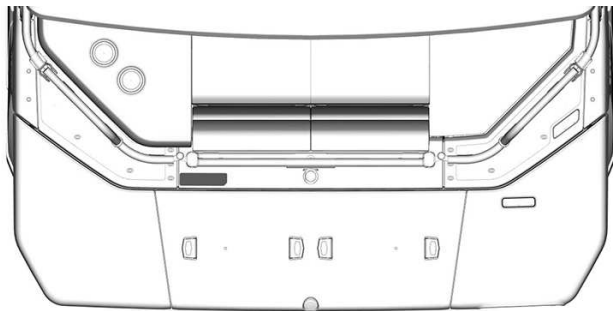

## Exhaust Drain Plug – Warning Label

**⚠ CAUTION**

Never remove this drain plug when engine is hot.  
Contact with hot water may result in skin burn.

**NOTICE**

Refer to the operator's guide for flushing exhaust system procedure.  
Make sure the exhaust drain plug is tight before launching the boat.

6411 

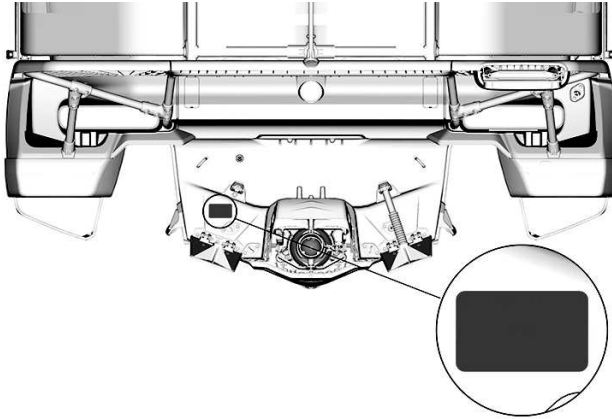

## Swimmer – Warning Label

### **⚠ WARNING**

Avoid serious personal injury or death.

- Make sure the engine is OFF before using the boarding ladder.
- Stay away from the jet pump as it could pick up debris and throw it rearward.
- Keep clothing and hair away from the intake grate when the engine is running to avoid entanglement and drowning.

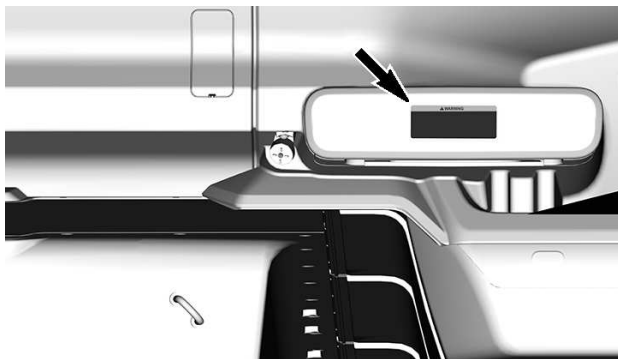

**BASE MODELS**

**⚠ WARNING**

Avoid serious personal injury or death.

- Make sure the engine is OFF before using the boarding ladder.
- Stay away from the jet pump as it could pick up debris and throw it rearward.
- Keep clothing and hair away from the intake grate when the engine is running to avoid entanglement and drowning.

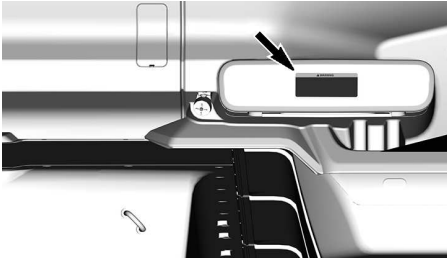

**BASE MODELS**

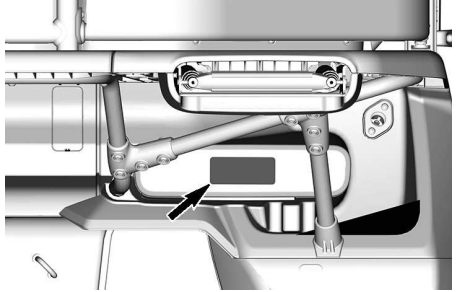

**CRUISE AND SPORT MODELS**

**⚠ WARNING**

Avoid serious personal injury or death.

- Make sure the engine is OFF before using the boarding ladder.
- Stay away from the jet pump as it could pick up debris and throw it rearward.
- Keep clothing and hair away from the intake grate when the engine is running to avoid entanglement and drowning.

6000

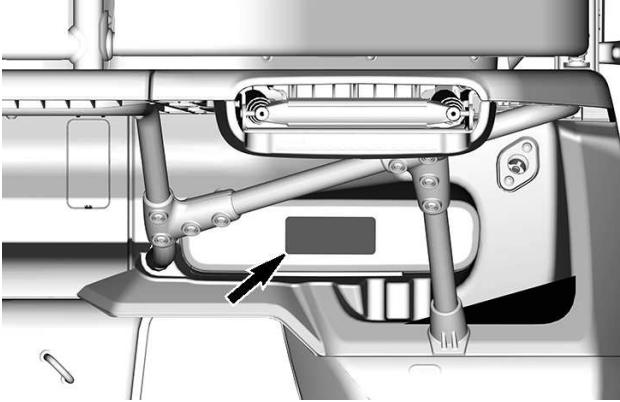

# Boarding Ladder – Warning Label

**⚠ WARNING**

- Safety instructions**
- Never use ladder when engine is running.
  - Stay on center and face ladder when using.
  - Never use ladder for jumping, diving or boarding out of water.
  - Always keep fingers clear of pinch points.

5725

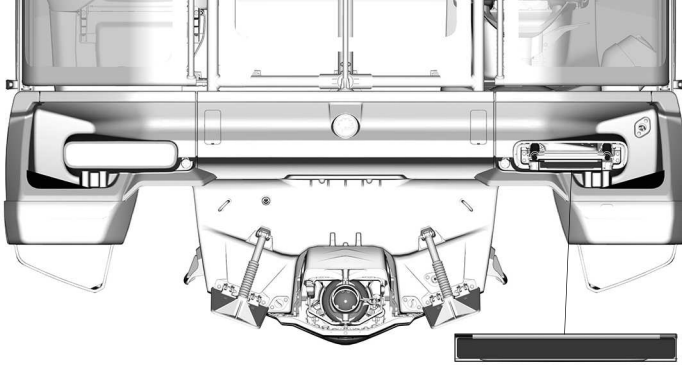

**BASE MODEL**

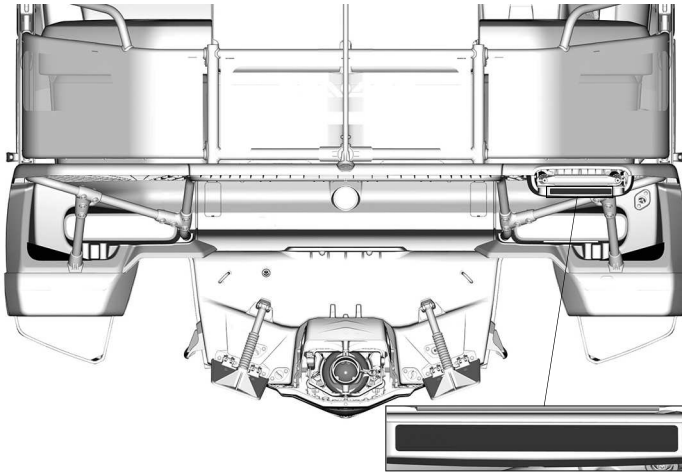

**MODEL WITH SWIM PLATFORM**



# iBR Gate - Moving Part – Warning Label

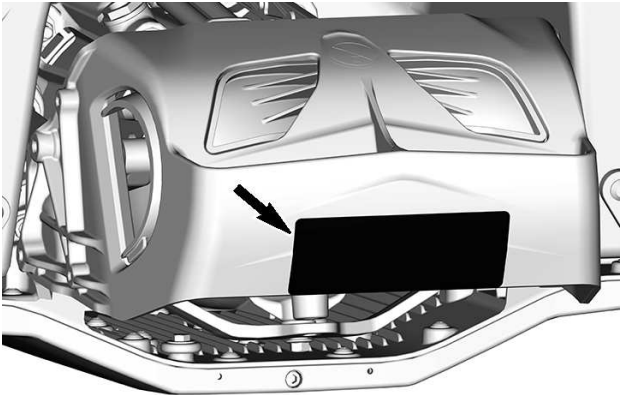

## Do Not Use to Onboard – Warning Pictogram

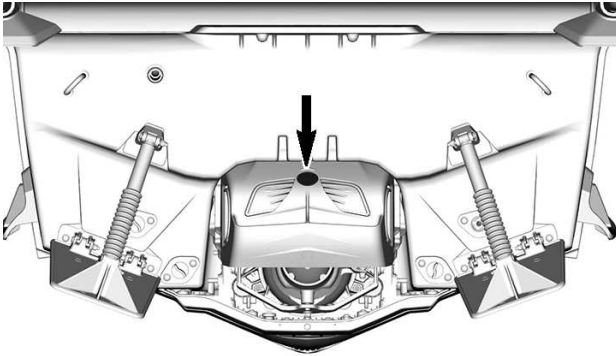

## Rinse – Notice Label

NOTICE

It is very important to flush the  
exhaust system with fresh water  
(from 1-1/2 to 2 minutes)  
after each use in salt  
water or foul water.



219905495

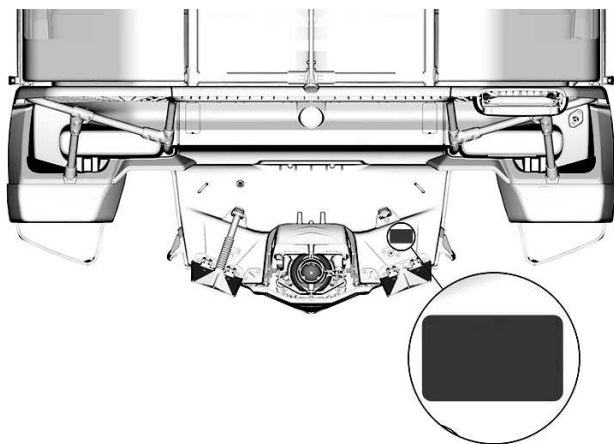

## Speed Tie System – Warning Label

### ⚠ WARNING

Read the operator's guide before use.

**ALWAYS** secure the rope to the boat's cleat to prevent it from detaching from the boat. The Speed Tie is designed as a quick rope management system. The cleat of the boat must be used as an anchoring point.

**DO NOT** let the rope loop dangle on the side of boat. Always fully retract and properly stow the Speed Tie rope before getting underway. A dangling rope loop may become entangled and cause the boat to stop suddenly.

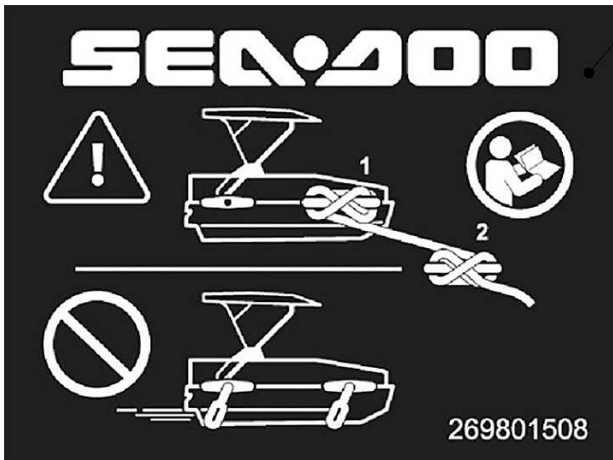

# Compliance and Capacity labels

## Canadian Compliance Notice Label

### CANADIAN COMPLIANCE NOTICE AVIS DE CONFORMITÉ CANADIEN

**MAXIMUM RECOMMENDED SAFE LIMITS  
LIMITES MAXIMALES DE SÉCURITÉ RECOMMANDÉES**

**MAX.**



**kg  
lbs/lb**

**MAX.**

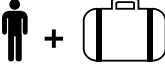

**kg  
lbs/lb**



THE RECOMMENDED SAFE LIMITS MAY HAVE TO BE REDUCED IN ADVERSE SEA AND WEATHER CONDITIONS.  
LES LIMITES MAXIMALES DE SÉCURITÉ RECOMMANDÉES PEUVENT DEVOIR ÊTRE RÉDUITES DANS LES CONDITIONS DE MER ET LES CONDITIONS MÉTÉOROLOGIQUES DIFFICILES.

OPERATE IN SHELTERED INLAND WATERS.  
OPÉREZ DANS DES EAUX INTÉRIEURES ABRITÉES.

**BOMBARDIER RECREATIONAL PRODUCTS INC. (YDV)**  
565 de la Montagne, Valcourt, J0E 2L0, QC, CA  
Rotaxstrasse 1, Gunskirchen, A-4623, AT

**MODEL / MODÈLE :**

THE MANUFACTURER DECLARES THAT THIS PRODUCT COMPLIES WITH THE CONSTRUCTION REQUIREMENTS OF THE SMALL VESSEL REGULATIONS, AS THEY READ ON THE DAY ON WHICH THE CONSTRUCTION OF THE VESSEL WAS STARTED OR ON THE DAY ON WHICH THE VESSEL WAS IMPORTED.  
LE FABRICANT ATTESTE QUE CE PRODUIT EST CONFORME AUX EXIGENCES DE CONSTRUCTION DU RÉGLEMENT SUR LES PETITS BÂTIMENTS EN VIGUEUR À LA DATE DU DÉBUT DE SA CONSTRUCTION OU DE SON IMPORTATION.

<p><b>EMISSION CONTROL SYSTEM INFORMATION</b> BOMBARDIER RECREATIONAL PRODUCTS INC. MEETS MY CALIFORNIA EVAP EMISSIONS REGULATIONS FOR SPARK-IGNITION MARINE WATERCRAFT. CALIFORNIA EVAP FAMILY</p>	   6270 CAN ICES-002/ NMB-002
---	--

EVAPORATIVE EMISSION CONTROL SYSTEM: SO. MEETS U.S. EPA EVAP STANDARDS USING CERTIFIED COMPONENTS. CONFORME AUX NORMES U.S. EPA EVAP VIA COMPOSANTES CERTIFIÉES. MAX. POWER / PUISSANCE      kW

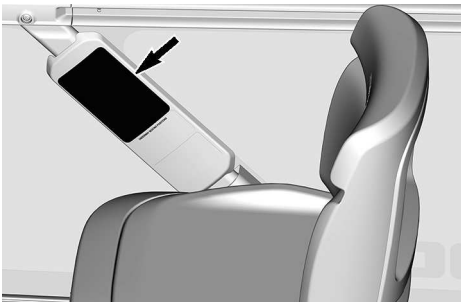

**LABEL SUPPORT NEXT TO OPERATOR SEAT**

## Underway Seating Positions Label

### Canadian Models

#### UNDERWAY SEATING POSITIONS

Make sure all passengers occupy a seat located and secured at the recommended location marked with a X before getting underway.

MAXIMUM PERSONS

5



Refer to the Operator's Guide for more details.

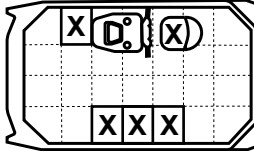

#### UNDERWAY SEATING POSITIONS

Make sure all passengers occupy a seat located and secured at the recommended location marked with a X before getting underway.

MAXIMUM PERSONS

7



Refer to the Operator's Guide for more details.

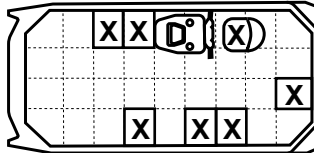

### BASE MODELS – 16 FT. AND 19 FT.

#### UNDERWAY SEATING POSITIONS

Make sure all passengers occupy a seat located and secured at the recommended location marked with a X before getting underway.

MAXIMUM PERSONS

9



Refer to the Operator's Guide for more details.

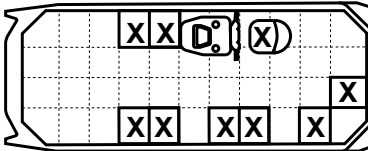

### CRUISE AND SPORT MODELS – 18 FT. AND 21 FT.

**UNDERWAY SEATING POSITIONS**

Make sure all passengers occupy a seat located and secured at the recommended location marked with a X before getting underway.

**MAXIMUM PERSONS**  
**9**

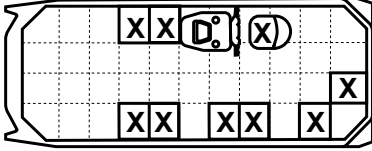

6222 Refer to the Operator's Guide for more details.

**USA Models**

**UNDERWAY SEATING POSITIONS**

Make sure all passengers occupy a seat located and secured at the recommended location marked with a X before getting underway.

**MAXIMUM PERSONS**  
**8**

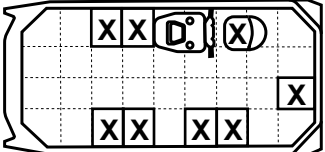

6274 Refer to the Operator's Guide for more details.

*BASE MODELS – 16 FT. AND 19 FT.*

**UNDERWAY SEATING POSITIONS**

Make sure all passengers occupy a seat located and secured at the recommended location marked with a X before getting underway.

**MAXIMUM PERSONS**  
**10**

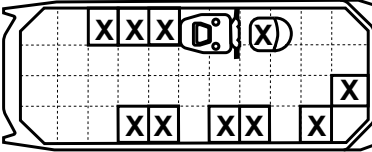

Refer to the Operator's Guide for more details.

*CRUISE AND SPORT MODELS – 18 FT. AND 21 FT.*

### UNDERWAY SEATING POSITIONS

Make sure all passengers occupy a seat located and secured at the recommended location marked with a X before getting underway.

MAXIMUM  
PERSONS

10



Refer to the Operator's Guide for more details.

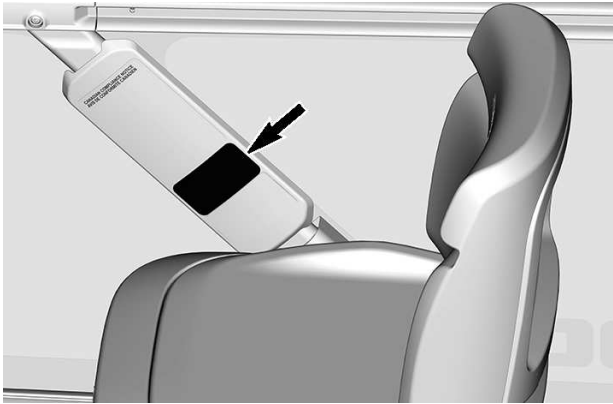
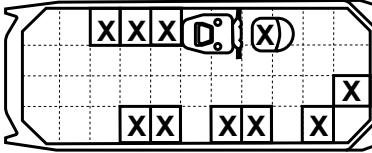

**LABEL SUPPORT NEXT TO OPERATOR SEAT**



**U.S. Coast Guard Compliance and Capacity Label**

FOR U.S. ONLY  
**MAXIMUM CAPACITIES**

**PERSONS OR LBS**

**LBS, PERSONS, GEAR**

THIS BOAT COMPLIES WITH U.S. COAST GUARD SAFETY STANDARDS IN EFFECT ON THE DATE OF CERTIFICATION BOMBARDIER RECREATIONAL PRODUCTS INC. 565 RUE DE LA MONTAGE, VALCOURT, QC, CANADA.

ASSEMBLED IN UNITED STATES

**MAXIMUM CAPACITIES LABEL**

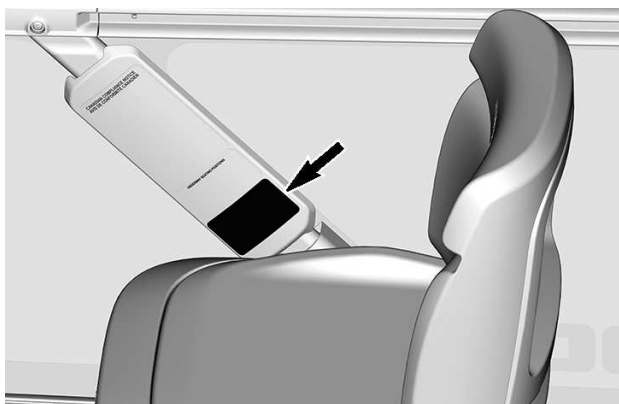

**LABEL SUPPORT NEXT TO OPERATOR SEAT**

## Technical Information Labels

### Fuel Tank Capacity – Notice Label



### FUEL TANK CAPACITY – NOTICE LABEL

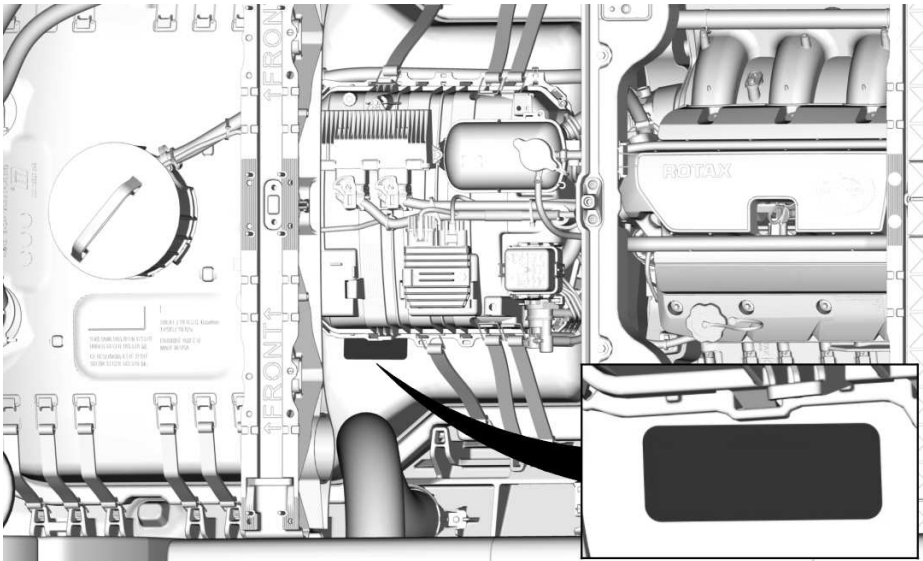

LABEL LOCATION – TILES REMOVED FOR CLARITY

**Air Intake Silencer – Notice Label****NOTICE**

- To comply with noise regulations, this engine is designed to operate with an air intake silencer.
- Operation without air intake silencer or with one not properly installed may cause engine damage.

219903177A

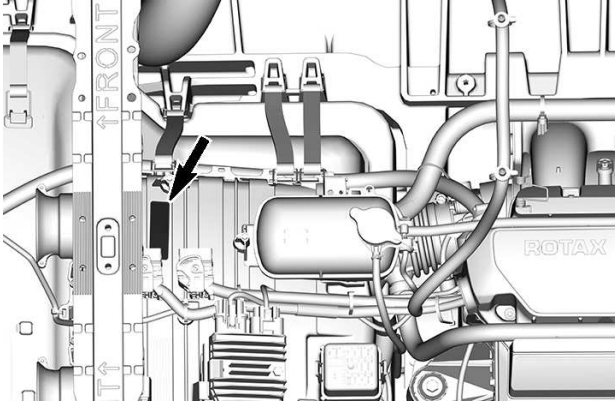
**AIR INTAKE SILENCER - NOTICE LABEL****AIR INTAKE SILENCER**

**Handlebar – Notice Label**

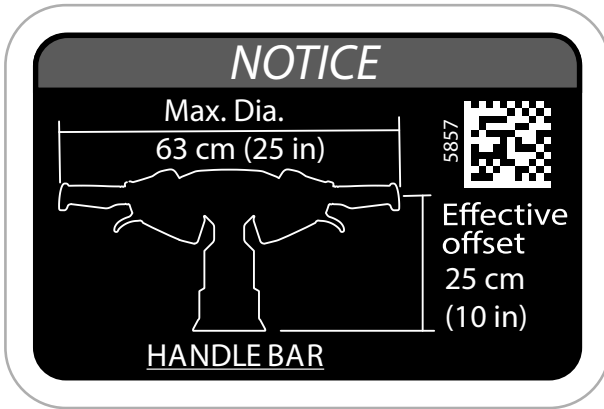

**HANDLEBAR NOTICE LABEL**

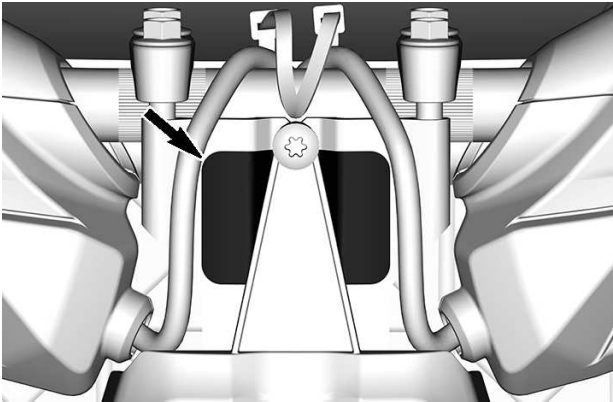

**UNDER STEERING COVER**

## Hang Tag

### California Proposition 65 Warning

 **WARNING.** Operating, servicing and maintaining a recreational marine vessel can expose you to chemicals including engine exhaust, carbon monoxide, phthalates, and lead, which are known to the State of California to cause cancer and birth defects or other reproductive harm. To minimize exposure, avoid breathing exhaust, service your vessel in a well-ventilated area and wear gloves or wash your hands frequently when servicing this vessel.



For more information go to  
[www.P65warnings.ca.gov/products/marine](http://www.P65warnings.ca.gov/products/marine)

219905280

## iBR Hang Tag



### How to brake

- Squeeze brake lever.

### How to reverse

- Maintain brake lever engaged.

### How to go forward

- Tap throttle lever to engage forward movement from neutral position.
- Squeeze throttle lever to accelerate.

### How to get to neutral

- Tap brake lever.

Refer to the operator's guide for more information.



211996001

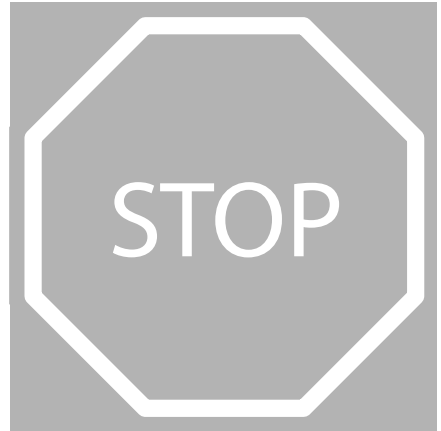

# iBR<sup>®</sup>

INTELLIGENT BRAKE AND REVERSE

THIRD GENERATION

- Allows you to stop sooner for greater peace of mind .
- Recognized by the U.S. Coast Guard for improving boating safety since 2009.
- The Third Generation provides more precise and responsive control when braking and docking.

## SEA DOO<sup>®</sup>

# PRE-RIDE INSPECTION

Always inspect and confirm the safe operating condition of your vehicle prior to ride.

Always follow the maintenance schedule described in this Operator's Guide.

## WARNING

**Perform a pre-ride inspection before each ride to detect potential problems during operation. The pre-ride inspection can help you monitor wear and deterioration before they become a problem. Correct any problems that you discover to reduce the risk of a breakdown or crash.**

Before using this vehicle, the operator should always perform the following pre-ride inspection check list.

Refer to *Maintenance Procedures* for details.

## What to Do Before Launching the Watercraft

### WARNING

**Make sure the engine is OFF with the tether cord cap disconnected from the engine cut-off switch before checking each of the following items. Should an item require the engine to start, make sure to clear gasoline vapors from the engine compartment before starting the engine by operating the bilge blower for at least 4 minutes.**

Check the items listed in the following table before launching the watercraft.

The **OPERATION** inspection procedures are described below the table.

ITEM	OPERATION
Hull	Inspect hull for damages. Properly clean the hull from aquatic invasive species (AIS).
Pontoon floats	Inspect for cracks. Properly clean the pontoon floats from aquatic invasive species (AIS).
Jet pump water intake	Inspect/ clean
Drain plugs	Tighten
Fuel tank	Refill
Engine compartment	Check for any visible fluid leaks and gasoline vapor odor. Operate blower for 4 minutes before starting the engine.

Engine oil	Check the level
Engine coolant	Check the level
Steering system	Check operation
iTC lever (throttle control)	Check operation.
iBR lever (brake and reverse)	Check operation.
All storage compartment covers, engine access covers, glove box and seats	Ensure they are closed and/ or latched.
Wakeboard rack (if equipped)	Inspect for damages and wear. Ensure it is properly latched.
Ski/ wakeboard pylon (if equipped)	Check operation. Inspect for damages and wear. Ensure it is properly latched.
Engine START/STOP button	Check operation, refer to <i>Starting the Engine</i> for the complete procedure.
Engine cut-off switch and the monitoring beeper	Check operation, refer to <i>Starting the Engine</i> for the complete procedure.
Master Switch	Check operation, refer to <i>Closing and Opening the Master Switch</i> .
Navigation Lights	Check operation of the three (3) lights. Refer to Console Switches and Night-Time Operation.
Battery condition and connections	Check every month
Sacrificial anodes	Inspect every month (more often in saltwater use) and change if necessary.

### **Hull**

Inspect hull for cracks, loose screws and other damages.

Properly clean the hull before launching the watercraft when moving to a different water plan to prevent from spreading aquatic invasive species. Refer to *What to Do After Leaving the Water* at the end of this section.



### **Pontoon Floats**

Inspect the pontoon floats for cracks.

Properly clean the outside and inside of the floats using the rinsing system before launching the watercraft when moving to a different water plan to prevent from aquatic invasive species. Refer to *What to Do After Leaving the Water* at the end of this section. Also refer to *Maintenance Procedures* section.

### **Jet Pump Water Intake**

Inspect ride plate and water inlet grate for cracks and other damages. Remove weeds, shells, debris or anything else that could restrict the flow of water and damage the propulsion unit. Clean as necessary. If any obstruction cannot be removed, refer to an authorized *Sea-Doo* dealer for servicing.

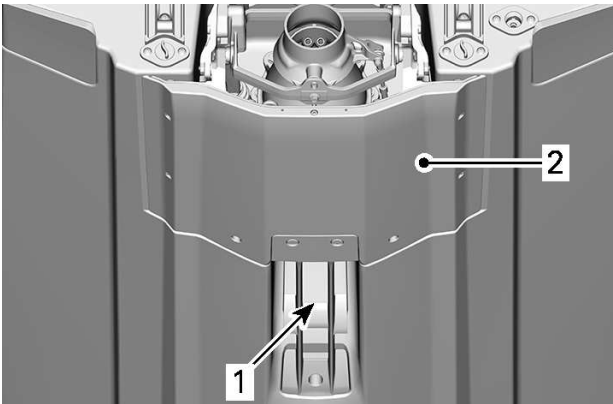

1. Water intake
2. Ride plate

### **Drain Plugs**

Secure bilge drain plugs.

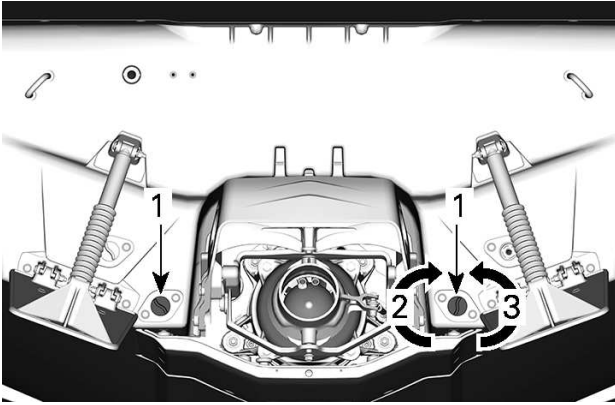

**BILGE DRAIN PLUGS**

1. Bilge drain plug
2. Tighten
3. Untighten

**⚠ WARNING**

Ensure bilge drain plugs are properly secured prior to launching the watercraft in water.

**Engine Compartment**

Operate the bilge blower for 4 minutes before starting the engine. Refer to Start-  
ing the Engine section.

Inspect the engine compartment for fuel vapor odor and verify blower operation.

To access the engine compartment, remove the engine access panel.

**⚠ WARNING**

Should any leak or gasoline odor be present, do not apply electrical power or start the engine. You should seek service from an authorized Sea-Doo dealer, repair shop, or person of your own choosing for maintenance, repair, or replacement. Please refer to the US EPA Emissions-related warranty contained here-in for information about warranty claims.

**Fuel Tank**

Fill the fuel tank.

**⚠ WARNING**

Strictly adhere to instructions detailed in *Fueling Procedure*.

### **Engine Oil**

Ensure that the oil level is within specification as described in the *Maintenance Procedures* section. Refer to Verifying the Engine Oil Level for the complete procedure.

#### **⚠ CAUTION**

**When operating the engine with the watercraft out of the water, the engine and heat exchanger in the ride plate may become very hot. Avoid any contact with hot engine parts and the ride plate as burns may occur.**

### **Engine Coolant**

Ensure coolant level is within specification as described in *Maintenance Procedures* section.

Check for coolant leaks on engine, in bilge and from ride plate.

### **Steering System**

Assisted by another person, check steering operation for free movement.

When the handlebar is horizontal, the jet pump nozzle should be in the straight ahead position. Ensure the jet pump nozzle pivots easily and in the same direction as the handlebar (e.g.: when handlebar is turned to the left, the nozzle opening must point towards the LH side of watercraft).

#### **⚠ WARNING**

**Check handlebar and corresponding steering nozzle operation before starting. Never turn handlebar while someone is near the rear of the watercraft. Keep away from steering moving parts (nozzle, iBR gate, linkages etc.).**

### **iTC Lever (throttle control)**

Check the iTC lever for free and smooth operation. Depress and release the lever to check for freedom of movement. It should return to its initial position immediately after it is released.

#### **⚠ WARNING**

**Check the iTC lever operation before starting the engine. If any friction is felt in the iTC lever, refer to an authorized *Sea-Doo* dealer.**

### **iBR Lever (brake and reverse)**

Check the iBR lever for free and smooth operation. Depress and release the lever to check for freedom of movement. It should return to its initial position immediately after it is released.

#### **⚠ WARNING**

**Check iBR lever operation before starting the engine. If any friction is felt in the iBR lever, refer to an authorized *Sea-Doo* dealer.**

### **Compartment Covers and Moveable Accessories**

Ensure the following are closed and/ or latched:

- Anchor storage
- Front storage compartment cover
- Engine access panels
- Glove box
- Seats
- Corner tables
- LinQ accessories
- Boarding ladder

#### **⚠ WARNING**

**Ensure the seat, rear platform, access panels, and all storage compartment covers are securely latched.**

### **Wakeboard Rack (if equipped)**

#### **⚠ WARNING**

**Ensure wakeboard rack is properly secured to watercraft body, and that the wakeboard is properly positioned and secured to the rack prior to using watercraft. Ensure wakeboard retaining straps are in good condition.**

### **Ski/ Wakeboard Pylon (if equipped)**

Make sure ski/ wakeboard pylon is correctly installed before using it.

### **Engine Cut-Off Switch and Engine START/STOP Button**

#### **⚠ WARNING**

**Always operate the bilge blower for at least 4 minutes before starting the engine to clear gasoline vapors from the engine compartment.**

Refer to *Starting the Engine in Operating Instructions*.

1. Press the start button once without installing the tether cord on the engine cut-off switch.
2. Install the tether cord cap on the engine cut-off switch.
3. Press the START/STOP button to start the engine, then stop it by pressing the START/STOP button a second time.
4. Restart the engine, then stop it by removing the tether cord from the engine cut-off switch.

#### **⚠ WARNING**

**Should the tether cord cap be loose or fail to remain on the engine cut-off switch, replace the tether cord immediately in order to avoid unsafe use. If removing the tether cord cap from the engine cut-off switch or pressing the START/STOP button does not stop the engine, do not use the watercraft. See your authorized Sea-Doo dealer.**

## What to Do After Launching the Watercraft

Check the items listed in the following table after launching the watercraft and before going for a ride. The **OPERATION** inspection procedures are described below the table.

ITEM	OPERATION
Information Center	Check operation.
Intelligent Brake and Reverse System (iBR)	Check operation.
Variable Trim System (VTS)	Check operation.

### **WARNING**

**Always operate the bilge blower for at least 4 minutes before starting the engine to clear gasoline vapors from the engine compartment.**

### *Information Center (Gauge)*

1. Press START/STOP button and install tether cord on the engine cut-off switch.
2. As the information center cycles through its self-test function, ensure all indications come on.

### **WARNING**

**Always attach the tether cord clip to your PFD or to the wrist (wrist strap required).**

### *iBR System*

### **NOTICE**

**Ensure there is sufficient space ahead and behind watercraft to safely carry out the iBR system test to avoid a collision. Watercraft will move during test.**

1. Remove the moorings lines securing the watercraft to the dock.
2. Start the engine and ensure the watercraft does not move.
3. On the left handlebar, depress the iBR lever completely in, the watercraft should move slowly backwards.
4. Release the iBR lever, there should not be any reverse thrust.

### **WARNING**

**Always ensure proper iBR system operation before taking the watercraft out for a ride.**

### **Variable Trim System (VTS)**

With the engine running in forward thrust, use the VTS system to move the jet pump nozzle up, and then down alternately to check VTS operation. Confirm the VTS position indicator movement in the information center.

Also test the VTS preset trim positions by double clicking the VTS UP/DOWN button (as applicable to model).

Refer to *Operating Instructions* for detailed instructions.

### **What to Do After Leaving the Water**

Aquatic Invasive Species (AIS) are non-native plant or animal species that threaten the diversity or abundance of the native species. They also threaten the natural ecology of the body of water they infest. AIS almost always has a negative impact on the waterway, its native species, and recreational or commercial activities.

Common examples of AIS are:

- Eurasian Watermilfoil
- Hydrilla
- Sea Lampreys
- Zebra Mussels
- Asian Carp
- Gobies.

Many other examples of AIS exist throughout the world's waterways.

A typical factor in AIS infestations is that the non-native species are introduced by human activity. Some AIS are introduced by commercial operations; however, AIS can be introduced through recreational boating activities. The transportation of recreational watercraft and water sports equipment between waterways can be a major factor in the spread of AIS.

As responsible watercraft owners, we **MUST** do our part to prevent the spread of these aquatic hitchhikers. Check your watercraft each time you leave the water! In many cases it is required by law, be sure to check the local regulations for the waterways you visit.

### **Clean, Drain and Dry - Everything, Every Time!**

After each boating trip, before you leave the water access, follow these three simple steps to stop the spread of AIS. This is the boater's way to help protect the environment from the damage that AIS can cause.

#### ***Clean***

Inspect and remove any visible plants, fish, animals, mud, or other debris from the watercraft (including hull, intake grate, and jet pump nozzle), trailer, and any water sports equipment, gears and accessories before leaving the water body.

Clean all parts, equipment, and gear that came in contact with the water.

#### ***Drain***

Drain and flush all water from the watercraft, exhaust system, bilge, pontoon floats, and every conceivable space or item that can hold water.

Dispose of unwanted live bait in the trash.

### ***Dry***

Allow everything to dry completely (for 5 days or more, refer to local laws) before visiting any other bodies of water.

---

## **ANNUAL SAFETY MAINTENANCE**

BRP recommend to have an annual safety inspection of your vehicle. Contact an authorized Sea-doo dealer for further details.

Though not required, it is recommended that an authorized BRP dealer performs the preseason preparation of your vehicle.

Each visit to your authorized Sea-Doo dealer is a great opportunity for your dealer to verify if your vehicle is included in any safety campaign. We also urge you to visit your authorized Sea-Doo dealer in a timely manner if you become aware of any safety related campaigns.



# **WATERCRAFT INFORMATION**

# PRIMARY CONTROLS

## Handlebar

The handlebar controls the direction of the watercraft. During forward operation, turning the handlebar to the right steers the watercraft to the right and inversely.

### **WARNING**

**Check handlebar and corresponding steering nozzle operation before starting. Never turn the handlebar while someone is near the rear of the watercraft. Keep away from the propulsion system.**

When operating in reverse, the steering direction is reversed. Turning the handlebar to the right while backing up steers the watercraft to the left.

## iTC Lever

The iTC lever on the RH handlebar controls the engine speed electronically.

To increase or maintain watercraft speed, pull the iTC lever with your finger.

To decrease watercraft speed, release the iTC lever.

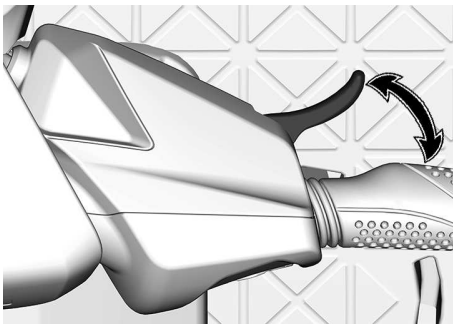

**ITC LEVER**

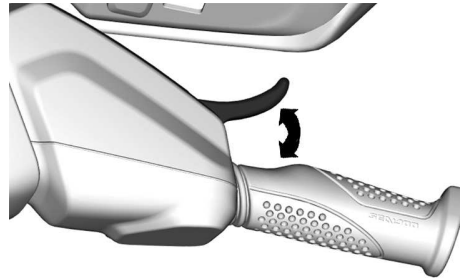

The iTC lever is spring loaded and should return to rest position (idle) when not pulled.

## intelligent Brake and Reverse (iBR) Lever

The iBR lever on the LH handlebar can electronically command:

- Brake
- Reverse
- Neutral.

### **NOTE:**

A minimum of 33% of iBR lever stroke is required to activate iBR functions.

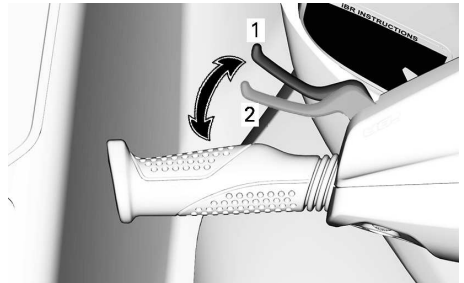

### **TYPICAL**

1. Lever rest position
2. 33% stroke required to activate iBR functions

At speeds above 17 km/h (11 MPH), pulling the iBR lever will engage the brake.

**NOTE:**

If the water current is 16 km/h (10 MPH) or above, the reverse cannot be engaged as the speed threshold for the reverse is exceeded.

At speeds below 16 km/h (10 MPH), pulling the iBR lever will engage reverse.

When the iBR lever is released after braking or reverse operation, the neutral is engaged.

**⚠ WARNING**

**If the throttle lever is still pulled in when releasing the iBR lever, forward movement will be initiated after a short delay. If forward acceleration is not desired, release the throttle lever.**

**NOTE:**

The neutral position can be fine tuned by trimming the iBR system.

Refer to *Operating Instructions* for detailed instructions.

## Master Switch

The master switch is located in the engine compartment.

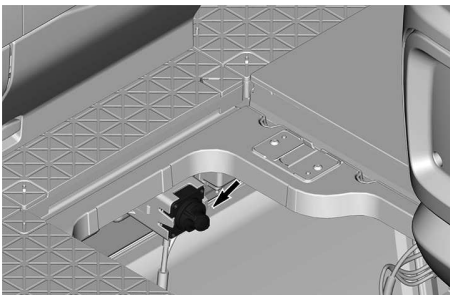

**TYPICAL**

It is accessible by removing the floor access panel identified in the following illustration.

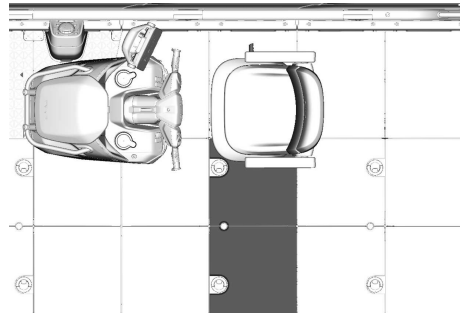

**TYPICAL**

### ***Closing and Opening the Master Switch***

The master switch allows to disconnect the battery from the watercraft. It should be used to safely remove the battery and for long term storage.

Turning the knob clockwise to ON position will close the master switch and supply electrical current from the battery to the watercraft.

Turning the knob counter-clockwise to OFF position will open the master switch and prevent the electrical current to flow from the battery to the watercraft.

### ***Removing the Master Switch Knob***

The master switch knob can also be removed to prevent unauthorized use of the vehicle.

To remove the master switch knob, turn the knob counter-clockwise from the OFF position.

To install, insert the knob in place and turn clockwise to reach the OFF position.

**NOTE:** Be careful to not drop the knob in the engine compartment when removing or installing the master switch knob.

## Engine Cut-Off Switch

The engine cut-off switch is located on the RH side of the console.



To allow engine starting, the tether cord cap must be securely snapped to the engine cut-off switch.

### **⚠ WARNING**

**Always attach the tether cord clip to the operator's personal flotation device (PFD) or wrist (wrist strap required) before starting the vehicle.**

To stop the engine, pull the tether cord cap from the engine cut-off switch.

### **⚠ WARNING**

**Should the engine be stopped, the brake function and all watercraft directional control is lost.**

### **⚠ WARNING**

**Always disconnect tether cord when watercraft is not in operation in order to prevent accidental engine starting or to avoid unauthorized use by others, children, and to prevent theft.**

## Radio Frequency Digitally Encoded Security System (RF D.E.S.S.)

The tether cord cap contains an electronic circuit (D.E.S.S.™ key) that is programmed to give it a unique

electronic serial number. This is the equivalent of a conventional key.

The D.E.S.S. system reads the key installed on the engine cut-off switch and only allows engine starting for keys it recognizes.

The D.E.S.S. system brings great flexibility. You can buy additional tether cords and have the D.E.S.S. keys programmed for your watercraft.

A total of ten D.E.S.S. keys can be programmed.

To have a key programmed to your watercraft, see your authorized BRP Sea-Doo dealer.

## Engine START/STOP Button

The engine START/STOP button is located on the LH handlebar.



TYPICAL - ENGINE START/STOP BUTTON

### *Engine Starting and Stopping*

Refer to *Operating Instructions* for complete procedures on how to start and stop the engine.

### *Waking Up the Electrical System*

Ensure the master switch is closed.

Press the START/STOP button once without installing the tether cord on the engine cut-off switch.

This will power up the electrical system; the information center will cycle through a self-test function.

The electrical system will stay powered up for approximately 75 seconds after the START/STOP button was depressed.

When the tether cord is installed on the engine cut-off switch, the system will be powered for 60 minutes.

Every time the START/STOP button is pressed, the countdown restarts. When the battery voltage drops below 12.3V, the LOW BATTERY indicator lamp will light up and the electrical system will shut down after 75 seconds.

### ***Post-Drive Battery Management (If equipped)***

This feature keeps the electrical system awake to allow using accessories when the engine is turned off. It also prevents draining the battery too much when using accessories. When the battery voltage reaches 12.3V or less, the system will automatically shut down to ensure enough power remains to start the engine.

When the electrical system is activated by pressing START/STOP briefly while the engine is shut down the wake-up time will be managed as follows:

- Key off: System will shut down after 75 seconds.
- Key on: System will shut down after 60 minutes or if the voltage threshold is reached.

# SECONDARY CONTROLS

## Right Controller

The right controller is located on the RH side of the handlebar.



**RIGHT CONTROLLER**

The right controller includes controls to navigate in the multifunction gauge.

- Arrow UP
- Arrow RH
- Arrow Down
- Arrow LH
- OK button.

In Cruise Control Mode, UP and DOWN arrows will increase and decrease the cruising speed.

## Left Controller

The left controller is located on the LH side of the handlebar.



**LEFT CONTROLLER**

## Variable Trim System (VTS) Button

The VTS button provides watercraft pitch trim adjustments by adjusting the vertical position of the jet nozzle.

The VTS can be electrically trimmed to desired attitude, or to one of two preset trim positions (full up, middle and full down).

Refer to *Operating Instructions* for details.

### NOTE:

The VTS button is used for Neutral adjustment. This is to adjust the neutral position of the watercraft. Refer to *Operating Modes* for details



### TYPICAL

1. Bow up
2. Bow down

## Cruise Control Button

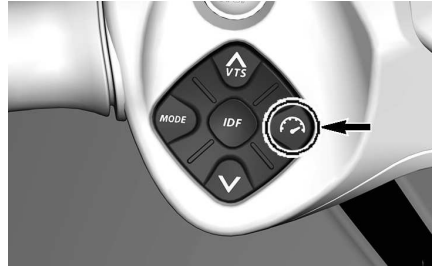

### TYPICAL

Allow to set a cruising speed.

## Mode Button

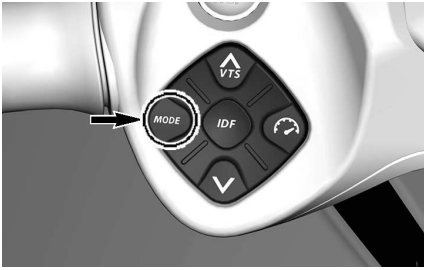

### TYPICAL

The Mode button is used to choose between Default, Sport, Ski (if equipped) or Eco mode.

Refer to *Operating Modes* for details.

## intelligent Debris Free Pump (iDF) Button (if equipped)

Located in the center of the left controller.

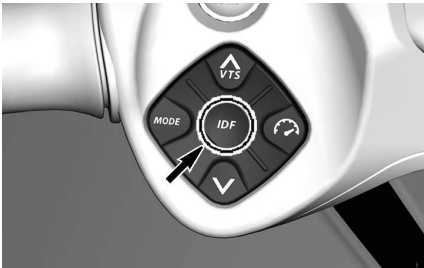

It allows to activate the iDF system. Refer to *Activating the intelligent Debris Free Pump System* in *Operating Instructions* section.

## Console Switches



### CONSOLE SWITCHES

## Horn Switch

To activate the horn, push on the switch.

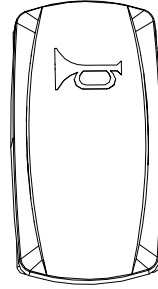

### HORN SWITCH

## Courtesy Lights Switch

To turn ON the courtesy lights, push on the switch.

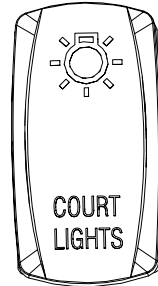

### COURTESY LIGHTS SWITCH

## Navigation Lights Switch

To turn ON the navigation lights, push on the upper part of the switch.

To turn ON the anchor light, push on the lower part of the switch.

To turn OFF either lights, put the switch back to its mid position.

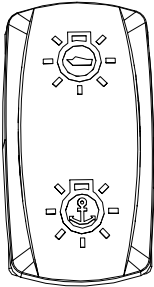

**NAVIGATION LIGHTS SWITCH**

***Bilge Pump Switch***

To activate the bilge pump, push on the upper part of the switch.

To deactivate the bilge pump, push on the lower part of the switch.

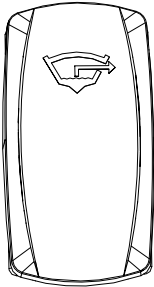

**BILGE PUMP SWITCH**

***Bilge Blower Switch***

To activate the bilge blower, push on the upper part of the switch.

To deactivate the bilge blower, push on the lower part of the switch.

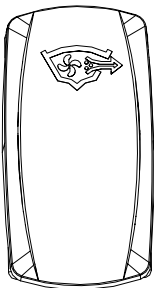

**BILGE BLOWER SWITCH**



# EQUIPMENT

Illustrations may not be accurate for every model and are only provided as a visual guide.

Some vehicle safety labels are not shown on illustrations. For information on vehicle safety labels, refer to *Important On-Product Labels*.

## Front and Rear Eyelets

Eyelets can be used for mooring, towing and as tie-down points when transporting your watercraft.



FRONT EYELET

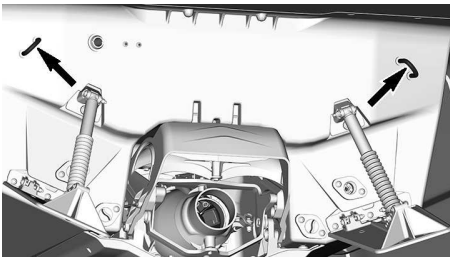

REAR EYELETS

### WARNING

Do not use these eyelets to lift the watercraft.

## NOTE:

- **Responsibility:** It is the owner's/operator's responsibility to ensure that mooring lines, towing lines, anchor chain(s), anchor lines and anchor(s) are adequate for the vessel's intended. Owners should also consider what action will be necessary when securing a tow line on board.
- **Non-metallic strong points:** Strong points shall be inspected before use. They shall be replaced if they show any signs of deterioration, visible surface cracks or permanent deformation.

## Horn

A horn is located on the right side, at the front of the watercraft. Refer to *Console Switches* for use.

It is used to signal other watercraft in the area your intentions while navigating or a danger.

**NOTE:** It is important to know and follow the official basic sound signals to use in the area to ensure good communication.

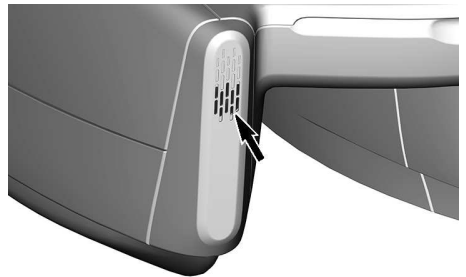

HORN

## Navigation Lights

This watercraft is equipped with navigation lights. Refer to *Console Switches* and *Night-Time Operation* for use.

Refer to *Rear Navigation Light Pole* in this section for the storage location and the installation procedure for the rear navigation light.

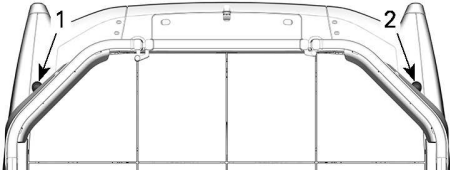

**FRONT NAVIGATION LIGHTS**

1. Red Navigation Light
2. Green Navigation Light

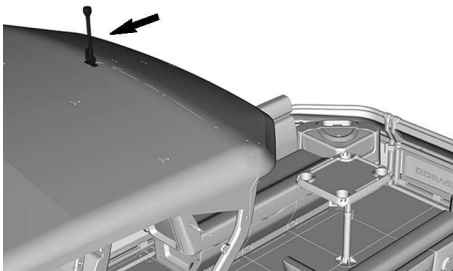

**ALL-ROUND NAVIGATION LIGHT**

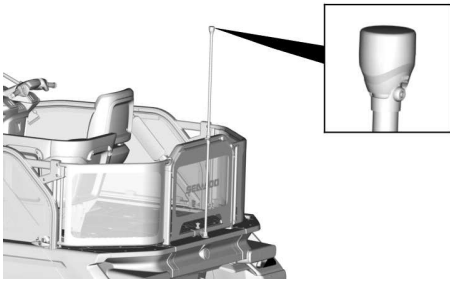

**REAR NAVIGATION LIGHT**

**Anchor Storage Compartment**

This watercraft has an anchor storage compartment located at the front of the vehicle, just below the front door. It is used to store the anchor and its rope when not in use.

1. To open, lift the cover using the holes on each side and remove it.

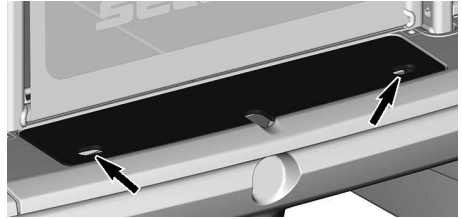

**ANCHOR STORAGE COMPARTMENT COVER**

2. Secure the storage compartment cover with the straps.

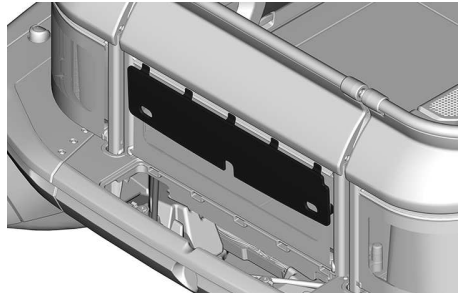

**ANCHOR STORAGE COMPARTMENT STRAPPED**

3. To close, unstrap the compartment and align all tabs of the cover with the openings on the vehicle.

**NOTICE**

**The anchor storage compartment cover is secured to the watercraft with a retaining cable. Do not let it hang when navigating.**

4. Push down on the compartment to secure the front tabs in the grommets.

**Front Door**

This watercraft has a door at the front to facilitate boarding from docks.

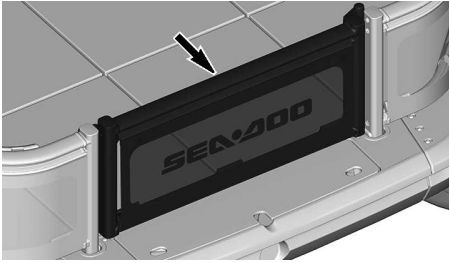
**FRONT DOOR**

Lift the door and rotate it to open inside the watercraft.

Lift the door and rotate it to close it. Make sure the latch is secured.

**⚠ WARNING**

**Always close all the doors securely before starting the engine.**

### Single Rear Door (If Equipped)

Some models have doors at the rear to facilitate boarding from dock.

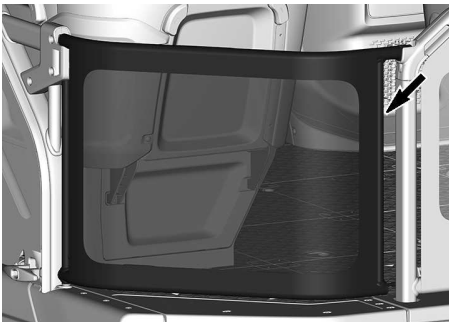
**REAR DOORS – BASE MODEL ONLY**

Lift the door and rotate it inside the watercraft.

When closing, make sure the latch is secured.

**⚠ WARNING**

**Always close all the doors securely before starting the engine.**

### Mooring Cleats

Use cleats for docking.

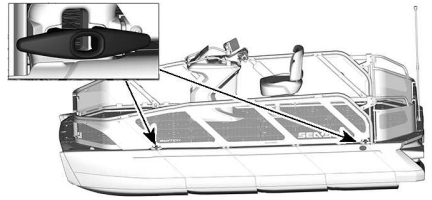

### Flooring System Tiles

This watercraft is equipped with a flooring system composed of tiles with various features (LinQ) to install and secure accessories.

Square tiles are in the center of the watercraft.

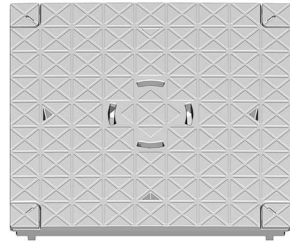
**SQUARE FLOOR TILE**

Rectangular tiles are on the sides of the watercraft.

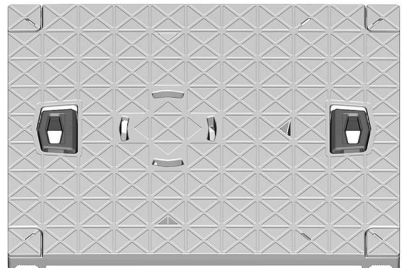
**RECTANGULAR FLOOR TILE**

## Deck Mats and Sun Pads (If Equipped)

Some models may be equipped with either deck mats or sun pads, installed on floor tiles.

Deck mats are thinner than sun pads.

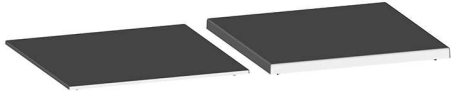

To remove, peel it starting with one of the corner.

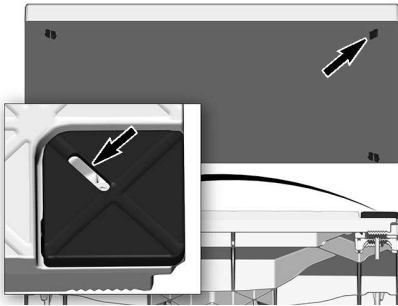

To install, simply push on each corner. Make sure the surface is completely flat and secured.

## LinQ Attachments

This watercraft is equipped with multiple LinQ attachments.

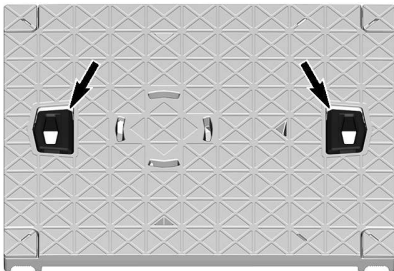

LINQ ATTACHMENTS

To use LinQ attachments, lift them, making sure they are fully extended and locked.

Refer to the accessory instruction sheet for proper installation.

To lower the LinQ attachments when not in use, squeeze tabs then push down. Make sure the LinQ attachments are fully retracted.

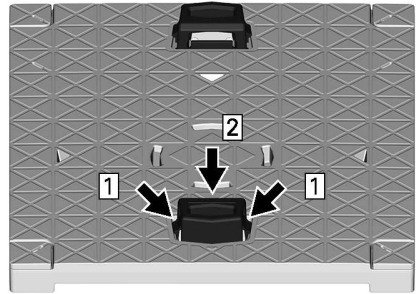

Step 1. Squeeze LinQ attachment tabs

Step 2. Push down LinQ attachments

### **⚠ CAUTION**

**To reduce the risk of injury, always lower the LinQ attachments when not in use.**

## Front Storage Compartment

The front storage compartment can be used to carry larger personal articles, such as Personal Floating Device (PFD), is located under the floor at the front of the vehicle.

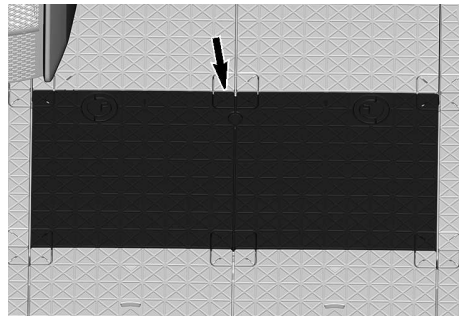

FRONT STORAGE COMPARTMENT

## Opening the Front Storage Compartment Cover

1. Pull on the latch handles.

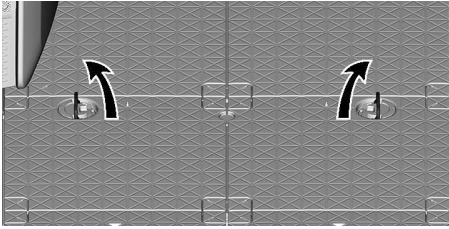

### PULL LATCH HANDLES

2. Turn the latch handles towards the center to unlock the front storage compartment cover.

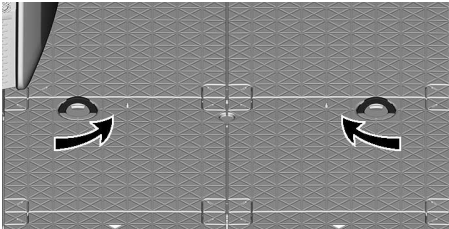

### TURN LATCH HANDLES

3. Remove the front storage compartment cover.

## Closing the Front Storage Compartment Cover

The installation is the reverse of the removal procedure. However, pay attention to the following.

1. Make sure the front storage compartment cover is correctly installed before locking it in position.
2. Turn the latch to lock the cover. It may require some force to compress the seal of the access cover before turning the lock.
3. Make sure the latch handles are flat on the cover when not in use.

## Glove Box

A small storage compartment for personal articles.

**NOTE:** The glove box is **not** watertight.

Pull on the latch to open.

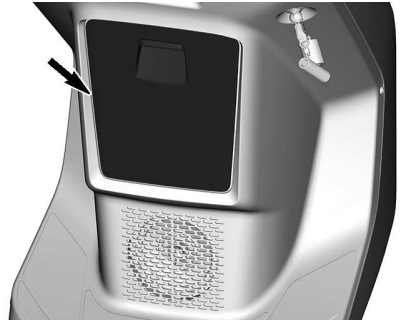

GLOVE BOX

## Rearview Mirror (If Equipped)

A rearview mirror is installed near the console so the driver can monitor the waters and the persons behind.

### ⚠ WARNING

- The operator must not rely exclusively on the mirror to monitor the waters and the persons behind the watercraft. The operator still has blind spots with this mirror.
- This mirror is convex to allow a wider view for the operator. Be aware that objects in mirror are closer than they appear.



REARVIEW MIRROR

## Courtesy Lights (If Equipped)

Courtesy lights are installed on the console.



**REAR COURTESY LIGHT**



**FRONT COURTESY LIGHT**

A dome light is installed on the bimini.

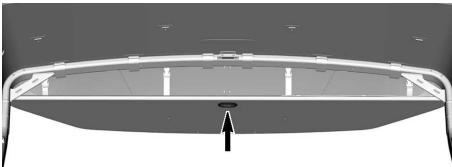

**DOME LIGHT**

Refer to *Secondary Controls* for switch use.

## BRP Audio System (if equipped)

The BRP Audio System is composed of two waterproof speaker enclosures that connect via Bluetooth to a smartphone.

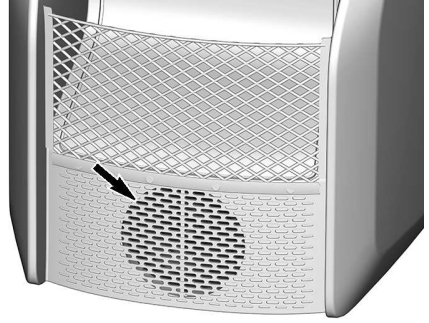

**FRONT SPEAKER**

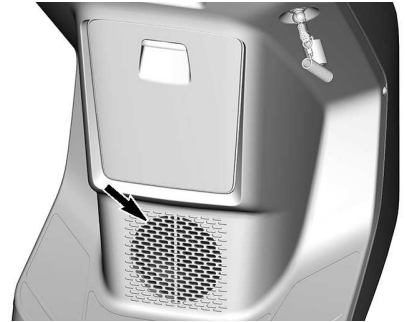

**REAR SPEAKER**

When the START/STOP button is pressed, the system will be powered for 75 seconds. When the tether cord is installed on the engine cut-off switch and the START/STOP switch is depressed, the system will be powered for 60 minutes. This will permit listening to the BRP Audio System for an extended period. When the battery drops below 12.3V, the LOW BATTERY indicator lamp will light up and the electrical system will shut down after 10 seconds to allow enough power in the battery to start the engine.

**Bluetooth Pairing Mode** - When the unit is powered On, the remote will automatically try to pair with the last connected device or will go in pairing mode if no paired devices are detected. When the system is in pairing mode, the **Play/Pause/Power (1)** light will blink. To manually enter the pairing mode, hold down the **Play/**

**Pause/Power** button for 1 second. The unit will emit 2 small beeps and the Play/Pause/Power button will start blinking to indicate it's in pairing mode. Search for BRP REMOTE from your device's Bluetooth menu.

**NOTE:**

All previously paired devices nearby must be turned OFF.

When paired, select a playlist or other source of music from your smartphone.

Never pair a smartphone or change the playlist or music source on the device while driving or operating the vehicle.

**⚠ WARNING**

Using a smartphone or trying to pair a device while driving can distract the driver from operating the watercraft. Always use buttons with caution and always stay alert on the water, keeping eye contact with your environment at all times.

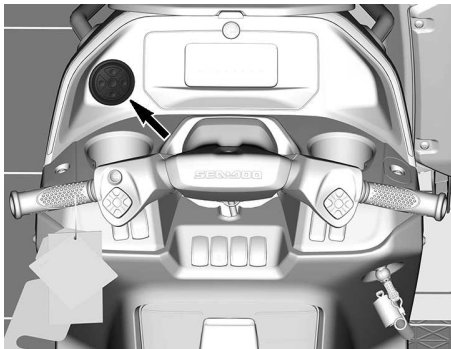

**KEYPAD**

The keypad is used to control the sound system.



1. Play/Pause/Power
2. Volume UP
3. Volume DOWN
4. Previous track
5. Next track

**Play/Pause/Power** - This button gives you the ability to play or to pause the current track with a single press. Pressing the button will turn the unit On if currently Off or holding the button for 3 seconds will turn the unit Off if currently On. The unit will emit 4 small beeps to indicate when power is turned Off. Note that all the buttons will illuminate when the unit is powered On.

**Volume Up and Volume Down** - These buttons will turn up or turn down the output of the volume. When the unit has reached the minimum or maximum output level, the unit will beep to indicate that no further adjustment is possible.

The USB port located inside the glove box compartment is only used to charge the smartphone, not to play music.

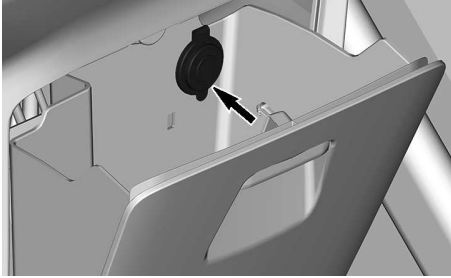

**⚠ CAUTION**

Prolonged exposure to loud music can damage your hearing. Therefore, we suggest a 10 minutes break time every 45 minutes of listening.

**Operator's Seat**

A seat is installed specifically for the operator of the watercraft.



**OPERATOR'S SEAT**



**ADJUSTABLE OPERATOR'S SEAT WITH ARMRESTS (IF EQUIPPED)**

**NOTE:** This seat is not designed to be removed and installed anywhere other than behind the console.

**Bolster**

A bolster is available on some models to give a higher and better view to the operator when navigating and docking.



**OPERATOR'S SEAT BOLSTER**

To use, simply lift the bolster in position. Make sure the bolster is secured before seating.





### OPERATOR'S SEAT BOLSTER IN USE

**NOTE:** The bolster should not be used for an extended time. It should only be used when executing specific maneuvers that requires higher view such as docking.

### Swivel Lock

The operator's seat is equipped with a swivel lock allowing to rotate the seat freely.



To unlock, pull up the handle and rotate the seat. To lock the seat in position, release the handle and the seat will lock in the nearest position (90 degrees increments).

To rotate the seat freely, push down on the handle. Pull up the handle to lock the seat.

### **⚠ WARNING**

**Lock driver seat in forward position so that the seat faces the handlebars during operation and does not swivel.**

### Fire Extinguisher Holder

#### **NOTE:**

Fire extinguisher is sold separately.

The fire extinguisher support is located under the operator's seat.

Use the rubber tie-downs to properly secure the fire extinguisher.

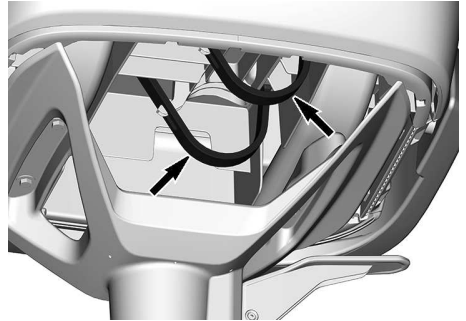

### FIRE EXTINGUISHER HOLDER

### Latching System

Some accessories are equipped with a latching system that secure them on tiles.

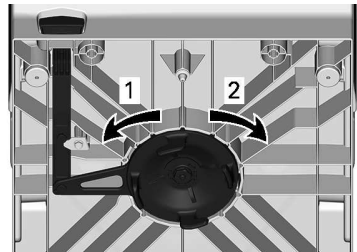

1. Locked position
2. Unlocked position

### Latching the Accessory

To install the accessory, the latching system must be in unlocked position first.

#### **⚠ WARNING**

**Do not install an accessory that shows signs of advanced deterioration. It might not be totally secured when locked in place.**

1. Install the accessory at a designed location and align the teeth with the circular holes on the tiles.

#### **NOTICE**

**Make sure the latching system and the tile are clean of any debris that might cause interference while installing the accessory.**

2. Push on the lever until it is locked in place.

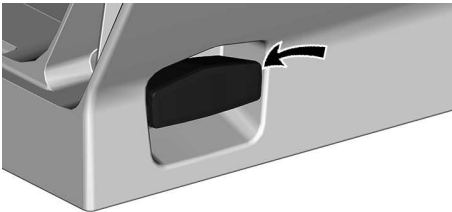

3. Rock the accessory from side-to-side to confirm it is correctly secured.

### Unlatching the Accessory

1. Pull the lever up then towards you to unlock the accessory.

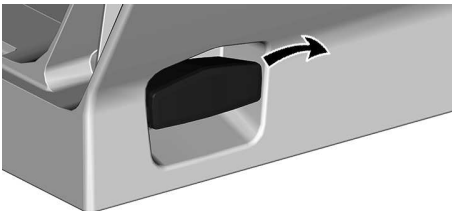

2. Lift the accessory to remove it from the tile.

### Passenger Seats

This watercraft comes equipped with a specific number of passenger's seats depending on its length. Refer to *Watercraft Safety Labels* for more information on the number of passenger allowed.



**PASSENGER SEAT**

All passenger seats are removable and can be fixed on the deck using a dedicated tile. With the watercraft at rest, the seat and table layout can be rearranged as needed.

Even at rest, the mass must be balanced from side to side and front to rear of the watercraft.

Before driving the watercraft, all seats must be relocated as per the *Underway Seating Positions* label affixed on the right side of the helm. This label indicates the best seat location in order to balance the passenger load.

Do not put all seats in the front so that the passenger weight becomes unevenly distributed between the bow and the stern of the watercraft. Excessive or unbalanced weight at the front can cause the bow of the watercraft to dive underwater, causing rapid deceleration.

In the same way, having too much weight at the back of the watercraft will prevent the watercraft from getting on plane.

Balance the mass equally on each side (Port and Starboard). This will help to maintain the optimal maneuverability of the watercraft.

**NOTE:** For maintenance, refer to *Care* subsection.

Refer to *Latching System* for removal and installation.

### ***Under Seat Compartment***

Each passenger's seat has a compartment underneath the cushion. Simply flip the cushion for access.

Personal Floating Devices (PFD) can be stored in this compartment for quick access.

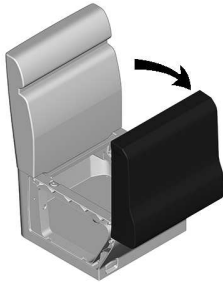

**NOTE:** Do not store breakable objects in the under seat compartment without proper protection.

### ***Passenger Handhold***

Each passenger's seat has a handhold under the edge of the cushion. Grab it to brace yourself while the watercraft is moving.



### ***Stern Bench (If Equipped)***

Some models come equipped with a stern bench. It is composed of two separate seats with foldable backrest.



The stern bench should always be installed at the stern (rear) of the watercraft and facing forward as it can be used to board and exit the watercraft if needed.

Fold the backrest all the way down until it clips. Make sure it is secured before boarding or exiting the watercraft.



**NOTE:** It is recommended to fold both backrests when boarding or exiting the watercraft via the stern bench.

**⚠ CAUTION**

**Do not stand on seats or folded backrest at any given time. Falling and/or getting stuck might occur.**

To unlock the backrest, push on the stopper. Unfold the backrest all the way up.

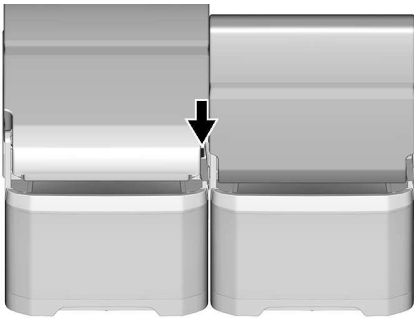

## Lounge Backrest (If Equipped)

Some models come equipped with lounge backrests at the bow (front) which allow passengers to lay down on the floor comfortably.

Each lounge backrest is considered a seat and must be included in the seat layout. Refer to *Underway Seating Positions* label for more information.



A soft armrest can be installed next to the lounge backrest. Simply slide the tab between two tiles.

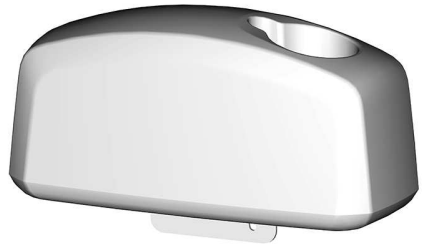

Store each soft armrest in an appropriate compartment when not in use or when riding at high speed and/or rough waters.

**⚠ WARNING**

**When at high speed and/or rough waters, make sure to hold onto the hand rail. Do NOT hold onto the soft armrests as they are not securely fixed on the deck.**

**NOTE:** For maintenance, refer to *Care* subsection.

Refer to *Latching System* for removal and installation.

## Corner Table

Some models come equipped with corner tables. Each has multiple cup holders.

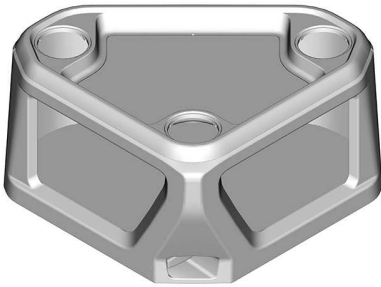

**⚠ CAUTION**

**Do not sit or stand on the table.**

**NOTE:** For maintenance, refer to *Care* subsection.

Refer to *Latching System* for removal and installation.

### USB Port

This watercraft is equipped with a USB port for charging smartphones or other devices.

When charging a smartphone, always make sure to route the cable such that there is no pressure on either end of the cable to prevent damage to cable or smartphone connectors.

**NOTE:**

For optimum performance, always use OEM USB cables. Low cost after-market cables may not have data lines and/or higher impedance which may result in poor charging performance or overheating.

Before and during use, make sure the seal around the USB charging port is intact and properly positioned.

After use, the USB charging port's integrated rubber cap should be installed to cover the connector.

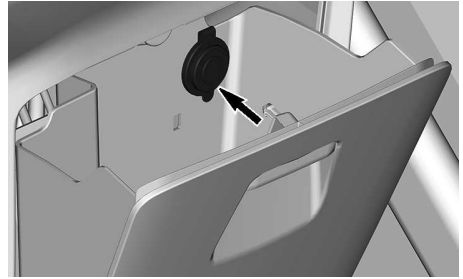

**USB PORT LOCATION - LOWER CONSOLE**

### 12-Volt Power Outlet

This watercraft is equipped with a 12-Volt power outlet used for charging.

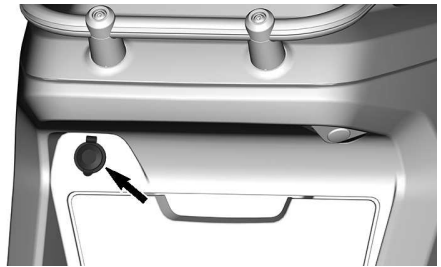

Before and during use, make sure the seal around the 12-Volt power outlet is intact and properly positioned.

After use, the 12-Volt power outlet's integrated rubber cap should be installed to cover the connector.

### Adjustable Table (If Equipped)

Some models come equipped with an adjustable table that can be moved to different locations on the watercraft.

The table top has multiple cup holders.

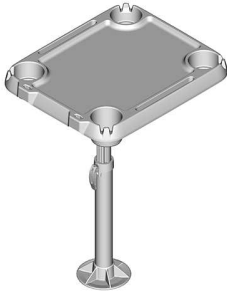

### ⚠ WARNING

- Do not sit on or lean against the table top
- Never leave the post installed without the table
- Always install the table when the post is in place
- Store table and post when riding at speeds above 8 km/h (5 MPH), or when trailering
- Load limit not to exceed 6,8 kg (15 lb).

### Configuring the Table

This table can be placed at different locations on the watercraft. Its height can also be adjusted for comfort.

### On the Deck

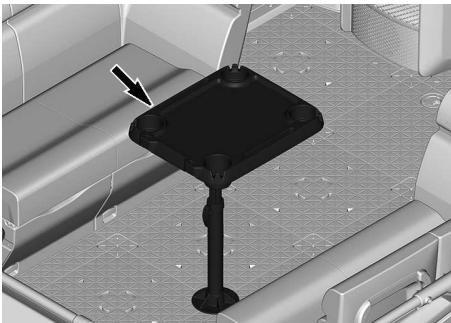
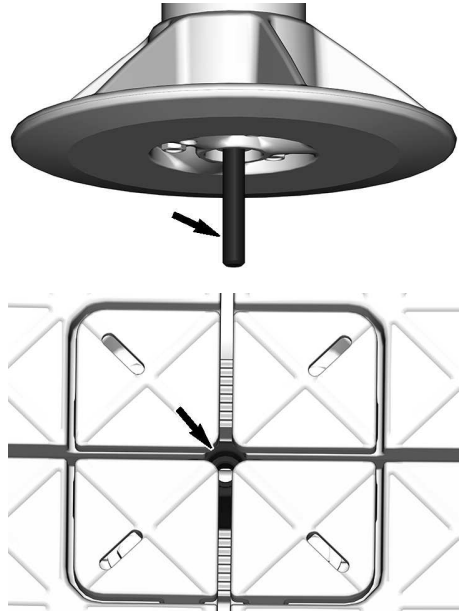

TABLE ON FRONT DECK

To install the adjustable table on the watercraft, place the stud in one of the nuts located between tiles and screw the table in place.

It can only be installed on bare tiles or deck mats. Do not install adjustable tables on sun pads. Refer to *Deck Mats and Sun Pads (If Equipped)* for more information.



To remove, simply unscrew the table.

Make sure the table top is not installed when installing or removing the adjustable table.

### Height Adjustment

To adjust the table height, unlock the lever under the table top and slide the upper tube up or down.

Lock the lever in place when the desired height is reached.

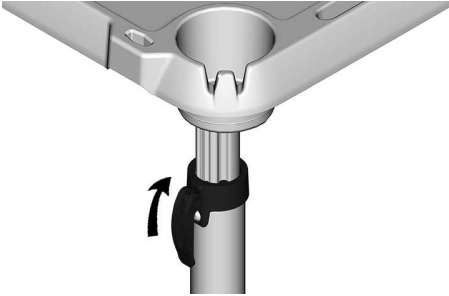

**UNLOCK THE TABLE LEVER**

### Between Seats

The table top can also be placed between seats with a corner backrest.

Make sure there are two tiles between both seats before installing.

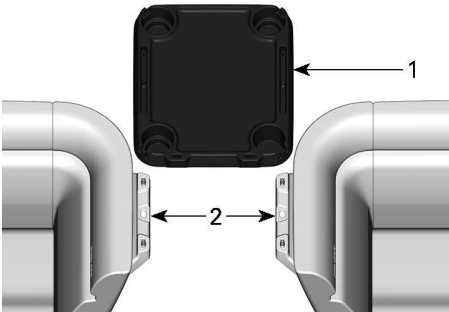

1. Table top
2. Accessory support

Install the table top on both accessory supports with the latches aligned with the grooves then lock the table top in place.

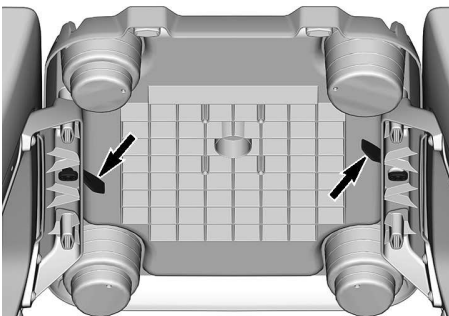

Do not install the table top on only one accessory support.

To remove, turn the latches until they are aligned with the grooves and remove the table top.

### Inflatable Holder (If Equipped)

Some models come equipped with an inflatable holder to attach various inflatable accessories at the rear for transport.

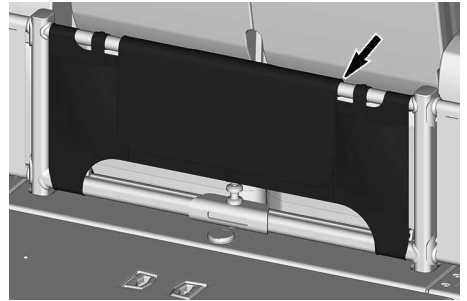

Use the central pocket to store the tow rope.

Use the straps on each side to attach an inflatable accessory at the rear.





## Tow Point

This watercraft comes equipped with a tow point at the rear to attach a watersport accessory with a rope.

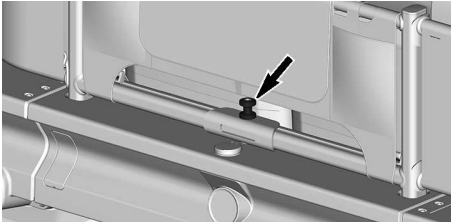

### **⚠ WARNING**

Make sure that nothing comes in interference with the watersport accessory's rope

## Ski/Wakeboard Pylon (if equipped)

Make sure ski/wakeboard pylon is correctly installed before using it.

### **⚠ WARNING**

Use caution with a skier/ wakeboarder in tow as tow rope may backlash to the watercraft when released. Never perform a sharp turn when towing a skier, wakeboarder or any toy. Always store the tow rope when not in use.

### **NOTICE**

The ski/ wakeboard pylon is designed for towing a skier or wakeboarder with a maximum weight of 114 kg (250 lb).

### **⚠ CAUTION**

Never use the ski pylon to tow an inflatable tube. Always use the watersport tow point to tow an inflatable tube.

## Rear Navigation Light Pole

This watercraft comes equipped with a light pole that is used as the rear navigation light at the stern (rear). Refer to *Console Switches* and *Night-Time Operation* for use.



### **Installing the Rear Navigation Light Pole**

1. Unfold the rear navigation light pole, slide the middle section and tighten the middle parts together to secure both parts.



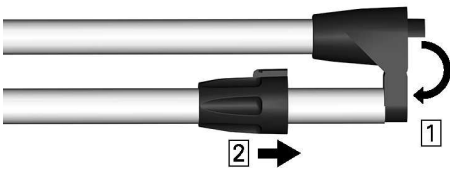

Step 1. Unfold the pole

Step 2. Slide the middle section towards the threads

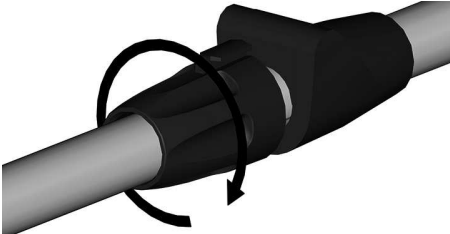

2. Open the light base cover.
3. Align the pole with the base and insert it.

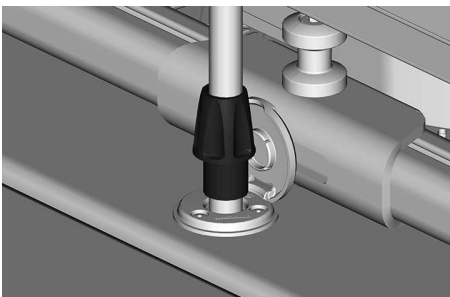

4. Lock the pole by screwing the ring in the base. Do not rotate the pole itself.
5. Ensure all navigation lights work correctly. Refer to *Console Switches* for switch information.

6. To remove the pole, follow this procedure in reverse. However, pay attention to the following.
7. Store the folded pole in the front storage compartment on the designated supports. Secure the pole with the straps.



## Boarding Ladder

This watercraft comes equipped with a convenient ladder used for boarding from the water.



**Without the swim platform.**

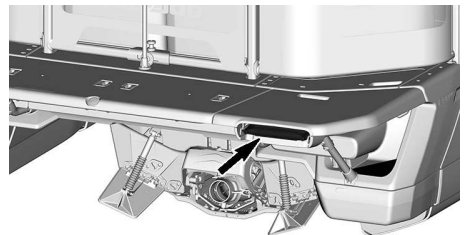

**Models with the swim platform.**

1. To deploy, push the ladder towards the front of the boat and up to unlock it.

2. Pull the ladder until it is fully deployed.

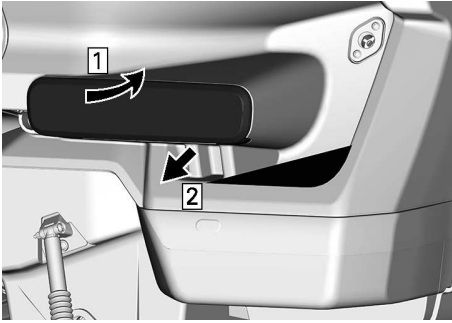

TYPICAL

Step 1. Push forward and up to disengage ladder

Step 2. Pull ladder to deploy

**Base Model shown, similar for models with the swim platform.**

3. Rotate it down until it sits on the rear of the watercraft.
4. To store the ladder, follow the procedure in reverse. Make sure it is properly secured.

### ⚠ WARNING

- Never use the ladder when the engine is running.
- Stay on center and face the ladder when using.
- Never use the ladder for pulling, towing, diving or jumping, or any other purpose other than as a boarding ladder.
- Always keep fingers clear of pinch joints.
- Only one person at a time on the ladder.

## Boarding Handle

This watercraft comes equipped with a handle used for boarding from the water.

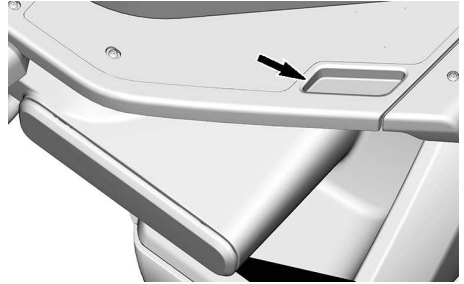

BOARDING HANDLE

## Pontoon Floats Rinsing System

The watercraft is equipped with a system used to rinse the pontoon floats. A tube is located under the deck and will drip water inside the pontoon floats to clean them up.

Refer to *Rinsing the Pontoon Floats* in the *Maintenance Procedures*.

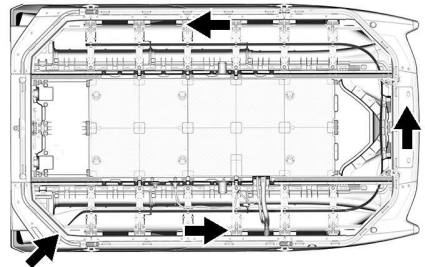

WATER FLOW

## Bilge Drain Plugs

Unscrew drain plugs whenever watercraft is on the trailer. This will allow water accumulated in the bilge to be evacuated and helps to reduce condensation.

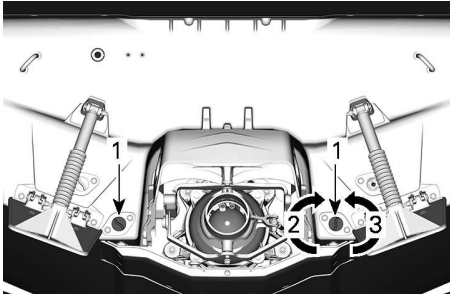

### BILGE DRAIN PLUGS

1. Bilge drain plug
2. Tighten
3. Untighten

### ⚠ WARNING

Ensure bilge drain plugs are properly secured prior to launching the watercraft in water.

## Bilge Pump

A bilge pump is installed to remove water that collects in the bilge. Refer to *Console Switches* for activation.

### NOTICE

- Do not operate for prolonged time if the bilge is dry. Battery drainage will occur and pump will be damaged.
- Always turn pump OFF after water is evacuated or before operating the engine above idle.
- The bilge pump is not automatic and should be monitored during the entire operation.

## Bilge Blower

The bilge blower is used to remove flammable fumes that may collect in the engine compartment. Refer to *Console Switches*.

Turn on bilge blower for at least 4 minutes before starting the engine.

### ⚠ WARNING

- Always operate the bilge blower for at least 4 minutes before starting the engine to clear gasoline vapors from the engine compartment.
- Operate this blower when the engine is at idle, while below cruising speed and after stopping the engine.

## Trim Tabs

This watercraft comes equipped with manually adjustable trim tabs at the rear. They can be adjusted to vary the time it takes for the watercraft to plane. They can also be used to adjust balance the watercraft side to side. Refer to *Adjusting the Trim Tabs Stiffness*.

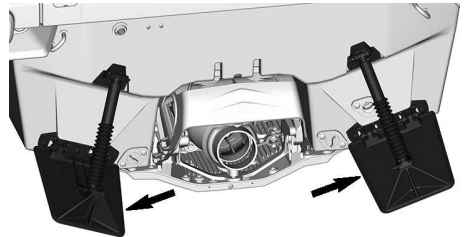

### Adjusting the Trim Tabs Stiffness

Adjusting the trim tabs stiffness will modify the behavior of the watercraft. Adjusting trim tabs stiffness in small increments will help avoid over-trimming, which occurs when the tabs are deflected too far. An over-trimmed watercraft will “plow” or “bow-steer”.

Adjusting both trim tabs to the same position will ensure side-to-side level.

Adjusting one side lower will help balance cargo load and/or passenger weight.

To get the watercraft to plane at a lower speed, adjust the trim tabs stiffer. Inversely, to get the watercraft to plane at a higher speed, adjust trim tabs softer.

To adjust, remove the fasteners and change the position of the gas spring lower mounting on the trim tabs.

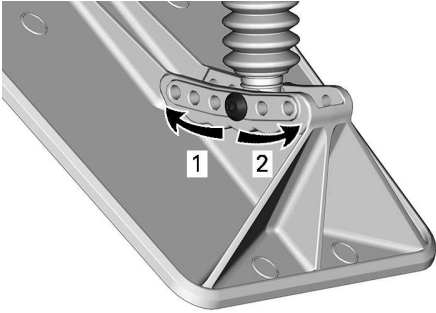

1. Higher speed to plane
2. Lower speed to plane

Install the fasteners and tighten to specification.

Tightening Torque	
M6 screw	$1.75 \pm 0.25$ Nm ( $15 \pm 2$ bf-in)

# 4.5" DIGITAL DISPLAY

## Multifunction Gauge Description

**⚠ WARNING**

Reading or tampering with the multifunction gauge can distract you from the operation of the vehicle, and particularly from constantly scanning the environment.  
Always pay attention to water conditions, and ensure your environment is clear and free from obstacles.  
Furthermore, when riding, only glance at the multifunction gauge briefly to stay focused on your environment.

The multifunction gauge includes digital gauges (temperature and tachometer), telltale lights, icons and a digital screen to see important information (speed, RPM, etc.).

### Lower Display

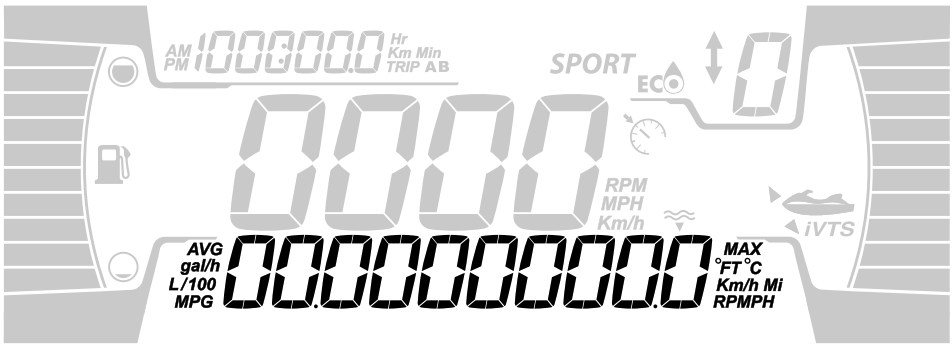

The lower display can cycle through the following:

- RPM
- Water temp : Displays the temperature of the water (if equipped)
- Depth (if equipped)
- Settings
- Messages
- Speed Stat (if equipped)
- Distance to Empty

### Left Lateral Display

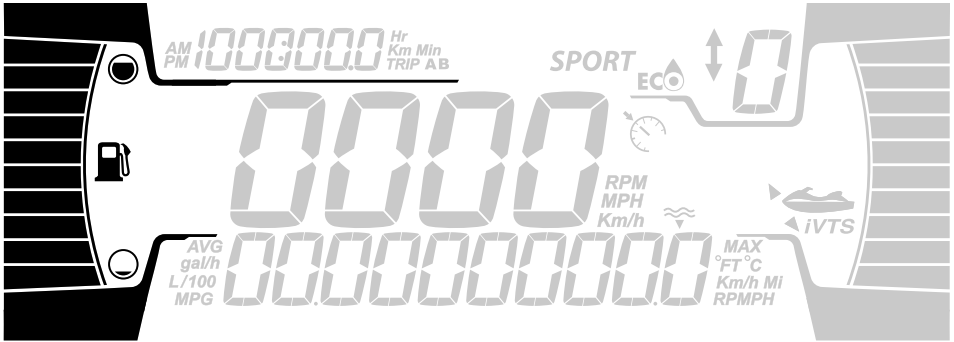

The left lateral display includes:

- Fuel level indicator

### Right Lateral Display

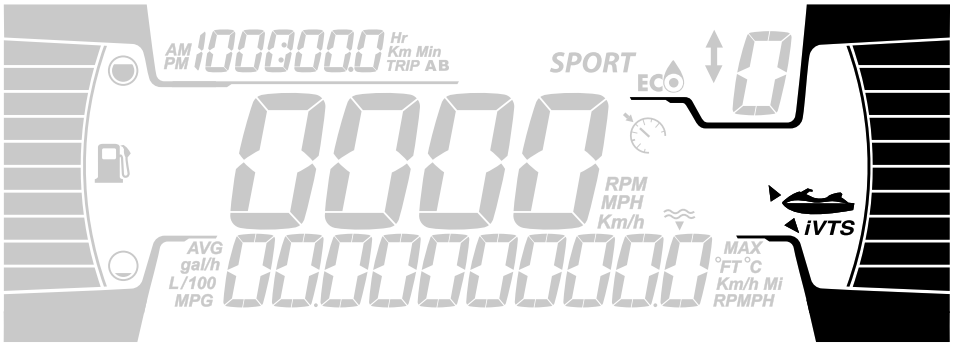

The right lateral display includes:

- VTS position

### Central Display

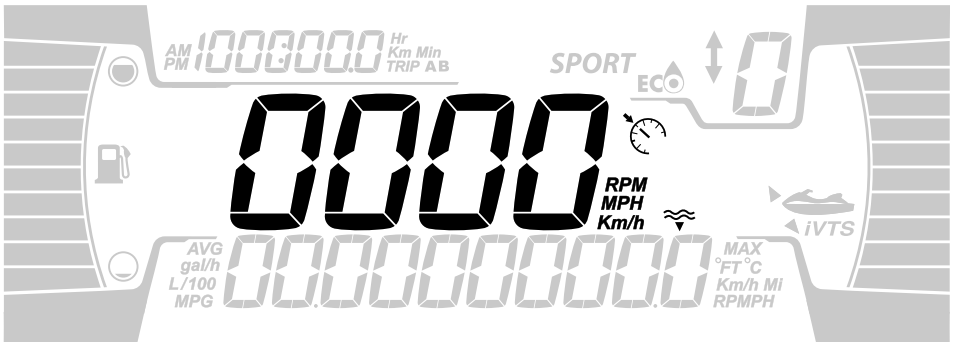

The central display includes:

- Watercraft speed
- Speed control indicator (if equipped)

The speed control indicator in this display is only activated when a target speed is set.

### iBR Position Display

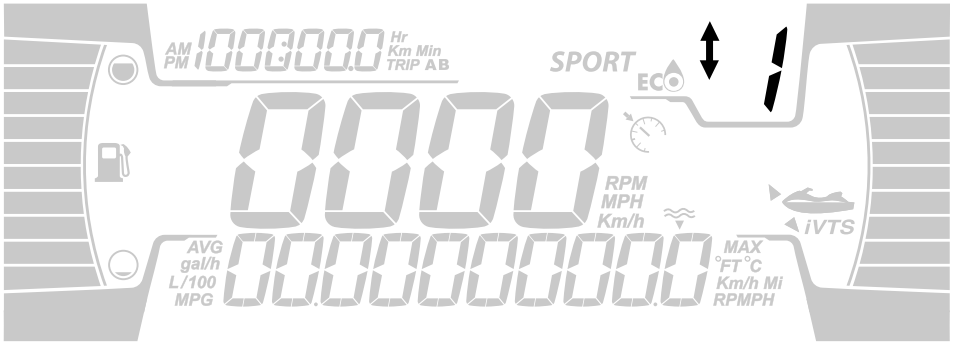

This display shows the iBR gear position (if equipped):

- N (neutral)
- F (forward)
- R (reverse)

It can also display the selected speed level (1 to 9) when the slow speed mode is selected.

### Left Upper Display

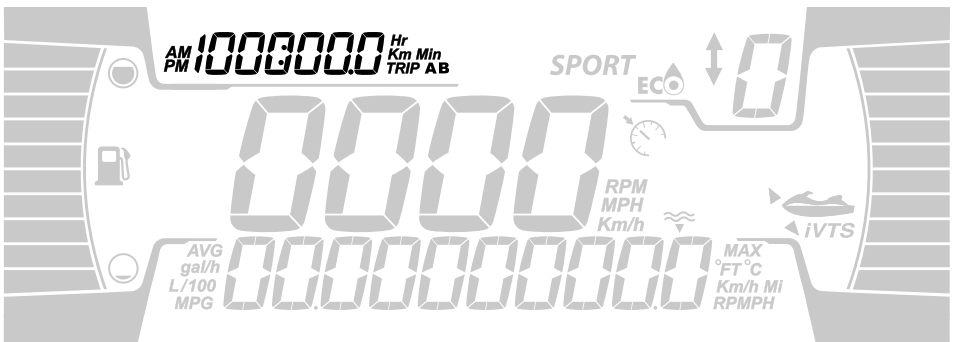

The left lateral display includes:

- Tripmeter
- Clock

The tripmeter cycles through the following:

- Watercraft hours : Displays the total vehicle hours
- Trip KM : Displays the distance since the last reset.

- Trip HR : Displays the time since the last reset.

**NOTE:**

The clock is shown only if the integrated GPS receives a signal from the satellites. This may take several seconds after waking up the system.

**MODE Display**

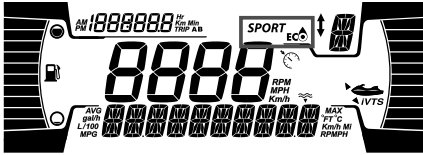

The MODE display indicates the selected alternative mode of operation:

- SPORT
- ECO

To cycle through the MODES;

- Press the MODE button to activate SPORT mode,
- Pressing the MODE button again will activate SKI mode (if equipped),
- Pressing the MODE button again will activate ECO mode.

**NOTE:**

SKI mode has no icon in the digital display. Refer to *operating modes* for more details.

**Warning Lamps and Indicators**

The following indicator lamps will alert you to a vehicle condition that may become serious. Some lamps will illuminate when starting the vehicle to make sure they work. If any lamps remain on after starting the vehicle, refer to the respective system warning lamp for further information.







**NOTE:**

Some warning indicators appear in the display of the multifunction gauge and function the same as an indicator lamp but do not display when starting the vehicle.



**Telltale Lights - Lower Bar**





Lights	Description
	ORANGE - Vehicle malfunction
	RED - The engine temperature is too high.
	GREEN - The neutral gear is selected
	RED - If illuminated while driving, it indicates a malfunction. Turn off all unnecessary electrical equipment and have the electrical and charging systems checked.
	RED - If illuminated while the engine is running or while driving, this indicates a malfunction. Stop the vehicle as soon as it is safe to do so and turn the engine off. Check the engine oil level. Have the lubrication system checked as soon as possible, even if the level appears to be correct.
	ORANGE - Illuminated when the fuel level is low or when the fuel tank is near empty. Refuel as soon as possible.
	ORANGE <b>Turned on:</b> Malfunction of the vehicle emissions control system <b>Blink:</b> Engine limitation, limp home mode is activated. Have the vehicle serviced immediately.

### Icons and Indicators - Multifunction Display

Icons	Description
<i>SPORT</i>	Denotes SPORT mode is selected.
	Denotes ECO mode is selected.
	Steady ON: indicates that the VTS is activated
	Denotes Cruise Control mode is activated

## Settings

Use the RIGHT arrow button or LEFT arrow button to navigate through setting menus. Use OK button to enter setting menu, to confirm selection or reset some values. Use UP arrow or DOWN arrow to change selected value.

### **Maintenance Reset**

Select **RES MAINT** and hold OK button to reset maintenance.

#### **NOTE:**

The maintenance reset can only be done within the first 15 seconds of ECM wake-up when a maintenance is required.

### **Display Codes**

Refer to *Displaying Fault Codes*.

### **Setting Tripmeter**

Select **TRIP** and press Trip to cycle through **Vehicle Hours**, **Trip KM** and **Trip HR**.

Press and hold Trip to reset selected trip info.

### **Setting Learning Key (if equipped)**

Connect a normal key to the vehicle. Select **L-KEY #** and press UP or DOWN arrow button to set the desired learning key level between 1 and 5.

Press and hold OK button to confirm.

#### **NOTE:**

The default learning key level is 1 (lowest performance).

### **Unit Selection**

Select **UNITS** and press UP or DOWN arrow button to change units.

#### **NOTE:**

Changing units will apply to all the displayed units.

### **Setting Brightness**

Select **BRIGHTNESS** and press UP or DOWN arrow button to adjust brightness level (from -4 to 4).

### **Setting Clock**

Select **CLOCK**.

1. Press OK button to select clock display.
2. Press UP or DOWN arrow button to select 12:00 AM PM or 24:00 time base.
3. Press OK button to confirm.
4. Press UP or DOWN arrow button to change hours.
5. Press OK button to confirm.

**NOTE:**

Menu available only if GPS is synchronized.

To exit **SETTINGS**, select **EXIT** and press OK button.

***Resetting Speed Statistics (If Equipped)***

Select **SPEED STAT** and press and hold OK button to reset the speed statistics.

**NOTE:**

The speed statistics are automatically reset after the gauge shut down.

***Setting Language***

The language of the display is factory setup by default in English. Refer to an authorized Sea-Doo dealer for language availability and to setup the gauge to your preference.

---

## BREAK-IN PERIOD

### Operation During Break-In Period

A break-in period of 10 operating hours is required before running the watercraft at sustained full throttle.

During this period, maximum throttle should not exceed 1/2 to 3/4 opening. However, brief full acceleration and speed variations contribute to a good break-in.

#### **NOTICE**

**Continued wide open throttle accelerations or operation, prolonged cruising speeds are detrimental during the break-in period.**

#### **NOTE:**

During the first 3 hours of operation, the engine management limits the engine maximum speed for engine protection. The engine performance will progressively increase during this period.

# OPERATING INSTRUCTIONS

## **⚠ WARNING**

Always perform the *Pre-Ride Inspection* before operating this watercraft. Be sure to read the *Safety Information* and the *Watercraft Information* sections and be thoroughly familiar with the iControl technology.

Should any control or instruction not be fully understood, refer to an authorized Sea-Doo dealer.

## **Boarding the Watercraft**

As with any watercraft, boarding should be done carefully.

Make sure to practice each boarding method until fully able to safely board in any potential condition.

## **⚠ WARNING**

Do not apply throttle when anyone is boarding or at rear of watercraft. Shut down the engine

## **Watercraft with iBR system**

## **⚠ WARNING**

Be aware of the iBR gate movement when starting the engine, shutting down the engine or using the iBR lever. Automatic movement of the gate may squeeze fingers or toes of people taking a hold on the back or your watercraft. Never use iBR gate as a supporting point to board the watercraft.

## **Boarding from a Dock**

The models with a front door only also have a stern bench that can be used for people to board from the rear.

1. Always use a designated door to board the watercraft from the dock. Do not jump or climb on the watercraft to board it.

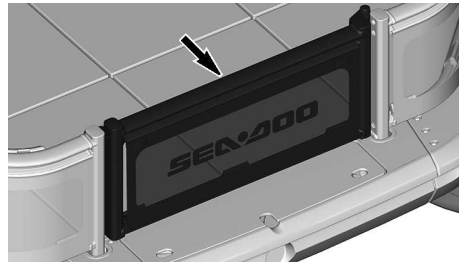

**FRONT DOOR**

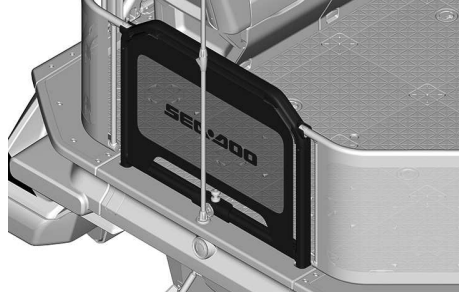

**REAR DOOR**

2. Lift the door and rotate it to open inside the watercraft. Make sure that no object or debris can block the door.
3. Lift the door and rotate it to close it. Make sure the latch is secured.

## **⚠ WARNING**

Always close all the doors securely before starting the engine.

## **Boarding from Shallow Water**

## **⚠ WARNING**

Never leave the engine running when someone is at the rear trying to board the watercraft using the boarding ladder.

1. Board the watercraft from the rear using the boarding ladder. Refer to *Boarding Ladder* subsection for more information. Do not climb on the watercraft from any other point than the ladder.

2. Ensure there is at least 90 cm (3 ft) of water underneath the lowest rear portion of the hull.

**NOTE:**

Before starting the engine and when the engine is already running, take into account that the hull will be lower in the water when all passengers are aboard. Be certain to maintain the specified depth so sand, pebbles and rocks will not be drawn up in the jet pump.

3. Depending on models, use the boarding handle or the rear hand rail to ensure balance when getting on the deck. Refer to *Boarding Handle* subsection for more information.

**NOTICE**

Starting the engine or riding the watercraft in shallower water may damage the impeller or other jet pump components.

*Boarding from Deep Water*

**⚠ WARNING**

Never leave the engine running when someone is at the rear trying to board the watercraft using the boarding ladder.

Refer to *Boarding from Shallow Water* for standard boarding procedure.

**⚠ WARNING**

- Keep limbs away from propulsion system or intake grate.
- Never use reverse gate (iBR) as a supporting point to board the watercraft.

Keep in mind that being in deep water can be strenuous. Make sure

someone monitors the person boarding the watercraft.

**⚠ WARNING**

Ask inexperienced riders to practice how to board the watercraft close to shore (all methods explained here) before venturing into deep water, especially when cargo is installed aboard on the rear platform.

**Starting the Engine**

**⚠ WARNING**

- Always operate the bilge blower for at least 4 minutes before starting the engine to clear gasoline vapors from the engine compartment.
- Operate this blower when the engine is at idle, while below cruising speed and after stopping the engine.

**⚠ WARNING**

Before starting the engine, the operator and passenger(s) should always:

- Be properly seated on the watercraft.
- Have a firm grip on a handhold.
- Wear appropriate protective clothing including a PFD approved by local authorities and a wet suit bottom if required by law.

**NOTICE**

Ensure there is at least 90 cm (3 ft) of water under the lowest rear portion of the hull when all passengers are aboard prior to starting the engine. Otherwise damage to the propulsion system components may occur.

1. Attach the tether cord clip to your PFD or to the wrist (wrist strap required).

### **⚠ WARNING**

The tether cord shall always be attached to the operators personal flotation device or to the wrist (wrist strap required) when starting or operating the watercraft.

2. Firmly grip handlebar with your left hand and place both feet on the deck.
3. Press the engine START/STOP button to wake up the electrical system.
4. Turn on the bilge blower for 4 minutes before starting the engine.
5. As the information center cycles through its self test function, install the tether cord on the engine cut-off switch.
6. Press the START/STOP button to start the engine.

### **NOTICE**

In the event the engine does not start right away, do not hold START/STOP button more than 10 seconds to avoid starter overheating. A rest period should be observed between the cranking cycles to allow the starter to cool down. Refer to *Troubleshooting* section.

7. Release the engine START/STOP button after engine is started.

## Shutting Off the Engine

### **⚠ WARNING**

To maintain watercraft directional control, the engine shall be running until the watercraft is stopped.

1. Press the engine START/STOP button, or
2. Pull off the tether cord cap from the engine cut-off switch.

### **⚠ WARNING**

Never leave the tether cord on the engine cut-off switch when disembarking watercraft to prevent theft, accidental engine starting, and to avoid unauthorized use by children or others.

If the engine is shut off using the START/STOP button and the tether cord is left on the engine cut-off switch, the electrical power will shut off after approximately 60 minutes to prevent battery discharge.

## Steering the Watercraft

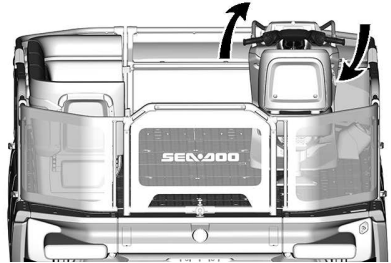

### **STEERING RIGHT**

Turning the handlebar pivots the jet pump nozzle which controls the watercraft direction. Turning the handlebar to the right will turn the watercraft to the right and inversely. You need to apply throttle to steer.

### **⚠ WARNING**

Throttle must be applied and handlebar turned to change the direction of the watercraft. Steering efficiency will differ depending on the amount of throttle applied, the number of passengers, the load, the water conditions and the environmental factors such as the wind.

Unlike a car, a watercraft needs some throttle to turn. Practice in a safe area applying the throttle and turning away from an imaginary object. This is a good collision avoidance technique.

### **⚠ WARNING**

**Directional control is reduced when the throttle is released and lost when the engine is off.**

The watercraft behaves differently with passenger(s) and requires greater skill. The passenger(s) shall grip the seat handle. Reduce speed and avoid sharp turns. Avoid choppy water conditions when carrying passenger(s).

## Shifting into Neutral

### **⚠ WARNING**

**The drive shaft and impeller are always turning when the engine is running, even when the iBR gate is set to the neutral position. Keep away from the propulsion system of the watercraft.**

When the watercraft is first started, the iBR system automatically sets the iBR gate to the neutral position by default.

From forward thrust position, tap the iBR lever. The gate will move to neutral.

If braking or reverse is used, the iBR gate will move to the neutral position when the iBR lever is released, if throttle is not applied.

### **NOTE:**

The throttle lever must be fully released for the iBR gate to move to the neutral position when the iBR lever is released.

If the engine is stopped in forward or reverse, the iBR gate will move to the neutral position on engine shutdown.

### **Adjusting the Neutral Position of the iBR**

When in NEUTRAL, if the watercraft creeps forward or backward, the iBR system may be trimmed.

### **NOTE:**

Movement of the watercraft when operating in neutral may be due to wind or water current.

1. Hold down the VTS up or down button for 0.5 Sec to enter the **Neutral Adjust** mode.

The message **Neutral Adjust** will be displayed.

2. Adjust the Neutral position:
  - Watercraft is moving forwards - press the VTS DOWN button.
  - Watercraft is reversing - press the VTS UP button.

Adjust to achieve no movement when the engine is at idle.



### **TYPICAL**

1. Bow up
2. Bow down
3. Press OK button or wait 25 sec to exit the **Neutral Adjust** mode.

## Shifting into Forward

From neutral, tap on the throttle lever to shift into forward. The gate will



move to forward thrust position and the watercraft will accelerate forward.

From reverse, release the iBR lever while applying throttle moderately.

From braking, simultaneously pull in the throttle lever while releasing the iBR lever. The watercraft will accelerate forward after a short delay.

## Shifting into Reverse

Reverse can only be engaged between idle speed and the threshold forward speed of 14 km/h (9 MPH).

1. Pull in the iBR lever at least 25% of the lever travel.
2. Release the iBR lever to end reverse operation.
3. Apply enough throttle to stop rearward movement.

### **⚠ WARNING**

**The brake function has no effect when travelling in reverse.**

When operating the iBR lever in reverse mode, the throttle lever can be used to control engine RPM, and thus the amount of reverse thrust produced.

By modulating both the iBR and throttle levers simultaneously, reverse thrust can be more precisely controlled. Too much RPM will create water turbulence and reduce reverse efficiency.

#### **NOTE:**

Engine power will be reduced to idle whenever the iBR lever position is changed.

Available engine power is limited in reverse mode, which limits reverse speed. However, speeds above 14

km/h (9 MPH) may be obtained in reverse depending on conditions.

### **⚠ WARNING**

**Only use reverse at slow speed and for the shortest time possible. Always ensure the path behind is clear of objects, obstacles and people.**

When operating in reverse, turn the handlebar in the opposite direction that you want to move the rear of the watercraft.

For example, to steer the rear of the watercraft to port (left), turn the handlebar to starboard (right).

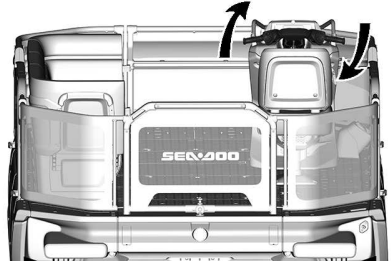

**STEERING RIGHT**

### **⚠ CAUTION**

**Steering direction in reverse thrust is opposite of forward thrust. To steer the stern to port (left) in reverse, turn the handlebar to starboard (right). To steer the stern to starboard (right), turn the handlebar to port (left). Reverse thrust operation should be practiced in open waters in order to become fully familiar with the controls and watercraft handling characteristics before operating in close quarters.**

## Braking

### WARNING

The engine must be running to be able to use the brake. The brake is only applicable when operating in forward movement, it has no effect on rearward velocity. The brake cannot prevent your watercraft from drifting due to current or wind.

The braking function can only be engaged during forward operation at or above the threshold speed of 17 km/h (11 MPH).

Braking is engaged and controlled when the iBR lever on the LH handlebar is pulled in at least 33% of its travel.

### WARNING

Braking should be practiced in open waters and at gradually increasing speeds in order to become fully familiar with the controls and watercraft handling characteristics.

When iBR lever is applied, the throttle lever command is overridden and engine throttle control is now dependant on the iBR lever position. Braking can thus be modulated by using only the iBR lever.

Watercraft deceleration is proportional to the braking force. The more the iBR lever is pulled in, the greater the braking force applied. The deceleration is also related to the total weight on the watercraft. A fully loaded watercraft (cargo and passengers) will not decelerate as fast as it could without this load.

### NOTE:

Be careful to gradually actuate the iBR lever to adjust intensity of the braking force and simultaneously release the throttle lever.

### CAUTION

When braking, riders must brace themselves against the deceleration force to prevent from moving forward on the watercraft and losing balance. The operator should always keep both hands on the handlebars, and all passengers should maintain a firm grip on their seat and/or the hand rail.

### WARNING

Stopping distance will vary depending on initial speed, load, wind, number of riders, water conditions, and the amount of braking power commanded by the operator. Always adjust your riding style accordingly.

When the watercraft slows to less than 16 km/h (10 MPH), braking mode ends and reverse mode is engaged. Release the iBR lever once the watercraft is stopped. Otherwise, a rearward movement will be initiated.

### CAUTION

As the watercraft slows to a stop, the wake created by the watercraft will catch up and tend to push the watercraft forward. Ensure there are no obstacles or bathers in the direction of travel.

If the throttle lever is still pulled in when releasing the iBR lever, the watercraft will accelerate forward after a short delay. Acceleration will be

proportional to the throttle lever position.

### **⚠ WARNING**

**If forward acceleration is not desired when the brake lever is released, release the throttle lever.**

### **⚠ WARNING**

**It is important to inform other operators who intend to follow in a convoy formation of the braking and maneuvering capability of your vehicle and that a greater distance should be maintained.**

### ***Braking in a Turn***

Throttle must be applied for turning to ensure directional control. However braking can be initiated during a turn using the iBR lever as previously described. Get ready to maintain your balance while the wake is crossing your watercraft.

### **⚠ CAUTION**

**As the watercraft slows to a stop while braking in a turn, the wake created by the watercraft will catch up and tend to push the watercraft sideways. Be prepared to maintain balance as the wake crossed the watercraft.**

## **Variable Trim System (VTS)**

The variable trim system (VTS) changes the vertical position of the jet pump nozzle to provide the operator with a fast, effective system to compensate for load, thrust, riding position and water conditions. Correctly adjusted, it can improve handling, reduce porpoising, and position the watercraft at its best riding attitude to attain maximum performance.

When first using the watercraft, the operator should become familiar with

the use of the variable trim system (VTS) at varying speeds and water conditions. A mid-range trim is generally used when cruising. Experience alone will dictate the best trim for the conditions. During the watercraft break-in period, when lower speeds are recommended, it is an excellent opportunity to become familiar with trim adjustment and its effects.

When the nozzle is positioned in an upward angle, the water thrust directs the bow of the watercraft upward. This position is used to optimize high speed.

When the nozzle is directed downward, the bow is forced downward and increases the watercraft turning capabilities. As with any watercraft, speed and operator body position and movement (body English), will determine the degree and sharpness of the watercraft turn. Porpoising can be reduced or eliminated if the nozzle is downward and speed is adjusted proportionately.

### **⚠ WARNING**

**Do not operate this watercraft at negative propulsion unit trim settings (bow down) at high speed. Instability in turn may result.**

### **NOTE:**

VTS position is indicated on a bar gauge in the right lateral display of the information center.

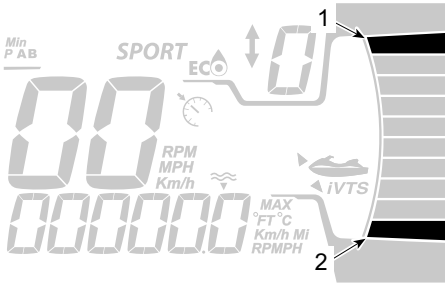

1. Bow up
2. Bow down

### Adjusting the VTS

Nine trim positions are available.

With the watercraft operating in forward thrust, proceed as follows.

#### NOTE:

Pressing the VTS trim button without the engine in forward thrust will only change the indication. The nozzle will move to the selected VTS trim position when forward thrust is engaged.

1. Press the VTS UP button once to trim the bow of the watercraft up to the next up trim position.
2. Press the VTS DOWN button once to trim the bow of the watercraft down to the next down trim position.



#### TYPICAL

1. Bow up
2. Bow down

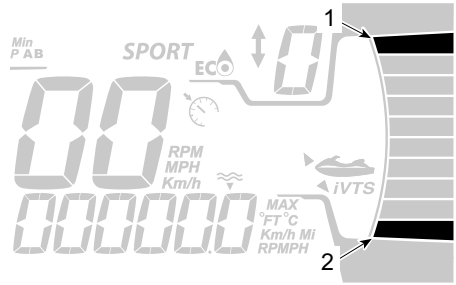

1. Bow up
2. Bow down

#### NOTE:

If the VTS UP or DOWN button is pressed and held, the pump nozzle will keep moving until the button is released at the desired trim attitude or the maximum trim position (up or down) is reached.

#### Using Preset Trim Positions

Three preset trim positions can be selected.

To select the highest trim position recorded, double-click on the VTS UP button (bow up).

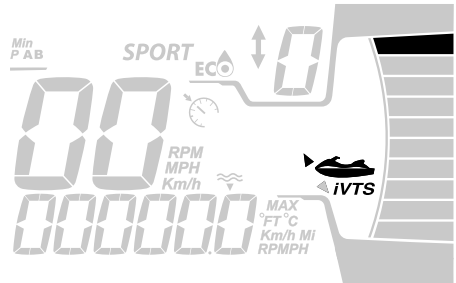

To select the lowest trim position recorded, double-click on the VTS DOWN button (bow down).

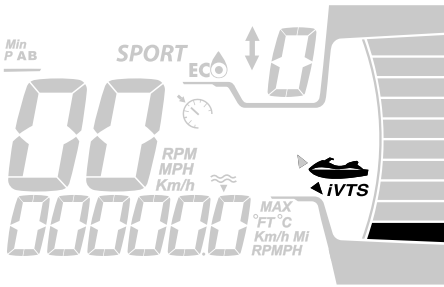

To select the mid trim position, it depends on the actual trim position. Double-click on the VTS UP button if it is positioned below mid trim or double-click on the VTS DOWN button if it is positioned above mid trim.

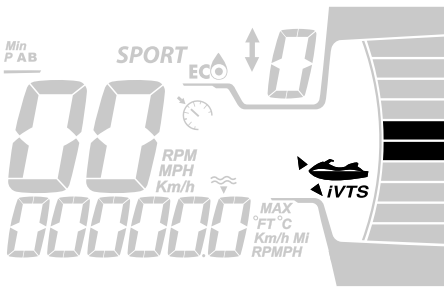

#### NOTE:

These preset trim positions are not adjustable.

### Activating the Intelligent Debris Free Pump System (iDF System) (if equipped)

The iDF system is designed to allow removing small debris or a cord caught in the jet pump by turning the propeller in reverse during a few seconds.

To activate the system, do the following:

1. Stop the engine.
2. Press and hold the iDF button.

The following messages can appear in the digital display during this step.

- **Engaging + R icon blinking** - The request is accepted and the sequence begins.
- **Stop engine then hold iDF** - Engine is still running and must be stopped before pressing the iDF button again.
- **High exhaust temperature** - Exhaust temperature is too high and needs to cool down before activating the sequence.
- **Disable** - The iDF system is not enabled on your watercraft, see an authorized Sea-Doo dealer to enable it.

3. Start engine when the message **Press start to go** is displayed.

When the sequence is completed, the message **Ready to start** will be displayed.

4. Apply throttle when requested.

If the message **Impeller blocked** is displayed - this indicates that the blocking is too important and the system cannot turn the propeller in the opposite direction. Have the watercraft servicing by an authorized Sea-Doo dealer.

5. After a few seconds, the engine will shut down automatically. **Engaging + R icon blinking** will appear.
6. Start engine when the message **Press start to go** is displayed.

When the sequence is completed, the message **Ready to start** will be displayed.

7. Start the engine and try the watercraft when the message **Ready to start** will be displayed.
8. If the propulsion system has not returned to 100% of its original performance due to any remaining debris, stop engine and perform these steps again.

A moderate clog of weeds may require multiple cycles before they can be entirely cleared out.

- Between cycles, it is more efficient to try to drive the watercraft to permit to it to plane in order to help dislodge any remaining weeds before reattempting the iDF cycle.

If the problem persists after several tries, try the *On-Beach Water Cleaning* procedure, refer to *Jet pump Water Intake and Impeller Cleaning* in *Special Procedures* section.

## General Operating Recommendations

### NOTICE

Combustion engines need air to operate; consequently this watercraft cannot be totally watertight. Any maneuvers such as turning constantly in tight circles, plunging the bow through waves, or capsizing the watercraft, that cause the air inlet openings to be under water may cause severe engine problems due to water ingestion. Refer to *How to Steer the Watercraft* in the *Operating Instructions* section and the *Warranty* section contained in this Operator's Guide.

### Rough Water or Poor Visibility Operation

Avoid operation in these conditions. If you must do so, proceed with caution using minimum speed.

### Crossing Wakes or Waves

1. The operator must grip the handlebar firmly and keep both feet on the deck.
2. The passenger (s) must grip the handhold of their seat with both

hands and keep both feet on the deck.

3. Reduce speed.
4. Always be prepared to steer and maintain your balance as necessary.
5. When going over waves, raise your body slightly off the seat to absorb the shocks with your legs.
6. When crossing wakes, always keep a safe distance from watercraft ahead.

### ⚠ WARNING

**When crossing wakes or waves, slow down. Operator and passenger(s) should brace themselves and hold tight on their seat's handhold or the hand rail. Do not jump wakes or waves - jumping can cause injuries such as back or spinal injury (paralysis).**

### Stopping/Docking

When the throttle is released, the watercraft is slowed by water drag against the hull. The stopping distance will vary depending on the watercraft size, weight, speed, water surface condition, presence and direction of wind and current.

The iBR system can also be used for slowing down or for stopping more quickly, and for increasing maneuverability especially when docking.

The operator should practice in open waters at various speeds to become familiarized with the stopping distances under different conditions. Stopping using the iBR system in a straight line and in a turn should be practiced extensively to become familiar with the handling characteristics of the watercraft under partial or full braking conditions.

**⚠ WARNING**

Always practice braking in open waters ensuring there are no watercrafts or boats in your immediate vicinity, especially astern. Other users of the waterways may not be able to maneuver or stop in time to avoid you should you unexpectedly come to a full stop in front of them.

**⚠ WARNING**

It is important to inform other operators who intend to follow in a convoy formation of the braking and maneuvering capability of your vehicle and that a greater distance should be maintained.

The operator should also practice docking with an imaginary dock using the various controls available (iBR lever and throttle lever).

Release the throttle at a sufficient distance before the expected landing area.

Reduce speed to idle.

Maneuver using a combination of the iBR lever and throttle lever, shifting to neutral, reverse, or forward as required.

Remember that when operating in reverse, steering direction is reversed. Turning the handlebars to the left will move the stern to the right when backing up, and vice-versa.

**⚠ WARNING**

Directional control is reduced when the throttle is released and lost when engine is off. Steering direction is reversed when operating the watercraft in reverse.

**Beaching****NOTICE**

It is not recommended to run the watercraft to the beach.

Drive slowly towards the beach and shut off the engine before the water is less than 90 cm (3 ft) deep under the lowest rear portion of the hull. Then pull the watercraft to the beach.

**NOTICE**

Riding the watercraft in shallow water may result in damage to the impeller, iBR components, or other jet pump components. Always shut off the engine before water is less than 90 cm (3 ft) deep and never use reverse or braking.

---

# OPERATING MODES

Press the MODE button to change the operating mode.

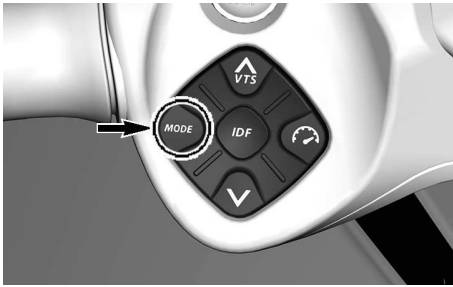

*TYPICAL*

## Touring Mode

By default, the watercraft is set to this riding mode of operation when started.

It is also called Normal riding mode.

The icon ECO +OFF appears in the display when this mode is selected.

## Sport Mode

SPORT MODE provides for instant throttle response but same accelerations than TOURING MODE.

Once activated, SPORT MODE will remain active until it is deactivated by the operator, or the engine is shut down whereby it defaults back to TOURING MODE.

### *Activating Sport Mode*

To activate the Sport mode, press once on the MODE button while in DEFAULT riding mode. Once activated, the SPORT icon will turn ON.

### *Deactivating Sport Mode*

A single press on MODE button will take you to the ECO mode.

## ECO Mode (Fuel Economy Mode)

ECO mode provides a smoother throttle application and increased fuel economy.

## Cruise Control Mode

Cruise control mode is a function of iTC (intelligent Throttle Control) system that allows the operator to set the desired watercraft speed.

This is useful when cruising for long distances, operating in limited speed zones, or towing a tuber, skier or wake boarder.

Once the speed is set, the operator can vary the watercraft speed using the UP/DOWN buttons on the RH keypad.

As you proceed under a constant speed setting, keep your attention level up to maintain good situational awareness.

Slowing down is a matter of pressing the DOWN button, or by pulling the iBR lever in.

If the iBR lever is pulled in for braking, the cruise control mode is overridden and **deactivated**.

Once the iBR lever is released and the throttle is pulled in to engage forward thrust, the cruise speed needs to be manually set again.

The speed setting previously set is deleted each time the cruise control is deactivated.

### *Prerequisite for Cruise Control Mode Activation*

Cruise Control Mode can be activated when the watercraft is at idle speed and up.

The watercraft must be in forward and must not have torque reduction due to faults.



## Activating the Cruise Control Mode

1. Make sure the watercraft is in forward.
2. Press the Cruise Control button on the left keypad. Immediately release the throttle lever after pressing the button. Otherwise the cruise control mode will not activate.

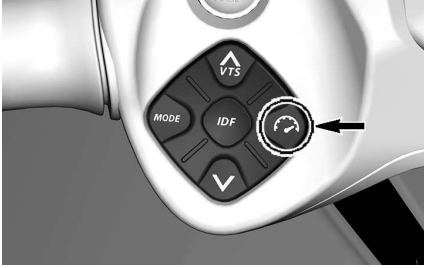

TYPICAL

A beep will be heard to indicate that the cruise control mode is now active, and the cruise control mode indicator will be lit.

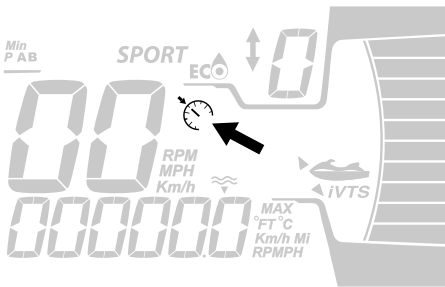

3. Using the UP/DOWN buttons on the right keypad, adjust the speed.

## Deactivating the Cruise Control Mode

To deactivate the cruise control mode, pull in the iBR lever or the iTC lever. The cruise control button can also be pressed.

Deactivation of cruise control mode is indicated by the cruise control indicator going off.

## Ski Mode (If Equipped)

Ski mode allows for repeated and precisely controlled launches, and a set towing speed, specifically for towing a skier or wake boarder.

**NOTE:** A GPS signal is required in order for the ski function to appear in the cluster. To obtain a suitable GPS signal, we recommend that you take the watercraft outside.

### RAMP Function

The RAMP function offers a pre-programmed setting for launching and accelerating the watercraft.

RAMP 1 provides:

- Slowest launch (smoothest)
- Slowest acceleration rate

RAMP 5 provides:

- Quickest launch
- Quickest acceleration rate

### TARGET SPEED Function

The TARGET SPEED function limits the maximum towing speed.

Once the RAMP has been selected, an average watercraft target speed for that RAMP will be visible in the numerical display.

The operator may increase or decrease the target speed to any value within the selected RAMP speed range.

### Using Ski Mode

1. Press MODE button to select the SKI mode.
2. Press OK button when SKI icon flashes.
3. Select ski ramp by using the UP or DOWN arrow button. Ramp 1 will give the slowest acceleration.

**NOTE:**

Acceleration ramp will not behave the same depending on the vehicle type, vehicle load and water conditions. For safety reasons, always start using ramp # 1 to familiarize your skier with acceleration and then change the ramp as needed.

4. Press OK or RIGHT arrow button to confirm acceleration ramp.
5. Select the maximum target speed by using the UP or DOWN arrow button.
6. Press OK or RIGHT arrow button to confirm.

**NOTE:**

At any moment you can use the LEFT and RIGHT arrow buttons to change the ramp and speed selection.

7. After your selection and when you are ready, press the OK button to activate the function.

The message **SKI READY** will display.

Keep throttle fully applied to ski.

Releasing the throttle or applying the brake will pause the SKI mode, simply press OK button to reactivate the SKI mode.

**NOTE:**

MODE remains active and ready until another driving mode is chosen.

***Deactivating Ski Mode***

To end a ski run and completely deactivate ski mode, release the throttle to idle, then press the MODE button.

# SPECIAL PROCEDURES

## Jet Pump Water Intake and Impeller Cleaning

### WARNING

Keep away from intake grate while engine is running. Items such as long hair, loose clothing or personal flotation device straps can become entangled in moving parts.

Weeds, shells or debris can get caught on the intake grate, drive shaft and/or impeller. A clogged water intake may cause troubles such as:

- **Cavitation:** Engine speed is high but watercraft moves slowly due to reduced jet thrust, jet pump components may be damaged.
- **Overheating:** Since the jet pump operation controls the flow of water to cool the exhaust system, a clogged intake will cause the engine to overheat and damage engine internal components.

If the water intake is clogged, activate the iDF. Refer to *How to Use the Intelligent Debris Free Pump System (iDF System)*.

### WARNING

If it is necessary to reach in to remove any foreign object caught in the propulsion system, the tether cord **MUST BE REMOVED** from the engine cut-off switch.

### *iBR Override Function*

When the iBR override function is activated, it allows the user to electrically move the iBR gate and nozzle through its full range of motion using the VTS control button.

### NOTE:

The iBR override function is only available when the engine is not running.

### WARNING

When moving the iBR gate using the iBR override function, ensure no one is near the rear of the watercraft. Movement of the gate may squeeze fingers.

### NOTICE

An object or tool caught in the iBR system when using the iBR override function may cause damage to the iBR components. Remove all rigid foreign objects that may obstruct the iBR gate travel before moving it.

### WARNING

If it is necessary to reach in to remove any foreign object caught in the propulsion system, strictly observe the following before proceeding:

- Remove tether cord from the engine cut-off switch.
- Wait at least 5 minutes.
- Do not press on START/STOP button. Should the START / STOP button be pressed, wait another 5 minutes.

### Activating iBR Override Function

1. Power up the electrical system by pressing the START/STOP button.
2. Install the tether cord on the engine cut-off switch.

**NOTE:** The tether cord must be installed to ensure the information center will not shut off all indications after its self test function. Electrical power will stay on for approximately 1 hour.

3. Pull in and hold the iBR lever for the entire procedure.

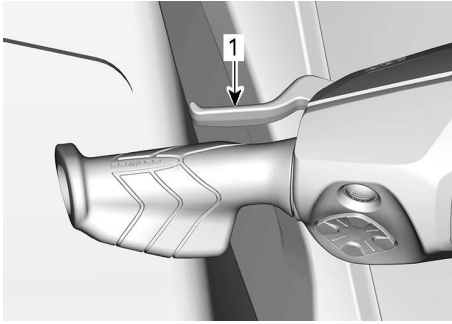

1. *iBR lever pulled and held*
4. When the **IBR OVERRIDE - PRESS MODE BUTTON** message appears in the multifunction gauge, press the MODE button.  
When the function is activated, a ON message will be shown.
5. While still holding the iBR lever in, press the VTS UP/DOWN button to move the iBR gate to the desired position. Ensure the VTS indication in the multifunction gauge changes with the iBR gate movement. If the iBR gate moves upwards, the indication moves upwards.
6. Release the iBR lever.
7. Remove the tether cord from the engine cut-off switch.

### **⚠ WARNING**

**If it is necessary to reach in to remove any foreign object caught in the propulsion system, strictly observe the following before proceeding:**

- Remove tether cord from the engine cut-off switch.
- Wait at least 5 minutes.
- Do not press on START/STOP button. Should the START / STOP button be pressed, wait another 5 minutes.

## Capsized Watercraft

This watercraft is designed so that it should not turn over easily due to its long and wide dimensions.

Always watch for weather changes and conditions deterioration. In stormy conditions, wear your PFD, as well as warm clothing, and keep a portable VHF radio or cellular phone in a dry packaging on you.

If the watercraft ever capsizes, remember that it will continue to float. It is usually best to remain with it, so you will be more easily located by others.

### **⚠ WARNING**

**When watercraft is capsized, do not attempt to turnover the watercraft or to restart the engine. Operator and passengers should always wear approved personal flotation devices.**

**Stay with your watercraft, reach for help and avoid hypothermia.**

## Submerged Watercraft

To limit damages to the engine, perform the following procedure as soon as possible.

1. Drain bilge. Remove water accumulation in the battery tray.
2. If it was submerged in salt water, spray bilge and all components with fresh water using a garden hose to stop the salt corroding effect.

### **NOTICE**

**Never try to crank or start the engine. Water trapped in intake manifold would flow towards the engine and possibly cause severe engine damage.**

3. Bring the watercraft to an authorized Sea-Doo dealer as soon as possible to have it serviced.

**NOTICE**

Failure to have the engine properly serviced may cause severe engine damage.

**Water-Flooded Engine****NOTICE**

Never try to crank or start the engine. Water trapped in intake manifold would flow towards the engine and possibly cause severe engine damage.

Bring the watercraft to an authorized Sea-Doo dealer as soon as possible to have it serviced.

**NOTICE**

Failure to have the engine properly serviced may cause severe engine damage.

**Towing the Watercraft in Water**

Special precautions should be taken when towing a Sea-Doo watercraft in water.

The maximum recommended towing speed is 8 km/h (5 MPH).

This will prevent the exhaust system from filling with water, which may lead to water being injected into and filling the engine. Without the engine running, there isn't any exhaust pressure to push the water out the exhaust outlet.

**NOTICE**

Failure to follow these instructions may result in damage to the engine. If you must tow a stranded watercraft in water, be sure not to exceed the maximum towing speed of 8 km/h (5 MPH).

**NOTICE**

Never tow a watercraft facing backwards as water may enter the engine or bilge.

**CAUTION**

A tow line shall always be made fast in such a way that it can be released when under load.

This page is intentionally blank

# MAINTENANCE

---

## MAINTENANCE SCHEDULE

Maintenance is very important to keep your watercraft in safe operating condition. The vehicle should be serviced as per the maintenance schedule.

Proper maintenance is the owner's responsibility. A warranty claim may be denied if, among other things, the owner or operator caused the problem through improper maintenance or use.

Perform periodic checks and follow the maintenance schedule. **The maintenance schedule does not exempt the pre-ride inspection.**

 **WARNING**

**Failure to properly maintain the watercraft according to the maintenance schedule and procedures can make it unsafe to operate.**



## Automatic Fire Extinguisher (If equipped)

It is the responsibility of the craft owner to ensure the fire-fighting equipment remains in serviceable condition and to inspect the automatic fire extinguisher before operating the boat. Refer to *Verifying the Automatic Extinguisher* and *Servicing the Automatic Fire Extinguisher* for additional information.

## EPA Regulation - Canadian and USA Watercrafts

**A repair shop or person of the owner's choosing may maintain, replace, or repair** emission control devices and systems. These instructions do not require components or service by BRP or authorized Sea-Doo dealers.

Although an authorized Sea-Doo dealer has an in-depth technical knowledge and tools to service your vehicle, the emission-related warranty is not conditioned on the use of an authorized Sea-Doo dealer or any other establishment with which BRP has a commercial relationship.

Proper maintenance is the owner's responsibility. A warranty claim may be denied if, among other things, the owner or operator caused the problem through improper maintenance or use.

For emission-related warranty claims, BRP is limiting the diagnosis and repair of emission-related parts to the authorized Sea-Doo dealers. For more information, please refer to the *US EPA Emissions Warranty* contained in the *warranty* section.

You must follow the instructions for fuel requirements in the fueling section of this manual. Even if gasoline containing greater than ten volume percent ethanol is readily available, the US EPA issued a prohibition against the use of gasoline containing greater than 10 vol% ethanol that applies to this vehicle. The use of gasoline containing greater than 10 vol% ethanol with this engine may harm the emission control system.

## Salt Water/ Dirty Water Usage

Whenever your watercraft is used in salt or dirty water, this type of usage requires maintenance tasks to be performed between the regular yearly intervals. These are identified as A+ in the chart below.

If you regularly ride in **salt or dirty water**, follow the A+ interval and perform the tasks outlined in the chart below.

## Maintenance Schedule

Make sure to perform proper maintenance at recommended intervals as indicated in the tables.

The maintenance chart indicates the items needing to be addressed based on 2 criteria, whichever happens first:

- Calendar time
- Watercraft hours.

Your driving habits determines the factors you shall adhere to. For example:

- Someone who uses their watercraft every weekend would follow the **hours reading** to determine the frequency of his maintenance.
- Someone who uses their watercraft seldomly over the year or only on a few occasions would follow the **calendar time** to determine the frequency of his maintenance.

**IMPORTANT:** The following tables show the appropriate maintenance application for the first 3 years. For subsequent years, repeat the same pattern alternatively.

<b>Maintenance Overview</b>		
Calendar Time	Hour meter	Regular/ Salt/ Dirty water
Every Month		<b>A+</b>
1 Year	100 Hours	<b>A</b>
Every Month		<b>A+</b>
2 Years	200 Hours	<b>A and B</b>
Every Month		<b>A+</b>
3 Years	300 Hours	<b>A</b>

**Rotax 1630 ACE Engines**

<b>REGULAR/ SALT/ DIRTY WATER</b>	<b>A+</b>	<b>A</b>	<b>B</b>
<b>A = Adjust</b> <b>C = Clean</b> <b>F = Flush</b> <b>I = Inspect</b> <b>L = Lubricate</b> <b>R = Replace</b> <b>T = Torque</b>	<b>After every ride in salt or dirty water</b>	<b>Every year or 100 Hours</b>	<b>Every 2 years or 200 Hours</b>
<b>Deck and Hull</b>			
Body panels and hardware		I, T	I, T
Deck components (Bimini, tow hook, doors/gates)		I	
Hull		I	
Pontoon floats		F	
Pontoons	F After every ride		
Sacrificial anode(s)	I Monthly	I	
<b>Electrical</b>			
Battery connections and condition*		I	
Electrical harness routing		I	
Fish finder transducer support		I, A	
Modules and applicable software updates		I	
Operation of control switches and lighting		I	
<b>Engine and Cooling</b>			
Engine compartment	F After every ride		
Engine compartment metallic components	L Monthly		
Engine coolant		R Every 5 years or 300 hour	
Engine cooling components (coolant concentration, coolant		I, A	

REGULAR/ SALT/ DIRTY WATER	A+	A	B
A = Adjust C = Clean F = Flush I = Inspect L = Lubricate R = Replace T = Torque	After every ride in salt or dirty water	Every year or 100 Hours	Every 2 years or 200 Hours
level, hose condition, clamps, leaks)			
Engine oil and oil filter		R	
Engine rubber mounts			I
Spark plugs			R
<b>Exhaust and Emissions</b>			
Exhaust	F After every ride	F	
Exhaust components (gaskets, pipes, muffler condition, leaks)*		I	
<b>Fuel and Air Delivery</b>			
Air delivery components and function (ducts, hoses, clamps)		I	
Fuel components and function (Fuel tank cap, fuel tank fixation, hose condition, leaks)*		I	
<b>iBR</b>			
iBR components and function*		I	
<b>Propulsion</b>			
Propulsion components and function*			I, L
<b>Steering and Controls</b>			
Steering components and function*		I	
Throttle operation		I	

\*For an extensive list of maintenance actions to be performed, refer to the Maintenance Checklist.

# MAINTENANCE PROCEDURES

This section includes instructions for basic maintenance procedures.

## **⚠ WARNING**

Turn off the engine and follow these maintenance procedures when performing maintenance. If you do not follow proper maintenance procedures you can be injured by hot parts, moving parts, electricity, chemicals or other hazards.

## **⚠ WARNING**

Should removal of a locking device (e.g. lock tabs, self-locking fasteners, etc.) be required, always replace with a new one.

## **NOTICE**

Never leave any object, rag, tool, etc., in the engine compartment or in the bilge.

## Fuel System Components and Functions

Once a year, visually inspect:

- Fuel cap
- Hoses
- Clamps
- Fuel tank straps

for crack, loose and other functional damages.

In the event a part needs to be replaced, visit your authorized Sea-Doo dealer.

Service of the engine installed in this boat requires special tools, training and identical replacement parts. The fuel system should be serviced only by a BRP trained technician. Do not attempt to service the fuel system yourself.

## Engine Access Panels

The engine access panels are located near the operator seat and can be removed to gain access to various maintenance items.

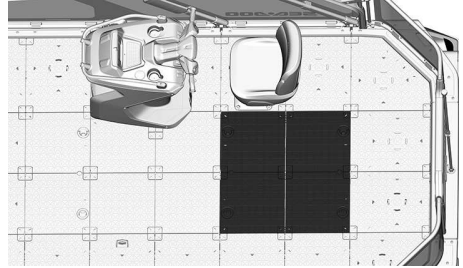

**ENGINE ACCESS PANELS**

### Opening the Engine Access Panels

1. Pull on the latch handles.

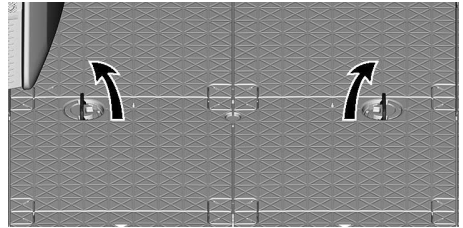

**PULL LATCH HANDLES**

2. Turn the latch handles towards the center to unlock the engine access panel.

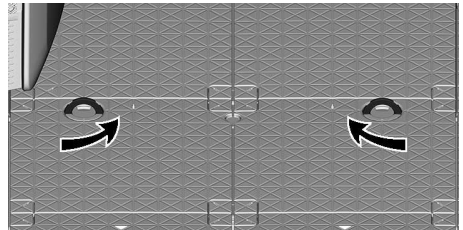

**TURN LATCH HANDLES**

3. Remove the engine access panel.

### Closing the Engine Access Panels

The installation is the reverse of the removal procedure. However, pay attention to the following.

1. Make sure the engine access panel is correctly installed before locking it in position.
2. Turn the latch to lock the cover. It may require some force to do so.
3. Make sure the latch handles are flat on the cover when not in use.

## Engine Oil

### Recommended Engine Oil

Rotax® engines were developed and validated using the XPS® oil.

BRP recommends the use of its XPS engine oil or an equivalent at all time.

Do not add any oil additives to the recommended engine oil. Damages caused by the use of an oil not suitable for the engine or by adding of an oil additives may not be covered by the BRP Limited Warranty.

#### XPS Recommended Engine Oil

5W40 synthetic oil

#### Engine Without a Supercharger

Use a **4-stroke SAE synthetic engine oil** meeting or exceeding the following lubricant industry specifications.

Always check the API service label certification on the oil container, it must contain at least one of the indicated standards.

- API service classification **SN** or,
- **JASO-MA2**

### Verifying the Engine Oil Level

#### NOTICE

**Watercraft must be level.**

#### CAUTION

**When operating the engine while the watercraft is out of water, the heat exchanger in the ride plate may become very hot. Avoid any contact with the ride plate as burns may occur.**

1. Raise the trailer tow pole, then block in position when the deck is level.
2. Install a garden hose on the exhaust system flushing connector. Refer to *Exhaust System* in this section for the procedure.

#### NOTICE

**Never run engine without supplying water to the exhaust system. Failure to cool exhaust system may severely damage it. Never run engine longer than 2 minutes. Drive line seal has no cooling when watercraft is out of water.**

3. Remove engine access panels.

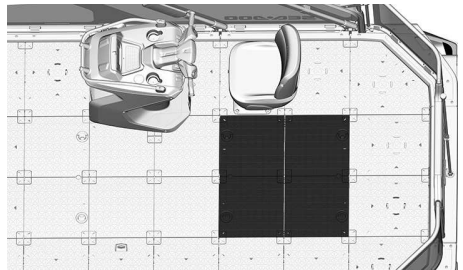

Make sure the master switch is on/closed. Refer to *Closing and Opening the Master Switch*.

4. Start the engine.
5. Open the water tap.
6. Run the COLD engine at **idle for 1 minute**.
7. Close water tap.
8. Bring engine RPM to 4000-4500 RPM for 15 seconds.

9. Stop the engine abruptly by pressing the start/stop button or removing the tether cord.
10. Wait 30 seconds for the oil to settle in the engine, then pull dipstick out and wipe clean.

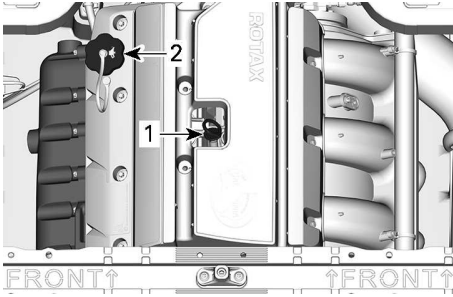

**TYPICAL**

1. Oil dipstick
2. Oil filler cap

11. Reinstall dipstick, push in completely.
12. Remove dipstick again and read oil level. It should be between the FULL and ADD marks.

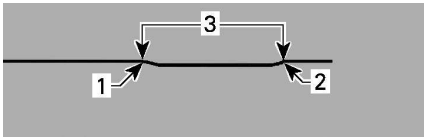

**TYPICAL**

1. Full
2. Add
3. Operating range

13. Add oil to ensure the level is between marks as required.
  1. Remove oil cap.
  2. Place a funnel in valve cover opening.
  3. Add a small amount of the recommended oil to reach the proper level.

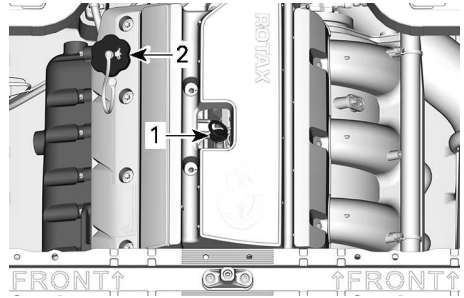

1. Oil dipstick
2. Oil filler cap

**NOTE:**

Every time oil is added in the engine, the complete procedure explained in this section must be carried out again. Otherwise, you will obtain a false oil level reading.

14. Properly reinstall oil cap and dipstick.

**NOTICE**

Ensure that oil filler cap is tighten properly. Otherwise engine oil can spill out.

**Replacing the Engine Oil and Oil Filter**

The oil change and filter replacement may be performed by an authorized Sea-Doo dealer, repair shop, or person of your own choosing.

**NOTICE**

**Do not overfill.**

## Engine Coolant

### Recommended Engine Coolant

<b>XPS Recommended Coolant</b>
Extended life pre-mixed coolant
<b>If the Recommended XPS Coolant is Not Available</b>
Use a low silicate, extended life ethylene-glycol premixed coolant (50%-50%) specifically formulated for internal combustion aluminum engines.

<b>NOTICE</b>
<b>Always use ethylene-glycol anti-freeze containing corrosion inhibitors specifically for internal combustion aluminum engines.</b>

To prevent antifreeze deterioration, always use the same brand and grade. Never mix different brands or grades unless cooling system is completely flushed and refilled.

### Verifying the Engine Coolant Level

<b>⚠ WARNING</b>
<b>Check coolant level with engine cold. Never add coolant when engine is hot.</b>

<b>⚠ CAUTION</b>
<b>Many components in the engine compartment may be very hot. Direct contact may result in skin burn.</b>

1. Remove engine access panels.

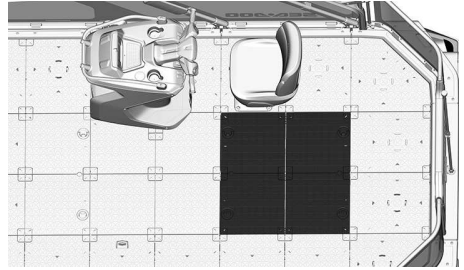

TYPICAL

2. Locate the expansion tank cap.

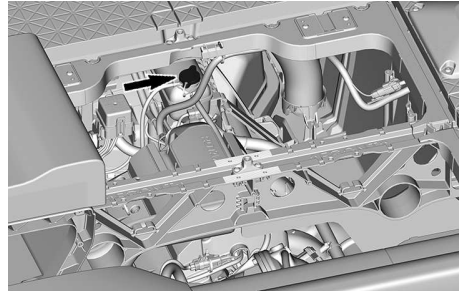

TYPICAL

With watercraft on a level surface, coolant level should be between MIN. and MAX. marks on coolant reservoir when engine is cold.

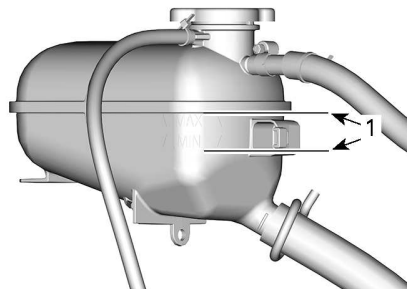

COOLANT EXPANSION TANK

1. Level between marks when engine is cold

### NOTE:

The watercraft is level when it is in water. When on a trailer, raise trailer tow pole and block in this position when the lower part of the hull is level.



Add coolant, see *Recommended Engine Coolant* for specification, to adjust coolant level between marks as required. Use a funnel to avoid spillage. Do not overfill.

3. Properly tighten the expansion tank cap. Reinstall seats.

**NOTE:**

A cooling system that frequently requires coolant is an indication of leaks or engine problems. See an authorized Sea-Doo dealer.

**Replacing the Engine Coolant**

Coolant replacement should be performed by an authorized Sea-Doo dealer, a repair shop or person of your own choosing.

**Ignition Coils**

**Accessing the Ignition Coil**

1. Remove tether cord from the engine cut-off switch.
2. Remove the engine access panels.

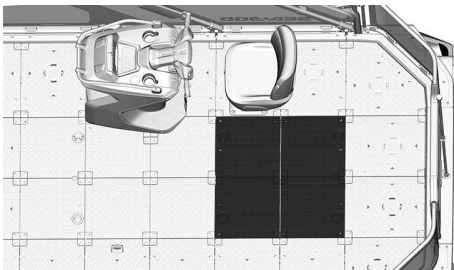

TYPICAL

3. Remove the engine cover.

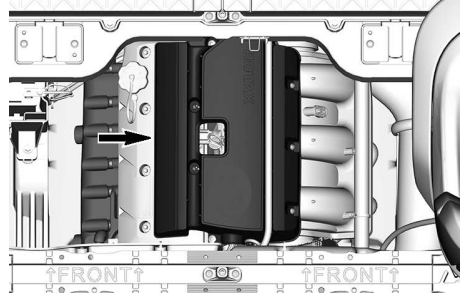

**Removing the Ignition Coil**

1. Disconnect ignition coil connector.

<b>NOTICE</b>
<b>Do not pry on ignition coil using any tool.</b>

2. Remove ignition coil retaining screw.
3. Remove ignition coil from spark plug by rotating coil side to side as you pull up.

**Installing the Ignition Coil**

1. Install ignition coil on spark plug.
2. Align the retaining screw hole of the ignition coil with the threaded hole on the valve cover.
3. Push the ignition coil all the way down until it rests on the valve cover.
4. Install and tighten retaining screw.

<b>Tightening Torque</b>	
Ignition coil retaining screw	9 ± 1 Nm (80 ± 9 lbf-in)

5. Reconnect ignition coil connector.

**Spark Plugs**

**Removing the Spark Plug**

1. Remove the ignition coils. Refer to *Removing the Ignition Coil*.
2. Clean the spark plug and cylinder head with compressed air.

3. Unscrew the spark plug completely using a spark plug socket.

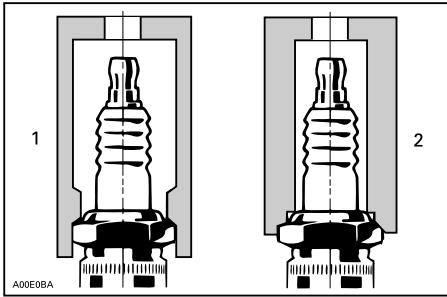

1. Approved socket
2. Improper socket

4. Use the ignition coil to take spark plug out of its hole.

### Installing the Spark Plug

Prior to installation, ensure the contact surfaces of the cylinder head and spark plug are free of grime.

1. Using a wire feeler gauge, check electrode gap as specified in *Technical Specifications*. Replace the spark plug if not to specification.

**NOTICE**

Do not adjust gap on this type of spark plug. The adjustment could weaken negative electrodes which may lead to electrode breaking and severe engine damage.

2. Apply anti-seize lubricant on the spark plug threads to prevent possible seizure.
3. Hand screw spark plug into cylinder head. Then, tighten the spark plug to specification with a spark plug socket.

Tightening Torque	
Spark plug	18 ± 2 Nm (159 ± 18 lbf-in)

4. Install the ignition coils. Refer to *Ignition Coil*.

## Exhaust System

**⚠ DANGER**

**DO NOT** run the engine indoors or without adequate ventilation or permit exhaust fumes to accumulate in confined areas. Engine exhaust contains carbon monoxide (CO) which, if inhaled, can cause serious brain damage or death.

### Flushing the Exhaust System

Flushing the exhaust system with fresh water is essential to neutralize corroding effects of salt or other chemical products present in water. It will help to remove sand, salt, shells or other particles in water jackets and/or hoses.

Exhaust system flushing should be performed when the watercraft is not expected to be used further the same day or when the watercraft is stored for any extended time.

**NOTICE**

Failure to flush the system, when necessary, will severely damage exhaust system. Make sure engine operates during entire procedure.

**⚠ WARNING**

Perform these operations in a well ventilated area. Certain components in the engine compartment may be very hot. Direct contact may result in skin burn. Do not touch any electrical part or jet pump area when engine is running.

**⚠ WARNING**

When operating the engine while the watercraft is out of the water, the heat exchanger in the ride plate may become very hot. Avoid any contact with ride plate as burns may occur.

1. Connect a garden hose to connector located at the rear of watercraft. **Do not open water tap yet.**

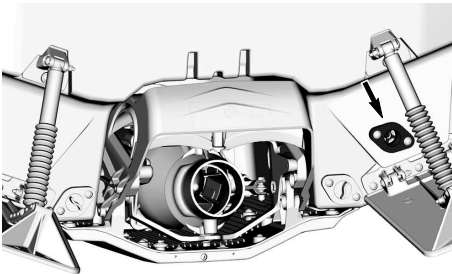

**NOTE:**

The following tool is recommended when a quick connect adapter is used to ease garden hose installation.

**Recommended Tool**

Flushing connector  
adapter  
295 500 473

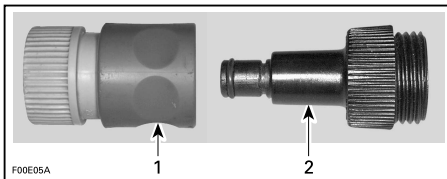

1. *Quick connect adapter*
2. *Flushing connector adapter*

2. Start the engine then immediately open the water tap.

**NOTICE**

Always start the engine before opening the water tap. Open water tap immediately after engine is started to prevent overheating. Never run engine without supplying water to the exhaust system when watercraft is out of water.

3. Run the engine 90 seconds at idle.

**NOTICE**

Never run engine longer than 2 minutes. Drive line seal has no cooling when watercraft is out of water.

4. Ensure water flows out of jet pump while flushing.
5. Close the water tap, run the engine at 5000 RPM for 5 seconds and then stop the engine.

**NOTICE**

Always close the water tap before stopping the engine.

**Ride Plate and Water Intake Grate**

*Inspecting the Ride Plate and the Water Intake Grate*

Inspect ride plate and jet pump water intake grate for damage. Visit your Sea-Doo dealer to have any damaged part repaired or replaced.

**⚠ WARNING**

The tether cord must always be removed prior to inspecting the intake grate.

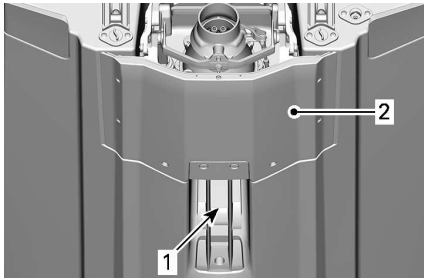

**INSPECT THESE AREAS**

1. Water intake
2. Ride plate

## Sacrificial Anodes

### Inspecting the Sacrificial Anodes

Sacrificial anodes are present on:

- Pump
- Ride plate.

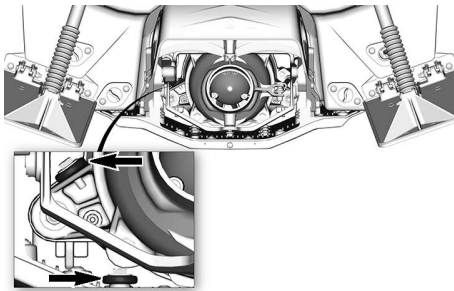

Check for wear. If worn more than half, see an authorized Sea-Doo dealer for anode replacement.

## Fuses

### Inspecting a Fuse

Check fuse condition and replace it if necessary.

<b>WARNING</b>
<p><b>Never use a higher rated fuse than specified.</b></p>

To remove fuse from holder, pull fuse out. Check if filament is melted.

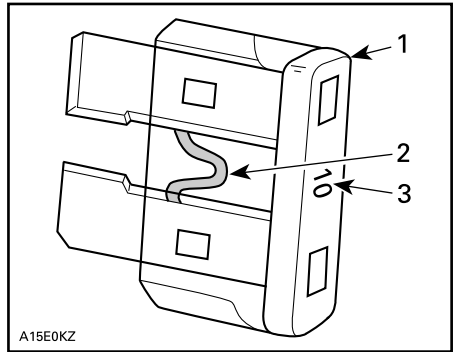

**TYPICAL**

1. Fuse
2. Check if melted
3. Fuse rating (Ampere)

<b>WARNING</b>
<p><b>If fuse burns out repeatedly, source of malfunction should be determined and corrected before restarting. Visit an authorized dealer for servicing.</b></p>

### Fuse Location

There are two (2) fuse boxes, one located in the engine compartment and one in the deck console.

To access the deck fuse box:

Remove console panel.

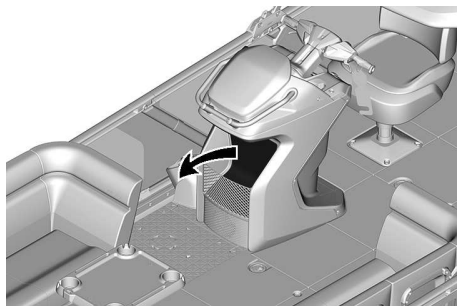

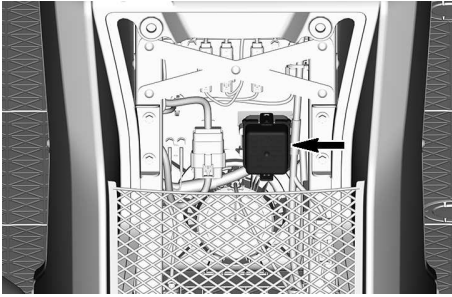

To access the engine fuse box:  
Remove engine access panels.

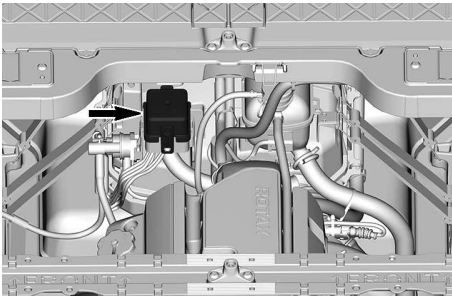
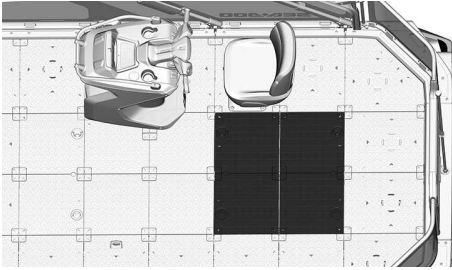

To remove the fuse box cover, squeeze locking tabs together, hold and pull fuse box cover to open.

**NOTE:**  
Fuse ratings and positions are illustrated on the fuse box cover.

Use the fuse remover/ installer tool included in the fuse box to ease fuse removal.

### Fuse Description

Refer to *Technical Specifications* for fuse rating and description.

### Rinsing the Pontoon Floats

Rinsing the pontoon floats with fresh water is essential to remove sand, salt, shells or other particles in the inner floats.

The pontoon float rinsing should be performed depending of the use; less often in clean water, more often if used in dirty water.

It is recommended to perform the pontoon float rinsing at least once a year or when the watercraft is stored for any extended time.

It should also be performed with warm water when going from a lake to another.

1. Connect a garden hose to connector located at the rear RH side of the watercraft, near the boarding ladder.

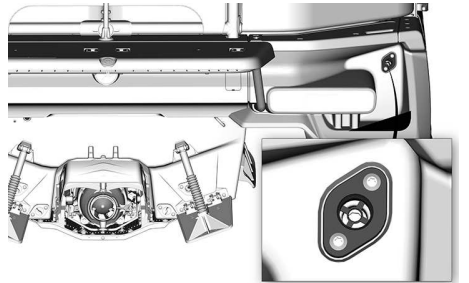

**NOTE:**  
The following tool is recommended when a quick connect adapter is used to ease garden hose installation.

Recommended Tool	
Flushing connector adapter 295500473	

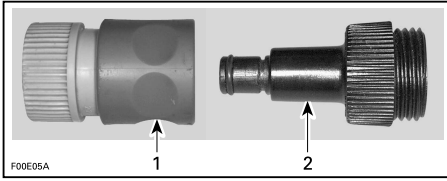

1. Quick connect adapter
2. Flushing connector adapter

2. Ensure water flows around and under the watercraft.
3. Close the water tap, wait until the water stops flowing.
4. Disconnect the garden hose and the flushing connector adapter (if used).

## Bimini Top

### Tightening the Bimini Structure Screws

Check regularly that the bimini structure fasteners have not loosened.

1. Tighten the bimini structure screws to specification periodically.

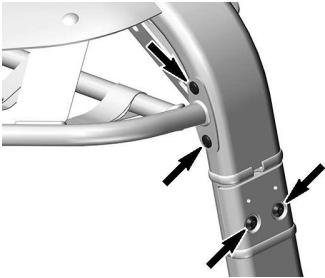

**FRONT BIMINI STRUCTURE SCREWS – LH SIDE**

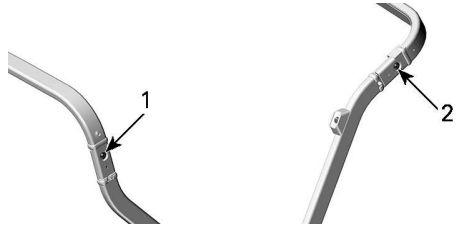

**MIDDLE AND REAR BIMINI STRUCTURE SCREWS – LH SIDE**

1. Middle screw
2. Rear screw

Tightening Torque	
Bimini structure screws	7.5 ± 0.5 Nm (66 ± 4 lbf-in)

### Adjusting the Canvas Tension

1. To adjust the canvas tension, release the clip from the middle section of the bimini structure to provide access to the tension bolt underneath. Refer to *Lowering the Bimini Top* subsection.



**BIMINI TENSION BOLT – LH SIDE**

2. Release tension before tightening the adjustment screws.
3. Turn the screw clockwise to apply tension.
4. Turn the screw counterclockwise to release tension.

---

# WATERCRAFT CARE

## Post-Operation Care

The following post-operation procedures have been developed to help preserve the long-term appearance and reliability of your boat.

**Saltwater usage:** Like any boat, extended mooring is not recommended. Proper flushing of the exhaust system is not possible with the boat in the water. In addition, infiltration of marine organisms and saltwater corrosion can adversely affect the life of many boat components.

**Freshwater usage:** Like any boat, if extended mooring is performed, be sure to remove it from the water periodically to clean the hull and the jet pump area to prevent deterioration. The frequency of maintenance required will depend on local water conditions.

The appropriate mooring cover should be used during extended mooring to avoid water accumulation from rainfall.

### ***Flushing the Exhaust System***

The exhaust system should be flushed daily when watercraft is used in salt or foul water.

Refer to *Maintenance Procedures*.

### ***Rinsing the Pontoon Floats***

The pontoon floats should be rinsed once a year or as needed.

Refer to *Maintenance Procedures*.

### ***Additional Care for Foul Water or Salt Water Operation***

When the watercraft is operated in foul water and particularly in salt water, additional care should be taken to protect the watercraft and its components.

Rinse watercraft bilge area with fresh water.

Never use a high pressure washer to clean the bilge. **USE LOW PRESSURE ONLY** (such as a garden hose).

High pressure can cause damages to electrical or mechanical systems.

 <b>CAUTION</b>
--

<b>Allow engine to cool before performing any maintenance.</b>
--

<b>NOTICE</b>
---------------

<b>Failure to perform proper care such as: watercraft rinsing, exhaust system flushing and anti-corrosion treatment, when watercraft is used in salt water, will result in damage to the watercraft and its components. Never leave the watercraft stored in direct sunlight.</b>
---

### ***Cleaning the Seats***

Clean and/ or dry all seats daily after riding, using XPS marine products. Visit your authorized Sea-Doo dealer for more information.

Do not leave anything wet like towels or swimsuits, or anything biological such as food or leaves on the seats. Permanent damage can occur.

### ***Deck and Hull***

Repair, clean and protect the watercraft as per procedures in *Watercraft Care* section.

### ***Repair***

If any repairs are needed to deck components or to the hull, contact your authorized Sea-Doo dealer.

### ***Cleaning***

Wash the hull, pontoon floats and deck with a soap and water solution (use only mild detergent). Rinse thoroughly with fresh water.

Remove marine organisms from the inside and outside of the hulls.

Use XPS marine products to clean and protect fabrics and clear vinyl like the Bimini top and balustrades.

**NOTICE**

**Never clean using the following products:**

- XPS S4 Heavy Duty Cleaner
- Strong detergent
- Degreasing agent
- Ammonia
- Acetone or other ketones
- Alcohol
- Toluene or other aromatic solvents
- Chlorinated solvents
- Mineral spirits
- Paint thinners
- Petroleum based products.

Stains may be removed from the seat and fiberglass using the XPS All Purpose Cleaner and Degreaser or the equivalent.

To clean the carpets, use XPS All Purpose Cleaner and Degreaser or an equivalent.

**⚠ WARNING**

**Never apply plastic or vinyl protector on the floor tiles as the surface will become slippery and the occupants may slip on the floor or fall overboard.**

Respect the environment by ensuring fuel, oil or cleaning solutions do not drain into the waterways.

**Protection**

If the watercraft is to be stored outside, cover it with an opaque tarpaulin to prevent sun rays and grime from affecting the plastic components, watercraft finish, as well as preventing dust accumulation.

**NOTICE**

**The watercraft should never be left in water for storage. Never leave the watercraft stored in direct sunlight. Never store watercraft in a plastic bag.**



# STORAGE AND PRESEASON PREPARATION

## Storage

### WARNING

Because fuel and oil are flammable, you should have an authorized Sea-Doo dealer, repair shop, or person of your own choosing to inspect the fuel system integrity as specified in the periodic inspection chart.

It is recommended that the watercraft be serviced by an authorized Sea-Doo dealer, repair shop, or person of your own choosing for storage, however the following operations can be performed by you with a minimum of tools.

### NOTE:

Carry out the following tasks in the same order as detailed in this section.

### NOTICE

Do not run the engine during the storage period.

## Propulsion System

### Cleaning the Jet Pump

### WARNING

Always remove tether cord from the engine cut-off switch to prevent unexpected engine starting before cleaning the jet pump area. Engine must not be running for this operation.

Rinse the jet pump by spraying water through its inlet and outlet openings.

Spray an anti-corrosive product on the propulsion system parts.

### Service Product

XPS Anti-corrosive lubricant or equivalent

### Inspecting the Jet Pump

Visit your authorized Sea-Doo dealer.

### Fuel System

#### Protecting the Fuel System

A fuel stabilizer should be added in the fuel tank to prevent fuel deterioration and fuel system gumming. Follow stabilizer manufacturers' instructions for proper use.

Fill up fuel tank completely. Make sure there is no water inside fuel tank.

### NOTICE

Should any water be trapped inside fuel tank, severe internal damage may occur to the fuel injection system.

## Engine and Exhaust

### Replacing the Engine Oil and Oil Filter

The oil change and filter replacement may be performed by an authorized Sea-Doo dealer, repair shop, or person of your own choosing.

### Lubricating the Engine Cylinders

1. Remove spark plugs, refer to appropriate engine service manual.
2. Spray lubricant in each cylinder through spark plug holes.

### XPS Lubricant and anti-corrosive

3. Fully depress the throttle lever. Depressing the throttle lever will prevent fuel from being injected and disable the ignition during engine cranking.
4. Press the START/STOP button to crank the engine a few turns. This will distribute the oil on the cylinder walls.
5. Apply anti-seize lubricant on spark plug threads, then reinstall them in the engine.
6. Install the ignition coils.

## Testing the Engine Coolant Density

If antifreeze is not replaced, test its density.

The antifreeze replacement and a density test should be performed by an authorized Sea-Doo dealer, repair shop or person of your own choosing. Refer to *Maintenance Schedule*.

### NOTICE

**Improper antifreeze density may result in freezing of the liquid in the cooling system if the watercraft is stored in an area where the freezing point is attained. This would seriously damage the engine.**

## Flushing the Exhaust System

Perform procedure as described in *Maintenance Procedures* section.

## Draining the Exhaust System

In areas where temperature may freeze, water trapped in the exhaust system and intercooler must be removed.

Using the flushing connector, inject pressurized air at 379 kPa (55 lbf/in<sup>2</sup>) into system until there is no more water flowing from jet pump and exhaust system drain.



The following hose can be fabricated to ease draining procedure.

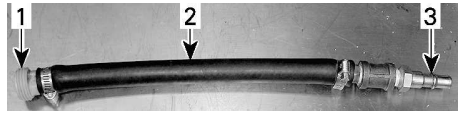

### TYPICAL

1. Flushing connector adapter
2. Hose 12.7 mm (1/2 in)
3. Air hose male adapter

### NOTICE

**Failure to drain the exhaust system may cause severe damage to the exhaust manifold.**

Remove special tools and close exhaust system drain plug.

## Electrical System

### Battery

#### Battery Maintenance

When storing the watercraft, the battery should always be stored in a warm, dry place.

### ⚠ WARNING

**Never charge or boost the battery while installed in the watercraft.**

This vehicle is equipped with a maintenance-free type battery, there is no need to add water to adjust electrolyte level.

### NOTICE

**Never remove the battery strip from caps or add electrolyte for the life of the battery.**

## Accessing the Battery

To access the battery, remove the engine access panels.

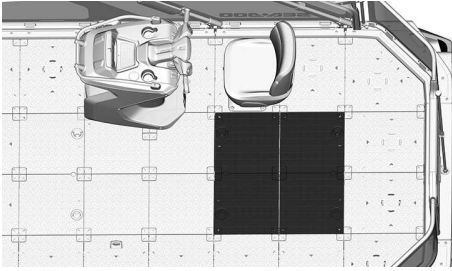

## Removing the Battery

Ensure the master switch is off/opened. Refer to *Master Switch*.

1. Disconnect BLACK (-) cable first, then RED (+) cable.

### NOTICE

**Always disconnect the BLACK (-) cable first, then the RED (+) cable.**

2. Unlatch the battery.

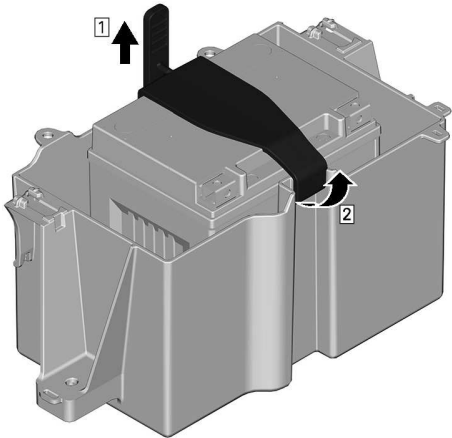

### UNLATCHING THE BATTERY

Step 1. Pull the strap rearwards

Step 2. Remove the battery clip

3. Remove battery.

## Charging the Battery

Use any automotive type battery charger. Always refer to the battery charger manufacturer's instructions.

## Cleaning the Battery

Clean battery casing and battery posts using a soft brush and a solution of baking soda and water.

Remove corrosion from battery cable terminals and battery posts using a firm wire brush.

Rinse with clear water then dry well.

## Installing the Battery

1. Connect the battery cables.

**NOTE:** Remove any water or debris if present in the compartment before installing the battery.

### NOTICE

**Reversed battery polarity will damage the voltage regulator.**

### NOTICE

**Always connect the RED (+) cable first, then the BLACK (-) cable.**

2. Tighten the battery cable screws to specification.

### Tightening Torque

Battery cable screw	$4 \pm 0.5$ Nm ( $35 \pm 4$ lbf-in)
---------------------	--

3. Apply dielectric grease on battery posts.
4. Cover positive battery post with rubber boot.
5. Verify cable routing and attachments.

## Engine Compartment

### Cleaning the Engine Compartment

1. Clean the bilge with hot water and detergent or with bilge cleaner.
2. Rinse thoroughly.
3. Lift front end of watercraft to completely drain bilge through the bilge drain plugs.

### Anticorrosion Treatment

1. Wipe off any residual water in the engine compartment.
2. Lubricate all metallic components in engine compartment.

Service Product
XPS Anti-corrosive lubricant or equivalent

3. Keep the engine access panel raised to prevent condensation or corrosion inside the engine compartment.

### Accessories Storage

Some accessories can be sensitive to humidity and enclosed area.

Make sure all removable accessories, including electronics and clothing are stored in a dry and ventilated area.

### Deck and Hull

Repair, clean and protect the watercraft as per procedures in *Watercraft Care* section.

### Preseason Preparation

The preseason preparation must be performed in conjunction with the *Maintenance Schedule*.

Ensure to perform all tasks included in the **Every Year or 100 Hours** table.

Preseason preparation maintenance may be performed by an authorized Sea-Doo dealer, repair shop or person of your own choosing.

---

# MAINTENANCE RECORDS

Send photocopy of maintenance record to BRP if needed.

Pre-delivery	
Serial number: _____	Signature/Print:
Mileage / km: _____	
Hours: _____	
Date: _____	
Dealer no: _____	
Notes: _____	
_____	
Refer to vehicle Pre-Delivery Bulletin for detailed installation procedures	

**First inspection**

Mileage / km:

\_\_\_\_\_

Hours:

\_\_\_\_\_

Date:

\_\_\_\_\_

Dealer no:

\_\_\_\_\_

Notes:

\_\_\_\_\_

\_\_\_\_\_

Signature/Print:

For maintenance schedule refer to Maintenance Information section of this operator's guide

**Service**

Mileage / km:

\_\_\_\_\_

Hours:

\_\_\_\_\_

Date:

\_\_\_\_\_

Dealer no:

\_\_\_\_\_

Notes:

\_\_\_\_\_

\_\_\_\_\_

Signature/Print:

For maintenance schedule refer to Maintenance Information section of this operator's guide

<b>Service</b>	
Mileage / km: _____ Hours: _____ Date: _____ Dealer no: _____ Notes: _____ _____	Signature/Print:
For maintenance schedule refer to Maintenance Information section of this operator's guide	

<b>Service</b>	
Mileage / km: _____ Hours: _____ Date: _____ Dealer no: _____ Notes: _____ _____	Signature/Print:
For maintenance schedule refer to Maintenance Information section of this operator's guide	

**Service**

Mileage / km:

\_\_\_\_\_

Hours:

\_\_\_\_\_

Date:

\_\_\_\_\_

Dealer no:

\_\_\_\_\_

Notes:

\_\_\_\_\_

\_\_\_\_\_

Signature/Print:

For maintenance schedule refer to Maintenance Information section of this operator's guide

**Service**

Mileage / km:

\_\_\_\_\_

Hours:

\_\_\_\_\_

Date:

\_\_\_\_\_

Dealer no:

\_\_\_\_\_

Notes:

\_\_\_\_\_

\_\_\_\_\_

Signature/Print:

For maintenance schedule refer to Maintenance Information section of this operator's guide



<b>Service</b>	
Mileage / km: _____ Hours: _____ Date: _____ Dealer no: _____ Notes: _____ _____	Signature/Print:
For maintenance schedule refer to Maintenance Information section of this operator's guide	

<b>Service</b>	
Mileage / km: _____ Hours: _____ Date: _____ Dealer no: _____ Notes: _____ _____	Signature/Print:
For maintenance schedule refer to Maintenance Information section of this operator's guide	

**Service**

Mileage / km:

\_\_\_\_\_

Hours:

\_\_\_\_\_

Date:

\_\_\_\_\_

Dealer no:

\_\_\_\_\_

Notes:

\_\_\_\_\_

\_\_\_\_\_

Signature/Print:

For maintenance schedule refer to Maintenance Information section of this operator's guide

**Service**

Mileage / km:

\_\_\_\_\_

Hours:

\_\_\_\_\_

Date:

\_\_\_\_\_

Dealer no:

\_\_\_\_\_

Notes:

\_\_\_\_\_

\_\_\_\_\_

Signature/Print:

For maintenance schedule refer to Maintenance Information section of this operator's guide

<b>Service</b>	
Mileage / km: _____ Hours: _____ Date: _____ Dealer no: _____ Notes: _____ _____	Signature/Print:
For maintenance schedule refer to Maintenance Information section of this operator's guide	

<b>Service</b>	
Mileage / km: _____ Hours: _____ Date: _____ Dealer no: _____ Notes: _____ _____	Signature/Print:
For maintenance schedule refer to Maintenance Information section of this operator's guide	

**Service**

Mileage / km:

\_\_\_\_\_

Hours:

\_\_\_\_\_

Date:

\_\_\_\_\_

Dealer no:

\_\_\_\_\_

Notes:

\_\_\_\_\_

\_\_\_\_\_

Signature/Print:

For maintenance schedule refer to Maintenance Information section of this operator's guide

**Service**

Mileage / km:

\_\_\_\_\_

Hours:

\_\_\_\_\_

Date:

\_\_\_\_\_

Dealer no:

\_\_\_\_\_

Notes:

\_\_\_\_\_

\_\_\_\_\_

Signature/Print:

For maintenance schedule refer to Maintenance Information section of this operator's guide

# TECHNICAL INFORMATION

# IDENTIFICATION NUMBERS

The main components of the watercraft (engine and hull) are identified by different serial numbers. It may sometimes become necessary to locate these numbers for warranty purposes or to trace the watercraft in the event of theft.

## Hull Identification Number

The Hull Identification Number (HIN) is located at the rear of watercraft.

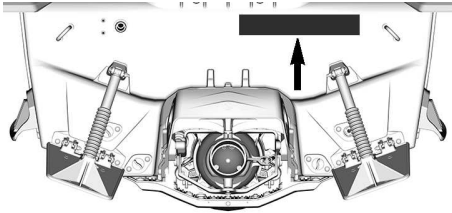

### TYPICAL

It is composed of 12 digits:

YDV	12345	L	2	22
		Model year		
		Year of production		
		Month of production		
Serial number (a letter may also be used as a digit)				
Manufacturer				

## Engine Identification Number

The Engine Identification Number (EIN) is located on the front end of the engine.

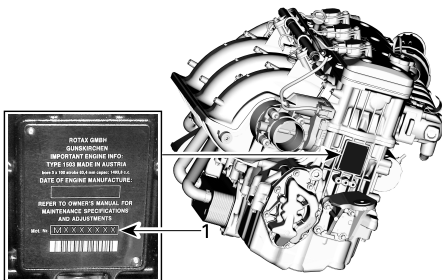

### TYPICAL

1. Engine Identification Number (EIN)

# COMPLIANCE

## Emission Control Hang Tag – 3 Stars

○



**One Star - Low Emission**  
 The one-star label identifies engines that meet the Air Resources Board's Personal Watercraft and Outboard marine engine 2001 exhaust emission standards. Engines meeting these standards have 75% lower emissions than conventional carbureted two-stroke engines. These engines are equivalent to the U.S. EPA's 2006 standards for Marine Engines.



**Two Stars - Very Low Emission**  
 The two-star label identifies engines that meet the Air Resources Board's Personal Watercraft and Outboard marine engine 2004 exhaust emission standards. Engines meeting these standards have 20% lower emissions than One-Star - Low-Emission engines.



**Three Stars - Ultra Low Emission**  
 The three-star label identifies engines that meet the Air Resources Board's Personal Watercraft and Outboard marine engine 2008 exhaust emission standards or the Sterndrive and Inboard marine engine 2003-2008 exhaust emission standards. Engines meeting these standards have 65% lower emissions than One-Star - Low-Emission engines.



**Four Stars - Super Ultra Low Emission**  
 The four-star label identifies engines that meet the Air Resources Board's Sterndrive and Inboard marine engine 2009 exhaust emission standards. Personal Watercraft and Outboard marine engines may also comply with these standards. Engines meeting these standards have 90% lower emissions than One-Star - Low-Emission engines.

**Bombardier Recreational Products Inc.**  
 VALCOURT, QUÉBEC, CANADA.  
 Cleaner Watercraft - Get the Facts  
 1-800-END-SMOG  
[www.arb.ca.gov](http://www.arb.ca.gov)

219906047

○



○



○



☑



○

**The Star Label means Cleaner Marine Engines**  
 This engine has been certified as at:

**The Symbol for Cleaner Marine Engines:**

**Cleaner Air and Water** - for a healthier lifestyle and environment.

**Better Fuel Economy** - burns up to 30 - 40 percent less gas and oil than conventional carbureted two-stroke engines, saving money and resources.

**Longer Emissions Warranty** - protects consumer for worry free operation.

### EMISSION CONTROL HANG TAG - 3 STARS

# Emission Control Label



**EMISSION CONTROL LABEL - 3 STARS**

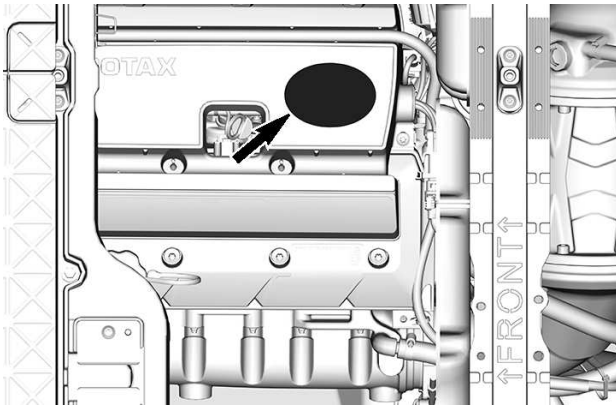

**ENGINE COVER**



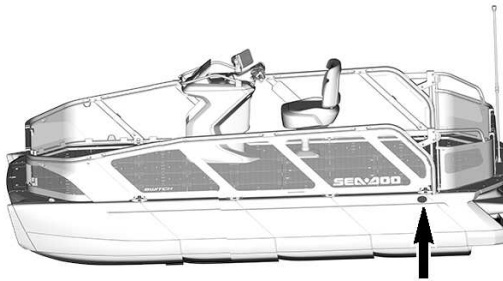



LH SIDE OF WATERCRAFT

## Emission Control System Information (EPA) Label

**EMISSION CONTROL SYSTEM INFORMATION**  
 BOMBARDIER RECREATIONAL PRODUCTS INC.  
 THIS ENGINE CONFORMS TO U.S. EPA &  
 CALIFORNIA EMISSIONS REGULATIONS FOR  
 MARINE SI ENGINES.  
 RENSEIGNEMENT SUR LE DISPOSITIF  
 ANTIPOLLUTION  
 CE MOTEUR EST CONFORME AUX NORMES  
 DE L'EPA DES É.-U. POUR LES MOTEURS  
 MARINS À ALLUMAGE COMMANDE.

  

ENGINE FAMILY / FAMILLE DE MOTEUR:  
 (EPA) \_\_\_\_\_ | (CA) \_\_\_\_\_  
 (FEL) \_\_\_\_\_ | (FEL) \_\_\_\_\_

EMISSION CONTROL SYSTEM / SYSTÈME  
 DE CONTRÔLE DES ÉMISSIONS:  
 DISPLACEMENT / CYLINDRÉE:  
  
 SEE OPERATOR'S GUIDE  
 (MAINTENANCE, FUEL, OIL, SPARK PLUG).  
 VOIR GUIDE D'OPÉRATEUR  
 (ENTRETIEN, ESSENCE, HUILE, BOUGIE.)

5730

## EMISSION CONTROL SYSTEM INFORMATION (EPA) LABEL

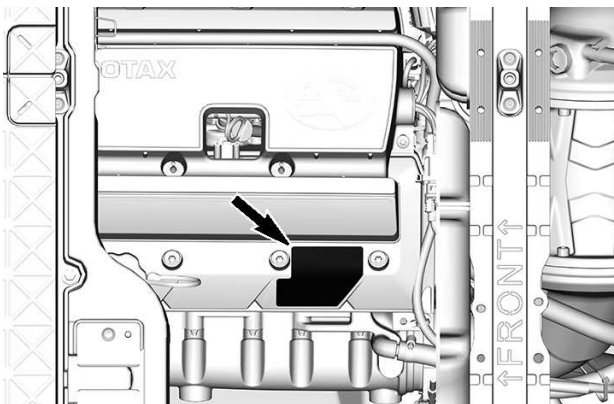

ENGINE COVER

## Fuel System Exemption Label

This boat complies with U.S. Coast Guard safety standards in effect on the date of certification with the exception of certain fuel system requirements associated with its fuel injected engines as authorized by U.S. Coast Guard grant of exemption (21EX0015). Maintenance of the fuel system in this boat should be performed only by experienced technicians using identical fuel system components.

THIS BOAT COMPLIES WITH U.S. COAST GUARD SAFETY STANDARDS IN EFFECT ON THE DATE OF CERTIFICATION WITH THE EXCEPTION OF CERTAIN FUEL SYSTEM REQUIREMENTS ASSOCIATED WITH ITS FUEL INJECTED ENGINE AS AUTHORIZED BY U.S. COAST GUARD GRANT OF EXEMPTION (21EX0015). MAINTENANCE OF THE FUEL SYSTEM IN THIS BOAT SHOULD BE PERFORMED ONLY BY EXPERIENCED TECHNICIANS USING IDENTICAL FUEL SYSTEM COMPONENTS. ALL PERSONS SHOULD WEAR A LIFEJACKET (PFD) WHILE OPERATING OR RIDING IN THIS WATERCRAFT.

BOMBARDIER RECREATIONAL PRODUCTS INC. VALCOURT, QC, CANADA



### FUEL SYSTEM EXEMPTION LABEL

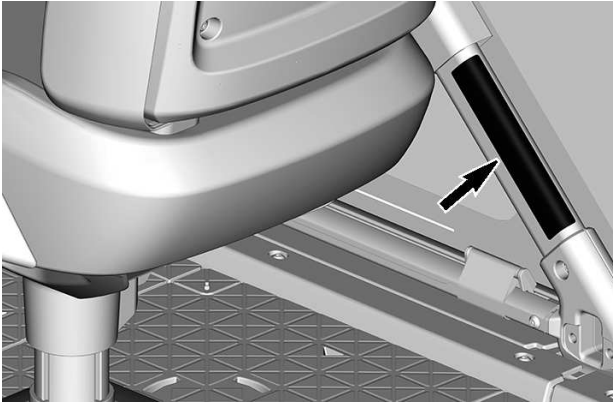

FUEL SYSTEM EXEMPTION LABEL – RH HAND RAIL

## BRP European Distribution SA

BRP is a member of the Association for Eco-Responsible Pleasure Craft, dedicated to the dismantling and recycling of pleasure boats and personal watercraft at the end of their life. The Unique Producer Identifier of BRP European Distribution SA is: FR219503\_18XCIB

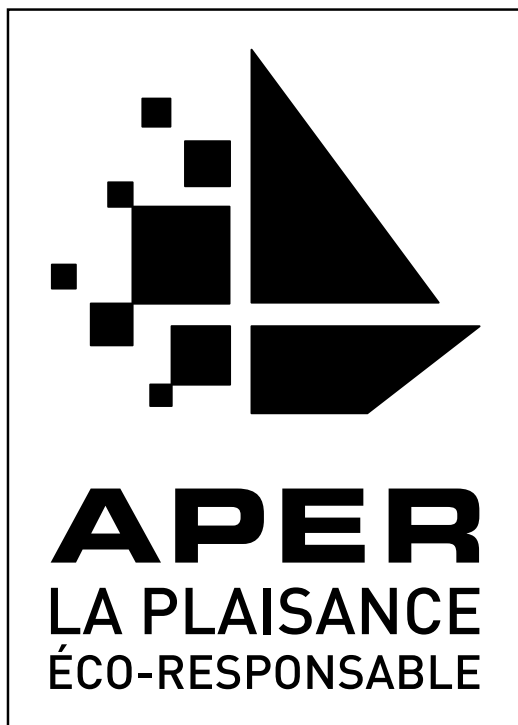

REP France - TRIMAN Signage  
For France only



**En fin de vie,  
votre bateau de plaisance  
doit être confié à  
l'éco-organisme dédié**

Plus d'infos sur [www.quefairedemesdechets.fr](http://www.quefairedemesdechets.fr)

Les bateaux de plaisance hors d'usage ne doivent pas être abandonnés, ni apportés en déchetterie ou lieu de vente. Ils doivent être confiés à l'éco-organisme dédié, qui procédera gratuitement à leur déconstruction et leur recyclage. Les demandes de déconstruction sont à effectuer sur [www.recyclermonbateau.fr](http://www.recyclermonbateau.fr)

---

# BRP RF DESS POST GEN3 (CAN)

## USA and Canada

This device complies with FCC Part 15 and Industry Canada license exempt RSS standard(s). Operation is subject to the following two conditions:

1. this device may not cause interference, and
2. this device must accept any interference, including interference that may cause undesired operation of the device.

This equipment has been tested and found to comply with the limits for a Class B digital device, pursuant to part 15 of the FCC Rules. These limits are designed to provide reasonable protection against harmful interference in a residential installation. This equipment generates, uses and can radiate radio frequency energy and, if not installed and used in accordance with the instructions, may cause harmful interference to radio communications. However, there is no guarantee that interference will not occur in a particular installation. If this equipment does cause harmful interference to radio or television reception, which can be determined by turning the equipment off and on, the user is encouraged to try to correct the interference by one or more of the following measures:

- Reorient or relocate the receiving antenna.
- Increase the separation between the equipment and receiver.
- Connect the equipment into an outlet on a circuit different from that to which the receiver is connected.
- Consult the dealer or an experienced radio/TV technician for help.

The device has been evaluated to meet general RF exposure requirement. The device can be used in portable exposure condition without restriction.

Le dispositif a été évalué à satisfaire l'exigence générale de l'exposition aux rf. L'appareil peut être utilisé dans des conditions d'exposition portatif sans restriction.

L'émetteur/récepteur exempt de licence contenu dans le présent appareil est conforme aux CNR d'Innovation, Sciences et Développement économique Canada applicables aux appareils radio exempts de licence.

1. l'appareil ne doit pas produire de brouillage, et
2. l'appareil doit accepter tout brouillage radioélectrique subi, même si le brouillage est susceptible d'en compromettre le fonctionnement.

Changes or modifications not expressly approved by the party responsible for compliance could void the user's authority to operate the equipment.

IC: 12006A-1001317030 For variant 1001316154 (CAN)

FCC ID: 2ACER 1001317030 For variant 1001316154 (CAN)

## Mexico



IFETEL

Marca: BRP Megatech

Número: BRME1023-28186

BRP Megatech Certificate number: 1450978

Modelo: 1001316154

NOM-208-SCFI-2016 (Disposición Técnica IFT-008-2015)

La operación de este equipo está sujeta a las siguientes dos condiciones:

1. Es posible que este equipo o dispositivo no cause interferencia perjudicial y
2. Este equipo o dispositivo debe aceptar cualquier interferencia, incluyendo la que pueda causar su operación no deseada.

## Brazil



Número: 05254-23-15603

BRP Megatech Certificate number: 1450991

Modelo: 1001316154

Este equipamento não tem direito à proteção contra interferência prejudicial e não pode causar interferência em sistemas devidamente autorizados. Para maiores informações, consulte o site da ANATEL.

## Japan

This device is granted pursuant to the Japanese Radio Law (電波法) and the Japanese Telecommunications Business Law (電気通信事業法). This device should not be modified (otherwise the granted designation number will become invalid).

## Europe

### Declaration of Conformity

Simplified EU Declaration of Conformity according Radio Equipment Directive 2014/ 53/EU



### DE

Hiermit erklärt BRP Megatech, dass der Funkanlagentyp 1001316154 der Richtlinie 2014/53/EU entspricht. Der vollständige Text der EU-Konformitätserklärung ist unter der folgenden Internetadresse verfügbar: <https://www.brp.com/en/corporatesocialresponsibility/productsafety.html>

### FR

Le soussigné, BRP Megatech, déclare que l'équipement radioélectrique du type 1001316154 est conforme à la directive 2014/53/UE. Le texte complet de la déclaration UE de conformité est disponible à l'adresse internet suivante: <https://www.brp.com/en/corporatesocialresponsibility/productsafety.html>

### BG

С настоящото BRP Megatech декларира, че този тип радиосъоръжение 1001316154 е в съответствие с Директива 2014/53/ЕС.

Цялостният текст на ЕС декларацията за съответствие може да се намери на следния интернет адрес: <https://www.brp.com/en/corporatesocialresponsibility/productsafety.html>

### EL

Με την παρούσα ο/η BRP Megatech, δηλώνει ότι ο ραδιοεξοπλισμός 1001316154 πληροί την οδηγία 2014/53/ΕΕ. Το πλήρες κείμενο της δήλωσης συμμόρφωσης ΕΕ διατίθεται στην ακόλουθη ιστοσελίδα στο διαδίκτυο: <https://www.brp.com/en/corporatesocialresponsibility/productsafety.html>

### CS

Tímto BRP Megatech prohlašuje, že typ rádiového zařízení 1001316154 je v souladu se směrnicí 2014/53/EU. Úplné znění EU prohlášení o shodě je k dispozici na této internetové adrese: <https://www.brp.com/en/corporatesocialresponsibility/productsafety.html>

## DA

Hermed erklærer BRP Megatech, at radioudstyrstypen 1001316154 er i overensstemmelse med direktiv 2014/53/EU.

EU-overensstemmelseserklæringens fulde tekst kan findes på følgende internetadresse: <https://www.brp.com/en/corporatesocialresponsibility/productsafety.html>

## ET

Käesolevaga deklareerib BRP Megatech, et käesolev raadioseadme tüüp 1001316154 vastab direktiivi 2014/53/EL nõuetele.

ELi vastavusdeklaratsiooni täielik tekst on kättesaadav järgmisel internetiaadressil: <https://www.brp.com/en/corporatesocialresponsibility/productsafety.html>

## ES

Por la presente, BRP Megatech declara que el tipo de equipo radioeléctrico 1001316154 es conforme con la Directiva 2014/53/UE.

El texto completo de la declaración UE de conformidad está disponible en la dirección Internet siguiente: <https://www.brp.com/en/corporatesocialresponsibility/productsafety.html>

## FI

BRP Megatech vakuuttaa, että radiolaitetyyppi 1001316154 on direktiivin 2014/53/EU mukainen. EU-vaatimustenmukaisuusvakuutuksen täysimittainen teksti on saatavilla seuraavassa internetosoitteessa: <https://www.brp.com/en/corporatesocialresponsibility/productsafety.html>

## EN

Hereby, BRP Megatech declares that the radio equipment type 1001316154 is in compliance with Directive 2014/53/EU. The full text of the EU declaration of conformity is available at the following internet address: <https://www.brp.com/en/corporatesocialresponsibility/product-safety.html>

## HR

BRP Megatech ovime izjavljuje da je radijska oprema tipa 1001316154 u skladu s Direktivom 2014/53/EU. Cjeloviti tekst EU izjave o sukladnosti dostupan je na sljedećoj internetskoj adresi: <https://www.brp.com/en/corporate-social-responsibility/productsafety.html>

## HU

BRP Megatech igazolja, hogy a 1001316154 típusú rádióberendezés megfelel a 2014/53/EU irányelvnek. Az EU-megfelelőségi nyilatkozat teljes szövege elérhető a következő internetes címen: <https://www.brp.com/en/corporate-social-responsibility/productsafety.html>

## IT

Il fabbricante, BRP Megatech, dichiara che il tipo di apparecchiatura radio 1001316154 è conforme alla direttiva 2014/53/UE.

Il testo completo della dichiarazione di conformità UE è disponibile al seguente indirizzo Internet: <https://www.brp.com/en/corporate-socialresponsibility/product-safety.html>

## LT

Aš, BRP Megatech, patvirtinu, kad radijo įrenginių tipas 1001316154 atitinka Direktyvą 2014/53/ES. Visas ES atitikties deklaracijos tekstas prieinamas šiuo interneto adresu: <https://www.brp.com/en/corporate-social-responsibility/productsafety.html>

## LV

Ar šo BRP Megatech deklarē, ka radioiekārta 1001316154 atbilst Direktīvai 2014/53/ES. Pilns ES atbilstības deklarācijas teksts ir pieejams šādā interneta vietnē: <https://www.brp.com/en/corporate-social-responsibility/productsafety.html>

## MT

B'dan, BRP Megatech, niddikjara li dan it-tip ta' tagħmir tar-radju 1001316154 huwa konformi mad-Direttiva 2014/53/UE. It-test kollu tad-dikjarazzjoni ta' konformità tal-UE huwa disponibbli f'dan l-indirizz tal-Internet li ġej: <https://www.brp.com/en/corporatesocialresponsibility/productsafety.html>

## NL

Hierbij verklaar ik, BRP Megatech, dat het type radioapparatuur 1001316154 conform is met Richtlijn 2014/53/EU.

De volledige tekst van de EU-conformiteitsverklaring kan worden geraadpleegd op het volgende internetadres: <https://www.brp.com/en/corporatesocialresponsibility/productsafety.html>

## PL

BRP Megatech niniejszym oświadcza, że typ urządzenia radiowego 1001316154 jest zgodny z dyrektywą 2014/53/UE. Pełny tekst deklaracji zgodności UE jest dostępny pod następującym adresem internetowym: <https://www.brp.com/en/corporatesocialresponsibility/productsafety.html>

## PT

O(a) abaixo assinado(a) BRP Megatech declara que o presente tipo de equipamento de rádio 1001316154 está em conformidade com a Diretiva 2014/53/UE.

O texto integral da declaração de conformidade está disponível no seguinte endereço de Internet: <https://www.brp.com/en/corporatesocialresponsibility/productsafety.html>

## RO

Prin prezenta, BRP Megatech declară că tipul de echipamente radio 1001316154 este în conformitate cu Directiva 2014/53/UE. Textul integral al declarației UE de conformitate este disponibil la următoarea adresă internet: <https://www.brp.com/en/corporatesocialresponsibility/productsafety.html>

## SV



Härmed försäkrar BRP Megatech att denna typ av radioutrustning 1001316154 överensstämmer med direktiv 2014/53/EU. Den fullständiga texten till EU-försäkran om överensstämmelse finns på följande webbadress: <https://www.brp.com/en/corporatesocialresponsibility/productsafety.html>

## SL

BRP Megatech potrjuje, da je tip radijske opreme 1001316154 skladen z Direktivo 2014/53/EU. Celotno besedilo izjave EU o skladnosti je na voljo na naslednjem spletnem naslovu: <https://www.brp.com/en/corporatesocialresponsibility/productsafety.html>

## SK

BRP Megatech týmto vyhlasuje, že rádiové zariadenie typu 1001316154 je v súlade so smernicou 2014/53/EÚ. Úplné EÚ vyhlásenie o zhode je k dispozícii na tejto internetovej adrese: <https://www.brp.com/en/corporatesocialresponsibility/productsafety.html>

## IS

BRP Megatech lýsir því hér með yfir að þráðlausí fjarskiptabúnaðurinn 1001316154 er í samræmi við tilskipun 2014/53/ESB. Óstytta texta ESB-samræmisyfirlýsingarinnar er að finna á veffanginu: <https://www.brp.com/en/corporatesocialresponsibility/productsafety.html>

## Liechtenstein

Hiermit erklärt BRP Megatech, dass der Funkanlagentyp 1001316154 der Richtlinie 2014/53/EU entspricht. Der vollständige Text der EU-Konformitätserklärung ist unter der folgenden Internetadresse verfügbar: <https://www.brp.com/en/corporatesocialresponsibility/productsafety.html>

## NO

Hermed erklærer BRP Megatech at radioutstyrstypen 1001316154 er i samsvar med direktiv 2014/53/EU. Hele teksten i EU-samsvarserklæringen finnes på følgende internettadresse: <https://www.brp.com/en/corporatesocialresponsibility/productsafety.html>

## RU

Компания BRP Megatech настоящим заявляет, что радиотехническое оборудование категории 1001316154 отвечает требованиям Директивы 2014/53/EU.

Полный текст декларации соответствия ЕС доступен на сайте : <https://www.brp.com/en/corporatesocialresponsibility/productsafety.html>

---

# BRP AUDIO SYSTEM

## USA and Canada :

This device complies with Part 15 of the FCC Rules / Innovation, Science and Economic Development Canada's licence-exempt RSS(s). Operation is subject to the following two conditions: :

1. this device may not cause interference, and
2. this device must accept any interference, including interference that may cause un- desired operation of the device.

This equipment has been tested and found to comply with the limits for a Class B digital device, pursuant to part 15 of the FCC Rules. These limits are designed to provide reasonable protection against harmful interference in a residential installation. This equipment generates, uses and can radiate radio frequency energy and, if not installed and used in accordance with the instructions, may cause harmful interference to radio communications. However, there is no guarantee that interference will not occur in a particular installation. If this equipment does cause harmful interference to radio or television reception, which can be determined by turning the equipment off and on, the user is encouraged to try to correct the interference by one or more of the following measures:

- Reorient or relocate the receiving antenna.
- Increase the separation between the equipment and receiver.
- Connect the equipment into an outlet on a circuit different from that to which the receiver is connected.
- Consult the dealer or an experienced radio/TV technician for help.

The device has been evaluated to meet general RF exposure requirement. The device can be used in portable exposure condition without restriction.

Le dispositif a été évalué à satisfaire l'exigence générale de l'exposition aux rf. L'appareil peut être utilisé dans des conditions d'exposition portatif sans restriction.

L'émetteur/récepteur exempt de licence contenu dans le présent appareil est conforme aux CNR d'Innovation, Sciences et Développement économique Canada applicables aux appareils radio exempts de licence. L'exploitation est autorisée aux deux conditions suivantes :

1. l'appareil ne doit pas produire de brouillage, et
2. l'appareil doit accepter tout brouillage radioélectrique subi, même si le brouillage est susceptible d'en compromettre le fonctionnement.

Changes or modifications not expressly approved by the party responsible for compliance could void the user's authority to operate the equipment.

IC: 22793-278003465

FCC ID: 2AAOY-278003465

## Mexico :

IFETEL

Marca: Mitek Corporation

Número: RCPMT2718-1330

Modelo: 278003465

NOM-208-SCFI-2016 (Disposición Técnica IFT-008-2015)

La operación de este equipo está sujeta a las siguientes dos condiciones:

1. es posible que este equipo o dispositivo no cause interferencia perjudicial y
2. este equipo o dispositivo debe aceptar cualquier interferencia, incluyendo la que pueda causar su operación no deseada.

**Brazil :**



Numero : 01649-23-11270

Este equipamento não tem direito à proteção contra interferência prejudicial e não pode causar interferência em sistemas devidamente autorizados. Para maiores informações, consulte o site da ANATEL.

**Japan**

This device is granted pursuant to the Japanese Radio Law (電波法) and the Japanese Telecommunications Business Law (電気通信事業法). This device should not be modified (otherwise the granted designation number will become invalid).

**Europe :**

**Declaration of Conformity**

Simplified EU Declaration of Conformity according Radio Equipment Directive 2014/ 53/EU



DE

Hiermit erklärt Mitek Corporation, dass der Funkanlagentyp 278003465 der Richtlinie 2014/53/EU entspricht. Der vollständige Text der EU-Konformitätserklärung ist unter der folgenden Internetadresse verfügbar: <https://www.operatorsguides.brp.com>

## FR

Le soussigné, Mitek Corporation, déclare que l'équipement radioélectrique du type 278003465 est conforme à la directive 2014/53/UE. Le texte complet de la déclaration UE de conformité est disponible à l'adresse internet suivante: <https://www.operatorsguides.brp.com>

## BG

С настоящото Mitek Corporation декларира, че този тип радиосъоръжение 278003465 е в съответствие с Директива 2014/53/ЕС. Цялостният текст на ЕС декларацията за съответствие може да се намери на следния интернет адрес: <https://www.operatorsguides.brp.com/>

## EL

Με την παρούσα ο/η Mitek Corporation, δηλώνει ότι ο ραδιοεξοπλισμός 278003465 πληροί την οδηγία 2014/53/ΕΕ. Το πλήρες κείμενο της δήλωσης συμμόρφωσης ΕΕ διατίθεται στην ακόλουθη ιστοσελίδα στο διαδίκτυο: <https://www.operatorsguides.brp.com/>

## CS

Tímto Mitek Corporation prohlašuje, že typ rádiového zařízení 278003465 je v souladu se směrnicí 2014/53/EU. Úplné znění EU prohlášení o shodě je k dispozici na této internetové adrese: <https://www.operatorsguides.brp.com>

## DA

Hermed erklærer Mitek Corporation, at radioudstyrstypen 278003465 er i overensstemmelse med direktiv 2014/53/EU.

EU-overensstemmelseserklæringens fulde tekst kan findes på følgende internetadresse: <https://www.operatorsguides.brp.com>

## ET

Käesolevaga deklareerib Mitek Corporation, et käesolev raadioseadme tüüp 278003465 vastab direktiivi 2014/53/EL nõuetele.

ELi vastavusdeklaratsiooni täielik tekst on kättesaadav järgmisel internetiaadressil: <https://www.operatorsguides.brp.com>

## ES

Por la presente, Mitek Corporation declara que el tipo de equipo radioeléctrico 278003465 es conforme con la Directiva 2014/53/UE.

El texto completo de la declaración UE de conformidad está disponible en la dirección Internet siguiente: <https://www.operatorsguides.brp.com>

## FI

Mitek Corporation vakuuttaa, että radiolaitetyyppi 278003465 on direktiivin 2014/53/EU mukainen. EU-vaatimustenmukaisuusvakuutuksen täysimittainen teksti on saatavilla seuraavassa internetosoitteessa: <https://www.operatorsguides.brp.com>

## EN

Hereby, Mitek Corporation declares that the radio equipment type 278003465 is in compliance with Directive 2014/53/EU. The full text of the EU declaration of conformity is available at the following internet address: <https://www.operatorsguides.brp.com>

## HR

Mitek Corporation ovime izjavljuje da je radijska oprema tipa 278003465 u skladu s Direktivom 2014/53/EU. Cjeloviti tekst EU izjave o sukladnosti dostupan je na sljedećoj internetskoj adresi: <https://www.operatorsguides.brp.com>

## HU

Mitek Corporation igazolja, hogy a 278003465 típusú rádióberendezés megfelel a 2014/53/EU irányelvnek. Az EU-megfelelőségi nyilatkozat teljes szövege elérhető a következő internetes címen: <https://www.operatorsguides.brp.com>

## IT

Il fabbricante, Mitek Corporation, dichiara che il tipo di apparecchiatura radio 278003465 è conforme alla direttiva 2014/53/UE.

Il testo completo della dichiarazione di conformità UE è disponibile al seguente indirizzo Internet: <https://www.operatorsguides.brp.com>

## LT

Aš, Mitek Corporation, patvirtinu, kad radijo įrenginių tipas 278003465 atitinka Direktyvą 2014/53/ES. Visas ES atitikties deklaracijos tekstas prieinamas šiuo interneto adresu: <https://www.operatorsguides.brp.com>

## LV

Ar šo Mitek Corporation deklarē, ka radioiekārta 278003465 atbilst Direktīvai 2014/53/ES. Pilns ES atbilstības deklarācijas teksts ir pieejams šādā interneta vietnē: <https://www.operatorsguides.brp.com>

## MT

B'dan, Mitek Corporation, niddikjara li dan it-tip ta' tagħmir tar-radju 278003465 huwa konformi mad-Direttiva 2014/53/UE. It-test kollu tad-dikjarazzjoni ta' konformità tal-UE huwa disponibbli f'dan l-indirizz tal-Internet li ġej: <https://www.operatorsguides.brp.com>

## NL

Hierbij verklaar ik, Mitek Corporation, dat het type radioapparatuur 278003465 conform is met Richtlijn 2014/53/EU.

De volledige tekst van de EU-conformiteitsverklaring kan worden geraadpleegd op het volgende internetadres: <https://www.operatorsguides.brp.com>

## PL

Mitek Corporation niniejszym oświadcza, że typ urządzenia radiowego 278003465 jest zgodny z dyrektywą 2014/53/UE. Pełny tekst deklaracji zgodności UE jest dostępny pod następującym adresem internetowym: <https://www.operatorsguides.brp.com>

## PT

O(a) abaixo assinado(a) Mitek Corporation declara que o presente tipo de equipamento de rádio 278003465 está em conformidade com a Diretiva 2014/53/UE.

O texto integral da declaração de conformidade está disponível no seguinte endereço de Internet: <https://www.operatorsguides.brp.com>

## RO

Prin prezenta, Mitek Corporation declară că tipul de echipamente radio 278003465 este în conformitate cu Directiva 2014/53/UE. Textul integral al declarației UE de conformitate este disponibil la următoarea adresă internet: <https://www.operatorsguides.brp.com>

## SV

Härmed försäkrar Mitek Corporation att denna typ av radioutrustning 278003465 överensstämmer med direktiv 2014/53/EU. Den fullständiga texten till EU-försäkran om överensstämmelse finns på följande webbadress: <https://www.operatorsguides.brp.com>

## SL

Mitek Corporation potrjuje, da je tip radijske opreme 278003465 skladen z Direktivo 2014/53/EU. Celotno besedilo izjave EU o skladnosti je na voljo na naslednjem spletnem naslovu: <https://www.operatorsguides.brp.com>

## SK

Mitek Corporation týmto vyhlasuje, že rádiové zariadenie typu 278003465 je v súlade so smernicou 2014/53/EÚ. Úplné EÚ vyhlásenie o zhode je k dispozícii na tejto internetovej adrese: <https://www.operatorsguides.brp.com>

## IS

Mitek Corporation lýsir því hér með yfir að þráðlausí fjarskiptabúnaðurinn 278003465 er í samræmi við tilskipun 2014/53/ESB. Óstytta texta ESB-samræmisýfirlýsingarinnar er að finna á veffanginu: <https://www.operatorsguides.brp.com>

## Liechtenstein

Hiermit erklärt Mitek Corporation, dass der Funkanlagentyp 278003465 der Richtlinie 2014/53/EU entspricht. Der vollständige Text der EU-Konformitätserklärung ist unter der folgenden Internetadresse verfügbar: <https://www.operatorsguides.brp.com>

## **NO**

Hermed erklærer Mitek Corporation at radioutstyrstypen 278003465 er i samsvar med direktiv 2014/53/EU. Hele teksten i EU-samsvarserklæringen finnes på følgende internettadresse: <https://www.operatorsguides.brp.com>

## **RU**

Компания Mitek Corporation настоящим заявляет, что радиотехническое оборудование категории 278003465 отвечает требованиям Директивы 2014/53/EU. Полный текст декларации соответствия ЕС доступен на сайте <https://www.operatorsguides.brp.com/>

---

# ENGINE EMISSIONS INFORMATION

## Manufacturer's Responsibility

Manufacturers of marine engines must determine the exhaust emission levels for each engine horsepower family and certify these engines with the United States of America Environmental Protection Agency (EPA). An emissions control information label, showing emission levels and engine specifications, must be placed on each Spark-Ignition Propulsion Marine Engines (SIPME) at the time of manufacture.

## Dealer's Responsibility

When performing service on a Sea-Doo SIPME that carry an emissions control information label, adjustments must be kept within published factory specifications.

Replacement or repair of any emission related component must be executed in a manner that maintains emission levels within the prescribed certification standards.

Dealers are not to modify the engine in any manner that would alter the horsepower or allow emission levels to exceed their predetermined factory specifications.

Exceptions include manufacturer's prescribed changes, such as altitude adjustments for example.

## Owner's Responsibility

The owner/operator is required to have engine maintenance performed to maintain emission levels within prescribed certification standards.

The owner/operator is not to, and should not allow anyone to modify the engine in any manner that would alter the horsepower or allow emissions levels to exceed their predetermined factory specifications.

## EPA Emission Regulations

Sea-Doo SIPME manufactured by BRP are certified to the EPA as conforming to the requirements of the regulations for the control of air pollution from new SIPME. This certification is contingent on certain adjustments being set to factory standards. For this reason, the factory procedure for servicing the product must be strictly followed and, whenever practicable, returned to the original intent of the design.

The responsibilities listed above are general and in no way a complete listing of the rules and regulations pertaining to the EPA requirements on exhaust emissions for marine products. For more detailed information on this subject, you may contact:

U. S. Environmental Protection Agency  
Certification Division  
Gasoline Engine Compliance Center  
2000 Traverwood Drive  
Ann Arbor MI 48105  
USA

## EPA INTERNET WEB SITE:

[www.epa.gov/otaq](http://www.epa.gov/otaq)

## Evaporative Emission Control System

Spark-Ignition Marine Watercraft (SIMW) sold in the State of California are certified to the California evaporative emissions regulations for SIMW of the California Air Resources Board (13 CCR 2850 to 2869). These models are equipped with an evaporative emission control system consisting of Low Permeation Fuel Tank (LPFT), Low Permeation Fuel Line (LPFL) and a Pressure Relief Valve (PRV).



# **TECHNICAL SPECIFICATIONS**

# ROTAX 1630 ACE

ENGINE		
Engine type	4-stroke, Single Over Head Camshaft (SOHC)	
Declared Power (as per ISO 8665 at propeller-shaft)	130	100 kW @ 6400 RPM
	170	125 kW @ 6400 RPM
Maximum engine operating speed	130	6200 +/- 200 RPM
	170	7400 +/- 200 RPM
Induction	Naturally-Aspirated	
Number of cylinders	3	
Number of valves	12 valves with hydraulic lifters (no adjustment)	
Bore	100 mm (3.9 in)	
Stroke	69.2 mm (2.7 in)	
Displacement	1 630.5 cm <sup>3</sup> (99.5 in <sup>3</sup> )	
Compression ratio	11:1	

FUEL SYSTEM	
Fuel injection type	Multipoint fuel injection with iTC (intelligent Throttle Control). Single throttle body (60 mm) with an actuator
Idle speed (not adjustable)	1800 ± 50 RPM

ELECTRICAL SYSTEM		
Total system output		650 W @ 6000 RPM
Ignition system type		IDI (Inductive Discharge Ignition)
Spark plug	Type	NGK, DCPR8E with solid post or equivalent
	Gap (not adjustable)	0.80 to 0.90 mm (.031 to .035 in)

LUBRICATION		
Engine oil	XPS recommended oil	XPS 5W40 Synthetic oil
	Alternative, or if the XPS product is not available	Use a 5W40 4-stroke SAE synthetic engine oil meeting or exceeding the following lubricant industry specifications. <b>API service classification SM or SN</b>
	Capacity	3 l (3.2 qt(liq.,US)) oil change w/filter 5 l (5.3 qt(liq.,US)) total

# SWITCH COMPACT

COOLING SYSTEM		
Type		Closed loop cooling system
Coolant	XPS recommended coolant	XPS Extended life pre-mixed coolant
	If the XPS product is not available	Use a low silicate, extended life ethylene glycol premixed coolant (50%-50%) specifically formulated for internal combustion aluminium engines
	Capacity	5.4 l (5.7 qt (liq.,US)) total

FUEL SYSTEM		
Fuel Pump		In-tank electrical
Fuel	Type	Regular unleaded gasoline
	Recommended octane	87 (AKI) 91 (RON)
Fuel tank capacity (including reserve)		109.8 l (29 gal(liq.,US))

ELECTRICAL SYSTEM		
Battery		12 V, 32 A•h
Transducer liquid (if equipped)	XPS recommended coolant	BRP Extended life pre-mixed coolant
	If the XPS product is not available	Use a low silicate, extended life ethylene glycol premixed coolant (50%-50%) specifically formulated for internal combustion aluminium engines
	Capacity	135 ml (4.6 fl oz (US))

ELECTRICAL SYSTEM (Engine Fuse Box)			
Engine fuse box	OBD	F1	3 A
	O2 Sensors	F2	3 A

<b>ELECTRICAL SYSTEM (Engine Fuse Box)</b>			
	Accessories Connector (Battery)	F3	15 A
	Accessories Connector (Switched)	F4	15 A
	ECM	F5	5 A
	Charge	F6	30 A
	Deck (FB2)	F7	15 A
	Diagnostic Tool	F8	15 A
	iBR	F9	30 A
	12V Deck 1	F10	30 A
	Start/Stop	F11	3 A
	Battery	F12	30 A
	12V Deck 2	F13	30 A
	Fuel Inj., Ing. Coils and Fuel Pump	F14	15 A

<b>ELECTRICAL SYSTEM (Console Fuse Box)</b>			
Console fuse box	Horn	F15	5 A
	Navigation Lights	F16	2 A

<b>ELECTRICAL SYSTEM (Console Fuse Box)</b>			
	Bilge Pump 1	F17	4 A
	Blower	F18	4 A
	GPS	F19	2 A
	Bilge Pump 2	F20	4 A
	USB Port	F21	3 A
	12V Outlet	F22	10 A
	Sound System Power	F23	15 A
	Cluster	F24	3 A
	DS (D.E.S. S. post)	F25	2 A
	Sound System Remote	F26	3 A
	Spare	F27	MAX 5 A

<b>PROPULSION</b>		
Propulsion system		Sea-Doo® jet pump
Jet pump	Type	Axial flow, single stage. Large hub with double row ball bearings
	Material	Aluminum
Impeller		Stainless steel
Transmission	Type	Direct drive

<b>iBR and VTS</b>	
VTS system	Electronically-controlled through the VTS control button

<b>WEIGHT</b>		
Dry weight (All weights are approximate and should be verified by actual weighing, if necessary)	Compact	751 kg (1656 lb)
	Sport Compact	798 kg (1759 lb)

<b>LOADING CAPACITY</b>		
Number of passenger (driver incl.)		5
Load limit (passenger(s) and luggage, including accessories)	Canadian Models	375 kg (825 lb)
	USA Models	375 kg (825 lb)
Storage capacity	Compact	413 l (109 gal (liq.,US))
	Sport Compact	547 l (144 gal (liq.,US))

<b>DIMENSIONS</b>		
Maximum length		3908.2 mm (153.87 in)
Overall width		2374.8 mm (93.50 in)
Overall height (bimini top down, if equipped)	Compact	1825.9 mm (71.89 in)
	Sport Compact	1983.3 mm (74.15 in)

This page is intentionally blank



# WARRANTY

---

# **BRP LIMITED WARRANTY USA AND CANADA: 2025 SEA-DOO® WATERCRAFT**

## **1) SCOPE OF THE LIMITED WARRANTY**

Bombardier Recreational Products Inc. ("BRP") warrants its 2025 Sea-Doo watercraft ("Product(s)") sold by authorized BRP Dealers (as hereinafter defined) in the United States of America ("USA") and in Canada from defects in material or workmanship for the period and under the conditions described below.

This limited warranty will become null and void if:

1. The Product was used for racing or any other competitive activity, at any point, even by a previous owner; or
2. The Product has been altered or modified in such a way so as to adversely affect its operation, performance or durability, or has been altered or modified to change its intended use.

Non-factory installed parts and accessories are not covered under this limited warranty. Please refer to the applicable parts and accessories limited warranty text.

## **2) LIMITATIONS OF LIABILITY**

TO THE EXTENT PERMITTED BY LAW, THIS WARRANTY IS EXPRESSLY GIVEN AND ACCEPTED IN LIEU OF ANY AND ALL OTHER WARRANTIES, EXPRESSED OR IMPLIED, INCLUDING WITHOUT LIMITATION ANY WARRANTY OF MERCHANTABILITY OR FITNESS FOR A PARTICULAR PURPOSE. TO THE EXTENT THAT THEY CANNOT BE DISCLAIMED, THE IMPLIED WARRANTIES ARE LIMITED IN DURATION TO THE LIFE OF THE EXPRESS WARRANTY. INCIDENTAL AND CONSEQUENTIAL DAMAGES ARE EXCLUDED FROM COVERAGE UNDER THIS WARRANTY. SOME STATES/PROVINCES DO NOT ALLOW FOR THE DISCLAIMERS, LIMITATIONS AND EXCLUSIONS IDENTIFIED ABOVE. AS A RESULT, THEY MAY NOT APPLY TO YOU. THIS WARRANTY GIVES YOU SPECIFIC RIGHTS, AND YOU MAY ALSO HAVE OTHER LEGAL RIGHTS WHICH MAY VARY FROM STATE TO STATE, OR PROVINCE TO PROVINCE.

Neither the distributor, any BRP dealer nor any other person has been authorized to make any affirmation, representation or warranty regarding the product, other than those contained in this limited warranty, and if made, shall not be enforceable against BRP.

BRP reserves the right to modify this limited warranty at any time, being understood that such modification will not alter the warranty conditions applicable to the Products sold while this warranty is in effect.

## **3) EXCLUSIONS—ARE NOT WARRANTED**

The following are not warranted under any circumstances: The following are not warranted under any circumstances:

- Normal wear and tear;
- Routine maintenance items, tune ups, adjustments;
- Damage caused by negligence or failure to provide proper maintenance and/or storage, as described in the Operator's Guide;
- Damage resulting from removal of parts, improper repairs, service, maintenance, modifications or use of parts not manufactured or approved by BRP or

resulting from repairs done by a person that is not an authorized servicing BRP dealer;

- Damage caused by abuse, abnormal use, neglect or operation of the product in a manner inconsistent with the recommended operation described in the Product's Operator's Guide;
- Damage resulting from accident, submersion, fire, theft, vandalism or any act of God;
- Operation with fuels, oils or lubricants which are not suitable for use with the Product (see the Operator's Guide);
- Damages from rust, corrosion or exposure to the elements;
- Damage resulting from water or snow ingestion;
- Incidental or consequential damages, or damages of any kind including without limitation transportation expenses, towing, storage, telephone, rental, taxi, inconvenience, insurance coverage, loan payments, loss of time, loss of income or time missed for downtime experience due to service work;
- Damages from cooling system or jet pump blockage by foreign material; and
- Damages related to gel coat finish including but not limited to cosmetic gel coat finish, blisters or fiberglass delamination caused by blisters, crazing, spider or hairline cracks.

#### **4) WARRANTY COVERAGE PERIOD**

This limited warranty will be in effect from (1) the date of delivery to the first retail consumer, or (2) the date the product is first put into use, whichever occurs first and for the applicable period below:

The repair or replacement of parts or the performance of service under this warranty does not extend the life of this limited warranty beyond its original expiration date.

1. THIRTY-SIX (36) consecutive months, for private use owners except that the deck and structure are covered for ONE HUNDRED AND TWENTY (120) consecutive months.
2. FOUR (4) consecutive months, for commercial use owners except that the deck and the structure are covered for TWELVE (12) consecutive months. A Product is used commercially when it is used in connection with any work or employment that generates income during any part of the warranty period. A Product is also used commercially when, at any point during the warranty period, it is licensed for commercial use.
3. For emission-related components, please also refer to the US EPA Emission-Re- lated Warranty.
4. For Sea-Doo personal watercrafts produced by BRP for sale in the State of California or New York that are originally sold to a resident or subsequently warranty registered to a resident in the State of California or New York, please also refer to the applicable California and New York Emissions Control Warranty Statement contained herein.
5. For Sea-Doo personal watercrafts produced by BRP for sale in the State of California that are originally sold to a resident or subsequently warranty registered to a resident in the State of California, please also refer to the California Evaporative Emissions Control System Warranty Statement contained herein.

#### **5) CONDITIONS TO HAVE WARRANTY COVERAGE**

This warranty coverage is available only if each of the following conditions has been fulfilled:

1. The Product must be purchased as new and unused by its first owner from a Dealer authorized to sell the Products in the country in which the sale occurred (“Dealer”);
2. The BRP specified pre-delivery inspection process must be completed, documented and signed by the purchaser;
3. The Product must have undergone proper registration by an authorized Dealer;
4. The Product must be purchased in the country in which the purchaser resides;
5. Routine maintenance outlined in the Operator’s Guide must be timely performed in order to maintain warranty coverage. BRP reserves the right to make warranty coverage contingent upon proof of proper maintenance.

BRP will not honor this limited warranty to any private use owner or commercial use owner if one of the preceding conditions has not been met. Such limitations are necessary in order to allow BRP to preserve both the safety of its products, and also that of its consumers and the general public.

## **6) WHAT TO DO TO OBTAIN WARRANTY COVERAGE**

The customer must cease using the Product upon the appearance of an anomaly, notify a servicing BRP dealer within three (3) days of the appearance of the anomaly and provide the Dealer with reasonable access to the Product and reasonable opportunity to repair it.

The customer must also present to the Dealer, proof of purchase of the Product and must sign the repair/work order prior to starting the repair in order to validate the warranty repair.

All parts replaced under this limited warranty become the property of BRP.

## **7) WHAT BRP WILL DO**

BRP’s obligations under this warranty are limited to, at its sole discretion, repairing or replacing parts found defective under normal use, maintenance and service without charge for parts and labor, at any authorized BRP dealer during the warranty coverage period under the conditions described herein. No claim of breach of warranty shall be cause for cancellation or rescission of the sale of the Product to the owner.

In the event that service is required outside of the country of original sale, the owner will bear responsibility for any additional charges due to local practices and conditions, such as, but not limited to, freight, insurance, taxes, license fees, import duties, and any and all other financial charges, including those levied by governments, states, territories and their respective agencies.

BRP reserves the right to improve or modify products from time to time without assuming any obligation to modify products previously manufactured.

## **8) TRANSFER**

If the ownership of a Product is transferred during the warranty coverage period, this limited warranty, subject to its terms and conditions, shall also be transferred

and be valid for the remaining coverage period provided BRP or an authorized Product

## **9) CONSUMER ASSISTANCE**

In the event of a controversy or a dispute in connection with this limited warranty, BRP suggests that you try to resolve the issue at the dealership level. We recommend discussing the issue with the authorized dealer's service manager or owner.

If the matter still remains unresolved, contact BRP by filling out the customer contact form at *WWW.BRP.COM* or contact BRP by mail at one of the addresses listed under the Contact Us section of this guide.

---

# US EPA EMISSION-RELATED WARRANTY

Bombardier Recreational Products Inc. ("BRP") warrants to the ultimate purchaser and each subsequent purchaser that this new engine, including all parts of its exhaust emission control system and its evaporative emission control system, meets two conditions:

1. It is designed, built, and equipped so it conforms at the time of sale to the ultimate purchaser with the requirements of 40 CFR 1045 and 40 CFR 1060.
2. It is free from defects in materials and workmanship that may keep it from meeting the requirements of 40 CFR 1045 and 40 CFR 1060.

Where a warrantable condition exists, BRP will repair or replace, as it elects, any part or component with a defect in materials or workmanship that would increase the engine's emissions of any regulated pollutant within the stated warranty period at no cost to the owner, including expenses related to diagnosing and repairing or replacing emission-related parts. All defective parts replaced under this warranty become the property of BRP.

For all emission-related warranty claims, BRP is limiting the diagnosis and repair of emission-related parts to the authorized Sea-Doo dealers, unless for emergency re-pairs as required by item 2 of the following list.

As a certifying manufacturer, BRP will not deny emission-related warranty claims based on any of the following:

1. Maintenance or other service BRP or BRP's authorized facilities performed.
2. Engine/equipment repair work that an operator performed to correct an unsafe, emergency condition attributable to BRP as long as the operator tries to restore the engine/equipment to its proper configuration as soon as possible.
3. Any action or inaction by the operator unrelated to the warranty claim.
4. Maintenance that was performed more frequently than BRP specify.
5. Anything that is BRP fault or responsibility
6. The use of any fuel that is commonly available where the equipment operates unless BRP written maintenance instructions state that this fuel would harm the equipment's emission control system and operators can readily find the proper fuel. See maintenance information section and fuel requirements of fueling section.

## Emission-Related Warranty Period

The emission-related warranty is valid for the following period whichever comes first:

	Hours	Months
Exhaust emission-related components	175	30
Evaporative emission-related components	N/A	24

## Components Covered

The emission-related warranty covers all components whose failure would increase an engine's emissions of any regulated pollutant, including the following listed components:

For exhaust emissions, emission-related components include any engine parts related to the following systems:

- Air-induction system
- Fuel system
- Ignition system
- Exhaust gas recirculation systems

The following parts are also considered emission-related components for exhaust emissions:

- Aftertreatment devices
- Crankcase ventilation valves
- Sensors
- Electronic control units

The following parts are considered emission-related components for evaporative emissions:

- Fuel tank
- Fuel cap
- Fuel line
- Fuel line fittings
- Clamps\*
- Pressure relief valves\*
- Control valves\*
- Control solenoids\*
- Electronic controls\*
- Vacuum control diaphragms\*
- Control cables\*
- Control linkages\*
- Purge valves
- Vapor hoses
- Liquid/ vapor separator
- Carbon canister
- Canister mounting brackets
- Carburetor purge port connector

**NOTE:**

\* As related to the evaporative emission control system.

Emission-related components also include any other part whose only purpose is to reduce emissions or whose failure will increase emissions without significantly degrading engine/ equipment performance.

**Limited Applicability**

As a certifying manufacturer, BRP may deny emission-related warranty claims for failures that have been caused by the owner's or operator's improper maintenance or use, by accidents for which the manufacturer has no responsibility, or by acts of God. For example, an emission-related warranty claim need not be

honored for failures that have been directly caused by the operator's abuse of the engine/ equipment or the operator's use of the engine/ equipment in a manner for which it was not designed and are not attributable to the manufacturer in any way.

If you have any questions regarding your warranty rights and responsibilities or for the name and location of the nearest authorized BRP Dealer you should contact BRP by filling out the customer contact form at [www.brp.com](http://www.brp.com) or contact BRP by mail at one of the addresses listed under the *Contact Us* section of this guide, or call at 1-888-272-9222.



---

# CALIFORNIA EVAPORATIVE EMISSIONS CONTROL SYSTEM WARRANTY STATEMENT

## Your Warranty Rights and Obligations

The California Air Resources Board is pleased to explain the evaporative emissions control system's warranty on your 2025 spark-ignition marine watercraft (SIMW). In California, new spark-ignition marine watercraft must be designed, built, and equipped to meet the State's stringent anti-smog standards. Bombardier Recreational Products Inc. must warrant the evaporative emissions control system on your spark-ignition marine watercraft for the period listed below, provided there has been no abuse, neglect or improper maintenance of your spark-ignition marine watercraft.

Your evaporative emissions control system may include parts such as: canisters, carburetors, clamps, connectors, filters, fuel caps, fuel lines, fuel tanks, valves, vapor hoses, and other associated evaporative emissions control system components.

## Manufacturer's Warranty Coverage

This evaporative emissions control system is warranted for two years. If any evaporative emission-related part on your spark-ignition marine watercraft is defective, the part will be repaired or replaced by Bombardier Recreational Products Inc.

### Parts Covered:

- Clamp(s)\*
- Fuel Cap
- Fuel Line(s)
- Fuel Line Fitting(s)
- Fuel Tank
- Pressure Relief Valve(s)\*
- Vapor Hose(s)
- All other parts not listed that may affect the evaporative emissions control system.

### NOTE:

\* As related to the evaporative emission control system.

## Owner's Warranty Responsibilities

As the spark-ignition marine watercraft owner, you are responsible for performance of the required maintenance listed in your owner's manual. Bombardier Recreational Products Inc. recommends that you retain all receipts covering maintenance on your spark-ignition marine watercraft, but Bombardier Recreational Products Inc. cannot deny warranty solely for the lack of receipts.

As the spark-ignition marine watercraft owner, you should however be aware that Bombardier Recreational Products Inc. may deny you warranty coverage if your spark-ignition marine watercraft or a part has failed due to abuse, neglect, improper maintenance or unapproved modifications.

You are responsible for presenting your spark-ignition marine watercraft to a Bombardier Recreational Products Inc. distribution center or service center as soon as the problem exists. The warranty repairs should be completed in a

reasonable amount of time, not to exceed 30 calendar days. If you have question regarding your warranty coverage, you should contact Bombardier Recreational Products Inc. at 1-888-272-9222.

---

# CALIFORNIA AND NEW YORK EMISSION CONTROL WARRANTY STATEMENT FOR MODEL YEAR 2025 SEA-DOO PERSONAL WATERCRAFT

## Your Warranty Rights and Obligations

The California Air Resources Board, the New York State Department of Environmental Conservation and Bombardier Recreational Products Inc. ("BRP") are pleased to explain the emission control system warranty on your Model Year 2025 Sea-Doo personal watercraft. In California and New York, new personal watercraft engines must be designed, built and equipped to meet the State's stringent anti-smog standards. BRP must warrant the emission control system on your personal watercraft engine for the period of time listed below provided there has been no abuse, neglect or improper maintenance of your watercraft engine.

Your emission control system may include parts such as the fuel injection system, the ignition system and catalytic converter. Also included may be hoses, belts, connectors and other emission related assemblies.

Where a warrantable condition exists, BRP will repair your personal watercraft engine at no cost to you including diagnosis, parts and labor provided that such work is performed by an authorized BRP dealer.

### ***Manufacturer's Limited Warranty Coverage***

This emission limited warranty covers Model Year 2025 Sea-Doo personal watercrafts certified and produced by BRP for sale in California or New York, that are originally sold in California or New York to a California or New York resident or subsequently warranty registered to a California or New York resident. The BRP limited warranty conditions for Sea-Doo personal watercrafts are still applicable to these models with the necessary modifications. Select emission control parts of your 2025 Sea-Doo personal watercraft are warranted from the date of delivery to the first retail consumer for a period of 4 years, or for 250 hours of use, whichever occurs first. However, warranty coverage based on the hourly period is only permitted for personal watercraft equipped with the appropriate hour meters or their equivalent. If any emission-related part on your engine is defective under warranty, the part will be repaired or replaced by BRP.

### ***Parts Covered for a Model Year 2025 Sea-Doo Personal Watercraft***

Air box	Intake and exhaust valve and seals
Air intake adapter	Intake manifold
Crankcase ventilation valve	Intake manifold air pressure and temperature sensor (MAPTS)
Engine coolant temperature sensor (CTS)	Intake manifold seal
Engine control module (ECM)	Knock sensor (KS)
Fuel filter	Spark plugs

Fuel injectors	Supercharger
Fuel pressure regulator	Throttle body
Fuel pump	Throttle body seal
Fuel rail	Throttle position sensor (TPS)
Ignition coils	Wire harness and connectors

The emission warranty covers damage to other engine components that is caused by the failure of a warranted part. The BRP operator's guide provided contains written instructions for the proper maintenance and use of your personal watercraft. All emission warranty parts are warranted by BRP for the entire warranty period of the personal watercraft, unless the part is scheduled for replacement as required maintenance in the operator's guide.

Emission warranty parts that are scheduled for replacement, as required maintenance, are warranted by BRP for the period of time before the first scheduled replacement date for that part. Emission warranty parts that are scheduled for regular inspection, but not regular replacement, are warranted by BRP for the entire warranty period of the personal watercraft. Any emission warranty part repaired or replaced under the terms of this warranty statement is warranted by BRP for the remainder of the warranty period of the original part. All parts replaced under this limited warranty become the property of BRP.

Maintenance receipts and records should be transferred to each subsequent owner of the personal watercraft.

### ***Owner's Warranty Responsibilities***

As the owner of a 2025 Sea-Doo personal watercraft, you are responsible for the performance of the required maintenance listed in your operator's guide. BRP recommends that you retain all receipts covering maintenance of your personal watercraft engine, but BRP cannot deny warranty solely for the lack of receipts or your failure to ensure the performance of all scheduled maintenance.

As the owner of a Sea-Doo personal watercraft, you should however be aware that BRP may deny your warranty coverage if your engine or a part has failed due to abuse, neglect, improper maintenance or unapproved modifications.

You are responsible for presenting your engine to an authorized BRP Sea-Doo dealer as soon as a problem exists. The warranty repairs will be completed in a reasonable amount of time, not to exceed 30 days.

If you have any questions regarding your warranty rights and responsibilities or for the name and location of the nearest authorized BRP Sea-Doo dealer you should contact the Customer Assistance Center at 1-888-272-9222.

### **STAR RATING SYSTEM**

For California and New York, your 2025 Sea-Doo spark-ignition marine watercraft (SIMW) has a special environmental label required by the California Air Resources Board. The label has 3 stars. A hangtag, provided with your

spark-ignition marine watercraft (SIMW), describes the meaning of the star rating system.

## ***The Star Label Means Cleaner Marine Engines***

The Symbol for Cleaner Marine Engines:



F18L3CQ

### ***Cleaner Air and Water***

For a healthier lifestyle and environment.

### ***Better Fuel Economy***

Burns up to 30 - 40 percent less gas and oil than conventional carbureted two-stroke engines saving money and resources.

### ***Longer Emission Warranty***

Protects consumer for worry free operation.

### ***One Star – Low Emission***

The one-star label identifies personal watercraft, outboard, stern drive and inboard engines that meet the Air Resources Board's Personal Watercraft and Outboard marine engine 2001 exhaust emission standards. Engines meeting these standards have 75% lower emissions than conventional carbureted two-stroke engines. These engines are equivalent to the U.S. EPA's 2006 standards for marine engines.

### ***Two Stars – Very Low Emission***

The two-star label identifies personal watercraft, outboard, stern drive and inboard engines that meet the Air Resources Board's Personal Watercraft and Outboard marine engine 2004 exhaust emission standards. Engines meeting these standards have 20% lower emissions than One Star - Low-Emission engines.

### ***Three Stars – Ultra Low Emission***

The three-star label identifies engines that meet the Air Resources Board's Personal Watercraft and Outboard marine engine 2008 exhaust emission standards or the Stern drive and Inboard marine engine 2003 exhaust emission standards. Engines meeting these standards have 65% lower emissions than One Star - Low Emission engines.

### ***Four Stars – Super Ultra Low Emission***

The four-star label identifies engines that meet the Air Resources Board's Stern--drive and Inboard marine engine 2012 exhaust emission standards. Personal

SEA-DOO PERSONAL WATERCRAFT

Watercraft and Outboard marine engines may also comply with these standards. Engines meeting these standards have 90% lower emissions than One Star – Low Emission engines.

**For more information:**

Cleaner Watercraft – Get the Facts  
1 800 END-SMOG  
[www.arb.ca.gov](http://www.arb.ca.gov)

---

# **BRP INTERNATIONAL LIMITED WARRANTY: 2025 SEA-DOO® WATERCRAFT**

## **1) SCOPE OF THE LIMITED WARRANTY**

Bombardier Recreational Products Inc. ("BRP") warrants its 2025 Sea-Doo watercraft ("Product(s)") sold by distributors or dealers authorized by BRP to distribute the Products outside of the United States of America ("USA"), Canada, member states of the European Economic Area (which is comprised of the states of the European Union plus the United Kingdom, Norway, Iceland and Liechtenstein) ("EEA"), Turkey, member states of the Commonwealth of the Independent States (including Ukraine and Turkmenistan) ("CIS") from defects in material or workmanship for the period and under the conditions described below.

This limited warranty will become null and void if:

1. The Product was used for racing or any other competitive activity, at any point, even by a previous owner; or
2. The Product has been altered or modified in such a way so as to adversely affect its operation, performance or durability, or has been altered or modified to change its intended use.

Non-factory installed parts and accessories are not covered under this limited warranty. Please refer to the applicable parts and accessories limited warranty text.

## **2) LIMITATIONS OF LIABILITY**

TO THE EXTENT PERMITTED BY LAW, THIS WARRANTY IS EXPRESSLY GIVEN AND ACCEPTED IN LIEU OF ANY AND ALL OTHER WARRANTIES, EXPRESSED OR IMPLIED, INCLUDING WITHOUT LIMITATION ANY WARRANTY OF MERCHANTABILITY OR FITNESS FOR A PARTICULAR PURPOSE. TO THE EXTENT THAT THEY CANNOT BE DISCLAIMED, THE IMPLIED WARRANTIES ARE LIMITED IN DURATION TO THE LIFE OF THE EXPRESS WARRANTY. INCIDENTAL AND CONSEQUENTIAL DAMAGES ARE EXCLUDED FROM COVERAGE UNDER THIS WARRANTY. SOME STATES/PROVINCES DO NOT ALLOW FOR THE DISCLAIMERS, LIMITATIONS AND EXCLUSIONS IDENTIFIED ABOVE. AS A RESULT, THEY MAY NOT APPLY TO YOU. THIS WARRANTY GIVES YOU SPECIFIC RIGHTS, AND YOU MAY ALSO HAVE OTHER LEGAL RIGHTS WHICH MAY VARY FROM COUNTRY TO COUNTRY. BRP SHALL NOT BE HELD LIABLE IF PRODUCTS OR WARRANTY PARTS ARE NOT AVAILABLE IN CERTAIN COUNTRIES FOR REASONS OUTSIDE OF BRP'S CONTROL.

For Products purchased in Australia, refer to the Australia specific section below.

Neither the distributor, any BRP Distributor/Dealer nor any other person has been authorized to make any affirmation, representation or warranty regarding the product, other than those contained in this limited warranty, and if made, shall not be enforceable against BRP.

BRP reserves the right to modify this limited warranty at any time, being understood that such modification will not alter the warranty conditions applicable to the Products sold while this warranty is in effect.

## **3) EXCLUSIONS – ARE NOT WARRANTED**

The following are not warranted under any circumstances:

- Normal wear and tear;
- Routine maintenance items, tune ups, adjustments;
- Damage caused by negligence or failure to provide proper maintenance and/or storage, as described in the Operator's Guide;
- Damage resulting from removal of parts, improper repairs, service, maintenance, modifications or use of parts not manufactured or approved by BRP or resulting from repairs done by a person that is not an authorized servicing BRP Distributor/ Dealer;
- Damage caused by abuse, abnormal use, neglect or operation of the product in a manner inconsistent with the recommended operation described in the Product's Operator's Guide;
- Damage resulting from accident, submersion, fire, theft, vandalism or any act of God;
- Operation with fuels, oils or lubricants which are not suitable for use with the Product (see the Operator's Guide);
- Damages from rust, corrosion or exposure to the elements;
- Damage resulting from water or snow ingestion;
- Incidental or consequential damages, or damages of any kind including without limitation transportation expenses, towing, storage, telephone, rental, taxi, inconvenience, insurance coverage, loan payments, loss of time, loss of income or time missed for downtime experience due to service work;
- Damages from cooling system or jet pump blockage by foreign material;
- Damages to gel coat finish including but not limited to cosmetic gel coat finish defects, blisters, starrng, crazing and fiberglass delamination caused by blisters, crazing, spider or hairline cracks.

#### **4) WARRANTY COVERAGE PERIOD**

This limited warranty will be in effect from (1) the date of delivery to the first retail consumer, or (2) the date the product is first put into use, whichever occurs first and for the applicable period below:

1. THIRTY-SIX (36) consecutive months, for private use owners except that the deck and structure are covered for SIXTY (60) consecutive months. For AUSTRALIA and NEW ZEALAND only, THIRTY-SIX (36) consecutive months for private, recreational use except that the deck and structure are covered for SIXTY (60) consecutive months.
2. FOUR (4) consecutive months, for commercial use owners except that the deck and structure are covered for TWELVE (12) consecutive months. A Product is used commercially when it is used in connection with any work or employment that generates income during any part of the warranty period. A Product is also used commercially when, at any point during the warranty period, it is licensed for commercial use.

The repair or replacement of parts or the performance of service under this warranty does not extend the life of this warranty beyond its original expiration date.

The warranty coverage period identified above are a minimal limited warranty period which can be extended by any applicable warranty promotional program, as the case may be.



Note that the duration and any other modalities of the warranty coverage are subject to the applicable national or local legislation in the customer's country.

## **5) FOR PRODUCTS SOLD IN AUSTRALIA ONLY**

Our goods come with guarantees that cannot be excluded under the Australian Consumer Law.

You are entitled to a replacement or refund for a major failure and for compensation for any other reasonably foreseeable loss or damage.

You are also entitled to have the goods repaired or replaced if the goods fail to be of acceptable quality and the failure does not amount to a major failure.

Nothing in these Warranty terms and conditions should be taken to exclude, restrict or modify the application of any condition, warranty, guarantee, right or remedy conferred or implied under the Competition and Consumer Act 2010 (Cth), including the Australian Consumer Law or any other law, where to do so would contravene that law, or cause any part of these terms and conditions to be void. The benefits given to you under this limited warranty are in addition to other rights and remedies that you have under Australian law.

## **6) CONDITIONS TO HAVE WARRANTY COVERAGE**

This warranty coverage is available only if each of the following conditions has been fulfilled:

1. The Product must be purchased as new and unused by its first owner from a Distributor/Dealer authorized to distribute Products in the country in which the sale occurred ("Distributor/Dealer");
2. The BRP specified pre-delivery inspection process must be completed, documented and signed by the purchaser;
3. The Product must have undergone proper registration by an authorized Distributor/ Dealer;
4. The Product must be purchased in the country in which the purchaser resides;
5. Routine maintenance outlined in the Operator's Guide must be timely performed in order to maintain warranty coverage. BRP reserves the right to make warranty coverage contingent upon proof of proper maintenance.

BRP will not honor this limited warranty to any private use owner or commercial use owner if one of the preceding conditions has not been met. Such limitations are necessary in order to allow BRP to preserve both the safety of its products, and also that of its consumers and the general public.

## **7) WHAT TO DO TO OBTAIN WARRANTY COVERAGE**

The customer must cease using the Product upon the appearance of an anomaly, notify a servicing BRP Distributor/Dealer within two (2) months of the appearance of the anomaly and provide the Distributor/Dealer with reasonable access to the Product and reasonable opportunity to repair it.

The notification period is subject to the applicable national or local legislation in customer's country.

The customer must also present to the Distributor/Dealer, proof of purchase of the Product and must sign the repair/work order prior to starting the repair in order to validate the warranty repair.

All parts replaced under this limited warranty become the property of BRP.

## **8) WHAT BRP WILL DO**

To the extent permitted by law, BRP's obligations under this warranty are limited to, at its sole discretion, repairing or replacing parts found defective under normal use, maintenance and service without charge for parts and labor, at any authorized BRP Distributor/Dealer during the warranty coverage period under the conditions described herein. No claim of breach of warranty shall be cause for cancellation or rescission of the sale of the Product to the owner. You may have other legal rights which may vary from country to country.

In the event that service is required outside of the country of original sale, the owner will bear responsibility for any additional charges due to local practices and conditions, such as, but not limited to, freight, insurance, taxes, license fees, import duties, and any and all other financial charges, including those levied by governments, states, territories and their respective agencies.

BRP reserves the right to improve or modify products from time to time without assuming any obligation to modify products previously manufactured.

## **9) TRANSFER**

If the ownership of a Product is transferred during the warranty coverage period, this limited warranty, subject to its terms and conditions, shall also be transferred and be valid for the remaining coverage period provided BRP or an authorized Product Distributor/Dealer receives a proof that the former owner agreed to the transfer of ownership, in addition to the coordinates of the new owner.

## **10) CONSUMER ASSISTANCE**

In the event of a controversy or a dispute in connection with this limited warranty, BRP suggests that you try to resolve the issue at the BRP Distributor/Dealer level. We recommend discussing the issue with the authorized BRP Distributor/Dealer's service manager or owner.

If the matter still remains unresolved, contact BRP by filling out the customer contact form at [www.brp.com](http://www.brp.com) or contact BRP by mail at one of the addresses listed under the *Contact Us* section of this guide.

---

# **BRP LIMITED WARRANTY FOR THE EUROPEAN ECONOMIC AREA, THE COMMONWEALTH OF THE INDEPENDENT STATES AND TURKEY: 2025 SEA-DOO® WATERCRAFT**

## **1) SCOPE OF THE LIMITED WARRANTY**

Bombardier Recreational Products Inc. ("BRP") warrants its 2025 Sea-Doo watercraft ("Product(s)") sold by distributors or dealers authorized by BRP to distribute the Products in member states of the European Economic Area (which is comprised of the states of the European Union plus the United Kingdom, Norway, Iceland and Liechtenstein) ("EEA"), Turkey, member states of the Commonwealth of the Independent States (including Ukraine and Turkmenistan) ("CIS") ("Distributor/Dealer") from defects in material or workmanship for the period and under the conditions described below.

This limited warranty will become null and void if:

1. The Product was used for racing or any other competitive activity, at any point, even by a previous owner; or
2. The Product has been altered or modified in such a way so as to adversely affect its operation, performance or durability, or has been altered or modified to change its intended use.

Non-factory installed parts and accessories are not covered under this limited warranty. Please refer to the applicable parts and accessories limited warranty text.

## **2) LIMITATIONS OF LIABILITY**

TO THE EXTENT PERMITTED BY LAW, THIS WARRANTY IS EXPRESSLY GIVEN AND ACCEPTED IN LIEU OF ANY AND ALL OTHER WARRANTIES, EXPRESSED OR IMPLIED, INCLUDING WITHOUT LIMITATION ANY WARRANTY OF MERCHANTABILITY OR FITNESS FOR A PARTICULAR PURPOSE. TO THE EXTENT THAT THEY CANNOT BE DISCLAIMED, THE IMPLIED WARRANTIES ARE LIMITED IN DURATION TO THE LIFE OF THE EXPRESS WARRANTY. INCIDENTAL AND CONSEQUENTIAL DAMAGES ARE EXCLUDED FROM COVERAGE UNDER THIS WARRANTY. SOME STATES/PROVINCES DO NOT ALLOW FOR THE DISCLAIMERS, LIMITATIONS AND EXCLUSIONS IDENTIFIED ABOVE. AS A RESULT, THEY MAY NOT APPLY TO YOU. THIS WARRANTY GIVES YOU SPECIFIC RIGHTS, AND YOU MAY ALSO HAVE OTHER LEGAL RIGHTS WHICH MAY VARY FROM STATE TO STATE, OR PROVINCE TO PROVINCE. BRP SHALL NOT BE HELD LIABLE IF PRODUCTS OR WARRANTY PARTS ARE NOT AVAILABLE IN CERTAIN COUNTRIES FOR REASONS OUTSIDE OF BRP'S CONTROL.

For Products purchased in France, refer to the France specific section below.

Neither the distributor, any BRP Distributor/Dealer nor any other person has been authorized to make any affirmation, representation or warranty regarding the product, other than those contained in this limited warranty, and if made, shall not be enforceable against BRP.

BRP reserves the right to modify this limited warranty at any time, being understood that such modification will not alter the warranty conditions applicable to the Products sold while this warranty is in effect.

### **3) EXCLUSIONS – ARE NOT WARRANTED**

The following are not warranted under any circumstances: The following are not warranted under any circumstances:

- Normal wear and tear;
- Routine maintenance items, tune ups, adjustments;
- Damage caused by negligence or failure to provide proper maintenance and/or storage, as described in the Operator's Guide;
- Damage resulting from removal of parts, improper repairs, service, maintenance, modifications or use of parts not manufactured or approved by BRP or resulting from repairs done by a person that is not an authorized servicing BRP Distributor/ Dealer;
- Damage caused by abuse, abnormal use, neglect or operation of the product in a manner inconsistent with the recommended operation described in the Product's Operator's Guide;
- Damage resulting from accident, submersion, fire, theft, vandalism or any act of God;
- Operation with fuels, oils or lubricants which are not suitable for use with the Product (see the Operator's Guide);
- Damages from rust, corrosion or exposure to the elements;
- Damage resulting from water or snow ingestion;
- Incidental or consequential damages, or damages of any kind including without limitation transportation expenses, towing, storage, telephone, rental, taxi, inconvenience, insurance coverage, loan payments, loss of time, loss of income or time missed for downtime experience due to service work.
- Damages from cooling system or jet pump blockage by foreign material;
- Damages to gel coat finish including but not limited to cosmetic gel coat finish defects, blisters, starring, crazing and fiberglass delamination caused by blisters, crazing, spider or hairline cracks.

### **4) WARRANTY COVERAGE PERIOD**

This limited warranty will be in effect from (1) the date of delivery to the first retail consumer, or (2) the date the product is first put into use, whichever occurs first and for the applicable period below:

1. THIRTY-SIX (36) consecutive months, for private, recreational use except that the deck and structure are covered for EIGHTY FOUR (84) consecutive months.
2. FOUR (4) consecutive months, for commercial use owners except that the deck and structure are covered for TWELVE (12) consecutive months. A Product is used commercially when it is used in connection with any work or employment that generates income during any part of the warranty period. A Product is also used commercially when, at any point during the warranty period, it is licensed for commercial use.

The repair or replacement of parts or the performance of service under this warranty does not extend the life of this warranty beyond its original expiration date.

The warranty coverage period identified above are a minimal limited warranty period which can be extended by any applicable warranty promotional program, as the case may be.

Note that the duration and any other modalities of the warranty coverage are subject to the applicable national or local legislation in the customer's country.

## 5) FOR PRODUCTS SOLD IN FRANCE ONLY

The seller shall deliver goods that are complying with the contract and shall be responsible for defects existing upon delivery. The seller shall also be responsible for defects resulting from packaging, assembling instructions or the installation when it is its responsibility per the contract or if accomplished under its responsibility. To be compliant with the contract, the good shall:

1. Be fit for normal use for goods similar thereto and, if applicable:
  - Correspond to the description provided by the seller and have the qualities presented to the buyer though sample or model;
  - Have the qualities that a buyer may legitimately expect considering the public declarations of the seller, the manufacturer of its representative, including in advertising or labeling; or
2. Have the characteristics mutually agreed upon as between the parties or be fit for the specific use intended by the buyer and brought to the attention of the seller and which accepted.

The action for failure to comply is prescribed after two years after delivery of the goods. The seller is responsible for the warranty for hidden defects of the good sold if such hidden defects are rendering the good unfit for the intended use, or if they diminish its use in such a way that the buyer would not have acquired the good or would have given a lesser price, had he known. The action for such hidden defects shall be taken by the buyer within 2 years of the discovery of the defect.

## 6) CONDITIONS TO HAVE WARRANTY COVERAGE

This warranty coverage is available only if each of the following conditions has been fulfilled:

1. The Product must be purchased as new and unused by its first owner from a Distributor/Dealer authorized to distribute Products in the country (or in the case of the EEA, union of countries) in which the sale occurred (“Distributor/ Dealer”);
2. The BRP specified pre-delivery inspection process must be completed, documented and signed by the purchaser;
3. The Product must have undergone proper registration by an authorized Distributor/ Dealer;
4. The Product must be purchased in the country (or in the case of the EEA, union of countries) in which the purchaser resides;
5. Routine maintenance outlined in the Operator’s Guide must be timely performed in order to maintain warranty coverage. BRP reserves the right to make warranty coverage contingent upon proof of proper maintenance.

BRP will not honor this limited warranty to any private use owner or commercial use owner if one of the preceding conditions has not been met. Such limitations

are necessary in order to allow BRP to preserve both the safety of its products, and also that of its consumers and the general public.

## **7) WHAT TO DO TO OBTAIN WARRANTY COVERAGE**

The customer must cease using the Product upon the appearance of an anomaly, notify a servicing BRP Distributor/Dealer within two (2) months of the appearance of the anomaly and provide the Distributor/Dealer with reasonable access to the Product and reasonable opportunity to repair it.

The notification period is subject to the applicable national or local legislation in customer's country.

The customer must also present to the Distributor/Dealer, proof of purchase of the Product and must sign the repair/work order prior to starting the repair in order to validate the warranty repair.

All parts replaced under this limited warranty become the property of BRP.

## **8) WHAT BRP WILL DO**

To the extent permitted by law, BRP's obligations under this warranty are limited to, at its sole discretion, repairing or replacing parts found defective under normal use, maintenance and service without charge for parts and labor, at any authorized BRP Distributor/Dealer during the warranty coverage period under the conditions described herein. No claim of breach of warranty shall be cause for cancellation or rescission of the sale of the Product to the owner. You may have other legal rights which may vary from country to country.

In the event that service is required outside of the country of original sale, or for EEA residents, if service is required outside of the EEA, the owner will bear responsibility for any additional charges due to local practices and conditions, such as, but not limited to, freight, insurance, taxes, license fees, import duties, and any and all other financial charges, including those levied by governments, states, territories and their respective agencies.

BRP reserves the right to improve or modify products from time to time without assuming any obligation to modify products previously manufactured.

## **9) TRANSFER**

If the ownership of a Product is transferred during the warranty coverage period, this limited warranty, subject to its terms and conditions, shall also be transferred and be valid for the remaining coverage period provided BRP or an authorized Product Distributor/Dealer receives a proof that the former owner agreed to the transfer of ownership, in addition to the coordinates of the new owner.

## **10) CONSUMER ASSISTANCE**

In the event of a controversy or a dispute in connection with this limited warranty, BRP suggests that you try to resolve the issue at the dealership level. We recommend discussing the issue with the authorized Distributor/Dealer's service manager or owner.

If the matter still remains unresolved, contact BRP by filling out the customer contact form at *WWW.BRP.COM* or contact BRP by mail at one of the addresses listed under the Contact Us section of this guide.

**This page is intentionally blank**



# TROUBLESHOOTING

# TROUBLESHOOTING GUIDELINES

## ENGINE WILL NOT START

1. **Master switch opened.**
  - Close the master switch.
2. **Tether cord removed.**
  - Press START/STOP button.
  - Install tether cord cap over engine cut-off switch within 5 seconds after depressing the START/STOP button.
  - Press START/STOP button.
3. **ECM does not recognize the D.E.S.S. key.**
  - Refer to an authorized Sea-Doo dealer.
4. **Burnt fuse: main, electric starter or ECM.**
  - Check wiring then replace fuse(s).
5. **Discharged battery.**
  - Refer to an authorized Sea-Doo dealer.

### **WARNING**

**Do not charge or boost the battery while installed on the watercraft. Electrolyte is poisonous and dangerous. Avoid contact with eyes, skin and clothing.**

6. **Battery connections, corroded or loose. Bad ground.**
  - Refer to an authorized Sea-Doo dealer.
7. **Water-flooded engine.**
  - Refer to Water-Flooded Engine in Special Procedures.
8. **Faulty sensor or ECM.**
  - Seek service from an authorized Sea-Doo dealer, repair shop, or person of your own choosing for maintenance, repair, or replacement. Please refer to the US EPA Emission-Related Warranty contained herein for information about warranty claims.
9. **Seized jet pump.**
  - Try to clean. Otherwise, refer to an authorized Sea-Doo dealer.

## ENGINE CRANKS SLOWLY

1. **Loose battery cable connections.**
  - Check/clean/tighten.
2. **Discharged or weak battery.**
  - Refer to an authorized Sea-Doo dealer.
3. **Worn starter.**
  - Refer to an authorized Sea-Doo dealer.

**ENGINE TURNS NORMALLY BUT WILL NOT START**

1. **Fuel tank empty or water-contaminated.**
  - *Refill. Siphon and fill with fresh fuel.*
2. **Fouled/defective spark plugs.**
  - *Replace.*
3. **Blown fuse.**
  - *Check wiring then replace fuse(s).*
4. **Water-flooded engine.**
  - *Refer to Water-Flooded Engine in Special Procedures.*
5. **Engine management system fault detected (check engine pilot lamp is ON).**
  - *Seek service from an authorized Sea-Doo dealer, repair shop, or person of your own choosing for maintenance, repair, or replacement. Please refer to the US EPA Emission-Related Warranty contained herein for information about warranty claims.*
6. **Faulty fuel system.**
  - *Seek service from an authorized Sea-Doo dealer, repair shop, or person of your own choosing for maintenance, repair, or replacement. Please refer to the US EPA Emission-Related Warranty contained herein for information about warranty claims.*

**ENGINE MISFIRES, RUNS IRREGULARLY**

1. **Fouled/defective/worn spark plugs.**
  - *Replace.*
2. **Fuel: Level too low, stale or water-contaminated.**
  - *Siphon and/or refill.*
3. **Faulty ignition coil(s).**
  - *Seek service from an authorized Sea-Doo dealer, repair shop, or person of your own choosing for maintenance, repair, or replacement. Please refer to the US EPA Emission-Related Warranty contained herein for information about warranty claims.*
4. **Clogged injectors.**
  - *Seek service from an authorized Sea-Doo dealer, repair shop, or person of your own choosing for maintenance, repair, or replacement. Please refer to the US EPA Emission-Related Warranty contained herein for information about warranty claims.*
5. **Engine management system fault detected (check engine pilot lamp is ON).**
  - *Refer to Monitoring System.*

## ENGINE SMOKE

1. **Oil level too high.**
  - *Seek service from an authorized Sea-Doo dealer, repair shop, or person of your own choosing for maintenance, repair, or replacement. Please refer to the US EPA Emission-Related Warranty contained herein for information about warranty claims.*
2. **Water ingestion, coolant leak or damaged cylinder head gasket.**
  - *Seek service from an authorized Sea-Doo dealer, repair shop, or person of your own choosing for maintenance, repair, or replacement. Please refer to the US EPA Emission-Related Warranty contained herein for information about warranty claims.*
3. **Internal engine damage.**
  - *Seek service from an authorized Sea-Doo dealer, repair shop, or person of your own choosing for maintenance, repair, or replacement. Please refer to the US EPA Emission-Related Warranty contained herein for information about warranty claims.*

## ENGINE OVERHEATS

1. **Clogged exhaust cooling system.**
  - *Flush the exhaust cooling system.*
2. **Engine coolant level too low.**
  - *Refer to Maintenance Procedures.*
3. **Quick connect adapter left in flushing connector.**
  - *Remove adapter from flushing connector and retry watercraft. If problem persists, seek service from an authorized Sea-Doo dealer, repair shop, or person of your own choosing for maintenance, repair, or replacement. Please refer to the US EPA Emission-Related Warranty contained herein for information about warranty claims.*

**ENGINE LACKS ACCELERATION OR POWER**

1. **Learning key used.**
  - *Use a Normal key.*
2. **Not in Sport mode.**
  - *Select Sport mode.*
3. **Jet pump water intake clogged.**
  - *Clean. Refer to Jet Pump Water Intake and Impeller Cleaning in Special Procedures section.*
4. **Damaged impeller or worn-out wear ring.**
  - *Replace. Refer to an authorized Sea-Doo dealer.*
5. **Engine oil level too high.**
  - *Seek service from an authorized Sea-Doo dealer, repair shop, or person of your own choosing for maintenance, repair, or replacement. Please refer to the US EPA Emission-Related Warranty contained herein for information about warranty claims.*
6. **Weak spark.**
  - *Refer to ENGINE MISFIRES, RUNS IRREGULARLY.*
7. **Engine management system fault detected (check engine pilot lamp is ON).**
  - *Refer to Monitoring System.*
8. **Clogged injectors.**
  - *Seek service from an authorized Sea-Doo dealer, repair shop, or person of your own choosing for maintenance, repair, or replacement. Please refer to the US EPA Emission-Related Warranty contained herein for information about warranty claims.*
9. **Low fuel pressure.**
  - *Seek service from an authorized Sea-Doo dealer, repair shop, or person of your own choosing for maintenance, repair, or replacement. Please refer to the US EPA Emission-Related Warranty contained herein for information about warranty claims.*
10. **Water in fuel.**
  - *Siphon and replace.*
11. **Engine damaged by water ingestion.**
  - *Refer to an authorized Sea-Doo dealer.*

### WATERCRAFT CAN NOT REACH TOP SPEED

1. **Jet pump water intake clogged.**
  - Clean. Refer to *Jet Pump Water Intake and Impeller Cleaning* in *Special Procedures* section.
2. **Damaged impeller or worn-out wear ring.**
  - Replace. Refer to an authorized *Sea-Doo* dealer.
3. **Engine management system fault detected (check engine pilot lamp is ON).**
  - Refer to *Monitoring System*.

### WATERCRAFT STAYS IN NEUTRAL AFTER OPERATING THE iBR LEVER

1. **The iBR gate stays in neutral.**
  - Release the throttle to idle RPM.

### iBR WILL NOT RETURN TO NEUTRAL POSITION (iBR INDICATOR LIGHT ON)

1. **iBR jammed with debris.**
  - Clean and check for damage in the iBR gate and nozzle area.
2. **iBR system malfunction.**
  - Remove tether cord, wait four minutes, reinstall key and check iBR light to ensure fault is cleared.
  - Refer to an authorized *Sea-Doo* dealer if fault persists or reoccurs frequently.

### iBR WILL NOT RETURN TO NEUTRAL POSITION (iBR INDICATOR LIGHT OFF)

1. **Throttle lever not fully released during operation.**
  - Release throttle lever fully to ensure iBR gate returns to neutral.
2. **Throttle lever does not fully return to null when released.**
  - Refer to an authorized *Sea-Doo* dealer.

**ABNORMAL NOISE FROM PROPULSION SYSTEM**

1. **Weeds or debris jammed around impeller.**
  - *Clean. Refer to Jet Pump Water Intake and Impeller Cleaning in Special Procedures section.*
  - *Check for damage.*
2. **Damaged impeller shaft or drive shaft.**
  - *Refer to an authorized Sea-Doo dealer.*
3. **Water intrusion in jet pump causing bearing seizure.**
  - *Refer to an authorized Sea-Doo dealer.*

**WATER FOUND IN BILGE**

1. **Bilge pump system malfunction.**
  - *Have system inspected by an authorized Sea-Doo dealer.*
2. **Exhaust system leak.**
  - *Refer to an authorized Sea-Doo dealer.*
3. **Carbon ring at drive shaft worn.**
  - *Refer to an authorized Sea-Doo dealer.*
4. **Hull and/or Deck seal displaced or fasteners loose.**
  - *Refer to an authorized Sea-Doo dealer.*

# MONITORING SYSTEM

A system monitors the electronic components of the EMS (engine management system) iBR, and other components of the electrical system. When a fault occurs, it sends visual messages through the information center and/or audible signals through a beeper to inform you of a particular condition.

A fault code may also be recorded.

When a minor or transient fault occurs, the fault message and beeper will cease automatically if the condition that caused the fault does not exist anymore.

Releasing the throttle and letting the engine return to idle speed may allow normal operation to come back. If this does not work, try removing and reinstalling the tether cord on the engine cut-off switch.

The electronic system will react differently depending on the fault type. In severe failure, the engine may not be allowed to be started. In other cases, the engine will operate in limp home mode (reduced speed).

When a fault occurs, please refer to the *US EPA Emission-Related Warranty* contained herein for information about warranty claims.

## Fault Codes

When a fault occurs, a numerical fault code may be recorded depending on the fault type and system.

These fault codes are used by authorized Sea-Doo dealers for troubleshooting the watercraft systems when comparing them to a fault list.

Fault codes can be viewed in the information center multifunction display however, this function is only available if a fault is still active.

If there is an active fault code, it may be viewed by the operator on the multifunction display. The operator may

then choose to call his authorized Sea-Doo dealer to pass on the fault code. The dealer will then advise the operator on the steps to take to solve the problem, or to stop using the watercraft and to bring it in to the dealer for repairs.

## Displaying Fault Codes

Select **CODES**. If a fault code has occurred during your riding cycle, a **CODES** menu will be available in the settings menu. Press OK to see the list of faults.

### NOTE:

During normal riding conditions some fault codes may occur. Before contacting your local dealer, remove the key, make sure to wait 2 minutes until the electrical system shut down, then press start to wake up the electrical system. This will ensure occurred fault to disappear and only the active codes will remain ON in the **CODES** menu.

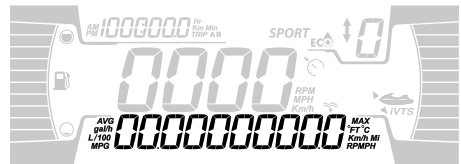







## Indicator Lamps Description (4.5" Digital Display)

The indicator lights (pilot lamps) and messages displayed in the information center will inform you of a particular condition or if an anomaly occurs.

For information on usual indicator lights, refer to appropriate digital display.

Indicator Light / Icon (ON)	Message Display	Description
	LOW or HIGH BATTERY VOLTAGE	Low/high battery voltage
	HIGH TEMPERATURE	Engine or exhaust system overheating
	CHECK ENGINE or LIMP HOME MODE	Check engine (minor fault req. maint.) or LIMP HOME MODE (major eng. fault)
	LOW OIL PRESSURE	Low oil pressure
	IBR MODULE ERROR	Light is steady with a buzzer and a check engine light: iBR system fault (refer to an authorized Sea-Doo dealer)
	–	Light is flashing: iBR system fault (refer to an authorized Sea-Doo dealer)
	–	Light is steady with no buzzer: iBR system still functional but needs to be inspected by an authorized Sea-Doo dealer

Message Display	Description
HIGH EXHAUST TEMPERATURE	High exhaust temperature detected
HIGH ENGINE TEMPERATURE	High engine temperature detected
CHECK ENGINE	Engine system malfunction and/or requiring maintenance
LIMP HOME MODE	Major fault detected, engine power limited
FUEL SENSOR FAULT	Fuel level sensor fault
WATER TEMP SENSOR DEFECTIVE	Problem with water temperature sensor, not sending water temperature info.

<b>Message Display</b>	<b>Description</b>
IBR MODULE ERROR	iBR system malfunction
MAINTENANCE REQUIRED	Watercraft maintenance required

***NOTICE***

**Running engine with low oil pressure may severely damage the engine.**

## Beeper Code Information

Beeper Codes	Description
1 long beep (while installing tether cord on watercraft engine cut-off switch)	<b>Bad D.E.S.S. system connection.</b> Reinstall tether cord cap correctly on the engine cut-off switch.
	<b>Wrong D.E.S.S. key.</b> Use a tether cord that has been programmed for the watercraft.
	<b>Defective D.E.S.S. key.</b> Use another tether cord with programmed D.E.S.S. key.
	<b>Defective engine cut-off switch.</b> Refer to an authorized Sea-Doo dealer.
	<b>Improper operation of ECM or defective wiring harness.</b> Seek service from an authorized Sea-Doo dealer, repair shop, or person of your own choosing for maintenance, repair, or replacement. Please refer to the <i>US EPA Emission-Related Warranty</i> contained herein for information about warranty claims.
A 2 seconds beep every 15 minutes interval	<b>Engine management system fault.</b> Seek service from an authorized Sea-Doo dealer, repair shop, or person of your own choosing for maintenance, repair, or replacement. Please refer to the <i>US EPA Emission-Related Warranty</i> contained herein for information about warranty claims.
	<b>iBR system fault.</b> Refer to an authorized Sea-Doo dealer.
A 2 seconds beep every 10 minutes interval	<b>Low fuel level.</b> Refill fuel tank. If problem persists, refer to an authorized Sea-Doo dealer.

Beeper Codes	Description
2 second beeps	<p><b>High engine temperature coolant.</b> See <i>Engine Overheating</i>.</p>
	<p><b>Low oil pressure.</b> Turn off engine as soon as possible. Check oil level and refill. Seek service from an authorized Sea-Doo dealer, repair shop, or person of your own choosing for maintenance, repair, or replacement. Please refer to the <i>US EPA Emission-Related Warranty</i> contained herein for information about warranty claims.</p>
Constant beep (Stops when vehicle is turned OFF)	<p><b>High exhaust temperature.</b> Seek service from an authorized Sea-Doo dealer, repair shop, or person of your own choosing for maintenance, repair, or replacement. Please refer to the <i>US EPA Emission-Related Warranty</i> contained herein for information about warranty claims.</p>

**NOTICE**

**If the monitoring beeper continuously sounds, stop engine as soon as possible.**

# **CUSTOMER INFORMATION**

---

# DATA PRIVACY INFORMATION

Bombardier Recreational Products Inc., its affiliates and subsidiaries (“BRP”) is committed to protecting your privacy and support a general policy of openness about how we collect, use and disclose your personal information in the course of managing our relationship with you. **More details can be found by visiting BRP’s Privacy Policy at: <https://brp.com/en/privacy-policy.html> or by scanning the QR Code below.**

Please be assured that we have appropriate security measures in place to ensure that your personal information is protected against loss and unauthorized access.

Your personal information that may be collected by BRP, directly from you or from authorized dealers or authorized third parties, includes:

- **Contact, Demographic & Registration Information** (e.g., name, full address, phone number, email, gender, ownership history, language of communication)
- **Vehicle Information** (e.g., serial number, purchase and delivery date, unit usage, vehicle location and movements)
- **Third Party Information** (e.g., information received from BRP partners, joint marketing activities information, social media)
- **Technological Information** (e.g., IP address, type of device, operating system, browser type, webpages you view, cookies and similar technologies when you use BRP or dealers’ websites or mobile application)
- **Interaction with BRP Information** (e.g., information collected when you call BRP’s in-house sales representatives, buy items on a BRP website, sign up for BRP emails, participate in BRP-sponsored contests and sweepstakes or attend BRP-sponsored events)
- **Transactional Information** (e.g., information necessary to handle returns, payment information when you purchase our products or services through our websites or mobile applications and other issues related to your purchase of BRP products)

This information may be used and processed for the following purposes:

- Safety & Security
- Customer Support for Sales and After Sales (e.g., complete or follow up with you about your purchase or maintenance)
- Registration & Warranty
- Communication (e.g., sending you a BRP satisfaction survey)
- Online Behavioural Advertising, Profiling and Location-Based Services (e.g., offer customized experience)
- Compliance & Dispute Resolution
- Marketing & Advertising
- Assistance (e.g., help with any delivery issues, handle returns, and other issues related to your purchase of BRP products).

We also may use personal information to generate aggregated or statistical data that no longer identifies you personally.

**Your personal information may be disclosed to the following: BRP, BRP’s authorized dealerships, distributors, service providers, advertising and market research partners and other authorized third parties.**

We may receive information about you from diverse sources, including third parties, such as BRP’s authorized dealerships and partners, with whom we offer

services or engage in joint-marketing activities. We may also receive information about you from social media platforms when you interact with us on those platforms.

Depending on the circumstances, your personal information may be communicated outside the region where you reside. Your personal information is retained only for as long as necessary for the purpose for which we obtained it and according to our retention policies.

To exercise your data privacy rights (e.g. right of access, right of rectification), to withdraw your consent in order to be removed from the address list for marketing purposes or for the satisfaction survey or for general data privacy questions, please contact BRP's Data Protection Officer at or by mail at **privacyofficer@brp.com** or by mail at:  
BRP Legal Service, 726 St-Joseph, Valcourt, Quebec, Canada, J0E 2L0.

**When BRP processes your personal information, they do so in compliance with its Privacy Policy available at: <https://www.brp.com/en/privacy-policy.html> or by using the following QR Code.**



---

# CONTACT US

*www.brp.com*

## **Asia Pacific**

### **BRP Asia**

107D and 107E, 17/F, Tower 1,  
Grand Century Place, Mongkok,  
Kowloon, Hong Kong

### **Australia**

Level 26  
477 Pitt Street  
Sydney, NSW 2020

### **China**

上海市徐汇区衡山路10号6号楼301  
Rm 301, Building 6,  
No.10 Heng Shan Rd,  
Shanghai, China

### **Japan**

21F Shinagawa East One Tower  
2-16-1 Konan, Minato-ku-ku,  
Tokyo 108-0075

### **New Zealand**

Suite 1.6, 2-8 Osborne Street,  
Newmarket, Auckland 2013

## **Europe, Middle East and Africa**

### **Belgium**

Oktrooi plein 1  
9000 Gent

### **Czech Republic**

Stefanikova 43a  
Prague 5  
150 00

### **Germany**

Itterpark 11  
40724 Hilden

### **Finland**

Isoaavantie 7  
PL 8040  
96101 Rovaniemi

### **France**

Arteparc Bâtiment B  
Route de la côte d'Azur,



13 590 Meyreuil

**Norway**

Ingvald Ystgaardsvei 15  
N-7484 Trondheim  
Salg, marketing, ettermarked

**Sweden**

Spinnvägen 15  
903 61 Umeå  
Sweden 90821

**Switzerland**

Avenue d'Ouchy 4-6  
1006 Lausanne

**Latin America**

**Brazil**

Av. James Clerck Maxwell, 230  
Campinas, Sao Paulo  
CEP 13069-380

**Mexico**

Av. Ferrocarril 202  
Parque Industrial Querétaro  
Santo Rosa Jauregui, Querétaro  
C.P. 76220

**North America**

**Canada**

3200A, rue King Ouest,  
Suite 300  
Sherbrooke (Québec) J1L 1C9

**United States of America**

10101 Science Drive  
Sturtevant, Wisconsin  
53177

---

## CHANGE OF ADDRESS/OWNERSHIP

If your address has changed or if you are the new owner of the boat, be sure to notify BRP by either:

- Notifying an authorized Sea-Doo dealer.
- **North America Only:** calling at 1 888 272-9222.
- Mailing one of the change of address cards on the following pages at one of the BRP addresses indicated in the *Contact Us* section of this guide.

In case of change of ownership, please join a proof that the former owner agreed to the transfer.

Notifying BRP, even after the expiration of the limited warranty, is very important as it enables BRP to reach the boat owner if necessary, like when safety recalls are initiated. It is the owner's responsibility to notify BRP.

**STOLEN UNITS:** In the event that your boat is stolen, you should notify your area's distributor warranty department of such. We will ask you to provide your name, address, phone number, Hull Identification Number and date it was stolen.



This page is  
intentionally blank



This page is  
intentionally blank















**WATERCRAFT**

Model No. \_\_\_\_\_

**HULL**

Identification Number (H.I.N.) \_\_\_\_\_

**ENGINE**

Identification Number (E.I.N.) \_\_\_\_\_

**OWNER:** \_\_\_\_\_  
NAME

\_\_\_\_\_  
No. STREET APT

\_\_\_\_\_  
CITY STATE/PROVINCE ZIP/POSTAL CODE

**Purchase Date**    |    |    |  
YEAR    MONTH    DAY

**Warranty Expiry Date**    |    |    |  
YEAR    MONTH    DAY

To be completed by the authorized Sea-Doo dealer at the time of the sale.

DEALER IMPRINT AREA

## **⚠ WARNING**

Disregarding any of the safety precautions and instructions contained in the operator's guide, safety video and on product safety labels could cause injury including the possibility of death.



®TM and the BRP logo are trademarks of BOMBARDIER RECREATIONAL PRODUCTS INC. or its affiliates.

©2024 BOMBARDIER RECREATIONAL PRODUCTS INC. ALL RIGHTS RESERVED.

[www.brp.com](http://www.brp.com)

**ALUMACRAFT®**

**MANITOU®**

**SEA-DOO®**

**CAN-AM®**

**QUINTREX®**

**SKI-DOO®**

**LYNX®**

**ROTAX®**

219002414