

can-am



MAVERICK MAX SERIES

OPERATOR'S GUIDE

Includes Safety, Vehicle and Maintenance Information

**NON
STOP**

⚠ WARNING

Read this operator's guide thoroughly. It contains important safety information.
Minimum recommended operator age: 16 or older with a valid driver's license.
Keep this operator's guide with the vehicle at all times.
The removal or modification of evaporative emission-related parts on this OHRV is illegal.
Violators may be subject to civil and/or criminal penalties under California and federal law.

219002389

Original Instruction

WARNING

YOUR VEHICLE CAN BE HAZARDOUS TO OPERATE. A collision or roll-over can occur quickly, if you fail to take proper precautions, even during routine maneuvers such as turning and driving on hills or over obstacles. For your safety, understand and follow all the warnings contained in this operator's guide and on the labels on your vehicle. Failure to follow these warnings can result in **SEVERE INJURY OR DEATH.** Keep this operator's guide with the vehicle at all times.

WARNING

Disregarding any of the safety precautions and instructions contained in the Operators's Guide, Safety video and on product safety labels could cause injury including the possibility of death.

WARNING

This vehicle may exceed the performance of other vehicles you may have ridden in the past. Take time to familiarize yourself with your new vehicle.

CALIFORNIA PROPOSITION 65 WARNING

WARNING

Operating, servicing and maintaining an off-road vehicle can expose you to chemicals including engine exhaust, carbon monoxide, phthalates, and lead, which are known to the State of California to cause cancer and birth defects or other reproductive harm. To minimize exposure, avoid breathing exhaust, do not idle the engine except as necessary, service your vehicle in a well-ventilated area and wear gloves or wash your hands frequently when servicing your vehicle. For more information go to www.p65warnings.ca.gov/products/passenger-vehicle.

™® Trademarks of BRP or its affiliates.

This is a non-exhaustive list of trademarks that are the property of Bombardier Recreational Products Inc. or its affiliates.

Trademarks may not be registered in every jurisdiction.

Can-Am®

D.E.S.S.™

DPST™

ROTAX®

Maverick®

XPS®

All rights reserved. No parts of this Operator's guide may be reproduced in any form without the prior written permission of Bombardier Recreational Products Inc.

©Bombardier Recreational Products Inc. (BRP) 2024

Deutsch	Dieses Handbuch ist möglicherweise in Ihrer Landessprache verfügbar. Bitte wenden Sie sich an Ihren Händler oder besuchen Sie: www.operatorsguides.brp.com
English	This guide may be available in your language. Check with your dealer or go to: www.operatorsguides.brp.com
Español	Es posible que este manual esté disponible en su idioma. Consulte a su distribuidor o visite: www.operatorsguides.brp.com
Français	Ce guide peut être disponible dans votre langue. Vérifier avec votre concessionnaire ou aller à: www.operatorsguides.brp.com
Italiano	Questa guida potrebbe essere disponibile nella propria lingua. Contattare il concessionario o consultare: www.operatorsguides.brp.com
中文	本手册可能有您的语种的翻译版本。请向经销商询问，或者登录 www.operatorsguides.brp.com 查询。
日本語	このガイドは、言語によって翻訳版が用意されています。ディーラーに問い合わせるか、次のアドレスでご確認ください： www.operatorsguides.brp.com
Nederlands	Deze handleiding kan beschikbaar zijn in uw taal. Vraag het aan uw dealer of ga naar: www.operatorsguides.brp.com
Norsk	Denne boken kan finnes tilgjengelig på ditt eget språk. Kontakt din forhandler eller gå til: www.operatorsguides.brp.com
Português	Este manual pode estar disponível em seu idioma. Fale com sua concessionária ou visite o site: www.operatorsguides.brp.com
Русский	Воспользуйтесь руководством на вашем языке. Узнайте о его наличии у дилера или на странице по адресу www.operatorsguides.brp.com
Suomi	Käyttöohjekirja voi olla saatavissa omalla kielelläsi. Tarkista jälleenmyyjältä tai käy osoitteessa: www.operatorsguides.brp.com
Svenska	Denna bok kan finnas tillgänglig på ditt språk. Kontakta din återförsäljare eller gå till: www.operatorsguides.brp.com

Covered Models

Maverick MAX DS Turbo Maverick MAX DS Turbo RR

Maverick MAX RS Turbo RR

Maverick MAX X ds Turbo RR

Maverick MAX X rc Turbo RR

Maverick MAX X rs Turbo RR Maverick MAX X rs Turbo RR with Smart Shox
--

In Canada, products are distributed and serviced by Bombardier Recreational Products Inc. (BRP).

In the USA, products are distributed and serviced by BRP US Inc.

In the European Economic Area (which is comprised of the member states of the European Union plus the United Kingdom, Norway, Iceland and Liechtenstein), the Commonwealth of the Independent States (including Ukraine and Turkmenistan) and Turkey, products are distributed and serviced by BRP European Distribution S.A. and other affiliates or subsidiaries of BRP.

For all other countries, products are distributed and serviced by Bombardier Recreational Products Inc. (BRP) or its affiliates.

TABLE OF CONTENTS

GENERAL INFORMATION

GENERAL INFORMATION	10
Know Before you Go	10
Safety Messages	10
About this Operator's Guide.....	11

SAFETY INFORMATION

GENERAL PRECAUTIONS	14
Avoid Carbon Monoxide Poisoning.....	14
Avoid Gasoline Fires and Other Hazards	14
Avoid Burns from Hot Parts	14
Be A Responsible Rider	14
Respect of the Environment.....	15
Accessories and Modifications	16
SAFE OPERATION - RESPONSIBILITIES	18
Owner - Be Responsible.....	18
Operator - Be Qualified and Responsible	18
Riding Carefully	19
Occupant Restraint System	20
Terrain Condition	20
PRE-RIDE INSPECTION	21
Pre-Ride Inspection Check List	21
PREPARE TO RIDE	24
Before You Ride	24
Riding Gear.....	24
AVOID ACCIDENTS	27
Avoid Rollovers and Tipovers	27
Avoid Collisions	28
RIDING YOUR VEHICLE	29
Practice Exercises	29
Off-Road Operation	30
General Riding Techniques	30
MOVING LOADS AND DOING WORK	36
Working with Your Vehicle.....	36
Carrying Loads.....	36
IMPORTANT ON-PRODUCT LABELS (CANADA/UNITED STATES)	40
Hang Tag.....	40
Safety Labels	42
Compliance Labels	60
Technical Information Labels	62
IMPORTANT ON-PRODUCT LABELS (ALL COUNTRIES EXCEPT CANADA/UNITED STATES)	63
Safety Pictogram	63
Compliance Labels	79
Technical Information Labels	82

REPORTING SAFETY DEFECTS	84
VEHICLE INFORMATION	
PRIMARY CONTROLS	86
Steering Wheel.....	86
Accelerator Pedal	86
Brake Pedal	86
Shift Lever.....	87
SECONDARY CONTROLS	89
RF D.E.S.S Key and RF D.E.S.S. Post.....	89
Engine Start/Stop Button	90
Headlight Dimmer Switch	90
2WD/4WD/Front Diff Lock (if Equipped) Switch.....	90
Riding Mode Switch	91
Keypad	91
Override Switch.....	92
Winch Switch	92
Horn Switch (On applicable models).....	93
Smart-Shox Suspension Mode Switch (On Applicable Models)	93
EQUIPMENT	94
Tilt Steering.....	95
Cup Holders.....	95
Passenger Handholds.....	95
Glove Box	96
Tool Kit	96
Footrests.....	96
Doors.....	97
Seat Belts	97
Seats.....	99
Fuel Reservoir Cap.....	102
Cargo Rack.....	102
Recovery Hook.....	103
Wheel Scraper	103
12-Volt Power Outlet.....	103
Central Rearview Mirror	104
Winch (If Equipped)	104
4.5" DIGITAL DISPLAY	106
MULTIFUNCTION DISPLAY	106
SETTINGS.....	108
7.6" DIGITAL DISPLAY (KEYPAD)	110
Multifunction Display	110
Settings	112
TUNE YOUR RIDE	114
DPS Function	114
Suspension Adjustment Guidelines.....	114
Suspension Factory Settings	116
Suspension Adjustments.....	118
FUEL	123
FUEL REQUIREMENTS	123
Vehicle Fueling Procedure	123

BREAK-IN PERIOD	125
Operation During Break-In.....	125
BASIC PROCEDURES	126
Starting the Engine.....	126
Waking Up the Electrical System.....	126
Operating the Shift Lever.....	126
Choosing the Correct Range (Low or High).....	126
Stopping the Engine and Parking the Vehicle.....	127
Tips for Maximizing Drive Belt Durability.....	128
SPECIAL PROCEDURES	129
What to do if Water Entered the CVT.....	129
What to do if Battery is Drained Out.....	129
What to Do if Vehicle Rolled Over.....	129
What to do if Vehicle is Submerged.....	129
TRANSPORTING THE VEHICLE	130
Using Vehicle Power to Climb Onto Trailering Equipment.....	131
Using a Winch to Pull Vehicle Onto Trailering Equipment.....	131
Securing Vehicle for Transport.....	132
Getting Vehicle Out of Trailer.....	132
LIFTING AND SUPPORTING THE VEHICLE	133
Front of Vehicle.....	133
Rear of Vehicle.....	133

MAINTENANCE

MAINTENANCE SCHEDULE	136
EPA Regulation - Canadian and USA Vehicles.....	136
Air Filter Maintenance Guideline.....	136
Severe Duty Use.....	137
Deep Mud / Water Use.....	137
Maintenance Schedule.....	138
Maintenance Records.....	149
MAINTENANCE PROCEDURES	154
ENGINE AIR FILTER.....	154
Front Grille Kit.....	155
CVT Air Filter.....	155
EVAPORATIVE EMISSION SYSTEM PRE-FILTER (If Equipped).....	156
ENGINE OIL.....	157
ENGINE OIL FILTER.....	159
RADIATOR.....	160
ENGINE COOLANT.....	160
EXHAUST SYSTEM.....	163
FRONT DIFFERENTIAL.....	163
GEARBOX.....	165
SPARK PLUGS.....	166
CVT COVER.....	169
Drive Belt.....	171
Drive and Driven Pulleys.....	172
BATTERY.....	172
FUSES.....	173
Lights.....	175
DRIVE SHAFT BELLOWS.....	175

WHEEL BEARING	176
WHEELS AND TIRES	176
Suspensions	177
BRAKES	178
SEAT BELTS	179
CAGE	179
VEHICLE CARE	182
Vehicle Cleaning and Protection	182
STORAGE AND PRESEASON PREPARATION	183

TECHNICAL INFORMATION

VEHICLE IDENTIFICATION	186
Vehicle Identification Number	186
Engine Identification Number	186
BRP RF DESS POST GEN3 (CAN)	187
USA and Canada	187
Mexico	188
Brazil	188
Japan	189
Europe	189
EVAPORATIVE EMISSION CONTROL SYSTEM	193
NOISE EMISSION CONTROL SYSTEM REGULATION (CANADA AND UNITED STATES)	194
NOISE EMISSION AND VIBRATION VALUES (ALL COUNTRIES EXCEPT CANADA/UNITED STATES)	195
DECLARATION OF CONFORMITY	196
EU Declaration of Conformity	196
UK Declaration of Conformity	197
EAC DECLARATION OF CONFORMITY	198

TECHNICAL SPECIFICATIONS

TECHNICAL SPECIFICATIONS	200
---------------------------------------	------------

TROUBLESHOOTING

TROUBLESHOOTING GUIDELINES	212
MESSAGES IN MULTIFUNCTION GAUGE	216

WARRANTY

BRP LIMITED WARRANTY FOR CANADA AND USA: 2025 CAN-AM® SSV	218
1) Scope of the Limited Warranty	218
2) Limitations of Liability	218
3) EXCLUSIONS – Are Not Warranted	218
4) Warranty Coverage Period	219
5) Conditions to Have Warranty Coverage	219
6) What to Do to Obtain Warranty Coverage	220

7) What BRP Will Do 220

8) Transfer 220

9) Consumer Assistance 220

US EPA EMISSION - RELATED WARRANTY 221

 Emission-Related Warranty Period 221

 Components Covered 221

 Limited Applicability 222

CALIFORNIA EVAPORATIVE EMISSIONS CONTROL WARRANTY STATEMENT 224

 Your Warranty Rights And Obligations 225

 OHRV Manufacturer’s Warranty Coverage 225

 Owner’s Warranty Responsibilities 226

BRP LIMITED WARRANTY FOR INTERNATIONAL: 2025 CAN-AM® SSV 227

 1) Scope of the Limited Warranty 227

 2) Limitation of Liability 227

 3) EXCLUSIONS – Are Not Warranted 228

 4) Warranty Coverage Period 228

 5) For Products Sold In Australia Only 229

 6) Conditions to Have Warranty Coverage 229

 7) What to Do to Obtain Warranty Coverage 230

 8) What BRP Will Do 230

 9) Transfer 230

 10) Consumer Assistance 230

BRP LIMITED WARRANTY FOR THE EUROPEAN ECONOMIC AREA, THE COMMONWEALTH OF THE INDEPENDENT STATES AND TURKEY: 2025 CAN-AM® SSV 232

 1) Scope of the Limited Warranty 232

 2) Limitations of Liability 232

 3) EXCLUSIONS – Are Not Warranted 233

 4) Warranty Coverage Period 233

 5) For Products Sold In France Only 234

 6) Conditions to Have Warranty Coverage 234

 7) What to Do to Obtain Warranty Coverage 235

 8) What BRP Will Do 235

 9) Transfer 235

 10) Consumer Assistance 236

CUSTOMER INFORMATION

DATA PRIVACY INFORMATION 238

CONTACT US 240

 Asia Pacific 240

 Europe, Middle East and Africa 240

 Latin America 241

 North America 241

CHANGE OF ADDRESS AND OWNERSHIP 242

This page is intentionally blank

GENERAL INFORMATION

GENERAL INFORMATION

Congratulations on your purchase of a new Can-Am® side-by-side vehicle. It's backed by the BRP limited warranty and a network of authorized Can-Am Off-road dealers ready to provide the parts, accessories or service you may require.

At delivery, you were informed of the warranty coverage and signed the Pre-delivery Check List to ensure your new vehicle was prepared to your entire satisfaction.

Your dealer is committed to your satisfaction. If you need more information, please ask your dealer.

Know Before you Go

To learn how to reduce the risk of accident for you or bystanders, read this Operator's Guide before you operate the vehicle.

Also, read all safety labels on your vehicle and watch the *Safety Video* located at:

<https://can-am.brp.com/off-road/safety>

Or use the following QR code.



This vehicle is for off-road use only. It is mainly for general recreational use but it may also be used for utility purposes.

Failure to follow the warnings contained in this Operator's Guide can result in **SERIOUS INJURY** or **DEATH**.

Safety Messages

The types of safety messages, what they look like and how they are used in this guide are explained as follows:

The safety alert symbol  indicates a potential injury hazard.

 WARNING
Indicates a potential hazard which, if not avoided, could result in serious injury or death.

 CAUTION
Indicates a hazardous situation which, if not avoided, could result in minor or moderate injury.

NOTICE

Indicates an instruction which, if not followed, could result in severely damaged vehicle components or other property.

About this Operator's Guide

This Operator's Guide has been prepared to acquaint the owner/operator of a new vehicle with the various vehicle controls, maintenance and safe operating instructions. It is indispensable for the proper use of the product.

Keep this Operator's Guide in the vehicle as you can refer to it for things such as maintenance, troubleshooting and instructing others.

Note that this guide is available in several languages. In the event of any discrepancy, the English version shall prevail.

If you want to view and/or print an extra copy of your Operator's Guide, simply visit the following website:

www.operatorsguides.brp.com

The information contained in this document is correct at the time of publication. BRP, however, maintains a policy of continuous improvement of its products without imposing upon itself any obligation to install them on products previously manufactured. Due to late changes, some differences between the manufactured product and the descriptions and/or specifications in this guide may occur. BRP reserves the right at any time to discontinue or change specifications, designs, features, models or equipment without incurring any obligation upon itself.

This Operator's Guide should remain with the vehicle when it is sold.

This page is intentionally blank

SAFETY INFORMATION

GENERAL PRECAUTIONS

Avoid Carbon Monoxide Poisoning

All engine exhaust contains carbon monoxide, a deadly gas. Breathing carbon monoxide can cause headaches, dizziness, drowsiness, nausea, confusion and eventually death.

Carbon monoxide is a colorless, odorless, tasteless gas that may be present even if you do not see or smell any engine exhaust. Deadly levels of carbon monoxide can collect rapidly, and you can quickly be overcome and unable to save yourself. Also, deadly levels of carbon monoxide can linger for hours or days in enclosed or poorly ventilated areas. If you experience any symptoms of carbon monoxide poisoning, leave the area immediately, get fresh air and seek medical treatment.

To prevent serious injury or death from carbon monoxide:

- Never run the vehicle in poorly ventilated or partially enclosed areas such as garages, carports or barns. Even if you try to ventilate engine exhaust with fans or open windows and doors, carbon monoxide can rapidly reach dangerous levels.
- Never run the vehicle outdoors where engine exhaust can be drawn into a building through openings such as windows and doors.

Avoid Gasoline Fires and Other Hazards

Gasoline is extremely flammable and highly explosive. Fuel vapors can spread and be ignited by a spark or flame many feet away from the engine. To reduce the risk of fire or explosion, follow these instructions:

- Use only an approved gasoline container to store fuel.
- Never fill the gasoline container on the vehicle - an electrical static discharge may ignite the fuel.
- Never carry gasoline container(s) or any dangerous liquids on the cargo rack.
- Strictly adhere to instructions in *Vehicle Fueling Procedure*.
- Never start or operate the engine if the fuel cap is not properly installed.

Gasoline is poisonous and can cause injury or death.

- Never siphon gasoline by mouth.
- If you swallow gasoline, get any in your eye(s), or inhale gasoline vapor, see a doctor immediately.

If gasoline spills on you, wash with soap and water and change your clothes.

Avoid Burns from Hot Parts

Certain components like brake rotors and exhaust components become hot during operation. Avoid contact with those parts during and shortly after operation to avoid burn wounds.

Be A Responsible Rider

At BRP, we believe there's an opportunity for everyone in the powersports and marine communities to come together and rethink how we approach safety, riding etiquette, and the environment. We believe that when we empower all riders to ride responsibly—to look out for each other and safeguard our trails and

playgrounds—we inspire an industry to welcome newcomers, build a more caring community and generate positive experiences.

Whether you ride on trails, roads, water or snow, BRP is committed to driving positive change. That's why we're making the Responsible Rider program a key part of our Corporate Social Responsibility initiative through action, education and community empowerment.

To learn more about Responsible Rider, including tips and tricks on safety, riding etiquette and the environment, visit:

– CANAMOFFROAD.COM/RESPONSIBLE-RIDER/



Respect of the Environment

The guidelines that we support are not designed to limit your fun, but to preserve the beautiful freedom that you can experience only with an off-road vehicle!

These guidelines will keep operators and passengers healthy, happy and able to introduce others to what they know and enjoy about their favorite pastime. So, the next time you hit the trails, we ask you to remember that you are paving the way for the future of our sport. Help us lead it down the right path! From all of us at BRP, thank you for doing your share.

There is nothing more exhilarating than off-road adventures. Venturing onto trails that cross wild areas is an exciting and healthy sport. However, as the number of people using these recreational parks increases, so does the potential for damage to the environment. Abuse of land, facilities and resources inevitably leads to restrictions and closures of both private and public land.

In essence, the greatest threat to our sport, is all around us. Which leaves us with one logical choice. We must always ride responsibly.

The vast majority respect the law and the environment. Each of us must set an example for those who are new to the sport, young and old alike.

It is in every one's best interest to tread lightly into our recreational areas. Because, in the long run, to protect the sport we must preserve the environment.

Recognizing the importance of this issue and the need for off-road riders to do their share in preserving areas that make it possible to enjoy our sport, BRP invite all off-road riders to remember that respecting the environment is not only critical to the future of our industry but to future generations.

You are a good ambassador for your sport when you follow the principles below.

Become informed. Obtain maps, regulations and other information from the Off-road clubs, the Forest Service or from other public land agencies. Learn the rules and follow them and that goes for speed limits, too!

Avoid running over young trees, shrubs, and grasses and don't cut wood. On flatlands or areas where trail riding is popular, it's important to ride only where authorized. Remember, there is a link between protecting your environment and your own safety.

Respect wildlife and be particularly sensitive of animals that are rearing young or suffering from food shortage. Stress can sap scarce energy reserves. Refrain from riding in areas where only animals are intended to tread!

Obey gate closures and regulatory signs and remember, light treaders don't litter!

Stay out of wilderness areas. They're closed to all vehicles. Know where the boundaries are.

Obtain permission to travel across private land. Respect the rights of land-owners and other people's privacy. Remember, the technology has lowered the noise factor considerably, but you still shouldn't rev your engines where quiet "is the order of the day".

Off-road riders know all too well the efforts that have been made throughout the sport's history to enjoy access to areas where people can ride safely and responsibly. This effort continues today, as strong as ever.

Respecting the areas where we ride... wherever they may be... is the principal way to ensure future enjoyment for all.

Take the opportunity to admire nature and all its wonders, is an experience cherished by off-road riders. Respect the nature and wildlife will help our sport to grow!

Finally, you don't have to leave big tracks or careen through a virgin forest to show you can ride. So whether you're driving a high performance BRP off-road vehicle or any other make or model, show you know what you're doing.

Accessories and Modifications

Any modifications or addition of accessories approved by BRP may affect the handling of your vehicle. It is important to take the time to get familiar with the vehicle once modifications are made to understand how to adapt your driving behavior accordingly.

Avoid installing equipment not specifically approved by BRP for the vehicle and avoid unauthorized modifications. These modifications and equipment have not been tested by BRP and may create hazards. For example, they could:

- Create a loss of control and increase risk of crash
- Cause overheating or short circuits increasing the risk of fire or burn injuries
- Affect the protection features provided by the vehicle.
- Affect the behavior of the trailer when the vehicle is transported
- Cause a risk of losing objects on the road when transported.

Your vehicle may also become illegal to ride.

See your authorized BRP Off-road dealer for available BRP accessories for your vehicle.

For safety reasons, some BRP accessories must be installed by a BRP dealer but if you decide to install the accessory by yourself, when not required to be done by the dealer, it is important to follow all the instructions carefully and, if applicable, understand all the information on how to use the product or for servicing.

If the accessory has been installed on your vehicle by another person than you, BRP strongly recommends you to read the corresponding instruction sheet as there may be more for information on how to use it safely or for the servicing.

The instruction sheets can be found at this address:

– [HTTPS://INSTRUCTIONS.BRP.COM](https://instructions.brp.com)

SAFE OPERATION - RESPONSIBILITIES

This is a high performance off-road vehicle. Operators must be responsible and use care to avoid rollovers, tipovers, collisions, and other accidents. Even with vehicle safety features (such as protective structure, seat belts, doors) and protective gear (such as a helmet), there is always a risk of injury or death in these accidents. To reduce the risk of serious injury or death, follow the rules in this section.

Owner - Be Responsible

Read this Operator's Guide and watch the *Safety Video*. Refer to the link at the beginning of the Operator's Guide.

Always inspect and confirm the safe operating condition of your vehicle prior to ride. Always follow the maintenance schedule described in this Operator's Guide.

Never allow anyone to operate your vehicle unless they are responsible and can be trusted with a high performance vehicle. Consider supervising new or young operators and setting rules and limits (e.g., whether they can carry a passenger, what they may do with the vehicle, where they may ride, etc.) for anyone using your vehicle.

Select the appropriate key (see *RF D.E.S.S Key and RF D.E.S.S. Post*) based on the operator's experience, vehicle use and environment.

Discuss the safety information with anyone who will be using the vehicle. Be sure that all operators and passengers meet the qualifications below and agree to follow the safety information. Help users become familiar with the vehicle.

We encourage you to have an Annual Safety Inspection of your vehicle. Please contact an authorized BRP dealer for further details. Though not required, it is recommended that an authorized BRP dealer performs the preseason preparation of your vehicle. Each visit to your authorized BRP dealer is a great opportunity for your dealer to verify if your vehicle is included in any safety campaign. We also urge you to visit your authorized BRP dealer in a timely manner if you become aware of any safety related campaigns.

Operator - Be Qualified and Responsible

Read this Operator's Guide and watch the safety video. Refer to the link at the beginning of the Operator's Guide.

Become completely familiar with the operational controls and the general operation of the vehicle.

Get familiar with this Off-Highway Vehicle (OHV); it may exceed the performance of other OHV you may have ridden. This is a high performance vehicle. Inexperienced riders may overlook risks and be surprised by the specific behavior of this vehicle in any terrain condition.

Take a training course if available (contact an authorized Can-Am Off-road dealer to find out about training course availability as well as on the internet at <http://www.rohva.org/>), and perform the practice exercises in *Practice Exercises*. Practice driving in a suitable area free of hazards and feel the response of each control. Drive at low speeds. Higher speeds require greater experience, knowledge and suitable riding conditions.

Be at least 16 years of age.

Be tall enough to be properly seated: back against the backrest with the seat belt fastened, to hold the steering wheel with both hands and still be able to reach the full stroke of brake and accelerator pedals with the right foot and to firmly plant left foot on the footrest.

Have a proper driver's license in accordance with local laws.

Never use this vehicle with drugs or alcohol, or if tired or ill. These slow reaction time and impair judgment.

Carrying Passengers

Only carry one passenger per available seat. All passengers must be properly seated in the cockpit.

The passengers must be tall enough to always be properly seated: back against the backrest with seat belt fastened, holding both handholds, and feet firmly planted on the footrests.

Never carry passengers who has used drugs or alcohol, or is tired or ill. These slow reaction time and impair judgment.

Instruct the passengers to read the vehicle's safety labels.

Never carry passengers if you judge his ability or judgement insufficient to concentrate on the terrain conditions and adapt accordingly. More specifically for side-by-side vehicles, the passengers must also pay constant attention to the terrain ahead and be able to brace for bumps.

Riding Carefully

- This vehicle handles differently from other vehicles. A collision or rollover can occur quickly, during abrupt maneuvers such as doing sharp turns, acceleration or deceleration and driving on hills or over obstacles, if you fail to take proper precautions.
- Never operate at excessive speeds. Always go at a speed that is proper for the terrain, visibility, and operating conditions, and your experience.
- Never attempt jumps, side slides, donuts or any other stunts.
- Never attempt rapid acceleration or deceleration when performing a sharp turn. This may result in a roll over.
- Never attempt skidding or sliding. If vehicle starts to skid or slide, counter steer in the direction of skidding or sliding. On extremely slippery surfaces, such as ice, go slowly and be very cautious in order to reduce the chance of skidding out of control.
- Always be sure there are no obstacles or people behind the vehicle when you operate in reverse. Pay attention to blind spots. When it is safe to proceed in reverse, go slowly.
- Never exceed the stated load limits for this vehicle. Reduce speed, allow for greater braking distance and follow other instructions in *Moving Loads and Doing Work*.
- Always remember that this vehicle is heavy! Its pure weight alone may entrap you should it tip or rollover.

Occupant Restraint System

- This vehicle is designed to carry one driver and up to three passengers, all wearing proper protective gears (refer to *Riding Gear* in this section).
- The driver and passengers must latch the doors or the side nets and wear the seat belts at all times when riding.
- Before riding, everyone aboard should know how to unbuckle their seat belt rapidly. Knowing how to properly detach your seat belt is a crucial skill that can save your life in an emergency situation. In the event of an accident or vehicle malfunction, being able to quickly release your seat belt can help you escape the vehicle and avoid potential hazards such as fire or sinking. Additionally, knowing to quickly release your seat belt can also help you assist others such as children or older persons.

Terrain Condition

- Driving on public roads poses risks such as collisions and may be illegal in your jurisdiction. Only proceed with caution on roads and road segments where the usage of your vehicle is permitted.
- This vehicle is not designed to ride on paved surfaces; if you must shortly use the vehicle on such surfaces, avoid abrupt inputs to steering wheel, accelerator and brake pedals.
- Always go slowly and be extra careful when operating on unfamiliar terrain. Always be alert to changing terrain conditions when operating this vehicle. Take the time to learn how the vehicle performs in different environments.
- Never operate on excessively rough, slippery or loose terrain until you have learned and practiced the skills necessary to control this vehicle on such terrain. Always be especially cautious on these kinds of terrain.
- Never operate this vehicle on hills too steep for the vehicle or your abilities. Practice on small inclines.
- Always follow proper procedures for climbing or going down hills as described in *Riding Your Vehicle*. Check the terrain carefully before you start up or down any hill. Never climb or descend hills with excessively slippery or loose surfaces. Never go over the top of any hill at high speed.
- Never attempt steep hills or side hilling when pulling a trailer (if equipped with hitch).
- Always check for obstacles before operating in a new area. Always follow proper procedures when operating over obstacles as described in *Riding Your Vehicle*.
- Never operate this vehicle in fast flowing water or in water deeper than specified in *Riding Your Vehicle*. Remember that wet brakes may have reduced stopping ability. Test your brakes after leaving water. If necessary, apply them several times to let friction dry out the brakes.
- Always ensure to properly park the vehicle on the flattest terrain section available. Put shift lever in PARK, stop engine and remove key before leaving the vehicle.
- Never assume that the vehicle will go everywhere safely. Sudden changes in terrain caused by holes, depressions, banks, softer or harder “ground” or other irregularities may cause the vehicle to topple or become unstable. To avoid this, slow down and always observe the terrain ahead. If the vehicle does begin to topple or rollover, the best advice is to immediately steer in the direction of the rollover! Never attempt to prevent a rollover with your arms or legs. You should keep your limbs inside the cage.

PRE-RIDE INSPECTION

Always inspect and confirm the safe operating condition of your vehicle prior to ride. Always follow the maintenance schedule described in this Operator's Guide.

WARNING

Perform a pre-ride inspection before each ride to detect any potential problem that could occur during operation. The pre-ride inspection can help you monitor component wear and deterioration before they become a problem. Correct any problem that you discover to reduce the risk of a breakdown or crash.

Before using this vehicle, the operator should always perform the following pre-ride inspection check list.

Refer to *Maintenance Procedures* for details.

Pre-Ride Inspection Check List

What to Do Before Starting the Engine (Key OFF)

ITEMS TO BE INSPECTED	INSPECTION TO PERFORM	✓
Coolant	Check coolant level.	
Brake fluid	Check brake fluid level.	
Engine air filter	Inspect engine air filter, replace if needed.	
Engine air filter housing	Inspect engine air filter housing and clean if necessary (when riding in dusty conditions or sand).	
Radiator	Check radiator for cleanliness.	
Front grille	Inspect front grille kit for cleanliness.	
CVT air filter	Inspect and clean the CVT air filter (when riding in dusty conditions).	
Exhaust system	If not already done, clean the area surrounding the exhaust system especially if during the last ride, the vehicle was used in a swamp, bog, hay or dead leaves.	
Drive shaft bellows	Check drive shaft bellows condition.	
Tires	Check tire pressure and condition. Refer to <i>Technical Specifications</i> and adjust according to load.	
Wheels	Check wheels for damage and for abnormal play. Make sure that lug nuts	

ITEMS TO BE INSPECTED	INSPECTION TO PERFORM	✓
	and beadlocks screws (if equipped) are tightened. Refer to <i>Wheels and Tires</i> in <i>Maintenance Procedures</i> for torque specification.	
Cargo and load	Cargo Load: If you transport a cargo, respect the maximum cargo rack capacity. Refer to <i>Technical Specifications</i> . Ensure the weight of the operator, passengers, cargo, trailer tongue and added accessories does not exceed the vehicle total load allowed. Refer to <i>Technical Specifications</i> .	
	If you are pulling a trailer or another equipment (if equipped with a hitch): <ul style="list-style-type: none"> - Check hitch and trailer ball condition. - Respect the tongue capacity and towing capacity as indicated on the label affixed to the hitch or refer to <i>Technical Specifications</i>. - Ensure trailer is properly secured to hitch. 	
Rear cargo rack	Check if the cargo on rack is properly secured.	
Chassis and suspension	Check underneath vehicle for any debris on chassis or suspension components (upper and lower arms, wheels, shock absorber, springs) and clean them properly.	

What to Do Before Starting the Engine (Key ON)

ITEMS TO BE INSPECTED	INSPECTION TO PERFORM	✓
Digital display	Check operation of indicator lamps in the digital display (With the D.E.S.S. key ON, briefly push the Start / Stop button).	
	Check for messages in gauge.	
Lights	Check operation and cleanliness of <ul style="list-style-type: none"> - Headlights (High and Low) - Taillights - Brake lights. 	

ITEMS TO BE INSPECTED	INSPECTION TO PERFORM	✓
Seats, doors and seat belts	Check seat adjustment and make sure locking device is properly engaged before riding.	
	Check doors for any damage. Have the doors replaced if any damage is found. Close both doors and confirm that they latch securely.	
	Check seat belts for any damage (including retractors, buckles and semi-cinching tabs). Fasten seat belts and confirm that they latch and unlatch securely and tightened against the body.	
Accelerator pedal	Press on the accelerator pedal a few times to ensure it operates freely and it returns to the rest position when released.	
Brake pedal	Press down on the brake pedal and make sure you feel firm resistance and that it fully returns to position when released.	
Fuel level	Check the fuel level.	

What to Do After the Engine is Started

ITEMS TO BE INSPECTED	INSPECTION TO PERFORM	✓
Engine oil (with warm engine)	Check engine oil level.	
Steering	Check if steering operates freely by completely turning it from side to side.	
RF D.E.S.S. post	Check if D.E.S.S. post is working properly by pulling the D.E.S.S. key from D.E.S.S. post.	
Shift lever	Check operation of shift lever (P, R, N, H and L).	
2WD/4WD/Front Diff Lock (If equipped) selector	Check operation of 2WD/4WD/Front Diff Lock (If equipped) selector.	
Brakes	Drive forward slowly a few feet and apply brakes. The brake pedal must feel firm when applied. The pedal must return to rest position when released. The brakes must respond adequately to the driver's input.	

PREPARE TO RIDE

Before You Ride

Perform pre-ride inspection to confirm the safe operating condition of your vehicle. Refer to *Pre-Ride Inspection*.

Driver and passenger must:

- Be properly seated.
- Close both doors and fasten seat belts.
- Wear appropriate riding gear. (Refer to *Riding Gear* below.)

Riding Gear

It is important that the operator and passenger always wears appropriate protective clothing and apparel, including:

- An approved helmet
- Eye protection
- Boots
- Gloves
- A long sleeved shirt or jacket
- Long pants.

Depending on conditions, anti-fogging goggles may be required.

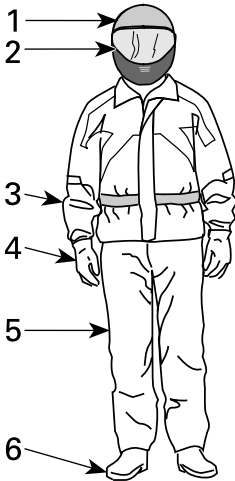

RIDING GEAR

1. Approved helmet
2. Eye and face protection
3. Long sleeves shirt or jacket
4. Gloves
5. Long pants
6. Boots (over-the-ankle footwear)

Weather conditions should help you decide how to dress. To maximize comfort and avoid frostbites in winter, dress for the coldest weather expected. Thermal underwear next to the skin also provides good insulation.

Never wear any loose clothing that may get entangled in the vehicle or on tree branches and shrubs.

Helmets and Eye Protection

Helmets protect the head and brain from injury. Even with the vehicle's cage and doors, objects can enter the cockpit and strike the head, or the head can strike the cage itself or objects outside the vehicle. Even the best helmet is no guarantee against injury, but statistics indicate that helmet use significantly reduces the risk of brain injury. So, be safe and always wear a helmet while riding.

Choosing a Helmet

Helmets should be manufactured to meet the appropriate standard in your state, province or country and should fit properly.

A helmet with face protection is a better choice as it protects also against frontal impacts. It can also protect against debris, stones, insects, the elements, etc.

An open-face helmet does not offer the same protection for the face and chin. If you wear an open-face helmet, you should use a snap-on face shield and/or a pair of goggles. Ordinary glasses or sunglasses are not sufficient eye protection for riders. They can shatter or fly off, and they allow wind and airborne objects to reach the eyes.

For winter riding conditions, a stocking type cap, balaclava and face mask should always be carried or worn.

Use tinted face shields or goggles in the daytime only; do not use them at night or in poor illumination. Do not use them if they impair your ability to discern color.

Other Riding Gear

Footwear

Always wear closed toe footwear. Sturdy over-the-ankle boots with non-slip soles offer more protection and allow you to plant your foot properly on footrest.

Avoid long shoelaces that can be tangled in the accelerator or brake pedals.

For winter riding conditions, rubber soled boots with either a nylon or leather uppers, with removable felt liners are best suited.

Avoid rubber boots. Rubber boots may get trapped behind or between pedals, impairing the proper operation of brake and accelerator pedals.

Gloves

Full-fingered gloves protect hands from the wind, sun, heat, cold and flying objects. Gloves that fit snugly will improve grip on the steering wheel and help reduce hand fatigue. Sturdy, reinforced motorcycle or ATV gloves help protect hands better in the event of an accident or a rollover. If gloves are too bulky, it may be difficult to operate the controls.

For winter riding conditions, hands should be protected by a pair of snowmobile gloves which have sufficient insulation and allow use of thumbs and fingers for operation of controls.

Jackets, Pants and Riding Suits

Wear a jacket or a long sleeved shirt and long pants, or a full riding suit. Quality ATV-type protective gear will provide comfort, and it can help you avoid being distracted by adverse environmental elements. In case of a crash, good quality protective gear made of sturdy material may prevent or reduce injury.

In cool-weather riding, protect yourself against hypothermia. Hypothermia, a condition of low body temperature, can cause loss of concentration, slowed reactions and loss of smooth, precise muscle movement. In cool conditions, proper protective gear like a windproof jacket and insulated layers of clothing are essential. Even while riding at moderate temperatures, you can feel very cold due to the wind.

Protective gear that is appropriate for cold-weather riding may be too hot when stopped. Dress in layers so that clothing can be removed as desired. Topping the protective gear with a windproof outer layer can prevent cold air from reaching the skin.

Rain Gear

If you must ride in wet weather, a rain suit or a waterproof riding suit is recommended. On long rides, it is a good idea to carry rain gear. A dry rider will be much more comfortable and alert.

Hearing Protection

Long-term exposure to wind and engine noise when riding can cause permanent hearing loss. Properly worn hearing protective devices such as earplugs can help prevent hearing loss. Check local laws before using any hearing protective devices.

AVOID ACCIDENTS

Avoid Rollovers and Tipovers

Side-by-side vehicles handle differently from other vehicles. Side-by-side vehicles are designed to handle off-road terrain (for example, their wheel base and track width, ground clearance, suspension, drivetrain, tires, etc.), and, as a result, can overturn in situations where vehicles designed for use primarily on paved or smooth terrain may not.

A rollover or other accident can occur quickly during abrupt maneuvers such as sharp turns or hard acceleration or deceleration when turning, or when driving on hills or over obstacles. Abrupt maneuvers or aggressive driving can cause rollovers or loss of control even in flat open areas. If the vehicle rolls over, any part of your body (such as arms, legs, or head) outside of the cockpit can be crushed and trapped by the cage or other parts of the vehicle. You can also be injured by impact with the ground, cockpit or other objects.

To reduce the risk of rollovers:

- Use care when turning.
 - Do not turn the steering wheel too far or too fast for your speed and environment. Adjust steering inputs according to your speed and environment.
 - Slow down before entering a turn. Avoid hard braking during a turn.
 - Avoid sudden or hard acceleration when turning, even from a stop or low speed.
- Never attempt donuts, skids, slides, fishtails, jumps, or other stunts. If vehicle starts to skid or slide, steer in the direction of the skid or slide. Never slam the brakes and lock the wheels.
- Avoid paved surfaces. This vehicle is not designed to operate on paved surfaces and is more likely to roll over. If you must drive on pavement, turn gradually, go slowly, and avoid abrupt acceleration and braking.

This vehicle can roll over sideways or tip over forward or backwards on slopes or uneven terrain.

- Avoid side hilling (driving along the slope rather than up or down a hill). When possible, drive straight up and down inclines rather than across them. If you must side hill, use extreme caution and avoid slippery surfaces, objects, or depressions. If you feel the vehicle start to rollover or slide sideways, steer downhill if possible.
- Avoid steep hills and follow procedures in this guide for climbing and descending hills.
- Sudden changes in terrain such as holes, depressions, banks, softer or harder ground or other irregularities may cause the vehicle to tip or become unstable. Observe the terrain ahead and slow down in areas of uneven terrain.

This vehicle will handle differently when carrying or pulling a load.

- Reduce speed and follow instructions in this manual for carrying cargo or pulling a trailer.
- Avoid hills and rough terrain.
- Allow more distance to stop.

Be Prepared in Case of Rollover

- Fasten side nets and fasten seat belt to help you avoid sticking out arms or legs.

- Close both doors and fasten seat belt to help you avoid sticking out arms or legs.
- Never grab the cage while riding. Hands can be crushed between the cage and the ground in a rollover. Keep hands on the steering wheel or handholds.
- Never try to stop a rollover using your arms or legs. If you think that the vehicle may tip or roll, the driver should keep both hands on the steering wheel and the left foot firmly planted on the footrest. The passenger should keep both hands on the handholds and both feet firmly planted on the floor.

Avoid Collisions

This vehicle can reach high speeds. At higher speeds, there is an increased risk of losing control, particularly in challenging off-road conditions, and the risk of injury in a collision is greater. Never operate at excessive speeds. Always go at a speed that is proper for the terrain, visibility, and operating conditions, and your experience. Consider reserving use of the performance key for situations in which full speed and acceleration capability are appropriate.

Driving on public street, road or highway, even dirt or gravel ones poses risks such as collisions and may be illegal in your jurisdiction. Only proceed with caution on roads and road segments where the usage of your vehicle is permitted. This vehicle is not designed for operation on roads. For example, it does not meet motor vehicle safety standards that apply to automobiles. In many jurisdictions it is not legal to operate this vehicle on public roads.

This vehicle does not have the same kind of protection for collisions as a car; for example, there are no air bags, the cockpit is not fully enclosed, and it is not designed for collisions with other vehicles. Therefore, it is particularly important to fasten seat belts and close doors and wear an approved helmet.

RIDING YOUR VEHICLE

Practice Exercises

Before you go out for a ride, it is very important to familiarize yourself with the handling of your vehicle by practicing in a controlled environment. If possible, it is also a very good idea to take a more formal training course to sharpen your skills and increase your knowledge of the vehicle.

Find a suitable area to practice and perform the following exercises. It should be at least 45 x 45 m (150 x 150 ft) free of obstacles like trees and rocks. Once you've selected a suitable permitted location, proceed with the following exercises.

Turning Exercises

Turning is one of the most frequent causes of accidents. It is easier for the vehicle to lose traction or rollover if you turn too sharply, or go too fast. Slow down when you approach a turn.

- First learn how to perform slight right turns at very low speeds. Release the throttle before turning and slowly reapply the throttle when turning.
- Repeat turning exercise but this time maintain the throttle at the level while turning.
- Finally, repeat turning exercise while accelerating slowly.
- Practice exercises turning on the other side.

Note how your vehicle reacts in these different exercises. We recommend releasing the throttle before entering a turn to help initiate directional change. You will feel the lateral force increasing with the speed and with your steering input. The lateral force should be maintained as low as possible to make sure it does not cause the vehicle to roll over.

U Turn Exercises

Practice doing U turns.

- Accelerate slowly and while remaining at low speed, then gradually turn the steering wheel to the right until you have completed the U turn.
- Repeat U turn exercise with different steering inputs and always at a very low speed.
- Repeat U turn exercise on the other side.

As mentioned before in this guide, do not ride on paved surfaces as the vehicle behavior will not be the same, increasing the risk of rollover.

Braking Exercises

Practice braking to get familiar with the brake response.

- Do it at low speed first, then increase the speed.
- Practice braking in straight line at different speeds and different braking force.
- Practice emergency braking; optimal braking is obtained in straight line, with high force applied, without locking the wheels.

Remember, braking distance depends on vehicle speed, load and the type of surface. Also, the tires and brakes conditions play a major role.

Reverse Exercises

The next step involves using the reverse.

- Install 1 cone marker on both sides of the vehicle beside each rear wheel. Move the vehicle forward until you can see the cone markers, then stop the vehicle. Acknowledge the distance required to see obstacles behind you.
- Learn how the vehicle handles itself in reverse and reacts with steering inputs.
- Always perform this reverse exercise at slow speeds.
- Become familiar with the usage of the override function. Do not steer while using the override as it increases the risks of rollover.

Emergency Engine Stopping Exercise

Learn how to stop your engine quickly in an emergency situation.

- While running at low speed, simply remove the RF D.E.S.S. key from the D.E. S.S. post.

This is to familiarize you with the vehicle's reaction when the engine is turned off while driving and to develop this reflex.

Off-Road Operation

The very nature of off-road operation is dangerous. Any terrain, which has not been specially prepared to carry vehicles, presents an inherent danger where terrain substance, shape and steepness are unpredictable. The terrain itself presents a continual element of danger, which must be knowingly accepted by anyone venturing over it.

An operator who takes a vehicle off-road should always exercise the utmost care in selecting the safest path and keeping close watch on the terrain ahead of him. The vehicle should never be operated by anyone who is not completely familiar with the driving instructions applicable to the vehicle, nor should it be operated on steep or treacherous terrain.

General Riding Techniques

General Driving Tips

Care, caution, experience and driving skill are the best precautions against the hazards of vehicle operation.

Whenever there is the slightest doubt that the vehicle can safely negotiate an obstacle or a particular piece of terrain, always choose an alternate route.

In off-road operation, power and traction, not speed, are important. Never drive faster than visibility and your own ability to select a safe route permit. Always go slowly and be extra careful when operating on unfamiliar terrain. Always be alert to changing terrain conditions when operating this vehicle. Be especially cautious on excessively rough, slippery, icy or loose terrain.

Constantly watch the terrain ahead for sudden changes in slopes or obstacles, such as rocks or stumps, that may cause loss of stability, resulting in tip over or rollover.

Never operate the vehicle if the controls do not function normally. See an authorized Can-Am Off-road dealer.

To maintain proper control it is strongly advised that you keep your hands on the steering wheel and within easy reach of all controls. The same holds true for your feet. To minimize the possibility of any leg or foot injury, keep your left foot on the footrest and right foot on the floor at all times. Staying completely within the cockpit will also help keep you from striking objects outside the vehicle.

Watch for and avoid branches and other objects that could enter the passenger compartment and strike you or your passengers.

Operating in Reverse

When operating in reverse, check that the path behind the vehicle is free of people or obstacles. Pay attention to blind spots. When it is safe to proceed in reverse, go slowly and avoid sharp turns.

⚠ WARNING

Steering inputs in reverse operation increase the risk of rollover.

NOTE:

In reverse operation, the engine RPM is limited thus limiting the vehicle reverse speed.

⚠ WARNING

When driving downhill in reverse, gravity can increase the vehicle speed above safe reverse speed.

Crossing Roads

If you have to cross a road, ensure to have complete visibility on both sides for incoming traffic and decide on exit point on other side of road. Drive in a straight line toward that point. Do not make sharp direction changes or abrupt accelerations as it may result in a rollover situation. Do not travel on sidewalks or bicycle trails as they are designated specifically for those uses.

Riding on Paved Surfaces

Avoid paved surfaces. This vehicle is not designed to operate on paved surfaces and is more likely to roll over. If you must drive on pavement, turn gradually, go slowly, and avoid abrupt acceleration and braking.

Shallow Water Crossing

Water can be a unique hazard. If it is too deep the vehicle may “float” and topple. Check the water depth and current before you attempt to cross any water. Water depth should not exceed the center of the wheel for vehicle to safely cross the obstacle. Beware of slippery surfaces such as rocks, grass, logs, etc., both in the water and on its banks. A loss of traction may occur. Do not attempt to enter the water at high speed.

Water will affect the braking ability of your vehicle. Make sure you dry the brakes by applying them several times after the vehicle leaves the water.

Mud or marsh lands may be encountered near water. Be prepared for sudden "holes" or changes in depth. Similarly so, be watchful of hazards such as rocks, logs, etc., partially covered by vegetation.

Riding on Snow or Ice

When performing pre-ride inspection, pay special attention to locations on the vehicle where snow and/or ice accumulations may obstruct visibility of the tail lamp, clog ventilation openings, block the radiator, fan, engine air intake and CVT air intake, and interfere with the movement of controls. Before starting with your vehicle, check the steering, accelerator and brake pedals for interference free operation.

Whenever this vehicle is ridden on a snow covered drive path, the tire grip is generally reduced causing the vehicle to react differently to control inputs from the operator. On low grip surfaces, the steering responses are not as crisp and precise, stopping distances are lengthened and acceleration is also affected. Slow down and do not "gun" the accelerator. This will only result in spinning of the tires and possibly in an over steering slide of the vehicle. Avoid hard braking. This will possibly result in a straight line slide of the vehicle. Again, the best advice is to safely reduce speed in anticipation of a maneuver to give yourself time and distance in order to keep control of the vehicle.

As you drive your vehicle over a loose snow covered surface, snow dust will be picked up in the wake turbulence of the moving vehicle and transported to contact and accumulate or melt on some exposed components including rotating parts like brake discs. Water, snow or ice may affect the response time of the brake system of your vehicle. Even when not required to reduce vehicle speed apply brakes frequently to prevent ice or snow accumulation and to dry brake pads and discs. While doing so in low risk driving situations you will test for grip level and keep yourself alerted to how the vehicle reacts to your control inputs. Always keep brake and accelerator pedals and floor boards free of snow and ice. Frequently wipe snow off seat, steering wheel, headlights and tail lamps.

The depth of the snow cover may hide rocks, tree stumps or other objects and if it is wet may totally impede the drivability as the vehicle becomes bogged down or completely loses traction in slushy snow. Look far ahead and always be watchful of any visible clues that might indicate the presence of such obstacles. In doubt steer clear. Avoid driving on any frozen waterways before checking that the ice will safely support the vehicle, its riders and its load of cargo.

At the end of each ride it is a good practice to clean the vehicle and all moving components (brakes, steering components, drivelines, controls, radiator fan etc.) from any snow or ice accumulations. Wet snow will turn to ice during the shut down period and become more difficult to remove at the next pre-ride inspection.

Riding on Sand

Sand and riding on sand dunes is another unique experience but there are some basic precautions that should be observed. Wet, deep or fine sand may create a loss of traction and cause the vehicle to slide, drop off or become "bogged" down. If this occurs look for a firmer base. Again, the best advice is to slow down and be watchful of the conditions.

When riding in sand dunes it is advisable to equip the vehicle with an antenna type safety flag. This will help make your location more visible to others over the next sand dune. Proceed carefully should you see another safety flag ahead.

Riding on Gravel, Loose Stones or Other Slippery Surfaces

Riding on loose stones or gravel is very similar to riding on ice. They will affect the steering of vehicle, possibly causing it to slide and tip over especially at high speeds. In addition, braking distance may be affected. Remember that “gunning” the throttle or sliding may cause loose stones to be ejected rearwards into the path of another rider’s way. Never do it deliberately.

If you do get into a slide or skid, it may help to turn the steering wheel into the direction of the skid until you regain control. Never jam the brakes and lock the wheels.

Crossing Obstacles

Use the low range (L) for crossing obstacles.

Obstacles on the “trail” should be traversed with caution. This includes rocks, fallen trees, and depressions. You should avoid them whenever possible. Remember that some obstacles are too large or dangerous to cross and should be avoided. As a guideline, never attempt to cross an obstacle higher than the ground clearance of the vehicle. Small rocks or small fallen trees may be safely crossed - approach obstacle at low speed and as much as possible at a right angle. Adjust speed without losing momentum and do not accelerate abruptly. Passenger must grasp both handholds firmly and brace feet on the floor. Hold steering firmly without closing your fists around it and proceed. Be aware that the obstacle may be slippery or may move while crossing.

Hill Driving Conditions

When driving on hills or slopes, two things are highly important: be prepared for slippery surfaces or terrain variations and obstacles and brace yourself properly inside vehicle. If you climb or descend a hill that is too slippery or has too loose a surface, you can lose control. If you go over the top of a hill at high speed, you may not have time to prepare for the terrain on the other side. Avoid parking on a slope. Always put the shift lever in PARK when stopped or parked, especially on an incline, to avoid rolling. If you must park on a steep incline, block the wheels using rocks or bricks.

Uphill Driving

Use the low range (L) for uphill driving.

Due to its configuration, this vehicle has very good traction even while climbing, so much so that tip over is possible before traction is lost. For example, it is common to encounter terrain situations where the top of the hill has eroded to a point that the hill peak rises very sharply. This vehicle is not designed to negotiate such a condition. Take an alternate route.

It is also wise to know the terrain condition on the other side of the hill or bank. All too often there exists a sharp drop-off that is impossible to negotiate or descend.

If you feel that the slope is getting too steep to climb, apply brakes to immobilize vehicle. Put shift lever in reverse (R), and back down the hill, barely releasing brakes to remain at low speed. Do not attempt to turn around. Never coast down hill while vehicle is in neutral. Do not perform hard braking as it increases the risk of tipover.

Downhill Driving

This vehicle can climb steeper slopes than it can descend safely. Therefore, it is essential to assure that a safe route exists to descend a slope before you climb it.

Decelerating while negotiating a slippery downhill slope could “toboggan” the vehicle, causing it to slide. Maintain steady speed and/or accelerate slightly to regain control. Never slam brakes and lock the wheels.

Side Hilling

Whenever possible, side hilling (driving across a slope rather than up or down it) should be avoided. If necessary, do so with extreme caution. Side hilling on steep inclines could result in rollover. In addition, slippery or unfirm surfaces could result in uncontrollable side sliding. Avoid all objects or depressions that will intensify the raising of one side of the vehicle higher than the other, thus causing rollover. If you feel the vehicle start to rollover or slide sideways, steer downhill if possible.

WARNING

Be careful when loading and transporting liquid reservoirs. They can affect vehicle stability when side hilling by pulling downhill and increasing the risk of a rollover.

Drop-Offs

This vehicle is not designed to negotiate drop-offs. It will “bottom-out” and usually stop if either the front or rear wheels are driven over a drop-off. If the drop is sharp or deep, the vehicle will nose dive and tip over.

Avoid negotiating drop-offs. Reverse and select an alternate route.

Recreational, Group and Distance Riding

Respect the rights and limitations of others. Stay away from areas designated for other types of off road use. This includes snowmobile trails, equestrian trails, cross country ski trails, mountain bike trails, etc. Never assume there are no other users on the trail. Always stay to the right of the trail and do not zig zag to one side of the trail then the other. Be prepared to stop or pull off to the side if another trail user appears in front of you.

Join a local side-by-side vehicle club. It will provide you with a map and advice or inform you where you can ride. If a club does not exist in your area, help to start one. Group riding and club activities provide a pleasurable, social experience. Never use with drugs or alcohol, or tired or ill.

Always keep a safe distance from other riders. Your judgment of speed, terrain conditions, weather, mechanical condition of your vehicle and the “trust in judgment” you have in others around you will help you make a better choice of

appropriate safe distance. This vehicle, like any other motorized vehicle, cannot stop “on a dime”.

Before you ride, tell someone where you are planning to travel and your expected time of return.

Depending on the length of your ride, carry additional tools or emergency equipment. Find out where you can get additional gasoline. Be prepared for the possible conditions you may encounter. An emergency first aid kit should always be a consideration.

Environment

One of the benefits of this vehicle is that it can take you off the beaten path away from most communities. However, you should always respect nature and the rights of others to enjoy it. Do not ride in environmentally sensitive areas. Do not drive over forest crops or shrubs, nor cut down trees or take down fencing, nor spin your wheels and destroy the terrain. “Tread Lightly”.

This vehicle can cause OHV wildfires if debris builds up near the exhaust or other engine hot spots and ignites then falls off into dry grass. Avoid riding in wet areas, through muskeg or tall grass, where debris can build up. Should you ride in those areas, inspect and remove all debris from your engine and hot spots. Refer to *Vehicle Care* for details.

Chasing wildlife is in many areas illegal. Wildlife can die of exhaustion after being chased by a motorized vehicle. If you encounter animals on the trail, stop and observe quietly and with caution. It will be one of the better memories of your life.

Observe the rule “what you take in, carry out”. Do not litter. Do not start campfires unless you have permission to do so, and then only away from dry areas. The hazards you may create on the trail may cause injury to others or yourself, even at a later date.

Respect farm lands. Always obtain the permission of the landowner before riding on private land. Respect crops, farm animals and property lines.

Finally, do not pollute streams, lakes or rivers and do not modify the engine or exhaust system, or remove any of its components as it will alter the vehicle emissions.

MOVING LOADS AND DOING WORK

Working with Your Vehicle

Your vehicle can help you perform a number of different LIGHT tasks ranging from snow removal to carrying cargo. A variety of accessories are available from your authorized Can-Am dealer. To prevent possible injury, follow the instructions and warnings that accompany the accessory. Always respect the load limits of the vehicle. Overloading the vehicle can overstress the components and cause failure. Avoid overexerting yourself if you lift or pull heavy loads or manually push the vehicle.

Always be aware that the cargo may slide or fall off and cause an accident.

Carrying Loads

Any load carried on the vehicle will affect the handling, stability and braking distance of the vehicle. Do not exceed the load limits of the vehicle, including the weight of operator, passenger, cargo, accessories and trailer tongue weight. Always be aware that the cargo may slide or fall off and cause an accident.

Load Limit of the Vehicle	
399 kg (880 lb)	Includes occupants, cargo, added accessories, and tongue weight (if applicable)

The following is an example of suitable total vehicle load distribution:

Example of Suitable Vehicle Total Loads (Low Range)				
OPERATOR AND PASSENGER	CARGO LOAD	ACCESSORIES	TONGUE WEIGHT	TOTAL VEHICLE LOAD
331 kg (730 lb)	18 kg (40 lb)	0 kg (0 lb)	50 kg (110 lb)	399 kg (880 lb)

NOTE:

When the gearbox is in the high range, the combined weight on cargo rack and tongue weight must not exceed the cargo rack capacity, refer to *Technical Specifications*.

To reduce the risk to lose control or the load carried, follow these recommendations.

Vehicle Settings When Carrying Load

When the total load exceeds 195 kg (430 lb), including weight of operator, passenger, cargo, accessories and, if applicable, trailer tongue weight, inflate the tires to maximum pressure. Refer to *Technical Specifications*

When carrying a passenger or heavy loads readjust suspension accordingly.

When carrying heavy loads on the cargo rack or pulling a loaded trailer operate with the shift lever in L (low range).

Loading the Cargo Rack

NOTICE

Do not exceed the maximum cargo rack capacity.

For cargo rack capacity, refer to *Technical Specifications*.

Load cargo as low as possible – a higher load can raise the vehicle's center of gravity, which can reduce stability. Position cargo on the rack as evenly distributed as possible.

Secure the load on the cargo rack. Do not secure cargo to the cage or other part of the vehicle. If it is not properly secured, a load may slide or fall off, possibly striking occupants or bystanders; or it may shift during riding, affecting the handling of the vehicle.

Objects that are high may affect visibility for the driver and may act as projectiles in case of an accident. Loads that protrude sideways can get snagged or caught in bush, branches or other obstacles. Avoid covering and obstructing the brake lights with the cargo. Ensure no cargo protrudes outside the cargo rack and that cargo will not interfere with your visibility or control of the vehicle.

Do not overload cargo rack.

⚠ WARNING

Never carry gasoline container(s) or any dangerous liquids on the cargo rack.

⚠ WARNING

Never overload, tow or carry cargo improperly. Safely reduce speed according to terrain conditions when carrying cargo or pulling a trailer, and avoid hills and rough terrain. Allow greater distance for braking. Always secure cargo as low as possible to reduce the effect of a higher center of gravity. Failure to follow the recommendations here could cause changes in vehicle handling which could lead to an accident.

Hauling a Load

NOTICE

A BRP approved rear hitch must be properly installed on the vehicle for hauling trailers.

Never pull a load by attaching it to the cage or any other accessories; this can cause the vehicle to tip over. Use only the trailer hitch (if installed) or winch (if installed) to pull a load.

In an emergency situation, use the recovery hook to recover a stuck vehicle.

When pulling loads with a chain or cable, ensure that there is no slack before starting and maintain tension while pulling.

When pulling loads with a chain or cable, be sure to brake progressively. The inertia of the load could lead to an impact.

When hauling a load, respect the maximum hauling capacity. See *Pulling a Trailer* below.

⚠ WARNING

A slack in the chain or cable can cause it to break and snap back.

When pulling another vehicle, be sure that someone is controlling the pulled vehicle. They must brake and steer to prevent the vehicle from going out of control.

Before pulling loads with a winch, refer to the winch manufacturer's instructions.

Reduce your speed when hauling a load and turn gradually. Avoid hills and rough terrain. Never attempt steep hills. Allow more distance for braking, especially on inclined surfaces and when a passenger is on board. Be careful not to skid or slide.

Pulling a Trailer

NOTICE

A BRP approved rear hitch must be properly installed on the vehicle for hauling trailers.

Riding this vehicle with a trailer substantially increases the risk of toppling, especially on inclined slopes. If a trailer is used behind the vehicle make sure that its hitch is compatible with the one on the vehicle. Make sure the trailer is horizontal with the vehicle. (In some instances a special extension may have to be installed on the vehicle hitch). Use security chains or cables to secure the trailer with the vehicle.

Reduce your speed when pulling a trailer and turn gradually. Avoid hills and rough terrain. Never attempt steep hills. Allow more distance for braking, especially on inclined surfaces and when a passenger is on board. Be careful not to skid or slide.

Improperly loading a trailer may cause loss of control.

Always make sure load is evenly distributed and safely secured on the trailer; an evenly balanced trailer is easier to control.

Always put the shift lever to L (low range) for hauling a trailer – in addition to providing more torque, operating in low range helps account for the increased load on the rear tires.

When stopped or parked, block the vehicle and trailer wheels from possible movement.

Use caution when disconnecting a loaded trailer; it or its load may topple on you or others.

When hauling a trailer, respect the maximum tongue weight and towing capacity indicated on the label affixed to the hitch.

Make sure there is at least some weight on the tongue.

IMPORTANT ON-PRODUCT LABELS (CANADA/ UNITED STATES)

Hang Tag

Canada/United States

This vehicle comes with a hang tag and labels containing important safety information.

Any person who rides this vehicle should read and understand this information before riding.

WARNING

**THIS VEHICLE IS INTENDED FOR RECREATIONAL USE AND SECONDARY GENERAL UTILITY APPLICATIONS
NO OPERATOR UNDER AGE 16**

TRAINING COURSES TO TEACH ROV DRIVING ARE AVAILABLE. FOR INFORMATION CONTACT

YOUR DEALER.

**Read the Operator's Guide and Safety Labels and Watch the Safety Video.
Follow All Instructions and Warnings.**

CHECK WITH YOUR DEALER TO FIND OUT ABOUT STATE OR LOCAL LAWS REGARDING ROV OPERATION.

Improper Use of Off-Highway Vehicles Can Cause Severe Injury or Death

Be Prepared

- Fasten seat belts and make sure nets or doors are securely latched in place.
- Wear an approved helmet and protective gear.
- Each rider must be able to sit with back against seat, foot flat on the floor or on footrest, and hands on steering wheel or handholds. Stay completely inside the vehicle.



Drive Responsibly

Avoid loss of control and rollovers:

- Avoid abrupt maneuvers, sideways sliding, skidding or fishtailing, and never do donuts.
- Avoid hard acceleration when turning, even from a stop.
- Slow down before entering a turn.
- Plan for hills, rough terrain, ruts, and other changes in traction and terrain. Avoid paved surfaces.
- Avoid side hilling (riding across slopes).

Rollovers have caused severe injuries and death, even on flat, open areas.

Be Sure Riders Pay Attention and Plan Ahead

If you think or feel the vehicle may tip or roll, reduce your risk of injury:

- Keep a firm grip on the steering wheel or handholds and brace yourself.
- Do not put any part of your body outside of the vehicle for any reason.



Require Proper Use of Your Vehicle

Do your part to prevent injuries:

- Do not allow careless or reckless driving.
- Make sure operators are 16 or older with a valid driver's license.
- Do not let people drive or ride after using alcohol or drugs.
- Do not allow operation on public roads (unless designated for off-highway vehicle access) – collisions with cars and trucks can occur.
- Do not exceed seating capacity: see information on back side of this card



THIS HANG TAG CAN'T BE REMOVED BEFORE SALE.

Tilt Table Test Result

BOMBARDIER RECREATIONAL PRODUCTS INC.
VEHICLE MODEL
TILT TABLE RESULT

Measurement of lateral stability, in degrees, of a sample, standard condition vehicle (with an operator and a passenger load - 430 pounds) as measured by the manufacturer in accordance with the tilt table lateral stability test in the ANSI/ROHVA standard for Recreational Off-Highway Vehicles. Vehicle modification, accessories, and loading can affect lateral stability.

Training courses to teach ROV driving are available. For information contact your dealer and/or rohva.org.

Check with your dealer to find out about state or local laws regarding ROV operation.

THIS HANG TAG IS NOT TO BE REMOVED BEFORE SALE.

VEHICLE MODEL NAME:

ENGINE DESCRIPTION:

EPA CERTIFIED

NET NORMALIZED EMISSION RATE:

ON A TO 10 SCALE, 0 BEING THE CLEANEST.

BOMBARDIER RECREATIONAL PRODUCTS INC
NO TO BE REMOVED PRIOR SALE



Vehicle seating capacity:

Occupants

⚠ WARNING. Operating, servicing and maintaining an off-road vehicle can expose you to chemicals including engine exhaust, carbon monoxide, phthalates, and lead, which are known to the State of California to cause cancer and birth defects or other reproductive harm.

To minimize exposure, avoid breathing exhaust, do not idle the engine except as necessary, service your vehicle in a well-ventilated area and wear gloves or wash your hands frequently when servicing your vehicle.

For more information go to www.P65Warnings.ca.gov/products/passenger-vehicle



704906872

⚠ WARNING

GET FAMILIAR WITH THIS OFF-HIGHWAY VEHICLE (OHV); IT MAY EXCEED THE PERFORMANCE OF OTHER OHV YOU MAY HAVE RIDDEN.

THIS IS A HIGH PERFORMANCE OHV. INEXPERIENCED RIDERS MAY OVERLOOK RISKS AND BE SURPRISED BY THE SPECIFIC BEHAVIOR OF THIS OHV IN ANY TERRAIN CONDITION.



704906872

THIS HANGTAG IS NOT TO BE REMOVED BEFORE SALE.

Safety Labels

Read and understand all the safety labels on your vehicle.

These labels are affixed to the vehicle for the safety of the operator, passenger or bystanders.

The following labels are on your vehicle, and they should be considered permanent parts of the vehicle. If missing or damaged, they can be replaced free of charge. See an authorized Can-Am dealer.

NOTE:

In the event of any discrepancy between this guide and the vehicle, the safety labels on the vehicle have precedence over the labels in this guide.

General Safety Label

Improper Use of Off-Highway Vehicles Can Cause Severe Injury or Death

Be Sure Riders Pay Attention and Plan Ahead

If you think or feel the vehicle may tip or roll, reduce your risk of injury:

- Keep a firm grip on the steering wheel or handholds and brace yourself.
- Do not put any part of your body outside of the vehicle for any reason.

Be Prepared

- Fasten seat belts and close doors.
- Wear an approved helmet and protective gear.
- Each rider must be able to sit with back against seat, foot flat on the floor or on footrest, and hands on steering wheel or handholds. Stay completely inside the vehicle.

WARNING

Drive Responsibly
Avoid loss of control and rollovers:

- Avoid abrupt maneuvers, sideways sliding, skidding or fishtailing, and never do donuts.
- Slow down before entering a turn, even from a stop.
- Avoid hard acceleration when turning, and other changes in traction and terrain.
- Avoid paved surfaces.
- Avoid side hilling (riding across slopes).

Rollovers have caused severe injuries and death, even on flat, open areas.



Patent : www.brp.com/en/about-brp/patents.html



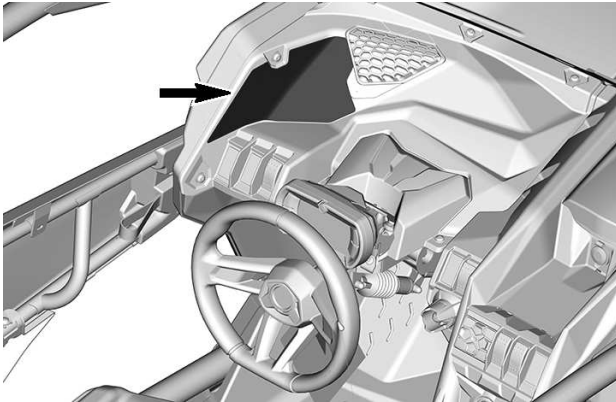

Operator Safety Label

⚠ WARNING

Improper Use of Off-Highway Vehicles Can Cause Severe Injury or Death

DRIVER UNDER 16

Be prepared in case of rollover





NEVER • Hold the cage while riding.
• Try to stop a rollover using your arm or leg.

ALWAYS • Fasten seat belts and close doors.

Require Proper Use of Your Vehicle
Do your part to prevent injuries:

- Do not allow careless or reckless driving.
- Make sure operators are 16 or older with a valid driver's license.
- Do not allow operation on public roads (unless designated for off-highway vehicle access) collisions with cars and trucks can occur.
- Do not let people drive or ride after using alcohol or drugs.
- Do not exceed seating capacity: 4 occupants.

Read and understand all safety labels, locate and read operator's guide. Watch the safety video using the QR code link or visit Can-am web site before operation.



8154

4X

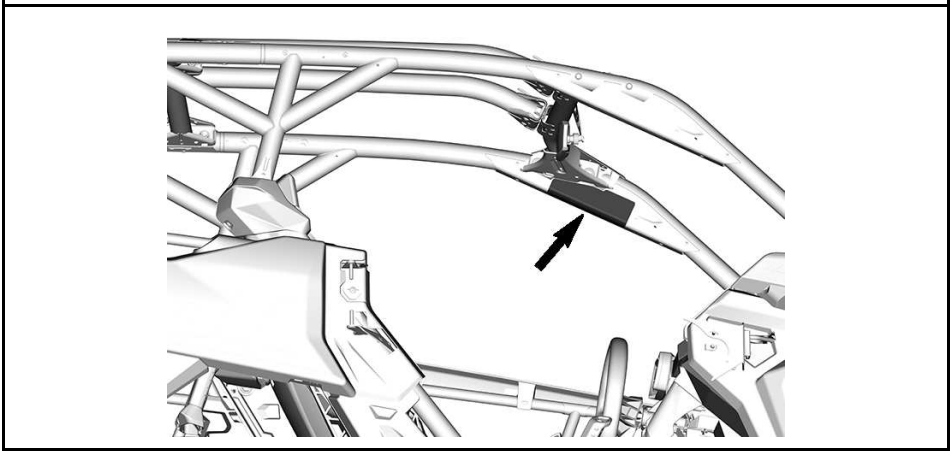

Passenger Safety Label

⚠ WARNING

PASSENGER
 Improper Use of Off-Highway Vehicles
 Can Cause Severe Injury or Death
 Be prepared in case of rollover

NEVER • Hold the cage while riding.
 • Try to stop a rollover
 using your arm or leg.

ALWAYS • Fasten seat belts
 and close doors.



Be Prepared

- Fasten seat belts and close doors.
- Wear an approved helmet and protective gear.
- Each rider must be able to sit with back against seat, foot flat on the floor or on footrest, and hands on handholds. Stay completely inside the vehicle.

Be sure riders pay attention and plan ahead
 If you think or feel the vehicle may tip or roll, reduce your risk of injury:

- Keep a firm grip on handholds and brace yourself.
- Do not put any part of your body outside of the vehicle for any reason.

Passenger qualifications and responsibilities

- Do not ride after using drugs or alcohol.
- Ask the operator to slow down or stop if you feel uncomfortable when riding

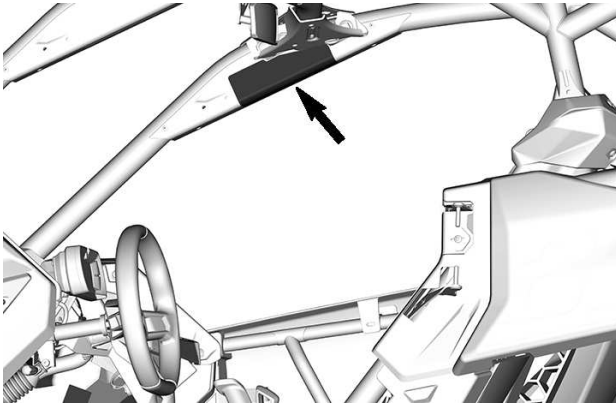

Central Rear Passengers Safety Label

⚠ WARNING

PASSENGER(S) Improper Use of this Vehicle Can Cause Severe Injury or Death.

Be prepared

- Fasten seat belt and make sure net and/or door is securely latched in place.
- Wear an approved helmet and protective gear.

You must be able to sit with back against seat, foot flat on the floor or on footrest, and hands on handholds. Stay completely inside the vehicle.

Be sure riders pay attention and plan ahead.

If you think or feel the vehicle may tip or roll, reduce your risk of injury:

- Keep a firm grip on handholds and brace yourself.
- Do not put any part of your body outside of the vehicle for any reason.

Passenger qualifications and responsibilities

- Do not ride after using drugs or alcohol.
- Ask the operator to slow down or stop if you feel uncomfortable when riding.

⚠ WARNING



Be prepared

- Fasten seat belt and make sure net and/or door is securely latched in place.
- Wear an approved helmet and protective gear.

You must be able to sit with back against seat, foot flat on the floor or on footrest, and hands on handholds. Stay completely inside the vehicle.

PASSENGER(S)

Improper Use of this Vehicle Can Cause Severe Injury or Death.

Be sure riders pay attention and plan ahead!

- If you think or feel the vehicle may tip or roll, reduce your risk of injury.
- Keep a firm grip on handholds and brace yourself.
- Do not put any part of your body outside of the vehicle for any reason.

Passenger qualifications and responsibilities

- Do not ride after using drugs or alcohol.
- Ask the operator to slow down or stop if you feel uncomfortable when riding.



704906655

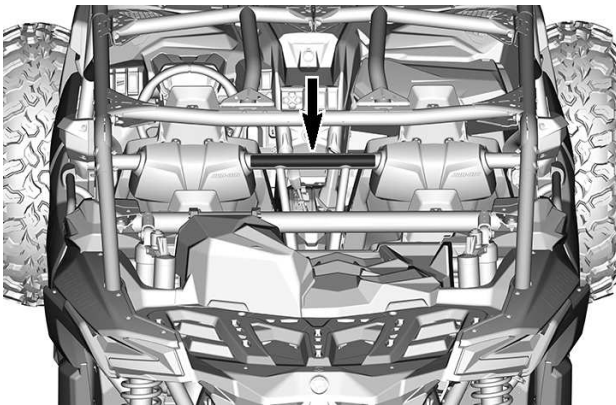

Tire Pressure Label

⚠ WARNING

Improper tire pressure or overloading can cause loss of control. **Loss of control can result in severe injury or death.**

- An under-inflated tire can come off the rim
- Use Max pressure if total load exceeds 195 kg (430 lb).

COLD TIRE PRESSURE	TIRE SIZE PACKAGE	30		32	
		DS / XDS / RS	XMR	XRS	XRC
Minimum	Front, kPa (psi)	124 (18)	152 (22)	124 (18)	179 (26)
	Rear, kPa (psi)	124 (18)	179 (26)	124 (18)	207 (30)
Maximum	Front, kPa (psi)	124 (18)	179 (26)	124 (18)	193 (28)
	Rear, kPa (psi)	124 (18)	234 (34)	124 (18)	276 (40)
MAX LOAD CAPACITY: kg (lb)		399 (880)			

4x

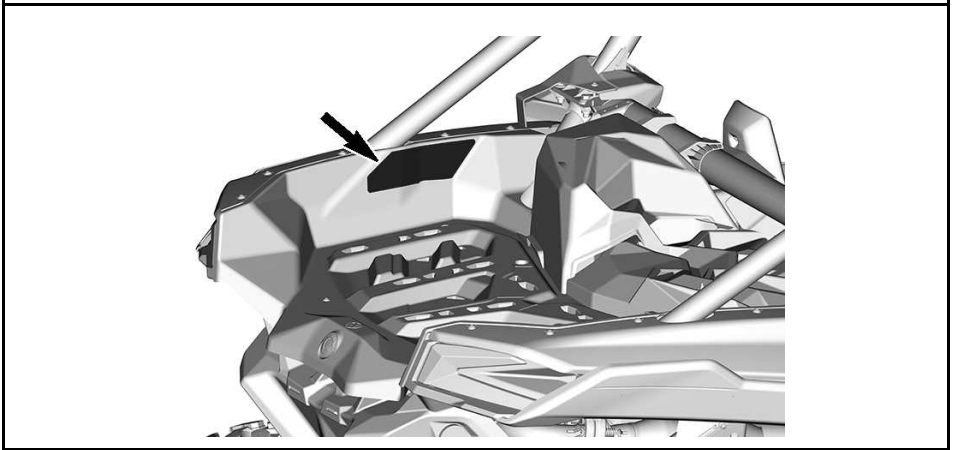

Off-Road Vehicle Label

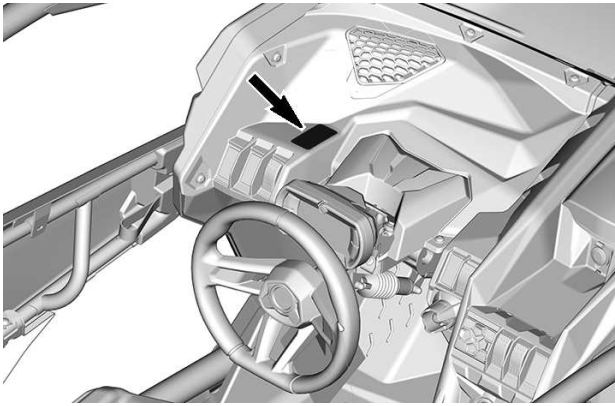

High Performance Vehicle Label

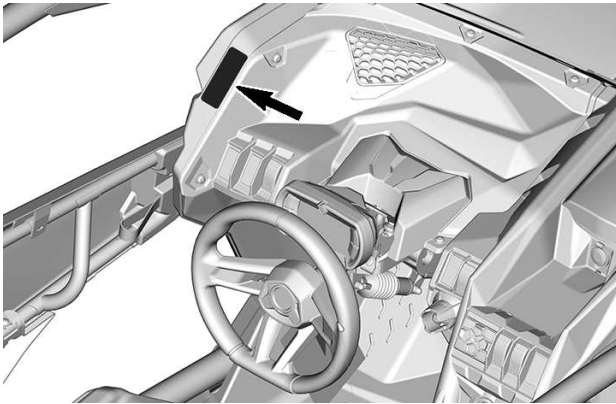
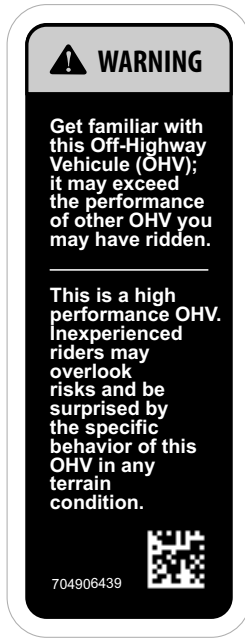

Vehicle Load Capacity Label

⚠ WARNING

Overloading can cause loss of control. Loss of control can result in severe injury or death.

NEVER exceed REAR LOAD CAPACITY, evenly distributed, includes trailer tongue weight if applicable.

NEVER exceed the VEHICLE LOAD CAPACITY, including weight of operator, passenger (s), accessories and trailer tongue weight.

NEVER carry passenger on this carrier.

ALWAYS secure the load.



83976

2 occupants	4 occupants
90 (200)	68 (150)

REAR LOAD CAPACITY: kg (lb)

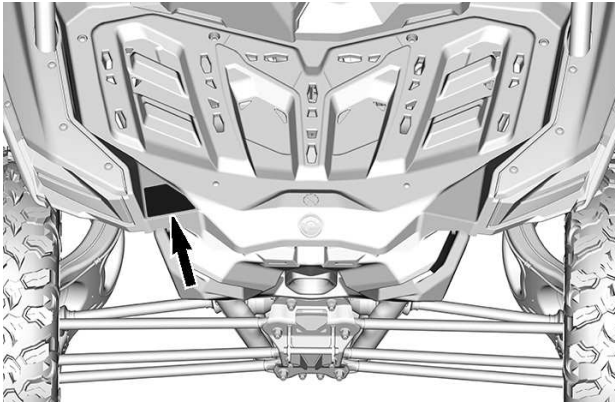

Cargo Warning Label

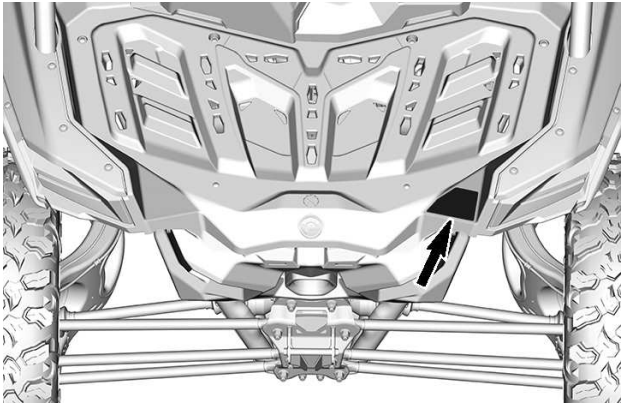
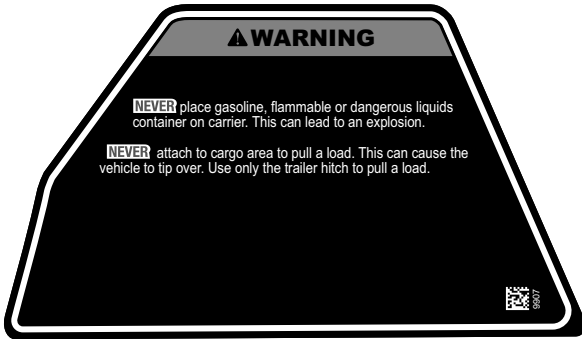

Rear LH Passenger Rollover Warning Label

⚠ WARNING



Be prepared in case of rollover
If the vehicle rolls over, any part of your body (such as arms, legs, or head) outside of the cockpit can be crushed by the cage or other parts of the vehicle. Fasten seat belt and make sure net and/or door is securely latched in place to help you avoid sticking out arms or legs.

NEVER hold the cage while riding.
NEVER try to stop a rollover using your arm or leg.



704906835

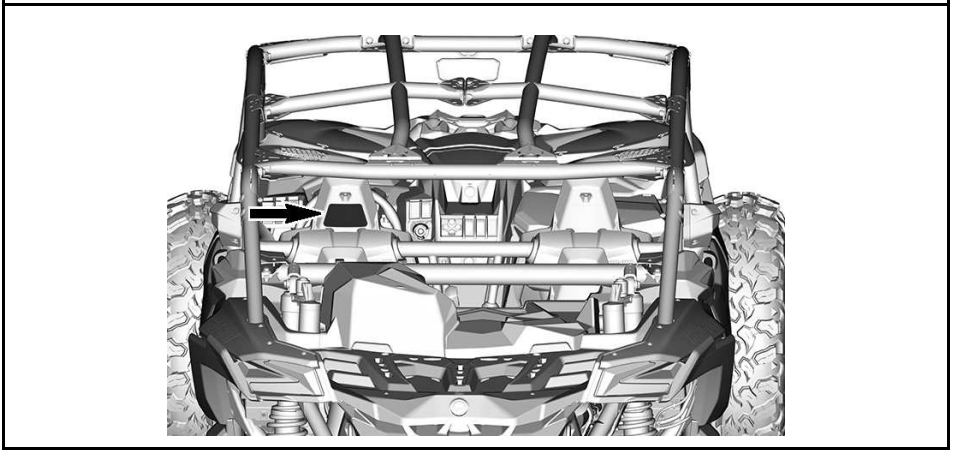

Rear RH Passenger Rollover Warning Label

⚠ WARNING



Be prepared in case of rollover
 If the vehicle rolls over, any part of your body (such as arms, legs, or head) outside of the cockpit can be crushed by the cage or other parts of the vehicle. Fasten seat belt and make sure net and/or door is securely latched in place to help you avoid sticking out arms or legs.

NEVER hold the cage while riding.
NEVER try to stop a rollover using your arm or leg.



704906835

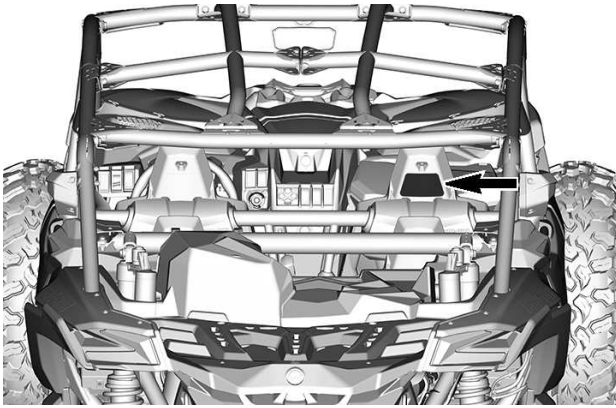

Door Warning Label

⚠ WARNING

Do NOT put your arm outside of the vehicle, there is a risk of SEVERE INJURY.

Front LH Side



Front RH Side



Rear LH Side



Rear RH Side

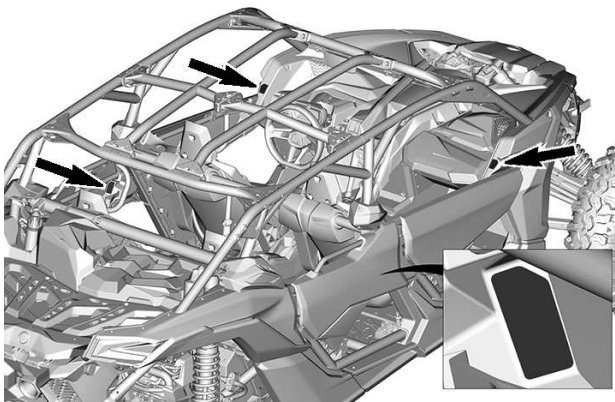

Cage Warning Label

⚠ WARNING

NEVER attach to the cage to pull a load.
This can cause the vehicle to tip over.



9550

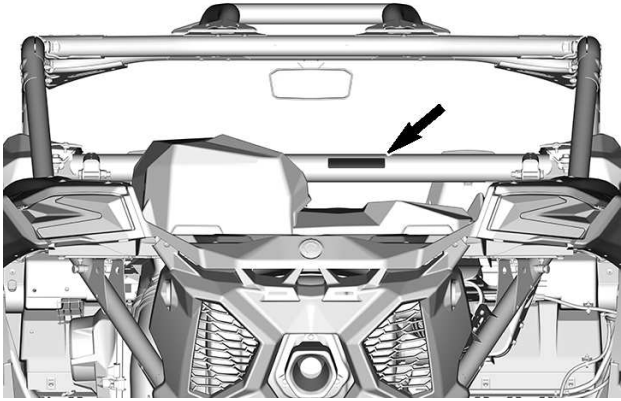

Shift Lever Warning Label

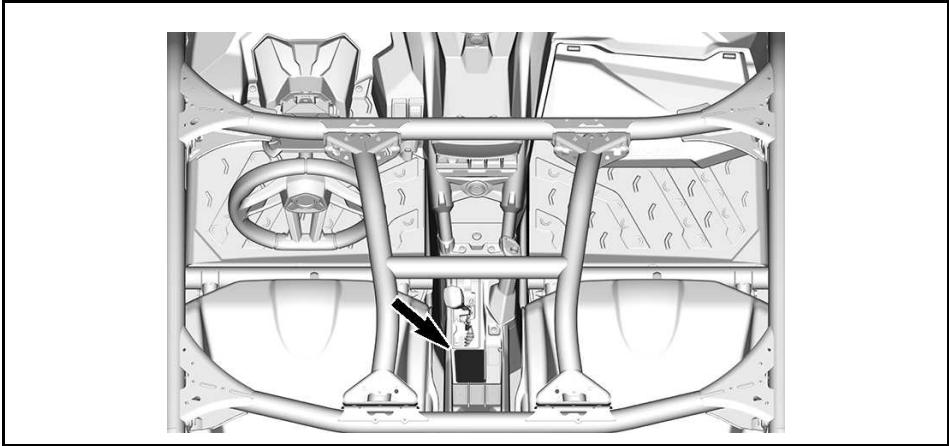
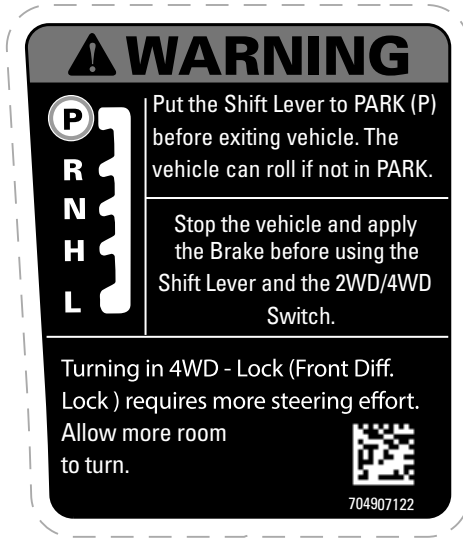

Recover Stuck Vehicle Only Label

NOTICE

**USE ONLY TO RECOVER
STUCK VEHICLE.
NEVER USE TO PULL A LOAD**



7410

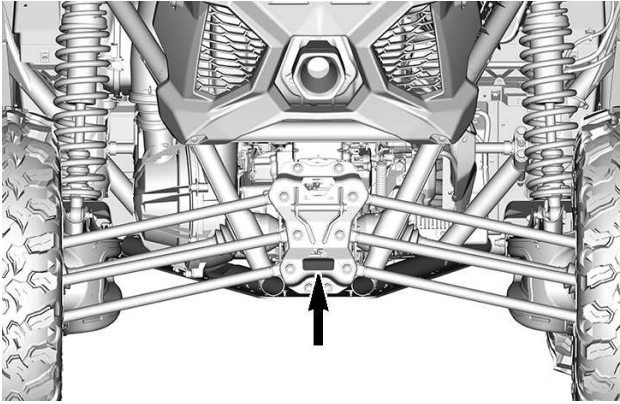

Never Attach Here to Pull a Load Label

NOTICE

NEVER attach here
to pull a load



7408

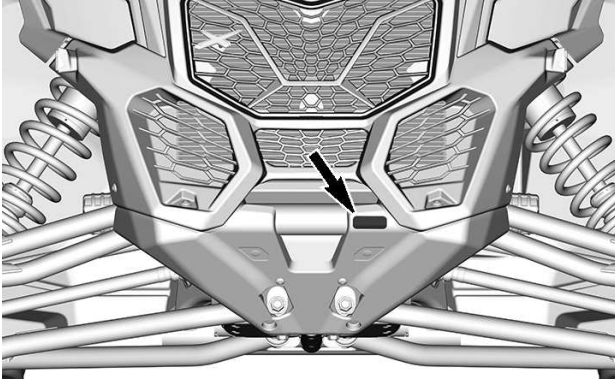

Winch Warnings - On Winch

⚠ WARNING

- Locate and read operator's guide. Improper use can result in SEVERE INJURY or DEATH. Follow all instructions and warnings.
- Always use the hand strap to manipulate the hook and rope.
- Never put your fingers into the hook.
- Avoid putting your hand between hook and hawse or roller fairlead. You can crush your fingers.
- Never use the winch to lift objects or people.

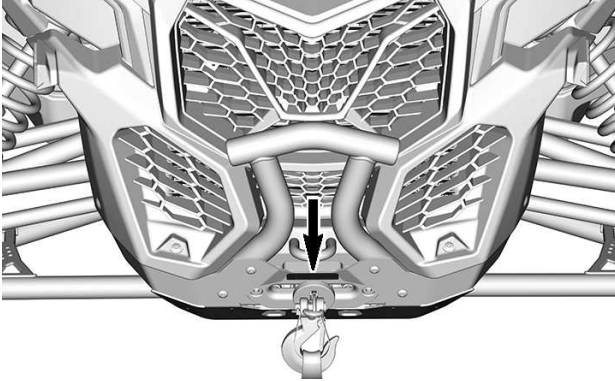
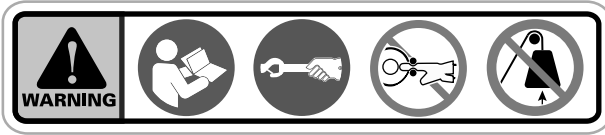

Compliance Labels

Emission Control Information (Typical)

CARB model	Other Model
<p>VEHICLE EMISSIONS CONTROL INFORMATION</p> <p>THIS VEHICLE IS CERTIFIED TO OPERATE ON UNLEADED GASOLINE AND CONFORMS TO U.S. EPA & CALIFORNIA EMISSIONS REGULATIONS FOR 2015 AND 2016 MODEL YEAR VEHICLES. LE VEHICULE EST CERTIFIÉ POUR FONCTIONNER À L'ÉNERGIE GAZOLINE ET EST CONFORME AUX NORMES DE L'EPA ET CALIFORNIA POUR LES ANNÉES 2015 ET 2016.</p> <p>Engine Family / Famille de moteur</p> <p>Transmission Family / Famille de transmission</p> <p>Certification standards (EPA) / Normes de certification (EPA)</p> <p>Displacement / Cylindres</p> <p>Emission control system / Système de contrôle des émissions</p> <p>EC 121</p> <p>10015</p> <p>THIS VEHICLE CONFORMS TO CALIFORNIA EVAPORATIVE EMISSIONS REGULATIONS APPLICABLE TO NEW/OPEN-HEAD SPORT VEHICLES AND IS CERTIFIED TO 1.2 TGM/GRAV PER DAY EVAPORATIVE EMISSIONS CONTROL SYSTEM.</p> <p>SEE OPERATOR'S GUIDE FOR MAINTENANCE SCHEDULE AND FUEL, OIL AND SPARK PLUG SPECIFICATIONS. VOIR LE MANUEL D'UTILISATION ET LES SPECIFICATIONS TECHNIQUES DE L'ENTRETIEN ET DE LA VITUE D'ALLUMAGE DANS LE GUIDE DE L'OPÉRATEUR.</p>	<p>VEHICLE EMISSIONS CONTROL INFORMATION</p> <p>THIS VEHICLE IS CERTIFIED TO OPERATE ON UNLEADED GASOLINE AND CONFORMS TO U.S. EPA & CALIFORNIA EMISSIONS REGULATIONS FOR 2015 AND 2016 MODEL YEAR VEHICLES. LE VEHICULE EST CERTIFIÉ POUR FONCTIONNER À L'ÉNERGIE GAZOLINE ET EST CONFORME AUX NORMES DE L'EPA ET CALIFORNIA POUR LES ANNÉES 2015 ET 2016.</p> <p>Engine Family / Famille de moteur</p> <p>Transmission Family / Famille de transmission</p> <p>Certification standards (EPA) / Normes de certification (EPA)</p> <p>Displacement / Cylindres</p> <p>Emission control system / Système de contrôle des émissions</p> <p>EC 121</p> <p>9571</p> <p>SEE OPERATOR'S GUIDE FOR MAINTENANCE SCHEDULE AND FUEL, OIL AND SPARK PLUG SPECIFICATIONS. VOIR LE MANUEL D'UTILISATION ET LES SPECIFICATIONS TECHNIQUES DE L'ENTRETIEN ET DE LA VITUE D'ALLUMAGE DANS LE GUIDE DE L'OPÉRATEUR.</p>

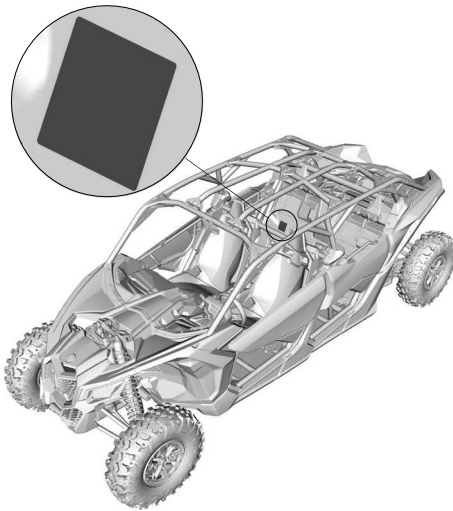

LABEL LOCATION

ANSI/ROHVA Label

BRP certifies that this ROV complies with the American National Standard for Recreational Off-Highway Vehicles, ANSI / ROHVA 1 - 2016 Standard.

BRP certifie que ce véhicule récréatif hors-route est conforme à la norme "American National Standard for Recreational Off-Highway Vehicles", ANSI / ROHVA 1 - 2016.

This roll over protective structure meets the performance requirements of ISO 3471:2008 .

Cette structure de protection contre le retournement respecte les requis de performance de la norme ISO 3471:2008 .



704906982

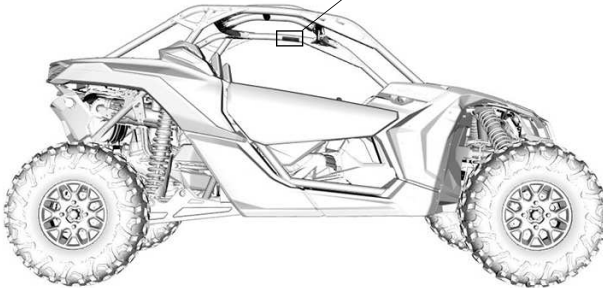
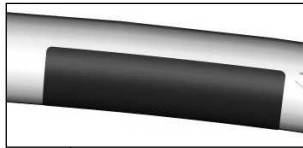

LABEL LOCATION

Technical Information Labels Recommended Fuel

Inside fuel tank cap cover

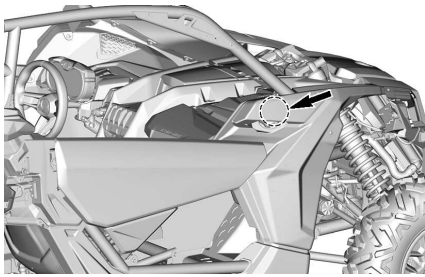
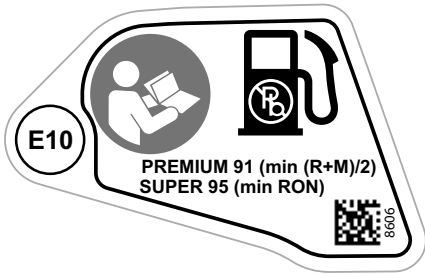

Air Filter Maintenance

On engine air filter housing

AIR FILTER MAINTENANCE

Maintenance must be performed as specified in the operator's guide. Air filter maintenance should increase in frequency in more severe (dusty) conditions.

ENTRETIEN DU FILTRE À AIR

L'entretien doit être effectué tel que spécifié dans le guide du conducteur. Entretien le filtre à air plus souvent dans des conditions plus extrêmes (milieux poussiéreux).

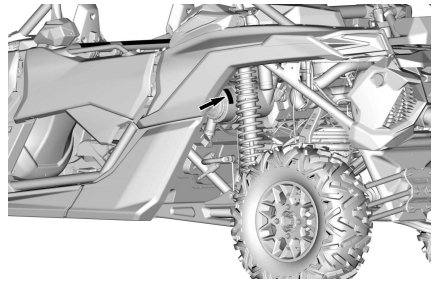

IMPORTANT ON-PRODUCT LABELS (ALL COUNTRIES EXCEPT CANADA/UNITED STATES)

Safety Pictogram

Read and understand all the safety labels on your vehicle.

These labels are affixed to the vehicle for the safety of the operator, passenger or bystanders.

The following labels are on your vehicle, and they should be considered permanent parts of the vehicle. If missing or damaged, they can be replaced free of charge. See an authorized Can-Am Off-road dealer.

NOTE:

In the event of any discrepancy between this guide and the vehicle, the safety labels on the vehicle have precedence over the labels in this guide.

General Safety Label

⚠ WARNING

- Read and understand all safety labels, locate and read operator's guide. Watch the safety video using the QR code link or visit Can-am web site before operation.
- Avoid loss of control and rollovers: Avoid abrupt maneuvers, side-ways sliding, skidding or fishtailing, and never do donuts. Avoid hard acceleration when turning, even from a stop. Slow down before entering a turn. Plan for hills, rough terrain, ruts, and other changes in traction and terrain. Avoid paved surfaces. Avoid side hilling (riding across slopes).
- Rollovers have caused severe injuries and death, even on flat, open areas
- Do not allow operation on public roads (unless designated for off-highway vehicle access) – collisions with cars and trucks can occur.
- Do not exceed seating capacity: 4 occupants.
- Make sure operators are 16 or older with a valid driver's license.

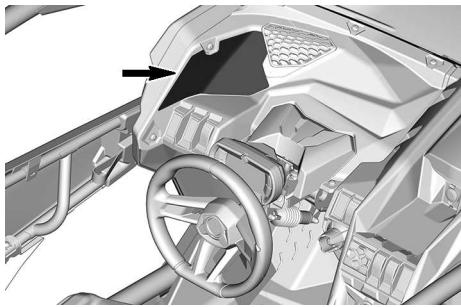
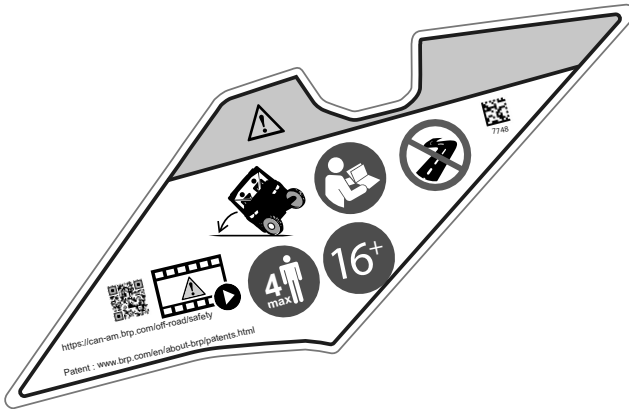

Operator Safety Label

⚠ WARNING

- Always wear an approved helmet and protective gear.
- Always wear ear protection.
- Fasten seat belts.
- Do not ride after using alcohol or drugs.
- Fasten seat belts and close doors or latch lateral nets.
- If you think or feel the vehicle may tip or roll, reduce your risk of injury : Keep a firm grip on the steering wheel or handholds and brace yourself. Do not put any part of your body outside of the vehicle for any reason.
- Always stay completely inside the vehicle.
- Never hold the cage while riding.
- Each rider must be able to sit with back against seat, foot flat on the floor or on footrest, and hands on steering wheel or handholds.

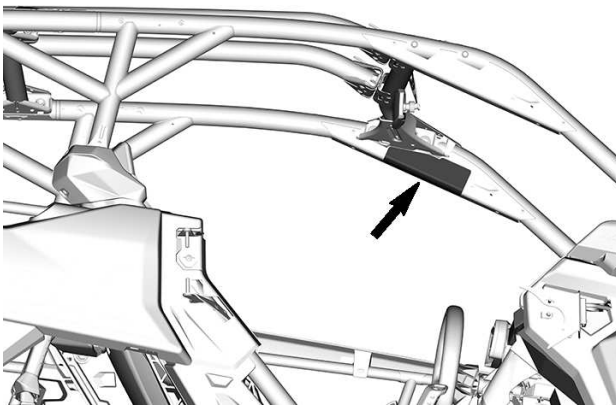

Passenger Safety Label

⚠ WARNING

- Always wear an approved helmet and protective gear.
- Always wear ear protection.
- Fasten seat belts.
- Do not ride after using alcohol or drugs.
- Fasten seat belts and close doors or latch lateral nets.
- If you think or feel the vehicle may tip or roll, reduce your risk of injury : Keep a firm grip on the steering wheel or handholds and brace yourself. Do not put any part of your body outside of the vehicle for any reason.
- Always stay completely inside the vehicle.
- Never hold the cage while riding.
- Each rider must be able to sit with back against seat, foot flat on the floor or on footrest, and hands on steering wheel or handholds.

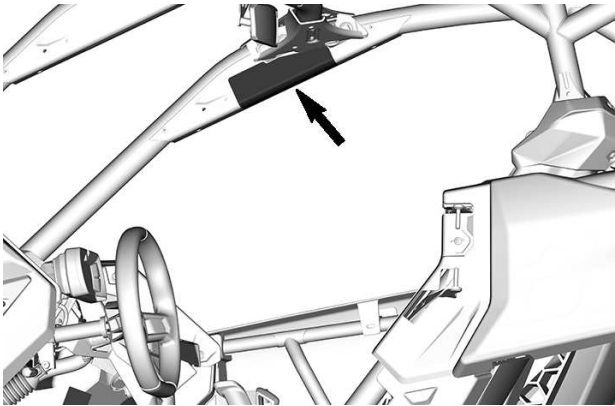
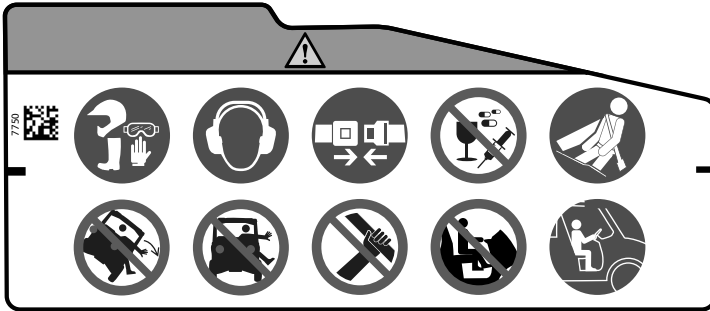

Central Rear Passengers Safety Label

WARNING

- Always wear an approved helmet and protective gear.
- Always wear ear protection.
- Fasten seat belts.
- Each rider must be able to sit with back against seat, foot flat on the floor or on footrest, and hands on steering wheel or handholds.
- Always stay completely inside the vehicle.
- Do not ride after using alcohol or drugs.



7751

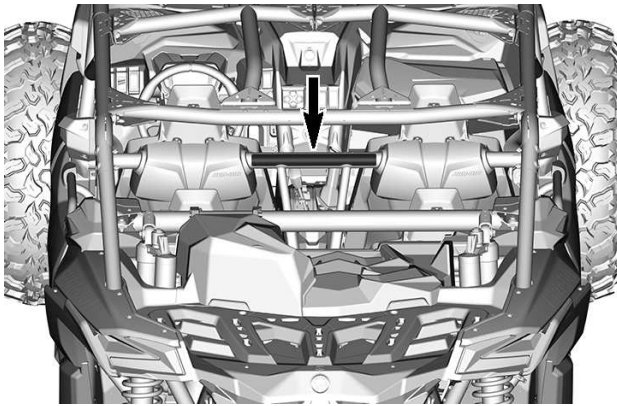

Tire Pressure Label

⚠ WARNING

- Locate and read operator's guide. Improper tire pressure or overloading can cause loss of control, resulting in SEVERE INJURY or DEATH.
- Always maintain proper tire pressure as shown. Use Max pressure if total load exceeds 195 kg (430 lb).

		⚠					
		< 195 (430)		> 195 (430)			
		kPa (psi)		kg (lb)			
30	DS / XDS / RS	124 (18)	124 (18)	124 (18)	124 (18)	286 (630)	
	XMR	117 (17)	165 (24)	124 (18)	214 (31)		
32	XRS	124 (18)	124 (18)	124 (18)	124 (18)		
	XRC	138 (20)	179 (26)	145 (21)	221 (32)		

		⚠					
		< 195 (430)		> 195 (430)			
		kPa (psi)		kg (lb)			
30	DS	124 (18)	124 (18)	124 (18)	124 (18)	286 (630)	
32	XRS	124 (18)	124 (18)	124 (18)	124 (18)		
	XRC	138 (20)	179 (26)	145 (21)	221 (32)		

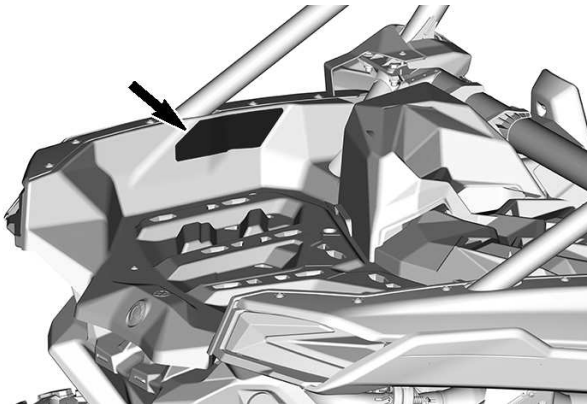

Never Attach Here to Pull a Load Label

NOTICE

Never attach here to pull a load.

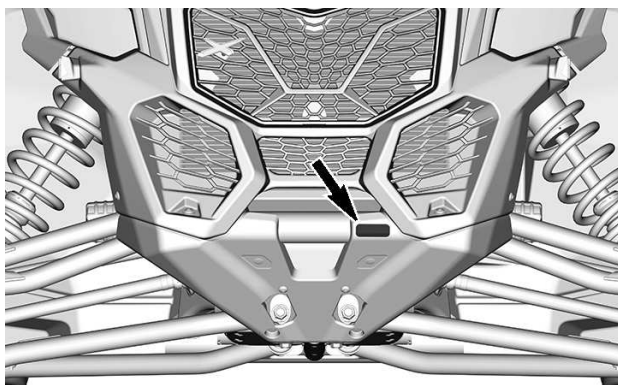
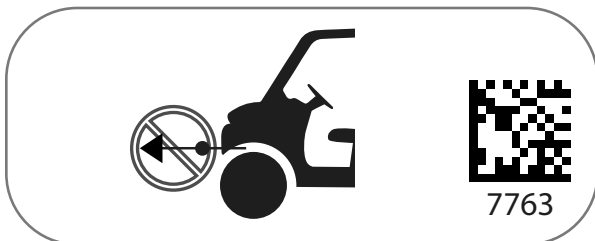

Vehicle Load Capacity Label

⚠ WARNING

- Locate and read operator's guide. Improper tire pressure or overloading can cause loss of control, resulting in SEVERE INJURY or DEATH.
- NEVER exceed the vehicle load capacity, including weight of operator, passenger, cargo, accessories and trailer tongue weight if applicable.

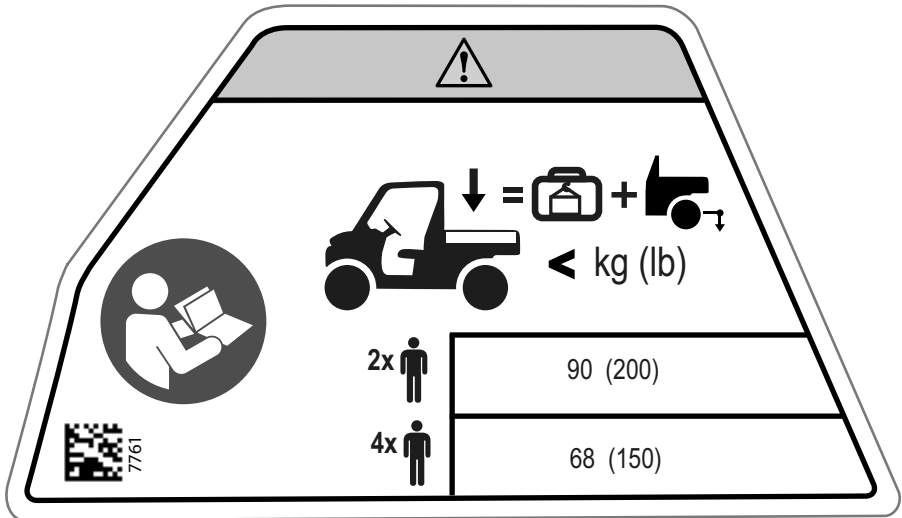

The diagram shows a trapezoidal label with a warning symbol at the top. In the center, a silhouette of a utility vehicle is shown with a downward arrow pointing to it, followed by an equals sign, a briefcase icon, a plus sign, and another utility vehicle icon with a downward arrow. Below this is the text "< kg (lb)". To the left of the vehicle is a circular icon of a person reading a document. Below the vehicle are two human icons: one labeled "2x" and one labeled "4x". To the right of these icons is a table with two rows. The first row shows "90 (200)" and the second row shows "68 (150)". A QR code and the number "7761" are located in the bottom left corner of the label.

2x	90 (200)
4x	68 (150)

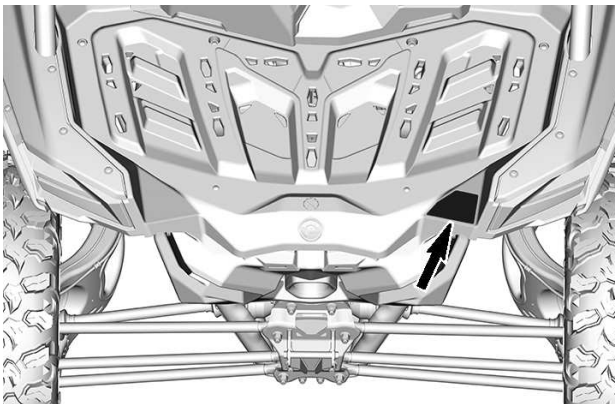

Cargo Warning Label

⚠ WARNING

- Locate and read operator's guide.
- NEVER carry passenger in cargo box.
- NEVER place gasoline, flammable or dangerous liquids container on carrier. This can lead to an explosion.
- Reduce speed when carrying a load.
- NEVER attach to cargo area to pull a load.

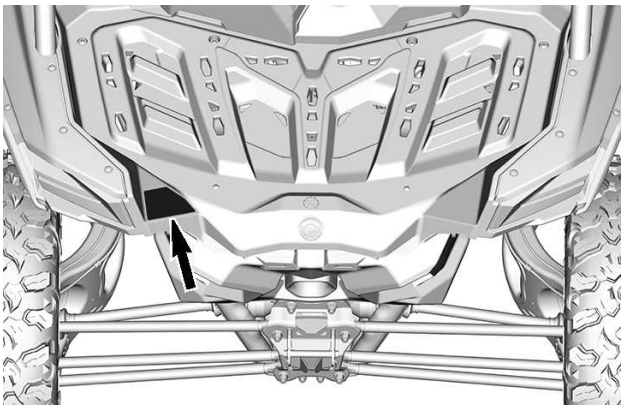

Rear LH Passenger Rollover Warning Label

⚠ WARNING

- Never hold the cage while riding.
- If you think or feel the vehicle may tip or roll, reduce your risk of injury : Keep a firm grip on the steering wheel or handholds and brace yourself. Do not put any part of your body outside of the vehicle for any reason.
- Always stay completely inside the vehicle.

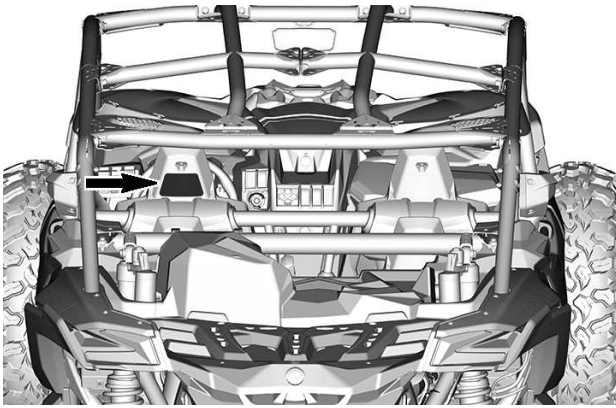
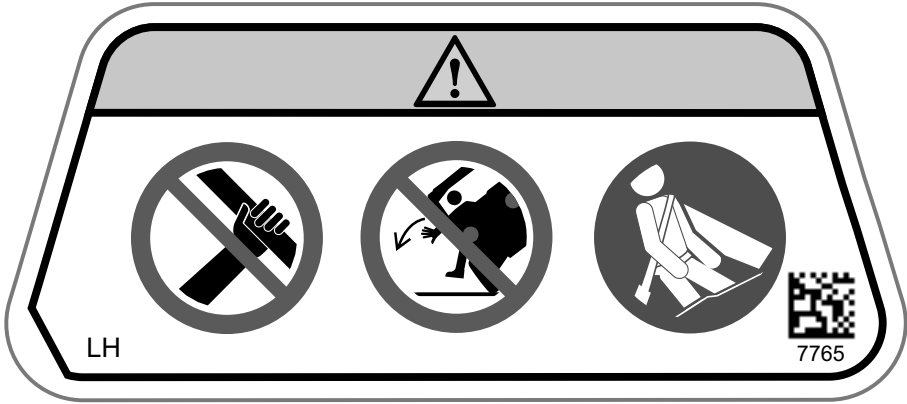

Rear RH Passenger Rollover Warning Label

WARNING

- Never hold the cage while riding.
- If you think or feel the vehicle may tip or roll, reduce your risk of injury : Keep a firm grip on the steering wheel or handholds and brace yourself. Do not put any part of your body outside of the vehicle for any reason.
- Always stay completely inside the vehicle.

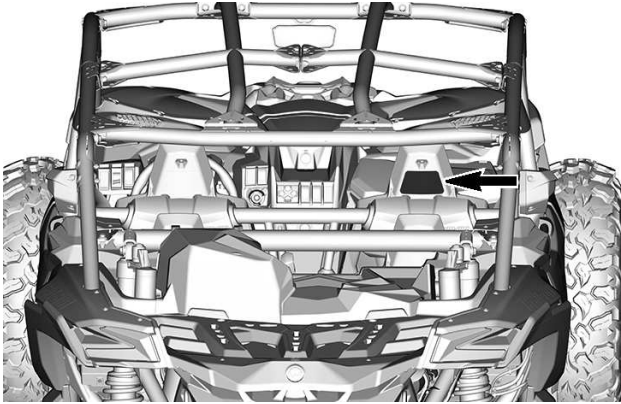
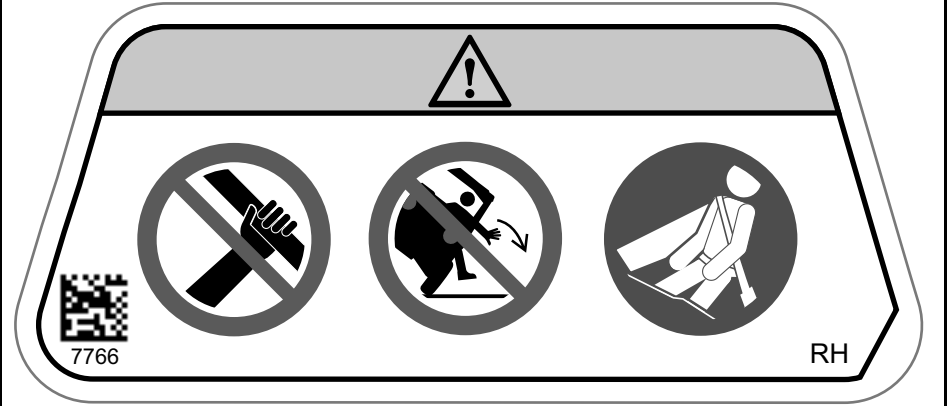

Door Warning Label

⚠ WARNING

Do NOT put your arm outside of the vehicle, there is a risk of SEVERE INJURY.

Front LH Side



Front RH Side



Rear LH Side



Rear RH Side

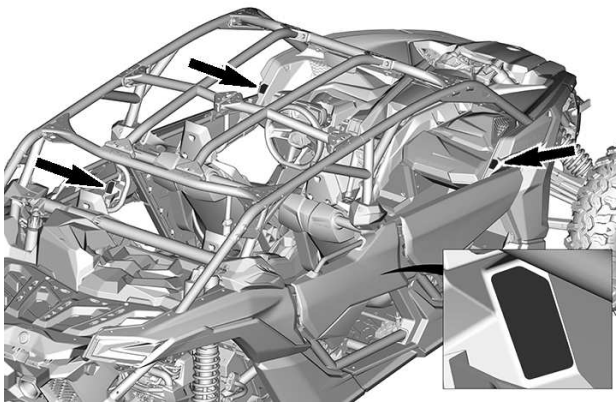

Cage Warning Label

⚠ WARNING

NEVER attach to the cage to pull a load. This can cause the vehicle to tip over. Use only the trailer hitch or recovery hook to pull a load.

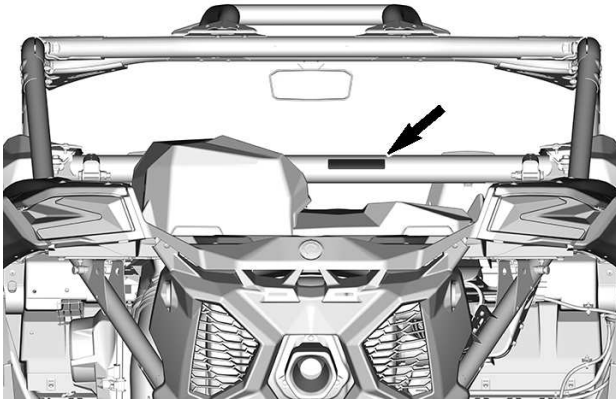

Shift Lever Warning Label

⚠ WARNING

- Stop the vehicle and apply the brake before using the shift lever and the 2WD/4WD switch.
- Put the shift lever to PARK (P) before exiting vehicle. The vehicle can roll if not in PARK.

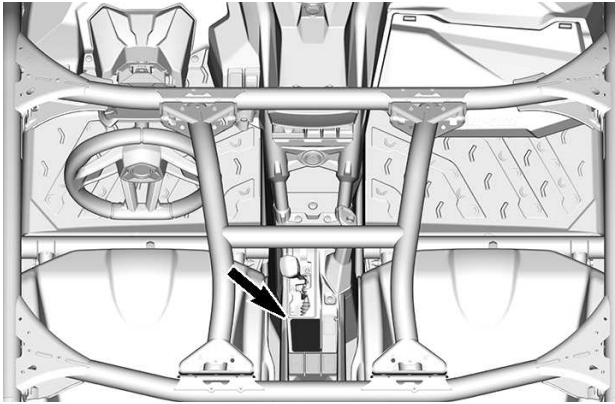
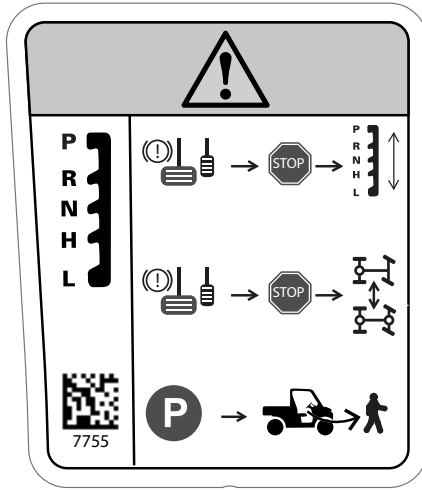

Recover Stuck Vehicle Only Label

NOTICE

Use only to recover stuck vehicle. Never use to pull a load. Trailer hitch installation required. Refer to operator's guide.

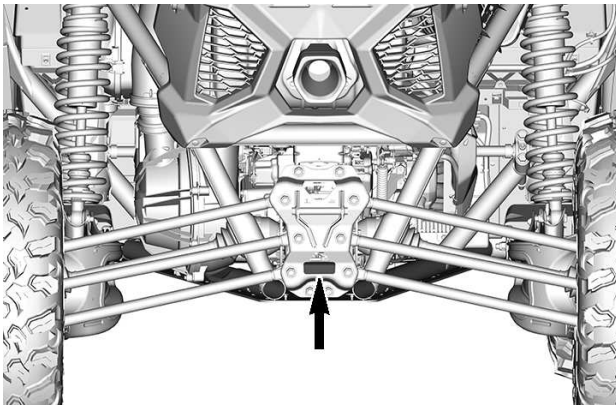
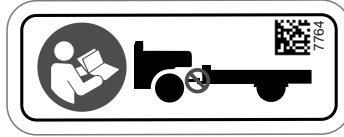

Winch Warnings - On Winch

⚠ WARNING

- Locate and read operator's guide. Improper use can result in SEVERE INJURY or DEATH. Follow all instructions and warnings.
- Always use the hand strap to manipulate the hook and rope.
- Never put your fingers into the hook.
- Avoid putting your hand between hook and hawse or roller fairlead. You can crush your fingers.
- Never use the winch to lift objects or people.

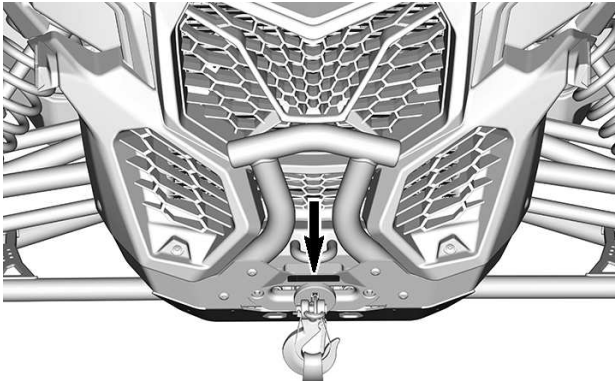
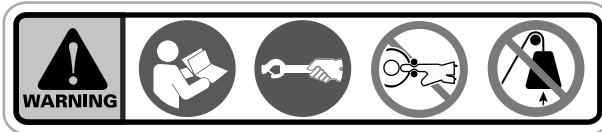

Eurasian Union Only Warning Label

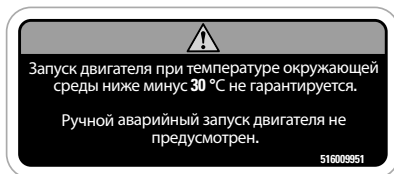

Compliance Labels

Emission Control Information (Typical)

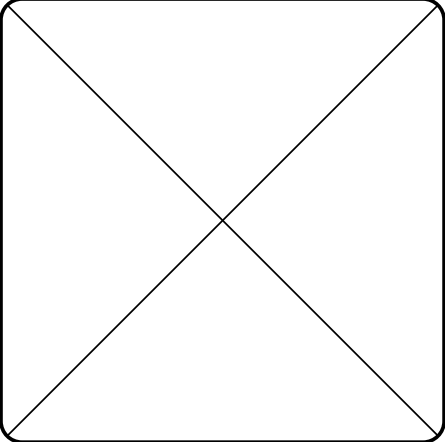
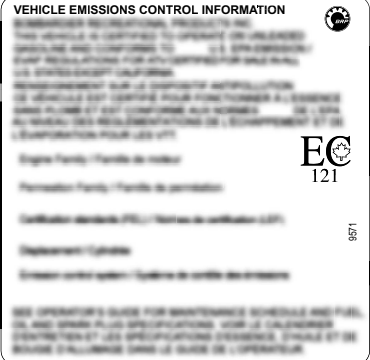
EN Certification	Other Model
	

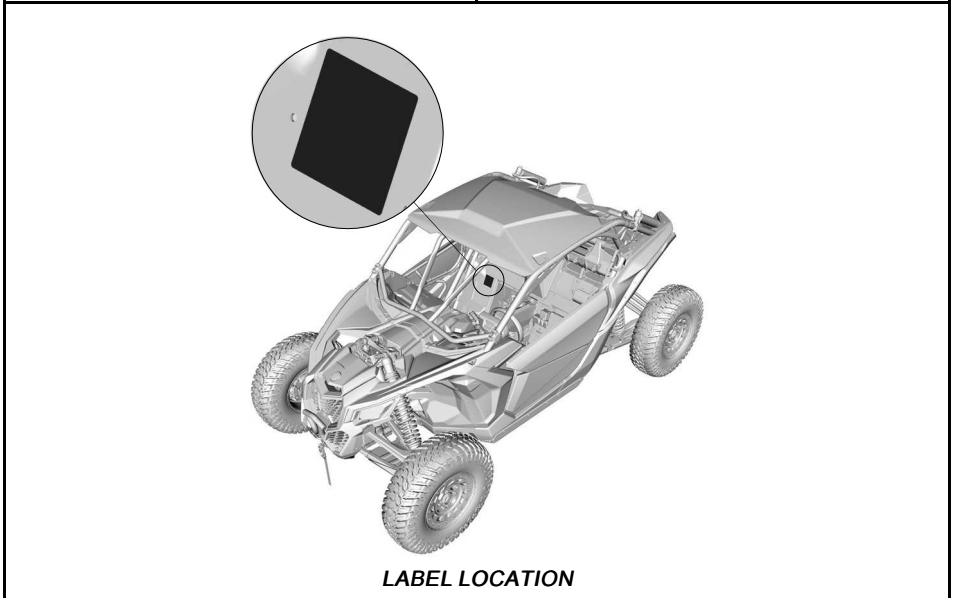

ANSI/ROHVA Label

BRP certifies that this ROV complies with the American National Standard for Recreational Off-Highway Vehicles, ANSI / ROHVA 1 - 2016 Standard.

BRP certifie que ce véhicule récréatif hors-route est conforme à la norme "American National Standard for Recreational Off-Highway Vehicles", ANSI / ROHVA 1 - 2016.

This roll over protective structure meets the performance requirements of ISO 3471:2008 .

Cette structure de protection contre le retournement respecte les requis de performance de la norme ISO 3471:2008 .



704906982

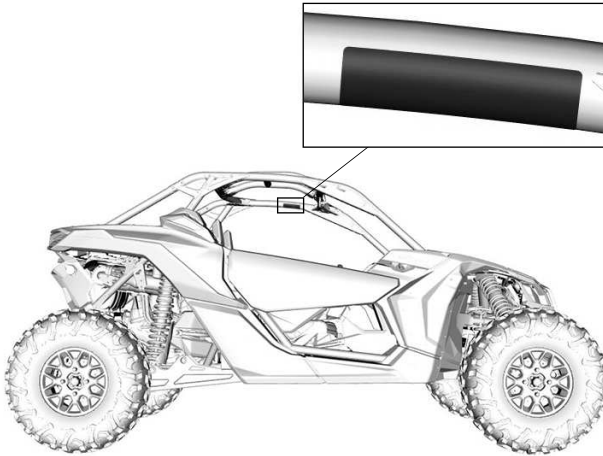

LABEL LOCATION

NRMM Conformity Label

Locate on the top of the cylinder head.

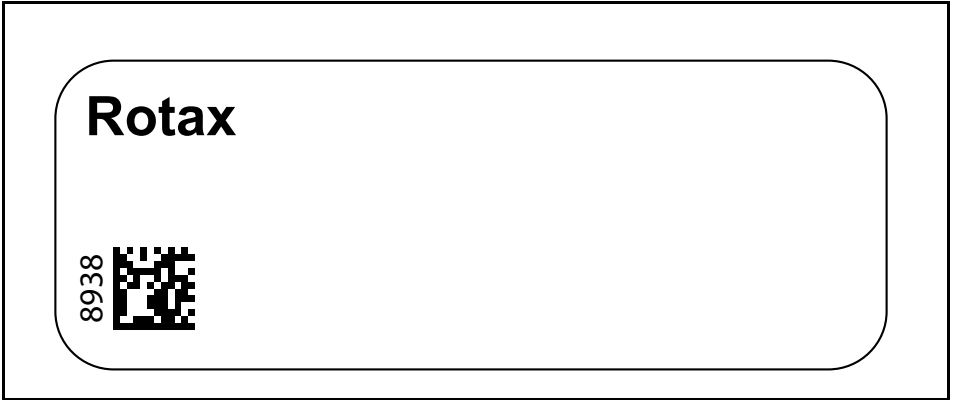

Technical Information Labels Recommended Fuel

Inside fuel tank cap cover

NOTICE

Use unleaded fuel only. Recommended octane rating: PREMIUM 91 (min (R+M)/2) or SUPER 95 (min RON). Refer to operator's guide.

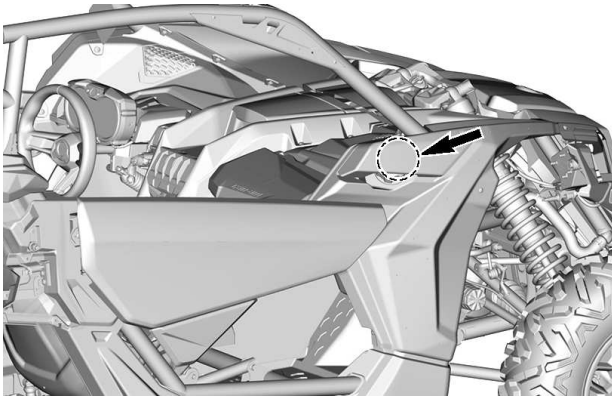
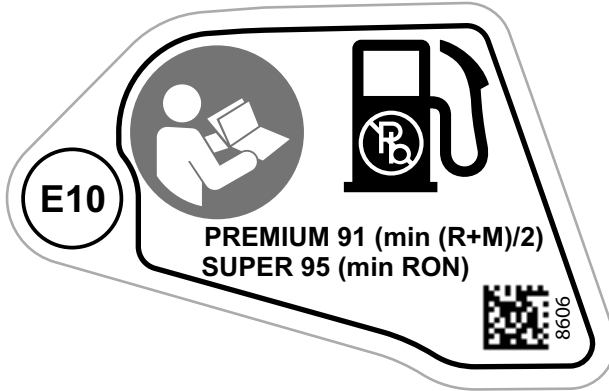

Air Filter Maintenance

On engine air filter housing

NOTICE

Refer to Operator's Guide for air filter maintenance schedule and instructions.

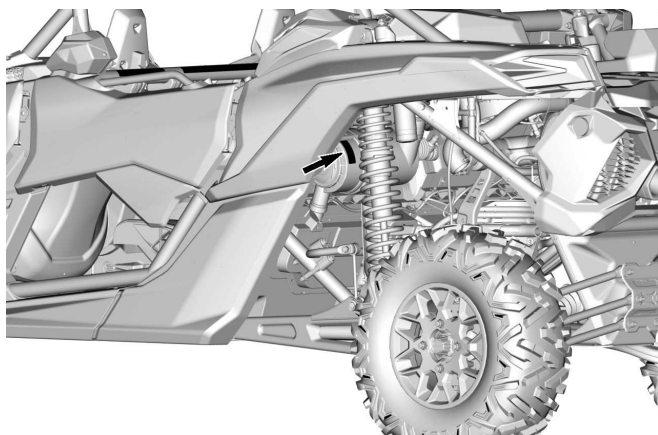
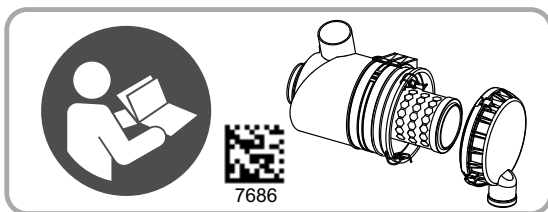

REPORTING SAFETY DEFECTS

In Canada, if you believe that your vehicle has a defect which could cause a crash or could cause injury or death, you should immediately inform Transport Canada in addition to notifying Bombardier Recreational Products Inc.

If Transport Canada receives similar complaints, it may open an investigation, and if it finds that a safety defect exists in a group of vehicles, it may order a recall and remedy campaign. However, Transport Canada cannot become involved in any individual problems between you, your dealer or Bombardier Recreational Products Inc.

To contact Transport Canada:



819-994-3328 (Gatineau-Ottawa area or internationally)
Toll free : 1 800-333-0510 (in Canada)



Transport Canada - ASFAD
330 Sparks Street
Ottawa, ON
K1A 0N5



<https://www.tc.gc.ca/recalls>

VEHICLE INFORMATION

PRIMARY CONTROLS

It is important to know the location and operation of all controls, and to develop and practice smooth and coordinated use of them.

NOTE:

Some vehicle safety labels are not shown on illustrations. For information on vehicle safety labels, refer to *Important On-Product Labels*.

Steering Wheel

The steering wheel is located in front of the driver's seat.

The steering wheel steers the vehicle to the left or right.

Turn the steering wheel in the direction you want to go.



1. Steering wheel

Grip the steering wheel with both hands, without having thumbs rolled around the steering wheel.

CAUTION

Under rough trail conditions or when crossing an obstacle, the steering wheel could suddenly jerk on one side, causing hand or wrist injuries if the thumbs are rolled around the steering wheel.

Models with DPS

The DPS (Dynamic Power Steering) reduces the effort to turn the steering wheel.

Accelerator Pedal

The accelerator pedal is located on the right side of the brake pedal.

The accelerator pedal controls the engine speed.

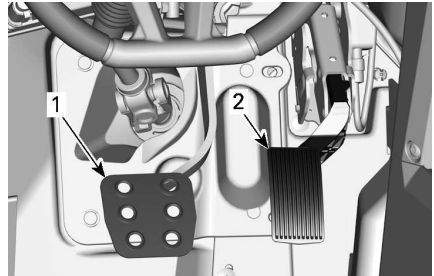

TYPICAL

1. Brake pedal
2. Accelerator pedal

To increase or maintain vehicle speed, press on the accelerator pedal with your right foot.

To decrease vehicle speed, release the accelerator pedal.

The accelerator pedal is spring loaded and should return to rest position (idle) when not pressed.

NOTE:

The accelerator pedal should never be disassembled.

Brake Pedal

The brake pedal is located on the left side of the accelerator pedal.

The brake pedal function is to slow down or stop the vehicle.

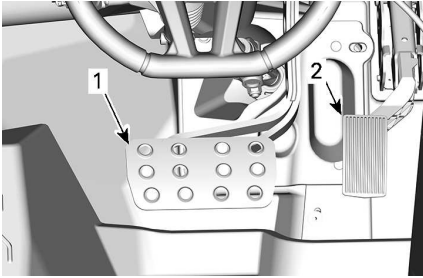
**XRC MODELS**

1. Brake pedal
2. Accelerator pedal

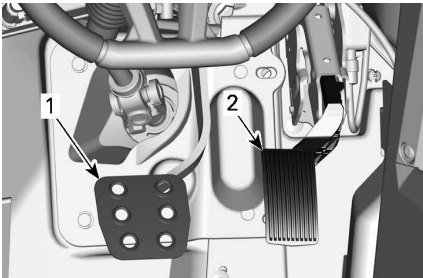
**ALL OTHER MODELS**

1. Brake pedal
2. Accelerator pedal

To decrease vehicle speed or to stop vehicle, press down the brake pedal with your right foot.

The brake pedal is spring loaded and should return to rest position when not pressed.

Shift Lever

The shift lever is located on the lower console, between the seats.

The shift lever is used to change the gearbox position.

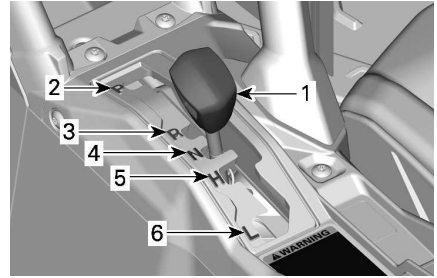

1. Shift lever
2. Park
3. Reverse
4. Neutral
5. High range (forward)
6. Low range (forward)

The vehicle must be stopped and brakes applied prior to selecting any gear.

⚠ WARNING

This gearbox is not designed to shift while vehicle is moving.

Park

The park position locks the gearbox to help prevent vehicle movement.

⚠ WARNING

Always use the PARK (P) position when the vehicle is not in operation. The vehicle can roll if the shift lever is not set to P (PARK).

Reverse

The reverse position allows the vehicle to go backwards.

Depending upon your particular vehicle configuration, a back-up alarm may be equipped on the vehicle. It goes on automatically when the reverse gear is selected.

NOTE:

In reverse operation, the engine RPM is limited thus limiting the vehicle reverse speed.

⚠ WARNING

When driving downhill in reverse, gravity can increase the vehicle speed above safe reverse speed.

Neutral

The neutral position disengages the gearbox.

High Range (Forward)

This position selects the high speed range of the gearbox. It is the normal driving speed range. It allows the vehicle to reach its maximum speed.

Low Range (Forward)

This position selects the low speed range of the gearbox. It allows the vehicle to move slowly with maximum torque at the wheels.

NOTICE

Use the low speed range to pull a trailer, carry heavy cargo, go over obstacles or drive uphill and downhill.

SECONDARY CONTROLS

Some vehicle safety labels are not shown on illustrations.

For information on vehicle safety labels, refer to *Important On-Product Labels*.

RF D.E.S.S Key and RF D.E.S.S. Post

RF D.E.S.S. Post

The D.E.S.S. post is located on the upper console.

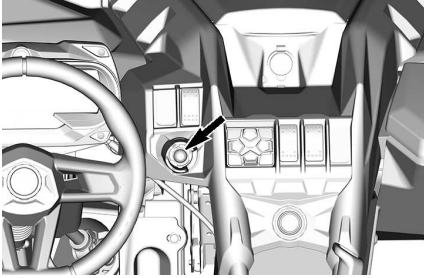

RF D.E.S.S. Key

For all D.E.S.S. related option, see an authorized Can-Am dealer for information.

Digitally Encoded Security System (D.E.S.S.)

This vehicle is delivered with 1 D.E.S.S. S. key.

The ignition keys contain an electronic circuit that gives it a unique electronic serial number.

The D.E.S.S. system reads the key code and allows engine starting for keys it recognizes.

This vehicle can be operated using different types of key programming:

- Performance
- Normal

Refer to your dealer for complete information.

NOTE:

Additional keys are available from your dealer as an accessory.

⚠ WARNING

Rollovers, tipovers, collisions and loss of control resulting in serious injury or death are possible with the performance or normal key. Using the normal key is not a substitute for the operator being prepared, qualified, and operating with care.

Performance Key

The performance key allows the user to access the full torque of the engine as well as the top speed of the vehicle.

This may be useful for riders who prefer crisper throttle response, and for environments where higher speeds and greater acceleration are appropriate. For example, in wide-open straight trails, operators may prefer the performance key.

Normal Key

The normal key limits the vehicle speed to 70 km/h (43 MPH) and 50% torque reduction.

⚠ WARNING

On steep downhills, the engine speed limiter may not prevent the vehicle from accelerating beyond this speed.

This key may be useful for riders who prefer more gradual acceleration, or for riding in environments where full speed and high acceleration are not desirable. For example, in narrow, winding trails, operators may prefer a normal key.

D.E.S.S. Flexibility

The D.E.S.S. of your vehicle can be programmed by your authorized Can-Am Off-road dealer to accept up to 8 different keys.

If you have more than one D.E.S.S. equipped your vehicle, each can be programmed by your authorized Can-Am Off-road dealer to accept the other vehicle D.E.S.S. keys.

Engine Start/Stop Button

The engine start / stop button is located on the upper console.

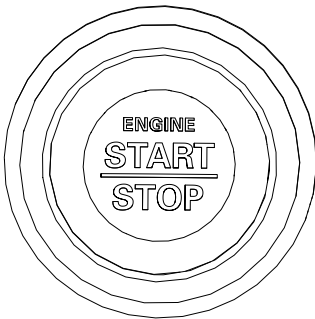

When pressed and held, it starts the engine.

If the engine is running, when pressed, it stops the engine.

NOTE:

The RF D.E.S.S. key must be installed on the RF D.E.S.S. post to allow engine start.

To power up the electrical system without starting the engine, refer to *Waking Up the Electrical System*

Headlight Dimmer Switch

The headlight dimmer switch is located on the LH side of dashboard.

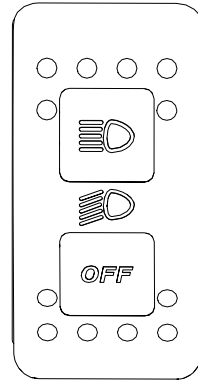

This switch is used to select either the headlights low or high beams.

Hold the lower button to turn the headlights off. Simply push the same button to turn the headlights back on.

2WD/4WD/Front Diff Lock (if Equipped) Switch

The 2WD/4WD/Front Diff Lock switch is located on the upper console.

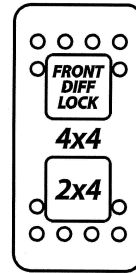

This switch selects 2 wheel drive or 4 wheel drive mode when the vehicle is stopped and the engine is running.

The front diff. lock can be activated on the fly, no need to stop the vehicle to engage. To deactivate, push again on the switch. When the vehicle is turned off, the front diff lock will be deactivated.

NOTICE

Never go from 4X4 with the front diff locked to 2X4. Always unlock the front differential before putting the vehicle in 2X4 mode.

NOTICE

The vehicle must be stopped to engage or disengage 2WD/4WD switch. Mechanical damage may occur if switch is engaged or disengaged while driving.

The front differential is fully locked when the switch is pushed upward. It's a momentary position. When the front diff is locked, the switch light will illuminate and a message will appear in the cluster for 2 seconds to say "DIFF LOCK". The light will turn off when the differential is unlocked and a message in the cluster will appear and show "SMART-LOK", meaning that you are back in the automatic mode.

When the front differential is locked, the effort to turn the steering wheel might be higher and the response might be slower.

⚠ WARNING

Abruptly changing direction can cause loss of control or injury. Never engage Front Diff Lock before entering a turn or when turning.

The 4WD mode is engaged when the switch is in the middle position.

The 2WD mode is engaged when the switch is pushed downwards. The vehicle is then rear wheel drive only.

Riding Mode Switch

On Some Models Only

This switch is used to choose between the TRAIL or TRAIL ACTIV mode.

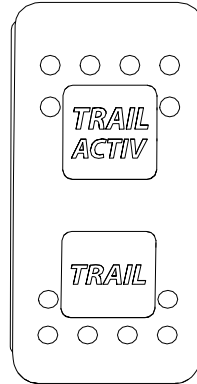
**TRAIL**

This mode must be used during all normal riding.

The front differential will automatically synchronize the front wheels as needed.

TRAIL ACTIV

This mode is used to increase traction on the front drive train.

This will optimize traction while going out of a corner and/or while doing hard acceleration by the detection of the engine torque required by the driver.

When using this mode, you need to adjust of your driving style as the front drivetrain is going to pull more than usually.

⚠ WARNING

The fully locked option of the front differential reduces the maneuverability of the vehicle in certain conditions.

Keypad

The keypad is used to navigate through various menus and options

when the 7.6" Digital Display is installed.

The keypad is located on the upper console.

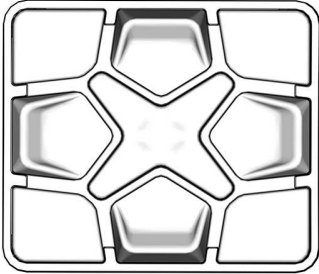

Override Switch

The override switch is located above the D.E.S.S. post.

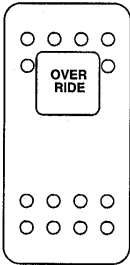

The override switch is used to:

- Bypass the engine speed limiter in reverse by allowing maximum engine torque. Refer to *Entering the Override Mode*.
- Temporarily deactivate the electronic drive belt protection (if available and activated on your model).
- Erase the MAINTENANCE REQUIRED message, refer to 4.5" Digital Display or to 7.6" Digital Display (Keypad).
- Allow the vehicle to be driven in the eventuality of an accelerator pedal failure. Refer to *Entering the Manual Limp Home Mode*.

Entering the Override Mode

Press and hold the override switch to enter the bypass mode.

WARNING

Use the "override" mode only if the vehicle is caught in mud or other soft terrain and the "low range" is not enough. Make sure the area is secure before using the "override" mode. Do not use the "override" mode when driving normally in reverse, this would result in excessive speed.

Release the override switch to exit the bypass mode.

Entering the Manual Limp Home Mode

If one or both the pedal position sensor(s) is (are) defective, the accelerator pedal will not respond.

Depending on the type of failure, pressing and holding the Override Switch, will temporarily restore the response of the pedal OR temporarily increase the engine speed to be able to drive the vehicle.

Releasing the Override Switch will release the throttle and let the engine return to idle speed.

Winch Switch

The winch can be controlled from inside and outside the vehicle with the winch control switch located in the upper console.

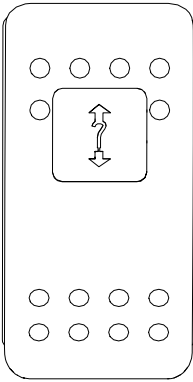

Refer to your *Winch Guide* included with your vehicle for proper winch operation.

Horn Switch (On applicable models)

To activate the horn, push on the switch.

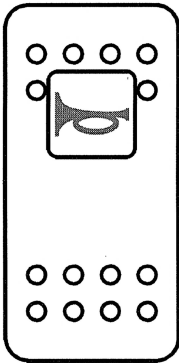

Smart-Shox Suspension Mode Switch (On Applicable Models)

The Smart-Shox suspension mode switch is located on the upper console.

There is 3 suspension modes: Sport, Sport +, and Comfort.

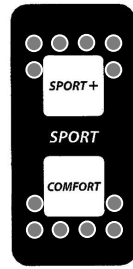

Refer to *Tune Your Ride* for more information.

EQUIPMENT

NOTE:
Some vehicle safety labels are not shown on illustrations. For information

on vehicle safety labels, refer to *Important On-Product Labels*.

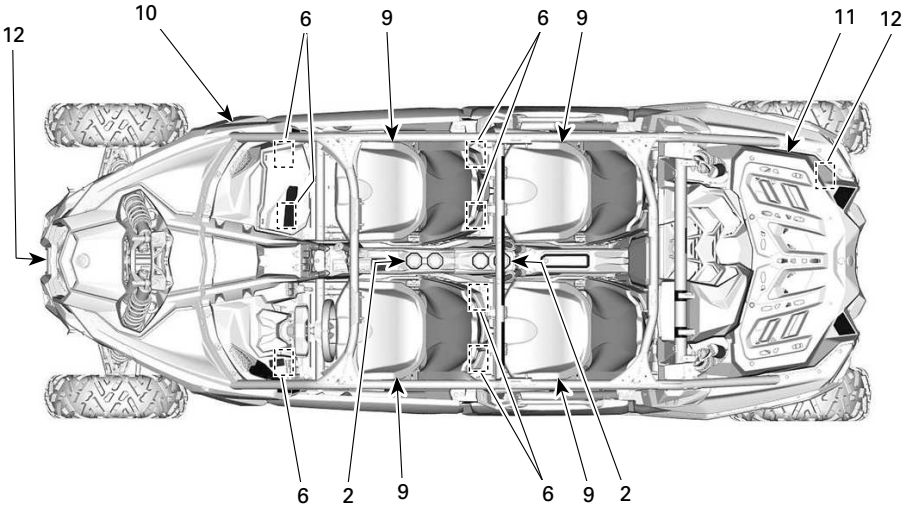

TYPICAL - MAVERICK MAX (TOP)

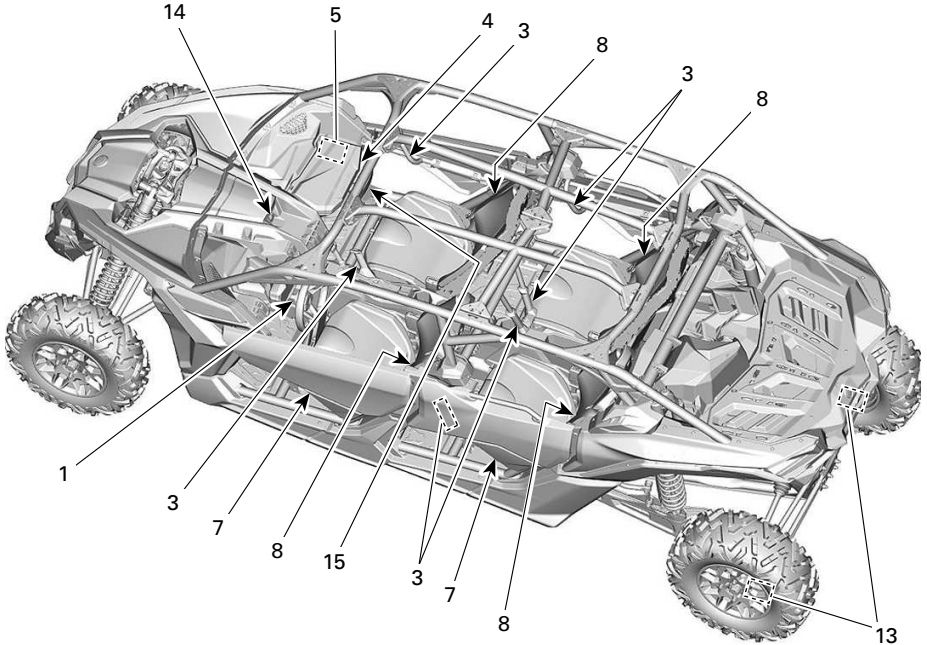

TYPICAL - MAVERICK MAX (SIDE)

1. Tilt Steering
2. Cup Holder
3. Passenger Handholds
4. Glove Box
5. Tool Kit
6. Footrests
7. Doors
8. Seat Belts
9. Seats
10. Fuel Reservoir Cap
11. Cargo Rack
12. Recovery Hook
13. Wheel Scraper
14. 12-Volt Power Outlet
15. Central Rearview Mirror

Tilt Steering

The steering wheel height is adjustable.

Adjust the steering wheel height to face your chest, not your head.

To adjust steering wheel height:

1. Unlock steering by pulling the tilt lever toward you.
2. Move steering wheel to the desired position.
3. Release tilt lever to lock steering wheel in position.

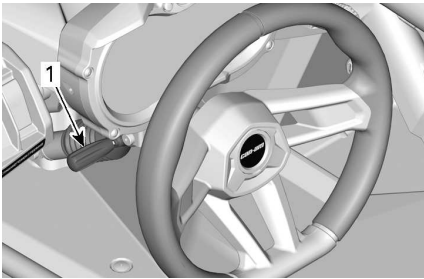

1. Tilt lever

⚠ WARNING

Never adjust the steering wheel height while riding. You may lose control.

Cup Holders

There are two cup holders for the front occupants and two for the rear occupants.

All cup holders are located on the lower console.

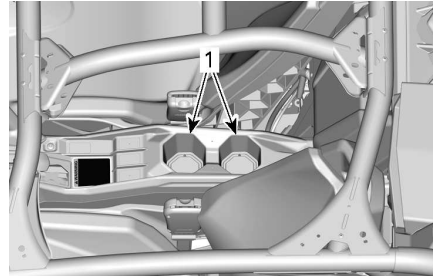

TYPICAL

1. Cup holders

NOTE:

Do not use cup holders while riding in rough conditions.

Passenger Handholds

There is one passenger handhold on the console and one in the RH door.

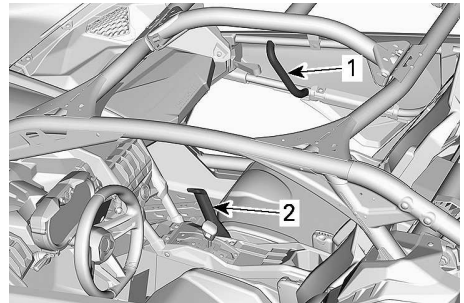

1. Door handhold
2. Console handhold

At rear, there are two passenger handholds on the cage cross member and one in each door.

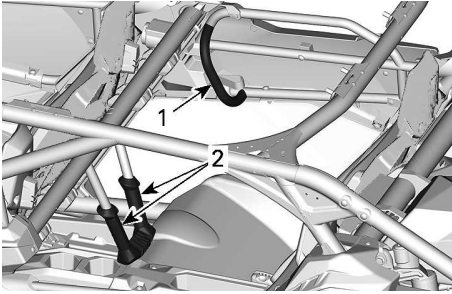

1. Door handhold
2. Console handhold

Adjust the seat position in order to get a solid and comfortable grip on the handholds. Refer to *Seats* for adjustment procedure.

Holding the handholds helps the passenger brace against the movement of the vehicle and helps keep hands and body inside the cockpit in the event of a rollover.

⚠ WARNING

Never use any part of vehicle cage as handholds. Hands can be struck by objects outside the cockpit or crushed in a rollover.

Glove Box

The vehicle is equipped with a closed glove box intended to carry light objects.

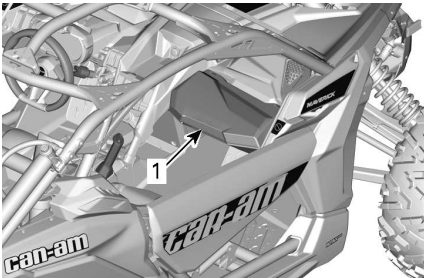

1. Glove box

Glove Box Capacity

Glove Box Capacity	
MAXIMUM LOAD	5 kg (11 lb)

Tool Kit

A tool kit with basic tools is provided. It is located in the glove box.

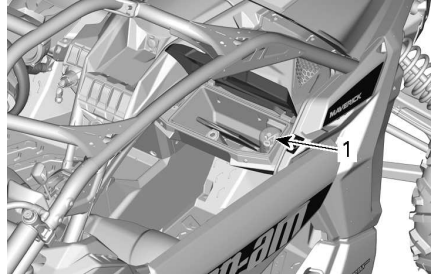

1. Tool kit

Footrests

The vehicle is equipped with driver and passengers footrests to allow firmly planting feet on vehicle floor, which helps to maintain proper body position while riding.

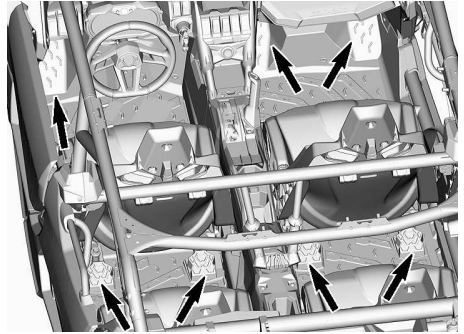

The footrests help minimize the risk of leg or foot injury.

Always wear appropriate footwear. See *Riding Gear*.

Doors

The vehicle is equipped with doors to help occupants keep their body and limbs inside the vehicle, reducing the risk of injury.

The doors can also prevent the intrusion of branches and other foreign objects into the passenger compartment.

⚠ WARNING

Never operate vehicle unless both doors are closed and secured.

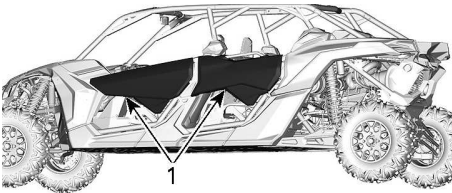

1. Door closed and locked in place

To unlock doors, pull on the strap to release the latch.

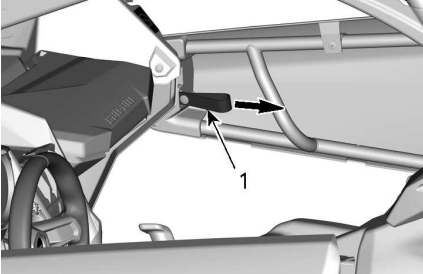

1. Latch strap

Seat Belts

This vehicle is equipped with 3-point seat belts to help protect driver and passengers in the event of a collision, rollover, or tipover. The seat belts can

help keep occupants stay in the passenger compartment.

⚠ WARNING

Wear seat belts properly at all times. Seat belts reduce the risk of injury in case of a crash and help to keep limbs inside the cockpit during a rollover or any accidents. Before riding, everyone aboard should know how to unbuckle their seat belt rapidly. Knowing how to properly detach your seat belt is a crucial skill that can save your life in an emergency situation. In the event of an accident or vehicle malfunction, being able to quickly release your seat belt can help you escape the vehicle and avoid potential hazards such as fire or sinking. Additionally, knowing to quickly release your seat belt can also help you assist others such as children or older persons.

If driver's seat belt is not fastened when:

- The ignition is turned ON, the seat belt indicator lamp will flash.
- The engine is started and shift lever is moved out of PARK, vehicle speed will be limited to a maximum of approximately 20 km/h (12 MPH) on flat ground.

⚠ WARNING

The vehicle may reach higher or lower speed depending on inclines.

To remind you to fasten the seat belt, the multifunction gauge will display the following message: ENGINE

LIMITATION ENGAGED FASTEN SEAT BELT.

⚠ WARNING

There is no indicator light or message for the passengers seat belts. The driver is responsible for the passengers safety and should ensure the passengers buckles their seat belts.

3-Point Seat Belts

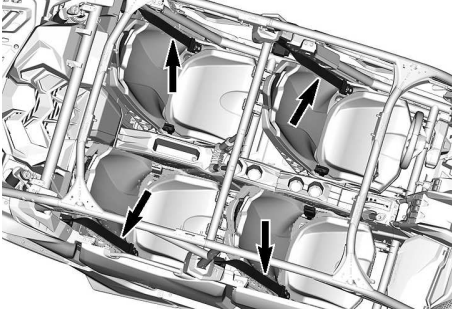

⚠ WARNING

Wear seat belt properly. Make sure it remains securely fastened and tightened against the body. Make sure it is not twisted or defective.

The seat belt is equipped with a semi-cinching tab.

This device locks the seat belt in the adjusted position.



TYPICAL - LOCKED POSITION

1. Semi-cinching tab

To fasten the seat belt, insert the latch plate into the buckle, then pull the belt to ensure it is properly fastened.

Adjust the seat belt tightly against your body by pulling the shoulder belt upwards.



TYPICAL

To detach the seat belt, push on the red button on the buckle.

4-Point Seat Belts

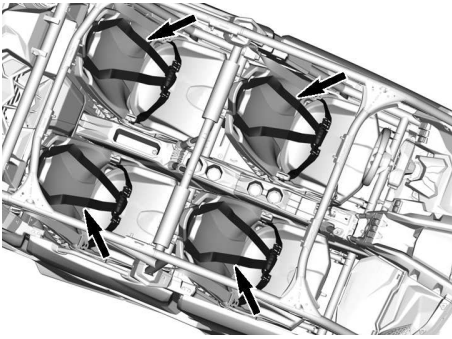

⚠ WARNING

Wear seat belt properly. Make sure it remains securely fastened and tightened against the body. Make sure it is not twisted or defective.

To fasten the seat belt, insert the latch plate into the buckle, then pull the belt to ensure it is properly fastened.



On both sides, adjust the seat belt tightly against your body by pulling the excess of the lap belt towards the inside. The buckle must be centered at the waistline (as low as possible).



To loosen the seat belt, hold the lap belt with one hand and pull the red strap outwards.



To detach the seat belt, push on the red button on the buckle.

Seats

Seat Forward and Rearward Adjustment

The seats can be adjusted forward or backward.

Slide the adjustment lever, place the seat at the desired position, then release the lever.

Try to move the seat forward and backward to make sure it is properly locked in place.

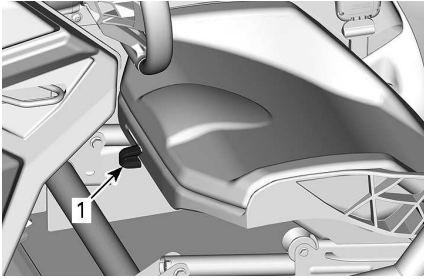

1. Adjustment lever

⚠ WARNING

Never adjust the seat position while the vehicle is moving.

Seat Cushion Removal and Installation

Unclip the cushion retaining tab.



Pull up the rear of the cushion, then free the cushion from the seat frame by pulling it off towards the rear.

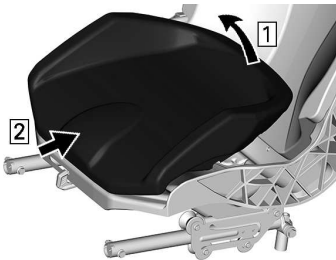

To install, reverse the removal procedure.

Seat Removal and Installation

Remove the seat cushion.

Remove all four anchor points.

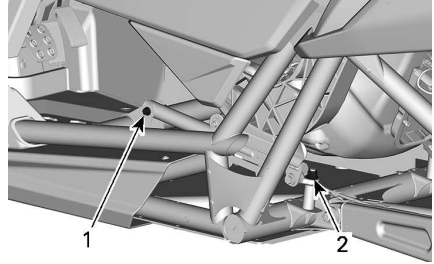

PARTS REMOVED FOR CLARITY

1. Front anchor point
2. Rear anchor point

To install, reverse the removal installation, however pay attention to the following.

Install seat using **NEW** nuts. Tighten to specification.

⚠ WARNING

Use new nuts when installing seat anchor points.

Tightening Torque

Rear anchor point	71 ± 15 Nm (52 ± 11 lbf-ft)
Front anchor point	28 ± 3.5 Nm (20 ± 3 lbf-ft)

Seat Height Adjustment

Seat height can be adjusted using the anchor points. See *Seat Removal and Installation*.

Setup in HIGH Position

Remove the seat cushion.

Remove both nuts securing the rear anchor points.

Remove both nuts securing the front anchor points.

Assemble both rear anchor points as shown. Use **NEW** nuts.

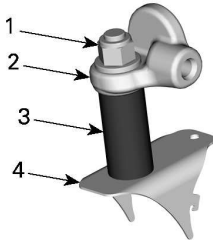

REAR ANCHOR POINT IN HIGH POSITION

1. Retaining nut
2. Seat frame
3. Sleeve
4. Vehicle frame

Install both front anchor points as shown. Use **NEW** nuts.

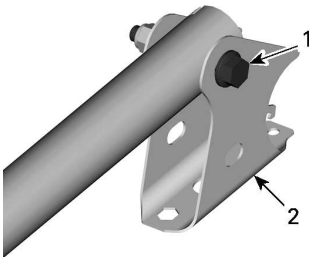

FRONT ANCHOR POINTS IN HIGH POSITION

1. Retaining bolt
2. Seat support

Tighten nuts to specification.

Tightening Torque	
Rear anchor point	71 ± 15 Nm (52 ± 11 lbf-ft)
Front anchor point	28 ± 3.5 Nm (20 ± 3 lbf-ft)

Setup in LOW Position

Remove the seat cushion.

Remove both nuts securing the rear anchor points.

Remove both nuts securing the front anchor points.

Assemble both rear anchor points as shown. Use **NEW** nuts.

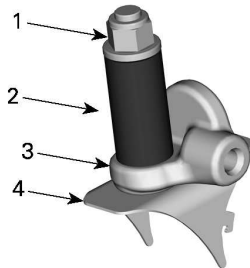

REAR ANCHOR POINT IN HIGH POSITION

1. Retaining nut
2. Sleeve
3. Seat frame
4. Vehicle frame

Install both front anchor points as shown. Use **NEW** nuts.

⚠ WARNING

Use new nuts when installing seat anchor points. Ensure both anchor points at the front and both anchor points at the rear are set to the same position (HIGH or LOW) before riding the vehicle.

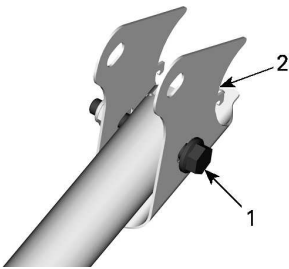

FRONT ADJUSTMENT MECHANISM IN POSITION LOW

1. Retaining bolt
2. Bracket support

⚠ WARNING

Use new nuts when installing seat anchor points. Ensure both anchor points at the front and both anchor points at the rear are set to the same position (HIGH or LOW) before riding the vehicle.

Tighten nuts to specification.

Tightening Torque	
Rear anchor points	71 ± 15 Nm (52 ± 11 lbf-ft)
Front anchor points	28 ± 3.5 Nm (20 ± 3 lbf-ft)

Fuel Reservoir Cap

Open fuel reservoir cap cover.

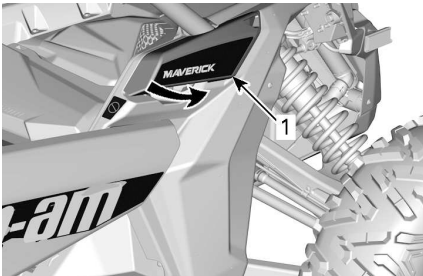

1. Fuel reservoir cap cover

The fuel reservoir cap is located at front on the right hand side of the vehicle.

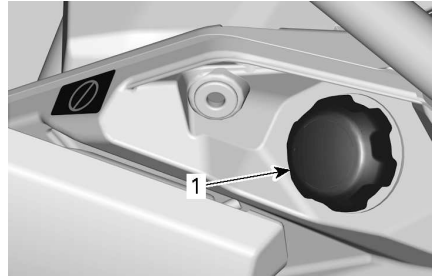

1. Fuel reservoir cap

Refer to *Fuel* for information on fueling procedure and fuel requirements.

Cargo Rack

Cargo rack is convenient for carrying equipment and various other cargo. It must never be used to carry a passenger.

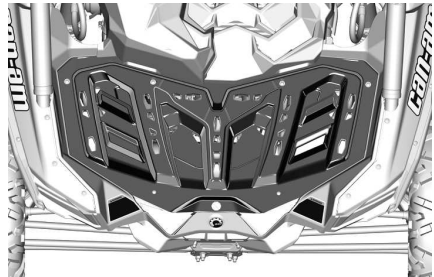

CARGO RACK

⚠ WARNING

- Never carry a passenger on a cargo rack.
- Cargo must never interfere with the drivers line of sight or affect his ability to properly steer the vehicle.
- Do not overload the vehicle.
- Always ensure all cargo is properly secured and does not extend out passed the rack.
- Never carry gasoline container (s) or any dangerous liquids on the cargo rack.

Refer to *Technical Specifications* for cargo weight recommendations.

Recovery Hook

Convenient hook that can be used to recover a stuck vehicle.

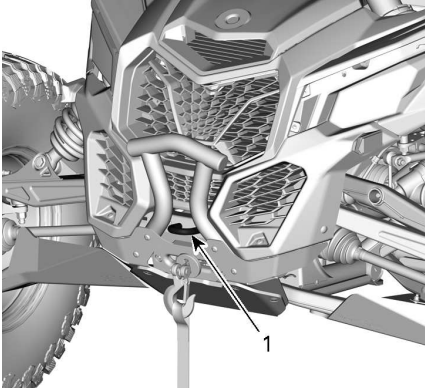

1. Front recovery hook

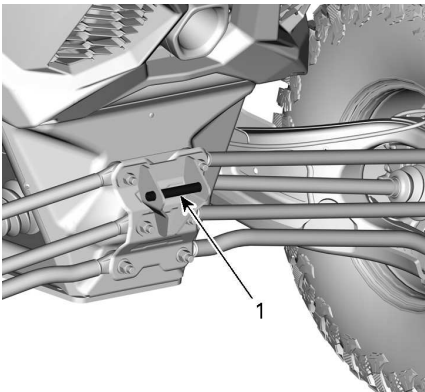

ALL MODELS

1. Rear recovery hook

NOTICE

Recovery hooks are designed to recover a stuck vehicle, they should not be used to carry a load, to attach a pulley or other mechanical devices that can overload the attachment point. Failure to do so can cause damages to the vehicle frame.

Wheel Scraper

Located inside the rear wheels to reduce accumulation of mud in the wheels that can damage parts inside the wheels.

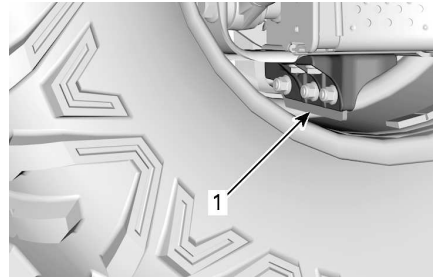

1. Wheel scraper

Check wheel scraper condition. Replace when wear exceeds wear limit at any location.

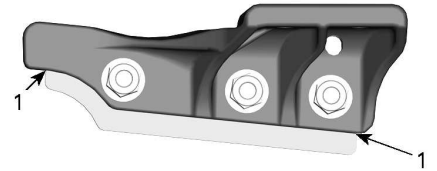

1. Wear limit

12-Volt Power Outlet

Convenient for handheld spotlight or other portable equipment.

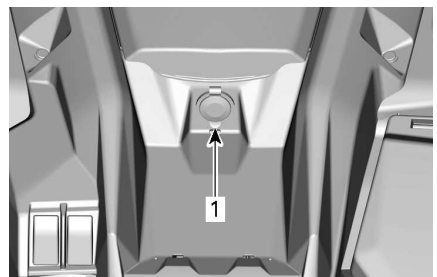

1. 12 V power outlet

Remove protective cap to use. Always reinstall it after use to protect against weather.

Central Rearview Mirror

This vehicle comes equipped with a central rearview mirror.

Be aware that objects in mirror are closer than they appear.

The mirror can be adjusted to suit driver's preference.

To adjust mirror; loosen knob located behind mirror and tighten it to secure mirror in position.

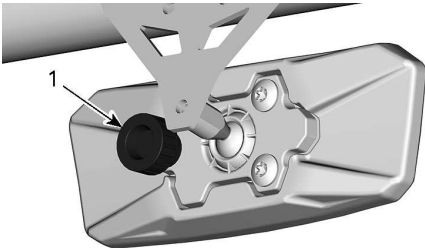

BEHIND THE MIRROR

1. Knob

⚠ WARNING

**Do not adjust mirrors while riding.
You could lose control.**

Winch (If Equipped)

⚠ WARNING

To avoid severe injury or death or important components damages.

- **Never use the winch cable/rope to retain a vehicle during trailering.**
- **Never ride with the winch cable/rope attached to a load or another vehicle.**
- **Only use the winch to help a stuck vehicle (snow, mud, etc.).**
- **Always refer to the winch manufacturer's instruction before pulling loads.**

The winch can be actuated inside the vehicle using the winch control switch on the upper console.

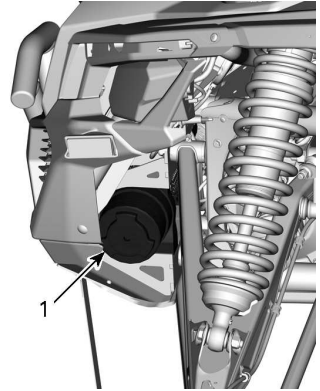

1. Winch

NOTE:

Using the winch intensively over a long period of time may discharge the battery.

The following tips will help to reduce the risk of discharging the battery:

Always unreel manually: Unlock the cable using the handle then pull on the hook strap to unreel.

It is recommended to let the vehicle run while winching. Do not stop vehicle immediately after winching to let battery recharge.

Also, when winching for more than 30 seconds, it is recommended to increase engine RPM in the range of 3000 RPM to increase charging power to the battery.

NOTE:

Make sure vehicle is in NEUTRAL (N) before increasing engine RPM.

Refer to your winch *Guide* included with your vehicle for proper winch operation.

Intensive use of the winch may cause the built-in circuit breakers to momentarily turn OFF. In such a case, wait a moment, then continue winching. The breakers automatically turn ON once they cooled down.

4.5" DIGITAL DISPLAY

MULTIFUNCTION DISPLAY

Lower Display



May display the following:

- RPM
- Speed statistics
- Engine Temperature
- Battery Voltage
- Settings
- Messages

Use LOWER button to change the displayed information.

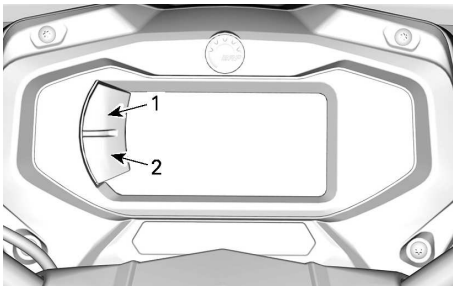

1. Upper button
2. Lower button

Left Lateral Display

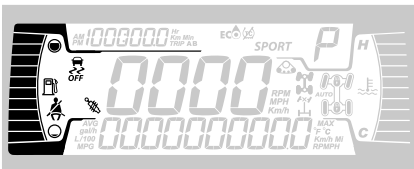

The left lateral display includes:

- Fuel level indicator
- Seat belt icon
- Traction control icon (if equipped)
- Smart-Shox suspension icon (if equipped)

Right Lateral Display

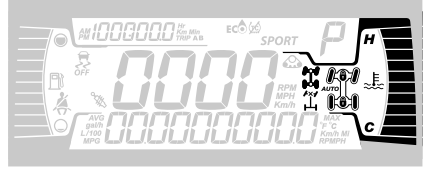

The left lateral display includes:

- Engine Temperature
- 2X4 / 4X4 telltale (if equipped)
- Front differential lock - Smart-Lok icon (if equipped)

Icon	Description
	2X4 icon
	4X4 icon
	Front differential lock - Smart-Lok icon

Central Display

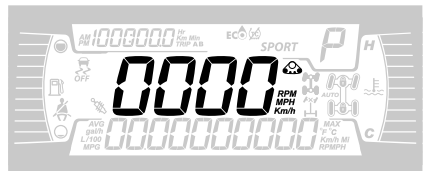

The central display includes:

- Vehicle speed in km/h or MPH or RPM.
- Track kit Active (if equipped)

Transmission Display

Position

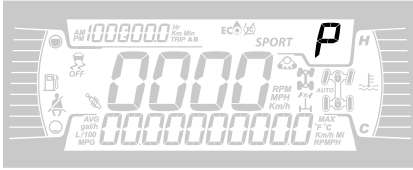

This display shows gear position of gearbox:

- P (Park)
- R (Reverse)
- N (Neutral)
- H (High Range)
- L (Low Range)
- - (Invalid Range)

Engine Mode Display

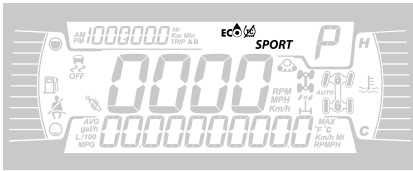

The MODE display indicates the selected mode of operation:

- ECO OFF (nothing is display)
- ECO
- WORK

To change between modes, hold LOWER button and short press LOWER button to cycle through available modes.

Drive Mode	Message at Activation
Eco OFF	ECO OFF
Eco	ECO MODE
Work	WORK MODE

The Traction Control icon  is also displays in this area.

Trip Display

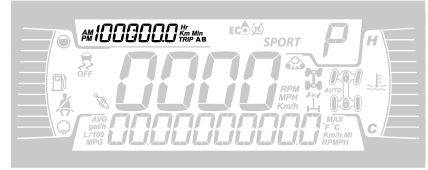

This display shows trip information:

- Cumulative distance odometer
- Trip A
- Trip B
- Vehicle hour meter
- Clock

Use UPPER button to change the displayed information.

Hold UPPER button to reset Trip A/B meters.

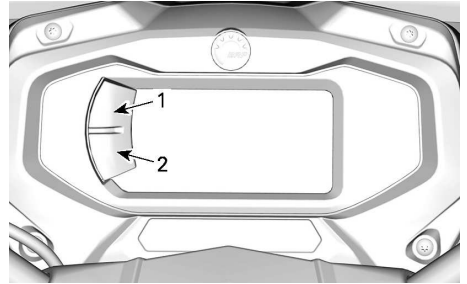









1. Upper button
2. Lower button



Indicator Lamps

Warning and Telltale Lights



WARNING and Telltale Lights	
	ORANGE - Vehicle Malfunction
	BLUE - High Beam
	RED - The engine temperature is too high.

WARNING and Telltale Lights	
	GREEN - Neutral
	RED - Brake lock lever is engaged or malfunction of the brake system
	RED - The battery voltage too low or problem with the electrical system
	RED - Low oil pressure Normally ON when engine is OFF
	ORANGE - Low fuel level
	ORANGE Turn on: Malfunction of the vehicle emissions control system Blink: Engine problems, the limp home mode is activated. Have the vehicle serviced immediately.

Icons and Indicators	
	maintenance is required. - See your authorized Can-Am Off-road dealer or person of your own choosing for the maintenance.
	- Track kit active (when installed).
	- Denote front differential lock - Smart-Lok is activated. (If Equipped)

SETTINGS

The buttons to navigate through menus are located on the left side of the LCD display.

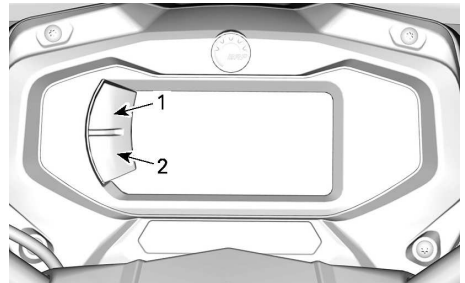



1. Upper button
2. Lower button

Setup

Using LOWER button, select **SETTINGS** and hold to enter setting menu.

Icons and Indicators

Icons and Indicators	
<i>SPORT</i>	- Denotes SPORT mode is selected.
	- Denotes ECO mode is selected.
	When lit, seat belt not buckled with vehicle immobilized. Flashing when vehicle is moving.
	- When lit, indicates that a

Maintenance Reset

NOTE:

Only when the maintenance icon is displayed.

Using LOWER button, select **RES MAINT** and hold to reset maintenance.

Fault Codes

Available only when at least one code is activated.

Using LOWER button, select **CODES** and hold to see active fault codes.

Fault codes will be scrolled on the Lower Display.

Reset Stats

Using LOWER button, select **RESET STAT** and hold to reset.

Unit Selection

This multifunction gauge is factory preset in Imperial units but it is possible to change it to Metric units.

Using LOWER button, select **UNITS** and hold button to change units.

Setting Clock

All of the following action must be performed using the LOWER button.

1. Select **CLOCK** and hold to adjust clock.
2. Press the button to select clock display.
3. Push and hold the button for 1 second.
4. Press the button to select 12:00 AM PM or 24:00 time base.
5. Push and hold the button to acknowledge selection.
6. Press the button to change hours (hours flash).
7. Push and hold the button to acknowledge hour selection.
8. Press the button to switch to minutes (minutes flash).

9. Push and hold the button to acknowledge minutes selection.

Setting Language

The gauge display language can be changed.

Refer to an authorized Can-Am Off-road dealer for language availability and to setup the gauge to your preference.

Setting Brightness

The brightness of the LCD display can be adjusted.

Using LOWER button, select **BRIGHTNESS** and hold button to change brightness.

Using LOWER button, adjust brightness then push and hold the button to acknowledge selection.

7.6" DIGITAL DISPLAY (KEYPAD)

Multifunction Display

⚠ WARNING

Do not adjust the display while riding, you could lose control.

Lower Display



May display the following:

- RPM
- Speed statistics
- Engine Temperature
- Battery Voltage
- Settings
- Messages
- Active DPS mode

The SPEED STAT display shows the maximum and the average speed. Hold MENU or OK button for 1 second to reset.

Left Lateral Display

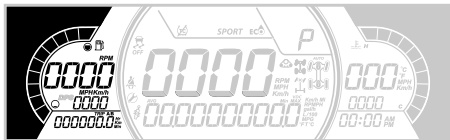

The left lateral display includes:

- Fuel level indicator
- Tripmeter (A - B)
- Odometer
- Vehicle Hour meter
- DPS indicator
- RPM
- Vehicle speed

NOTE:

When the vehicle speed is indicated here, the RPMs are automatically indicated in the central part and vice versa.

Right Lateral Display

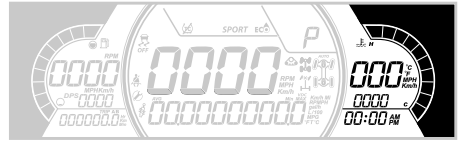

The right lateral display includes:

- Engine Temperature
- Clock
- Utility Speed limiter indicator

The speed indicator in this display is activated when the central display shows information other than the speed. Otherwise it is blank.

Central Display



May display the following:

- RPM
- Vehicle speed

Transmission Display

Position

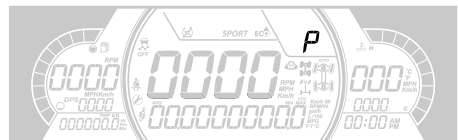

This display shows gears position of gearbox:

- P (Park)
- R (Reverse)
- N (Neutral)
- H (High range)
- L (Low range)
- - (Invalid gear)

Engine Mode Display

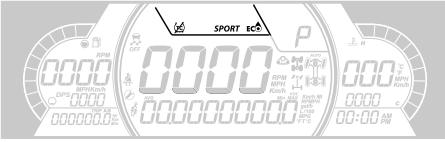

The engine mode display indicates the selected mode of operation:

- SPORT
- ECO

A message of the selected mode will be displayed on the lower display at activation and deactivation as follow:

Drive Mode	Message at Activation
Sport	SPORT MODE
ECO	ECO MODE



The Traction Control icon  is also displays in this area.

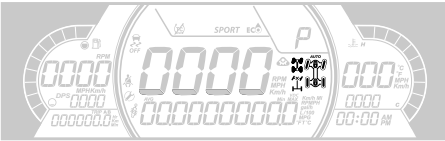

Middle Right Display



The middle right display indicates the selected mode of operation:

- 2X4
- 4X4
- Front differential lock (Smart-Lok)
- Track kit active (when installed).

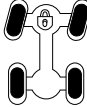
Icon	Description
	2X4 icon
	4X4 icon

Icon	Description
	Front differential lock
	Track kit active (when installed).

Middle Left Display







The middle left lateral display includes:





- Traction Control icon
- Seat belt reminder
- Maintenance reminder
- Smart-Shok suspension

Indicator Lamps





Warning and Telltale Lights





WARNING and Telltale Lights	
	ORANGE - Vehicle Malfunction
	BLUE - High Beam
	RED - The engine temperature is too high.
	GREEN - Neutral
	RED - Brake lock lever is engaged or malfunction of the brake system

WARNING and Telltale Lights	
	RED - The battery voltage too low or problem with the electrical system
	RED - Low oil pressure Normally ON when engine is OFF
	ORANGE - Low fuel level
	ORANGE Turn on: Malfunction of the vehicle emissions control system Blink: Engine problems, the limp home mode is activated. Have the vehicle serviced immediately.

Icons and Indicators

Icons and Indicators	
	- Denotes SPORT mode is selected.
	- Denotes ECO mode is selected.
	- When lit, seat belt not buckled with vehicle immobilized. - Flashing when vehicle is moving.
	- When lit, indicates that a maintenance is required. - See your authorized Can-Am Off-road dealer or person of your own choosing for the maintenance.

Icons and Indicators	
	Track kit active (If Equipped)
	- Denote front differential lock. When this option is available.

Settings

Setup

Using MENU button on the keypad, select **SETTINGS** and hold to enter setting menu.

OK button can be pressed instead of holding MENU button.

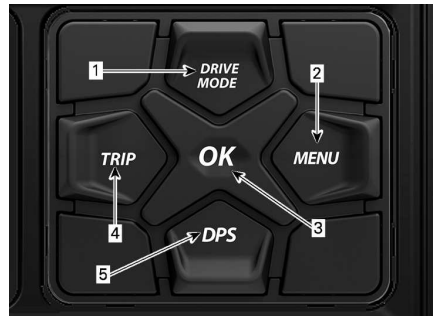

5 BUTTONS KEYPAD

1. DRIVE MODE button
2. MENU button
3. OK button
4. TRIP button
5. DPS button

Maintenance Reset

NOTE:

Only when the maintenance icon is displayed.

Using MENU button, select **RES MAINT** and hold to reset maintenance.

Fault Codes

Available only when at least one code is activated.

Using MENU button, select **CODES** and hold to see active fault codes.

Fault codes will be scrolled on the Lower Display.

Reset Stats

Using MENU button, select **RESET STAT** and hold to reset.

Unit Selection

This multifunction gauge is factory preset in Imperial units but it is possible to change it to Metric units.

Using MENU button, select **UNITS** and hold button to change units.

Speed/RPM

The speed and RPM display can be swapped.

Using MENU button, select **SPEED/RPM** and hold button to invert speed and RPM display.

Setting Clock

All of the following action must be performed using the MENU button.

1. Select **CLOCK** and hold to change time.
2. Press the button to select clock display.
3. Push and hold the button for 1 second.
4. Press the button to select 12:00 AM PM or 24:00 time base.
5. Push and hold the button or OK button to acknowledge selection.
6. Press the button to change hours (hours flash).
7. Push and hold the button or OK button to acknowledge hour selection
8. Push the button to switch to minutes (minutes flash).

9. Push and hold the button to acknowledge minutes selection.

Setting Brightness

The brightness of the LCD display can be adjusted.

Using MENU button, select **BRIGHTNESS** and hold MENU button to select the brightness setting.

Using MENU button, adjust brightness then push and hold MENU button to acknowledge selection.

Setting Language

The gauge display language can be changed.

Refer to an authorized Can-Am Off-road dealer for language availability and to setup the gauge to your preference.

DPS Modes

The lower display can show which DPS mode is active. Refer to *Tune Your ride*.

TUNE YOUR RIDE

DPS Function

The Tri-Mode Dynamic Power Steering (DPS) offers easy steering assistance to the rider. The level of assistance will automatically adapt according to the vehicle's speed and rider's demand, in order to provide maximum steering power at lower speed where the demand is normally higher. As speed increases, the assistance is progressively reduced to keep maximum steering feel and precision to the rider.

It is possible to choose between three modes of assistance: Minimum, Medium and Maximum. Each mode will continue to automatically adapt to the vehicle's speed and rider's demand, so it does not require to be changed when riding. These modes are used to set the level of assistance to match each rider's preferences.

The following DPS modes are preset in the vehicle.

DPS MODE	
DPS MAX.	Maximum steering assist
DPS MED.	Medium steering assist
DPS MIN.	Minimum steering assist

To show the active DPS mode, proceed as follows:

1. Press and release **DPS** button.

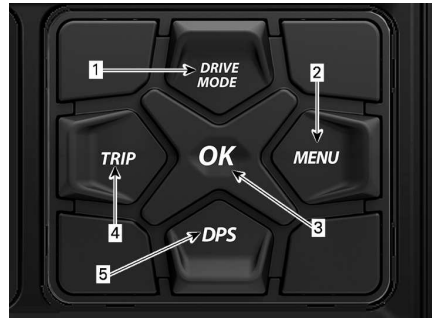

1. **DPS** button

2. Check the multifunction gauge to confirm the active DPS mode.

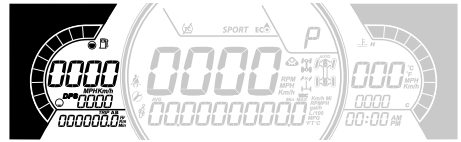

7.6" DIGITAL DISPLAY SHOWN

To change the DPS mode, proceed as follows:

3. Press and release **DPS** button.
4. Check the multifunction gauge to confirm the active DPS mode.
5. Press and hold **DPS** button for 2 seconds to go to the next setting.
6. Release **DPS** button.
7. Repeat until desired setting is selected.

NOTE:

The DPS adjustment will not be possible if the gearbox is set to **REVERSE**.

Suspension Adjustment Guidelines

Handling and comfort of the vehicle depend upon suspension adjustments.

⚠ WARNING

Suspension adjustment could affect vehicle handling.

Always take time to familiarize yourself with the vehicle's behavior after any suspension adjustment has been made.

Choice of suspension adjustments vary with vehicle load, personal preference, riding speed and terrain condition.

The best way to set up the suspension, is to start from factory settings, then customize each adjustment one at a time.

Front and rear adjustments are inter-related. It may be necessary to readjust the rear shock absorbers after adjusting front shock absorbers for instance.

Test run the vehicle under the same conditions; trail, speed, load, etc. Change one adjustment and retest. Proceed methodically until you are satisfied.

Following are guidelines to fine-tune suspension.

Adjustment Location

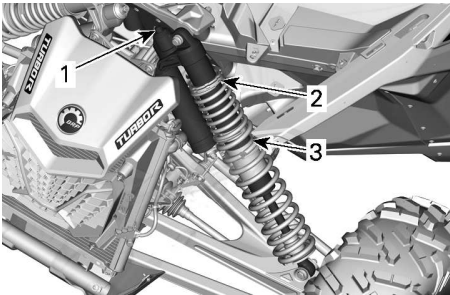

TYPICAL - WITHOUT REBOUND DAMPING - FRONT SUSPENSION

1. Compression damping
2. Preload
3. Spring Crossover

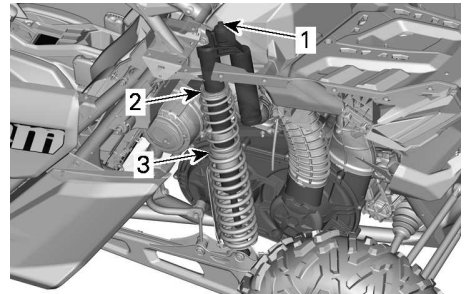

TYPICAL - WITHOUT REBOUND DAMPING - REAR SUSPENSION

1. Compression damping
2. Preload
3. Spring Crossover

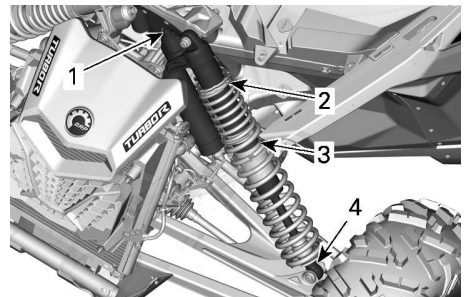

TYPICAL - WITH REBOUND DAMPING - FRONT SUSPENSION

1. Compression damping (high speed and low speed)
2. Preload
3. Spring Crossover
4. Rebound damping

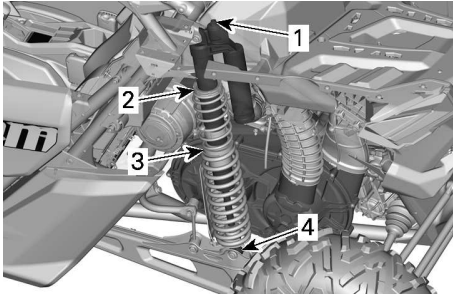

TYPICAL - WITH REBOUND DAMPING - REAR SUSPENSION

1. Compression damping (high speed and low speed)
2. Preload
3. Spring Crossover
4. Rebound damping

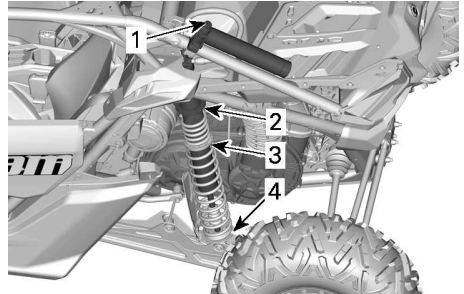

TYPICAL - WITH REBOUND DAMPING AND REMOTE RESERVOIR - REAR SUSPENSION

1. Compression damping (high speed and low speed)
2. Preload
3. Spring Crossover
4. Rebound damping

Suspension Factory Settings

For adjustment procedures, refer to *Suspension Adjustments*.

Front Suspension Factory Settings

Spring Preload	
Maverick MAX DS Turbo Maverick MAX DS Turbo RR	11.8 mm (0.465 in)
Maverick MAX X ds Turbo RR	19.5 mm (0.77 in)
Maverick MAX RS Turbo RR	67.5 mm (2.66 in)
Maverick MAX X rs Turbo RR	64.9 mm (2.56 in)
Maverick MAX X rs Turbo RR with Smart-Shox	57.3 mm (2.26 in)

Compression Damping	
Maverick MAX DS Turbo Maverick MAX DS Turbo RR Maverick MAX RS Turbo RR	Position 2

Compression Damping (LOW SPEED)	
Maverick MAX X ds Turbo RR	2 turns
Maverick MAX X rs Turbo RR	3 turns

Compression Damping (HIGH SPEED)	
Maverick MAX X ds Turbo RR	2 turns
Maverick MAX X rs Turbo RR	3 turns

Rebound Damping	
Maverick MAX X rs Turbo RR	Position 12

Crossover ring position	
Maverick MAX DS Turbo	94.5 mm (3.72 in)
Maverick MAX RS Turbo	52.3 mm (2.06 in)
Maverick MAX X rs Turbo RR	38.1 mm (1.5 in)
Maverick MAX X rs Turbo RR with Smart-Shox	53.6 mm (2.11 in)

Rear Suspension Factory Settings

Spring Preload	
Maverick MAX DS Turbo	91.8 mm (3.614 in)
Maverick MAX X ds Turbo RR	99.5 mm (3.92 in)
Maverick MAX X rs Turbo RR	210.4 mm (8.28 in)
Maverick MAX RS Turbo RR	235.2 mm (9.26 in)
Maverick MAX X rs Turbo RR with Smart-Shox	164.9 mm (6.49 in)

Compression Damping	
Maverick MAX DS Turbo Maverick MAX RS Turbo RR	Position 2

Compression Damping (LOW SPEED)	
Maverick MAX X ds Turbo RR	2 Turns
Maverick MAX X rs Turbo RR	3 Turns

Compression Damping (HIGH SPEED)	
Maverick MAX X ds Turbo RR Maverick MAX X rs Turbo RR	3 Turns

Rebound Damping	
Maverick MAX X ds Turbo RR Maverick MAX X rs Turbo RR	Position 12

Crossover ring position	
Maverick MAX DS Turbo	74.7 mm (2.94 in)
Maverick MAX X ds Turbo RR	71.6 mm (2.82 in)
Maverick MAX X rs Turbo RR	44.7 mm (1.76 in)
Maverick MAX RS Turbo RR	66.5 mm (2.62 in)
Maverick MAX X rs Turbo RR with Smart-Shox	93 mm (3.66 in)

Suspension Adjustments

Spring Preload Adjustment

Shorten the spring for a firmer ride and rough riding condition or when pulling a trailer (if equipped with hitch).

Lengthen the spring for a softer ride and smooth riding condition.

 WARNING
<p>The left and right shock adjustment on front or rear suspension must always be set to the same position.</p> <p>Never adjust one shock only. Uneven adjustment can cause poor handling and loss of stability, which could lead to an accident.</p>

Lift the vehicle. Spring length should be measured without load on the wheels.

Spring length should be equal on both sides.

Adjust by loosening lock ring and turning adjuster ring as desired. Use tool from vehicle tool kit.

NOTE:

Factory settings are suitable for almost all conditions. Take into consideration that an increase in ground clearance can affect the handling of the vehicle.

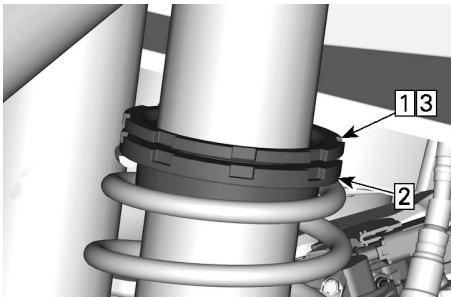

TYPICAL

1. Loosen top locking ring
2. Turn adjusting ring accordingly
3. Tighten top locking ring

Adjusting Spring Crossover

Dual compression rate crossover point can be modified by adjusting the crossover rings position. See an authorized Can-Am dealer.

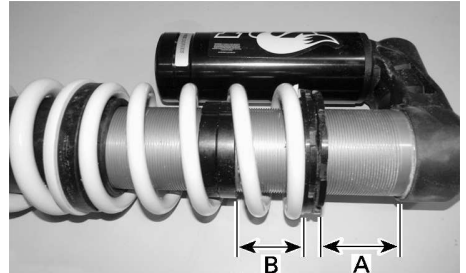

TYPICAL - CROSSOVER ADJUSTMENT - REAR SHOCK

- A. Spring preload
- B. Crossover ring position

Compression Damping Adjustments (If Equipped)

Compression damping controls how the shock absorber reacts when riding.

Position	Setting	Result on Big Bumps
1	Soft	Softer compression damping
2	Medium (Factory)	Medium compression damping
3	Hard	Firmer compression damping

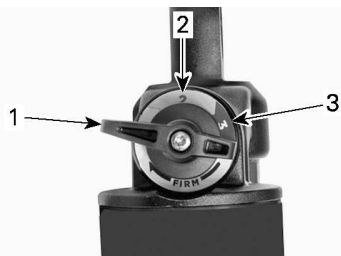

1. Position 1
2. Position 2
3. Position 3

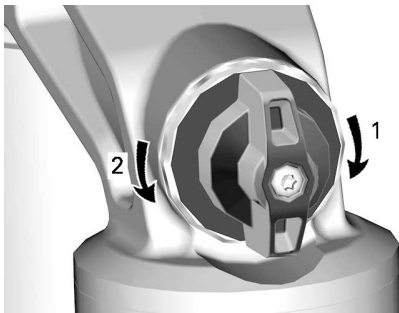

COMPRESSION DAMPING

1. *Increases* damping (stiffer)
2. *Decreases* damping (softer)

Turn adjuster clockwise to **increase** shock damping action (stiffer).

Turn adjuster counterclockwise to **decrease** shock damping action (softer).

Action	Result
Increasing compression damping force	Firmer compression damping
Decreasing compression damping force	Softer compression damping

⚠ WARNING
Make sure compression damping setting is the same on both sides.

Low Speed Compression Damping (If Equipped)

Low speed compression damping controls how the shock absorber reacts to a low suspension velocity (slow compression strokes, in most cases when riding at lower speeds).

Action	Result on Big Bumps
Increasing low speed compression damping force	Firmer compression damping (slow compression)
Decreasing low speed compression damping force	Softer compression damping (slow compression)

To adjust the low speed compression damping:

1. Turn the adjuster clockwise until it stops.
2. Turn adjuster counterclockwise by the required turns.

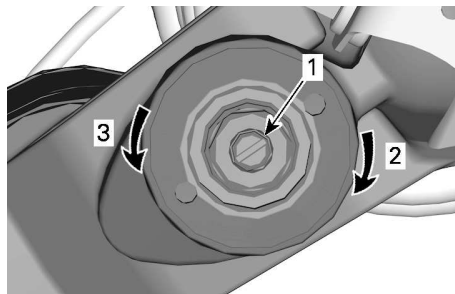

LOW SPEED COMPRESSION DAMPING (USE A SCREWDRIVER)

1. Adjustment screw
2. *Increases* compression damping (stiffer)
3. *Decreases* compression damping (softer)

Turning it clockwise (H) **increases** shock damping action (stiffer).

Turning it counterclockwise (S) **decreases** shock damping action (softer).

High Speed Compression Damping (If Equipped)

High speed compression damping controls how the shock absorber reacts to a high suspension velocity (quick compression strokes, in most cases when riding at higher speeds).

Action	Result on Small Bumps
Increasing high speed compression damping force	Firmer compression damping (fast compression)
Decreasing high speed compression damping force	Softer compression damping (fast compression)

To adjust the high speed compression damping:

1. Turn the adjuster clockwise until it stops.
2. Turn adjuster counterclockwise by the required turns.

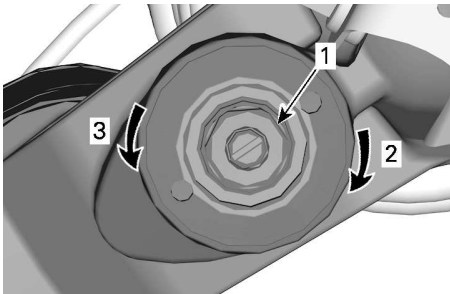

HIGH SPEED COMPRESSION DAMPING (USE A 17 MM WRENCH)

1. Adjustment screw
2. **Increases** compression damping (stiffer)
3. **Decreases** compression damping (softer)

Rebound Damping (If Equipped)

To adjust the rebound damping:

1. Turn the adjuster clockwise until it stops.
2. Turn adjuster counterclockwise to the required position (clicks).

Use a flat screwdriver to adjust it.

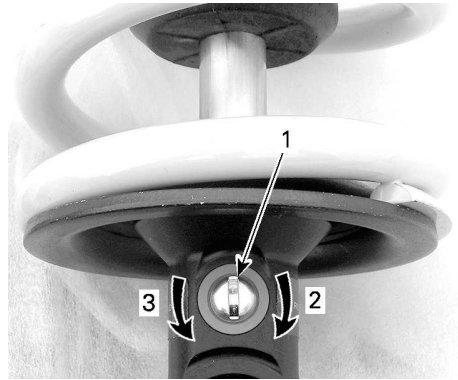

1. Rebound adjuster
2. **Increases** rebound (stiffer)
3. **Decreases** rebound (softer)

Smart-Shox Suspension Mode

The Smart-Shox suspension is an electronic-controlled compression and rebound damping system integrated in each shock absorbers.

It is possible to choose between three modes of damping. These modes set the level of damping to match the rider's preferences.

The following Smart-Shox modes are preset in the vehicle.

Smart-Shox Mode	
COMFORT	This mode provides maximum comfort. The suspension moves freely while controlling body movement to avoid bottoming out and enhance cornering and acceleration.
SPORT	This mode enhance handling and provides comfort in straight line. The suspension minimizes body movement in cornering, accelerating and braking while offering optimal calibration to face bumpy trails.
SPORT+	This mode is all about performance, forget comfort. In full stiffness all the time and ready to tackle the most extreme situations.

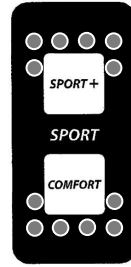

The shock icon is blinking when changing the mode.

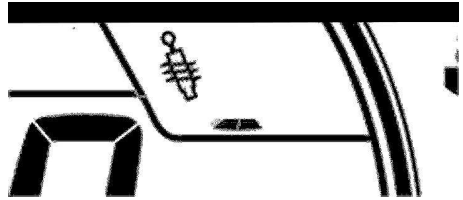

TYPICAL — 4.5" DIGITAL DISPLAY

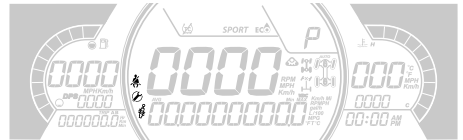

TYPICAL — 7.6" DIGITAL DISPLAY

To select the Smart-Shox mode, proceed as follows:

1. Position the button on the desired mode.

2. Check the lower display of the gauge to confirm the active Smart-Shox mode.

FUEL

FUEL REQUIREMENTS

NOTICE

Always use fresh gasoline. Gasoline will oxidize; the result is loss of octane, volatile compounds, and the production of gum and varnish deposits which can damage the fuel system.

Alcohol fuel blending varies by country and region. Your vehicle has been designed to operate using the recommended fuels, however, be aware of the following:

- Use of fuel containing alcohol above the percentage specified by government regulations is not recommended and can result in the following problems in the fuel system components:
 - Starting and operating difficulties.
 - Deterioration of rubber or plastic parts.
 - Corrosion of metal parts.
 - Damage to internal engine parts.
- Inspect frequently for the presence of fuel leaks or other fuel system abnormalities if you suspect the presence of alcohol in gasoline exceeds the current government regulations.
- Alcohol blended fuels attract and hold moisture which may lead to fuel phase separation and can result in engine performance problems or engine damage.

Recommended Fuel

Use premium unleaded gasoline with an AKI (R+M)/2 octane rating of 91, or an RON octane rating of 95.

Use unleaded gasoline containing **MAXIMUM 10%** ethanol.

E10

NOTICE

Never experiment with other fuels. Engine or fuel system damages may occur with the use of an inadequate fuel.

NOTICE

Do NOT use fuel from fuel pumps labeled E85.

Use of fuel labeled E15 is prohibited by U.S. EPA Regulations.

Vehicle Fueling Procedure

WARNING

- **Fuel is flammable and explosive under certain conditions.**
- **Never use an open flame to check fuel level.**
- **Never smoke or allow flame or spark in vicinity.**
- **Always work in a well-ventilated area.**
- **Vehicle must be on a level surface to perform fueling.**

1. Place vehicle on a level surface.
2. Stop engine.

WARNING

Always stop engine before refueling.

3. Have driver and passenger get out of vehicle.

⚠ WARNING

Do not allow anyone to remain in the vehicle while fueling. If there is a fire or explosion during fueling, a vehicle occupant could be unable to quickly leave the area.

4. Open the fuel reservoir cap cover.

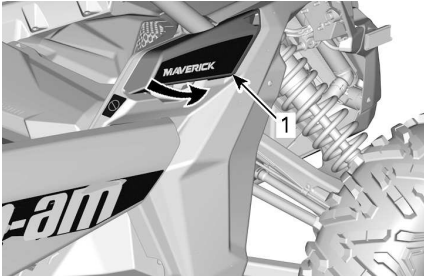

1. Fuel reservoir cap cover

5. Slowly unscrew the fuel reservoir cap counterclockwise to remove it.

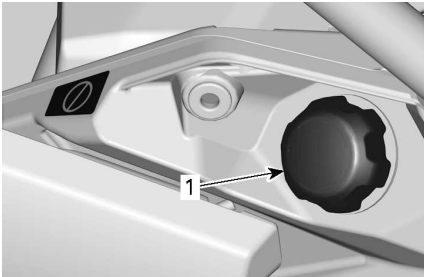

1. Fuel reservoir cap

⚠ WARNING

If a differential pressure condition is noticed (whistling sound heard when loosening fuel reservoir cap) have vehicle inspected and/or repaired before further operation.

6. Insert the spout into the filler neck.
7. Pour fuel slowly so that air can escape from the tank and prevent fuel flow back. Be careful not to spill fuel.

8. Stop filling when the fuel reaches the bottom of filler neck. Do not overfill.

⚠ WARNING

Never top up the fuel tank before placing the vehicle in a warm area. As temperature increases, fuel expands and may overflow.

9. Fully tighten fuel reservoir cap clockwise until you hear a clicking noise.

⚠ WARNING

Always wipe off any fuel spillage from the vehicle.

BREAK-IN PERIOD

Operation During Break-In

A break-in period of 10 operating hours or 300 km (200 mi) is required for the vehicle.

Engine

During the break-in period:

- Avoid full throttle operation.
- Avoid pressing accelerator pedal more than 3/4 of the stroke.
- Avoid sustained accelerations.
- Avoid prolonged cruising speeds.
- Avoid engine overheating.

However, brief accelerations and speed variations contribute to a good break-in.

Brakes

 WARNING
--

<p>New brakes will not operate at their maximum efficiency until their break-in is completed. Braking performance may be reduced, so use extra caution.</p>
--

<p>Apply moderate braking force for the 40 to 50 first braking events.</p>

Drive Belt

A new belt requires a break in period of 50 km (30 mi).

During the break-in period:

- Avoid strong acceleration and deceleration.
- Avoid pulling a load.
- Avoid high speed cruising.

BASIC PROCEDURES

Starting the Engine

Install D.E.S.S. key on D.E.S.S. post.

Press the brake pedal.

NOTE:

If shift lever is not set to PARK (P) or (N) NEUTRAL, the brake pedal must be pressed to allow engine starting.

Press the engine start button and hold until the engine starts.

NOTE:

Do not press the accelerator pedal. If the accelerator pedal is pressed at least 20%, the engine will not start.

Release the engine start button immediately when the engine has started.

NOTICE

If engine does not start after a few seconds, do not hold the engine start button more than 10 seconds. Refer to *Troubleshooting* section.

Wait approximately 10 seconds to let engine oil flow through engine and turbo.

Waking Up the Electrical System

Press and release the START button for less than half a second and the electrical system will turn ON:

- For 20 seconds, **without** powering any equipment, if the D.E.S.S. key is **NOT** installed on the D.E.S.S. post.
- For 10 minutes, powering equipment, if the D.E.S.S. key is installed on the D.E.S.S. post. The electrical system will shutdown after 20 seconds if the D.E.S.S. key is removed.

NOTICE

Waking up the electrical system repeatedly or using electrical equipment will discharge the battery and you may not be able to start the engine.

Operating the Shift Lever

Apply brakes and select the desired shift lever position.

Release brakes.

NOTICE

When changing gear selection, always completely stop the vehicle and apply the brakes prior to shifting. Damage to the gearbox may occur.

Choosing the Correct Range (Low or High)

It is important to limit situations known to make the drive belt slip excessively. The main reason the drive belt will slip is if the gearbox is in high range when it should be in low range.

Pay attention to the following:

Low Range

Low range should be used whenever:

- Pulling
- Pushing
- Hauling a load
- 4x4 applications
- Mud holes
- Water holes
- Crossing obstacles
- Climbing onto trailer
- Hill climbing

It is also recommended to use low range if driving for prolonged periods at speeds under 24 km/h (15 MPH)

Please refer to *Break-In Period* in this guide for information in regards to belt break-in period.

High Range

High is the default riding range.

Electronic Drive Belt Protection (if available and activated on your model)

Some vehicles have the electronic drive belt protection function activated.

Refer to your authorized Can-Am dealer for availability and possible activation.

This function is activated when riding at too slow speed for the **high range**, such as in the following situations:

- Pulling
- Pushing
- Hauling a load
- 4x4 applications
- Mud holes
- Water holes
- Crossing obstacles
- Climbing onto trailer
- Hill climbing

In the above mentioned situations the electronic drive belt protection will help protect the CVT drive belt from being damaged by activating the engine torque limiter. The gauge will also scroll a **LOW GEAR** message, suggesting the operator to immobilize the vehicle and set to LOW GEAR.

Whenever the electronic drive belt protection is activated, you MUST shift in LOW range. Refer to *Operating the Shift Lever*.

The message **BELT OVERHEAT** and the ! telltale light will turn ON when the belt temperature is over 75 °C (167 °F) for more than 1 minute. A buzzer will also be activate once every 10 minutes.

When the temperature return below 70 °C (158 °F), the warning will turn off.

If the situation does not allow you to shift in LOW range, it is possible to temporarily deactivate the electronic drive belt protection by pressing on the override switch. Refer to *Override Switch*.

WARNING

DO NOT USE THE OVERRIDE SWITCH if the slope is too steep and that there might be a risk of tipover. Apply brakes to immobilize vehicle. Put shift lever in reverse (R), and back down the hill, barely releasing brakes to remain at low speed. Do not attempt to turn around. Never coast down hill while vehicle is in neutral. Do not perform hard braking as it increases the risk of tipover.

Stopping the Engine and Parking the Vehicle

WARNING

Avoid parking brake on steep slope as the vehicle may roll away.

WARNING

Always put the vehicle in PARK when stopped or parked to prevent rolling.

WARNING

Avoid parking in places where hot parts can start a fire.

When stopped or parked always bring shift lever to park position. This is especially important when parking on a slope. On very steep inclines or if the vehicle is carrying a cargo, the wheels should be blocked using rocks or bricks.

Select the flattest terrain available for parking.

Release accelerator pedal and use brakes to completely stop the vehicle.

Set shift lever in PARK position.

Press the start / stop button to stop the engine.

Remove D.E.S.S key from its post.

If you must park on a steep incline or if the vehicle is carrying cargo, block the wheels using rocks or bricks.

Before stopping the engine and parking the vehicle following a more intense ride, let vehicle run idle for a period of 20 to 30 seconds to allow for cooling of the turbo system.

Tips for Maximizing Drive Belt Durability

Riding style and conditions have a direct impact on drive belt durability. Your vehicle features a CVT system design that is optimized to offer the best performance. The CVT and drive belt have successfully endured thousands of miles of durability tests. However, to maximize drive belt durability and to prevent premature failures, it is important that the operator understands the limits of a belt driven CVT system and adapts their riding style and speed accordingly.

If riding in any of the conditions listed below, BRP highly recommends not to constantly hold the throttle wide open (WOT) for more than five (5) minutes.

- High ambient temperatures (above 30 °C/86 °F)
- Heavy loads: Passengers / Heavy cargo
- Heavy drag: Soft sand / Hill climbing / Mud / Using a track kit.

After a few minutes at WOT, partially release the accelerator and allow the CVT to cool down.

For more tips for maximizing the drive belt durability, refer to *Choosing the Correct Range (Low or High)*.

SPECIAL PROCEDURES

What to do if Water Entered the CVT

If water is present in the CVT, the engine will accelerate but the vehicle will remain still.

NOTICE

Stop the engine and drain the water to avoid damage to the CVT.

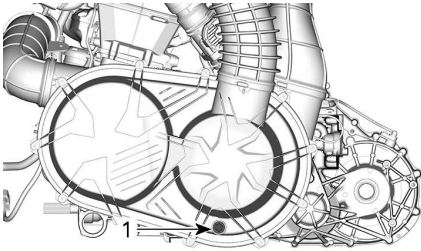

1. CVT drain

The CVT drain is accessible from under the rear of vehicle on the LH side.

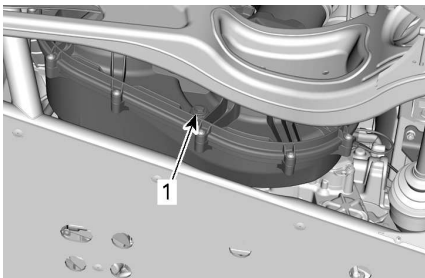

1. CVT drain

See an authorized Can-Am dealer to have the CVT inspected and cleaned.

What to do if Battery is Drained Out

The vehicle can be jump started by using the red (+) cable to the battery positive pole and the black (-) cable to the vehicle chassis.

To access the battery, move the passenger seat completely forward. Refer to *Seats in Equipment*.

NOTICE

Do not connect any electrical source to the steering column or components which are in contact with DPS.

What to Do if Vehicle Rolled Over

Abrupt maneuvers, sharp turns, side hilling or accident may cause vehicle to rollover.

Should the vehicle be rolled over, it will be necessary to have it transported to an authorized Can-Am Off-road dealer for inspection as soon as possible. **NEVER START THE ENGINE!**

Points to be verified, including but not limited to:

- All fluid levels
- Seat belts, including retractors, buckles and semi-cinching tabs
- Cage and its attachment points
- Steering system
- Suspension and its attachment points.

What to do if Vehicle is Submerged

Should the vehicle become immersed, it will be necessary to have it transported to an authorized Can-Am Off-road dealer as soon as possible.

NOTICE

Never start the engine as immersion of the vehicle can cause serious damage to the engine if the correct restart procedure is not followed.

TRANSPORTING THE VEHICLE

When contacting a towing or transporting service, be sure to ask if they have a flatbed trailer, loading ramp or power ramp to safely lift the vehicle and tie-down straps. Ensure the vehicle is properly transported as specified in this section.

NOTICE

Do not tow this vehicle — towing can seriously damage the vehicle's drive system.

NOTICE

Avoid using chains to tie the vehicle — they may damage the surface finish or plastic components.

⚠ WARNING

To avoid severe injury or death or important components damages.

- Never use the winch cable/rope to retain a vehicle during trailering.
- Never ride with the winch cable/rope attached to a load or another vehicle.
- Only use the winch to help a stuck vehicle (snow, mud, etc.).
- Always refer to the winch manufacturer's instruction before pulling loads.

⚠ WARNING

Make sure all seats, accessories, cargo and loose objects inside the vehicle are properly secured, or remove it to prevent from failing on the road and creating a hazard for following vehicles.

⚠ WARNING

Always transport the vehicle facing forward to avoid damaging the windshield or other components. Parts may detach during transport.

⚠ WARNING

Before attempting to mount vehicle onto a platform or a trailer, make sure to respect the following safety precautions.

SAFETY PRECAUTIONS

Carrying equipment	The carrying item (platform or trailer or flat bed) must be of appropriate dimensions and capacity to safely support and transport the vehicle.
Hauling vehicle	Do not exceed vehicle hauling capacity and specifications. Ensure the trailer or platform is properly secured to the hauling vehicle hitch.
Visibility	Ensure you have a good visibility during the entire maneuver.
Terrain	The hauling vehicle and trailer must be on a leveled surface. Use wheel chocks on trailer and hauling vehicle to avoid any movement.
Ramps	Use ramps with proper rating and secure ramps to the trailer or platform. Avoid steep ramps.

SAFETY PRECAUTIONS	
Bystanders	Always make sure bystanders are not close to the vehicle or the trailering equipment while climbing up.
Seat and Accessories	Make sure all seats, accessories and cargo are properly secured, or remove it to prevent from falling on the road and creating a hazard for following vehicles.

Using Vehicle Power to Climb Onto Trailering Equipment

When vehicle can climb on its own power, proceed as follows;

1. Wear protective gear.
2. Fasten seat belt.
3. Use low gear only (if equipped).
4. When driving remain seated at all times.
5. Ensure proper alignment on rails or platform.
6. Start from a sufficient distance from the trailer to align the vehicle in a straight line with the ramps. Never attempt to turn while getting closer to the ramp. Rear wheels might not be aligned once you get to the ramp and vehicle may fall off.
7. Slowly climb the front wheels onto the ramp to verify alignment.
8. Back off the vehicle, verify ramps are still secure, then proceed at proper speed.
9. Carefully drive vehicle onto platform or trailer. Use sufficient speed to climb without spinning or abruptly accelerating. Avoid acceleration while on ramps to prevent ramps movement.
10. If trailer is inclined towards front, simply let vehicle roll in without acceleration.

11. Once vehicle is climbed, put shift lever to Park. Apply brake locking mechanism (if equipped).

When vehicle cannot move on its own power, or in case overshooting is a risk or if any dangerous condition prevents for embarking on its own power, proceed using a winch;

Using a Winch to Pull Vehicle Onto Trailering Equipment

When vehicle cannot climb on its own power, proceed as follows;

WARNING

Have the help of an assistant. One person should be in vehicle to have access to vehicle steering, brakes and winch switch, while the other person controls the environment and safety of the maneuver.

WARNING

Ensure the winch hook can be safely attached to a proper anchoring point. Use proper rigging.

NOTE:

If vehicle can be started safely, let engine idle during winching to avoid draining the battery.

1. Place shift lever to NEUTRAL (N).
2. If the vehicle is equipped with a winch, use the winch to roll the vehicle on the platform.
3. If the vehicle is not equipped with a winch, proceed as follows:
 1. Attach strap to lower front bumper anchor.
 2. Attach the strap to the winch cable of the towing vehicle.
 3. Pull the vehicle on the flatbed trailer with the winch.
4. Put shift lever to Park. Apply brake locking mechanism (if equipped).

Securing Vehicle for Transport

⚠ WARNING

To avoid severe injury or death or damage to important components.

- Never use the winch cable/rope to retain a vehicle during trailering.
- Never ride with the winch cable/rope attached to a load or another vehicle.
- Only use the winch to help a stuck vehicle (snow, mud, etc.).
- Always refer to the winch manufacturer's instructions before pulling loads.

1. Remove the key from the D.E.S.S. post.
2. At rear, secure the vehicle on both sides using a strap around the suspension arm as close to the wheel as possible.
3. At front, secure the vehicle on both sides using a strap around the lower suspension arm as close to the wheel as possible.

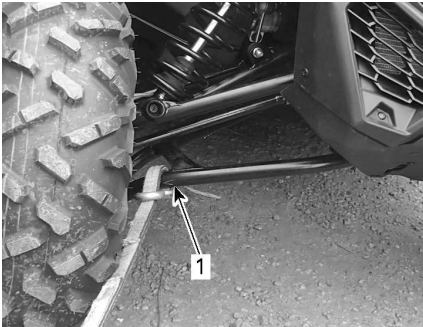

1. Front lower suspension arm

4. Strap the rear tires by using tire towing straps.
5. Firmly attach the rear suspension tie-down straps to both sides of the rear of the trailer with ratchets.

6. Ensure that both the front and rear wheels are firmly attached to the trailer.

Getting Vehicle Out of Trailer

⚠ WARNING

Vehicle may have moved during transport. Ensure vehicle is properly aligned with ramps before proceeding.

⚠ WARNING

Visibility will be greatly reduced when backing off from the trailer. Have the help of an assistant to ensure proper alignment and safe environment.

LIFTING AND SUPPORTING THE VEHICLE

Front of Vehicle

Place vehicle on a flat non slippery ground.

Engage the 4WD mode.

Ensure vehicle shift lever is set to PARK.

Install an hydraulic jack under the round tube.

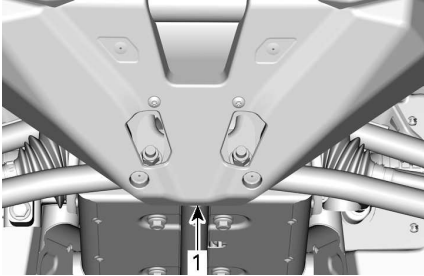

FRONT OF VEHICLE

1. Hydraulic jack position

Lift front of vehicle and install a jack stand on each side under frame as shown below:

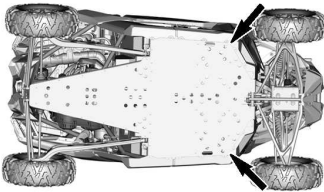

JACK STAND POSITIONS - FRONT OF VEHICLE

Lower hydraulic lift and ensure vehicle is supported safely onto both jack stands.

Rear of Vehicle

Place vehicle on a flat non slippery ground.

Activate 4WD mode.

Ensure vehicle shift lever is set to PARK.

Install an hydraulic jack under the vehicle.

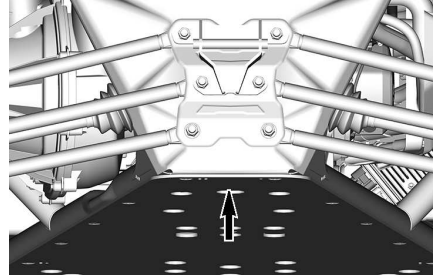

REAR OF VEHICLE

1. Hydraulic jack position

Lift rear of vehicle and install a jack stand on each side under frame as shown below:

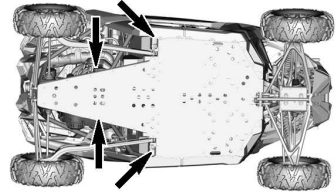

JACK STAND POSITIONS - REAR OF VEHICLE

Lower hydraulic lift and ensure vehicle is supported safely onto both jack stands.

This page is intentionally blank

MAINTENANCE

MAINTENANCE SCHEDULE

Maintenance is very important to keep your vehicle in safe operating condition. The vehicle should be serviced as per the maintenance schedule.

Proper maintenance is the owner's responsibility. A warranty claim may be denied if, among other things, the owner or operator caused the problem through improper maintenance or use.

Perform periodic checks and follow the maintenance schedule. **The maintenance schedule does not exempt the pre-ride inspection.**

WARNING

Failure to properly maintain the vehicle according to the maintenance schedule and procedures can make it unsafe to operate.

EPA Regulation - Canadian and USA Vehicles

A repair shop or person of the owner's choosing may maintain, replace, or repair emission control devices and systems. These instructions do not require components or service by BRP or authorized Can-Am Off-road dealers.

Although an authorized Can-Am Off-road dealer has an in-depth technical knowledge and tools to service your vehicle, the emission-related warranty is not conditioned on the use of an authorized Can-Am Off-road dealer or any other establishment with which BRP has a commercial relationship.

Proper maintenance is the owner's responsibility. A warranty claim may be denied if, among other things, the owner or operator caused the problem through improper maintenance or use.

For emission-related warranty claims, BRP is limiting the diagnosis and repair of emission-related parts to the authorized Can-Am Off-road dealers. For more information, please refer to the *US EPA Emission-Related Warranty* contained in the *Warranty* section.

You must follow the instructions for fuel requirements in the fueling section of this manual. Even if gasoline containing greater than ten volume percent ethanol is readily available, the US EPA issued a prohibition against the use of gasoline containing greater than 10 vol% ethanol that applies to this vehicle. The use of gasoline containing greater than 10 vol% ethanol with this engine may harm the emission control system.

Air Filter Maintenance Guideline

Air filter maintenance should be adjusted according to riding conditions.

Air filter maintenance must be increased in frequency when riding on snow, dry sand, dirt, gravel or similar conditions which have a high dust or particle dispersion.

Riding in a group in these conditions will require increasing the air filter maintenance frequency further.

NOTE:

Accessory filters and pre-filter are available for such conditions. Contact an authorized Can-Am off-road dealer for details.

Severe Duty Use

If your vehicle is used in the following conditions, refer to the *Severe Duty* section of the maintenance schedule.

- Repeated hauling of loads at more than 75% the maximum capacity.
 - The increase workload applied to the drive system accelerates the differentials, gearbox/transmission, and engine oil life. This reduces internal component longevity if not replaced more frequently.
- Driving at excessive speeds for prolonged amount of time.

Commercial/work and rental vehicles must also use the *Severe Duty* maintenance schedule.

Higher than the average use requires more frequent fluid and wear component replacement than trail, recreational, or occasional utility purposes.

Extreme Cold Condition

An engine that is frequently operated at or below an ambient temperature of -25 °C (-13 °F) will require an increase in service and maintenance schedule.

Any combustion engine operated at these low ambient temperature will collect an increased amount of condensation at every startup/warm-up.

Since the engine is not reaching operating temperatures for extended periods of time, the oil is starting to be strongly diluted with water and gas residue (more water content).

An engine needs to reach operating temperature, in order to be able to evaporate condensate out of the oil.

If daily usage (work or leisure driving cycle) is similar to those mentioned below, BRP strongly recommends changing the oil at least once a month.

Parameters of an increase in service and maintenance schedule:

- Engine not reaching the proper operating temperature during normal daily usage
- Multiple starts and stops without reaching operating temperature
- Short idle periods
- Low RPM driving cycle in short distances without reaching operating temperature.

NOTE:

BRP strongly recommends the installation of a block heater to help warm up the liquids, this will also help to extend the oil lifetime.

Deep Mud / Water Use

Whether your vehicle is a X mr model or was accessorized for deep mud / water use, this type of usage requires more frequent maintenance and inspections to ensure debris has not infiltrated mechanical components.

If you regularly ride in deep mud or water, refer to the *Deep Mud / Water* section of the maintenance schedule.

After every ride, be sure to perform the *Post Operation Care for Deep Mud / Water Environment*.

Post Operation Care for Deep Mud / Water Environment

- Rinse the vehicle and its components with fresh water.
- Clean the CVT air filters.
- Drain the CVT compartment and clean if any water or mud is found.
- Inspect and clean engine air filters and engine air filter housing.
- Clean debris around exhaust pipe and muffler area and the spark arrester.
- Clean radiator.
- Visually inspect for any water accumulation in the vent hoses (fuel tank, gear-box, front differential and rear final drive). If there is water, bring the vehicle to your nearest authorized Can-Am off-road dealer for inspection and servicing of main components related to the vents.
- Clean front and rear shock absorbers to prevent seal from damage by dust or dirt.
- Clean drive shaft bellows and the propeller shaft yokes or boots.

Maintenance Schedule

Make sure to perform proper maintenance at recommended intervals as indicated in the tables.

The maintenance chart intervals are based on 3 factors:

- Calendar time
- Vehicle hours
- Odometer reading.

Take in account whichever comes first to determine the maintenance threshold.

Your driving habits determines the factors you shall adhere too. For example:

- Someone who uses their vehicle every other weekend trail riding with friends would most likely follow the **odometer reading** to determine the maintenance interval.
- Someone who uses their vehicle seldomly over the year or only on a few occasions (hunting, camping) would most likely follow the **calendar time** to determine the maintenance interval.
- Someone who uses their vehicle daily / weekly for long periods of time such as agricultural / work would most likely follow the **vehicle hours** to determine the maintenance interval.

IMPORTANT: The following tables show the appropriate maintenance application for the first 3 years. For subsequent years, repeat the same pattern alternatively.

Regular Maintenance Overview

Calendar Years	Vehicle Hours	Odometer	Regular Duty
1	100	3 000 km (1,900 mi)	A
2	200	6 000 km (3,700 mi)	A and B
3	300	9 000 km (5,600 mi)	A

Severe Duty and Mud/Water Maintenance Overview

Calendar Years	Vehicle Hours	Odometer	Severe Duty and Deep Mud / Water
0.5	50	1 500 km (900 mi)	A+
1	100	3 000 km (1,900 mi)	A+ and A
1.5	150	4 500 km (2,800 mi)	A+
2	200	6 000 km (3,700 mi)	A+ and A and B
2.5	250	7 500 km (4,700 mi)	A+
3	300	9 000 km (5,600 mi)	A+ and A

REGULAR DUTY	A	B
A = Adjust C = Clean I = Inspect L = Lubricate R = Replace T = Torque	Every year or 100 hours or 3 000 km (1,900 mi)	Every 2 years or 200 hours or 6 000 km (3,700 mi)
Air and Fuel Delivery		
Engine air filter	I,C or R	
Air delivery components and function (airbox, throttle body, ducts, clamps)*	I,C	
Fuel components and function (fuel tank cap, fuel tank, hoses, clamps, leaks)*	I	
Fuel pump pressure		I
Body/Chassis and Accessories		
Cage fasteners	T	
Seat belts retractors, buckles and semi-cinching	I,C	
Winch	I,C	
Door latches, hinges and key barrels	L,T	
Engine and Cooling		
Engine oil and filter	R	
Spark plugs (regardless of calendar times)		R
Engine seal and gaskets	I	
Engine cooling components (coolant level and specific gravity, hose condition, clamps, leaks)*	I,A	
Engine coolant	R Every 5 years or 12 000 km (7,500 mi)	
Radiator	C	
Exhaust and Emissions		
Fuel tank vent breather filter (Non-EVAP models)	R	
Canister vent pre-filter (CARB and EVAP models)		R
Exhaust components (gaskets, pipes, muffler condition, leaks)*	I	
Muffler spark arrester	C	

REGULAR DUTY	A	B
A = Adjust C = Clean I = Inspect L = Lubricate R = Replace T = Torque	Every year or 100 hours or 3 000 km (1,900 mi)	Every 2 years or 200 hours or 6 000 km (3,700 mi)
Debris around exhaust pipe and muffler area	C	
Brakes		
Brake components (caliper, disc(s), brake line, pads, master cylinder)*	I,C,L,A	
Brake fluid	R Every 2 years	
Drive		
Gearbox oil	Replace at first 3 000 km (1,900 mi) and at 6 000 km (3,700 mi), then follow the regular schedule	
Gearbox oil	I,A	R
Front differential oil	I,A	R
Tires (wear/pressure)	I,A	
Wheel lug nuts	T	
Rear wheel scrapers wear plates	I,C	
Wheel beadlock bolts (if equipped)	T	
Drive components (drive shaft (bellow, joint, seals,) propeller shaft U-Joints, wheel bearing)*	I	
Controls		
Gearbox position lever operation		I,A
Throttle operation		I
Continuously Variable Transmission (CVT)		
CVT components (air filter, drive and driven pulley cleaning, drive belt, drive pulley rollers and hub bearing)*	I,C,L	
Electrical		
Battery connections and condition	I,C	
Fault codes module and applicable software updates	I	

REGULAR DUTY	A	B
A = Adjust C = Clean I = Inspect L = Lubricate R = Replace T = Torque	Every year or 100 hours or 3 000 km (1,900 mi)	Every 2 years or 200 hours or 6 000 km (3,700 mi)
Operation of control switches and lighting*	I	
Steering		
Steering components and function*	I	
Suspension		
Suspension components (shock absorber, spherical bearing, ball joint, suspension arm, stabilizer bar)*	I,C,L,T	
Stabilizer bar bushings	I,L Recommended every 1000 km (620 mi)	

*For an extensive list of maintenance actions to be performed, refer to Can-Am Off-road dealer.

SEVERE DUTY	A+	A	B
A = Adjust C = Clean I = Inspect L = Lubricate R = Replace T = Torque	Every 6 months or 50 hours or 1 500 km (900 mi)	Every year or 100 hours or 3 000 km (1,900 mi)	Every 2 years or 200 hours or 6 000 km (3,700 mi)
Air and Fuel Delivery			
Engine air filter	I,C	R	
Air delivery components and function (airbox, throttle body, ducts, clamps)*	I,C		
Fuel components and function (fuel tank cap, fuel tank, hoses, clamps, leaks)*		I	
Fuel pump pressure			I
Body/Chassis and Accessories			
Cage fasteners		T	
Seat belts retractors, buckles and semi-cinching		I,C	
Winch	I,C		
Door latches, hinges and key barrels		L,T	
Engine and Cooling			
Engine oil and filter	R		
Spark plugs (regardless of calendar times)			R
Engine seal and gaskets		I	
Engine cooling components (coolant level and specific gravity, hose condition, clamps, leaks)*		I,A	
Engine coolant	R Every 5 years or 12 000 km (7,500 mi)		
Radiator		C	
Exhaust and Emissions			
Fuel tank vent breather filter (Non-EVAP models)		R	
Canister vent pre-filter (CARB and EVAP models)			R
Exhaust components		I	

SEVERE DUTY	A+	A	B
A = Adjust C = Clean I = Inspect L = Lubricate R = Replace T = Torque	Every 6 months or 50 hours or 1 500 km (900 mi)	Every year or 100 hours or 3 000 km (1,900 mi)	Every 2 years or 200 hours or 6 000 km (3,700 mi)
(gaskets, pipes, muffler condition, leaks)*			
Muffler spark arrester	C		
Debris around exhaust pipe and muffler area	C		
Brakes			
Brake components (caliper, disc(s), brake line, pads, master cylinder)*	I,C,A	C,L	
Brake fluid	R Every 2 years		
Drive			
Gearbox oil	Replace at first 1 500 km (900 mi) and at 3 000 km (1,900 mi), then follow the regular schedule		
Gearbox oil	I,A	R	
Front differential oil	I,A	R	
Tires (wear/pressure)	I,A		
Wheel lug nuts	T		
Rear wheel scrapers wear plates		I,C	
Wheel beadlock bolts (if equipped)		T	
Drive components (drive shaft (bellow, joint, seals,) propeller shaft U-Joints, wheel bearing)*	I		
Controls			
Gearbox position lever operation		I,A	
Throttle operation		I	
Continuously Variable Transmission (CVT)			
CVT components (air filter, drive and driven pulley cleaning, drive belt, drive pulley rollers and hub bearing)*		I,C,L	
Electrical			

SEVERE DUTY	A+	A	B
A = Adjust C = Clean I = Inspect L = Lubricate R = Replace T = Torque	Every 6 months or 50 hours or 1 500 km (900 mi)	Every year or 100 hours or 3 000 km (1,900 mi)	Every 2 years or 200 hours or 6 000 km (3,700 mi)
Battery connections and condition		I,C	
Fault codes module and applicable software updates		I	
Operation of control switches and lighting*		I	
Steering			
Steering components (rack and pinion, steering column, tie-rod)*	I		
Suspension			
Suspension components (shock absorber, spherical bearing, ball joint, suspension arm, stabilizer bar)*	I,C,L	T	
Stabilizer bar bushings	I,L Recommend ed every 1 000 km (620 mi)		

DEEP MUD / WATER	A+	A	B
A = Adjust C = Clean I = Inspect L = Lubricate R = Replace T = Torque	Every 6 months or 50 hours or 1 500 km (900 mi)	Every year or 100 hours or 3 000 km (1,900 mi)	Every 2 years or 200 hours or 6 000 km (3,700 mi)
Air and Fuel Delivery			
Engine air filter	I,C	R	
Air delivery components and function (airbox, throttle body, ducts, clamps)*	I,C		
Fuel components and function (fuel tank cap, fuel tank, hoses, clamps, leaks)*		I	
Fuel pump pressure			I
Body/Chassis and Accessories			
Cage fasteners		T	
Seat belts retractors, buckles and semi-cinching		I,C	
Winch	I,C		
Door latches, hinges and key barrels		L,T	
Engine and Cooling			
Engine oil and filter	I	R	
Spark plugs (regardless of calendar times)			R
Engine seal and gaskets		I	
Engine cooling components (coolant level and specific gravity, hose condition, clamps, leaks)*		I,A	
Engine coolant	R Every 5 years or 12 000 km (7,500 mi)		
Radiator	C		
Exhaust and Emissions			
Fuel tank vent breather filter (Non-EVAP models)		R	
Canister vent pre-filter (CARB and EVAP models)			R
Exhaust components	I		

DEEP MUD / WATER	A+	A	B
A = Adjust C = Clean I = Inspect L = Lubricate R = Replace T = Torque	Every 6 months or 50 hours or 1 500 km (900 mi)	Every year or 100 hours or 3 000 km (1,900 mi)	Every 2 years or 200 hours or 6 000 km (3,700 mi)
(gaskets, pipes, muffler condition, leaks)*			
Muffler spark arrester	C		
Debris around exhaust pipe and muffler area	C		
Brakes			
Brake components (caliper, disc(s), brake line, pads, master cylinder)*	I,C,A	C,L	
Brake fluid	R Every 2 years		
Drive			
Gearbox oil	Replace at first 1 500 km (900 mi) and at 3 000 km (1,900 mi), then follow the regular schedule		
Gearbox oil	I,A		R
Front differential oil	I,A		R
Tires (wear/pressure)	I,A		
Wheel lug nuts	T		
Rear wheel scrapers wear plates	I,C		
Wheel beadlock bolts (if equipped)		T	
Drive components (drive shaft (bellow, joint, seals,) propeller shaft U-Joints, wheel bearing)*	I		
Gearbox output splines		C,L	
Controls			
Gearbox position lever operation		I,A	
Throttle operation	I		
Continuously Variable Transmission (CVT)			
CVT components (air filter, drive and driven pulley cleaning, drive belt, drive pulley rollers and hub bearing)*		I,C,L	

DEEP MUD / WATER	A+	A	B
A = Adjust C = Clean I = Inspect L = Lubricate R = Replace T = Torque	Every 6 months or 50 hours or 1 500 km (900 mi)	Every year or 100 hours or 3 000 km (1,900 mi)	Every 2 years or 200 hours or 6 000 km (3,700 mi)
Electrical			
Battery connections and condition		I,C	
Fault codes module and applicable software updates		I	
Operation of control switches and lighting*		I	
Steering			
Steering components (rack and pinion, steering column, tie-rod)*	I		
Suspension			
Suspension components (shock absorber, spherical bearing, ball joint, suspension arm, stabilizer bar)*	I,C,L	T	
Stabilizer bar bushings	I,L Recommend ed every 1 000 km (620 mi)		

Maintenance Records

Send photocopy of maintenance record to BRP if needed.

Pre-delivery	
Serial number: _____ Mileage / km: _____ Hours: _____ Date: _____ Dealer no: _____ Notes: _____ _____ _____	Signature/Print: _____
Refer to vehicle Pre-Delivery Bulletin for detailed installation procedures	

FIRST inspection	
Mileage / km: _____ Hours: _____ Date: _____ Dealer no: _____ Notes: _____ _____ _____	Signature/Print: _____
For maintenance schedule refer to Maintenance Information section of this operator's guide	

Service

Mileage / km:

Hours:

Date:

Dealer no:

Notes:

Signature/Print:

For maintenance schedule refer to Maintenance Information section of this operator's guide

Service

Mileage / km:

Hours:

Date:

Dealer no:

Notes:

Signature/Print:

For maintenance schedule refer to Maintenance Information section of this operator's guide

Service

Mileage / km:

Hours:

Date:

Dealer no:

Notes:

Signature/Print:

For maintenance schedule refer to Maintenance Information section of this operator's guide

Service	
Mileage / km: _____ Hours: _____ Date: _____ Dealer no: _____ Notes: _____ _____	Signature/Print:
For maintenance schedule refer to Maintenance Information section of this operator's guide	

Service	
Mileage / km: _____ Hours: _____ Date: _____ Dealer no: _____ Notes: _____ _____	Signature/Print:
For maintenance schedule refer to Maintenance Information section of this operator's guide	

Service	
Mileage / km: _____ Hours: _____ Date: _____ Dealer no: _____ Notes: _____ _____	Signature/Print:
For maintenance schedule refer to Maintenance Information section of this operator's guide	

Service

Mileage / km:

Hours:

Date:

Dealer no:

Notes:

Signature/Print:

For maintenance schedule refer to Maintenance Information section of this operator's guide

Service

Mileage / km:

Hours:

Date:

Dealer no:

Notes:

Signature/Print:

For maintenance schedule refer to Maintenance Information section of this operator's guide

Service

Mileage / km:

Hours:

Date:

Dealer no:

Notes:

Signature/Print:

For maintenance schedule refer to Maintenance Information section of this operator's guide

Service	
Mileage / km: _____ Hours: _____ Date: _____ Dealer no: _____ Notes: _____ _____	Signature/Print:
For maintenance schedule refer to Maintenance Information section of this operator's guide	

Service	
Mileage / km: _____ Hours: _____ Date: _____ Dealer no: _____ Notes: _____ _____	Signature/Print:
For maintenance schedule refer to Maintenance Information section of this operator's guide	

Service	
Mileage / km: _____ Hours: _____ Date: _____ Dealer no: _____ Notes: _____ _____	Signature/Print:
For maintenance schedule refer to Maintenance Information section of this operator's guide	

MAINTENANCE PROCEDURES

This section includes instructions for basic maintenance procedures.

Due to the complexity of some of the maintenance procedures, good mechanical skills are required. If you are not comfortable with these procedures, do not hesitate to contact an authorized Can-Am off-road dealer, repair shop or person of your own choosing.

⚠ WARNING

Unless otherwise indicated, always remove D.E.S.S. key from the D.E.S.S. post before performing any maintenance and remove key.

⚠ WARNING

Should removal of a locking device be required (e.g. lock tab, self-locking fastener, etc.), always replace it with a new one.

ENGINE AIR FILTER

NOTICE

Never modify the air intake system. Otherwise, engine performance degradation or damage can occur. The engine is calibrated to operate specifically with these components.

Engine Air Filter Replacement Guideline

Engine air filter inspection and replacement frequency should be adjusted according to riding conditions as it is critical to ensure proper engine performance and life span.

Engine air filter inspection and replacement frequency must be increased for the following severe riding conditions:

- Riding on dry sand.
- Riding on dry dirt covered surfaces.

- Riding on dry gravel trails or similar conditions.
- Riding in areas with high concentration of seeds or crop husks.
- Riding in severe snow conditions.

NOTICE

When riding in dusty conditions or sand, the air box needs to be cleaned before every ride.

NOTE:

Riding in a group, under these conditions, increases the frequency of the air filter maintenance.

Engine Air Filter Removal

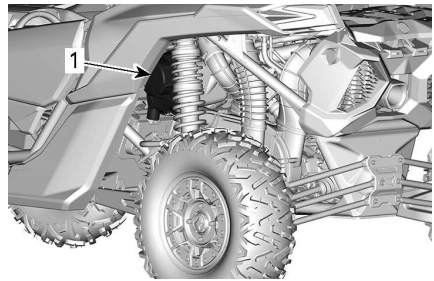

LH REAR OF VEHICLE

1. Air filter housing

Remove the air filter cover by releasing the retaining clamps.

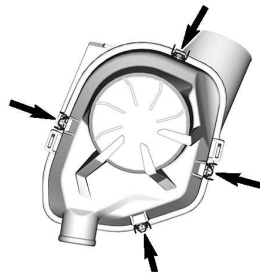

Remove the filter cartridge.

Engine Air Filter Housing Cleaning

Inspect air filter housing for cleanliness.

NOTICE

If sand or other particles are found in air filter housing, clean it using a vacuum cleaner.

Engine Air Filter Cleaning

Inspect the filter for any signs of leaks. A streak of dust on the clean side of the filter is a telltale sign. Replace filter if there is any damages. Eliminate any source of air leaks before installing a new filter.

Clean engine air filter by tapping out heavy dust from paper element, this will allow dirt and dust to get out of the paper filter.

NOTICE

It is not recommended to blow compressed air on the paper element; this could damage the paper fibers and reduce its filtration ability when used in dusty environments. If engine air filter is too dirty and cannot be cleaned following the recommended procedure, it should be replaced.

Use a clean damp cloth to wipe both the filter sealing surface and the inside of the outlet tube. Ensure that the outlet tube sealing area is undamaged.

Inspect air filter housing for cleanliness.

Engine Air Filter Installation

Install air filter cartridge.

Install filter cover with the "TOP" mark upwards (duckbill valve downwards).

Secure cover using the retaining clamps.

Front Grille Kit

1. Remove debris from front grille.
2. Clean front grille with water.

CVT Air Filter

CVT air filter inspection and cleaning frequency should be adjusted according to riding conditions as it is critical to ensure proper engine performance and life span.

CVT air filter inspection and cleaning frequency must be increased for the following severe riding conditions:

- Riding on dry sand.
- Riding on dry dirt covered surfaces.
- Riding on dry gravel trails or similar conditions.
- Riding in muddy conditions.
- Riding in areas with high concentration of seeds or crop husks.
- Riding in severe snow conditions.

NOTE:

Riding in a group, under these conditions, increases the frequency of the air filter maintenance.

CVT Air Filter Removal

Open the air box cover.

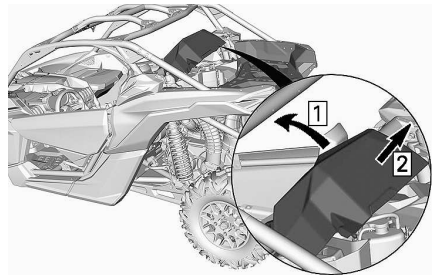

Remove CVT filter from vehicle.

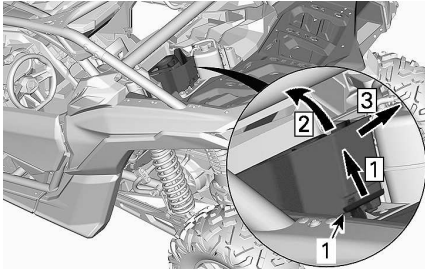

1. CVT air filter

1. Unlatch
2. Lift the rear part
3. Pull off

CVT Air Filter Inspection and Cleaning

Inspect filter and replace if necessary.

Remove CVT filter. Refer to *CVT Filter Removal* and clean it using soft soap and water then rinse with water.

Gently shake off excess water and allow filter to dry at room temperature.

CVT Air Filter Installation

Reinstall filter:

- Insert the three tabs at front of the filter in the corresponding slots
- Securely latch the filter.

Reinstall the air box cover. Make sure it is properly secured.

EVAPORATIVE EMISSION SYSTEM PRE-FILTER (If Equipped)

Evaporative Emission System Pre-Filter Replacement

1. Remove the protective plate.

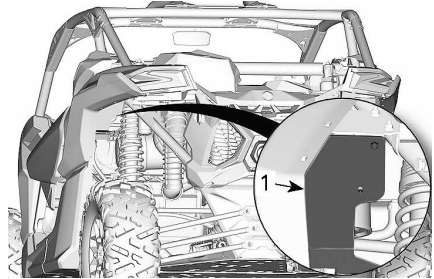

1. Protective plate

2. Remove the hose clamps.

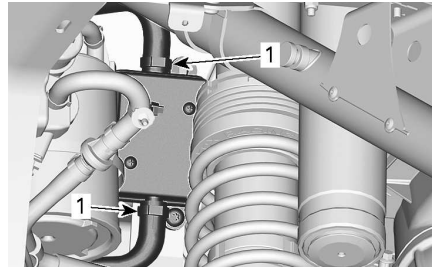

1. Hose clamps

3. Remove the retaining screw.
4. Remove the pre-filter assembly.

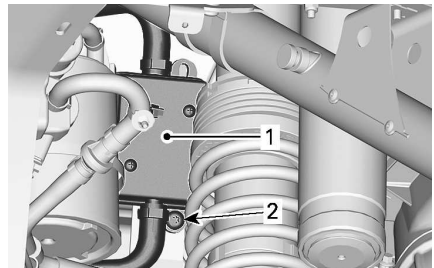

1. Filter
2. Retaining screw

5. Install a new pre-filter assembly. Secure the hoses using clamps.

Tightening Torque	
Pre-filter retaining screw	2.5 ± 0.5 Nm (22 ± 4 lbf-in)

6. Reinstall the protective plate.

Tightening Torque	
Protective plate retaining screw	6.5 ± 0.5 Nm (58 ± 4 lbf-in)

ENGINE OIL

Engine Oil Level Verification

NOTICE

Operating the engine with an improper level may severely damage engine.

With the engine at normal operating temperature, place vehicle on a level surface and check the oil level as follows:

1. Start engine and let it idle for at least 20 seconds.
2. Stop engine.
3. Unscrew dipstick then remove it and wipe clean.

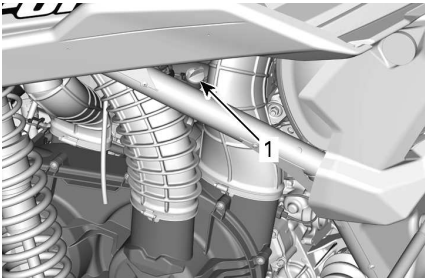

LH REAR OF VEHICLE

1. Dipstick

4. Reinstall dipstick, screw it in completely.
5. Remove dipstick and check oil level. It should be near or equal to the upper mark.



TYPICAL

1. MIN
2. MAX
3. Operating range

To add oil, remove the dipstick. Place a funnel into the dipstick tube.

Add a small amount of recommended oil and recheck oil level.

Repeat the above procedures until oil level reaches the dipstick's upper mark.

NOTE:

Do not overfill. Wipe off any spillage.

Properly tighten dipstick.

Recommended Engine Oil

Rotax® engines were developed and validated using the XPS® oil.

BRP recommends the use of its XPS engine oil or an equivalent at all time.

Damages caused by the use of an oil not suitable for the engine may not be covered by the BRP Limited Warranty.

XPS Recommended Engine Oil	
General purpose	5W40 Synthetic blend oil
Cold temperature	0W40 Synthetic oil
Warm temperature	10W50 Synthetic oil

XPS Recommended Engine Oil
If the recommended XPS Engine Oil Is Not Available
Use a 4-stroke SAE engine oil meeting or exceeding the following lubricant industry specifications.
Always check the API service label certification on the oil container, it must contain at least one of the indicated standards.
<ul style="list-style-type: none"> – API service classification SN, or – JASO MA2.

Engine Oil Change

⚠ CAUTION
The engine oil can be very hot. Wait until engine oil is warm.

NOTICE
Engine oil and oil filter must be replaced at the same time.

1. Bring engine to its normal operating temperature.
2. Place vehicle on a level surface.
3. Remove dipstick.
4. Place a drain pan under the engine drain plug area.

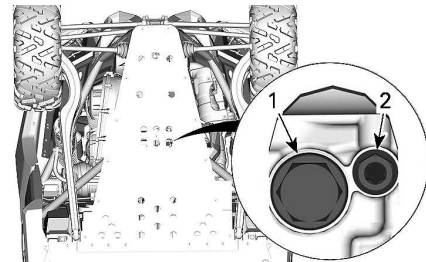

UNDERNEATH REAR OF VEHICLE

1. Magnetic drain plug
2. Secondary drain plug

5. Clean the drain plugs area.

6. To avoid spillage, install a funnel between the drain holes and the skid plate.

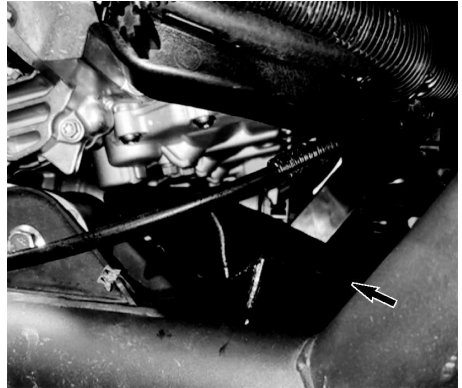

FUNNEL – 529000155

7. Unscrew drain plugs and discard the gasket rings.

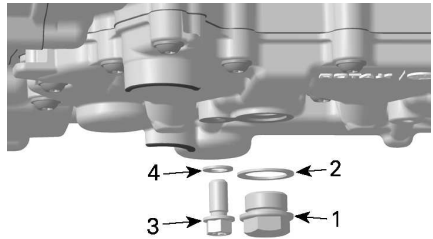

1. Magnetic drain plug
2. Gasket ring
3. Secondary drain plug
4. Gasket ring

8. Replace oil filter. Refer to *Oil Filter*.
9. Allow oil to drain completely from the crankcase.
10. Clean the magnetic drain plug from metal shavings and residue. Presence of debris gives an indication of internal engine damage.
11. Install a **NEW** gasket ring on the drain plug.

NOTICE
Never use the gasket ring a second time. Always replace by a new one.

12. Install and tighten drain plug to the recommended specification.

Tightening Torque	
Secondary drain plug	15 ± 2 Nm (133 ± 18 lbf-in)
Magnetic drain plug	30 ± 3 Nm (22 ± 2 lbf-ft)

13. Refill engine with recommended engine oil.

ENGINE OIL FILTER

Oil Filter Access

Access the oil filter by the RH rear of the vehicle.

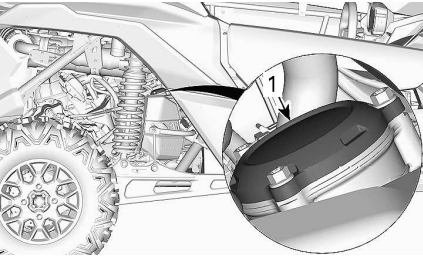

1. Oil filter cover

Oil Filter Removal

Clean oil filter area.

Remove oil filter cover.

Remove oil filter.

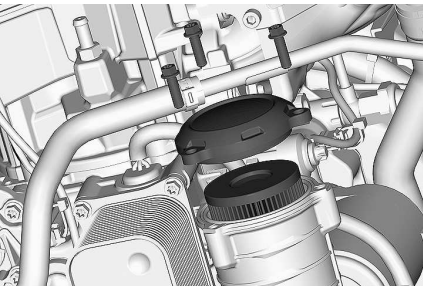

Oil Filter Installation

Check and clean the oil filter inlet and outlet area for dirt and other contaminations.

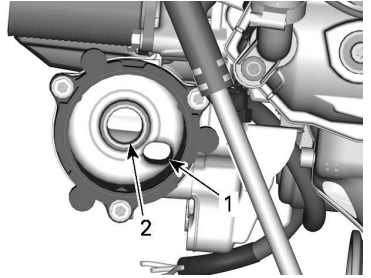

1. Outlet to the engine oil providing system
2. Inlet from the oil pump to the oil filter

Install a **NEW** O-ring on oil filter cover.

Install the new filter into the cover.

Apply engine oil on O-ring and filter seal.

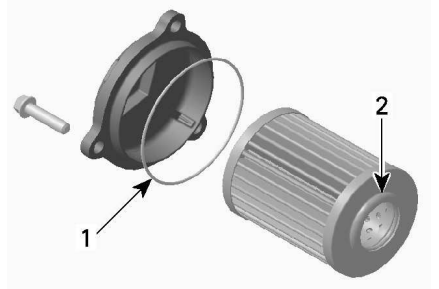

1. Slightly oil
2. Slightly oil

NOTICE

Pay attention to avoid pinching the O-ring during filter and cover installation.

Install the cover on the engine.

Tighten oil filter cover screws to recommended specification.

Tightening Torque	
Oil filter cover screws	10 ± 1 Nm (89 ± 9 lbf-in)

RADIATOR

Radiator Inspection and Cleaning

⚠ CAUTION
Wait for the radiator to cool down before proceeding.

1. Remove the front fascia.

NOTICE
Do not attempt to remove the lower grilles

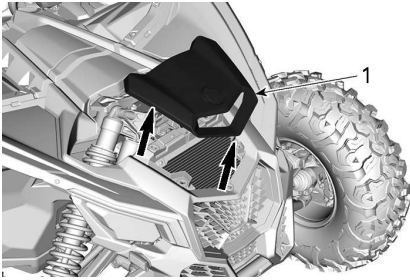

2. Inspect radiator and hoses for leaks or any damage.
3. Inspect radiating fins. They must be clean, free of mud, dirt, leaves and any other deposit that would prevent the radiator to cool properly.
4. Rinse the radiator fins using a garden hose.

⚠ CAUTION
Never clean radiator with your hands when it is hot. Let the radiator cool down before cleaning.

NOTICE
Be careful not to damage the radiating fins when cleaning. Do not use any object/tool that could damage the fins. When hosing, use low pressure only. Never use a HIGH PRESSURE washer.

5. Reinstall all removed parts.

ENGINE COOLANT

Engine Coolant Level Verification

⚠ WARNING
Check coolant level with engine cold.

1. Place vehicle on a level surface.
2. Remove service cover by unlatching the rear lifting it upwards.

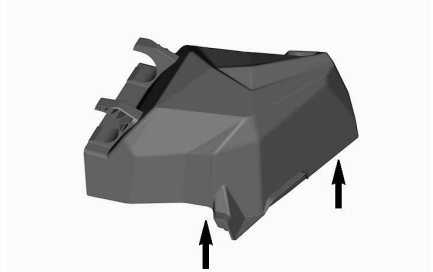

LIFTING REAR OF SERVICE COVER

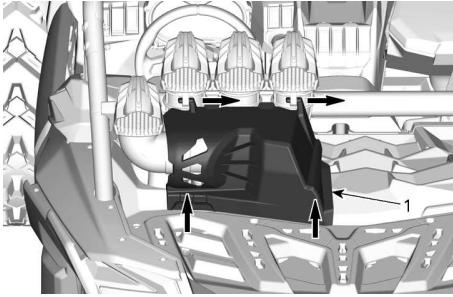

3. Ensure cooling system is full up to the MAX line.



NOTE:

Coolant level can be checked by looking at the side of the coolant reservoir.

4. Add coolant in system as necessary. Use a funnel to avoid spillage. **Do not overfill.** Refer to *Cooling System Refilling and Bleeding*

Recommended Engine Coolant

XPS Recommended Coolant
Extended life pre-mixed coolant
If XPS is not available
Distilled water and antifreeze solution (50% distilled water, 50% antifreeze)

NOTICE

Always use ethylene-glycol anti-freeze containing corrosion inhibitors specifically for internal combustion aluminum engines.

Engine Coolant Replacement

Cooling System Draining

⚠ WARNING

In order to avoid potential burns, do not remove the pressure cap or loosen the coolant drain plug if the engine is hot.

Lift the rear of the vehicle approximately 40 cm (16 in).

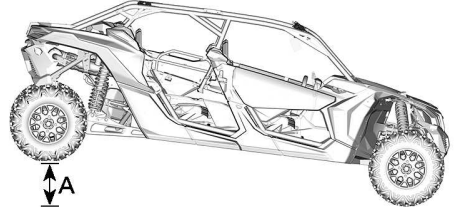

A. 40 cm(16 in)

Place a drain pan under the lower hose of the radiator.

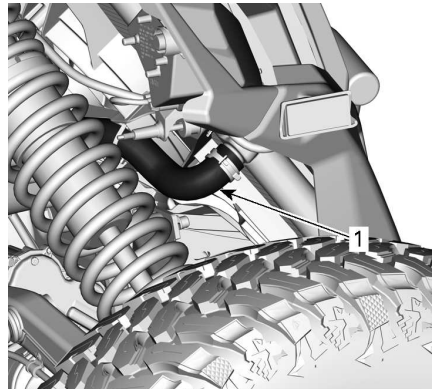

1. Lower hose

Install a large hose pincher on the lower hose of the radiator.

Slowly detach hose from radiator.

Remove coolant reservoir pressure cap.

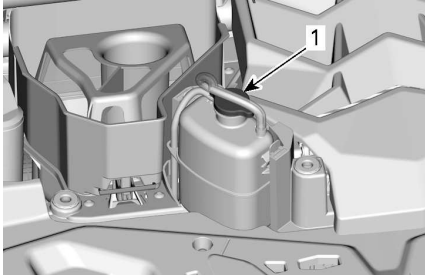

1. Pressure cap

Wait until the coolant flow stops or decreases.

Remove the hose pincher to drain the rest of the coolant.

Install radiator hose clamp.

Tightening Torque	
Radiator hose clamp	2.5 to 3.5 Nm (22 to 31 lbf-in)

Fill cooling system with coolant, refer to *Cooling System Refilling and Bleeding* procedure.

Cooling System Refilling and Bleeding

1. Remove the pressure cap.

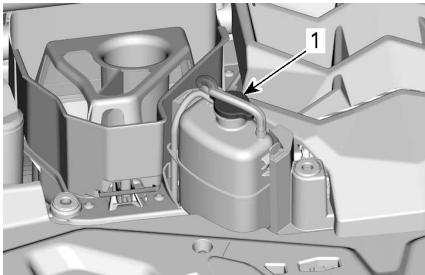

1. Pressure cap

2. Fill the cooling system until level reaches the MAX line on the coolant reservoir.



3. Install pressure cap.
4. Run engine at idle with the pressure cap **on** until the cooling fan cycles 2 times.
5. Depress throttle pedal two or three times.
6. Stop engine and let it cool down.

Add coolant if necessary.

⚠ WARNING
In order to avoid potential burns, do not remove the pressure cap or loosen the coolant drain plug if the engine is hot.

7. After the next ride following this procedure, check coolant level. Add coolant as required. Refer to *Engine Coolant Level Verification*.

EXHAUST SYSTEM

Cleaning the Area Surrounding the Exhaust System

⚠ WARNING

Debris accumulation could lead to a vehicle fire when the exhaust system is hot and the debris are dried.

In some cases, that could result in serious property damages, injuries or even death.

Clean often and regularly the area surrounding the exhaust system when riding in swamp, bog, hay or dead leaves.

In other situations, clean as per maintenance schedule requirement.

Also, check all exhaust heat shields for damage regularly and replaced when needed.

⚠ CAUTION

Never perform this operation immediately after the engine has been running because exhaust system is very hot.

1. From the rear of the vehicle, clean the areas around the muffler.
2. Clean the areas around the exhaust pipe and the exhaust manifold.

⚠ WARNING

Clean also under the heat shields.

Muffler Spark Arrestor Cleaning

The mufflers must be periodically purged of accumulated carbon.

⚠ CAUTION

Never perform this operation immediately after the engine has been running as exhaust system is very hot.

Remove retaining screws securing muffler cover in place and remove muffler cover.

Pull out spark arrestor and remove carbon deposits using a brush.

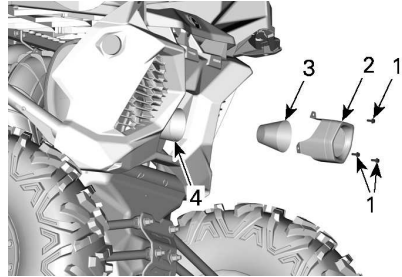

1. Retaining screws
2. Muffler cover
3. Spark arrestor

NOTICE

Use a metallic soft brush and be careful to avoid damaging spark arrestor mesh.

Inspect mesh of spark arrestor for any damage. Replace as needed.

Inspect spark arrestor chamber in muffler. Remove any debris as needed.

Reinstall the spark arrestor in the reverse of the removal procedure. Tighten retaining screws to specification.

Tightening Torque

Muffler cover screws	10 ± 2 Nm (89 ± 18 lbf-in)
----------------------	-------------------------------

FRONT DIFFERENTIAL

Front Differential Oil Level Verification

Clean filler plug prior to check oil level.

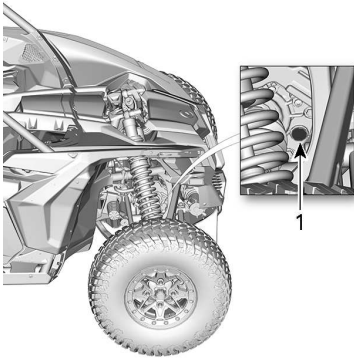

1. Filler plug

With vehicle on a level surface, check oil level by removing filler plug. Oil level must reach the lower edge.

Tightening Torque	
Filler plug	16.25 ± 2.75 Nm (144 ± 24 lbf-in)

Recommended Front Differential Oil

The XPS oil is specially formulated to meet the lubrication requirements of this differential. BRP strongly recommends the use of its XPS oil.

NOTICE
Do not use another type of oil when servicing.

XPS Recommended Front Differential Oil
75W90 Synthetic gear oil
Alternative if XPS Product is not Available
75W90 (API GL-5) synthetic gear oil

Front Differential Oil Change

Place vehicle on a level surface. Set the gearbox to PARK.

From underneath of vehicle, clean drain plug area.

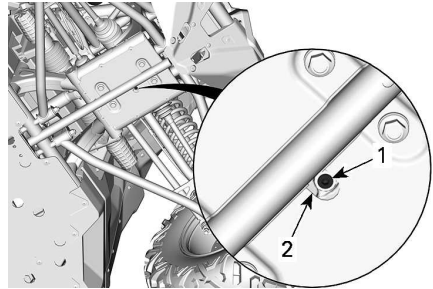

UNDERNEATH THE VEHICLE

1. Drain plug
2. Access hole

Place a drain pan under the front differential.

Access the drain plug through the hole in the skid plate.

Remove drain plug.

Unscrew filler plug.

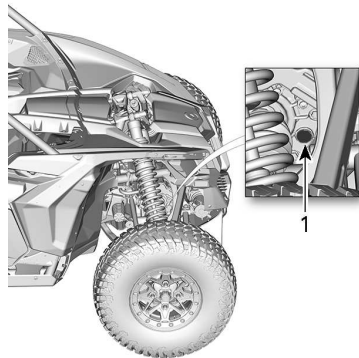

1. Filler plug

Install drain plug.

Tightening Torque	
Drain plug	2.75 ± .25 Nm (24 ± 2 lbf-in)

Refill front differential with recommended oil.

Tightening Torque	
Filler plug	16.25 ± 2.75 Nm (144 ± 24 lbf-in)

GEARBOX

Gearbox Oil Level Verification

Place the vehicle on a level surface. Select PARK position.

Check the gearbox oil level by removing the gearbox oil level plug located at the rear of vehicle, on the RH side.

NOTICE
Pay attention not to lose the oil level plug O-ring.

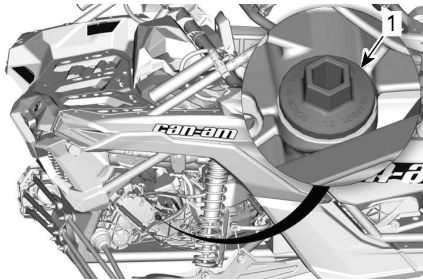

1. Gearbox oil level plug

Reinstall the plug, screw it in completely.

Remove plug again and check oil level on the dipstick. It should be near or equal to the upper mark.



1. MIN.
2. MAX.
3. Operating range

To add oil, place a funnel into the oil level plug hole.

Add a small amount of recommended oil and recheck oil level.

Repeat the above procedures until oil level reaches the dipstick's upper mark.

NOTE:

Do not overfill. Wipe off any spillage.

NOTICE
Operating the gearbox with an improper oil level may severely damage gearbox.

Properly tighten the plug.

Tightening Torque	
Gearbox oil level plug	5 ± 0.6 Nm (44 ± 5 lbf-in)

Recommended Gearbox Oil

The XPS oil is specially formulated to meet the lubrication requirements of this gearbox. BRP strongly recommends the use of its XPS oil.

NOTICE
Do not use another type of oil when servicing.

XPS Recommended Gearbox Oil
75W140 Synthetic gear oil
Alternative, or if not available
75W 140 API GL-5 Synthetic gear oil

Gearbox Oil Change

Oil change should be done with a warm engine.

CAUTION
The gearbox oil can be very hot.

Place the vehicle on a level surface.

Clean drain plug area.

Clean the oil level plug area.

Under the vehicle, place a drain pan underneath the magnetic drain plug area.

Remove the gearbox oil level plug (dipstick).

NOTICE
Pay attention not to lose the oil level plug O-ring.

Remove the magnetic gearbox drain plug and discard sealing ring.

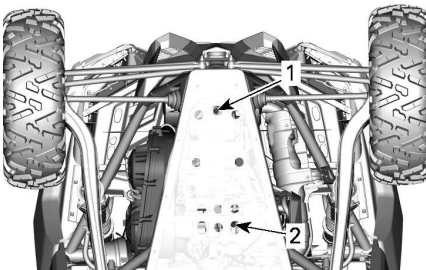

1. Gearbox drain plug
2. Engine oil drain plug

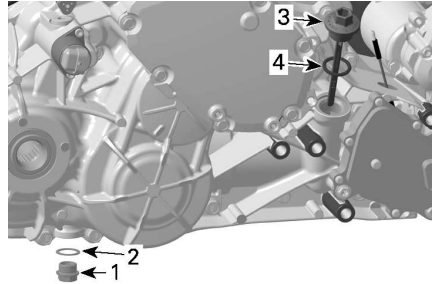

1. Magnetic drain plug
2. Sealing ring (discard)
3. Gearbox oil level plug (dipstick)
4. O-ring

Let oil completely drain from gearbox.

Install the drain plug.

NOTE:

Clean drain plug from any metallic particles prior to installation.

Reinstall magnetic drain plug.

Always install a **NEW** sealing ring.

Tightening Torque	
Magnetic drain plug	30 ± 3 Nm (22 ± 2 lbf-ft)

Refill gearbox.

NOTICE
Use ONLY the recommended type of oil.

Check oil level, refer to *Gearbox Oil Level Verification*.

Dispose gearbox oil as per your local environmental regulations.

SPARK PLUGS

Access to Spark Plugs (Models without Intercooler)

Remove the air inlet cover and the grille.

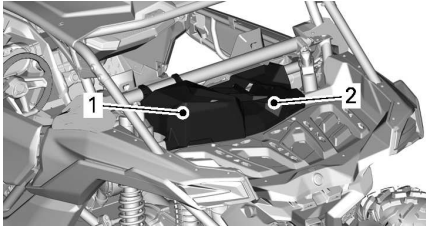

1. Air inlet cover
2. Grille

Remove the protective plate rear retaining screws.

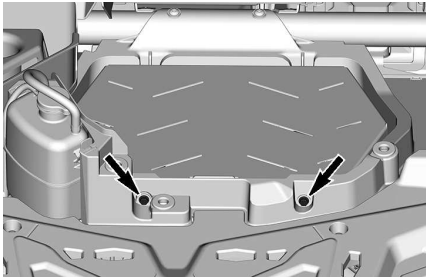

1. Service cover
2. Grille

Remove the intercooler rear retaining screws.

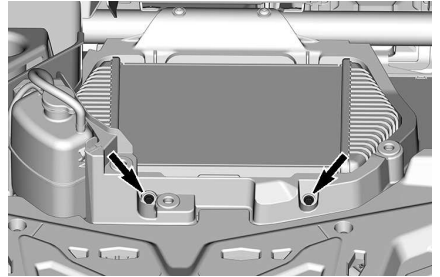

Remove the service cover.

Remove the service cover.

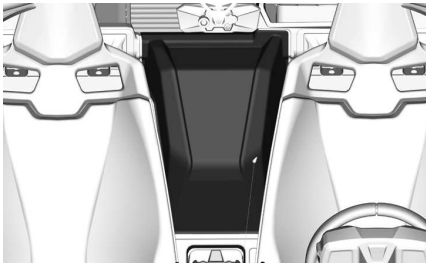

Remove the protective plate front retaining screws.

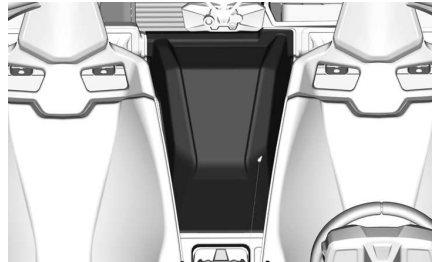

Remove the intercooler front retaining screws.

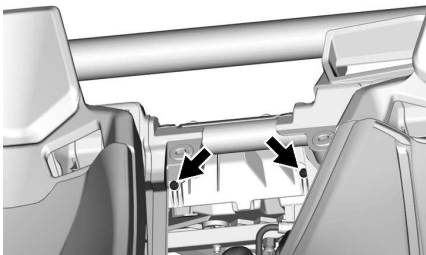

Remove the protective plate.

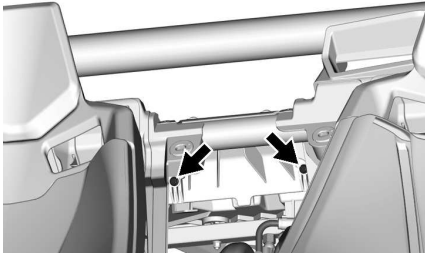

Disconnect intercooler hose.

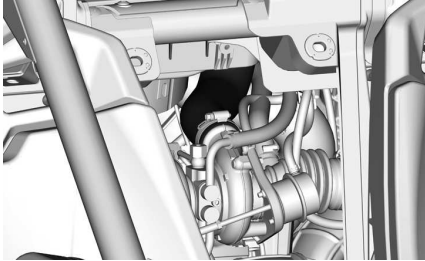

Open intercooler and crankcase hose support by removing the screw.

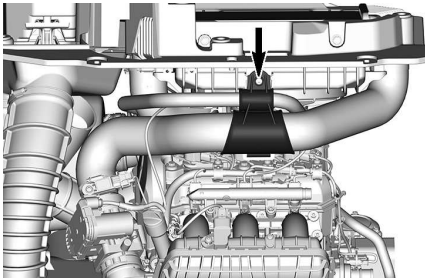

Lift intercooler assembly.

Disconnect the intercooler fan connector.

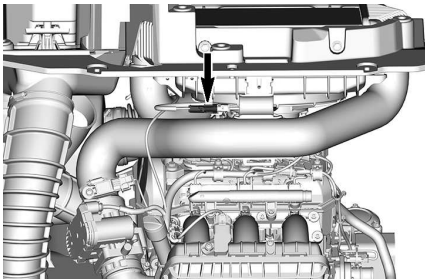

Move intercooler assembly aside

Removing the Spark Plug

1. Disconnect CAPS (camshaft position sensor).

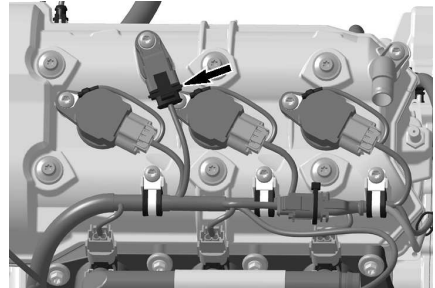

2. Remove:

- Ignition coil retaining screws
- Ground connector.

3. Disconnect ignition coil connectors.

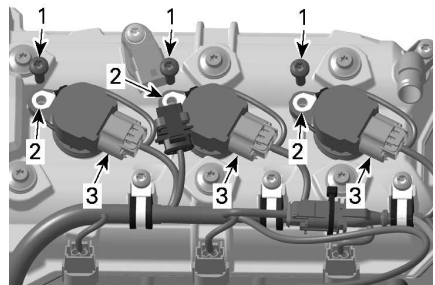

1. Retaining screws
2. Ground connectors
3. Ignition coil connectors

NOTICE

Do not pry on ignition coil with a tool.

4. Remove ignition coils with gaskets from spark plug by rotating coil side to side as you pull up.
5. Clean spark plug and cylinder head with pressurized air.

⚠ CAUTION

Always wear safety goggles when using pressurized air.

6. Unscrew the spark plugs completely using a spark plug socket.
7. Use ignition coil as a puller.

Installing the Spark Plug

Prior to installation make sure that contact surface of cylinder head and spark plug is free of grime.

Using a feeler gauge, set the spark plug gap.

Spark Plug Gap

0.7 to 0.8 mm
(.028 to .031 in)

Screw spark plug into cylinder heads by hand and tighten to specification using a torque wrench.

⚠ CAUTION

Do not overtighten spark plugs, engine damage can occur.

Tightening Torque

Spark plug	11 Nm (97 lbf-in)
------------	----------------------

Install the ignition coil on the spark plug.

Align the retaining screw hole of the ignition coil with the threaded hole on the valve cover.

Push the ignition coil all the way down until it rests on the valve cover.

Install and tighten retaining screw.

Tightening Torque

Ignition coil retaining screw	9 ± 1 Nm (80 ± 9 lbf-in)
-------------------------------	-----------------------------

Reinstall all other removed parts using the reverse of removal procedure.

NOTE:

Make sure to reconnect the intercooler fan connector (if equipped).

Tightening Torque

Protective plate retaining screws (models without intercooler)	8 ± 1 Nm (71 ± 9 lbf-in)
Intercooler retaining screws (if equipped)	

CVT COVER

For a better understanding, some illustrations are taken with engine out of vehicle. To perform the following instructions, it is not necessary to remove engine.

⚠ WARNING

**Never touch CVT while engine is running.
Never drive vehicle when CVT cover is removed.**

⚠ CAUTION

Engine must be cool before cover is removed.

NOTICE

**This CVT is lubrication free.
Never lubricate any components except drive pulley bearing.**

CVT Cover Access

CVT cover can be accessed from the LH side at the rear of vehicle.

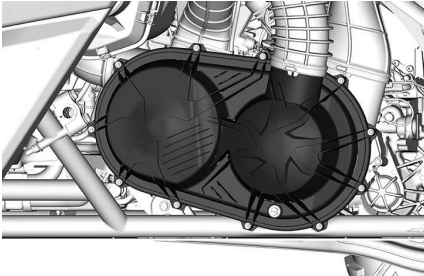

PARTS REMOVED FOR CLARITY

CVT Cover Removal

NOTE: The following procedure is the same for Turbo engines and Turbo RR engines.

Loosen CVT inlet hose clamp(s).

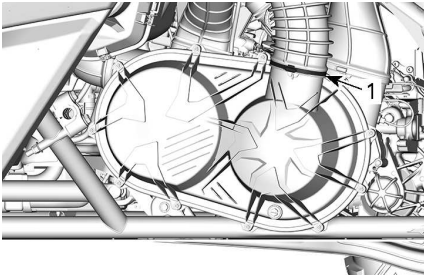

1. Clamp

Remove all CVT cover retaining screws.

Remove the center top screw last to support the cover during removal.

NOTE:

Do not use an impact tool to remove CVT cover screws.

Remove the CVT cover and its gasket.

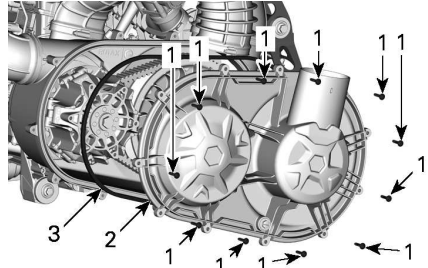

TURBO ENGINE SHOWN

- 1. CVT cover screws
- 2. CVT cover
- 3. Gasket

Check inside front and rear CVT outlet hoses to make sure there are no debris.

CVT Cover Installation

Install the center top screw first.

Tighten the CVT cover screws as per following sequence.

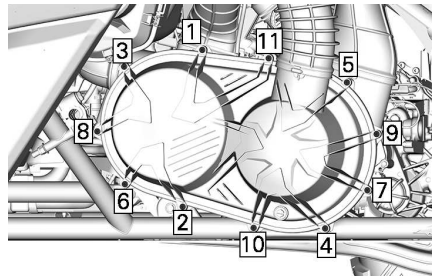

Tightening Torque	
CVT Cover screws	7 ± 0.8 Nm (62 ± 7 lbf-in)

Drive Belt

Drive Belt Removal

NOTE: The following procedure is the same for Turbo engines and Turbo RR engines.



NOTICE

In case of a drive belt failure, the CVT, cover and air outlet must be cleaned.

Please refer to *Tips for Maximizing Drive Belt Durability* in *Basic Procedures* for some IMPORTANT information.

Remove the CVT Cover.

Open the driven pulley.

Required Tools	
Puller/locking tool 529 000 088	
Driven pulley adaptor 708 200 720	

Insert the pulley adaptor in the driven pulley threaded hole, then screw it in.

Insert the puller/locking tool in the pulley adaptor threaded hole, then screw it in to open the pulley.

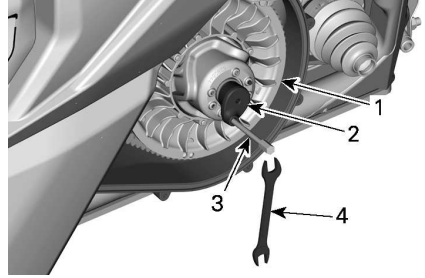

1. Fixed sheave of driven pulley
2. Adaptor (in glove box)
3. Puller/locking tool (in tool kit)
4. Wrench (in tool kit)

To remove belt, slip the belt over the top edge of fixed sheave, as shown.

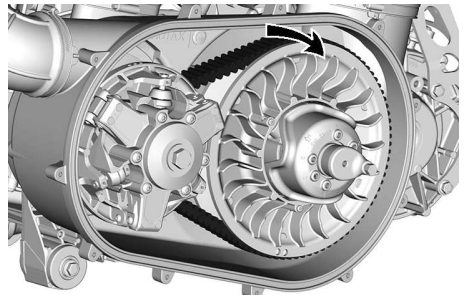

TURBO ENGINE SHOWN

Drive Belt Installation

For installation, reverse the removal procedure. Pay attention to following details.

The maximum drive belt life span is obtained when the drive belt has the proper rotation direction. Install it so that the arrow printed on belt is pointing towards front of the vehicle, viewed from top.

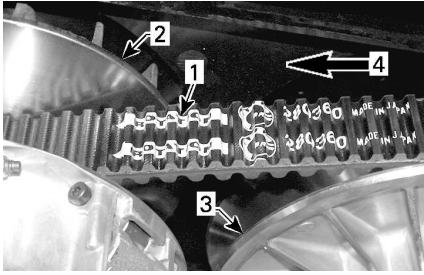

1. Arrow printed on belt
2. Drive pulley (front)
3. Driven pulley (rear)
4. Rotation direction

Turn the driven pulley until the lowest portion of the cogs on the external surface of the drive belt is even with the driven pulley edge.

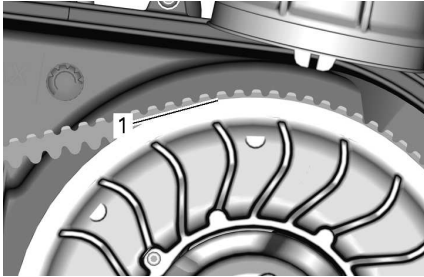

1. Lowest portion of cogs even with driven pulley edge

Drive and Driven Pulleys

Drive and Driven Pulleys Inspection

This inspection must be performed by an authorized Can-Am dealer, repair shop, or person of your own choosing for maintenance, repair, or replacement.

Drive Pulley

1. Inspect the bushings of the sliding sheave and all rollers of the drive pulley, replace worn parts.

Driven Pulley

Inspect the bushings of the cam and of the sliding sheave of the driven pulley, replace worn parts.

BATTERY

Battery Maintenance

NOTICE

Never charge a battery while installed in vehicle.

These vehicles are equipped with a VRLA battery (Valve Regulated Lead Acid). It is a maintenance-free type battery, there is no need to add water to adjust electrolyte level.

NOTICE

Never remove the battery sealing cap.

Battery Access

To access the battery, move the passenger seat completely forward, refer to *Seat in Equipment*.

Battery Removal

Disconnect BLACK (-) cable first then RED (+) cable.

NOTICE

Always respect this order for disassembly; disconnect BLACK (-) cable first.

Remove battery holder retaining screws.

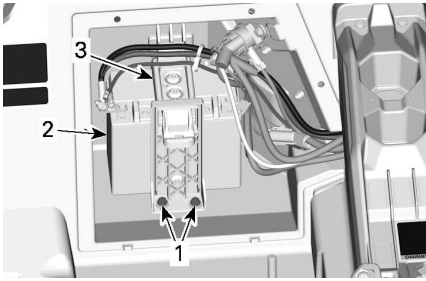

1. Battery holder retaining screws
2. Battery
3. Battery holder

Remove battery holder.

Remove battery.

Battery Cleaning

Clean battery, battery casing and battery posts using a solution of baking soda and water.

Remove corrosion from battery cable terminals and battery posts using a firm wire brush. Battery casing should be cleaned by soft brush and baking soda solution.

Battery Installation

Battery installation is the reverse of the removal procedure, however, pay attention to the following.

NOTICE

Reversed battery polarity will damage the voltage regulator.

NOTICE

Always connect RED (+) cable first then BLACK (-) cable.

FUSES

Fuse Replacement

If a fuse is burnt, replace it by one of the same rating.

NOTICE

Do not use a higher rated fuse as this can cause severe damage.

Fuses and Fusible Links

Front Fuse Box and Dynamic Power Steering (DPS) Fuse

To access the front fuse box or the DPS fuse, remove the front service cover.

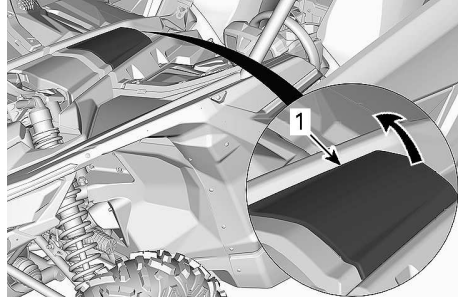

1. Front service cover

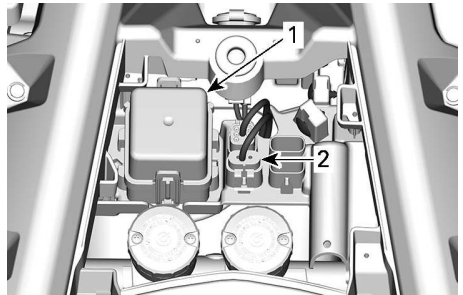

1. Front fuse box
2. DPS fuse

Rear Fuse Box

To access the rear fuse box, remove the LH rear passenger seat. Refer to *Seats in Equipment*.

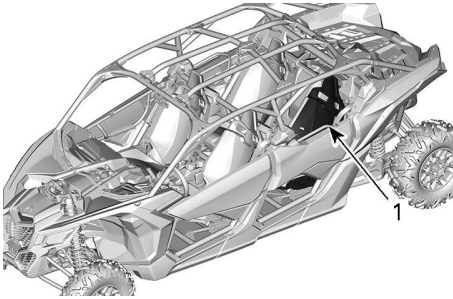

1. LH rear passenger seat

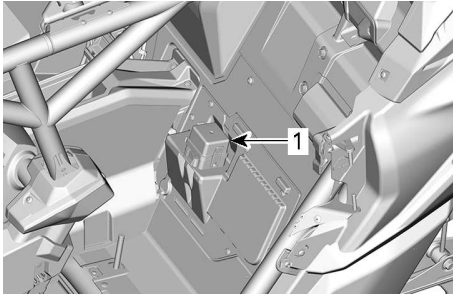

1. Rear fuse box

Fusible Links

The fusible links are on the starter solenoid harness.

In the event that a fusible link blows, see a Can-Am SSV dealer, a repair shop or the person of your choosing.

Fuse Box Description

Front Fuse Box		
No	DESCRIPTION	RAT ING
F7	4WD actuator	10 A
F11	Lights	20 A
F12	DC Outlet Connector DC3	10 A
F14	Accessories	30 A
F16	Taillights	10 A

Front Fuse Box		
No	DESCRIPTION	RAT ING
F22	Smart-Shox (only for Turbo RR models)	20 A
F23	Smart-Lok	20 A
R3	Accessories Engine Control Module (ECM)	-
R4	Head lamp relay (only for Turbo RR models)	-
R8	Brake Relay	-

Rear Fuse Box		
No	DESCRIPTION	RAT ING
F4	Gauge Relay	10 A
F5	Ignition Fuel injectors Fuel pump	10 A
F6	Engine Control Module (ECM)	10 A
F8	Start switch Clock	10 A
F9	Cooling fan	25 A
F17	Intercooler fan	25 A
F18	EVAP/Oxygen Sensor	10 A
R1	Cooling fan	-
R2	Main	-
R10	Intercooler fan	-

NOTE:

Fuses are identified on the fuse box cover.

Fusible Links		
No	DESCRIPTION	RATING
1	Main	16 AWG
2	Accessories	16 AWG

The following fuse holders are located near the battery.

Regulator Fuse Holder		
No	DESCRIPTION	RATING
-	Regulator	50 A
-	Dynamic power steering (DPS)	40 A

Lights

Always check light operation after replacement.

The headlights and taillights are LEDs (Light Emitting Diode). This technology has proven itself on the reliability.

NOTE:

Headlight or taillight internal LEDs can not be replaced. In case of a malfunction, the headlight or taillight assembly must be replaced.

In the unlikely event they do not work, have them checked by an authorized Can-Am SSV dealer, repair shop or person of your choosing.

DRIVE SHAFT BELLOWS

Drive Shaft Bellows Inspection

Visually inspect drive shaft bellows conditions.

Check bellows for cracks, tears, leaking grease, etc.

Repair or replace damaged parts as necessary.

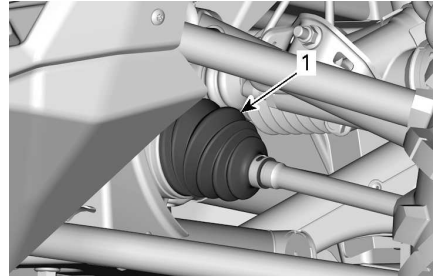

FRONT OF VEHICLE

1. Inner drive shaft bellow

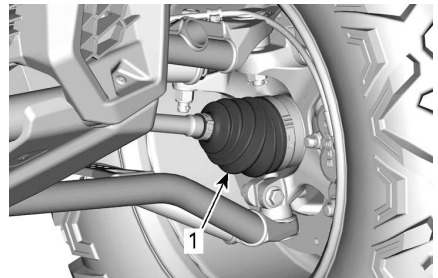

FRONT OF VEHICLE

1. Outer drive shaft bellow

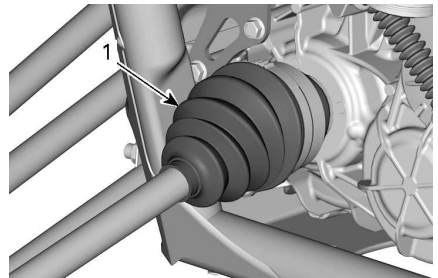

REAR OF VEHICLE

1. Inner drive shaft bellow

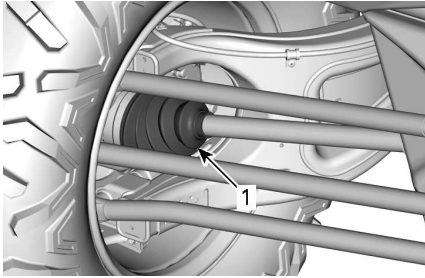

REAR OF VEHICLE

1. Outer drive shaft bellow

WHEEL BEARING

Wheel Bearing Inspection

Lift and support vehicle. Refer to *Lifting and Supporting the Vehicle*.

Push and pull the wheels from the upper edge to feel the play.

See an authorized Can-Am dealer, a repair shop or person of your choosing if there is abnormal play.



TYPICAL

WHEELS AND TIRES

Wheel Removal

Loosen nuts then lift and support vehicle. Refer to *Lifting and Supporting Vehicle*.

Remove lug nuts then remove wheel.

Wheel Installation

If tires are unidirectional, their rotation must be kept in a specific direction.

Unidirectional tires have inscriptions on the sidewall.

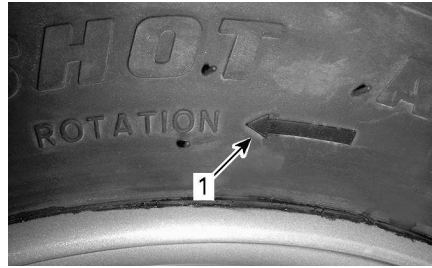

TYPICAL

1. Direction of rotation

Tighten wheel lug nuts to the specified torque using the illustrated sequence.

NOTE:

Do not use any type of lubricant on the lug nuts threads before tightening.

Tightening Torque	
Wheel lug nuts	120 ± 5 Nm (89 ± 4 lbf-ft)



NOTICE

Always use the recommended wheel lug nuts for the type of wheel. Using a different lug nut could cause damages to the rim or studs.

Tire Pressure

⚠ WARNING

Tire pressure greatly affects vehicle handling and stability. Insufficient pressure may cause tire to deflate and rotate on wheel. Overpressure may burst the tire. Always follow recommended pressure. NEVER set tire pressure below minimum. It could cause the tire to dislodge from the rim.

Check pressure when tires are cold before using the vehicle. Tire pressure changes with temperature and altitude. Recheck pressure if one of these conditions has changed.

Refer to the *Tires Pressure and Maximum Load Label* on your vehicle for applicable pressure.

NOTE:

Although the tires are specifically designed for off-road use, a flat may still occur. Therefore, it is recommended to carry a tire gauge, tire pump and a repair kit.

Tire Inspection

Check tire for damage and wear. Replace if necessary.

⚠ WARNING

Do not rotate tires. The front and rear tires have a different size. The left and right tires have different unidirectional tread patterns.

Tire Replacement

Tire replacement should be performed by an authorized Can-Am Off-road dealer, a repair shop or a person of your choosing.

⚠ WARNING

Replace tires only with the same type and size as original tires. For unidirectional tread pattern, ensure that the tires are installed in the correct direction of rotation. Tires should be replaced, by an experienced person, in accordance with tire industry standards and tools.

Suspensions

Front Suspension Lubrication

Lubricate upper and lower suspension arms.

XPS synthetic suspension grease

There are 2 grease fittings on each suspension arm.

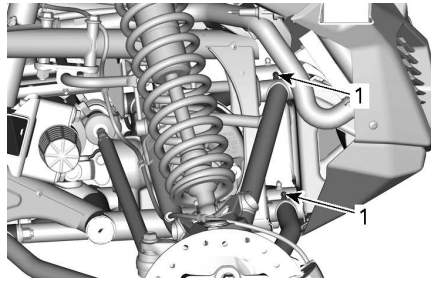

TYPICAL - FRONT SUSPENSION

1. Grease fittings

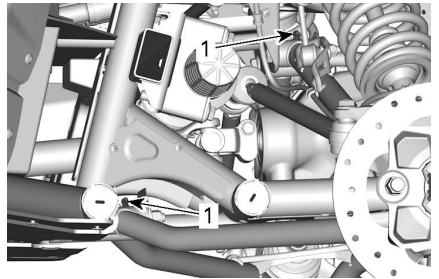

TYPICAL - FRONT SUSPENSION

1. Grease fittings

Stabilizer Bar Lubrication

Lubricate both stabilizer bars.

XPS synthetic suspension grease

There is one grease fitting on each front suspension side.

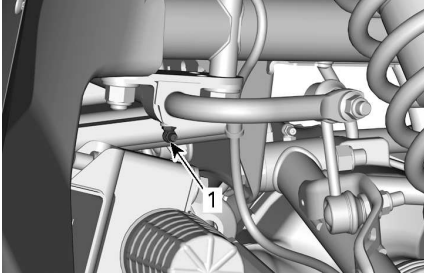

TYPICAL - FRONT STABILIZER BAR

1. Grease fitting

There is one grease fitting on each rear suspension side.

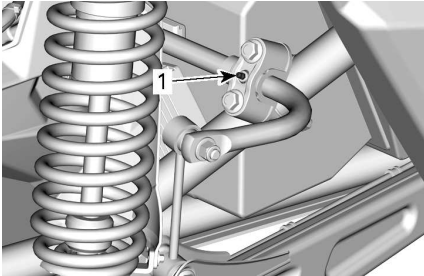

TYPICAL - REAR STABILIZER BAR

1. Grease fitting

Suspension Inspection

See an authorized Can-Am dealer, a repair shop or person of your choosing if any problem is detected.

Shock Absorbers

Inspect shock absorber for leaks, bump stop wear out or other damages. Verify fasteners are still well tightened.

Front Suspension Arms

Check suspension arms for cracks, bending or other damages.

Rear Suspension Arms

Check suspension arms, trailing and control links for cracks, bending or other damages.

Verify the transverse suspension arm nuts tightening torque.

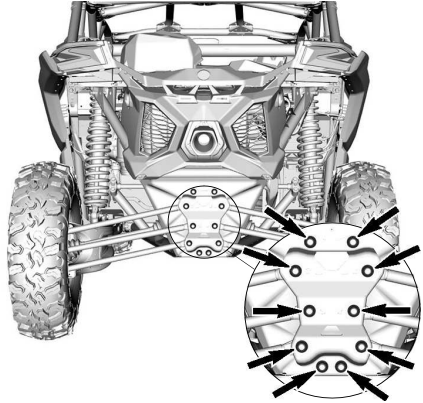

Tightening Torque	
Transverse arm nuts	95 ± 5 Nm (70 ± 4 lbf-ft)

BRAKES

Brake Fluid Reservoir Level Verification

Remove the front service cover.

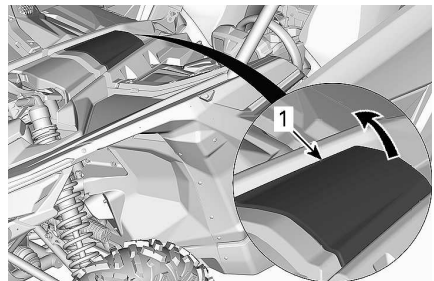

1. Front service cover

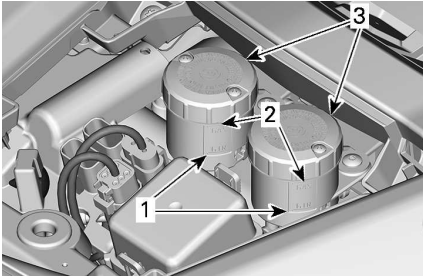

1. MIN
2. MAX
3. Master cylinder reservoirs

With vehicle on a level surface, check brake fluid in reservoirs for proper level. Brake fluid level should be between MIN and MAX. marks.

NOTE:

A low level may indicate leaks or worn brake pads.

Adding Brake Fluid

Clean filler cap before removing.

Add fluid as required. **Do not overfill.**

NOTE:

Ensure filler cap diaphragm is pushed inside the cap before closing the brake fluid reservoir.

Recommended Brake Fluid

Always use brake fluid meeting the specification DOT 4 only.

NOTICE
<p>To avoid serious damage to the braking system, do not use fluids other than the recommended one, nor mix different fluids for topping up.</p> <p>Do not use brake fluid taken from old or already opened containers.</p>

Brake Inspection

The brake inspection, maintenance and repair should be performed by an

authorized Can-Am dealer, a repair shop or person of your choosing.

However, verify the following between visits to your dealer:

- Brake fluid level
- Brake system for fluid leaks
- Brake pads wear
- Brake discs condition
- Brake cleanliness

⚠ WARNING
<p>The brake fluid replacement or brake system maintenance and repairs should be performed by an authorized Can-Am Off-road dealer.</p>

SEAT BELTS

Seat Belt Cleaning

To clean dirt and debris from the seat belts, sponge the straps with mild soap and water. Do not use bleach, dye, or household detergents.

⚠ WARNING
<p>Do not use pressure washer to clean seat belt components. Use of pressure washer can permanently damage seat belt components.</p>

CAGE

Cage Fasteners

Periodically, verify the cage fasteners tightening.

Central Reinforcement



FRONT FASTENERS

Tightening Torque	
M12 nut	95 ± 5 Nm (70 ± 4 lbf-ft)
M6 x 16 screws	10 ± 2 Nm (89 ± 18 lbf-in)

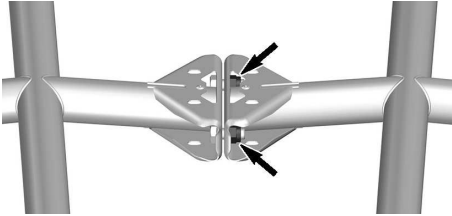

CENTRAL FASTENERS

Tightening Torque	
M12 nut	95 ± 5 Nm (70 ± 4 lbf-ft)



REAR FASTENERS

Tightening Torque	
M12 nut	95 ± 5 Nm (70 ± 4 lbf-ft)

Lateral Members

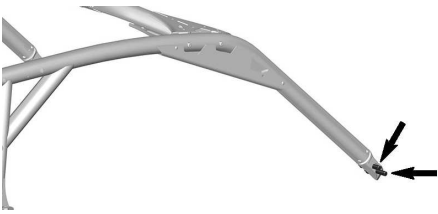

FRONT LOWER FASTENERS

Tightening Torque	
M12 x 60	110 ± 10 Nm (81 ± 7 lbf-ft)

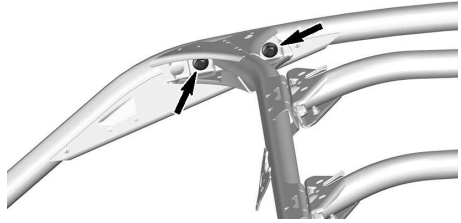

FRONT UPPER FASTENERS

Tightening Torque	
M12 x 30	110 ± 10 Nm (81 ± 7 lbf-ft)

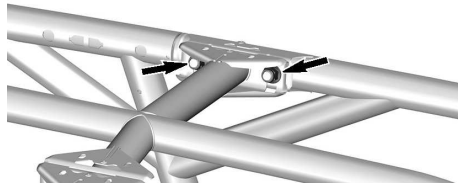

CENTRAL UPPER FASTENERS

Tightening Torque	
M12 nut	95 ± 5 Nm (70 ± 4 lbf-ft)

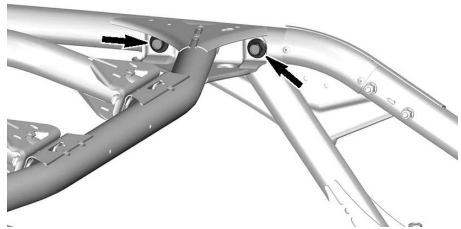

REAR UPPER FASTENERS

Tightening Torque	
M12 x 30	110 ± 10 Nm (81 ± 7 lbf-ft)

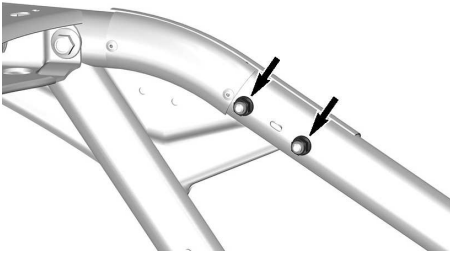

OBLIQUE REAR TUBE

Tightening Torque	
M8 nut	24.5 ± 3.5 Nm (181 ± 2 lbf-ft)

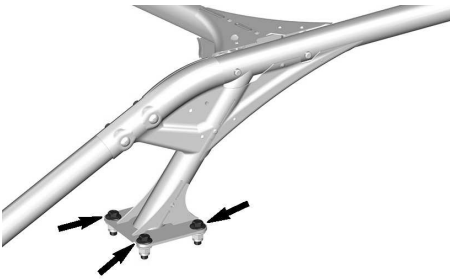

REAR LOWER FASTENERS

Tightening Torque	
M12 x 30	95 ± 5 Nm (70 ± 4 lbf-ft)

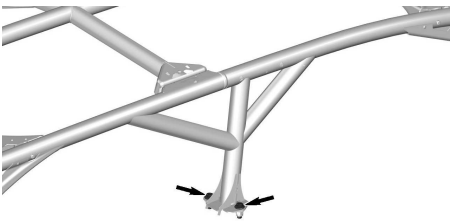

CENTRAL LOWER FASTENERS

Tightening Torque	
M12 x 30	95 ± 5 Nm (70 ± 4 lbf-ft)

VEHICLE CARE

Vehicle Cleaning and Protection

NOTICE

Never use a high pressure washer to clean the vehicle. USE LOW PRESSURE ONLY (like a garden hose). High pressure can cause damage to electrical or mechanical components.

Pay attention to certain areas where salt-water, mud or debris can accumulate and potentially cause:

- Fire
- Wear
- Interference
- Corrosion.

This list includes but is not limited to:

- Around exhaust system and between muffler and muffler cover
- Under and around the fuel tank
- Radiator
- Shock absorbers
- Around front and rear differentials
- Around and underneath engine and gearbox
- Inside wheels
- On top of skid plates.

⚠ WARNING

Debris accumulation could lead to a vehicle fire when the exhaust system is hot and the debris are dried.

In some cases, that could result in serious property damages, injuries or even death.

Clean often and regularly the area surrounding the exhaust system when riding in swamp, bog, hay or dead leaves.

In other situations, clean as per maintenance schedule requirement.

fresh water is necessary to preserve vehicle and its components after each operating day.

Metallic parts lubrication is highly recommended.

Use anti-corrosive lubricant or an equivalent.

XPS Lubricant and anti-corrosive

Painted parts which are damaged should be properly repainted to prevent rust.

When required, wash the body with warm water and soap (only use mild detergent). Apply non-abrasive wax.

NOTICE

Never clean plastic parts with strong detergent, degreasing agent, paint thinner, acetone, etc.

Protect the vehicle with a cover to prevent dust accumulation during storage.

NOTICE

The vehicle has to be stored in a cool and dry place and covered with an opaque tarpaulin. This will prevent sun rays and grime from affecting plastic components and vehicle finish.

When vehicle is used in salt-water environment rinsing the vehicle with

STORAGE AND PRESEASON PREPARATION

When a vehicle is not in use for more than 4 months, proper storage is a necessity.

If the vehicle is to be remain inactive for more than 21 days, disconnect the BLACK (-) cable of the battery.

The use of a low amperage trickle charger is recommended to keep battery fully charged.

Before using your vehicle after storage, a preparation is required.

See an authorized Can-Am Off-road dealer, a repair shop, or a person of your own choosing to have your vehicle prepared properly.

While reading this Operator's Guide, remember that:

 WARNING
Indicates a potential hazard which, if not avoided, could result in serious injury or death.

This page is intentionally blank

TECHNICAL INFORMATION

VEHICLE IDENTIFICATION

The main components of your vehicle (engine and frame) are identified by different serial numbers. It may sometimes become necessary to locate these numbers for warranty purposes or to trace your vehicle in the event of loss.

These numbers are required by the authorized Can-Am Off-road dealer to complete warranty claims properly.

We strongly recommend that you take note of all the serial numbers on your vehicle and supply them to your insurance company.

Vehicle Identification Number

The VIN label is located behind the right passenger seat.

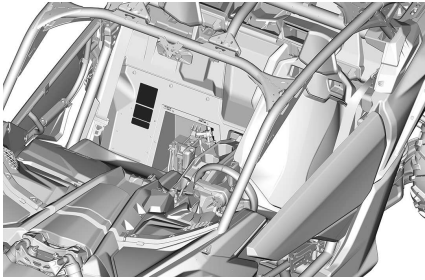

TYPICAL

NRMM Models



All Other Models

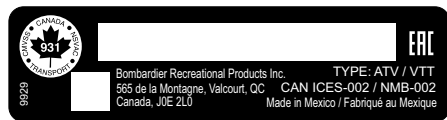

Engine Identification Number

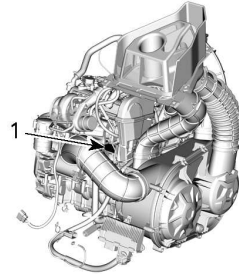

TYPICAL — ENGINE SERIAL NUMBER LABEL

1. EIN (Engine Identification Number)

BRP RF DESS POST GEN3 (CAN)

USA and Canada

This device complies with FCC Part 15 and Industry Canada license exempt RSS standard(s). Operation is subject to the following two conditions:

1. this device may not cause interference, and
2. this device must accept any interference, including interference that may cause undesired operation of the device.

This equipment has been tested and found to comply with the limits for a Class B digital device, pursuant to part 15 of the FCC Rules. These limits are designed to provide reasonable protection against harmful interference in a residential installation. This equipment generates, uses and can radiate radio frequency energy and, if not installed and used in accordance with the instructions, may cause harmful interference to radio communications. However, there is no guarantee that interference will not occur in a particular installation. If this equipment does cause harmful interference to radio or television reception, which can be determined by turning the equipment off and on, the user is encouraged to try to correct the interference by one or more of the following measures:

- Reorient or relocate the receiving antenna.
- Increase the separation between the equipment and receiver.
- Connect the equipment into an outlet on a circuit different from that to which the receiver is connected.
- Consult the dealer or an experienced radio/TV technician for help.

The device has been evaluated to meet general RF exposure requirement. The device can be used in portable exposure condition without restriction.

Le dispositif a été évalué à satisfaire l'exigence générale de l'exposition aux rf. L'appareil peut être utilisé dans des conditions d'exposition portatif sans restriction.

L'émetteur/récepteur exempt de licence contenu dans le présent appareil est conforme aux CNR d'Innovation, Sciences et Développement économique Canada applicables aux appareils radio exempts de licence.

1. l'appareil ne doit pas produire de brouillage, et
2. l'appareil doit accepter tout brouillage radioélectrique subi, même si le brouillage est susceptible d'en compromettre le fonctionnement.

Changes or modifications not expressly approved by the party responsible for compliance could void the user's authority to operate the equipment.

IC: 12006A-1001317030 For variant 1001316154 (CAN)

FCC ID: 2ACER 1001317030 For variant 1001316154 (CAN)

Mexico



IFETEL

Marca: BRP Megatech

Número: BRME1023-28186

BRP Megatech Certificate number: 1450978

Modelo: 1001316154

NOM-208-SCFI-2016 (Disposición Técnica IFT-008-2015)

La operación de este equipo está sujeta a las siguientes dos condiciones:

1. Es posible que este equipo o dispositivo no cause interferencia perjudicial y
2. Este equipo o dispositivo debe aceptar cualquier interferencia, incluyendo la que pueda causar su operación no deseada.

Brazil



Número: 05254-23-15603

BRP Megatech Certificate number: 1450991

Modelo: 1001316154

Este equipamento não tem direito à proteção contra interferência prejudicial e não pode causar interferência em sistemas devidamente autorizados. Para maiores informações, consulte o site da ANATEL.

Japan

This device is granted pursuant to the Japanese Radio Law (電波法) and the Japanese Telecommunications Business Law (電気通信事業法). This device should not be modified (otherwise the granted designation number will become invalid).

Europe

Declaration of Conformity

Simplified EU Declaration of Conformity according Radio Equipment Directive 2014/ 53/EU



DE

Hiermit erklärt BRP Megatech, dass der Funkanlagentyp 1001316154 der Richtlinie 2014/53/EU entspricht. Der vollständige Text der EU-Konformitätserklärung ist unter der folgenden Internetadresse verfügbar: <https://www.brp.com/en/corporate-social-responsibility/product-safety.html>

FR

Le soussigné, BRP Megatech, déclare que l'équipement radioélectrique du type 1001316154 est conforme à la directive 2014/53/UE. Le texte complet de la déclaration UE de conformité est disponible à l'adresse internet suivante: <https://www.brp.com/en/corporate-social-responsibility/product-safety.html>

BG

С настоящото BRP Megatech декларира, че този тип радиосъоръжение 1001316154 е в съответствие с Директива 2014/53/ЕС.

Цялостният текст на ЕС декларацията за съответствие може да се намери на следния интернет адрес: <https://www.brp.com/en/corporate-social-responsibility/product-safety.html>

EL

Με την παρούσα ο/η BRP Megatech, δηλώνει ότι ο ραδιοεξοπλισμός 1001316154 πληροί την οδηγία 2014/53/ΕΕ. Το πλήρες κείμενο της δήλωσης συμμόρφωσης ΕΕ διατίθεται στην ακόλουθη ιστοσελίδα στο διαδίκτυο: <https://www.brp.com/en/corporate-social-responsibility/product-safety.html>

CS

Tímto BRP Megatech prohlašuje, že typ rádiového zařízení 1001316154 je v souladu se směrnicí 2014/53/EU. Úplné znění EU prohlášení o shodě je k dispozici na této internetové adrese: <https://www.brp.com/en/corporate-social-responsibility/product-safety.html>

DA

Hermed erklærer BRP Megatech, at radioudstyrstypen 1001316154 er i overensstemmelse med direktiv 2014/53/EU.

EU-overensstemmelseserklæringens fulde tekst kan findes på følgende internetadresse: <https://www.brp.com/en/corporate-social-responsibility/product-safety.html>

ET

Käesolevaga deklareerib BRP Megatech, et käesolev raadioseadme tüüp 1001316154 vastab direktiivi 2014/53/EL nõuetele.

ELi vastavusdeklaratsiooni täielik tekst on kättesaadav järgmisel internetiaadressil: <https://www.brp.com/en/corporate-social-responsibility/product-safety.html>

ES

Por la presente, BRP Megatech declara que el tipo de equipo radioeléctrico 1001316154 es conforme con la Directiva 2014/53/UE.

El texto completo de la declaración UE de conformidad está disponible en la dirección Internet siguiente: <https://www.brp.com/en/corporate-social-responsibility/product-safety.html>

FI

BRP Megatech vakuuttaa, että radiolaitetyyppi 1001316154 on direktiivin 2014/53/EU mukainen. EU-vaatimustenmukaisuusvakuutuksen täysimittainen teksti on saatavilla seuraavassa internetosoitteessa: <https://www.brp.com/en/corporate-social-responsibility/product-safety.html>

EN

Hereby, BRP Megatech declares that the radio equipment type 1001316154 is in compliance with Directive 2014/53/EU. The full text of the EU declaration of conformity is available at the following internet address: <https://www.brp.com/en/corporate-social-responsibility/product-safety.html>

HR

BRP Megatech ovime izjavljuje da je radijska oprema tipa 1001316154 u skladu s Direktivom 2014/53/EU. Cjeloviti tekst EU izjave o sukladnosti dostupan je na sljedećoj internetskoj adresi: <https://www.brp.com/en/corporate-social-responsibility/product-safety.html>

HU

BRP Megatech igazolja, hogy a 1001316154 típusú rádióberendezés megfelel a 2014/53/EU irányelvnek. Az EU-megfelelőségi nyilatkozat teljes szövege elérhető a következő internetes címen: <https://www.brp.com/en/corporate-social-responsibility/product-safety.html>

IT

Il fabbricante, BRP Megatech, dichiara che il tipo di apparecchiatura radio 1001316154 è conforme alla direttiva 2014/53/UE.

Il testo completo della dichiarazione di conformità UE è disponibile al seguente indirizzo Internet: <https://www.brp.com/en/corporate-social-responsibility/product-safety.html>

LT

Aš, BRP Megatech, patvirtinu, kad radijo įrenginių tipas 1001316154 atitinka Direktyvą 2014/53/ES. Visas ES atitikties deklaracijos tekstas prieinamas šiuo interneto adresu: <https://www.brp.com/en/corporate-social-responsibility/product-safety.html>

LV

Ar šo BRP Megatech deklarē, ka radioiekārta 1001316154 atbilst Direktīvai 2014/53/ES. Pilns ES atbilstības deklarācijas teksts ir pieejams šādā interneta vietnē: <https://www.brp.com/en/corporate-social-responsibility/product-safety.html>

MT

B'dan, BRP Megatech, niddikjara li dan it-tip ta' taghmir tar-radju 1001316154 huwa konformi mad-Direttiva 2014/53/UE. It-test kollu tad-dikjarazzjoni ta' konformità tal-UE huwa disponibbli f'dan l-indirizz tal-Internet li ġej: <https://www.brp.com/en/corporate-social-responsibility/product-safety.html>

NL

Hierbij verklaar ik, BRP Megatech, dat het type radioapparatuur 1001316154 conform is met Richtlijn 2014/53/EU.

De volledige tekst van de EU-conformiteitsverklaring kan worden geraadpleegd op het volgende internetadres: <https://www.brp.com/en/corporate-social-responsibility/product-safety.html>

PL

BRP Megatech niniejszym oświadcza, że typ urządzenia radiowego 1001316154 jest zgodny z dyrektywą 2014/53/UE. Pełny tekst deklaracji zgodności UE jest dostępny pod następującym adresem internetowym: <https://www.brp.com/en/corporate-social-responsibility/product-safety.html>

PT

O(a) abaixo assinado(a) BRP Megatech declara que o presente tipo de equipamento de rádio 1001316154 está em conformidade com a Diretiva 2014/53/UE.

O texto integral da declaração de conformidade está disponível no seguinte endereço de Internet: <https://www.brp.com/en/corporate-social-responsibility/product-safety.html>

RO

Prin prezenta, BRP Megatech declară că tipul de echipamente radio 1001316154 este în conformitate cu Directiva 2014/53/UE. Textul integral al declarației UE de conformitate este disponibil la următoarea adresă internet: <https://www.brp.com/en/corporate-social-responsibility/product-safety.html>

SV

Härmed försäkrar BRP Megatech att denna typ av radioutrustning 1001316154 överensstämmer med direktiv 2014/53/EU. Den fullständiga texten till EU-försäkringen om överensstämmelse finns på följande webbadress: <https://www.brp.com/en/corporate-social-responsibility/product-safety.html>

SL

BRP Megatech potrjuje, da je tip radijske opreme 1001316154 skladen z Direktivo 2014/53/EU. Celotno besedilo izjave EU o skladnosti je na voljo na naslednjem spletnem naslovu: <https://www.brp.com/en/corporate-social-responsibility/product-safety.html>

SK

BRP Megatech týmto vyhlasuje, že rádiové zariadenie typu 1001316154 je v súlade so smernicou 2014/53/EÚ. Úplné EÚ vyhlásenie o zhode je k dispozícii na tejto internetovej adrese: <https://www.brp.com/en/corporate-social-responsibility/product-safety.html>

IS

BRP Megatech lýsir því hér með yfir að þráðlausi fjarskiptabúnaðurinn 1001316154 er í samræmi við tilskipun 2014/53/ESB. Óstytta texta ESB-samræmisýfirlýsingarinnar er að finna á veffanginu: <https://www.brp.com/en/corporate-social-responsibility/product-safety.html>

Liechtenstein

Hiermit erklärt BRP Megatech, dass der Funkanlagentyp 1001316154 der Richtlinie 2014/53/EU entspricht. Der vollständige Text der EU-Konformitätserklärung ist unter der folgenden Internetadresse verfügbar: <https://www.brp.com/en/corporate-social-responsibility/product-safety.html>

NO

Hermed erklærer BRP Megatech at radioutstyrstypen 1001316154 er i samsvar med direktiv 2014/53/EU. Hele teksten i EU-samsvarserklæringen finnes på følgende internettadresse: <https://www.brp.com/en/corporate-social-responsibility/product-safety.html>

RU

Компания BRP Megatech настоящим заявляет, что радиотехническое оборудование категории 1001316154 отвечает требованиям Директивы 2014/53/EU.

Полный текст декларации соответствия ЕС доступен на сайте <https://www.brp.com/en/corporate-social-responsibility/product-safety.html>

EVAPORATIVE EMISSION CONTROL SYSTEM

California Models with Evaporative Emission Control System

Beginning with the 2018 model-year vehicles, some California models are certified to meet the CARB (California Air Resources Board) TP-933. These models are equipped with an evaporative emission control system consisting of a low permeation fuel tank (LPFT), low permeation fuel lines (LPFL) and an actively purged carbon canister.

The following statement is required by the CCR (California Code of Regulation): An add-on or modified part must be compliant with applicable ARB evaporative emission control standards. A violation of this requirement is punishable by civil and/or criminal punishment.

NOISE EMISSION CONTROL SYSTEM REGULATION (CANADA AND UNITED STATES)

USA and Canada Only

Tampering with Noise Control System Is Prohibited!

U.S. Federal law and Canadian provincial laws may prohibit the following acts or the causing there of:

1. The removal or rendering inoperative by any person other than for purposes of maintenance, repair or replacement of any device or element of design incorporated into any new vehicle for the purpose of noise control prior to its sale or delivery to the ultimate purchaser or while it is in use or
2. The use of the vehicle after such device or element of design has been removed or rendered inoperative by any person.

Among those Acts Presumed to Constitute Tampering Are the Acts Listed Below:

1. Removal or alteration or the puncturing of the mufflers or any engine component which conducts removal of engine exhaust gases.
2. Removal or alteration or the puncturing of any part of the intake system.
3. Replacing any moving parts of the vehicle or parts of the exhaust or intake system, with parts other than those specified by the manufacturer.
4. Lack of proper maintenance.

NOISE EMISSION AND VIBRATION VALUES (ALL COUNTRIES EXCEPT CANADA/UNITED STATES)

Noise emission and Vibration values are measured in accordance with Machinery Directive 2006/42/EC on a paved surface, at neutral or without belt.

MODEL		900 ACE TURBO RR
NOISE EMISSION AND VIBRATION VALUES		
Noise	Sound pressure level (L_{pA})	83 dB (A) (Uncertainty (K_{pA}) 3dB)
	Sound power level (L_{WA})	99 dB (A) (Uncertainty (K_{WA}) 3dB)
Vibration	Hand-arm system	Less than 2.5 m/s ²
	Whole body at seat	Less than 0.5 m/s ²

DECLARATION OF CONFORMITY

EU Declaration of Conformity



565 de la Montagne Street
Valcourt (Québec) J0E 2L0
Canada

www.brp.com

EU Declaration of Conformity

Authorized Representative: BRP-Rotax GmbH Co. KG, Rotaxstrasse 1, Gunskirchen, A-4623 Austria

This declaration of conformity is issued under the sole responsibility of the manufacturer.

The undersigned, representing the manufacturer, hereby declares that model year **2025 Side** by **Side Vehicles** marked with the **CE** mark and a 17-character vehicle identification number (VIN) structured as **3JBxxxxxRxxxxxxx** under commercial names **Can-Am Traxter**, **Can-Am Maverick Sport**, **Can-Am Maverick**, and **Can-Am Maverick R** comply with all the relevant provisions of the following Directives and Regulations:

Machinery (MD) Directive 2006/42/EC as amended up to and including Regulation (EU) 2019/1243	ISO 12100:2010 & EN 16990:2020
Non-Road Mobile Machinery (NRMM) Regulation (EU) 2016/1628 on gaseous pollutants as amended up to and including Regulation (EU) 2022/992	Category ATS, Stage V emission limits
Electromagnetic Compatibility (EMC) Directive 2014/30/EU as amended up to and including Regulation (EU) 2018/1139	CISPR 12:2007/A1:2009 & IEC 61000-6-1:2007 or UN R10.05 or later version
Battery Directive 2006/66/EC as amended up to and including Directive (EU) 2018/849 and, Regulation (EU) 1103/2010 on battery capacity labelling	EN 50342-7:2015
Radio Equipment (RED) Directive 2014/53/EU as amended up to and including Regulation (EU) 2023/1717 (If fitted with radio frequency (RF) D.E.S.S. key)	Art. 3.1a: IEC 62368-1:2014 Art. 3.1b: CISPR 25:2016 & ISO 11452-2:2004 Art. 3.2: ETSI EN 300 330 V2.1.1:2017

Luc Bouchard

Luc Bouchard (Mar 26, 2024 09:34 EDT)

Luc Bouchard, Eng.
Director, Product Development, Can-Am SSV
Bombardier Recreational Products Inc.

Valcourt, QC, Canada

Mar 26, 2024

SKI-DOO LYNX SEV-DOO ENVIROIDE ROTAX CAN-AM

UK Declaration of Conformity



565 de la Montagne Street
Valcourt (Québec) J0E 2L0
Canada
www.brp.com

UK Declaration of Conformity

Authorized Representative: BRP Recreational Products UK Ltd., (BWM Accountants Limited),
Suite 5.1, 12 Tithebarn Street, Liverpool, L2 2DT

This declaration of conformity is issued under the sole responsibility of the manufacturer.

The undersigned, representing the manufacturer, hereby declares that model year **2025 Side by Side Vehicles** marked with the ^{UK}CA mark and a 17-character vehicle identification number (VIN) structured as **3JBxxxxxRxxxxxxx** under commercial names **Can-Am Traxter**, **Can-Am Maverick Sport**, **Can-Am Maverick**, and **Can-Am Maverick R** comply with all the relevant provisions of the following Statutory Instruments:

Supply of Machinery (Safety) Regulations 2008, UK SI 2008/1597 as amended up to and including SI 2022/1393	ISO 12100:2010 & EN 16990:2020
Non-Road Mobile Machinery (Type-Approval and Emission of Gaseous and Particulate Pollutants) Regulations 2018, UK SI 2018/764 as amended up to and including SI 2022/1273	Category ATS, Stage V emission limits
Electromagnetic Compatibility Regulations 2016, UK SI 2016/1091 as amended up to and including SI 2022/1393	CISPR 12:2007/A1:2009 & IEC 61000-6-1:2007 or UN R10.05 or later version
Batteries and Accumulators (Placing on the Market) Regulations 2008, UK SI 2008/2164 as amended up to and including UK SI 2020/1540	EN 50342-7:2015
Radio Equipment Regulations 2017, UK SI 2017/1206 as amended up to and including SI 2023/328 (If fitted with radio frequency (RF) D.E.S.S. key)	Art. 3.1a: IEC 62368-1:2014 Art. 3.1b: CISPR 25:2016 & ISO 11452-2:2004 Art. 3.2: ETSI EN 300 330 V2.1.1:2017

Luc Bouchard

Luc Bouchard (Mar 26, 2024 09:34 EDT)

Luc Bouchard, Eng.
Director, Product Development, Can-Am SSV
Bombardier Recreational Products Inc.

Valcourt, QC, Canada

Mar 26, 2024

SKI-DOO LYNX SEA-DOO EVERSEAS ROTAX CAN-AM

EAC DECLARATION OF CONFORMITY

**Left blank for Eurasian Conformity
mark where applicable**

TECHNICAL SPECIFICATIONS

TECHNICAL SPECIFICATIONS

Engine		
Engine type	ROTAX® 900 ACE TURBO / TURBO RR	
	4-stroke, Double Over Head Camshaft (DOHC), dry sump, liquid cooled	
Number of cylinders	3	
Number of valves	12 valves (self-adjusting hydraulic valve lifters)	
Bore	74 mm (2.91 in)	
Stroke	69.7 mm (2.74 in)	
Displacement	899.31 cm ³ (54.88 in ³)	
Maximum HP RPM	Turbo	7800 RPM
	Turbo RR	7800 RPM
Exhaust system	NRMM models	Catalyst
	Other models	Spark arrestor approved by USDA Forest Service
Air filter	Donaldson high-performance filter	

LUBRICATION SYSTEM		
Type	Dry sump	
Oil filter	Oil filter	Replaceable cartridge oil filter
Engine oil	Capacity	3.5 l (3.7 qt (liq.,US))
	Recommended XPS oil	5W40 Synthetic oil or 10W50 Synthetic oil

LUBRICATION SYSTEM		
	Alternate oil if XPS products are not available	If not available, use a 5W40 or 10W50 motor oil that meets the requirements for API service classification SN or JASO MA2
COOLING SYSTEM		
Coolant	Type	Extended life pre-mixed coolant. Ethyl glycol / water mix (50%/50%). or coolant specifically designed for aluminum engines
	Capacity	7.7 l (2.03 gal (liq.,US))
TRANSMISSION		
Type		CVT (Continuously Variable Transmission)
Engagement	Turbo	2150 RPM
	Turbo RR	2150 RPM
ELECTRICAL SYSTEM		
Magneto generator output	Turbo	650 W @ 6000 RPM
	Turbo RR	850 W @ 6000 RPM
Spark plug	Quantity	3
	Make and type	NGK LMAR9AI-8D
	Gap	0.7 to 0.8 mm (.028 to .031 in)
Battery	Type	Maintenance free SLA
	Voltage	12 volts
	Nominal rating	20 A•h
	Power starter output	1.34 kW

ELECTRICAL SYSTEM	
Headlight	2 x 20W LED
Taillight	2 x 3W LED
Signature lights	2 x 2W LED
Fuses	Refer to <i>Fuses in Maintenance</i>

FUEL SYSTEM			
Fuel pump	Type	Electric (in fuel tank)	
Fuel	Type	Premium unleaded gasoline - Refer to <i>Fuel Requirements</i>	
	Minimum Octane rating	North America	87 AKI (R+M)/2
		Outside North America	92 RON
	Recommended Octane rating	North America	91 AKI (R+M)/2
Outside North America		95 RON	
Fuel tank capacity		± 40 l (10.6 gal (liq.,US))	
Fuel remaining when low fuel light turns ON		± 12 l (3.2 gal (liq.,US))	

GEARBOX		
Type	Dual range (HI-LO) with PARK, neutral and reverse	
Gearbox oil	Capacity	Refill: 1.25 l (42 fl oz (US)) New or overhaul:(1.5 l (51 fl oz (US)) when new)
	Recommended XPS oil	75W140 Synthetic gear oil
	Alternate oil if XPS products are not available	Synthetic gear oil 75W140 API GL-5

DRIVE SYSTEM		
Front drive		Selectable 2WD / 4WD with Smart-Lok electronic locking differential and front diff lock
Front drive ratio		3.6:1
Rear drive		Integrated to transmission, helical gears
Rear drive ratio		3.43:1
Front differential oil	Capacity	350 ml (11.83 fl oz (US))
	Recommended XPS oil	75W90 Synthetic gear oil
	Alternate oil if XPS products are not available	Synthetic gear oil 75W90 API GL-5
CV joint grease		CV joint grease

STEERING	
Type	Rack and pinion
Steering wheel	Adjustable tilt steering

FRONT SUSPENSION		
Suspension type	MAX DS MAX X ds MAX RS MAX X rs	Double suspension A-arms with sway bar
	MAX X rc	Trophy truck inspired double arched A-arm with sway bar
Suspension travel	MAX DS MAX X ds	508 mm (20 in)
	MAX RS MAX X rs MAX X rs with Smart-Shox MAX X rc	559 mm (22 in)
Shock absorber	Quantity	2

FRONT SUSPENSION			
	Type	MAX DS MAX RS	SHOWA HPG 2.5 shocks with piggyback reservoir. Dual speed compression, dual-rate spring.
		MAX X ds	FOX† 2.5 PODIUM shocks with piggyback reservoir and dual speed compression and rebound adjustments
		MAX X rs MAX X rc	FOX† 2.5 PODIUM RC2 shocks with piggyback reservoir and bypass, dual speed compression and rebound adjustments
		MAX X rs with Smart-Shox	FOX† 2.5 PODIUM RC2† Piggyback with bypass and Smart-Shox** Technology featuring DDA Valve (Dynamic Damping Adjustment)
Preload adjustment type			Threaded spring retainer

REAR SUSPENSION			
Suspension type			Torsional Trailing Suspension-arm X (TTX) with sway bar
Suspension travel		MAX DS MAX X ds	508 mm (20 in)
		MAX RS MAX X rs MAX X rs with Smart-Shox MAX X rc	559 mm (22 in)
Shock absorber	Quantity		2
	Type	MAX DS MAX RS	SHOWA HPG 2.5 shocks with piggyback reservoir. Dual speed compression, dual-rate spring.
		MAX X ds	FOX† 2.5 PODIUM shocks with piggyback

REAR SUSPENSION			
			reservoir and dual speed compression and rebound adjustments
		MAX X rs MAX X rc	FOX† 3.0 PODIUM shocks with piggyback reservoir and bypass, dual speed compression and rebound adjustments
		MAX X rc Turbo	FOX† 3.0 PODIUM RC2† with bypass, dual speed compression and rebound adjustments
		MAX X rs with Smart-Shox	FOX† 3.0 PODIUM† with bypass and Smart-Shox** Technology featuring DDA Valve (Dynamic Damping Adjustment)
Preload adjustment type			Threaded spring retainer

BRAKES		
Front brake	Qty	2
	Type	262 mm (10.3 in) ventilated brake disc with hydraulic twin-pistons calipers of 32 mm (1.26 in)
Rear brake	Qty	2
	Type	248 mm (9.8 in) ventilated brake disc with hydraulic twin-pistons calipers of 28 mm (1.1 in)
Brake fluid	Type	DOT 4
	Capacity	320 ml (10.8 fl oz (US))
Caliper		Floating
Brake pad material		Sintered high performance

BRAKES	
Minimum brake pad thickness	0.5 mm (.02 in)
Minimum brake disc thickness	4 mm (.157 in)
Maximum brake disc warpage	0.2 mm (.01 in)

TIRES			
Pressure			Recommended tire inflation pressure is found on the Tire Label. Refer to appropriate <i>Important On-Product Labels</i> section for its location.
Size	Front	MAX DS MAX RS MAX X ds	255/80R14 30x10R14
		MAX X rs	255/85R15 32x10R15
	Rear	MAX DS MAX RS MAX X ds	255/80R14 30x10R14
		MAX X rs MAX X rc	255/85R15 32x10R15
Minimum tire thread depth			3 mm (0.118 in)

WHEELS			
Type		MAX DS MAX RS	Cast aluminum wheels
		MAX X ds MAX X rs	Cast aluminum beadlock wheels
Rim size	Front	MAX DS MAX X ds MAX RS	35.6 x 17.8 cm (14 x 7 in)
		MAX X rc MAX X rs	38.1 x 17.8 cm (15 x 7 in)
	Rear	MAX DS	35.6 x 17.8 cm

WHEELS			
		MAX X ds MAX RS	(14 x 7 in)
		MAX X rc MAX X rs	38.1 x 17.8 cm (15 x 7 in)
Wheel lug nuts torque			120 ± 5 Nm (89 ± 4 lbf-ft)
Wheel Offset	Front	MAX DS MAX RS	55.1 mm (2.2 in)
		MAX X ds MAX X rs	55 mm (2.2 in)
	Rear	MAX DS MAX RS	55.1 mm (2 in)
		MAX X ds MAX X rs	55 mm (2.2 in)

CHASSIS	
Cage type	Dual-phase 980 steel

DIMENSIONS		
Overall length	MAX DS MAX RS MAX X ds	416.6 cm (164 in)
	MAX X rs MAX X rc	419.1 cm (165 in)
Overall width	MAX DS MAX X ds	162.5 cm (64 in)
	MAX RS	183.9 cm (72.4 in)
	MAX X rs MAX X rc	184.7 cm (72.7 in)
Overall height	MAX DS	167.1 cm (65.8 in)
	MAX X ds	167.6 cm (66 in)
	MAX RS MAX X rs	174 cm

DIMENSIONS			
		MAX X rc	(68.5 in)
Wheelbase			342.9 cm (135 in)
Wheel track	Front	MAX DS MAX X ds	136 cm (53.5 in)
		MAX RS MAX X rs	156.4 cm (61.6 in)
	Rear	MAX DS MAX X ds	133.1 cm (52.4 in)
		MAX RS MAX X rs	153.4 cm (60.4 in)
Ground clearance		MAX DS MAX X ds	33 cm (13 in)
		MAX RS	40.6 cm (16 in)
		MAX X rs MAX X rc	40.6 cm (16 in)

LOADING CAPACITY AND WEIGHT			
Dry weight		MAX DS	821 kg (1,810 lb)
		MAX X ds	833.7 kg (1,838 lb)
		MAX RS MAX X rc	880.9 kg (1,942 lb)
		MAX X rs	903.1 kg (1,991 lb)
		MAX X rs with Smart-Shox	956 kg (2103 lb)
Weight distribution (front/rear)			44/56
Total vehicle load allowed (including driver, passengers, all other loads and added accessories)			399 kg (880 lb)
Gross vehicle weight rating	MAX DS	1270 kg	

LOADING CAPACITY AND WEIGHT		
		(2,800 lb)
	MAX X ds	1282 kg (2,826 lb)
	MAX RS	1320 kg (2,910 lb)
	MAX X rs	1352 kg (2,981 lb)
	MAX X rs with Smart-Shox	1360 kg (2,998 lb)
Cargo rack capacity		91kg (200 lb)

This page is intentionally blank

TROUBLESHOOTING

TROUBLESHOOTING GUIDELINES

CVT BELT IS SLIPPING

1. **Water has entered in the CVT.**
 - *Refer to Special Procedures.*

"-" IS DISPLAYED ON THE GEARBOX POSITION DISPLAY

1. **Shift lever is between 2 positions.**
 - *Properly position the shift lever in the desired position.*
2. **Shift lever is not properly adjusted.**
 - *Contact an authorized Can-Am dealer.*
3. **Electrical communication error.**
 - *Contact an authorized Can-Am dealer.*

ENGINE DOES NOT TURN

1. **D.E.S.S. key is not installed on D.E.S.S. post.**
 - *Securely install key to D.E.S.S. post.*
2. **Shift lever is not set on PARK.**
 - *Set shift lever to either in PARK or press the brake pedal.*
3. **Burnt fuse.**
 - *Check fuses.*
4. **Weak battery or loose connections.**
 - *Check charging system fuse.*
 - *Check fault message in cluster.*
 - *Check battery connections and terminals condition.*
 - *Have the battery checked by an authorized Can-Am dealer.*
5. **Defective engine start button.**
 - *Contact an authorized Can-Am dealer.*
6. **Defective starter solenoid.**
 - *Contact an authorized Can-Am dealer.*
7. **D.E.S.S. key not recognized is displayed in the multifunction gauge.**
 - *Clean D.E.S.S. key.*

ENGINE TURNS OVER BUT FAILS TO START**1. Flooded engine (spark plug wet when removed).**

- *(If the engine does not start and it is fuel-flooded, the drowned mode can be activated to prevent fuel injection and to cut ignition while cranking. Proceed as follows:*
 - *Install key on D.E.S.S. post.*
 - *Press completely and HOLD accelerator pedal.*
 - *Press the engine START button.**The engine should be cranked for 10 seconds. Release engine START button.*
Release accelerator pedal and start/crank engine again to allow starting.
If it does not work:
 - *Remove the spark plugs (tools are supplied in tool kit). Refer to Spark Plugs in Maintenance Procedures.*
 - *Crank engine several times.*
 - *Install new spark plugs if possible or clean and dry spark plugs.*
 - *If engine does not start, seek service from an authorized Can-Am dealer, repair shop, or person of your own choosing for maintenance, repair, or replacement. Please refer to the US EPA Emission-Related Warranty contained herein for information about warranty claims.*

2. No fuel to the engine (spark plug dry when removed).

- *Check fuel tank level.*
- *Check fuel pump fuse.*
- *Obstructed fuel pump pre-filter or fuel pump failure. Seek service from an authorized Can-Am dealer, repair shop, or person of your own choosing for maintenance, repair, or replacement. Please refer to the US EPA Emission-Related Warranty contained herein for information about warranty claims.*

3. Spark plug/ignition (no spark).

- *Check ignition fuse.*
- *Remove spark plug then reconnect to ignition coil.*
- *Start engine with spark plug grounded to the engine away from spark plug hole. If no spark appears, replace spark plug.*
- *If trouble persists, seek service from an authorized Can-Am dealer, repair shop, or person of your own choosing for maintenance, repair, or replacement. Please refer to the US EPA Emission-Related Warranty contained herein for information about warranty claims.*

ENGINE LACKS ACCELERATION OR POWER

1. **Seat belt not buckled properly. Check cluster message.**
 - *Buckle up seat belt.*
2. **Fouled or damaged spark plug.**
 - *Replace spark plugs.*
3. **Engine air filter plugged or dirty.**
 - *Check air filter and replace if necessary.*
 - *Check deposits in engine air filter housing.*
4. **Water in CVT**
 - *Drain water from CVT. Refer to Special Procedures.*
5. **CVT dirty or worn-out.**
 - *Contact an authorized Can-Am dealer.*
6. **Lack of fuel**
 - *Dirty or clogged fuel pump pre-filter. Seek service from an authorized Can-Am dealer, repair shop, or person of your own choosing for maintenance, repair, or replacement. Please refer to the US EPA Emission-Related Warranty contained herein for information about warranty claims.*
7. **Engine is in Torque Limitation mode (if equipped).**
 - *Engine torque is gradually limited for protection when coolant temperature is too high. Check multifunction gauge display for engine temperature.*
 - *Let engine cool down.*
8. **Engine is in limp home mode.**
 - *Multifunction gauge CHECK ENGINE indicator lamp is on and display shows LIMP HOME, seek service from an authorized Can-Am dealer, repair shop, or person of your own choosing for maintenance, repair, or replacement. Please refer to the US EPA Emission-Related Warranty contained herein for information about warranty claims.*

ENGINE OVERHEATS

1. **Low coolant level in cooling system.**
 - *Check coolant level and refill. See Maintenance Procedures. Seek service from an authorized Can-Am dealer, repair shop, or person of your own choosing for maintenance, repair, or replacement. Please refer to the US EPA Emission-Related Warranty contained herein for information about warranty claims.*
2. **Cooling fan is not working.**
 - *Ensure cooling fan is not jammed and working properly.*
 - *Check fan fuse. See Fuses in the Maintenance Procedures.*
3. **Dirty radiators fins.**
 - *Check and clean radiator fins. See Maintenance Procedures.*

ENGINE MISFIRE

1. **Fouled/damaged/worn spark plug.**
 - *Replace spark plugs as required.*
2. **Water in fuel.**
 - *Drain fuel system and refill with fresh fuel.*

THE RPM INCREASES BUT THE VEHICLE DOES NOT MOVE

1. **Water in the CVT.**
 - *Drain water from CVT. See Special Procedures.*
2. **CVT dirty or worn-out or belt failure.**
 - *Contact an authorized Can-Am dealer.*

PARTIAL OR NO RESPONSE FROM THE ACCELERATOR PEDAL INPUTS (CHECK ENGINE IS ON AND PPS FAULT MESSAGE IS DISPLAYED)

1. **Partial failure of the accelerator pedal sensors (PPS).**
 - *Use the override switch to retrieve accelerator pedal operation. Contact an authorized Can-Am dealer.*
2. **Total failure of the accelerator pedal sensors (PPS).**
 - *Use the override switch to bypass the accelerator pedal and increase the engine speed in order to move vehicle. Contact an authorized Can-Am dealer.*

SHOCK ICON IS BLINKING FAST WHILE VEHICLE MALFUNCTION TELLTALE IS ON

1. **Partial failure of Smart-Shox system: Front or rear shock absorbers become full stiff (Sport+ like).**
 - *Change Smart-Shox mode to Sport+ to have a similar setting at front and rear. The vehicle remains rideable. Contact an authorized Can-Am dealer.*
2. **Total failure of Smart-Shox system: Front and rear shock absorbers become full stiff (Sport+ like).**
 - *The vehicle remains rideable. Contact an authorized Can-Am dealer.*

MESSAGES IN MULTIFUNCTION GAUGE

If an abnormal engine condition occurs, the following messages can be combined with a pilot lamp.

Message	Description
D.E.S.S. KEY NOT RECOGNIZED	D.E.S.S. key requires cleaning.
BAD KEY	Indicates that you have used the wrong D.E.S.S. key, use the proper key for this vehicle.
CHECK ENGINE	All active or previously activated faults that require attention. No engine limitation engaged.
LIMP HOME	Critical faults requiring diagnostic as soon as possible. An engine limitation is engaged and/or the engine behavior is modified.
TPS FAULT	Throttle body fault, generally followed by a Limp Home message.
BRAKE SWITCH FAULT	Brake signal fault.
CHECK DPS	Check engine pilot light on. Indicates that the DPS (Dynamic Power Steering) does not work properly. See an authorized Can-Am dealer.
PPS FAULT	Faulty Pedal Position Sensor(s) (PPS). Refer to <i>Override Switch</i> in <i>Secondary Controls</i> to drive the vehicle in the limp home mode.
MANUAL LIMP HOME	Confirms the Manual Limp Home is engaged using the Override Switch in case of a PPS fault.
FUEL SENSOR FAULT	When the fuel sender resistor value is out of range the multifunction gauge (analog/digital) will detect it and display the message.
CHECK SMART-LOK	Check engine pilot light on. Indicates that the Smart-Lok does not work properly. See an authorized Can-Am dealer.
BELT OVERHEAT	Indicate that the electronic drive belt protection is activated. The temperature in the vicinity of the drive belt is too high. Move the shift lever in LOW position and reduce the speed.

WARRANTY

BRP LIMITED WARRANTY FOR CANADA AND USA: 2025 CAN-AM® SSV

1) Scope of the Limited Warranty

Bombardier Recreational Products Inc. ("BRP") warrants its 2025 Can-Am SSV (the "Product") sold by an authorized dealer in the United States of America ("USA") and in Canada (a "BRP Dealer") from defects in material or workmanship for the period and under the conditions described below.

This limited warranty will become null and void if:

1. the Product was used for racing or any other competitive activity, at any point, even by a previous owner; or
2. the Product has been altered or modified in such a way so as to adversely affect its operation, performance or durability, or has been altered or modified to change its intended use.

Non-factory installed parts and accessories are not covered under this limited warranty. Please refer to the applicable parts and accessories limited warranty text.

2) Limitations of Liability

TO THE EXTENT PERMITTED BY LAW, THIS WARRANTY IS EXPRESSLY GIVEN AND ACCEPTED IN LIEU OF ANY AND ALL OTHER WARRANTIES, EXPRESSED OR IMPLIED, INCLUDING WITHOUT LIMITATION ANY WARRANTY OF MERCHANTABILITY OR FITNESS FOR A PARTICULAR PURPOSE. TO THE EXTENT THAT THEY CANNOT BE DISCLAIMED, THE IMPLIED WARRANTIES ARE LIMITED IN DURATION TO THE LIFE OF THE EXPRESS WARRANTY. INCIDENTAL AND CONSEQUENTIAL DAMAGES ARE EXCLUDED FROM COVERAGE UNDER THIS WARRANTY. SOME STATES/PROVINCES DO NOT ALLOW FOR THE DISCLAIMERS, LIMITATIONS AND EXCLUSIONS IDENTIFIED ABOVE. AS A RESULT, THEY MAY NOT APPLY TO YOU. THIS WARRANTY GIVES YOU SPECIFIC RIGHTS, AND YOU MAY ALSO HAVE OTHER LEGAL RIGHTS WHICH MAY VARY FROM STATE TO STATE, OR PROVINCE TO PROVINCE.

Neither the distributor, any BRP Dealer nor any other person has been authorized to make any affirmation, representation or warranty regarding the Product, other than those contained in this limited warranty, and if made, shall not be enforceable against BRP.

BRP reserves the right to modify this limited warranty at any time, being understood that such modification will not alter the warranty conditions applicable to the Products sold while this warranty is in effect.

3) EXCLUSIONS – Are Not Warranted

The following are not warranted under any circumstances:

- Normal wear and tear;
- Routine maintenance items, tune ups, adjustments;
- Damage caused by negligence or failure to provide proper maintenance and/or storage, as described in the Operator's Guide;
- Damage resulting from removal of parts, improper repairs, service, maintenance, modifications or use of parts not manufactured or approved by BRP or

resulting from repairs done by a person that is not an authorized servicing BRP Dealer;

- Damage caused by abuse, abnormal use, neglect or operation of the Product in a manner inconsistent with the recommended operation described in the Product's Operator's Guide;
- Damage resulting from accident, submersion, fire, theft, vandalism or any act of God;
- Operation with fuels, oils or lubricants which are not suitable for use with the Product (see the Operator's Guide);
- Damages from rust, corrosion or exposure to the elements;
- Damage resulting from water or snow ingestion;
- Incidental or consequential damages, or damages of any kind including without limitation transportation expenses, towing, storage, telephone, rental, taxi, inconvenience, insurance coverage, loan payments, loss of time, loss of income or time missed for downtime experience due to service work.

4) Warranty Coverage Period

This limited warranty will be in effect from (1) the date of delivery to the first retail consumer, or (2) the date the Product is first put into use, whichever occurs first and for the applicable period below:

1. **SIX (6) consecutive months**, for private use or commercial use owners.
2. **For emission-related components**, please also refer to the US EPA Emission-Related Warranty.
3. **For evaporative emission-related components of California models equipped with evaporative emission control system produced by BRP for sale in the State of California** that are originally sold to a resident or subsequently warranty registered to a resident in the State of California, also refer to the California Evaporative Emissions Control Warranty Statement.

The repair or replacement of parts or the performance of service under this warranty does not extend the life of this limited warranty beyond its original expiration date.

5) Conditions to Have Warranty Coverage

This warranty coverage is available only if each of the following conditions has been fulfilled:

1. The Product must be purchased as new and unused by its first owner from a BRP Dealer authorized to sell the Product in the country in which the sale occurred;
2. The BRP specified pre-delivery inspection process must be completed, documented and signed by the purchaser;
3. The Product must have undergone proper registration by an authorized BRP Dealer;
4. The Product must be purchased in the country in which the purchaser resides;
5. Routine maintenance outlined in the Operator's Guide must be timely performed in order to maintain warranty coverage. BRP reserves the right to make warranty coverage contingent upon proof of proper maintenance.

BRP will not honor this limited warranty to any private use owner or commercial use owner if one of the preceding conditions has not been met. Such limitations are necessary in order to allow BRP to preserve both the safety of its products, and also that of its consumers and the general public.

6) What to Do to Obtain Warranty Coverage

The customer must cease using the Product upon the appearance of an anomaly, notify a servicing BRP Dealer within three (3) days of the appearance of the anomaly and provide the BRP Dealer with reasonable access to the Product and reasonable opportunity to repair it.

The customer must also present to the BRP Dealer, proof of purchase of the Product and must sign the repair/work order prior to starting the repair in order to validate the warranty repair.

All parts replaced under this limited warranty become the property of BRP.

7) What BRP Will Do

BRP's obligations under this warranty are limited to, at its sole discretion, repairing or replacing parts found defective under normal use, maintenance and service without charge for parts and labor, at any authorized BRP Dealer during the warranty coverage period under the conditions described herein. No claim of breach of warranty shall be cause for cancellation or rescission of the sale of the Product to the owner.

In the event that service is required outside of the country of original sale, the owner will bear responsibility for any additional charges due to local practices and conditions, such as, but not limited to, freight, insurance, taxes, license fees, import duties, and any and all other financial charges, including those levied by governments, states, territories and their respective agencies.

BRP reserves the right to improve or modify products from time to time without assuming any obligation to modify products previously manufactured.

8) Transfer

If the ownership of a Product is transferred during the warranty coverage period, this limited warranty, subject to its terms and conditions, shall also be transferred and be valid for the remaining coverage period provided BRP or an authorized BRP Distributor/Dealer receives a proof that the former owner agreed to the transfer of ownership, in addition to the coordinates of the new owner.

9) Consumer Assistance

In the event of a controversy or a dispute in connection with this limited warranty, BRP suggests that you try to resolve the issue at the dealership level. We recommend discussing the issue with the authorized BRP Dealer's service manager or owner.

If the matter still remains unresolved, contact BRP by filling out the customer contact form at www.brp.com or contact BRP by mail at one of the addresses listed under the *Contact Us* section of this guide.

US EPA EMISSION - RELATED WARRANTY

Bombardier Recreational Products Inc. ("BRP") warrants to the ultimate purchaser and each subsequent purchaser that this new vehicle, including all parts of its exhaust emission control system and its evaporative emission control system, meets two conditions:

1. It is designed, built, and equipped so it conforms at the time of sale to the ultimate purchaser with the requirements of 40 CFR 1051 and 40 CFR 1060.
2. It is free from defects in materials and workmanship that may keep it from meeting the requirements of 40 CFR 1051 and 40 CFR 1060.

Where a warrantable condition exists, BRP will repair or replace, as it elects, any part or component with a defect in materials or workmanship that would increase the engine's emissions of any regulated pollutant within the stated warranty period at no cost to the owner, including expenses related to diagnosing and repairing or replacing emission-related parts. All defective parts replaced under this warranty become the property of BRP.

For all emission-related warranty claims, BRP is limiting the diagnosis and repair of emission-related parts to the authorized Can-Am dealers, unless for emergency repairs as required by item 2 of the following list.

As a certifying manufacturer, BRP will not deny emission-related warranty claims based on any of the following:

1. Maintenance or other service BRP or BRP's authorized facilities performed.
2. Engine/equipment repair work that an operator performed to correct an unsafe, emergency condition attributable to BRP as long as the operator tries to restore the engine/equipment to its proper configuration as soon as possible.
3. Any action or inaction by the operator unrelated to the warranty claim.
4. Maintenance that was performed more frequently than BRP specify.
5. Anything that is BRP fault or responsibility.
6. The use of any fuel that is commonly available where the equipment operates unless BRP written maintenance instructions state that this fuel would harm the equipment's emission control system and operators can readily find the proper fuel. See maintenance information section and fuel requirements of fueling section.

Emission-Related Warranty Period

The emission-related warranty is valid for the following period whichever comes first.

	HOURS	MONTHS	KILOMETERS
Exhaust emission-related components	500	30	5000
Evaporative emission-related components	N/A	24	N/A

Components Covered

The emission-related warranty covers all components whose failure would increase an engine's emissions of any regulated pollutant, including the following listed components:

1. For exhaust emissions, emission-related components include any engine parts related to the following systems:
 - Air-induction system
 - Fuel system
 - Ignition system
 - Exhaust gas recirculation systems.
2. The following parts are also considered emission-related components for exhaust emissions:
 - After treatment devices
 - Crankcase ventilation valves
 - Sensors
 - Electronic control units.
3. The following parts are considered emission-related components for evaporative emissions:
 - Fuel tank
 - Fuel cap
 - Fuel line
 - Fuel line fittings
 - Clamps*
 - Pressure relief valves*
 - Control valves*
 - Control solenoids*
 - Electronic controls*
 - Vacuum control diaphragms*
 - Control cables*
 - Control linkages*
 - Purge valves
 - Vapor hoses
 - Liquid/vapor separator
 - Carbon canister
 - Canister mounting brackets
 - Carburetor purge port connector.

NOTE: *As related to the evaporative emission control system.

4. Emission-related components also include any other part whose only purpose is to reduce emissions or whose failure will increase emissions without significantly degrading engine/equipment performance.

Limited Applicability

As a certifying manufacturer, BRP may deny emission-related warranty claims for failures that have been caused by the owner's or operator's improper maintenance or use, by accidents for which the manufacturer has no responsibility, or by acts of God. For example, an emission-related warranty claim need not be honored for failures that have been directly caused by the operator's abuse of the engine/equipment or the operator's use of the engine/equipment in a manner for which it was not designed and are not attributable to the manufacturer in anyway.

If you have any question regarding your warranty rights and responsibility or for the name and location of the nearest authorized BRP dealer, you should contact BRP by filling out the customer contact form at www.brp.com or contact BRP by mail at one of the addresses listed under the CONTACT US section of this guide, or call at 1-888-272-9222.

CALIFORNIA EVAPORATIVE EMISSIONS CONTROL WARRANTY STATEMENT

The warranty periods begin on the date the new Off-Highway Recreational Vehicle ("OHRV") is delivered to an ultimate purchaser.

Bombardier Recreational Products Inc. ("BRP") warrants to the ultimate purchaser and each subsequent purchaser that the OHRV is:

1. Designed, built, and equipped so as to conform, at the time of sale, with all applicable laws, rules and regulations; and
2. Free from defects in materials and workmanship that may cause the failure of a warranted part. All replacement parts must be identical in all material respects to that part as described in BRP's Executive Order of Certification application.

The warranty on emissions-related parts function as follows:

1. Repair or replacement of any warranted part must be performed at no charge to the OHRV owner, at a warranty station, except in the case of a temporary repair when a warranted part or a warranty station is not reasonably available to the OHRV owner. In the event a temporary repair is permitted, repairs may be performed at any available service establishment, or by the owner, using any replacement part. BRP must reimburse the owner for his or her expenses including diagnostic charges for such temporary repair or replacement, not to exceed BRP's suggested retail price for all warranted parts replaced and labor charges based on BRP's recommended time allowance for the warranty repair and the geographically appropriate hourly labor rate.
2. The lack of availability of warranted parts or the incompleteness of repairs within a reasonable time period, not to exceed 30 days from the time the OHRV is initially presented to the warranty station for repair, will qualify the need for a temporary repair.
3. Any warranted part which is not scheduled for replacement as part of maintenance in the written instructions must be warranted for the warranty period defined below. If any such part fails during the warranty period, it must be repaired or replaced by BRP. Any such part repaired or replaced under warranty must be fully warranted.
4. Any warranted part which is scheduled only for regular inspection in the written instructions must be warranted for the warranty period defined below. A statement in such written instructions to the effect of "repair or replace as necessary" does not reduce the period of warranty coverage. Any such part repaired or replaced under warranty is warranted for the remaining warranty period.
5. Any warranted part which is scheduled for replacement as part of maintenance in the written instructions is warranted for the period of time prior to the first scheduled replacement point for that part. If the part fails before the first scheduled replacement point, the part will be repaired or replaced by BRP. Any such part repaired or replaced under warranty is warranted for the remainder of the period prior to the first scheduled replacement point for the part.
6. Warranty services or repairs are provided at all manufacturer dealerships that are owned by the manufacturer or franchised to service the subject OHRVs.
7. The OHRV owner will not be charged for diagnostic labor which leads to the determination that a warranted part is, in fact, defective, provided that such diagnostic work is performed at a warranty station.

8. BRP is liable for damages to other vehicle components proximately caused by a failure, under warranty, of any warranted part.
9. Any replacement part designated by BRP may be used in warranty repairs provided without charge to the OHRV owner. Such use will not reduce the warranty obligations of BRP, except that BRP will not be liable for repair or replacement of any replacement part which is not a warranted part.
10. Any add-on or modified part exempted by the Air Resources Board from the prohibitions of section 27156 of the California Vehicle Code may be used on an OHRV. Such use, in and of itself, will not be grounds for disallowing a warranty claim. BRP is not liable to warrant failures of warranted parts caused by the use of an add-on or modified part (s) unless such part (s) are also warranted.

Conditions and exclusions:

- BRP may deny you warranty coverage if your OHRV or a part has failed directly due to abuse, neglect, improper maintenance or unapproved modifications.

Your Warranty Rights And Obligations

The California Air Resources Board is pleased to explain the evaporative emissions control system warranty on your 2025 Off-Road Sport Vehicle. In California, new off-highway recreational vehicles must be designed, built, and equipped to meet the State's stringent anti-smog standards. BRP must warrant the evaporative emissions control system on your Off-Road Sport Vehicle for the periods of time listed below provided there has been no abuse, neglect, improper maintenance, or unapproved modification of your Off-Road Sport Vehicle.

Your evaporative emissions control system may include parts such as the carburetor or fuel-injection system, fuel tank, fuel hoses, carbon canister, and engine computer. Also included may be hoses, belts, connectors and other evaporative emissions-related assemblies. Where a warrantable condition exists, Bombardier Recreational Products Inc. will repair your Off-Road Sport Vehicle at no cost to you including diagnosis, parts and labor.

OHRV Manufacturer's Warranty Coverage

The warranty period for this OHRV is 60 months, or 5000 miles, or 500 hours, whichever comes first.

Parts covered:

1. Canister Mounting Bracket(s)
2. Carbon Canister
3. Purge Port Connector
4. Clamp(s)*
5. Electronic Control*
6. Fuel Cap
7. Filler Neck
8. Filler Neck Hose
9. Fuel Line(s)
10. Fuel Line Fitting(s)
11. Fuel Tank
12. Pressure Relief Valve(s)*

13. Purge Valve(s)
14. Check Valve(s)*
15. Vapor Hose(s)
16. Flow Reducer
17. Filter(s)*
18. Fuel pump
19. All other parts not listed that may affect the evaporative emissions control system

NOTE: *As related to the evaporative emission control system.

If any evaporative emissions-related part on your Off-Road Sport Vehicle is defective the part will be repaired or replaced by Bombardier Recreational Products Inc.

Owner's Warranty Responsibilities

As the Off-Road Sport Vehicle owner you are responsible for the performance of the required maintenance listed in your owner's manual. Bombardier Recreational Products Inc. recommends that you retain all receipts covering maintenance on your Off-Road Sport Vehicle, but Bombardier Recreational Products Inc. cannot deny warranty solely for the lack of receipts or for failure to ensure the performance of a scheduled maintenance.

As an owner you are responsible for presenting your Off-Road Sport Vehicle to a Bombardier Recreational Products Inc. dealer as soon as a problem exists. The warranty repairs should be completed in a reasonable time, not to exceed 30 days.

As an Off-Road Sport Vehicle owner, you should also be aware that Bombardier Recreational Products Inc. may deny you warranty coverage if your Off-Road Sport Vehicle or a part has failed due to abuse, neglect, improper maintenance or unapproved modifications.

If you have any questions regarding your warranty rights and responsibilities, you should contact:

- Bombardier Recreational Products Inc. at 1-888-272-9222, or
- The California Air Resources Board at 4001 Iowa Avenue, Riverside, CA 92507.

BRP LIMITED WARRANTY FOR INTERNATIONAL: 2025 CAN-AM® SSV

1) Scope of the Limited Warranty

Bombardier Recreational Products Inc. ("**BRP**") warrants its 2025 Can-Am SSV (the "**Product**") sold by distributors or dealers authorized by BRP to distribute the Products outside of the United States of America ("**USA**"), Canada, member states of the European Economic Area (which is comprised of the states of the European Union plus the United Kingdom, Norway, Iceland and Liechtenstein) ("**EEA**"), member states of the Commonwealth of the Independent States (including Ukraine and Turkmenistan) ("**CIS**") and Turkey (a "**BRP Distributor/Dealer**") from defects in material or workmanship for the period and under the conditions described below.

This limited warranty will become null and void if:

1. the Product was used for racing or any other competitive activity, at any point, even by a previous owner; or
2. the Product has been altered or modified in such a way so as to adversely affect its operation, performance or durability, or has been altered or modified to change its intended use.

Non-factory installed parts and accessories are not covered under this limited warranty. Please refer to the applicable parts and accessories limited warranty text.

2) Limitation of Liability

TO THE EXTENT PERMITTED BY LAW, THIS WARRANTY IS EXPRESSLY GIVEN AND ACCEPTED IN LIEU OF ANY AND ALL OTHER WARRANTIES, EXPRESSED OR IMPLIED, INCLUDING WITHOUT LIMITATION ANY WARRANTY OF MERCHANTABILITY OR FITNESS FOR A PARTICULAR PURPOSE. TO THE EXTENT THAT THEY CANNOT BE DISCLAIMED, THE IMPLIED WARRANTIES ARE LIMITED IN DURATION TO THE LIFE OF THE EXPRESS WARRANTY. INCIDENTAL AND CONSEQUENTIAL DAMAGES ARE EXCLUDED FROM COVERAGE UNDER THIS WARRANTY. SOME JURISDICTIONS DO NOT ALLOW FOR THE DISCLAIMERS, LIMITATIONS AND EXCLUSIONS IDENTIFIED ABOVE. AS A RESULT, THEY MAY NOT APPLY TO YOU. THIS WARRANTY GIVES YOU SPECIFIC RIGHTS, AND YOU MAY ALSO HAVE OTHER LEGAL RIGHTS WHICH MAY VARY FROM COUNTRY TO COUNTRY. BRP SHALL NOT BE HELD LIABLE IF PRODUCTS OR WARRANTY PARTS ARE NOT AVAILABLE IN CERTAIN COUNTRIES FOR REASONS OUTSIDE OF BRP'S CONTROL.

For Products purchased in Australia, refer to the Australia specific section below.

Neither the BRP Distributor/Dealer nor any other person has been authorized to make any affirmation, representation or warranty regarding the Product, other than those contained in this limited warranty, and if made, shall not be enforceable against BRP.

BRP reserves the right to modify this limited warranty at any time, being understood that such modification will not alter the warranty conditions applicable to the Products sold while this warranty is in effect.

3) EXCLUSIONS – Are Not Warranted

The following are not warranted under any circumstances:

- Normal wear and tear;
- Routine maintenance items, tune ups, adjustments;
- Damage caused by negligence or failure to provide proper maintenance and/or storage, as described in the Operator's Guide;
- Damage resulting from removal of parts, improper repairs, service, maintenance, modifications or use of parts not manufactured or approved by BRP or resulting from repairs done by a person that is not an authorized servicing BRP Distributor/ Dealer;
- Damage caused by abuse, abnormal use, neglect or operation of the product in a manner inconsistent with the recommended operation described in the Product's Operator's Guide;
- Damage resulting from accident, submersion, fire, theft, vandalism or any act of God;
- Operation with fuels, oils or lubricants which are not suitable for use with the Product (see the Operator's Guide);
- Damages from rust, corrosion or exposure to the elements;
- Damage resulting from water or snow ingestion;
- Incidental or consequential damages, or damages of any kind including without limitation transportation expenses, towing, storage, telephone, rental, taxi, inconvenience, insurance coverage, loan payments, loss of time, loss of income or time missed for downtime experience due to service work.

The following list includes, without limitation, items that are considered wear items and that are not covered under BRP's limited warranty unless failure is a direct result of a defect in material or workmanship:

- Batteries
- Brake pads
- Brake disks and drums
- Clutch plates / pads
- Clutch sliders
- Clutch springs
- Clutch replaceable bushings
- Drive belts
- Filters
- Finished and unfinished surfaces
- Fuses
- Light bulbs / sealed beam
- Lubricants
- Spark plugs
- Suspension bushings
- Suspension slider shoes
- Suspension springs
- Tires.

4) Warranty Coverage Period

This limited warranty will be in effect from (1) the date of delivery to the first retail consumer, or (2) the date the Product is first put into use, whichever occurs first and for the applicable period below:

1. **SIX (6) consecutive months**, for private use or commercial use owners

In AUSTRALIA and NEW ZEALAND only, this warranty will be in effect from (1) the date of delivery to the first retail consumer or (2) the date the Product is first put into use, whichever occurs first, and for a period of TWELVE (12) CONSECUTIVE MONTHS and THIRTY-SIX (36) CONSECUTIVE MONTHS for Powertrain Engine and Transmission systems only, for private use or commercial use.

The repair or replacement of parts or the performance of service under this warranty does not extend the life of this warranty beyond its original expiration date.

The warranty coverage period identified above are a minimal limited warranty period which can be extended by any applicable warranty promotional program, as the case may be.

Note that the duration and any other modalities of the warranty coverage are subject to the applicable national or local legislation in the customer's country.

5) For Products Sold In Australia Only

Our goods come with guarantees that cannot be excluded under the Australian Consumer Law.

You are entitled to a replacement or refund for a major failure and for compensation for any other reasonably foreseeable loss or damage.

You are also entitled to have the goods repaired or replaced if the goods fail to be of acceptable quality and the failure does not amount to a major failure.

Nothing in these Warranty terms and conditions should be taken to exclude, restrict or modify the application of any condition, warranty, guarantee, right or remedy conferred or implied under the Competition and Consumer Act 2010 (Cth), including the Australian Consumer Law or any other law, where to do so would contravene that law, or cause any part of these terms and conditions to be void. The benefits given to you under this limited warranty are in addition to other rights and remedies that you have under Australian law.

6) Conditions to Have Warranty Coverage

This warranty coverage is available only if each of the following conditions has been fulfilled:

1. The Product must be purchased as new and unused by its first owner from a BRP Distributor/Dealer authorized to distribute the Product in the country in which the sale occurred;
2. The BRP specified pre-delivery inspection process must be completed, documented and signed by the purchaser;
3. The Product must have undergone proper registration by an authorized BRP Distributor/Dealer;
4. The Product must be purchased in the country in which the purchaser resides;
5. Routine maintenance outlined in the Operator's Guide must be timely performed in order to maintain warranty coverage. BRP reserves the right to make warranty coverage contingent upon proof of proper maintenance.

BRP will not honor this limited warranty to any private use owner or commercial use owner if one of the preceding conditions has not been met. Such limitations are necessary in order to allow BRP to preserve both the safety of its products, and also that of its consumers and the general public.

7) What to Do to Obtain Warranty Coverage

The customer must cease using the Product upon the appearance of an anomaly, notify a servicing BRP Distributor/Dealer within two (2) months of the appearance of the anomaly and provide the BRP Distributor/Dealer with reasonable access to the Product and reasonable opportunity to repair it.

The notification period is subject to the applicable national or local legislation in customer's country.

The customer must also present to the BRP Distributor/Dealer, proof of purchase of the Product and must sign the repair/work order prior to starting the repair in order to validate the warranty repair.

All parts replaced under this limited warranty become the property of BRP.

8) What BRP Will Do

To the extent permitted by law, BRP's obligations under this warranty are limited to, at its sole discretion, repairing or replacing parts found defective under normal use, maintenance and service without charge for parts and labor, at any authorized BRP Distributor/Dealer during the warranty coverage period under the conditions described herein. No claim of breach of warranty shall be cause for cancellation or rescission of the sale of the Product to the owner. You may have other legal rights which may vary from country to country.

In the event that service is required outside of the country of original sale, the owner will bear responsibility for any additional charges due to local practices and conditions, such as, but not limited to, freight, insurance, taxes, license fees, import duties, and any and all other financial charges, including those levied by governments, states, territories and their respective agencies.

BRP reserves the right to improve or modify products from time to time without assuming any obligation to modify products previously manufactured.

9) Transfer

If the ownership of a Product is transferred during the warranty coverage period, this limited warranty, subject to its terms and conditions, shall also be transferred and be valid for the remaining coverage period provided BRP or an authorized BRP Distributor/Dealer receives a proof that the former owner agreed to the transfer of ownership, in addition to the coordinates of the new owner.

10) Consumer Assistance

In the event of a controversy or a dispute in connection with this limited warranty, BRP suggests that you try to resolve the issue at the BRP Distributor/Dealer level. We recommend discussing the issue with the authorized BRP Distributor/Dealer's service manager or owner.

If the matter still remains unresolved, contact BRP by filling out the customer contact form at www.brp.com or contact BRP by mail at one of the addresses listed under the *Contact Us* section of this guide.

BRP LIMITED WARRANTY FOR THE EUROPEAN ECONOMIC AREA, THE COMMONWEALTH OF THE INDEPENDENT STATES AND TURKEY: 2025 CAN-AM® SSV

1) Scope of the Limited Warranty

Bombardier Recreational Products Inc. ("BRP") warrants its 2025 Can-Am SSV (the "Product") sold by distributors or dealers authorized by BRP to distribute the Product in member states of the European Economic Area (which is comprised of the states of the European Union plus the United Kingdom, Norway, Iceland and Liechtenstein) ("EEA"), member states of the Commonwealth of the Independent States (including Ukraine and Turkmenistan) ("CIS") and Turkey ("BRP Distributor/Dealer") from defects in material or workmanship for the period and under the conditions described below.

This limited warranty will become null and void if:

1. the Product was used for racing or any other competitive activity, at any point, even by a previous owner; or
2. the Product has been altered or modified in such a way so as to adversely affect its operation, performance or durability, or has been altered or modified to change its intended use.

Non-factory installed parts and accessories are not covered under this limited warranty. Please refer to the applicable parts and accessories limited warranty text.

2) Limitations of Liability

TO THE EXTENT PERMITTED BY LAW, THIS WARRANTY IS EXPRESSLY GIVEN AND ACCEPTED IN LIEU OF ANY AND ALL OTHER WARRANTIES, EXPRESSED OR IMPLIED, INCLUDING WITHOUT LIMITATION ANY WARRANTY OF MERCHANTABILITY OR FITNESS FOR A PARTICULAR PURPOSE. TO THE EXTENT THAT THEY CANNOT BE DISCLAIMED, THE IMPLIED WARRANTIES ARE LIMITED IN DURATION TO THE LIFE OF THE EXPRESS WARRANTY. INCIDENTAL AND CONSEQUENTIAL DAMAGES ARE EXCLUDED FROM COVERAGE UNDER THIS WARRANTY. SOME JURISDICTIONS DO NOT ALLOW FOR THE DISCLAIMERS, LIMITATIONS AND EXCLUSIONS IDENTIFIED ABOVE. AS A RESULT, THEY MAY NOT APPLY TO YOU. THIS WARRANTY GIVES YOU SPECIFIC RIGHTS, AND YOU MAY ALSO HAVE OTHER LEGAL RIGHTS WHICH MAY VARY FROM COUNTRY TO COUNTRY. BRP SHALL NOT BE HELD LIABLE IF PRODUCTS OR WARRANTY PARTS ARE NOT AVAILABLE IN CERTAIN COUNTRIES FOR REASONS OUTSIDE OF BRP'S CONTROL.

For Products purchased in France, refer to the France specific section below.

Neither the BRP Distributor/Dealer nor any other person has been authorized to make any affirmation, representation or warranty regarding the Product, other than those contained in this limited warranty, and if made, shall not be enforceable against BRP.

BRP reserves the right to modify this limited warranty at any time, being understood that such modification will not alter the warranty conditions applicable to the Products sold while this warranty is in effect.

3) EXCLUSIONS – Are Not Warranted

The following are not warranted under any circumstances:

- Normal wear and tear;
- Routine maintenance items, tune ups, adjustments;
- Damage caused by negligence or failure to provide proper maintenance and/or storage, as described in the Operator's Guide;
- Damage resulting from removal of parts, improper repairs, service, maintenance, modifications or use of parts not manufactured or approved by BRP or resulting from repairs done by a person that is not an authorized servicing BRP Distributor/Dealer;
- Damage caused by abuse, abnormal use, neglect or operation of the Product in a manner inconsistent with the recommended operation described in the Product's Operator's Guide;
- Damage resulting from accident, submersion, fire, theft, vandalism or any act of God;
- Operation with fuels, oils or lubricants which are not suitable for use with the Product (see the Operator's Guide);
- Damages from rust, corrosion or exposure to the elements;
- Damage resulting from water or snow ingestion;
- Incidental or consequential damages, or damages of any kind including without limitation transportation expenses, towing, storage, telephone, rental, taxi, inconvenience, insurance coverage, loan payments, loss of time, loss of income or time missed for downtime experience due to service work.

The following list includes, without limitation, items that are considered wear items and that are not covered under BRP's limited warranty unless failure is a direct result of a defect in material or workmanship:

- Batteries
- Brake pads
- Brake disks and drums
- Clutch plates / pads
- Clutch sliders
- Clutch springs
- Clutch replaceable bushings
- Drive belts
- Filters
- Finished and unfinished surfaces
- Fuses
- Light bulbs / sealed beam
- Lubricants
- Spark plugs
- Suspension bushings
- Suspension slider shoes
- Suspension springs
- Tires.

4) Warranty Coverage Period

This limited warranty will be in effect from (1) the date of delivery to the first retail consumer, or (2) the date the Product is first put into use, whichever occurs first and for the applicable period below:

1. **TWENTY-FOUR (24) consecutive months**, for private use owners.
2. **SIX (6) consecutive months**, for commercial use owners.

A Product is used commercially when it is used in connection with any work or employment that generates income during any part of the warranty period. A Product is also used commercially when, at any point during the warranty period, it is licensed for commercial use.

The repair or replacement of parts or the performance of service under this warranty does not extend the life of this warranty beyond its original expiration date.

The warranty coverage period identified above are a minimal limited warranty period which can be extended by any applicable warranty promotional program, as the case may be.

Note that the duration and any other modalities of the warranty coverage are subject to the applicable national or local legislation in the customer's country.

5) For Products Sold In France Only

The seller shall deliver goods that are complying with the contract and shall be responsible for defects existing upon delivery. The seller shall also be responsible for defects resulting from packaging, assembling instructions or the installation when it is its responsibility per the contract or if accomplished under its responsibility. To be compliant with the contract, the good shall:

1. Be fit for normal use for goods similar thereto and, if applicable:
 - Correspond to the description provided by the seller and have the qualities presented to the buyer through sample or model;
 - Have the qualities that a buyer may legitimately expect considering the public declarations of the seller, the manufacturer of its representative, including in advertising or labeling; or
2. Have the characteristics mutually agreed upon as between the parties or be fit for the specific use intended by the buyer and brought to the attention of the seller and which were accepted by the seller.

The action for failure to comply is prescribed after two years after delivery of the goods. The seller is responsible for the warranty for hidden defects of the good sold if such hidden defects are rendering the good unfit for the intended use, or if they diminish its use in such a way that the buyer would not have acquired the good or would have given a lesser price, had he known. The action for such hidden defects shall be taken by the buyer within 2 years of the discovery of the defect.

6) Conditions to Have Warranty Coverage

This warranty coverage is available only if each of the following conditions has been fulfilled:

1. The Product must be purchased as new and unused by its first owner from a BRP Distributor/Dealer authorized to distribute Products in the country, or in the case of the EEA union of countries, in which the sale occurred;
2. The BRP specified pre-delivery inspection process must be completed, documented and signed by the purchaser;

3. The Product must have undergone proper registration by an authorized BRP Distributor/Dealer;
4. The Product must be purchased in the country, or in the case of the EEA union of countries, in which the purchaser resides;
5. Routine maintenance outlined in the Operator's Guide must be timely performed in order to maintain warranty coverage. BRP reserves the right to make warranty coverage contingent upon proof of proper maintenance.

BRP will not honor this limited warranty to any private use owner or commercial use owner if one of the preceding conditions has not been met. Such limitations are necessary in order to allow BRP to preserve both the safety of its products, and also that of its consumers and the general public.

7) What to Do to Obtain Warranty Coverage

The customer must cease using the Product upon the appearance of an anomaly, notify a servicing BRP Distributor/Dealer within two (2) months of the appearance of the anomaly and provide the Distributor/Dealer with reasonable access to the Product and reasonable opportunity to repair it.

The notification period is subject to the applicable national or local legislation in customer's country.

The customer must also present to the BRP Distributor/Dealer, proof of purchase of the Product and must sign the repair/work order prior to starting the repair in order to validate the warranty repair.

All parts replaced under this limited warranty become the property of BRP.

8) What BRP Will Do

To the extent permitted by law, BRP's obligations under this warranty are limited to, at its sole discretion, repairing or replacing parts found defective under normal use, maintenance and service without charge for parts and labor, at any authorized BRP Distributor/Dealer during the warranty coverage period under the conditions described herein. No claim of breach of warranty shall be cause for cancellation or rescission of the sale of the Product to the owner. You may have other legal rights which may vary from country to country.

In the event that service is required outside of the country of original sale, or for EEA residents if service is required outside of the EEA, the owner will bear responsibility for any additional charges due to local practices and conditions, such as, but not limited to, freight, insurance, taxes, license fees, import duties, and any and all other financial charges, including those levied by governments, states, territories and their respective agencies.

BRP reserves the right to improve or modify products from time to time without assuming any obligation to modify products previously manufactured.

9) Transfer

If the ownership of a Product is transferred during the warranty coverage period, this limited warranty, subject to its terms and conditions, shall also be transferred and be valid for the remaining coverage period provided BRP or an authorized

BRP Distributor/Dealer receives a proof that the former owner agreed to the transfer of ownership, in addition to the coordinates of the new owner.

10) Consumer Assistance

In the event of a controversy or a dispute in connection with this limited warranty, BRP suggests that you try to resolve the issue at the BRP Distributor/Dealer level. We recommend discussing the issue with the authorized BRP Distributor/Dealer's service manager or owner.

If the matter still remains unresolved, contact BRP by filling out the customer contact form at www.brp.com or contact BRP by mail at one of the addresses listed under the *Contact Us* section of this guide.

CUSTOMER INFORMATION

DATA PRIVACY INFORMATION

Bombardier Recreational Products Inc., its affiliates and subsidiaries (“BRP”) is committed to protecting your privacy and support a general policy of openness about how we collect, use and disclose your personal information in the course of managing our relationship with you. **More details can be found by visiting BRP’s Privacy Policy at: <https://brp.com/en/privacy-policy.html> or by scanning the QR Code below.**

Please be assured that we have appropriate security measures in place to ensure that your personal information is protected against loss and unauthorized access.

Your personal information that may be collected by BRP, directly from you or from authorized dealers or authorized third parties, includes:

- **Contact, Demographic & Registration Information** (e.g., name, full address, phone number, email, gender, ownership history, language of communication)
- **Vehicle Information** (e.g., serial number, purchase and delivery date, unit usage, vehicle location and movements)
- **Third Party Information** (e.g., information received from BRP partners, joint marketing activities information, social media)
- **Technological Information** (e.g., IP address, type of device, operating system, browser type, webpages you view, cookies and similar technologies when you use BRP or dealers’ websites or mobile application)
- **Interaction with BRP Information** (e.g., information collected when you call BRP’s in-house sales representatives, buy items on a BRP website, sign up for BRP emails, participate in BRP-sponsored contests and sweepstakes or attend BRP-sponsored events)
- **Transactional Information** (e.g., information necessary to handle returns, payment information when you purchase our products or services through our websites or mobile applications and other issues related to your purchase of BRP products)

This information may be used and processed for the following purposes:

- Safety & Security
- Customer Support for Sales and After Sales (e.g., complete or follow up with you about your purchase or maintenance)
- Registration & Warranty
- Communication (e.g., sending you a BRP satisfaction survey)
- Online Behavioural Advertising, Profiling and Location-Based Services (e.g., offer customized experience)
- Compliance & Dispute Resolution
- Marketing & Advertising
- Assistance (e.g., help with any delivery issues, handle returns, and other issues related to your purchase of BRP products).

We also may use personal information to generate aggregated or statistical data that no longer identifies you personally.

Your personal information may be disclosed to the following: BRP, BRP’s authorized dealerships, distributors, service providers, advertising and market research partners and other authorized third parties.

We may receive information about you from diverse sources, including third parties, such as BRP’s authorized dealerships and partners, with whom we offer

services or engage in joint-marketing activities. We may also receive information about you from social media platforms when you interact with us on those platforms.

Depending on the circumstances, your personal information may be communicated outside the region where you reside. Your personal information is retained only for as long as necessary for the purpose for which we obtained it and according to our retention policies.

To exercise your data privacy rights (e.g. right of access, right of rectification), to withdraw your consent in order to be removed from the address list for marketing purposes or for the satisfaction survey or for general data privacy questions, please contact BRP's Data Protection Officer at or by mail at **privacyofficer@brp.com** or by mail at:

BRP Legal Service, 726 St-Joseph, Valcourt, Quebec, Canada, J0E 2L0.

When BRP processes your personal information, they do so in compliance with its Privacy Policy available at: <https://www.brp.com/en/privacy-policy.html> or by using the following

QR Code.



CONTACT US

www.brp.com

Asia Pacific

BRP Asia

107D and 107E, 17/F, Tower 1,
Grand Century Place, Mongkok,
Kowloon, Hong Kong

Australia

Level 26
477 Pitt Street
Sydney, NSW 2020

China

上海市徐汇区衡山路10号6号楼301
Rm 301, Building 6,
No.10 Heng Shan Rd,
Shanghai, China

Japan

21F Shinagawa East One Tower
2-16-1 Konan, Minato-ku-ku,
Tokyo 108-0075

New Zealand

Suite 1.6, 2-8 Osborne Street,
Newmarket, Auckland 2013

Europe, Middle East and Africa

Belgium

Oktrooi plein 1
9000 Gent

Czech Republic

Stefanikova 43a
Prague 5
150 00

Germany

Itterpark 11
40724 Hilden

Finland

Isoaavantie 7
PL 8040
96101 Rovaniemi

France

Arteparc Bâtiment B
Route de la côte d'Azur,

13 590 Meyreuil

Norway

Ingvald Ystgaardsvei 15
N-7484 Trondheim
Salg, marketing, ettermarked

Sweden

Spinnvägen 15
903 61 Umeå
Sweden 90821

Switzerland

Avenue d'Ouchy 4-6
1006 Lausanne

Latin America

Brazil

Av. James Clerck Maxwell, 230
Campinas, Sao Paulo
CEP 13069-380

Mexico

Av. Ferrocarril 202
Parque Industrial Querétaro
Santo Rosa Jauregui, Querétaro
C.P. 76220

North America

Canada

3200A, rue King Ouest,
Suite 300
Sherbrooke (Québec) J1L 1C9

United States of America

10101 Science Drive
Sturtevant, Wisconsin
53177

CHANGE OF ADDRESS AND OWNERSHIP

If your address has changed or if you are the new owner of the vehicle, be sure to notify BRP by either:

- Notifying an authorized Can-Am dealer.
- **North America Only:** calling at 1 888 272-9222.
- Mailing one of the change of address cards on the following pages at one of the BRP addresses indicated in the *Contact Us* section of this guide.

In case of change of ownership, please join a proof that the former owner agreed to the transfer.

Notifying BRP, even after the expiration of the limited warranty, is very important as it enables BRP to reach the vehicle owner if necessary, like when safety recalls are initiated. It is the owner's responsibility to notify BRP.

STOLEN UNITS: If your personal vehicle is stolen, you should notify BRP or an authorized Can-Am dealer. We will ask you to provide your name, address, phone number, the vehicle identification number and the date it was stolen.

CHANGE OF ADDRESS

CHANGE OF OWNERSHIP



VEHICLE IDENTIFICATION NUMBER

Model Number					Vehicle Identification Number (V.I.N.)																		

OLD ADDRESS
OR PREVIOUS OWNER:

NAME _____

NO. _____ STREET _____ APT _____

CITY _____ STATE/PROVINCE _____ ZIP/POSTAL CODE _____

COUNTRY _____ TELEPHONE _____

NEW ADDRESS
OR NEW OWNER:

NAME _____

NO. _____ STREET _____ APT _____

CITY _____ STATE/PROVINCE _____ ZIP/POSTAL CODE _____

COUNTRY _____ TELEPHONE _____

E-MAIL ADDRESS _____

CHANGE OF ADDRESS

CHANGE OF OWNERSHIP



VEHICLE IDENTIFICATION NUMBER

Model Number					Vehicle Identification Number (V.I.N.)																		

OLD ADDRESS
OR PREVIOUS OWNER:

NAME _____

NO. _____ STREET _____ APT _____

CITY _____ STATE/PROVINCE _____ ZIP/POSTAL CODE _____

COUNTRY _____ TELEPHONE _____

NEW ADDRESS
OR NEW OWNER:

NAME _____

NO. _____ STREET _____ APT _____

CITY _____ STATE/PROVINCE _____ ZIP/POSTAL CODE _____

COUNTRY _____ TELEPHONE _____

E-MAIL ADDRESS _____

This page is
intentionally blank

CHANGE OF ADDRESS <input type="checkbox"/>	CHANGE OF OWNERSHIP <input type="checkbox"/>	
VEHICLE IDENTIFICATION NUMBER		
Model Number	Vehicle Identification Number (V.I.N.)	
OLD ADDRESS OR PREVIOUS OWNER:	NAME	
	NO.	STREET
	APT	
	CITY	STATE/PROVINCE
	ZIP/POSTAL CODE	
	COUNTRY	TELEPHONE
NEW ADDRESS OR NEW OWNER:	NAME	
	NO.	STREET
	APT	
	CITY	STATE/PROVINCE
	ZIP/POSTAL CODE	
	COUNTRY	TELEPHONE
	E-MAIL ADDRESS	

CHANGE OF ADDRESS <input type="checkbox"/>	CHANGE OF OWNERSHIP <input type="checkbox"/>	
VEHICLE IDENTIFICATION NUMBER		
Model Number	Vehicle Identification Number (V.I.N.)	
OLD ADDRESS OR PREVIOUS OWNER:	NAME	
	NO.	STREET
	APT	
	CITY	STATE/PROVINCE
	ZIP/POSTAL CODE	
	COUNTRY	TELEPHONE
NEW ADDRESS OR NEW OWNER:	NAME	
	NO.	STREET
	APT	
	CITY	STATE/PROVINCE
	ZIP/POSTAL CODE	
	COUNTRY	TELEPHONE
	E-MAIL ADDRESS	

This page is
intentionally blank

NOTE: _____

NOTE: _____

NOTE: _____

NOTE: _____

NOTE: _____

NOTE: _____

NOTE: _____

NOTE: _____

NOTE: _____

Model No. _____

VEHICLE

IDENTIFICATION NUMBER (V.I.N.) _____

ENGINE

IDENTIFICATION NUMBER (E.I.N.) _____

Owner: _____

NAME

No.

STREET

APT

CITY

STATE/PROVINCE

ZIP/POSTAL CODE

Purchase Date _____

YEAR

MONTH

DAY

Warranty Expiry Date _____

YEAR

MONTH

DAY

To be completed by the dealer at the time of the sale.

DEALER IMPRINT AREA

⚠ WARNING

TO REDUCE RISK OF SERIOUS INJURY OR DEATH,

- Read this operator's guide and safety labels.
- Watch the safety video.



BE PREPARED

- Fasten seat belts and make sure neets and/or doors are securely latched in place.
- Wear an approved helmet and protective gear.
- Each rider must be able to sit with back against seat, foot flat on the floor or on the footrest, and hands on steering wheel or handholds. Stay completely inside the vehicle.

DRIVE RESPONSIBLY

- Avoid loss of control and rollovers.
- Avoid abrupt maneuvers, sideways sliding, skidding or fishtailing and never do donuts.
- Avoid hard acceleration when turning, even from a stop.
- Slow down before entering a turn.
- Plan for hills, rough terrain, ruts and other changes in traction and terrain.
- Avoid paved surfaces.
- Avoid side hilling (riding across slopes).

BE QUALIFIED AND RESPONSIBLE

- Do not allow careless or reckless driving.
- Driver must be at least 16 years old with a valid driver's license.
- Do not operate after using drugs or alcohol.
- Do not allow operation on public roads (unless designated for off-highway vehicle access where collisions with cars and trucks can occur).
- Do not exceed vehicle seating capacity.

®TM and the BRP logo are trademarks of BOMBARDIER RECREATIONAL PRODUCTS INC. or its affiliates.

©2024 BOMBARDIER RECREATIONAL PRODUCTS INC. ALL RIGHTS RESERVED.

www.brp.com

**ALUMA
CRAFT®**

CAN-AM®

LYNX®

MANITOU®

ROTAX®

QUINTREX®

SEA-DOO®

SKI-DOO®