



MANITOU.

OPERATOR'S GUIDE

P/N 3019-0024560
REV. APR. 2024

WARNING

Operating, servicing and maintaining a recreational marine vessel can expose you to chemicals including engine exhaust, carbon monoxide, phthalates, and lead, which are known to the State of California to cause cancer and birth defects or other reproductive harm. To minimize exposure, avoid breathing exhaust, service your vessel in a well-ventilated area and wear gloves or wash your hands frequently when servicing this vessel. For more information go to www.P65warnings.ca.go/marine

Dear Manitou Owner,

You have likely spent a great deal of time researching your many choices in the boat market, and so we are especially honored by your selection. Because our boats are unequalled in both quality and style, you, like many other boaters, have chosen Manitou, and we would like to thank you for that choice.

In order to lengthen the life of your boat, proper use and care are required. Please take the time to review the information provided in this manual and in the accompanying National Marine Manufacturers Association (NMMA) Boat/Deck Style Boats Owner's Manual. You will find operating, cleaning, and maintenance tips, as well as guidance on boating safety and water rules. This information is vital to your own safety and that of your passengers. Please read it carefully.

At Manitou we take pride in building the safest boats in the industry. Please take the time to notice your boat's extra safety features. You will agree that your family's carefree boating experience is our top priority. You bought a boat for family fun, and Manitou's quality will give you the peace of mind to relax and enjoy your time spent boating for years to come.

Shortly after your warranty registration is received by the factory, you may receive a Manitou customer satisfaction survey. We want to hear from you! If you do not receive this survey, please contact Manitou by email at manitou.consumers@brp.com.

Thanks again for choosing Manitou.

CRUISE

Value Model shown with

- Standard Bimini
- Rotax S Engine
- Outboard Engine Optional



EXPLORE

Recreation Model shown with

- Sport Bimini
- Rotax S Single Engine with MAX Deck Optional
- Outboard Engine Optional
- Black Painted Tubes



EXPLORE MAX (Dual Engine)

Recreation Model shown with

- Sport Bimini
- Rotax S Dual Engines
- Outboard Engines Optional
- Black Painted Tubes



LX

Sport Model shown with

- Sport Arch

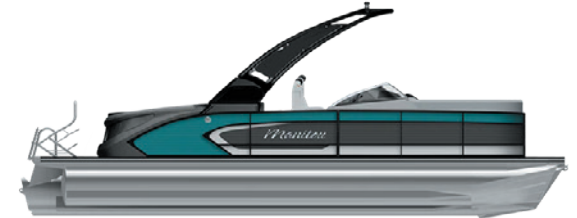

XT

Luxury Model shown with

- Sport Arch

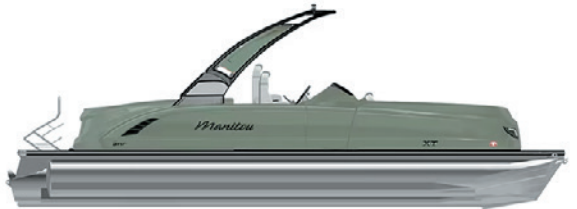

SECTION 1	
Important Safety Information	3
SECTION 2	
Introduction	3
About This Operator's Guide	3
Before Your First Outing	4
Working Together	5
SECTION 3	
Ownership	6
Intended Use	6
Owner's Packet	6
Warranty Procedures	7
Boat Identification	7
State or Provincial Registration	8
Insurance	8
Trash Disposal	8
Sanitary Waste Disposal	8
SECTION 4	
Safety	9
Carbon monoxide	9
Safe Boat Practices	10
Safe Operation	11
Swimming Safety	12
Water Skiing Safety	13
Safety Labels	14
Required Safety Equipment	16
Other Safety Considerations	17
Hazardous Conditions	18
Compliance Labels	19
SECTION 5	
Operating your Manitou Boat	22
Fuel	23
Fueling	24
Launching Your Boat	25
Boat Capacity Information	26
Boarding	26
Stowing Onboard Gear	28
Weight Distribution	28
Steering	28
Navigation & Right-of-Way Rules	29
Boat Speed	29
Trimming	29
Docking	30
Loading & Trailering Your Boat	30
Boat Trailer Laws	31
Towing Capacity	31
Tongue Weight	31
Trailer Hitch	31
Safety Chains	32
Backing a Trailer with a Trailer	32
Trailering Reminders	32

Storing Your Boat	33
Blocking	34
SECTION 6	
Electrical Equipment	35
Electrical Wiring System	35
Maximus DCM	35
Batteries	35
Lights	36
Docking Lights	36
Anchor Light	36
Switches	37
Instrument Panel	37
Digital Display	37
Instrument Panel Descriptions	38
SECTION 7	
Controls	42
Steering System	42
Autopilot	43
iDOCK Joy Stick Steering	44
Dual Engine Controls	50
Shift and Throttle Control System	51
SECTION 8	
Other Components	52
Livewell	52
Sport Arch	52
Rotax Outboard Equipped Models	53
Swim Platform on Rotax Models	53
Stern Boarding Ladder	54
SECTION 9	
Cleaning your Manitou	55
Flooring	55
Fabric Tops and Covers	56
Snaps and Zippers	57
Vinyl-Coated Fabrics	57
Exterior Surface & Graphics Care	58
SECTION 10	
Maintaining your Manitou	59
Corrosion	59
Aluminum Surfaces	60
Battery and Electrical Care	60
SECTION 11	
Aquatic Invasive Species (AIS)	61
SECTION 12	
Designated Seating Positions	63
SECTION 13	
Index	64
WARRANTY:	
Refer to the Warranty Guide for further information regarding warranty and CARB warranty specific to your Boat.	

SECTION 1: IMPORTANT SAFETY NOTIFICATION

You must understand all of the safety statements shown on your boat and in this manual. Important safety-related information is highlighted in this manual using the designations shown below. You should understand all such designations prior to operating your Manitou.

DANGER

Indicates an imminently hazardous situation which, if not avoided, will result in death or serious injury.

WARNING

Indicates a potentially hazardous situation which, if not avoided, could result in death or serious injury.

CAUTION

Indicates a potentially hazardous situation which, if not avoided, could result in minor or moderate injury.

NOTICE

Notice indicates installation, operation, or maintenance information which is important and, if not followed, could result in property damage.

You are likely to encounter a variety of situations beyond those listed in this manual that require safe practices. Be ready, and make safety a first priority at all times!

SECTION 2: INTRODUCTION

Congratulations! As the owner of a Manitou boat, you can look forward to enjoying the water with family and friends for years to come. Not only have you purchased one of the highest quality boats on the market, but you have also bought the peace of mind that comes from knowing that Manitou stands behind each and every boat it sells. Should you encounter a problem covered by Manitou's warranty, Manitou will work with your dealer to fix it quickly, so that you can get back to boating.

ABOUT THIS OPERATOR'S GUIDE

This Operator's Guide has been prepared to acquaint the owner / operator or passenger with this boat and its various controls, maintenance and safe riding instructions. Keep this Operator's Guide in the boat as you can refer to it for the operation, instructing others, maintenance and troubleshooting. This Operator's Guide is available in several languages. In the event of any discrepancy, the English version shall prevail.

If you want to view and/or print an extra copy of your Operator's Guide, simply visit **www.operatorsguides.brp.com**

The information contained in this Operator's Guide is correct at the time of printing. However, BRP Marine US Inc. maintains a policy of continuous improvement of products without imposing upon itself any obligation to install them on products previously manufactured. Due to late changes, some differences between the manufactured product and the descriptions and / or specifications in this guide may occur. BRP Marine US Inc. reserves the right at any time to discontinue or change specifications, designs, features, models or equipment without incurring any obligation upon itself.

BEFORE YOUR FIRST OUTING

Before you take your Manitou boat out on the water for its maiden voyage, please take the time to get to know your new boat. Start with the following steps:

- Take a look through your owner's packet and become familiar with the information found there.
- Read this manual, taking special note of safety warnings and other critical information.
- Familiarize yourself with the safety labels throughout your boat. Understand their meaning, and be ready to point them out to passengers.
- Review the NMMA *Boat/Deck Style Boats Owner's Manual*, included in your owner's packet.
- Require any other individual who may be operating your boat to read and review this manual and all materials in your owner's packet.

Next, before you take your Manitou boat out for the first time; become familiar with the boat itself. The following steps are very important:

- Sit in the captain's chair and make sure you know what buttons and switches control various features.
- Familiarize yourself with how to read each gauge on your boat's control panel.
- Take note of your boat's width and length.
- Ensure that any other individual who may be operating your boat has also completed these steps.

Finally, remember that you are responsible at all times for ensuring the safety of your boat's passengers and that of other waterway users. Practice courteous and responsible boating each time you enjoy your Manitou boat! Join us in our efforts to drive positive changes and foster a more caring community with our Responsible Rider program.

The Responsible Rider program is a key element of our Corporate Social Responsibility initiative that invites everyone in the marine community to come together and rethink how we approach safety, riding etiquette, and the environment.

To learn more about Responsible Rider, including tips and tricks on safety, boating etiquette and the environment, visit manitoupontoonboats.com/responsible-rider Or, use this QR code.



WORKING TOGETHER

Successful boat ownership is built on teamwork. The manufacturer, dealer, and boat owner each have a role to play in the goal of ensuring the best possible on-the-water experience for years to come. Each role carries its own responsibilities, which can be described as follows.

MANUFACTURER'S ROLE

We hold ourselves to rigorous manufacturing standards throughout the process of building each Manitou boat. To ensure the highest quality, we perform rigorous inspections and testing.

DEALER'S ROLE

Your dealer has a responsibility to inspect and prepare your Manitou before delivery. Upon completion of the sale of a Manitou boat to you, your dealer should also complete the following steps:

- Register your boat with Manitou.
- Ensure your understanding of important precautions required for the safe use of your Manitou boat.
- Provide you with an orientation to the general operation of your Manitou boat.
- Furnish you with a complete owner's packet that includes all of the manuals and information regarding your new Manitou boat and any other components related to your purchase.

OWNER'S ROLE

Owner responsibilities include, but are not limited to, the following:

- Examine the boat and confirm that all systems are working properly before you accept delivery.
- Review in detail all manuals, literature, and instructions enclosed in the owner's packet, and use all equipment in accordance with those instructions.
- Read and understand the Manitou limited product warranty.
- Operate all equipment in accordance with the manufacturer's instructions.
- Render proper maintenance and periodic servicing to the boat, motor, and components in accordance with the manufacturer's requirements and recommendations.
- Clean and maintain your boat on a regular schedule.
- Learn and obey all local, state, provincial, and federal laws pertaining to the use and transport of your boat.
- Insure your boat.
- Complete and pass a boating safety course.
- Read and obey all safety labels on your boat.
- Make safety your first priority at all times

SECTION 3: OWNERSHIP

INTENDED USE

Manitou boats are designed for boating on inland waterways, rivers, lakes, and bays only. It is important to understand that dangerous situations that can arise from the misuse of your Manitou boat.

Dangerous situations include those in which swells and high waves may damage your boat, cause an operator to lose control of the boat, and put passengers in harm's way. As such, all Great Lakes and ocean use should be strictly avoided.

WARNING

High waves coming over the bow of your Manitou boat are dangerous and may damage or dent walls.

WARNING

Do not use your Manitou boat to pull a parasail, kite, glider, or any other device that may become airborne.

OWNER'S PACKET

Your owner's packet provides a variety of useful information sources. It includes the following:

- This owner's manual, including warranty information.
- *Boat/Deck Style Boats Owner's Manual*, a publication of the National Marine Manufacturers Association (NMMA).
- Critical safety information from the United States Coast Guard (USCG) and NMMA.
- Care and cleaning information for your boat's surfaces and materials.
- Manuals and information about the operation of your Manitou.
- Seating Positions Document

Your boat dealer may also include information about other components in the owner's packet.

In sum, the materials in your owner's packet provide operation, service, specifications, maintenance, warranty, and other helpful information. It is important to read and understand all of the material contained in your owner's packet prior to operating your boat.

WARRANTY PROCEDURES

Please read the Manitou warranty coverage so that you know what is covered under its terms.

You are required to obtain warranty work through an authorized Manitou dealer. The dealer is your first contact for warranty issues, and will be best suited to respond to any issues that may arise with your boat boat.

BOAT IDENTIFICATION

A permanent record of your boat is maintained by BRP Marine US Inc. Tracked using your boat's Hull Identification Number (HIN), this record includes information on your boat's equipment and accessories, the name of the dealership from which you purchased it, and the date it was shipped.

The HIN tag is attached to the riser on the starboard side of the boat near the stern. The HIN should also be listed on your registration.

To ensure a quick response when you contact your dealer regarding warranty or other work for your Manitou boat, please provide the HIN, the model length, and the color of your boat. Not providing this information may unnecessarily delay the claims process. For your future convenience, we suggest that you note this information in the following table.



HIN Tag Location

HIN

Model

Length

Color

STATE OR PROVINCIAL REGISTRATION

All watercraft must display registration numbers on the starboard and port sides of the vessel. Your boat must be registered in its main state or province of usage. Registration numbers and validation stickers must be displayed according to your state or provincial laws and regulations.

INSURANCE

As a boat owner, you are legally responsible for any damages or injuries caused by your boat. In the majority of states and provinces, this holds true even if a person other than the owner is operating the boat when an accident occurs. Just as you do for your home and automobile, you should carry adequate personal liability and property damage insurance on your boat. Protect your investment by also insuring your boat, motor, and trailer against physical damage or theft. Contact your insurance agent for coverage information.

TRASH DISPOSAL

It is important to act responsibly to keep our lakes and waterways clean. Plastic refuse dumped in the water is known to kill fish and other marine wildlife, and may also cause damage to boat propellers and water intakes. Some forms of waterborne garbage litter beaches and cause infection and illness. USCG regulations prohibit the dumping of plastic refuse or other garbage mixed with plastics anywhere in the water. Dumping of other forms of trash in the water within specified distances from shore is also prohibited.

SANITARY WASTE DISPOSAL

You are responsible for obeying all local laws concerning sanitary waste disposal. If your boat has a marine toilet or other sanitary device, contact the USCG, local marina, or your dealer for information regarding proper disposal of sanitary waste. Under no circumstances should such waste be dumped into the water.

It is illegal for any vessel to dump plastic ANYWHERE in the ocean or navigable waters of the United States. Annex V of MARPOL TREATY is an International Law for a cleaner, safer marine environment. Violation of those requirements is a Class D felony and may result in a civil penalty, up to a \$25,000 fine and imprisonment.

 U.S. lakes, rivers, bays or sounds and 3 miles from shore ILLEGAL TO DUMP: Plastic and Garbage Paper Metal Rags Crookery Glass Dunnage Food	 3 to 12 miles ILLEGAL TO DUMP: Plastic Dunnage, lining and packing materials that float, also if not ground to less than one inch Paper Metal Rags Crookery Glass Food	 12 to 25 miles ILLEGAL TO DUMP: Plastic Dunnage, lining and packing materials that float	 Outside 25 miles ILLEGAL TO DUMP: Plastic
---	---	---	---

Regional state and local regulations may further restrict the disposal of garbage. The discharge of all garbage into the Great Lakes or their connecting tributary waters is prohibited.

NMMA
National Marine Manufacturers Association

DISCHARGE OF OIL PROHIBITED

The federal Water Pollution Act prohibits the discharge of oil or oily waste into or upon navigable waters of the United States, or the waters of the Contiguous Zone, or which may affect natural resources belonging to, or under the exclusive management authority of the United States, if such discharge causes a film or discoloration of the surface of the water or causes a sludge or emulsion beneath the surface of the water. Violators are subject to substantial civil penalties and/or criminal sanctions including fines and imprisonment.

NMMA
National Marine Manufacturers Association

SECTION 4: SAFETY

As the owner of the boat, it is your responsibility to be a safe boater, to follow and enforce safety rules, to know and adhere to the rules of the water, and to use common sense at all times. It is important that anyone to whom you entrust your boat also understands these responsibilities.

Make sure you understand each of the safety warnings found on your boat and commit to following the safe boating recommendations found in this section.

Then, before you embark on any outing, check that all safety equipment is on board and in working condition. This includes one wearable personal flotation device (PFD) for each person on board, and all other USCG-required safety equipment. Federal Law requires that when a vessel is underway, children under 13 years of age must wear their lifejacket. Exceptions are when below deck or within an enclosed cabin. State laws may vary. Check with your state boating safety officials. Confirm that each passenger aboard the boat is aware of the location of these items. Learn more about these safety requirements, as well as additional boat safety information at the USCG website; www.uscgboating.org.

CARBON MONOXIDE

Exhaust fumes contain carbon monoxide (CO), which is an odorless and colorless gas. Carbon monoxide is toxic and can be fatal if breathed over an extended period of time. Symptoms of CO inhalation include, but are not limited to, dizziness, nausea, headache, sleepiness, vomiting, throbbing in the temples, muscular twitching, and an inability to think clearly. If these symptoms are present and persist in you or another individual, seek urgent medical attention.

On your boat, carbon monoxide in engine exhaust can accumulate within enclosed areas during operation at slow speeds or when stopped in the water. Using the rear enclosure while the boat is underway increases the risk of CO accumulation in your boat, and the presence of a tail wind can increase accumulation. Provide adequate ventilation at all times, and increase speed as needed.

DANGER

Carbon monoxide can be harmful or fatal if inhaled. Keep exhaust outlets clear of blockage, away from open windows. Provide adequate ventilation at all times.

SAFE BOATING PRACTICES

Boating safety is a serious issue. You are responsible for your own safety, the safety of your passengers, and the safety of fellow waterway users. The following are some basic safe boating recommendations that must be observed:

- Never operate the boat, or allow others to operate the boat, while under the influence of drugs or alcohol. This is a federal offense and can carry a significant penalty.
- Keep your boat and its equipment in a safe and usable condition. Regularly inspect the boat, engine, and safety equipment for any signs of damage or disrepair.
- Ensure that a throwable flotation device and a fire extinguisher are on your boat at all times. This equipment must meet regulation standards, be easily accessed, and be maintained in working condition.
- Check weather and water conditions before launching. Be prepared for sudden changes in the boating environment, and for cooler or warmer conditions than originally anticipated.
- In case of an emergency involving the primary operator, confirm that at least one other person on board the boat knows the basic and safe operations of the boat.
- Never allow an inexperienced person to operate your boat.
- Become familiar with local, state, and provincial boating laws and regulations. Observe them at all times.
- It is strongly recommended that you complete and pass a boating safety class.

WARNING

Intoxication and boating do NOT mix! Never operate your boat while under the influence of alcohol or drugs.

WARNING

Read, follow, and understand all safety labels on your boat.

SAFE OPERATION

"Safe operation" means that neither you nor your passengers misuse the boat, but instead make a practice of applying good judgment at all times. In addition to any applicable safety laws, recommendations, or procedures, establish the habit of following general safe-operation guidelines:

- Load your boat according to the limits set on the capacity tag. Do not overload your boat. Evenly distribute the load from bow to stern, and ensure that the weight on your boat is evenly distributed at all times. Reduce the load if weather conditions include high winds, rough seas, fog, storm warnings, or small craft advisories.
- Direct all passengers to remain seated while the boat is under power. While the boat is moving, boat passengers should remain clear of any areas that are not designated for seating, including the bow, transom, railings, sundeck pad, and furniture backrests. Be sure to have driver swivel seat locked in the forward facing position. Any rear facing seats should not be used when underway. If a swivel fishing seat is present on your boat, it should not be used for seating if the boat is traveling faster than five miles per hour.

WARNING

Do not sit on the bow of the boat while it is under power.

- Keep all boat gates closed while the boat is under power in order to prevent falls overboard and injuries.
- Maintain your speed at or below the posted speed limit. Avoid excessive speeds, especially close to shore.
- Learn and follow the rules of navigation. Ensure that all boat drivers are familiar with these rules.
- Know the maximum horsepower capacity rating on the certification plate of your motor and do not exceed it. Exceeding the horsepower capacity of your boat and motor can lead to serious conditions that may result in accidents or injuries.
- Become familiar with the length of time it takes to stop your boat from various speed levels. Remember that, unlike a car, a boat does not have brakes.
- Confirm that the engine is off and the propeller is completely stopped before allowing anyone to enter the water or re-board from the water.
- Use a boat hook or other suitable device to protect your boat while docking. Never use your hands or feet to control your boat's movement toward the dock. Your boat's weight and forward momentum could cause serious injury to a limb that becomes caught between the boat and a dock.

WARNING

Never exceed the maximum horsepower or weight capacity of your boat.

SWIMMING SAFETY

When swimming from your boat, the following basic safe swimming recommendations must be observed:

- Anchor the boat and shut off the motor before anyone enters the water.
- Swim in the presence of others. Never swim alone.
- Swim on the shore side of the boat, away from other boat traffic.
- Designate a person on the boat to observe swimmers at all times.
- Use the ladder to enter the water for your safety. Unknown water depths and other variables make ladder entry the safest method.
- Use a ladder or other safe means of reboarding.
- Swimmers must not use the boat tubes to enter or leave the water.

WARNING

Never allow swimmers or water skiers to enter or exit the boat with the engine running or the propeller moving. Never back up your boat to reach a person in the water.

WARNING

Never dive from any part of the boat. Water depths can be unpredictable, and serious injuries or death can occur from diving into shallow water.

WARNING

Children must be under adult supervision at all times, both in the water and on the boat.

WARNING

Swimming can be hazardous. Follow all safety rules.

WATER SKIING SAFETY

Water skiing poses several hazards in addition to those discussed under the "Swimming Safety" section. The following basic safe water skiing rules must be observed.

- The ski tow bar is rated for a maximum of 300 pounds (136kg). Do not pull multiple towables; pull only one towable at a time.
- Start the engine only when the skier is a safe distance from the boat.
- Accelerate the boat slowly forward until the rope is taut.
- Before applying the throttle, check for traffic ahead.
- Follow the skier's signals to set the optimum speed for the skier.
- Designate a passenger, other than the boat's driver, to act as spotter. The spotter should watch the skier and inform the driver when the skier is down.
- When the skier goes down, look for the skier's "OK" signal.
- Approach the downed skier on the starboard side only. Stop the motor once you are close.
- Always be aware of shallow water and obstructions.
- Do not ski after dark.
- Do not ski near swimmers or in crowded boat traffic. Keep away from fishermen.

WARNING

Keep a downed skier in sight at all times. All water skiers are required to wear a USCG approved PFD at all times.

CAUTION

Designate a passenger to act as a spotter. The driver must not also act as a spotter.

WARNING

Cruise and Explore models: Never carry loads on the rear platform when practicing watersports. The rope may interfere with the cargo and unsecure it, becoming an obstacle to the person being towed. Ski pylon is for skiing, wakeboarding and knee boarding only. To be used by 1 person. Do not use ski pylon for any other purpose (i.e. tubing, parasailing, towing, etc).

For more information on water skiing safety, visit www.boatus.org.

SAFETY LABELS

The safety labels present on your Manitou boat serve as reminders of important safety considerations. Following are the labels commonly found on Manitou boats. Note their locations on your own boat, read them carefully, and follow their directives. Ask passengers to do the same. Contact your local Manitou pontoon dealership for replacement of any safety or warning labels.

⚠ DANGER		
	<p>CONTACT WITH A SPINNING PROPELLER WILL CAUSE SERIOUS INJURY OR DEATH.</p> <p>STAY CLEAR OF BOAT AND STAY OFF SWIM PLATFORM AND BOARDING LADDER WHILE ENGINE IS RUNNING.</p>	<p>CARBON MONOXIDE (CO) CAN CAUSE BRAIN DAMAGE OR DEATH.</p> <ul style="list-style-type: none"> • Engine and generator exhaust contains odorless and colorless carbon monoxide gas. • Carbon monoxide will be around the back of the boat when engines or generators are running. <p>MOVE TO FRESH AIR if you feel nausea, headache, dizziness, or drowsiness.</p>

⚠ DANGER	
<ul style="list-style-type: none"> • CONTACT WITH A SPINNING PROPELLER WILL CAUSE SERIOUS INJURY OR DEATH. • SHUT OFF ENGINES while people are in the water near the boat, on the swim platform, or on the boarding ladder. • NEVER OPERATE IN REVERSE TOWARD A PERSON in the water. 	

⚠ DANGER	
	<p>CONTACT WITH A SPINNING PROPELLER WILL CAUSE SERIOUS INJURY OR DEATH.</p> <p>STAY CLEAR OF BOAT AND STAY OFF SWIM PLATFORM AND BOARDING LADDER WHILE ENGINE IS RUNNING.</p>



⚠ WARNING

ALWAYS SECURELY BOTH BUNGEE TO THE PIVOTING COVER TO PREVENT OCCUPANTS FROM BEING STRIKED BY THE COVER IN THE EVENT OF AN UNDERWATER IMPACT WITH THE ENGINE.

- CONSULT THE OPERATOR'S GUIDE OR SERVICE MANUAL PRIOR TO DISCONNECTING THE BUNGEE FROM THE COVER.

⚠ WARNING

ALWAYS SECURELY ATTACH THE TWO (2) TENSIONING STRAPS BETWEEN BIMINI AND RAIL WHILE BIMINI IS OPEN TO PREVENT INJURY.

⚠ WARNING	
Failure to follow these warnings could cause SEVERE INJURY or DEATH.	
<ul style="list-style-type: none"> • CARBON MONOXIDE (CO) CAN CAUSE BRAIN DAMAGE OR DEATH. <ul style="list-style-type: none"> - Engine and generator exhaust contains odorless and colorless carbon monoxide gas. - Signs of carbon monoxide poisoning include nausea, headache, dizziness, drowsiness, and lack of consciousness. - MOVE TO FRESH AIR if anyone shows signs of carbon monoxide poisoning. - See Operator's Guide for additional information regarding carbon monoxide poisoning. • CHECK WEATHER FORECAST BEFORE LEAVING DOCK and heed all weather advisories • WEAR SAFETY LANYARD at all times when operating boat to prevent unmanned boat operation. • NEVER OPERATE WHILE UNDER THE INFLUENCE of drugs or alcohol. • DO NOT OVERLOAD THE BOAT. ENSURE THE WEIGHT IS PROPERLY AND EVENLY DISTRIBUTED fore and aft and on both sides of the boat to avoid poor handling, sudden loss of control, swamping and/or capsizing. 	<ul style="list-style-type: none"> • PASSENGERS SHOULD WEAR U.S. COAST GUARD APPROVED LIFE JACKETS. • MAKE SURE THAT ALL PASSENGERS ARE PROPERLY SEATED WHILE UNDERWAY. To avoid passengers falling overboard or being ejected from the boat, do not allow passengers to sit on seat backs, gunwales, or outmost deck edges while boat is moving. • REDUCE SPEED BEFORE ATTEMPTING SUDDEN OR SHARP TURNS, AND MAINTAIN SAFE SPEEDS for water conditions and environment at all times. Maneuverability at high speed is limited, and sudden turns may cause loss of boat control. • KEEP PROPER LOOKOUT AND SAFE DISTANCE for the conditions at all times to avoid collisions. • OBEY APPLICABLE NAVIGATION RULES AND BOATING LAWS. • USE CAUTION AND PROPER LIGHTING during nighttime boating and boating in adverse weather. • READ THE OPERATOR'S GUIDE AND COMPLETE THE BOATER'S PRE-OPERATION CHECKLIST prior to boat operation.

⚠ WARNING
<p>NO VENTILATION IS PROVIDED. FUEL VAPORS ARE A FIRE AND EXPLOSION HAZARD. TO AVOID INJURY OR DEATH, DO NOT STORE FUEL OR FLAMMABLE LIQUIDS HERE.</p>

⚠ MISE EN GARDE
<p>NE PAS ENTREPOSER DE RÉSERVOIR À ESSENCE DANS CET ESPACE.</p>

⚠ WARNING





DO NOT OVERLOAD THE BOW AS THIS MAY CAUSE POOR HANDLING OR NOSEDIVING. DISTRIBUTE PASSENGERS EVENLY AND RESPECT APPROPRIATE SEATING POSITIONS WHILE UNDERWAY.

AVOID PERSONAL INJURY OR DEATH FROM FALLING OVER THE BOW. DO NOT SIT ON OR HANG LEGS OVER THE FORWARD END OF DECK. IF PRESENT, DO NOT OCCUPY FORWARD PEDESTAL SEATS WHILE UNDERWAY.

⚠ WARNING

AVOID SERIOUS INJURY OR DEATH FROM FIRE OR EXPLOSION RESULTING FROM LEAKING FUEL. INSPECT SYSTEM FOR LEAKS FREQUENTLY.

CONTENTS CAN BE UNDER PRESSURE. AVOID SERIOUS INJURY OR DEATH FROM FIRE OR EXPLOSION. OPEN SLOWLY IN WELL VENTILATED AREA. NO SMOKING OR OPEN FLAMES.

USE ONLY GASOLINE UP TO E10 (MAXIMUM 10% OF ETHANOL CONTENT)   

NEVER USE GASOLINE WITH ETHANOL CONTENT HIGHER THAN 10%. THE USE OF GASOLINE WITH ETHANOL CONTENT HIGHER THAN 10% CAN DAMAGE THE ENGINE AND THE FUEL SYSTEM AND WILL VOID THE MANUFACTURER'S WARRANTY.

⚠ WARNING

SKI PYLON IS TO BE USED BY (1) ONE PERSON ONLY FOR SKIING, WAKEBOARDING, AND KNEEBOARDING ONLY. DO NOT USE THE SKI PYLON FOR ANY OTHER PURPOSE (I.E. TUBING, PARASAILING, TOWING, ETC.)

⚠ MISE EN GARDE

DANGER DE BLESSURE GRAVE OU DE MORT RÉSULTANT D'UNE EXPLOSION OU D'UN INCENDIE PROVOQUÉ PAR UNE FUITE DE CARBURANT. INSPECTER LE SYSTÈME RÉGULIÈREMENT POUR S'ASSURER QU'IL N'Y A AUCUNE FUITE.

⚠ WARNING



PINCH POINT.
Keep hands and fingers clear.

⚠ WARNING

AVOID SERIOUS INJURY OR DEATH FROM FIRE, EXPLOSION OR ELECTRICAL SHOCK.

- The power supply for this device must be connected to a Ground Fault Circuit Interrupt (GFCI) protected outlet.
- When using an extension cord, connect the AC charger plug before connecting to the GFCI protected AC outlet.
- Make connection in an open atmosphere free of explosive fumes.
- Make connection in a secure manner that will avoid contact with the water.
- Do not operate this charger if submerged in water.

⚠ WARNING

PROPELLER INJURY HAZARD

ONLY ENTER WATER WITH THE CAPTAIN'S PERMISSION
Failure to adhere to this warning may result in severe bodily injury and/or death.



- **PROPELLERS TURN AUTOMATICALLY**
This could injure someone in the water
- The boat will move suddenly in any direction
- It is NOT SAFE to be in the water near the boat
- DO NOT enter the water or position yourself where you could fall into the water due to sudden boat movement

⚠ WARNING

DO NOT OCCUPY THE REARWARD FACING SEATS INCLUDING THE SWIM PLATFORM WHILE THE ENGINE IS RUNNING. THIS CAN RESULT IN CONTACT WITH A MOVING PROPELLER, OR EJECTION FROM BOAT CAUSING CUTS, LACERATIONS, SEVERE INJURY, OR DEATH. THESE AREAS SHOULD ONLY BE OCCUPIED WHEN THE BOAT IS AT REST AND THE ENGINE IS OFF.

LX & XT SPORT ARCH TOP BIMINI (IF EQUIPPED):

⚠ WARNING

AVOID INJURY OR DEATH FROM FALLING OVERBOARD. CLOSE AND LATCH THE DOOR BEFORE GETTING UNDERWAY. STAY INSIDE GATES AND RAILS AND REMAIN SEATED WHILE UNDERWAY.

⚠ WARNING

TOP SHOULD NOT BE USED WHEN VESSEL SPEED EXCEEDS 45 MPH. NEVER TOW/TRAILER BOAT WITH THE TOP OPEN OR TOP ACCESSORIES IN USE.

VALUE MODELS:

⚠ WARNING

BIMINI SHOULD NOT BE OPEN WHEN VESSEL SPEED EXCEEDS 20 MPH. NEVER TOW/TRAILER BOAT WITH THE BIMINI RAISED. ALWAYS LOWER BIMINI, INSTALL BOOT AND USE TRAILERING BRACKETS TO SECURE BIMINI PRIOR TO TRAILERING

RECREATION MODELS:

⚠ WARNING

BIMINI SHOULD NOT BE OPEN WHEN VESSEL SPEED EXCEEDS 30 MPH. PINS SHOULD ALWAYS BE INSERTED WHEN BIMINI IS OPEN. NEVER TOW/TRAILER BOAT WITH THE BIMINI RAISED. ALWAYS LOWER BIMINI, INSTALL BOOT AND USE TRAILERING BRACKETS TO SECURE BIMINI PRIOR TO TRAILERING.

⚠ WARNING

- ALWAYS SECURELY ATTACH BUNGEE TO THE PIVOTING COVER TO PREVENT OCCUPANTS FROM BEING STRUCK BY THE COVER IN THE EVENT OF AN UNEXPECTED IMPACT WITH THE ENGINE.
- CONSULT THE OPERATOR'S GUIDE OR SERVICE MANUAL PRIOR TO DISCONNECTING THE BUNGEE FROM THE

REQUIRED SAFETY EQUIPMENT

As a boat owner, you are responsible for supplying all legally required safety equipment. Contact USCG for details pertaining to required safety equipment, and consult local, state, and provincial authorities for any additional applicable laws and regulations. For your convenience, the following lists provide the minimum requirements for onboard safety equipment.

REQUIRED ONBOARD SAFETY EQUIPMENT

- Fire Extinguisher
- Visual Distress Signal
- Navigation Lights
- Horn
- Throwable Flotation Device
- One PFD per Person on Board

RECOMMENDED ONBOARD SAFETY EQUIPMENT

- Anchor and Anchor Line
- Tow Line
- Dock Fenders
- Boat Hook
- Warm Clothing
- Oar or Paddle
- Compass
- VHF Radio
- Flashlight
- First Aid Kit
- Sunscreen Lotion
- Warm Clothing
- Rain Gear
- Extra Food
- Extra Water

CAUTION

When on, in, or near water, ensure that children wear PFDs at all times.

OTHER SAFETY CONSIDERATIONS

FUEL SYSTEM SAFETY

When fueling your Manitou boat, it is important to be aware that gasoline can pose a health and safety hazard. Gasoline is highly flammable, and mishandling it can result in injury or death. Always observe all posted safety warnings while fueling your boat, including no smoking requirements.

⚠ WARNING

Always turn off the engine while fueling your boat.

⚠ WARNING

Never smoke while fueling your boat.

⚠ WARNING

Gasoline vapors are highly explosive. To prevent a possible explosion and fire, check for fumes or an accumulation of fuel before starting the engine.

STOP SWITCH LANYARD

The stop switch lanyard is a safety device designed to automatically stop the engine when the lanyard is detached from the emergency stop switch. When your boat is under power, the lanyard clip should be attached to the driver's clothing, leg, or arm. If the driver moves away from the emergency stop switch, the power will be cut, preventing your boat from running without a driver present at the controls.

Note: The stop switch lanyard on your boat may differ from the one shown here.

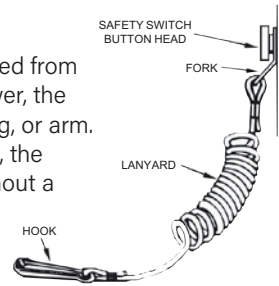

⚠ WARNING

The stop switch lanyard must not be removed or modified. It must always be kept clear of any obstruction that could interfere with its operation.

⚠ WARNING

The driver should always attach the stop switch lanyard clip to his or her clothing, leg, or arm when the engine is running.

United States Federal Law requires the use of stop switch lanyards

HAZARDOUS CONDITIONS

Changing conditions on any body of water can present a unique danger to you and your boat. Hazards such as underwater stumps, unexpected sandbars, or shallow water should be avoided. If you are unfamiliar with the waters, discuss potential hazards with other boaters who are familiar with the area. Then proceed with caution.

Always check the weather before boating, and postpone your trip if hazardous weather conditions are predicted. While on your boat, continue to check the weather periodically.

Manitou is not responsible for any damage or personal injury that may occur while using your boat in hazardous boating conditions, including, but not limited to, damage caused by stumps, sandbars, shallow waters, wave swells, and similar conditions.

WARNING

If you should damage your boat because of any hazardous condition, take your boat to a qualified Manitou dealer and have it inspected. Do not continue to use your boat until it has been inspected.

COMPLIANCE LABELS





Several compliance labels are affixed to the vessel to demonstrate compliance with Federal boating and/or emissions standards. These labels may include the United States Coast Guard Capacity Plate, Canadian Compliance Notice, California Air Resources Board Certification Label, United States Environmental Protection Agency Compliance Statement, the European Union CE mark, and the United Kingdom UKCA compliance mark. These various labels are affixed to the vessel, as applicable, and must not be altered or modified in any way. Federal laws require these labels to remain installed on the vessel. If these applicable labels are damaged, they must be replaced immediately by contacting your local Manitou dealer.

Example of Capacity Plate



The United States Coast Guard capacity plate lists the maximum approved number of persons, maximum weight, and maximum horsepower for a given vessel. Under the U.S. Coast Guard Federal Boat Safety Act of 1971, boats less than 20 feet powered with an inboard, outboard, or stern drive engine manufactured after November 1, 1972, must display a capacity plate defining the safe load limits. This plate must be mounted where you can see it when preparing to get underway. The capacity plate is located on the starboard side captain's station to the right of the steering wheel. Capacity plates should never be removed, altered, or tampered with. Many states have statutes prohibiting the carriage of people and gear in excess of the stated capacity or the installation of a motor that exceeds the recommended horsepower limit. Additionally, you may void your insurance policy if you are found to have exceeded the limits stated on your capacity plate.

**Example of Canadian Compliance Notice
for Boats Greater than 6 Meters
(only applicable to boats sold in Canada)**

CANADIAN COMPLIANCE NOTICE AVIS DE CONFORMITÉ CANADIEN	
BRP USA INC. LANSING, MICHIGAN, USA MODEL / MODÈLE: EXPLORE 22 SHP 575	
MAXIMUM RECOMMENDED SAFE LIMITS LIMITES MAXIMALES DE SÉCURITÉ RECOMMANDÉES	
 	10 750 kg 1653 lbs/lb
+ 	+ 
1291 kg 2846 lbs/lb	
<small>THE MANUFACTURER DECLARES THAT THIS VESSEL COMPLES WITH THE PLEASURE CRAFT CONSTRUCTION REQUIREMENTS OF THE SMALL VESSEL REGULATIONS, AS THEY READ ON THE DAY ON WHICH THE CONSTRUCTION OF THE VESSEL WAS STARTED OR ON THE DAY ON WHICH THE VESSEL WAS IMPORTED. LE FABRICANT ATTESTE QUE CE BÂTIMENT EST CONFORME AUX EXIGENCES DE CONSTRUCTION DES EMBARCATIONS DE PLAISANCE DU RÈGLEMENT SUR LES PETITS BÂTIMENTS, EN VIGUEUR À LA DATE DU DÉBUT DE SA CONSTRUCTION OU À LA DATE DE SON IMPORTATION.</small>	
MB BRP 22 SHP575	3018-0022648

The Canadian Compliance Notice is a statement from the manufacturer or importer that a vessel is built according to the construction requirements of the Small Vessel Regulations. The Small Vessel Regulations require, with a few exceptions, all pleasure craft of less than 24 meters, and as of April 29, 2011, all non-pleasure vessels of not more than 15 gross tonnage, that are or can be fitted with engine(s) to have a Compliance Notice affixed to them in a conspicuous position plainly visible from the helm. By law, the Compliance Notice must be permanently affixed to the pleasure craft.

California Air Resources Board (CARB) Emission Control System Information Label (only applicable to boats sold in California)

EMISSION CONTROL SYSTEM INFORMATION
 MEETS CURRENT CALIFORNIA EVAP EMISSIONS REGULATIONS FOR
 SPARK-IGNITION MARINE WATERCRAFT
 MANUFACTURER: TRITON INDUSTRIES
 CALIFORNIA EVAP FAMILY: NTTIPVSSL111
 EMISSIONS CONTROL SYSTEM: SO 32-MY22CAL18-24

California Proposition 65 Hangtag

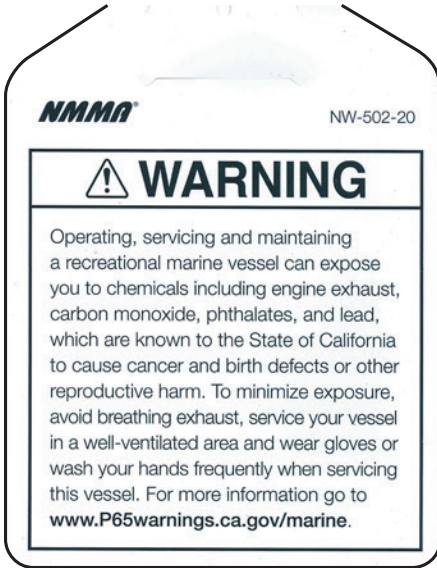

The California Proposition 65 also known as the Safe Drinking Water and Toxic Enforcement Act of 1986 requires a variety of specific consumer warnings to be placed on products to notify consumers of potential exposure to certain chemicals the State of California identifies as cancer-causing or causing reproductive harm. Any vessels sold in the state of California are required to display a proposition 65 hangtag with specific boat related information for consumers.

California Air Resources Board Hang Tag

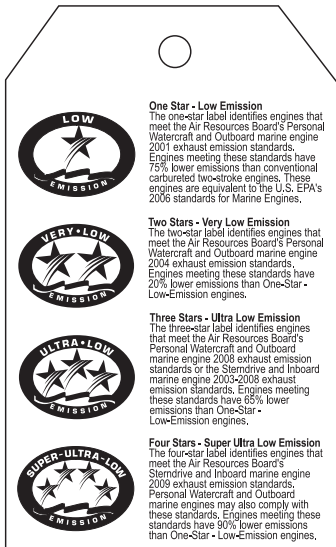

The Spark-Ignition Marine Engine and Watercraft regulations cover any spark-ignited engine that is used to propel a marine watercraft, including personal watercraft, outboard engines, and sterndrive/inboard (e.g. propeller driven vessels, jet boats, air boats, hovercraft) engines. The California Emission Control System Information label provides compliance information regarding evaporative emissions from the vessel's fuel system. The label includes the evaporative family name, model year, manufacturer, and the emissions control system type. This label is required for any new boat offered for sale in the state of California.

**European Union CE Certification Mark and United Kingdom (UKCA)
Compliance Mark (Only applicable to boats sold into the European Union or
United Kingdom)**



The letters 'CE' appear on many products traded on the extended Single Market in the European Economic Area (EEA). They signify that products sold in the EEA have been assessed to meet high safety, health, and environmental protection requirements. By affixing the CE marking to a product, a manufacturer declares that the product meets all the legal requirements for CE marking and can be sold throughout the EEA. This also applies to products made in other countries that are sold in the EEA. The United Kingdom Conformity Assessment (UKCA) mark is a new UK product marking that will be required for certain goods sold in Great Britain (England, Wales, and Scotland). It applies to most goods that previously required the CE mark.

SECTION 5: OPERATING YOUR MANITOU BOAT

To make the most of your Manitou boating experience, it is important to get to know your boat. In this section you will find practical steps and specific actions needed to operate your boat for maximum enjoyment. Please read and make a habit of using this information.

STRONG POINTS

Be aware of your boat's designated secure locations for:

- Anchoring/Mooring: **Front Center Bow Eye**
- Trailing/Loading: **Front Center Bow Eye** and **Rear Lifting Eyes**
-

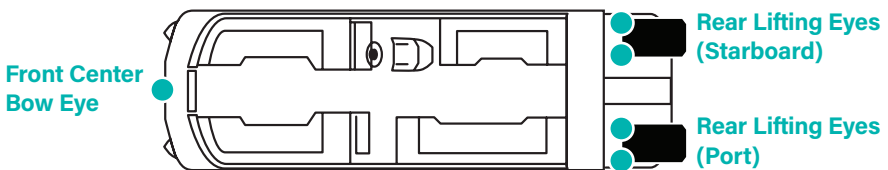

NOTICE

The eye on the center tube is NOT for lifting the vessel. If lifted from this location damage will occur.

FUEL

Your vessel's fuel system contains the following main components:

FUEL TANK. Contains gasoline that is delivered to the outboard engine via a fuel pick up tube and fuel lines. The fuel tank also contains a fuel fill line, fuel vent line, a fuel sending unit, and an evaporative emissions system.

VENT LINE. Responsible for allowing air into the fuel tank when fuel is depleted from the engine. This prevents negative pressure (i.e. vacuum) on the fuel tank as well as vapor lock. Venting also helps to allow trouble-free filling of the fuel tank.

FUEL FILL LINE. Delivers fuel from the exterior mounted fuel cap to the fuel tank

FUEL SENDING UNIT. Responsible for communicating the fuel level to the onboard computer. Fuel level is displayed on the onboard digital display.

EVAPORATIVE EMISSIONS SYSTEM. This system is responsible for reducing the amount of fuel vapors that escape to the atmosphere.

WARNING

Tampering with the fuel system is not recommended and can lead to fuel leaks, explosion injury or death. Service should only be performed by a trained technician. Please see your local Manitou dealer if you believe service to your system is required.

Fuel blending varies by country and region. Your boat has been designed to operate using the recommended fuels; however, be aware of the following:

- Alcohol blended fuels attract and hold moisture which may lead to fuel phase separation and can result in engine performance problems or engine damage.
- Use of fuel containing alcohol above the percentage specified by government regulation can result in the following problems in outboard engines and fuel system components:
 - Vapor lock or fuel starvation
 - Starting and operating difficulties
 - Deterioration of rubber or plastic parts
 - Corrosion of metal parts
 - Damage to internal engine parts

Have your dealer inspect for fuel leaks or other fuel system abnormalities if you suspect the presence of alcohol in gasoline exceeds the current government regulation limits.

Refer to the manual for your outboard engine regarding recommended octane ratings specific to your engine. As a minimum, unleaded gasoline with an AKI (R+M)/2 octane rating of 87 should be used unless otherwise stated in the engine specifications.

BIOBUTANOL (Bu16) FUEL. Biobutanol is a four-carbon alcohol produced from

renewable, plant-derived energy sources in a fermentation process similar to beer and wine production. Biobutanol delivers more renewable energy content than ethanol while remaining compatible with current vehicles, boats, and infrastructure. Biobutanol does not phase separate in the presence of water like ethanol and is less corrosive to fuel system components such as fuel tanks, fuel fittings and fuel hoses. Biobutanol blended fuel (either isobutanol or n-butanol) may be used in all Manitou Boat Boats. Biobutanol blended fuel (Bu16 - up to 16.1% by volume) has been approved for use by the National Marine Manufacturers Association (NMMA).

REC-90 FUEL. It's an ethanol-free, 90-octane unleaded gasoline blend for use in marine engines. Ethanol found in other gasoline blends can damage marine engines.

USE IN NORTH AMERICA:

NOTICE - Do NOT use fuel from fuel pumps labeled E85. Never experiment with other fuels. The use of unleaded gasoline containing alcohol above the percentage specified by government regulations is not recommended. Use of fuel labeled E15 is prohibited by U.S. EPA Regulations

USE OUTSIDE NORTH AMERICA:

The use of unleaded gasoline containing alcohol above the percentage specified by local government regulations is not recommended.

USE IN THE EUROPEAN UNION:

Deployment of Alternative Fuels Infrastructure Directive 2014/94/EU. This directive provides harmonized labeling across Europe to effectively assist consumers in identifying the compatibility of fuels supplied at refueling points with an engine. All Manitou Boat Boats are compatible with up to 10% ethanol fuel blends (E10). The decal shown below should be present near the fuel filler cap of all recreational vessels.

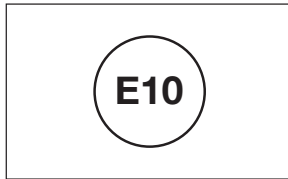

Decal

FUELING

When fueling your boat's main fuel tank, follow these steps:

- Working in a well-ventilated area, remove the fuel tank cap. The contents may be under pressure; remove the cap carefully.
- Insert the fuel supply nozzle.
- After filling the tank to approximately 25 percent capacity, stop the pump, and inspect the engine and fuel tank area for signs of possible leaks or other issues.
- If no issues are detected, continue pumping.
- Stop filling the tank before fuel overflow occurs. Doing so leaves space in the tank for thermal expansion.

Note: If fuel cannot be pumped into the tank at a reasonable rate, contact your Manitou dealer.

Remember that gasoline is most often pumped from underground tanks so it is cooler than the outside air. As the gasoline warms, it will expand. This can cause a fuel tank overflow if the tank is completely full.

Note: It is important to manually control the pump. Do not use the automatic shut-off valve on the nozzle. Instead, stand by the tank and control the pump manually.

At all times, be aware that gasoline is very volatile. Follow these precautions while fueling:

- Shut off the engine.
- Extinguish all lit cigarettes or any other nearby open flames.
- Be cautious when fueling during hot weather.
- Stop fueling before the tank reaches capacity to allow for fuel expansion.
- Follow all safety labels posted on the fuel pump.

WARNING

Leaking fuel is a fire and explosion hazard. Regularly examine your boat's fuel system for leaks or corrosion. If needed, ask a marine service center to complete this inspection.

LAUNCHING YOUR BOAT

Launch ramps are normally busy places, so be ready to launch before approaching the ramp. Prior to backing down the launch ramp, complete these steps:

1. Remove all tie-downs.
2. Load all personal gear.
3. Make sure drain plugs are installed on your boat.
4. Properly secure all loose gear.
5. Lock the winch and trailer unit.
6. Inventory your safety equipment.
7. Disconnect the trailer wiring from your vehicle.

For a successful launch, take note of the following precautions:

- Confirm the length of the ramp and depth of the water. A short ramp can cause trailer damage.
- Ensure that all people, trailers, and other impediments are out of the way before you begin backing up.
- Once the boat is in the water, lower the engine into the water, and start it according to its owner's manual.
- Remove the safety cable and drive the boat off the trailer.
- Once the boat is in the water, cut the engine, tie off the boat, and remove your trailer from the launch ramp immediately. This allows others to launch their boats.

Note: If it is difficult to move the boat off of its trailer, it may be necessary to back into deeper water.

CAUTION

The launching information and instructions provided in this manual are intended to provide general guidelines only. Refer to your NMMA manual and trailer owner's manual for additional information.

BOAT CAPACITY INFORMATION

It is important to know the capacity of your boat so that you do not allow it to become overloaded. An informational plate showing the capacity of your Manitou boat is located on the captain's stand. This plate shows maximum weight, person, and horsepower capacities.

Note: The weight rating for your boat includes the engine, people, and all of your gear.

The engine horsepower should never exceed the posted rating. Exceeding this rating may cause damage to your boat and will void your warranty.

WARNING

Read, understand, and follow the capacity information for your boat. The maximum capacity plate is located on the captain's stand.

BOARDING

Require that your passengers board the boat in an orderly and careful manner, one person at a time. Prohibit jumping into the boat or entering by climbing onto the boat tubes. Always use a boarding ladder when entering or exiting from the water. Review the following safety rules with your passengers. Note that while your boat's floorplan may differ from that shown in the following diagram, the same safety rules apply.

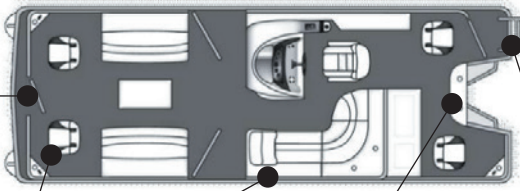

⚠ DO NOT sit on the bow with legs or arms hanging from the boat

⚠ DO NOT sit on the fishing seats while the boat is moving faster than 5 mph

⚠ DO NOT sit on the rails or furniture backs

⚠ DO NOT ride on the sundeck pads while boat is moving

⚠ DO NOT sit in the back entry area while the boat is moving



⚠ DO NOT sit in rearward facing seats when the boat is moving

⚠ DO NOT sit in rearward facing seats when the boat is moving

⚠ DO NOT sit or stand on swim platform when the boat is moving

STOWING ONBOARD GEAR

Your boat has been designed to accommodate storage of gear and belongings. To avoid loss overboard, tripping and falling hazards, or problems with boat operation, loose items should be stowed in the boat's storage compartments before your departure from the shore or dock.

When loading large or awkwardly shaped items onto your boat, do not attempt to carry them on board yourself. Instead, pass the object to a person who is already on the boat. Do the same when unloading your boat.

WEIGHT DISTRIBUTION

Onboard weight distribution affects the ride and handling of your boat. It is important to disperse the weight of passengers and onboard gear evenly in your boat. Avoid excessive weight at either the bow or the stern of the boat.

WARNING

Excessive weight at the bow of your boat can cause the nose to dive underwater, resulting in rapid deceleration.

STEERING

Boat steering is affected by a number of forces, and is different from steering a car. A boat is not self-centering, and engine and propeller torque, trim tab settings, boat speed, and the actions of waves and currents can all affect steering. For a safe ride, a boat driver must pay constant attention to steering. Keep the following in mind as you steer your Manitou boat:

- Be aware that as you steer, the stern responds first by swinging in the opposite direction of the bow. The bow follows a smaller turning radius than the stern. When you are leaving the dock or trying to avoid an object in the water, awareness of this swing is critical.
- Leave plenty of room to make a turn.
- Slow the speed of your boat while turning, and avoid tight, fast turns. Sharp, high-speed turning can endanger your passengers and cause you to lose control of the vessel.
- Leaving the engine trimmed up when you are turning can result in engine ventilation. For more information about engine ventilation, please refer to the owner's manual for your engine.
- Trim the engine down for better handling, especially when you are making tight turns.
- If you are caught in heavy waves, head either directly into the waves or enter them at a slight angle. Reduce your speed, but maintain enough power to move your boat safely.

NAVIGATION AND RIGHT-OF-WAY RULES

Knowing the rules of navigation and right-of-way can prevent boating accidents. Here are several important rules to keep in mind at all times:

- When meeting another boat head on, keep to its starboard, or right, side whenever possible.
- When crossing the path of another boat, you must give way if the other boat is on your starboard side.
- When passing another boat, the boat you are passing has the right-of-way.
- When your boat is being passed, you are expected to maintain your original direction and speed, in order to allow the other boat to pass safely.

Note: Sailboats, windsurfers, kayaks, canoes, and paddleboards have the right-of-way under all circumstances.

You are likely to encounter boaters who do not know or follow these rules. In that situation, you must give way in order to avoid a collision.

BOAT SPEED

The safest speed for your boat depends on water and weather conditions, your boating experience, and the amount of boat traffic present. Your maneuvering speed, or maximum speed at which you can turn your boat and not lose control, must also be taken into account. In general, when you encounter any potentially hazardous situation, adjust your boat speed accordingly. Slower speeds provide more time to respond.

For example, never travel directly behind a water skier. The boat pulling the skier may stop suddenly, causing you to collide with it in seconds. Here's the math for this situation: At 25 MPH, your boat travels more than 35 feet per second. If a boat 200 feet ahead of you stops suddenly and you continue traveling at 25 MPH, your boat will collide into the stopped boat in less than six seconds.

Note: With open bimini top, maximum speed is (model reference on page 1):

- **Cruise Models (Standard Bimini): 20 MPH**
- **Explore Models (Sport Bimini): 50 MPH**
- **LX/XT Models (Sport Arch): 45 MPH**

TRIMMING

The outboard engine can be trimmed to adjust your boat's angle for given loads and water conditions. Follow these performance tips for trimming your Manitou:

- On VP and SHP models, keep the engine trimmed down when accelerating and turning, but trim up while underway.
- Manitou V-Toon boats with higher horsepower engines are likely to ride higher in the water, allowing more rapid acceleration and greater responsiveness in turns.
- Avoid over-trimming. Too great a trim hinders performance and creates excessive engine noise and motor ventilation.

Note: On two-tube boats, trimming the motor does not significantly affect the boat's riding attitude.

DOCKING

Always approach a dock slowly, and ideally against the wind or current. As your boat nears the dock, swing the boat parallel to the structure. If the wind or current is from the stern of your boat, approach the dock slowly at a slight angle, with the engine in slow reverse.

Tie down your boat on the downwind side of the dock. Use fenders over the side between the boat and the dock to protect your boat from damage.

WARNING

Never use your hands or feet to push your boat away from a dock. Use a boat hook or other suitable device.

LOADING AND TRAILERING YOUR BOAT

To load your boat onto its trailer, follow these steps:

1. Back the trailer down the launch ramp until the bunks are about three-quarters submerged in the water.
2. In the towing vehicle, set the parking brake. Also, put the transmission into Park for an automatic transmission, or leave it in gear for a manual transmission. Turn off the vehicle's engine.
3. Place blocks behind the towing vehicle's rear wheels.
4. In the boat, with its speed set to minimum, approach the trailer. Ensure that the engine is trimmed up as far as possible to avoid hitting the shore bottom.
5. Center the boat on the support bunks and steer the boat straight toward the winch stand. Drive the boat between the bunks at a slow speed, using short power bursts.
6. Once the boat is loaded, turn off the engine and tilt it up. Attach the safety cable and exit the ramp to allow others to load.
7. Turn off all boat accessories and the master switch.
8. If your boat is equipped with a livewell, drain it. Also, run your bilge pump to drain the in-tube storage and transom, if applicable.
9. Connect the trailer light harness, and check all lights.
10. Lower and secure the Standard and Sport Bimini. On the Sport Arch, only the bimini canvas must be stowed if equipped.
11. Secure the engine on the engine's trailering bracket.
12. Attach the tie-down straps. For more information, refer to your boat trailer owner's manual.

CAUTION

The loading information and instructions provided in this manual are intended to provide general guidelines only. For additional information, refer to your NMMA manual and trailer owner's manual.

BOAT TRAILER LAWS

Boat trailer laws vary from state to state and province to province. It is your responsibility to understand the laws of the state or province in which you are boating.

TOWING CAPACITY

Towing capacity is determined by several factors. The first factor is your vehicle's Gross Vehicle Weight Rating (GVWR). The GVWR is determined by the vehicle's manufacturer. It specifies the maximum weight that can be safely carried by the vehicle. The total weight of the vehicle, including passengers and cargo, can be compared to the GVWR to determine the weight capacity available for pulling a trailer.

Example: A truck has a GVWR of 9,600 pounds, and a curb weight of 6,600 pounds. This leaves a 3,000-pound carrying capacity.

Trailers also display a rating label that lists the maximum carrying capacity of the trailer, or Gross Trailer Weight Rating (GTWR). Do not exceed your trailer's GTWR at any time. Compare the total weight of the boat, including the engine, fuel, water and all other items being carried on the boat, to the GTWR.

WARNING

Exceeding your trailer's capacity is dangerous and may result in personal injury or property damage.

TONGUE WEIGHT

The tongue weight is the percentage of the total weight of the loaded trailer on its tongue, which is the V-shaped portion of the trailer that extends from the trailer frame to the coupler. The ideal tongue weight falls between five and ten percent of the GTWR.

Example: If the weight of the loaded trailer is 3,000 pounds, then the weight on the tongue should be no less than 150 pounds and no more than 300 pounds.

Excessive tongue weight causes the front end of the towing vehicle to sway during driving. Alternatively, insufficient tongue weight causes the trailer to sway or fishtail.

TRAILER HITCH

Hitches are specified by five classes, labeled from Class I to Class V. These classes relate to the hitch's capacity in pounds.

Always use a hitch with the same class number as the trailer. Most boat trailers connect to a hitch ball that is connected to the towing vehicle. Note that the hitch coupler on your trailer must match the size of the hitch ball on your towing vehicle. The correct ball size needed is usually marked on the trailer coupler.

SAFETY CHAINS

Safety chains are a precaution in case the trailer uncouples from the hitch during transport. The chains keep the trailer connected to the towing vehicle. Always use these safety chains, and cross them for added security.

For specific operation and safety instructions, refer to your trailer owner's manual.

BACKING A VEHICLE WITH A TRAILER

If you do not have experience backing up with a trailer, practice backing up with a trailer before you go to a launch ramp site. It is important to become accustomed to using your trailer. Do not oversteer when backing up. Instead, turn the steering wheel gradually. Enlist the help of someone familiar with maneuvering a trailer, and practice in an open area at first, until you get a feel for backing up safely.

Note: Backing up a trailer is the opposite of backing up your vehicle. If the trailer needs to travel to the right, you will turn the steering wheel to the left. The opposite is also true.

TRAILERING REMINDERS

To avoid accidents, keep the full height of your trailered Manitou in mind at all times. Measure the height of your boat on the trailer and allow for an additional eight inches of clearance. Keep the following guidelines in mind:

- When traveling with your boat and trailer, check all routes for vertical clearance.
- Always be aware of clearances when entering filling stations, motels, or other places where overheads are present.
- Stopping time and distance will be longer after loading your boat at a boat ramp because trailer brakes will be wet. Adjust your driving accordingly.
- After loading your boat onto the trailer, apply the brake several times at a slow speed to dry the brake pads.
- Stow and store loose items to prevent objects from blowing from the boat or becoming damaged during transport.
- **On Cruise and Explore models, DO NOT trailer with the top open or in the up and zipped ("radar") position. Instead, stow and secure the bimini top into the protection boot, lower the entire bimini down, and secure it using available T-pins and/or trailering brackets.**
- If you have a sport arch, do not lower it before trailering. Make sure the arch is fully raised with the star knobs securely installed. If equipped with a bimini top (canvas), tightly secure it using all available straps.
- Store the table and any seat pads that are not hinged and attached.
- On two-tube boats with large motors, consider using a transom saver to support the motor. An unsupported motor may cause tube or deck damage and could void your warranty.

WARNING

Wet trailer brakes may significantly increase stopping distances.

WARNING

- **Do not trailer with the mooring cover installed. Doing so may also result in damage to the cover and your boat.**
- **Make sure seat pads, table, accessories, loose items and cargo are stored and properly secured, or remove it before trailering.**
- **Cruise and Explore bimini: Do not trailer with the bimini top open or in the up and zipped (“radar”) position. Bimini must be lowered and secured for trailering. Refer to the trailering reminders.**

CAUTION

The height of your trailered boat can be a safety factor during transport. Keep this in mind while considering your travel route.

STORING YOUR BOAT

When preparing your boat for storage, follow these basic storage recommendations:

- Drain any freshwater systems to prevent freezing and damage to tanks and lines.
- Fill the permanent fuel tank to minimize condensation. Use a gas stabilizer, making sure to follow the label directions on the stabilizer and in your engine manual.
- Remove water from the livewell, motor pod, in-tube storage chamber, and storage areas.
- Lubricate the steering mechanism, shifter, and shift cables. For more information, review your engine owner’s manual.
- Prepare your engine for storage. For more information, review your engine owner’s manual.
- Store the boat in a dry, clean area. Store indoors if possible.
- Painted fiberglass components must be covered with a barrier material before shrink-wrap to protect it from damage.
- Cover your boat with shrink-wrap during storage to help keep it clean for future use. Note that the mooring cover is not made for winter storage. Do not allow excessive ice or snow to build up on the shrink-wrap.
- If you store your boat on a trailer, position the trailer on blocks to keep its wheels off the ground. This helps avoid tire deterioration.

Note: When winterizing a V-Toon, check the sealed transom for water by opening the access plate. If water is present, remove the drain plug located at the bottom rear of the center tube and let the water drain out. Then coat the drain plug with a thread sealant, and replace it.

Note: If a significant amount of water was present, consult your dealer to determine its cause.

BLOCKING

If you will be placing your Manitou boat on blocks for storage, it is important to place the blocks under the most structurally sound areas of the boat. The diagrams below illustrate these locations for two- and three-tube hulls. Ensure that the boat's weight is evenly distributed between the blocks.

Note: The boat should only be lifted vertically from the bow and stern mooring eyes. Do not lift with the straps at an angle—the straps must lift the boat directly from above.

TWO-TUBE HULL

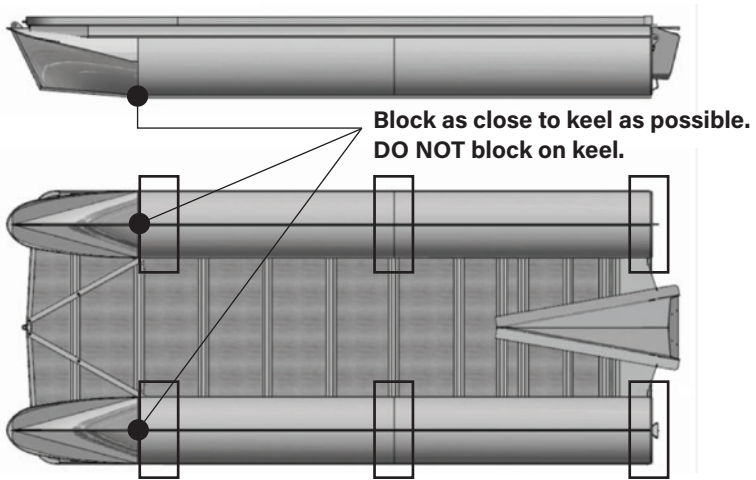

THREE-TUBE HULL

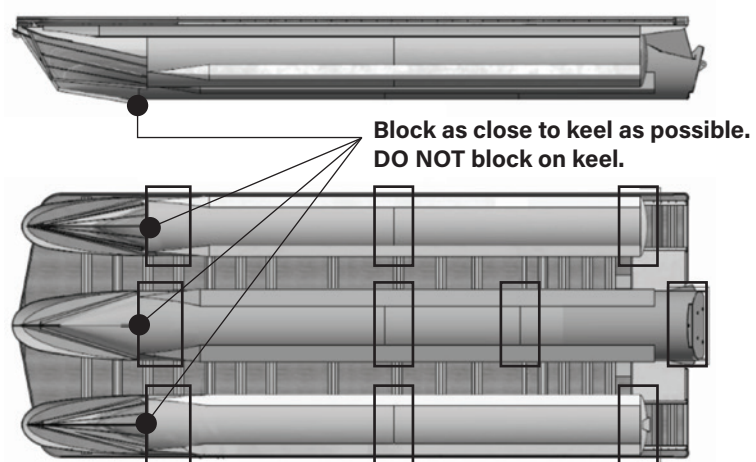

SECTION 6: ELECTRICAL EQUIPMENT

In this section, you will learn more about your Manitou boat's onboard electrical systems, including instruments, controls, wiring, and other components.

Please note that some items described in this section may not be present on your Manitou model. This section provides a general overview of onboard equipment. For more detailed information, check with your Manitou dealer.

ELECTRICAL WIRING SYSTEM

All systems on your boat are powered by a 12-volt DC negative ground electrical system. This system has been fully inspected at the Manitou factory. It is recommended that any work involving adding electrical equipment to your boat be completed by your Manitou dealer. Incorrect wiring of electrical circuits can result in fire and damage to your boat's electrical system.

All Manitou models have a fuse block, as pictured.

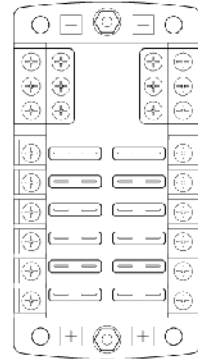

MAXIMUS DCM

The XT and LX models are equipped with a digital switching system. This system, located under the helm, allows the user to control, monitor, and troubleshoot the electronics of the boat through the display. More information about the Maximus DCM can be found in your owner's package.

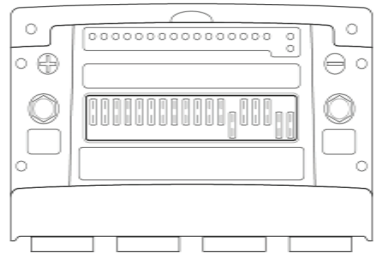

NOTICE

Refer to the owner's manuals for your engine and trailer for their specific wiring and electrical requirements.

BATTERIES

The batteries on your boat were installed by your Manitou dealer. Inspect the batteries frequently for cleanliness and tight connections. Confirm that they are tied down securely. The battery compartment should be well ventilated at all times. Please refer to your battery owner's manual for further instructions.

If you need to replace a battery, install the same type that was originally mounted on your boat. The replacement battery must meet the minimum requirements specified by your engine owner's manual.

LIGHTS

The lights on your Manitou boat serve different purposes. Some are for navigation and safety needs, while others are for your comfort and convenience. The lights present on your Manitou boat vary by model. Please contact your Manitou dealer before adding any extra lights to your boat. Navigation Lights, Including Stern and Bow Lights

Boats must display navigation lights when they are being operated between sunset and sunrise and during periods of poor visibility, including rain and fog. These lights help to alert other boaters of your presence and course.

Follow all laws concerning the use of navigation lights. The green navigation light is always on the starboard (right) side of the boat. The red navigation light is always on the port (left) side of the boat. Please keep this information in mind as you see other boats approaching you on the water.

Note: The appearance of the docking and navigation lights on your boat may differ from those shown here.



Navigation Light

Docking Light

DOCKING LIGHTS

Docking lights are intended to be used only while you are docking the boat at night. Do not use these lights while cruising on the water. The lights are very bright, and may temporarily blind other drivers.

ANCHOR LIGHT

The anchor light is a white light located on the top of your bimini, sport arch, or tower. Use this light while your boat is anchored on the water after dark so that other boaters can see your boat. It must also be used while the boat is underway after dark, with the three position Anchor/ Navigation switch set to the navigation position. While at rest, with the anchor down, set the switch to the anchor setting. Once underway again, return the switch to the navigation position.

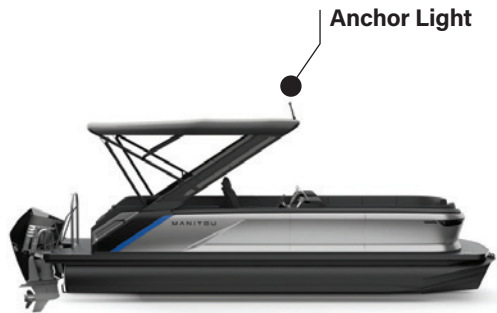

Anchor Light

Note: It is important to know and follow all laws related to the use of the anchor light.

SWITCHES

Electrical switches control the supply of power to your boat's components. Switches may be two-position (either on or off), or three-position (in which the center position is off). On a three-position switch, the switch position determines which components are activated. Some switches have an adjacent push-button reset breaker, and others have automotive-style fuses mounted inside the helm. These breakers and fuses protect the electrical components from damage by power surges.

Note: If you reset a breaker and it immediately trips again, there may be an electrical problem that needs attention. Do not attempt a second reset. Consult your Manitou dealer for more information.

If you replace a breaker, replace it with the same size breaker. Note, too, that there are other switches that are not on the dash, such as the switches for the bilge and galley pumps. These have a pop-breaker near their location.

INSTRUMENT PANEL

The instrument panel installed on your Manitou boat displays information about your engine and related systems. The instrument panel is located on the helm of your boat. The normal readings of the gauges provide a reference point to judge your boat's operations. Although some gauges fluctuate, you should investigate the cause of any sudden or irregular changes in gauge readings. Some of your boat's switches are also found in the helm area.

DIGITAL DISPLAY

Your Manitou boat will have a digital display on the instrument panel. This screen displays information and provides controls for a variety of different functions on your boat. It integrates instrumentation and controls from electronically-controlled engines communicating via SAE J1939 and NMEA 2000 protocols. The display is a multi-functional tool that lets you view different display settings, engine parameters and service codes.

To clean your digital display, use a soft cloth. If necessary, you can also use window cleaner or alcohol to clean the glass portion of the display. Never use harsh or abrasive cleaners on the unit.

For information on using the digital display, review the Garmin® manual included in your owner's packet.

GUIDE TO YOUR BOAT'S INSTRUMENT PANEL

The information that follows provides a reference for your boat's gauges, including normal gauge readings where applicable. Your boat's switches are also shown. Switches and gauges present in the helm area vary by Manitou model. Use the table below to locate your model, then turn to that page.

INSTRUMENT PANEL DESCRIPTIONS

CRUISE MODELS

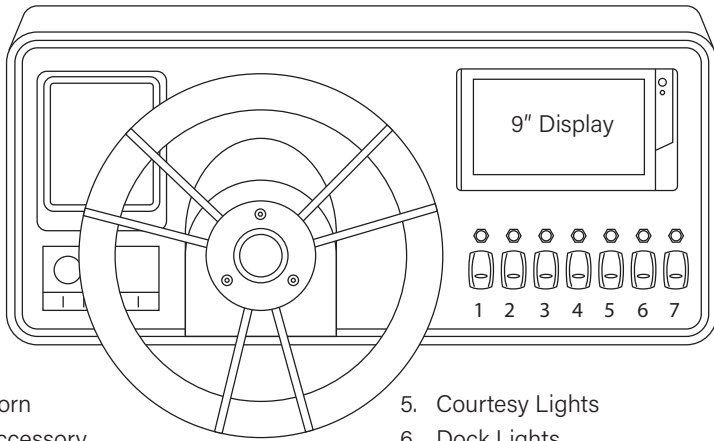

- 1. Horn
- 2. Accessory
- 3. Forward Bilge Pump
- 4. Aft Bilge Pump
- 5. Courtesy Lights
- 6. Dock Lights
- 7. Navigation & Anchor Lights

EXPLORE MODELS

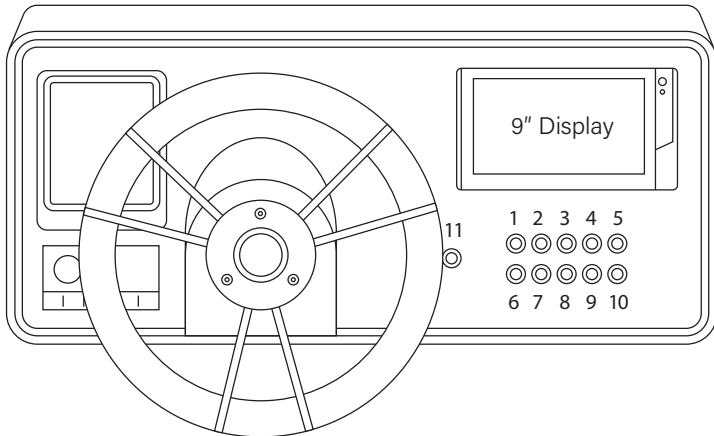

- 1. Navigation & Anchor Lights
- 2. Docking Lights
- 3. Courtesy Lights
- 4. Exterior Lights
- 5. Forward Bilge Pump
- 6. Aft Bilge Pump
- 7. USB outlet
- 8. Accessories
- 9. Accessories 1
- 10. Accessories 2
- 11. Horn

EXPLORE MAX MODELS

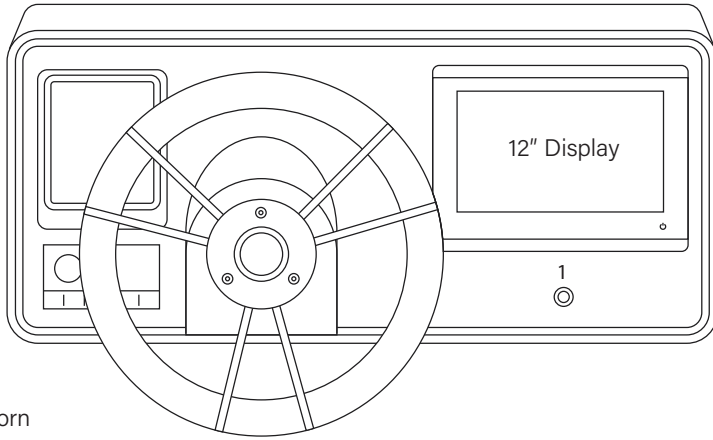

1. Horn

LX

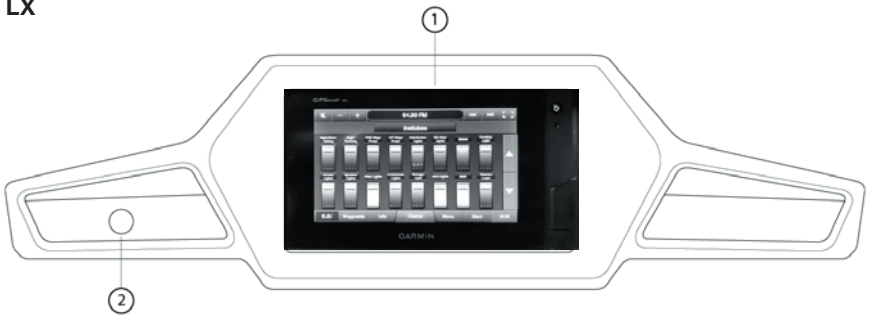

1. The Garmin® digital display provides information for monitoring your boat's performance. It allows you to view engine health messages, including diagnostic messages, fault alerts and parameter information. More information on the Garmin® digital display can be found in your owner's package. It has detailed information on the functionality and customization options of this display unit.

Switches and lighting controls are accessed through your Garmin® touch screen.

2. Horn

XT

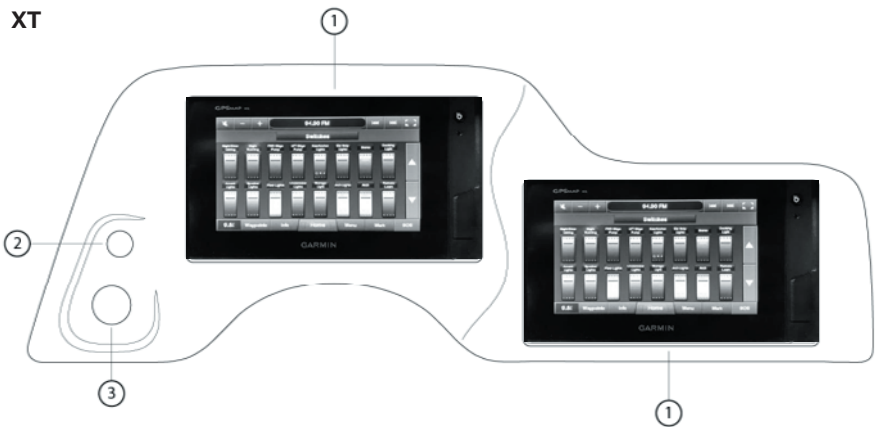

1. The Garmin® digital display provides information for monitoring your boat's performance. It allows you to view engine health messages, including diagnostic messages, fault alerts and parameter information. More information on the Garmin® digital display can be found in your owner's package. It has detailed information on the functionality and customization options of this display unit.

Switches and lighting controls are accessed through your Garmin® touch screen.

2. Horn

3. USB Power

SECTION 7: CONTROLS

Having confidence in using the controls on your boat is essential for safe and proper operation. Careful practice on the water will aid in building the skills needed to make the most of your Manitou boat's controls. This section provides an overview of the steering, engine, and shift and throttle controls that may be present on your Manitou boat.

STEERING SYSTEM

Your Manitou model is equipped with one of several possible steering systems. It is important to review the owner's manual for your specific steering system for additional information concerning maintenance, use, and safety. Also, schedule regular steering maintenance with your Manitou dealer.

Your Manitou boat is equipped with one of the following steering systems:

- **TILT MECHANICAL SYSTEM:** As with the no-tilt mechanical system, the steering wheel connects to a cable that transfers the wheel's movement to the engine. However, with this steering system you will be able to adjust the tilt of your steering wheel on the helm. Use this feature to set the height and angle of the steering wheel for your comfort.
- **HYDRAULIC SYSTEM:** With this steering system, the steering wheel movement pumps hydraulic fluid through the hoses to a cylinder that transfers movement to the engine. A hydraulic steering system makes controlling the boat easier because turning the steering wheel requires less force.
- **POWER ASSIST STEERING:** The power assist unit uses an electronically controlled hydraulic pump to provide steering power to your steering system. Power assist steering provides the driver with an automotivestyle steering experience, even with larger outboard engines.
- **ELECTRO HYDRAULIC SYSTEM:** This system contains an electric steering helm unit that provides the steering position electronically to an onboard hydraulic pump. This pump subsequently steers the engines.
- **FULLY ELECTRIC SYSTEM:** This system has both an electronic helm unit, and also electric steering actuators. The system is fully electronic which removes the need for bulky rigging related to pumps and hydraulic hoses.
- **JOYSTICK UPGRADE:** The joystick upgrade can be added to select dual engine boats. The joystick allows for effortless rotation, translation, or forward/backward motion of the boat. See the joystick steering section below for operation details.

All steering systems require periodic maintenance to remain trouble-free and safe. Regular checks are essential. Visually inspect the cables at least twice each month during boating season. If you detect problems in the steering system, do not use the boat until your dealer has inspected the system and resolved the problem.

Be aware that steering varies from boat to boat, depending on the engine and make of boat. Getting a feel for your own boat's steering system is important. Before each outing, turn the wheel a full turn from left to right. Check that the outboard engine is turning correctly, freely, and smoothly.

AUTOPILOT & AUTOMATIC SET POINT FUNCTIONS (IF EQUIPPED)

Auto-pilot is not approved for Explore Max vessels with twin S150 iDock engines.

An autopilot or an automatic set point function will allow your boat to automatically hold a course, a heading, a position or a drift point by controlling the engine(s).

Some engines are equipped with an automatic engine control systems. These automated systems do not constitute a replacement for the driver.

The driver is responsible at all time for the safety of the boat's occupants and its surroundings.

Refer to the controls manual provided with the owner's packet for details of operation of these automatic functions.

WARNING

The driver must always perform active supervision even when using the autopilot or any automatic engines features. Activating these features will make components move automatically and could lead to injuries or even death.

WARNING

Always make sure no swimmers or other obstacles are near the engine or the engine propeller area, especially when these automatic functions are activated.

IDOCK JOYSTICK STEERING

The iDock system consists of a hydraulic steering helm, hydraulic hoses, hydraulic fluid, an electronic joystick directional control, network wiring, a control module, and an hydraulic steering manifold assembly on each outboard. The control module monitors and controls the steering system. The EMM monitors the control module, stores fault codes and activates the engine monitor should a fault code be generated. As the steering wheel is turned hydraulic fluid in the helm begins moving through the steering system. The iDock pressure sensor signals the control module of an increase in hydraulic pressure in the direction of the turn. The control module then detects a pressure differential between the two pressure sensors and turns ON the steering pump providing steering assistance. The control module monitors iDock Pressure Sensor (APS) voltage. The control module also monitors the steering position sensor. As the outboard approaches the steering system stop, the control module turns OFF the steering pump to maximize system efficiency. When the joystick is activated, the mode valve locks out hydraulic fluid from the helm enabling the joystick to control direction. Joystick inputs control operation of the direction valve. The direction valve reverses the flow of hydraulic fluid through the steering manifold, depending on joystick inputs, and turn the outboards to port or starboard.



⚠ WARNING

The safety information provided here is intended to inform you of the dangers that may be present before, during, and after installation. It is critical to read and understand this information.

Failure to comply with any warning, notice or caution may lead to loss of steering control resulting in a collision or ejection from the boat, possibly resulting in property damage, injury, or death.

SAFETY INFORMATION

Only operate the boat if all components are in proper working condition. Safe operation depends upon proper installation and maintenance of the system, and the common sense, safe judgment, knowledge, and expertise of the operator. Every installer and operator of the steering system should know the following requirements before installing or operating the steering system. If you have any questions regarding any of these warnings, contact the dealer that installed the system.

Prior to every use:

1. Verify immediate steering response when turning steering wheel.
2. Inspect all steering hoses, fittings, and electrical harnesses for wear, kinks, or leaks.
3. Check for binding, loose, worn or leaking steering or shift/throttle control components.
4. Verify that proper shift and throttle response is available for all control handles.

During use:

1. Wear a Coast Guard-approved PFD with the ignition lanyard attached at all times.
2. Only allow those who are familiar with the operation of the steering system operate the boat.
3. If boat is equipped with multiple helms, ensure that only one is used at a time.
4. Know and adhere to all applicable federal, state, and municipal laws and regulations that govern boating in your area.

CAUTION

It is recommended to practice using the joystick in all operating ranges before starting the calibration procedure. Improper use of the joystick can result in machine damage or personal injury.

NOTICE

On boats where the engines violate the edges of the vessel when turned, be sure to have enough room around the docks so the engines do not hit the dock.

IDOCK SYSTEM USE

IMPORTANT: In strong currents or extremely windy conditions, the boat may not be able to overcome the yaw of the boat. If this happens, stop the movement of the boat, realign the vessel, and continue docking.

TRANSFERRING TO AND FROM JOYSTICK MODE

To transfer to joystick mode, move the throttle control levers to the NEUTRAL position and push the power button on the joystick. The power button will be illuminated in blue when joystick mode is enabled.

To transfer out of joystick mode and back to binnacle control, push the RPM+ button on the binnacle. The LED lights on the binnacle will become illuminated when the binnacle is in control.

NOTE: The binnacle levers must be in the NEUTRAL position to transfer out of joystick mode.

Refer to the image below for the operating ranges of the joystick before starting any joystick use.

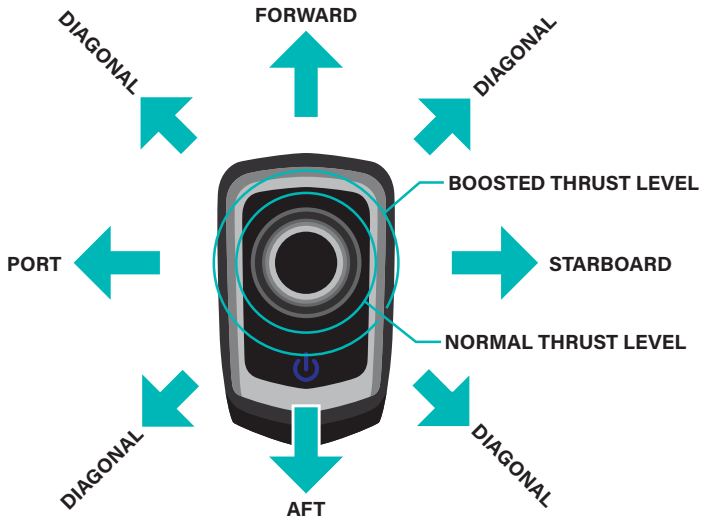

FORWARD

While in joystick control, push the joystick forward to move the boat forward.

When the joystick is pushed forward, both the port and the starboard engines will apply forward thrust.

To increase the movement, push the joystick harder (past the detent) in the forward direction.

To turn the boat to port while moving the boat forward, twist the joystick counterclockwise.

To turn the boat to starboard while moving forward, twist the joystick clockwise.

To correct for over steering, let go of the joystick to allow the joystick to return to the center position or push the joystick aft.

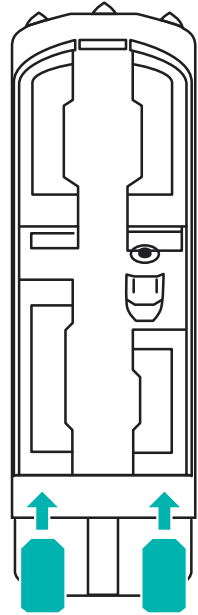

AFT

While in joystick control, move the joystick back to move the boat aft.

When the joystick is pushed aft, both the port and starboard engines will provide reverse thrust to move the vessel aft.

To increase the movement, push the joystick harder (past the detent) in the aft direction.

To turn the boat to port while moving the boat aft, twist the joystick counterclockwise.

To turn the boat to starboard while moving aft, twist the joystick clockwise.

To correct for over steering aft, let go of the joystick to allow the joystick to return to the center position or push the joystick forward.

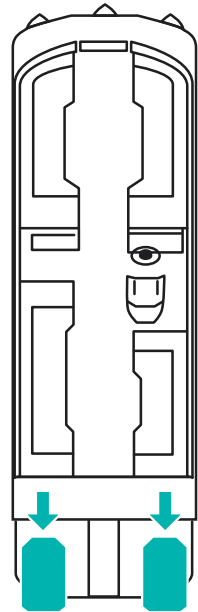

STARBOARD

While in joystick control, move the joystick to the right to move the boat to starboard.

When the joystick is pushed to starboard, the port engine will provide reverse thrust while the starboard engine will provide forward thrust to walk the boat starboard.

To increase the movement, push the joystick harder (past the detent) in the starboard/right direction.

To move the boat forward while moving the boat to starboard, push the joystick forward.

To move the boat aft while moving in a starboard direction, push the joystick aft.

To correct for over steering, let go of the joystick to allow the joystick to return to the center position or push the joystick right.

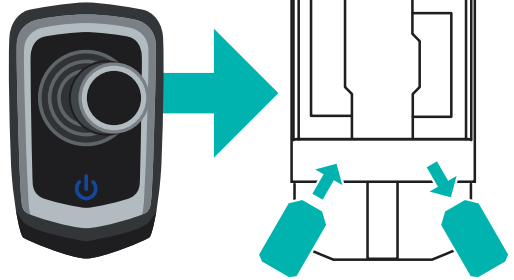

PORT

While in joystick control, move the joystick to the left to move the boat to port.

When the joystick is pushed to port, the port engine will provide forward thrust while the starboard engine will provide reverse thrust to walk the boat to port.

To increase the movement, push the joystick harder (past the detent) in the port/left direction.

To move the boat forward while moving to port, push the joystick forward.

To move the boat aft while moving to port, push the joystick aft.

To correct for over steering, let go of the joystick to allow the joystick to return to the center position or push the joystick right.

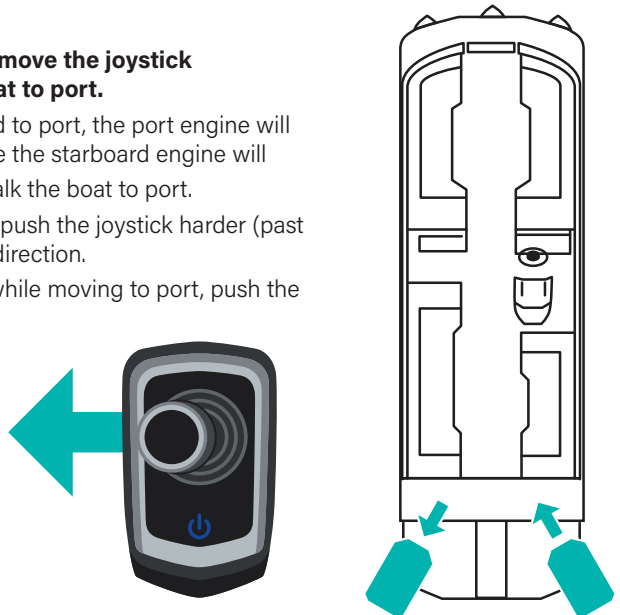

PORT SPIN

While in joystick control, twist the joystick counterclockwise to spin the boat to port.

When the joystick is turned counterclockwise, the port engine will provide reverse thrust and the starboard engine will provide forward thrust to spin the boat to port.

To increase the movement, twist the joystick further counterclockwise.

To move the boat forward while in a port spin, move the joystick forward.

To move the boat aft while in a port spin, move the joystick aft.

To correct for over steering in a port spin, let go of the joystick to allow the joystick to return to the center position or twist the joystick clockwise.

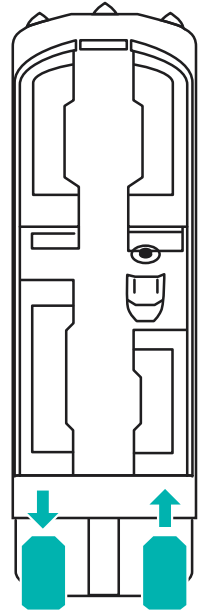

STARBOARD SPIN

While in joystick control, twist the joystick clockwise to spin the boat to starboard.

When the joystick is turned clockwise, the port engine will provide forward thrust while the starboard engine will provide reverse thrust to spin the vessel starboard.

To increase the movement, twist the joystick further clockwise.

To move the boat forward while in a starboard spin, move the joystick forward.

To move the boat aft while in a starboard spin, move the joystick aft.

To correct for over steering in a starboard spin, let go of the joystick to allow the joystick to return to the center position or twist the joystick counterclockwise.

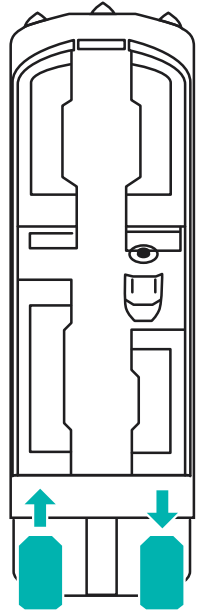

DUAL ENGINE CONTROLS

Your Manitou boat may be equipped with dual engine controls. If you are unfamiliar with the operation of these controls, it is important to take time to learn more about how to safely and efficiently maneuver your boat using these controls.

Each lever of the dual engine control operates a single engine. The left (or port) lever adjusts the speed and rotational direction of the port-side engine. In the same way, the right (or starboard) lever operates the starboard-side engine. When the two levers are in the same position, the engines work together to move the boat in a straight line. When the two levers are in different positions, the boat responds by pivoting or spinning in one direction or the other, according to the positions used.

To master the operation of the dual engine control, first practice on the water in an area where there is no risk of collision or running aground. You will also want to practice docking maneuvers using the dual engine control. Remember at all times that boat speed affects the driver's ability to maneuver. At first, keep your engine speeds low to allow for safe practice. Increase to higher speeds as you gain familiarity with the controls' effect on steering. For detailed instructions on using the optional dual engine controls feature, please refer to the controls manual provided in the owner's packet.

- A POWERSYNC** Synchronize multiple engine RPMs and control multiple engines by combining shift and throttle functions with the push of a button. Boat operators can now operate multi-engine boats by using a single control lever.
- B ENGINE TRIM** A single master engine trim switch is installed on the shift lever to control all engines. Conveniently located individual trim switches for easy operation and fine-tuning adjustments.
- C F-N-R INDICATORS** Forward-Neutral-Reverse (F-N-R) indicators easily identify gear position for added safety and usability.
- D RPM TUNE** This exclusive feature is a virtual rpm cruise control ranging from idle to wide-open throttle. Press the "RPM" button on the control to fine-tune the engine rpm slightly higher or lower; this makes it easy to find the exact trolling speed or optimize fuel economy at cruise. Engine rpm is increased or decreased in 50 rpm increments.



SHIFT AND THROTTLE CONTROL SYSTEM

The shift and throttle control system on your boat will vary depending on the brand of motor and the steering options you have selected. The control system described in this section may vary slightly from the control on your boat. For specific maintenance, use, and safety information, refer to the shift and throttle control owner's manual provided by the engine manufacturer.

FORWARD AND REVERSE

To shift into forward, rotate the control lever forward about 35 degrees. To shift into reverse, rotate the control lever backward.

POWER TRIM AND TILT SWITCH

The power trim and tilt switch is attached to the control lever grip. It is operated using your thumb. Pushing the switch upward trims and tilts the motor upward. Pushing the switch downward trims and tilts the motor downward. While the trim and tilt switch is in use, the trim gauge located on the instrument panel will indicate the angle of the propeller relative to the hull. As you push the switch up or down, the gauge should reflect this change.

TIPS FOR USING THE SHIFT AND THROTTLE CONTROL SYSTEM

The following tips will aid you when you are using the shift and throttle control system:

- When shifting between forward and reverse, always pause for a few seconds in neutral before reversing the propeller. This will prevent damage to the engine.
- When maneuvering at slow speed, you can reverse the propeller to slow or stop the boat's forward movement.
- When moving in reverse, gradually increase boat speed. Accelerating at high speed while in reverse may create a wake that can flood the stern area of your boat.

Please keep in mind that this information may not apply to your specific shift and throttle control system. To learn more, read the shift and throttle control owner's manual enclosed with your Manitou owner's packet. You may also consult with your dealer or the engine manufacturer for more information.

SECTION 8: OTHER COMPONENTS

LIVEWELL

Your Manitou boat may be equipped with a livewell. A livewell is a tank used to keep bait and harvested fish alive. The livewell is aerated by the fresh water that is pumped into the tank.

You can turn the livewell pump on and off manually by using the designated accessory switch in the helm area. When this switch is in the On position, the pump runs continuously.

It is important to be aware of water and air temperatures to determine when and how often you should aerate the livewell. The pump draws water from below the waterline of the boat and pumps it into the livewell tank through the aerator head. The aerator head can be adjusted to control the volume of water flowing into the livewell tank. Oxygen content increases as incoming water hits the surface of the water already in the livewell tank. This added oxygen helps keep fish in the livewell alive.

Note: The pump works best when the boat is at rest or moving very slowly. At faster speeds, the pump is unable to draw water.

The stand pipe overflow tube keeps your livewell tank from overflowing with water. It sets the maximum water level allowed in the tank. As water enters and fills up the tank, the stand pipe allows the overflow to drain out below the deck of the boat. Stand pipes can be cut down if lower water levels are desired. For additional information, consult your Manitou dealer.

SPORT ARCH

Manitou LX and XT boat models are equipped with a sport arch. The sport arch should be in the raised position most of the time, including during trailering. Some circumstances, such as passing under a low bridge while on the water or fitting under a lift at a dock, may require lowering the sport arch. The sport arch is lowered and raised via the digital display. The bimini top (if equipped) is designed to be open when operating at speeds less than 45 MPH.



! CAUTION

If an arch is present on your Manitou boat, note the arch must be in a raised position during trailering.

ROTAX OUTBOARD EQUIPPED MODELS

MAX DECK

The pivoting cover of the MAX Deck swim platform can be manually lifted to a vertical position to access integrated Rotax S engine or the stern lifting eyes. To achieve the vertical position, the two bungee cords must be detached from the pivoting cover.

⚠ WARNING

Always confirm that the bungee cords are re-attached and secured on the pivoting cover after service or maintenance operations have been performed. Severe injury or death could occur from the unattached pivoting cover striking an occupant in the event of an underwater impact with the outboard engine.

⚠ WARNING

Avoid severe injury or death from the pivoting cover suddenly dropping down. Always secure the pivoting cover in the vertical position or remove it from the platform, when disconnecting the bungee cords.

LINQ ACCESSORIES

Only install accessories compatible with the LinQ anchor system.

To use retractable LinQ anchors, lift them, making sure they are fully extended and locked. Refer to the accessory instruction sheet for proper installation at instructions.brp.com/e-instruction.html#tab=1
To lower the LinQ anchors when not in use, squeeze tabs then push down.



LEARN MORE

⚠ CAUTION

The LinQ attachment points are used to carry accessories and should always be retracted when not in use to reduce the risk of injury.

Stand clear of the swim platform when raising or lowering the integrated Rotax S engine. When tilted up, the outboard engine will push open the pivoting cover, creating a pinch point hazard. Personal injury can result from contact with the moving cover.

⚠ WARNING

Do not mount anything to the surface of the pivoting cover. Serious injury or death could occur from flying objects as a result of the outboard engine impacting an underwater object and forcing the pivoting cover open.



MODELS WITH SINGLE ROTAX S ENGINE

Oil fill (A) and freshwater flushing port (B) are located on the port side of the swim platform. The oil level is displayed on the instrument cluster.



MODELS WITH TWIN ROTAX S ENGINES

Oil fill (A) and freshwater flushing ports - port (B) and starboard (C) - are located on the center of the swim platform under the rear rigging hatch. The oil level is displayed on the instrument cluster.

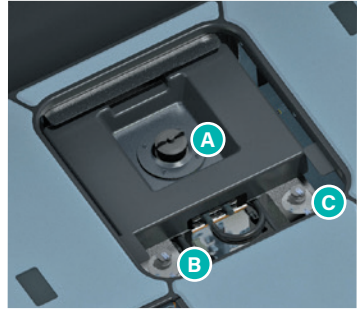

STERN BOARDING LADDER

The stern boarding ladder is located in the stern of the boat and comes as a standard feature. Do not leave your ladder deployed while the boat is under power.

⚠️ WARNING

Do not use any ladder while the engine is running. Swimmers must not exit or enter the boat when the engine is running or the propeller is in motion.

⚠️ WARNING

Always use a boarding ladder to enter and exit your boat. Do not climb on the boat tubes.



⚠️ CAUTION

The maximum weight rating for the ladder is 300 pounds.

SECTION 9: CLEANING YOUR MANITOU BOAT

Your Manitou boat is designed to provide lasting enjoyment now and into the future. In this section, you'll learn the best practices for cleaning each of the surfaces in your boat. Following these practices consistently will extend the life of the quality materials built into every boat.

If you are cleaning your boat on the water, confirm that any cleaning products used are safe for release into aquatic environments. Never wash non-biodegradable chemicals into waterways.

FLOORING

Manitou boats offer two types of flooring—vinyl and Compass HB. The care and maintenance of these flooring types is described in this section.

VINYL FLOORING

Your Manitou boat may have vinyl flooring. As with all flooring, this surface will benefit from regular cleaning. Follow these steps for cleaning vinyl flooring:

1. Rinse the vinyl flooring with cool water, and use a deck brush or other soft-to-medium stiffness brush to remove grime and debris.
2. Apply floor soap or cleanser with the brush, and allow the cleanser to penetrate and loosen the soil and debris for two to three minutes.
3. Lightly scrub the area with the brush, and then rinse the area with clear water.
4. If needed, repeat this process.

Certain substances can stain vinyl flooring. Avoid spilling chemicals, dyes and inks, and other materials. Rubber tires may also cause stains. When necessary, you may be able to remove some stains with a vinyl floor cleaner. Do not use harsh chemicals such as tar remover, acetone, kerosene, or oxalic acid. Test any new product in an inconspicuous location before use, and follow label directions carefully.

Note: Some cleaning products may make vinyl flooring slippery, during cleaning or afterward. When using unfamiliar products, test them carefully to reduce the likelihood of slips and falls.

Over time, the plywood subflooring on your Manitou boat may lift slightly at its seams. If a small ridge in your vinyl flooring becomes noticeable, it will not affect the integrity or longevity of your flooring.

NOTICE

Heavy or sharp objects may permanently damage vinyl flooring.

SPRADLING COMPASS HB™ FLOORING

Your Manitou boat may have Spradling Compass HB flooring. This flooring is a hybrid material that mixes both PVC and carpet yarns to make a highly durable surface well-suited to marine environments.

Caring for Spradling brand flooring is similar to caring for other types of marine flooring. Regularly remove soil and debris by vacuuming or hosing off the flooring. If a deeper cleaning is needed, standard carpet cleaning products may be used. Allow the flooring to dry completely before storing. Do not use acetone, Pine-Sol®, or citrus-based cleaners on your Compass HB flooring.

FABRIC TOPS AND COVERS

Your Manitou boat includes a bimini top as a standard feature, and may also have a mooring cover or deck enclosure. These are made with Utopia HD® polyester fabrics designed for use in marine environments. This fabric is specially coated to resist water, sun, and mildew damage.

Note: Although the fabric they are made of is water resistant, bimini tops and boat covers are not leak-proof at their seams. To learn about available seam-sealing products, consult your Manitou dealer.

Top and cover fabrics can be cleaned to prevent the buildup of soil. Each month, brush off any loose dirt or debris, and then hose down the fabric with fresh water. If needed, use a mild detergent such as Ivory® or Woolite®. To avoid breaking down the water-repellant and mildewrepellant coating, do not allow soap or water to fully penetrate the fabric. Ensure quick drying by cleaning top and cover fabrics on a sunny day.

Clean each fabric item before any period in which it will be stored. Always avoid rolling or storing your fabric cover when it is wet or damp. Doing so can encourage the growth of mold and mildew.

Note: Mooring covers are not intended for winter storage. Please see the section titled "Storing Your Boat" in this manual for more information on storage practices.

To best maintain the fabric items on your Manitou boat, always observe the following recommendations:

- Protect fabric from sharp edges or corners. Repair all tears and rips immediately.
- Avoid parking your covered boat under trees. Tree sap contains chemicals that can break down fabrics.
- Do not allow water or heavy snow to stand or puddle on fabric items.
- Never machine wash and dry the fabric items.
- Do not use solvents to clean fabric items.
- Do not clean fabric items in a commercial car wash.
- Do not pressure wash or steam clean your fabric items.

SNAPS AND ZIPPERS

The snaps and zippers on the fabric items on your new Manitou boat may be stiff at first, but will loosen with use. To ease the opening and closing of snaps, you can lubricate them with petroleum jelly. To protect the fabric from tears, do not pull on the cover to unsnap a row of snaps. Instead, proceed one-by-one, gripping the snap itself. Use care when starting a zipper to prevent damage. Never force a zipper to move.

VINYL-COATED FABRICS

It is important to keep acrylic and Napa topcoat vinyl-coated fabrics clean and stain free. Before cleaning these fabrics, determine the level of soiling. Then follow the appropriate directions provided in this section.

Note: Always remove stains immediately.

LIGHT SOILING

1. Dampen a soft cloth with a solution of one part household liquid dish soap to nine parts warm water.
2. Rub the soiled area gently.
3. Rinse the area with a warm water-dampened cloth.

HEAVY SOILING

1. Dampen a soft white cloth with a solution of one part Formula 409® or Fantastik® to one part water.
2. Rub the soiled area gently.
3. Rinse the area with a warm water-dampened cloth.

STAIN REMOVAL

1. Dampen a soft white cloth with a solution of one part household bleach to nine parts water.
2. Rub the soiled area gently.
3. Rinse the area with a warm water-dampened cloth to fully remove the bleach solution.

Note: All cleaning methods must be followed by a thorough rinse with clean warm water.

GENERAL PRECAUTIONS

There are a number of important things you and your passengers should be aware of in maintaining the vinyl-coated fabrics on your boat. Ensure that everyone observes the following precautions:

- Suntan lotion, tree pollen, and wet leaves can contain dyes that cause permanent stains on vinyl-coated fabrics. Avoid situations in which vinyl-coated fabrics may be exposed to these substances.
- Certain household cleaners, powdered abrasives, steel wool, and industrial cleaners can damage and discolor your vinyl-coated fabric items.

- Dry cleaning fluids and lacquer solvents should not be used on vinyl coated fabric. These substances will remove printed patterns and gloss.
- All waxes should be used with caution. Many waxes contain solvents and dyes that may permanently damage the protective coating of the vinyl-coated fabric.
- Never clean your vinyl-coated fabric items with a pressure washer. The force of the water is likely to cause damage.
- Never use kerosene, gasoline, or acetone to clean vinyl-coated fabric. These products will remove the protective coating.
- Do not use any silicone-based products. They will extract the plasticizer from the vinyl and leave the vinyl-coated fabric hard, brittle, and prone to cracking.

Under certain conditions, vinyl-coated fabrics may develop a condition known as "pink stain," (or "pinking"). Although Manitou's use of high quality materials and fabrication helps avoid this condition, the following precautions should be followed:

- Cover your boat when it is not in use. Be sure to allow adequate venting to avoid trapping moisture.
- Remove wet or damp towels, gear, or swimsuits from the boat as soon as possible.
- Control moisture in cabinets and lockers by leaving them open when possible, and by using moisture-absorbing desiccants.

EXTERIOR SURFACE AND GRAPHICS CARE

In some situations, streaks may appear on the outside of the boat's exterior aluminum panels. These streaks are caused by moisture build-up on the panel walls. To remove the streaks, use one cup of Simple Green® mixed with four cups of water in a spray bottle. Spray and wipe. Avoid the use of a stronger mixture, which may damage your boat's vinyl graphics.

Your Manitou boat sports today's finest pressure-sensitive graphics. These graphics require little maintenance and should be treated like a painted wall.

Clean all powder-coated surfaces regularly. Cleaning with cool or lukewarm water is recommended. Should soiled surfaces require the use of a cleaning agent, choose a neutral detergent such as mild dish soap, apply the cleanser, and rinse immediately with cold water. Avoid the use of solvents, alcohols, and abrasive cleaners as these may damage the surface.

SECTION 10: MAINTAINING YOUR MANITOU BOAT

Regular maintenance is an important part of making the most of your Manitou boat. In this section, you will learn the actions you must take to preserve and protect your new boat, ensuring its value for years to come.

CORROSION

All metal parts of a boat, including the hull, are subject to corrosion. Two primary types of corrosion affect boats—galvanic corrosion and stray current corrosion. Both types of corrosion can occur in any water that is not pure, but are most often found in salty, brackish, high-mineral, or polluted waters. These types of waters are conductive. Since conductivity increases with water temperature, corrosive action is accelerated in warmer climates.

Bare hull or unpainted boat used in these water conditions must be removed from the water and rinsed off after each use. Keels and strakes require special attention during the rinse off. Bare hull boat must never be moored overnight, nor should they be stored on carpeted bunk-style trailers. Do not store an unprotected aluminum boat in salt water. Your Manitou dealer must check both the trailer and boat for internal stray current.

Ask your dealer to recommend a qualified and experienced company to bottom paint your hull. This will help protect your boat and reduce the likelihood of corrosion. Note that boat with keels and strakes can be difficult to properly bottom paint. An experienced professional painter is a must.

Anodes, if properly installed, will also help. Discuss this with your Manitou dealer.

Note: Damage to your Manitou boat due to marine corrosion is not covered under the Manitou warranty.

Never charge your batteries while the boat is sitting on its trailer, especially if the trailer has wooden or carpeted bunks. Instead, remove the battery from the boat before charging it.

Note: Even after you have rinsed your salt-water boat with fresh water, some salt will still be present. Salt buildup under the boats, often held by the trailer bunk wood or carpet, is an excellent electricity conductor and may cause corrosion if you choose to charge the battery while it is on board your trailered boat.

ALUMINUM SURFACES

Rinse all aluminum surfaces of your boat regularly. Use water and mild detergents for cleaning and protecting the aluminum boat tubes. Do not use harsh chemicals or abrasives. Remove stains or light corrosion on the tubes with a high-quality metal polish. Remove algae, scum, or other marine growth while it is still wet, as these are difficult to remove once they dry.

DO NOT use aluminum cleaners on the tubes. This reacts with the factory-installed wax on the tubes and may result in swirls that will not come out unless the tubes are buffed.

Note: Over a period of time, unpainted bright aluminum surfaces will oxidize, taking on a dull gray appearance. This oxidized coating is normal and does not harm the aluminum.

EXPLORE MAX DUAL ENGINE DECK CLEAN UP

Meguiars Mirror Glaze Swirl Remover 2.0 (#9) is recommended for cleaning and removing light blemishes from the textured surfaces of the plastic material on the Explore Max Dual Engine deck.



BATTERY AND ELECTRICAL CARE

Batteries must be held securely in the battery tray. Check the battery connections. They should be clean and tight at all times. If you detect wiring damage anywhere on your boat, consult your Manitou dealer.

During periods in which you use your boat infrequently, “trickle-charge” your battery regularly to ensure that it will be ready for use when you need it. Follow all instructions in your battery owner’s manual.

⚠ WARNING

Batteries contain sulfuric acid, which can cause severe personal injury and property damage if not handled with care. Protect your eyes, skin, and clothing when working with your boat’s battery.

SECTION 11: AQUATIC INVASIVE SPECIES (AIS)

Aquatic Invasive Species (AIS) are non-native plant or animal species that threaten the diversity or abundance of the native species. They also threaten the natural ecology of the body of water they infest. AIS almost always have a negative impact on the waterway, its native species, and recreational or commercial activities on the waterway.

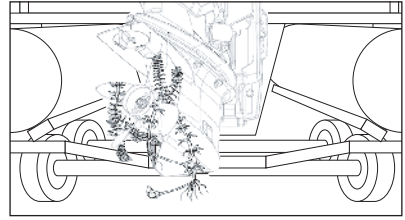

Common examples of AIS are; Eurasian watermilfoil, hydrilla, sea lampreys, zebra mussels, Asian carp, and gobies. Many other examples of AIS exist throughout the world's waterways.

A typical factor in AIS infestations is that the non-native species are introduced by human activity. Some AIS are introduced by commercial operations; however AIS can be introduced through recreational boating activities. The transportation of recreational boats and water sports equipment between waterways can be a major factor in the spread of AIS.

Small pieces of plants or animals hanging from a propeller, trailer or wakeboard can transfer enough biological material to establish an AIS in a new waterway. The early reproductive stages of many AIS are microscopic; small amounts of water in a bilge, live well, cooler or trapped in a compartment can contain enough organisms to establish an infestation.

As responsible boat owners we MUST do our part to prevent the spread of these aquatic hitchhikers. Check your boat each time you leave the water! In many cases it is required by law, be sure to check the local regulations for the waterways where you boat.

CLEAN, DRAIN & DRY – EVERYTHING, EVERY TIME!

Before you leave a waterway, follow the procedure below to help prevent the spread of AIS.

CLEAN

Inspect and remove any visible mud, aquatic plants, fish or animals from the boat, trailer and any water sports equipment before transporting your equipment.

DRAIN

Remove all water from the boat, including ballast, bilge, livewell, engine and gearcase. Dispose of unwanted live bait in the trash.

DRY

Allow the boat to completely dry before visiting any other bodies of water.

AIS INSPECTION CHECKLIST

Before you leave a waterway, follow the procedure below to help prevent the spread of AIS.

Location	Reference	Inspection Items	✓
Boat	1	Hull	
	2	Floor	
	3	Livewell	
	4	Transom Well	
		Water Inlet & Outlet Fittings	
		Anchors & Lines	
		Boarding Ladder	
		Transducers & Other Attachments to the Hull	
Accessories		Fishing Tackle & Fishing Lines	
		Bait Buckets	
		Landing Nets	
		Water Sports Equipment (Skis, Wakeboards, etc.)	
		Tow Ropes	
Outboard(s)	5	Water Intake Screens	
	6	Gearcase	
	7	Propeller	
Trailer	8	Bunks and/or Rollers	
	9	Fenders & Frame	
	10	Tires & Wheels (including Spare Tire)	
		License Plate & Bracket	
		Lights & Wiring	

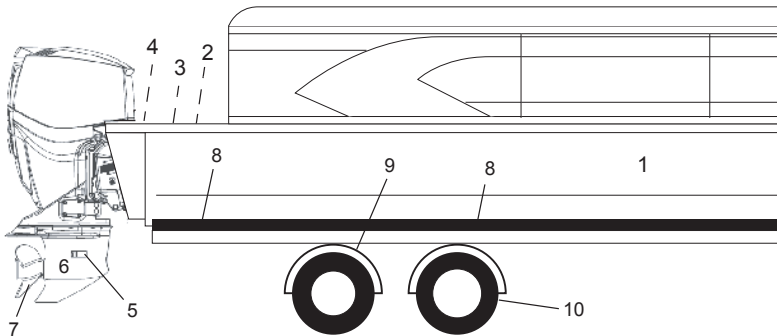

SECTION 12:

DESIGNATED SEATING POSITIONS

Please reference the capacity label for the number of persons and weight capacity specific to your boat. Never exceed the number of persons or weight capacity stated on the on either the US Coast Guard Capacity label or the Canadian Compliance Notice label. As the captain, you are responsible for properly loading the boat and ensuring your passengers are safely secured. Keep in mind the limits defined on capacity plates apply in good to moderate weather conditions. In rough waters, keep the weight well below the limit. In ideal weather conditions, it is recommended that you distribute your load evenly and avoid abrupt changes in distribution. This is especially important if your boat's capacity is fully used or if weather conditions deteriorate. It is also important to remember that people represent a 'live' load and moving about affects a boat quite differently than static loads. In general, shift human or other weight only after stopping or slowing.

The number of persons and weight capacities may vary depending on the country in which your boat is operated. If you have questions regarding the locations of passengers or weight capacity for your boat, please contact your local Manitou dealer for additional information.

In addition to the US Coast Guard Capacity label, refer to Manitou's Seating Locations Guide for model-specific seating position recommendations.

SECTION 13: INDEX

A

Accessory 40, 52
Alcohol 10, 23, 24, 37, 58
Aluminum Surfaces 60
Anchor Light 36, 38
Aquatic Invasive Species 61

B

Batteries 35, 59, 60
Blocking 34
Boarding 12, 26, 54, 62
Boat Speed 28, 29, 50
Boating Safety 1, 6, 10
Breaker 37

C

Capacity 11, 19, 24, 26, 31, 63
Carbon Monoxide 9
Cleaning 1, 6, 55, 56, 57, 58, 60
Controls 17, 35, 37-51
Corrosion 23, 25, 59, 60

D

Designated Seating Positions 7, 63
Digital Display 37, 38, 39, 40
Docking 11, 30, 36, 38, 44
Dual Engine Controls 50

E

Electrical Equipment 35
Engine Horsepower 26
Ethanol 24
Exterior Surface 58

F

Fabric 56, 57, 58
Flooring 55, 56
Fuel 17, 22, 23, 24, 25, 31, 33
Fuel System Safety 17
Fueling 17, 24
Fuses 37

G

Galvanic Corrosion 59
Gasoline 17, 23, 24, 25, 58
Graphics 58

H

Hazardous Situation 3, 29
Horn 16, 38, 39, 40
Hull Identification Number (HIN) 7

I

iDOCK Joystick Steering 44
Instrument Panel 37, 38, 39, 40
Insurance 8, 19
Intended Use 6

J

Joystick Steering (iDOCK) 44

L

Ladder 12, 26, 54, 62
Launch Ramp 25, 30, 32
Launching 10, 25
Light(s) 16, 28, 30, 36, 38, 39, 40, 62
Livewell 30, 33, 52, 61, 62
Loading 28, 30, 32, 55

M

Mooring Cover 32, 33, 56

N

Navigation 11, 29, 36

Navigation Lights 16, 36, 38

O

Owner's Packet 4, 5, 6, 37, 43, 51

P

Paint 33, 58, 59

Passengers 1, 4, 6, 10, 11, 14, 26, 28, 31, 42, 57, 63

Personal Flotation Device (PFD) 9, 13, 16

S

Safety Chains 32

Safety Equipment 9, 10, 16, 25

Safety Labels 4, 5, 10, 14, 15, 25

Safety Statements 3

Sanitary Waste Disposal 8

Shift and Throttle Control System 42, 51

Snaps 57

Speed 9, 11, 13, 28, 29

Sport Arch 32, 36, 52

Stain Removal 57

Star Knobs 32

Steering 19, 28, 32, 33, 41, 43

Steering Systems 42, 44

Stern Boarding Ladder 54

Stop Switch Lanyard 17

Storage 28, 30, 33, 34, 56

Storing Your Boat 33, 56

Stowing Onboard Gear 28

Stray Current Corrosion 59

Swimming Safety 12, 13

Switches 4, 37, 38, 39, 40

T

Tongue Weight 31

Towing 30, 31, 32, 52

Trailer 8, 25, 30, 31, 32, 33, 35, 59, 61, 62

Trailer Hitch 31

Trailerling 30, 32

Trash Disposal 8

Trim Gauge 51

Trimming 29

V

Vinyl-Coated Fabrics 57, 58

Vinyl Flooring 55

W

Warranty 1, 2, 5, 6, 7, 32

Water Depth 12

Water Skiing 13

Water Skiing Safety 13

Weather 10, 11, 18, 25, 29, 63

Weight Distribution 28

Winterizing 33

Wiring 25, 35, 60, 62

Z

Zippers 57



BRP REIMAGINES THE WAY YOU ACCESS YOUR WORLD

Manitou is one of many success stories from BRP, the global company behind some of the most daringly innovative products and experiences that move you. Because it's not about the destination, it's about the journey — yours.

Discover our brands:

ski-doo **LYNX** **SEA-DOO** **CAN-AM** **ROTAX** **ALUMACraft** **MANITOU** **QUINTREX**

www.brp.com

