

***can-am***



**MAVERICK R – X AND X RS SERIES**

# OPERATOR'S GUIDE

Includes Safety, Vehicle and Maintenance Information

**NOV 4**

## **⚠ WARNING**

Read this operator's guide thoroughly. It contains important safety information. Minimum recommended operator age: 16 or older with a valid driver's license. The removal or modification of evaporative emission-related parts on this OHRV is illegal. Violators may be subject to civil and/or criminal penalties under California and federal law. Keep this operator's guide with the vehicle at all times.

**219002376**

**Original Instructions**

### **WARNING**

**YOUR VEHICLE CAN BE HAZARDOUS TO OPERATE.** A collision or roll-over can occur quickly, if you fail to take proper precautions, even during routine maneuvers such as turning and driving on hills or over obstacles. For your safety, understand and follow all the warnings contained in this operator's guide and on the labels on your vehicle. Failure to follow these warnings can result in **SEVERE INJURY OR DEATH.** Keep this operator's guide with the vehicle at all times.

### **WARNING**

Disregarding any of the safety precautions and instructions contained in the operator's guide, **SAFETY VIDEO** and on-product safety labels could cause injury including the possibility of death.

### **WARNING**

This vehicle may exceed the performance of other vehicles you may have ridden in the past. Take time to familiarize yourself with your new vehicle.

## **CALIFORNIA PROPOSITION 65 WARNING**

### **WARNING**

Operating, servicing and maintaining an off-road vehicle can expose you to chemicals including engine exhaust, carbon monoxide, phthalates, and lead, which are known to the State of California to cause cancer and birth defects or other reproductive harm. To minimize exposure, avoid breathing exhaust, do not idle the engine except as necessary, service your vehicle in a well-ventilated area and wear gloves or wash your hands frequently when servicing your vehicle. For more information go to [www.p65warnings.ca.gov/products/passenger-vehicle](http://www.p65warnings.ca.gov/products/passenger-vehicle).

TM® Trademarks of BRP or its affiliates.

This is a non-exhaustive list of trademarks that are the property of Bombardier Recreational Products Inc. or its affiliates.

Trademarks may not be registered in every jurisdiction.

Can-Am®

D.E.S.S.™

DPS®

XPS®

ROTAX®

Maverick®

X®

All rights reserved. No parts of this Operator's guide may be reproduced in any form without the prior written permission of Bombardier Recreational Products Inc.

©Bombardier Recreational Products Inc. (BRP) 2023

Deutsch	Dieses Handbuch ist möglicherweise in Ihrer Landessprache verfügbar. Bitte wenden Sie sich an Ihren Händler oder besuchen Sie: <a href="http://www.operatorsguides.brp.com">www.operatorsguides.brp.com</a>
English	This guide may be available in your language. Check with your dealer or go to: <a href="http://www.operatorsguides.brp.com">www.operatorsguides.brp.com</a>
Español	Es posible que este manual esté disponible en su idioma. Consulte a su distribuidor o visite: <a href="http://www.operatorsguides.brp.com">www.operatorsguides.brp.com</a>
Français	Ce guide peut être disponible dans votre langue. Vérifier avec votre concessionnaire ou aller à: <a href="http://www.operatorsguides.brp.com">www.operatorsguides.brp.com</a>
Italiano	Questa guida potrebbe essere disponibile nella propria lingua. Contattare il concessionario o consultare: <a href="http://www.operatorsguides.brp.com">www.operatorsguides.brp.com</a>
中文	本手册可能有您的语种的翻译版本。请向经销商询问，或者登录 <a href="http://www.operatorsguides.brp.com">www.operatorsguides.brp.com</a> 查询。
日本語	このガイドは、言語によって翻訳版が用意されています。ディーラーに問い合わせるか、次のアドレスでご確認ください： <a href="http://www.operatorsguides.brp.com">www.operatorsguides.brp.com</a>
Nederlands	Deze handleiding kan beschikbaar zijn in uw taal. Vraag het aan uw dealer of ga naar: <a href="http://www.operatorsguides.brp.com">www.operatorsguides.brp.com</a>
Norsk	Denne boken kan finnes tilgjengelig på ditt eget språk. Kontakt din forhandler eller gå til: <a href="http://www.operatorsguides.brp.com">www.operatorsguides.brp.com</a>
Português	Este manual pode estar disponível em seu idioma. Fale com sua concessionária ou visite o site: <a href="http://www.operatorsguides.brp.com">www.operatorsguides.brp.com</a>
Русский	Воспользуйтесь руководством на вашем языке. Узнайте о его наличии у дилера или на странице по адресу <a href="http://www.operatorsguides.brp.com">www.operatorsguides.brp.com</a>
Suomi	Käyttöohjekirja voi olla saatavissa omalla kielelläsi. Tarkista jälleenmyyjältä tai käy osoitteessa: <a href="http://www.operatorsguides.brp.com">www.operatorsguides.brp.com</a>
Svenska	Denna bok kan finnas tillgänglig på ditt språk. Kontakta din återförsäljare eller gå till: <a href="http://www.operatorsguides.brp.com">www.operatorsguides.brp.com</a>

Covered Models
Maverick R X
Maverick R X rs
Maverick R X rs with Smart-Shox

In Canada, products are distributed and serviced by Bombardier Recreational Products Inc. (BRP).

In the USA, products are distributed and serviced by BRP US Inc.

In the European Economic Area (which is comprised of the member states of the European Union plus the United Kingdom, Norway, Iceland and Liechtenstein), the Commonwealth of the Independent States (including Ukraine and Turkmenistan) and Turkey, products are distributed and serviced by BRP European Distribution S.A. and other affiliates or subsidiaries of BRP.

For all other countries, products are distributed and serviced by Bombardier Recreational Products Inc. (BRP) or its affiliates.

# TABLE OF CONTENTS

## GENERAL INFORMATION

<b>FOREWORD</b> .....	<b>10</b>
Know Before you Go .....	10
Safety Messages .....	10
About this Operator's Guide .....	11
Respect of the Environment .....	11

## SAFETY INFORMATION

<b>BEFORE YOU GO</b> .....	<b>14</b>
Operating Age and Ability .....	14
Drugs and Alcohol .....	14
Protective Gear .....	14
Required Equipment .....	17
<b>GET FAMILIAR WITH THE VEHICLE</b> .....	<b>18</b>
Off-Road Operation .....	18
Steering .....	18
Braking .....	19
Programmable D.E.S.S. Key .....	19
Vehicle Blind Spots .....	19
Rear View Camera .....	21
Front View Camera .....	23
Carrying Loads .....	23
Hauling a Load .....	24
Accessories and Modifications .....	24
<b>RIDE SAFELY</b> .....	<b>26</b>
General Driving Tips .....	26
Riding in a Group .....	27
Operating in Reverse .....	27
Crossing Roads .....	27
Riding on Paved Surfaces .....	27
Shallow Water Crossing .....	28
Riding on Snow or Ice .....	28
Riding on Sand .....	29
Riding on Gravel, Loose Stones or Other Slippery Surfaces .....	29
Crossing Obstacles .....	29
Hill Driving Conditions .....	29
Avoid Collisions .....	32
Avoid Rollovers and Tipovers .....	32
Terrain Condition .....	33
Avoid Carbon Monoxide Poisoning .....	34
Avoid Gasoline Fires and Other Hazards .....	35
Avoid Burns from Hot Parts .....	35
<b>PRACTICE EXERCISES</b> .....	<b>36</b>
Turning Exercises .....	36
U Turn Exercises .....	36
Braking Exercises .....	36
Reverse Exercises .....	37

Emergency Engine Stopping Exercise.....	37
<b>IMPORTANT ON-PRODUCT LABELS (CANADA/UNITED STATES) .....</b>	<b>38</b>
Hang Tag.....	38
Safety Labels.....	40
Safety Compliance Hang Tag.....	54
<b>IMPORTANT ON-PRODUCT LABELS (ALL COUNTRIES EXCEPT CANADA/UNITED STATES) .....</b>	<b>55</b>
Safety Pictogram.....	55
<b>PRE-RIDE INSPECTION CHECK LIST.....</b>	<b>69</b>
What to Do Before Starting the Engine (Key OFF).....	69
What to Do Before Starting the Engine (Key ON).....	70
What to Do After the Engine is Started.....	70
<b>REPORTING SAFETY DEFECTS.....</b>	<b>72</b>

## **VEHICLE INFORMATION**

<b>PRIMARY CONTROLS .....</b>	<b>74</b>
STEERING WHEEL.....	74
SHIFT PADDLES.....	74
ACCELERATOR PEDAL.....	75
BRAKE PEDAL.....	75
ELECTRONIC SHIFT LEVER.....	75
PARK BUTTON.....	76
NEUTRAL BUTTON.....	77
LOW RANGE BUTTON.....	77
MANUAL MODE BUTTON.....	77
<b>SECONDARY CONTROLS .....</b>	<b>79</b>
RF D.E.S.S Key and RF D.E.S.S. Post.....	79
ENGINE START/STOP BUTTON.....	79
HEADLIGHT DIMMER SWITCH.....	80
OVERRIDE SWITCH.....	80
KEYPAD.....	81
HORN SWITCH (on applicable models).....	82
<b>EQUIPMENT .....</b>	<b>83</b>
TILT/TELESCOPIC STEERING WHEEL.....	83
PASSENGER HANDHOLDS.....	83
CENTRAL STORAGE COMPARTMENT.....	83
GLOVE BOX.....	84
TROUBLESHOOTING TOOLS.....	84
CENTRAL REARVIEW MIRROR.....	85
FOOTRESTS.....	85
DOORS.....	85
SEAT BELTS.....	86
SEATS.....	87
FUEL RESERVOIR CAP.....	89
CARGO RACK.....	89
RECOVERY POINTS.....	90
CUP HOLDERS.....	90
<b>4.5" DIGITAL DISPLAY .....</b>	<b>91</b>
Multifunction Display.....	91
Warning Lamps and Indicators.....	92
Settings.....	93

<b>10.25" COLOR TOUCHSCREEN DISPLAY</b> .....	<b>95</b>
Default Display .....	95
Navigating the Digital Display .....	95
Center Display .....	95
Views Display .....	96
Right APP Menu .....	98
Left APP Menu .....	105
Icons and Indicators - Multifunction Display .....	106
Pairing Your Smartphone Through Bluetooth .....	107
BRP Connect .....	108
Quick Tour of the BRP GO! App .....	109
Messages in Touchscreen Display .....	110
<b>TUNE YOUR RIDE</b> .....	<b>111</b>
Drive Mode .....	111
Engine Mode .....	111
4WD Mode .....	111
DPS Function .....	112
Suspension Adjustment Guidelines .....	113
Suspension Factory Settings .....	113
Suspension Adjustments .....	115
<b>FUEL</b> .....	<b>120</b>
FUEL REQUIREMENTS .....	120
VEHICLE FUELING PROCEDURE .....	120
<b>BREAK-IN PERIOD</b> .....	<b>122</b>
Operation During Break-In .....	122
<b>BASIC PROCEDURES</b> .....	<b>123</b>
STARTING THE ENGINE .....	123
WAKING UP THE ELECTRICAL SYSTEM .....	123
OPERATING THE SHIFT LEVER .....	123
CHOOSING THE CORRECT RANGE (LOW OR HIGH) .....	124
STOPPING THE ENGINE AND PARKING THE VEHICLE .....	124
<b>SPECIAL PROCEDURES</b> .....	<b>125</b>
PERMANENT NEUTRAL or MECHANICAL NEUTRAL ACTIVATION .....	125
LIMP HOME MODE .....	126
DEAD BATTERY .....	126
ROLLED OVER VEHICLE .....	128
SUBMERGED VEHICLE .....	128
<b>TRANSPORTING THE VEHICLE</b> .....	<b>129</b>
Using Vehicle Power to Climb Onto Trailering Equipment .....	130
Using a Winch to Pull Vehicle Onto Trailering Equipment .....	131
Securing Vehicle for Transport .....	131
Getting Vehicle Out of Trailer .....	132
<b>LIFTING AND SUPPORTING THE VEHICLE</b> .....	<b>133</b>
Front of Vehicle .....	133
Rear of Vehicle .....	133

## **MAINTENANCE**

<b>MAINTENANCE SCHEDULE</b> .....	<b>136</b>
EPA Regulation - Canadian and USA Vehicles .....	136
Air Filter Maintenance Guideline .....	136
Severe Duty Use .....	137

Deep Mud / Water Use .....	137
Maintenance Schedule .....	138
Maintenance Records .....	146
<b>MAINTENANCE PROCEDURES .....</b>	<b>151</b>
ENGINE AIR FILTER .....	151
FRONT GRILLE .....	152
EVAPORATIVE EMISSION SYSTEM PRE-FILTER (If Equipped) .....	153
ENGINE OIL .....	153
ENGINE OIL FILTER .....	156
FRONT RADIATOR .....	157
INTERCOOLER AND REAR RADIATOR .....	158
ENGINE COOLANT .....	159
EXHAUST SYSTEM .....	161
GEARBOX .....	162
DISCONNECT UNIT .....	167
FRONT DIFFERENTIAL .....	168
REAR FINAL DRIVE .....	170
BATTERY .....	171
FUSES .....	173
LIGHTS .....	176
SPARK PLUGS .....	176
DRIVE SHAFT BELLOWS .....	180
WHEEL BEARING .....	180
WHEELS AND TIRES .....	181
SUSPENSION .....	183
BRAKES .....	185
SEAT BELTS .....	186
CAGE .....	186
<b>VEHICLE CARE .....</b>	<b>188</b>
Vehicle Cleaning and Protection .....	188
<b>STORAGE AND PRESEASON PREPARATION .....</b>	<b>189</b>

### **TECHNICAL INFORMATION**

<b>VEHICLE IDENTIFICATION .....</b>	<b>192</b>
Vehicle Identification Number .....	192
Engine Identification Number .....	192
Transmission Identification Number .....	192
<b>COMPLIANCE LABELS .....</b>	<b>193</b>
Emission Control Information .....	193
ANSI/ROHVA Label .....	194
NRMM Comformity Label .....	195
Fuel Ethanol Content .....	195
<b>TECHNICAL INFORMATION LABELS .....</b>	<b>196</b>
Verifying the Engine Oil Level .....	196
Recommended Fuel .....	197
Air Filter Maintenance .....	198



**RADIO FREQUENCY DIGITALLY ENCODED SECURITY SYSTEM (RF D. E.S.S. KEY)..... 199**  
**EVAPORATIVE EMISSION CONTROL SYSTEM ..... 200**  
**NOISE EMISSION CONTROL SYSTEM REGULATION (CANADA AND UNITED STATES)..... 201**  
**NOISE EMISSION AND VIBRATION VALUES..... 202**  
 Machinery Directive 2006/42/EC Compliant Models ..... 202  
**DECLARATION OF CONFORMITY ..... 203**  
 EU Declaration of Conformity..... 203  
 UK Declaration of Conformity..... 204  
**EAC DECLARATION OF CONFORMITY ..... 205**

**TECHNICAL SPECIFICATIONS**

**TECHNICAL SPECIFICATIONS ..... 208**  
 ENGINE..... 208  
 VEHICLE ..... 210

**TROUBLESHOOTING**

**TROUBLESHOOTING GUIDELINES ..... 224**  
**DIGITAL DISPLAY MESSAGES..... 227**

**WARRANTY**

**BRP LIMITED WARRANTY FOR CANADA AND USA: 2024 CAN-AM® SSV ..... 230**  
 1) Scope of the Limited Warranty ..... 230  
 2) Limitations of Liability ..... 230  
 3) EXCLUSIONS – Are Not Warranted ..... 230  
 4) Warranty Coverage Period ..... 231  
 5) Conditions to Have Warranty Coverage ..... 231  
 6) What to Do to Obtain Warranty Coverage ..... 232  
 7) What BRP Will Do..... 232  
 8) Transfer ..... 232  
 9) Consumer Assistance ..... 232  
**US EPA EMISSION - RELATED WARRANTY ..... 233**  
 Emission-Related Warranty Period ..... 233  
 Components Covered ..... 233  
 Limited Applicability ..... 234  
**CALIFORNIA EVAPORATIVE EMISSIONS CONTROL WARRANTY STATEMENT ..... 236**  
 Your Warranty Rights And Obligations ..... 237  
 OHRV Manufacturer’s Warranty Coverage ..... 237  
 Owner’s Warranty Responsibilities ..... 238  
**BRP LIMITED WARRANTY FOR INTERNATIONAL: 2024 CAN-AM® SSV ..... 239**  
 1) Scope of the Limited Warranty ..... 239  
 2) Limitation of Liability ..... 239  
 3) EXCLUSIONS – Are Not Warranted ..... 240  
 4) Warranty Coverage Period ..... 240

5) For Products Sold In Australia Only .....	241
6) Conditions to Have Warranty Coverage .....	241
7) What to Do to Obtain Warranty Coverage .....	242
8) What BRP Will Do .....	242
9) Transfer .....	242
10) Consumer Assistance .....	242
<b>BRP LIMITED WARRANTY FOR THE EUROPEAN ECONOMIC AREA, THE COMMONWEALTH OF THE INDEPENDENT STATES AND TURKEY: 2024 CAN-AM® SSV .....</b>	<b>244</b>
1) Scope of the Limited Warranty .....	244
2) Limitations of Liability .....	244
3) EXCLUSIONS – Are Not Warranted .....	245
4) Warranty Coverage Period .....	246
5) For Products Sold In France Only .....	246
6) Conditions to Have Warranty Coverage .....	246
7) What to Do to Obtain Warranty Coverage .....	247
8) What BRP Will Do .....	247
9) Transfer .....	248
10) Consumer Assistance .....	248

**CUSTOMER INFORMATION**

<b>DATA PRIVACY INFORMATION .....</b>	<b>250</b>
<b>CONTACT US .....</b>	<b>252</b>
Asia Pacific .....	252
Europe, Middle East and Africa .....	252
Latin America .....	253
North America .....	253
<b>CHANGE OF ADDRESS AND OWNERSHIP .....</b>	<b>254</b>

# GENERAL INFORMATION

---

# FOREWORD

Congratulations on your purchase of a new Can-Am® side-by-side vehicle. It's backed by the BRP limited warranty and a network of authorized Can-Am Off-road dealers ready to provide the parts, accessories or service you may require.

Your dealer is committed to your satisfaction. He has taken training to perform the initial setup and inspection of your side-by-side vehicle as well as completed the final adjustment before you took possession. If you need more complete servicing information, please ask your authorized Can-Am Off-road dealer.

At delivery, you were informed of the warranty coverage and signed the Pre-delivery Check List to ensure your new vehicle was prepared to your entire satisfaction.

## Know Before you Go

To learn how to reduce the risk of accident for you or bystanders, read this Operator's Guide before you operate the vehicle.

Also, read all safety labels on your vehicle and watch the *Safety Video* located at:

<https://can-am.brp.com/off-road/safety>

Or use the following QR code.



This vehicle is for off-road use only. It is mainly for general recreational use but it may also be used for utility purposes.

Failure to follow the warnings contained in this Operator's Guide can result in **SERIOUS INJURY** or **DEATH**.

## Safety Messages

The types of safety messages, what they look like and how they are used in this guide are explained as follows:

The safety alert symbol  indicates a potential injury hazard.

 <b>WARNING</b>
Indicates a potential hazard which, if not avoided, could result in serious injury or death.

 <b>CAUTION</b>
Indicates a hazardous situation which, if not avoided, could result in minor or moderate injury.

## NOTICE

**Indicates an instruction which, if not followed, could result in severely damaged vehicle components or other property.**

### About this Operator's Guide

This Operator's Guide has been prepared to acquaint the owner/operator of a new vehicle with the various vehicle controls, maintenance and safe operating instructions. It is indispensable for the proper use of the product.

Keep this Operator's Guide in the vehicle as you can refer to it for things such as maintenance, troubleshooting and instructing others.

Note that this guide is available in several languages. In the event of any discrepancy, the English version shall prevail.

If you want to view and/or print an extra copy of your Operator's Guide, simply visit the following website:

**[www.operatorsguides.brp.com](http://www.operatorsguides.brp.com)**

The information contained in this document is correct at the time of publication. BRP, however, maintains a policy of continuous improvement of its products without imposing upon itself any obligation to install them on products previously manufactured. Due to late changes, some differences between the manufactured product and the descriptions and/or specifications in this guide may occur. BRP reserves the right at any time to discontinue or change specifications, designs, features, models or equipment without incurring any obligation upon itself.

This Operator's Guide should remain with the vehicle when it is sold.

### Respect of the Environment

The guidelines that we support are not designed to limit your fun, but to preserve the beautiful freedom that you can experience only with an off-road vehicle!

These guidelines will keep operators and passengers healthy, happy and able to introduce others to what they know and enjoy about their favorite pastime. So, the next time you hit the trails, we ask you to remember that you are paving the way for the future of our sport. Help us lead it down the right path! From all of us at BRP, thank you for doing your share.

There is nothing more exhilarating than off-road adventures. Venturing onto trails that cross wild areas is an exciting and healthy sport. However, as the number of people using these recreational parks increases, so does the potential for damage to the environment. Abuse of land, facilities and resources inevitably leads to restrictions and closures of both private and public land.

In essence, the greatest threat to our sport, is all around us. Which leaves us with one logical choice. We must always ride responsibly.

The vast majority respect the law and the environment. Each of us must set an example for those who are new to the sport, young and old alike.

It is in every one's best interest to tread lightly into our recreational areas. Because, in the long run, to protect the sport we must preserve the environment.

Recognizing the importance of this issue and the need for off-road riders to do their share in preserving areas that make it possible to enjoy our sport, BRP invite all off-road riders to remember that respecting the environment is not only critical to the future of our industry but to future generations.

You are a good ambassador for your sport when you follow the principles below.

**Become informed.** Obtain maps, regulations and other information from the Off-road clubs, the Forest Service or from other public land agencies. Learn the rules and follow them and that goes for speed limits, too!

**Avoid** running over young trees, shrubs, and grasses and don't cut wood. On flatlands or areas where trail riding is popular, it's important to ride only where authorized. Remember, there is a link between protecting your environment and your own safety.

**Respect wildlife** and be particularly sensitive of animals that are rearing young or suffering from food shortage. Stress can sap scarce energy reserves. Refrain from riding in areas where only animals are intended to tread!

**Obey** gate closures and regulatory signs and remember, light treaders don't litter!

**Stay out** of wilderness areas. They're closed to all vehicles. Know where the boundaries are.

**Obtain permission** to travel across private land. Respect the rights of land-owners and other people's privacy. Remember, the technology has lowered the noise factor considerably, but you still shouldn't rev your engines where quiet "is the order of the day".

Off-road riders know all too well the efforts that have been made throughout the sport's history to enjoy access to areas where people can ride safely and responsibly. This effort continues today, as strong as ever.

Respecting the areas where we ride... wherever they may be... is the principal way to ensure future enjoyment for all.

Take the opportunity to admire nature and all its wonders, is an experience cherished by off-road riders. Respect the nature and wildlife will help our sport to grow!

Finally, you don't have to leave big tracks or careen through a virgin forest to show you can ride. So whether you're driving a high performance BRP off-road vehicle or any other make or model, show you know what you're doing.

# **SAFETY INFORMATION**

---

# BEFORE YOU GO

## WARNING

Disregarding any of the safety precautions and instructions contained in this section could cause injury including the possibility of death.

### Operating Age and Ability

Operators must be qualified.

Make sure the operator is 16 or older. Your state (or province) may have additional requirements.

Laws regarding the minimum age and licensing requirements vary from one jurisdiction to another. Be sure to contact the local authorities for information regarding the legal operation of an off-road vehicle in the intended jurisdiction of use.

BRP highly recommends that you take a safety riding course. Basic training is required for the safe operation of any off-road vehicles.

Operation of this vehicle with a disability that impairs vision, reaction time, judgment, or operation of the controls is not recommended.

The safe use of this vehicle depends on many conditions such as visibility, speed, weather, environment, traffic, vehicle condition and the condition of the operator.

The performance of this vehicle may significantly exceed that of other off-road vehicles you have operated. Therefore, use by novice or inexperienced operators is not recommended.

Each passenger must be tall enough to always be properly seated: back against the backrest with seat belt fastened, holding both handholds, and feet firmly planted on the floor.

### Drugs and Alcohol

Never ride after consuming alcohol or drugs.

Riding this vehicle requires the operator and passenger(s) to be sober, attentive and alert.

The use of drugs and alcohol, singly or in combination, decreases reaction time, impedes judgment, impairs vision, and inhibits your ability to safely ride.

### Protective Gear

It is important that the operator and passenger always wears appropriate protective clothing and apparel, including:

- An approved helmet
- Eye protection
- Boots
- Gloves
- A long sleeved shirt or jacket
- Long pants.

Depending on conditions, anti-fogging goggles may be required.



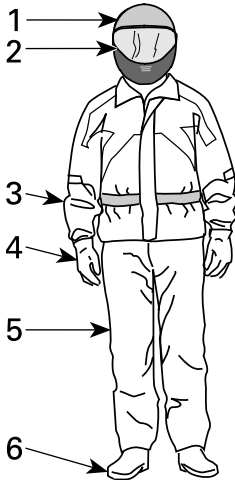

### **RIDING GEAR**

1. *Approved helmet*
2. *Eye and face protection*
3. *Long sleeves shirt or jacket*
4. *Gloves*
5. *Long pants*
6. *Boots (over-the-ankle footwear)*

Weather conditions should help you decide how to dress. To maximize comfort and avoid frostbites in winter, dress for the coldest weather expected. Thermal underwear next to the skin also provides good insulation.

Never wear any loose clothing that may get entangled in the vehicle or on tree branches and shrubs.

### ***Helmets and Eye Protection***

Helmets protect the head and brain from injury. Even with the vehicle's cage and doors, objects can enter the cockpit and strike the head, or the head can strike the cage itself or objects outside the vehicle. Even the best helmet is no guarantee against injury, but statistics indicate that helmet use significantly reduces the risk of brain injury. So, be safe and always wear a helmet while riding.

### **Choosing a Helmet**

Helmets should be manufactured to meet the appropriate standard in your state, province or country and should fit properly.

A helmet with face protection is a better choice as it protects also against frontal impacts. It can also protect against debris, stones, insects, the elements, etc.

An open-face helmet does not offer the same protection for the face and chin. If you wear an open-face helmet, you should use a snap-on face shield and/or a pair of goggles. Ordinary glasses or sunglasses are not sufficient eye protection for riders. They can shatter or fly off, and they allow wind and airborne objects to reach the eyes.

For winter riding conditions, a stocking type cap, balaclava and face mask should always be carried or worn.

Use tinted face shields or goggles in the daytime only; do not use them at night or in poor illumination. Do not use them if they impair your ability to discern color.

### **Other Riding Gear**

#### **Footwear**

Always wear closed toe footwear. Sturdy over-the-ankle boots with non-slip soles offer more protection and allow you to plant your foot properly on footrest.

Avoid long shoelaces that can be tangled in the accelerator or brake pedals.

For winter riding conditions, rubber soled boots with either a nylon or leather uppers, with removable felt liners are best suited.

Avoid rubber boots. Rubber boots may get trapped behind or between pedals, impairing the proper operation of brake and accelerator pedals.

#### **Gloves**

Full-fingered gloves protect hands from the wind, sun, heat, cold and flying objects. Gloves that fit snugly will improve grip on the steering wheel and help reduce hand fatigue. Sturdy, reinforced motorcycle or ATV gloves help protect hands better in the event of an accident or a rollover. If gloves are too bulky, it may be difficult to operate the controls.

For winter riding conditions, hands should be protected by a pair of snowmobile gloves which have sufficient insulation and allow use of thumbs and fingers for operation of controls.

#### **Jackets, Pants and Riding Suits**

Wear a jacket or a long sleeved shirt and long pants, or a full riding suit. Quality ATV-type protective gear will provide comfort, and it can help you avoid being distracted by adverse environmental elements. In case of a crash, good quality protective gear made of sturdy material may prevent or reduce injury.

In cool-weather riding, protect yourself against hypothermia. Hypothermia, a condition of low body temperature, can cause loss of concentration, slowed reactions and loss of smooth, precise muscle movement. In cool conditions, proper protective gear like a windproof jacket and insulated layers of clothing are essential. Even while riding at moderate temperatures, you can feel very cold due to the wind.

Protective gear that is appropriate for cold-weather riding may be too hot when stopped. Dress in layers so that clothing can be removed as desired. Topping the protective gear with a windproof outer layer can prevent cold air from reaching the skin.

#### **Rain Gear**

If you must ride in wet weather, a rain suit or a waterproof riding suit is recommended. On long rides, it is a good idea to carry rain gear. A dry rider will be much more comfortable and alert.

## Hearing Protection

Long-term exposure to wind and engine noise when riding can cause permanent hearing loss. Properly worn hearing protective devices such as earplugs can help prevent hearing loss. Check local laws before using any hearing protective devices.

## Required Equipment

As the owner of an off-road vehicle, you are responsible for ensuring that all required safety equipment is aboard. Check your local regulations about requirements.

This could include:

- First aid kit
- Sling: to help a defective or stuck vehicle
- Tool kit
- Phone in a watertight compartment designed for this application
- Current local map.

For a long ride, you should also include the following:

- Snack
- Flashlight.

---

# GET FAMILIAR WITH THE VEHICLE

This vehicle may exceed the performance of other vehicles you may have ridden. Take time to familiarize yourself with your new vehicle.

Inexperienced operators may overlook risks and be surprised by vehicle's specific behavior and terrain conditions. Ride slowly. Excessive speed and reckless driving can kill.

Make sure you read and understand the content of this operator's guide to become completely familiar with the controls and operation of this vehicle before embarking on your first trip or taking on a passenger(s).

Take time to practice driving solo in a suitable traffic-free area to become accustomed to the feel and response of each control.

It is very important to inform any operator, regardless of his experience, of the handling characteristics of this vehicle. The configuration, such as vehicle height, width, suspension type, tires type, and type vary from a model to another. The vehicle handling is greatly influenced by these characteristics.

## Off-Road Operation

The very nature of off-road operation is dangerous. Any terrain, which has not been specially prepared to carry vehicles, presents an inherent danger where terrain substance, shape and steepness are unpredictable. The terrain itself presents a continual element of danger, which must be knowingly accepted by anyone venturing over it.

An operator who takes a vehicle off-road should always exercise the utmost care in selecting the safest path and keeping close watch on the terrain ahead of him. The vehicle should never be operated by anyone who is not completely familiar with the driving instructions applicable to the vehicle, nor should it be operated on steep or treacherous terrain.

The traction of the tires will vary depending on the surface conditions and the tread pattern.

The traction may be reduced on many surfaces (rock, sand, mud, snow, ice, etc.). Reduce your speed and allow more space to turn.

### **WARNING**

**Never stand behind or near a rotating tire. Debris could be projected causing severe injuries.**

## Steering

The front wheels are steered by the steering wheel.

Steering behavior will vary depending of the grip of the tires on the ground.

The Dynamic Power Steering (DPS) to reduce the effort to turn the steering wheel.

Riding with passenger(s) or when carrying loads will affect the steering control and vehicle handling. Pay attention and reduce the speed.

## Braking

Braking performances may vary suddenly under certain conditions.

Always remember that the vehicle braking distance may be affected when riding with passenger(s) and when loaded with cargo at the rear.

Never jam the brakes. Be sure to use restraint in braking to keep from blocking the wheels in order to avoid surprises that could lead to a loss of control.

## Programmable D.E.S.S. Key

The D.E.S.S. key can be programmed to limit the speed of the vehicle and the engine torque.

Enabling first time users and less experienced operators to learn how to operate while gaining the necessary confidence and control.

## Vehicle Blind Spots

A blind spot is an area outside the driver's field of vision that cannot be seen in the rear-view mirror or, through the front and side openings.

In general, the taller and longer the vehicle is, the bigger the blind spots are.

For this reason, it is important to familiarize yourself with the blind spots of the vehicle created by its design, especially if it is a new vehicle.

The blind spots are all around the vehicles. The blind spots are located in front, at the rear and on the sides of the vehicle.

Be mindful about persons around the vehicle, other vehicles or nearby objects when operating the vehicle in reverse.

Pay attention to the vehicle blind spots when climbing or backing off from the platform, trailer or flat bed.

**IMPORTANT:** Even if a vehicle is equipped with mirrors (interior or exterior) or cameras (front or rear), there will always be remaining blind spots all around the vehicle.

## Driver's Visibility Areas

The following images illustrate the approximate driver's visibility areas when he is well seated and his seat belt properly fasten.

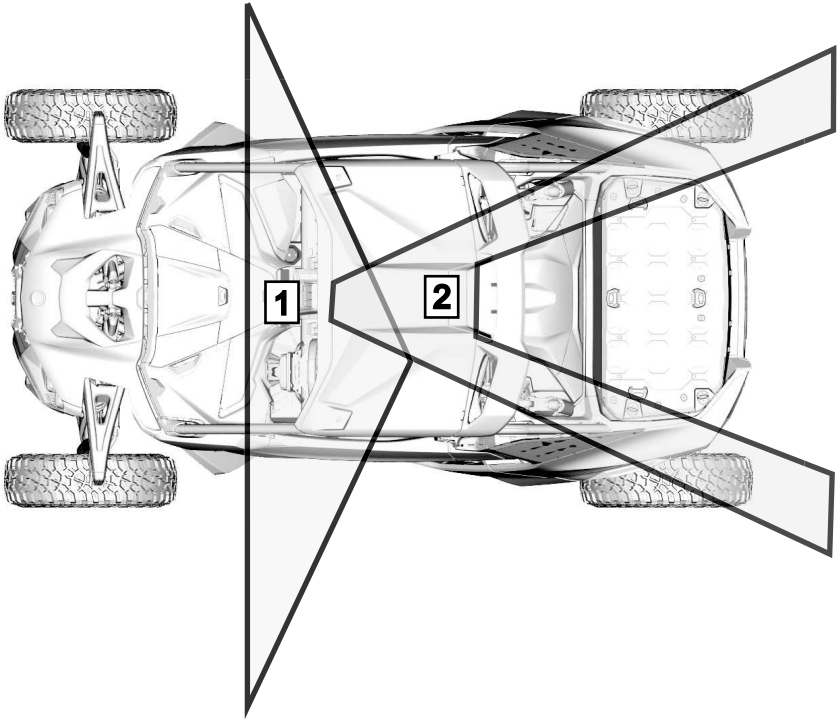

1. *Approximate driver's field of vision*
2. *Approximate rear-view mirror field of vision*

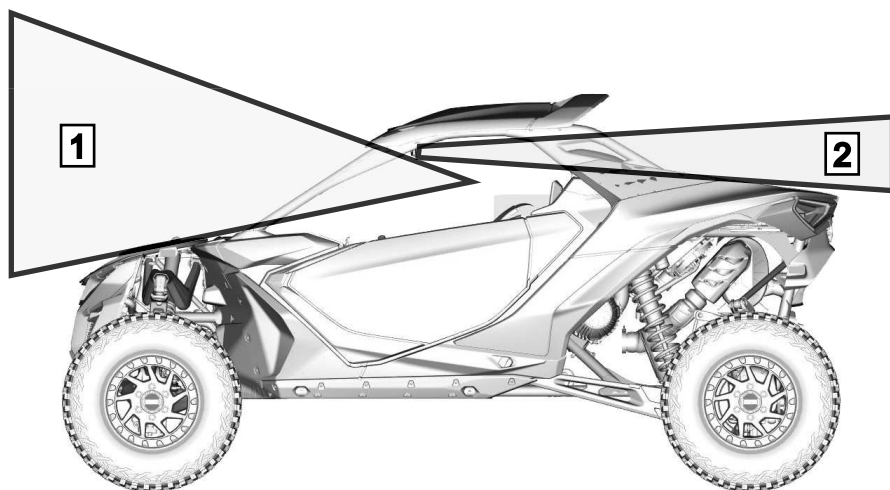

1. Approximate driver's field of vision
2. Approximate rear-view mirror field of vision

## Rear View Camera

This vehicle is equipped with a rear view camera positioned under of the rear cargo rack.

This camera is in operation when the engine is running and the select lever is set to REVERSE.

**IMPORTANT:** After moving the shifter in the D position, the rear camera will remain activated until the vehicle is going forward up to approximately 20 km/h (12 MPH).

The camera can also be accessed by the touchscreen display when the vehicle is not in Reverse or engine not running. See *10.25" COLOR TOUCHSCREEN DISPLAY* for instruction on how to access.

The rear view behind the vehicle is then displayed in the large display.

The rear view camera uses a wide-angle lens, the distances and objects shown in the display are different from the real size.

Rear view camera visibility is limited, always make sure that the immediate surrounding of the vehicle is clear before backing up slowly. Reducing the volume of the radio or music is also recommended before backing up.

Moving in reverse by checking only the rear view camera image from the display could cause an accident.

In case of doubt, ask someone to help you during the maneuver.

## Rear View Camera Visibility Areas

The following images illustrate the approximate rear view camera visibility areas.

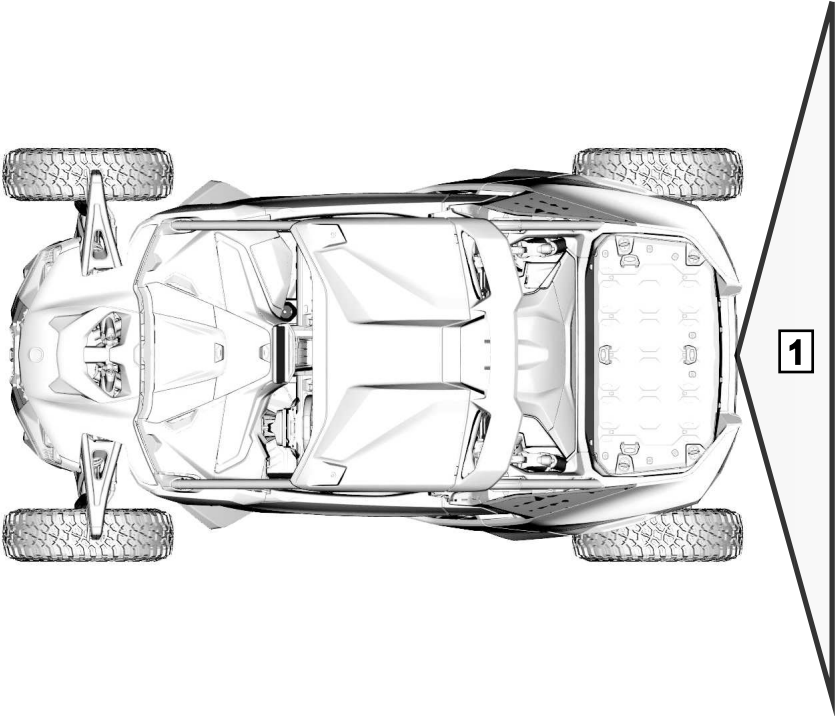

1. Approximate rear camera cone of vision

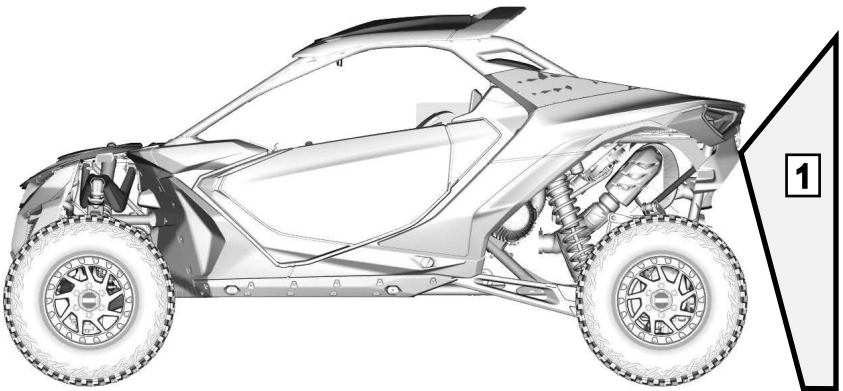

1. Approximate rear camera cone of vision



## Front View Camera

The X rs models are equipped with a front view camera positioned in the top of the front fascia.

This camera is activated by selecting the APP menu icon in the bottom-right corner of the display then the applet *CAMERA*.

The front view in front of the vehicle is then displayed in the large display.

The front view camera uses a wide-angle lens, the distances and objects shown in the display are different from the real size.

Front view camera visibility is limited, always make sure that the immediate surrounding of the vehicle is clear before driving forwards slowly.

Driving forwards by checking only the front view camera image from the display could cause an accident.

In case of doubt, ask someone to help you during the maneuver.

## Carrying Loads

### WARNING

**Failure to follow these recommendations when carrying loads could lead to a loss of control and possibly in a tip over.**

### WARNING

**Never carry gasoline container(s) or any dangerous liquids on the cargo rack.**

Any load carried on the vehicle will affect the handling, stability and braking distance of the vehicle. Appropriate loading and weight distribution are therefore important.

Do not exceed the load limits of the vehicle, including the weight of operator, passenger, cargo and accessories.

Always be aware that the cargo may slide or fall off and cause an accident.

When carrying loads it is very important to follow the recommendations:

- Never exceed the maximum cargo capacity. Refer to *Important On-Product Labels* or *Technical Specifications* for the applicable cargo load capacity of the vehicle.
- When carrying heavy loads on the cargo rack operate the vehicle in low range.
- When carrying a passenger or heavy loads readjust suspension accordingly
- Always reduce your speed, turn gradually and allow longer braking distance when carrying loads.

Load cargo as low as possible – a higher load can raise the vehicle's center of gravity, which can reduce stability. Position cargo on the rack as evenly distributed as possible.

Secure the load on the cargo rack. Do not secure cargo to the cage or other part of the vehicle. If it is not properly secured, a load may slide or fall off, possibly striking occupants or bystanders; or it may shift during riding, affecting the handling of the vehicle.

Objects that are high may affect visibility for the driver and may act as projectiles in case of an accident. Loads that protrude sideways can get snagged or caught in bush, branches or other obstacles.

Avoid covering and obstructing the brake lights with the cargo.

Ensure cargo stays far away from the exhaust outlet.

Ensure no cargo protrudes outside the cargo rack and that cargo will not interfere with your visibility or control of the vehicle.

## Hauling a Load

Never pull a load by attaching it to the cage or any other accessories; this can cause the vehicle to tip over.

Use only the winch (if installed) to pull the vehicle or a load.

In an emergency situation, use the recovery hook to recover a stuck vehicle.

### NOTICE

**Never use the front recovery hook or the rear recovery point to pull a load. These points must be used to pull a stuck vehicle.**

When pulling loads with a chain or cable, ensure that there is no slack before starting and maintain tension while pulling. Brake progressively, the inertia of the load could lead to an impact.

### WARNING

**A slack in the chain or cable can cause it to break and snap back.**

When pulling another vehicle, be sure that someone is controlling the pulled vehicle. They must brake and steer to prevent the vehicle from going out of control.

Before pulling loads with a winch, refer to the winch manufacturer's instructions.

Reduce your speed when hauling a load and turn gradually. Avoid hills and rough terrain. Never attempt steep hills. Allow more distance for braking, especially on inclined surfaces and when a passenger is on board. Be careful not to skid or slide.

## Accessories and Modifications

Any modifications or addition of accessories approved by BRP may affect the handling of your vehicle. It is important to take the time to get familiar with the vehicle once modifications are made to understand how to adapt your driving behavior accordingly.

Avoid installing equipment not specifically approved by BRP for the vehicle and avoid unauthorized modifications. These modifications and equipment have not been tested by BRP and may create hazards. For example, they could:

- Create a loss of control and increase risk of crash
- Cause overheating or short circuits increasing the risk of fire or burn injuries
- Affect the protection features provided by the vehicle
- Affect the behavior of the trailer when the vehicle is transported
- Cause a risk of losing objects on the road when transported.

Your vehicle may also become illegal to ride.

Ask your authorized BRP dealer for suitable available accessories for your vehicle.

---

# RIDE SAFELY

This vehicle handles differently from other vehicles. A collision or rollover can occur quickly, during abrupt maneuvers such as doing sharp turns, acceleration or deceleration and driving on hills or over obstacles, if you fail to take proper precautions.

Never operate at excessive speeds. Always go at a speed that is proper for the terrain, visibility, and operating conditions, and your experience.

Never attempt jumps, side slides, donuts or any other stunts.

Never attempt rapid acceleration or deceleration when performing a sharp turn. This may result in a roll over.

Never attempt skidding or sliding. If vehicle starts to skid or slide, counter steer in the direction of skidding or sliding. On extremely slippery surfaces, such as ice, go slowly and be very cautious in order to reduce the chance of skidding out of control.

Always be sure there are no obstacles or people behind the vehicle when you operate in reverse. Pay attention to blind spots. When it is safe to proceed in reverse, go slowly.

Never exceed the stated load limits for this vehicle.

Always remember that this vehicle is heavy! Its pure weight alone may entrap you should it tip or rollover.

## General Driving Tips

Care, caution, experience and driving skill are the best precautions against the hazards of vehicle operation.

Whenever there is the slightest doubt that the vehicle can safely negotiate an obstacle or a particular piece of terrain, always choose an alternate route.

In off-road operation, power and traction, not speed, are important. Never drive faster than visibility and your own ability to select a safe route permit. Always go slowly and be extra careful when operating on unfamiliar terrain. Always be alert to changing terrain conditions when operating this vehicle. Be especially cautious on excessively rough, slippery, icy or loose terrain.

Constantly watch the terrain ahead for sudden changes in slopes or obstacles, such as rocks or stumps, that may cause loss of stability, resulting in tip over or rollover.

Never operate the vehicle if the controls do not function normally. See an authorized Can-Am Off-road dealer.

To maintain proper control it is strongly advised that you keep your hands on the steering wheel and within easy reach of all controls. The same holds true for your feet. To minimize the possibility of any leg or foot injury, keep your left foot on the footrest and right foot on the floor at all times. Staying completely within the cockpit will also help keep you from striking objects outside the vehicle.

Watch for and avoid branches and other objects that could enter the passenger compartment and strike you or your passengers.

## Riding in a Group

Before starting out, designate a “trail boss” to lead the group and another person to follow-up at the end of the group. Ensure that all members of the group are aware of the proposed route and destination.

When riding with others, limit your abilities to the experience of others.

Never overtake the trail boss or, for that matter, any other vehicles.

It's important to keep a safe distance between each vehicle but each one behind the leader should know the position of the machine ahead.

## Operating in Reverse

### WARNING

Steering inputs in reverse operation increase the risk of rollover.

### WARNING

When driving downhill in reverse, gravity can increase the vehicle speed above safe reverse speed.

Always make sure that the rear immediate surrounding of the vehicle is clear to ensure no one is behind before backing up slowly. Reducing the volume of the radio or music is also recommended before backing up. Pay attention to blind spots.

When it is safe to proceed in reverse, go slowly and avoid sharp turns.

In reverse operation, the engine RPM is limited thus limiting the vehicle reverse speed.

When using the override button in reverse, in case it is needed to get unstuck, the speed and the torque limitation are increased.

## Crossing Roads

If you have to cross a road, ensure to have complete visibility on both sides for incoming traffic and decide on exit point on other side of road. Drive in a straight line toward that point. Do not make sharp direction changes or abrupt accelerations as it may result in a rollover situation. Do not travel on sidewalks or bicycle trails as they are designated specifically for those uses.

## Riding on Paved Surfaces

Avoid paved surfaces. This vehicle is more likely to roll over on pavement because of the increase tire grip.

If you must drive on pavement, turn gradually, go slowly, and avoid abrupt acceleration and braking.

## Shallow Water Crossing

Water can be a unique hazard. If it is too deep the vehicle may “float” and topple. Check the water depth and current before you attempt to cross any water. Water depth should not exceed the center of the wheel for vehicle to safely cross the obstacle. Beware of slippery surfaces such as rocks, grass, logs, etc., both in the water and on its banks. A loss of traction may occur. Do not attempt to enter the water at high speed.

Water will affect the braking ability of your vehicle. Make sure you dry the brakes by applying them several times after the vehicle leaves the water.

Mud or marsh lands may be encountered near water. Be prepared for sudden “holes” or changes in depth. Similarly so, be watchful of hazards such as rocks, logs, etc., partially covered by vegetation.

## Riding on Snow or Ice

When performing pre-ride inspection, pay special attention to locations on the vehicle where snow and/or ice accumulations may obstruct visibility of the tail lamp, clog ventilation openings, block the radiator, fan, engine air intake, and interfere with the movement of controls.

Before starting with your vehicle, check the steering, accelerator and brake pedal for interference free operation.

Whenever this vehicle is ridden on a snow covered drive path, the tire grip is generally reduced causing the vehicle to react differently to control inputs from the operator. On low grip surfaces, the steering responses is not as crisp and precise, stopping distances are lengthened and acceleration is also affected. Slow down and be gentle with accelerator input. Too much accelerator input will only result in spinning of the tires and possibly in an over steering slide of the vehicle. Avoid hard braking. This will possibly result in a straight line slide of the vehicle caused by locked wheels. Again, the best advice is to safely reduce speed in anticipation of maneuvers to give yourself time and distance in order to keep control of the vehicle.

As you drive your vehicle over a loose snow covered surface, snow dust will be picked up in the wake turbulence of the moving vehicle and transported to contact and accumulate or melt on some exposed components including rotating parts like brake discs. Water, snow or ice may affect the response time of the brake system of your vehicle. Even when not required to reduce vehicle speed apply brakes frequently to prevent ice or snow accumulation and to dry brake pads and discs. While doing so in low risk driving situations you will test for grip level and keep yourself alerted to how the vehicle reacts to your control inputs. Always keep brake and accelerator pedals and floor boards free of snow and ice. Frequently wipe snow off seat, steering wheel, headlights and tail lamps.

The depth of the snow cover may hide rocks, tree stumps or other objects and if it is wet may totally impede the drivability as the vehicle becomes bogged down or completely loses traction in slushy snow. Look far ahead and always be watchful of any visible clues that might indicate the presence of such obstacles. In doubt steer clear. Avoid driving on any frozen waterways before checking that the ice will safely support the vehicle, its riders and its load of cargo.

At the end of each ride it is a good practice to clean the vehicle and all moving components (brakes, steering components, drivelines, controls, radiator fan etc.) from any snow or ice accumulations. Wet snow will turn to ice during the shut down period and become more difficult to remove at the next pre-ride inspection.

## **Riding on Sand**

Sand and riding on sand dunes is another unique experience but there are some basic precautions that should be observed. Wet, deep or fine sand may create a loss of traction and cause the vehicle to slide, drop off or become “bogged” down. If this occurs look for a firmer base. Again, the best advice is to slow down and be watchful of the conditions.

When riding in sand dunes it is advisable to equip the vehicle with an antenna type safety flag. This will help make your location more visible to others over the next sand dune. Proceed carefully should you see another safety flag ahead.

## **Riding on Gravel, Loose Stones or Other Slippery Surfaces**

Riding on loose stones or gravel is very similar to riding on ice. They will affect the steering of vehicle, possibly causing it to slide and tip over especially at high speeds.

In addition, braking distance may be affected.

Remember that rapid accelerations or sliding may cause loose stones to be ejected rearwards into the path of another rider's way. Never do it deliberately.

During a slide or a skid, counter steer may help to regain the control. Never jam the brakes and lock the wheels.

## **Crossing Obstacles**

It is a good practice to use the low range (L) when crossing obstacles.

Obstacles on the “trail” should be traversed with caution. This includes rocks, fallen trees, and depressions. You should avoid them whenever possible. Remember that some obstacles are too large or dangerous to cross and should be avoided. As a guideline, never attempt to cross an obstacle higher than the ground clearance of the vehicle. Small rocks or small fallen trees may be safely crossed - approach obstacle at low speed and as much as possible at a right angle. Adjust speed without losing momentum and do not accelerate abruptly. Passenger must grasp both handholds firmly and brace feet on the floor. Hold steering firmly without closing your fists around it and proceed. Be aware that the obstacle may be slippery or may move while crossing.

## **Hill Driving Conditions**

When driving on hills or slopes, two things are highly important: be prepared for slippery surfaces or terrain variations and obstacles and brace yourself properly inside vehicle.

If you climb or descend a hill that is too slippery or has too loose a surface, you can lose control.

If you go over the top of a hill at high speed, you may not have time to prepare for the terrain on the other side.

Avoid parking on a slope.

Always put the vehicle in PARK when stopped or parked, especially on an incline, to avoid rolling. If you must park on a steep incline, block the wheels using rocks or bricks.

### ***Uphill Driving***

It is a good practice to use the low range (L) for uphill driving.

Due to its configuration, this vehicle has very good traction even while climbing, so much so that tip over is possible before traction is lost. For example, it is common to encounter terrain situations where the top of the hill has eroded to a point that the hill peak rises very sharply. This vehicle is not designed to negotiate such a condition. Take an alternate route.

It is also wise to know the terrain condition on the other side of the hill or bank. All too often there exists a sharp drop-off that is impossible to negotiate or descend.

If you feel that the slope is getting too steep to climb, apply brakes to immobilize vehicle. Put the transmission in reverse (R), and back down the hill, barely releasing brakes to remain at low speed. Do not attempt to turn around. Never coast down hill while vehicle is in neutral. Do not perform hard braking as it increases the risk of tipover.

### ***Downhill Driving***

This vehicle can climb steeper slopes than it can descend safely. Therefore, it is essential to assure that a safe route exists to descend a slope before you climb it.

Decelerating while negotiating a slippery downhill slope could lock the wheels causing the vehicle to slide. Maintain steady speed and/or accelerate slightly to regain control. Never slam brakes and lock the wheels.

### ***Side Hilling***

Whenever possible, side hilling (driving across a slope rather than up or down it) should be avoided. If necessary, do so with extreme caution. Side hilling on steep inclines could result in rollover. In addition, slippery or unfirm surfaces could result in uncontrollable side sliding. Avoid all objects or depressions that will intensify the raising of one side of the vehicle higher than the other, thus causing rollover. If you feel the vehicle start to rollover or slide sideways, steer downhill if possible.

#### **WARNING**

**Be careful when loading and transporting liquid reservoirs. They can affect vehicle stability when side hilling by pulling downhill and increasing the risk of a rollover.**



## **Drop-Offs**

This vehicle is not designed to negotiate excessive drop-offs.

It will “bottom-out” and usually stop if either the front or rear wheels are driven over a drop-off.

If the drop is sharp or deep, the vehicle will nose dive and tip over.

Avoid negotiating excessive drop-offs.

Reverse and select an alternate route.

## **Recreational, Group and Distance Riding**

Respect the rights and limitations of others. Stay away from areas designated for other types of off road use. This includes snowmobile trails, equestrian trails, cross country ski trails, mountain bike trails, etc. Never assume there are no other users on the trail. Always stay to the right of the trail and do not zig zag to one side of the trail then the other. Be prepared to stop or pull off to the side if another trail user appears in front of you.

Join a local side-by-side vehicle club. It will provide you with a map and advice or inform you where you can ride. If a club does not exist in your area, help to start one. Group riding and club activities provide a pleasurable, social experience. Never use with drugs or alcohol, or tired or ill.

Always keep a safe distance from other riders. Your judgment of speed, terrain conditions, weather, mechanical condition of your vehicle and the “trust in judgment” you have in others around you will help you make a better choice of appropriate safe distance. This vehicle, like any other motorized vehicle, cannot stop “on a dime”.

Before you ride, tell someone where you are planning to travel and your expected time of return.

Depending on the length of your ride, carry additional tools or emergency equipment. Find out where you can get additional gasoline. Be prepared for the possible conditions you may encounter. An emergency first aid kit should always be a consideration.

## **Environment**

One of the benefits of this vehicle is that it can take you off the beaten path away from most communities. However, you should always respect nature and the rights of others to enjoy it. Do not ride in environmentally sensitive areas. Do not drive over forest crops or shrubs, nor cut down trees or take down fencing, nor spin your wheels and destroy the terrain. “Tread Lightly”.

This vehicle can cause OHV wildfires if debris builds up near the exhaust or other engine hot spots and ignites then falls off into dry grass. Avoid riding in wet areas, through muskeg or tall grass, where debris can build up. Should you ride in those areas, inspect and remove all debris from your engine and hot spots. Refer to *Vehicle Care* for details.

Chasing wildlife is in many areas illegal. Wildlife can die of exhaustion after being chased by a motorized vehicle. If you encounter animals on the trail, stop and observe quietly and with caution. It will be one of the better memories of your life.

Observe the rule “what you take in, carry out”. Do not litter. Do not start campfires unless you have permission to do so, and then only away from dry areas. The hazards you may create on the trail may cause injury to others or yourself, even at a later date.

Respect farm lands. Always obtain the permission of the landowner before riding on private land. Respect crops, farm animals and property lines.

Finally, do not pollute streams, lakes or rivers and do not modify the engine or exhaust system, or remove any of its components as it will alter the vehicle emissions.

## **Avoid Collisions**

This vehicle can reach high speeds. At higher speeds, there is an increased risk of losing control, particularly in challenging off-road conditions, and the risk of injury in a collision is greater. Never operate at excessive speeds. Always go at a speed that is proper for the terrain, visibility, and operating conditions, and your experience. Consider reserving use of the performance key for situations in which full speed and acceleration capability are appropriate.

Driving on public street, road or highway, even dirt or gravel ones poses risks such as collisions and may be illegal in your jurisdiction. Only proceed with caution on roads and road segments where the usage of your vehicle is permitted. This vehicle is not designed for operation on roads. For example, it does not meet motor vehicle safety standards that apply to automobiles. In many jurisdictions it is not legal to operate this vehicle on public roads.

This vehicle does not have the same kind of protection for collisions as a car; for example, there are no air bags, the cockpit is not fully enclosed, and it is not designed for collisions with other vehicles. Therefore, it is particularly important to fasten seat belts and close doors and wear an approved helmet.

## **Avoid Rollovers and Tipovers**

Side-by-side vehicles handle differently from other vehicles. Side-by-side vehicles are designed to handle off-road terrain (for example, their wheel base and track width, ground clearance, suspension, drivetrain, tires, etc.), and, as a result, can overturn in situations where vehicles designed for use primarily on paved or smooth terrain may not.

A rollover or other accident can occur quickly during abrupt maneuvers such as sharp turns or hard acceleration or deceleration when turning, or when driving on hills or over obstacles. Abrupt maneuvers or aggressive driving can cause rollovers or loss of control even in flat open areas. If the vehicle rolls over, any part of your body (such as arms, legs, or head) outside of the cockpit can be crushed and trapped by the cage or other parts of the vehicle. You can also be injured by impact with the ground, cockpit or other objects.

To reduce the risk of rollovers:

- Use care when turning.

- Do not turn the steering wheel too far or too fast for your speed and environment. Adjust steering inputs according to your speed and environment.
- Slow down before entering a turn. Avoid hard braking during a turn.
- Avoid sudden or hard acceleration when turning, even from a stop or low speed.
- Never attempt donuts, skids, slides, fishtails, jumps, or other stunts. If vehicle starts to skid or slide, counter steer may help to regain the control. Never jam the brakes and lock the wheels.
- Avoid paved surfaces. This vehicle is not designed to operate on paved surfaces and is more likely to roll over. If you must drive on pavement, turn gradually, go slowly, and avoid abrupt acceleration and braking.

This vehicle can roll over sideways or tip over forward or backwards on slopes or uneven terrain.

- Avoid side hilling (driving along the slope rather than up or down a hill). When possible, drive straight up and down inclines rather than across them. If you must side hill, use extreme caution and avoid slippery surfaces, objects, or depressions. If you feel the vehicle start to rollover or slide sideways, steer downhill if possible.
- Avoid steep hills and follow procedures in this guide for climbing and descending hills.
- Sudden changes in terrain such as holes, depressions, banks, softer or harder ground or other irregularities may cause the vehicle to tip or become unstable. Observe the terrain ahead and slow down in areas of uneven terrain.

This vehicle will handle differently when carrying or pulling a load.

- Reduce speed and follow instructions in this manual for carrying cargo.
- Avoid hills and rough terrain.
- Allow more distance to stop.

### **Be Prepared in Case of Rollover**

- Close both doors and fasten seat belt to help you avoid sticking out arms or legs.
- Never grab the cage while riding. Hands can be crushed between the cage and the ground in a rollover. Keep hands on the steering wheel or handholds.
- Never try to stop a rollover using your arms or legs. If you think that the vehicle may tip or roll, the driver should keep both hands on the steering wheel and the left foot firmly planted on the footrest. The passenger should keep both hands on the handholds and both feet firmly planted on the floor.

### **Terrain Condition**

- Driving on public roads poses risks such as collisions and may be illegal in your jurisdiction. Only proceed with caution on roads and road segments where the usage of your vehicle is permitted.
- Avoid paved surfaces. This vehicle is more likely to roll over on pavement because of the increase tire grip. If you must shortly use the vehicle on such surfaces, avoid abrupt inputs to steering wheel, accelerator and brake pedal.
- Always go slowly and be extra careful when operating on unfamiliar terrain. Always be alert to changing terrain conditions when operating this vehicle. Take the time to learn how the vehicle performs in different environments.

- Never operate on excessively rough, slippery or loose terrain until you have learned and practiced the skills necessary to control this vehicle on such terrain. Always be especially cautious on these kinds of terrain.
- Never operate this vehicle on hills too steep for the vehicle or your abilities. Practice on small inclines.
- Always follow proper procedures for climbing or going down hills as described in *Riding Your Vehicle*. Check the terrain carefully before you start up or down any hill. Never climb or descend hills with excessively slippery or loose surfaces. Never go over the top of any hill at high speed.
- Always check for obstacles before operating in a new area. Always follow proper procedures when operating over obstacles as described in *Riding Your Vehicle*.
- Never operate this vehicle in fast flowing water or in water deeper than specified in *Riding Your Vehicle*. Remember that wet brakes may have reduced stopping ability. Test your brakes after leaving water. If necessary, apply them several times to let friction dry out the brakes.
- Always ensure to properly park the vehicle on the flattest terrain section available. Put vehicle in PARK, stop engine and remove key before leaving the vehicle.
- Never assume that the vehicle will go everywhere safely. Sudden changes in terrain caused by holes, depressions, banks, softer or harder "ground" or other irregularities may cause the vehicle to topple or become unstable. To avoid this, slow down and always observe the terrain ahead. If the vehicle does begin to topple or rollover, the best advice is to immediately steer in the direction of the rollover! Never attempt to prevent a rollover with your arms or legs. You should keep your limbs inside the cage.

## **Avoid Carbon Monoxide Poisoning**

All engine exhaust contains carbon monoxide, a deadly gas. Breathing carbon monoxide can cause headaches, dizziness, drowsiness, nausea, confusion and eventually death.

Carbon monoxide is a colorless, odorless, tasteless gas that may be present even if you do not see or smell any engine exhaust. Deadly levels of carbon monoxide can collect rapidly, and you can quickly be overcome and unable to save yourself. Also, deadly levels of carbon monoxide can linger for hours or days in enclosed or poorly ventilated areas. If you experience any symptoms of carbon monoxide poisoning, leave the area immediately, get fresh air and seek medical treatment.

To prevent serious injury or death from carbon monoxide:

- Never run the vehicle in poorly ventilated or partially enclosed areas such as garages, carports or barns. Even if you try to ventilate engine exhaust with fans or open windows and doors, carbon monoxide can rapidly reach dangerous levels.
- Never run the vehicle outdoors where engine exhaust can be drawn into a building through openings such as windows and doors.

## Avoid Gasoline Fires and Other Hazards

Gasoline is extremely flammable and highly explosive. Fuel vapors can spread and be ignited by a spark or flame many feet away from the engine. To reduce the risk of fire or explosion, follow these instructions:

- Use only an approved gasoline container to store fuel.
- Never fill the gasoline container on the vehicle - an electrical static discharge may ignite the fuel.
- Never carry gasoline container(s) or any dangerous liquids on the cargo rack.
- Strictly adhere to instructions in *Vehicle Fueling Procedure*.
- Never start or operate the engine if the fuel cap is not properly installed.

Gasoline is poisonous and can cause injury or death.

- Never siphon gasoline by mouth.
- If you swallow gasoline, get any in your eye(s), or inhale gasoline vapor, see a doctor immediately.

If gasoline spills on you, wash with soap and water and change your clothes.

## Avoid Burns from Hot Parts

Certain components like brake rotors and exhaust components become hot during operation. Avoid contact with those parts during and shortly after operation to avoid burn wounds.

---

# PRACTICE EXERCISES

Before you go out for a ride, it is very important to familiarize yourself with the handling of your vehicle by practicing in a controlled environment. If possible, it is also a very good idea to take a more formal training course to sharpen your skills and increase your knowledge of the vehicle.

Find a suitable area to practice and perform the following exercises. It should be at least 45 m (150 ft) by 45 m (150 ft) free of obstacles like trees and rocks. Once you've selected a suitable permitted location, proceed with the following exercises.

## Turning Exercises

Turning is one of the most frequent causes of accidents. It is easier for the vehicle to lose traction or rollover if you turn too sharply, or go too fast. Slow down when you approach a turn.

- First learn how to perform slight right turns at very low speeds. Release the throttle before turning and slowly reapply the throttle when turning.
- Repeat turning exercise but this time maintain the throttle at the level while turning.
- Finally, repeat turning exercise while accelerating slowly.
- Practice exercises turning on the other side.

Note how your vehicle reacts in these different exercises. We recommend releasing the throttle before entering a turn to help initiate directional change. You will feel the lateral force increasing with the speed and with your steering input. The lateral force should be maintained as low as possible to make sure it does not cause the vehicle to roll over.

## U Turn Exercises

Practice doing U turns.

- Accelerate slowly and while remaining at low speed, then gradually turn the steering wheel to the right until you have completed the U turn.
- Repeat U turn exercise with different steering inputs and always at a very low speed.
- Repeat U turn exercise on the other side.

As mentioned before in this guide, avoid paved surfaces. This vehicle is more likely to roll over on pavement because of the increase tire grip. If you must shortly use the vehicle on such surfaces, avoid abrupt inputs to steering wheel, accelerator and brake pedal.

## Braking Exercises

Practice braking to get familiar with the brake response.

- Do it at low speed first, then increase the speed.
- Practice braking in straight line at different speeds and different braking force.
- Practice emergency braking; optimal braking is obtained in straight line, with high force applied, without locking the wheels.

Remember, braking distance depends on vehicle speed, load and the type of surface. Also, the tires and brakes conditions play a major role.

## Reverse Exercises

The next step involves using the reverse.

- Install 1 cone marker on both sides of the vehicle beside each rear wheel. Move the vehicle forward until you can see the cone markers, then stop the vehicle. Acknowledge the distance required to see obstacles behind you.
- Learn how the vehicle handles itself in reverse and reacts with steering inputs.
- Always perform this reverse exercise at slow speeds.
- Become familiar with the usage of the override function. Do not steer while using the override as it increases the risks of rollover.

## Emergency Engine Stopping Exercise

Learn how to stop your engine quickly in an emergency situation.

- While running at low speed, simply remove the RF D.E.S.S. key from the D.E. S.S. post.
- The vehicle transmission will automatically put in NEUTRAL.
- Stop the vehicle and put the transmission on PARK

This is to familiarize you with the vehicle's reaction when the engine is turned off while driving and to develop this reflex.

# IMPORTANT ON-PRODUCT LABELS (CANADA/ UNITED STATES)

## Hang Tag

This vehicle comes with a hang tag and labels containing important safety information.

### **WARNING**

**THIS VEHICLE IS INTENDED FOR RECREATIONAL USE AND SECONDARY GENERAL UTILITY APPLICATIONS  
NO OPERATOR UNDER AGE 16**

**TRAINING COURSES TO TEACH ROV DRIVING ARE AVAILABLE. FOR INFORMATION CONTACT YOUR DEALER.**

**Read the Operator's Guide and Safety Labels and Watch the Safety Video.**

**Follow All Instructions and Warnings.**

**CHECK WITH YOUR DEALER TO FIND OUT ABOUT STATE OR LOCAL LAWS REGARDING ROV OPERATION.**

Improper Use of Off-Highway Vehicles Can Cause Severe Injury or Death

Be Prepared

- Fasten seat belts and make sure nets or doors are securely latched in place.
- Wear an approved helmet and protective gear.
- Each rider must be able to sit with back against seat, foot flat on the floor or on footrest, and hands on steering wheel or handholds. Stay completely inside the vehicle.

Drive Responsibly

- Avoid loss of control and rollovers:
  - Avoid abrupt maneuvers, sideways sliding, skidding or fishtailing, and never do donuts.
  - Avoid hard acceleration when turning, even from a stop.
  - Slow down before entering a turn.
- Plan for hills, rough terrain, ruts, and other changes in traction and terrain. Avoid paved surfaces.
- Avoid side hilling (riding across slopes).

Rollovers have caused severe injuries and death, even on flat, open areas.

Be Sure Riders Pay Attention and Plan Ahead if you think or feel the vehicle may tip or roll, reduce your risk of injury:

- Keep a firm grip on the steering wheel or handholds and brace yourself.
- Do not put any part of your body outside of the vehicle for any reason.

Require Proper Use of Your Vehicle

- Do your part to prevent injuries:
  - Do not allow careless or reckless driving.
  - Make sure operators are 16 or older with a valid driver's license.
  - Do not let people drive or ride after using alcohol or drugs.
  - Do not allow operation on public roads (unless designated for off-highway vehicle access) – collisions with cars and trucks can occur.
  - Do not exceed seating capacity; see information on back side of this card



Any person who rides this vehicle should read and understand this information before riding.

## Tilt Table Test Result

BOMBARDIER RECREATIONAL PRODUCTS INC.  
VEHICLE MODEL  
TILT TABLE RESULT

Measurement of lateral stability, in degrees, of a sample, standard condition vehicle (with an operator and a passenger load - 430 pounds) as measured by the manufacturer in accordance with the tilt table lateral stability test in the ANSI/ROHVA standard for Recreational Off-Highway Vehicles. Vehicle modification, accessories, and loading can affect lateral stability.

Training courses to teach ROV driving are available. For information contact your dealer and/or rohva.org.

Check with your dealer to find out about state or local laws regarding ROV operation.

THIS HANG TAG IS NOT TO BE REMOVED BEFORE SALE.

VEHICLE MODEL NAME:

ENGINE DESCRIPTION:

**EPA CERTIFIED**

NER (NORMALIZED EMISSION RATE) =

ON 0 TO 10 SCALE, 0 BEING THE CLEANEST.

BOMBARDIER RECREATIONAL PRODUCTS INC  
"NO TO BE REMOVED PRIOR SALE."



Vehicle seating capacity:

Occupants

**THIS HANG TAG CAN'T BE REMOVED BEFORE SALE.**



## High Performance Hang Tag



# WARNING

**GET FAMILIAR WITH THIS OFF-HIGHWAY VEHICLE (OHV); IT MAY EXCEED THE PERFORMANCE OF OTHER OHV YOU MAY HAVE RIDDEN.**

---

**THIS IS A HIGH PERFORMANCE OHV. INEXPERIENCED RIDERS MAY OVERLOOK RISKS AND BE SURPRISED BY THE SPECIFIC BEHAVIOR OF THIS OHV IN ANY TERRAIN CONDITION.**



704906437

**THIS HANGTAG CAN'T BE REMOVED BEFORE SALE.**

## **Safety Labels**

Read and understand all the safety labels on your vehicle.

These labels are affixed to the vehicle for the safety of the operator, passenger or bystanders.

The safety labels on your vehicle should be considered permanent parts of the vehicle.

If missing or damaged, they can be replaced free of charge. See an authorized Can-Am Off-Road dealer.

**IMPORTANT:** In the event of any discrepancy between this guide and the vehicle, the safety labels on the vehicle have precedence over the labels in this guide.

## Operator – Warning Label

**▲ WARNING**

**Improper Use of Off-Highway Vehicles Can Cause Severe Injury or Death**

**Be Prepared**

- Fasten seat belts and close doors.
- Wear an approved helmet and protective gear.
- Each rider must be able to sit with back against seat, feet flat on the floor or on footrest, and hands on steering wheel or handgrips. Stay completely inside the vehicle.

**Drive Responsibly**

Avoid loss of control and rollovers:

- Avoid abrupt maneuvers, sideways sliding, studding or fishtailing, and never do donuts.
- Slow down before entering a turn.
- Avoid hard acceleration when turning, even from a stop.
- Plan for hills, rough terrain, ruts, and other changes in traction and terrain. Avoid paved surfaces.
- Avoid side hilling (riding across slopes).

**Be Sure Riders Pay Attention and plan Ahead**

If you think or feel the vehicle may tip or roll, reduce your risk of injury:



- Keep a firm grip on the steering wheel or handgrips and brace yourself.
- Do not put any part of your body outside of the vehicle for any reason.

**Rollovers have caused severe injuries and death, even on flat, open areas.**

**Require proper use of your vehicle**

- Do your part to prevent injuries.
- Do not allow careless or reckless driving.
- Make sure all operators are 16 or older with a valid driver's license.
- Do not allow operation on public roads, (unless designated for off-highway vehicle access), collision with cars and trucks can occur.
- Do not let people drive or ride after using alcohol or drugs.
- Do not exceed seating capacity, 2 occupants.

Read and understand all safety labels, locate and read operator's guide. Watch the safety video using the QR code link or visit Can-am website before operation.

NEVER DRINK AND DRIVE

NEVER DRINK AND DRIVE

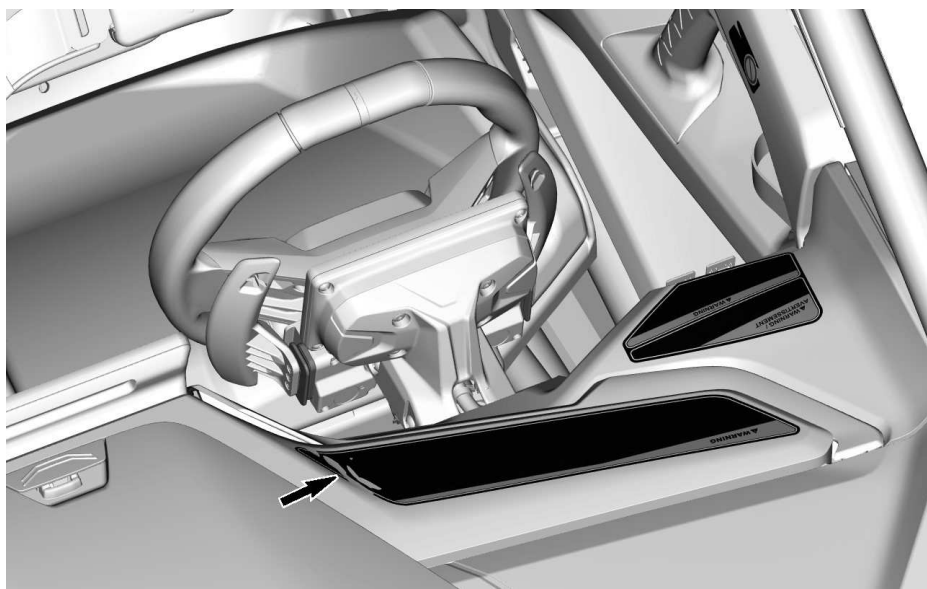

## Passenger – Warning Label



## Rollover – Left Warning Label

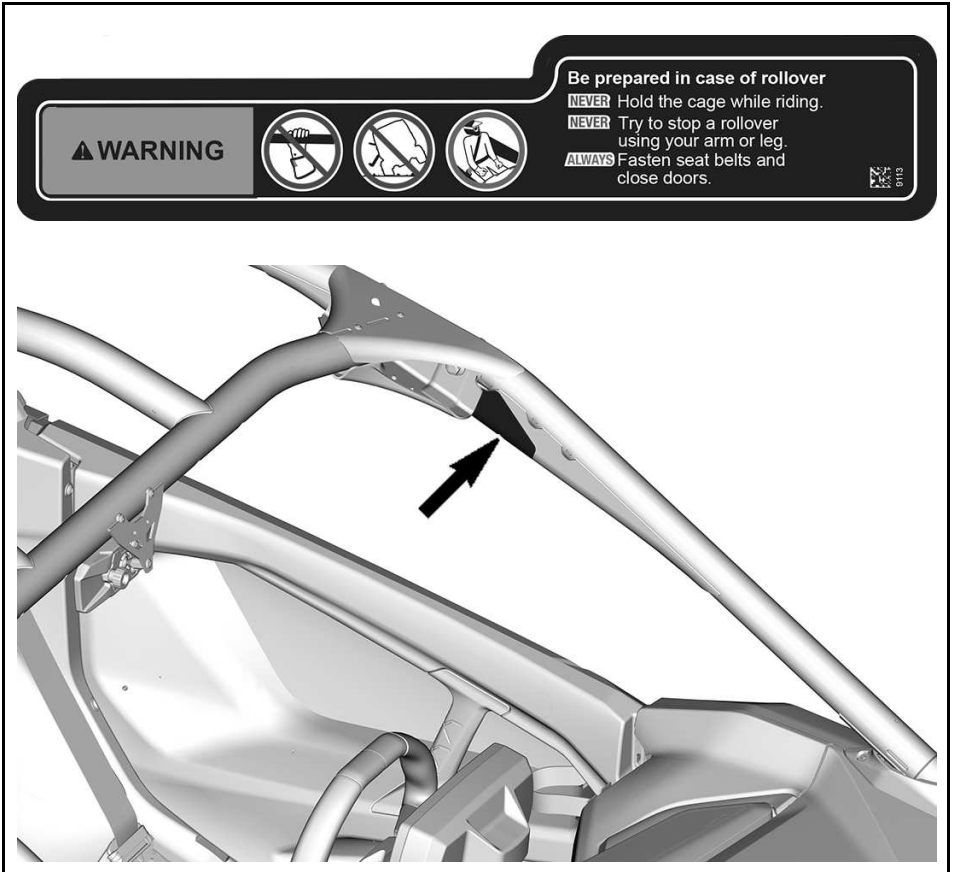

## Rollover – Right Warning Label

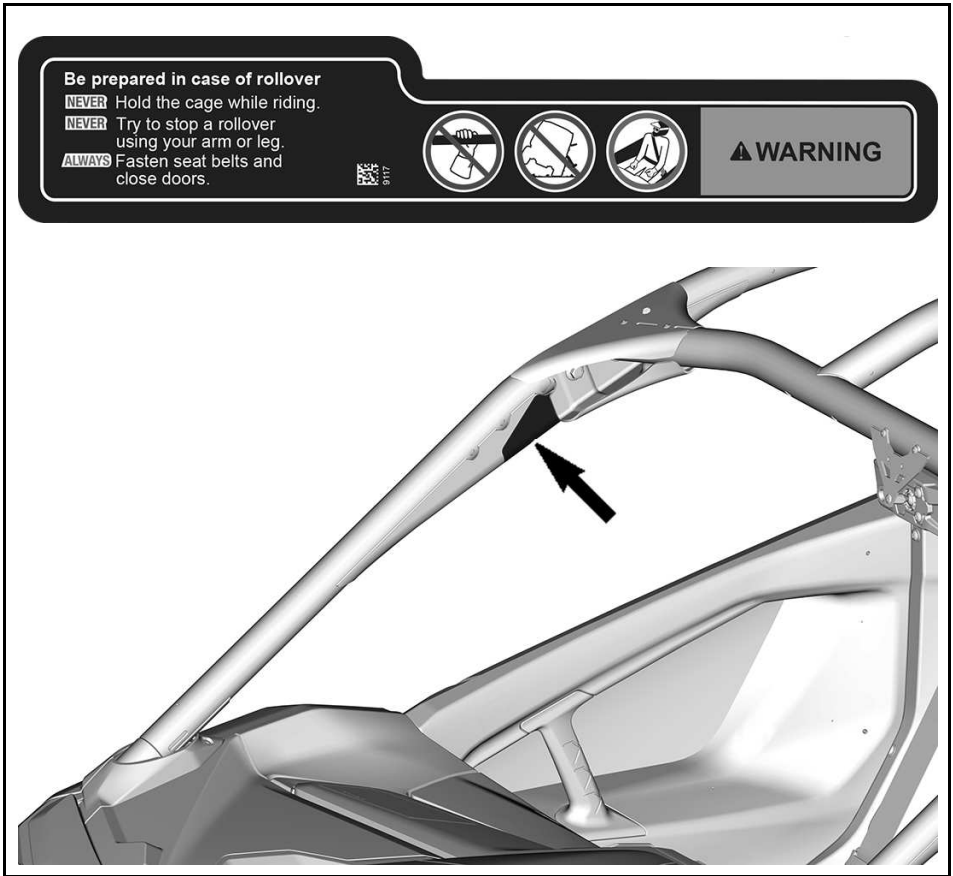

## High-Performance Vehicle – Warning Label

**⚠ WARNING /  
AVERTISSEMENT**

This vehicle is an off road vehicle not intended for use on public roads.

Ce véhicule est conçu pour un usage hors route et n'est pas destiné aux voies publiques.



**⚠ WARNING**

Get familiar with this Off-Highway vehicle (OHV); it may exceed the performance of other OHV you may have ridden. This is a high performance OHV. Inexperienced riders may overlook risks and be surprised by the specific behavior of this OHV in any terrain condition.

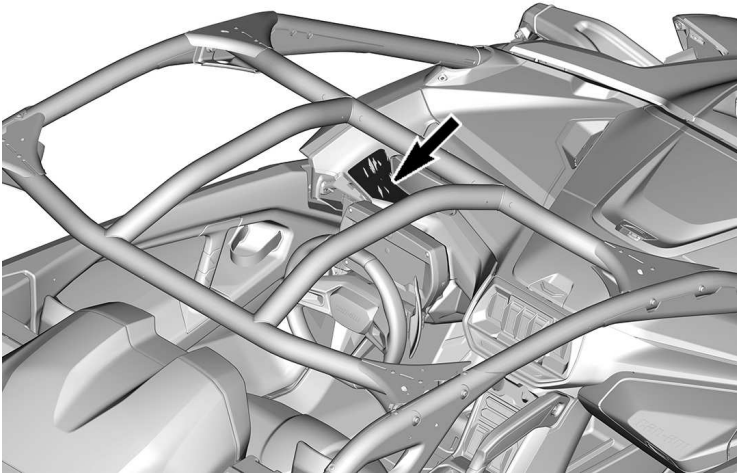

## Tire Pressure and Maximum Load - Warning Label

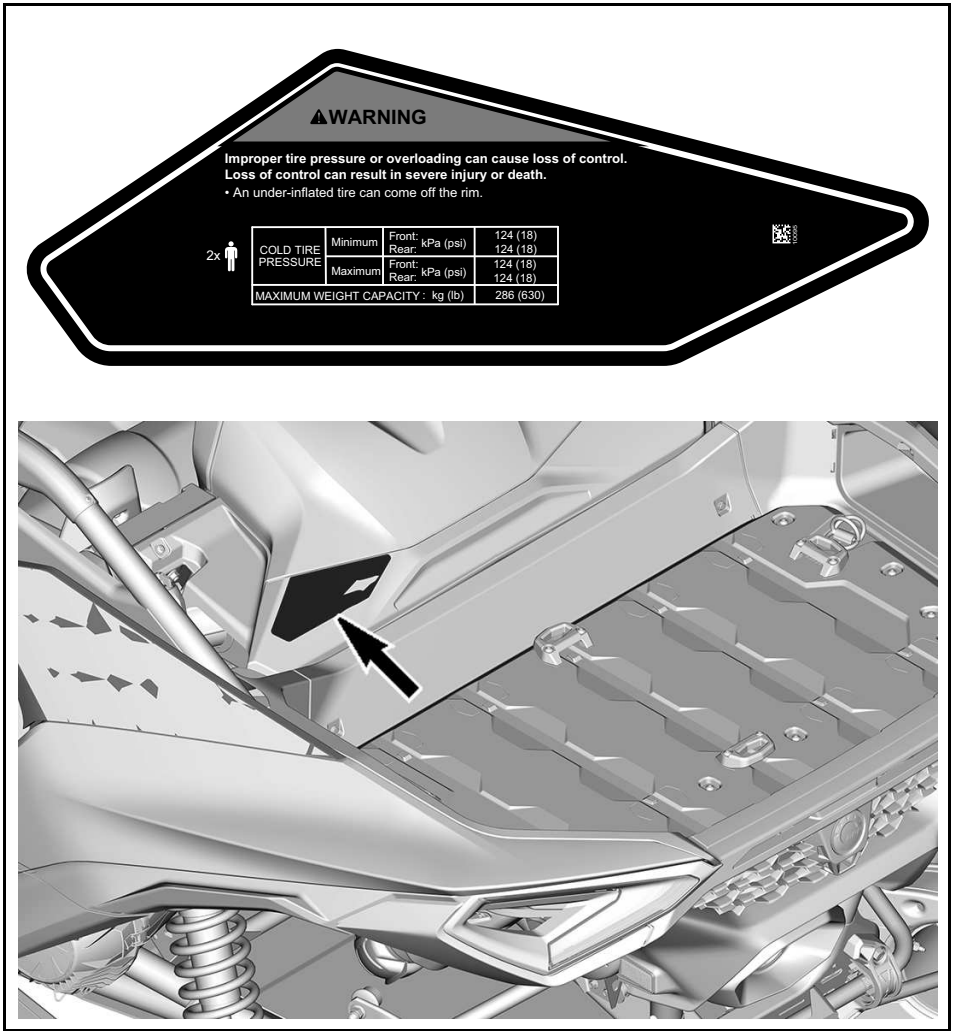



## Park Selection - Warning Label

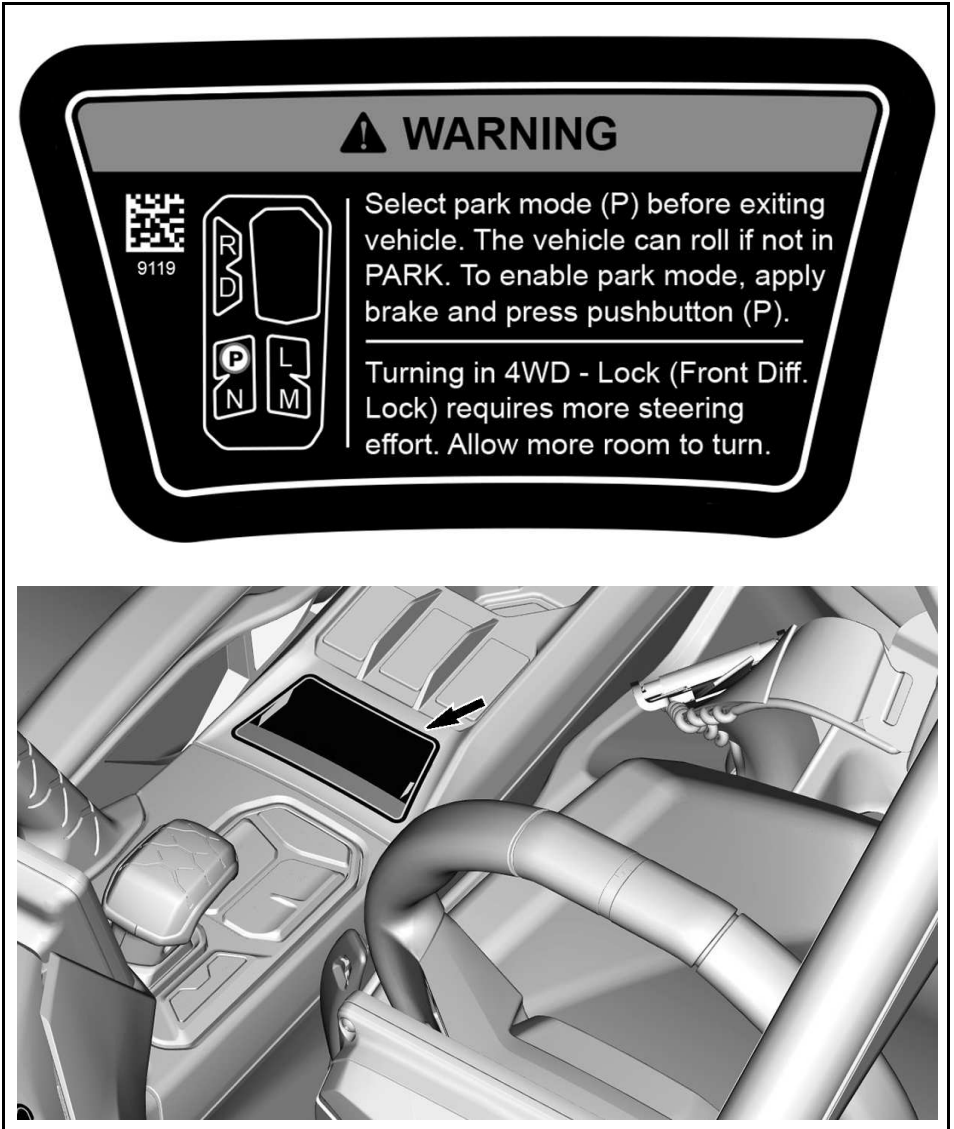

## Cargo Load Capacity - Warning Label

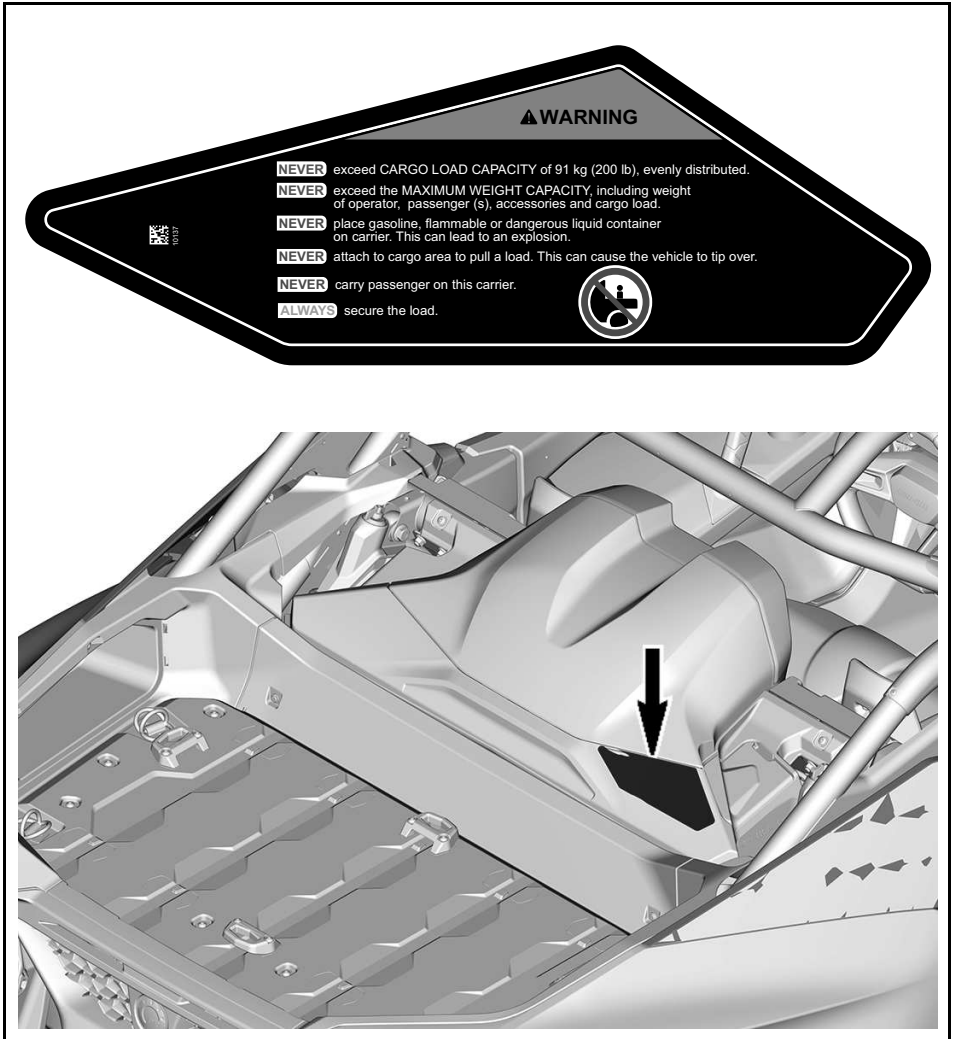

## Cage Warning Label

### **⚠ WARNING**

**NEVER** attach to the cage to pull a load.  
This can cause the vehicle to tip over.



9550

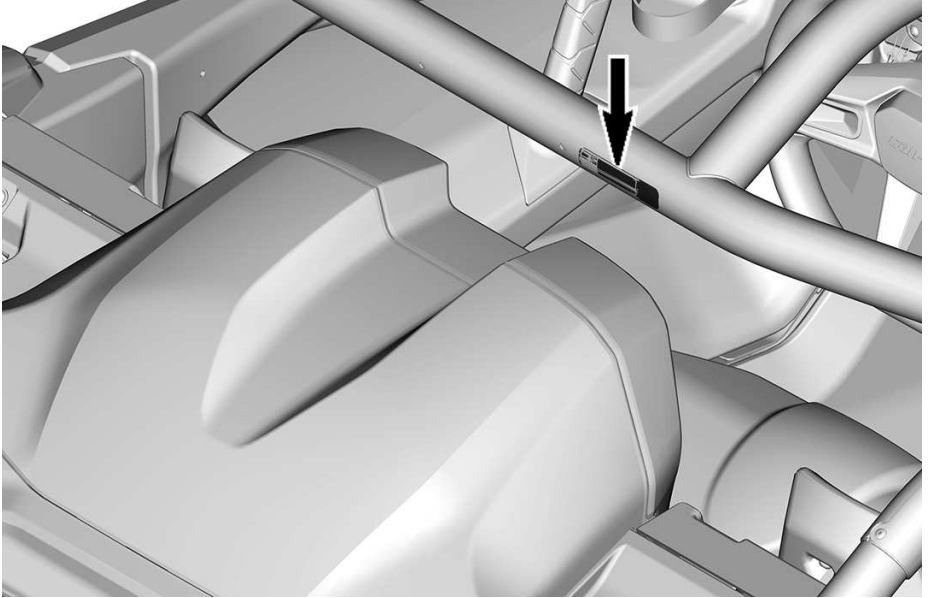

## Door Warning Label

**⚠ WARNING**

**Do NOT put your arm outside of the vehicle. There is a risk of SEVERE INJURY.**

LH Side



RH Side

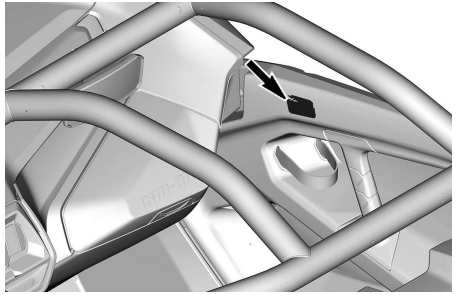
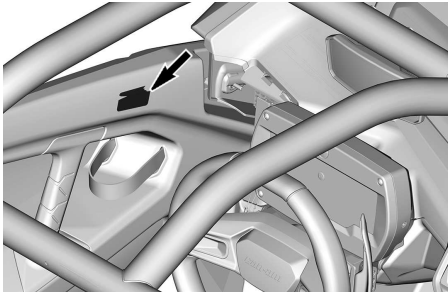

## Towing With Permanent Neutral- Notice Label

### **NOTICE**

To avoid transmission damage, before towing this vehicle, put it in permanent neutral state by turning the engine OFF, applying brake and pressing neutral (N) pushbutton 5 seconds until message appears in the cluster. Reverse process to disable.

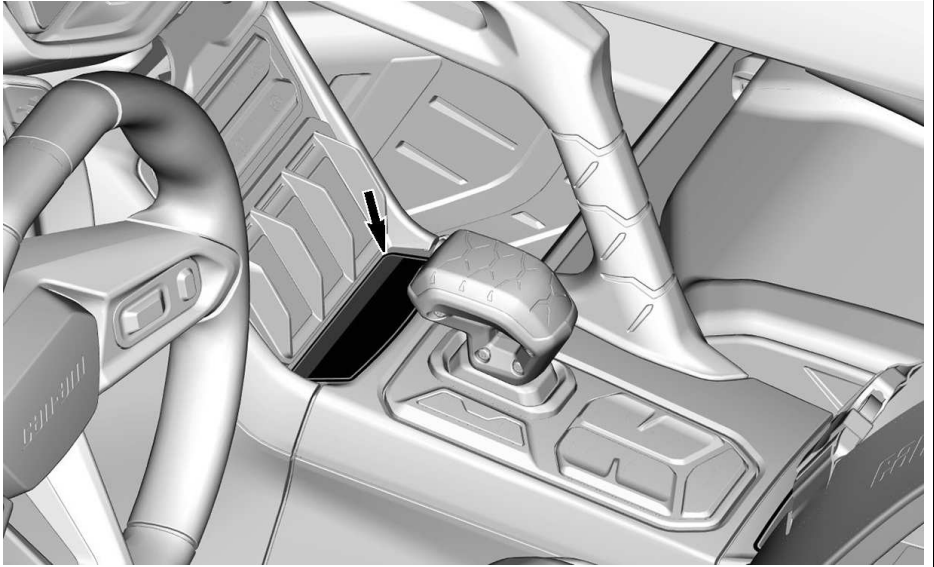

## Recover Stuck Vehicle - Notice Label

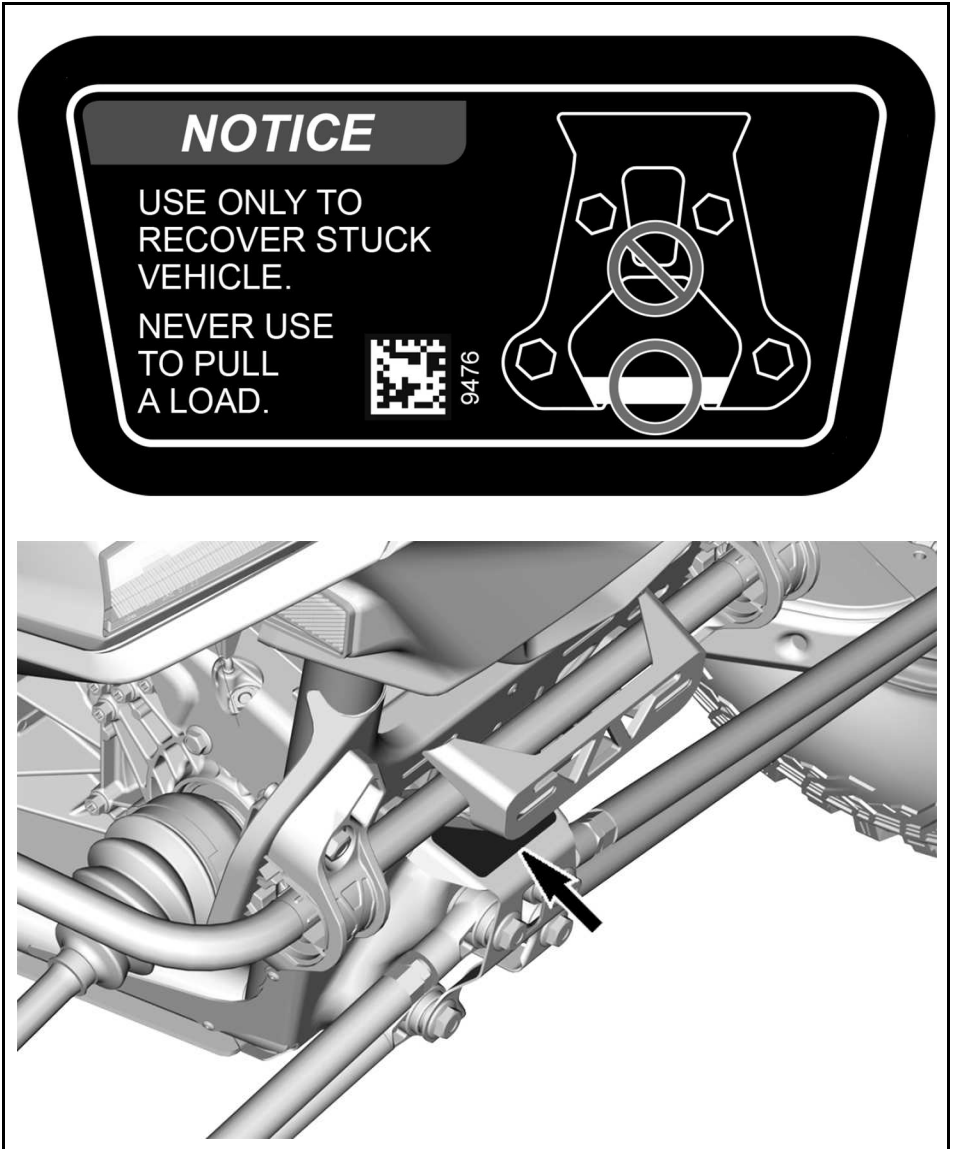

## Coolant Hot - Warning Label

**⚠ WARNING**

Do not open when HOT.

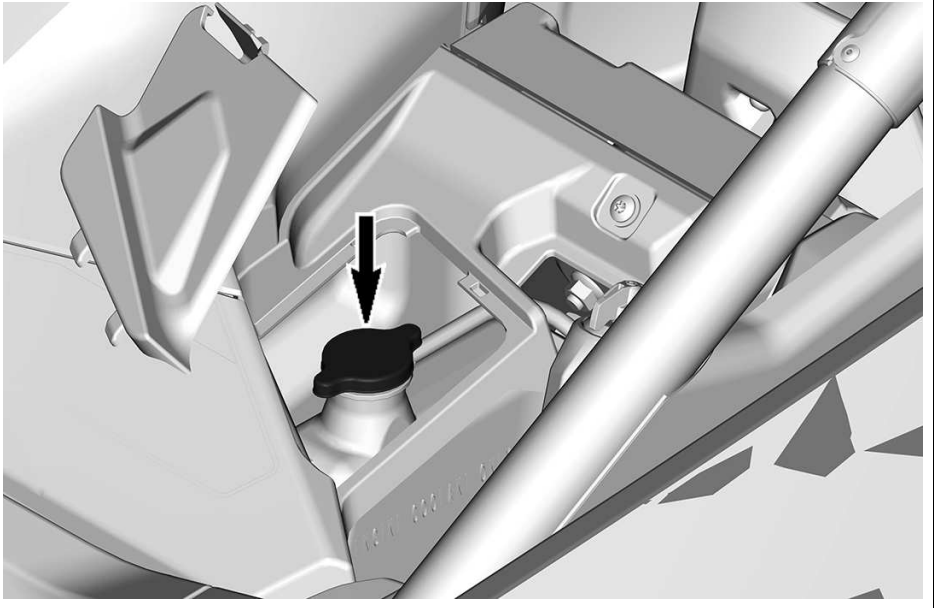

## Safety Compliance Hang Tag

This vehicle comes with hang tags containing important safety information.

Any person who rides this vehicle should read and understand this information before riding.

## California Proposition 65 Warning Hang Tag

 **WARNING.** Operating, servicing and maintaining an off-road vehicle can expose you to chemicals including engine exhaust, carbon monoxide, phthalates, and lead, which are known to the State of California to cause cancer and birth defects or other reproductive harm.

To minimize exposure, avoid breathing exhaust, do not idle the engine except as necessary, service your vehicle in a well-ventilated area and wear gloves or wash your hands frequently when servicing your vehicle.

For more information go to  
[www.P65Warnings.ca.gov/products/  
passenger-vehicle](http://www.P65Warnings.ca.gov/products/passenger-vehicle)



704906872



---

# IMPORTANT ON-PRODUCT LABELS (ALL COUNTRIES EXCEPT CANADA/UNITED STATES)

## Safety Pictogram

Read and understand all of the safety labels on your vehicle.

These labels are affixed to the vehicle for the safety of the operator, passenger, and bystanders.

The safety labels on your vehicle should be considered permanent parts of the vehicle.

If missing or damaged, they can be replaced free of charge. See an authorized Can-Am Off-road dealer.

**IMPORTANT:** In the event of any discrepancy between this guide and the vehicle, the safety labels on the vehicle have precedence over the labels in this guide.

## Operator – Warning Label

### **WARNING**

- Locate and read operator's guide. Improper vehicle use can result in SEVERE INJURY or DEATH. Follow all instructions and warnings.
- Fasten seat belts.
- Always wear an approved helmet and protective gear.
- Each rider must be able to sit with back against seat, feet flat on the floor or on footrests, and hands on steering wheel or handholds.
- Always fasten seat belts and close doors.
- Always wear ear protection.
- Do not exceed seating capacity: 2 occupants.
- Make sure all operators are 16 or older with a valid driver's licence.
- In case of tip or roll, keep a firm grip on steering wheel or handholds and brace yourself.
- Do not put any part of your body outside of the vehicle for any reason. Stay completely inside the vehicle.
- Rollovers have caused severe injuries and death, even on flat, open areas.
- Do not allow operation on public roads (unless designated for off-highway vehicle access), collision with cars and trucks can occur.
- Never use with drugs or alcohol.
- Do not allow anyone to ride if not able to sit with back against seat, feet flat on the floor or on footrests, and hands on the steering wheel.
- Watch the safety video before riding.

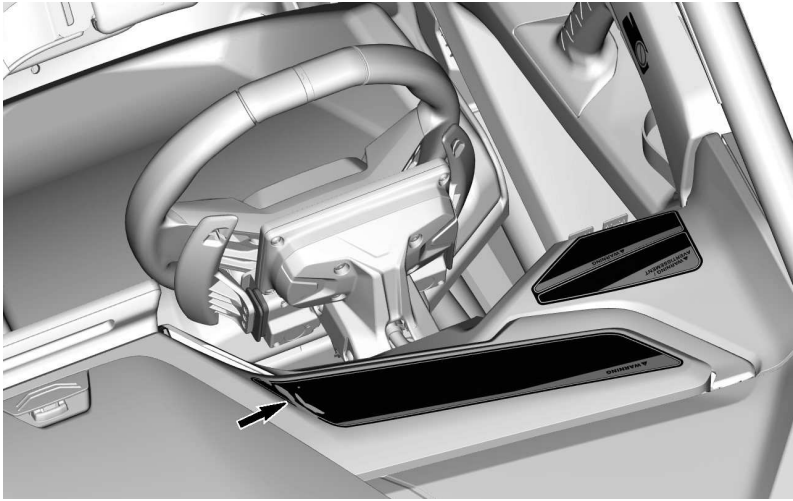
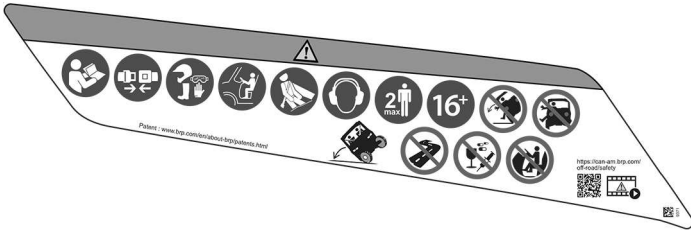

## Passenger – Warning Label

### WARNING

- Always wear an approved helmet and protective gear.
- Always wear ear protection.
- Fasten seat belts and close doors.
- Rollovers have caused severe injuries and death, even on flat, open areas.
- Each rider must be able to sit with back against seat, feet flat on the floor or on footrests, and hands on steering wheel or handholds.
- Never use with drugs or alcohol.
- In case of tip or roll, keep a firm grip on handholds and brace yourself.
- Do not put any part of your body outside of the vehicle for any reason. Stay completely inside the vehicle.
- Do not allow anyone to ride if not able to sit with back against seat, feet flat on the floor or on footrests, and hands on handholds.

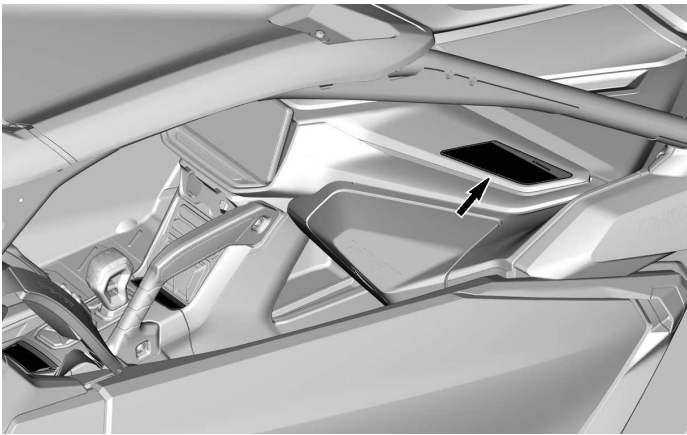

## Rollover – Left Warning Label

### ⚠ WARNING

- Always fasten seat belts and close doors.
- Do not put any part of your body outside of the vehicle for any reason. Stay completely inside the vehicle.
- Never hold the cage while riding.

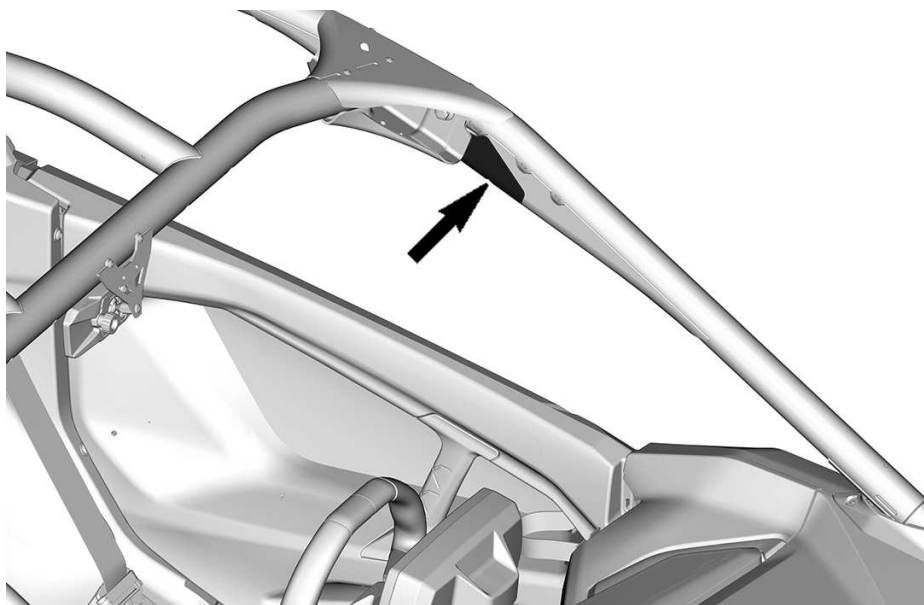

## Rollover – Right Warning Label

### ⚠ WARNING

- Never hold the cage while riding.
- Do not put any part of your body outside of the vehicle for any reason. Stay completely inside the vehicle.
- Always fasten seat belts and close doors.

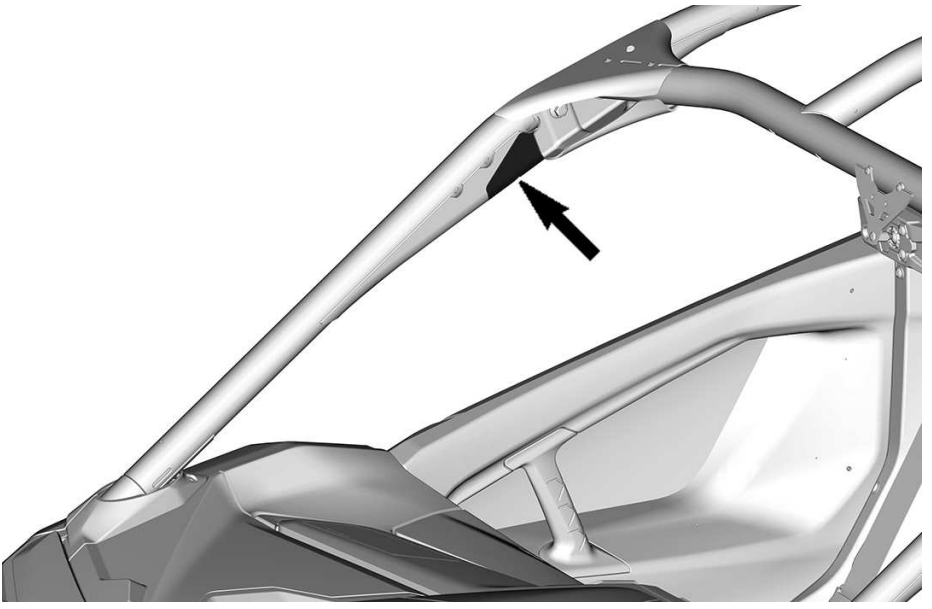

## Tire Pressure and Maximum Load - Warning Label

### ⚠ WARNING

- Locate and read operator's guide.
- **ALWAYS** maintain proper tire pressure as shown. Improper tire pressure or overloading can cause loss of control, resulting in **SEVERE INJURY** or **DEATH**.
- **NEVER** exceed the cargo load capacity of 91 kg (200 lb)
- **NEVER** exceed the load capacity of 286 kg (630 lb) including weight of operator, cargo and , accessories.

32	XRS	124 (18) kPa (psi)	91 (200) kg (lb)	286 (630) kg (lb)		
2x						

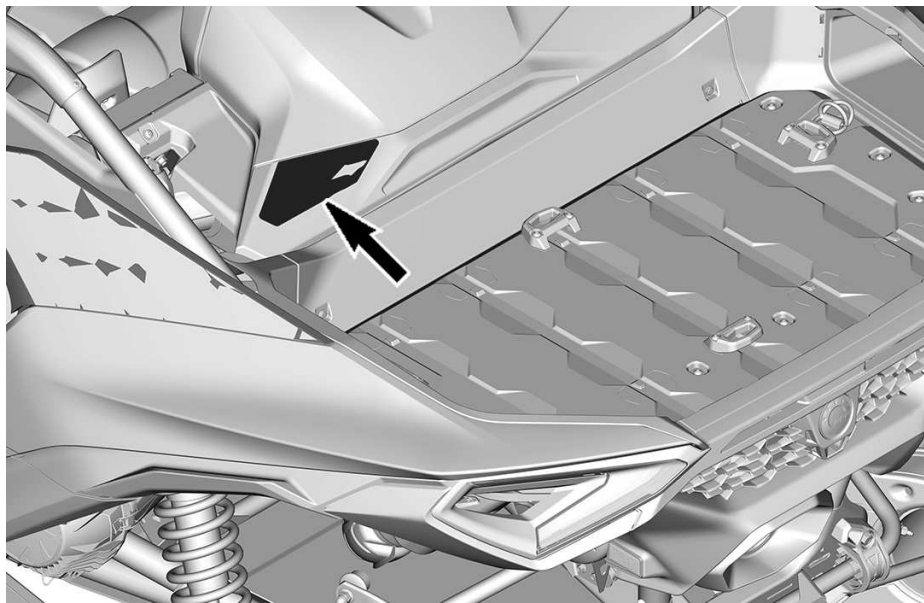

## Park Selection - Warning Label

### ⚠ WARNING

- Locate and read operator's guide.
- Turning in 4WD-Lock (Front Diff Lock) requires more steering effort, Allow more effort to turn.
- Select PARK before existing vehicle. the vehicle can roll if not in PARK. to able PARK, apply brake and press the P button.

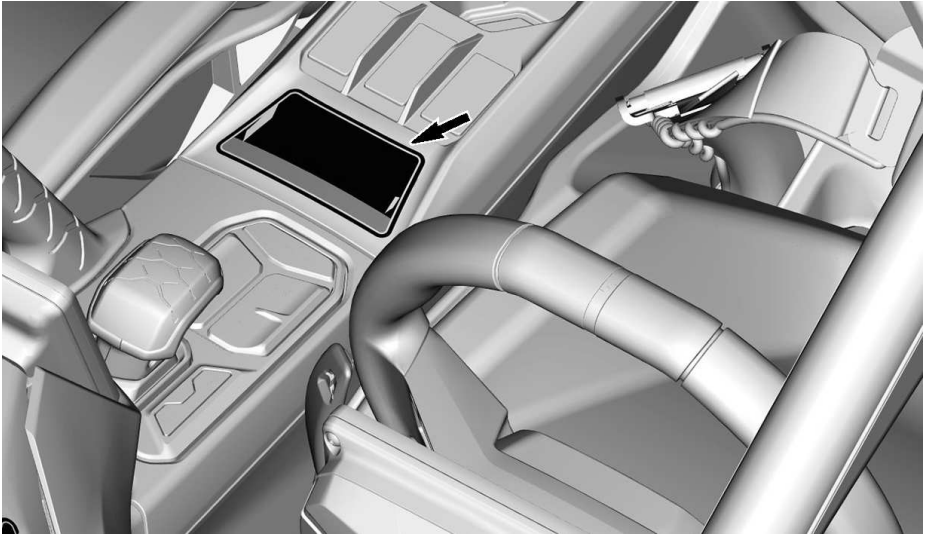
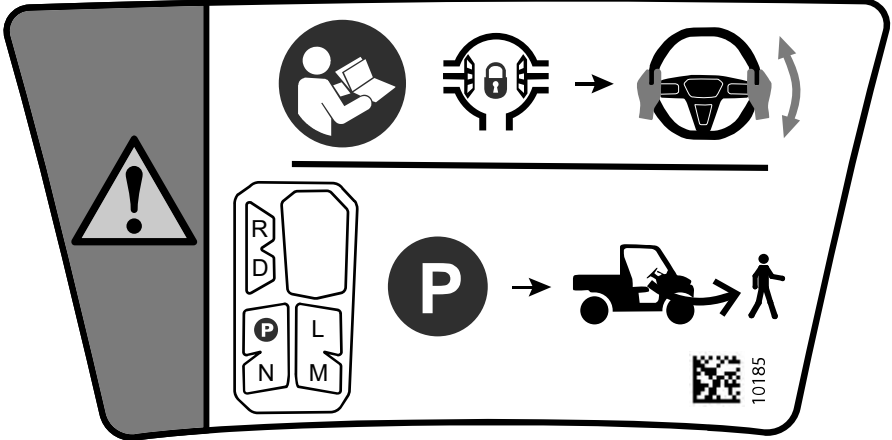



## Cargo Load Capacity - Warning Label

### **⚠ WARNING**

Locate and read operator's guide.  
**NEVER** carry passengers in cargo box.  
**NEVER** place gasoline, flammable or dangerous liquids containers on carrier. This can lead to an explosion.  
**NEVER** attach to cargo area to pull a load.  
Reduce speed when carrying a load.

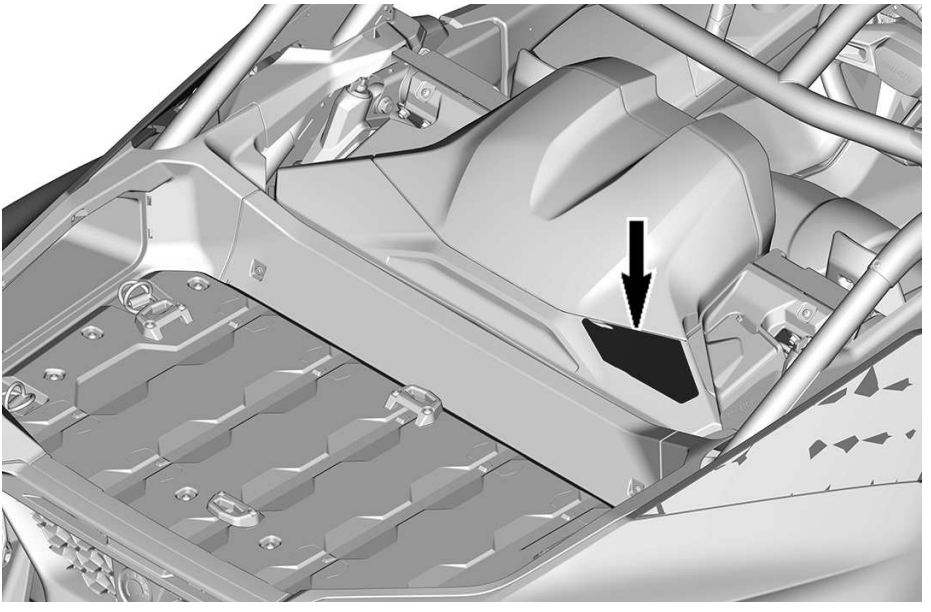

## Cage Warning Label

**⚠ WARNING**

**NEVER** attach to the cage to pull a load. This can cause the vehicle to tip over. Use only the recovery hook to recover a stuck vehicle.



7694

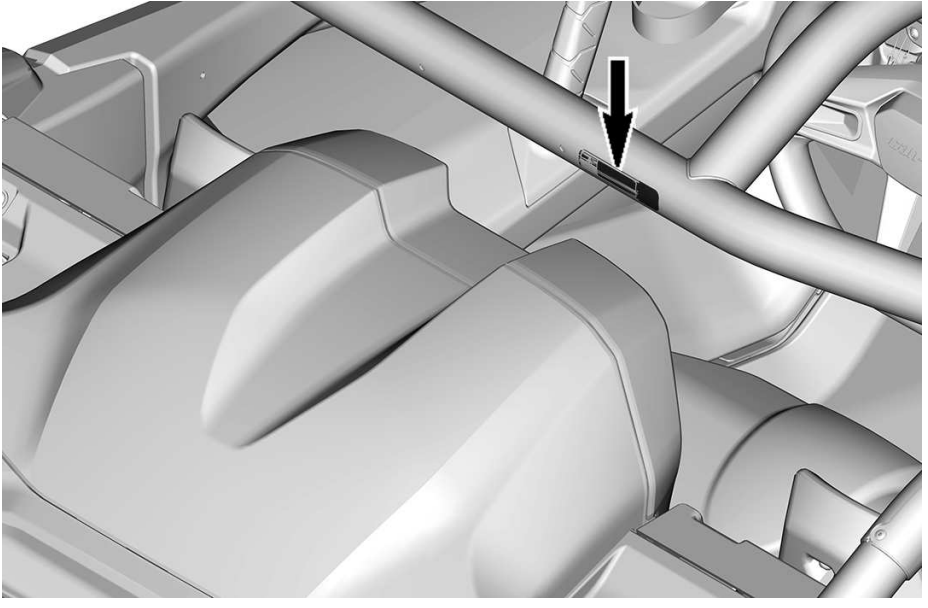

## Door Warning Label

### **WARNING**

**Do NOT put your arm outside of the vehicle. There is a risk of SEVERE INJURY.**

LH Side



RH Side

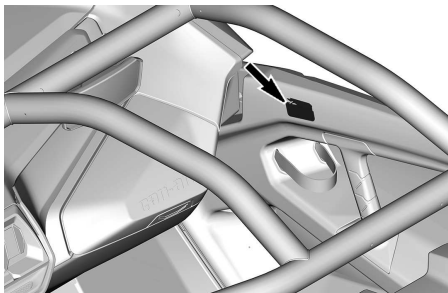
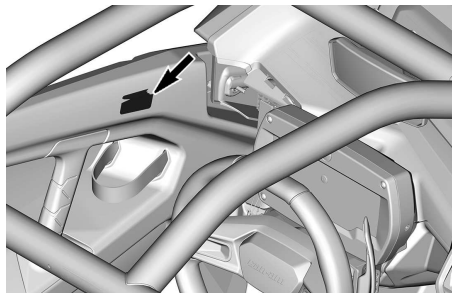

## Towing With Permanent Neutral- Notice Label

### NOTICE

1. Turn engine OFF.
2. Wake up the electrical system.
3. Press and hold the brake pedal.
4. Press and hold the NEUTRAL button at least 5 seconds.
5. Verify that the "Permanent Neutral" message is shown in the digital display.
6. The vehicle can be towed.
7. The Permanent Neutral can be deactivated by waking up the electrical system, holding the brake and holding the NEUTRAL button at least 5 seconds.

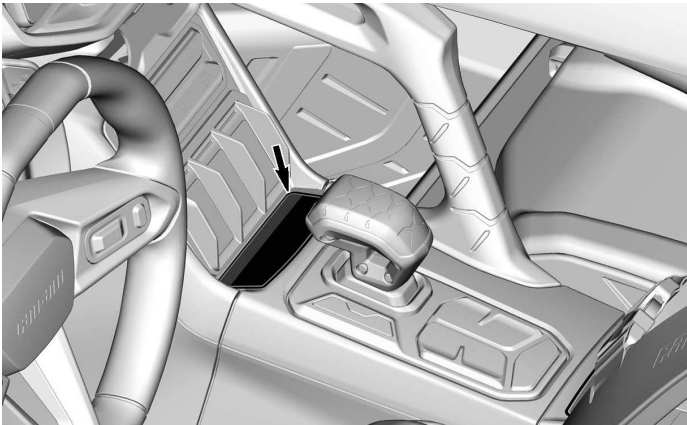
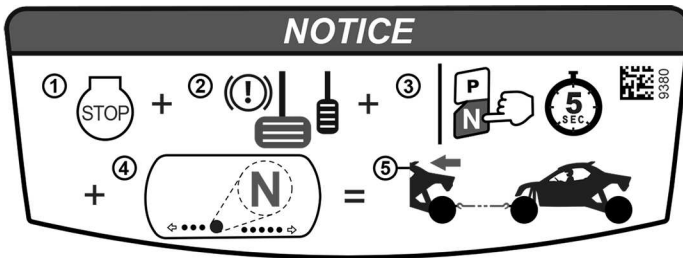

## Recover Stuck Vehicle - Notice Label

### NOTICE

Use only to recover a stuck vehicle. Never use to pull a load.

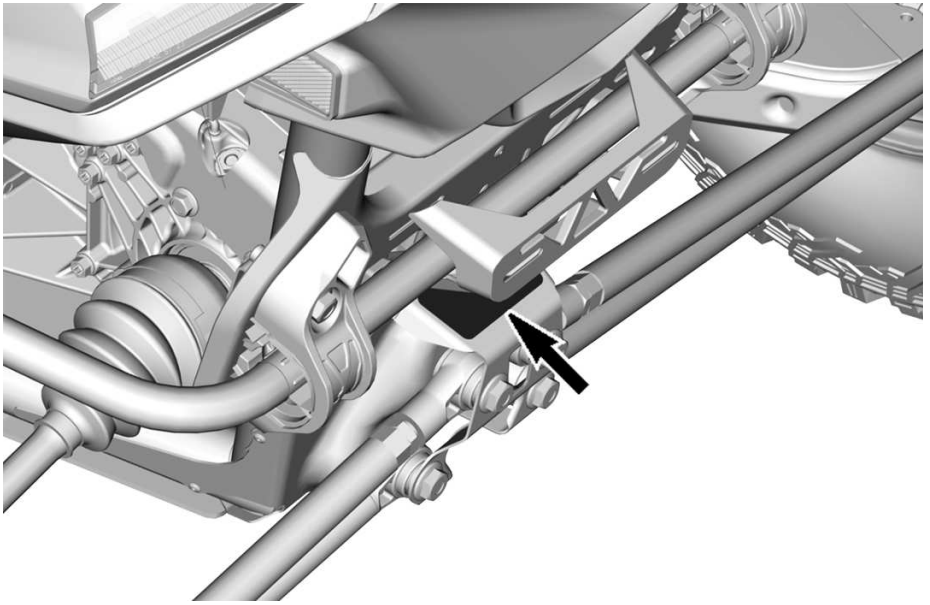

## Coolant Hot - Warning Label

**⚠ WARNING**

**Do not open when HOT.**

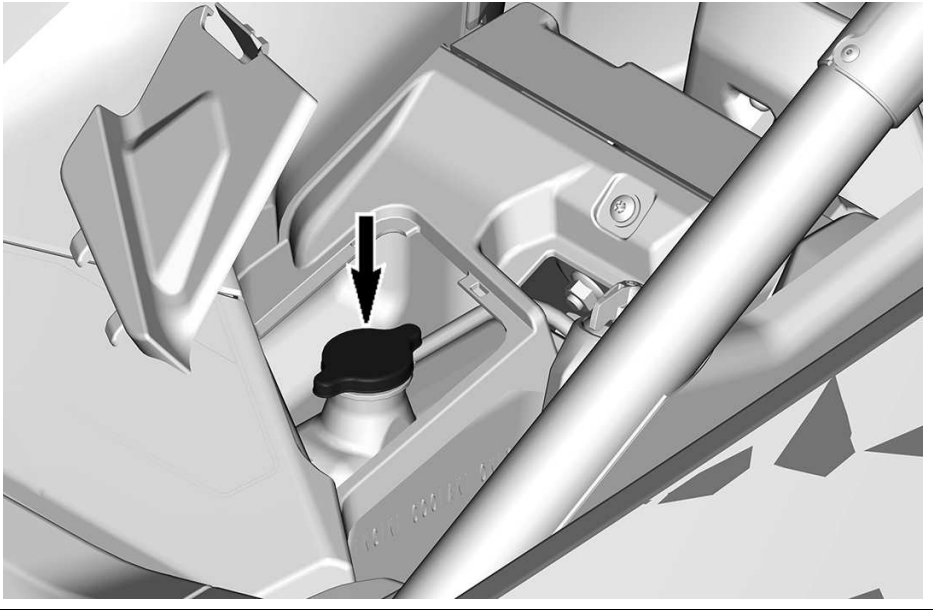

# PRE-RIDE INSPECTION CHECK LIST

## What to Do Before Starting the Engine (Key OFF)

ITEMS TO INSPECT	INSPECTION TO PERFORM	✓
Coolant	Check coolant level.	
Brake fluid	Check brake fluid level.	
Engine air filter	Inspect engine air filter and replace if necessary.	
Engine air filter housing	Inspect engine air filter housing and clean if necessary (when riding in dusty conditions or sand).	
Radiator(s)	Check front and rear radiators for cleanliness.	
Front grille	Inspect front grille kit for cleanliness.	
Exhaust system	Clean area around exhaust system, especially if vehicle was used in a swamp, hay field, or in dry leaves.	
Drive shaft bellows	Check drive shaft bellows condition.	
Tires	Check tire pressure and condition. Refer to <i>Technical Specifications</i> and adjust according to load.	
Wheels	Check wheels for damage and abnormal play. Ensure that lug nuts and beadlock screws (if equipped) are tight. Refer to <i>Wheels and Tires in Maintenance Procedures</i> for torque specifications.	
Cargo and load	<b>Cargo Load:</b> If you transport cargo, respect maximum rear cargo rack capacity. Refer to <i>Technical Specifications</i> . Ensure that total weight of operator, passenger, cargo, and added accessories does not exceed total vehicle load allowed. Refer to <i>Technical Specifications</i> .	
Chassis and suspension	Check under vehicle for any debris on chassis or suspension components (upper and lower arms, wheels, shock absorbers, springs), and clean them properly.	

## What to Do Before Starting the Engine (Key ON)

ITEMS TO INSPECT	INSPECTION TO PERFORM	✓
Digital display	Check operation of indicator lamps in digital display (with D.E.S.S. key ON, briefly press ENGINE START/STOP button).	
	Check for messages on gauge.	
Lights	Check operation and cleanliness of the following: <ul style="list-style-type: none"> <li>- Headlights (high and low)</li> <li>- Taillights</li> <li>- Brake lights</li> </ul>	
Seats, doors, and seat belts	Check seat adjustment and ensure that locking device is properly engaged before riding.	
	Check doors for damage. Have doors replaced if damaged. Close both doors and confirm that they latch up to second latch.	
	Check seat belts for any damage (including retractors, buckles, and semi-cinching tabs). Fasten seat belts and ensure that they remain securely fastened and tightened against occupant's body.	
Accelerator pedal	Press on accelerator pedal a few times. Pedal should operate freely and return to its rest position when released.	
Brake pedal	Press down on brake pedal and make sure that you feel firm resistance. Pedal should return fully to its rest position when released.	
Fuel level	Check fuel level.	

## What to Do After the Engine is Started

ITEMS TO INSPECT	INSPECTION TO PERFORM	✓
Steering	Check if steering operates freely by completely turning wheel from side to side. Adjust steering wheel to a comfortable position.	
RF D.E.S.S. post	Check operation of D.E.S.S. post by pulling D.E.S.S. key from post. Engine must stop.	



ITEMS TO INSPECT	INSPECTION TO PERFORM	✓
Shift lever/ Console keypad buttons	Check operation of the shift lever (R/D) and console keypad buttons (P, L, M, N, and Override).	
Brakes	Slowly drive forward a few feet and then apply brakes. Brake pedal must feel firm when applied. Pedal must return to its rest position when released. Brakes must respond adequately to driver's input.	
2WD/4WD selector	Check operation of 2WD/4WD selector. Move vehicle slowly and try to select/deselect 2WD and 4WD modes.	
Engine oil	Check engine oil level with a warm engine.	

---

# REPORTING SAFETY DEFECTS

In Canada, if you believe that your vehicle has a defect which could cause a crash or could cause injury or death, you should immediately inform Transport Canada in addition to notifying Bombardier Recreational Products Inc.

If Transport Canada receives similar complaints, it may open an investigation, and if it finds that a safety defect exists in a group of vehicles, it may order a recall and remedy campaign. However, Transport Canada cannot become involved in any individual problems between you, your dealer or Bombardier Recreational Products Inc.

## To contact Transport Canada:



819-994-3328 (Gatineau-Ottawa area or internationally)  
Toll free : 1 800-333-0510 (in Canada)



Transport Canada - ASFAD  
330 Sparks Street  
Ottawa, ON  
K1A 0N5



<https://www.tc.gc.ca/recalls>

# VEHICLE INFORMATION

# PRIMARY CONTROLS

It is important to know the location and operation of all controls, and to develop and practice smooth and coordinated use of them.

Some vehicle safety labels are not shown on illustrations. For information on vehicle safety labels, refer to *Important On-Product Labels*.

## STEERING WHEEL

The steering wheel is located in front of the driver's seat.

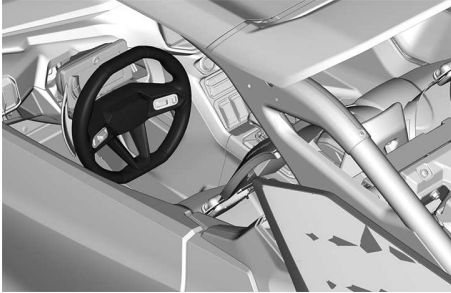

**STEERING WHEEL - TYPICAL**

It is used to steer the vehicle to the left or right. Turn the steering wheel in the direction you want to go.

Hold the steering wheel firmly with both hands, without closing your fists around it and proceed.

### CAUTION

**Under rough trail conditions or when crossing an obstacle, the steering wheel could suddenly jerk to one side, causing hand or wrist injuries if your fists are wrapped around the steering wheel.**

When driving, the Dynamic Power Steering (DPS) reduces the effort required to turn the steering wheel.

The steering wheel also includes many controls.

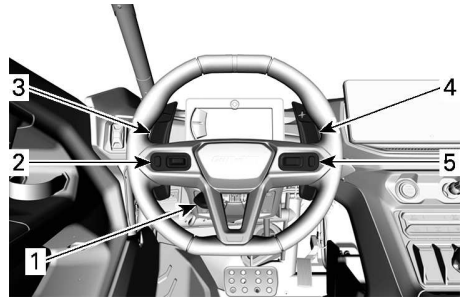

1. Tilt/telescopic lever
2. Left steering control (Applet switch and Focus Control)
3. Left shift paddle
4. Right shift paddle
5. Right steering control (Ride settings and Push To Talk)

## SHIFT PADDLES

Shift paddle are located behind the steering wheel.

Pressing the left paddle allows to downshift gear instead the right paddle upshift gear.

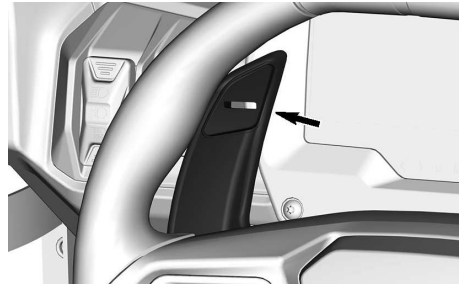

**LEFT PADDLE — DOWNSHIFT**

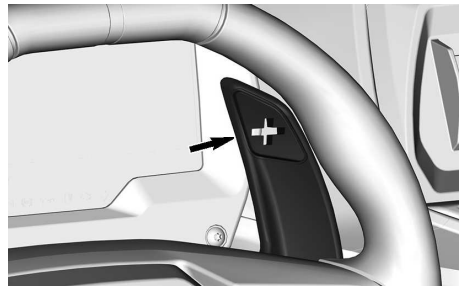

**RIGHT PADDLE — UPSHIFT**

The shift paddles must be used to change gears when the Manual mode is selected.

## Tip In Mode

When in automatic mode, pressing one of the shift paddle will activate the Tip In mode.

Pressing the right (upshift) or the left (downshift) paddle will select the next upper gear or the previous gear.

This gear will be held until either upshift or downshift RPM are reached.

To get out of the Tip In mode and go back to full Automatic mode, just hold one of the paddle for a few seconds.

## Shift Paddles Deactivation

Also, in AUTO mode the shift paddles can be deactivated to avoid accidental shifting.

To deactivate the shift paddles, press the M button for more than 5 seconds. A padlock  will appear in the upper portion of the digital display.

Pressing the M button again during more than 5 seconds will reactivate the shift paddles.

## ACCELERATOR PEDAL

The accelerator pedal is the right-most pedal.

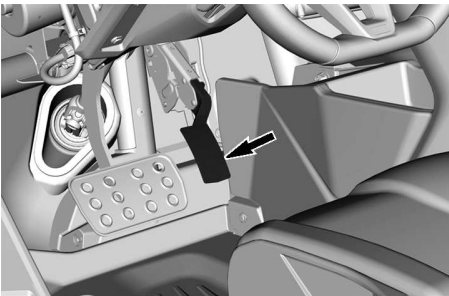

The accelerator pedal controls the vehicle speed and acceleration.

To increase or maintain vehicle speed, press on the accelerator pedal with your right foot.

To decrease vehicle speed, release the accelerator pedal.

The accelerator pedal is spring loaded and should return to its resting position (idle) when not pressed.

## BRAKE PEDAL

The brake pedal is located to the left and is wider than the accelerator pedal.

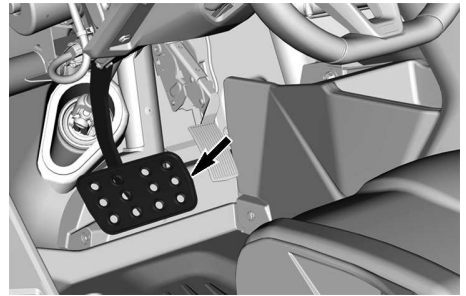

The brake pedal function is to slow or stop the vehicle.

To decrease vehicle speed or to stop the vehicle, press down on the brake pedal with your right foot.

The brake pedal is spring loaded and should return to its original position (released) when not pressed.

## ELECTRONIC SHIFT LEVER

The electronic shift lever is located on the central console, to the right of the driver's seat.

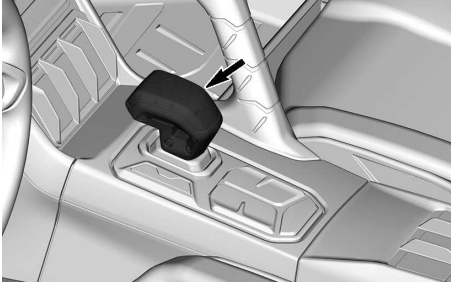

The lever is used to put the transmission into REVERSE or DRIVE (Forward).

To shift into REVERSE:

- Press the brake pedal and push the lever forward until the digital display shows **R**.
- Release the lever. After you release the shift lever, it will return to the center position.

**NOTE:**

Once in Reverse, if the lever is pushed forward again and held for a few seconds, the transmission will toggle between Low and Hi range. This can also be done using the L button below the shift lever.

To shift into DRIVE:

- Press the brake pedal and pull the lever rearward until the digital display shows **D**.
- Release the lever.

**NOTE:**

Once in Drive, if the lever is pulled rearwards again and held for a few seconds, the transmission will toggle between Low and Hi range. This can also be done using the L button below the shift lever.

When the D position is selected after restarting the vehicle, the last setting used will be reused automatically (automatic, manual, LOW or HI range).

When the transmission is in gear (R or D), the vehicle can move slowly, or creep, without any accelerator pedal input. Many factors can influence the creep behavior: Transmission temperature, cargo weight, Range (Low or High), type of terrain and slope, to name a few. The user should beware of a potential creeping at all times when it is in gear.

**⚠ WARNING**

**Always apply the brake when stopped and select Park (P) before exiting the vehicle to avoid unattended vehicle movement.**

## PARK BUTTON

The park button (P) is located behind the electronic shift lever.

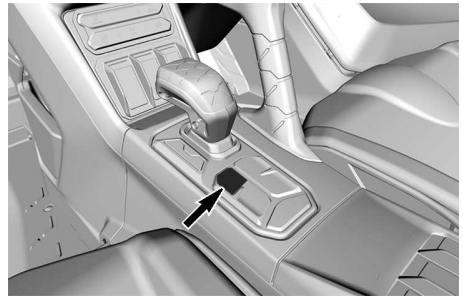

This button puts the transmission in PARK.

The PARK must be engaged each time the driver leaves the vehicle.

A buzzer will sound any time the driver's door is opened without the PARK engaged.

**⚠ WARNING**

**Always select the Park (P) position when the vehicle is not in motion to avoid accidental vehicle movements.**

The vehicle will automatically go to park when it is immobilized and the engine is shutdown.

## NEUTRAL BUTTON

The Neutral (N) button is located behind the electronic shift lever.

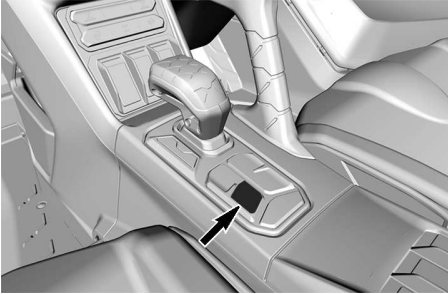

This button puts the transmission in neutral.

### NOTICE

**This position must NEVER be used to tow the vehicle. Severe transmission and gearbox damage will occur.**

**To tow the vehicle, refer to *Permanent Neutral or Mechanical Neutral Activation in Special Procedures* for the complete procedure.**

Neutral is selected by pressing the “N” button. The **N** icon appears in the digital display when the transmission is in neutral.

The vehicle will go back to park position when it shutdown.

If a permanent neutral or a mechanical neutral is needed, refer to *Permanent Neutral and Mechanical Neutral Activation in Special Procedures* section.

## LOW RANGE BUTTON

The Low (L) range button is located behind the electronic shift lever.

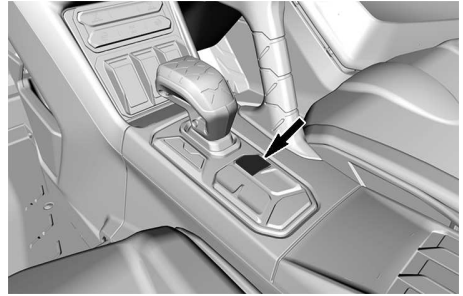

This button allows the low-speed range of the gearbox to be selected.

This vehicle can switch between low and high while moving. There will be a power interruption during the H to L or L to H shift, so make sure to perform the shift in a safe location (ex. a straight flat section) at constant speed.

The Low range allows the vehicle to move slowly with the maximum torque at the wheels.

### NOTICE

**To avoid vehicle damages, it is a good practice to select the Low range each time the vehicle goes over obstacles, drives uphill or downhill, or when carrying heavy cargo.**

To select the Low range, press the “L” button until the **L** icon appears in the digital display.

This button allows also to switch between Low and Hi range by pressing it during more than 2 seconds.

It is also possible to toggle between Low and Hi range using the *Electronic Shift Lever*.

## MANUAL MODE BUTTON

The Manual (M) mode button is located behind the electronic shift lever.

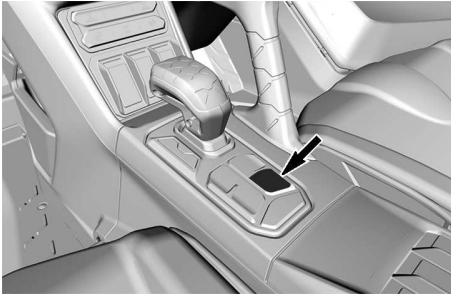

This button engages or disengages the Manual shifting mode.

The Manual mode allows you to change gears, using the paddles at the steering wheel, on demand instead of waiting for the vehicle to decide.

In Manual mode, pressing the paddle shift, located behind the steering wheel allows to upshift or downshift gear.

- Left paddle = Downshift
- Right paddle = Upshift

It is also possible to switch from manual to automatic mode, and vice versa, by pulling and holding simultaneously both shift paddles ( $\pm 1$  second).

In AUTO mode, pressing the M button more than 5 seconds will deactivate the shift paddles to avoid accidental shifting. A padlock  is displayed in the digital display.

To reactivate the shift paddles function, press the Manual mode button again for more than 5 second until the padlock  disappears in the digital display.



## SECONDARY CONTROLS

Some vehicle safety labels are not shown in the illustrations.

For information on vehicle safety labels, refer to *Important On-Product Labels*.

### RF D.E.S.S Key and RF D.E.S.S. Post

#### RF D.E.S.S. Post

The D.E.S.S. post is located on the upper console.

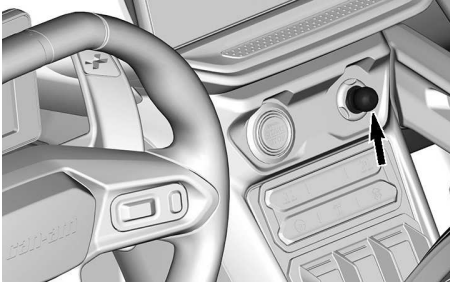

#### RF D.E.S.S. Key

For all D.E.S.S. related option, see an authorized Can-Am dealer for information.

### Digitally Encoded Security System (D.E.S.S.)

This vehicle is delivered with 1 D.E.S.S. key.

The ignition keys contain an electronic circuit that gives it a unique electronic serial number.

The D.E.S.S. system reads the key code and allows engine starting for keys it recognizes.

This vehicle can be operated using different types of key programming: Refer to your dealer for complete information.

#### NOTE:

Additional keys are available from your dealer as an accessory.

### **WARNING**

**Rollovers, tipovers, collisions and loss of control resulting in serious injury or death are possible with the performance or normal key. Using the normal key is not a substitute for the operator being prepared, qualified, and operating with care.**

#### D.E.S.S. Flexibility

The D.E.S.S. system of the vehicle can be programmed to recognize up to 8 different keys.

In this case, if you are the owner of many vehicles using a D.E.S.S. key, it is possible to use any of them with this vehicle.

Refer to your authorized Can-Am Off-road dealer to program the other D.E.S.S. keys.

### ENGINE START/STOP BUTTON

The ENGINE START/STOP button is located on the upper console, to the right of the steering wheel.

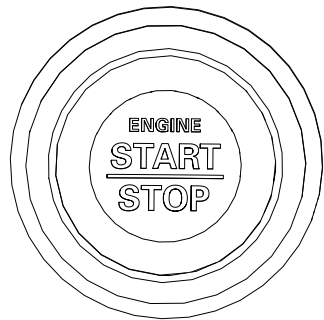

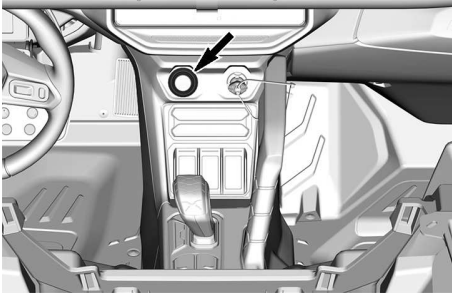

With the D.E.S.S. key inserted, press and hold the ENGINE START/STOP button to start the engine.

Press the same button to stop the engine,

To power up the electrical system without starting the engine, refer to *Waking Up the Electrical System*.

## HEADLIGHT DIMMER SWITCH

The headlight dimmer switch is located on the left-hand side of the dashboard.

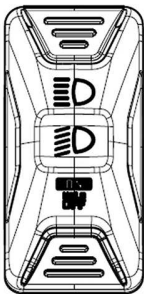

This switch is used to select either the low or high beams for the headlights.

Press and hold the lower button to turn the headlights off. Press the same button again to turn the headlights back on.

## OVERRIDE SWITCH

The override switch is located behind the electronic shifter.

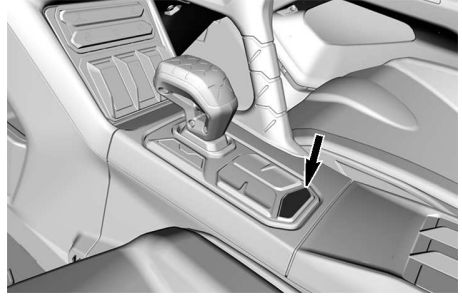

The override switch is used for the following:

- To bypass the engine speed limiter in reverse by allowing maximum engine torque. Refer to *Entering the Override Mode*.
- To allow the vehicle to be driven in the event of an accelerator pedal failure. Refer to *Entering the Manual Limp Home Mode*.
- In the case of a transmission fault, a message into the digital display will appear "Press override to confirm the standstill". This will allow select the Park. Then the electrical system can be completely shut off and woke up again. In most cases, this action will be enough to heal the fault. If not, see an authorized Can-Am Off-road dealer.

### ENTERING THE OVERRIDE MODE

While in reverse, press and hold the Override switch to enter the override (i.e., bypass) mode.

#### **⚠ WARNING**

**Use the override mode only if the vehicle is caught in mud or other soft terrain and the low range is not sufficient in reverse. Make sure that the area is secure before using the override mode. Do not use the override mode when driving normally in reverse. This would result in excessive speed.**

Release the Override switch to exit this mode.

### Entering the Manual Limp Home Mode

If one or both of the pedal position sensor(s) is (are) defective, the accelerator pedal will not respond.

Depending on the type of failure, pressing and holding the Override switch will temporarily restore the response of the pedal OR temporarily increase the engine speed to allow the vehicle to be driven.

Releasing the Override switch will release the throttle and allow the engine return to idle speed.

## KEYPAD

The keypad is located on the upper console.

The first click will show the current setting.

To change a setting, click again until the desired mode is reached.

On the X and X rs models, the keypad is used to navigate through various menus and options in the digital display and the touchscreen display.

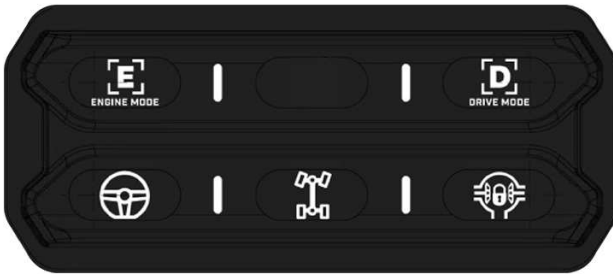



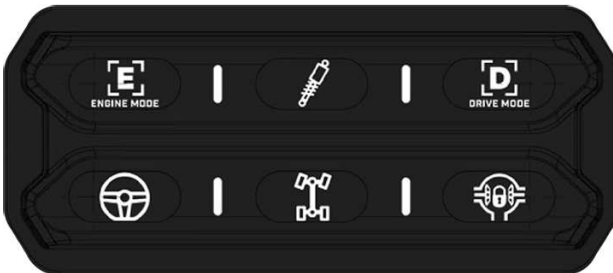

**X AND X RS MODELS WITHOUT SAS SUSPENSION**



**X RS MODEL WITH SAS SUSPENSION**

Icon	Use	Application
 ENGINE MODE	Switch between different engine modes*	<ul style="list-style-type: none"> <li>- Normal</li> <li>- Sport</li> <li>- Sport+</li> </ul>

	Switch between different suspension modes*	<ul style="list-style-type: none"> <li>- Comfort</li> <li>- Sport</li> <li>- Sport+</li> </ul>
	Switch between different drive modes*	<ul style="list-style-type: none"> <li>- Normal</li> <li>- Sport</li> <li>- Sport+</li> <li>- Custom</li> </ul>
	Switch between different power steering resistances*	<ul style="list-style-type: none"> <li>- Min</li> <li>- Med</li> <li>- Max</li> </ul>
	Switch between different traction modes*	<ul style="list-style-type: none"> <li>- 2WD</li> <li>- 4WD Trail</li> <li>- 4WD Trail Active</li> </ul>
	Activate or deactivate the front differential lock	<ul style="list-style-type: none"> <li>- If the vehicle is in 2WD, automatically goes in 4WD + Diff Lock</li> <li>- Once Diff Lock is removed, the vehicle will stay in 4WD</li> </ul>
* Refer to <i>Tune Your Ride</i> for more information.		

## HORN SWITCH (on applicable models)

To activate the horn, press the switch.

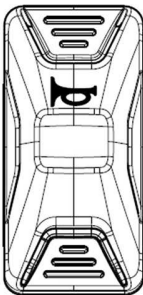

# EQUIPMENT

Some vehicle safety labels are not shown on illustrations. For information on vehicle safety labels, refer to *Important On-Product Labels*.

## TILT/TELESCOPIC STEERING WHEEL

<b>⚠ WARNING</b>
<b>Do not adjust the steering wheel position while driving. This may cause loss of control.</b>
<b>If the lever cannot be raised to the fixed position, adjust the steering wheel again. Driving without locking the steering wheel is dangerous and may cause the loss of control.</b>

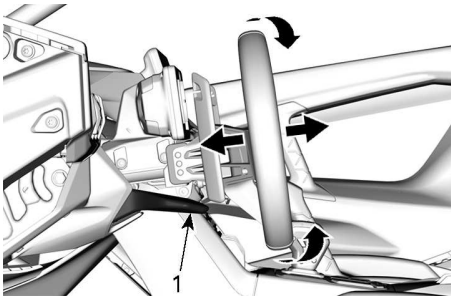

TILT AND TELESCOPIC MOVEMENTS

1. *Adjusting lever*
1. Adjust the seat position.
2. Move the adjusting lever down.
3. Move the steering wheel to the desired position.
4. Hold the steering wheel in this position and raise the adjusting lever to lock the mechanism in place.
5. Confirm that the steering wheel is securely locked by attempting to move it up, down, forward and backward.

## PASSENGER HANDHOLDS

There is one passenger handhold on the console and one in the right-hand door.

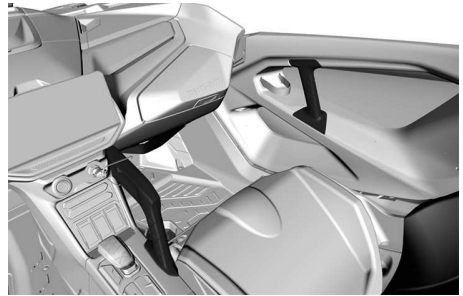

Holding the handholds helps the passenger brace against the movement of the vehicle and helps keep hands and body inside the cockpit in the event of a rollover.

<b>⚠ WARNING</b>
<b>Never use any part of vehicle cage as handholds. Hands can be struck by objects outside the cockpit or crushed in a rollover.</b>

Adjust the seat position in order to get a solid and comfortable grip on the handholds. Refer to *Seat Forward and Rearward Adjustment*.

## CENTRAL STORAGE COMPARTMENT

This compartment is located in the middle of the console.

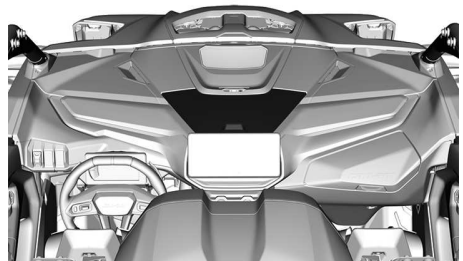

It is designed to hold small articles, like a cellphone.

This compartment includes the following:

- A 12-volt power outlet

- A dual USB port to charge your devices
- An additional USB with a screw-on cap is provided. This port must be used to UPDATE or PROGRAM the touchscreen display. Also, it can be used to charge a cellphone and connect the BRPGO app to the touchscreen display.

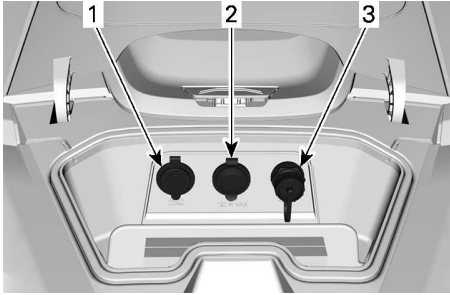

1. Dual USB port
2. 12- volt power outlet
3. Touchscreen USB port

## GLOVE BOX

The vehicle is equipped with a closed glove box, which is intended to carry light objects.

### NOTICE

This storage compartment can become hot during summer and also when using the vehicle at slow speed for a long period of time. Storing an electronic device like a cell phone is not recommended under these conditions because hot temperatures can cause permanent damage to the phone and its battery.

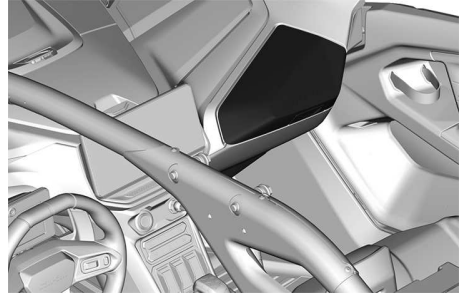

Glove Box Capacity	
Maximum load	5 kg (11 lb)



## TROUBLESHOOTING TOOLS



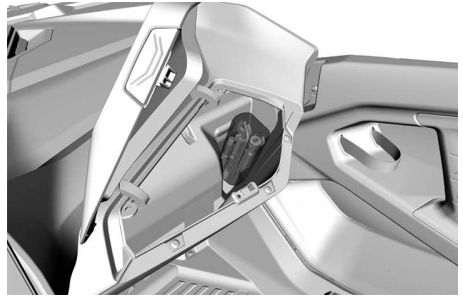



The vehicle comes with basic troubleshooting tools to help you in some situations.

The tools are located in the glove box.



The following troubleshooting tools are included with the vehicle:

Shift drum rotation tool	
Suspension adjustment tool	
Tool kit:	2-way screwdriver (flat and Phillips) 

	Pliers	
	Socket wrench, 14/16 mm	
	Open-end wrench, 15/17 mm	
	Open-end wrench, 10/13 mm	
	Combination wrench, 8 mm	
	T30 Torx key	
	Pressure gauge	

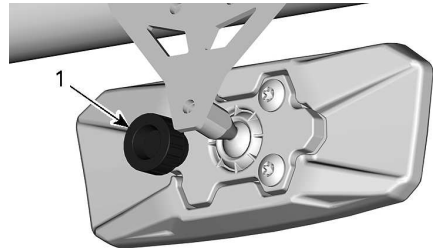
**BEHIND THE MIRROR**

1. Knob

**⚠ WARNING**

**Do not adjust mirrors while riding. You could lose control.**

## CENTRAL REARVIEW MIRROR

This vehicle comes equipped with a central rearview mirror.

Be aware that objects in the mirror are closer than they appear.

The mirror can be adjusted to suit driver's preference.

To adjust the mirror, loosen the knob located behind the mirror and tighten it to secure the mirror in position.

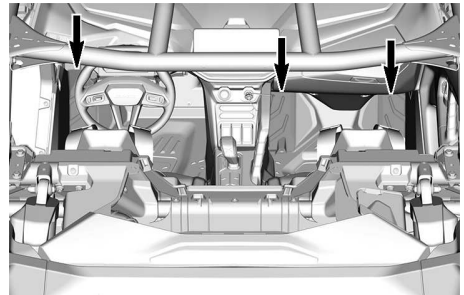

The footrests help minimize the risk of leg or foot injury.

Always wear appropriate riding gear.

## DOORS

The vehicle is equipped with doors to help occupants keep their body and limbs inside the vehicle, reducing the risk of injury.

The doors can also prevent the intrusion of branches and other foreign objects into the passenger compartment.

**⚠ WARNING**

**Never operate vehicle unless both doors are closed and secured.**

To open a door, pull on the strap to release the latch.

**SEAT BELTS**

This vehicle is equipped with seat belts to help to protect and keep the driver and passengers inside the cockpit in the event of a collision, rollover, or tip-over.

**⚠ WARNING**

**Wear seat belts properly at all times. Seat belts reduce the risk of injury in a crash and help keep limbs inside the cockpit during a rollover or accident.**

If the driver's seat belt is not fastened:

- When the ignition is turned ON, the seat belt indicator lamp will flash.
- When the engine is started, the vehicle is released from PARK, and the shift lever is moved to the "D" position, the vehicle speed will be limited to a maximum of approximately 20 km/h (12 mph) on flat ground.

**⚠ WARNING**

**The vehicle may reach higher or lower speed depending on inclines.**

To remind you to fasten the seat belts, the multifunction gauge will display the following message: ENGINE LIMITATION ENGAGED FASTEN SEAT BELT.

**⚠ WARNING**

**There is no indicator light or message for the passenger seat belt. The driver is responsible for the passenger's safety and should ensure that the passenger fastens their seat belt.**

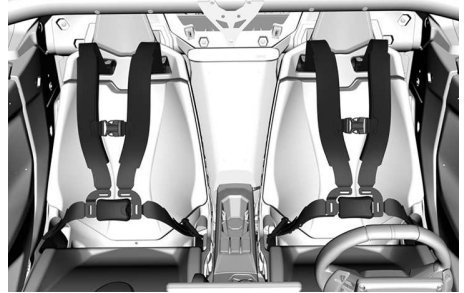
**4-POINT SEAT BELTS****⚠ WARNING**

**Wear seat belt properly. Make sure it remains securely fastened and tightened against the body. Make sure it is not twisted or defective.**

To fasten the seat belt, insert the latch plate into the buckle, then pull the belt to ensure it is properly fastened.





On both sides, adjust the seat belt tightly against your body by pulling the excess of the lap belt towards the inside. The buckle must be centered at the waistline (as low as possible).



To loosen the seat belt, hold the lap belt with one hand and pull the red strap outwards.



To detach the seat belt, push on the red button on the buckle.

## SEATS

### ADJUSTING THE SEAT POSITION

The seats can be adjusted forward or backward.

#### **⚠ WARNING**

**Never adjust the seat position while the vehicle is moving.**

1. Slide the adjustment lever to the right side.

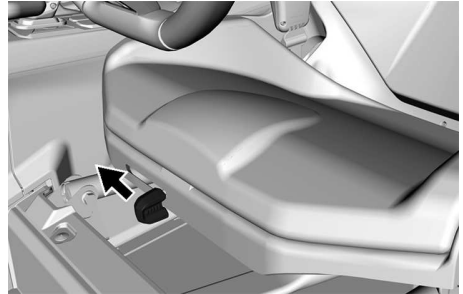

2. Move the seat to the desired position, then release the lever.
3. Try to move the seat forward and backward to make sure it is properly locked in place.

### Removing and Installing the Seat Cushion

1. Pull up the rear of the cushion, then free the cushion from the seat frame by pulling it off towards the rear.

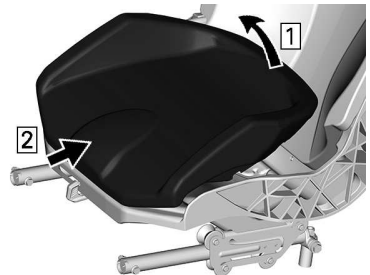

2. To install, reverse the removal procedure.

### REMOVING AND INSTALLING A SEAT

1. Remove the seat cushion.
2. Remove all four anchor points.

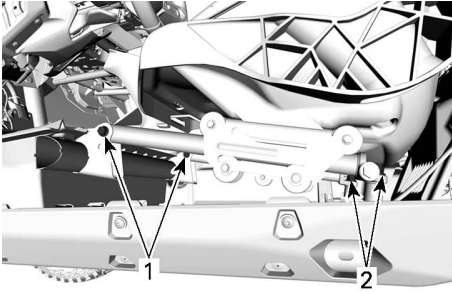
**SEAT ANCHOR POINTS**

1. Front anchor points
  2. Rear anchor points
3. Detach seat belt retractors and attachment points from the frame.

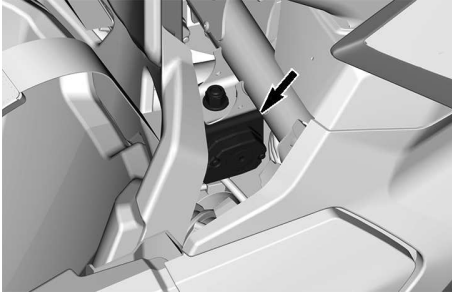
**SEAT BELT RETRACTOR - TYPICAL**

4. Discard all elastic stop nuts.
5. Remove the seat from the vehicle.
6. Before re-installing the seat, select the desired height adjustment.

The rear height is determined by the presence or absence of the sleeve.

- Install the sleeve for the maximum height.
- Remove the sleeve to put the seat in its lowest height.

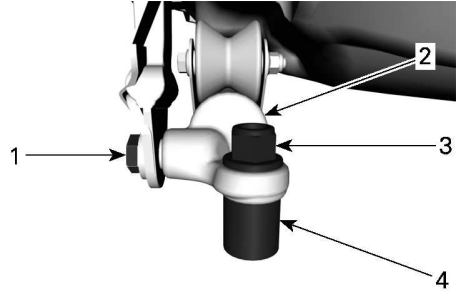
**REAR ANCHOR POINT - TYPICAL**

1. Seat belt bolt
2. Track
3. Elastic nut
4. Sleeve

The front height is determined by the position of the seat rails in their supports.

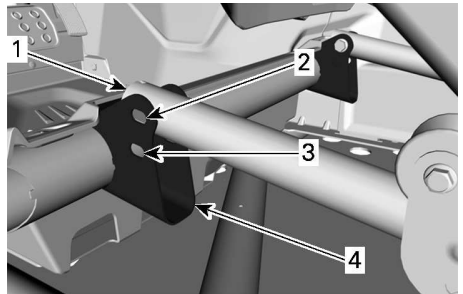

1. Seat rail
2. Upper position hole
3. Lower position hole
4. Seat support

7. Installation is the reverse of the removal. However, pay attention to the following.

**⚠ WARNING**

**Use new nuts when installing seat anchor points.**

Tightening Torque	
Rear anchor point	64.5 ± 6.5 Nm (48 ± 5 lbf-ft)
Front anchor point	24.5 ± 3.5 Nm (18 ± 3 lbf-ft)
Seat belt retractor and attachment points	64.5 ± 6.5 Nm (48 ± 5 lbf-ft)

## FUEL RESERVOIR CAP

The fuel reservoir cap is located at front on the right hand side of the vehicle.

To reach it, open the fuel reservoir cap cover.

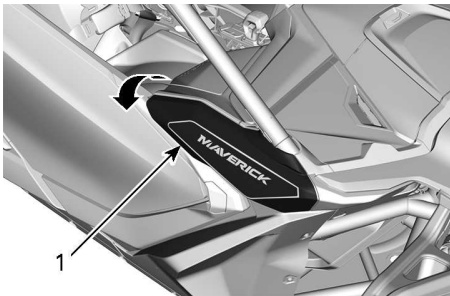

1. Fuel reservoir cap cover

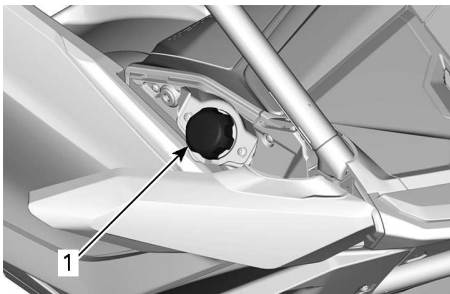

1. Fuel reservoir cap

Refer to *Fuel* for information on fueling procedure and fuel requirements.

## CARGO RACK

The cargo rack is convenient for carrying equipment and various other cargo.

### ⚠ WARNING

- Never carry a passenger on a cargo rack.
- Cargo must never interfere with the driver's line of sight or affect their ability to properly steer the vehicle.
- Do not overload the vehicle.
- Always ensure that all cargo is properly secured and does not extend beyond the rack.
- Never carry gasoline container (s) or any dangerous liquids on the cargo rack.



Always refer to *Vehicle Load Capacity Label* and *Cargo Warning Label* for load capacity and cargo information.

## ANCHORING HOOKS

To help to secure cargo inside the cargo box, four anchoring hooks are installed on the floor of the cargo box.

Also, four LinQ™ attachments are included to secure any BRP LinQ accessories. They can be installed in many configuration depending on which accessory is used.

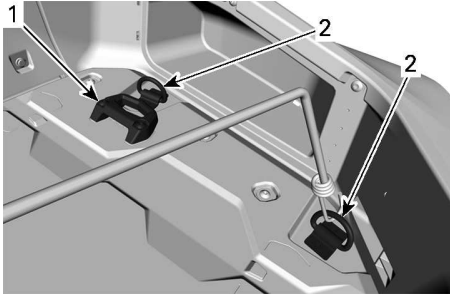

**CARGO BOX - RIGHT SIDE (TYPICAL)**

1. LinQ attachment
2. Anchoring hook

## RECOVERY POINTS

The vehicle is equipped with a front recovery hook and a rear recovery point.

These recovery points must be only used to recover a stuck vehicle.

### NOTICE

Recovery points are designed to recover a stuck vehicle only. They should not be used to carry a load or to attach a pulley or other mechanical device that can overload the attachment point. Doing so can cause damage to the vehicle frame.

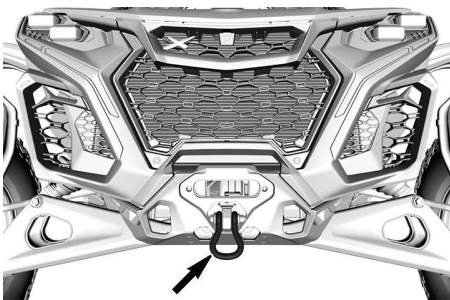

**FRONT RECOVERY HOOK**

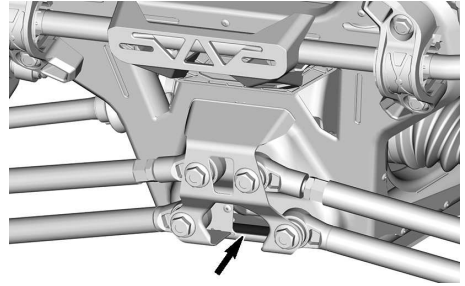

**REAR RECOVERY POINT**

## CUP HOLDERS

Three cup holders are available for your convenience.

### NOTE:

Do not use cup holders while riding in rough conditions.

Two cup holders are located at the rear of the lower console.

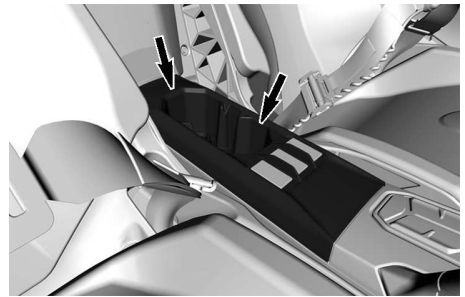

**CUP HOLDERS IN LOWER CONSOLE**

Another one is located on the floor, in front of the passenger's seat.

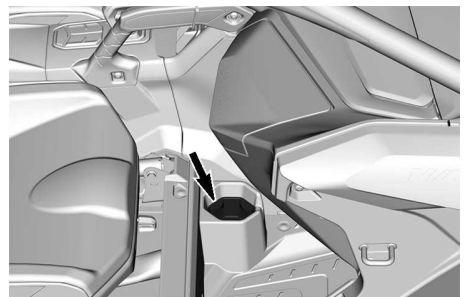

**FRONT CUP HOLDER**

# 4.5" DIGITAL DISPLAY

## Multifunction Display Lower Display

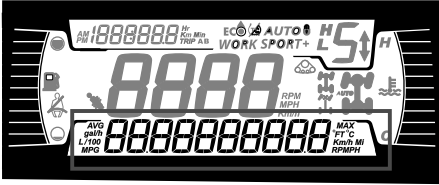

May display the following:

- RPM
- Speed statistics
- Engine Temperature
- Battery Voltage
- Settings
- Messages

Use LOWER button to change the displayed information.

## Left Lateral Display



The left lateral display includes:

- Fuel level indicator
- Seat belt icon
- Smart-Shox suspension icon

## Right Lateral Display

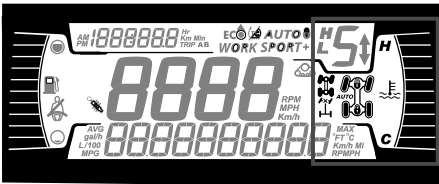

The right lateral display includes:

- Engine Temperature
- 2WD/4WD/Diff lock

Icon	Description
	2x4 icon
	4X4 icon
	Front differential lock

## Central Display



Display the vehicle speed in km/h or MPH or RPM.

## Transmission

## Position

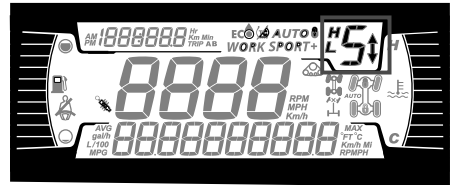

This display shows gear position of gearbox:

- P (Park)
- R (Reverse)
- N (Neutral)
- H (High Range)
- L (Low Range)
- Gear 1 to 7
- - (Invalid Range)

## Engine Mode Display



The MODE display indicates the selected mode of operation:

- AUTO mode
- NORMAL
- SPORT
- SPORT+
-  : Shift paddles deactivated in AUTO mode.

Drive Mode	Message at Activation
Normal	NORMAL MODE
Sport	SPORT MODE
Sport+	SPORT+ MODE

### Trip Display

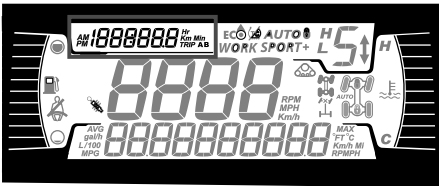

This display shows trip information:

- Cumulative distance odometer
- Trip A
- Trip B
- Vehicle hour meter
- Clock

Use UPPER button to change the displayed information.

Hold UPPER button to reset Trip A/B meters.

## Warning Lamps and Indicators







The following indicator lamps will alert you to a vehicle condition that may become serious. Some lamps will illuminate when starting the vehicle to make sure they work. If any lamps remain on after starting the vehicle, refer to the respective system warning lamp for further information.



### NOTE:

Some warning indicators appear in the display of the multifunction gauge and function the same as an indicator lamp but do not display when starting the vehicle.



### Telltale Lights - Lower Bar



Warning and Telltale Lights	
	ORANGE - Vehicle Malfunction
	BLUE - High Beam
	RED - The engine temperature is too high.
	GREEN - Neutral
	RED - (Blinking) Accelerator pedal and the brake are activated simultaneously for a certain time (a torque limitation is active)
	RED - Low battery.

Warning and Telltale Lights	
	RED - Low oil pressure (Normally ON at engine OFF)
	ORANGE - Low fuel level
	ORANGE - Check engine

### Icons and Indicators - Multifunction Display

Icons and Indicators	
<b>SPORT</b>	Denotes SPORT mode is selected.
	When lit, seat belt not buckled with vehicle immobilized.  Flashing when vehicle is moving.
	When lit, indicated that the shift paddles are deactivate.  Press the M button more than 5 seconds to reactivate the shift paddles.

### Settings

The buttons to navigate through menus are located on the left side of the LCD display.

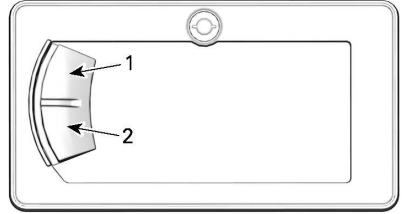

1. Upper button
2. Lower button

### Setup

Using LOWER button, select **SETTINGS** and hold to enter setting menu.

### Maintenance Reset

#### NOTE:

Only when the maintenance icon is displayed.

Using LOWER button, select **RES MAINT** and hold to reset maintenance.

### Fault Codes

Available only when at least one code is activated.

Using LOWER button, select **CODES** and hold to see active fault codes.

Fault codes will be scrolled on the Lower Display.

### Reset Stats

Using LOWER button, select **RESET STAT** and hold to reset.

### Unit Selection

This multifunction gauge is factory preset in Imperial units but it is possible to change it to Metric units.

Using LOWER button, select **UNITS** and hold button to change units.

### **Setting Clock**

All of the following action must be performed using the LOWER button.

1. Select **CLOCK** and hold to adjust clock.
2. Press the button to select clock display.
3. Push and hold the button for 1 second.
4. Press the button to select 12:00 AM PM or 24:00 time base.
5. Push and hold the button to acknowledge selection.
6. Press the button to change hours (hours flash).
7. Push and hold the button to acknowledge hour selection.
8. Press the button to switch to minutes (minutes flash).
9. Push and hold the button to acknowledge minutes selection.

### **Setting Language**

The gauge display language can be changed.

Refer to an authorized Can-Am Off-road dealer for language availability and to setup the gauge to your preference.

### **Setting Brightness**

The brightness of the LCD display can be adjusted.

Using LOWER button, select **BRIGHTNESS** and hold button to change brightness.

Using LOWER button, adjust brightness then push and hold the button to acknowledge selection.



# 10.25" COLOR TOUCHSCREEN DISPLAY

## Default Display

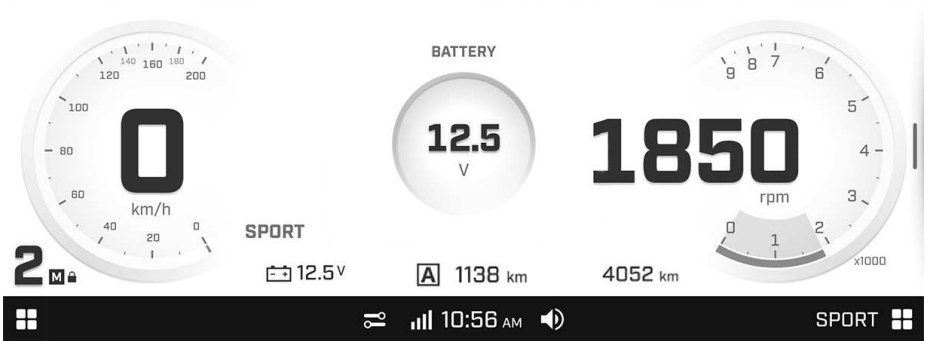

A dark mode is also available when riding in the evening or at night.

## Navigating the Digital Display

### **⚠ WARNING**

**Reading or tampering with the digital displays can distract you from the operation of the vehicle, particularly from constantly scanning the environment. Always pay attention to road conditions, ensure your environment is clear and free from obstacles. Furthermore, when riding, only glance at the digital displays briefly to maintain awareness of road conditions.**

We recommend that you practice selecting some functions on the infotainment center before starting your ride. You will get used to them, and they will be easier to use during the ride.

The display is touchscreen, you can navigate the different menus and functions while the vehicle is at rest.

The touchscreen is disabled at 5 km/h (3 MPH).

The steering wheel multifunction buttons can also be used to navigate the menus and functions of the display, even when the vehicle is moving.

Pressing the **Applet Switcher** button on the LH side of the steering will allow you to cycle through the apps in the right lateral display, in the order that can be defined in the preferences.

## Center Display

In full-gauge view, long tap in the upper-center area of the screen to show one of the following extra gauges. Use additional long taps to cycle through the extra gauges:

- Battery Voltage
- Gear Indicator
- Boost % (turbo boost percentage)

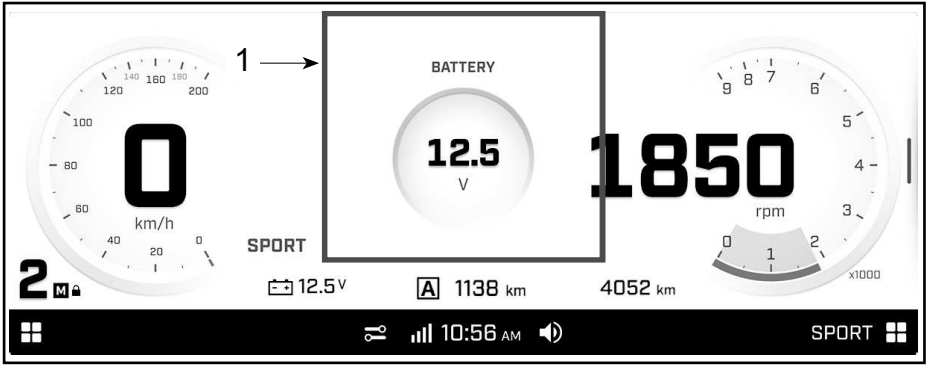

1. Long tap in this area to view extra gauges

In full-gauge view, long tap in the lower-center area of the screen to show the following information. Use additional long taps to cycle through the items:

- Trip A distance
- Trip A hours
- Trip B distance
- Trip B hours

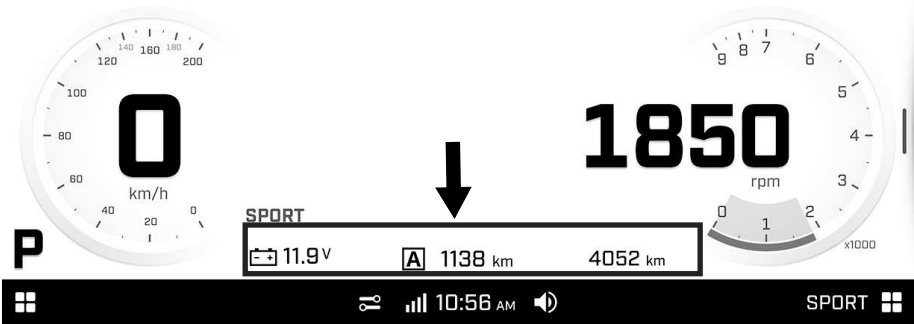

## Views Display

To change from full-gauge view to narrow view, press the applet switcher or drag the divider from the right side of the display.

To change back to full-gauge view, long press on the applet switcher or drag the divider to its original position.

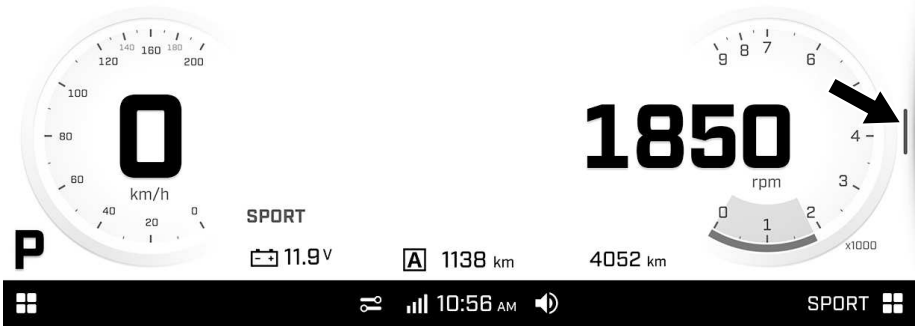

The sizes of the left and right lateral displays cannot be adjusted.

### Left Lateral Display

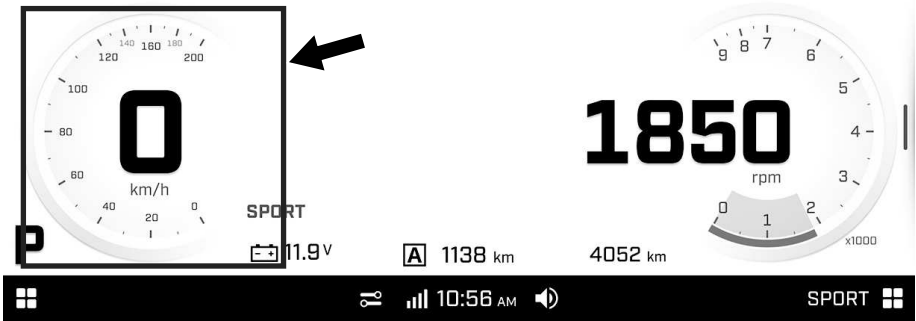

In narrow view, the left lateral display includes:

- Gauge
  - Battery voltage
  - Vehicle hours or Odometer
  - Speedometer
  - Trip meter
- Tachometer
- Media

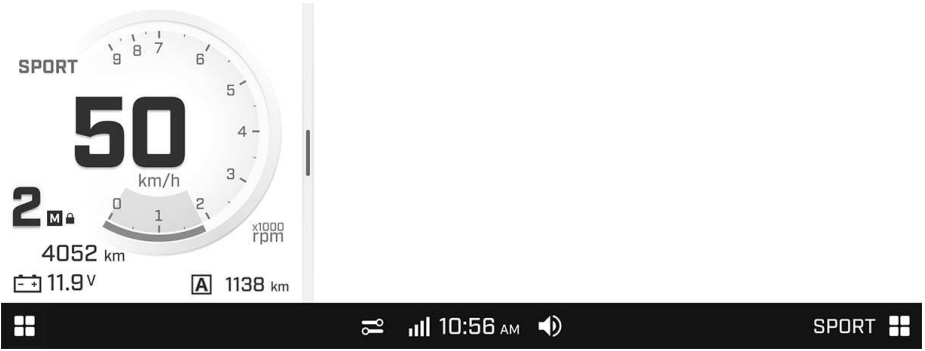

**NOTE:**

To select between Gauge or Media, press the App Menu icon on the bottom left of the screen.

In narrow view, long tap the trip meter to show one of the following. Use additional long taps to cycle through the items.

- Trip A distance
- Trip A hours
- Trip B distance
- Trip B hours

**Right Lateral Display**

In narrow view, the right lateral display includes various apps. Refer to *Right APP Menu* for more information.

**Right APP Menu**

To access the right app menu, tap the **App Menu** icon in the bottom-right corner.

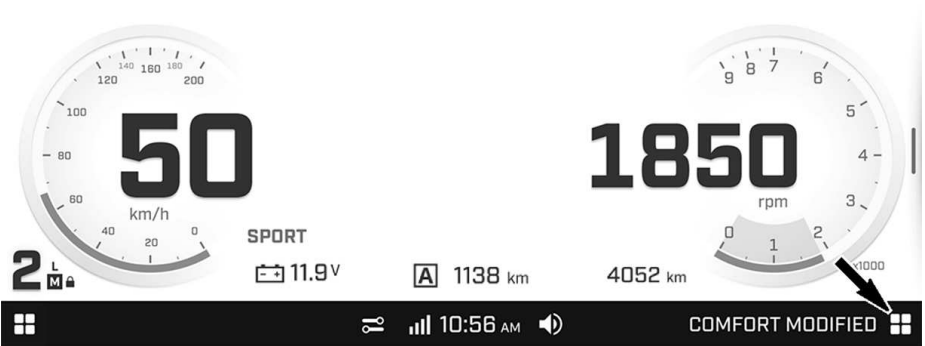

Select through the illustrated icons to open the corresponding app.

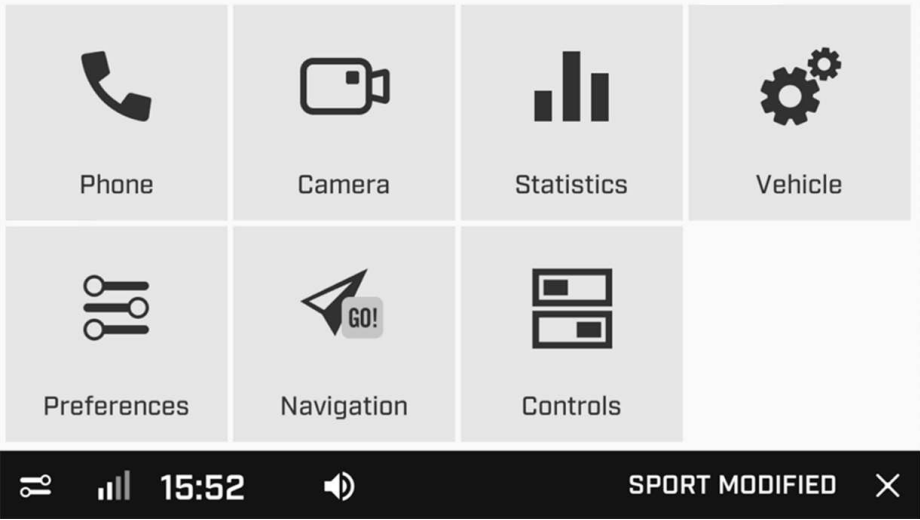

## Phone



To have access to the *Phone* menu, a phone and a headset must be paired. Refer to *Pair Your Smartphone Through Bluetooth*.

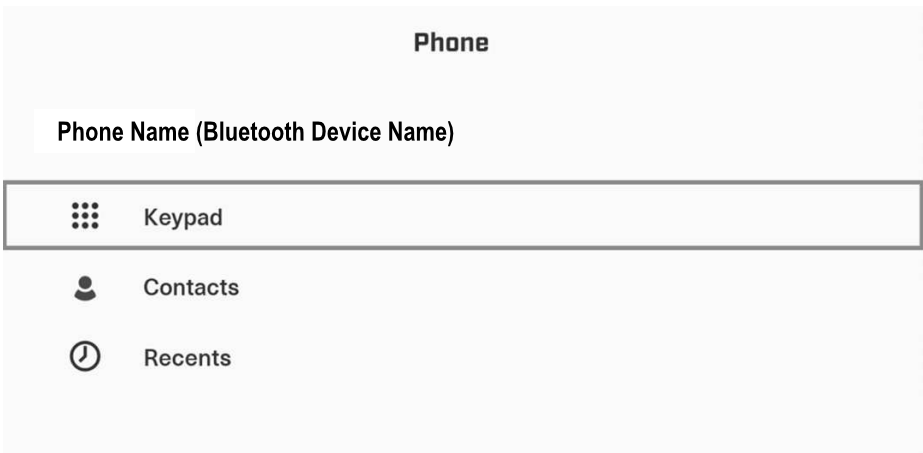

The *Phone* applet is used to access the following:

- The keypad
- The phone contact list
- The phone history

## Camera

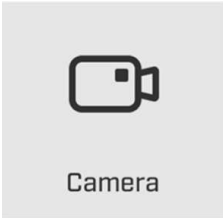

Allow to active the vehicle's cameras (if equipped) to view the areas behind or in front of the vehicle.

## Statistics



### Statistics

||■ Current Ride

**A** Trip A

**B** Trip B

The *Statistics* applet is used to access the following:

- Trip distance information
- Trip elapsed time information
- Average speed

Three sets of statistics are stored in memory.

- Trip A can be reset independently.
- Trip B can be reset independently.
- Current ride statistics will be reset when the vehicle restart.

## Vehicle Settings

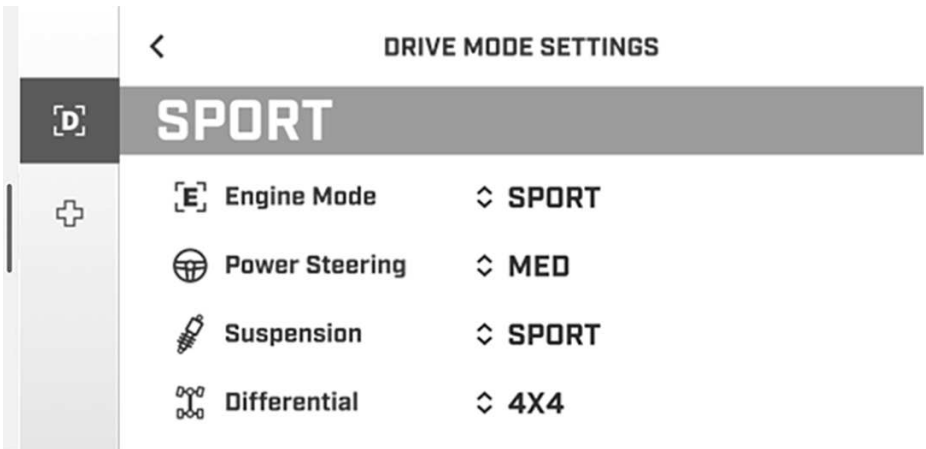
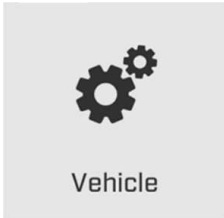

The *Vehicle Settings* menu is used for the following:

- Adjusting the drive mode settings
- Viewing vehicle health:
  - Vehicle information
  - Maintenance
  - Faults (codes and descriptions)

## Preferences



The *Preferences* applet is used for the following:

- Adjusting the display brightness and appearance (LIGHT/DARK/AUTO)
- Pairing Bluetooth devices:
  - Phone
  - Driver headset
  - Passenger headset
- Connecting the vehicle to a Wi-Fi network
- Accessing to the *Audio* menu
  - Configure the audio output (headset or speaker (if equipped))
  - Access to Fade/Balance configuration
- Accessing *General* settings:
  - Adjusting the units (Imperial/Metric)
  - Setting the language
  - Setting the date and time
  - Updating the software via WiFi
  - Getting information about the manufacturer information and device regulatory compliance
  - Resetting the display to factory settings
- Defining the apps to be used with the Applet Switcher button while riding
- Defining the settings to be used with the Ride Settings button while riding

It is recommended that you check regularly for software updates.

## Quick Preferences

To access the *Quick Preferences* menu, tap the following icon.

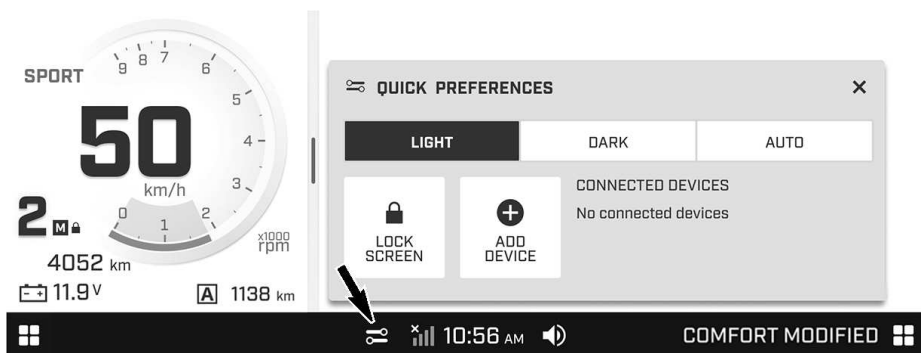

The *Quick Preferences* menu is used for the following:

- Adjusting the display appearance (LIGHT/DARK/AUTO)
- Locking the screen (press and hold anywhere on the screen to unlock)
- Adding a Bluetooth device
- Viewing connected Bluetooth devices

## Navigation



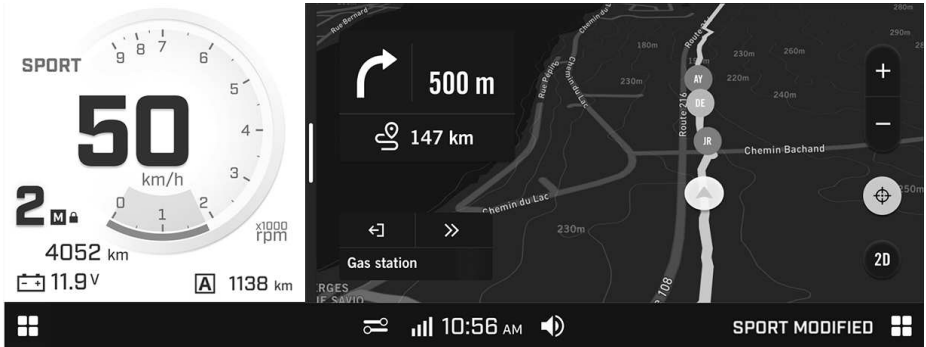

To use the Navigation applet on the display, you must connect via USB connection a mobile device with the BRP GO! app. The app can be downloaded from the Apple App Store or Google Play Store via a simple search.

The mobile device must be connected with a USB cable to the touchscreen USB port (with a screw-on cap) located in the central storage compartment.

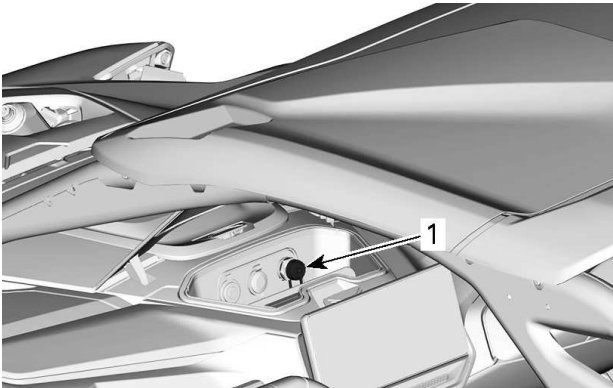

1. Touchscreen USB port

For more information on the BRP GO! app (installed and opened), see the BRP GO! section in this document or visit the Can-Am Off-Road website.

– [www.brpconnecttutorial.com](http://www.brpconnecttutorial.com)

User agrees that personal data (contact list and call history) be transferred to the cluster when device is connected.

User's personal data will be deleted from the cluster when the device is disconnected.

## Controls

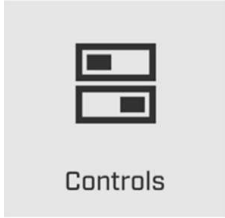

The Controls menu is used for the following:

- Controlling your accessories
- Adding an accessory to the Controls menu
- Deleting an accessory from the Controls menu
- Edit SMART CONTROL CENTER buttons (optional)

After opening the *Controls* menu, press the 3 dots on the upper right side of the screen.



Select the required action.

## Manage Accessory



Add Accessory



Delete Accessory

## Left APP Menu

To access the left app menu, tap the **App Menu** icon in the bottom-left corner.

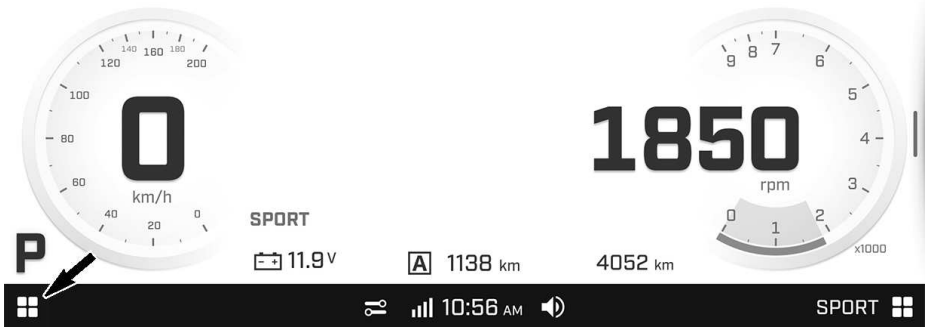

Tap an icon to open the corresponding app.

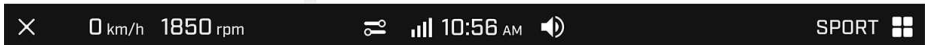
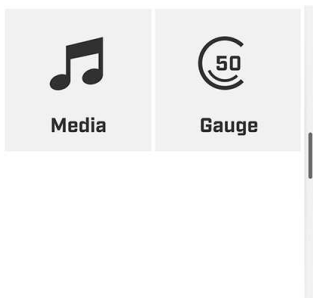

## Media

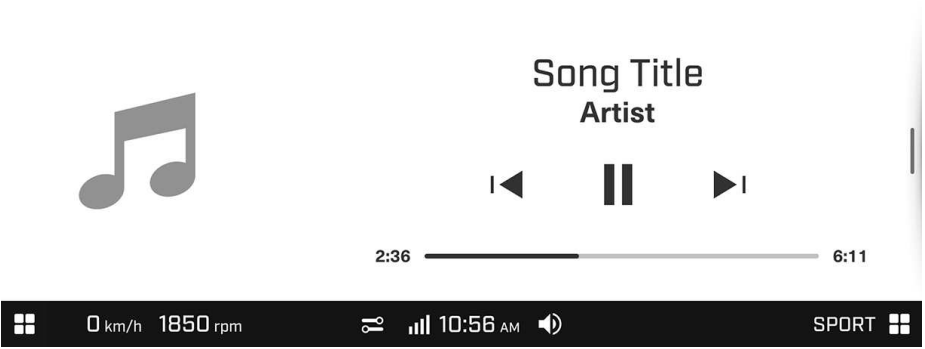

The Media applet is used to:

- Control song choice and volume in the helmet or vehicle audio system
- View song information (when available)

This vehicle is not equipped with speakers. An appropriate helmet audio system is required to listen to music.



A speaker kit can also be added as accessories.

## Gauge

The *Gauge* menu is used to return to the Default display.

## Icons and Indicators - Multifunction Display

Icon	Description
	App menu
	Audio volume
	Bluetooth
	Clock
	Quick preferences
	Drive modes
	Smartphone network connection

Icon	Description
	Temperature
	Wi-Fi

## Pairing Your Smartphone Through Bluetooth

### On the Vehicle

1. Open the *App* menu.
2. From the *Preferences* menu, choose **Bluetooth**.

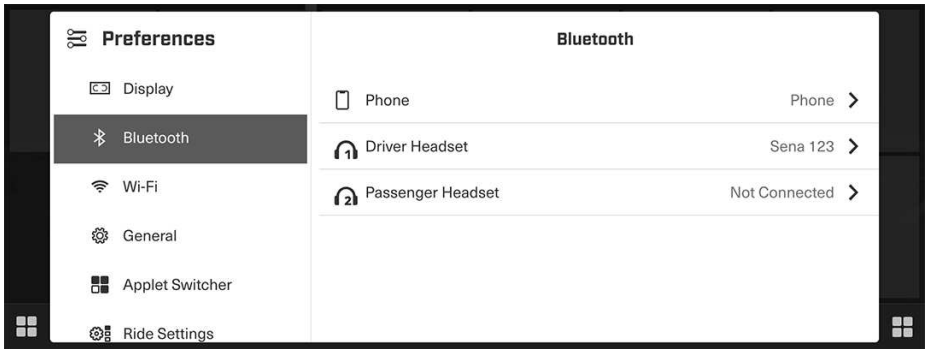

3. Expand **Phone**.
4. Select **Add Device**.

### NOTE:

Up to two smartphones can be paired with the vehicle. However, only one will connect at any given time.

### ON THE PHONE

1. Activate your phone's Bluetooth™ function.

### NOTE:

Refer to your phone manufacturer's user guide for the detailed procedure.

Once the vehicle display finds your phone, its name (i.e, **BRP\_[last 4 digits of the vehicle's VIN]**) will appear on the phone.

2. On the vehicle display, select your phone's name.
3. A confirmation number will appear on your phone *and* on the vehicle display. Make sure that these numbers match.
4. On your phone, tap **Pair**.
5. Allow **Contacts and Favorites Sync** on your phone to use **Recent** and **Contacts** in the phone app.

A notification will confirm the pairing.

### ***Pairing a Helmet***

To pair a helmet, refer to *Pairing your Smartphone Through Bluetooth*. Then select **Driver Headset** or **Passenger Headset**.

## **BRP Connect**

Follow these steps to set up your smartphone with *BRP Connect*.

### ***1) Download the BRP GO! Smartphone App***

Download the BRP GO! app via the App Store for Apple™ or the Google™ Play Store for Android.

### ***2) Connect Your Smartphone Using a USB Cable***

It is recommended to use an original charging cable from the smartphone OEM to optimize transfer between the phone and the vehicle.

The USB cable must be connected to the USB port with a screw-on cap located in the central storage compartment.

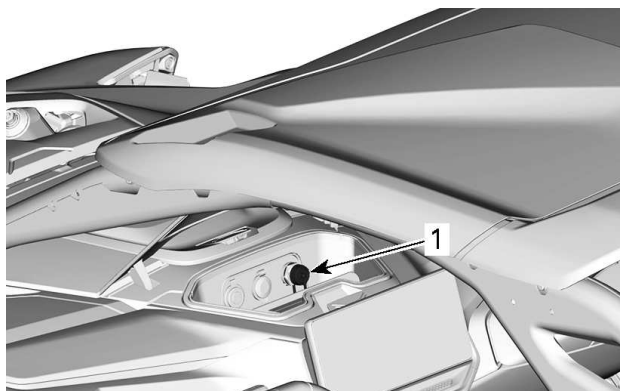

1. USB port with a screw-on cap

1. Unlock your phone screen
2. Connect your phone charging cable
3. A checkmark will appear on your phone screen once the connection is done.

### ***3) Access the Navigation Applet***

The Navigation applet can be selected either by tapping the **App Menu** icon in the bottom-right corner of the touchscreen display or using the left applet switch on the steering wheel.

In the App Menu, select "Navigation".



## Quick Tour of the BRP GO! App



1. My Profile: Manage your profile and your account settings.
2. Playground: Select your playground to see content related to your vehicle.
3. Navigation: Access all the navigation features of the app such as route planning, turn-by-turn navigation, friends location, offline navigation, and more. Maps may vary depending on the region where you are located.
4. BRP Connect: See the list of compatible apps that can be used on the vehicle's display. You can also access from there the Vehicle Connection Guide to help you connect your phone to your vehicle's display.

5. FAQ: This link takes you to answers of common questions asked by riders like you. An internet connection is required.
6. Rides: Easily access your planned and completed rides made with the Navigation features of the BRP GO! app.
7. Accessories, Parts and Gear: This link takes you to the online store of your vehicle. An internet connection is required.

## Messages in Touchscreen Display

Infotainment notifications include messages regarding connected devices

Notifications will always appear at the top right corner of the screen.

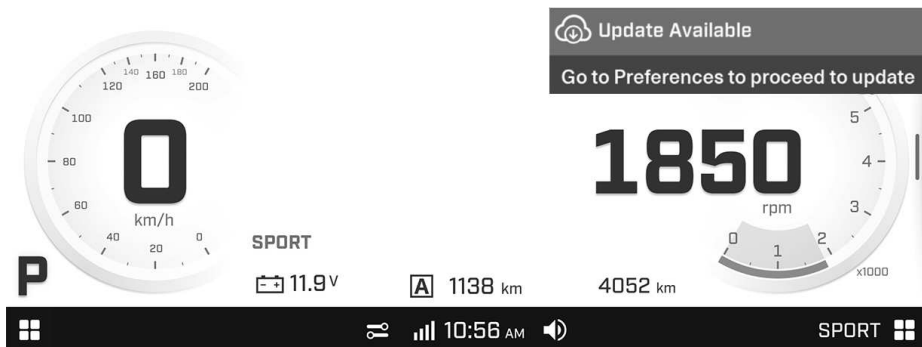



# TUNE YOUR RIDE

## Drive Mode

Use this button  on the keypad to select the Drive modes

The drive modes are a combination of many predetermined settings.

MODE	SUSPENSION	DPS	4WD
Normal	Comfort	Max	TRAIL
Sport	Sport	Max	TRAIL Active
Sport+	Sport+	Max	TRAIL Active

You can also create a personalized Drive mode by choosing the settings that best suit your driving style.

## Engine Mode

Use this button  on the keypad to select the Engine modes

The NORMAL setting reduces the fuel consumption and the comfort by limiting throttle response and selecting a higher gear to maintain an optimal cruising setting. Use the NORMAL mode can also be used on bumpy trails to provide smoother ride conditions.

The SPORT mode provides a crisper throttle response.

The SPORT+ mode provides a crisper throttle response without turbo lag and maintains higher turbo speed t low engine load for an optimal dynamic response.

### NOTE:

The transmission behavior is also impacted by the engine mode. The SPORT and SPORT+ modes will shift at higher rpm, downshift sooner and maintain a lower gear to optimize acceleration and response.

To change between engine modes, press ENGINE MODE button on keypad to cycle through available modes.

MODE	Setting
Normal	Low shifting point Idle speed around 1500 RPM Use for a smooth ride
Sport	Higher shifting point than Normal mode Idle speed around 1800 RPM Use for a more sportive ride
Sport+	Higher shifting point without boost lag Idle speed around 2500 RPM Use for the extreme ride

## 4WD Mode

Use this button  on the keypad to setup the differential modes.

The first press will show the current 4WD state.

A second press will change the 4WD mode to the next one.

The 4WD will mechanically engages only when the engine is running and can be activated on the fly.

To engage 4WD with the engine off, apply full throttle and hear to confirm for the 4WD solenoid engagement.

## 4WD Trail

This mode must be used during all normal riding.

The front differential will automatically synchronize the front wheels as needed.

## 4WD Trail Active

This mode is used to increase traction on the front drive train.

This will optimize traction while going out of a corner and/or while doing hard acceleration by the detection of the engine torque required by the driver.

When using this mode, you need to adjust of your driving style as the front drivetrain is going to pull more than usually.

### 4WD Front Diff Lock

This mode locks the front differential.

The front differential is kept locked until the button is pushed again to unlock.

When using this mode, you need to adjust of your driving style as the front drivetrain is going to pull more than usually.

<b>⚠ WARNING</b>
<b>The fully locked option of the front differential reduces the maneuverability of the vehicle in certain conditions.</b>

### DPS Function

The tri-mode Dynamic Power Steering (DPS) offers easy steering assistance to the rider. The level of assistance adapts automatically according to the vehicle's speed and the rider's demand, in order to provide maximum steering power at lower speeds, where the demand is normally higher. As speed increases, the level of assistance is progressively reduced to keep maximum precision and steering feel for the rider.

It is possible to choose between three modes of assistance: Minimum, Medium, and Maximum. These modes are used to set the level of assistance to match each rider's preferences. Each mode will continue to adapt

automatically, so it does not need to be changed while riding.

The following DPS modes are preset in the vehicle.

DPS MODE	
DPS MAX.	Maximum steering assist
DPS MED.	Medium steering assist
DPS MIN.	Minimum steering assist

To view the active DPS mode, proceed as follows:

1. Press and release the **DPS** button  on the keypad or the right control on the steering wheel.

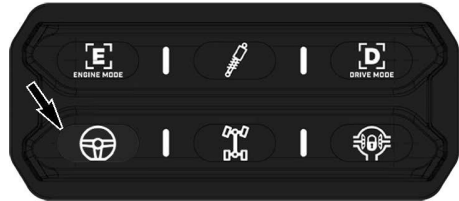

DPS BUTTON ON KEYPAD - TYPICAL

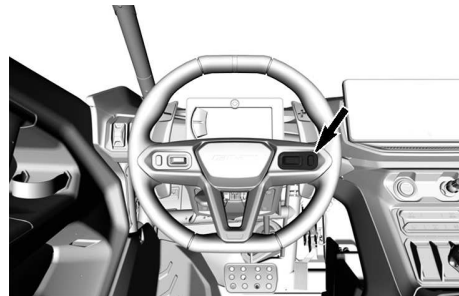

STEERING WHEEL - RIGHT CONTROL

2. Check the message into the digital display to confirm the active DPS mode.

To change the DPS mode, proceed as follows:

3. Press and release **DPS** button.

4. Check the message into the digital display to confirm the active DPS mode.
5. Press and hold the **DPS** button for 2 seconds to go to the next setting.
6. Release the **DPS** button.
7. Repeat until desired setting is obtained.

**NOTE:**

The DPS adjustment will not be possible if the gearbox is set to **REVERSE**.

## Suspension Adjustment Guidelines

Handling and comfort of the vehicle depend upon suspension adjustments.

### **⚠ WARNING**

**Suspension adjustment could affect vehicle handling. Always take time to familiarize yourself with the vehicle's behavior after any suspension adjustment has been made.**

Choice of suspension adjustments vary with vehicle load, personal preference, riding speed and terrain condition.

The best way to set up the suspension, is to start from factory settings, then customize each adjustment one at a time.

Front and rear adjustments are inter-related. It may be necessary to readjust the rear shock absorbers after adjusting front shock absorbers for instance.

Test run the vehicle under the same conditions; trail, speed, load, etc.

## Suspension Factory Settings

For adjustment procedures, refer to *Suspension Adjustments*.

### Front Suspension Factory Settings

Change one adjustment and retest. Proceed methodically until you are satisfied.

Following are guidelines to fine-tune suspension.

### SHOCK ADJUSTMENT LOCATION

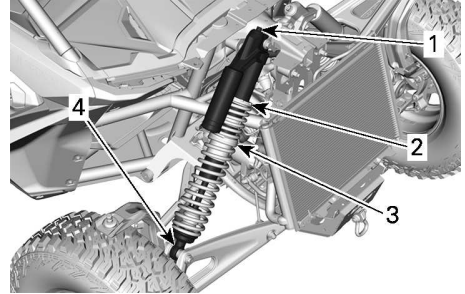

#### TYPICAL - FRONT SUSPENSION

1. Compression damping (high speed and low speed)
2. Preload
3. Spring crossover
4. Rebound damping

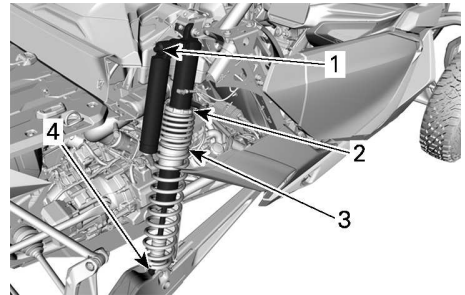

#### TYPICAL - REAR SUSPENSION

1. Compression damping (high speed and low speed)
2. Preload
3. Spring crossover
4. Rebound damping

Spring Preload	
Maverick R X	44.1 mm (1.74 in)
Maverick R X rs	83 mm (3.27 in)
Maverick R X rs with Smart-Shox	83.5 mm (3.29 in)

Crossover ring position	
Maverick R X	99.1 mm (3.9 in)
Maverick R X rs	114.3 mm (4.5 in)
Maverick R X rs with Smart-Shox	51.6 mm (2.03 in)

Compression Damping	
Maverick R X	Position 2

Compression Damping (LOW SPEED)	
Maverick R X rs	2 turns

Compression Damping (HIGH SPEED)	
Maverick R X rs	2 turns

Rebound Damping	
Maverick R X rs	Position 12

## Rear Suspension Factory Settings

Spring Preload	
Maverick R X	283.9 mm (11.2 in)

Maverick R X rs	212.9 mm (8.4 in)
Maverick R X rs with Smart-Shox	235.1 mm (9.26 in)

Crossover ring position	
Maverick R X	55.9 mm (2.2 in)
Maverick R X rs	114.3 mm (4.5 in)
Maverick R X rs with Smart-Shox	101.6 mm (4 in)

Compression Damping	
Maverick R X	Position 2

Compression Damping (LOW SPEED)	
Maverick R X rs	2 turns

Compression Damping (HIGH SPEED)	
Maverick R X rs	2 turns

Rebound Damping	
Maverick R X rs	Position 12

## Suspension Adjustments

### *Spring Preload Adjustment*

Shorten the spring for a firmer ride and rough riding conditions, or when carrying a load.

Lengthen the spring for a softer ride and smooth riding conditions.

### **WARNING**

**The left and right shock adjustment on front or rear suspension must always be set to the same position. Never adjust one shock only. Uneven adjustment can cause poor handling and loss of stability, which could lead to an accident.**

Lift the vehicle. The spring length should be measured without any load on the wheels.

The spring length should be the same on both sides.

Adjust by loosening the lock ring and turning the adjuster ring as desired. Use the tool from the vehicle tool kit.

**NOTE:**

Factory settings are suitable for almost all conditions. Take into consideration that an increase in ground clearance can affect the handling of the vehicle.

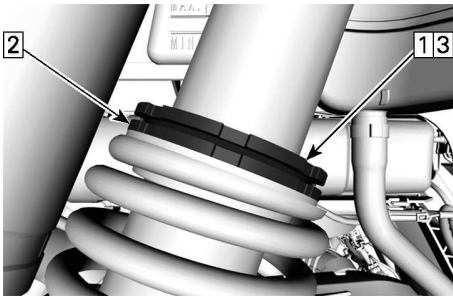

**TYPICAL**

1. Loosen top locking ring
2. Turn adjusting ring accordingly
3. Tighten top locking ring

**Adjusting Spring Crossover**

Dual compression rate crossover point can be modified by adjusting the crossover rings position. See an authorized Can-Am dealer.

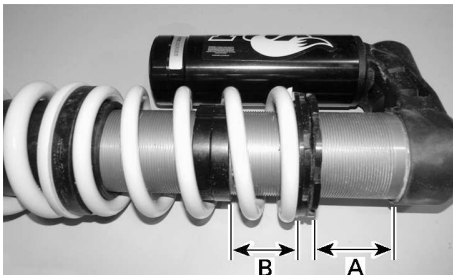

**TYPICAL - CROSSOVER ADJUSTMENT - REAR SHOCK**

- A. Spring preload
- B. Crossover ring position

**Low-Speed Compression Damping (If Equipped)**

Low-speed compression damping controls how the shock absorber reacts to a low suspension velocity (slow compression strokes, in most cases when riding at lower speeds).

Action	Result on Big Bumps
Increasing low-speed compression damping force	Firmer compression damping (slow compression)
Decreasing low-speed compression damping force	Softer compression damping (slow compression)

To adjust the low speed compression damping:

1. Turn the adjuster screw clockwise until it stops.
2. Turn the adjuster screw counter-clockwise the required number of turns.

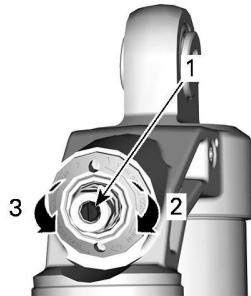

**LOW-SPEED COMPRESSION DAMPING (USE A SCREWDRIVER)**

1. Adjustment screw
2. **Increases** compression damping (stiffer)
3. **Decreases** compression damping (softer)

**High-Speed Compression Damping (If Equipped)**

High-speed compression damping controls how the shock absorber reacts to a high suspension velocity

(quick compression strokes, in most cases when riding at higher speeds).

Action	Result on Small Bumps
Increasing high-speed compression damping force	Firmer compression damping (fast compression)
Decreasing high-speed compression damping force	Softer compression damping (fast compression)

To adjust the high-speed compression damping:

1. Turn the adjuster nut clockwise until it stops.
2. Turn the adjuster nut counterclockwise the required number of turns.

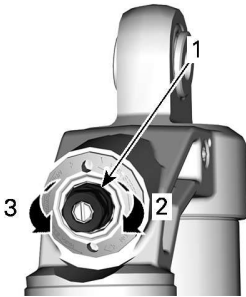

#### **HIGH-SPEED COMPRESSION DAMPING (USE A 17-MM WRENCH)**

1. *Adjustment screw*
2. **Increases** compression damping (*stiffer*)
3. **Decreases** compression damping (*softer*)

#### **Rebound Damping (If Equipped)**

Using a flat screwdriver, adjust the rebound damping as follows:

1. Turn the adjuster clockwise until it stops.
2. Turn the adjuster counterclockwise to the required position (clicks).

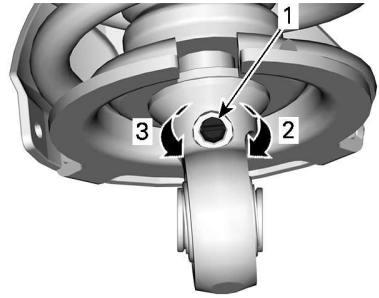

1. *Rebound adjuster*
2. **Increases** rebound (*stiffer*)
3. **Decreases** rebound (*softer*)

#### **Smart-Shox Suspension Mode**

The Smart-Shox suspension is an electronically controlled compression and rebound damping system that is integrated into each shock absorber.

It is possible to choose between three modes of damping. These modes set the level of damping to match the rider's preferences.

The following Smart-Shox modes are preset in the vehicle.

Smart-Shox Mode	
COMFORT	This mode provides maximum comfort. The suspension moves freely while controlling body movement to avoid bottoming. It also enhances cornering and acceleration.
SPORT	This mode enhances handling and provides comfort in a straight line. The suspension minimizes body movement when cornering, accelerating, and braking while offering optimal calibration for bumpy trails.
SPORT+	This mode is all about performance. Forget comfort. Ready all the time to tackle the most extreme situations.

To select the Smart-Shox mode, proceed as follows:

Using the Keypad (X rs model only):

1. Press the Suspension (top-center) button on the keypad.

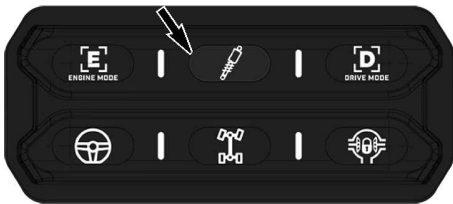

2. Check the touchscreen or the 4.5" digital display for the selected mode.



### 10.25" TOUCHSCREEN

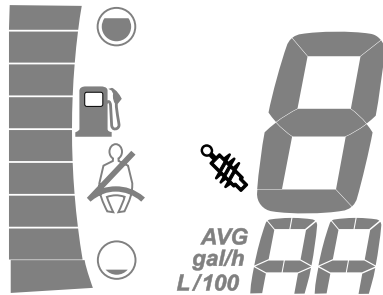

### 4.5" DIGITAL DISPLAY

3. Press the Suspension button again, until the correct mode is displayed.

Using the Steering Wheel Controls:

1. Use the right steering control to navigate to the *Drive Mode Settings* menu on the touchscreen.

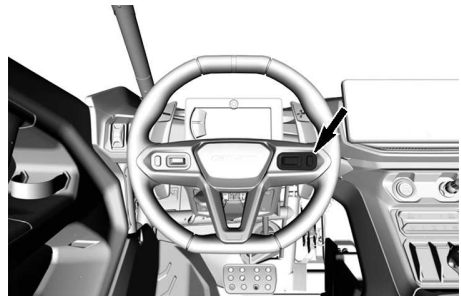

2. Check the touchscreen for the selected mode.
3. Press the right steering control again, until the correct mode is displayed.

Using the Touchscreen:

1. Tap the **App Mode** icon in the bottom-right corner of the screen.



2. Select **Drive Mode Settings**.
3. Scroll to the desired suspension mode.

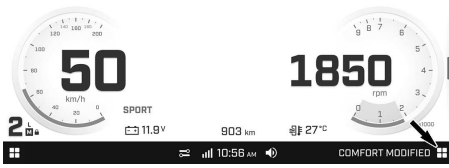

# FUEL

## FUEL REQUIREMENTS

### NOTICE

Always use fresh gasoline. Gasoline will oxidize; the result is loss of octane, volatile compounds, and the production of gum and varnish deposits which can damage the fuel system.

Alcohol fuel blending varies by country and region. Your vehicle has been designed to operate using the recommended fuels, however, be aware of the following:

- Use of fuel containing alcohol above the percentage specified by government regulations is not recommended and can result in the following problems in the fuel system components:
  - Starting and operating difficulties.
  - Deterioration of rubber or plastic parts.
  - Corrosion of metal parts.
  - Damage to internal engine parts.
- Inspect frequently for the presence of fuel leaks or other fuel system abnormalities if you suspect the presence of alcohol in gasoline exceeds the current government regulations.
- Alcohol blended fuels attract and hold moisture which may lead to fuel phase separation and can result in engine performance problems or engine damage.

### **Recommended Fuel**

Use premium unleaded gasoline with an AKI (R+M)/2 octane rating of 91, or an RON octane rating of 95.

Use unleaded gasoline containing MAXIMUM 10% ethanol.

**E10**

### NOTICE

Never experiment with other fuels. Engine or fuel system damages may occur with the use of an inadequate fuel.

### NOTICE

Do NOT use fuel from fuel pumps labeled E85.

Use of fuel labeled E15 is prohibited by U.S. EPA Regulations.

## VEHICLE FUELING PROCEDURE

### ⚠ WARNING

- Fuel is flammable and explosive under certain conditions.
- Never use an open flame to check fuel level.
- Never smoke or allow flame or spark in vicinity.
- Always work in a well-ventilated area.
- Vehicle must be on a level surface to perform fueling.

1. Place vehicle on a level surface.
2. Stop engine.

### ⚠ WARNING

Always stop engine before refueling.

3. Have driver and passenger get out of vehicle.

**⚠ WARNING**

**Do not allow anyone to remain in the vehicle while fueling. If there is a fire or explosion during fueling, a vehicle occupant could be unable to quickly leave the area.**

4. Open the fuel reservoir cap cover.

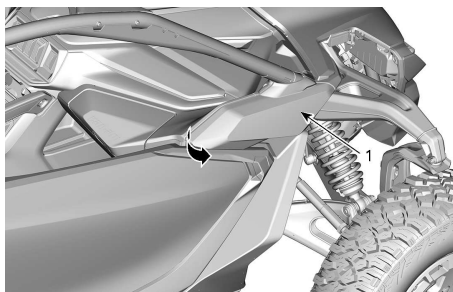

1. Fuel reservoir cap cover

5. Slowly unscrew the fuel reservoir cap counterclockwise to remove it.

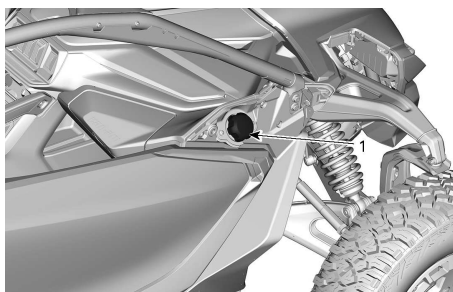

1. Fuel reservoir cap

**⚠ WARNING**

**If a differential pressure condition is noticed (whistling sound heard when loosening fuel reservoir cap) have vehicle inspected and/or repaired before further operation.**

6. Insert the spout into the filler neck.
7. Pour fuel slowly so that air can escape from the tank and prevent

fuel flow back. Be careful not to spill fuel.

8. Stop filling when the fuel reaches the bottom of filler neck. **Do not overfill.**

**⚠ WARNING**

**Never top up the fuel tank before placing the vehicle in a warm area. As temperature increases, fuel expands and may overflow.**

9. Fully tighten fuel reservoir cap clockwise until you hear a clicking noise.

**⚠ WARNING**

**Always wipe off any fuel spillage from the vehicle.**

---

# BREAK-IN PERIOD

## Operation During Break-In

A break-in period of 10 operating hours or 300 km (200 mi) is required for the vehicle.

### *Engine*

During the break-in period:

- Avoid full throttle operation.
- Avoid pressing accelerator pedal more than 3/4 of the stroke.
- Avoid sustained accelerations.
- Avoid prolonged high speeds.
- Avoid engine overheating.

However, brief accelerations and speed variations contribute to a good break-in.

### *Brakes*

 <b>WARNING</b>
<p><b>New brakes will not operate at their maximum efficiency until their break-in is completed. Braking performance may be reduced, so use extra caution.</b></p> <p><b>Apply moderate braking force for the 40 to 50 first braking events.</b></p>

# BASIC PROCEDURES

While reading this Operator's Guide, remember that:



## WARNING

Indicates a potential hazard which, if not avoided, could result in serious injury or death.

## STARTING THE ENGINE



### WARNING

**After starting the vehicle, when the engine is not at operating temperature, the vehicle may move slightly when position D or R is selected.**

**To avoid unattended vehicle movement, always set to park before exiting the vehicle when the engine is running.**

1. Install D.E.S.S. key on D.E.S.S. post.
2. Press the brake pedal.
3. Press the engine start button and hold until the engine starts.

### NOTE:

Do not press the accelerator pedal. If the accelerator pedal is pressed at least 20%, the engine will not start.

4. Release the engine start button immediately when the engine has started.

### NOTICE

**If engine does not start after a few seconds, do not hold the engine start button more than 10 seconds. Refer to *Troubleshooting* section.**

5. Wait approximately 10 seconds to let engine oil flow through engine and turbo before driving.

## WAKING UP THE ELECTRICAL SYSTEM

1. Press and release the START button for less than half a second and the electrical system will turn ON:
  - For 20 seconds, **without** powering any equipment, if the D.E.S.S. key is **NOT** installed on the D.E.S.S. post.
  - For 10 minutes, powering equipment, if the D.E.S.S. key is installed on the D.E.S.S. post. The electrical system will shutdown after 20 seconds if the D.E.S.S. key is removed.

### NOTICE

**Waking up the electrical system repeatedly or using electrical equipment will discharge the battery and you may not be able to start the engine.**

## OPERATING THE SHIFT LEVER

1. Apply brakes (the vehicle must be completely stopped).
2. Pull the shifter rearward to select the **D** (drive) position or push the shifter forward to select the **R** (reverse) position.
3. Release brakes.

### NOTICE

**When changing gear selection, always completely stop the vehicle and apply the brakes prior to shifting. Failure to do so may damage the gearbox.**

## CHOOSING THE CORRECT RANGE (LOW OR HIGH)

### High Range

High is the default riding range.

### Low Range

Low range should be used as needed whenever:

- Pulling or recovery
- Pushing
- Hauling a load
- 4x4 applications
- Mud holes
- Water holes
- Crossing obstacles
- Climbing onto trailer
- Hill climbing

3. Release the accelerator pedal and use brakes to completely stop the vehicle.
4. Push the PARK button.
5. Press the start / stop button to stop the engine.
6. Remove the D.E.S.S key from its post.
7. Block the wheels using rocks or bricks if you must park on a steep incline or if the vehicle is carrying cargo.
8. Before stopping the engine and parking the vehicle following a more intense ride, let vehicle run idle for a period of 1 to 2 minutes to allow for cooling of the turbo system.

## STOPPING THE ENGINE AND PARKING THE VEHICLE

 **WARNING**

**Avoid parking on steep slope as the vehicle may roll away.**

 **WARNING**

**Always put the vehicle in PARK when stopped or parked to prevent rolling.**

 **WARNING**

**Avoid parking in places where hot parts can start a fire.**

1. When stopped or parked always put the vehicle in PARK.

This is especially important when parking on a slope. On very steep inclines or if the vehicle is carrying a cargo, the wheels should be blocked using rocks or bricks.

2. Select the flattest terrain available for parking.

# SPECIAL PROCEDURES

## PERMANENT NEUTRAL or MECHANICAL NEUTRAL ACTIVATION

The PERMANENT neutral and the MECHANICAL neutral are different than the NORMAL neutral (N button).

### NORMAL neutral:

This function is selected by pressing the “N” button.

The vehicle will go back to PARK position when the engine is shutdown.

The N icon appears in the digital display when the transmission is in neutral.

### PERMANENT neutral:

This neutral is selected by pressing the “N” button near the shifter at least 5 seconds.

The message “Permanent Neutral” will be displayed in the digital display.

The vehicle stays on neutral after the engine is shutdown.

The permanent neutral must be used to tow the vehicle.

### MECHANICAL neutral:

This neutral is set up manually by using the following procedure.

The mechanical neutral must be used when you experience a dead battery without possibility to activate the electrical system using a jump start or by installing a battery charger (refer to *Dead Battery*) or when a problem occurs with the shifting actuator.

2. The message “Permanent Neutral” will be displayed in the digital display.
3. Turn engine OFF.

### **Mechanical Neutral Activation**

1. Select the most flat ground as possible near the vehicle.
2. Ask someone to press and hold the brake pedal during the entire procedure.

If not possible, block the wheels to avoid any unexpected vehicle movements using rocks, pieces of wood or other suitable objects.

3. Remove the transmission actuator connector.

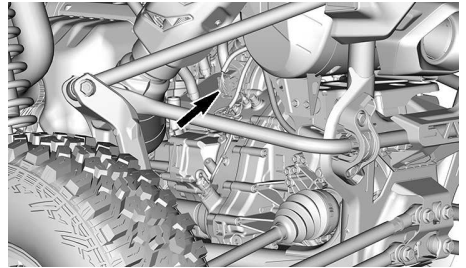

4. Remove the two screws holding the transmission actuator.

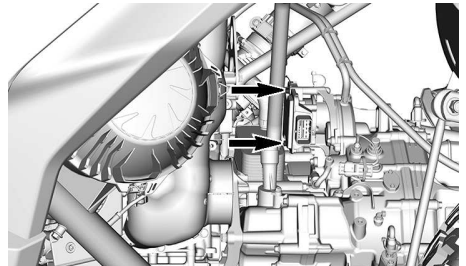

5. Remove the transmission actuator.

### **Permanent Neutral Activation**

1. Press and hold the NEUTRAL button at least 5 seconds.

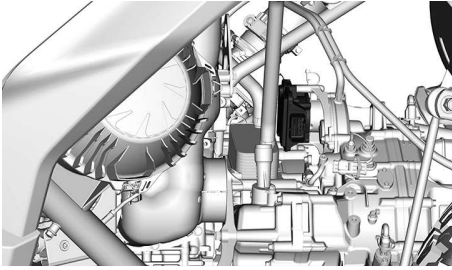

6. Insert the neutral activation tool (located in the glove box) instead of the transmission actuator.

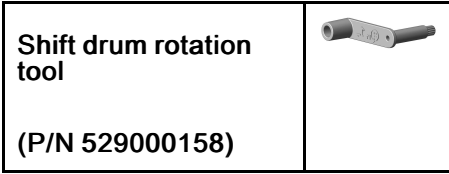

7. Turn the tool toward the left of the vehicle until the tool stops.

**NOTICE**

**Make sure to follow the instruction molded on the tool.**

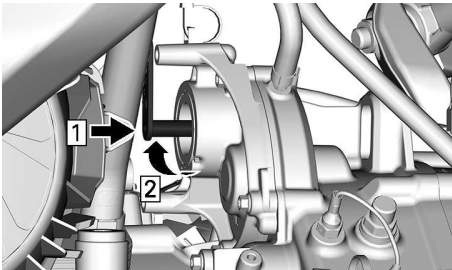

8. Start turning in the other way for approximately seven and a quarter turns.

Pay attention during this step, a slight "click" will be heard when reaching the neutral position.

9. Move away from the vehicle and check if the vehicle can be moved by releasing the brake or trying to rock the vehicle.

If yes, continue the procedure.

If no, redo the procedure.

10. Remove the shift drum rotation tool.
11. Reinstall it and align the hole of the tool handle with the upper actuator threaded hole.
12. Secure the tool in place by using one of the previously removed screws.
13. See an authorized Can-Am Off-road dealer as soon as possible.

## LIMP HOME MODE

The Limp Mode is activated automatically to restricts engine power but allows you to continue your ride in case of a components malfunction or under certain conditions.

This mode is often caused by engine overheating, low engine oil conditions, low battery voltage, or other electrical or sensor malfunctions.

When the Limp Home mode is activated, the "Check Engine" icon  is turned ON and the "LIMP HOME MODE" message is displayed in the digital display.

In LIMP HOME, the engine RPM is limited and therefore the vehicle speed.

In the event vehicle goes into the LIMP HOME mode, have the vehicle transported in your authorized Can-Am off-road dealer as soon as possible.

If you operate the vehicle in LIMP HOME, avoid abrupt maneuvers and immediately go to the nearest authorized Can-Am Off-road dealer to have your vehicle serviced before riding again.

## DEAD BATTERY

If the battery is dead or too weak to



crank the engine, it can be jump started.

**⚠ WARNING**

**Connect the jumper cables as specified in the jump start procedure.**

1. Park the booster vehicle close to the front of your vehicle.
2. Open the front fuse compartment cover located in the center of the dash.
3. Remove the positive post cover and clean any corrosion from the battery posts before connecting the jumper cables.

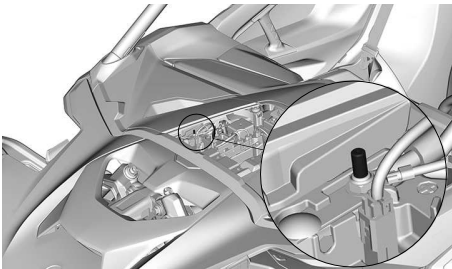

4. Begin by connecting one end of the RED jumper lead to the positive (+) post of the discharged battery.
5. Then connect the other end of the RED jumper lead to the positive (+) post of the booster vehicle's battery.
6. Connect one end of the BLACK jumper lead to the negative (-) post of the discharged battery.

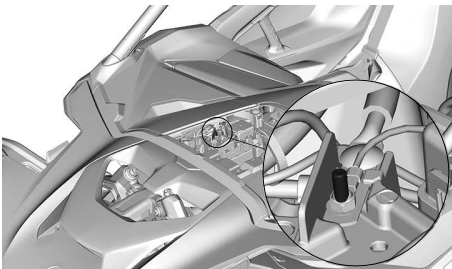

7. Connect the other end of the BLACK jumper lead to the negative (-) post of the booster vehicle's battery.
8. Start the booster vehicle and let it run to idle.
9. Start your vehicle in the usual way. If the engine does not start, wait a few minutes before repeating the attempt in order to protect the starter motor and the booster battery.

**NOTE:**

If it still does not start, there might be a problem with the starting system. Have the vehicle transported (see *Transporting the Vehicle*) and repaired by an authorized Cam-Am Off-Road dealer.

10. Once the vehicle has been started, let both vehicles run at idle for a few minutes before disconnecting the jumper cables.
11. Remove the jumper cables in the reverse order that they were connected.

**NOTE:**

If the engine stops shortly after it has been started or when the jumper cables are disconnected, there might be a problem with the charging system. Have the vehicle transported (see *Transporting the Vehicle*) and repaired by an authorized Cam-Am Off-Road dealer.

12. Fully recharge the battery with a battery charger (see *Maintenance Procedures*) or have it recharged by a qualified service station as soon as possible.

After recharging the battery, have the vehicle inspected by an authorized *Can-Am Off-Road* dealer.

## ROLLED OVER VEHICLE

Abrupt maneuvers, sharp turns, side hilling or accident may cause vehicle to rollover.

Should the vehicle be rolled over, it will be necessary to have it transported to an authorized Can-Am Off-road dealer for inspection as soon as possible. **NEVER START THE ENGINE!**

Points to be verified, including but not limited to:

- All fluid levels
- Air filter box and air filter for contamination
- Seat belts, including retractors, buckles and semi-cinching tabs
- Cage and its attachment points
- Steering system
- Suspension and its attachment points.

## SUBMERGED VEHICLE

Should the vehicle become immersed, it will be necessary to have it transported to an authorized Can-Am Off-road dealer as soon as possible.

### **NOTICE**

**Never start the engine as immersion of the vehicle can cause serious damage to the engine if the correct restart procedure is not followed.**

# TRANSPORTING THE VEHICLE

When contacting a towing or transporting service, be sure to ask if they have a flatbed trailer, loading ramp or power ramp to safely lift the vehicle and tie-down straps. Ensure the vehicle is properly transported as specified in this section.

## NOTICE

Do not tow this vehicle without engaging the PERMANENT neutral or the MECHANICAL neutral — towing can seriously damage the vehicle's drive system.

## NOTICE

Avoid using chains to tie the vehicle — they may damage the surface finish or plastic components.

## ⚠ WARNING

To avoid severe injury or death or important components damages.

- Never use the winch cable/rope to retain a vehicle during trailering.
- Never ride with the winch cable/rope attached to a load or another vehicle.
- Only use the winch to help a stuck vehicle (snow, mud, etc.).
- Always refer to the winch manufacturer's instruction before pulling loads.

## ⚠ WARNING

Make sure all accessories, cargo and loose objects inside the vehicle are properly secured, or remove it to prevent from failing on the road and creating a hazard for following vehicles.

## ⚠ WARNING

Always transport the vehicle facing forward to avoid damaging the windshield or other components. Parts may detach during transport.

## ⚠ WARNING

Before attempting to mount vehicle onto a platform or a trailer, make sure to respect the following safety precautions.

### Safety Precautions

Carrying equipment	The carrying item (platform or trailer or flat bed) must be of appropriate dimensions and capacity to safely support and transport the vehicle.
Hauling vehicle	Do not exceed vehicle hauling capacity and specifications. Ensure the trailer or platform is properly secured to the hauling vehicle hitch.

Safety Precautions	
Visibility	Ensure you have a good visibility during the entire maneuver.
Terrain	The hauling vehicle and trailer must be on a leveled surface. Use wheel chocks on trailer and hauling vehicle to avoid any movement.
Ramps	Use ramps with proper rating and secure ramps to the trailer or platform. Avoid steep ramps.
Bystanders	Always make sure bystanders are not close to the vehicle or the trailering equipment while climbing up.
Accessories and cargo	Make sure all accessories, cargo and loose objects inside the vehicle are properly secured, or remove it to prevent from failing on the road and creating a hazard for following vehicles.

## Using Vehicle Power to Climb Onto Trailering Equipment

When vehicle can climb on its own power, proceed as follows;

1. Wear protective gear.
2. Fasten seat belt.
3. Use the Low range and the 4WD mode.
4. When driving remain seated at all times.
5. Ensure proper alignment on rails or platform.
6. Start from a sufficient distance from the trailer to align the vehicle in a straight line with the ramps. Never attempt to turn while getting closer to the ramp. Rear wheels might not be aligned once you get to the ramp and vehicle may fall off.
7. Slowly climb the front wheels onto the ramp to verify alignment.
8. Back off the vehicle, verify ramps are still secure, then proceed at proper speed.
9. Carefully drive the vehicle onto platform or trailer. Use sufficient speed to climb without spinning or abruptly accelerating. Avoid

acceleration while on ramps to prevent ramps movement.

10. If trailer is inclined towards front, simply let vehicle roll in without acceleration.
11. Once vehicle is climbed, active the Park and stop the engine.

 <b>WARNING</b>
<b>When vehicle cannot move on its own power, or in case overshooting is a risk or if any dangerous condition prevents for embarking on its own power, proceed using a winch.</b>

## Using a Winch to Pull Vehicle Onto Trailering Equipment

When vehicle cannot climb on its own power, proceed as follows;

### ⚠ WARNING

Have the help of an assistant. One person should be in vehicle to have access to vehicle steering, brakes and winch switch, while the other person controls the environment and safety of the maneuver.

### ⚠ WARNING

Ensure the winch hook can be safely attached to a proper anchoring point. Use proper rigging.

### NOTE:

If vehicle can be started safely, let engine idle during winching to avoid draining the battery.

1. Choice one of the following options:
  1. Start the engine and select the NEUTRAL (N).
  2. If the engine cannot be started, use the PERMANENT neutral.
  3. If the electrical system cannot be powered (or boosted) or if the shifting actuator is defective, use the MECHANICAL neutral.
2. If the vehicle is equipped with a winch, use the winch to roll the vehicle on the platform.
3. If the vehicle is not equipped with a winch:
  1. Attach a strap to the front recovery hook.
  2. Attach the strap to the winch cable of the trailering equipment.
  3. Load the vehicle onto or into the trailering equipment.

4. When loaded, engage the PARK and attach the vehicle securely.

## Securing Vehicle for Transport

### ⚠ WARNING

To avoid severe injury or death or damage to important components.

- Never use the winch cable/rope to retain a vehicle during trailering.
- Never ride with the winch cable/rope attached to a load or another vehicle.
- Only use the winch to help a stuck vehicle (snow, mud, etc.).
- Always refer to the winch manufacturer's instructions before pulling loads.

1. Ensure the PARK is selected (if possible).
2. Remove the key from the D.E.S.S. post.
3. Secure the vehicle by using UTV tire-bonnets so that the vehicle suspension is free to move during transportation.

If not possible, secure the rear of the vehicle on both sides using a strap around the trailing arm as close to the wheel as possible.

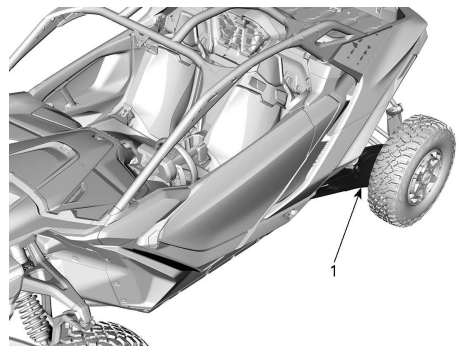

1. Trailing arm

Secure the front of the vehicle on both sides using a strap through the triangle in the lower suspension arm as close to the wheel as possible.



4. Ensure that both the front and rear wheels are firmly attached to the trailer.

## Getting Vehicle Out of Trailer

### **⚠ WARNING**

Vehicle may have moved during transport. Ensure vehicle is properly aligned with ramps before proceeding.

### **⚠ WARNING**

Visibility will be greatly reduced when backing off from the trailer. Have the help of an assistant to ensure proper alignment and safe environment.

# LIFTING AND SUPPORTING THE VEHICLE

## Front of Vehicle

1. Place vehicle on a flat non slippery ground.
2. Block the rear wheels properly to avoid any unexpected vehicle movements
3. Install an hydraulic jack under the rear of the front lower plate.

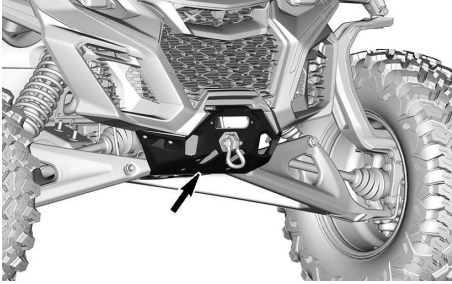

4. Lift front of vehicle and install a jack stand on each side under frame as shown below.

### NOTICE

**Make sure to align the jack stands with the tubular frame under the skid plate.**

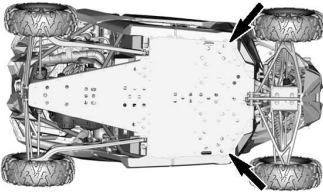

### JACK STAND POSITIONS - FRONT OF VEHICLE

5. Lower hydraulic lift and ensure vehicle is supported safely onto both jack stands.

## Rear of Vehicle

1. Place vehicle on a flat non slippery ground.
2. Block the front wheels properly to avoid any unexpected vehicle movements
3. Install an hydraulic jack under the vehicle.

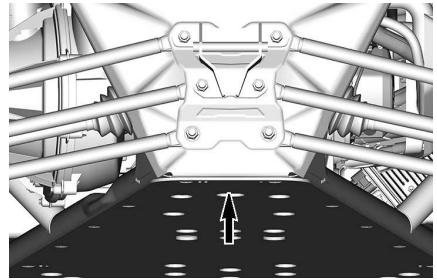

### REAR OF VEHICLE

1. Hydraulic jack position

4. Lift rear of vehicle and install a jack stand on each side under frame as shown below.

### NOTICE

**Make sure to align the jack stands with the tubular frame under the skid plate.**

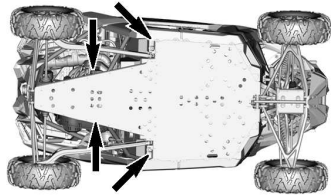

### JACK STAND POSITIONS - REAR OF VEHICLE

5. Lower hydraulic lift and ensure vehicle is supported safely onto both jack stands.

This page is intentionally blank



# MAINTENANCE

---

# MAINTENANCE SCHEDULE

Maintenance is very important to keep your vehicle in safe operating condition. The vehicle should be serviced as per the maintenance schedule.

Proper maintenance is the owner's responsibility. A warranty claim may be denied if, among other things, the owner or operator caused the problem through improper maintenance or use.

Perform periodic checks and follow the maintenance schedule. **The maintenance schedule does not exempt the pre-ride inspection.**

## WARNING

**Failure to properly maintain the vehicle according to the maintenance schedule and procedures can make it unsafe to operate.**

## EPA Regulation - Canadian and USA Vehicles

**A repair shop or person of the owner's choosing may maintain, replace, or repair** emission control devices and systems. These instructions do not require components or service by BRP or authorized Can-Am Off-road dealers.

Although an authorized Can-Am Off-road dealer has an in-depth technical knowledge and tools to service your vehicle, the emission-related warranty is not conditioned on the use of an authorized Can-Am Off-road dealer or any other establishment with which BRP has a commercial relationship.

Proper maintenance is the owner's responsibility. A warranty claim may be denied if, among other things, the owner or operator caused the problem through improper maintenance or use.

For emission-related warranty claims, BRP is limiting the diagnosis and repair of emission-related parts to the authorized Can-Am Off-road dealers. For more information, please refer to the *US EPA Emission-Related Warranty* contained in the *Warranty* section.

You must follow the instructions for fuel requirements in the fueling section of this manual. Even if gasoline containing greater than ten volume percent ethanol is readily available, the US EPA issued a prohibition against the use of gasoline containing greater than 10 vol% ethanol that applies to this vehicle. The use of gasoline containing greater than 10 vol% ethanol with this engine may harm the emission control system.

## Air Filter Maintenance Guideline

Air filter maintenance should be adjusted according to riding conditions.

Air filter maintenance must be increased in frequency when riding on snow, dry sand, dirt, gravel or similar conditions which have a high dust or particle dispersion.

Riding in a group in these conditions will require increasing the air filter maintenance frequency further.

### NOTE:

Accessory filters and pre-filter are available for such conditions. Contact an authorized Can-Am off-road dealer for details.

## Severe Duty Use

If your vehicle is used in the following conditions, refer to the *Severe Duty* section of the maintenance schedule.

- Sand dunes riding.
- Driving at excessive speeds for prolonged amount of time.
- Repeated carrying of loads at more than 75% the maximum capacity.
  - The increase workload applied to the drive system accelerates the differentials, gearbox/transmission, and engine oil life. This reduces internal component longevity if not replaced more frequently.

### **Extreme Cold Condition**

An engine that is frequently operated at or below an ambient temperature of  $-25^{\circ}\text{C}$  ( $-13^{\circ}\text{F}$ ) will require an increase in service and maintenance schedule.

Any combustion engine operated at these low ambient temperature will collect an increased amount of condensation at every startup/warm-up.

Since the engine is not reaching operating temperatures for extended periods of time, the oil is starting to be strongly diluted with water and gas residue (more water content).

An engine needs to reach operating temperature, in order to be able to evaporate condensate out of the oil.

If daily usage (work or leisure driving cycle) is similar to those mentioned below, BRP strongly recommends changing the oil at least once a month.

Parameters of an increase in service and maintenance schedule:

- Engine not reaching the proper operating temperature during normal daily usage
- Multiple starts and stops without reaching operating temperature
- Short idle periods
- Low RPM driving cycle in short distances without reaching operating temperature.

### **NOTE:**

BRP strongly recommends the installation of a block heater to help warm up the liquids, this will also help to extend the oil lifetime.

## Deep Mud / Water Use

This type of usage requires more frequent maintenance and inspections to ensure debris has not infiltrated mechanical components.

If you ride in deep mud or water, be sure to perform the following *Post Operation Care for Deep Mud / Water Environment* list.

### **Post Operation Care for Deep Mud / Water Environment**

- Rinse the vehicle and its components with fresh water.
- Inspect and clean engine air filter and engine air filter housing.

- Clean radiators and intercooler.
- Visually inspect for any water accumulation in the vent hoses (fuel tank, gear-box, front differential and rear final drive). If there is water, bring the vehicle to your nearest authorized Can-Am Off-road dealer for inspection and servicing of main components related to the vents.
- Clean front and rear shock absorbers to prevent seal from damage by dust or dirt.
- Clean drive shaft bellows and the propeller shaft yokes or bellows.

## Maintenance Schedule

Make sure to perform proper maintenance at recommended intervals as indicated in the tables.

The maintenance chart intervals are based on 3 factors:

- Calendar time
- Vehicle hours
- Odometer reading.

Take in account whichever comes first to determine the maintenance threshold.

Your driving habits determines the factors you shall adhere too. For example:

- Someone who uses their vehicle every other weekend trail riding with friends would most likely follow the **odometer reading** to determine the maintenance interval.
- Someone who uses their vehicle seldomly over the year or only on a few occasions (hunting, camping) would most likely follow the **calendar time** to determine the maintenance interval.
- Someone who uses their vehicle daily / weekly for long periods of time such as agricultural / work would most likely follow the **vehicle hours** to determine the maintenance interval.

**IMPORTANT:** The following tables show the appropriate maintenance application for the first 3 years. For subsequent years, repeat the same pattern alternatively.

Regular Maintenance Overview			
Calendar Years	Vehicle Hours	Odometer	Regular Duty
1	100	3000 km (1900 mi)	A
2	200	6000 km (3700 mi)	A + B
3	300	9000 km (5600 mi)	A

<b>Severe Duty and Mud/Water Maintenance Overview</b>			
Calendar Years	Vehicle Hours	Odometer	Severe Duty and Deep Mud / Water
0.5	50	1500 km (900 mi)	A+
1	100	3000 km (1900 mi)	A+ / A
1.5	150	4500 km (2800 mi)	A+
2	200	6000 km (3700 mi)	A+ / A / B
2.5	250	7500 km (4700 mi)	A+
3	300	9000 km (5600 mi)	A+ / A

<b>REGULAR DUTY</b>	<b>A</b>	<b>B</b>
<b>A = Adjust</b> <b>C = Clean</b> <b>I = Inspect</b> <b>L = Lubricate</b> <b>R = Replace</b> <b>T = Torque</b>	<b>Every year</b> <b>or</b> <b>100 hours</b> <b>or</b> <b>3000 km</b> <b>(1900 mi)</b>	<b>Every 2 years</b> <b>or</b> <b>200 hours</b> <b>or</b> <b>6000 km</b> <b>(3700 mi)</b>
<b>Air and Fuel Delivery</b>		
Engine air filter	I, C, R	
Air delivery components and function (airbox, throttle body, ducts, clamps)*	I, C	
Fuel components and function (Fuel tank cap, fuel tank, hoses, clamps, leaks)*		I
Fuel pump pressure		I
<b>Body and Chassis</b>		
Cage fasteners	T	
Seat belts retractors, buckles and semi-cinching	I, C	
<b>Engine and Cooling</b>		
Engine oil and filter	R	
Engine cooling components (coolant specific gravity, coolant level, hoses condition, clamps, leaks)*	I, C, A	
Coolant	<b>R</b> Every 5 years or 12 000 km (7500 mi)	
Spark plugs		<b>R</b> As per vehicle hours and odometer only, Not calendar time
Radiators	C	
Engine seals and gaskets	I	
<b>Exhaust and Emissions</b>		
Fuel tank vent breather filter (except EVAP models)	R	
Canister vent pre-filter (EVAP models)		R
Exhaust components (gaskets, pipes, muffler condition, leaks)*	I	
Exhaust clamping rings		I
Muffler spark arrester	C	

<b>REGULAR DUTY</b>	<b>A</b>	<b>B</b>
<b>A = Adjust</b> <b>C = Clean</b> <b>I = Inspect</b> <b>L = Lubricate</b> <b>R = Replace</b> <b>T = Torque</b>	<b>Every year</b> <b>or</b> <b>100 hours</b> <b>or</b> <b>3000 km</b> <b>(1900 mi)</b>	<b>Every 2 years</b> <b>or</b> <b>200 hours</b> <b>or</b> <b>6000 km</b> <b>(3700 mi)</b>
Debris around exhaust pipe and muffler area	C	
<b>Brake</b>		
Brake components and function (brake pads, brake discs, calipers, brake lines, master cylinder)*	I, C, L	
Brake fluid	<b>R</b> <b>Every 2 years</b>	
<b>Drive</b>		
Gearbox oil and filter	Replace at first 3000 km (1900 mi) and at 6000 km (3700 mi), then follow the regular schedule	
Gearbox oil and filter	I, A	R
Drive components (drive shaft (bellows, joints, seals), propeller shaft U-joint, wheel bearing)*	I	
Front differential oil	I	R
Final drive oil	Replace at first 3000 km (1900 mi) and at 6000 km (3700 mi), then follow the regular schedule	
Final drive oil	I	R
Disconnect unit oil		R
Tires (wear and pressure)	I, A	
Wheel beadlock screws (if equipped)	T	
Wheel lug nuts	T	
Rear wheel scrappers and rock deflectors	I, C	
<b>Electrical</b>		
Battery connections and condition	I, C	
Operation of control switches and lighting	I	
Electronic modules (Fault codes and applicable software updates)	I	
<b>Steering</b>		
Steering components and function (rack and pinion, steering column, tie-rod)*	I	

<b>REGULAR DUTY</b>	<b>A</b>	<b>B</b>
<b>A = Adjust</b> <b>C = Clean</b> <b>I = Inspect</b> <b>L = Lubricate</b> <b>R = Replace</b> <b>T = Torque</b>	<b>Every year</b> <b>or</b> <b>100 hours</b> <b>or</b> <b>3000 km</b> <b>(1900 mi)</b>	<b>Every 2 years</b> <b>or</b> <b>200 hours</b> <b>or</b> <b>6000 km</b> <b>(3700 mi)</b>
<b>Suspension</b>		
Suspension components and function (shock absorber, spherical bearings, ball joints, suspension arms, stabilizer bar links and clamps)*	<b>I, C, L, T</b>	
Stabilizer bar bushings lubrication	<b>L</b> Recommended every 1000 km (620 mi)	
*For an extensive list of maintenance actions to be performed, refer to your local Can-Am Off-road dealer.		



<b>SEVERE DUTY</b>	<b>A+</b>	<b>A</b>	<b>B</b>
<b>A = Adjust</b> <b>C = Clean</b> <b>I = Inspect</b> <b>L = Lubricate</b> <b>R = Replace</b> <b>T = Torque</b>	<b>Every 6 months</b> or <b>50 hours</b> or <b>1500 km (900 mi)</b>	<b>Every year</b> or <b>100 hours</b> or <b>3000 km (1900 mi)</b>	<b>Every 2 years</b> or <b>200 hours</b> or <b>6000 km (3700 mi)</b>
<b>Air and Fuel Delivery</b>			
Engine air filter	I, C	R	
Air delivery components and function (airbox, throttle body, ducts, clamps)*	I, C		
Fuel components and function (Fuel tank cap, fuel tank, hoses, clamps, leaks)*			I
Fuel pump pressure			I
<b>Body and Chassis</b>			
Cage fasteners		T	
Seat belts retractors, buckles and semi-cinching		I, C	
<b>Engine and Cooling</b>			
Engine oil and filter	R		
Engine cooling components (coolant specific gravity, coolant level, hoses condition, clamps, leaks)*		I, C, A	
Coolant	R Every 5 years or 12 000 km (7500 mi)		
Spark plugs		R As per vehicle hours and odometer only. Not calendar time	
Radiators		C	
Engine seals and gaskets		I	
<b>Exhaust and Emissions</b>			
Fuel tank vent breather filter (except EVAP models)		R	
Canister vent pre-filter (EVAP models)			R

<b>SEVERE DUTY</b>	<b>A+</b>	<b>A</b>	<b>B</b>
<b>A = Adjust</b> <b>C = Clean</b> <b>I = Inspect</b> <b>L = Lubricate</b> <b>R = Replace</b> <b>T = Torque</b>	Every 6 months or 50 hours or 1500 km (900 mi)	Every year or 100 hours or 3000 km (1900 mi)	Every 2 years or 200 hours or 6000 km (3700 mi)
Exhaust components (gaskets, pipes, muffler condition, leaks)*		I	
Exhaust clamping rings			I
Muffler spark arrester	C		
Debris around exhaust pipe and muffler area		C	
<b>Brake</b>			
Brake components and function (brake pads, brake discs, calipers, brake lines, master cylinder)*	I, C, L		
Brake fluid	R Every 2 years		
<b>Drive</b>			
Gearbox oil and filter	Replace at first 1500 km (900 mi) and at 3000 km (1900 mi), then follow the regular schedule		
Gearbox oil and filter	I, A	R	
Drive components (drive shaft (bellows, joints, seals), propeller shaft U-joint, wheel bearing)*	I		
Front differential oil	I	R	
Final drive oil	Replace at first 1500 km (900 mi) and at 3000 km (1900 mi), then follow the regular schedule		
Final drive oil	I	R	
Disconnect unit oil			R
Tires (wear and pressure)	I, A		
Wheel beadlock screws (if equipped)		T	
Wheel lug nuts	T		
Rear wheel scrappers and rock deflectors		I, C	
<b>Electrical</b>			
Battery connections and condition		I, C	

<b>SEVERE DUTY</b>	<b>A+</b>	<b>A</b>	<b>B</b>
<b>A = Adjust</b> <b>C = Clean</b> <b>I = Inspect</b> <b>L = Lubricate</b> <b>R = Replace</b> <b>T = Torque</b>	<b>Every 6 months</b> <b>or</b> <b>50 hours</b> <b>or</b> <b>1500 km</b> <b>(900 mi)</b>	<b>Every year</b> <b>or</b> <b>100 hours</b> <b>or</b> <b>3000 km</b> <b>(1900 mi)</b>	<b>Every 2 years</b> <b>or</b> <b>200 hours</b> <b>or</b> <b>6000 km</b> <b>(3700 mi)</b>
Operation of control switches and lighting		I	
Electronic modules (Fault codes and applicable software updates)		I	
<b>Steering</b>			
Steering components and function (rack and pinion, steering column, tie-rod)*	I		
<b>Suspension</b>			
Suspension components and function (shock absorber, spherical bearings, ball joints, suspension arms, stabilizer bar links and clamps)*	I, C, L, T		
Stabilizer bar bushings lubrication	L Recommended every 1000 km (620 mi)		
*For an extensive list of maintenance actions to be performed, refer to your local Can-Am Off-road dealer.			

## Maintenance Records

Send photocopy of maintenance record to BRP if needed.

Pre-delivery	
Serial number: _____ Mileage / km: _____ Hours: _____ Date: _____ Dealer no: _____ Notes: _____ _____	Signature/Print: _____
Refer to vehicle Pre-Delivery Bulletin for detailed installation procedures	

FIRST inspection	
Mileage / km: _____ Hours: _____ Date: _____ Dealer no: _____ Notes: _____ _____	Signature/Print: _____
For maintenance schedule refer to Maintenance Information section of this operator's guide	

<b>Service</b>	
Mileage / km: _____ Hours: _____ Date: _____ Dealer no: _____ Notes: _____ _____	Signature/Print:
For maintenance schedule refer to Maintenance Information section of this operator's guide	

<b>Service</b>	
Mileage / km: _____ Hours: _____ Date: _____ Dealer no: _____ Notes: _____ _____	Signature/Print:
For maintenance schedule refer to Maintenance Information section of this operator's guide	

<b>Service</b>	
Mileage / km: _____ Hours: _____ Date: _____ Dealer no: _____ Notes: _____ _____	Signature/Print:
For maintenance schedule refer to Maintenance Information section of this operator's guide	

**Service**

Mileage / km:

\_\_\_\_\_

Hours:

\_\_\_\_\_

Date:

\_\_\_\_\_

Dealer no:

\_\_\_\_\_

Notes:

\_\_\_\_\_

\_\_\_\_\_

Signature/Print:

For maintenance schedule refer to Maintenance Information section of this operator's guide

**Service**

Mileage / km:

\_\_\_\_\_

Hours:

\_\_\_\_\_

Date:

\_\_\_\_\_

Dealer no:

\_\_\_\_\_

Notes:

\_\_\_\_\_

\_\_\_\_\_

Signature/Print:

For maintenance schedule refer to Maintenance Information section of this operator's guide

**Service**

Mileage / km:

\_\_\_\_\_

Hours:

\_\_\_\_\_

Date:

\_\_\_\_\_

Dealer no:

\_\_\_\_\_

Notes:

\_\_\_\_\_

\_\_\_\_\_

Signature/Print:

For maintenance schedule refer to Maintenance Information section of this operator's guide

<b>Service</b>	
Mileage / km: _____ Hours: _____ Date: _____ Dealer no: _____ Notes: _____ _____	Signature/Print:
For maintenance schedule refer to Maintenance Information section of this operator's guide	

<b>Service</b>	
Mileage / km: _____ Hours: _____ Date: _____ Dealer no: _____ Notes: _____ _____	Signature/Print:
For maintenance schedule refer to Maintenance Information section of this operator's guide	

<b>Service</b>	
Mileage / km: _____ Hours: _____ Date: _____ Dealer no: _____ Notes: _____ _____	Signature/Print:
For maintenance schedule refer to Maintenance Information section of this operator's guide	

**Service**

Mileage / km:

\_\_\_\_\_

Hours:

\_\_\_\_\_

Date:

\_\_\_\_\_

Dealer no:

\_\_\_\_\_

Notes:

\_\_\_\_\_

\_\_\_\_\_

Signature/Print:

For maintenance schedule refer to Maintenance Information section of this operator's guide

**Service**

Mileage / km:

\_\_\_\_\_

Hours:

\_\_\_\_\_

Date:

\_\_\_\_\_

Dealer no:

\_\_\_\_\_

Notes:

\_\_\_\_\_

\_\_\_\_\_

Signature/Print:

For maintenance schedule refer to Maintenance Information section of this operator's guide

**Service**

Mileage / km:

\_\_\_\_\_

Hours:

\_\_\_\_\_

Date:

\_\_\_\_\_

Dealer no:

\_\_\_\_\_

Notes:

\_\_\_\_\_

\_\_\_\_\_

Signature/Print:

For maintenance schedule refer to Maintenance Information section of this operator's guide



# MAINTENANCE PROCEDURES

This section includes instructions for basic maintenance procedures.

Due to the complexity of some of the maintenance procedures, good mechanical skills are required. If you are not comfortable with these procedures, do not hesitate to contact an authorized Can-Am off-road dealer, repair shop or person of your own choosing.

**⚠ WARNING**

Unless otherwise indicated, always remove D.E.S.S. key from the D.E.S.S. post before performing any maintenance and remove key.

**⚠ WARNING**

Should removal of a locking device be required (e.g. lock tab, self-locking fastener, etc.) , always replace it with a new one.

## ENGINE AIR FILTER

**NOTICE**

Never modify the air intake system. Otherwise, engine performance degradation or damage can occur. The engine is calibrated to operate specifically with these components.

### Engine Air Filter Replacement Guideline

Engine air filter inspection and replacement frequency should be adjusted according to riding conditions as it is critical to ensure proper engine performance and life span.

Engine air filter inspection and replacement frequency must be increased for the following severe riding conditions:

- Riding on dry sand.
- Riding on dry dirt covered surfaces.

- Riding on dry gravel trails or similar conditions.
- Riding in areas with high concentration of seeds or crop husks.
- Riding in severe snow conditions.

**NOTICE**

When riding in dusty conditions or sand, the air box needs to be cleaned before every ride.

**NOTE:**  
Riding in a group, under these conditions, increases the frequency of the air filter maintenance.

### Removing the Engine Air Filter

1. From the left-rear wheel well, open the four retaining clips on the air filter cover.

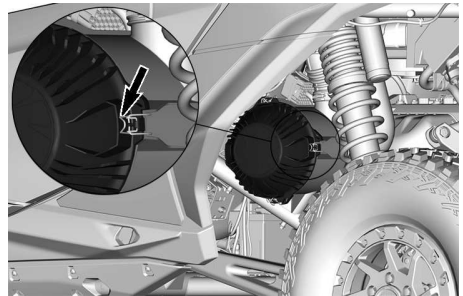

RETAINING CLIP - TYPICAL

2. Remove the air filter element from its housing.

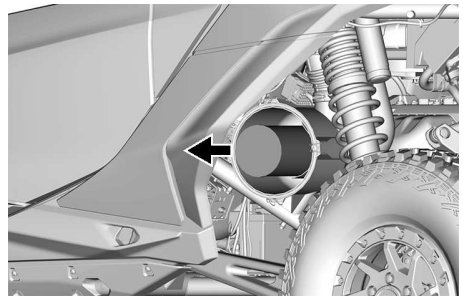

### Cleaning the Engine Air Filter

1. Inspect the filter for any signs of leaks. A streak of dust on the clean

side of the filter is a telltale sign. Replace filter if there is any damages. Eliminate any source of air leaks before installing a new filter.

2. Clean engine air filter by tapping out heavy dust from paper element, this will allow dirt and dust to get out of the paper filter.

### NOTICE

**It is not recommended to blow compressed air on the paper element; this could damage the paper fibers and reduce its filtration ability when used in dusty environments. If engine air filter is too dirty and cannot be cleaned following the recommended procedure, it should be replaced.**

3. Use a clean damp cloth to wipe both the filter sealing surface and the inside of the outlet tube. Ensure that the outlet tube sealing area is undamaged.
4. Inspect air filter housing for cleanliness.

### *Cleaning the Engine Air Filter Housing*

1. Inspect air filter housing for cleanliness.

### NOTICE

**If sand or other particles are found in air filter housing, clean it using a vacuum cleaner.**

### *Installing the Engine Air Filter*

1. Insert the new engine air filter element into its housing.

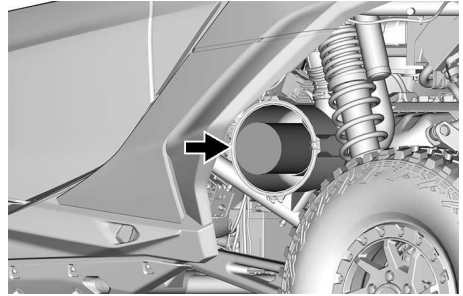

2. Ensure that the element is properly seated.
3. Position the air filter cover on the housing and secure it using the four retaining clips.

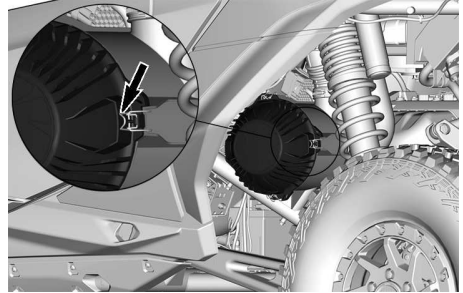

RETAINING CLIP - TYPICAL

## FRONT GRILLE

### *Removing the Front Grille*

The front grille is located in fascia.

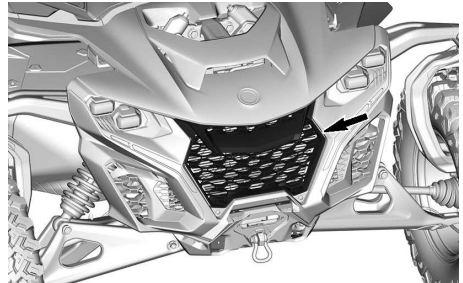

1. Press down the upper section of the grille.
2. Carefully pull the grille forward to release its four tabs from the spring clips in the fascia.

### Installing the Front Grille

1. Carefully press the grille into the fascia so that its four tabs engage the spring clips.
2. Verify that the grille is properly clipped.

### EVAPORATIVE EMISSION SYSTEM PRE-FILTER (If Equipped)

#### Replacing the Evaporative Emission System Pre-Filter

The pre-filter is located under the right-rear fender.

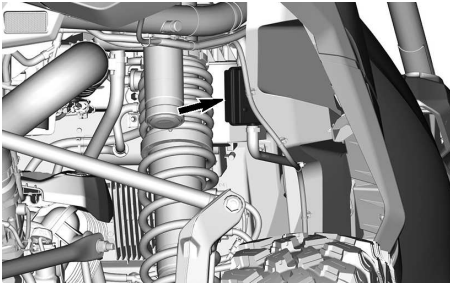

1. Remove the Oetiker clamps that secure the inlet and outlet hoses to the pre-filter.

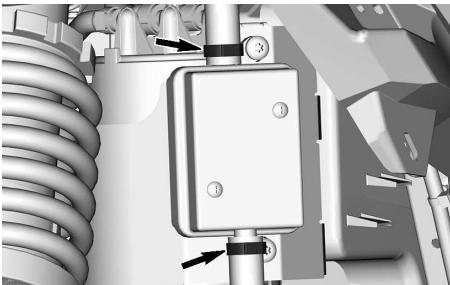

2. Disconnect the hoses from the pre-filter
3. Remove both retaining screws.

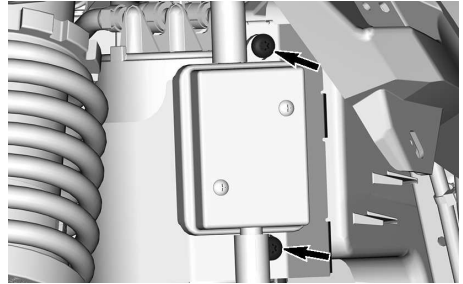

4. Remove the pre-filter assembly.
5. Secure the new pre-filter on frame.

Tightening Torque	
Pre-filter screws	2.5 ± 0.5 Nm (22 ± 4 lbf-in)

6. Connect the inlet and outlet hoses to the pre-filter.
7. Secure the hoses using new Oetiker clamps.

### ENGINE OIL

#### Recommended Engine Oil

NOTICE
<b>Do not fill the engine oil into the gearbox. The gearbox requires DCT oil and gear oil.</b>

Rotax® engines were developed and validated using the XPS® oil. BRP recommends the use of its XPS engine oil or an equivalent at all time. Damages caused by the use of an oil not suitable for the engine may not be covered by the BRP Limited Warranty.

XPS Recommended Engine Oil	
General purpose	5W40 Synthetic oil
Cold temperature	0W40 Synthetic oil
Warm temperature	10W50 Synthetic oil

If the recommended XPS engine oil is not available:

- Use a 4-stroke SAE engine synthetic oil meeting or exceeding the following lubricant industry specifications
- Always check the API service label certification on the oil container, it must contain the indicated standards.
  - **API service classification SN and JASO MA2**

### Verifying the Engine Oil Level

**NOTICE**

Operating the engine with an improper oil level may severely damage the engine.

The engine oil level must be checked at normal operating temperature, either after riding or after letting the engine idle for at least 10 min.

**NOTE:**

The engine is at normal operating temperature when the temperature indicator on the right lateral display shows 5 bars.

1. Place the vehicle on a level surface.
2. Engage the PARK.
3. Start the engine and let it idle for at least 20 seconds.
4. Stop the engine.

**NOTICE**

The engine oil level verification must be performed within 1 minute after engine shutdown.

5. Through the right-rear wheel well, unscrew the dipstick. Then remove it and wipe it clean.

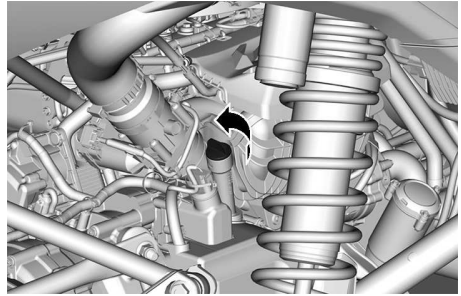

6. Reinsert the dipstick and screw it in completely.
7. Remove the dipstick and check the oil level. It should be at or near the upper (MAX) mark.

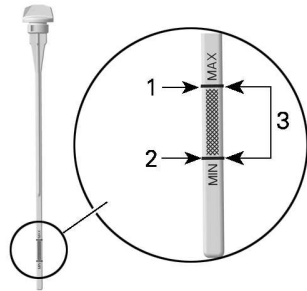

1. MAX
  2. MIN
  3. Operating range
8. If oil needs to be added, insert a funnel into the dipstick tube.
  9. To avoid overfilling, add a small amount of recommended engine oil then recheck the oil level. Refer to *Recommended Engine Oil*.

<p>Oil Quantity Between MIN and MAX Marks</p>
<p>600 ml (20.3 fl oz (US))</p>

- Repeat the previous step until the oil level reaches the upper (MAX) mark on the dipstick.

**NOTICE**

**Do not overfill.**

- Install the dipstick and tighten it properly.
- Wipe off any spillage.

### Changing the Engine Oil

The engine oil and filter must be changed at the same time, with a warm engine.

**CAUTION**

**The engine oil can be very hot. Allow it to cool sufficiently before you begin.**

- Place the vehicle on a level surface.
- Put the vehicle on PARK.
- Start the engine and let it run at idle for at least 2 minutes.
- Stop the engine.
- Remove the dipstick.
- Clean the area around the drain plugs.

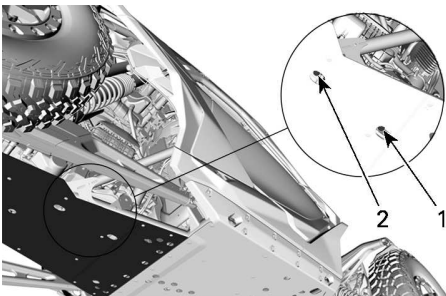

- Magnetic drain plug (magneto cover)
- Magnetic drain plug (oil tank cover)

- To avoid spillage, install a funnel between the drain holes and the skid plate.

<p><b>Funnel</b></p> <p><b>(P/N 529000155)</b></p>	
--	--

- Place a drain pan under both engine drain plugs.
- Unscrew both magnetic drain plugs. Discard the gasket rings and O-ring.

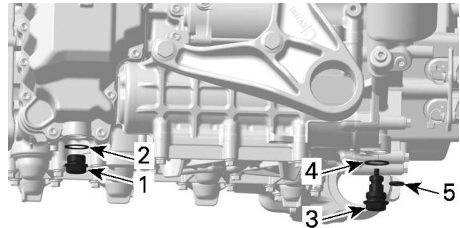

- Magnetic drain plug (magneto cover)
- O-ring
- Magnetic drain plug (oil tank cover)
- Gasket ring
- O-ring

- Allow the oil to drain completely from the crankcase.
- Clean the magnetic drain plugs of metal shavings and residue. The presence of debris gives an indication of internal engine damage.
- Install new gasket rings and O-rings on the magnetic drain plugs.

**NOTICE**

**Never re-use gasket rings or O-rings. Always replace them with NEW ones. A missing or damaged O-ring will cause a loss of oil pressure and possible engine damage.**

13. Tighten the magnetic drain plugs to specification.

Tightening Torque	
Magnetic drain plugs	30 ± 3 Nm (22 ± 2 lbf-ft)

14. Replace the oil filter. Refer to *Replacing the Engine Oil Filter*.  
 15. Refill the engine with the recommended engine oil. Refer to *Recommended Engine Oil*

Engine Oil Capacity	
Engine oil and engine oil filter replacement	2.8 l (2.96 qt (liq.,US))

16. After filling, start the engine and check the oil level, refer to *Verifying the Oil Level*.  
 17. Wipe off any spillage.  
 18. Dispose of the used oil and filter per local environmental regulations.

## ENGINE OIL FILTER

### Engine Oil Filter Location

The oil filter is located on the right side of the engine.

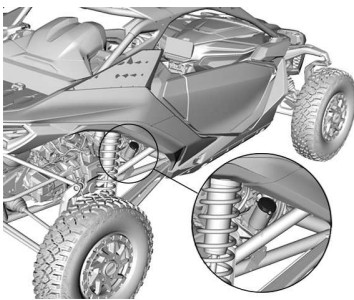

### Replacing The Engine Oil Filter

1. Clean the oil filter area.

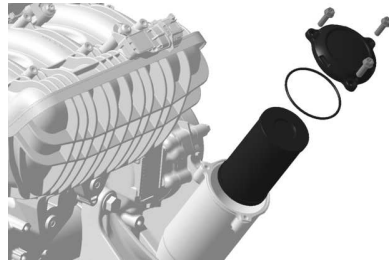

2. Remove the oil filter cover. Discard the O-ring.  
 3. Remove and discard the oil filter.  
 4. Check and clean the oil filter inlet/outlet area for dirt and other contaminations.

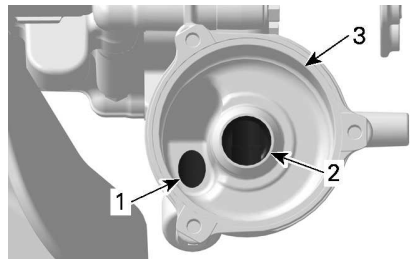

1. Oil inlet orifice from the oil pressure pump  
 2. Oil outlet orifice to the engine lubrication system  
 3. Oil filter housing
5. Wet a **NEW** O-ring with engine oil and slip it onto the oil filter cover.  
 6. Install a **NEW** engine oil filter into the oil filter cover.  
 7. Apply engine oil to the seal on the open end of the oil filter.



### APPLY ENGINE OIL HERE

8. Install the new filter into its housing.

**NOTICE**

Engine oil filter and gearbox oil filter are similar, do not mix them. The engine oil filter has a closed end while the gearbox oil filter is opened on both ends and the word gearbox is also marked on it.

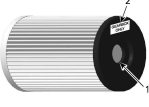
Engine Oil Filter	Gearbox Oil Filter
 <p>1. Closed end</p>	 <p>1. Opened end (relief valve) 2. Gearbox indication</p>

9. Tighten oil filter cover screws to specification.

**NOTICE**

Pay attention to avoid pinching the O-ring during filter and cover installation.

**Tightening Torque**

Oil filter cover screws	9 ± 1 Nm (80 ± 9 lbf-in)
-------------------------	-----------------------------

10. Wipe off any oil spillage on the engine.
11. Dispose of the used oil filter as per your local environmental regulations.

**FRONT RADIATOR**

**Inspecting and Cleaning the Front Radiator**

1. Remove the front grille, refer to *Removing the Front Grille*.

**CAUTION**

Before proceeding, wait for the radiator to cool.

2. Inspect the radiator hoses for leaks or damage. Replace if necessary.

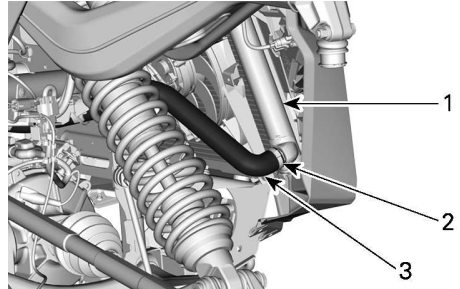

**LOWER RADIATOR HOSE**

1. Radiator
2. Hose clamp
3. Lower radiator hose

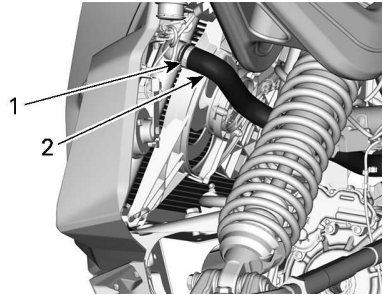

**UPPER RADIATOR HOSE**

1. Hose clamp
2. Upper radiator hose
3. Inspect the radiator fins. They must be free of any foreign material that would impair cooling.
4. Use a garden hose to rinse the fins.

**NOTICE**

Be careful not to damage the radiator fins when cleaning. Use a low-pressure stream of water. Never use a HIGH-PRESSURE washer. Do not use any tool that could damage the fins.

5. Re-install the front grille. Refer to *Installing the Front Grille*.

**INTERCOOLER AND REAR RADIATOR**

*Inspecting and Cleaning the Intercooler / Rear Radiator*

1. Inspect the radiator hoses for leaks or damage. Replace if necessary.

**CAUTION**

Before proceeding, wait for the radiator to cool.

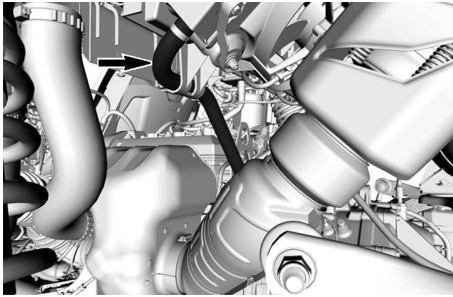

LOWER RADIATOR HOSE — LEFT-REAR WHEEL WELL

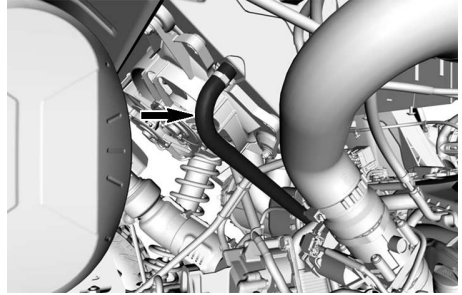

UPPER RADIATOR HOSE — RIGHT-REAR WHEEL WELL

2. Remove the plastic rivet on the top of the air intake grille located behind seats.

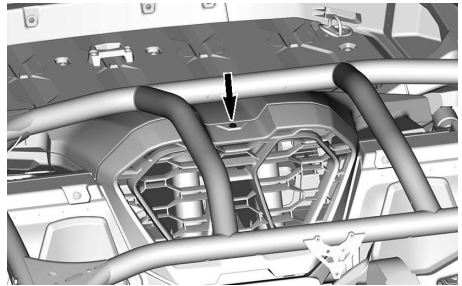

3. Unclip and remove the air intake grille.
4. Inspect the intercooler fins and the radiator fins. They must be free of any foreign material that would impair cooling.
5. Use a garden hose to clean the intercooler and the rear radiator fins.

**NOTICE**

Be careful not to damage the intercooler fins or radiator fins when cleaning. Use a low-pressure stream of water. Never use a HIGH-PRESSURE washer. Do not use any tool that could damage the fins.



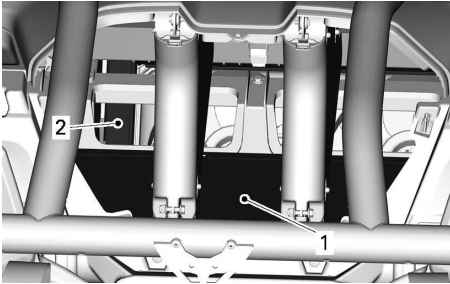

1. Intercooler
2. Rear radiator

## ENGINE COOLANT

### Recommended Engine Coolant

<b>XPS Recommended Coolant</b>
Extended life pre-mixed coolant
<b>If XPS is not available</b>
Distilled water and antifreeze solution (50% distilled water, 50% antifreeze)

### NOTICE

**Always use ethylene-glycol anti-freeze containing corrosion inhibitors specifically for internal combustion aluminum engines.**

### Verifying the Engine Coolant Level

#### **⚠ WARNING**

Check coolant level with engine cold.

1. Place the vehicle on a level surface.
2. To remove the service cover, depress the latch and tilt the cover rearward.

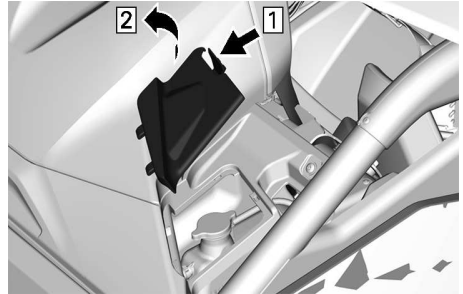

### REMOVING THE SERVICE COVER

1. Depress latch
2. Tilt rearward
3. Check that the coolant level is at the MAX line on the side of the reservoir.



4. Add coolant to the reservoir as necessary. Refer to *Cooling System Refilling and Bleeding*

### Engine Coolant Replacement

#### Draining the Cooling System

#### **⚠ WARNING**

**In order to avoid potential burns, do not remove the pressure cap or loosen the coolant drain plug if the engine is hot.**

1. Lift the rear of the vehicle approximately 30 cm (12 in).

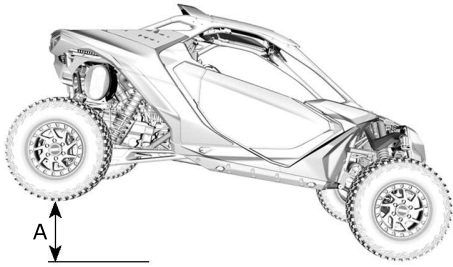

A. A = 30 cm (12 in)

- Place a drain pan under the lower radiator hose.

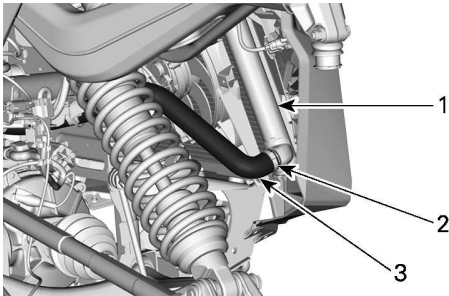

- Radiator
- Oetiker clamp
- Lower radiator hose

- Install a large hose pincher on the lower radiator hose.
- Remove the Oetiker clamp and slowly disconnect the hose from the radiator.
- Remove the coolant reservoir pressure cap.

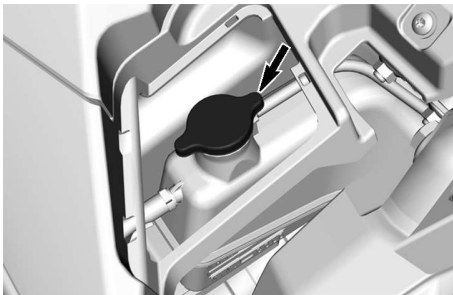

- Wait until the coolant flow stops.

- Remove the hose pincher to drain the remaining coolant from the system.
- Install the radiator hose using a new Oetiker clamp.
- Fill the cooling system with coolant. Refer to *Refilling and Bleeding the Cooling System*.

### Refilling and Bleeding the Cooling System

- Remove the pressure cap.

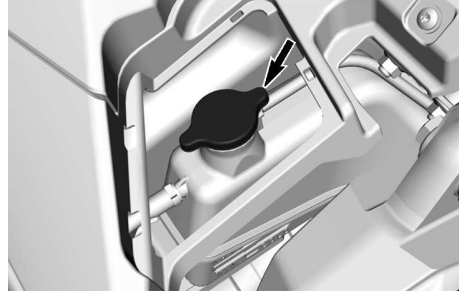

- Add coolant until the level reaches the MAX line on the coolant reservoir. Refer to *Recommended Engine Coolant*. Use a funnel to avoid spillage. **Do not overfill.**



- Install the pressure cap.
- Run the engine at idle with the pressure cap **on**, allowing the front cooling fans to cycle twice.
- Depress the accelerator pedal five (5) times to rev engine around 4000 RPM for 1–2 seconds.
- Stop the engine and let it cool down.

**⚠ WARNING**

In order to avoid potential burns, do not remove the pressure cap or loosen the coolant drain plug if the engine is hot.

7. Add coolant if necessary.
8. After the next ride following this procedure, check the coolant level. Add coolant as required. Refer to *Verifying the Engine Coolant Level*.

**EXHAUST SYSTEM**

*Cleaning the Area Surrounding the Exhaust System*

**⚠ WARNING**

Debris accumulation could lead to a vehicle fire when the exhaust system is hot and the debris are dried.

In some cases, that could result in serious property damages, injuries or even death.

Clean often and regularly the area surrounding the exhaust system when riding in swamp, bog, hay or dead leaves.

In other situations, clean as per maintenance schedule requirement.

Also, check all exhaust heat shields for damage regularly and replaced when needed.

**⚠ CAUTION**

Never perform this operation immediately after the engine has been running because exhaust system is very hot.

1. From the rear of the vehicle, clean the areas around the muffler.
2. Clean the areas around the exhaust pipe and the exhaust manifold.

**⚠ WARNING**

Clean also under the heat shields.

*Cleaning the Muffler Spark Arrestor*

The muffler spark arrestor must be periodically purged of accumulated carbon.

**⚠ CAUTION**

Never perform this operation immediately after the engine has been running, as the exhaust system will be very hot.

1. Remove the screws that secure the exhaust tip to its supports. Then remove the exhaust tip.

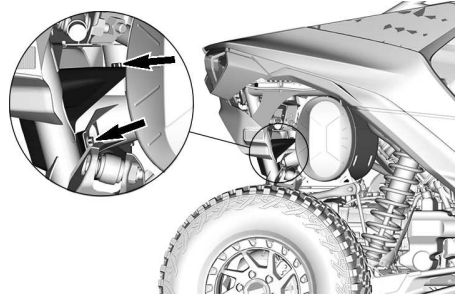

**EXHAUST TIP SCREWS — RIGHT SIDE (TYPICAL)**

2. Pull the spark arrestor from the exhaust outlet pipe.

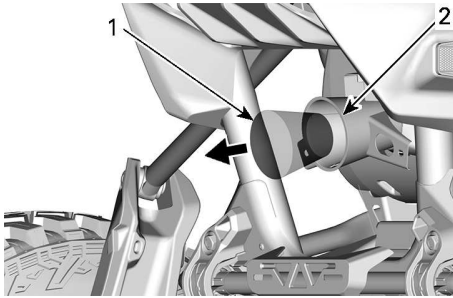

1. Spark arrestor
2. Outlet pipe

**NOTICE**

Use a soft metallic brush and be careful to avoid damaging the spark arrestor mesh.

3. Remove carbon deposits from the spark arrestor using a brush.
4. Inspect the spark arrestor mesh for any damage. Replace as needed.
5. Inspect the inside of the exhaust outlet pipe. Remove any debris as needed.
6. Place the spark arrestor back inside the outlet pipe.
7. Apply a drop of threadlocker on exhaust tip screw threads.

**Loctite 243 (Blue)**

8. Position the exhaust tip on its supports and tighten the screws to specification.

**Tightening Torque**

Exhaust tip screws	24.5 ± 3.5 Nm (18 ± 2.5 lbf-in)
--------------------	------------------------------------

**GEARBOX**

*Recommended Gearbox DCT Oil*

**NOTICE**

Please note that the gearbox Dual Clutch Transmission system (DCT) is a high performing, high maintenance system which requires high quality and performing oil to function safely, properly and to maintain its expected lifecycle. The gearbox DCT was developed and validated using the XPS DCT oil.

Damages caused using an oil which does not meet or exceed the XPS DCT oil specifications may not be covered by BRP's limited warranty. Do not use another type of oil when servicing.

**XPS Recommended Gearbox DCT Oil**

XPS full synthetic DCT Oil

**If the XPS product is not available**

Contact your authorized Can-Am Off-road dealer

**Verifying the DCT Gearbox Oil Level**

1. Place the vehicle on a level surface.

**NOTICE**

To obtain a good level reading, the vehicle must be horizontal in both directions (laterally and longitudinally). An angled vehicle alignment causes incorrect DCT gearbox oil level readings and may influence gearbox behavior.

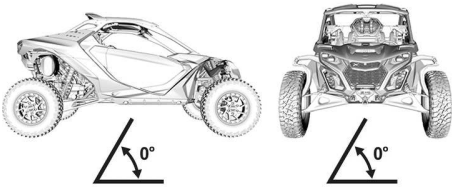

**VEHICLE ON LEVEL SURFACE**

2. Select the PARK position.
3. Start the engine and let it idle for at least 1 minute.
4. Stop the engine.
5. Clean the area around the DCT gearbox oil level plug.

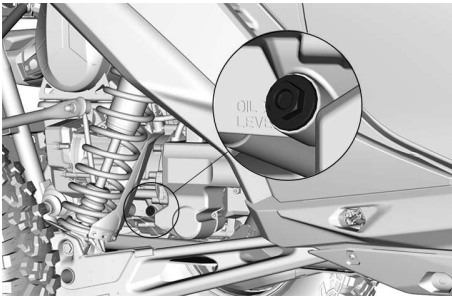

**RIGHT-REAR WHEEL WELL**

6. Remove the oil level plug and discard the O-ring.

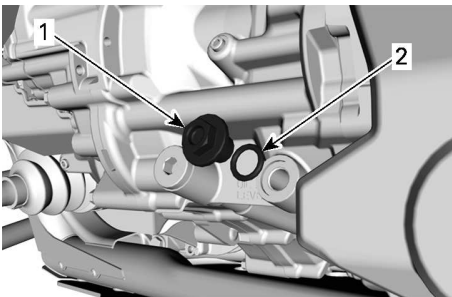

1. Oil level plug
2. O-ring (discard)

7. Check the oil level. It should be at the top of the outermost thread of the oil level hole.

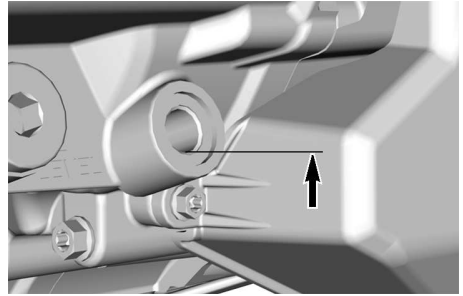

**OIL LEVEL**

8. To adjust the oil level, fill a syringe with the recommended oil. Refer to *Recommended DCT Gearbox Oil*.
9. Add oil through the hole until it reaches the proper level.
10. Re-install the oil level plug with a **NEW** O-ring and tighten it to specification.

Tightening Torque	
DCT gearbox oil level plug	5 ± 0.6 Nm (44 ± 5 lbf-in)

11. Wipe off any spillage.

**Changing the DCT Gearbox Oil and Filter**

1. Operate the vehicle for a few minutes to warm the DCT oil.
2. Place the vehicle on a level surface.

NOTICE
<p>To obtain a good level reading, the vehicle must be horizontal in both directions (laterally and longitudinally). An angled vehicle alignment will cause an incorrect gearbox DCT oil level reading and may influence gearbox behavior.</p>

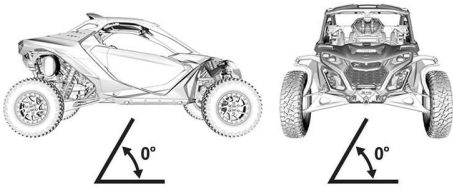

3. Select the PARK position and stop the engine.
4. From underneath the vehicle, clean the area around both drain plugs.

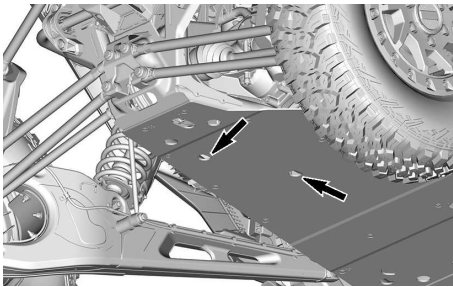

**DRAIN PLUG OPENINGS**

5. Place a drain pan under the gear box drain plugs.
6. Remove both magnetic drain plugs. Discard the gasket rings and O-ring.
7. Clean the magnetic drain plugs of metal shavings and residue.

**NOTICE**

The presence of fine abrasives is acceptable.

8. Remove the screws that hold the hydraulic valve and oil filter protective cover in place. Then remove the cover.

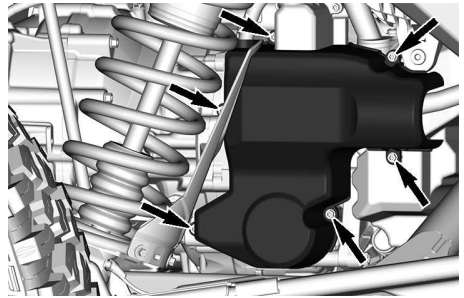

**RIGHT-REAR WHEEL WELL**

9. Clean the area around the oil filter cover.
10. Cut the locking tie and unplug the temperature sensor connector.

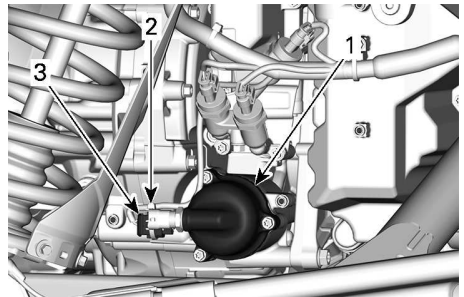

1. Oil filter cover
2. Locking tie
3. Temperature sensor connector

11. Remove the filter cover and discard the O-ring.

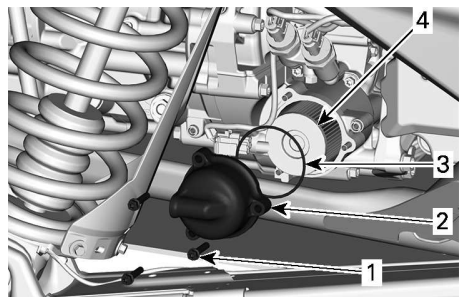

1. Oil filter cover screws
2. Oil filter cover
3. O-ring (discard it)
4. Oil filter

12. Check and clean the areas around the oil filter inlet and outlet.

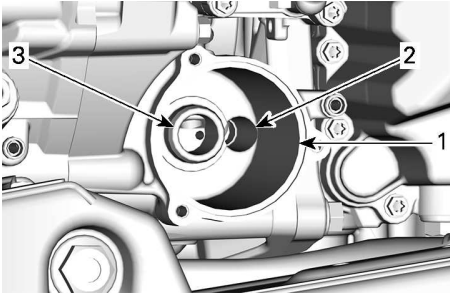

1. Oil filter housing
2. Oil inlet orifice from vane pump
3. Oil outlet orifice

13. Remove the oil drain plug from the hydraulic valve cover. Discard the sealing ring.

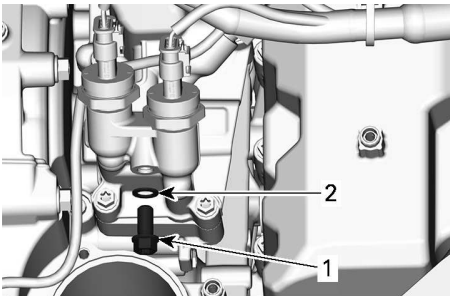

1. Oil drain plug
2. Sealing ring (discard it)

14. Let the oil flow completely out of the hydraulic housing.

15. Re-install the hydraulic housing drain plug with a new sealing ring and tighten to specification.

Tightening Torque	
Hydraulic housing drain plug	15 ± 2 Nm (133 ± 18 lbf-in)

16. Apply a thin layer of DCT oil onto the seal of the new gearbox oil filter.

## NOTICE

The engine oil filter and gearbox oil filter are similar. Do not confuse them.

The engine oil filter has a closed end, whereas the gearbox oil filter is open at both ends. The gearbox oil filter has the "GEARBOX ONLY" marked on it.

Engine Oil Filter	Gearbox Oil Filter
<p>1. Closed end</p>	<p>1. Open end (relief valve) 2. "GEARBOX ONLY" indication</p>

17. Install the new oil filter into its housing.

18. Coat a new O-ring with DCT oil and slip it onto the oil filter cover.

19. Install the filter cover and tighten the screws to specification.

Tightening Torque	
Filter cover screws	11 ± 1 Nm (97 ± 9 lbf-in)

20. Connect the temperature sensor and secure the cable to the connector housing with a locking tie.

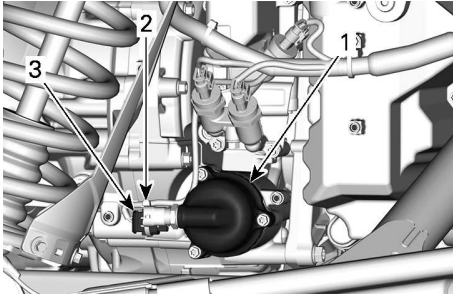

1. Oil filter cover
2. Locking tie
3. Temperature sensor connector

21. Install a new O-ring and gasket rings on the gearbox drain plugs.

### NOTICE

**A missing or damaged O-ring could lead to internal leaking of the gearbox and subsequent DCT oil pressure failure.**

22. Install the both gearbox drain plugs and tighten them to specification.

#### Tightening Torque

Gearbox drain plugs	30 ± 3 Nm (22 ± 2 lbf-ft)
---------------------	------------------------------

23. From the RH side of the engine,, clean the area around the DCT gearbox oil level plug.

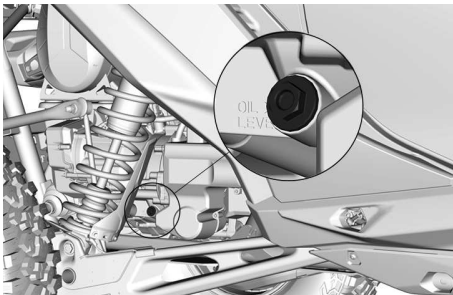

#### RIGHT-REAR WHEEL WELL

24. Remove the level plug and the O-ring.

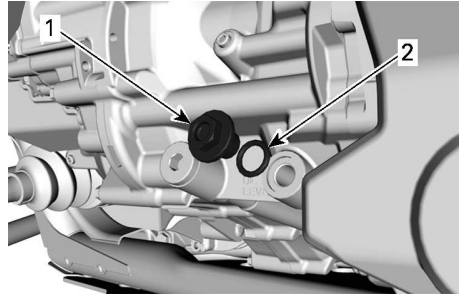

1. Oil level plug
2. O-ring

25. From the LH side of the engine, remove the gearbox filler plug and discard the gasket ring.

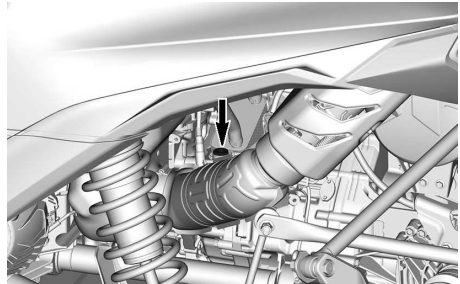

26. Fill a syringe with the recommended DTC oil. Refer to *Recommended DCT Gearbox Oil*.

#### Gearbox DCT oil quantity

3 to 3.5 l  
(3.17 to 3.7 qt (liq.,US))

27. Add the oil through the filler plug hole until the oil level reaches the top of the outermost thread of the oil level hole.



## DISCONNECT UNIT

### Recommended Disconnect Unit Oil

#### NOTICE

Do not fill the disconnect unit with other type of oil than the recommended one.

#### XPS Recommended Disconnect Unit Oil

5W40 Synthetic oil

If the recommended XPS engine oil is not available:

- Use a 4-stroke SAE engine synthetic oil meeting or exceeding the following lubricant industry specifications
- Always check the API service label certification on the oil container, it must contain the indicated standards.
  - **API service classification SN, and JASO MA2**

### Changing the Disconnect Unit Oil

1. Place the vehicle on a level surface.
2. Select the PARK position and stop the engine.
3. Clean the area around the oil drain plug.

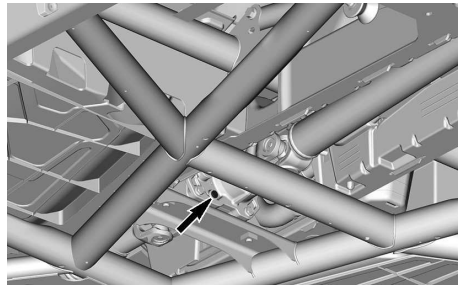

SKID PLATE REMOVED FOR CLARITY

4. Place a drain pan under the disconnect unit drain plug area.
5. Remove the oil level plug.
6. Allow the oil to drain completely.

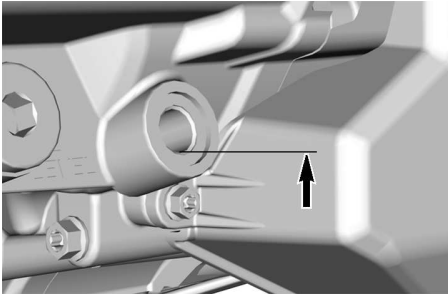

#### OIL LEVEL

28. Re-install the oil filler plug with a new gasket ring and tighten it to specification.

#### Tightening Torque

DCT Gearbox oil filler plug	$30 \pm 3 \text{ Nm}$ ( $22 \pm 2 \text{ lbf-ft}$ )
-----------------------------	--

29. Re-install the oil level plug and tighten it to specification.

#### NOTICE

Replace the O-ring if brittle or damage.

#### Tightening Torque

DCT gearbox oil level plug	$5 \pm 0.6 \text{ Nm}$ ( $44 \pm 5 \text{ lbf-in}$ )
----------------------------	---

30. Wipe off any spillage.

31. Start engine and let it idle for at least 1 minute, then check the DCT oil level, refer to *Verifying the Gearbox DCT Oil Level*.

32. Adjust the level if necessary.

33. Install the hydraulic valve filter protective cover.

#### Tightening Torque

Hydraulic valve filter protective cover screws	$11 \pm 1 \text{ Nm}$ ( $97 \pm 9 \text{ lbf-in}$ )
--	--

34. Dispose of the used oil and filter per local environmental regulations.

7. Install the drain plug and tighten it to specification.

Tightening Torque	
Disconnect unit drain plug	2.5 ± 0.5 Nm (22 ± 4 lbf-in)

8. Remove the filler plug.

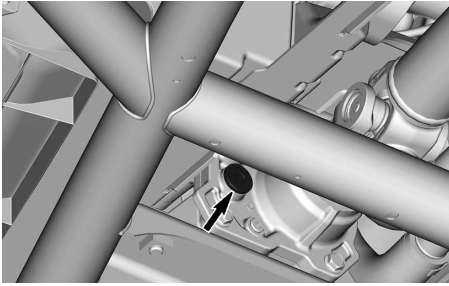

9. Fill a syringe with the recommended oil. Refer to *Recommended Disconnect Unit Oil*.

Disconnect Unit Oil Quantity
65 ml (2.2 fl oz (US))

10. Install the filler plug and tighten it to specification.

Tightening Torque	
Disconnect unit filler plug	16.5 ± 2.5 Nm (146 ± 22 lbf-in)

11. Reinstall the central skid plate.

## FRONT DIFFERENTIAL

### *Recommended Front Differential Oil*

The XPS oil is specially formulated to meet the lubrication requirements of this differential. BRP strongly recommends the use of its XPS oil.

### **NOTICE**

**Do not use another type of oil when servicing.**

### **XPS Recommended Front Differential Oil**

75W90 Synthetic gear oil

### **Alternative if XPS Product is not Available**

75W90 (API GL-5) synthetic gear oil

### **Verifying the Front Differential Oil Level**

1. Park the vehicle on a level surface.
2. Select the PARK position and stop the engine.
3. Clean the area around the front differential oil level plug.

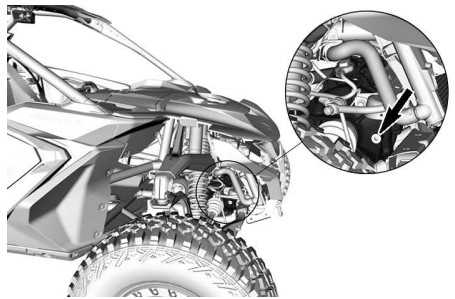

4. Remove the plug and the O-ring.

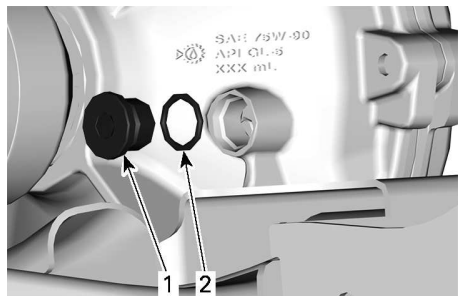

1. Oil level plug
2. O-ring

5. Check the oil level. It should be at the top of the outermost thread of the oil level hole.

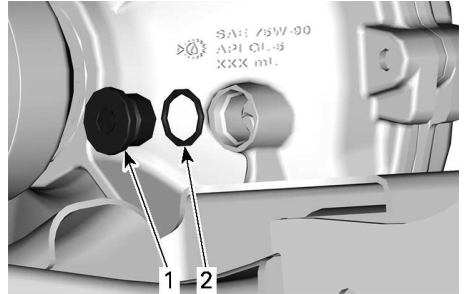
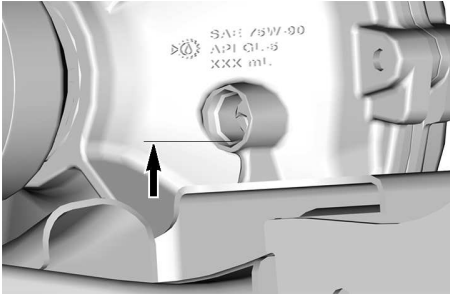

6. To adjust the oil level, fill a syringe with the recommended front differential oil. Refer to *Recommended Front Differential Oil*.
7. Add oil through the hole until it reaches the proper level.
8. Inspect the oil level plug O-ring. Replace if necessary
9. Re-install the oil level plug with the O-ring and tighten to specification.

1. Oil level plug
2. O-ring

5. From underneath the vehicle, clean the area around the drain plug.

Tightening Torque	
Front differential oil level plug	16.5 ± 2.5 Nm (146 ± 22 lbf-in)

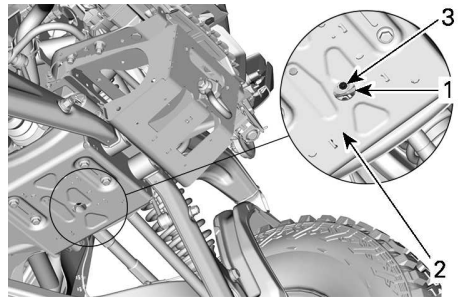

10. Wipe off any spillage.

1. Access hole
2. Skid plate
3. Drain plug

### Changing the Front Differential Oil

1. Place the vehicle on a level surface.
2. Select the PARK position and stop the engine.
3. Clean the area around the oil level plug.

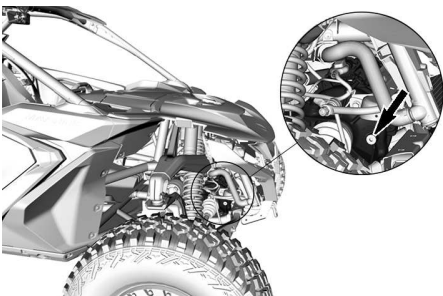

6. Place a drain pan under the front differential.
7. Access the drain plug through the hole in the skid plate. Then remove the drain plug and the O-ring.
8. Inspect the drain plug O-ring. Replace if necessary
9. Once all of the oil has drained from the front differential, install the drain plug with the O-ring. Tighten to specification.

4. Remove the oil level plug and the O-ring.

Tightening Torque	
Front differential drain plug	2.5 ± 0.5 Nm (22 ± 4 lbf-in)

10. Using the recommended oil, refill the front differential through the oil level hole. Refer to *Recommended Front Differential Oil*.
11. Ensure that the oil level reaches the top of the outermost thread of the oil level hole.
12. Inspect the oil level plug O-ring. Replace if necessary
13. Install the oil level plug with the O-ring. Tighten to specification.

Tightening Torque	
Front differential oil level plug	16.5 ± 2.5 Nm (146 ± 22 lbf-in)

14. Wipe off any spillage.

## REAR FINAL DRIVE

### *Recommended Final Drive Oil*

The XPS oil is specially formulated to meet the lubrication requirements of this final drive.

BRP strongly recommends the use of its XPS oil.

NOTICE
<b>Do not use another type of oil when servicing.</b>

XPS Recommended Final Drive Oil
75W140 Synthetic gear oil
If the XPS Product is not Available
Use a 75W140 synthetic gear oil that meets the API GL-5 specification.

### *Verifying the Rear Final Drive Oil Level*

1. Park the vehicle on a level surface.

2. Select the PARK position and stop the engine.
3. From the left side, clean the area around the rear final drive oil level plug.

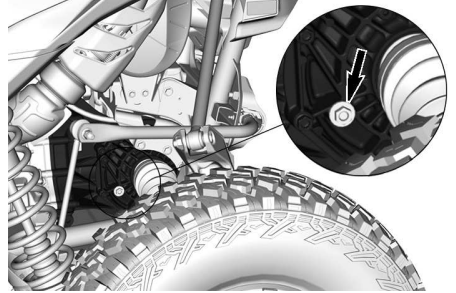

4. Remove the rear final drive oil level plug and the O-ring.
5. Check the oil level. The oil should be level with the bottom of the hole.
6. To adjust the oil level, fill a syringe with the recommended oil. Refer to *Recommended Final Drive Oil*.
7. Add a small amount of oil through the oil level hole until it reaches the bottom of the hole.
8. Inspect the oil level plug O-ring. Replace if necessary
9. Install the oil level plug with the O-ring and tighten to specification.

Tightening Torque	
Rear final drive oil level plug	5 ± 0.6 Nm (44 ± 5 lbf-in)

### *Changing the Rear Final Drive Oil*

1. Park the vehicle on a level surface.
2. Select the PARK position and stop the engine.
3. From the left side, clean the area around the rear final drive oil level plug.

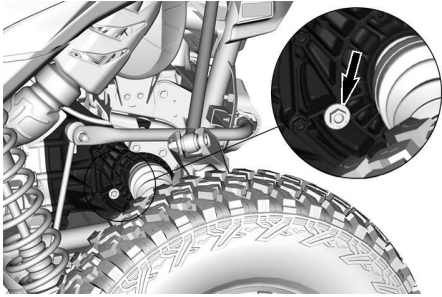

**OIL LEVEL PLUG**

4. From the right side, clean the area around the magnetic drain plug.

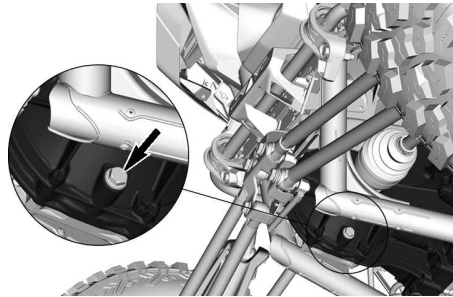

**MAGNETIC DRAIN PLUG — SKID PLATE NOT SHOWN**

5. Place a drain pan under the magnetic drain plug area.
6. Remove the magnetic drain plug and discard the sealing ring.

**NOTE:**

Allow oil to flow completely out of the final drive.

7. Remove the final drive oil level plug and the O-ring.
8. Clean the magnetic drain plug of metal shavings and residue.

**NOTE:**

The presence of fine shavings is acceptable.

9. Install the magnetic drain plug with a new sealing ring and tighten to specification.

**NOTICE**

**Never use a sealing ring a second time. Always replace it with a new one.**

**NOTE:**

Allow oil to flow completely out of the final drive before installing the plug.

**Tightening Torque**

Rear final drive drain plug	30 ± 3 Nm (22 ± 2 lbf-ft)
-----------------------------	------------------------------

10. Fill a syringe with the recommended oil. Refer to *Recommended Final Drive Oil*.
11. Add oil through the hole until the it is level with the bottom of the hole.
12. Inspect the oil level plug O-ring. Replace if necessary
13. Re-install the oil level plug with the O-ring and tighten to specification.

**Tightening Torque**

Rear final drive oil level plug	5 ± 0.6 Nm (44 ± 5 lbf-in)
---------------------------------	-------------------------------

**BATTERY**

**Battery Maintenance**

**NOTICE**

**Never charge a battery while installed in vehicle.**

These vehicles are equipped with a VRLA battery (Valve Regulated Lead Acid). It is a maintenance-free type battery, there is no need to add water to adjust electrolyte level.

**NOTICE**

**Never remove the battery sealing cap.**

## Battery Access

Access the battery through the service panel behind the driver's seat. Refer to *Removing and Installing a Seat*.

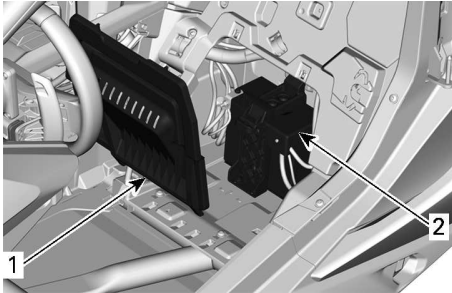

1. Service panel
2. Battery

## Removing the Battery

1. Remove the hex head screw and lock washers that secure the black cable to the negative (-) terminal of the battery. Then disconnect the cable.

### NOTICE

Always respect this order for disassembly. Always disconnect the BLACK (-) cable first.

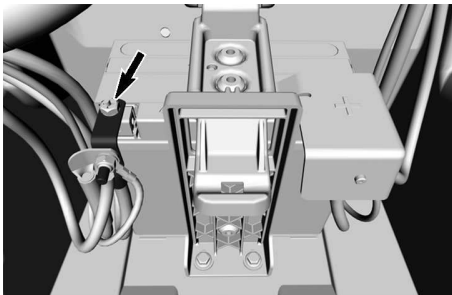

2. Remove the two hex head screws and flat washers that secure the battery holder to the bottom of the battery compartment.

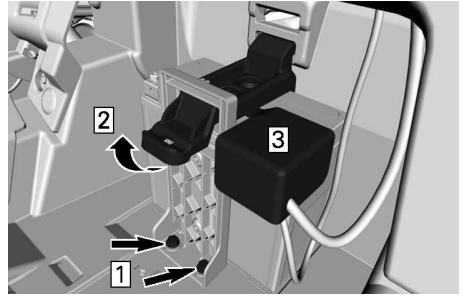

1. Remove screws
2. Pull upward
3. Remove cap

3. Pull upward on the holder, then remove it.
4. Remove the positive terminal cap.
5. Remove the hex head screw and lock washers that secure the red cable to the positive (+) terminal of the battery. Then disconnect the cable.

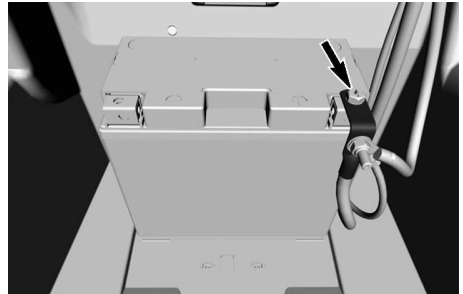

6. Remove the battery.

## Battery Cleaning

Clean battery, battery casing and battery posts using a solution of baking soda and water.

Remove corrosion from battery cable terminals and battery posts using a firm wire brush. Battery casing should be cleaned by soft brush and baking soda solution.

## Installing the Battery

1. Place the battery in its compartment.

2. Connect the red cable to the positive (+) terminal of the battery, using the hex head screw and lock washers. Tighten to specification.

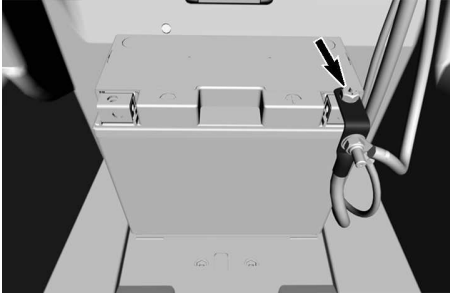

**NOTICE**

**Always respect this order for assembly. Always connect the RED (+) cable first.**

**Tightening Torque**

Positive terminal screw	5.0 ± 0.5 Nm (44 ± 4 lbf-in)
-------------------------	---------------------------------

3. Place the protective cap over the positive terminal.
4. Position the battery holder on the battery. Ensure that the top part of the holder is properly engaged in its slot.

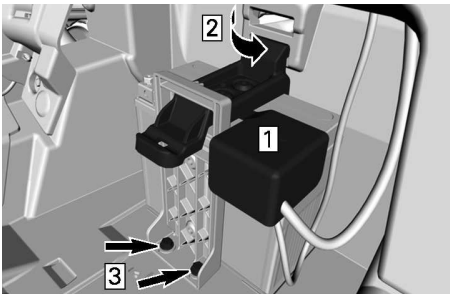

1. Place positive terminal cap
2. Engage holder in slot
3. Install screws and washers

5. Install the two battery holder retaining screws and flat washers. Tighten to specification.

**Tightening Torque**

Battery holder retaining screws	5 ± 1 Nm (44 ± 4 lbf-in)
---------------------------------	-----------------------------

6. Connect the black cable to the negative (-) terminal of the battery, using the hex head screw and lock washers. Tighten to specification.

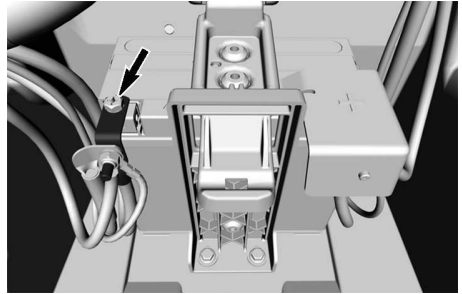

**Tightening Torque**

Negative terminal screw	5.0 ± 0.5 Nm (44 ± 4 lbf-in)
-------------------------	---------------------------------

**FUSES**

**Replacing a Fuse**

If a fuse is burnt, replace it by one of the same rating.

**NOTICE**

**Do not use a higher rated fuse as this can cause severe damage.**

1. To open the fuse box, remove the O-rings installed on both locks.

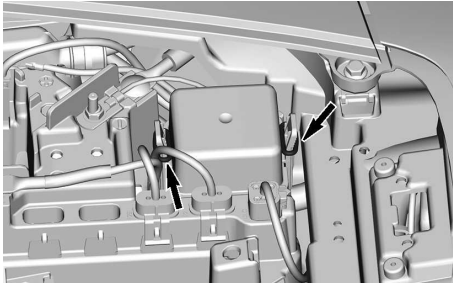

2. Press both tab against the cover and pull it upwards.

### **Fuse Box and Fuse Holder Locations**

#### **Front Fuse Box**

The front fuse box is located under the front fuse box cover in the center of the dashboard.

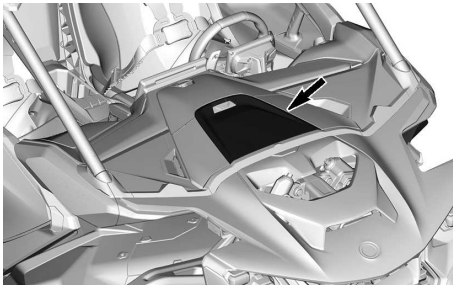

**FRONT FUSE BOX COVER**

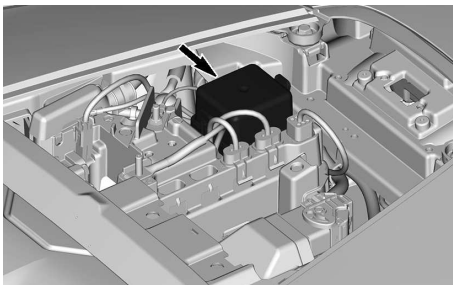

**FRONT FUSE BOX**

#### **Fuse Holders**

The fuse holders are also located under the front fuse box cover, next to the front fuse box.

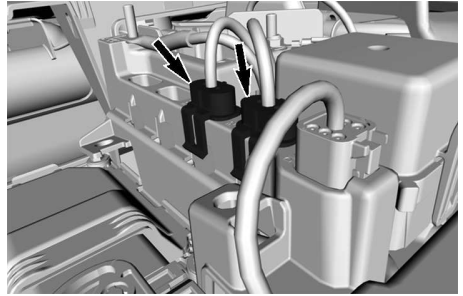

#### **Fusible Links**

There are two fusible links on the vehicle. One of them is located near the front fuse box.

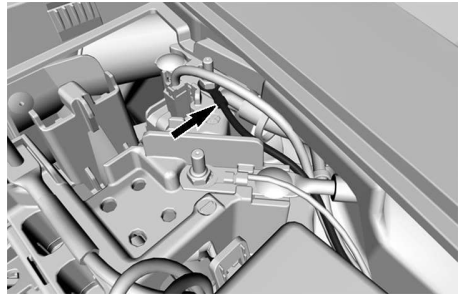

The other one is located under the center console.

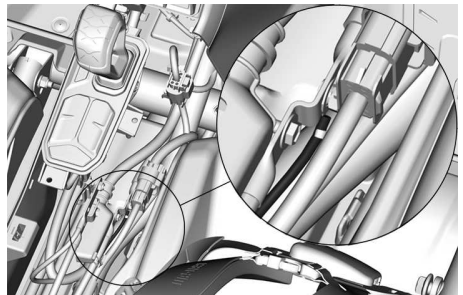

In the event that a fusible link blows, see your *Can-Am Off-Road* dealer.

#### **Rear Fuse Boxes**

The rear fuse boxes are located on the rear baffle cover behind the driver's seat. These include the engine fuse box and the vehicle fuse box.



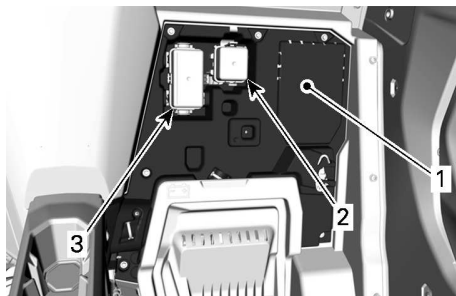

1. Rear bulkhead panel
2. Engine fuse box
3. Vehicle fuse box

### Fuse Box and Fuse Holder Descriptions

#### Front Fuse Box

Front Fuse Box		
No.	DESCRIPTION	RATING
F7	Sensor and switch light	10 A
F11	Headlamp	10 A
F12	DC1–DC3	10 A
F14	ACC post	20 A
F16	Taillamp	10 A
F22	BCM SAS (if equipped)	20 A
F23	BCM Smart Lock	20 A
R3	Accessory relay	—
R4	Headlamp relay	—
R8	BRK relay	—

#### Fuse Holders

Fuse Holders		
No.	DESCRIPTION	RATING
F2	DPS	40 A
F29	10.25-in. Color Touchscreen Display (if equipped)	20 A

#### Rear Fuse Box - Vehicle

Rear Fuse Box - Vehicle		
No.	DESCRIPTION	RATING
F4	Relay Speedo	10 A
F5	Coil/SS1–SS2	10 A
F6	ECM	10 A
F8	Key Switch/Clock	10 A
F17	Engine Turbo Intercooler	25 A
F18	EVAP Lambda	10 A
F28	Fuel Pump	10 A
F34	Main Relay Lamp	25 A
F35	Inj - Speed sensor - Oxygen sensor	10 A
R1	Engine Fan Relay	—
R2	Main Relay	—
R10	Engine Turbo Intercooler Fan 1 relay	—

#### Rear Fuse Box - Engine

Rear Fuse Box - Engine		
No.	DESCRIPTION	RAT ING
F17	Engine Turbo Intercooler Fan 1	25 A
F27	Gearbox ACT	25 A
F30	Gearbox Fan 1	15 A
F31	Gearbox Fan 2	15 A
F32	Intercooler Fan 2	25 A
R5	Gearbox Fan Relay	—
R10	Engine Turbo Intercooler Fan 2 relay	—

## Fusable Links

Fusable Links		
No.	DESCRIPTION	RAT ING
FL-1	Fuse link 1	14 AWG
FL-2	Fuse link 2	14 AWG

## LIGHTS

### Light Bulb Replacement

No bulb replacement is required for this vehicle.

It is equipped with LEDs (Light Emitting Diode) lights. This technology has proven itself to be very reliable.

In the unlikely event that one light does not work, have it checked by an authorized Can-Am Off-road dealer, repair shop or person of your own choosing.

### Headlight Beam Aiming

1. Remove the headlight cover.

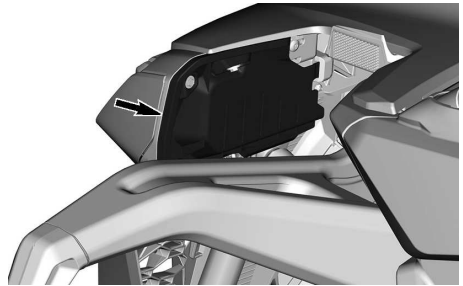

2. Turn adjustment screws to adjust beam height to your convenience. The beam aiming screw is located under the headlight module.

### NOTE:

Adjust left and right headlights evenly.

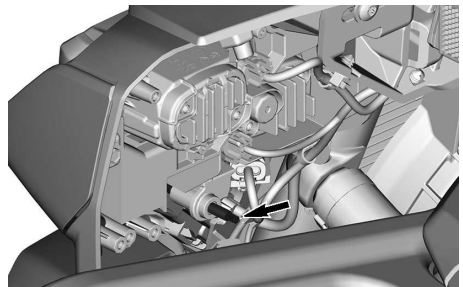

## SPARK PLUGS

### Spark Plug Access

To access the spark plugs, the intercooler must be removed.

1. Disconnect the two intercooler fan connectors. Then remove the fan harness from its plastic hooks.

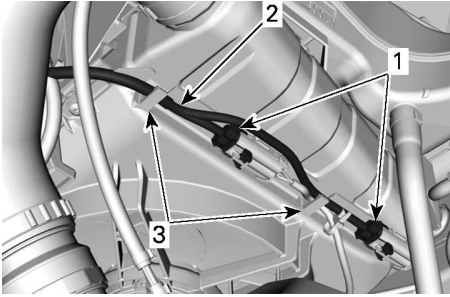

**RIGHT-REAR WHEEL WELL**

1. Fan connectors
2. Fan harness
3. Plastic hooks

2. Loosen the hose clamps on the left and right intercooler hoses. Then disconnect the hoses from the intercooler.

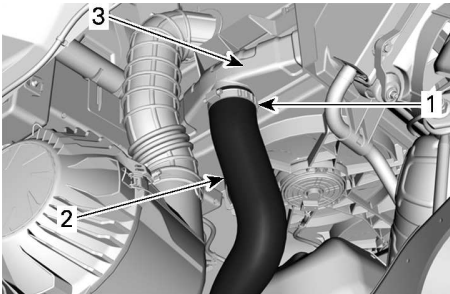

**LEFT-REAR WHEEL WELL**

1. Hose clamp
2. Left intercooler hose
3. Intercooler

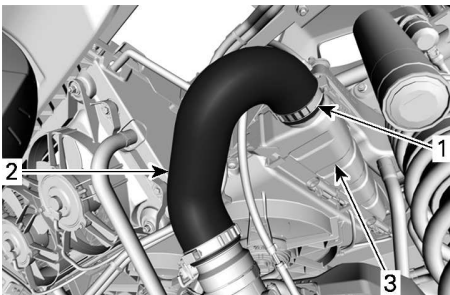

**RIGHT-REAR WHEEL WELL**

1. Hose clamp
2. Right intercooler hose
3. Intercooler

3. Remove the plastic rivet on the top of the air intake grille.

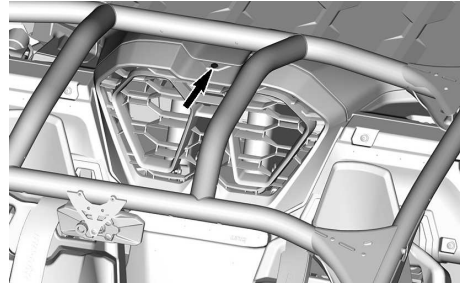

4. Pull towards the front to remove the air intake grille.

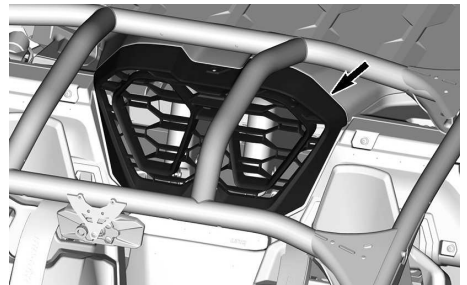

5. Remove the plastic rivets and screws that secure the air intake assembly to the cargo rack. Then remove the air intake assembly.

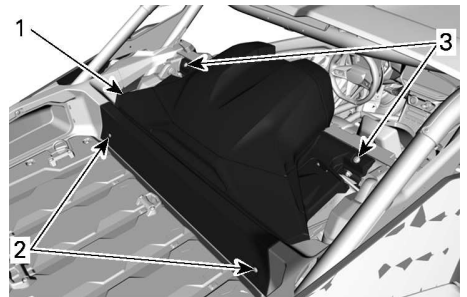

1. Air intake assembly
2. Plastic rivets
3. Screws

6. Remove the screws and flat washers from the cargo rack. Then remove the cargo rack.

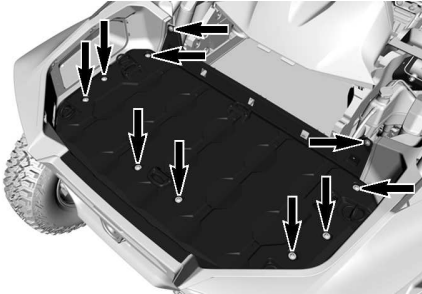

7. Remove the screws that retain the acoustic baffles to the intercooler support and the chassis. Then remove the baffle from each side of the intercooler.

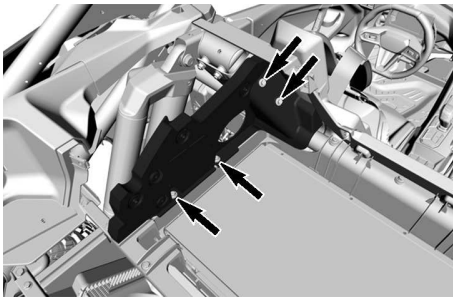

**ACOUSTIC BAFFLE - LEFT - TYPICAL**

8. Remove the screw and flat washer that retain the coolant reservoir to the intercooler support. Then move it aside.

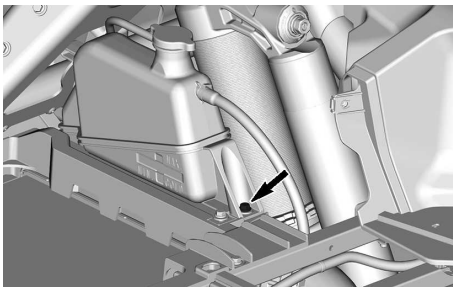

9. On LH side, detach the air filter intake hose from the side baffle.

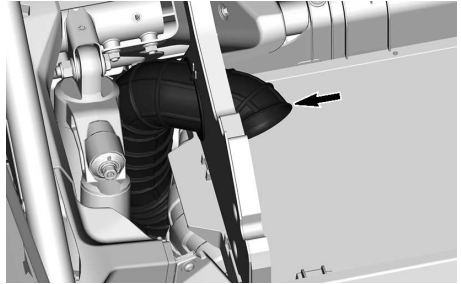

10. Remove the screws from the intercooler support. Then remove the intercooler.

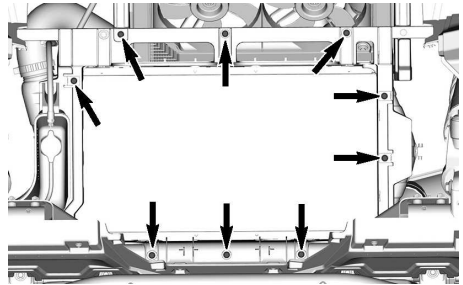

The spark plugs are now accessible.

When re-installing the above-mentioned components, pay attention to the following:

Tightening Torques	
Intercooler hose clamps	6 ± 0.5 Nm (53 ± 4 lbf-in)
Air intake assembly screws	2.5 ± 0.5 Nm (22 ± 4 lbf-in)
Cargo rack screws	3.5 ± 0.5 Nm (31 ± 4 lbf-in)
Acoustic baffle screws (into chassis)	8 ± 1 Nm (71 ± 9 lbf-in)
Acoustic baffle screws (into intercooler support)	5.5 ± 0.5 Nm (49 ± 4 lbf-in)

Tightening Torques	
Coolant reservoir screw	4.5 ± 0.5 Nm (40 ± 4 lbf-in)
Air intake hose clamp	6 ± 0.5 Nm (53 ± 4 lbf-in)
Intercooler support screws	8 ± 1 Nm (71 ± 9 lbf-in)

### Removing the Spark Plug

1. Disconnect the ignition coil connector.
2. Remove the ignition coil screw.

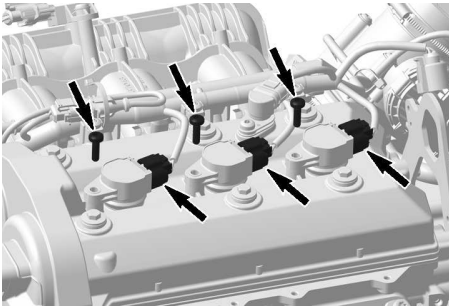

3. Remove ignition coils with gaskets from spark plug by rotating coil side to side as you pull up.

### NOTICE

Do not pry on ignition coil with a tool.

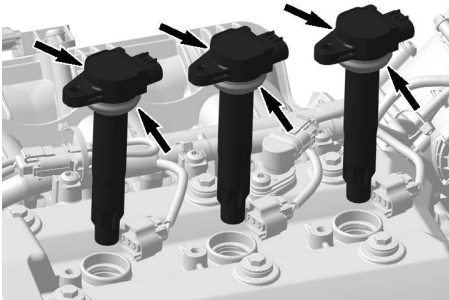

4. Using a spark plug socket, release the torque applied to the spark plug.

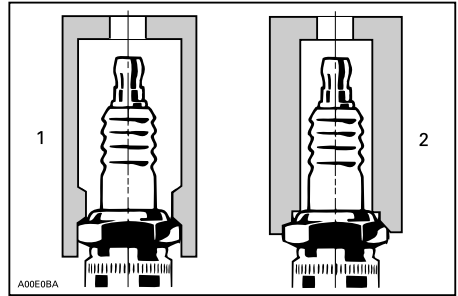

1. Approved socket
2. Improper socket

5. Clean the spark plug hole using pressurized air.
6. Remove the spark plug.
7. Use ignition coil as a puller to extract the spark plug from its hole.

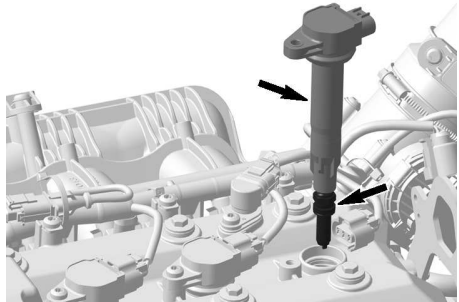

### Inspecting the Spark Plug

1. Using a feeler gauge, inspect electrode gap as specified.

Spark Plug	
Manufacturer and type	NGK SILMAR9F7
Electrode gap	0.6 - 0.7 mm (.024 - .028 in)

### NOTICE

Replace spark plug if out of specification.

## Troubleshooting a Fouled Spark Plug

1. Fouling of the spark plug is indicated by irregular running or misfiring of the engine, decreased engine speed due to misfiring, reduced performance, and increased fuel consumption.
2. Other possible causes are: use of an incorrect or bad fuel, defective ignition system, incorrect spark plug gap, loss of compression, or lubricating oil entering the combustion chamber.
3. The plug face of a fouled spark plug has either a wet or dry black carbon deposit. Such coatings form a conductive connection between the center electrode and the ground electrode.

## Spark Plug Analysis

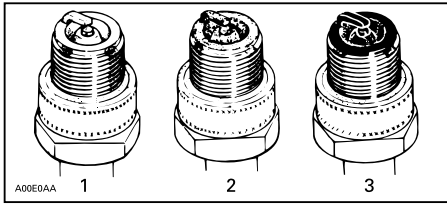

### TYPICAL

1. Overheated (light gray, white)
2. Normal (light brown, brown)
3. Fouled (black, wet or dry, dark deposits, gray, melted coating)

The plug face reveals the condition of the engine, operating condition, method of driving and fuel mixture. For this reason it is advisable to inspect the spark plug at prescribed intervals, examining the plug face (i.e. the part of the plug projecting into the combustion chamber).

## Installing the Spark Plug

1. Prior to installation make sure that contact surfaces of the cylinder head and spark plug are free of grime.

2. Hand screw spark plug into cylinder head, then tighten with a torque wrench and an appropriate socket.

Tightening Torque	
Spark plug	14 ± 1 N·m (124 ± 9 lbf·in)

3. Install ignition coil and plug the connector.

Tightening Torque	
Ignition coil screw	9 ± 1 N·m (80 ± 9 lbf·in)

## DRIVE SHAFT BELLOWS

### Inspecting the Drive Shaft Bellow

1. Visually inspect drive shaft bellows conditions.
2. Check bellows for cracks, tears, leaking grease, etc.
3. Replace damaged bellows as necessary.

## WHEEL BEARING

### Inspecting the Wheel Bearing

1. Lift and support vehicle.
2. Push and pull the wheel from the upper edge to feel the play.



3. See an authorized Can-Am Off-road dealer, a repair shop or person of your choosing if there is abnormal play.

## WHEELS AND TIRES

### Removing a Wheel

1. Loosen nuts then lift and support vehicle.
2. Remove lug nuts then remove wheel.

### Installing a Wheel

1. Make sure the wheel studs are free of any dirt or metal chips.

**⚠ WARNING**

**Do not use any type of lubricant on the studs or lug nut threads before tightening.**

2. Lift the wheel onto the studs.
3. Install the wheel lug nuts and tighten by hand until snug.

**NOTICE**

**Always use the recommended wheel lug nuts for the type of wheel. Using a different lug nut could cause damages to the rim or studs.**

4. Tighten to the specified torque, using the sequence shown below.

**Tightening Torque**

Wheel lug nuts	120 ± 5Nm (88.5 ± 4 lbf-ft)
----------------	--------------------------------



### Tire Pressure

**⚠ WARNING**

**Tire pressure greatly affects vehicle handling and stability. Insufficient pressure may cause tire to deflate and rotate on wheel. Overpressure may burst the tire. Always follow recommended pressure. NEVER set tire pressure below minimum. It could cause the tire to dislodge from the rim.**

Check pressure when tires are cold before using the vehicle. Tire pressure changes with temperature and altitude. Recheck pressure if one of these conditions has changed.

Refer to the *Tires Pressure and Maximum Load Label* on your vehicle for applicable pressure.

**NOTE:**

Although the tires are specifically designed for off-road use, a flat may still occur. Therefore, it is recommended to carry a tire gauge, tire pump and a repair kit.

### Inspecting a Tire

1. Check tire for damage and wear.
2. Replace if necessary.

### Tire Replacement

Tire replacement should be performed by an authorized Can-Am Off-road dealer, a repair shop or a person of your choosing.

**⚠ WARNING**

**Replace tires only with the same type and size as original tires. For unidirectional tread pattern, ensure that the tires are installed in the correct direction of rotation. Tires should be replaced, by an experienced person, in accordance with tire industry standards and tools.**

## Tire Mounting on Beadlock Wheels

1. Mount the tire on the wheel:
  1. On the opposite side of the beadlock, apply tire mounting lube on both bead of the tire and wheel to ensure that it proper seating during inflation. Mount the inner bead over the wheel.
  2. Seat the tire outer bead in the the shoulder of the beadlock inner ring and center the tire.

### NOTICE

The difference between the smallest gap and the biggest gap should not exceed 3 mm (1/8 in).

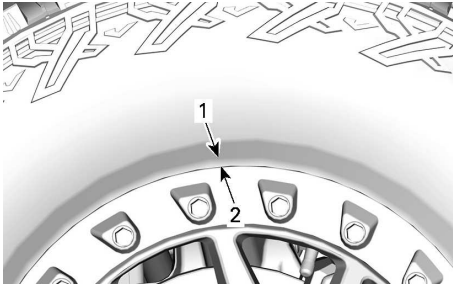

1. Tire outer bead
  2. Beadlock inner ring shoulder
2. Install all of the beadlock screws. To avoid cross-threading, start the screws by hand.
  3. Tighten the beadlock screws per the following specification and sequence:

### NOTE:

To ensure even pressure on the beadlock clamp ring, tighten the screws a few turns at a time.

#### Tightening Torque

Beadlock screws (FIRST TORQUE)	$4 \pm 1$ Nm ( $35 \pm 9$ lbf-in)
--------------------------------	--------------------------------------

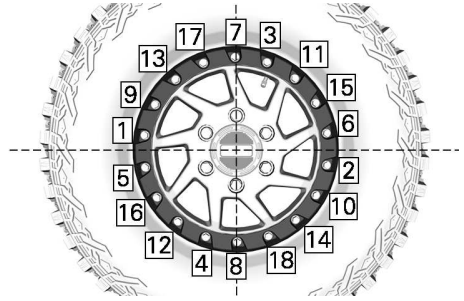

TYPICAL - TIGHTENING SEQUENCE

#### Tightening Torque

Beadlock screws (SECOND TORQUE)	$14 \pm 1$ Nm ( $124 \pm 9$ lbf-in)
---------------------------------	--

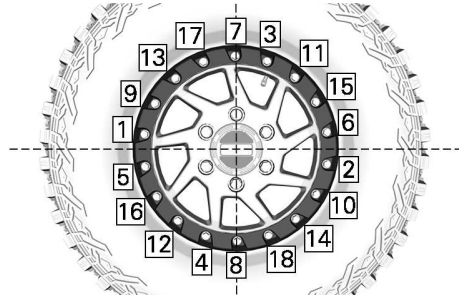

TYPICAL - TIGHTENING SEQUENCE

4. At this time, check whether the tire is still centered on the wheel. Reposition it if necessary.
5. Torque the beadlock screws a **third** time, using the same sequence:

#### Tightening Torque

Beadlock screws (THIRD TORQUE)	$29 \pm 1$ Nm ( $21 \pm 1$ lbf-ft)
--------------------------------	---------------------------------------



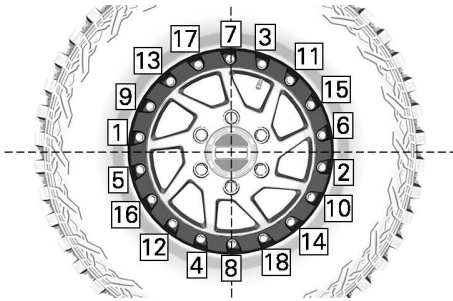

**TYPICAL - TIGHTENING SEQUENCE**

**NOTE:**

The beadlock clamp ring should be in contact with the beadlock inner ring. The beadlock clamp ring can flex slightly to match the tire bead. THIS IS NORMAL.

- Verify the gap between the tire and the beadlock clamp ring. It should be approximately equal all around the ring.

**NOTICE**

The difference between the smallest gap and the biggest gap should not exceed 3 mm (1/8 in).

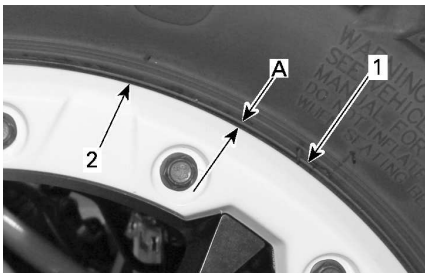

- Tire
  - Beadlock clamp ring edge
- A. Gap equal all around beadlock clamp ring

- If the gap is not acceptable, proceed as follows:
  - Loosen all of the screws.

- Check the tire position on the wheel and reposition it if necessary.
- Restart the torquing sequence described above.
- Torque the beadlock screws a **final** time, following the indicated sequence:

<b>Tightening Torque</b>	
Beadlock screws (FINAL TORQUE)	29 ± 1 Nm (21 ± 1 lbf-ft)

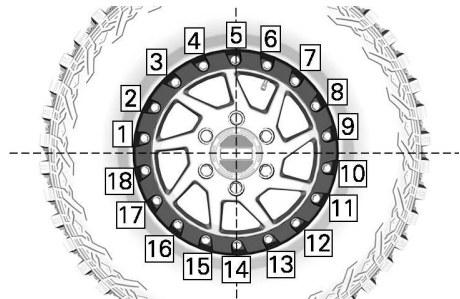

**TYPICAL - FINAL TIGHTENING SEQUENCE**

- Inflate the tire to seat the inner bead on the wheel. Always employ best practices, such as using a tire safety cage.

**⚠ WARNING**

Never exceed the tire's recommended maximum pressure for seating beads.

## SUSPENSION

### *Inspecting the Suspension*

See an authorized Can-Am Off-road dealer, a repair shop or a person of your choosing if any problem is detected.

### **Shock Absorbers**

- Inspect shock absorber for leaks, bump stop wear out or other damages.

- Verify if fasteners are still well tightened.

Tightening Torque	
M14 bolt	140 ± 10 Nm (103 ± 7lbf-ft)

### Front Suspension Arms

- Check suspension arms for cracks, bending or other damages.
- Re-tighten the suspension arm bolts to specifications at ride height.

### NOTICE

To avoid suspension bushings damages, never lift the vehicle from the ground to re-tighten suspension arm fasteners. When possible, always apply the tightening torque by the bolt head and not by using the nut to ensure optimal clamping.

Tightening Torque	
Upper suspension arm bolts	185 ± 5 Nm (136 ± 4 lbf-ft)
Lower suspension arm front bolts	185 ± 5 Nm (136 ± 4 lbf-ft)
Lower suspension arm rear bolts	240 ± 5 Nm (177 ± 4 lbf-ft)

### Rear Suspension Arms

- Check trailing arms for distortion, cracks or bending.
- Re-tighten trailing arms to specifications.

### NOTICE

The suspension arms must be tightened on the M14 bolt head and not on the nut (when possible) to insure optimal clamping.

Tightening Torque	
All M14 bolts)	170 ± 20 Nm (125 ± 157 lbf-ft)

### Stabilizer Bar

- Check stabilizer bars for cracks, bending or, other damaged.

### Lubricating the Suspension

#### Stabilizer Bar

- Lubricate stabilizer bars using the following product.

XPS synthetic suspension grease

### Stabilizer Bar Grease Fitting Locations

There is a grease fitting under each front stabilizer bar bushings.

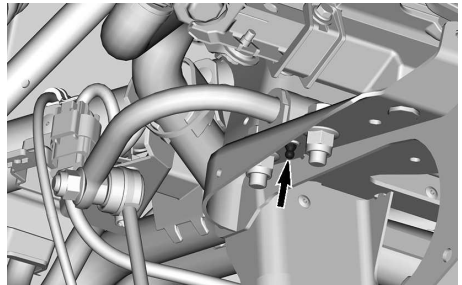

FRONT RH SIDE SHOWN- BEHIND THE FRONT RADIATOR

There is also a grease fitting on each of the rear stabilizer bar bushings.

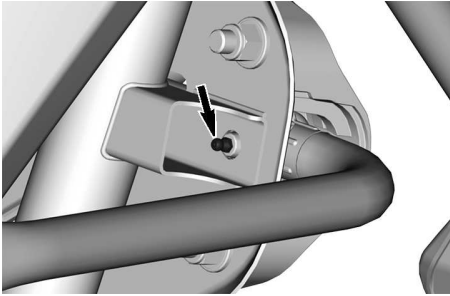

REAR STABILIZER BAR - LEFT SIDE - TYPICAL

## BRAKES

### Verifying the Brake Fluid Level

1. Place the vehicle on a level surface.
2. Remove the fuse box cover.
3. Remove the front service cover.

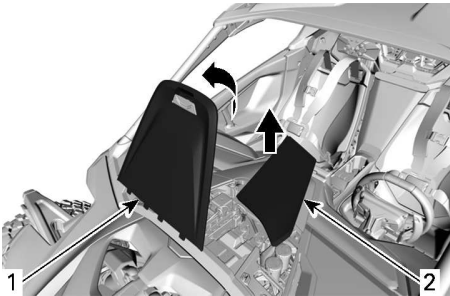

1. Fuse box cover
2. Front service cover

4. Using the marks on the brake fluid reservoirs, check the fluid level. The proper level should be between the LOWER and UPPER lines.

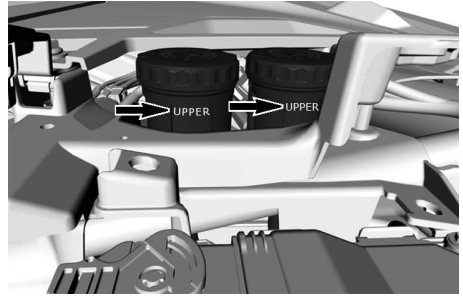

BRAKE FLUID RESERVOIRS - FROM PASSENGER SIDE

### NOTE:

A low fluid level may indicate a leak or worn brake pads.

### Adding Brake Fluid

1. Clean filler cap before removing.
2. Add fluid as required. **Do not overfill.**
3. Close filler cap and tighten its screws to specification.

### NOTICE

Ensure filler cap diaphragm is pushed inside the cap before closing the brake fluid reservoir.

Ensure filler cap diaphragm is pushed inside the cap before closing the brake fluid reservoir.

Tightening Torque	
Filler cap screws	0.75 ± 0.2 Nm (6.6 ± 1.8 lbf-in)

### Recommended Brake Fluid

Always use brake fluid meeting the specification DOT 4 only.

#### NOTICE

To avoid serious damage to the braking system, do not use fluids other than the recommended one, nor mix different fluids for topping up.  
Do not use brake fluid taken from old or already opened containers.

### Brake Inspection

The brake inspection, maintenance and repair should be performed by an authorized Can-Am dealer, a repair shop or person of your choosing.

However, verify the following between visits to your dealer:

- Brake fluid level
- Brake system for fluid leaks
- Brake pad wear
- Brake cleanliness

#### ⚠ WARNING

The brake fluid replacement or brake system maintenance and repairs should be performed by an authorized Can-Am dealer.

## SEAT BELTS

### Cleaning a Seat Belt

1. Sponge the straps with mild soap and water to clean dirt and debris from the seat belts.

#### ⚠ WARNING

Do not use pressure washer to clean seat belt components. Use of pressure washer can permanently damage seat belt components.

#### NOTICE

Do not use bleach, dye, or household detergents.

## CAGE

### Tightening the Cage Fasteners

The tightness of the cage fasteners must be periodically checked.

1. Tighten the front fasteners to specification.

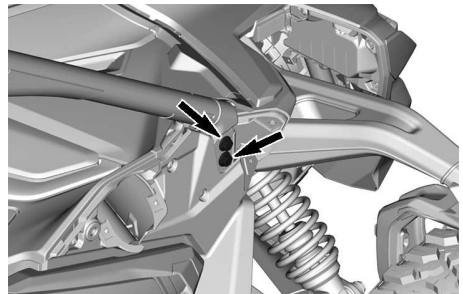

FRONT FASTENERS - TYPICAL

#### Tightening Torque

M12 x 60 screws	110 ± 10 Nm (81 ± 7 lbf-ft)
-----------------	--------------------------------

2. Tighten the front lateral fasteners to specification.

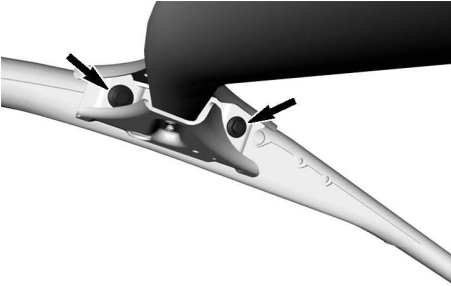

**FRONT LATERAL FASTENERS - TYPICAL**

Tightening Torque	
M12 x 30 screws	110 ± 10 Nm (81 ± 7 lbf-ft)

3. Tighten the rear lateral fasteners to specification.

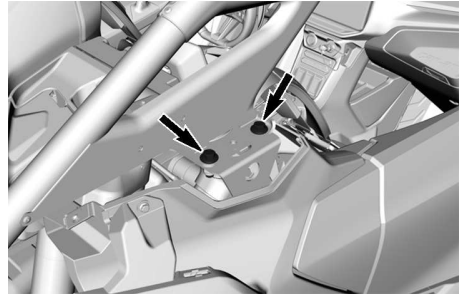

**REAR FASTENERS - TYPICAL**

Tightening Torque	
M12 x 30 screws	110 ± 10 Nm (81 ± 7 lbf-ft)

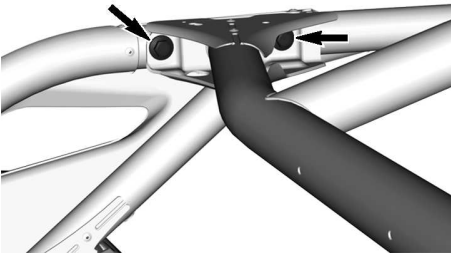

**REAR LATERAL FASTENERS - TYPICAL**

Tightening Torque	
M12 x 30 screws	110 ± 10 Nm (81 ± 7 lbf-ft)

4. Tighten the rear fasteners to specification.

---

# VEHICLE CARE

## Vehicle Cleaning and Protection

### NOTICE

**When using a high pressure washer to clean the vehicle, proceed carefully around seats, electrical components and decals. Also maintain a good distance between the nozzle and the surface being washed.**

Pay attention to certain areas where salt-water, mud or debris can accumulate and potentially cause:

- Fire
- Wear
- Interference
- Corrosion.

This list includes but is not limited to:

- Around exhaust system and between muffler and muffler cover
- Under and around the fuel tank
- Radiator
- Shock absorbers
- Around front and rear differentials
- Around and underneath engine and gearbox
- Inside wheels
- On top of skid plates.

### WARNING

**Debris accumulation could lead to a vehicle fire when the exhaust system is hot and the debris are dried.**

**In some cases, that could result in serious property damages, injuries or even death.**

**Clean often and regularly the area surrounding the exhaust system when riding in swamp, bog, hay or dead leaves.**

**In other situations, clean as per maintenance schedule requirement.**

with fresh water is necessary to preserve vehicle and its components after each operating day.

Painted parts which are damaged should be properly repainted to prevent rust.

When required, wash the body with warm water and soap (only use mild detergent). Apply non-abrasive wax.

### NOTICE

**Never clean plastic parts with strong detergent, degreasing agent, paint thinner, acetone, etc.**

Protect the vehicle with a cover to prevent dust accumulation during storage.

### NOTICE

**The vehicle has to be stored in a cool and dry place and covered with an opaque tarpaulin. This will prevent sun rays and grime from affecting plastic components and vehicle finish.**

When vehicle is used in salt-water or mud environment rinsing the vehicle

---

## STORAGE AND PRESEASON PREPARATION

When a vehicle is not in use for more than 4 months, proper storage is a necessity.

If the vehicle is to remain inactive for more than 21 days, disconnect the BLACK (-) cable of the battery.

The use of a low amperage trickle charger is recommended to keep battery fully charged.

Before using your vehicle after storage, a preparation is required.

See an authorized Can-Am Off-road dealer, a repair shop, or a person of your own choosing to have your vehicle prepared properly.

While reading this Operator's Guide, remember that:



### **WARNING**

Indicates a potential hazard which, if not avoided, could result in serious injury or death.

This page is intentionally blank



# TECHNICAL INFORMATION

# VEHICLE IDENTIFICATION

The main components of your vehicle (engine and frame) are identified by different serial numbers. It may sometimes become necessary to locate these numbers for warranty purposes or to trace your vehicle in the event of loss.

These numbers are required by the authorized Can-Am Off-road dealer to complete warranty claims properly.

We strongly recommend that you take note of all the serial numbers on your vehicle and supply them to your insurance company.

## Vehicle Identification Number

The VIN label is located on the panel under the glove box.

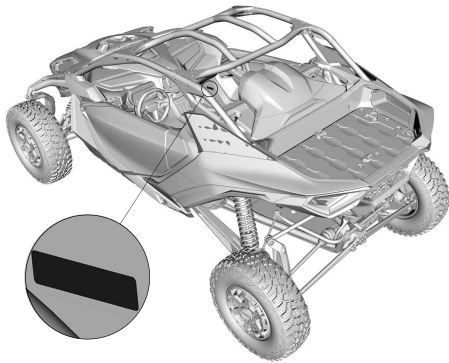

The vehicle is also equipped with an engraved VIN on the frame. It is located on the right lower front member of the frame, just below the front differential.

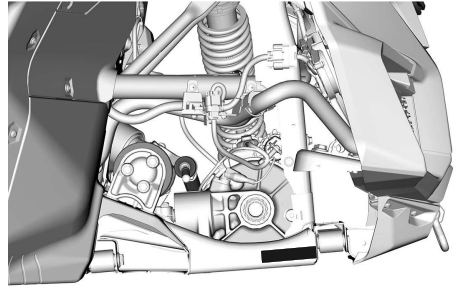

## Engine Identification Number

The engine serial number plate is located on the right of the engine near the engine oil filter housing.

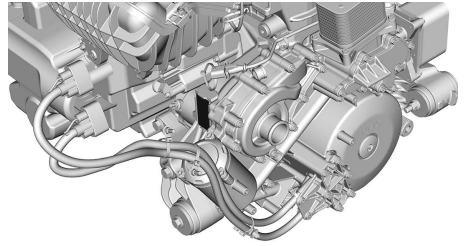

## Transmission Identification Number

The transmission identification number plate is located on the LH side of the gearbox, near the final drive.

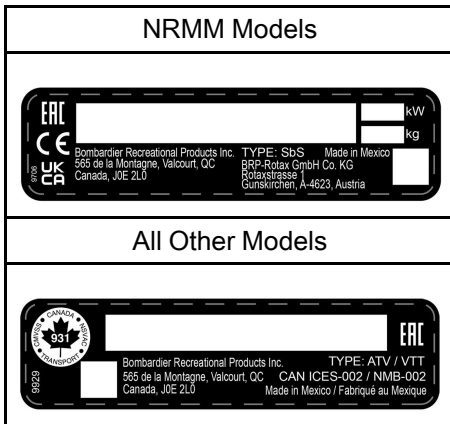
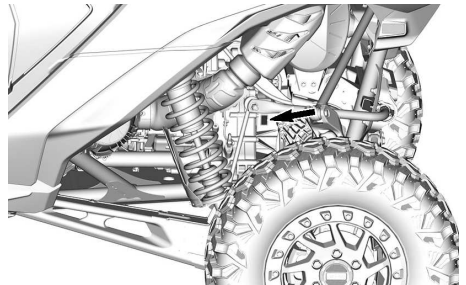

### NRMM Models

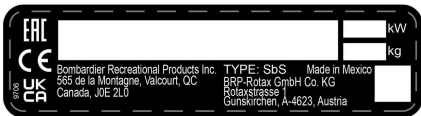

### All Other Models



# COMPLIANCE LABELS

## Emission Control Information

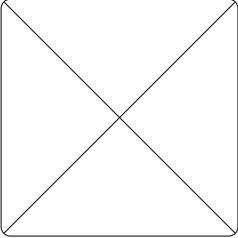
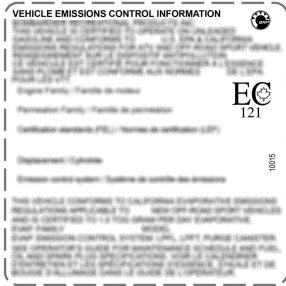
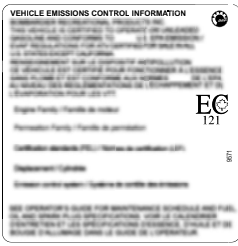
NRMM	CARB	Other Models
		

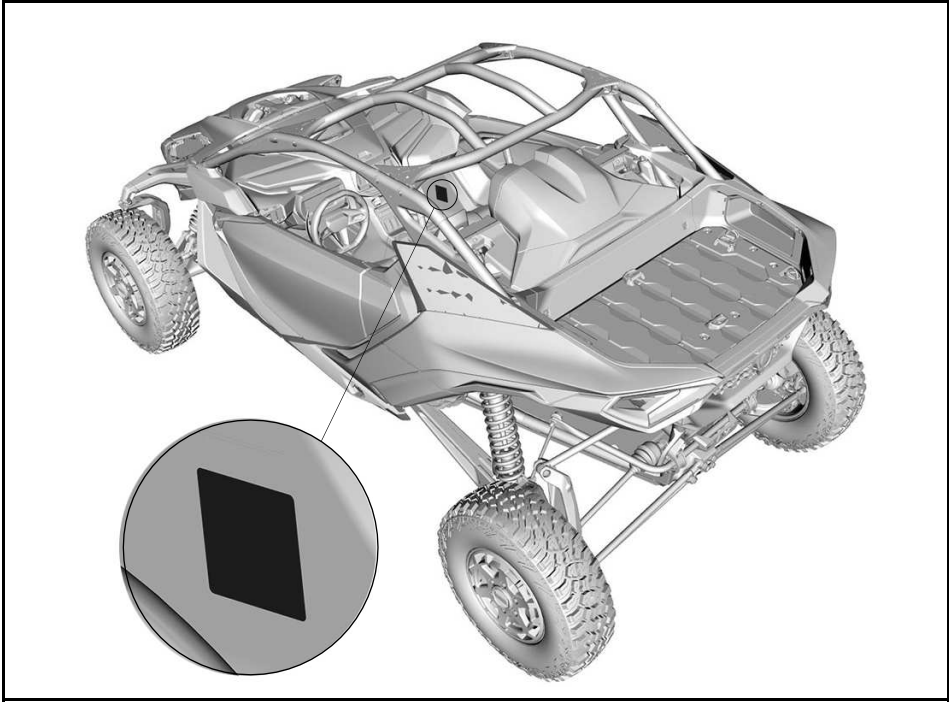

## ANSI/ROHVA Label

BRP certifies that this ROV complies with the American National Standard for Recreational Off-Highway Vehicles, ANSI / ROHVA 1 - 2016 Standard.

BRP certifie que ce véhicule récréatif hors-route est conforme à la norme "American National Standard for Recreational Off-Highway Vehicles", ANSI / ROHVA 1 - 2016.

This roll over protective structure meets the performance requirements of ISO 3471: 2008 .

Cette structure de protection contre le retournement respecte les requis de performance de la norme ISO 3471: 2008 .



704906982

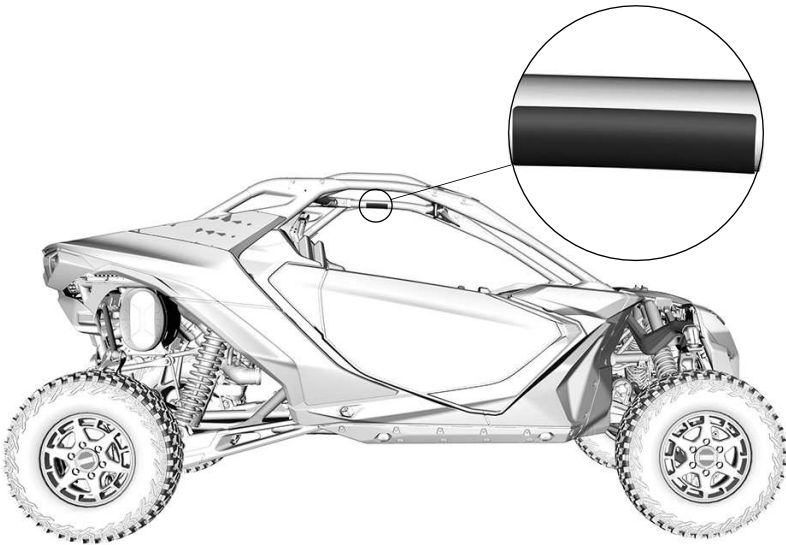

## NRMM Conformity Label

# Rotax

8938

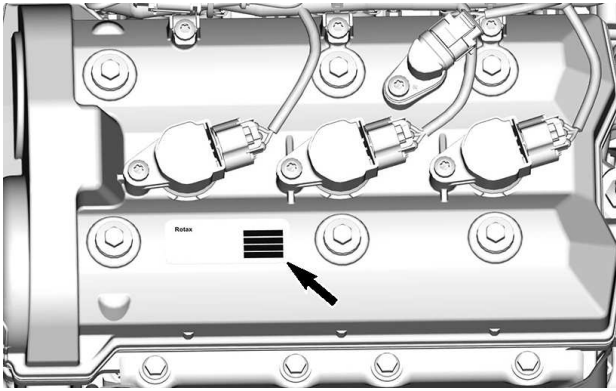

## Fuel Ethanol Content

This label is located near the gas cap.



# TECHNICAL INFORMATION LABELS

## Verifying the Engine Oil Level

### ⚠ CAUTION

Find and follow the procedure indicates in the operator's guide. The engine of this SSV has been developed and validated using the BRP XPS Synthetic 4-stroke oil. Engine oil and certain components in the engine compartment may be hot. Direct contact may result in skin burn.

1. The engine **MUST** be at operation temperature.
2. Vehicle must be level to perform verification.
3. Let the engine run at idle for at least 20 seconds.
4. Stop the engine and wipe the dipstick.
5. Screw dipstick in completely before checking the oil level.

### North American Models



### Models Outside North America

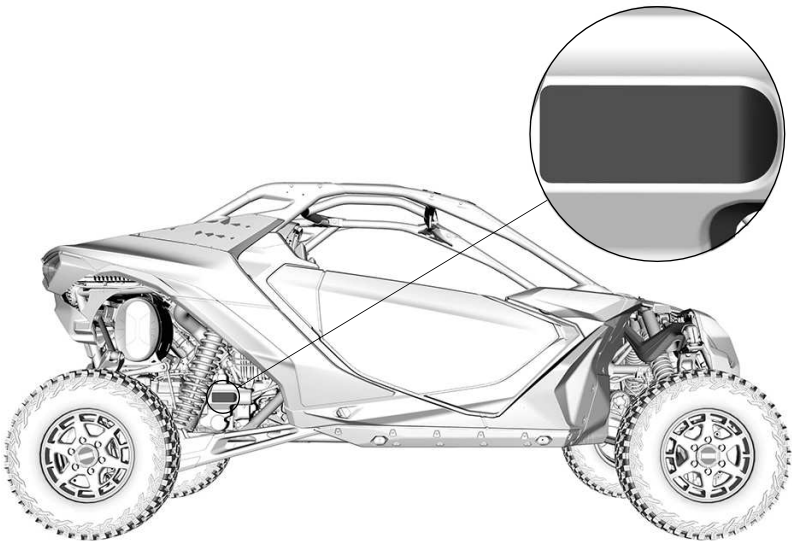
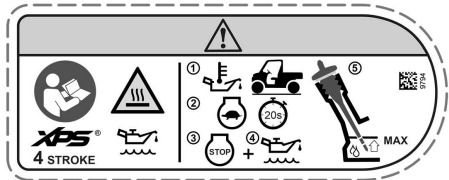

## Recommended Fuel

Inside fuel tank cap cover

### NOTICE

Use unleaded fuel only. Recommended octane rating: PREMIUM 91 (min (R+M)/2) or SUPER 95 (min RON). Refer to operator's guide.

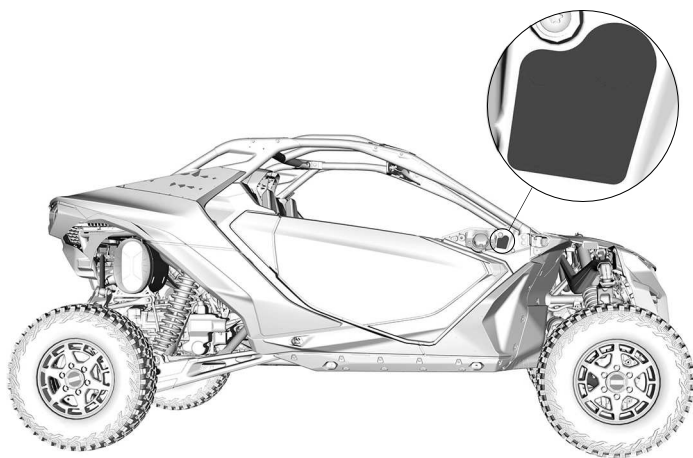
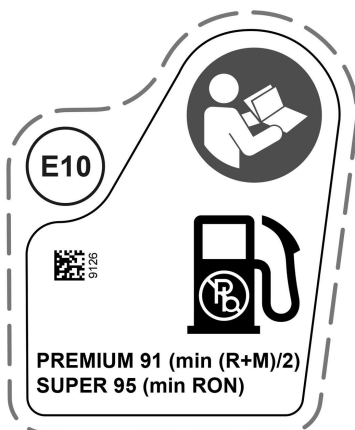

## Air Filter Maintenance

On engine air filter housing

### NOTICE

**Refer to Operator's Guide for air filter maintenance schedule and instructions.**

#### AIR FILTER MAINTENANCE

Maintenance must be performed as specified in the operator's guide. Air filter maintenance should increase in frequency in more severe (dusty) conditions.

#### ENTRETIEN DU FILTRE À AIR

L'entretien doit être effectué tel que spécifié dans le guide du conducteur. Entretien le filtre à air plus souvent dans des conditions plus extrêmes (milieux poussiéreux).



9480

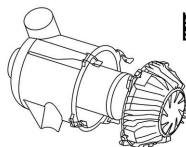

9480

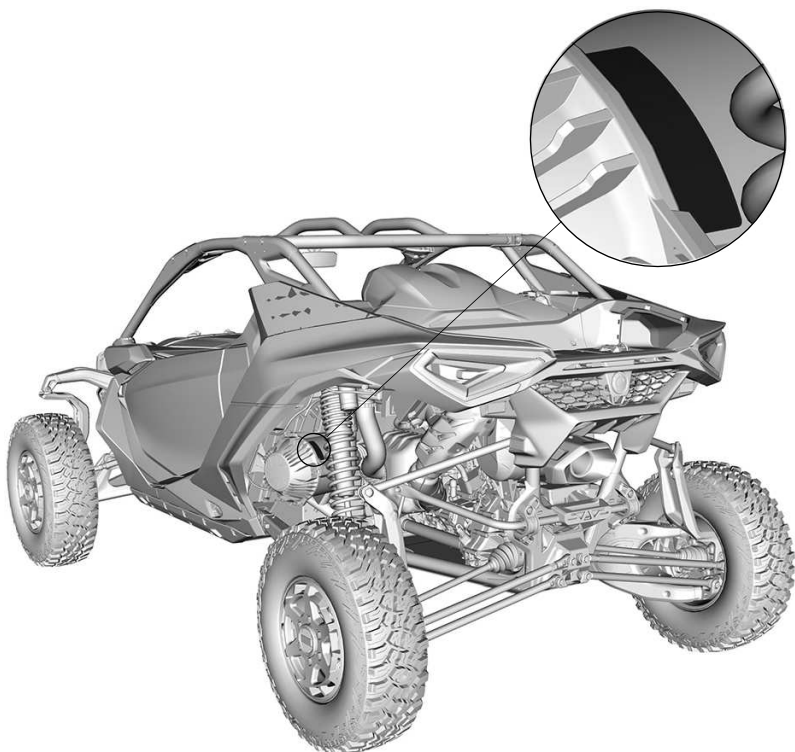



---

# **RADIO FREQUENCY DIGITALLY ENCODED SECURITY SYSTEM (RF D.E.S.S. KEY)**

This device complies with FCC Part 15 and Industry Canada license exempt RSS standard(s).

Operation is subject to the following two conditions: (1) this device may not cause interference, and (2) this device must accept any interference, including interference that may cause undesired operation of the device.

Changes or modifications not expressly approved by the party responsible for compliance could void the user's authority to operate the equipment.

IC Registration Number: 12006A-1001317030

FCC ID: 2ACER-1001317030

We, the party responsible for compliance, declare under our sole responsibility that the device is in conformity with the provisions of the following Council Directive: 2014/53/EU. To which this declaration relates is in conformity with the essential requirements and other relevant requirements. The product is in conformity with the following directives, harmonized standards and regulations:

Radio Equipment Directive (RED) 2014/53/EU and Harmonized Standards:

- IEC 62368-1:2014, CISPR 25:2016, ISO 11452-2:2004, ETSI EN 300 330 V2.1.1:2017

Radio Equipment Statutory Instrument 2017/1206 and Designated Standards:

- IEC 62368-1:2014, CISPR 25:2016, ISO 11452-2:2004, ETSI EN 300 330 V2.1.1:2017

---

# EVAPORATIVE EMISSION CONTROL SYSTEM

## California Models with Evaporative Emission Control System

Beginning with the 2018 model-year vehicles, some California models are certified to meet the CARB (California Air Resources Board) TP-933. These models are equipped with an evaporative emission control system consisting of a low permeation fuel tank (LPFT), low permeation fuel lines (LPFL) and an actively purged carbon canister.

The following statement is required by the CCR (California Code of Regulation): An add-on or modified part must be compliant with applicable ARB evaporative emission control standards. A violation of this requirement is punishable by civil and/or criminal punishment.

---

# **NOISE EMISSION CONTROL SYSTEM REGULATION (CANADA AND UNITED STATES)**

## **USA and Canada Only**

### **Tampering with Noise Control System Is Prohibited!**

U.S. Federal law and Canadian provincial laws may prohibit the following acts or the causing there of:

1. The removal or rendering inoperative by any person other than for purposes of maintenance, repair or replacement of any device or element of design incorporated into any new vehicle for the purpose of noise control prior to its sale or delivery to the ultimate purchaser or while it is in use or
2. The use of the vehicle after such device or element of design has been removed or rendered inoperative by any person.

### **Among those Acts Presumed to Constitute Tampering Are the Acts Listed Below:**

1. Removal or alteration or the puncturing of the mufflers or any engine component which conducts removal of engine exhaust gases.
2. Removal or alteration or the puncturing of any part of the intake system.
3. Replacing any moving parts of the vehicle or parts of the exhaust or intake system, with parts other than those specified by the manufacturer.
4. Lack of proper maintenance.

---

# NOISE EMISSION AND VIBRATION VALUES

## Machinery Directive 2006/42/EC Compliant Models

Noise emission and Vibration values are measured in accordance with Machinery Directive 2006/42/EC on a paved surface, at neutral.

Noise Emission and Vibration Values		
Noise	Sound pressure level (LpA)	85 dB (A) (Uncertainty (KpA) 3dB)
	Sound power level (LWA)	100 dB (A) (Uncertainty (KwA) 3dB)
Vibration	Hand-arm system	Less than 2.5 m/s <sup>2</sup>
	Whole body at seat	Less than 0.5 m/s <sup>2</sup>

# DECLARATION OF CONFORMITY

## EU Declaration of Conformity



565 de la Montagne Street  
Valcourt (Québec) J0E 2L0  
Canada  
www.brp.com

### EU Declaration of Conformity

**Authorized Representative:** BRP-Rotax GmbH Co. KG, Rotaxstrasse 1, Gunskirchen, A-4623 Austria

This declaration of conformity is issued under the sole responsibility of the manufacturer.

The undersigned, representing the manufacturer, hereby declares that model year **2024 Side by Side Vehicles** marked with the **CE** mark and a 17-character vehicle identification number (VIN) structured as **3JBxxxxxxRxxxxxxx** under commercial name **Can-Am Maverick R** comply with all the relevant provisions of the following Directives and Regulations:

Machinery (MD) Directive 2006/42/EC as amended up to and including Regulation (EU) 2019/1243	ISO 12100:2010 & EN 16990:2020
Non-Road Mobile Machinery (NRMM) Regulation (EU) 2016/1628 on gaseous pollutants as amended up to and including Regulation (EU) 2022/992	Category ATS, Stage V emission limits
Electromagnetic Compatibility (EMC) Directive 2014/30/EU as amended up to and including Regulation (EU) 2018/1139	CISPR 12:2007/A1:2009 & IEC 61000-6-1:2007 or UN R10.04 or later version
Battery Directive 2006/66/EC as amended up to and including Directive (EU) 2018/849 and, Regulation (EU) 1103/2010 on battery capacity labelling	EN 50342-7:2015
Radio Equipment (RED) Directive 2014/53/EU as amended up to and including Regulation (EU) 2018/1139 (if fitted with radio frequency (RF) D.E.S.S. key)	Art. 3.1a: IEC 62368-1:2014 Art. 3.1b: CISPR 25:2016 & ISO 11452-2:2004 Art. 3.2: ETSI EN 300 330 V2.1.1:2017

  
Luc Bouchard (Feb 24, 2023 15:28 EST)

Luc Bouchard, Eng.  
Director, Product Development, Can-Am SSV  
Bombardier Recreational Products Inc.

Valcourt, QC, Canada

Feb 24, 2023

**ski-doo LYNX SEA-DOO EVINRUDE ROTAX CAN-AM**

# UK Declaration of Conformity



565 de la Montagne Street  
Valcourt (Québec) J0E 2L0  
Canada  
www.brp.com

## UK Declaration of Conformity

Authorized Representative : BRP Recreational Products UK Ltd.,  
Castle Chambers, 43 Castle Street, Liverpool, L2 9SH

This declaration of conformity is issued under the sole responsibility of the manufacturer.

The undersigned, representing the manufacturer, hereby declares that model year 2024 Side by Side Vehicles marked with the <sup>UK</sup>CA mark and a 17-character vehicle identification number (VIN) structured as 3JBxxxxxRxxxxxxx under commercial name Can-Am Maverick R comply with all the relevant provisions of the following Statutory Instruments:

Supply of Machinery (Safety) Regulations 2008, UK SI 2008/1597 as amended up to and including SI 2020/1112	ISO 12100:2010 & EN 16990:2020
Non-Road Mobile Machinery (Type-Approval and Emission of Gaseous and Particulate Pollutants) Regulations 2018, UK SI 2018/764 as amended up to and including SI 2020/1393	Category ATS, Stage V emission limits
Electromagnetic Compatibility Regulations 2016, UK SI 2016/1091 as amended up to and including SI 2020/1112	CISPR 12:2007/A1:2009 & IEC 61000-6-1:2007 or UN R10.04 or later version
Batteries and Accumulators (Placing on the Market) Regulations 2008, UK SI 2008/2164 as amended up to and including UK SI 2020/904	EN 50342-7:2015
Radio Equipment Regulations 2017, UK SI 2017/1206 as amended up to and including SI 2020/1112  (If fitted with radio frequency (RF) D.E.S.S. key)	Art. 3.1a: IEC 62368-1:2014 Art. 3.1b: CISPR 25:2016 & ISO 11452-2:2004 Art. 3.2: ETSI EN 300 330 V2.1.1:2017

  
Luc Bouchard (Feb 24, 2023 16:28 EST)

Luc Bouchard, Eng.  
Director, Product Development, Can-Am SSV  
Bombardier Recreational Products Inc.

Valcourt, QC, Canada

Feb 24, 2023

**ski-doo LYNX SEADOO Evinrude ROTAX can-am**

---

# EAC DECLARATION OF CONFORMITY

**Left blank for Eurasian Conformity  
mark where applicable**

This page is intentionally blank



# **TECHNICAL SPECIFICATIONS**

---

# TECHNICAL SPECIFICATIONS

## ENGINE

Engine	
Engine type	ROTAX® 999cc with turbocharger
Number of cylinders	3
Number of valves	2 intake and 2 exhaust valves by cylinder (self adjusting hydraulic valve lifters)
Bore	78 mm (3.1 in)
Stroke	69.7 mm (2.7 in)
Displacement	999 cm <sup>3</sup> (60.8 in <sup>3</sup> )
Maximum HP RPM	8000 RPM

Lubrication System			
Type		Dry sump	
Oil filter	Oil filter	Replaceable cartridge oil filter	
Engine oil	Capacity		2.8 l (3 qt (liq., US))
	Recommended XPS oil	General purpose	5W40 Synthetic oil
		Cold temperature	0W40 Synthetic oil
		Warm temperature	10W50 Synthetic oil
	If the XPS products is not available		Use a 4-stroke SAE engine synthetic oil meeting or exceeding the following lubricant industry specifications. Always check the API service label certification on the oil container, it must contain the indicated standards. – <b>API service classification SN, and JASO MA2</b>

Transmission	
Type	7-gears Dual Wet Clutch Transmission (DCT)
Shift mode	Automatic gear select mode and manual shift mode (paddles)
Gear selection	Low and High ranges on the fly activation
Available driving modes	3 (normal/Sport/Sport+)

<b>Gearbox</b>			
Type		Dual range (HI-LO) with PARK, neutral and reverse	
Gearbox oil	Capacity	Refill	3 to 3.5 l (3.17 to 3.7 qt (liq.,US))
		New or renew	4.9 l (5.2 qt (liq.,US))
	Recommended XPS oil		XPS full synthetic DCT Oil
	If the XPS products is not available		Contact your authorized Can-Am Off-road dealer

## VEHICLE

<b>Intake System</b>	
Air filter	Donaldson high performance filter

<b>Exhaust System</b>		
Exhaust system	NRMM models	Catalyst + Spark arrestor
	Other models	Spark arrestor approved by USDA Forest Service

<b>Cooling System</b>			
Coolant	Type	Main front radiator with rear dual fan intercoolers	
	Recommended XPS coolant		Extended life pre-mixed coolant
	If the XPS products is not available		Ethyl glycol / water mix (50%/50%). or coolant specifically designed for aluminum engines
	Capacity		8.7 l (2.3 gal (liq.,US))

Electrical System		
Magneto generator output		1 700 W
Spark plug	Quantity	3
	Make and type	NGK SIMLAR9F7
	Gap	0.6 to 0.7 mm (0.023 to 0.028 in)
Battery	Type	Maintenance free SLA
	Voltage	12 volts
	Nominal rating	20 A•h
	Power starter output	800 W
Headlight		LEDs
Taillight		LEDs
Signature lights		LEDs
Fuses		Refer to <i>Fuses in Maintenance</i>
Camera	X	Rear
	X rs	Front and rear

Fuel System			
Fuel delivery		Electronic fuel injection (EFI)	
Fuel pump	Type	Electric (in fuel tank)	
Injectors		2 by cylinder	
Throttle body		54 mm	
Fuel	Type	Premium unleaded gasoline - Refer to <i>Fuel Requirements</i>	
	Recommend ed Octane rating	North America	91 AKI (R+M)/2
		Outside North America	95 RON

<b>Fuel System</b>	
Fuel tank capacity	50 l (13.2 gal (liq.,US))
Fuel remaining when low fuel light turns ON	7 l (1.85 gal (liq.,US))

Drive System		
Front drive		Spiral bevel gear Lockable front differential with exclusive Smart-Lok
Front drive ratio		3.6:1
Front differential oil	Capacity	350 ml (11.8 fl oz (US))
	Recommended XPS differential oil	XPS 75W90 Synthetic gear oil
	If the XPS products is not available	Synthetic gear oil 75W90 API GL-5
Rear final drive		Spiral bevel gear / Final drive
Rear final drive ratio		4.09:1
Rear final drive oil	Capacity	500 ml (17 fl oz (US))
	Recommended XPS final drive oil	XPS 75W140 Synthetic gear oil
	If the XPS products is not available	Synthetic gear oil 75W140 API GL-5
Disconnect unit	Capacity	65 ml (2.2 fl oz (US))
	Recommended XPS final drive oil	5W40 Synthetic oil
	If the XPS products is not available	Use a 4-stroke SAE engine synthetic oil meeting or exceeding the following lubricant industry specifications. Always check the API service label certification on the oil container, it must contain the indicated standards. – <b>API service classification SN, and JASO MA2</b>
CV joint grease		CV joint grease

Steering	
Type	Center take-off rack and pinion
Steering wheel	Telescopic adjustable tilt steering





Front Suspension			
Suspension type		Double suspension arms with aluminum tall knuckle and stabilizer bar	
Suspension travel		63.5 mm (25 in)	
Shock absorber	Quantity		2
	Type	X	FOX 2.5 PODIUM Piggyback with QS3 compression adjustment
		X rs	FOX 2.5 PODIUM RC2 Piggyback with bypass, dual speed compression and rebound adjustments
		X rs SAS	FOX 2.5 PODIUM Piggyback with bypass and Smart-Shox Technology featuring Live Valve gen 3 (Dual Valve compression & rebound)
Preload adjustment type		Threaded	

Rear Suspension			
Suspension type		4 Link Trailing arm with aluminum tall knuckle	
Suspension travel	X	63.5 mm (25 in)	
	X rs	64.8 mm (25.5 in)	
	X rs SAS	66 mm (26 in)	
Shock absorber	Quantity		2
	Type	X	FOX† 2.5 PODIUM Piggyback with QS3† compression adjustment and bottom-out control
		X rs	FOX 3.0 PODIUM RC2 Piggyback with bypass, dual speed compression and rebound adjustments
		X rs SAS	FOX 3.0 PODIUM Piggyback with bypass and Smart-Shox Technology featuring Live Valve gen 3 (Dual Valve compression & rebound)
Preload adjustment type		Threaded	

<b>Brakes</b>		
Front brake	Qty	2
	Disc brake	One piece cast iron brake rotor of 265 mm (10.4 in)
	Caliper	Hydraulic three-pistons calipers of 32 mm (1.3 in)
Rear brake	Qty	2
	Disc brake	One piece cast iron brake rotor of 255 mm (10 in)
	Caliper	Hydraulic 2-pistons calipers of 30 mm (1.2 in)
Brake fluid	Type	DOT 4
	Capacity	310 ml (10.5 fl oz (US))
Caliper		Floating
Brake pad material		Sintered high performance
Minimum brake pad thickness		0.5 mm (.02 in)
Minimum brake disc thickness		4 mm (.157 in)
Maximum brake disc warpage		0.2 mm (.01 in)

Tires		
Pressure	Front	Recommended tire inflation pressure is found on the Tire Label. Refer to appropriate <i>Important On-Product Labels</i> section for its locations.
Size	X	255/80R15 (UT30x10R15NHS)
	X rs	255/80R16 (UT32x10R16NHS)
Minimum tire thread depth		3 mm (.118 in)

Wheels			
Type		X	Aluminum Flow Formed
		X rs	Aluminum Flow Formed Beadlock
Rim size	Front	X	38.1 x 17.8 cm (15 x 7.0J in)
		X rs	40.6 x 17.8 cm (16 x 7 in)
	Rear	X	38.1 x 17.8 cm (15 x 7.0J in)
		X rs	40.6 x 17.8 cm (16 x 7 in)
Wheel lug nuts torque			120 ± 5 Nm (89 ± 4 lbf-ft)
Wheel Offset	Front	78.9 mm (3.1 in)	
	Rear	78.9 mm (3.1 in)	
Chassis			
Cage type		Dual-phase 980 steel	
Dimensions			
Overall length		X	352.2 cm (138.7 in)
		X rs	355.6 cm (140 in)
Overall width	Ride height		198 cm (78.1 in)
	Maximum in suspension stroke		202 cm (79.4 in)
Overall height		X	177.8 cm (70.4 in)
		X rs	181.5 cm (71,5 in)

<b>Dimensions</b>	
Wheelbase	274.3 cm (108 in)
Ground clearance	43.2 cm (17 in)

Loading Capacity and Weight		
Dry weight	X	1 009 kg (2,225 lb)
	X rs	1 016 kg (2,240 lb)
	X rs SAS	1 020 kg (2,250 lb)
Total vehicle load allowed (including driver, passengers, all other loads and added accessories)		286 kg (630 lb)
Gross vehicle dry weight rating		286 kg (630 lb)
Cargo rack capacity		90 kg (200 lb)

This page is intentionally blank



# TROUBLESHOOTING

---

# TROUBLESHOOTING GUIDELINES

## 1. "-" IS DISPLAYED ON THE GEARBOX POSITION DISPLAY

- *Electrical communication error.*
  - *Contact an authorized Can-Am Off-road dealer.*

## 2. ENGINE DOES NOT TURN

- *D.E.S.S. key is not installed on D.E.S.S. post.*
  - *Securely install key to D.E.S.S. post.*
- *Burnt fuse.*
  - *Check fuses.*
- *Weak battery or loose connections.*
  - *Check charging system fuse.*
  - *Check fault message in digital display.*
  - *Check battery connections and terminals condition.*
  - *Have the battery checked by an authorized Can-Am Off-road dealer.*
- *Defective engine start button.*
  - *Contact an authorized Can-Am dealer.*
- *Defective starter solenoid.*
  - *Contact an authorized Can-Am dealer.*
- *D.E.S.S. key not recognized is displayed in the multifunction gauge.*
  - *Clean D.E.S.S. key.*

## 3. ENGINE TURNS OVER BUT FAILS TO START

- *Flooded engine (spark plug wet when removed).*
  - *(If the engine does not start and it is fuel-flooded, the drowned mode can be activated to prevent fuel injection and to cut ignition while cranking. Proceed as follows:*
    - *Install key on D.E.S.S. post.*
    - *Press completely and HOLD accelerator pedal.*
    - *Press the engine START button.**The engine should be cranked for 10 seconds. Release engine START button.*
    - *Release accelerator pedal and start/crank engine again to allow starting.**If it does not work:*
    - *Remove the spark plugs (tools are supplied in tool kit). Refer to Spark Plugs in Maintenance Procedures.*
    - *Crank engine several times.*
    - *Install new spark plugs if possible or clean and dry spark plugs.*
    - *If engine does not start, seek service from an authorized Can-Am dealer, repair shop, or person of your own choosing for maintenance, repair, or replacement. Please refer to the US EPA Emission-Related Warranty contained herein for information about warranty claims.*
- *No fuel to the engine (spark plug dry when removed).*
  - *Check fuel tank level.*
  - *Check fuel pump fuse.*

- *Obstructed fuel pump pre-filter or fuel pump failure. Seek service from an authorized Can-Am dealer, repair shop, or person of your own choosing for maintenance, repair, or replacement. Please refer to the US EPA Emission-Related Warranty contained herein for information about warranty claims.*
- *Spark plug/ignition (no spark).*
  - *Check ignition fuse.*
  - *Remove spark plug then reconnect to ignition coil.*
  - *Start engine with spark plug grounded to the engine away from spark plug hole. If no spark appears, replace spark plug.*
  - *If trouble persists, seek service from an authorized Can-Am dealer, repair shop, or person of your own choosing for maintenance, repair, or replacement. Please refer to the US EPA Emission-Related Warranty contained herein for information about warranty claims.*

#### **4. ENGINE LACKS ACCELERATION OR POWER**

- *Seat belt not buckled properly. Check cluster message.*
  - *Buckle up seat belt.*
- *Fouled or damaged spark plug.*
  - *Replace spark plugs.*
- *Engine air filter plugged or dirty.*
  - *Check air filter and replace if necessary.*
  - *Check deposits in engine air filter housing.*
- *Lack of fuel*
  - *Dirty or clogged fuel pump pre-filter. Seek service from an authorized Can-Am dealer, repair shop, or person of your own choosing for maintenance, repair, or replacement. Please refer to the US EPA Emission-Related Warranty contained herein for information about warranty claims.*
- *Engine is in Torque Limitation mode (if equipped).*
  - *Engine torque is gradually limited for protection when coolant temperature is too high. Check multifunction gauge display for engine temperature.*
  - *Let engine cool down.*
- *Engine is in limp home mode.*
  - *Multifunction gauge CHECK ENGINE indicator lamp is on and display shows LIMP HOME, seek service from an authorized Can-Am dealer, repair shop, or person of your own choosing for maintenance, repair, or replacement. Please refer to the US EPA Emission-Related Warranty contained herein for information about warranty claims.*

#### **5. ENGINE OVERHEATS**

- *Low coolant level in cooling system.*
  - *Check coolant level and refill. See Maintenance Procedures. Seek service from an authorized Can-Am dealer, repair shop, or person of your own choosing for maintenance, repair, or replacement. Please refer to the US EPA Emission-Related Warranty contained herein for information about warranty claims.*

- *Cooling fan is not working.*
  - *Ensure cooling fans (at front and rear radiators) are not jammed and working properly.*
  - *Check fan fuse. See Fuses in the Maintenance Procedures.*
- *Dirty radiators fins.*
  - *Check and clean radiator fins. See Maintenance Procedures.*

## **6. ENGINE MISFIRE**

- *Fouled/damaged/worn spark plug.*
  - *Replace spark plugs as required.*
- *Water in fuel.*
  - *Drain fuel system and refill with fresh fuel.*

## **7. PARTIAL OR NO RESPONSE FROM THE ACCELERATOR PEDAL INPUTS (CHECK ENGINE IS ON AND PPS FAULT MESSAGE IS DISPLAYED)**

- *Partial failure of the accelerator pedal sensors (PPS).*
  - *Use the override switch to retrieve accelerator pedal operation. Contact an authorized Can-Am dealer.*
- *Total failure of the accelerator pedal sensors (PPS).*
  - *Use the override switch to bypass the accelerator pedal and increase the engine speed in order to move vehicle. Contact an authorized Can-Am dealer.*



## **8. SHOCK ICON IS BLINKING FAST WHILE VEHICLE MALFUNCTION TELLTALE IS ON**

- *Partial failure of Smart-Shox system: Front or rear shock absorbers become full stiff (Sport+ like).*
  - *Change Smart-Shox mode to Sport+ to have a similar setting at front and rear. The vehicle remains rideable. Contact an authorized Can-Am dealer.*
- *Total failure of Smart-Shox system: Front and rear shock absorbers become full stiff (Sport+ like).*
  - *The vehicle remains rideable. Contact an authorized Can-Am dealer.*

---

## DIGITAL DISPLAY MESSAGES

If an abnormal engine condition occurs, the following messages can be combined with a pilot lamp.

Message	Description
D.E.S.S. KEY NOT RECOGNIZED	D.E.S.S. key requires cleaning.
BAD KEY	Indicates that you have used the wrong D.E.S.S. key, use the proper key for this vehicle.
CHECK ENGINE	All active or previously activated faults that require attention. No engine limitation engaged.
LIMP HOME	Critical faults requiring diagnostic as soon as possible. An engine limitation is engaged and/or the engine behavior is modified.
TPS FAULT	Throttle body fault, generally followed by a Limp Home message.
BRAKE SWITCH FAULT	Brake signal fault.
CHECK DPS	Check engine pilot light on (  ). Indicates that the DPS (Dynamic Power Steering) does not work properly. See an authorized Can-Am dealer.
PPS FAULT	Faulty Pedal Position Sensor(s) (PPS). Refer to <i>Override Switch</i> in <i>Secondary Controls</i> to drive the vehicle in the limp home mode.
MANUAL LIMP HOME	Confirms the Manual Limp Home is engaged using the Override Switch in case of a PPS fault.
FUEL SENSOR FAULT	When the fuel sender resistor value is out of range the multifunction gauge (analog/digital) will detect it and display the message.
CHECK SMART-LOK	The warning exclamation point light on (  ). Indicates that the Smart-Lok does not work properly. See an authorized Can-Am dealer.

This page is intentionally blank

# WARRANTY

---

# **BRP LIMITED WARRANTY FOR CANADA AND USA: 2024 CAN-AM® SSV**

## **1) Scope of the Limited Warranty**

Bombardier Recreational Products Inc. ("BRP") warrants its 2024 Can-Am SSV ("Product(s)") sold by authorized BRP Dealers (as hereinafter defined) in the United States of America ("USA") and in Canada from defects in material or workmanship for the period and under the conditions described below.

This limited warranty will become null and void if:

1. the Product was used for racing or any other competitive activity, at any point, even by a previous owner; or
2. the Product has been altered or modified in such a way so as to adversely affect its operation, performance or durability, or has been altered or modified to change its intended use.

Non-factory installed parts and accessories are not covered under this limited warranty. Please refer to the applicable parts and accessories limited warranty text.

## **2) Limitations of Liability**

**TO THE EXTEND PERMITTED BY LAW, THIS WARRANTY IS EXPRESSLY GIVEN AND ACCEPTED IN LIEU OF ANY AND ALL OTHER WARRANTIES, EXPRESSED OR IMPLIED, INCLUDING WITHOUT LIMITATION ANY WARRANTY OF MERCHANTABILITY OR FITNESS FOR A PARTICULAR PURPOSE. TO THE EXTENT THAT THEY CANNOT BE DISCLAIMED, THE IMPLIED WARRANTIES ARE LIMITED IN DURATION TO THE LIFE OF THE EXPRESS WARRANTY. INCIDENTAL AND CONSEQUENTIAL DAMAGES ARE EXCLUDED FROM COVERAGE UNDER THIS WARRANTY. SOME STATES/PROVINCES DO NOT ALLOW FOR THE DISCLAIMERS, LIMITATIONS AND EXCLUSIONS IDENTIFIED ABOVE. AS A RESULT, THEY MAY NOT APPLY TO YOU. THIS WARRANTY GIVES YOU SPECIFIC RIGHTS, AND YOU MAY ALSO HAVE OTHER LEGAL RIGHTS WHICH MAY VARY FROM STATE TO STATE, OR PROVINCE TO PROVINCE.**

Neither the distributor, any BRP dealer nor any other person has been authorized to make any affirmation, representation or warranty regarding the product, other than those contained in this limited warranty, and if made, shall not be enforceable against BRP.

BRP reserves the right to modify this limited warranty at any time, being understood that such modification will not alter the warranty conditions applicable to the Products sold while this warranty is in effect.

## **3) EXCLUSIONS – Are Not Warranted**

The following are not warranted under any circumstances:

- Normal wear and tear;
- Routine maintenance items, tune ups, adjustments;
- Damage caused by negligence or failure to provide proper maintenance and/or storage, as described in the Operator's Guide;
- Damage resulting from removal of parts, improper repairs, service, maintenance, modifications or use of parts not manufactured or approved by BRP or



resulting from repairs done by a person that is not an authorized servicing BRP dealer;

- Damage caused by abuse, abnormal use, neglect or operation of the product in a manner inconsistent with the recommended operation described in the Product’s Operator’s Guide;
- Damage resulting from accident, submersion, fire, theft, vandalism or any act of God;
- Operation with fuels, oils or lubricants which are not suitable for use with the Product (see the Operator’s Guide);
- Damages from rust, corrosion or exposure to the elements;
- Damage resulting from water or snow ingestion;
- Incidental or consequential damages, or damages of any kind including without limitation transportation expenses, towing, storage, telephone, rental, taxi, inconvenience, insurance coverage, loan payments, loss of time, loss of income or time missed for downtime experience due to service work.

#### 4) Warranty Coverage Period

This limited warranty will be in effect from (1) the date of delivery to the first retail consumer, or (2) the date the product is first put into use, whichever occurs first and for the applicable period below:

1. SIX (6) consecutive months, for private use or commercial use owners
2. **For emission-related components**, please also refer to the US EPA Emission-Related Warranty.
3. **For evaporative emission-related components of California models equipped with evaporative emission control system produced by BRP for sale in the State of California** that are originally sold to a resident or subsequently warranty registered to a resident in the State of California, also refer to the California Evaporative Emissions Control Warranty Statement.

The repair or replacement of parts or the performance of service under this warranty does not extend the life of this limited warranty beyond its original expiration date.

#### 5) Conditions to Have Warranty Coverage

This warranty coverage is available **only** if **each** of the following conditions has been fulfilled:

1. The Product must be purchased as new and unused by its first owner from a Dealer authorized to sell the Products in the country in which the sale occurred (“Dealer”);
2. The BRP specified pre-delivery inspection process must be completed, documented and signed by the purchaser;
3. The Product must have undergone proper registration by an authorized Dealer;
4. The Product must be purchased in the country in which the purchaser resides;
5. Routine maintenance outlined in the Operator’s Guide must be timely performed in order to maintain warranty coverage. BRP reserves the right to make warranty coverage contingent upon proof of proper maintenance.

BRP will not honor this limited warranty to any private use owner or commercial use owner if one of the preceding conditions has not been met. Such limitations are necessary in order to allow BRP to preserve both the safety of its products, and also that of its consumers and the general public.

## **6) What to Do to Obtain Warranty Coverage**

The customer must cease using the Product upon the appearance of an anomaly, notify a servicing BRP dealer within three (3) days of the appearance of the anomaly and provide the Dealer with reasonable access to the Product and reasonable opportunity to repair it.

The customer must also present to the Dealer, proof of purchase of the Product and must sign the repair/work order prior to starting the repair in order to validate the warranty repair.

All parts replaced under this limited warranty become the property of BRP.

## **7) What BRP Will Do**

BRP's obligations under this warranty are limited to, at its sole discretion, repairing or replacing parts found defective under normal use, maintenance and service without charge for parts and labor, at any authorized BRP dealer during the warranty coverage period under the conditions described herein. No claim of breach of warranty shall be cause for cancellation or rescission of the sale of the Product to the owner.

In the event that service is required outside of the country of original sale, the owner will bear responsibility for any additional charges due to local practices and conditions, such as, but not limited to, freight, insurance, taxes, license fees, import duties, and any and all other financial charges, including those levied by governments, states, territories and their respective agencies.

BRP reserves the right to improve or modify products from time to time without assuming any obligation to modify products previously manufactured.

## **8) Transfer**

If the ownership of a Product is transferred during the warranty coverage period, this limited warranty, subject to its terms and conditions, shall also be transferred and be valid for the remaining coverage period provided BRP or an authorized Product Distributor/Dealer receives a proof that the former owner agreed to the transfer of ownership, in addition to the coordinates of the new owner.

## **9) Consumer Assistance**

In the event of a controversy or a dispute in connection with this limited warranty, BRP suggests that you try to resolve the issue at the dealership level. We recommend discussing the issue with the authorized dealer's service manager or owner.

If the matter still remains unresolved, contact BRP by filling out the customer contact form at [www.brp.com](http://www.brp.com) or contact BRP by mail at one of the addresses listed under the Contact Us section of this guide.

---

# US EPA EMISSION - RELATED WARRANTY

Bombardier Recreational Products Inc. ("BRP") warrants to the ultimate purchaser and each subsequent purchaser that this new vehicle, including all parts of its exhaust emission control system and its evaporative emission control system, meets two conditions:

1. It is designed, built, and equipped so it conforms at the time of sale to the ultimate purchaser with the requirements of 40 CFR 1051 and 40 CFR 1060.
2. It is free from defects in materials and workmanship that may keep it from meeting the requirements of 40 CFR 1051 and 40 CFR 1060.

Where a warrantable condition exists, BRP will repair or replace, as it elects, any part or component with a defect in materials or workmanship that would increase the engine's emissions of any regulated pollutant within the stated warranty period at no cost to the owner, including expenses related to diagnosing and repairing or replacing emission-related parts. All defective parts replaced under this warranty become the property of BRP.

For all emission-related warranty claims, BRP is limiting the diagnosis and repair of emission-related parts to the authorized Can-Am dealers, unless for emergency repairs as required by item 2 of the following list.

As a certifying manufacturer, BRP will not deny emission-related warranty claims based on any of the following:

1. Maintenance or other service BRP or BRP's authorized facilities performed.
2. Engine/equipment repair work that an operator performed to correct an unsafe, emergency condition attributable to BRP as long as the operator tries to restore the engine/equipment to its proper configuration as soon as possible.
3. Any action or inaction by the operator unrelated to the warranty claim.
4. Maintenance that was performed more frequently than BRP specify.
5. Anything that is BRP fault or responsibility.
6. The use of any fuel that is commonly available where the equipment operates unless BRP written maintenance instructions state that this fuel would harm the equipment's emission control system and operators can readily find the proper fuel. See maintenance information section and fuel requirements of fueling section.

## Emission-Related Warranty Period

The emission-related warranty is valid for the following period whichever comes first.

	HOURS	MONTHS	KILOMETERS
Exhaust emission-related components	500	30	5000
Evaporative emission-related components	N/A	24	N/A

## Components Covered

The emission-related warranty covers all components whose failure would increase an engine's emissions of any regulated pollutant, including the following listed components:

1. For exhaust emissions, emission-related components include any engine parts related to the following systems:
  - Air-induction system
  - Fuel system
  - Ignition system
  - Exhaust gas recirculation systems.
2. The following parts are also considered emission-related components for exhaust emissions:
  - After treatment devices
  - Crankcase ventilation valves
  - Sensors
  - Electronic control units.
3. The following parts are considered emission-related components for evaporative emissions:
  - Fuel tank
  - Fuel cap
  - Fuel line
  - Fuel line fittings
  - Clamps\*
  - Pressure relief valves\*
  - Control valves\*
  - Control solenoids\*
  - Electronic controls\*
  - Vacuum control diaphragms\*
  - Control cables\*
  - Control linkages\*
  - Purge valves
  - Vapor hoses
  - Liquid/vapor separator
  - Carbon canister
  - Canister mounting brackets
  - Carburetor purge port connector.

**NOTE:** \*As related to the evaporative emission control system.

4. Emission-related components also include any other part whose only purpose is to reduce emissions or whose failure will increase emissions without significantly degrading engine/equipment performance.

### **Limited Applicability**

As a certifying manufacturer, BRP may deny emission-related warranty claims for failures that have been caused by the owner's or operator's improper maintenance or use, by accidents for which the manufacturer has no responsibility, or by acts of God. For example, an emission-related warranty claim need not be honored for failures that have been directly caused by the operator's abuse of the engine/equipment or the operator's use of the engine/equipment in a manner for which it was not designed and are not attributable to the manufacturer in anyway.

If you have any question regarding your warranty rights and responsibility or for the name and location of the nearest authorized BRP dealer, you should contact BRP by filling out the customer contact form at [www.brp.com](http://www.brp.com) or contact BRP by mail at one of the addresses listed under the CONTACT US section of this guide, or call at 1-888-272-9222.

---

# CALIFORNIA EVAPORATIVE EMISSIONS CONTROL WARRANTY STATEMENT

The warranty periods begin on the date the new Off-Highway Recreational Vehicle ("OHRV") is delivered to an ultimate purchaser.

Bombardier Recreational Products Inc. ("BRP") warrants to the ultimate purchaser and each subsequent purchaser that the OHRV is:

1. Designed, built, and equipped so as to conform, at the time of sale, with all applicable laws, rules and regulations; and
2. Free from defects in materials and workmanship that may cause the failure of a warranted part. All replacement parts must be identical in all material respects to that part as described in BRP's Executive Order of Certification application.

The warranty on emissions-related parts function as follows:

1. Repair or replacement of any warranted part must be performed at no charge to the OHRV owner, at a warranty station, except in the case of a temporary repair when a warranted part or a warranty station is not reasonably available to the OHRV owner. In the event a temporary repair is permitted, repairs may be performed at any available service establishment, or by the owner, using any replacement part. BRP must reimburse the owner for his or her expenses including diagnostic charges for such temporary repair or replacement, not to exceed BRP's suggested retail price for all warranted parts replaced and labor charges based on BRP's recommended time allowance for the warranty repair and the geographically appropriate hourly labor rate.
2. The lack of availability of warranted parts or the incompleteness of repairs within a reasonable time period, not to exceed 30 days from the time the OHRV is initially presented to the warranty station for repair, will qualify the need for a temporary repair.
3. Any warranted part which is not scheduled for replacement as part of maintenance in the written instructions must be warranted for the warranty period defined below. If any such part fails during the warranty period, it must be repaired or replaced by BRP. Any such part repaired or replaced under warranty must be fully warranted.
4. Any warranted part which is scheduled only for regular inspection in the written instructions must be warranted for the warranty period defined below. A statement in such written instructions to the effect of "repair or replace as necessary" does not reduce the period of warranty coverage. Any such part repaired or replaced under warranty is warranted for the remaining warranty period.
5. Any warranted part which is scheduled for replacement as part of maintenance in the written instructions is warranted for the period of time prior to the first scheduled replacement point for that part. If the part fails before the first scheduled replacement point, the part will be repaired or replaced by BRP. Any such part repaired or replaced under warranty is warranted for the remainder of the period prior to the first scheduled replacement point for the part.
6. Warranty services or repairs are provided at all manufacturer dealerships that are owned by the manufacturer or franchised to service the subject OHRVs.
7. The OHRV owner will not be charged for diagnostic labor which leads to the determination that a warranted part is, in fact, defective, provided that such diagnostic work is performed at a warranty station.

8. BRP is liable for damages to other vehicle components proximately caused by a failure, under warranty, of any warranted part.
9. Any replacement part designated by BRP may be used in warranty repairs provided without charge to the OHRV owner. Such use will not reduce the warranty obligations of BRP, except that BRP will not be liable for repair or replacement of any replacement part which is not a warranted part.
10. Any add-on or modified part exempted by the Air Resources Board from the prohibitions of section 27156 of the California Vehicle Code may be used on an OHRV. Such use, in and of itself, will not be grounds for disallowing a warranty claim. BRP is not liable to warrant failures of warranted parts caused by the use of an add-on or modified part (s) unless such part (s) are also warranted.

Conditions and exclusions:

- BRP may deny you warranty coverage if your OHRV or a part has failed directly due to abuse, neglect, improper maintenance or unapproved modifications.

## Your Warranty Rights And Obligations

The California Air Resources Board is pleased to explain the evaporative emissions control system warranty on your 2024 Off-Road Sport Vehicle. In California, new off-highway recreational vehicles must be designed, built, and equipped to meet the State's stringent anti-smog standards. BRP must warrant the evaporative emissions control system on your Off-Road Sport Vehicle for the periods of time listed below provided there has been no abuse, neglect, improper maintenance, or unapproved modification of your Off-Road Sport Vehicle.

Your evaporative emissions control system may include parts such as the carburetor or fuel-injection system, fuel tank, fuel hoses, carbon canister, and engine computer. Also included may be hoses, belts, connectors and other evaporative emissions-related assemblies. Where a warrantable condition exists, Bombardier Recreational Products Inc. will repair your Off-Road Sport Vehicle at no cost to you including diagnosis, parts and labor.

## OHRV Manufacturer's Warranty Coverage

The warranty period for this OHRV is 60 months, or 5000 miles, or 500 hours, whichever comes first.

Parts covered:

1. Canister Mounting Bracket(s)
2. Carbon Canister
3. Purge Port Connector
4. Clamp(s)\*
5. Electronic Control\*
6. Fuel Cap
7. Filler Neck
8. Filler Neck Hose
9. Fuel Line(s)
10. Fuel Line Fitting(s)
11. Fuel Tank
12. Pressure Relief Valve(s)\*

13. Purge Valve(s)
14. Check Valve(s)\*
15. Vapor Hose(s)
16. Flow Reducer
17. Filter(s)\*
18. Fuel pump
19. All other parts not listed that may affect the evaporative emissions control system

**NOTE:** \*As related to the evaporative emission control system.

If any evaporative emissions-related part on your Off-Road Sport Vehicle is defective the part will be repaired or replaced by Bombardier Recreational Products Inc.

### **Owner's Warranty Responsibilities**

As the Off-Road Sport Vehicle owner you are responsible for the performance of the required maintenance listed in your owner's manual. Bombardier Recreational Products Inc. recommends that you retain all receipts covering maintenance on your Off-Road Sport Vehicle, but Bombardier Recreational Products Inc. cannot deny warranty solely for the lack of receipts or for failure to ensure the performance of a scheduled maintenance.

As an owner you are responsible for presenting your Off-Road Sport Vehicle to a Bombardier Recreational Products Inc. dealer as soon as a problem exists. The warranty repairs should be completed in a reasonable time, not to exceed 30 days.

As an Off-Road Sport Vehicle owner, you should also be aware that Bombardier Recreational Products Inc. may deny you warranty coverage if your Off-Road Sport Vehicle or a part has failed due to abuse, neglect, improper maintenance or unapproved modifications.

If you have any questions regarding your warranty rights and responsibilities, you should contact:

- Bombardier Recreational Products Inc. at 1-888-272-9222, or
- The California Air Resources Board at 4001 Iowa Avenue, Riverside, CA 92507.



---

# **BRP LIMITED WARRANTY FOR INTERNATIONAL: 2024 CAN-AM® SSV**

## **1) Scope of the Limited Warranty**

Bombardier Recreational Products Inc. ("BRP") warrants its 2024 Can-Am SSV ("Product(s)") sold by distributors or dealers authorized by BRP to distribute the Products outside of the United States of America ("USA"), Canada, member states of the European Economic Area (which is comprised of the states of the European Union plus the United Kingdom, Norway, Iceland and Liechtenstein) ("EEA"), Turkey, member states of the Commonwealth of the Independent States (including Ukraine and Turkmenistan) ("CIS") from defects in material or workmanship for the period and under the conditions described below.

This limited warranty will become null and void if:

1. the Product was used for racing or any other competitive activity, at any point, even by a previous owner; or
2. the Product has been altered or modified in such a way so as to adversely affect its operation, performance or durability, or has been altered or modified to change its intended use.

Non-factory installed parts and accessories are not covered under this limited warranty. Please refer to the applicable parts and accessories limited warranty text.

## **2) Limitation of Liability**

**TO THE EXTENT PERMITTED BY LAW, THIS WARRANTY IS EXPRESSLY GIVEN AND ACCEPTED IN LIEU OF ANY AND ALL OTHER WARRANTIES, EXPRESSED OR IMPLIED, INCLUDING WITHOUT LIMITATION ANY WARRANTY OF MERCHANTABILITY OR FITNESS FOR A PARTICULAR PURPOSE. TO THE EXTENT THAT THEY CANNOT BE DISCLAIMED, THE IMPLIED WARRANTIES ARE LIMITED IN DURATION TO THE LIFE OF THE EXPRESS WARRANTY. INCIDENTAL AND CONSEQUENTIAL DAMAGES ARE EXCLUDED FROM COVERAGE UNDER THIS WARRANTY. SOME STATES/PROVINCES DO NOT ALLOW FOR THE DISCLAIMERS, LIMITATIONS AND EXCLUSIONS IDENTIFIED ABOVE. AS A RESULT, THEY MAY NOT APPLY TO YOU. THIS WARRANTY GIVES YOU SPECIFIC RIGHTS, AND YOU MAY ALSO HAVE OTHER LEGAL RIGHTS WHICH MAY VARY FROM COUNTRY TO COUNTRY. BRP SHALL NOT BE HELD LIABLE IF PRODUCTS OR WARRANTY PARTS ARE NOT AVAILABLE IN CERTAIN COUNTRIES FOR REASONS OUTSIDE OF BRP'S CONTROL.**

For Products purchased in Australia, refer to the Australia-specific section below.

Neither the distributor, any BRP Distributor/Dealer nor any other person has been authorized to make any affirmation, representation or warranty regarding the product, other than those contained in this limited warranty, and if made, shall not be enforceable against BRP.

BRP reserves the right to modify this limited warranty at any time, being understood that such modification will not alter the warranty conditions applicable to the Products sold while this warranty is in effect.

### 3) EXCLUSIONS – Are Not Warranted

The following are not warranted under any circumstances:

- Normal wear and tear;
- Routine maintenance items, tune ups, adjustments;
- Damage caused by negligence or failure to provide proper maintenance and/or storage, as described in the Operator's Guide;
- Damage resulting from removal of parts, improper repairs, service, maintenance, modifications or use of parts not manufactured or approved by BRP or resulting from repairs done by a person that is not an authorized servicing BRP Distributor/Dealer;
- Damage caused by abuse, abnormal use, neglect or operation of the product in a manner inconsistent with the recommended operation described in the Product's Operator's Guide;
- Damage resulting from accident, submersion, fire, theft, vandalism or any act of God;
- Operation with fuels, oils or lubricants which are not suitable for use with the Product (see the Operator's Guide);
- Damages from rust, corrosion or exposure to the elements;
- Damage resulting from water or snow ingestion;
- Incidental or consequential damages, or damages of any kind including without limitation transportation expenses, towing, storage, telephone, rental, taxi, inconvenience, insurance coverage, loan payments, loss of time, loss of income or time missed for downtime experience due to service work.

The following list includes, without limitation, items that are considered wear items and that are not covered under BRP's limited warranty unless failure is a direct result of a defect in material or workmanship:

- Batteries
- Brake pads
- Brake disks and drums
- Clutch plates / pads
- Clutch sliders
- Clutch springs
- Clutch replaceable bushings
- Drive belts
- Filters
- Finished and unfinished surfaces
- Fuses
- Light bulbs / sealed
- Lubricants
- Spark plugs
- Suspension bushings
- Suspension slider shoes
- Suspension springs
- Tires

### 4) Warranty Coverage Period

This limited warranty will be in effect from (1) the date of delivery to the first retail consumer, or (2) the date the product is first put into use, whichever occurs first and for the applicable period below:

1. SIX (6) consecutive months, for private use or commercial use owners

In AUSTRALIA and NEW ZEALAND only, this warranty will be in effect from (1) the date of delivery to the first retail consumer or (2) the date the product is first put into use, whichever occurs first, and for a period of TWELVE (12) CONSECUTIVE MONTHS and THIRTY SIX (36) CONSECUTIVE MONTHS for Powertrain Engine and Transmission systems only, for private use or commercial use.

The repair or replacement of parts or the performance of service under this warranty does not extend the life of this warranty beyond its original expiration date.

The warranty coverage period identified above are a minimal limited warranty period which can be extended by any applicable warranty promotional program, as the case may be.

Note that the duration and any other modalities of the warranty coverage are subject to the applicable national or local legislation in the customer's country.

## 5) For Products Sold In Australia Only

Our goods come with guarantees that cannot be excluded under the Australian Consumer Law.

You are entitled to a replacement or refund for a major failure and for compensation for any other reasonably foreseeable loss or damage.

You are also entitled to have the goods repaired or replaced if the goods fail to be of acceptable quality and the failure does not amount to a major failure.

Nothing in these Warranty terms and conditions should be taken to exclude, restrict or modify the application of any condition, warranty, guarantee, right or remedy conferred or implied under the Competition and Consumer Act 2010 (Cth), including the Australian Consumer Law or any other law, where to do so would contravene that law, or cause any part of these terms and conditions to be void. The benefits given to you under this limited warranty are in addition to other rights and remedies that you have under Australian law.

## 6) Conditions to Have Warranty Coverage

This warranty coverage is available **only** if **each** of the following conditions has been fulfilled:

1. The Product must be purchased as new and unused by its first owner from a Distributor/Dealer authorized to distribute Products in the country in which the sale occurred ("Distributor/Dealer");
2. The BRP specified pre-delivery inspection process must be completed, documented and signed by the purchaser;
3. The Product must have undergone proper registration by an authorized Distributor/Dealer;
4. The Product must be purchased in the country in which the purchaser resides;
5. Routine maintenance outlined in the Operator's Guide must be timely performed in order to maintain warranty coverage. BRP reserves the right to make warranty coverage contingent upon proof of proper maintenance.

BRP will not honor this limited warranty to any private use owner or commercial use owner if one of the preceding conditions has not been met. Such limitations are necessary in order to allow BRP to preserve both the safety of its products, and also that of its consumers and the general public.

## **7) What to Do to Obtain Warranty Coverage**

The customer must cease using the Product upon the appearance of an anomaly, notify a servicing BRP Distributor/Dealer within two (2) months of the appearance of the anomaly and provide the Distributor/Dealer with reasonable access to the Product and reasonable opportunity to repair it.

The notification period is subject to the applicable national or local legislation in customer's country.

The customer must also present to the Distributor/Dealer, proof of purchase of the Product and must sign the repair/work order prior to starting the repair in order to validate the warranty repair.

All parts replaced under this limited warranty become the property of BRP.

## **8) What BRP Will Do**

To the extent permitted by law, BRP's obligations under this warranty are limited to, at its sole discretion, repairing or replacing parts found defective under normal use, maintenance and service without charge for parts and labor, at any authorized BRP Distributor/Dealer during the warranty coverage period under the conditions described herein. No claim of breach of warranty shall be cause for cancellation or rescission of the sale of the Product to the owner. You may have other legal rights which may vary from country to country.

In the event that service is required outside of the country of original sale, the owner will bear responsibility for any additional charges due to local practices and conditions, such as, but not limited to, freight, insurance, taxes, license fees, import duties, and any and all other financial charges, including those levied by governments, states, territories and their respective agencies.

BRP reserves the right to improve or modify products from time to time without assuming any obligation to modify products previously manufactured.

## **9) Transfer**

If the ownership of a Product is transferred during the warranty coverage period, this limited warranty, subject to its terms and conditions, shall also be transferred and be valid for the remaining coverage period provided BRP or an authorized Product Distributor/Dealer receives a proof that the former owner agreed to the transfer of ownership, in addition to the coordinates of the new owner.

## **10) Consumer Assistance**

In the event of a controversy or a dispute in connection with this limited warranty, BRP suggests that you try to resolve the issue at the dealership level. We recommend discussing the issue with the authorized Distributor/Dealer's service manager or owner.

If the matter still remains unresolved, contact BRP by filling out the customer contact form at [www.brp.com](http://www.brp.com) or contact BRP by mail at one of the addresses listed under the Contact Us section of this guide.

---

# **BRP LIMITED WARRANTY FOR THE EUROPEAN ECONOMIC AREA, THE COMMONWEALTH OF THE INDEPENDENT STATES AND TURKEY: 2024 CAN-AM® SSV**

## **1) Scope of the Limited Warranty**

Bombardier Recreational Products Inc. ("BRP") warrants its 2024 Can-Am SSV ("Product(s)") sold by distributors or dealers authorized by BRP to distribute the Products in member states of the European Economic Area (which is comprised of the states of the European Union plus the United Kingdom, Norway, Iceland and Liechtenstein) ("EEA"), Turkey, member states of the Commonwealth of the Independent States (including Ukraine and Turkmenistan) ("CIS") ("Distributor/Dealer") from defects in material or workmanship for the period and under the conditions described below.

This limited warranty will become null and void if:

1. the Product was used for racing or any other competitive activity, at any point, even by a previous owner; or
2. the Product has been altered or modified in such a way so as to adversely affect its operation, performance or durability, or has been altered or modified to change its intended use.

Non-factory installed parts and accessories are not covered under this limited warranty. Please refer to the applicable parts and accessories limited warranty text.

## **2) Limitations of Liability**

**TO THE EXTEND PERMITTED BY LAW, THIS WARRANTY IS EXPRESSLY GIVEN AND ACCEPTED IN LIEU OF ANY AND ALL OTHER WARRANTIES, EXPRESSED OR IMPLIED, INCLUDING WITHOUT LIMITATION ANY WARRANTY OF MERCHANTABILITY OR FITNESS FOR A PARTICULAR PURPOSE. TO THE EXTENT THAT THEY CANNOT BE DISCLAIMED, THE IMPLIED WARRANTIES ARE LIMITED IN DURATION TO THE LIFE OF THE EXPRESS WARRANTY. INCIDENTAL AND CONSEQUENTIAL DAMAGES ARE EXCLUDED FROM COVERAGE UNDER THIS WARRANTY. SOME STATES/PROVINCES DO NOT ALLOW FOR THE DISCLAIMERS, LIMITATIONS AND EXCLUSIONS IDENTIFIED ABOVE. AS A RESULT, THEY MAY NOT APPLY TO YOU. THIS WARRANTY GIVES YOU SPECIFIC RIGHTS, AND YOU MAY ALSO HAVE OTHER LEGAL RIGHTS WHICH MAY VARY FROM STATE TO STATE, OR PROVINCE TO PROVINCE. BRP SHALL NOT BE HELD LIABLE IF PRODUCTS OR WARRANTY PARTS ARE NOT AVAILABLE IN CERTAIN COUNTRIES FOR REASONS OUTSIDE OF BRP'S CONTROL.**

For Products purchased in France, refer to the France-specific section below.

Neither the distributor, any BRP Distributor/Dealer nor any other person has been authorized to make any affirmation, representation or warranty regarding the product, other than those contained in this limited warranty, and if made, shall not be enforceable against BRP.

BRP reserves the right to modify this limited warranty at any time, being understood that such modification will not alter the warranty conditions applicable to the Products sold while this warranty is in effect.

### 3) EXCLUSIONS – Are Not Warranted

The following are not warranted under any circumstances:

- Normal wear and tear;
- Routine maintenance items, tune ups, adjustments;
- Damage caused by negligence or failure to provide proper maintenance and/or storage, as described in the Operator's Guide;
- Damage resulting from removal of parts, improper repairs, service, maintenance, modifications or use of parts not manufactured or approved by BRP or resulting from repairs done by a person that is not an authorized servicing BRP Distributor/Dealer;
- Damage caused by abuse, abnormal use, neglect or operation of the product in a manner inconsistent with the recommended operation described in the Product's Operator's Guide;
- Damage resulting from accident, submersion, fire, theft, vandalism or any act of God;
- Operation with fuels, oils or lubricants which are not suitable for use with the Product (see the Operator's Guide);
- Damages from rust, corrosion or exposure to the elements;
- Damage resulting from water or snow ingestion;
- Incidental or consequential damages, or damages of any kind including without limitation transportation expenses, towing, storage, telephone, rental, taxi, inconvenience, insurance coverage, loan payments, loss of time, loss of income or time missed for downtime experience due to service work.

The following list includes, without limitation, items that are considered wear items and that are not covered under BRP's limited warranty unless failure is a direct result of a defect in material or workmanship:

- Batteries
- Brake pads
- Brake disks and drums
- Clutch plates / pads
- Clutch sliders
- Clutch springs
- Clutch replaceable bushings
- Drive belts
- Filters
- Finished and unfinished surfaces
- Fuses
- Light bulbs / sealed
- Lubricants
- Spark plugs
- Suspension bushings
- Suspension slider shoes
- Suspension springs
- Tires

## 4) Warranty Coverage Period

This limited warranty will be in effect from (1) the date of delivery to the first retail consumer, or (2) the date the product is first put into use, whichever occurs first and for the applicable period below:

1. TWENTY-FOUR (24) consecutive months, for private use owners.
2. SIX (6) consecutive months, for commercial use owners.

A Product is used commercially when it is used in connection with any work or employment that generates income during any part of the warranty period. A Product is also used commercially when, at any point during the warranty period, it is licensed for commercial use.

The repair or replacement of parts or the performance of service under this warranty does not extend the life of this warranty beyond its original expiration date.

The warranty coverage period identified above are a minimal limited warranty period which can be extended by any applicable warranty promotional program, as the case may be.

Note that the duration and any other modalities of the warranty coverage are subject to the applicable national or local legislation in the customer's country.

## 5) For Products Sold In France Only

The seller shall deliver goods that are complying with the contract and shall be responsible for defects existing upon delivery. The seller shall also be responsible for defects resulting from packaging, assembling instructions or the installation when it is its responsibility per the contract or if accomplished under its responsibility. To be compliant with the contract, the good shall:

1. Be fit for normal use for goods similar thereto and, if applicable:
  - Correspond to the description provided by the seller and have the qualities presented to the buyer though sample or model;
  - Have the qualities that a buyer may legitimately expect considering the public declarations of the seller, the manufacturer of its representative, including in advertising or labeling; or
2. Have the characteristics mutually agreed upon as between the parties or be fit for the specific use intended by the buyer and brought to the attention of the seller and which accepted.

The action for failure to comply is prescribed after two years after delivery of the goods. The seller is responsible for the warranty for hidden defects of the good sold if such hidden defects are rendering the good unfit for the intended use, or if they diminish its use in such a way that the buyer would not have acquired the good or would have given a lesser price, had he known. The action for such hidden defects shall be taken by the buyer within 2 years of the discovery of the defect.

## 6) Conditions to Have Warranty Coverage

This warranty coverage is available **only** if **each** of the following conditions has been fulfilled:



1. The Product must be purchased as new and unused by its first owner from a Distributor/Dealer authorized to distribute Products in the country (or in the case of the EEA, union of countries) in which the sale occurred (“Distributor/Dealer”);
2. The BRP specified pre-delivery inspection process must be completed, documented and signed by the purchaser;
3. The Product must have undergone proper registration by an authorized Distributor/Dealer;
4. The Product must be purchased in the country (or in the case of the EEA, union of countries) in which the purchaser resides;
5. Routine maintenance outlined in the Operator’s Guide must be timely performed in order to maintain warranty coverage. BRP reserves the right to make warranty coverage contingent upon proof of proper maintenance.

BRP will not honor this limited warranty to any private use owner or commercial use owner if one of the preceding conditions has not been met. Such limitations are necessary in order to allow BRP to preserve both the safety of its products, and also that of its consumers and the general public.

## **7) What to Do to Obtain Warranty Coverage**

The customer must cease using the Product upon the appearance of an anomaly, notify a servicing BRP Distributor/Dealer within two (2) months of the appearance of the anomaly and provide the Distributor/Dealer with reasonable access to the Product and reasonable opportunity to repair it.

The notification period is subject to the applicable national or local legislation in customer’s country.

The customer must also present to the Distributor/Dealer, proof of purchase of the Product and must sign the repair/work order prior to starting the repair in order to validate the warranty repair.

All parts replaced under this limited warranty become the property of BRP.

## **8) What BRP Will Do**

To the extent permitted by law, BRP’s obligations under this warranty are limited to, at its sole discretion, repairing or replacing parts found defective under normal use, maintenance and service without charge for parts and labor, at any authorized BRP Distributor/Dealer during the warranty coverage period under the conditions described herein. No claim of breach of warranty shall be cause for cancellation or rescission of the sale of the Product to the owner. You may have other legal rights which may vary from country to country.

In the event that service is required outside of the country of original sale, or for EEA residents, if service is required outside of the EEA, the owner will bear responsibility for any additional charges due to local practices and conditions, such as, but not limited to, freight, insurance, taxes, license fees, import duties, and any and all other financial charges, including those levied by governments, states, territories and their respective agencies.

BRP reserves the right to improve or modify products from time to time without assuming any obligation to modify products previously manufactured.

## **9) Transfer**

If the ownership of a Product is transferred during the warranty coverage period, this limited warranty, subject to its terms and conditions, shall also be transferred and be valid for the remaining coverage period provided BRP or an authorized Product Distributor/Dealer receives a proof that the former owner agreed to the transfer of ownership, in addition to the coordinates of the new owner.

## **10) Consumer Assistance**

In the event of a controversy or a dispute in connection with this limited warranty, BRP suggests that you try to resolve the issue at the dealership level. We recommend discussing the issue with the authorized Distributor/Dealer's service manager or owner.

If the matter still remains unresolved, contact BRP by filling out the customer contact form at [www.brp.com](http://www.brp.com) or contact BRP by mail at one of the addresses listed under the Contact Us section of this guide.

# **CUSTOMER INFORMATION**

---

# DATA PRIVACY INFORMATION

Bombardier Recreational Products inc., its affiliates and subsidiaries (“BRP”) is committed to protecting your privacy and support a general policy of openness about how we collect, use and disclose your personal information in the course of managing our relationship with you. **More details can be found by visiting BRP’s Privacy Policy at: <https://brp.com/en/privacy-policy.html> or by scanning the QR Code below.**

Please be assured that we have appropriate security measures in place to ensure that your personal information is protected against loss and unauthorized access.

Your personal information that may be collected by BRP, directly from you or from authorized dealers or authorized third parties, includes:

- **Contact, Demographic & Registration Information** (e.g., name, full address, phone number, email, gender, ownership history, language of communication)
- **Vehicle Information** (e.g., serial number, purchase and delivery date, unit usage, vehicle location and movements)
- **Third Party Information** (e.g., information received from BRP partners, joint-marketing activities information, social media)
- **Technological Information** (e.g., IP address, type of device, operating system, browser type, webpages you view, cookies and similar technologies when you use BRP or dealers’ websites or mobile application)
- **Interaction with BRP Information** (e.g., information collected when you call BRP’s in-house sales representatives, buy items on a BRP web Site, sign up for BRP emails, participate in BRP-sponsored contests and sweepstakes or attend BRP-sponsored events)
- **Transactional Information** (e.g., information necessary to handle returns, payment information when you purchase our products or services through our websites or mobile applications and other issues related to your purchase of BRP products)

This information may be used and processed for the following purposes:

- Safety & Security
- Customer Support for Sales & After Sales (e.g., complete or follow up with you about your purchase or maintenance)
- Registration & Warranty
- Communication (e.g., sending you a BRP satisfaction survey)
- Online Behavioural Advertising, Profiling and Location-Based Services (e.g., offer customized experience)
- Compliance & Dispute Resolution
- Marketing & Advertising
- Assistance (e.g., help with any delivery issues, handle returns, and other issues related to your purchase of BRP products).

We also may use personal information to generate aggregated or statistical data that no longer identifies you personally.

**Your personal information may be disclosed to the following: BRP, BRP’s authorized dealerships, distributors, service providers, advertising & market research partners and other authorized third parties.**

We may receive information about you from diverse sources, including third parties, such as BRP’s authorized dealerships and partners, with whom we offer

services or engage in joint-marketing activities. We may also receive information about you from social media platforms such as Facebook and Twitter, when you interact with us on those platforms.

Depending on the circumstances, your personal information may be communicated outside the region where you reside. Your personal information is retained only for as long as necessary for the purpose for which we obtained it and according to our retention policies.

To exercise your data privacy rights (e.g. right of access, right of rectification), to withdraw your consent in order to be removed from the address list for marketing purposes or for the satisfaction survey or for general data privacy questions, please contact BRP's Data Protection Officer at or by mail at **privacyofficer@brp.com** or by mail at:  
BRP Legal Service, 726 St-Joseph, Valcourt, Quebec, Canada, J0E 2L0.

**When BRP processes your personal information, they do so in compliance with its Privacy Policy available at: <https://www.brp.com/en/privacy-policy.html> or by using the following QR Code.**



---

# CONTACT US

*www.brp.com*

## **Asia Pacific**

### **BRP Asia**

107D and 107E, 17/F, Tower 1,  
Grand Century Place, Mongkok,  
Kowloon, Hong Kong

### **Australia**

Level 26  
477 Pitt Street  
Sydney, NSW 2020

### **China**

上海市徐汇区衡山路10号6号楼301  
Rm 301, Building 6,  
No.10 Heng Shan Rd,  
Shanghai, China

### **Japan**

21F Shinagawa East One Tower  
2-16-1 Konan, Minato-ku-ku,  
Tokyo 108-0075

### **New Zealand**

Suite 1.6, 2-8 Osborne Street,  
Newmarket, Auckland 2013

## **Europe, Middle East and Africa**

### **Belgium**

Oktrooi plein 1  
9000 Gent

### **Czech Republic**

Stefanikova 43a  
Prague 5  
150 00

### **Germany**

Itterpark 11  
40724 Hilden

### **Finland**

Isoaavantie 7  
PL 8040  
96101 Rovaniemi

### **France**

Arteparc Bâtiment B  
Route de la côte d'Azur,

13 590 Meyreuil

**Norway**

Ingvald Ystgaardsvei 15  
N-7484 Trondheim  
Salg, marketing, ettermarked

**Sweden**

Spinnvägen 15  
903 61 Umeå  
Sweden 90821

**Switzerland**

Avenue d'Ouchy 4-6  
1006 Lausanne

**Latin America**

**Brazil**

Av. James Clerck Maxwell, 230  
Campinas, Sao Paulo  
CEP 13069-380

**Mexico**

Av. Ferrocarril 202  
Parque Industrial Querétaro  
Santo Rosa Jauregui, Querétaro  
C.P. 76220

**North America**

**Canada**

3200A, rue King Ouest,  
Suite 300  
Sherbrooke (Québec) J1L 1C9

**United States of America**

10101 Science Drive  
Sturtevant, Wisconsin  
53177

---

## CHANGE OF ADDRESS AND OWNERSHIP

If your address has changed or if you are the new owner of the vehicle, be sure to notify BRP by either:

- Notifying an authorized Can-Am dealer.
- **North America Only:** calling at 1 888 272-9222.
- Mailing one of the change of address cards on the following pages at one of the BRP addresses indicated in the *Contact Us* section of this guide.

In case of change of ownership, please join a proof that the former owner agreed to the transfer.

Notifying BRP, even after the expiration of the limited warranty, is very important as it enables BRP to reach the vehicle owner if necessary, like when safety recalls are initiated. It is the owner's responsibility to notify BRP.

**STOLEN UNITS:** If your personal vehicle is stolen, you should notify BRP or an authorized Can-Am dealer. We will ask you to provide your name, address, phone number, the vehicle identification number and the date it was stolen.





This page is  
intentionally blank



This page is  
intentionally blank





NOTE: \_\_\_\_\_

\_\_\_\_\_

\_\_\_\_\_

\_\_\_\_\_

\_\_\_\_\_

\_\_\_\_\_

\_\_\_\_\_

\_\_\_\_\_

\_\_\_\_\_

\_\_\_\_\_

\_\_\_\_\_

\_\_\_\_\_

\_\_\_\_\_

\_\_\_\_\_

\_\_\_\_\_

\_\_\_\_\_

\_\_\_\_\_

\_\_\_\_\_

\_\_\_\_\_

\_\_\_\_\_

\_\_\_\_\_

\_\_\_\_\_

\_\_\_\_\_









Model No. \_\_\_\_\_

**VEHICLE**

IDENTIFICATION NUMBER (V.I.N.) \_\_\_\_\_

**ENGINE**

IDENTIFICATION NUMBER (E.I.N.) \_\_\_\_\_

**Owner:** \_\_\_\_\_

NAME

No.

STREET

APT

CITY

STATE/PROVINCE

ZIP/POSTAL CODE

**Purchase Date** \_\_\_\_\_ | \_\_\_\_\_ | \_\_\_\_\_ | \_\_\_\_\_  
YEAR MONTH DAY

**Warranty Expiry Date** \_\_\_\_\_ | \_\_\_\_\_ | \_\_\_\_\_ | \_\_\_\_\_  
YEAR MONTH DAY

To be completed by the dealer at the time of the sale.

DEALER IMPRINT AREA

## **⚠ WARNING**

### TO REDUCE RISK OF SERIOUS INJURY OR DEATH,

- Read this operator's guide and safety labels.
- Watch the safety video.



### BE PREPARED

- Fasten seat belts and make sure necks and/or doors are securely latched in place.
- Wear an approved helmet and protective gear.
- Each rider must be able to sit with back against seat, foot flat on the floor or on the footrest, and hands on steering wheel or handholds. Stay completely inside the vehicle.

### DRIVE RESPONSIBLY

- Avoid loss of control and rollovers.
- Avoid abrupt maneuvers, sideways sliding, skidding or fishtailing and never do donuts.
- Avoid hard acceleration when turning, even from a stop.
- Slow down before entering a turn.
- Plan for hills, rough terrain, ruts and other changes in traction and terrain.
- Avoid paved surfaces.
- Avoid side hilling (riding across slopes).

### BE QUALIFIED AND RESPONSIBLE

- Do not allow careless or reckless driving.
- Driver must be at least 16 years old with a valid driver's license.
- Do not operate after using drugs or alcohol.
- Do not allow operation on public roads (unless designated for off-highway vehicle access where collisions with cars and trucks can occur).
- Do not exceed vehicle seating capacity.

®TM and the BRP logo are trademarks of BOMBARDIER RECREATIONAL PRODUCTS INC. or its affiliates.

©2023 BOMBARDIER RECREATIONAL PRODUCTS INC. ALL RIGHTS RESERVED.

[www.brp.com](http://www.brp.com)

**ALUMACRAFT®**

**CAN-AM®**

**LYNX®**

**MANITOU®**

**QUINTREX®**

**ROTAX®**

**SEA-DOO®**

**SKI-DOO®**

219002376