

# SEA-DOO®



## GTX AND WAKE PRO SERIES

# OPERATOR'S GUIDE

Includes Safety, Use and Maintenance Information

# SEA-DOO GTX 4

### WARNING

Read this guide thoroughly. It contains important safety information.  
Minimum recommended operators age: 16 years old.  
Keep this operator's guide with the watercraft at all times.

---

219002353

Original Instructions

# CALIFORNIA PROPOSITION 65 WARNING

## WARNING

Operating, servicing and maintaining a recreational marine vessel can expose you to chemicals including engine exhaust, carbon monoxide, phthalates, and lead, which are known to the State of California to cause cancer and birth defects or other reproductive harm. To minimize exposure, avoid breathing exhaust, service your vessel in a well-ventilated area and wear gloves or wash your hands frequently when servicing this vessel. For more information go to:  
[www.p65warnings.ca.gov/marine](http://www.p65warnings.ca.gov/marine)

In Canada, products are distributed and serviced by Bombardier Recreational Products Inc. (BRP).

In the USA, products are distributed and serviced by BRP US Inc.

In the European Economic Area (which is comprised of the member states of the European Union plus the United Kingdom, Norway, Iceland and Liechtenstein), the Commonwealth of the Independent States (including Ukraine and Turkmenistan) and Turkey, products are distributed and serviced by BRP European Distribution S.A. and other affiliates or subsidiaries of BRP.

For all other countries, products are distributed and serviced by Bombardier Recreational Products Inc. (BRP) or its affiliates.

™® Trademarks of BRP or its affiliates.

This is a non-exhaustive list of trademarks that are the property of Bombardier Recreational Products Inc. or its affiliates.

Trademarks may not be registered in every jurisdictions:

ACETM	D.E.S.S.TM	ECOTM	iBRTM
iControlTM	iTCTM	GTITM	GTRTM
LinQ®	ROTAX®	SEA-DOO®	Sea-Doo LKTM
T.O.P.S.TM	VTSTM	WakeTM 170	XPS®

All rights reserved. No parts of this Operator's Guide may be reproduced in any form without the prior written permission of Bombardier Recreational Products Inc.

©Bombardier Recreational Products Inc. (BRP) 2023

---

# KNOW BEFORE YOU GO

## Basic Rules for Safe PWC Operation

### Know Before You Go: Basic Rules For Safe PWC Operation

**Improper operation can result in severe injury or death.**

#### Operators Must Be Qualified

- ☑ Make sure operator is 16 or older and has taken a boater safety course. Your state (or province) may have additional requirements.



#### Operators Must Avoid Collisions

- ☑ Scan constantly for people, objects and other watercraft.
- ☑ Stay far enough away from others so you can always safely coast to a stop.
- ☑ Do not release throttle when trying to steer away from objects-as with other powerboats, **you need throttle to steer.**



#### Protect All Riders

- ☑ Falls can result in severe injury or death.
- ☑ All riders must wear shorts with neoprene (wet suit material) to keep water from being forcefully injected into rectum or vagina during a fall backward. Riders not wearing neoprene shorts have received severe rectal, vaginal, and internal injuries resulting in permanent damages.
- ☑ All riders must wear an approved PFD (Personal Flotation Device).
- ☑ Be sure riders are properly seated and holding on. Riders can be thrown off PWC during unexpected acceleration or aggressive operation. Avoid aggressive operation, sharp turns, and unexpected acceleration.
- ☑ Do not apply throttle when anyone is boarding or at rear of PWC.
- ☑ Do not jump wakes or waves - jumping can cause injuries such as back or spinal injury (paralysis).

Do not ride if you are not dressed appropriately.

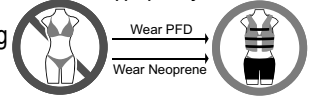

#### Do not permit reckless operation:

- ☑ Do not go near others to spray or splash them with water, go too close to other boats, or go too fast for traffic conditions.
- ☑ Never ride after consuming alcohol or drugs.

## Available Languages

Deutsch	Dieses Handbuch ist möglicherweise in Ihrer Landessprache verfügbar. Bitte wenden Sie sich an Ihren Händler oder besuchen Sie: <a href="http://www.operatorsguides.brp.com">www.operatorsguides.brp.com</a>
English	This guide may be available in your language. Check with your dealer or go to: <a href="http://www.operatorsguides.brp.com">www.operatorsguides.brp.com</a>
Español	Es posible que este manual esté disponible en su idioma. Consulte a su distribuidor o visite: <a href="http://www.operatorsguides.brp.com">www.operatorsguides.brp.com</a>
Français	Ce guide peut être disponible dans votre langue. Vérifier avec votre concessionnaire ou aller à: <a href="http://www.operatorsguides.brp.com">www.operatorsguides.brp.com</a>
Italiano	Questa guida potrebbe essere disponibile nella propria lingua. Contattare il concessionario o consultare: <a href="http://www.operatorsguides.brp.com">www.operatorsguides.brp.com</a>
中文	本手册可能有您的语种的翻译版本。请向经销商询问，或者登录 <a href="http://www.operatorsguides.brp.com">www.operatorsguides.brp.com</a> 查询。
日本語	このガイドは、言語によって翻訳版が用意されています。ディーラーに問い合わせるか、次のアドレスでご確認ください： <a href="http://www.operatorsguides.brp.com">www.operatorsguides.brp.com</a>
Nederlands	Deze handleiding kan beschikbaar zijn in uw taal. Vraag het aan uw dealer of ga naar: <a href="http://www.operatorsguides.brp.com">www.operatorsguides.brp.com</a>
Norsk	Denne boken kan finnes tilgjengelig på ditt eget språk. Kontakt din forhandler eller gå til: <a href="http://www.operatorsguides.brp.com">www.operatorsguides.brp.com</a>
Português	Este manual pode estar disponível em seu idioma. Fale com sua concessionária ou visite o site: <a href="http://www.operatorsguides.brp.com">www.operatorsguides.brp.com</a>
Русский	Воспользуйтесь руководством на вашем языке. Узнайте о его наличии у дилера или на странице по адресу <a href="http://www.operatorsguides.brp.com">www.operatorsguides.brp.com</a>
Suomi	Käyttöohjekirja voi olla saatavissa omalla kielelläsi. Tarkista jälleenmyyjältä tai käy osoitteessa: <a href="http://www.operatorsguides.brp.com">www.operatorsguides.brp.com</a>
Svenska	Denna bok kan finnas tillgänglig på ditt språk. Kontakta din återförsäljare eller gå till: <a href="http://www.operatorsguides.brp.com">www.operatorsguides.brp.com</a>

Covered Models
GTX 170 GTX 170 iDF and AUDIO GTX 230 GTX 230 iDF and AUDIO GTX 300 GTX 300 AUDIO
GTX Limited 300
Wake PRO 230

---

# TABLE OF CONTENTS

KNOW BEFORE YOU GO .....	1
<b>GENERAL INFORMATION</b>	
FOREWORD .....	12
Know Before You Go .....	12
Safety Messages .....	12
About this Operator's Guide.....	12
<b>SAFETY INFORMATION</b>	
BEFORE YOU GO.....	16
Operating Age and Ability .....	16
Drugs and Alcohol .....	16
Safe Boating Courses .....	16
Applicable Boating Laws .....	16
Protective Gear .....	16
Helmets: Weighing the Risks vs Benefits .....	17
Required Equipment .....	17
GET FAMILIAR WITH THE WATERCRAFT .....	19
Jet Thrust.....	19
Steering .....	19
Tether Cord (Safety Lanyard) .....	19
Braking .....	20
Learning Key (available as accessory) .....	20
Cargo and Storage .....	20
Accessories and Modifications.....	21
RIDE SAFELY .....	22
Riding with Passenger(s).....	22
Avoiding Collisions.....	22
Riding Behaviors .....	22
Speeding .....	23
Reboarding .....	23
Moving Parts .....	23
Know the Waters .....	24
Navigation Rules .....	24
Night-Time Operation.....	24
Carbon Monoxide (CO) Poisoning.....	25
Gasoline Fires and Other Hazards .....	25
Burns From Hot Parts .....	26
Watersports (Towing with the Watercraft) .....	26
PRACTICE EXERCISES .....	29
Where to Practice Exercises .....	29
Practice Exercises .....	29
FUELING.....	31
Fueling Procedure .....	31
Fuel Requirements .....	31
Recommended Fuel .....	32
TRANSPORTING THE WATERCRAFT .....	33
IMPORTANT ON-PRODUCT LABELS .....	35
Watercraft Safety Labels .....	35

Canadian Compliance Notice Label ..... 58  
 Hang Tag ..... 59  
**PRE-RIDE INSPECTION** ..... **62**  
 What to Do Before Launching the Watercraft ..... 62  
 What to Do After Launching the Watercraft ..... 68  
 What to Do After Leaving the Water ..... 69  
**ANNUAL SAFETY MAINTENANCE** ..... **71**

**WATERCRAFT INFORMATION**

**CONTROLS** ..... **74**  
 Handlebar ..... 75  
 Throttle Lever ..... 75  
 Right Controller ..... 75  
 BRP Connect Button (if equipped) ..... 75  
 Engine Cut-Off Switch ..... 75  
 Left Controller ..... 76  
 Engine START/STOP Button ..... 77  
 intelligent Brake and Reverse (iBR) Lever ..... 78  
**EQUIPMENT** ..... **80**  
 Front Storage Compartment ..... 81  
 Fire Extinguisher Holder ..... 81  
 Safety Kit Holder ..... 82  
 Steering Tilt Handle ..... 82  
 Glove Box ..... 82  
 BRP Audio Premium System ..... 84  
 Seat ..... 85  
 Passenger Handholds ..... 87  
 Boarding Platform ..... 87  
 Wakeboard Rack (Wake Models) ..... 87  
 Retractable Ski Pylon (WAKE Models) ..... 89  
 Mooring Cleats ..... 91  
 Boarding Ladder (If Equipped) ..... 91  
 Front and Rear Eyelets ..... 92  
 Bilge Drain Plugs ..... 93  
**7.6" DIGITAL DISPLAY** ..... **94**  
 Basic Functions ..... 94  
 Indicator Lamps ..... 95  
 Settings ..... 96  
 Messages in Multifunction Gauge ..... 98  
**LARGE PANORAMIC 7.8" WIDE LCD DISPLAY** ..... **100**  
 Basic Functions ..... 100  
 Settings ..... 102  
 Programming the Ski Mode ..... 104  
 Pairing Your Smartphone Via Bluetooth ..... 104  
 BRP GO! App ..... 105  
 Quick Tour of the BRP GO! App ..... 106  
 Messages in Multifunction Gauge ..... 107  
**BREAK-IN PERIOD** ..... **109**  
 Operation During Break-In Period ..... 109  
**OPERATING INSTRUCTIONS** ..... **110**  
 Boarding the Watercraft ..... 110

Starting the Engine .....	114
Shutting Off the Engine .....	115
Steering the Watercraft .....	115
Shifting into Neutral .....	116
Shifting into Forward .....	116
Shifting into Reverse .....	117
Braking .....	118
Variable Trim System (VTS) .....	119
Activating the Intelligent Debris Free Pump System (iDF System) (if equipped) .....	121
General Operating Recommendations .....	122
<b>OPERATING MODES .....</b>	<b>125</b>
Touring Mode .....	125
Sport Mode .....	125
ECO Mode (Fuel Economy Mode) .....	126
Speed Control Modes (If Equipped) .....	126
Ski Mode (If Equipped) .....	129
<b>SPECIAL PROCEDURES .....</b>	<b>131</b>
Jet Pump Water Intake and Impeller Cleaning .....	131
Capsized Watercraft .....	133
Submerged Watercraft .....	134
Water-Flooded Engine .....	134
Towing the Watercraft in Water .....	134
 <b>MAINTENANCE</b> 	
<b>MAINTENANCE SCHEDULE .....</b>	<b>138</b>
EPA Regulation - Canadian and USA Watercrafts .....	138
Salt Water/ Dirty Water Usage .....	139
Maintenance Schedule .....	139
<b>MAINTENANCE PROCEDURES .....</b>	<b>144</b>
Engine Service Cover .....	144
Engine Oil .....	145
Engine Coolant .....	147
Ignition Coils .....	148
Spark Plugs .....	149
Exhaust System .....	149
Ride Plate and Water Intake Grate .....	151
Sacrificial Anodes .....	151
Ski/ Wakeboard Pylon (if equipped) .....	152
Fuses .....	152
<b>WATERCRAFT CARE .....</b>	<b>154</b>
Post-Operation Care .....	154
Seat Cleaning .....	154
Body and Hull .....	154
<b>STORAGE AND PRESEASON PREPARATION .....</b>	<b>156</b>
Storage .....	156
Preseason Preparation .....	159



<b>MAINTENANCE RECORDS</b> .....	<b>160</b>
----------------------------------	------------

### **TECHNICAL INFORMATION**

<b>IDENTIFICATION NUMBERS</b> .....	<b>170</b>
Hull Identification Number .....	170
Engine Identification Number .....	170
Engine Manufacturer Identification .....	170
<b>COMPLIANCE</b> .....	<b>171</b>
Emission Control Hang Tag – 3 Stars .....	171
Emission Control Label – 3 Stars.....	172
EPA Compliance Label .....	173
Regulation Exemption Label .....	174
BRP European Distribution SA .....	175
<b>RF D.E.S.S. KEY</b> .....	<b>176</b>
<b>MULTIFUNCTION GAUGE REGULATORY INFORMATION</b> .....	<b>178</b>
<b>BRP AUDIO SYSTEM</b> .....	<b>182</b>
<b>ENGINE EMISSIONS INFORMATION</b> .....	<b>183</b>
Manufacturer's Responsibility .....	183
Dealer's Responsibility .....	183
Owner's Responsibility .....	183
EPA Emission Regulations .....	183
Evaporative Emission Control System .....	183
<b>EU DECLARATION OF CONFORMITY</b> .....	<b>184</b>
Left blank for EU Conformity .....	184
<b>UK DECLARATION OF CONFORMITY</b> .....	<b>185</b>
Left blank for UK Conformity .....	185
<b>EAC DECLARATION OF CONFORMITY</b> .....	<b>186</b>

### **TECHNICAL SPECIFICATIONS**

<b>ENGINE</b> .....	<b>188</b>
Rotax 1630 ACE - 170 .....	188
Rotax 1630 ACE - 230 .....	189
Rotax 1630 ACE - 300 .....	191
<b>VEHICLE</b> .....	<b>193</b>
GTX and Wake PRO.....	193

### **TROUBLESHOOTING**

<b>TROUBLESHOOTING GUIDELINES</b> .....	<b>198</b>
<b>MONITORING SYSTEM</b> .....	<b>204</b>
Fault Codes.....	204
Indicator Lights and Message Display Information.....	205
Beeper Code Information .....	207

## WARRANTY

<b>BRP LIMITED WARRANTY – USA AND CANADA: 2024 SEA-DOO PERSONAL WATERCRAFT</b> .....	<b>210</b>
1) SCOPE OF THE LIMITED WARRANTY .....	210
2) LIMITATIONS OF LIABILITY .....	210
3) EXCLUSIONS–ARE NOT WARRANTED .....	210
4) WARRANTY COVERAGE PERIOD .....	211
5) CONDITIONS TO HAVE WARRANTY COVERAGE.....	211
6) WHAT TO DO TO OBTAIN WARRANTY COVERAGE .....	212
7) WHAT BRP WILL DO.....	212
8) TRANSFER.....	212
9) CONSUMER ASSISTANCE .....	213
<b>US EPA EMISSION-RELATED WARRANTY</b> .....	<b>214</b>
Emission-Related Warranty Period .....	214
Components Covered .....	215
Limited Applicability .....	215
<b>CALIFORNIA EVAPORATIVE EMISSIONS CONTROL SYSTEM WARRANTY STATEMENT</b> .....	<b>217</b>
Your Warranty Rights and Obligations.....	217
Manufacturer’s Warranty Coverage.....	217
Owner’s Warranty Responsibilities.....	217
<b>CALIFORNIA AND NEW YORK EMISSION CONTROL WARRANTY STATEMENT FOR MODEL YEAR 2024 SEA-DOO® PERSONAL WATERCRAFT</b> .....	<b>219</b>
Your Warranty Rights and Obligations.....	219
Star Rating System .....	221
<b>BRP INTERNATIONAL LIMITED WARRANTY: 2024 SEA-DOO® WATERCRAFT</b> .....	<b>223</b>
1) SCOPE OF THE LIMITED WARRANTY .....	223
2) LIMITATIONS OF LIABILITY .....	223
3) EXCLUSIONS–ARE NOT WARRANTED .....	223
4) WARRANTY COVERAGE PERIOD .....	224
FOR PRODUCTS SOLD IN AUSTRALIA ONLY .....	225
5) CONDITIONS TO HAVE WARRANTY COVERAGE.....	225
6) WHAT TO DO TO OBTAIN WARRANTY COVERAGE .....	225
7) WHAT BRP WILL DO.....	226
8) TRANSFER.....	226
9) CONSUMER ASSISTANCE .....	226
<b>BRP LIMITED WARRANTY FOR THE EUROPEAN ECONOMIC AREA, THE COMMONWEALTH OF THE INDEPENDENT STATES AND TURKEY: 2024 SEA-DOO® PERSONAL WATERCRAFT</b> .....	<b>227</b>
1) SCOPE OF THE LIMITED WARRANTY .....	227
2) LIMITATIONS OF LIABILITY .....	227
3) EXCLUSIONS–ARE NOT WARRANTED .....	228
4) WARRANTY COVERAGE PERIOD .....	228
FOR PRODUCTS SOLD IN FRANCE ONLY.....	229
5) CONDITIONS TO HAVE WARRANTY COVERAGE.....	229
6) WHAT TO DO TO OBTAIN WARRANTY COVERAGE .....	230
7) WHAT BRP WILL DO.....	230
8) TRANSFER.....	230
9) CONSUMER ASSISTANCE .....	230
10) CONSUMER ASSISTANCE .....	230

**CUSTOMER INFORMATION**

**DATA PRIVACY INFORMATION .....232**  
**CONTACT US .....234**  
    Asia Pacific ..... 234  
    Europe, Middle East and Africa ..... 234  
    Latin America ..... 235  
    North America ..... 235  
**CHANGE OF ADDRESS/OWNERSHIP .....236**

This page is intentionally blank

# GENERAL INFORMATION

# FOREWORD

Congratulations on your purchase of a new Sea-Doo® personal watercraft (PWC) (hereinafter referred to as “watercraft”). It is backed by the BRP warranty and a network of authorized Sea-Doo watercraft dealers ready to provide the parts, service or accessories you may require.

Your dealer is committed to your satisfaction. He has taken training to perform the initial setup and inspection of your watercraft as well as completed the final adjustment before you took possession. If you need more complete servicing information, please ask your dealer.

At delivery, you were also informed of the warranty coverage and signed the *Pre-Delivery Check List* to ensure your new watercraft was prepared to your entire satisfaction.

## Know Before You Go

To learn how to reduce the risk for you or other persons being injured or killed, read the following sections before you operate the watercraft:

- *Safety Information*
- *Watercraft Information.*

Read and understand all safety labels on your watercraft and watch attentively the *Safety Video* located at:

<https://www.sea-doo.com/safety>

Or, use the following QR code.



## Safety Messages

This operator’s guide utilizes the following symbols and words to emphasize particular information:

The safety alert symbol  indicates a potential injury hazard.

### DANGER

Indicates a potential hazard which, if not avoided, will result in serious injury or death.

### WARNING

Indicates a potential hazard which, if not avoided, could result in serious injury or death.

### CAUTION

Indicates a potentially hazardous situation which, if not avoided, could result in minor or moderate injury.

### NOTICE

Indicates an instruction which, if not followed, could severely damage watercraft components or other property.

## About this Operator’s Guide

This operator’s guide has been prepared to acquaint the owner / operator or passenger with this watercraft and its various controls, maintenance and safe riding instructions.

Keep this Operator’s Guide in the watercraft as you can refer to it for the operation, instructing others, maintenance and troubleshooting. This operator’s guide needs to remain with the watercraft at all time.

This guide is available in several languages. In the event of any discrepancy, the English version shall prevail.

If you want to view and/or print an extra copy of your operator’s guide, simply visit the following website:

[www.operatorsguides.brp.com](http://www.operatorsguides.brp.com)

The information contained in this document are correct at the time of publication. However, BRP maintains a policy of continuous improvement of its products without imposing upon itself any obligation to install them on products previously manufactured. Due to late changes, some differences between the manufactured product and the descriptions and / or specifications in this guide may occur. BRP reserves the right at any time to discontinue or change specifications, designs, features, models or equipment without incurring any obligation upon itself.

This page is intentionally blank



# **SAFETY INFORMATION**

# BEFORE YOU GO

## WARNING

Disregarding any of the safety precautions and instructions included in this section could cause injury including the possibility of death. Any potential operator should read and understand this guide before operating the watercraft.

### Operating Age and Ability

Operators must be qualified. Make sure the operator is 16 or older and has taken a boater safety course. Your state (or province) may have additional requirements. Laws regarding the minimum age and licensing requirements vary from one jurisdiction to another. Be sure to contact the local boating authorities for information regarding the legal operation of a watercraft in the intended jurisdiction of use.

Operation of this watercraft with a disability that impairs vision, reaction time, judgment, or operation of the controls is not recommended.

Remember that sun, wind, fatigue or illness may impair your judgment and reaction time.

Each passenger must be able to simultaneously place both feet firmly flat against each footwell when properly seated.

### Drugs and Alcohol

Never ride after consuming alcohol or drugs. Riding on a watercraft requires the operator and passenger(s) to be sober, attentive and alert. The use of drugs and alcohol, singly or in combination, decreases reaction time, impedes judgment, impairs vision, and inhibits your ability to safely ride on a watercraft.

### Safe Boating Courses

Many countries recommend or require a boating safety course. Check with your local competent authorities.

### Applicable Boating Laws

Check boating laws applicable to the waterways where you intend to use your watercraft. Learn the local navigation rules.

### Protective Gear

All riders **MUST** wear:

1. An approved **Personal Flotation Device (PFD)** meeting your country regulations. The size of the PFD shall be appropriate for the wearer.
2. **Shorts with neoprene** (wetsuit material) to keep water from being forcefully injected into rectum or vagina during a fall backward. Riders not wearing neoprene shorts have received severe rectal, vaginal, and internal injuries resulting in permanent damage. Normal swimwear does not adequately protect against forceful entry of water into the lower male or female body opening(s).

Footwear, gloves, safety goggles or glasses can be worn. Wind, water spray, bugs and speed may cause a person's eyes to water and create blurred vision.

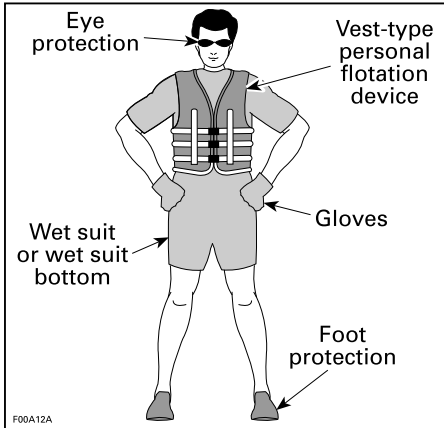

If you are planning a ride in cold weather or water, consider adding appropriate warm clothing such as a complete wet suit or dry suit. Not only will it make your ride more comfortable, but it may delay or protect you from hypothermia if you fall into cold water. Be prepared for changing conditions.

## Helmets: Weighing the Risks vs Benefits

Since each option minimizes some risks, but increases others, before each ride you must decide whether to wear or not wear a helmet based on your particular situation. If you decide to wear a helmet, look for helmets that meet DOT or Snell standards, and if possible, choose one designed for motorized watersports.

Helmets are designed to offer some degree of protection in case of impacts to the head. In most motorized sports, the benefits of wearing a helmet clearly outweigh the drawbacks. However, in the case of motorized watersports such as riding personal watercraft, this is not necessarily true as there are some particular risks associated with the water.

### **Benefits**

A helmet helps to reduce the risk of injury in case of a head impact against a hard surface such as another craft in the case of a collision. Similarly, a helmet with a chin guard might help prevent injuries to the face, jaw or teeth.

### **Risks**

On the other hand, in some situations when falling off the watercraft, helmets have a tendency to catch the water, like a “bucket”, and put severe stresses on the neck or spine. This could result in choking, severe or permanent neck or spine injury or death. Helmets may also interfere with peripheral vision and hearing, or increase fatigue which could contribute to increase the risk of a collision.

## Required Equipment

As the owner of the watercraft, you are responsible for ensuring that all required safety equipment is aboard. Check your local regulations about requirements.

This could include:

- Fire extinguisher. Maintenance, repair and refilling must be carried out in accordance with the manufacturer's instructions.
- A watertight flashlight or approved flares
- Sound-producing device (horn, whistle or bell etc.)
- Visual Distress Signal
- Phone in a watertight compartment designed for this application
- Current local map
- First aid kit
- Throw rope.

---

# GET FAMILIAR WITH THE WATERCRAFT

The performance of this watercraft may exceed the performance of other watercrafts you may have operated. Do not assume that all watercrafts handle identically.

Make sure you read and understand the content of this operator's guide to become completely familiar with the controls and operation of the watercraft before embarking on your first trip, or taking on a passenger(s). If you have not had the opportunity to do so, practice in a suitable traffic-free area to become accustomed to the feel and response of each control. Be fully familiar with all controls before accelerating above idle speed.

## Jet Thrust

Your watercraft features a jet drive propulsion system. The water is drawn up from underneath the watercraft from the intake grate and is accelerated by the venturi to produce thrust. This accelerated water is going out at the rear of the craft.

All riders must wear shorts with neoprene (wetsuit material) to keep water from being forcefully injected into rectum or vagina during a fall backward. Riders not wearing neoprene shorts have received severe rectal, vaginal, and internal injuries resulting in permanent damage. Normal swimwear does not adequately protect against forceful entry of water into the lower male or female body opening(s).

The jet pump may pick up debris and throw it rearward causing a risk of injuring people, damaging the jet pump, or other property.

Do not start the engine or operate the watercraft if anyone is in the water nearby, or near the rear of the watercraft.

## Steering

Your watercraft has a steerable nozzle at the rear of the boat controlled by the handlebars which direct the stream of water from left to right. To turn the watercraft, both steering and power are necessary.

Do not release the throttle when trying to steer away from objects — as with other powerboats, you need power to steer.

If the engine is shut off, steering is lost.

## Tether Cord (Safety Lanyard)

Keep the tether cord clip attached to the operator's PFD or wrist (wrist strap required) at all times and keep it free from snagging on the handlebars to help ensure the engine stops should the operator fall off.

If the operator falls off the watercraft and the tether cord is not attached as recommended, the engine will not stop and the watercraft will keep running without a driver. The operator may not be able to swim back to it.

After riding, always remove the tether cord from the engine cut-off switch to avoid unauthorized use by children or others and to prevent starting in a closed environment (e.g.: garage).

To prevent accidental starting, always detach the tether cord from the engine cut-off switch when swimmers are boarding, nearby, or during removal of any weeds or debris from the intake grate.

## **Braking**

Most watercrafts have no means of braking.

On some models, advancement in technologies now permits us to offer a braking system called the iBR (intelligent Brake and Reverse). Practice braking maneuvers in a safe traffic-free area to become familiar with handling under braking and with stopping distances under various operating conditions.

Stopping distance will vary depending on initial speed, load, wind, number of riders and water conditions. The amount of braking power commanded by the operator using the iBR lever will also affect stopping distance.

When braking, riders must brace themselves against the deceleration force to prevent from moving forward on the watercraft and losing balance.

When operating an iBR equipped watercraft, be aware that other boats following or operating in close proximity may not be able to stop as quickly. Inform the operator of a watercraft who intends to follow you in a convoy formation of the braking capability of your watercraft and the need of keeping a greater distance between watercraft.

The brake feature of the iBR system cannot prevent your watercraft from drifting due to current or wind. It has no braking effect on the rearward velocity. Also note that your engine must be running to be able to use the brake.

## **Learning Key (available as accessory)**

The Sea-Doo LK™ learning key limits the speed of the watercraft. It could be an option for first time users and less experienced operators to learn how to operate the watercraft.

Visit your BRP authorized Sea-Doo dealer to see if this accessory is available for your model.

## **Cargo and Storage**

Do not store any objects in areas that are not designed specifically for storage.

Do not transport cargo on the rear platform unless it is properly secured with a BRP LinQ™ certified accessory. Compatible accessories which are not BRP certified may not be considered as fit for this purpose.

When carrying loads on the rear platform or onto cargo accessories, reduce your speed and adapt your driving behavior to reduce the risk of ejection from the watercraft or contact with cargo possibly leading to injuries.

Do not exceed the payload or passenger capacities for your watercraft. Overloading can affect manoeuvrability, stability and performance. Also, heavy seas reduce capacity.

Never carry loads on the rear platform when practicing watersports. The cargo may interfere with the rope and get unlatched, becoming an obstacle to the person being towed.

Refer to *Technical Specifications* for the maximum loading capacity.

## Accessories and Modifications

Any modifications or addition of accessories approved by BRP may affect the handling of your vehicle. It is important to take the time to get familiar with the vehicle once modifications are made to understand how to adapt your driving behavior accordingly.

Avoid installing equipment not specifically approved by BRP for the vehicle and avoid unauthorized modifications. These modifications and equipment have not been tested by BRP and may create hazards. For example, they could:

- Create a loss of control and increase risk of crash
- Cause overheating or short circuits increasing the risk of fire or burn injuries
- Affect the protection features provided by the vehicle.

Your vehicle may also become illegal to ride.

As an example, installing an additional GPS or cell phone support may prevent the driving capabilities of the vehicle and increase the risk of a loss of control.

**Ask your authorized BRP dealer for suitable available accessories for your vehicle.**

---

# RIDE SAFELY

## Riding with Passenger(s)

The operator is responsible to inform and protect the passenger(s) invited to ride.

Instruct all passenger(s) to use the handholds, seat strap, or to hold on to the waist of the person in front of them. Each passenger must be able to simultaneously place both feet firmly flat against each footwell when properly seated.

Be sure riders are properly seated and holding on. Riders can be thrown off watercraft during unexpected acceleration or aggressive operation. Avoid aggressive operation, sharp turns, and unexpected acceleration.

Falls can result in severe injury or death.

All riders must wear shorts with neoprene (wet suit material) to keep water from being forcefully injected into rectum or vagina during a fall backward. Riders not wearing neoprene shorts have received severe rectal, vaginal, and internal injuries resulting in permanent damage.

When going over waves, riders(s) may raise their body slightly off the seat to absorb the shocks with their legs.

When braking or decelerating, riders must brace themselves against the deceleration force to prevent from moving forward on the watercraft and losing balance.

Riding with passenger(s) makes the watercraft handle differently and requires greater skill.

## Avoiding Collisions

Scan your surroundings constantly for people, objects and other watercraft.

Stay far enough away from others so you can always safely coast to a stop. Do not release throttle when trying to steer away from objects – as with other powerboats, you need throttle to steer.

Be alert for conditions that may limit your visibility or block your vision of others.

Do not go near others to spray or splash them with water, go too close to other boats, or go too fast for traffic conditions. You may misjudge the ability of the watercraft or your own riding skills and strike a boat or person.

If your watercraft is equipped with a braking system, be aware that other boats following or operating in close proximity may not be able to stop as quickly.

Stopping distance will vary depending on initial speed, load, wind and water conditions. The amount of braking power commanded by the operator using the iBR lever will also affect stopping distance.

Although the preferable manoeuvre to avoid an obstacle is to steer away while applying throttle, the iBR can also be used by fully braking and turning in the direction to avoid the obstacle.

## Riding Behaviors

Ride within your limits and level of riding ability.



Scan constantly for people, objects and other watercraft. Stay far enough away from others so you can always safely coast to a stop.

Avoid aggressive operation, sharp turns, and unexpected acceleration that can cause riders to be thrown off.

Avoid riding in very rough waters or practicing extreme manoeuvres like jumping wakes or waves - jumping can cause injuries such as back or spinal injuries (paralysis).

## Speeding

While your watercraft has the capacity of operating at high speeds, it is strongly recommended that high-speed operation only be applied when ideal conditions exist and are permitted. Higher speed operation requires a higher degree of skill and increases the risk of severe injuries.

The forces generated on the body of riders while turning, negotiating waves or wakes, operating in choppy waters, or falling off the watercraft, especially at higher speeds, may cause injury including the possibility of broken bones or more serious bodily injuries.

## Reboarding

Operator and passenger(s) need to know how to swim and how to reboard the watercraft from the water. Boarding in deep water can be strenuous.

Also, make sure you and all passengers know how to reboard when accessories are installed at the rear. Board the watercraft from the rear and carefully get around the accessories. If you have difficulties, you should know how to remove the accessories and move them towards the front to provide better access to the boarding platform.

If the accessories are too heavy, swim toward the side, use passenger handhold and/or seat strap to lift yourself aboard.

Ask inexperienced riders to practice how to board the watercraft close to shore (all methods explained here) before venturing into deep water, especially when cargo is installed aboard on the rear platform.

To prevent accidental starting, always detach the tether cord from the engine cut-off switch when passenger(s) swimmers are boarding.

## Moving Parts

Never turn handlebar while someone is near the rear of watercraft. Keep away from steering moving parts (nozzle, iBR gate, linkages, etc.).

Keep away from the intake grate while the engine is running. Items such as long hair, loose clothing, or PFD straps can become entangled in moving parts.

Be aware of the iBR gate movement when starting the engine, shutting down the engine or using the iBR lever. Automatic movement of the gate may squeeze fingers or toes of people taking a hold on the back or your watercraft.

## Know the Waters

Know the waters in which the watercraft is to be operated.

Plan your route and avoid shallow waters or hidden rocks, rapids, as well as other possible risks. When leaving dock always inform someone you trust on land of your planned route, and estimated time of arrival. They can then contact rescue if you are late and did not reach them.

Current, tides, rapids, hidden obstacles, wakes and waves, etc., can affect safe operation. It is not advisable to operate the watercraft in rough waters or inclement weather. Keep an eye on the weather. Check local weather broadcasts before departure. Be alert to changing conditions.

Keep accurate and up-to-date charts of the boating area on board. Before getting underway, check water conditions in the planned boating area.

Ensure there is enough fuel on board for the planned trip. Always verify fuel level before use and during the ride. Apply the principle of 1/3 of the fuel to reach your destination, 1/3 to return, and keep 1/3 in reserve. Allow for changes due to adverse weather or other delays.

In shallow water, proceed with caution and at very low speeds. Grounding or abrupt stops may result in injury and watercraft damage. Always be alert for debris and objects in the water. They could be picked up and thrown rearward by the jet pump onto people.

## Navigation Rules

Always ride responsibly and safely. Use common sense and courtesy.

Operating a watercraft can be compared with driving on unmarked highways and roads. To prevent collisions or avoid other boaters, a system of operating rules must be followed. Generally keep to your right and safely avoid collisions by keeping a safe distance from other watercrafts, boats, people and objects.

Make sure you know and understand the navigation system applicable to the waterways where you intend to use the watercraft.

Navigational aids on shore or on waters, such as signs or buoys, can assist you in identifying safe waters. They can indicate:

- whether you should keep to the right (starboard) or to the left (port) of the buoy
- which channel you can continue
- whether you are entering a restricted or controlled area such as a no wake or low speed zone
- hazards
- speed limits, no power craft or boating, anchorage and other useful information.

Respect no wake zones, the environment, and the rights of other users of the waterways.

## Night-Time Operation

This watercraft is not designed for night-time operation.

## Carbon Monoxide (CO) Poisoning

All engine exhaust contains carbon monoxide (CO), a deadly gas. Breathing CO can cause headaches, dizziness, drowsiness, nausea, confusion and eventually death.

Carbon monoxide is a colorless, odorless, tasteless gas that may be present even if you do not see or smell any engine exhaust. Deadly levels of CO can collect rapidly, and you can quickly be overcome and unable to save yourself. Also, deadly levels of CO can linger for hours or days in enclosed or poorly ventilated areas. If you experience any symptoms of CO poisoning, leave the area immediately, get fresh air and seek medical treatment.

To prevent serious injury or death from CO:

- Never run the watercraft in poorly ventilated or partially enclosed areas such as boat houses, garage, seawalls or other watercrafts in close proximity. Even if you try to ventilate engine exhaust, CO can rapidly reach dangerous levels.
- Never run the watercraft outdoors where engine exhaust can be drawn into a building through openings such as windows and doors.
- Never stand behind the watercraft while the engine is running. A person standing behind a running engine may inhale high concentrations of exhaust fumes.

After riding, always remove the tether cord from the engine cut-off switch to avoid unauthorized use by children or others and to prevent starting in a closed environment (ex: garage).

## Gasoline Fires and Other Hazards

Gasoline is extremely flammable and highly explosive. Fuel vapors can spread and be ignited by a spark or flame many feet away from the engine. To reduce the risk of fire or explosion, follow these instructions:

- Use only an approved red gasoline container to store fuel.
- Strictly adhere to the instructions in *Fueling* section.
- Never start watercraft if gasoline or gasoline vapor odors is present in the engine compartment.
- Never start or operate the engine if the fuel cap is not properly secured.
- Do not carry gasoline containers in ANY of the storage compartments.
- Use only a BRP approved LinQ fuel caddy, which shall be properly installed and secured.
- Never refill the fuel caddy on the watercraft, refill on the dock or shore.
- Never tow a skier or a wakeboarder while having a fuel caddy installed on the swim platform.

Gasoline is poisonous and can cause injury or death.

- Never siphon gasoline with your mouth.
- If you swallow gasoline, get any in your eyes, or inhale gasoline vapors, see a doctor immediately.

If gasoline is spilled on you, wash thoroughly with soap and water and change your clothes.

## **Burns From Hot Parts**

Certain components may become hot during operation. Avoid contact during and shortly after operation to avoid burns.

## **Watersports (Towing with the Watercraft)**

### **Models with a Seating Capacity of 3 or More Only**

#### ***Attachment and Towing Devices***

Certain watercraft models come equipped with tow eyelets or a ski pylon.

Use the ski pylon, if equipped, to attach a tow rope for a skier or wake boarder.

Use the rear tow eyelet to attach a tow rope for a tube.

Do not use these attachment points or any other portion of the watercraft to tow a parasail, kites, gliders or any devices which can become airborne or for pulling any other craft. Personal injury or severe damage may occur.

Never carry loads on the rear platform when practicing watersports. The cargo may interfere with the rope and unsecure it, becoming an obstacle to the person being towed.

#### ***Watercraft Capacity When Towing***

Always carry an observer to observe the person being towed and inform the operator about the participant's hand signals. The operator must focus his attention on operating the watercraft and the waters ahead.

You need to have seats for everyone: operator, observer, towed person. Therefore, if you are the only vessel, your watercraft must have a seating capacity of 3 or more and you can tow only one person.

#### ***Towing and Observing***

If you have never towed someone behind your watercraft before, it is a good idea to spend some hours as an observer, working with and learning from an experienced operator. It is also important to be aware of the skill and experience of the person being towed.

Pulling a tube, skier or wakeboarder makes the watercraft handle differently and requires greater skill.









Always respect the safety and comfort of the person being towed.

Proceed with only as much speed as required and follow the observers' instructions.

Never make sharp turns while towing skier or rider(s). Sharp turns may result in sudden acceleration or the skier's/ rider's speed. Do not use the braking system unless absolutely necessary. Remember that although this watercraft is manoeuvrable and has stopping capabilities, the person in tow may not be able to avoid an obstacle, or your watercraft.

The driver, the observer and the person being towed, skier or rider(s), need to learn the hand signals before departure.

Participate in watersports only in safe areas. Stay away from other watercrafts, channels, beaches, restricted areas, swimmers, and heavily travelled waterways and underwater obstructions.

Hand Signals			
<b>1. Speed up</b> Thumbs up		<b>5. Cut motor</b> Slashing hand across throat	
<b>2. Slow down</b> Thumbs down		<b>6. OK after fall</b> Hands clasped over the head	
<b>3. Turn</b> Circling motion above head followed by pointing in the direction of the turn		<b>7. Stop</b> Hand raised with fingers outstretched	
<b>4. Back to shore</b> Pat top of head		<b>8. All OK</b> An "O" made with the thumb and index finger	

### ***Fallen Skier or Rider***

Any fall may result in injury: Give immediate attention to a person who has fallen. He or she is vulnerable in the water alone and may not be seen by other boaters.

Always keep the fallen skier or rider in view and on the driver's side of the watercraft. Circle fallen skier or rider slowly to return the tow rope handle or pick up the fallen skier/ rider. Always turn engine OFF when a skier/ rider is getting into or out of the watercraft or is near the watercraft.

### ***Tow Rope***

Never wrap the tow rope around your wrist, hand, or any body part. The rope may suddenly lose its slack and cause serious injuries, such as amputation.

Both the operator and observer shall monitor the location of the tow rope when participating in water sports. A slack tow rope can become entangled with a person(s) or objects on the watercraft or in the water, particularly when making a tight turn or circling, and cause serious personal injury.

Do not pull the tow rope in front of other boats and be careful not to run over the rope with the watercraft because it could get trapped in the jet pump.

Do not tow a person in any water sport on a short tow rope such that the person inhales exhaust fumes in concentration. Inhalation of concentrated exhaust fumes, which contain carbon monoxide, can result in CO poisoning, personal injury and death.

Always use a tow rope of proper tensile strength and of sufficient length. Inspect the rope and connectors before each use. Do not use if damaged. Make sure that the tow rope is adequately secured to your watercraft.

Always disconnect and safely stow the tow rope in the watercraft when not in use. While some watercraft are equipped or can be fitted with a specially designed towing mechanism, avoid installing a tow pole on a watercraft. It can become a hazard should someone fall on it.

---

# PRACTICE EXERCISES

It is always a good idea to practice and get familiar with all controls, functions and handling characteristics of your watercraft before venturing on the water.

## Where to Practice Exercises

Find a suitable area to practice the exercises. Ensure that the area meets the following requirements:

- No traffic
- No obstacles
- No swimmers
- No current
- Ample space to maneuver
- Adequate water depth

## Practice Exercises

Practice the following exercises.

### *Turning*

Practice turning in circles in both directions at slow speed.

When comfortable with the exercise, increase difficulty by making some figure 8.

When this is mastered, repeat the above exercises but at increased speed.

### *Stopping Distances*

Practice stopping the watercraft in a straight line at various speeds and braking force. Remember that watercraft speed, load, water conditions, current and wind also affect stopping distances.

Practice releasing the throttle while going at speed and feel the deceleration rate with different speed.

Repeat exercise, but this time while applying iBR lever (if equipped). Note that the iBR system takes control of the throttle.

### *Steering and Avoiding an Obstacle*

Practice obstacle avoidance (choose a virtual point on the water) by steering watercraft and maintaining throttle.

Repeat exercise, but this time release throttle while turning.

Repeat exercise, but this time while applying iBR lever (If equipped). Note that the iBR system takes control of the throttle.

### **NOTE:**

With this exercise, you will learn that you need throttle to steer the watercraft in a different direction.

### *Reverse*

Practice reverse operation to learn how the watercraft operates in reverse and reacts with steering inputs.

**NOTE:**

Remember that steering direction is reversed when backing.

***Docking***

Practice docking using the throttle, the steering and the iBR (if equipped) to become familiar with the response of the watercraft and to develop good control skills.

***Slow Speed Mode, Ski Mode and Speed Limiter Mode (if equipped)***

If your watercraft has any of these modes, it is also important to understand their operation and to become familiar with these features prior to using them on a ride with other people.

 **WARNING**

**The ski and the speed limiter modes are not an automatic pilot; they will not drive the watercraft for you.**



---

# FUELING

## Fueling Procedure

### WARNING

**Gasoline is extremely flammable and highly explosive under certain conditions. Follow the instructions in this section explicitly. Improper handling of fuel could result in property damage, serious injury or death. Leaking fuel is a fire and explosion hazard. Inspect system for leaks frequently.**

Fuel is flammable and explosive under certain conditions. Do not smoke or allow open flames or sparks in the vicinity.

1. Stop engine.
2. Have the operator and passenger(s) get out of watercraft.
3. If on the water, moor the watercraft securely to the dock.
4. Unscrew slowly the fuel cap counterclockwise to stabilize pressure before removing it.

#### NOTE:

A short whistling sound is normal.

5. Insert the spout into the filler neck.

#### NOTE:

Be certain that you are putting fuel in the right location and not using a ventilation hole or ski pylon hole by mistake.

6. Pour fuel slowly so the air can escape from the tank and prevent fuel flow back. Be careful not to spill fuel.
7. Stop filling after the release of the gas pump nozzle handle and wait a moment before removing the spout. Do not retract the gas pump nozzle to put more fuel into the fuel tank. Do not overfill.
8. Install fuel tank cap and tighten it clockwise until you hear a ratchet sound.
9. Always wipe off any fuel spillage from the watercraft.
10. After refueling, always open or remove the seat or the lateral panel (depending on models) and ensure there is no gasoline odor inside the engine compartment. Do not start watercraft if you smell gasoline odor.

## Fuel Requirements

### NOTICE

**Always use fresh gasoline.**

Gasoline will oxidize; the result is loss of octane, volatile compounds, and the production of gum and varnish deposits which can damage the fuel system.

Alcohol fuel blending varies by country and region. Your vehicle has been designed to operate using the recommended fuels, however, be aware of the following:

- Use of fuel containing alcohol above the percentage specified by government regulations is not recommended and can result in the following problems in the fuel system components:
  - Starting and operating difficulties.
  - Deterioration of rubber or plastic parts.
  - Corrosion of metal parts.
  - Damage to internal engine parts.
- Inspect frequently for the presence of fuel leaks or other fuel system abnormalities if you suspect the presence of alcohol in gasoline exceeds the current government regulations.
- Alcohol blended fuels attract and hold moisture which may lead to fuel phase separation and can result in engine performance problems or engine damage.

### Recommended Fuel

The gasoline must have the following minimum octane requirements:

Engine	Recommended Fuel
300	Use Premium gasoline with an AKI (RON+MON)/2 octane rating of 92 or an RON octane rating of 95.
All other	Use common gasoline with an AKI (RON+MON)/2 octane rating of 87 or an RON octane rating of 91.

Use unleaded gasoline containing MAXIMUM 10% ethanol.



**NOTICE**

**Never experiment with other fuels. Engine or fuel system damages may occur with the use of an inadequate fuel.**

**NOTICE**

**Do NOT use fuel from fuel pumps labeled E85.**

Use of fuel labeled E15 is prohibited by U.S. EPA Regulations.

---

# TRANSPORTING THE WATERCRAFT

## NOTICE

**The span of the trailer bunks including bunk width should be adjusted to provide support throughout the full length of the hull. The ends of both trailer bunks should not exceed the length of the watercraft.**

Ensure the trailer wheels are positioned so that the center of gravity of the watercraft is slightly ahead of the wheels to properly support the weight of the watercraft.

Carry the watercraft in its normal operating position.

Check the applicable laws and regulations in your area concerning towing a trailer, especially for the following items:

- Brake system
- Tow vehicle weight
- Mirrors.

Respect tow vehicle maximum weight capacity and the tongue weight capacity as recommended by the manufacturer.

Tie the watercraft to both front and rear (bow/stern) eyelets so that it is firmly secured on the trailer. Use additional tie-downs if necessary.

Ensure fuel tank cap, front storage compartment cover, glove box cover, boarding platform and seat are properly latched.

Make sure all accessories and cargo are properly secured.

Observe trailering safety precautions.

Do not route ropes or tie-downs over the seat or attach them to the grab handle to avoid these parts permanently damaged. Wrap ropes or tie-downs with rags or similar protectors where they can come into contact with the watercraft body.

A Sea-Doo cover can protect the watercraft, particularly when driving on dirt roads, to prevent dirt entry through the air inlet openings.

When transporting 2 watercrafts, it may be necessary to remove the inner wakeboard rack, if equipped.

For more information, see the following video: SEA-DOO HOW TO SERIES - PROPER WATERCRAFT TRAILERING

<https://www.youtube.com/watch?v=mXtHWldt7yl>

Or, use the following QR code.



**⚠ WARNING**

**Make sure all seats, accessories and cargo are properly secured, or remove it to prevent from falling on the road and creating a hazard for following vehicles.**

---

# IMPORTANT ON-PRODUCT LABELS

## Watercraft Safety Labels

These labels are affixed to the vehicle for the safety of the operator, passengers or bystanders.

The operator and when applicable, the passenger, shall read and understand this information before riding.

The labels illustrated on the following pages are on your watercraft. If missing or damaged, they can be replaced free of charge. See an authorized Sea-Doo dealer.

### **NOTE:**

In the event of any discrepancy between this guide and the vehicle, the safety labels on the vehicle have precedence over the labels in this guide.

## General Information – Warning Label

**⚠ WARNING**

**Require Proper Operation of the Boat**  
Improper operation can result in severe injury or death.

**16+** **Operators Must Be Qualified**  
Make sure operator is 16 or older and has taken a boater safety course. Your state (or province) may have additional requirements.

**Operators Must Avoid Collisions**

- ✔ Scan constantly for people, objects and other watercraft.
- ✔ Stay far enough away from others so you can always safely coast to a stop.
- ✘ Do not release throttle when trying to steer away from objects—as with other powerboats, you need throttle to steer.

**Read Operator's Guide**  
Watch safety video.  
(<https://www.sea-doo.com/owners/safety/safety-video.html>)

**Protect All Riders**

- ✔ **Wear shorts with neoprene (wet suit material) and an approved PFD (personal flotation device)** - see Rider Safety section of this label. Tell riders to read the Rider Safety section and make sure they are dressed appropriately.
- ✘ Do not apply throttle when anyone is boarding or at rear of PWC.
- ✔ Be sure riders are properly seated and holding on.
- ✔ Avoid aggressive operation, sharp turns, and unexpected acceleration that can cause riders to be thrown off.
- ✔ Do not jump waves or wakes – jumping can cause injuries such as back or spinal injuries (paralysis).

**Do Not Permit Reckless Operation:**

- ✘ Do not go near others to spray or splash them with water, go too close to other boats, or go too fast for traffic conditions.
- ✘ Never ride after consuming alcohol or drugs.



**RIDER SAFETY**

**Falls Can Result in Severe Injury or Death**

- ✔ You must wear shorts with neoprene (wet suit material) to keep water from being forcefully injected into rectum or vagina during a fall backward. Riders not wearing neoprene shorts have received severe rectal, vaginal, and internal injuries resulting in permanent damage.
- ✔ You must wear an approved PFD (personal flotation device).
- ✔ Be sure you are properly seated and holding on. Riders can be thrown off PWC during unexpected acceleration or aggressive operation.
- ✘ Never ride after consuming alcohol or drugs.

**Do not ride if you are not dressed appropriately.**



Wear PFD

Wear Neoprene



See Operator's Guide

Patents :  
[www.brp.com/en/about-brp/patents.html](http://www.brp.com/en/about-brp/patents.html)

5632



## GENERAL INFORMATION – WARNING LABEL

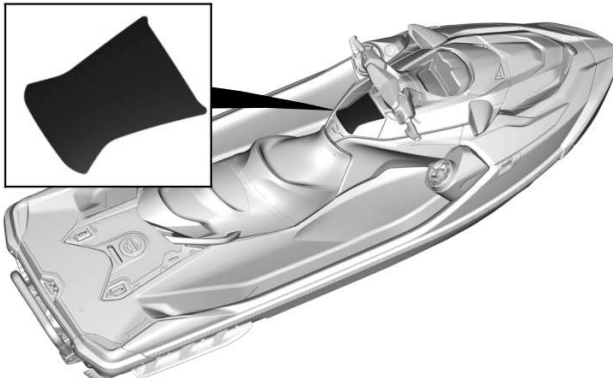

TYPICAL – LABEL LOCATION

## High Performance Vehicle - Warning Label



## HIGH PERFORMANCE VEHICLE - WARNING LABEL

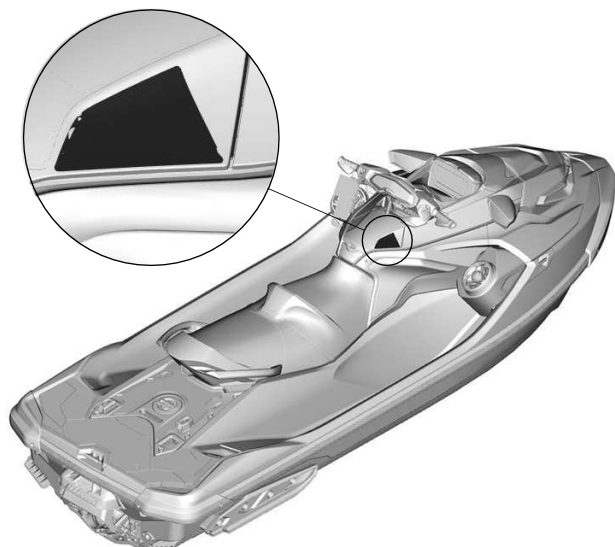



## LABEL LOCATION

**Glove Box - Notice Label**

**NOTICE**

Refer to the operator's guide for recommendations on how to use the glove box .



5677

**GLOVE BOX - NOTICE LABEL**



**TYPICAL - LABEL LOCATION**



**Recommended Fuel Notice Label (GTX 300 Only)**

<b>NOTICE</b>	Use premium unleaded gasoline with an AKI (RON+MON) /2 octane rating of 91, or an RON octane rating of 95.	 5707
---------------	--	---

**RECOMMENDED FUEL - NOTICE LABEL**

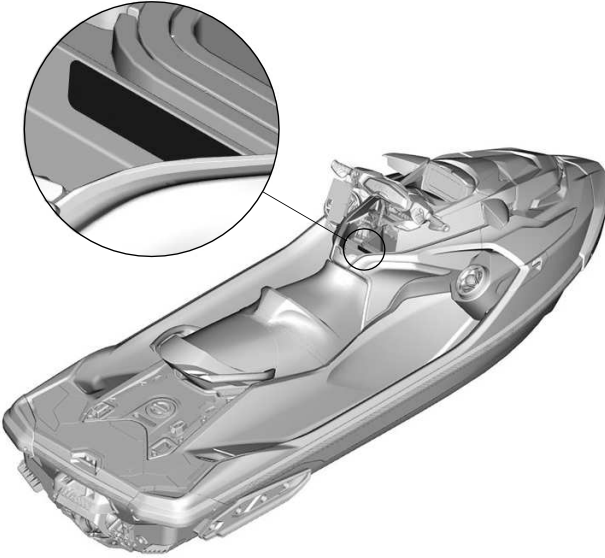

**TYPICAL - LABEL LOCATION**

## Fueling Procedure - Warning Label

### ⚠ AVERTISSEMENT

- Après avoir fait le plein toujours ouvrir le siège afin de s'assurer qu'il n'y ait pas d'émanation d'essence dans le compartiment moteur.
- Les émanations d'essence peuvent provoquer des incendies ou des explosions.
- Éviter de trop remplir le réservoir d'essence. • Éviter de renverser de l'essence.
- Essuyer immédiatement l'essence renversée • Garder la motomarine à l'écart des flammes et des étincelles. • Ne pas démarrer la motomarine en présence d'essence liquide ou d'émanation d'essence. • Toujours remettre le siège en place avant de démarrer la motomarine.

### ⚠ WARNING

- After refueling, always open the seat to ensure there is no gasoline vapor odor inside the engine compartment.
- Gasoline vapor may cause fire or explosion.
- Do not overfill gas tank. • Avoid spilling gasoline. • Wipe up spilled gasoline immediately.
- Keep the watercraft away from open flames and sparks.
- Do not start watercraft if liquid gasoline or gasoline vapor odor is present.
- Always replace the seat before starting.



## FUELING PROCEDURE - WARNING LABEL

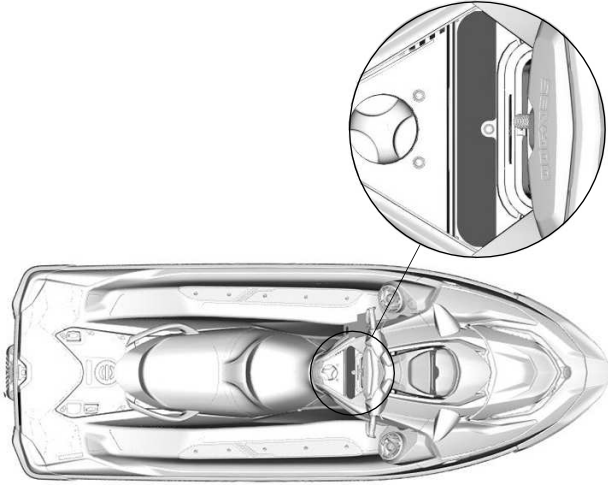

TYPICAL - LABEL LOCATION

## Battery - Warning Label

<p><b>⚠ Avertissement</b></p> <ul style="list-style-type: none"> <li>• Enlever la batterie du bateau avant de la charger.</li> <li>• Ne pas trop charger la batterie.</li> <li>• Un chargement excessif pourrait faire exploser la batterie.</li> </ul>	<p><b>⚠ WARNING</b></p> <ul style="list-style-type: none"> <li>• Remove battery from boat before charging.</li> <li>• Do not overcharge battery.</li> <li>• Improper charging of battery can cause explosion.</li> </ul> <div style="text-align: right;">   <small>219905305</small> </div>
---	--

### BATTERY – WARNING LABEL



TYPICAL – LABEL LOCATION

**Air Intake Silencer - Notice Label**

**NOTICE**

- To comply with noise regulations, this engine is designed to operate with an air intake silencer.
- Operation without air intake silencer or with one not properly installed may cause engine damage.

219903177A

**AIR INTAKE SILENCER - NOTICE LABEL**



**TYPICAL - LABEL LOCATION**

**Do Not Open When Hot - Warning Label**



**DO NOT OPEN WHEN HOT - WARNING LABEL**

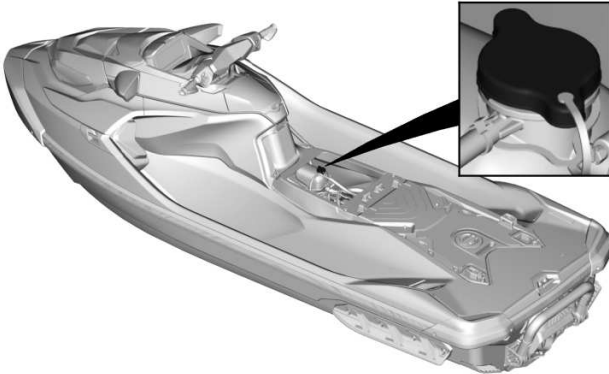

**TYPICAL - LABEL LOCATION**

## Engine Oil Level - Notice Label



### ENGINE OIL LEVEL - NOTICE LABEL

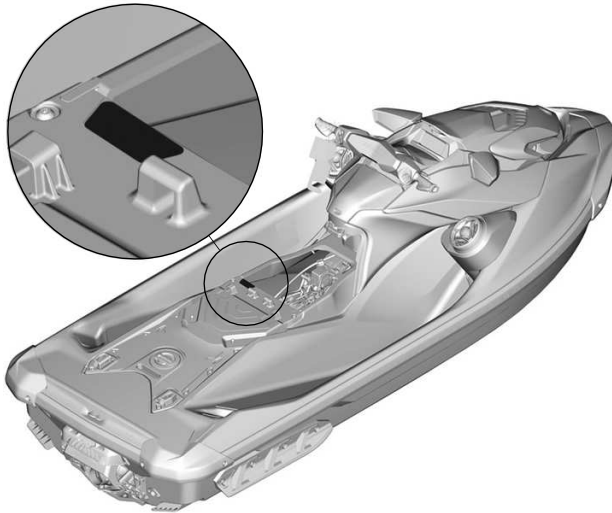

### TYPICAL - LABEL LOCATION

**Hot Components - Caution Label**



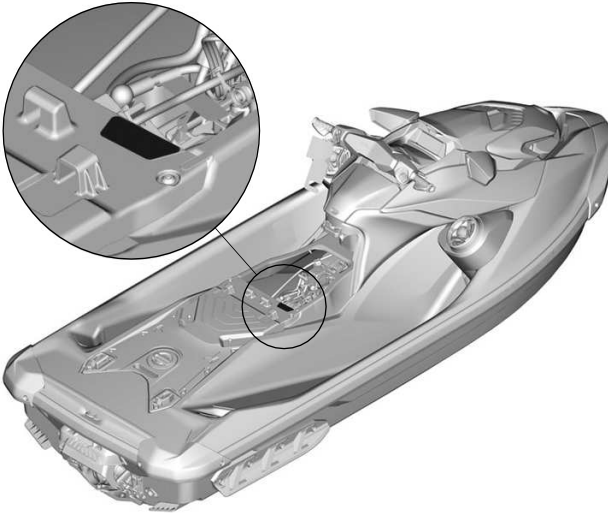

**HOT COMPONENTS - CAUTION LABEL**



**TYPICAL - LABEL LOCATION**

**Do Not Sit Pictogram - Warning Label**

	<p><b>⚠ WARNING</b></p> <p>If a Ski-Pylon can be used on this PWC, always install the rear seat to prevent injury when in use.</p> <p>Before riding the PWC make sure to properly install and lock the seat(s) into place.</p>  <p>5978</p>
--	--

**DO NOT SIT PICTOGRAM - WARNING LABEL**



**LABEL LOCATION**



**Passenger Appropriate Attire - Warning Pictogram**

<b>⚠ WARNING</b>	
<ul style="list-style-type: none"> <li>- Refer to the general safety label located on the glove box.</li> <li>- Riders must always wear an approved PFD.</li> <li>- Riders must always wear shorts with neoprene (wet-suit material).</li> </ul>	



**PASSENGER APPROPRIATE ATTIRE – WARNING PICTOGRAM**

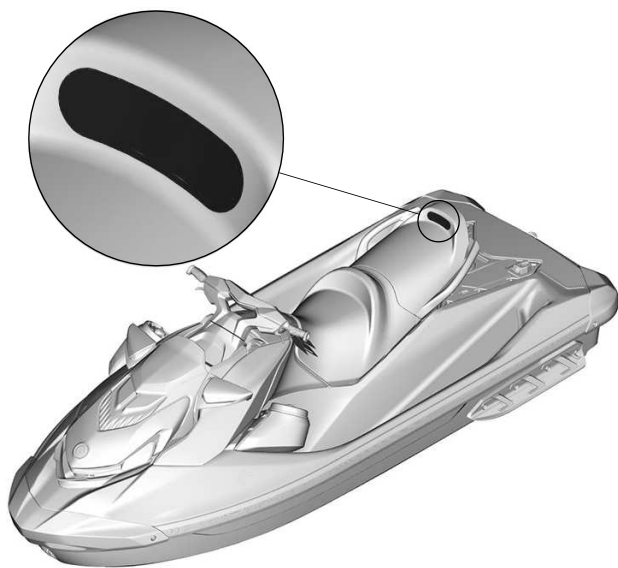

**TYPICAL – LABEL LOCATION**

**Wakeboard Support – Warning Label (if equipped)**



**WAKEBOARD SUPPORT – WARNING LABEL**

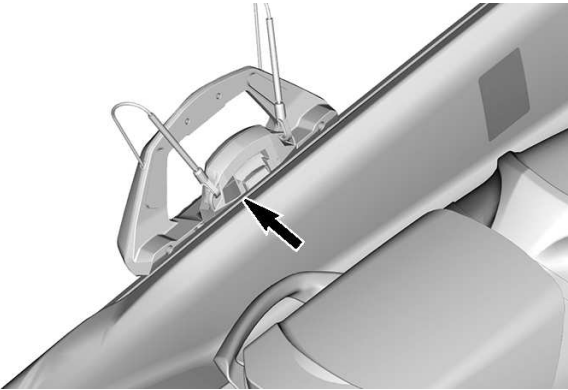

**LABEL LOCATION**

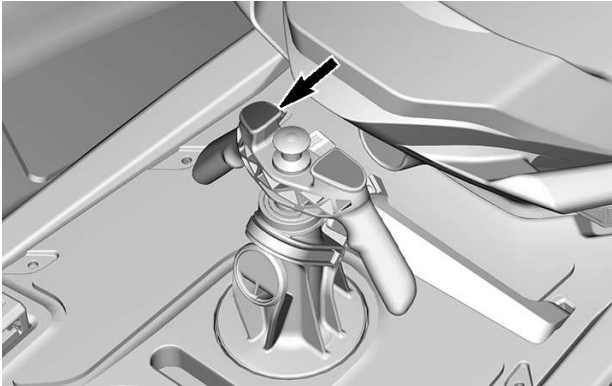
**Retractable Ski Post – Use – Warning Label (if equipped)****RETRACTABLE SKI POST – USE – WARNING LABEL****LABEL LOCATION**

**Retractable Ski Post – Spotter and Weight – Warning Label (if equipped)**



**RETRACTABLE SKI POST – SPOTTER AND WEIGHT – WARNING LABEL**

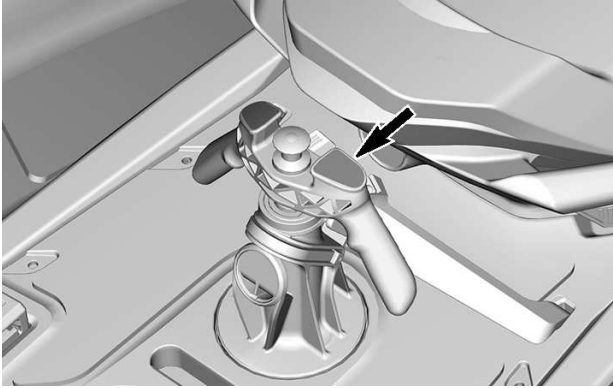

**LABEL LOCATION**

**No fuel – Warning Molded Pictogram**

**⚠ WARNING**

Never put gasoline in this hole. Gasoline is extremely flammable and highly explosive. Fuel vapors can spread and be ignited by a spark or flame many feet away.



**NO FUEL – WARNING MOLDED PICTOGRAM**

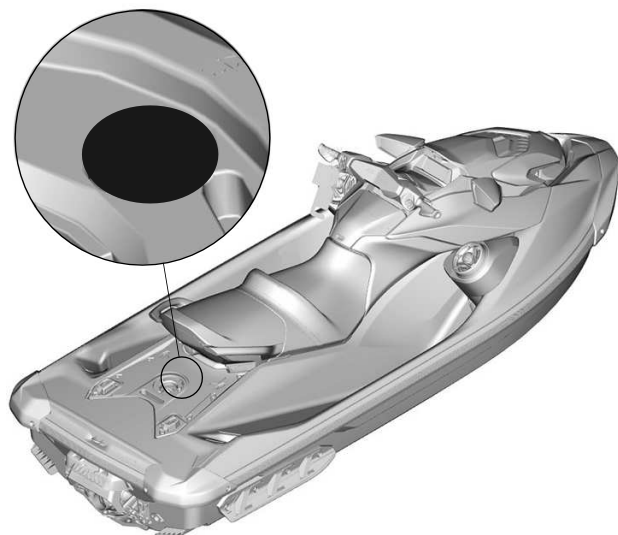

**TYPICAL – LABEL LOCATION**

## Re-Boarding - Warning Label

**⚠ WARNING**

**AVOID SERIOUS INJURY OR DEATH:**

- Engine must be turned off before re-boarding.
- Keep away from propulsion system and intake grate.

**WHEN RE-BOARDING:**

- Re-board one person at a time.
- Stay centered to keep balance.

Never use the boarding step (if so equipped) for pulling, towing, jumping or boarding a PWC that is out of water or any purpose for which it was not designed.



219905498

### RE-BOARDING - WARNING LABEL



TYPICAL – LABEL LOCATION

**Exhaust System Flushing – Supercharged Engines**

**NOTICE**

It is very important to flush the exhaust system with fresh water (from 1-1/2 to 2 minutes) after each use in salt water or foul water.



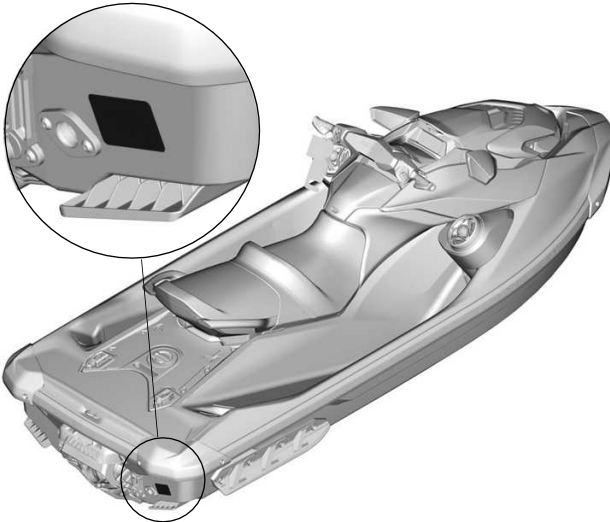

219905495

**EXHAUST SYSTEM FLUSHING – SUPERCHARGED ENGINES**



**LABEL LOCATION**

**Tip Over - Caution Label**

<b>⚠ CAUTION</b>	
When operating the engine while the watercraft is out of the water, the heat exchanger in the ride plate may become very hot. Avoid any contact with plate as burns may occur.	
219905494 	
	<ul style="list-style-type: none"><li>• Roll boat</li><li>• on bumper rail.</li><li>• Grab inlet grate and step.</li><li>• Make sure engine is off.</li></ul>
<b>NOTICE</b>	

**TIP OVER - CAUTION LABEL**

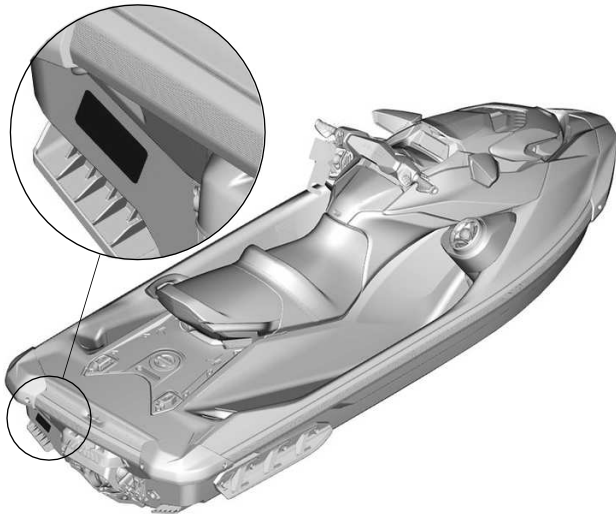

**TYPICAL - LABEL LOCATION**



**Do Not Use to Onboard**



**DO NOT USE TO ONBOARD – LABEL**

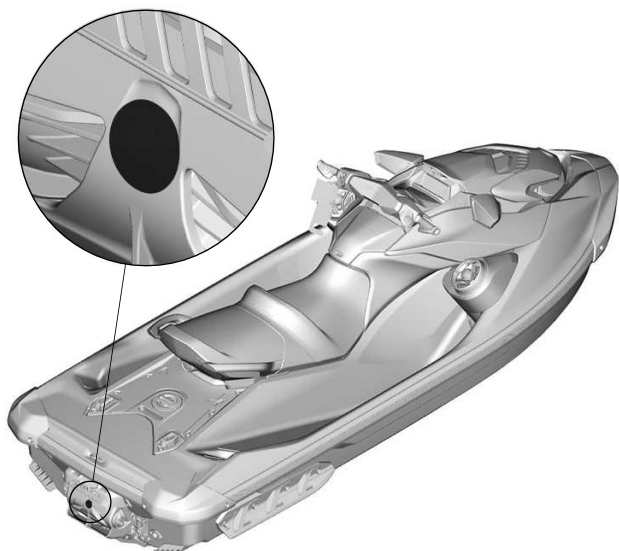

**TYPICAL – LABEL LOCATION**

**iBR Gate - Warning Label**



**IBR GATE - WARNING LABEL**

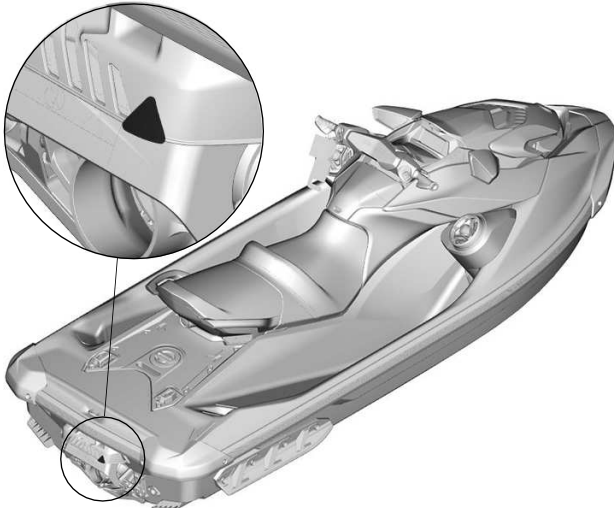

**TYPICAL - LABEL LOCATION**

**iBR Gate - Warning Label**





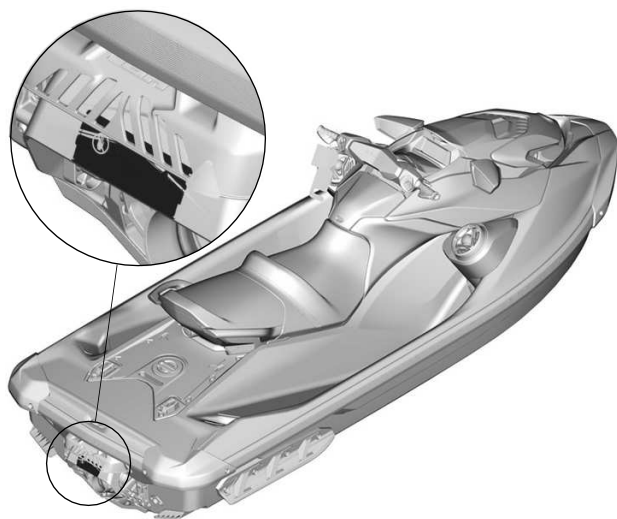

**IBR GATE - WARNING LABEL**



**TYPICAL - LABEL LOCATION**

## Canadian Compliance Notice Label

<b>CANADIAN COMPLIANCE NOTICE AVIS DE CONFORMITÉ CANADIEN</b>	
<b>MAXIMUM RECOMMENDED SAFE LIMITS LIMITES MAXIMALES DE SÉCURITÉ RECOMMANDÉES</b>	
<b>MAX.</b> 	<b>kg lbs/lb</b>
<b>MAX.</b>  + 	<b>kg lbs/lb</b>
<b>CATEGORY / CATÉGORIE:</b>	
MAXIMUM WAVE / VAGUE MAXIMALE: <b>m</b>	
MAXIMUM WIND SPEED / VITESSE DE VENT MAXIMALE: <b>knots/noeuds</b>	
<b>BOMBARDIER RECREATIONAL PRODUCTS INC. (YDV) 565 de la Montagne, Valcourt, J0E 2L0, QC, CA Rotaxstrasse 1, Gunsirichen, A-4623, AT</b>	
<b>MODEL / MODÈLE :</b>	
<p>THE MANUFACTURER DECLARES THAT THIS PRODUCT COMPLIES WITH THE CONSTRUCTION REQUIREMENTS OF THE SMALL VESSEL REGULATIONS, AS THEY READ ON THE DAY ON WHICH THE CONSTRUCTION OF THE VESSEL WAS STARTED OR ON THE DAY ON WHICH THE VESSEL WAS IMPORTED.</p> <p>LE FABRICANT ATTESTE QUE CE PRODUIT EST CONFORME AUX EXIGENCES DE CONSTRUCTION DU REGLEMENT SUR LES PETITS BÂTIMENTS EN VIGUEUR À LA DATE DU DÉBUT DE SA CONSTRUCTION OU DE SON IMPORTATION.</p>	
<b>MAXIMUM CAPACITIES ABOVE INFORMATION ALSO APPLIES IN THE U.S.A.</b>	    
<small>6 109</small>	<small>CAN ICES-002 / NMB-002</small>

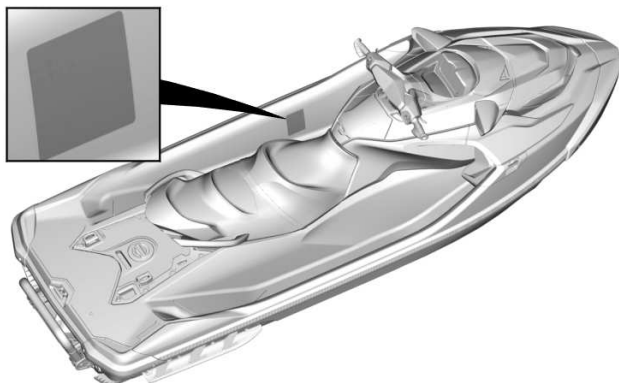

TYPICAL – LABEL LOCATION

## Hang Tag

### California Proposition 65 Warning

 **WARNING.** Operating, servicing and maintaining a recreational marine vessel can expose you to chemicals including engine exhaust, carbon monoxide, phthalates, and lead, which are known to the State of California to cause cancer and birth defects or other reproductive harm. To minimize exposure, avoid breathing exhaust, service your vessel in a well-ventilated area and wear gloves or wash your hands frequently when servicing this vessel.



For more information go to  
[www.P65warnings.ca.gov/products/marine](http://www.P65warnings.ca.gov/products/marine)

219905280

## iBR Hang Tag



### How to brake

- Squeeze brake lever.

### How to reverse

- Maintain brake lever engaged.

### How to go forward

- Tap throttle lever to engage forward movement from neutral position.
- Squeeze throttle lever to accelerate.

### How to get to neutral

- Tap brake lever.

Refer to the operator's guide for more information.



211990601

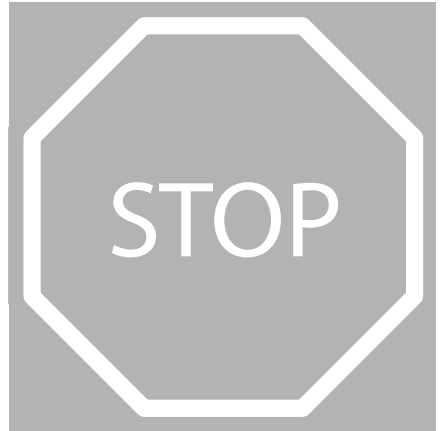

# iBR<sup>®</sup>

INTELLIGENT BRAKE AND REVERSE

THIRD GENERATION

- Allows you to stop sooner for greater peace of mind .
- Recognized by the U.S. Coast Guard for improving boating safety since 2009.
- The Third Generation provides more precise and responsive control when braking and docking.

## SEA DOO<sup>®</sup>

## High Performance Model - Hang Tag

 **WARNING**

THIS PWC IS A HIGH PERFORMANCE MODEL FOR SPORT TYPE RECREATIONAL AND/OR COMPETITIVE USE.

---

THIS PWC IS TO BE USED BY OPERATORS WITH SUBSTANTIAL EXPERIENCE.

**THIS HANGTAG IS NOT TO BE REMOVED BEFORE SALE**

219904038

 **WARNING**

THIS PWC IS A HIGH PERFORMANCE MODEL FOR SPORT TYPE RECREATIONAL AND/OR COMPETITIVE USE.

---

THIS PWC IS TO BE USED BY OPERATORS WITH SUBSTANTIAL EXPERIENCE.

**THIS HANGTAG IS NOT TO BE REMOVED BEFORE SALE**

# PRE-RIDE INSPECTION

Always inspect and confirm the safe operating condition of your vehicle prior to ride.

Always follow the maintenance schedule described in this Operator's Guide.

## WARNING

**Perform a pre-ride inspection before each ride to detect potential problems during operation. The pre-ride inspection can help you monitor wear and deterioration before they become a problem. Correct any problems that you discover to reduce the risk of a breakdown or crash.**

Before using this vehicle, the operator should always perform the following pre-ride inspection check list.

Refer to *Maintenance Procedures* for details.

## What to Do Before Launching the Watercraft

### WARNING

**Engine should be off and the tether cord cap should always be removed from the engine cut-off switch prior to verifying any of the following points. Only start watercraft once all items have been checked and operate properly.**

**NOTE:** Before starting the engine and taking off, it is recommended to shake vertically the rear of the watercraft to shake away any sand that may have accumulated near the propulsion and reverse systems.

Check the items listed in the following table before launching the watercraft.

ITEM	OPERATION
Hull	Inspect hull, ride plate and water inlet grate for damages. Properly clean the hull before launching the watercraft when moving to a different water plan to prevent from spreading aquatic invasive species (AIS)
Jet pump water intake	Inspect/clean
Drain plugs	Tighten
Fuel tank	Refill
Engine compartment	Check for any visible fluid leaks and gasoline vapor odor
Engine oil level	Check/refill



Engine coolant level	Check/refill
Steering system	Check operation
iTC lever	Check operation. (Depress and release the lever to check for freedom of movement. If any friction is felt in the throttle lever, refer to an authorized <i>Sea-Doo</i> dealer.)
iBR lever (if equipped)	Check operation. (Depress and release the lever to check for freedom of movement. If any friction is felt in the iBR lever, refer to an authorized <i>Sea-Doo</i> dealer.)
Front storage compartment cover (if equipped), glove box and seat	Ensure they are closed and latched.
Wakeboard rack (if equipped)	<ul style="list-style-type: none"> <li>– Ensure rack is properly installed and secured.</li> <li>– Make sure bungee cords are in good condition.</li> <li>– Ensure wakeboard is correctly installed in rack and secured.</li> </ul>
Ski/ wakeboard pylon (if equipped)	Inspect and check operation.
Engine START/STOP button	Check operation
Engine cut-off switch and the monitoring beeper	Check operation
Battery condition and connections	Check every month
Sacrificial anodes	Inspect every month (more often in saltwater use) and change if necessary

## Hull

Inspect hull for cracks and other damages.

Properly clean the hull before launching the watercraft when moving to a different water plan to prevent from spreading aquatic invasive species. Refer to *What to Do After Leaving the Water* at the end of this section.

## Jet Pump Water Intake

Remove weeds, shells, debris or anything else that could restrict the flow of water and damage the propulsion unit. Clean as necessary. If any obstruction cannot be removed, refer to an authorized *Sea-Doo* dealer for servicing.

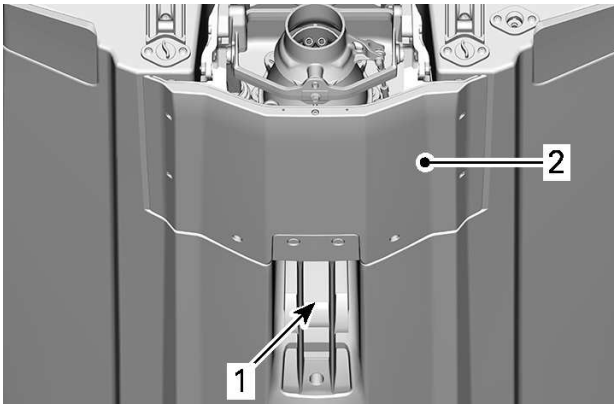

1. Water intake
2. Ride plate

### **Drain Plugs**

Secure bilge drain plugs.

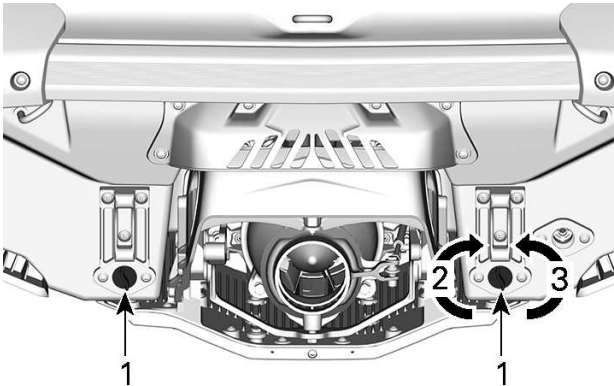

1. Bilge drain plug
2. Tighten
3. Untighten

### **⚠ WARNING**

Ensure bilge drain plugs are properly secured prior to launching the watercraft in water.

### **Fuel Tank**

Fill the fuel tank.

**⚠ WARNING**

Strictly adhere to instructions detailed in *Fueling Procedure*.

**Engine Compartment**

Inspect the engine compartment for fuel vapor odor.

**⚠ WARNING**

Should any leak or gasoline odor be present, do not apply electrical power or start the engine. You should seek service from an authorized *Sea-Doo* dealer, repair shop, or person of your own choosing for maintenance, repair, or replacement. Please refer to the *US EPA Emissions-related warranty* contained herein for information about warranty claims.

To access the engine compartment, remove the seats. Refer to *Removing the Seat*.

**Engine Oil**

Ensure oil level is within specification as described in *Maintenance Procedures* section.

**Engine Coolant**

Ensure coolant level is within specification as described in *Maintenance Procedures* section.

Check for coolant leaks on engine, in bilge and from ride plate.

**⚠ CAUTION**

When operating the engine with the watercraft out of the water, the engine and heat exchanger in the ride plate may become very hot. Avoid any contact with hot engine parts and the ride plate as burns may occur.

**Steering System**

Assisted by another person, check steering operation for free movement.

When the handlebar is horizontal, the jet pump nozzle should be in the straight ahead position. Ensure the jet pump nozzle pivots easily and in the same direction as the handlebar (e.g.: when handlebar is turned to the left, the nozzle opening must point towards the LH side of watercraft).

**⚠ WARNING**

Check handlebar and corresponding steering nozzle operation before starting. Never turn handlebar while someone is near the rear of the watercraft. Keep away from steering moving parts (nozzle, iBR gate, linkages etc.).

### ***iTC Lever (throttle control)***

Check the iTC lever for free and smooth operation. It should return to its initial position immediately after it is released.

**⚠ WARNING**

**Check the iTC lever operation before starting the engine. If any friction is felt in the iTC lever, refer to an authorized *Sea-Doo* dealer.**

### ***iBR Lever***

Check the iBR lever for free and smooth operation. It should return to its initial position immediately after it is released.

**⚠ WARNING**

**Check iBR lever operation before starting the engine. If any friction is felt in the iBR lever, refer to an authorized *Sea-Doo* dealer.**

### ***Storage Compartments, Boarding Platform and Seat***

Ensure the glove box, boarding platform, access panels, and seat are closed and latched.

**⚠ WARNING**

**Ensure the seat, boarding platform, access panels, and all storage compartment covers are securely latched.**

### ***Wakeboard Rack (if equipped)***

**⚠ WARNING**

**Ensure wakeboard rack is properly secured to watercraft body, and that the wakeboard is properly positioned and secured to the rack prior to using watercraft. Ensure wakeboard retaining straps are in good condition.**

### ***Ski/ Wakeboard Pylon (if equipped)***

Make sure ski/ wakeboard pylon is fully extended and locked before use. Completely retract and lock when not used.

**⚠ WARNING**

When using the ski pylon, never carry cargo or accessories on the boarding platform.

**⚠ WARNING**

Use caution with a skier/ wakeboarder in tow as tow rope may backlash to the watercraft when released. Never perform a sharp turn when towing a skier, wakeboarder or any toy. Always store the tow rope when not in use.

**NOTICE**

The ski/ wakeboard pylon is designed for towing a skier or wakeboarder with a maximum weight of 114 kg (250 lb).

**⚠ CAUTION**

Never use the ski pylon to tow an inflatable tube. Always use the rear cleat for towing an inflatable tube.

***Engine Cut-Off Switch and Engine START/STOP Button***

Press the start button once without installing the tether cord on the engine cut-off switch.

Install the tether cord cap on the engine cut-off switch.

Press the START/STOP button to start the engine, then stop it by pressing the START/STOP button a second time.

Restart the engine, then stop it by removing the tether cord from the engine cut-off switch.

**⚠ WARNING**

Should the tether cord cap be loose or fail to remain on the engine cut-off switch, replace the tether cord immediately in order to avoid unsafe use. If removing the tether cord cap from the engine cut-off switch or pressing the START/STOP button does not stop the engine, do not use the watercraft. See your authorized *Sea-Doo* dealer.

## What to Do After Launching the Watercraft

Check the items listed in the following table after launching the watercraft and before going for a ride.

### WARNING

**Engine should be off and the tether cord cap should always be removed from the engine cut-off switch prior to verifying any of the following points. Only start watercraft once all items have been checked and operate properly.**

**NOTE:** Before starting the engine and taking off, it is recommended to shake vertically the rear of the watercraft to shake away any sand that may have accumulated near the propulsion and reverse systems.

Check the items listed in the following table before launching the watercraft.

ITEM	OPERATION
Information Center	Check operation.
Intelligent Brake and Reverse System (iBR)	Check operation.
Variable Trim System (VTS)	Check operation.

### *Information Center (Gauge)*

1. Press START/STOP button and install tether cord on the engine cut-off switch.
2. As the information center cycles through its self-test function, ensure all indications come on.

### WARNING

**Always attach the tether cord clip to your PFD or to the wrist (wrist strap required).**

### *iBR System*

### NOTICE

**Ensure there is sufficient space ahead and behind watercraft to safely carry out the iBR system test to avoid a collision. Watercraft will move during test.**

1. Remove the moorings lines securing the watercraft to the dock.
2. Start the engine and ensure the watercraft does not move.
3. On the left handlebar, depress the iBR lever completely in, the watercraft should move slowly backwards.

4. Release the iBR lever, there should not be any reverse thrust.

### **WARNING**

**Always ensure proper iBR system operation before taking the watercraft out for a ride.**

#### ***Variable Trim System (VTS) (if equipped)***

With the engine running in forward thrust, use the VTS to move the jet pump nozzle up, and then down alternately to check VTS operation. Confirm the VTS position indicator movement in the information center.

Also test the VTS preset trim positions by double clicking the VTS UP/DOWN button (as applicable to model).

Refer to *Operating Instructions* for detailed instructions.

### **What to Do After Leaving the Water**

Aquatic Invasive Species (AIS) are non-native plant or animal species that threaten the diversity or abundance of the native species. They also threaten the natural ecology of the body of water they infest. AIS almost always has a negative impact on the waterway, its native species, and recreational or commercial activities.

Common examples of AIS are:

- Eurasian Watermilfoil
- Hydrilla
- Sea Lampreys
- Zebra Mussels
- Asian Carp
- Gobies.

Many other examples of AIS exist throughout the world's waterways.

A typical factor in AIS infestations is that the non-native species are introduced by human activity. Some AIS are introduced by commercial operations; however, AIS can be introduced through recreational boating activities. The transportation of recreational watercraft and water sports equipment between waterways can be a major factor in the spread of AIS.

As responsible watercraft owners, we **MUST** do our part to prevent the spread of these aquatic hitchhikers. Check your watercraft each time you leave the water! In many cases it is required by law, be sure to check the local regulations for the waterways you visit.

### **Clean, Drain and Dry - Everything, Every Time!**

After each boating trip, before you leave the water access, follow these three simple steps to stop the spread of AIS. This is the boater's way to help protect the environment from the damage that AIS can cause.

#### ***Clean***

Inspect and remove any visible plants, fish, animals, mud, or other debris from the watercraft (including hull, intake grate, and jet pump nozzle), trailer, and any water sports equipment, gears and accessories before leaving the water body.

Clean all parts, equipment, and gear that came in contact with the water.

### ***Drain***

Drain and flush all water from the watercraft, exhaust system, bilge, pontoon floats, and every conceivable space or item that can hold water.

Dispose of unwanted live bait in the trash.

### ***Dry***

Allow everything to dry completely (for 5 days or more, refer to local laws) before visiting any other bodies of water.



---

## **ANNUAL SAFETY MAINTENANCE**

BRP recommend to have an annual safety inspection of your vehicle. Contact an authorized Sea-doo dealer for further details.

Though not required, it is recommended that an authorized BRP dealer performs the preseason preparation of your vehicle.

Each visit to your authorized Sea-Doo dealer is a great opportunity for your dealer to verify if your vehicle is included in any safety campaign. We also urge you to visit your authorized Sea-Doo dealer in a timely manner if you become aware of any safety related campaigns.

This page is intentionally blank

# **WATERCRAFT INFORMATION**

---

## CONTROLS

Some vehicle safety labels are not shown on illustrations. For information on vehicle safety labels, refer to *Important On-Product Labels*.

Some indications, functions and features described in this section may not apply to every PWC model, or may be available as an option.

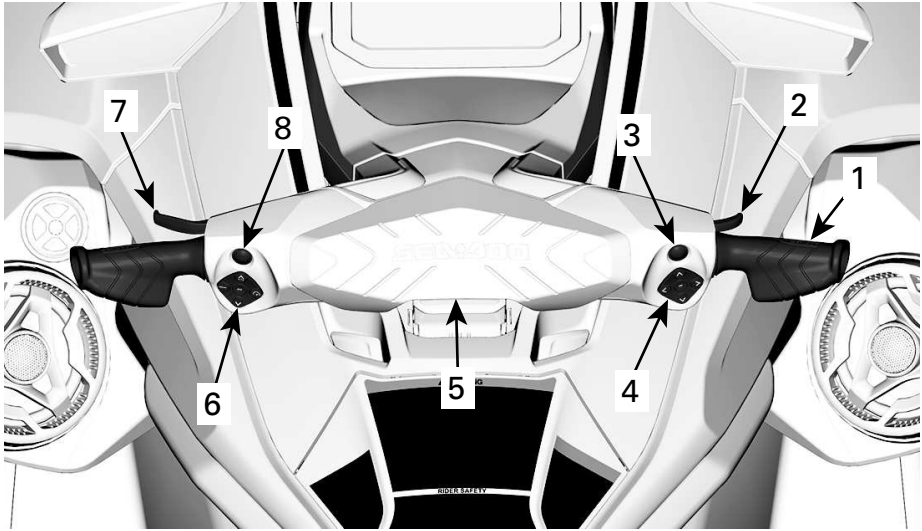

1. Handlebar
2. Throttle lever
3. BRP Connect Button (if equipped)
4. Right Controller
5. Engine Cut-Off Switch
6. Left Controller
7. iBR lever
8. Engine START/STOP Button

## Handlebar

The handlebar controls the direction of the watercraft. During forward operation, turning the handlebar to the right steers the watercraft to the right and inversely.

### **⚠ WARNING**

**Check handlebar and corresponding steering nozzle operation before starting. Never turn the handlebar while someone is near the rear of the watercraft. Keep away from the propulsion system.**

When operating in reverse, the steering direction is reversed. Turning the handlebar to the right while backing up steers the watercraft to the left.

## Throttle Lever

The throttle lever on the RH handlebar controls electronically the engine speed.

To increase or maintain watercraft speed, pull the throttle lever with your finger.

To decrease watercraft speed, release the throttle lever.

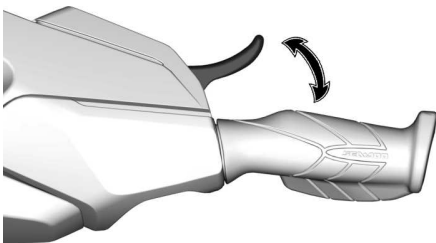

The throttle lever is spring loaded and should return to rest position (idle) when not pressed.

## Right Controller

The right controller is located on the RH side of the handlebar.



TYPICAL

The right controller includes controls to navigate in the multifunction gauge.

- Arrow UP
- Arrow RH
- Arrow Down
- Arrow LH
- OK button.

## BRP Connect Button (if equipped)

The BRP Connect button is located above the right controller.

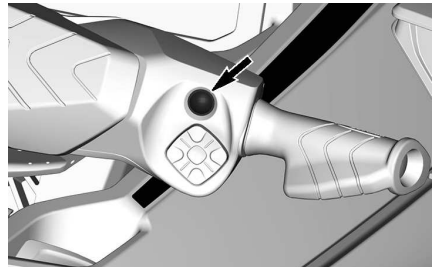

This button allows a quick access to BRP Connect. Each click will swap between apps view and functions view of the multifunction gauge.

## Engine Cut-Off Switch

The engine cut-off switch is located in the middle of the handlebar.

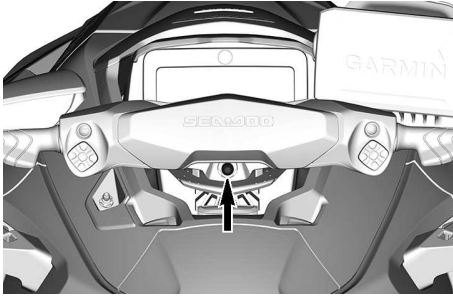

To allow engine starting, the tether cord cap must be securely snapped to the engine cut-off switch.

### ⚠ WARNING

**Always attach the tether cord clip to the operator's personal flotation device (PFD) or wrist (wrist strap required).**



#### TYPICAL

1. Tether cord cap on the engine cut-off switch
2. Tether cord secured to operator's PFD

To stop engine, pull the tether cord cap from the engine cut-off switch.

### ⚠ WARNING

**Should the engine be stopped, the brake function and all watercraft directional control is lost.**

### ⚠ WARNING

**Always disconnect tether cord when watercraft is not in operation in order to prevent accidental engine starting or to avoid unauthorized use by others, children, and to prevent theft.**

### Radio Frequency Digitally Encoded Security System (RF D.E.S.S.)

The tether cord cap contains an electronic circuit (D.E.S.S.™ key) that is programmed to give it a unique electronic serial number. This is the equivalent of a conventional key.

The D.E.S.S. system reads the key installed on the engine cut-off switch and only allows engine starting for keys it recognizes.

The D.E.S.S. system brings great flexibility. You can buy additional tether cords and have the D.E.S.S. keys programmed for your watercraft.

A total of ten D.E.S.S. keys can be programmed.

To have a key programmed to your watercraft, see your authorized BRP Sea-Doo dealer.

### Left Controller

The left controller is located on the LH side of the handlebar.



### Variable Trim System (VTS) Button

The VTS button provides watercraft pitch trim adjustments by adjusting the vertical position of the jet nozzle.

The VTS can be electrically trimmed to desired attitude, or to one of three preset trim positions (full up, middle and full down).

Refer to *Operating Instructions* for details.

#### NOTE:

The VTS button is used for Neutral adjustment. This is to adjust the neutral position of the watercraft. Refer to *Operating Modes* for details

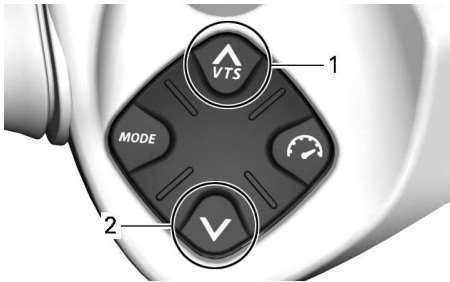

1. Bow up
2. Bow down

### Speed Control Button

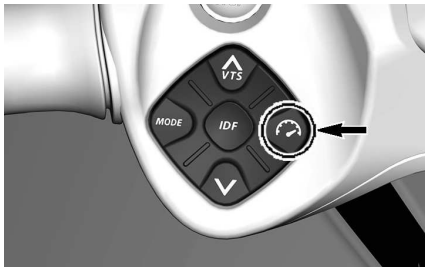

#### TYPICAL

Allow to set and control the speed related functions.

- Speed limiter
- Slow speed mode.

### Mode Button

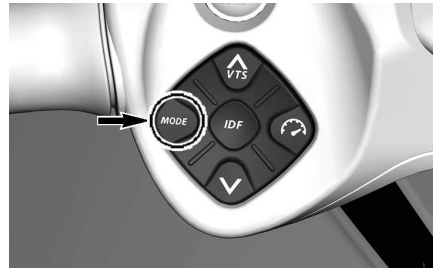

#### TYPICAL

It is used to choose between Normal, Sport or Eco mode.

Refer to *Operating Modes* for details.

### intelligent Debris Free Pump (iDF) Button (if equipped)

Located in the center of the left controller.



It allows to activate the iDF system. Refer to *Activating the intelligent Debris Free Pump System* in *Operating Instructions* section.

### Engine START/STOP Button

The engine START/STOP button is located on the LH handlebar.



**TYPICAL - ENGINE START/STOP BUTTON**

### **Engine Starting and Stopping**

Refer to *Operating Instructions* for complete procedures on how to start and stop the engine.

### **Waking Up the Electrical System**

Ensure the master switch is closed.

Press the START/STOP button once without installing the tether cord on the engine cut-off switch.

This will power up the electrical system; the information center will cycle through a self-test function.

The electrical system will stay powered up for approximately 75 seconds after the START/STOP button was depressed.

When the tether cord is installed on the engine cut-off switch, the system will be powered for 60 minutes.

Every time the START/STOP button is pressed, the countdown restarts. When the battery voltage drops below 12.3V, the LOW BATTERY indicator lamp will light up and the electrical system will shut down after 75 seconds.

### **Post-Drive Battery Management**

This feature keeps the electrical system awake to allow using accessories when the engine is turned off. It also

prevents draining the battery too much when using accessories. When the battery voltage reaches 12.3V or less, the system will automatically shut down to ensure enough power remains to start the engine.

When the electrical system is activated by pressing START/STOP briefly while the engine is shut down the wake-up time will be managed as follows:

- Key off: System will shut down after 75 seconds.
- Key on: System will shut down after 60 minutes or if the voltage threshold is reached.

### **intelligent Brake and Reverse (iBR) Lever**

The iBR lever on the LH handlebar can electronically command:

- Brake
- Reverse
- Neutral.

#### **NOTE:**

A minimum of 25% of iBR lever stroke is required to activate iBR functions.

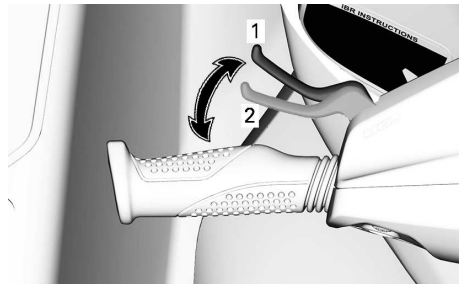

**TYPICAL**

1. Lever rest position
2. 25% stroke required to activate iBR functions

At speeds above 14 km/h (9 MPH), pulling the iBR lever will engage the brake.



**NOTE:**

If the water current is 14 km/h (9 MPH) or above, the reverse can not be engaged as the speed threshold for the reverse is exceeded.

At speeds below 14 km/h (9 MPH), pulling the iBR lever will engage reverse.

When the iBR lever is released after braking or reverse operation, the neutral is engaged.

**⚠ WARNING**

**If the throttle lever is still pulled in when releasing the iBR lever, forward movement will be initiated after a short delay. If forward acceleration is not desired, release the throttle lever.**

**NOTE:**

The neutral position can be fine tuned by trimming the iBR system.

Refer to *Operating Instructions* for detailed instructions.

# EQUIPMENT

Illustrations may not be accurate for every model and are only provided as a visual guide.

Some vehicle safety labels are not shown on illustrations. For information on vehicle safety labels, refer to *Watercraft Safety Labels*.

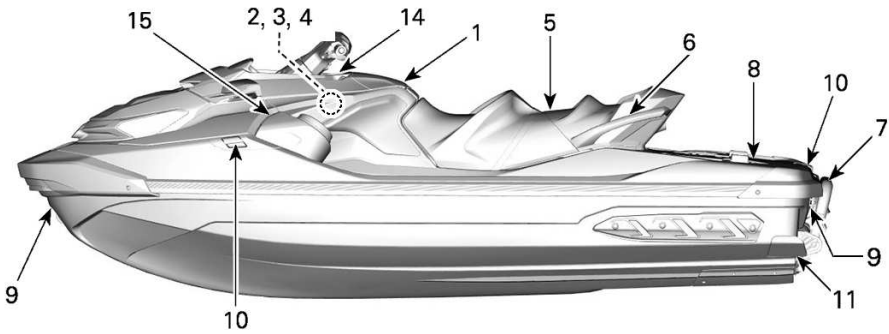

**TYPICAL**

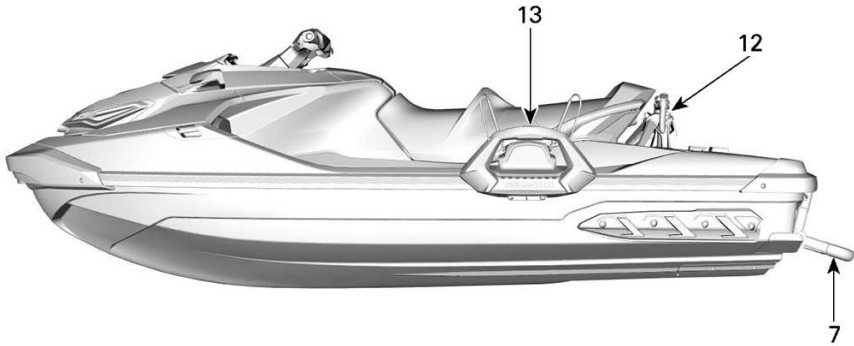

## **WAKE PRO MODELS**

1. Glove Box
2. Front Storage Compartment
3. Fire Extinguisher Holder
4. Safety Kit Holder
5. Seat
6. Passenger Handholds
7. Boarding Ladder (If Equipped)
8. Boarding Platform
9. Front and Rear Eyelets
10. Mooring Cleats
11. Bilge Drain Plugs
12. Retractable Ski Pylon (Wake PRO Model)
13. Wakeboard Rack (Wake PRO Model)
14. Steering Tilt Handle
15. BRP Audio Premium System (If Equipped)

## Front Storage Compartment

The front storage compartment that can be used to carry larger personal articles is located under the front cover.



FRONT STORAGE COMPARTMENT

### Front Storage Compartment Organizer Bag (If Equipped)

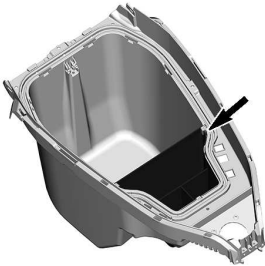

1. Front Storage Compartment Organizer Bag

### Opening the Front Storage Compartment Cover

Stop engine.

#### **⚠ WARNING**

**When the front storage compartment cover is opened, the controls are not accessible to the driver.**

Open the storage bin by pressing on the two release buttons and lifting the handlebar.

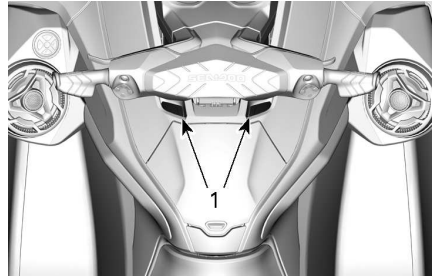

1. Release buttons

#### **NOTICE**

The maximum load allowable for the front storage compartment is 13 kg (30 lb) evenly distributed.

#### **⚠ WARNING**

Never leave any heavy or breakable objects loose in the front storage compartment. Do not overload. Never store or transport fuel or any other flammable products in this storage compartment. Never operate the watercraft with the storage compartment cover open or with improperly secured cargo.

## Fire Extinguisher Holder

### NOTE:

Fire extinguisher is sold separately.

The fire extinguisher support is located under the front storage bin cover.

Use the rubber tie-downs to properly secure the fire extinguisher.

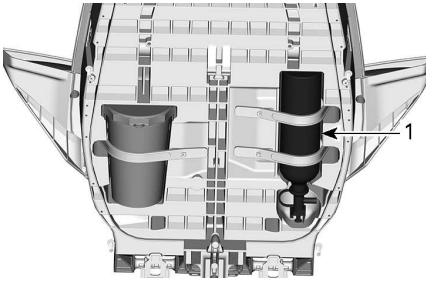

1. Fire extinguisher

## Safety Kit Holder

### NOTE:

Safety kit is sold separately.

The safety kit support is located under the front storage bin cover.

Use the rubber tie-downs to properly secure the safety kit.

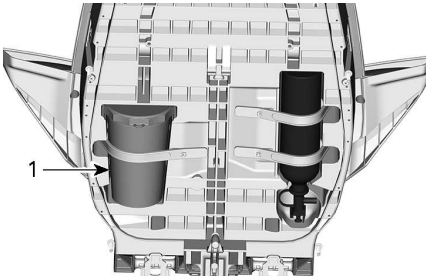

1. Safety Kit

## Steering Tilt Handle

The handlebar position can be adjusted to suit rider preferences.

To perform this adjustment, pull on the release handle at the base of the steering column just ahead of the glove box, and tilt the handlebars to the desired position.

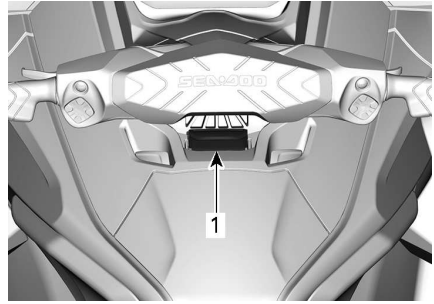

### TYPICAL

1. Release handle

When the handlebars are at the desired position, release the latch handle and ensure the latch pawl properly engages a groove in the steering support. Also ensure the latch handle is in the forward position.

### ⚠ WARNING

To prevent sudden movement of the steering column, always ensure the pawl on the steering column latch is properly engaged in one of the grooves on the steering support.

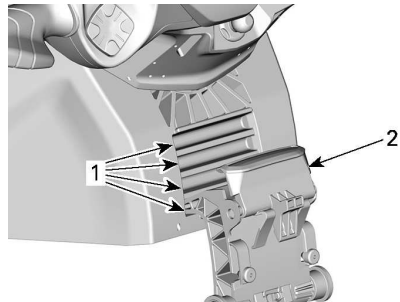

### TYPICAL – STEERING COLUMN ADJUSTMENT LATCH SECURED

1. Steering support grooves
2. Release handle locked

## Glove Box

A small, storage compartment for personal articles.

Push on cover latch to open glove box.

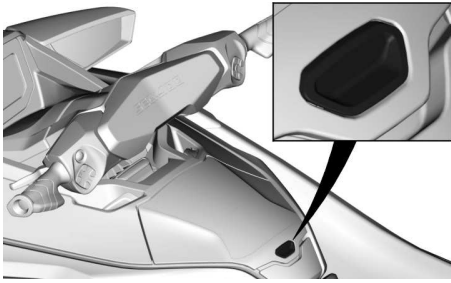

### Watertight Compartment

Inside the glove box is located a small watertight storage compartment for personal articles. Pull backwards on the two latches to open.



#### TYPICAL

There is a protective foam located inside the watertight compartment to protect a phone from damages. Make sure the smartphone is held in place by the foam and not the edges of the receptacle and that you can close the lid. Always make sure the foam is completely dry before using.

Refer to *Maximum Phone Size* chart.

Maximum Phone Size	
Length	160 mm (6.3 in)
Width	85 mm (3.3 in)

#### NOTE:

Due to variation in smartphone sizes and cases styles, ensure there is no pressure on connector and/or phone when closing the lid.

Some models are equipped with a USB port used for charging. When using the USB port to charge a smartphone, always make sure to route the cable such that there is no pressure on either ends of the cable to prevent damage to cable or smartphone connectors.

#### NOTE:

For optimum performance, always use OEM USB cables. Low cost after-market cables may not have data lines and/or higher impedance which may result in poor charging performance or overheating.

Many models of smartphones have a brittle female connector so extra care should be taken when inserting in the watertight compartment. BRP recommends to use a short cable (no more than 25 cm (10 in)) so there is less extra cable length to stow.

The models not equipped with USB charging port are instead equipped with a rubber seal to ensure watertightness. There is a ventilation membrane that balance pressure inside and outside the compartment to ensure it can be opened without suctioning water droplets inside. The membrane itself is watertight. Watertightness of the compartment is finally ensured by pressing the compartment's door on the surrounding seal, using the two latches.

To ensure that articles inside the compartment are protected from the environment, the following recommendations should be followed:

Before and during use:

- Make sure the seal is intact, cleared and properly positioned.

- Make sure the ventilation membrane is intact and properly positioned.
- Make sure the seal around the USB charging port (or rubber seal) is intact and properly positioned.
- Completely dry the compartment and its contents before closing.
- Make sure nothing gets pinched between cover and box when closing compartment.
- Always close the compartment completely using the 2 latches.

After use:

- Remove smartphone from compartment.
- The USB charging port's integrated rubber cap should be installed to cover the connector.
- Always close the compartment completely using the 2 latches.

#### NOTE:

Use of desiccant in the watertight compartment is recommended to eliminate condensation. Replace desiccant frequently.

## BRP Audio Premium System

The BRP Audio Premium sound system is composed of two waterproof speaker enclosures that connect to a smartphone via Bluetooth.

When the START/STOP button is pressed, the system will be powered for 75 seconds. When the tether cord is installed on the engine cut-off switch and the START/STOP switch is depressed, the system will be powered for 60 minutes. This will permit listening to the BRP Audio Premium system for an extended period. When the battery drops below 12.3V, the LOW BATTERY indicator lamp will light up and the electrical system will shut down after 10 seconds to allow enough power in the battery to start the engine.

## Bluetooth Pairing Mode – Except 7.8" Large Panoramic Display

When the unit is powered On, the remote will automatically try to pair with the last connected device or will go in pairing mode if no paired devices are detected. When the system is in pairing mode, the **Play/Pause/Power** (1) light will blink. To manually enter the pairing mode, hold down the **Play/Pause/Power** button for 1 second. The unit will emit 2 small beeps and the Play/Pause/Power button will start blinking to indicate it's in pairing mode. Search for BRP REMOTE from your device's Bluetooth menu.

## Bluetooth Pairing Mode – 7.8" Large Panoramic Display

The pairing is done with the display. Refer to *7.8" Large Panoramic Display*.

#### NOTE:

All previously paired devices nearby must be turned OFF.

When paired, select a playlist or other source of music from your smartphone.

Never pair a smartphone or change the playlist or music source on the device while driving or operating the vehicle.

### **WARNING**

**Using a smartphone or trying to pair a device while driving can distract the driver from operating the watercraft. Always use buttons with caution and always stay alert on the water, keeping eye contact with your environment at all times.**

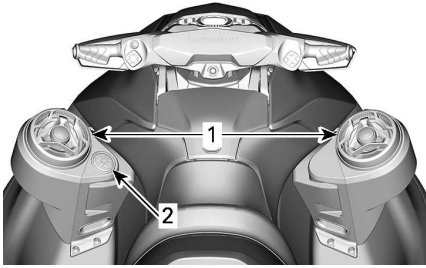
**TYPICAL**

1. Speakers
2. Keypad

The keypad is used to control the sound system.



1. Play/Pause/Power
2. Volume UP
3. Volume DOWN
4. Previous track
5. Next track

**Play/Pause/Power** - This button gives you the ability to play or to pause the current track with a single press. Pressing the button will turn the unit On if currently Off or holding the button for 3 seconds will turn the unit Off if currently On. The unit will emit 4 small beeps to indicate when power is turned Off. Note that all the buttons will illuminate when the unit is powered On.

**Volume Up and Volume Down** - These buttons will turn up or turn

down the output of the volume. When the unit has reached the minimum or maximum output level, the unit will beep to indicate that no further adjustment is possible.

On all vehicles except the ones equipped with the *Large Panoramic 7.8" Wide LCD Display*, the USB port located inside the glove box watertight compartment is only used to charge the smartphone, not to transfer the music.

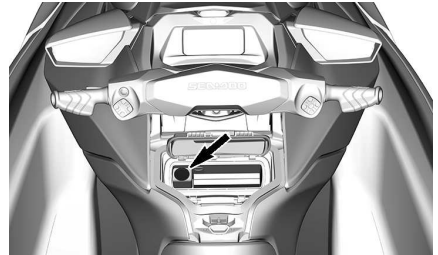
**TYPICAL**

⚠	<b>CAUTION</b>
<p><b>Prolonged exposition to loud music can damage your hearing. Therefore, we suggest a 10 minutes break time every 45 minutes of listening.</b></p>	

## Seat

This model comes equipped with an ergonomic seat narrowing towards the front with knee grab design allowing you to position your legs towards the inside of the footwells, minimizing upper body fatigue and granting you more control when cornering.

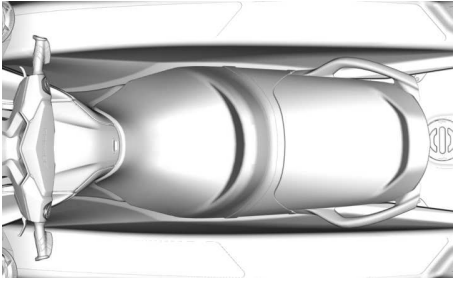

**ERGONOMIC SEAT**

**Removing the Seat**

1. Push on the two release buttons and lift the back end of the rear seat.

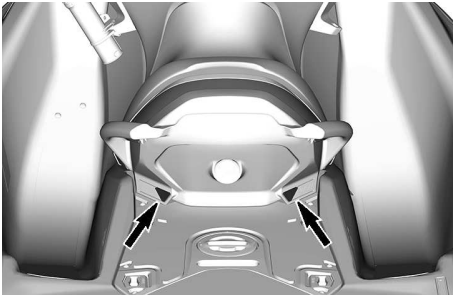

2. Then pull the latch handle up and remove the front seat from the watercraft.

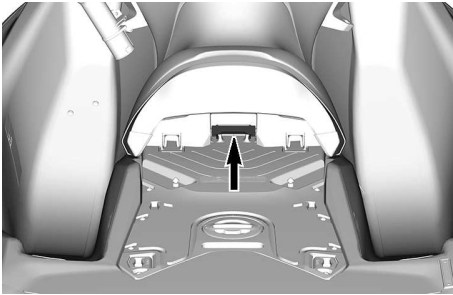

**Installing the Seat**

1. To install the seat, insert the forward end of the front seat in its retainer.

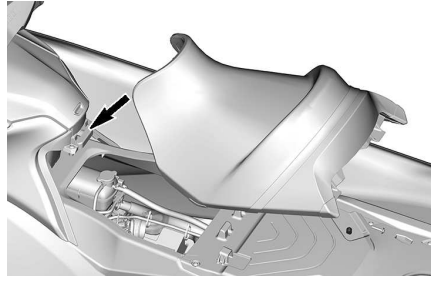

**SEAT RETAINER**

2. Push the rear end of the front seat down to lock it.
3. Pull upwards on the front seat to make sure it is locked in place.
4. Insert the forward part of the rear seat into the retainers.

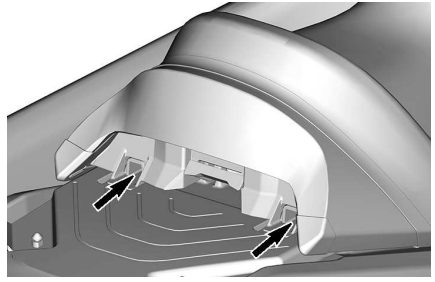

**SEAT RETAINERS**

5. Align the seat latches with the latch pins and firmly press down on the rear portion of the seat to lock it in place.

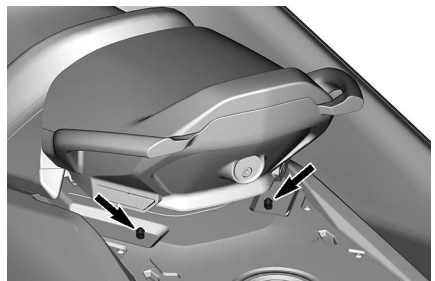

**LATCH PINS**

6. Pull up on the rear portion of the seat to ensure it is properly latched.



**⚠ CAUTION**

Ensure the latch is properly locked onto the pin.

**Passenger Handholds**

The seat strap provides a handhold for a passenger to hold on to when riding.

The sides of the molded grab handle at the rear of the seat also provide a handhold for a passenger. The rear portion of the molded grab handle provides a handhold for the skier/wakeboarder (if applicable) spotter or boarding the watercraft from the water.

**NOTICE**

Never use the molded grab handle to tow anything or to lift the watercraft.

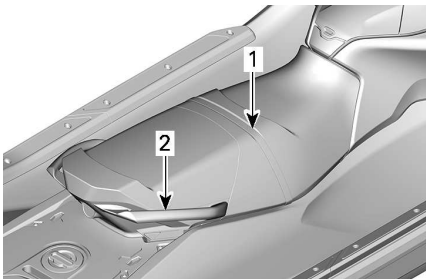

TYPICAL

1. Seat strap
2. Molded grab handle

**Boarding Platform**

A boarding platform covers the rear deck area.

**⚠ CAUTION**

The two LinQ attachment points are used to carry accessories and should always be retracted when not in use.

Two indentations in the platform are used as foot rests for the rear facing spotter when towing a skier, wakeboarder or tuber.

A ski pylon can be installed by removing the ski pylon hole cover in the middle of the platform. The ski pylon hole cover is **not** the fuel cap.

**⚠ CAUTION**

Always install ski pylon hole cover when ski pylon is not installed.

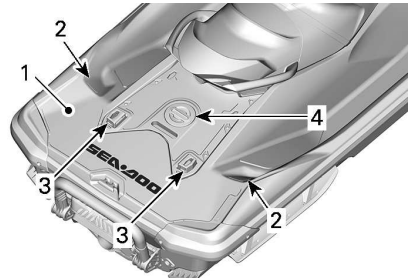

1. Boarding platform
2. Spotter foot rests
3. LinQ attachments
4. Ski pylon hole cover

**Wakeboard Rack (Wake Models)**

A convenient removable rack to carry a wakeboard on the watercraft when on the water.

**NOTE:**

The wakeboard rack can be installed on the LH side of the watercraft.

To install:

1. Insert the hooks on the lower portion of the rack into the lower retaining bracket located on the hull under the LH side bumper.

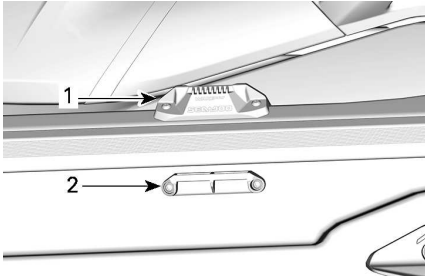

### RETAINING BRACKETS FOR WAKEBOARD RACK

1. Upper retaining bracket
2. Lower retaining bracket

2. Rotate the rack upwards and push the top of the rack inboard until the handle locks into the top retaining bracket.

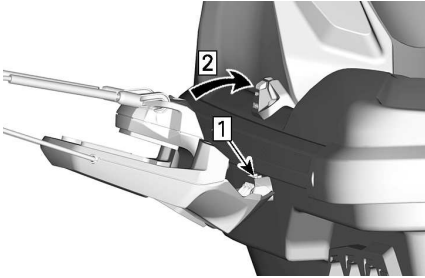

1. Insert
2. Rotate

### **⚠ WARNING**

If rack is not properly secured on the watercraft, it could become loose and detach unexpectedly, creating a risk of injury to people nearby. Periodically ensure the rack is properly locked on its support.

1. Insert the hooks of the lower portion of the rack into the lower retaining bracket
2. Rotate the rack upwards and push the top of the rack inboard.

3. When installing a wakeboard on the rack, position wakeboard fin(s) outward with the heel of the boots facing down near freeboard of the PWC.
4. Secure wakeboard using bungee cords.

### **⚠ WARNING**

To avoid possible injuries and cuts from the wakeboards fin(s), always place FIN(S) OUTWARDS.



### WAKEBOARD INSTALLED WITH FINS OUTWARD

5. After installation, pull and push wakeboard to ensure it is tightly secured to rack.

### **⚠ WARNING**

If the wakeboard is not properly secured on the rack, it could become loose and detach unexpectedly, creating a risk of injury to people nearby. To avoid:

- Inspect bungee cords condition and replace if damaged.
- Secure wakeboard properly on rack.
- Periodically ensure the board is properly attached.

**NOTE:**

When the wakeboard is removed from its rack, secure the bungee cords so that they will not move freely when riding watercraft.

**NOTICE**

The rack is designed to hold one wakeboard. Do not use to hold more than one wakeboard or to transport skis or any other object. Do not use rack(s) as mooring points or to reboard.

**⚠ WARNING**

With wakeboard and/or rack installed, operate with extra caution:

- NEVER perform aggressive maneuvers including a spin-out.
- NEVER jump waves.
- Use common sense and limit speed.

Otherwise, the wakeboard could detach or occupants could fall off and injure themselves against the wakeboard or rack.

**⚠ WARNING**

When trailering the watercraft, NEVER leave a wakeboard installed on the rack. Otherwise, wakeboard fin(s) could cause injury to bystanders or wakeboard could fly off on the road. The bungee cords are under tension and could spring back and whip someone when released. Use caution.

6. To remove the wakeboard rack, press the lever at the top of the rack and remove it from its retaining brackets.

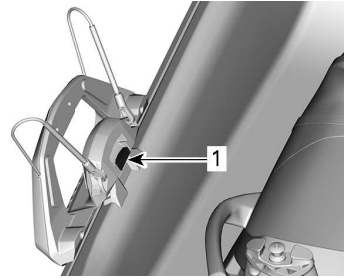
**WAKEBOARD RACK REMOVAL**

1. Press this handle to release wakeboard rack

**Retractable Ski Pylon (WAKE Models)**

Pull up on the knob to extend the pylon. Ensure both sections of pylon are fully extended and properly locked before attaching ski or wakeboard rope.

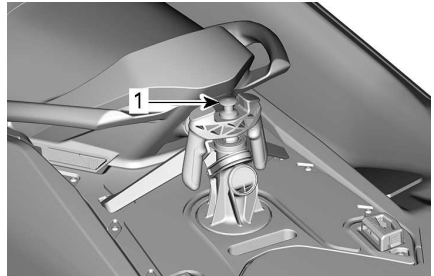
**SKI PYLON RETRACTED**

1. Pull on this knob to extend

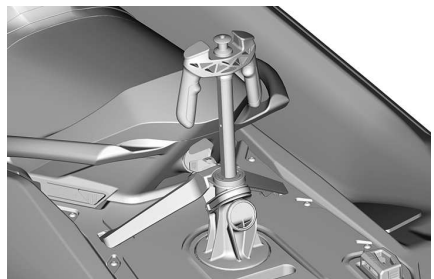
**SKI PYLON EXTENDED**

To retract the pylon, push straight down on the top.

If the pylon becomes difficult to extend or retract, simultaneously push in on

both sides of the locking clip toward front of watercraft.

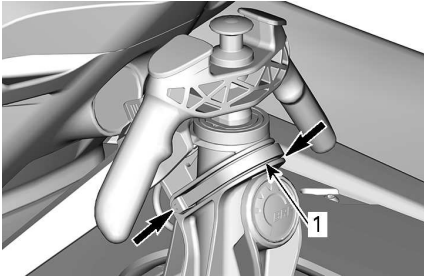

**TYPICAL - PUSH TOWARD FRONT TO UNLOCK AND REMOVE PYLON**

1. Locking clip

### **⚠ WARNING**

Make sure ski pylon is fully extended and locked before use. Completely retract and lock when not used. Use caution with skier/wakeboarder in tow as tow rope may backlash to watercraft when released. Never perform a sharp turn when towing a skier or wakeboarder. Always store tow rope when not in use.

### **⚠ WARNING**

When using the ski pylon, never carry cargo or accessories on the boarding platform.

### **⚠ WARNING**

Always install the passenger seat when the ski pylon is installed.

### **NOTICE**

The ski pylon is designed for towing a skier or wakeboarder with a maximum weight of 114 kg (250 lb).

Always have one person other than the operator as an observer.

### **NOTE:**

The handles on the ski pylon are provided as a handhold for the observer.

### **NOTICE**

Never use the ski pylon to tow other watercrafts. Respect the maximum load limit rating of the ski pylon. Overloading can affect maneuverability, stability and performance. In case of emergency, use rear mooring cleat to tow other watercraft.

### **Removing/Installing the Ski Pylon**

Remove the rear seat.

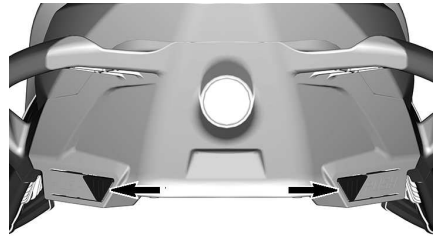

### **RELEASE BUTTONS**

Unlock the LinQ attachment.

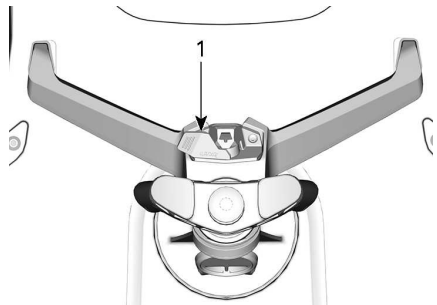

1. LinQ lever

Tilt the support toward the front and lift.

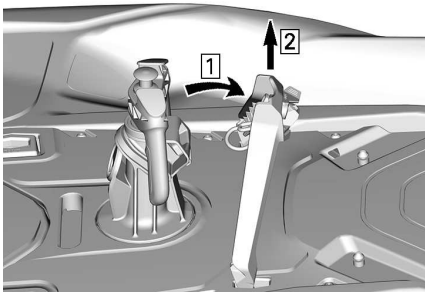

1. Tilt support
2. Lift support

Unscrew the pylon by turning it one quarter of a turn and lifting it.

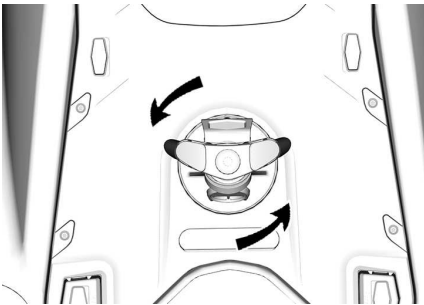

### NOTICE

It is very important to install the ski pylon hole cover to prevent water infiltration into the hull.

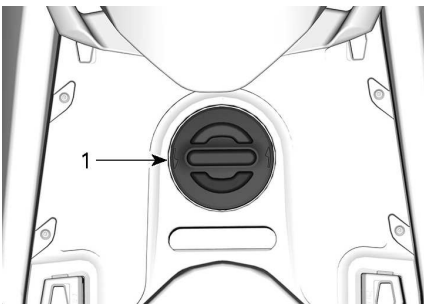

1. Ski pylon cover

When not in use, safely store the pylon and support in an appropriate location.

Never ride without the rear seat installed.

The installation is the reverse of the removal procedure.

## Mooring Cleats

These cleats can be used for docking. The rear cleat can be used to tow an inflatable tube.

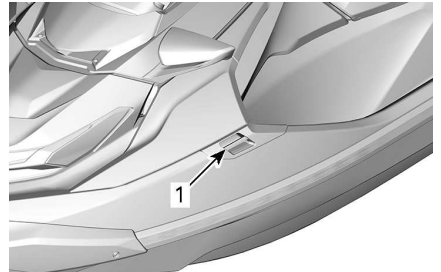

TYPICAL

1. Mooring cleats

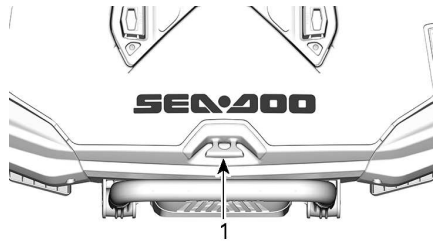

1. Mooring cleat

### ⚠ WARNING

Never use mooring cleats to pull or lift the watercraft.

## Boarding Ladder (If Equipped)

A convenient ladder used for boarding the watercraft from the water.

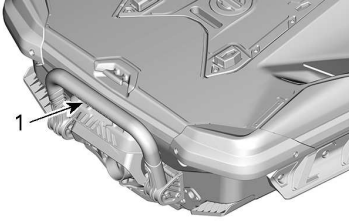
**TYPICAL**

1. Boarding ladder

**⚠ WARNING**

Do not apply throttle when anyone is boarding or at rear of watercraft. Shut down the engine

Pull down the ladder with your hand and hold until a foot or a knee is put on the ladder.

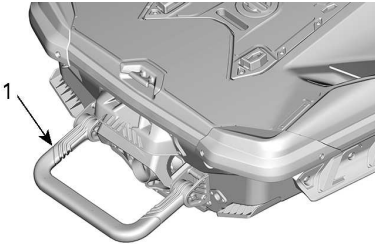
**TYPICAL**

1. Boarding ladder in lowered position

**NOTICE**

- Never use the ladder for boarding a watercraft that is out of water.
- Never use the ladder for pulling, towing, diving or jumping, or any other purpose other than as a boarding ladder.
- Stay on center of the ladder.
- Only one person at a time on the ladder.

**⚠ WARNING**

Be aware of the iBR gate movement when starting the engine, shutting down the engine or using the iBR lever. Automatic movement of the gate may squeeze fingers or toes of people taking a hold on the back or your watercraft. Never use iBR gate as a supporting point to board the watercraft.

**Front and Rear Eyelets**

Eyelets can be used for mooring, towing and as tie-down points when trailering your watercraft.

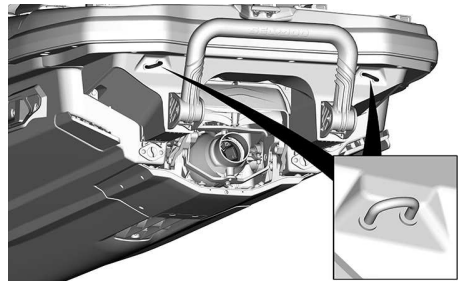
**TYPICAL – FRONT EYELET****REAR EYELETS****⚠ WARNING**

Do not use these eyelets to lift the watercraft.

**NOTE:**

- **Responsibility:** It is the owner's/ operator's responsibility to ensure that mooring lines, towing lines, anchor chain(s), anchor lines and anchor(s) are adequate for the vessel's intended use, i.e. the lines or chains do not exceed 80 % of the breaking strength of the respective strong point. Owners should also consider what action will be necessary when securing a tow line on board.
- **Non-metallic strong points:** Where non-metallic strong points are installed, their limited life time shall be taken into consideration. They shall be replaced once they show any signs of deterioration, visible surface cracks or permanent deformation.

**Bilge Drain Plugs**

Unscrew drain plugs whenever watercraft is on the trailer. This will allow water accumulated in the bilge to be evacuated and helps to reduce condensation.

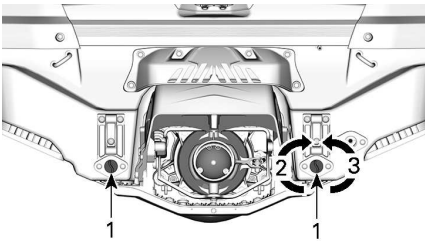
**TYPICAL**

1. Drain plugs
2. Tighten
3. Loosen

**NOTICE**

Ensure drain plugs are properly secured prior to launching the watercraft in water.

# 7.6" DIGITAL DISPLAY

## Basic Functions

### Multifunction Display



### Left Lateral Display

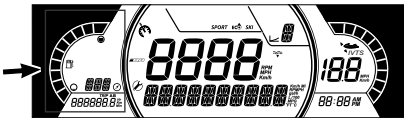

The left lateral display includes:

- Fuel level indicator
- Compass
- Distance to empty
- Time to empty
- Tripmeter

User can decide to display one the following on the tripmeter, located on the lower left display:

- Vehicle hours : Displays the total vehicle hours
- Trip KM : Displays the distance since the last reset.
- Trip HR : Displays the time since the last reset.

### NOTE:

The compass will be visible only when the PWC is moving and if the GPS receives a signal.

### **⚠ WARNING**

**Use the compass as a guide only.  
Not to be used for precision navigation purposes.**

### Central Display

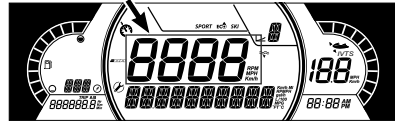

The central display shows the Vehicle speed.

### Right Lateral Display

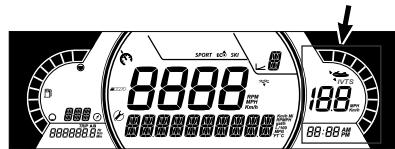

The right lateral display include:

- VTS position
- Target Speed indicator
- Time

The speed indicator in this display is only activated when a target speed is set.

### NOTE:

Clock is shown only if the integrated GPS receives a signal from the satellites. This may take several seconds after waking up the system.

### Lower Display

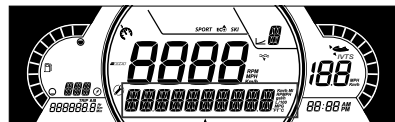

User can decide to display one the following:

- RPM : Displays the RPM of the engine
- Water temp (if equipped) : Displays the temperature of the water
- Depth (if equipped) : Displays the depth of the water



- Settings
- Messages
- Speed Stat (if equipped) : Displays the average and maximum speeds reached in the current riding cycle

### iBR Position Display

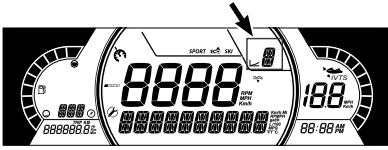

This display shows gears position of the iBR:

- N (neutral)
- F (forward)
- R (reverse)

It can also display the selected speed level (1 to 9) when the slow speed mode is selected.

### MODE Display

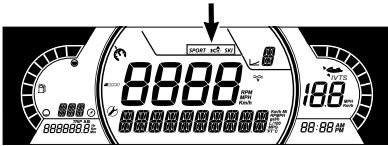

The MODE display indicate the selected alternative mode of operation:

- SPORT
- ECO
- SKI (if equipped)



To cycle through the MODES;



- Press MODE button,
- Acknowledge the safety message by pressing and holding MODE button will get the SPORT mode,
- Pressing MODE button again will activate the SKI mode (if equipped),
- Pressing MODE button again will activate the ECO mode.

## Indicator Lamps



### Warning and Telltale Lights









Lights	Description
!	ORANGE - Vehicle malfunction
	RED - The engine temperature is too high.
N	GREEN - The neutral gear is selected
	RED - If illuminate while driving, it indicates a malfunction. Turn off all unnecessary electrical equipment and have the electrical and charging systems checked.
	RED - If illuminate while the engine running or while driving, this indicates a malfunction. Stop the vehicle as soon as it is safe to do so and turn the engine off. Check the engine oil level. Have the lubrication system checked as soon as possible, even if the level being correct.

Lights	Description
	ORANGE - Illuminate when the fuel level is low or when the fuel tank is near empty. Refuel as soon as possible.
	ORANGE <b>Turned on:</b> Malfunction of the vehicle emissions control system <b>Blink:</b> Engine limitation, the limp home mode is activated. Have the vehicle serviced immediately.

### Icons and Indicators

Icons	Description
<i>SPORT</i>	Denote SPORT mode is selected.
	Denote ECO mode is selected.
<i>SKI</i>	Denote SKI mode is selected (If equipped)
	Indicate the direction of the vehicle. <b>Not to be used for precision navigation purposes.</b>
	Flashing: indicate that the Launch Control is ready.
	Steady ON: indicate that the VTS is activated. (if equipped)

Icons	Description
	When lit, indicates that a maintenance is required. See your authorized Sea-Doo dealer or person of your own choosing for the maintenance
	Denote Speed Limiter, Slow Speed or Ski mode is selected. (If equipped)
	When lit, indicates a failure of the iBR system. See your authorized Sea-Doo dealer or person of your own choosing for repairing.
	Fuel indicator
	Temperature indicator
	Speakers audio output (if equipped)

### Settings

To...	Action
Navigate in the menu	Single press on INFO
Enter menu	Long press INFO
Edit value	Single press on INFO
Change information display	Press TRIP

To...	Action
Reset Trip (when displayed)	Long press TRIP
Fault codes/ Maintenance	Long press INFO

Use the RIGHT arrow button or LEFT arrow button to navigate through setting menus. Use OK button to enter setting menu, to confirm selection or reset some values. Use UP arrow or DOWN arrow to change selected value.

### Settings Menu

Using the RIGHT or LEFT arrow button, select **SETTINGS** and press OK button to enter setting menus.

### Maintenance Reset

Select **RES MAINT** and hold OK button to reset maintenance.

#### NOTE:

The maintenance reset can only be done within the first 15 seconds of ECM wake-up when a maintenance is required.

### Display Codes

Refer to *Displaying Fault Codes*.

### Setting Tripmeter

Select **TRIP** and press UP or DOWN arrow button to cycle through **Vehicle Hours**, **Trip KM** and **Trip HR**.

Press and hold OK button to reset selected trip info.

### Setting Learning Key (if equipped)

Connect a normal key to the vehicle. Select **L-KEY #** and press UP or DOWN arrow button to set the desired learning key level between 1 and 5.

Press and hold OK button to confirm.

#### NOTE:

The default learning key level is 1 (lowest performance).

### Unit Selection

Select **UNITS** and press UP or DOWN arrow button to change units.

#### NOTE:

Changing units will apply to all the displayed units.

### Setting Brightness

Select **BRIGHTNESS** and press UP or DOWN arrow button to adjust brightness level (from -4 to 4).

### Setting Clock

Select **CLOCK**.

1. Press OK button to select clock display.
2. Press UP or DOWN arrow button to select 12:00 AM PM or 24:00 time base.
3. Press OK button to confirm.
4. Press UP or DOWN arrow button to change hours.
5. Press OK button to confirm.

#### NOTE:

Menu available only if GPS is synchronized.

To exit **SETTINGS**, select **EXIT** and press OK button.

### Resetting Speed Statistics (If Equipped)

Select **SPEED STAT** and press and hold OK button to reset the speed statistics.

#### NOTE:

The speed statistics are automatically reset after the gauge shut down.









## Setting Language

The language of the display is factory setup by default in English. Refer to

an authorized Sea-Doo dealer for language availability and to setup the gauge to your preference.

## Messages in Multifunction Gauge

Important information about vehicle condition is displayed on the multifunction gauge. When starting the engine, always look at the gauge for any indicator lamps or special messages.

Indicator Lamps (Malfunctions)			
Indicator Lamp	Message / Warning	Cause	What to Do
No indicator lamp	 BAD KEY	Defective key	Contact an authorized Sea-Doo dealer.
	 WRONG KEY	Wrong key	Use the right key for the vehicle or contact an authorized Sea-Doo dealer.
	 HIGH ENGINE TEMPERATURE	Engine is overheating	<ul style="list-style-type: none"> <li>– Stop and wait for engine to cool off.</li> <li>– Check for leaks.</li> <li>– Check coolant level and adjust (see <i>Maintenance Procedures</i>).</li> </ul>
	 LIMP HOME MODE	Important engine management component	Have the vehicle transported to the nearest authorized Sea-Doo dealer. If you operate the vehicle in LIMP HOME, avoid abrupt maneuvers. In LIMP HOME, the engine RPM is limited and therefore the vehicle speed.
	 LOW OIL - STOP ENGINE	Low oil pressure	<ul style="list-style-type: none"> <li>– Check for oil leaks.</li> <li>– Check oil level and adjust (see <i>Maintenance Procedures</i>).</li> </ul>

Important information messages can also be displayed temporarily to assist indicator lamps.

A combination of two different warnings can occur.

When a digital warning appears, it will show the warning for 6 seconds and then the warning will disappear for 60 seconds. During the 60 seconds, the small digital indicator will flash. This sequence will be repeated three times and then will stop for 15 minutes. During the 15 minutes only the indicator lamps will be activated.

# LARGE PANORAMIC 7.8" WIDE LCD DISPLAY

## Basic Functions

### LCD Display

#### Default Display



#### Multifunction Display



#### Left Lateral Display

The left lateral display includes:

- Fuel level indicator
- Speedometer
- Tripmeter
- Speed limiter
- Clock
- Driving modes
- Warning pop-up
- Distance or time to empty
- Water temperature
- Compass
- VTS position

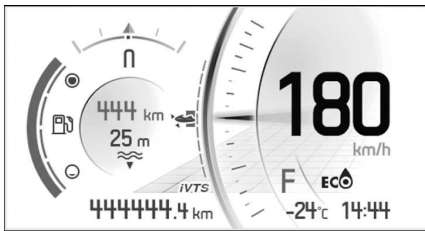

To select the value to be displayed in the tripmeter;

1. Access the Stats/Trip screen
2. Select the desired set of statistic to be shown (Total, A or B)

To adjust the VTS, press the VTS UP or VTS DOWN button.

#### Right Lateral Display

The right lateral display includes:

- Tachometer
- Audio volume
- Menu
  - Phone
  - Statistics
  - Audio
  - Settings

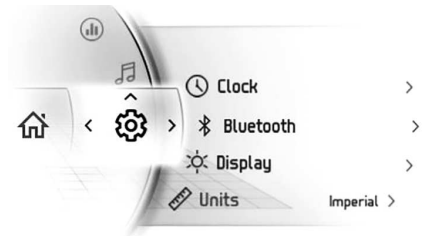

#### Navigating in the Digital Display

The multifunction gauge includes analog gauges (speedometer and tachometer), indicator lamps and an infotainment center with a digital screen.

We recommend you practice selecting some functions on the infotainment center before leaving the dock. You will get used to them and they will be easier to use once you leave the dock.

Pressing the OK button will get the Menu selection in the right screen, in this order:

- Phone
- Statistics
- Audio
- Settings

When an icon is selected, its related screen will appear.

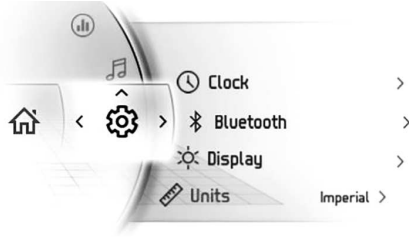

When an item is selected, this sets the item to the current value.

**Indicator Lamps**

**Warning and Telltale Lights**













Lights	Description
	ORANGE - Vehicle malfunction
	RED - The engine temperature is too high.
	GREEN - The neutral gear is selected
	RED - If illuminate while driving, it indicates a malfunction. Turn off all unnecessary electrical equipment and have the electrical and charging systems checked.

Lights	Description
	RED - If illuminate while the engine running or while driving, this indicates a malfunction. Stop the vehicle as soon as it is safe to do so and turn the engine off. Check the engine oil level. Have the lubrication system checked as soon as possible, even if the level being correct.
	ORANGE - Illuminate when the fuel level is low or when the fuel tank is near empty. Refuel as soon as possible.
	ORANGE <b>Turned on:</b> Malfunction of the vehicle emissions control system <b>Blink:</b> Engine limitation, the limp home mode is activated. Have the vehicle serviced immediately.

**Icons and Indicators**

Icons	Description
	Denote SPORT mode is selected.
	Denote ECO mode is selected.
	Denote SKI mode is selected (If equipped)
	Indicate the direction of the vehicle. <b>Not to be used for precision navigation purposes.</b>

Icons	Description
	Flashing: indicate that the Launch Control is ready.
	Steady ON: indicate that the VTS is activated.
	When lit, indicates that a maintenance is required. See your authorized Sea-Doo dealer or person of your own choosing for the maintenance
	Denote Speed Limiter, Slow Speed or Ski mode is selected. (If equipped)
	When lit, indicates a failure of the iBR system. See your authorized Sea-Doo dealer or person of your own choosing for repairing.
	Denote WATER DEPTH mode is selected (If equipped)
	Smartphone Network connection
	Bluetooth device
	Smartphone battery level indicator
	Fuel indicator

Icons	Description
	Temperature indicator
	Speakers audio output

## Settings

### Menu Switches

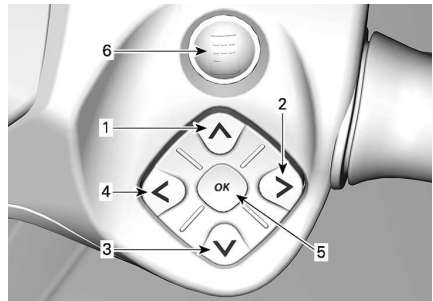

**RIGHT SIDE OF HANDLEBAR**

1. UP button
2. RIGHT button
3. DOWN button
4. LEFT button
5. OK button
6. BRP CONNECT button

Use the directional buttons to control numerous functions of the multifunction gauge.

Use the BRP Connect button for quick access to BRP connect. Each click will swap between apps view and functions view of the multifunction gauge.



## Menu

### BRP Connect



Before using BRP Connect, the app must be downloaded to the phone. The app can be downloaded from the Apple App Store or Google Play Store via a simple search. Not all phones are compatible.

Visit our website for more details:

[www.brpconnecttutorial.com](http://www.brpconnecttutorial.com)

#### NOTE:

The smartphone must be connected via Bluetooth **and** with a USB cable to the USB port located in the glove box.

User's personal data will be deleted from the cluster when phone pairing is deleted.

User agree that personal data (contact list and call history) be transferred to the cluster when smartphone is connected.

Contact list and call history are stored in cluster permanently. To delete these information you must un-pair your smartphone or overwrite using another smartphone.

## Statistics



The Statistics menu is used to get :

- Trip distance information
- Trip elapsed time information
- Instant fuel consumption
- Average fuel consumption
- Maximum speed
- Average speed

3 sets of statistics are kept in memory. Each set of statistics can be reset independently.

The LEFT button and RIGHT button will navigate between the 3 sets of statistics.

Holding the DOWN button when showing a stored value will reset it.

## Audio

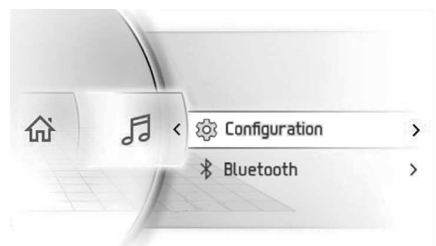

The phone Audio menu is to:

- Adjust the configuration of:
  - Auto volume control
  - Equalizer
  - Fade/Balance
- Access Bluetooth Audio Player

## Audio Control

### NOTE:

The directional buttons controls the audio commands when in the Home screen.

Use the directional buttons to control the audio volume. UP buttons for louder.

To mute the audio, push the DOWN button and hold it for more than one second. From the Mute setting, pushing UP button will reset the audio volume to its previous level.

A separate volume level is used for announcement (i. e.: Voice command from the BRP Connect Navigation App). During an announcement, the volume bar will display the announcement volume level. The volume bar will be yellow and the audio source will show **ANNOUNCEMENT**. It is possible to adjust the announcement volume level during the announcement.

When Bluetooth audio source is selected, the left and right functions will be as follows:

- Left: Previous song
- Right: Next song

## Audio Configuration

The Audio Configuration menu is as follows:

- Automatic volume control
- Equalizer
- Fade / Balance

## Settings

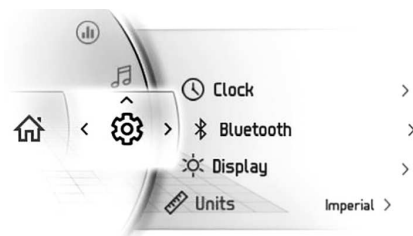

The Settings menu is to:

- Adjust clock
- Pair Bluetooth devices
- Adjust the display brightness
- Adjust the units (Imperial/Metric)
- Personalization distance or time to empty
- Set the language
- Get the version
- Show vehicle fault codes

## Programming the Ski Mode

1. Using the MODE button, select SKI.

The right display will change to show the Ski mode settings.

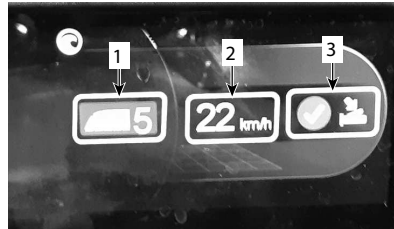

1. *Power ramp*
  2. *Desired speed*
  3. *Confirmation*
2. Adjust the appropriate power ramp (1 to 5).
    - 1 = low power and slow start.
    - 5 = Full power and fast start.
- The selection must be done accordingly to experience of the towed person, his weight and the water skiing equipment used (ski or board).
3. Select the desired speed by the towed person.
  4. Confirm your selection.

## Pairing Your Smartphone Via Bluetooth

1. On the vehicle

Bluetooth is now visible.

1. Short press the directional buttons to access menu.
  2. Go down and select "Settings" and press **RIGHT**.
  3. Select "Bluetooth" and press **RIGHT**.
  4. Select "Phone" and press **RIGHT**.
  5. Select "Add Phone" and press **RIGHT**.
2. On the phone
1. Activate your phone's Bluetooth function.

**NOTE:**

Refer to your manufacturer's user guide for detailed procedure.

2. Choose "BRP Connect".
3. A confirmation number will appear on your phone screen and the vehicle gauge screen. Make sure these numbers match.
4. Press "Pair" on your phone and select the green check mark on the vehicle gauge.
5. Allow Contacts and Favorite Sync on your phone.

**BRP GO! App**

Follow these steps to setup your smartphone with BRP Connect.

**Download the BRP GO! Smartphone App**

Download the BRP GO! app via the App Store for Apple™ or the Google™ Play Store for Android.

**Download Apps Compatible With BRP Connect**

Visit our website to know more about the compatible apps:

These apps will improve your riding experience. Some apps may require additional purchase to be compatible with the system or may require additional devices to be used.

[www.brpconnecttutorial.com](http://www.brpconnecttutorial.com)

**Connect Your Smartphone Using Your Charging / Data Transfer Cable**

It is recommended to use an original charging cable from the smartphone OEM to optimize transfer between the phone and the vehicle. Use the front USB port.

1. Unlock your phone screen
2. Connect your phone charging cable
3. A checkmark will appear on your phone screen once the connection is done.

**Access Your Apps**

Quick press the OK button to access Menu.

Push **UP** to select "Launch BRP Connect" and push **RIGHT**.

Select the app you would like to use and press OK.

- To leave the app, long press OK.
- To return to the Main Menu, press the BRP Connect Button.

## Quick Tour of the BRP GO! App

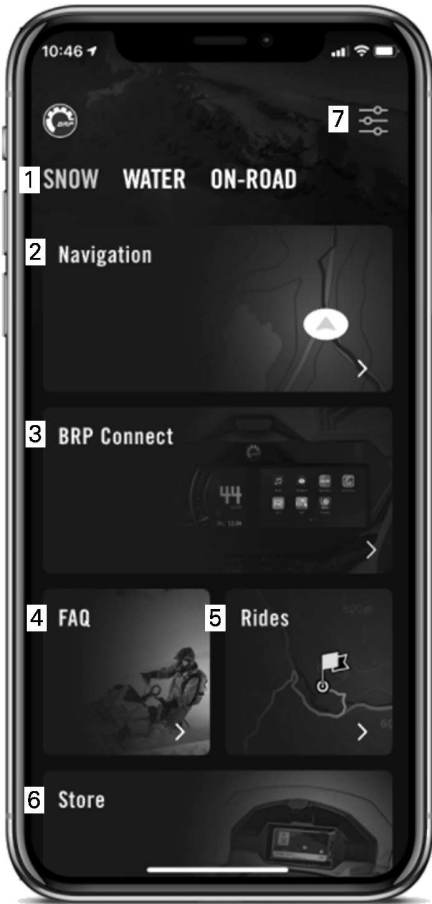









1. **Playground:** Select your playground to see content related to your vehicle. For Ski-Doo snowmobiles, select the Snow playground.
2. **Navigation:** Access all the navigation features of the app such as route planning, turn-by-turn navigation, friends location, offline navigation, and more. You can access thousands of snowmobile trails across North America and Europe on the map.

3. **BRP Connect:** See the list of compatible apps that can be used on the vehicle's display. You can also access from there the Vehicle Connection Guide to help you connect your phone to your vehicle's display.
4. **FAQ:** This link takes you to answers of common questions asked by riders like you. An internet connection is required.
5. **Rides:** Easily access your planned and completed rides made with the Navigation features of the BRP GO! app.
6. **Store:** This link takes you to the online store of your vehicle. An internet connection is required.
7. **Settings:** Manage your profile and your account settings.

## Messages in Multifunction Gauge

Important information about vehicle condition is displayed on the multifunction gauge. When starting the engine, always look at the gauge for any indicator lamps or special messages.

Indicator Lamps (Malfunctions)			
Indicator Lamp	Message / Warning	Cause	What to Do
No indicator lamp	 BAD KEY	Defective key	Contact an authorized Sea-Doo dealer.
	 WRONG KEY	Wrong key	Use the right key for the vehicle or contact an authorized Sea-Doo dealer.
	 HIGH ENGINE TEMPERATURE	Engine is overheating	<ul style="list-style-type: none"> <li>– Stop and wait for engine to cool off.</li> <li>– Check for leaks.</li> <li>– Check coolant level and adjust (see <i>Maintenance Procedures</i>).</li> </ul>
	 LIMP HOME MODE	Important engine management component	<p>Have the vehicle transported to the nearest authorized Sea-Doo dealer.</p> <p>If you operate the vehicle in LIMP HOME, avoid abrupt maneuvers.</p> <p>In LIMP HOME, the engine RPM is limited and therefore the vehicle speed.</p>
	 LOW OIL - STOP ENGINE	Low oil pressure	<ul style="list-style-type: none"> <li>– Check for oil leaks.</li> <li>– Check oil level and adjust (see <i>Maintenance Procedures</i>).</li> </ul>

Important information messages can also be displayed temporarily to assist indicator lamps.

A combination of two different warnings can occur.

When a digital warning appears, it will show the warning for 6 seconds and then the warning will disappear for 60 seconds. During the 60 seconds, the small digital indicator will flash. This sequence will be repeated three times and then will stop for 15 minutes. During the 15 minutes only the indicator lamps will be activated.

---

# BREAK-IN PERIOD

## Operation During Break-In Period

A break-in period of 5 operating hours is recommended before running the watercraft at sustained full throttle.

During this period, maximum throttle should not exceed 1/2 to 3/4 opening. However, brief full acceleration and speed variations contribute to a good break-in.

<i><b>NOTICE</b></i>
<b>Continued wide open throttle accelerations or operation, prolonged cruising speeds are detrimental during the break-in period.</b>

### NOTE:

During the first 3 hours of operation, the engine management limits the engine maximum speed for engine protection. The engine performance will progressively increase during this period.

# OPERATING INSTRUCTIONS

## **⚠ WARNING**

Always perform the *Pre-Ride Inspection* before operating this watercraft. Be sure to read the *Safety Information* and the *Watercraft Information* sections and be thoroughly familiar with the iControl technology.

Should any control or instruction not be fully understood, refer to an authorized Sea-Doo dealer.

## **Boarding the Watercraft**

As with any watercraft, boarding should be done carefully.

Make sure to practice each boarding method until fully able to safely board in any potential condition.

## **⚠ WARNING**

Do not apply throttle when anyone is boarding or at rear of watercraft. Shut down the engine

## **Watercraft with iBR system**

## **⚠ WARNING**

Be aware of the iBR gate movement when starting the engine, shutting down the engine or using the iBR lever. Automatic movement of the gate may squeeze fingers or toes of people taking a hold on the back or your watercraft. Never use iBR gate as a supporting point to board the watercraft.

## **Boarding from a Dock**

1. Slowly place one foot on the watercraft footboard nearest the dock while holding the handlebar, and at the same time, transfer the body weight to the other side in order to balance the watercraft.

2. Then bring the other foot over the seat and place it on the other footboard.
3. Push the watercraft away from the dock.



## **Boarding from Shallow Water**

## **⚠ WARNING**

Keep limbs away from propulsion system or intake grate. Never use propulsion systems a supporting point to board the watercraft.

1. Board the watercraft from either the side or the rear.
2. Ensure there is at least 90 cm (3 ft) of water underneath the lowest rear portion of the hull.

## **NOTE:**

Before starting the engine and when the engine is already running, take into account that the hull will be lower in the water when all passengers are aboard. Be certain to maintain the specified depth so sand, pebbles and rocks will not be drawn up in the jet pump.



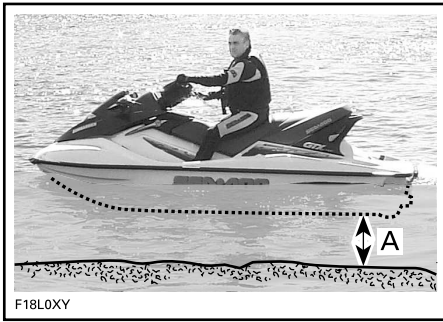

- A. Maintain at least 90 cm (3 ft) underneath the lowest rear portion of the hull when all passengers are aboard

### NOTICE

Starting the engine or riding the watercraft in shallower water may damage the impeller or other jet pump components. Stay on center of the step. Only one person at a time on the ladder.

### Boarding in Deep Water

#### ⚠ WARNING

Keep limbs away from propulsion system or intake grate. Never use propulsion systems a supporting point to board the watercraft.

#### ⚠ WARNING

Ask inexperienced riders to practice how to board the watercraft close to shore (all methods explained here) before venturing into deep water, especially when cargo is installed aboard on the rear platform.

### Operator Alone Without a Boarding Ladder

- Using one hand, grab the rear handle.



- Rear handle

### NOTE:

If cargo is properly secured on the boarding platform, it can be used as a handle or removed and set aside in the footwell to get access to the handle. Always properly secure the cargo before riding.

- With the other hand on the boarding platform, lift your body until you can lay one knee on the boarding platform.
- Lay the other knee on the boarding platform.



### TYPICAL

- Take hold the seat or the seat strap to help maintain your balance and step forward onto the footboards on either side of the seat.



TYPICAL

5. Sit astride the seat.

It is possible to swim toward side, use passenger handhold and/or seat strap to lift yourself aboard.

**NOTE:**

The side boarding method is not recommended as a first try boarding method. It must only be used in last resort as it is not the easiest method to board a watercraft.

**Operator Alone With a Boarding Ladder**

1. Swim to the rear of the watercraft.
2. Using one hand, lower the boarding ladder.



TYPICAL

3. Using the other hand, take hold of the edge of the boarding platform, then pull yourself up so that you can knee onto the boarding ladder.



TYPICAL

**NOTICE**

- Stay on center of the ladder.
- Only one person at a time on the ladder.

4. Reach forward with one hand and take hold of the molded handles on the sides of the back seat or the rear handle, then stand on the boarding ladder.

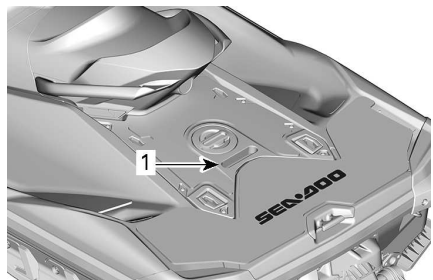

1. Rear handle



TYPICAL

**NOTE:**

If cargo is properly secured on the boarding platform, it can be used as a handle or removed and set aside in the footwell to get access to the handle. Always properly secure the cargo before riding.

5. With both hands on the handle behind the seat, step up onto the boarding platform.



TYPICAL



TYPICAL

6. Take hold of the seat strap to help maintain your balance and step forward onto the footboards on either side of the seat.



TYPICAL

7. Sit astride the seat.

**Operator with a Passenger**

1. The operator climbs on the watercraft in the same way as explained previously.

In choppy water, while in the water, the passenger may hold the watercraft steady to help the operator climb aboard.



TYPICAL

**NOTICE**

**Stay on center of the step. Only one person at a time on the step.**

2. The passenger then climbs onto the watercraft while the operator maintains balance by sitting as close as possible to the console.



TYPICAL - MODEL WITH BOARDING LADDER SHOWN



TYPICAL



TYPICAL

3. The passenger must sit astride the seat and maintain a firm grip of a handhold or the waist of the person in front of them.



TYPICAL

## Starting the Engine

### **⚠ WARNING**

Before starting the engine, the operator and passenger(s) should always:

- Be properly seated on the watercraft.
- Have a firm grip on a handhold or hold on to the waist of the person in front of them.
- Wear appropriate protective clothing including a PFD approved by local authorities and a wet suit bottom.

### **NOTICE**

Ensure there is at least 90 cm (3 ft) of water under the lowest rear portion of the hull when all passengers are aboard prior to starting the engine. Otherwise damage to the propulsion system components may occur.

1. Attach the tether cord clip to your PFD or to the wrist (wrist strap required).

### **⚠ WARNING**

The tether cord shall always be attached to the operators personal flotation device or to the wrist (wrist strap required) when starting or operating the watercraft.

2. Firmly grip handlebar with your left hand and place both feet on the footboards.
3. Press the engine START/STOP button to wake up the electrical system.
4. As the information center cycles through its self test function, install the tether cord on the engine cut-off switch.
5. Depress the START/STOP button to start the engine.

### **NOTICE**

In the event the engine does not start right away, do not hold START/STOP button more than 10 seconds to avoid starter overheating. A rest period should be observed between the cranking cycles to allow the starter to cool down. Refer to *Troubleshooting* section.

6. Release engine START/STOP button after engine is started.

## Shutting Off the Engine

### ⚠ WARNING

To maintain watercraft directional control, the engine shall be running until the watercraft is stopped.

1. Press the engine START/STOP button, or
2. Pull off the tether cord cap from the engine cut-off switch.

### ⚠ WARNING

Never leave the tether cord on the engine cut-off switch when disembarking watercraft to prevent theft, accidental engine starting, and to avoid unauthorized use by children or others.

If the engine is shut off using the START/STOP button and the tether cord is left on the engine cut-off switch, the electrical power will shut off after approximately 60 minutes to prevent battery discharge.

## Steering the Watercraft

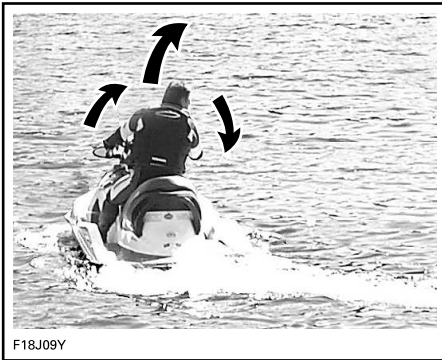

F18J09Y

Turning the handlebar pivots the jet pump nozzle which controls the watercraft direction. Turning the handlebar to the right will turn the watercraft to the right and inversely. You need to apply throttle to steer.

### ⚠ WARNING

Throttle must be applied and handlebar turned to change the direction of the watercraft. Steering efficiency will differ depending on the amount of throttle applied, the number of passengers, the load, the water conditions and the environmental factors such as the wind.

Unlike a car, a watercraft needs some throttle to turn. Practice in a safe area applying the throttle and turning away from an imaginary object. This is a good collision avoidance technique.

### ⚠ WARNING

Directional control is reduced when the throttle is released and lost when the engine is off.

The watercraft behaves differently with a passenger and requires greater skill. The passenger(s) shall grip the seat strap, the molded grab handle, or the waist of the person ahead of them. Reduce speed and avoid sharp turns. Avoid choppy water conditions when carrying a passenger.

### *Tight Turns and Other Special Maneuvers*

Any tight turns or special maneuvers that will cause the air inlet openings to be kept under water for a prolonged time, water will seep into the bilge.

Combustion engines need air to operate; consequently this watercraft cannot be totally watertight.

**NOTICE**

If the air inlet openings are kept under water, such as turning constantly in tight circles, plunging the bow through waves, or capsizing the watercraft, water may seep into the bilge, which may cause severe damage to internal parts of the engine. Refer to the *Warranty* section contained in this guide.

**Shifting into Neutral****⚠ WARNING**

The drive shaft and impeller are always turning when the engine is running, even when the iBR gate is set to the neutral position. Keep away from the propulsion system of the watercraft.

When the watercraft is first started, the iBR system automatically sets the iBR gate to the neutral position by default.

From forward thrust position, tap the iBR lever. The gate will move to neutral.

If braking or reverse is used, the iBR gate will move to the neutral position when the iBR lever is released, if throttle is not applied.

**NOTE:**

The throttle lever must be fully released for the iBR gate to move to the neutral position when the iBR lever is released.

If the engine is stopped in forward or reverse, the iBR gate will move to the neutral position on engine shutdown.

**Adjusting the Neutral Position of the iBR**

When in NEUTRAL, if the watercraft creeps forward or backward, the iBR system may be trimmed.

**NOTE:**

Movement of the watercraft when operating in neutral may be due to wind or water current.

1. Hold down the VTS up or down button for 0.5 Sec to enter the **Neutral Adjust** mode.

The message **Neutral Adjust** will be displayed.

2. Adjust the Neutral position:
  - Watercraft is moving forwards - press the VTS DOWN button.
  - Watercraft is reversing - press the VTS UP button.

Adjust to achieve no movement when the engine is at idle.



1. *Bow up*
  2. *Bow down*
3. Press OK button or wait 25 sec to exit the **Neutral Adjust** mode.

**Shifting into Forward**

From neutral, tap on the throttle lever to shift into forward. The gate will move to forward thrust position and the watercraft will accelerate forward.

From reverse, release the iBR lever while applying throttle moderately.

From braking, simultaneously pull in the throttle lever while releasing the iBR lever. The watercraft will accelerate forward after a short delay.

## Shifting into Reverse

Reverse can only be engaged between idle speed and the threshold forward speed of 14 km/h (9 MPH).

1. Pull in the iBR lever at least 25% of the lever travel.
2. Release the iBR lever to end reverse operation.
3. Apply enough throttle to stop rearward movement.

### **⚠ WARNING**

**The brake function has no effect when travelling in reverse.**

When operating the iBR lever in reverse mode, the throttle lever can be used to control engine RPM, and thus the amount of reverse thrust produced.

By modulating both the iBR and throttle levers simultaneously, reverse thrust can be more precisely controlled. Too much RPM will create water turbulence and reduce reverse efficiency.

### **NOTE:**

Engine power will be reduced to idle whenever the iBR lever position is changed.

Available engine power is limited in reverse mode, which limits reverse speed. However, speeds above 14 km/h (9 MPH) may be obtained in reverse depending on conditions.

### **⚠ WARNING**

**Only use reverse at slow speed and for the shortest time possible. Always ensure the path behind is clear of objects, obstacles and people.**

When operating in reverse, turn the handlebar in the opposite direction that you want to move the rear of the watercraft.

For example, to steer the rear of the watercraft to port (left), turn the handlebar to starboard (right).

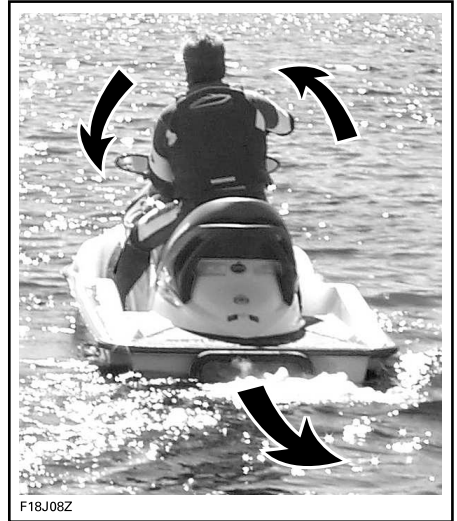

F18J08Z

**TYPICAL - STEERING DIRECTION REVERSED WHEN BACKING**

### **⚠ CAUTION**

**Steering direction in reverse thrust is opposite of forward thrust. To steer the stern to port (left) in reverse, turn the handlebar to starboard (right). To steer the stern to starboard (right), turn the handlebar to port (left). Reverse thrust operation should be practiced in open waters in order to become fully familiar with the controls and watercraft handling characteristics before operating in close quarters.**

## Braking

### WARNING

The engine must be running to be able to use the brake. The brake is only applicable when operating in forward movement, it has no effect on rearward velocity. The brake cannot prevent your watercraft from drifting due to current or wind.

The braking function can only be engaged during forward operation at or above the threshold speed of 14 km/h (9 MPH).

Braking is engaged and controlled when the iBR lever on the LH handlebar is pulled in at least 25% of its travel.

### WARNING

Braking should be practiced in open waters and at gradually increasing speeds in order to become fully familiar with the controls and watercraft handling characteristics.

When iBR lever is applied, the throttle lever command is overridden and engine throttle control is now dependant on the iBR lever position. Braking can thus be modulated by using only the iBR lever.

Watercraft deceleration is proportional to the braking force. The more the iBR lever is pulled in, the greater the braking force applied. The deceleration is also related to the total weight on the watercraft. A fully loaded watercraft (cargo and passengers) will not decelerate as fast as it could without this load.

### NOTE:

Be careful to gradually actuate the iBR lever to adjust intensity of the braking force and simultaneously release the throttle lever.

### CAUTION

When braking, riders must brace themselves against the deceleration force to prevent from moving forward on the watercraft and losing balance. The operator should always keep both hands on the handlebars, and all passengers should maintain a firm grip on their seat and/or the hand rail.

### WARNING

Stopping distance will vary depending on initial speed, load, wind, number of riders, water conditions, and the amount of braking power commanded by the operator. Always adjust your riding style accordingly.

When the watercraft slows to less than 14 km/h (9 MPH), braking mode ends and reverse mode is engaged. Release the iBR lever once the watercraft is stopped. Otherwise, a rearward movement will be initiated.

### CAUTION

As the watercraft slows to a stop, the wake created by the watercraft will catch up and tend to push the watercraft forward. Ensure there are no obstacles or bathers in the direction of travel.

If the throttle lever is still pulled in when releasing the iBR lever, the watercraft will accelerate forward after a short delay. Acceleration will be



proportional to the throttle lever position.

### **⚠ WARNING**

**If forward acceleration is not desired when the brake lever is released, release the throttle lever.**

### **⚠ WARNING**

**It is important to inform other operators who intend to follow in a convoy formation of the braking and maneuvering capability of your vehicle and that a greater distance should be maintained.**

### **Braking in a Turn**

Throttle must be applied for turning to ensure directional control. However braking can be initiated during a turn using the iBR lever as previously described. Get ready to maintain your balance while the wake is crossing your watercraft.

### **⚠ CAUTION**

**As the watercraft slows to a stop while braking in a turn, the wake created by the watercraft will catch up and tend to push the watercraft sideways. Be prepared to maintain balance as the wake crossed the watercraft.**

## **Variable Trim System (VTS)**

The variable trim system (VTS) changes the vertical position of the jet pump nozzle to provide the operator with a fast, effective system to compensate for load, thrust, riding position and water conditions. Correctly adjusted, it can improve handling, reduce porpoising, and position the watercraft at its best riding attitude to attain maximum performance.

When first using the watercraft, the operator should become familiar with

the use of the variable trim system (VTS) at varying speeds and water conditions. A mid-range trim is generally used when cruising. Experience alone will dictate the best trim for the conditions. During the watercraft break-in period, when lower speeds are recommended, it is an excellent opportunity to become familiar with trim adjustment and its effects.

When the nozzle is positioned in an upward angle, the water thrust directs the bow of the watercraft upward. This position is used to optimize high speed.

When the nozzle is directed downward, the bow is forced downward and increases the watercraft turning capabilities. As with any watercraft, speed and operator body position and movement (body English), will determine the degree and sharpness of the watercraft turn. Porpoising can be reduced or eliminated if the nozzle is downward and speed is adjusted proportionately.

### **NOTE:**

VTS position is indicated on a bar gauge in the right lateral display of the information center.

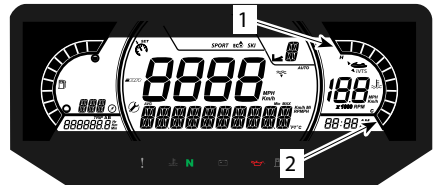

### **INFORMATION CENTER — VTS POSITION INDICATOR**

1. Bow up
2. Bow down

The VTS system allows for manually adjusting the trim position of the nozzle.

## VTS Trimming Methods

Available VTS Trimming Methods			
	GTX	RXT	WAKE PRO
VTS trim button	X	X	X
VTS "Presets"	X	X	X
VTS "Double Click" trimming (extended)	-	X	-
Launch Control	-	X	-
X = Indicates a <b>standard</b> feature - = See your Sea-Doo dealer for availability. N/A = Not Available			



1. Bow up
2. Bow down

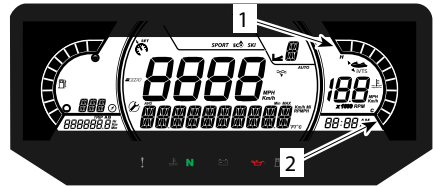

### INFORMATION CENTER — VTS POSITION INDICATOR

1. Bow up
2. Bow down

## Adjusting the VTS

Nine trim positions are available.

With the watercraft operating in forward thrust, proceed as follows.

### NOTE:

Pressing the VTS trim button without the engine in forward thrust will only change the indication. The nozzle will move to the selected VTS trim position when forward thrust is engaged.

1. Press the VTS UP button once to trim the bow of the watercraft up to the next up trim position.
2. Press the VTS DOWN button once to trim the bow of the watercraft down to the next down trim position.

### NOTE:

If the VTS UP or DOWN button is pressed and held, the pump nozzle will keep moving until the button is released at the desired trim attitude or the maximum trim position (up or down) is reached.

## Using Preset Trim Positions

Three preset trim positions can be selected.

To select the highest trim position recorded, double-click on the VTS UP button (bow up).



To select the lowest trim position recorded, double-click on the VTS DOWN button (bow down).



To select the mid trim position, it depends on the actual trim position. Double-click on the VTS UP button if it is positioned below mid trim or double-click on the VTS DOWN button if it is positioned above mid trim.

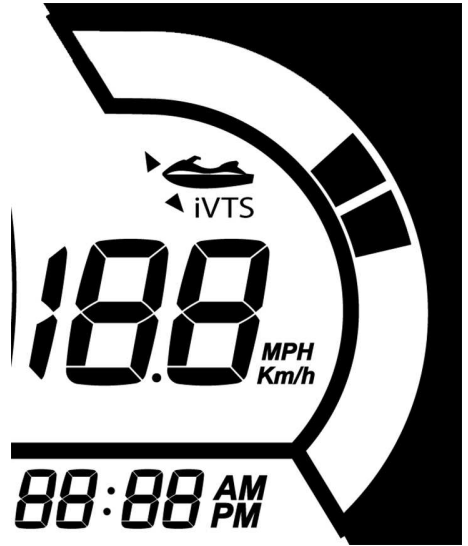

#### NOTE:

These preset trim positions are not adjustable.

### Activating the Intelligent Debris Free Pump System (iDF System) (if equipped)

The iDF system is designed to allow removing small debris or a cord caught in the jet pump by turning the propeller in reverse during a few seconds.

To activate the system, do the following:

1. Stop the engine.
2. Press and hold the iDF button.

The following messages can appear in the digital display during this step.

- **Engaging + R icon blinking** - The request is accepted and the sequence begins.
- **Stop engine then hold iDF** - Engine is still running and must be stopped before pressing the iDF button again.

- **High exhaust temperature** - Exhaust temperature is too high and needs to cool down before activating the sequence.
  - **Disable** - The iDF system is not enabled on your watercraft, see an authorized Sea-Doo dealer to enable it.
3. Start engine when the message **Press start to go** is displayed.

When the sequence is completed, the message **Ready to start** will be displayed.

4. Apply throttle when requested.

If the message **Impeller blocked** is displayed - this indicates that the blocking is too important and the system cannot turn the propeller in the opposite direction. Have the watercraft serviced by an authorized Sea-Doo dealer.

5. After a few seconds, the engine will shut down automatically. **Engaging + R icon blinking** will appear.
6. Start engine when the message **Press start to go** is displayed.

When the sequence is completed, the message **Ready to start** will be displayed.

7. Start the engine and try the watercraft when the message **Ready to start** will be displayed.
8. If the propulsion system has not returned to 100% of its original performance due to any remaining debris, stop engine and perform these steps again.

A moderate clog of weeds may require multiple cycles before they can be entirely cleared out.

- Between cycles, it is more efficient to try to drive the watercraft to permit to it to plane in order to help dislodge any remaining weeds before reattempting the iDF cycle.

If the problem persists after several tries, try the *On-Beach Water Cleaning* procedure, refer to *Jet pump Water Intake and Impeller Cleaning* in *Special Procedures* section.

## General Operating Recommendations

### NOTICE

**Combustion engines need air to operate; consequently this watercraft cannot be totally watertight. Any maneuvers such as turning constantly in tight circles, plunging the bow through waves, or capsizing the watercraft, that cause the air inlet openings to be under water may cause severe engine problems due to water ingestion. Refer to *How to Steer the Watercraft* in the *Operating Instructions* section and the *Warranty* section contained in this Operator's Guide.**

### *Rough Water or Poor Visibility Operation*

Avoid operation in these conditions. If you must do so, proceed with caution using minimum speed.

### *Crossing Wakes or Waves*

1. The operator must grip the handlebar firmly and keep both feet on the footboards.
2. The passenger must grip the handholds with both hands and keep both feet on the footboards.
3. Reduce speed.
4. Always be prepared to steer and maintain your balance as necessary.
5. When going over waves, raise your body slightly off the seat to absorb the shocks with your legs.
6. When crossing wakes, always keep a safe distance from watercraft ahead.

**⚠ WARNING**

**When crossing wakes or waves, slow down. Operator and passenger(s) should brace themselves and adopt a semi-standing position to help absorb the bumps. Do not jump wakes or waves - jumping can cause injuries such as back or spinal injury (paralysis).**

***Stopping/Docking***

When the throttle is released, the watercraft is slowed by water drag against the hull. The stopping distance will vary depending on the watercraft size, weight, speed, water surface condition, presence and direction of wind and current.

The iBR system can also be used for slowing down or for stopping more quickly, and for increasing maneuverability especially when docking.

The operator should practice in open waters at various speeds to become familiarized with the stopping distances under different conditions. Stopping using the iBR system in a straight line and in a turn should be practiced extensively to become familiar with the handling characteristics of the watercraft under partial or full braking conditions.

**⚠ WARNING**

**Always practice braking in open waters ensuring there are no watercrafts or boats in your immediate vicinity, especially astern. Other users of the waterways may not be able to maneuver or stop in time to avoid you should you unexpectedly come to a full stop in front of them.**

**⚠ WARNING**

**It is important to inform other operators who intend to follow in a convoy formation of the braking and maneuvering capability of your vehicle and that a greater distance should be maintained.**

The operator should also practice docking with an imaginary dock using the various controls available (iBR lever and throttle lever).

Release the throttle at a sufficient distance before the expected landing area.

Reduce speed to idle.

Maneuver using a combination of the iBR lever and throttle lever, shifting to neutral, reverse, or forward as required.

Remember that when operating in reverse, steering direction is reversed. Turning the handlebars to the left will move the stern to the right when backing up, and vice-versa.

**⚠ WARNING**

**Directional control is reduced when the throttle is released and lost when engine is off. Steering direction is reversed when operating the watercraft in reverse.**

***Beaching*****NOTICE**

**It is not recommended to run the watercraft to the beach.**

Drive slowly towards the beach and shut off the engine before the water is less than 90 cm (3 ft) deep under the

lowest rear portion of the hull. Then pull the watercraft to the beach.

***NOTICE***

**Riding the watercraft in shallow water may result in damage to the impeller, iBR components, or other jet pump components. Always shut off the engine before water is less than 90 cm (3 ft) deep and never use reverse or braking.**

# OPERATING MODES

Operating Mode Available	GTX	RXT-X	WAKE PRO
Touring mode	X	X	X
Sport mode	X	X	X
ECO mode	X	X	X
Speed limiter mode	X	X	X
Slow speed mode	X	X	X
Ski mode	-	-	X
Learning key mode	-	-	-

X = Indicates a **standard** feature  
 - = See a Sea-Doo dealer for availability.  
 N.A. = Not Available

To change the operating mode;

1. Press MODE button,
2. Acknowledge the safety message by pressing and holding MODE button will get the SPORT mode,
3. Pressing MODE button again will activate the ECO mode.



TYPICAL

## Touring Mode

By default, the watercraft is set to this riding mode of operation when started.

It is also called Normal riding mode.

The icon ECO +OFF appears in the display when this mode is selected.

## Sport Mode

SPORT MODE provides for instant throttle response and more rapid accelerations than DEFAULT riding MODE.

Once activated, SPORT MODE will remain active until it is deactivated by the operator, or the engine is shut

down whereby it defaults back to DE-FAULT riding MODE.

### **Activating Sport Mode**

To activate the Sport mode, press once on the MODE button while in DEFAULT riding mode. The sport icon will start to flash and a safety message will scroll. For safety reason, follow the instruction in the safety message to activate the sport mode. Once activated, the SPORT icon will turn ON.

### **Deactivating Sport Mode**

A single press on MODE button will take you to the ECO mode.

## **ECO Mode (Fuel Economy Mode)**

ECO mode provides a smoother throttle application and increased fuel economy.

## **Speed Control Modes (If Equipped)**

To enter one of the speed control modes, press SPEED CTRL button. Depending of the speed of the watercraft, only one of the following modes will be activated.

Once the desired mode is activated, press the SPEED CTRL button then change the value with the UP or DOWN arrow button while the SET LEVEL or SET SPEED message is active.

To exit the selected speed control mode, press MODE button or long press SPEED CTRL button.

### **Speed Limiter Mode**

Speed limiter mode is a function of iTC (intelligent Throttle Control) system that allows the operator to set the desired maximum watercraft speed.

This is useful when cruising for long distances, operating in limited speed zones, or towing a tuber, skier or wake boarder.

The operator must keep the throttle depressed to maintain forward speed.

Once the maximum speed is set, the operator can vary the watercraft speed from idle speed up to the set speed using the throttle lever. The set speed will not be exceeded even if the throttle lever is fully depressed.

As you proceed under a constant speed setting, keep your attention level up to maintain good situational awareness.

Slowing down is a matter of releasing the throttle lever further than the set point, or by pulling the iBR lever in.

If the iBR lever is pulled in for braking, Speed Limiter mode is overridden but **not deactivated**.

Once the iBR lever is released and the throttle is pulled in to engage forward thrust, the speed limiter function will reengage to limit the watercraft speed as it was set before.

### **Prerequisite for Speed Limiter Mode Activation**

Speed limiter MODE can be activated when the watercraft is going at more than 15 km/h (9 mi/h).

#### **NOTE:**

Speed limiter mode is not available if slow speed mode is engaged.

### **Activating Speed Limiter Mode**

1. Maintain a constant speed.
2. Press the Speed Control button on the left keypad.



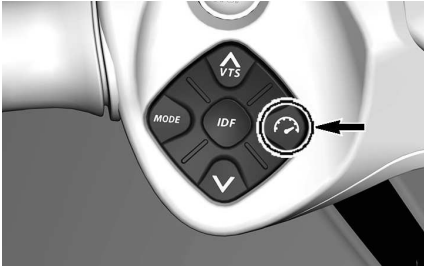

TYPICAL

You will hear a beep indicating that you are now in speed limiter mode, and a speed limiter MODE indicator will be lit.

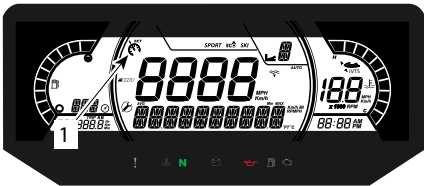

TYPICAL

1. Speed limiter/Slow Speed MODE INDICATOR

**NOTE:**

Activating speed limiter mode of operation only limits the maximum speed available when depressing the throttle lever. The throttle lever must be held in to maintain forward speed. Watercraft speed can be varied from idle up to the set cruise speed using the throttle lever once the speed limiter function is activated. Watercraft speed may vary depending on water conditions during use.

**Deactivating Speed Limiter Mode**

To deactivate speed limiter mode:

1. Release the throttle lever.
2. Press and hold the speed limiter button.

Deactivation of speed limiter mode is indicated by:

- The speed limiter indicator will go off.

**NOTE:**

If the throttle lever is not fully released when the button is pressed to deactivate the speed limiter mode, the speed limiter MODE indicator will remain on. The speed limiting function will stay active until the throttle is fully released, then the speed limiter MODE indicator will go out.

**Slow Speed Mode**

The Intelligent Throttle Control also allows for a Slow Speed Mode where the driver can adjust and set idle speed. This is useful when operating in slow speed zones where the driver must be especially attentive to possible obstacle avoidance.

If you accelerate above approximately 14 km/h (9 mi/h), Slow Speed Mode will be deactivated and the engine will return to idle RPM when the throttle is released.

Should a situation arise where the operator must stop or accelerate quickly away from a hazardous situation, pulling in the iBR lever, or pulling in on the throttle lever will deactivate slow speed mode and normal control of the watercraft will be returned to the operator.

**Prerequisite for Slow Speed Mode Activation**

Slow Speed MODE can be activated when the watercraft is going at less than 15 km/h (9 mi/h).

**NOTE:**

Speed limiter mode is not available if slow speed mode is engaged.

**Activating Slow Speed Mode**

To activate slow speed mode of operation:

1. Release the throttle lever to idle RPM.
2. Press the Speed Control button on the left keypad.

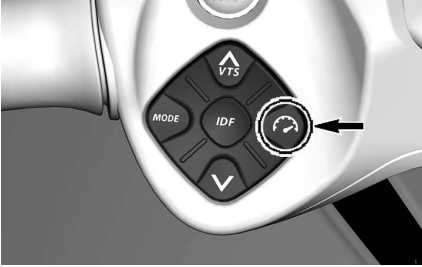

TYPICAL

The Speed limiter/Slow Speed indicator will come on in the multifunction display to indicate activation.



TYPICAL

1. Speed limiter/Slow Speed INDICATOR

A message will scroll in the multifunction display to specify that you are now in slow speed mode.

The default slow speed setting of 5 will show in the numerical display.

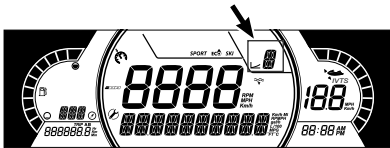

### Changing Set Slow Speed

To increase or decrease the set slow

speed, press the UP/DOWN button on the RH handlebar once, or repeatedly.

### NOTE:

There are 9 slow speed settings available (1 through 9). Adjust slow speed mode to desired speed.

When pressing the up/down button, a message "SET LEVEL" will appear. You can select from one of the 9 slow speed setting (1 to 9).

Level 5 is the default and it correspond to the normal idle of the vehicle. By using level 1-4 you can slow down the vehicle and go as slow as 1.5 km/h (1 mi/h). The slow speed mode can be used as a trolling mode and is useful for fishing. Level 6-9 gives you the ability to go up to 12 km/h (7 mi/h) without touching the throttle lever.

### WARNING

The operator must always be seated in driving position at all times when watercraft is at speed.  
- The tether cord must be attached to the operator's PFD or wrist (wrist strap required) at all times.

### NOTE:

Speed will vary depending on load, wind and waves conditions

### Deactivating Slow Speed Mode

The slow speed mode can be deactivated using any of the following methods:

- Pressing and holding the Speed Control button.
- Depressing the iBR lever.
- Accelerating past the set slow speed.

When deactivating SLOW SPEED MODE by accelerating using the throttle lever, the iBR gate stays in the forward position.

When using the iBR lever, the iBR gate will move towards the reverse position, then neutral when the lever is released.

SLOW SPEED MODE deactivation will be indicated in the following manner:

- The Speed Limiter indicator will go out

## Ski Mode (If Equipped)

Ski mode allows for repeated and precisely controlled launches, and a set towing speed, specifically for towing a skier or wake boarder.

**NOTE:** A GPS signal is required in order for the ski function to appear in the cluster. To obtain a suitable GPS signal, we recommend that you take the watercraft outside.

### **RAMP Function**

The RAMP function offers a pre-programmed setting for launching and accelerating the watercraft.

RAMP 1 provides:

- Slowest launch (smoothest)
- Slowest acceleration rate

RAMP 5 provides:

- Quickest launch
- Quickest acceleration rate

### **TARGET SPEED Function**

The TARGET SPEED function limits the maximum towing speed.

Once the RAMP has been selected, an average watercraft target speed for that RAMP will be visible in the numerical display.

The operator may increase or decrease the target speed to any value within the selected RAMP speed range.

## **Using Ski Mode**

1. Press MODE button to select the SKI mode.
2. Press OK button when SKI icon flashes.
3. Select ski ramp by using the UP or DOWN arrow button. Ramp 1 will give the slowest acceleration.

### **NOTE:**

Acceleration ramp will not behave the same depending on the vehicle type, vehicle load and water conditions. For safety reasons, always start using ramp # 1 to familiarize your skier with acceleration and then change the ramp as needed.

4. Press OK or RIGHT arrow button to confirm acceleration ramp.
5. Select the maximum target speed by using the UP or DOWN arrow button.
6. Press OK or RIGHT arrow button to confirm.

### **NOTE:**

At any moment you can use the LEFT and RIGHT arrow buttons to change the ramp and speed selection.

7. After your selection and when you are ready, press the OK button to activate the function.

The message **SKI READY** will display.

Keep throttle fully applied to ski.

Releasing the throttle or applying the brake will pause the SKI mode, simply press OK button to reactivate the SKI mode.

### **NOTE:**

MODE remains active and ready until another driving mode is chosen.

### ***Deactivating Ski Mode***

To end a ski run and completely deactivate ski mode, release the throttle to idle, then press the MODE button.

# SPECIAL PROCEDURES

## Jet Pump Water Intake and Impeller Cleaning

### WARNING

Keep away from intake grate while engine is running. Items such as long hair, loose clothing or personal flotation device straps can become entangled in moving parts.

Weeds, shells or debris can get caught on the intake grate, drive shaft and/or impeller. A clogged water intake may cause troubles such as:

- **Cavitation:** Engine speed is high but watercraft moves slowly due to reduced jet thrust, jet pump components may be damaged.
- **Overheating:** Since the jet pump operation controls the flow of water to cool the exhaust system, a clogged intake will cause the engine to overheat and damage engine internal components.

A weed clogged area can be cleaned as follows:

### WARNING

If it is necessary to reach in to remove any foreign object caught in the propulsion system, the tether cord **MUST BE REMOVED** from the engine cut-off switch.

### *In-Water Cleaning*

### NOTICE

Ensure there is at least 90 cm (3 ft) of water under the lowest rear portion of the hull when all passengers are aboard prior to starting the engine. Otherwise damage to the propulsion system components may occur.

### Models equipped with the iDF system

If the watercraft is equipped with the iDF system, use it now. Refer to *How to Use the intelligent Debris Free Pump System* in *Operating Instructions* section.

### Models without iDF system

1. Rock the watercraft several times. Most of the time, this will remove the blockage.
2. Start engine and make sure watercraft operates properly.

If the aforementioned method does not work:

3. With engine running and before applying throttle, pull the iBR lever in to select reverse operation.
4. Vary throttle quickly several times.
5. Repeat procedure if necessary.

If system is still blocked, move the watercraft out of the water for cleaning. Refer to *On-Beach Water Cleaning*.

### *On-Beach Water Cleaning*

### WARNING

The tether cord **MUST BE REMOVED** from the engine cut-off switch to prevent accidental engine starting before cleaning the jet pump area.

1. Place a cardboard or a carpet beside the watercraft to prevent scratching when turning the watercraft for cleaning.
2. Rotate the watercraft to any side for cleaning.

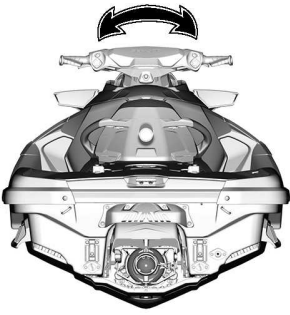
**TYPICAL**

3. If equipped, move the iBR to the forward position. Refer to *iBR Override Function* for detailed instructions.
4. Clean the water intake area.

If the system is still clogged, refer to an authorized Sea-Doo dealer for servicing.

**NOTICE**

**Inspect water intake grate for damage. Refer to an authorized Sea-Doo dealer for repair as necessary.**

***iBR Override Function***

When the iBR override function is activated, it allows the user to electrically move the iBR gate and nozzle through its full range of motion using the VTS control button.

**NOTE:**

The iBR override function is only available when the engine is not running.

**⚠ WARNING**

**When moving the iBR gate using the iBR override function, ensure no one is near the rear of the watercraft. Movement of the gate may squeeze fingers.**

**NOTICE**

**An object or tool caught in the iBR system when using the iBR override function may cause damage to the iBR components. Remove all rigid foreign objects that may obstruct the iBR gate travel before moving it.**

**⚠ WARNING**

**If it is necessary to reach in to remove any foreign object caught in the propulsion system, strictly observe the following before proceeding:**

- Remove tether cord from the engine cut-off switch.
- Wait at least 5 minutes.
- Do not press on START/STOP button. Should the START / STOP button be pressed, wait another 5 minutes.

**Activating iBR Override Function**

1. Power up the electrical system by pressing the START/STOP button.
2. Install the tether cord on the engine cut-off switch.

**NOTE:** The tether cord must be installed to ensure the information center will not shut off all indications after its self test function. Electrical power will stay on for approximately 1 hour.

3. Pull in and hold the iBR lever for the entire procedure.

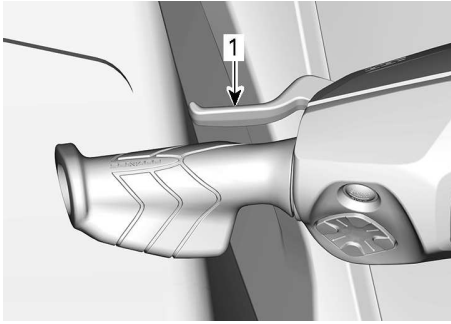

1. iBR lever pulled and held

4. When the **iBR OVERRIDE - PRESS MODE BUTTON** message appears in the multifunction gauge, press the MODE button.

When the function is activated, a ON message will be shown.

5. While still holding the iBR lever in, press the VTS UP/DOWN button to move the iBR gate to the desired position. Ensure the VTS indication in the multifunction gauge changes with the iBR gate movement. If the iBR gate moves upwards, the indication moves upwards.
6. Release the iBR lever.
7. Remove the tether cord from the engine cut-off switch.

### **⚠ WARNING**

If it is necessary to reach in to remove any foreign object caught in the propulsion system, strictly observe the following before proceeding:

- Remove tether cord from the engine cut-off switch.
- Wait at least 5 minutes.
- Do not press on START/STOP button. Should the START / STOP button be pressed, wait another 5 minutes.

## Capsized Watercraft

The watercraft is designed so that it should not turn over easily. Two sponsons mounted on the side of the hull assist watercraft stability. If it turns over, it will remain capsized.

To turn the watercraft upright, ensure the engine is off and the D.E.S.S. key is **NOT** on its post, then grab the inlet grate, step on a side bumper rail and use your weight to rotate the watercraft towards you.

### NOTE:

A label on the stern near the flushing connector provides instructions on how to turn the watercraft right side up. The label is upside down so that it can be read when the watercraft is overturned.



### TYPICAL

The engine features a Tip-Over Protection System (T.O.P.S.™). When the watercraft tips over, the engine is automatically stopped.

When the watercraft is returned to its normal operating position, the engine can be started normally.

**NOTICE**

When the watercraft has been turned over 5 minutes, do not attempt to crank the engine to avoid water ingestion that would damage the engine. See an authorized Sea-Doo dealer as soon as possible.

**NOTICE**

If the engine does not crank, do not attempt to start it anymore. Otherwise, the engine could be damaged. See an authorized Sea-Doo dealer as soon as possible.

As soon as possible, check for presence of water in the bilge. Drain as necessary when back to the shore.

**Submerged Watercraft**

To limit damages to the engine, perform the following procedure as soon as possible.

1. Drain bilge.
2. If it was submerged in salt water, spray bilge and all components with fresh water using a garden hose to stop the salt corroding effect.

**NOTICE**

Never try to crank or start the engine. Water trapped in intake manifold would flow towards the engine and possibly cause severe engine damage.

3. Bring the watercraft to an authorized Sea-Doo dealer as soon as possible to have it serviced.

**NOTICE**

Failure to have the engine properly serviced may cause severe engine damage.

**Water-Flooded Engine****NOTICE**

Never try to crank or start the engine. Water trapped in intake manifold would flow towards the engine and possibly cause severe engine damage.

Bring the watercraft to an authorized Sea-Doo dealer as soon as possible to have it serviced.

**NOTICE**

Failure to have the engine properly serviced may cause severe engine damage.

**Towing the Watercraft in Water**

Special precautions should be taken when towing a Sea-Doo watercraft in water.

The maximum recommended towing speed is 8 km/h (5 MPH).

This will prevent the exhaust system from filling with water, which may lead to water being injected into and filling the engine. Without the engine running, there isn't any exhaust pressure to push the water out the exhaust outlet.

**NOTICE**

Failure to follow these instructions may result in damage to the engine. If you must tow a stranded watercraft in water, be sure not to exceed the maximum towing speed of 8 km/h (5 MPH).



**NOTICE**

**Never tow a watercraft facing backwards as water intrusion may occur.**

**⚠ CAUTION**

**A tow line shall always be made fast in such a way that it can be released when under load.**

This page is intentionally blank

# MAINTENANCE

---

# MAINTENANCE SCHEDULE

Maintenance is very important to keep your watercraft in safe operating condition. The vehicle should be serviced as per the maintenance schedule.

Proper maintenance is the owner's responsibility. A warranty claim may be denied if, among other things, the owner or operator caused the problem through improper maintenance or use.

Perform periodic checks and follow the maintenance schedule. **The maintenance schedule does not exempt the pre-ride inspection.**

## WARNING

**Failure to properly maintain the watercraft according to the maintenance schedule and procedures can make it unsafe to operate.**

## EPA Regulation - Canadian and USA Watercrafts

**A repair shop or person of the owner's choosing may maintain, replace, or repair** emission control devices and systems. These instructions do not require components or service by BRP or authorized Sea-Doo dealers.

Although an authorized Sea-Doo dealer has an in-depth technical knowledge and tools to service your vehicle, the emission-related warranty is not conditioned on the use of an authorized Sea-Doo dealer or any other establishment with which BRP has a commercial relationship.

Proper maintenance is the owner's responsibility. A warranty claim may be denied if, among other things, the owner or operator caused the problem through improper maintenance or use.

For emission-related warranty claims, BRP is limiting the diagnosis and repair of emission-related parts to the authorized Sea-Doo dealers. For more information, please refer to the *US EPA Emissions Warranty* contained in the *warranty* section.

You must follow the instructions for fuel requirements in the fueling section of this manual. Even if gasoline containing greater than ten volume percent ethanol is readily available, the US EPA issued a prohibition against the use of gasoline containing greater than 10 vol% ethanol that applies to this vehicle. The use of gasoline containing greater than 10 vol% ethanol with this engine may harm the emission control system.

## Salt Water/ Dirty Water Usage

Whenever your watercraft is used in salt or dirty water, this type of usage requires maintenance tasks to be performed between the regular yearly intervals. These are identified as A+ in the chart below.

If you regularly ride in **salt or dirty water**, follow the A+ interval and perform the tasks outlined in the chart below.

## Maintenance Schedule

Make sure to perform proper maintenance at recommended intervals as indicated in the tables.

The maintenance chart indicates the items needing to be addressed based on 2 criteria, whichever happens first:

- Calendar time
- Watercraft hours.

Your driving habits determines the factors you shall adhere to. For example:

- Someone who uses their watercraft every weekend would follow the **hours reading** to determine the frequency of his maintenance.
- Someone who uses their watercraft seldomly over the year or only on a few occasions would follow the **calendar time** to determine the frequency of his maintenance.

**IMPORTANT:** The following tables show the appropriate maintenance application for the first 3 years. For subsequent years, repeat the same pattern alternatively.

<b>Maintenance Overview</b>		
Calendar Time	Hour meter	Regular/ Salt/ Dirty water
Every Month		<b>A+</b>
1 Year	100 Hours	<b>A</b>
Every Month		<b>A+</b>
2 Years	200 Hours	<b>A and B</b>
Every Month		<b>A+</b>
3 Years	300 Hours	<b>A</b>

**Rotax 1630 ACE Engines**

<b>Regular</b>	<b>A</b>	<b>B</b>
<b>A = Adjust</b> <b>C = Clean</b> <b>F = Flush</b> <b>I = Inspect</b> <b>L = Lubricate</b> <b>R = Replace</b> <b>T = Torque</b>	<b>Every year</b> <b>or</b> <b>100 Hours</b>	<b>Every 2 years</b> <b>or</b> <b>200 Hours</b>
<b>Air and Fuel Delivery</b>		
Air delivery components and function (ducts, hoses, clamps)	I, C	
Fuel components and function (Fuel tank cap, fuel tank fixation, hose condition, leaks)	I	
Supercharger		I
<b>Deck and Hull</b>		
Sacrificial anode(s)	I	
Body panels and hardware	I, T	
Hull	I	
<b>Engine and Cooling</b>		
Engine cooling components (coolant concentration, coolant level, hose condition, clamps, leaks)	I, A	
Engine oil and oil filter	R	
Ignition components and function	I	
Engine rubber mounts	I	
Spark plugs		R
Engine coolant	R Every 5 years or 300 hour	
<b>Exhaust and Emissions</b>		
Exhaust components (gaskets, pipes, muffler condition, leaks)	I	
Exhaust	F	
<b>iBR</b>		
iBR components and function	I,	
<b>Propulsion</b>		
Propulsion components and function	I	I, L
<b>Electrical</b>		
Battery connections and condition	I	

Regular	A	B
<b>A = Adjust</b> <b>C = Clean</b> <b>F = Flush</b> <b>I = Inspect</b> <b>L = Lubricate</b> <b>R = Replace</b> <b>T = Torque</b>	Every year or 100 Hours	Every 2 years or 200 Hours
Electrical harness routing	I	
Modules and applicable software updates	I	
Operation of control switches and lighting	I	
<b>Steering and Controls</b>		
Steering components and function	I	
Throttle operation	I	
<b>Feature</b>		
Fish finder transducer support	I, A	

<b>SALT/ DIRTY WATER</b>	<b>A+</b>	<b>A</b>	<b>B</b>
<b>A = Adjust</b> <b>C = Clean</b> <b>F = Flush</b> <b>I = Inspect</b> <b>L = Lubricate</b> <b>R = Replace</b> <b>T = Torque</b>	<b>After each ride in salt or dirty water or monthly when used in salt or dirty water</b>	<b>Every year or 100 Hours</b>	<b>Every 2 years or 200 Hours</b>
<b>Air and Fuel Delivery</b>			
Air delivery components and function (ducts, hoses, clamps)		I, C	
Fuel components and function (Fuel tank cap, fuel tank fixation, hose condition, leaks)		I	
Supercharger			I
<b>Deck and Hull</b>			
Sacrificial anode(s)	I Every month	I	
Body panels and hardware		I, T	
Hull		I	
<b>Engine and Cooling</b>			
Engine compartment	F After each ride		
Engine compartment metallic components	L Each month		
Engine cooling components (coolant concentration, coolant level, hose condition, clamps, leaks)		I, A	
Engine oil and oil filter		R	
Ignition components and function		I	
Engine rubber mounts		I	
Spark plugs			R
Engine coolant		R Every 5 years or 300 hour	
<b>Exhaust and Emissions</b>			
Exhaust components (gaskets, pipes, muffler condition, leaks)		I	



<b>SALT/ DIRTY WATER</b>	<b>A+</b>	<b>A</b>	<b>B</b>
<b>A = Adjust</b> <b>C = Clean</b> <b>F = Flush</b> <b>I = Inspect</b> <b>L = Lubricate</b> <b>R = Replace</b> <b>T = Torque</b>	After each ride in salt or dirty water or monthly when used in salt or dirty water	Every year or 100 Hours	Every 2 years or 200 Hours
Exhaust	F After each ride	F	
<b>iBR</b>			
iBR components and function		I,	
<b>Propulsion</b>			
Propulsion components and function		I	I, L
<b>Electrical</b>			
Battery connections and condition		I	
Electrical harness routing		I	
Modules and applicable software updates		I	
Operation of control switches and lighting		I	
<b>Steering and Controls</b>			
Steering components and function		I	
Throttle operation		I	
<b>Steering and Controls</b>			
Steering components and function		I	
Throttle operation		I	
<b>Feature</b>			
Fish finder transducer support		I, A	

# MAINTENANCE PROCEDURES

This section includes instructions for basic maintenance procedures.

## **⚠ WARNING**

Turn off the engine and follow these maintenance procedures when performing maintenance. If you do not follow proper maintenance procedures you can be injured by hot parts, moving parts, electricity, chemicals or other hazards.

## **⚠ WARNING**

Should removal of a locking device (e.g. lock tabs, self-locking fasteners, etc.) be required, always replace with a new one.

## **NOTICE**

Never leave any object, rag, tool, etc., in the engine compartment or in the bilge.

## Engine Service Cover



### **Removing the Engine Service Cover**

1. Remove the seats.
2. Remove the ski/ wake pylon cover.

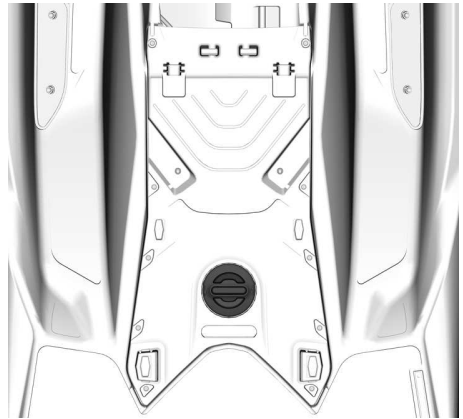

*TYPICAL*

3. Remove the screws.

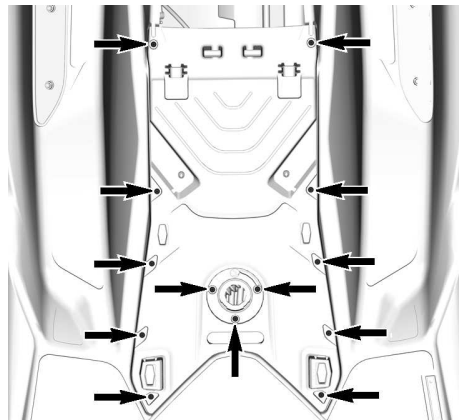

*TYPICAL*

4. Remove the cover.

### **Installing the Engine Service Cover**

1. The installation is the reverse of the removal procedure. However, pay attention to the following.
2. Install all screws.
3. Tighten screws to specification.

#### **Tightening Torque**

Engine service cover screw	$2.8 \pm 0.2$ Nm ( $25 \pm 2$ lbf-in)
----------------------------	--

## Engine Oil

### Recommended Engine Oil

Rotax® engines were developed and validated using the XPS® oil.

BRP recommends the use of its XPS engine oil or an equivalent at all time.

Damage caused by the use of an oil not suitable for the engine may not be covered by the BRP Limited Warranty.

XPS Recommended Engine Oil	
General purpose	5W40 synthetic blend oil
Warm temperature	10W50 synthetic oil

If the recommended XPS engine oil is not available:

Engine <b>Without</b> Supercharger	Use a <b>4-stroke SAE synthetic engine oil</b> meeting or exceeding the following lubricant industry specifications. Always check the API service label certification on the oil container, it must contain at least one of the indicated standards. <b>API service classification SN or JASO-MA2</b>
Engine <b>With</b> Supercharger	Use a <b>4-stroke SAE motorcycle engine oil compatible with wet clutches</b> meeting or exceeding the following lubricant industry specifications. Always check the API service label certification on the oil container, it must contain at least one of the indicated standards. <b>API service classification SN or JASO-MA2</b>

### Verifying the Engine Oil Level

#### NOTICE

Operating the engine with an improper level may severely damage engine.

#### CAUTION

Many components in the engine compartment may be very hot. Direct contact may result in skin burn.

If Watercraft is Out of the Water

**NOTICE**  
Watercraft must be level.

**CAUTION**  
When operating the engine while the watercraft is out of water, the heat exchanger in the ride plate may become very hot. Avoid any contact with the ride plate as burns may occur.

1. Raise trailer tow pole, then block in position when bumper rail is level.
2. Install a garden hose on the exhaust system flushing connector. Refer to *Exhaust System* in this section and follow the procedure.

**NOTICE**  
Never run engine without supplying water to the exhaust system. Failure to cool exhaust system may severely damage it. Never run engine longer than 2 minutes. Drive line seal has no cooling when watercraft is out of water.

3. Remove the seat(s).
4. Start the engine.
5. Open the water tap.
6. Run the COLD engine at idle for 30 seconds.
7. Close water tap.
8. Bring engine RPM to 4000-4500 RPM for 15 seconds.
9. Stop the engine abruptly by pressing the start/stop button or removing the tether cord.
10. Wait at least 30 seconds for the oil to settle in the engine, then pull dipstick out and wipe clean.

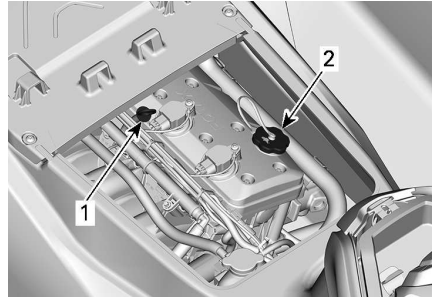

TYPICAL

1. Oil dipstick
2. Oil filler cap

11. Reinstall dipstick, push in completely.
12. Remove dipstick again and read oil level. It should be between the FULL and ADD marks.

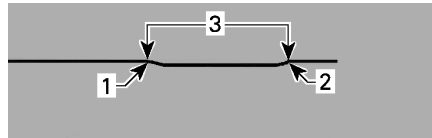

TYPICAL

1. Full
2. Add
3. Operating range

13. Add oil to ensure the level is between marks as required.
  1. Remove oil cap.
  2. Place a funnel in valve cover opening.
  3. Add a small amount of the recommended oil to reach the proper level.

**NOTICE**  
Do not overfill.

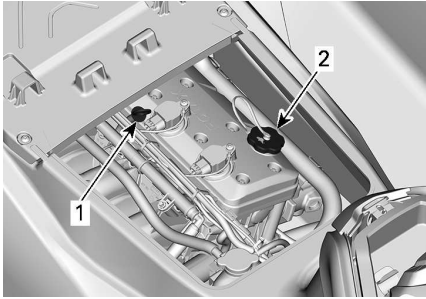

**TYPICAL**

1. Oil dipstick
2. Oil filler cap

**NOTE:**

Every time oil is added in the engine, the complete procedure explained in this section must be carried out again. Otherwise, you will obtain a false oil level reading.

14. Properly reinstall oil cap and dipstick.

**NOTICE**

**Ensure that oil filler cap is tightened properly. Otherwise engine oil can spill out.**

**Engine Oil Change and Oil Filter Replacement**

The oil change and filter replacement may be performed by an authorized Sea-Doo dealer, repair shop, or person of your own choosing.

**Engine Coolant**

**Recommended Engine Coolant**

**XPS Recommended Coolant**

Extended life pre-mixed coolant

If the Recommended XPS Coolant is Not Available

Use a low silicate, extended life ethylene-glycol premixed coolant (50%-50%) specifically formulated for internal combustion aluminum engines.

**NOTICE**

**Always use ethylene-glycol anti-freeze containing corrosion inhibitors specifically for internal combustion aluminum engines.**

To prevent antifreeze deterioration, always use the same brand and grade. Never mix different brands or grades unless cooling system is completely flushed and refilled.

**Engine Coolant Level**

**⚠ WARNING**

**Check coolant level with engine cold. Never add coolant when engine is hot.**

**⚠ CAUTION**

**Many components in the engine compartment may be very hot. Direct contact may result in skin burn.**

1. Remove seats.
2. Locate the expansion tank cap.

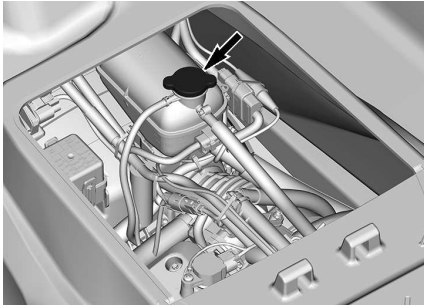

TYPICAL

With watercraft on a level surface, coolant level should be between MIN. and MAX. marks on coolant reservoir when engine is cold.

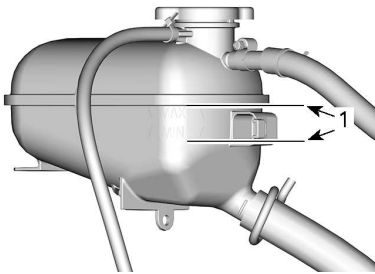

COOLANT EXPANSION TANK

1. Level between marks when engine is cold

**NOTE:**

The watercraft is level when it is in water. When on a trailer, raise trailer tow pole and block in this position when bumper rail is level.

Add coolant, see *Recommended Engine Coolant* for specification, to adjust coolant level between marks as required. Use a funnel to avoid spillage. Do not overfill.

3. Properly tighten the expansion tank cap. Reinstall seats.

**NOTE:**

A cooling system that frequently requires coolant is an indication of leaks or engine problems. See an authorized Sea-Doo dealer.

**Engine Coolant Replacement**

Coolant replacement should be performed by an authorized Sea-Doo dealer.

**Ignition Coils**

**Ignition Coil Access**

1. Remove tether cord from the engine cut-off switch.
2. Remove seat(s).
3. Remove engine service cover by removing the retaining screws.

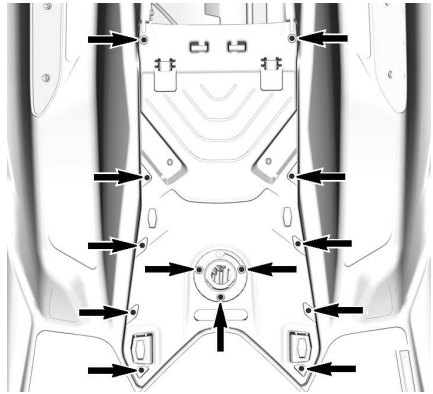

**Removing the Ignition Coil**

1. Disconnect ignition coil connector.

**NOTICE**

**Do not pry on ignition coil using any tool.**

2. Remove ignition coil retaining screw.
3. Remove ignition coil from spark plug by rotating coil side to side as you pull up.

**Installing the Ignition Coil**

1. Align the retaining screw hole of the ignition coil with the threaded hole on the valve cover.
2. Install the ignition coil on the spark plug and push it all the way down until it rests on the valve cover.

3. Install the retaining screw and tighten to specification below.

Tightening Torque	
Ignition coil retaining screw	$9 \pm 1 \text{ Nm}$ ( $80 \pm 9 \text{ lbf-in}$ )

4. Connect ignition coil connector.

## Spark Plugs

### Removing the Spark Plug

1. Remove the ignition coils. Refer to *Removing the Ignition Coil*.
2. Clean the spark plug and cylinder head with compressed air.
3. Unscrew the spark plug completely using a spark plug socket.

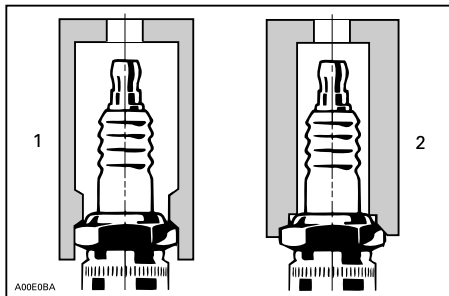

1. *Approved socket*
  2. *Improper socket*
4. Use the ignition coil to take spark plug out of its hole.

### Installing the Spark Plug

Prior to installation, ensure the contact surfaces of the cylinder head and spark plug are free of grime.

1. Using a wire feeler gauge, check electrode gap as specified in *Technical Specifications*. Replace the spark plug if not to specification.

## NOTICE

**Do not adjust gap on this type of spark plug. The adjustment could weaken negative electrodes which may lead to electrode breaking and severe engine damage.**

2. Apply anti-seize lubricant on the spark plug threads to prevent possible seizure.
3. Hand screw spark plug into cylinder head. Then, tighten the spark plug to specification with a spark plug socket.

Tightening Torque	
Spark plug	$18 \pm 2 \text{ Nm}$ ( $159 \pm 18 \text{ lbf-in}$ )

4. Install the ignition coils. Refer to *Ignition Coil*.

## Exhaust System

### DANGER

**DO NOT run the engine indoors or without adequate ventilation or permit exhaust fumes to accumulate in confined areas. Engine exhaust contains carbon monoxide (CO) which, if inhaled, can cause serious brain damage or death.**

### Flushing the Exhaust System

Flushing the exhaust system with fresh water is essential to neutralize corroding effects of salt or other chemical products present in water. It will help to remove sand, salt, shells or other particles in water jackets and/or hoses.

Exhaust system flushing should be performed when the watercraft is not expected to be used further the same day or when the watercraft is stored for any extended time.

**NOTICE**

Failure to flush the system, when necessary, will severely damage exhaust system. Make sure engine operates during entire procedure.

**⚠ WARNING**

Perform these operations in a well ventilated area. Certain components in the engine compartment may be very hot. Direct contact may result in skin burn. Do not touch any electrical part or jet pump area when engine is running.

**⚠ WARNING**

When operating the engine while the watercraft is out of the water, the heat exchanger in the ride plate may become very hot. Avoid any contact with ride plate as burns may occur.

1. Connect a garden hose to connector located at the rear of watercraft. **Do not open water tap yet.**

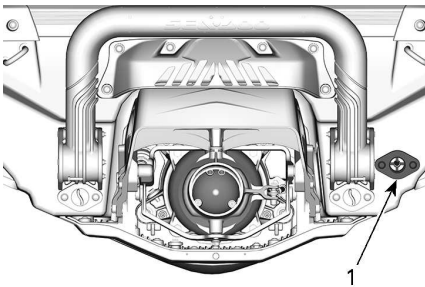

1. Water inlet connector

**NOTE:**

The following tool is recommended when a quick connect adapter is used to ease garden hose installation.

**Recommended Tool**

Flushing connector adapter  
295 500 473

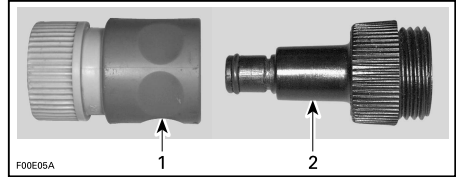

1. Quick connect adapter
2. Flushing connector adapter

2. Start the engine then immediately open the water tap.

**NOTICE**

Always start the engine before opening the water tap. Open water tap immediately after engine is started to prevent overheating. Never run engine without supplying water to the exhaust system when watercraft is out of water.

3. Run the engine 90 seconds at idle.

**NOTICE**

Never run engine longer than 2 minutes. Drive line seal has no cooling when watercraft is out of water.

4. Ensure water flows out of jet pump while flushing.
5. Close the water tap, run the engine at 5000 RPM for 5 seconds and then stop the engine.

**NOTICE**

Always close the water tap before stopping the engine.



- Disconnect the garden hose and the flushing connector adapter (if used).

## Ride Plate and Water Intake Grate

### *Inspecting the Ride Plate and the Water Intake Grate*

Inspect ride plate and jet pump water intake grate for damage. Visit your Sea-Doo dealer to have any damaged part repaired or replaced.

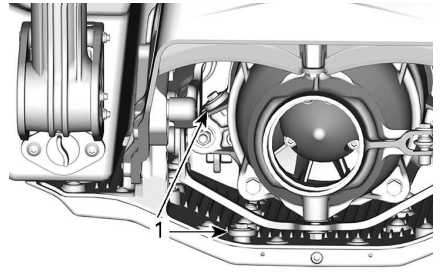

1. Sacrificial anodes

**⚠ WARNING**

The tether cord must always be removed from the engine cut-off switch prior to inspecting the intake grate.

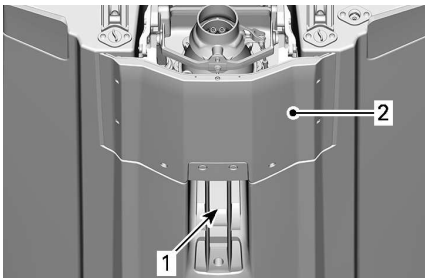

#### **INSPECT THESE AREAS**

- Water intake
- Ride plate

## Sacrificial Anodes

### *Inspecting the Sacrificial Anodes*

Sacrificial anodes are located on:

- Pump
- Ride plate
- Intercooler (if equipped).

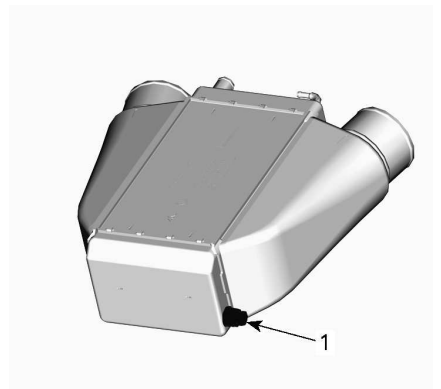

**INTERCOOLER - 230 (IF EQUIPPED)**

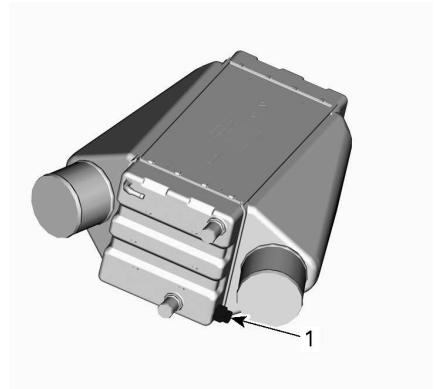

**INTERCOOLER - 300 (IF EQUIPPED)**

Check the sacrificial anodes for wear. If worn more than half, replace them.

### Removing the Sacrificial Anode

Unscrew sacrificial anode retaining nut and remove anode.

### Installing the Sacrificial Anode

Installation is the reverse of the removal procedure.

Tightening Torque
9 ± 1 Nm (80 ± 9 lbf-in)

## Ski/ Wakeboard Pylon (if equipped)

### Inspecting the Ski/ Wakeboard Pylon

Check the ski/ wakeboard pylon operation. Ensure it slides up and down easily.

Check the locking mechanism operation.

Check fasteners tightness. If something is found defective, don't use the ski/ wakeboard pylon and visit an authorized Sea-Doo dealer for repair.

### Lubricating the Ski/ Wakeboard Pylon

Clean ski/ wakeboard pylon and apply a light coat of super lube grease or equivalent.

Lubricate pylon throughout its length.

Wipe off all excess grease and reinstall pylon.

Extend and retract several times to distribute the lubricant.

## Fuses

### Fuse Location

All fuses are located inside a single fuse box.

To access the fuse box:

Remove seat(s).

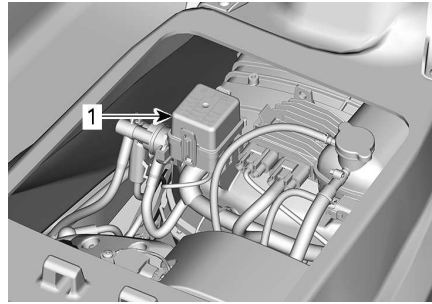

### TYPICAL

1. Fuse box

To remove a fuse box cover, squeeze locking tabs together, hold and pull fuse box cover to open.

### NOTE:

Fuse ratings and positions are illustrated on the fuse box cover.

Use the fuse remover/installer included in the fuse box to ease fuse removal.

### Inspecting a Fuse

Check fuse condition and replace it if necessary.

<b>⚠ WARNING</b>
<b>Never use a higher rated fuse than specified.</b>

To remove fuse from holder, pull fuse out. Check if filament is melted.

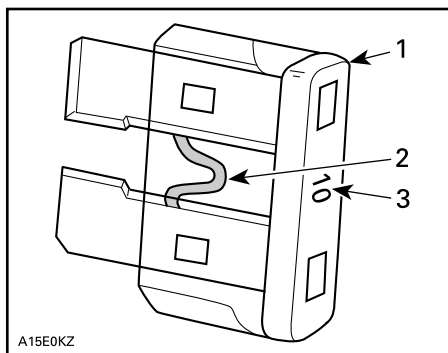

**TYPICAL**

1. Fuse
2. Check if melted
3. Ampere rating

Fuse	Rating	Description
11	5 A	ECM
12	30 A	Battery
13	15 A	Diagnostic Tool 2
14	15 A	Diagnostic Tool 1, Accessory connector

**⚠ WARNING**

If fuse burns out repeatedly, source of malfunction should be determined and corrected before restarting. Visit an authorized Sea-Doo dealer for servicing.

**Fuse Description**

Fuse	Rating	Description
1	-	Not used
2	15 A	Fuel Inj., Ign. Coils and Fuel Pump
3	3 A	Bilge Pump (if equipped)
4	-	Not used
5	-	Not used
6	30 A	Charge
7	5 A	Cluster
8	-	Not used
9	30 A	iBR
10	5 A	Start/Stop

# WATERCRAFT CARE

Remove the watercraft from the water every day.

## Post-Operation Care

### *Flushing the Exhaust System*

The exhaust system should be flushed daily when watercraft is used in salt or foul water.

Refer to *Maintenance Procedures*.

### *Additional Care for Foul Water or Salt Water Operation*

When the watercraft is operated in foul water and particularly in salt water, additional care should be taken to protect the watercraft and its components.

Rinse watercraft bilge area with fresh water.

Never use a high pressure washer to clean the bilge. **USE LOW PRESSURE ONLY** (such as a garden hose).

High pressure can cause damages to electrical or mechanical systems.

### **CAUTION**

Allow engine to cool before performing any maintenance.

### **NOTICE**

Failure to perform proper care such as: watercraft rinsing, exhaust system flushing and anti-corrosion treatment, when watercraft is used in salt water, will result in damage to the watercraft and its components. Never leave the watercraft stored in direct sunlight.

## Seat Cleaning

Before applying a cleaning product on the seat, try removing marks with a white eraser.

Many marks, as shoes marks, can be removed easily with this method.

## Body and Hull

### *Repair*

If any repairs are needed to body components or to the hull, contact your authorized Sea-Doo dealer.

### *Cleaning*

Wash the body and the hull with a soap and water solution (use only mild detergent). Rinse thoroughly with fresh water.

Remove marine organisms from the inside and outside of the hull.

### **NOTICE**

Never clean using the following products:

- XPS S4 Heavy Duty Cleaner
- Strong detergent
- Degreasing agent
- Ammonia
- Acetone or other ketones
- Alcohol
- Toluene or other aromatic solvents
- Chlorinated solvents
- Mineral spirits
- Paint thinners
- Petroleum based products.

Stains may be removed from the seat and fiberglass using the XPS All Purpose Cleaner and Degreaser or the equivalent.

To clean the carpets, use 3M™ Citrus Base Cleaner (24 oz spray can) or an equivalent.

### **WARNING**

Never apply plastic or vinyl protector on the carpets or seat as the surface will become slippery and the occupants may slip off the watercraft.

Respect the environment by ensuring fuel, oil or cleaning solutions do not drain into the waterways.

### ***Protection***

Apply a good quality marine wax to the body.

If the watercraft is to be stored outside, cover it with an opaque tarpaulin to prevent sun rays and grime from affecting the plastic components, watercraft finish, as well as preventing dust accumulation.

### ***NOTICE***

**The watercraft should never be left in water for storage. Never leave the watercraft stored in direct sunlight. Never store watercraft in a plastic bag.**

# STORAGE AND PRESEASON PREPARATION

## Storage

### **⚠ WARNING**

Because fuel and oil are flammable, you should have an authorized Sea-Doo dealer, repair shop, or person of your own choosing to inspect the fuel system integrity as specified in the periodic inspection chart.

It is recommended that the watercraft be serviced by an authorized Sea-Doo dealer, repair shop, or person of your own choosing for storage, however the following operations can be performed by you with a minimum of tools.

### NOTE:

Carry out the following tasks in the same order as detailed in this section.

### **NOTICE**

**Do not run the engine during the storage period.**

## *Propulsion System*

### Cleaning the Jet Pump

### **⚠ WARNING**

**Always remove tether cord from the engine cut-off switch to prevent unexpected engine starting before cleaning the jet pump area. Engine must not be running for this operation.**

Rinse the jet pump by spraying water through its inlet and outlet openings.

Spray an anti-corrosive product on the propulsion system parts.

### **Service Product**

XPS Anti-Corrosive Lubricant or equivalent

### Inspecting the Jet Pump

Visit your authorized Sea-Doo dealer.

## *Fuel System*

### Protecting the Fuel System

A fuel stabilizer should be added in the fuel tank to prevent fuel deterioration and fuel system gumming. Follow stabilizer manufacturers' instructions for proper use.

### **Service Product**

Fuel stabilizer

### **NOTICE**

**Fuel stabilizer should be added prior to engine lubrication to prevent the loss of the chemical properties of fuel and protect the fuel system against varnish deposits.**

Fill up fuel tank completely. Make sure there is no water inside fuel tank.

### **NOTICE**

**Should any water be trapped inside fuel tank, severe internal damage may occur to the fuel injection system.**

## *Engine and Exhaust*

### Flushing the Exhaust System

Perform procedure as described in *Maintenance Procedures* section.

### Replacing the Engine Oil and Oil Filter

The oil change and filter replacement may be performed by an authorized Sea-Doo dealer, repair shop, or person of your own choosing.

### Draining the Intercooler

It is important to expel any trapped water that may have accumulated from condensation in the intercooler.

Proceed as follows:

1. Remove the seat.
2. Remove the engine service cover. Refer to *Engine Service Cover*.
3. Ensure there is an alignment line drawn on the intercooler inlet hose. This will ensure the hose is not twisted or kinked at reinstallation.
4. Loosen the clamp retaining the intercooler inlet hose.
5. Remove the intercooler inlet hose from the intercooler.

#### NOTE:

This hose feeds the hot, compressed air from the engine supercharger to the intercooler inlet.

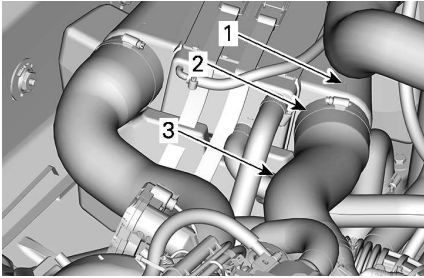

1. Hose alignment lines
2. Hose clamp
3. Intercooler inlet hose

6. The intercooler air side is self-draining into the intercooler inlet-side manifold. By disconnecting the intercooler inlet hose, the presence of condensed water can be visually assessed and properly drained off without the engine running.
7. Reinstall the intercooler air outlet hose, ensure it is properly aligned as prior to removal to ensure proper engine operation.

#### Draining the Exhaust System

In areas where temperature may freeze, water trapped in the exhaust system and intercooler must be removed.

Using the flushing connector, inject pressurized air at 379 kPa (55 lbf/in<sup>2</sup>) into system until there is no more water flowing from jet pump.

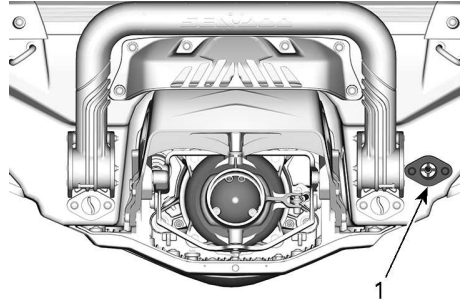

1. Flushing connector

The following hose can be fabricated to ease draining procedure.

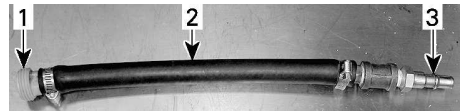

#### TYPICAL

1. Flushing connector adapter
2. Hose 12.7 mm (1/2 in)
3. Air hose male adapter

#### NOTICE

**Failure to drain the exhaust system may cause severe damage to the exhaust manifold.**

Remove special tools.

#### Lubricating the Engine Cylinders

1. Remove spark plugs. Refer to *Maintenance Procedures* section.
2. Spray lubricant in each cylinder through spark plug holes.

#### Service Product

XPS Anti-Corrosive Lubricant or equivalent

3. Fully depress the throttle lever. Depressing the throttle lever will

- prevent fuel from being injected and disable the ignition during engine cranking.
- Press the START/STOP button to crank the engine a few turns. This will distribute the oil on the cylinder walls.
  - Apply anti-seize lubricant on spark plug threads, then reinstall them in the engine. Refer to *Maintenance Procedures* section.
  - Install the ignition coils. Refer to *Maintenance Procedures* section.

### Testing the Engine Coolant Density

If antifreeze is not replaced, test its density.

The antifreeze replacement and a density test should be performed by an authorized Sea-Doo dealer, repair shop or person of your own choosing. Refer to *Maintenance Schedule*.

#### NOTICE

**Improper antifreeze density may result in freezing of the liquid in the cooling system if the watercraft is stored in an area where the freezing point is attained. This would seriously damage the engine.**

## Electrical System

### Battery

#### Battery Maintenance

When storing the watercraft, the battery should always be stored in a warm, dry place.

#### ⚠ WARNING

**Never charge or boost the battery while installed in the watercraft.**

This vehicle is equipped with a maintenance-free type battery, there is no

need to add water to adjust electrolyte level.

#### NOTICE

**Never remove the battery strip from caps or add electrolyte for the life of the battery.**

### Removing the Battery

- Remove the seat.
- Disconnect the battery cables.

#### NOTICE

**Always disconnect the BLACK (-) cable first, then the RED (+) cable.**

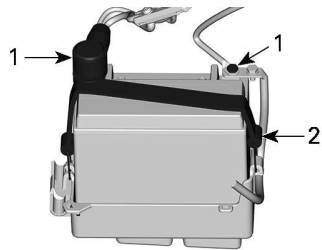

- Battery post
- Strap
- Remove the retaining strap.

### Charging the Battery

Use any automotive type battery charger. Always refer to the battery charger manufacturer's instructions.

### Cleaning the Battery

Clean battery casing and battery posts using a soft brush and a solution of baking soda and water.

Remove corrosion from battery cable terminals and battery posts using a firm wire brush.

Rinse with clear water then dry well.

### Installing the Battery

- Connect the battery cables.



**NOTE:** Remove any water or debris if present in the compartment before installing the battery.

### NOTICE

**Reversed battery polarity will damage the voltage regulator.**

### NOTICE

**Always connect the RED (+) cable first, then the BLACK (-) cable.**

2. Tighten the battery cable screws to specification.

### Tightening Torque

Battery cable screw	$4 \pm 0.5 \text{ Nm}$ ( $35 \pm 4 \text{ lbf-in}$ )
---------------------	---

3. Apply dielectric grease on battery posts.
4. Cover positive battery post with rubber boot.
5. Verify cable routing and attachments.

## Engine Compartment

### Cleaning the Engine Compartment

1. Clean the bilge with hot water and detergent or with bilge cleaner.
2. Rinse thoroughly.
3. Lift front end of watercraft to completely drain bilge through the bilge drain plugs.

### Anticorrosion Treatment

1. Wipe off any residual water in the engine compartment.
2. Lubricate all metallic components in engine compartment.

### Service Product

Lubricant and anti-corrosive or equivalent

### NOTE:

The seat should be removed during storage. This will prevent engine compartment condensation and possible corrosion.

### Body and Hull

Repair, clean and protect the watercraft as per procedures in *Watercraft Care* section.

## Preseason Preparation

The preseason preparation must be performed in conjunction with the *Maintenance Schedule*.

Ensure to perform all tasks included in the **Every Year or 100 Hours** table.

Preseason preparation maintenance may be performed by an authorized Sea-Doo dealer, repair shop or person of your own choosing.

---

# MAINTENANCE RECORDS

Send photocopy of maintenance record to BRP if needed.

Pre-delivery	
Serial number: _____	Signature/Print:
Mileage / km: _____	
Hours: _____	
Date: _____	
Dealer no: _____	
Notes: _____	
_____	
Refer to vehicle Pre-Delivery Bulletin for detailed installation procedures	

<b>First inspection</b>	
Mileage / km: _____ Hours: _____ Date: _____ Dealer no: _____ Notes: _____ _____	Signature/Print: _____    
For maintenance schedule refer to Maintenance Information section of this operator's guide	

<b>Service</b>	
Mileage / km: _____ Hours: _____ Date: _____ Dealer no: _____ Notes: _____ _____	Signature/Print: _____    
For maintenance schedule refer to Maintenance Information section of this operator's guide	

**Service**

Mileage / km:

Hours:

Date:

Dealer no:

Notes:

Signature/Print:

For maintenance schedule refer to Maintenance Information section of this operator's guide

**Service**

Mileage / km:

Hours:

Date:

Dealer no:

Notes:

Signature/Print:

For maintenance schedule refer to Maintenance Information section of this operator's guide

<b>Service</b>	
Mileage / km: _____ Hours: _____ Date: _____ Dealer no: _____ Notes: _____ _____	Signature/Print: _____ _____
For maintenance schedule refer to Maintenance Information section of this operator's guide	

<b>Service</b>	
Mileage / km: _____ Hours: _____ Date: _____ Dealer no: _____ Notes: _____ _____	Signature/Print: _____ _____
For maintenance schedule refer to Maintenance Information section of this operator's guide	

**Service**

Mileage / km:

Hours:

Date:

Dealer no:

Notes:

Signature/Print:

For maintenance schedule refer to Maintenance Information section of this operator's guide

**Service**

Mileage / km:

Hours:

Date:

Dealer no:

Notes:

Signature/Print:

For maintenance schedule refer to Maintenance Information section of this operator's guide

<b>Service</b>	
Mileage / km: _____ Hours: _____ Date: _____ Dealer no: _____ Notes: _____ _____	Signature/Print: _____ _____ _____
For maintenance schedule refer to Maintenance Information section of this operator's guide	

<b>Service</b>	
Mileage / km: _____ Hours: _____ Date: _____ Dealer no: _____ Notes: _____ _____	Signature/Print: _____ _____ _____
For maintenance schedule refer to Maintenance Information section of this operator's guide	

**Service**

Mileage / km:

Hours:

Date:

Dealer no:

Notes:

Signature/Print:

For maintenance schedule refer to Maintenance Information section of this operator's guide

**Service**

Mileage / km:

Hours:

Date:

Dealer no:

Notes:

Signature/Print:

For maintenance schedule refer to Maintenance Information section of this operator's guide



<b>Service</b>	
Mileage / km: _____ Hours: _____ Date: _____ Dealer no: _____ Notes: _____ _____	Signature/Print: _____ _____ _____
For maintenance schedule refer to Maintenance Information section of this operator's guide	

<b>Service</b>	
Mileage / km: _____ Hours: _____ Date: _____ Dealer no: _____ Notes: _____ _____	Signature/Print: _____ _____ _____
For maintenance schedule refer to Maintenance Information section of this operator's guide	

This page is intentionally blank

# TECHNICAL INFORMATION

# IDENTIFICATION NUMBERS

The main components of the watercraft (engine and hull) are identified by different serial numbers. It may sometimes become necessary to locate these numbers for warranty purposes or to trace the watercraft in the event of theft.

## Hull Identification Number

The Hull Identification Number (HIN) is located on footboard at the rear of watercraft.

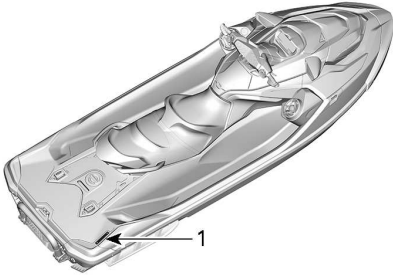

**TYPICAL**

1. Hull Identification Number (HIN)

It is composed of 12 digits:

YDV	12345	L	8	09
				Model year
				Year of production
				Month of production
				Serial number (a letter may also be used as a digit)
				Manufacturer

## Engine Identification Number

The Engine Identification Number (EIN) is located on the front end of the engine.

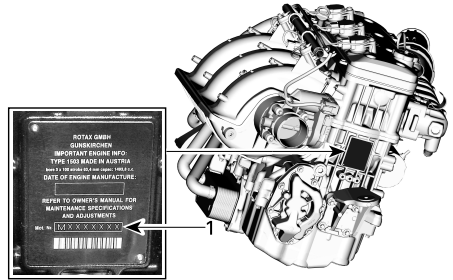

**TYPICAL**

1. Engine Identification Number (EIN)

## Engine Manufacturer Identification



**ENGINE MANUFACTURER IDENTIFICATION LABEL**

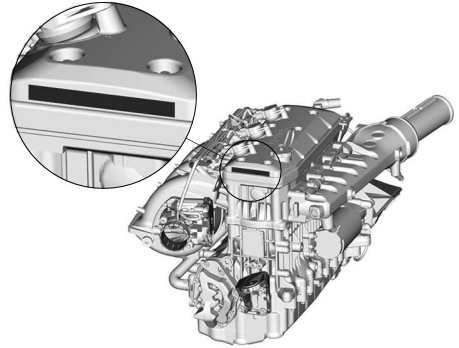

**LABEL LOCATION**

# COMPLIANCE

## Emission Control Hang Tag – 3 Stars

○



**One Star - Low Emission**  
The one-star label identifies engines that meet the Air Resources Board's Personal Watercraft and Outboard marine engine 2001 exhaust emission standards. Engines meeting these standards have 75% lower emissions than conventional carbureted two-stroke engines. These engines are equivalent to the U.S. EPA's 2006 standards for Marine Engines.



**Two Stars - Very Low Emission**  
The two-star label identifies engines that meet the Air Resources Board's Personal Watercraft and Outboard marine engine 2004 exhaust emission standards. Engines meeting these standards have 20% lower emissions than One-Star - Low-Emission engines.



**Three Stars - Ultra Low Emission**  
The three-star label identifies engines that meet the Air Resources Board's Personal Watercraft and Outboard marine engine 2008 exhaust emission standards or the Sterndrive and Inboard marine engine 2003-2008 exhaust emission standards. Engines meeting these standards have 65% lower emissions than One-Star - Low-Emission engines.





**Four Stars - Super Ultra Low Emission**  
The four-star label identifies engines that meet the Air Resources Board's Sterndrive and Inboard marine engine 2009 exhaust emission standards. Personal Watercraft and Outboard marine engines may also comply with these standards. Engines meeting these standards have 90% lower emissions than One-Star - Low-Emission engines.

**Bombardier Recreational Products Inc.**  
VALCOURT, QUÉBEC, CANADA.  
Cleaner Watercraft - Get the Facts  
1-800-END-SMOG  
[www.arb.ca.gov](http://www.arb.ca.gov)

219906047

○









**The Star Label means Cleaner Marine Engines**  
This engine has been certified as a:

**The Symbol for Cleaner Marine Engines:**

**Cleaner Air and Water** - for a healthier lifestyle and environment.

**Better Fuel Economy** - burns up to 30 - 40 percent less gas and oil than conventional carbureted two-stroke engines, saving money and resources.

**Longer Emissions Warranty** - protects consumer for worry free operation.

### EMISSION CONTROL HANG TAG - 3 STARS

## Emission Control Label – 3 Stars



*EMISSION CONTROL LABEL - 3 STARS*



*TYPICAL – LABEL LOCATION*

## EPA Compliance Label

EMISSION CONTROL SYSTEM INFORMATION	
BOMBARDIER RECREATIONAL PRODUCTS INC.	
THIS ENGINE CONFORMS TO	U.S. EPA & CALIFORNIA
EMISSIONS REGULATIONS FOR MARINE SI ENGINES.	
RENSEIGNEMENT SUR LE DISPOSITIF ANTI-POLLUTION	
CE MOTEUR EST CONFORME AUX NORMES	DE L'EPA
DES E.-U. POUR LES MOTEURS MARINS A ALLUMAGE COMMANDÉ.	
	ENGINE FAMILY / FAMILLE DE MOTEUR
(EPA)	CERTIFICATION STANDARDS
(FEL)	NORMES DE CERTIFICATION
(CA)	EMISSION CONTROL SYSTEM
(FEL)	SYSTÈME DE CONTRÔLE DES ÉMISSIONS
MEETS	CALIFORNIA EVAP EMISSIONS REGULATIONS FOR SPARK
IGNITION MARINE WATERCRAFT. EVAP FAMILY	
EVAPORATIVE EMISSION CONTROL SYSTEM: SO	
SEE OPERATOR'S GUIDE FOR MAINTENANCE SCHEDULE AND FUEL,	
OIL AND SPARK PLUG SPECIFICATIONS. VOIR LE CALENDRIER	
D'ENTRETIEN ET LES SPECIFICATIONS D'ESSENCE, D'HUILE ET DE	
BOUGIE D'ALLUMAGE DANS LE GUIDE DE L'OPÉRATEUR.	
	219905703

### EPA COMPLIANCE LABEL



### TYPICAL - LABEL LOCATION

## Regulation Exemption Label



### REGULATION EXEMPTION LABEL

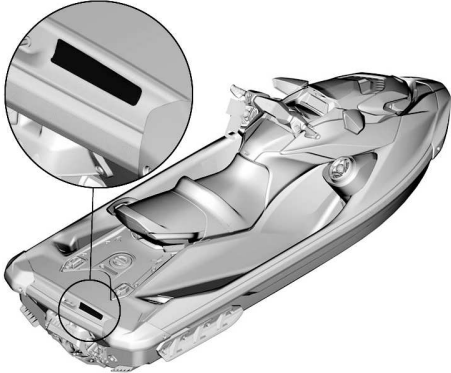

TYPICAL - LABEL LOCATION



## BRP European Distribution SA

BRP is a member of the Association for Eco-Responsible Pleasure Craft, dedicated to the dismantling and recycling of pleasure boats and personal watercraft at the end of their life. The Unique Producer Identifier of BRP European Distribution SA is: FR219503\_18XCIB



---

## RF D.E.S.S. KEY

This device complies with FCC Part 15 and Industry Canada license exempt RSS standard(s).

Operation is subject to the following two conditions: (1) this device may not cause interference, and (2) this device must accept any interference, including interference that may cause undesired operation of the device.

Changes or modifications not expressly approved by the party responsible for compliance could void the user's authority to operate the equipment.

IC Registration Number: 12006A-1001317030

FCC ID: 2ACER-1001317030

We, the party responsible for compliance, declare under our sole responsibility that the device is in conformity with the provisions of the following Council Directive: 2014/53/EU. To which this declaration relates is in conformity with the essential requirements and other relevant requirements. The product is in conformity with the following directives, harmonized standards and regulations:

Radio Equipment Directive (RED) 2014/53/EU and Harmonized Standards:

EN 300 330-2, EN 60950-1

This device complies with part 15 of the FCC Rules. Operation is subject to the following two conditions: (1) This device may not cause harmful interference, and (2) this device must accept any interference received, including interference that may cause undesired operation.

Changes or modifications not expressly approved by the party responsible for compliance could void the user's authority to operate the equipment.

*This device contains licence-exempt transmitter(s)/receiver(s) that comply with Innovation, Science and Economic Development Canada's licence-exempt RSS (s). Operation is subject to the following two conditions:*

(1) This device may not cause interference.

(2) This device must accept any interference, including interference that may cause undesired operation of the device.

*L'émetteur/récepteur exempt de licence contenu dans le présent appareil est conforme aux CNR d'Innovation, Sciences et Développement économique Canada applicables aux appareils radio exempts de licence. L'exploitation est autorisée aux deux conditions suivantes:*

(1) l'appareil ne doit pas produire de brouillage;

(2) l'appareil doit accepter tout brouillage radioélectrique subi, même si le brouillage est susceptible d'en compromettre le fonctionnement.

Radio Equipment Directive (RED)	2014/53/EU
Article 3.1a	Safety and health IEC 62368-1:2014
Article 3.1b	EMC CISPR 25:(2016); conducted emission CISPR 25:(2016); radiated emission ISO 11452-2 (2004); radiated electromagnetic field immunity
Article 3.2	Spectrum usage efficiency ETSI EN 300 330 V2.1.1 (2017-2)

# MULTIFUNCTION GAUGE REGULATORY INFORMATION

## Technical Information

### Transmitter:

- BT operating frequency range: 2402 – 2480 MHz
- BT version: 4.2 (no BTLE)
- BT output power: < 8.5 dBm

### Receiver:

- FM operating range: 76 - 108 MHz

## Manufacturer and Address

### Manufacturer:

- Robert Bosch LLC

### Address:

- 38000 Hills Tech Drive,  
Farmington Hills, MI 48331,  
USA

To display the regulatory information on the vehicle digital display: From the home screen, access the main menu and keep the joystick pressed down for more than 10 seconds.

## USA and Canada

This device complies with FCC Part 15 and Industry Canada license exempt RSS standard(s). Operation is subject to the following two conditions: (1) this device may not cause interference, and (2) this device must accept any interference, including interference that may cause undesired operation of the device.

Le présent appareil est conforme aux CNR d'Industrie Canada applicables aux appareils radio exempts de licence. L'exploitation est autorisée aux deux conditions suivantes:

- (1) l'appareil ne doit pas produire de brouillage, et
- (2) l'utilisateur de l'appareil doit accepter tout brouillage radioélectrique subi, même si le brouillage est susceptible d'en compromettre le fonctionnement.

Changes or modifications not expressly approved by the party responsible for compliance could void the user's authority to operate the equipment.

IC: 22868 - VDIBRHS01

FCC ID: 2AMJS - VDIBRHS01

RF exposure:

1. The equipment complies with FCC RF exposure limits set forth for an uncontrolled environment.
2. This equipment must be installed and operated with a separation distance of at least 20 cm from all persons.
3. The antenna(s) used for this transmitter must not be co-located or operating in conjunction with any other antenna or transmitter.

## Mexico

IFETEL

Marca: Robert Bosch LLC

Modelo(s): VIPHI2BT

Número: RCPBOVI18-0967

NOM-208-SCFI-2016

La operación de este equipo está sujeta a las siguientes dos condiciones: (1) es posible que este equipo o dispositivo no cause interferencia perjudicial y (2) este equipo o dispositivo debe aceptar cualquier interferencia, incluyendo la que pueda causar su operación no deseada.

## Brazil



03473-18-04473

Este equipamento opera em caráter secundário, isto é, não tem direito a proteção contra interferência prejudicial, mesmo de estações do mesmo tipo, e não pode causar interferência a sistemas operando em caráter primário.

### **Japan**

This device is granted pursuant to the Japanese Radio Law (電波法) and the Japanese Telecommunications Business Law (電気通信事業法).

This device should not be modified (otherwise the granted designation number will become invalid).

### **Europe**

#### **Declaration of Conformity**

Simplified EU Declaration of Conformity according Radio Equipment Directive 2014/53/EU



DE

Hiermit erklärt Robert Bosch LLC, dass der Funkanlagentyp VIPHI2BT der Richtlinie 2014/53/EU entspricht. Der vollständige Text der EU-Konformitätserklärung ist unter der folgenden Internetadresse verfügbar: eu-doc.bosch.com

FR

Le soussigné, Robert Bosch LLC, déclare que l'équipement radioélectrique du type VIPHI2BT est conforme à la directive 2014/53/UE.

Le texte complet de la déclaration UE de conformité est disponible à l'adresse internet suivante: eu-doc.bosch.com

BG

С настоящото Robert Bosch LLC декларира, че този тип радиосъоръжение VIPHI2BT е в съответствие с Директива 2014/53/ЕС.

Цялостният текст на ЕС декларацията за съответствие може да се намери на следния интернет адрес: eu-doc.bosch.com

EL

Με την παρούσα ο/η Robert Bosch LLC, δηλώνει ότι ο ραδιοεξοπλισμός VIPHI2BT πληροί την οδηγία 2014/53/ΕΕ. Το πλήρες κείμενο της δήλωσης συμμόρφωσης ΕΕ διατίθεται στην ακόλουθη ιστοσελίδα στο διαδίκτυο: eu-doc.bosch.com

CS

Tímto Robert Bosch LLC prohlašuje, že typ rádiového zařízení VIPHI2BT je v souladu se směrnicí 2014/53/EU. Úplné znění EU prohlášení o shodě je k dispozici na této internetové adrese: eu-doc.bosch.com

DA

Hermed erklærer Robert Bosch LLC, at radioudstyretypen VIPHI2BT er i overensstemmelse med direktiv 2014/53/EU.

EU-overensstemmelseserklæringens fulde tekst kan findes på følgende internetadresse: eu-doc.bosch.com

ET

Käesolevaga deklareerib Robert Bosch LLC, et käesolev raadioseadme tüüp VIPHI2BT vastab direktiivi 2014/53/EL nõuetele.

ELi vastavusdeklaratsiooni täielik tekst on kättesaadav järgmisel internetiaadressil: eu-doc.bosch.com

ES

Por la presente, Robert Bosch LLC declara que el tipo de equipo radioeléctrico VIPHI2BT es conforme con la Directiva 2014/53/UE.

El texto completo de la declaración UE de conformidad está disponible en la dirección Internet siguiente: eu-doc.bosch.com

FI

Robert Bosch LLC vakuuttaa, että radiolaitetyypin VIPHI2BT on direktiivin 2014/53/EU mukainen.

EU-vaatimustenmukaisuusvakuutuksen täysimittainen teksti on saatavilla seuraavassa internetosoitteessa: eu-doc.bosch.com

EN

Hereby, Robert Bosch LLC declares that the radio equipment type VIPHI2BT is in compliance with Directive 2014/53/EU.

The full text of the EU declaration of conformity is available at the following internet address: eu-doc.bosch.com

HR

Robert Bosch LLC ovime izjavljuje da je radijska oprema tipa VIPHI2BT u skladu s Direktivom 2014/53/EU.

Cjeloviti tekst EU izjave o sukladnosti dostupan je na sljedećoj internetskoj adresi: eu-doc.bosch.com

HU

Robert Bosch LLC igazolja, hogy a VIPHI2BT típusú rádióberendezés megfelel a 2014/53/EU irányelvnek.

Az EU-megfelelőségi nyilatkozat teljes szövege elérhető a következő internetes címen: eu-doc.bosch.com

IT

Il fabbricante, Robert Bosch LLC, dichiara che il tipo di apparecchiatura radio VIPHI2BT è conforme alla direttiva 2014/53/UE.

Il testo completo della dichiarazione di conformità UE è disponibile al seguente indirizzo Internet: eu-doc.bosch.com

LT  
 Aš, Robert Bosch LLC, patvirtinu, kad radijo įrenginių tipas VIPHI2BT atitinka Direktyvą 2014/53/ES.  
 Visas ES atitikties deklaracijos tekstas prieinamas šiuo interneto adresu: eu-doc.bosch.com

LV  
 Ar šo Robert Bosch LLC deklarē, ka radioiekārta VIPHI2BT atbilst Direktīvai 2014/53/ES.  
 Pilns ES atbilstības deklarācijas teksts ir pieejams šādā internetā vietnē: eu-doc.bosch.com

MT  
 B'dan, Robert Bosch LLC, niddikjara li dan it-tip ta' taghmir tar-radju VIPHI2BT huwa konformi mad-Direttiva 2014/53/UE.

It-test kollu tad-dikjarazzjoni ta' konformità tal-UE huwa disponibbli f'dan l-indirizz tal-Internet li ġej: eu-doc.bosch.com

NL  
 Hierbij verklaar ik, Robert Bosch LLC, dat het type radioapparatuur VIPHI2BT conform is met Richtlijn 2014/53/EU.

De volledige tekst van de EU-conformiteitsverklaring kan worden geraadpleegd op het volgende internetadres: eu-doc.bosch.com

PL  
 Robert Bosch LLC niniejszym oświadcza, że typ urządzenia radiowego VIPHI2BT jest zgodny z dyrektywą 2014/53/UE.

Pełny tekst deklaracji zgodności UE jest dostępny pod następującym adresem internetowym: eu-doc.bosch.com

PT  
 O(a) abaixo assinado(a) Robert Bosch LLC declara que o presente tipo de equipamento de rádio VIPHI2BT está em conformidade com a Diretiva 2014/53/UE.

O texto integral da declaração de conformidade está disponível no seguinte endereço de Internet: eu-doc.bosch.com

RO  
 Prin prezenta, Robert Bosch LLC declară că tipul de echipamente radio VIPHI2BT este în conformitate cu Directiva 2014/53/UE.

Textul integral al declarației UE de conformitate este disponibil la următoarea adresă internet: eu-doc.bosch.com

SV  
 Härmed försäkrar Robert Bosch LLC att denna typ av radioutrustning VIPHI2BT överensstämmer med direktiv 2014/53/EU.

Den fullständiga texten till EU-försäkran om överensstämmelse finns på följande webbadress: eu-doc.bosch.com

SL  
 Robert Bosch LLC potrjuje, da je tip radijske opreme VIPHI2BT skladen z Direktivo 2014/53/EU.

Celotno besedilo izjave EU o skladnosti je na voljo na naslednjem spletnem naslovu: eu-doc.bosch.com

SK  
 Robert Bosch LLC týmto vyhlasuje, že rádiové zariadenie typu VIPHI2BT je v súlade so smernicou 2014/53/EÚ.

Úplné EÚ vyhlásenie o zhode je k dispozícii na tejto internetovej adrese: eu-doc.bosch.com

IS  
 Robert Bosch LLC lýsir því hér með yfir að þráðlausi fjarskiptabúnaðurinn VIPHI2BT er í samræmi við tilskipun 2014/53/ESB.

Óstytta texta ESB-samræmisýfirlýsingarinnar er að finna á veffanginu: eu-doc.bosch.com

Liechtenstein  
 Hiermit erklärt Robert Bosch LLC, dass der Funkanlagentyp VIPHI2BT der Richtlinie 2014/53/EU entspricht.

Der vollständige Text der EU-Konformitätserklärung ist unter der folgenden Internetadresse verfügbar: eu-doc.bosch.com

NO  
 Hermed erklærer Robert Bosch LLC at radioustyrstypen VIPHI2BT er i samsvar med direktiv 2014/53/EU.

Hele teksten i EU-samsvarserklæringen finnes på følgende internettadresse: eu-doc.bosch.com

RU  
 Компания Robert Bosch LLC настоящим заявляет, что радиотехническое оборудование категории VIPHI2BT отвечает требованиям Директивы 2014/53/EU.

Полный текст декларации соответствия ЕС доступен на сайте eu-doc.bosch.com.

---

# BRP AUDIO SYSTEM

This equipment has been tested and found to comply with the limits for a Class B digital device, pursuant to Part 15 of the FCC rules. These limits are designed to provide reasonable protection against harmful interference in a residential installation.

This equipment generates, uses, and can radiate radio frequency energy and, if not installed and used in accordance with the instructions, may cause harmful interference to radio communications. However, this is no guaranty that interference will occur in a particular installation.

If this equipment does cause harmful interference to radio or television reception, which can be determined by turning the equipment off or on, you are encouraged to try to correct the interference by one or more of the following measure:

- Reorient or relocate the receiving antenna.
- Increase the separation between the equipment and receiver.
- Connect the equipment to an outlet on a different circuit than the one to which the receiver is connected.
- Consult the dealer or an experienced radio/TV technician for help.

Changes or modifications not expressly approved by Mitek Corporation could void the user's authority to operate this equipment. This device complies with Part 15 of the FCC rules.

Operation is subject to the following two conditions:

- (1) This device may not cause harmful interference, and
- (2) This device must accept any interference received, including interference that may cause undesired operation.

IC Registration Number:  
22793-278003465

FCC ID: 2AAOY - 278003465

*L'émetteur/ récepteur exempt de licence contenu dans le présent appareil est conforme aux CNR d'Innovation, Sciences et Développement économique Canada applicables aux appareils radio exempts de licence. L'exploitation est autorisée aux deux conditions suivantes :*

(1) l'appareil ne doit pas produire de brouillage;

(2) l'appareil doit accepter tout brouillage radioélectrique subi, même si le brouillage est susceptible d'en compromettre le fonctionnement.

Radio Equipment Directive (RED) 2014/53/EU and Harmonized Standards:

- ETSI EN 300 328 V2.1.1 (2016-11)
- ETSI EN301 489-1 V2.1.1 (2017-02)
- ETSI EN301 489-17 V3.1.1 (2017-02)
- EN 62479:2010



---

# ENGINE EMISSIONS INFORMATION

## Manufacturer's Responsibility

Manufacturers of marine engines must determine the exhaust emission levels for each engine horsepower family and certify these engines with the United States of America Environmental Protection Agency (EPA). An emissions control information label, showing emission levels and engine specifications, must be placed on each Spark-Ignition Propulsion Marine Engines (SIPME) at the time of manufacture.

## Dealer's Responsibility

When performing service on a Sea-Doo SIPME that carry an emissions control information label, adjustments must be kept within published factory specifications.

Replacement or repair of any emission related component must be executed in a manner that maintains emission levels within the prescribed certification standards.

Dealers are not to modify the engine in any manner that would alter the horsepower or allow emission levels to exceed their predetermined factory specifications.

Exceptions include manufacturer's prescribed changes, such as altitude adjustments for example.

## Owner's Responsibility

The owner/operator is required to have engine maintenance performed to maintain emission levels within prescribed certification standards.

The owner/operator is not to, and should not allow anyone to modify the engine in any manner that would alter the horsepower or allow emissions levels to exceed their predetermined factory specifications.

## EPA Emission Regulations

Sea-Doo SIPME manufactured by BRP are certified to the EPA as conforming to the requirements of the regulations for the control of air pollution from new SIPME. This certification is contingent on certain adjustments being set to factory standards. For this reason, the factory procedure for servicing the product must be strictly followed and, whenever practicable, returned to the original intent of the design.

The responsibilities listed above are general and in no way a complete listing of the rules and regulations pertaining to the EPA requirements on exhaust emissions for marine products. For more detailed information on this subject, you may contact:

U. S. Environmental Protection Agency  
Certification Division  
Gasoline Engine Compliance Center  
2000 Traverwood Drive  
Ann Arbor MI 48105  
USA

## EPA INTERNET WEB SITE:

[www.epa.gov/otaq](http://www.epa.gov/otaq)

## Evaporative Emission Control System

Spark-Ignition Marine Watercraft (SIMW) sold in the State of California are certified to the California evaporative emissions regulations for SIMW of the California Air Resources Board (13 CCR 2850 to 2869). These models are equipped with an evaporative emission control system consisting of Low Permeation Fuel Tank (LPFT), Low Permeation Fuel Line (LPFL) and a Pressure Relief Valve (PRV).

---

# EU DECLARATION OF CONFORMITY

Left blank for EU Conformity

---

# UK DECLARATION OF CONFORMITY

Left blank for UK Conformity

---

# EAC DECLARATION OF CONFORMITY

Left blank for Eurasian Conformity  
mark where applicable

# **TECHNICAL SPECIFICATIONS**

# ENGINE

## Rotax 1630 ACE - 170

Engine	
Engine type	4-stroke, Single Over Head Camshaft (SOHC)
Declared Power (Declared power as per ISO 8665 at propeller-shaft.)	125 kW @ 8000 RPM
Induction	Naturally-Aspirated
Number of cylinders	3
Number of valves	12 valves with hydraulic lifters (no adjustment)
Bore	100 mm (3.9 in)
Stroke	69.2 mm (2.7 in)
Displacement	1 630.5 cm <sup>3</sup> (99.5 in <sup>3</sup> )
Compression ratio	11:1

Fuel System	
Fuel injection type	Multipoint fuel injection with iTC (intelligent Throttle Control). Single throttle body (60 mm) with an actuator
Idle speed (not adjustable)	1800 ± 50 RPM

Electrical System		
Ignition system type		IDI (Inductive Discharge Ignition)
Spark plug (Do not attempt to adjust gap on this spark plug.)	Type	NGK, DCPR8E with solid post or equivalent
	Gap	0.80 to 0.90 mm (.031 to .035 in)

Lubrication			
Engine oil	Recommended XPS oil	General purpose	5W40 Synthetic blend oil
		Warm temperature	10W50 Synthetic oil
	Alternate oil if XPS products are not available		Use a <b>4-stroke SAE synthetic engine oil</b> meeting or exceeding the following lubricant industry specifications. Always check the API service label certification on the oil container, it must contain at least one of the indicated standards. <b>API service classification SN or JASO-MA2</b>
	Capacity	Oil change with filter	3 l (3.2 qt (liq.,US))
		Total	5 l (5.3 qt (liq.,US))

## Rotax 1630 ACE - 230

Engine	
Engine type	4-stroke, Single Over Head Camshaft (SOHC)
Declared Power (Declared power as per ISO 8665 at propeller-shaft.)	169.16 kW @ 8000 RPM
Induction	Supercharged and intercooled
Number of cylinders	3
Number of valves	12 valves with hydraulic lifters (no adjustment)
Bore	100 mm (3.9 in)
Stroke	69.2 mm (2.7 in)

Engine	
Displacement	1 630.5 cm <sup>3</sup> (99.5 in <sup>3</sup> )
Compression ratio	8.3:1

Fuel System	
Fuel injection type	Multipoint fuel injection with iTC (intelligent Throttle Control). Single throttle body (60 mm) with an actuator
Idle speed (not adjustable)	1750 ± 50 RPM

Electrical System		
Ignition system type		IDI (Inductive Discharge Ignition)
Spark plug (Do not attempt to adjust gap on this spark plug.)	Type	NGK, DCPR8E with solid post or equivalent
	Gap	0.80 to 0.90 mm (.031 to .035 in)

Lubrication			
Engine oil	Recom- mended XPS oil	General purpose	5W40 Synthetic blend oil
		Warm tempera- ture	10W50 Synthetic oil
	Alternate oil if XPS products are not available		<p>Use a <b>4-stroke SAE motorcycle engine oil compatible with wet clutches</b> meeting or exceeding the following lubricant industry specifications.</p> <p>Always check the API service label certification on the oil container, it must contain at least one of the indicated standards.</p> <p><b>API service classification SN or JASO-MA2</b></p>



Lubrication			
	Capacity	Oil change with filter	3 l (3.2 qt (liq.,US))
		Total	5 l (5.3 qt (liq.,US))

## Rotax 1630 ACE - 300

Engine	Rotax 1630 ACE - 300
Engine type	4-stroke, Single Over Head Camshaft (SOHC)
Declared Power <sup>(1)</sup>	217 kW @ 8000 RPM
Induction	Supercharged and intercooled
Number of cylinders	3
Number of valves	12 valves with hydraulic lifters (no adjustment)
Bore	100 mm (3.9 in)
Stroke	69.2 mm (2.7 in)
Displacement	1 630.5 cm <sup>3</sup> (99.5 in <sup>3</sup> )
Compression ratio	8.45:1

FUEL SYSTEM	
Fuel injection type	Multipoint fuel injection with iTC (intelligent Throttle Control). Single throttle body (60 mm) with an actuator
Idle speed (not adjustable)	1750 ± 50 RPM

ELECTRICAL SYSTEM		
Ignition system type		IDI (Inductive Discharge Ignition)
Spark plug <sup>(2)</sup>	Type	NGK, KR9C-G with solid post or equivalent
	Gap	0.80 to 0.90 mm (.031 to .035 in)

LUBRICATION			
Engine oil <sup>(3)</sup>	Recommended XPS oil	General purpose	5W40 Synthetic blend oil
		Warm temperature	10W50 Synthetic oil
	Alternate oil if XPS products are not available		<p>Use a <b>4-stroke SAE motorcycle engine oil compatible with wet clutches</b> meeting or exceeding the following lubricant industry specifications.</p> <p>Always check the API service label certification on the oil container, it must contain at least one of the indicated standards.</p> <p><b>API service classification SN or JASO-MA2</b></p>
	Capacity	Oil change with filter	3 l (3.2 qt (liq.,US))
		Total	5 l (5.3 qt (liq.,US))

(1) Declared power as per ISO 8665 at propeller-shaft.

(2) **NOTICE** Do not attempt to adjust gap on this spark plug.

(3) Refer to *Engine Oil* for detailed information.

# VEHICLE

## GTX and Wake PRO

BRP reserves the right to make changes in design and specifications and/or to make additions to, or improvements in its products without imposing any obligation upon itself to install them on its products previously manufactured.

Cooling System		
Type		Closed-loop cooling system (CLCS)
Coolant	Recommended	XPS Extended life pre-mixed coolant
	Alternative, or if not available	Use a low silicate, extended life ethylene-glycol premixed coolant (50%-50%) specifically formulated for internal combustion aluminum engines.
	Capacity	5.4 l (5.7 qt(liq.,US))

Fuel System			
Fuel pump			In-tank electrical
Fuel	Type	Rotax 1630 ACE - 170 Rotax 1630 ACE - 230	Regular unleaded Refer to <i>Fuel Requirements</i>
		Rotax 1630 ACE - 300	Premium unleaded Refer to <i>Fuel Requirements</i>
	Octane rating	Rotax 1630 ACE - 170 Rotax 1630 ACE - 230	87 Pump Posted AKI (RON+MON)/2 or 91 (RON) E10
		Rotax 1630 ACE - 300	91 Pump Posted AKI (RON+MON)/2 or 95 (RON) E10
Tank capacity		Full	70 l (18.5 gal(liq. US))
		Reserve (from low level signal - approx.)	14 l (3.7 gal(liq. US))

<b>Electrical System</b>			
Battery		12 V, 18 Ah	
Total system output		420 W @ 6000 RPM	
Fuses	F2	Fuel Inj., Ign. Coils and Fuel Pump	15 A
	F3	Bilge pump (if equipped)	3 A
	F6	Charge	30 A
	F7	Cluster	5 A
	F9	iBR	30 A
	F10	Start/ Stop	5 A
	F11	ECM	5 A
	F12	Battery	30 A
	F13	Diagnostic Connector (6), Accessory connector (2)	15 A
	F14	Diagnostic Connector (5), Accessory connector (1)	15 A
Relay	RY1	Main	—

<b>Propulsion</b>		
Propulsion system		Sea-Doo® jet pump
Jet pump	Type	Axial flow, single stage. Large hub with double row ball bearings
	Material	Aluminum
Impeller		Stainless steel
Transmission	Type	Direct drive

<b>Weight and Loading Capacity</b>		
Dry weight	GTX 170	352 kg (776 lb)
	GTX 170 (With sound system)	361 kg (796 lb)
	GTX 230	367 kg (809 lb)
	GTX 230 (With sound system)	376 kg (829 lb)
	GTX 300	366 kg (806 lb)
	GTX 300 (With sound system)	376 kg (829 lb)
	GTX Limited 300	385 kg (849 lb)
	Wake Pro 230	379 kg (855 lb)
Number of passenger (driver incl.)		3
Load limit (passenger(s) and luggage, including accessories)		272 kg (600 lb)
Storage capacity		98.9 l (26.1 gal(liq.,US))

<b>Dimensions</b>	
Overall length	345.1 cm (135.9 in)
Overall width	125.5 cm (49.4 in)
Overall height	113.8 cm (44.8 in)

This page is intentionally blank

# TROUBLESHOOTING

# TROUBLESHOOTING GUIDELINES

## ENGINE WILL NOT START

1. **Master switch opened.**
  - Close the master switch.
2. **Tether cord removed.**
  - Press START/STOP button.
  - Install tether cord cap over engine cut-off switch within 5 seconds after depressing the START/STOP button.
  - Press START/STOP button.
3. **ECM does not recognize the D.E.S.S. key.**
  - Refer to an authorized Sea-Doo dealer.
4. **Burnt fuse: main, electric starter or ECM.**
  - Check wiring then replace fuse(s).
5. **Discharged battery.**
  - Refer to an authorized Sea-Doo dealer.

### **WARNING**

**Do not charge or boost the battery while installed on the watercraft. Electrolyte is poisonous and dangerous. Avoid contact with eyes, skin and clothing.**

6. **Battery connections, corroded or loose. Bad ground.**
  - Refer to an authorized Sea-Doo dealer.
7. **Water-flooded engine.**
  - Refer to Water-Flooded Engine in Special Procedures.
8. **Faulty sensor or ECM.**
  - Seek service from an authorized Sea-Doo dealer, repair shop, or person of your own choosing for maintenance, repair, or replacement. Please refer to the US EPA Emission-Related Warranty contained herein for information about warranty claims.
9. **Seized jet pump.**
  - Try to clean. Otherwise, refer to an authorized Sea-Doo dealer.

## ENGINE CRANKS SLOWLY

1. **Loose battery cable connections.**
  - Check/clean/tighten.
2. **Discharged or weak battery.**
  - Refer to an authorized Sea-Doo dealer.
3. **Worn starter.**
  - Refer to an authorized Sea-Doo dealer.



**ENGINE TURNS NORMALLY BUT WILL NOT START**

1. **Fuel tank empty or water-contaminated.**
  - *Refill. Siphon and fill with fresh fuel.*
2. **Fouled/defective spark plugs.**
  - *Replace.*
3. **Blown fuse.**
  - *Check wiring then replace fuse(s).*
4. **Water-flooded engine.**
  - *Refer to Water-Flooded Engine in Special Procedures.*
5. **Engine management system fault detected (check engine pilot lamp is ON).**
  - *Seek service from an authorized Sea-Doo dealer, repair shop, or person of your own choosing for maintenance, repair, or replacement. Please refer to the US EPA Emission-Related Warranty contained herein for information about warranty claims.*
6. **Faulty fuel pump.**
  - *Seek service from an authorized Sea-Doo dealer, repair shop, or person of your own choosing for maintenance, repair, or replacement. Please refer to the US EPA Emission-Related Warranty contained herein for information about warranty claims.*

**ENGINE MISFIRES, RUNS IRREGULARLY**

1. **Fouled/defective/worn spark plugs.**
  - *Replace.*
2. **Fuel: Level too low, stale or water-contaminated.**
  - *Siphon and/or refill.*
3. **Faulty ignition coil(s).**
  - *Seek service from an authorized Sea-Doo dealer, repair shop, or person of your own choosing for maintenance, repair, or replacement. Please refer to the US EPA Emission-Related Warranty contained herein for information about warranty claims.*
4. **Clogged injectors.**
  - *Seek service from an authorized Sea-Doo dealer, repair shop, or person of your own choosing for maintenance, repair, or replacement. Please refer to the US EPA Emission-Related Warranty contained herein for information about warranty claims.*
5. **Engine management system fault detected (check engine pilot lamp is ON).**
  - *Refer to Monitoring System.*

## ENGINE SMOKE

### 1. Oil level too high.

- Seek service from an authorized Sea-Doo dealer, repair shop, or person of your own choosing for maintenance, repair, or replacement. Please refer to the US EPA Emission-Related Warranty contained herein for information about warranty claims.

### 2. Water ingestion, coolant leak or damaged cylinder head gasket.

- Seek service from an authorized Sea-Doo dealer, repair shop, or person of your own choosing for maintenance, repair, or replacement. Please refer to the US EPA Emission-Related Warranty contained herein for information about warranty claims.

### 3. Internal engine damage.

- Seek service from an authorized Sea-Doo dealer, repair shop, or person of your own choosing for maintenance, repair, or replacement. Please refer to the US EPA Emission-Related Warranty contained herein for information about warranty claims.

## ENGINE OVERHEATS

### 1. Clogged exhaust system.

- Flush exhaust system.

### 2. Engine coolant level too low.

- Refer to Maintenance Procedures.

### 3. Quick connect adapter left in flushing connector.

- Remove adapter from flushing connector and retry watercraft. If problem persists, seek service from an authorized Sea-Doo dealer, repair shop, or person of your own choosing for maintenance, repair, or replacement. Please refer to the US EPA Emission-Related Warranty contained herein for information about warranty claims.

**ENGINE LACKS ACCELERATION OR POWER**

1. **Learning key used.**
  - *Use a Normal key.*
2. **Not in Sport mode.**
  - *Select Sport mode.*
3. **Jet pump water intake clogged.**
  - *Clean. Refer to Jet Pump Water Intake and Impeller Cleaning in Special Procedures section.*
4. **Damaged impeller or worn-out wear ring.**
  - *Replace. Refer to an authorized Sea-Doo dealer.*
5. **Engine oil level too high.**
  - *Seek service from an authorized Sea-Doo dealer, repair shop, or person of your own choosing for maintenance, repair, or replacement. Please refer to the US EPA Emission-Related Warranty contained herein for information about warranty claims.*
6. **Weak spark.**
  - *Refer to ENGINE MISFIRES, RUNS IRREGULARLY.*
7. **Engine management system fault detected (check engine pilot lamp is ON).**
  - *Refer to Monitoring System.*
8. **Clogged injectors.**
  - *Seek service from an authorized Sea-Doo dealer, repair shop, or person of your own choosing for maintenance, repair, or replacement. Please refer to the US EPA Emission-Related Warranty contained herein for information about warranty claims.*
9. **Low fuel pressure.**
  - *Seek service from an authorized Sea-Doo dealer, repair shop, or person of your own choosing for maintenance, repair, or replacement. Please refer to the US EPA Emission-Related Warranty contained herein for information about warranty claims.*
10. **Water in fuel.**
  - *Siphon and replace.*
11. **Engine damaged by water ingestion.**
  - *Refer to an authorized Sea-Doo dealer.*

**WATERCRAFT CAN NOT REACH TOP SPEED**

1. **Jet pump water intake clogged.**
  - *Clean. Refer to Jet Pump Water Intake and Impeller Cleaning in Special Procedures section.*
2. **Damaged impeller or worn-out wear ring.**
  - *Replace. Refer to an authorized Sea-Doo dealer.*
3. **Engine management system fault detected (check engine pilot lamp is ON).**
  - *Refer to Monitoring System.*

**WATERCRAFT STAYS IN NEUTRAL AFTER OPERATING THE iBR LEVER**

1. **The iBR gate stays in neutral.**
  - *Release the throttle to idle RPM.*

**iBR WILL NOT RETURN TO NEUTRAL POSITION (iBR INDICATOR LIGHT ON)**

1. **iBR jammed with debris.**
  - *Clean and check for damage in the iBR gate and nozzle area.*
2. **iBR system malfunction.**
  - *Remove tether cord, wait four minutes, reinstall key and check iBR light to ensure fault is cleared.*
  - *Refer to an authorized Sea-Doo dealer if fault persists or reoccurs frequently.*

**iBR WILL NOT RETURN TO NEUTRAL POSITION (iBR INDICATOR LIGHT OFF)**

1. **Throttle lever not fully released during operation.**
  - *Release throttle lever fully to ensure iBR gate returns to neutral.*
2. **Throttle lever does not fully return to null when released.**
  - *Refer to an authorized Sea-Doo dealer.*

**ABNORMAL NOISE FROM PROPULSION SYSTEM**

1. **Weeds or debris jammed around impeller.**
  - *Clean. Refer to Jet Pump Water Intake and Impeller Cleaning in Special Procedures section.*
  - *Check for damage.*
2. **Damaged impeller shaft or drive shaft.**
  - *Refer to an authorized Sea-Doo dealer.*
3. **Water intrusion in jet pump causing bearing seizure.**
  - *Refer to an authorized Sea-Doo dealer.*

**WATER FOUND IN BILGE**

1. **Bilge pump system malfunction.**
  - *Have system inspected by an authorized Sea-Doo dealer.*
2. **Exhaust system leak.**
  - *Refer to an authorized Sea-Doo dealer.*
3. **Carbon ring at drive shaft worn.**
  - *Refer to an authorized Sea-Doo dealer.*
4. **Hull and/or Deck seal displaced or fasteners loose.**
  - *Refer to an authorized Sea-Doo dealer.*

---

# MONITORING SYSTEM

A system monitors the electronic components of the EMS (engine management system) iBR, and other components of the electrical system. When a fault occurs, it sends visual messages through the information center and/or audible signals through a beeper to inform you of a particular condition.

A fault code may also be recorded.

When a minor or transient fault occurs, the fault message and beeper will cease automatically if the condition that caused the fault does not exist anymore.

Releasing the throttle and letting the engine return to idle speed may allow normal operation to come back. If this does not work, try removing and reinstalling the tether cord on the engine cut-off switch.

The electronic system will react differently depending on the fault type. In severe failure, the engine may not be allowed to be started. In other cases, the engine will operate in limp home mode (reduced speed).

When a fault occurs, please refer to the *US EPA Emission-Related Warranty* contained herein for information about warranty claims.

## Fault Codes

When a fault occurs, a numerical fault code may be recorded depending on the fault type and system.

These fault codes are used by authorized Sea-Doo dealers for troubleshooting the watercraft systems when comparing them to a fault list.

Fault codes can be viewed in the information center multifunction display however, this function is only available if a fault is still active.

If there is an active fault code, it may be viewed by the operator on the multifunction display. The operator may

then choose to call his authorized Sea-Doo dealer to pass on the fault code. The dealer will then advise the operator on the steps to take to solve the problem, or to stop using the watercraft and to bring it in to the dealer for repairs.

## Displaying Fault Codes

Select **CODES**. If a fault code has occurred during your riding cycle, a **CODES** menu will be available in the settings menu. Press OK to see the list of faults.

### NOTE:



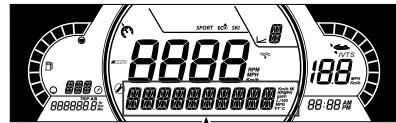

During normal riding conditions some fault codes may occur. Before contacting your local dealer, remove the key, make sure to wait 2 minutes until the electrical system shuts down, then press start to wake up the electrical system. This will ensure occurred fault to disappear and only the active codes will remain ON in the **CODES** menu.



## Indicator Lights and Message Display Information

The indicator lights (pilot lamps) and messages displayed in the information center will inform you of a particular condition or if an anomaly occurs.

For information on usual indicator lights, refer to appropriate digital display.

Indicator Light / Icon (ON)	Message Display	Description
	LOW or HIGH BATTERY VOLTAGE	Low/high battery voltage
	HIGH TEMPERATURE	Engine or exhaust system overheating
	CHECK ENGINE or LIMP HOME MODE	Check engine (minor fault req. maint.) or LIMP HOME MODE (major eng. fault)
	LOW OIL PRESSURE	Low oil pressure
	IBR MODULE ERROR	Light is steady with a buzzer and a check engine light: iBR system fault (refer to an authorized Sea-Doo dealer)
	—	Light is flashing: iBR system fault (refer to an authorized Sea-Doo dealer)
	—	Light is steady with no buzzer: iBR system still functional but needs to be inspected by an authorized Sea-Doo dealer

Message Display	Description
HIGH EXHAUST TEMPERATURE	High exhaust temperature detected
HIGH ENGINE TEMPERATURE	High engine temperature detected
CHECK ENGINE	Engine system malfunction and/or requiring maintenance
LIMP HOME MODE	Major fault detected, engine power limited
FUEL SENSOR FAULT	Fuel level sensor fault
WATER TEMP SENSOR DEFECTIVE	Problem with water temperature sensor, not sending water temperature info.

<b>Message Display</b>	<b>Description</b>
IBR MODULE ERROR	iBR system malfunction
MAINTENANCE REQUIRED	Watercraft maintenance required

***NOTICE***

**Running engine with low oil pressure may severely damage the engine.**



## Beeper Code Information

Beeper Codes	Description
1 long beep (while installing tether cord on watercraft engine cut-off switch)	<b>Bad D.E.S.S. system connection.</b> Reinstall tether cord cap correctly on the engine cut-off switch.
	<b>Wrong D.E.S.S. key.</b> Use a tether cord that has been programmed for the watercraft.
	<b>Defective D.E.S.S. key.</b> Use another tether cord with programmed D.E.S.S. key.
	<b>Defective engine cut-off switch.</b> Refer to an authorized Sea-Doo dealer.
	<b>Improper operation of ECM or defective wiring harness.</b> Seek service from an authorized Sea-Doo dealer, repair shop, or person of your own choosing for maintenance, repair, or replacement. Please refer to the <i>US EPA Emission-Related Warranty</i> contained herein for information about warranty claims.
A 2 seconds beep every 15 minutes interval	<b>Engine management system fault.</b> Seek service from an authorized Sea-Doo dealer, repair shop, or person of your own choosing for maintenance, repair, or replacement. Please refer to the <i>US EPA Emission-Related Warranty</i> contained herein for information about warranty claims.
	<b>iBR system fault.</b> Refer to an authorized Sea-Doo dealer.
A 2 seconds beep every 10 minutes interval	<b>Low fuel level.</b> Refill fuel tank. If problem persists, refer to an authorized Sea-Doo dealer.

Beeper Codes	Description
2 second beeps	<p><b>High engine temperature coolant.</b> See <i>Engine Overheating</i>.</p>
	<p><b>Low oil pressure.</b> Turn off engine as soon as possible. Check oil level and refill. Seek service from an authorized Sea-Doo dealer, repair shop, or person of your own choosing for maintenance, repair, or replacement. Please refer to the <i>US EPA Emission-Related Warranty</i> contained herein for information about warranty claims.</p>
Constant beep (Stops when vehicle is turned OFF)	<p><b>High exhaust temperature.</b> Seek service from an authorized Sea-Doo dealer, repair shop, or person of your own choosing for maintenance, repair, or replacement. Please refer to the <i>US EPA Emission-Related Warranty</i> contained herein for information about warranty claims.</p>

**NOTICE**

**If the monitoring beeper continuously sounds, stop engine as soon as possible.**

# WARRANTY

---

# **BRP LIMITED WARRANTY – USA AND CANADA: 2024 SEA-DOO PERSONAL WATERCRAFT**

## **1) SCOPE OF THE LIMITED WARRANTY**

Bombardier Recreational Products Inc. ("BRP") warrants its 2024 Sea-Doo watercraft ("Product(s)") sold by authorized BRP Dealers (as hereinafter defined) in the United States of America ("USA") and in Canada from defects in material or workmanship for the period and under the conditions described below.

This limited warranty will become null and void if:

1. the Product was used for racing or any other competitive activity, at any point, even by a previous owner; or
2. the Product has been altered or modified in such a way so as to adversely affect its operation, performance or durability, or has been altered or modified to change its intended use.

Non-factory installed parts and accessories are not covered under this limited warranty. Please refer to the applicable parts and accessories limited warranty text.

## **2) LIMITATIONS OF LIABILITY**

TO THE EXTENT PERMITTED BY LAW, THIS WARRANTY IS EXPRESSLY GIVEN AND ACCEPTED IN LIEU OF ANY AND ALL OTHER WARRANTIES, EXPRESSED OR IMPLIED, INCLUDING WITHOUT LIMITATION ANY WARRANTY OF MERCHANTABILITY OR FITNESS FOR A PARTICULAR PURPOSE. TO THE EXTENT THAT THEY CANNOT BE DISCLAIMED, THE IMPLIED WARRANTIES ARE LIMITED IN DURATION TO THE LIFE OF THE EXPRESS WARRANTY. INCIDENTAL AND CONSEQUENTIAL DAMAGES ARE EXCLUDED FROM COVERAGE UNDER THIS WARRANTY. SOME STATES/PROVINCES DO NOT ALLOW FOR THE DISCLAIMERS, LIMITATIONS AND EXCLUSIONS IDENTIFIED ABOVE. AS A RESULT, THEY MAY NOT APPLY TO YOU. THIS WARRANTY GIVES YOU SPECIFIC RIGHTS, AND YOU MAY ALSO HAVE OTHER LEGAL RIGHTS WHICH MAY VARY FROM STATE TO STATE, OR PROVINCE TO PROVINCE.

Neither the distributor, any BRP dealer nor any other person has been authorized to make any affirmation, representation or warranty regarding the product, other than those contained in this limited warranty, and if made, shall not be enforceable against BRP.

BRP reserves the right to modify this limited warranty at any time, being understood that such modification will not alter the warranty conditions applicable to the Products sold while this warranty is in effect.

## **3) EXCLUSIONS—ARE NOT WARRANTED**

The following are not warranted under any circumstances:

- Normal wear and tear;
- Routine maintenance items, tune ups, adjustments;
- Damage caused by negligence or failure to provide proper maintenance and/or storage, as described in the Operator's Guide;
- Damage resulting from removal of parts, improper repairs, service, maintenance, modifications or use of parts not manufactured or approved by BRP or

resulting from repairs done by a person that is not an authorized servicing BRP dealer;

- Damage caused by abuse, abnormal use, neglect or operation of the product in a manner inconsistent with the recommended operation described in the Product's Operator's Guide;
- Damage resulting from accident, submersion, fire, theft, vandalism or any act of God;
- Operation with fuels, oils or lubricants which are not suitable for use with the Product (see the Operator's Guide);
- Damages from rust, corrosion or exposure to the elements;
- Damage resulting from water or snow ingestion;
- Incidental or consequential damages, or damages of any kind including without limitation transportation expenses, towing, storage, telephone, rental, taxi, inconvenience, insurance coverage, loan payments, loss of time, loss of income or time missed for downtime experience due to service work;
- Damages from cooling system or jet pump blockage by foreign material; and
- Damages related to gel coat finish including but not limited to cosmetic gel coat finish, blisters or fiberglass delamination caused by blisters, crazing, spider or hairline cracks.

#### 4) WARRANTY COVERAGE PERIOD

This limited warranty will be in effect from (1) the date of delivery to the first retail consumer, or (2) the date the product is first put into use, whichever occurs first and for the applicable period below:

1. TWELVE (12) consecutive months, for private use owners.
2. FOUR (4) consecutive months, for commercial use owners.

A Product is used commercially when it is used in connection with any work or employment that generates income during any part of the warranty period. A Product is also used commercially when, at any point during the warranty period, it is licensed for commercial use.

1. For emission-related components, please also refer to the US EPA Emission-Related Warranty.
2. For Sea-Doo personal watercrafts produced by BRP for sale in the State of California or New York that are originally sold to a resident or subsequently warranty registered to a resident in the State of California or New York, please also refer to the applicable California and New York Emissions Control Warranty Statement contained herein.
3. For Sea-Doo personal watercrafts produced by BRP for sale in the State of California that are originally sold to a resident or subsequently warranty registered to a resident in the State of California, please also refer to the California Evaporative Emissions Control System Warranty Statement contained herein.

The repair or replacement of parts or the performance of service under this warranty does not extend the life of this limited warranty beyond its original expiration date.

#### 5) CONDITIONS TO HAVE WARRANTY COVERAGE

This warranty coverage is available **only** if **each** of the following conditions has been fulfilled:

1. The Product must be purchased as new and unused by its first owner from a Dealer authorized to sell the Products in the country in which the sale occurred (“Dealer”);
2. The BRP specified pre-delivery inspection process must be completed, documented and signed by the purchaser;
3. The Product must have undergone proper registration by an authorized Dealer;
4. The Product must be purchased in the country in which the purchaser resides;
5. Routine maintenance outlined in the Operator’s Guide must be timely performed in order to maintain warranty coverage. BRP reserves the right to make warranty coverage contingent upon proof of proper maintenance.

BRP will not honor this limited warranty to any private use owner or commercial use owner if one of the preceding conditions has not been met. Such limitations are necessary in order to allow BRP to preserve both the safety of its products, and also that of its consumers and the general public.

## **6) WHAT TO DO TO OBTAIN WARRANTY COVERAGE**

The customer must cease using the Product upon the appearance of an anomaly, notify a servicing BRP dealer within three (3) days of the appearance of the anomaly and provide the Dealer with reasonable access to the Product and reasonable opportunity to repair it.

The customer must also present to the Dealer, proof of purchase of the Product and must sign the repair/work order prior to starting the repair in order to validate the warranty repair.

All parts replaced under this limited warranty become the property of BRP.

## **7) WHAT BRP WILL DO**

BRP’s obligations under this warranty are limited to, at its sole discretion, repairing or replacing parts found defective under normal use, maintenance and service without charge for parts and labor, at any authorized BRP dealer during the warranty coverage period under the conditions described herein. No claim of breach of warranty shall be cause for cancellation or rescission of the sale of the Product to the owner.

In the event that service is required outside of the country of original sale, the owner will bear responsibility for any additional charges due to local practices and conditions, such as, but not limited to, freight, insurance, taxes, license fees, import duties, and any and all other financial charges, including those levied by governments, states, territories and their respective agencies.

BRP reserves the right to improve or modify products from time to time without assuming any obligation to modify products previously manufactured.

## **8) TRANSFER**

If the ownership of a Product is transferred during the warranty coverage period, this limited warranty, subject to its terms and conditions, shall also be transferred and be valid for the remaining coverage period provided BRP or an authorized

Product Distributor/Dealer receives a proof that the former owner agreed to the transfer of ownership, in addition to the coordinates of the new owner.

## **9) CONSUMER ASSISTANCE**

In the event of a controversy or a dispute in connection with this limited warranty, BRP suggests that you try to resolve the issue at the dealership level. We recommend discussing the issue with the authorized dealer's service manager or owner.

If the matter still remains unresolved, contact BRP by filling out the customer contact form at [www.brp.com](http://www.brp.com) or contact BRP by mail at one of the addresses listed under the Contact Us section of this guide.

---

# US EPA EMISSION-RELATED WARRANTY

Bombardier Recreational Products Inc. ("BRP") warrants to the ultimate purchaser and each subsequent purchaser that this new engine, including all parts of its exhaust emission-control system and its evaporative emission-control system, meets two conditions:

1. It is designed, built, and equipped so it conforms at the time of sale to the ultimate purchaser with the requirements of 40 CFR 1045 and 40 CFR 1060It.
2. It is free from defects in materials and workmanship that may keep it from meeting the requirements of 40 CFR 1045 and 40 CFR 1060.

Where a warrantable condition exists, BRP will repair or replace, as it elects, any part or component with a defect in materials or workmanship that would increase the engine's emissions of any regulated pollutant within the stated warranty period at no cost to the owner, including expenses related to diagnosing and repairing or replacing emission-related parts. All defective parts replaced under this warranty become the property of BRP.

For all emission-related warranty claims, BRP is limiting the diagnosis and repair of emission-related parts to the authorized Sea-Doo dealers, unless for emergency repairs as required by item 2 of the following list.

As a certifying manufacturer, BRP will not deny emission-related warranty claims based on any of the following:

1. Maintenance or other service BRP or BRP's authorized facilities performed.
2. Engine/equipment repair work that an operator performed to correct an unsafe, emergency condition attributable to BRP as long as the operator tries to restore the engine/equipment to its proper configuration as soon as possible.
3. Any action or inaction by the operator unrelated to the warranty claim.
4. Maintenance that was performed more frequently than BRP specify.
5. Anything that is BRP fault or responsibility
6. The use of any fuel that is commonly available where the equipment operates unless BRP written maintenance instructions state that this fuel would harm the equipment's emission control system and operators can readily find the proper fuel. See maintenance information section and fuel requirements of fueling section.

## Emission-Related Warranty Period

The emission-related warranty is valid for the following period whichever comes first:

	Hours	Months	Kilo meters
Exhaust emission-related components	175	30	N/A
Evaporative emission-related components	N/A	24	N/A



## Components Covered

The emission-related warranty covers all components whose failure would increase an engine's emissions of any regulated pollutant, including the following listed components:

1. For exhaust emissions, emission-related components include any engine parts related to the following systems:
  - Air-induction system
  - Fuel system
  - Ignition system
  - Exhaust gas recirculation systems
2. The following parts are also considered emission-related components for exhaust emissions:
  - Aftertreatment devices
  - Crankcase ventilation valves
  - Sensors
  - Electronic control units
3. The following parts are considered emission-related components for evaporative emissions:
  - Fuel tank
  - Fuel cap
  - Fuel line
  - Fuel line fittings
  - Clamps\*
  - Pressure relief valves\*
  - Control valves\*
  - Control solenoids\*
  - Electronic controls\*
  - Vacuum control diaphragms\*
  - Control cables\*
  - Control linkages\*
  - Purge valves
  - Vapor hoses
  - Liquid/ vapor separator
  - Carbon canister
  - Canister mounting brackets
  - Carburetor purge port connector

### NOTE:

\* As related to the evaporative emission control system.

4. Emission-related components also include any other part whose only purpose is to reduce emissions or whose failure will increase emissions without significantly degrading engine/ equipment performance.

## Limited Applicability

As a certifying manufacturer, BRP may deny emission-related warranty claims for failures that have been caused by the owner's or operator's improper maintenance or use, by accidents for which the manufacturer has no responsibility, or

by acts of God. For example, an emission-related warranty claim need not be honored for failures that have been directly caused by the operator's abuse of the engine/ equipment or the operator's use of the engine/equipment in a manner for which it was not designed and are not attributable to the manufacturer in anyway.

If you have any question regarding your warranty rights and responsibility or for the name and location of the nearest authorized BRP dealer, you should contact BRP by filling out the customer contact form at [www.brp.com](http://www.brp.com) or contact BRP by mail at one of the addresses listed under the CONTACT US section of this guide, or call at 1-888-272-9222.

---

# CALIFORNIA EVAPORATIVE EMISSIONS CONTROL SYSTEM WARRANTY STATEMENT

## Your Warranty Rights and Obligations

The California Air Resources Board is pleased to explain the evaporative emissions control system's warranty on your 2024 spark-ignition marine watercraft (SIMW). In California, new spark-ignition marine watercraft must be designed, built, and equipped to meet the State's stringent anti-smog standards. Bombardier Recreational Products Inc. must warrant the evaporative emissions control system on your spark-ignition marine watercraft for the period listed below, provided there has been no abuse, neglect or improper maintenance of your spark-ignition marine watercraft.

Your evaporative emissions control system may include parts such as: canisters, carburetors, clamps, connectors, filters, fuel caps, fuel lines, fuel tanks, valves, vapor hoses, and other associated evaporative emissions control system components

## Manufacturer's Warranty Coverage

This evaporative emissions control system is warranted for two years. If any evaporative emission-related part on your spark-ignition marine watercraft is defective, the part will be repaired or replaced by Bombardier Recreational Products Inc.

Parts covered:

1. Clamp(s)\*
2. Fuel Cap
3. Fuel Line(s)
4. Fuel Line Fitting(s)
5. Fuel Tank
6. Pressure Relief Valve(s)\*
7. Vapor Hose(s)
8. All other parts not listed that may affect the evaporative emissions control system

### NOTE:

\* As related to the evaporative emission control system.

## Owner's Warranty Responsibilities

As the spark-ignition marine watercraft owner, you are responsible for performance of the required maintenance listed in your owner's manual. Bombardier Recreational Products Inc. recommends that you retain all receipts covering maintenance on your spark-ignition marine watercraft, but Bombardier Recreational Products Inc. cannot deny warranty solely for the lack of receipts.

As the spark-ignition marine watercraft owner, you should however be aware that Bombardier Recreational Products Inc. may deny you warranty coverage if your spark-ignition marine watercraft or a part has failed due to abuse, neglect, improper maintenance or unapproved modifications.

You are responsible for presenting your spark-ignition marine watercraft to a Bombardier Recreational Products Inc. distribution center or service center as

soon as the problem exists. The warranty repairs should be completed in a reasonable amount of time, not to exceed 30 calendar days. If you have question regarding your warranty coverage, you should contact Bombardier Recreational Products Inc. at 1-888-272-9222.

---

# CALIFORNIA AND NEW YORK EMISSION CONTROL WARRANTY STATEMENT FOR MODEL YEAR 2024 SEA-DOO® PERSONAL WATERCRAFT

## Your Warranty Rights and Obligations

The California Air Resources Board, the New York State Department of Environmental Conservation and Bombardier Recreational Products Inc. ("BRP") are pleased to explain the emission control system warranty on your Model Year 2024 Sea-Doo personal watercraft. In California and New York, new personal watercraft engines must be designed, built and equipped to meet the State's stringent anti-smog standards. BRP must warrant the emission control system on your personal watercraft engine for the period of time listed below provided there has been no abuse, neglect or improper maintenance of your watercraft engine.

Your emission control system may include parts such as the fuel injection system, the ignition system and catalytic converter. Also included may be hoses, belts, connectors and other emission related assemblies.

Where a warrantable condition exists, BRP will repair your personal watercraft engine at no cost to you including diagnosis, parts and labor provided that such work is performed by an authorized BRP dealer.

### ***Manufacturer's Limited Warranty Coverage***

This emission limited warranty covers Model Year 2024 Sea-Doo personal watercrafts certified and produced by BRP for sale in California or New York, that are originally sold in California or New York to a California or New York resident or subsequently warranty registered to a California or New York resident. The BRP limited warranty conditions for Sea-Doo personal watercrafts are still applicable to these models with the necessary modifications. Select emission control parts of your 2024 Sea-Doo personal watercraft are warranted from the date of delivery to the first retail consumer for a period of 4 years, or for 250 hours of use, whichever occurs first. However, warranty coverage based on the hourly period is only permitted for personal watercraft equipped with the appropriate hour meters or their equivalent. If any emission-related part on your engine is defective under warranty, the part will be repaired or replaced by BRP.

### ***Parts Covered for a Model Year 2024 Sea-Doo Personal Watercraft***

Supercharger	Air intake adapter
Throttle position sensor	Spark plugs
Intake manifold air pressure sensor	Ignition coils
Intake manifold air temperature sensor	Air box
Engine temperature sensor	Intake and exhaust valve and seals
Knock sensor	Intake manifold

Engine control module ECM	Crankcase ventilation valve
Throttle body	Throttle body seal
Ful rail	Intake manifold seal
Fuel injectors	Wire harness and connectors
Fuel pressure regulator	Fuel filter
Fuel pump	-

The emission warranty covers damage to other engine components that is caused by the failure of a warranted part. The BRP operator's guide provided contains written instructions for the proper maintenance and use of your personal watercraft. All emission warranty parts are warranted by BRP for the entire warranty period of the personal watercraft, unless the part is scheduled for replacement as required maintenance in the operator's guide.

Emission warranty parts that are scheduled for replacement, as required maintenance, are warranted by BRP for the period of time before the first scheduled replacement date for that part. Emission warranty parts that are scheduled for regular inspection, but not regular replacement, are warranted by BRP for the entire warranty period of the personal watercraft. Any emission warranty part repaired or replaced under the terms of this warranty statement is warranted by BRP for the remainder of the warranty period of the original part. All parts replaced under this limited warranty become the property of BRP.

Maintenance receipts and records should be transferred to each subsequent owner of the personal watercraft.

### ***Owner's Warranty Responsibilities***

As the owner of a 2024 Sea-Doo personal watercraft, you are responsible for the performance of the required maintenance listed in your operator's guide. BRP recommends that you retain all receipts covering maintenance of your personal watercraft engine, but BRP cannot deny warranty solely for the lack of receipts or your failure to ensure the performance of all scheduled maintenance.

As the owner of a Sea-Doo personal watercraft, you should however be aware that BRP may deny your warranty coverage if your engine or a part has failed due to abuse, neglect, improper maintenance or unapproved modifications.

You are responsible for presenting your engine to an authorized BRP Sea-Doo dealer as soon as a problem exists. The warranty repairs will be completed in a reasonable amount of time, not to exceed 30 days.

If you have any questions regarding your warranty rights and responsibilities or for the name and location of the nearest authorized BRP Sea-Doo dealer you should contact the Customer Assistance Center at 1-888-272-9222.

## Star Rating System

For California and New York, your 2024 Sea-Doo watercraft (SIMW) has a special environmental label required by the California Air Resources Board. The label has 3 stars. A hangtag, provided with the Product (SIMW), describes the meaning of the star rating system.

### *The Star Label Means Cleaner Marine Engines*

The Symbol for Cleaner Marine Engines:



F18L3CQ

### *Cleaner Air and Water*

For a healthier lifestyle and environment.

### *Better Fuel Economy*

Burns up to 30 - 40 percent less gas and oil than conventional carbureted two-stroke engines saving money and resources.

### *Longer Emission Warranty*

Protects consumer for worry free operation.

### *One Star – Low Emission*

The one-star label identifies personal watercraft, outboard, stern drive and inboard engines that meet the Air Resources Board's Personal Watercraft and Outboard marine engine 2001 exhaust emission standards. Engines meeting these standards have 75% lower emissions than conventional carbureted two-stroke engines. These engines are equivalent to the U.S. EPA's 2006 standards for marine engines.

### *Two Stars – Very Low Emission*

The two-star label identifies personal watercraft, outboard, stern drive and inboard engines that meet the Air Resources Board's Personal Watercraft and Outboard marine engine 2004 exhaust emission standards. Engines meeting these standards have 20% lower emissions than One Star - Low-Emission engines.

### *Three Stars – Ultra Low Emission*

The three-star label identifies engines that meet the Air Resources Board's Personal Watercraft and Outboard marine engine 2008 exhaust emission standards or the Stern drive and Inboard marine engine 2003 exhaust emission standards. Engines meeting these standards have 65% lower emissions than One Star – Low Emission engines.

### *Four Stars – Super Ultra Low Emission*

SEA-DOO® PERSONAL WATERCRAFT

The four-star label identifies engines that meet the Air Resources Board's Stern--drive and Inboard marine engine 2012 exhaust emission standards. Personal Watercraft and Outboard marine engines may also comply with these standards. Engines meeting these standards have 90% lower emissions than One Star – Low Emission engines.

For more information:	Cleaner Watercraft – Get the Facts 1 800 END-SMOG <b><a href="http://www.arb.ca.gov">www.arb.ca.gov</a></b>
-----------------------	---



---

# **BRP INTERNATIONAL LIMITED WARRANTY: 2024 SEA-DOO® WATERCRAFT**

## **1) SCOPE OF THE LIMITED WARRANTY**

("Product(s)") sold by distributors or dealers authorized by BRP to distribute the Products outside of the United States of America ("USA"), Canada, member states of the European Economic Area (which is comprised of the states of the European Union plus the United Kingdom, Norway, Iceland and Liechtenstein) ("EEA"), Turkey, member states of the Commonwealth of the Independent States (including Ukraine and Turkmenistan) ("CIS") from defects in material or workmanship for the period and under the conditions described below.

This limited warranty will become null and void if:

1. the Product was used for racing or any other competitive activity, at any point, even by a previous owner; or
2. the Product has been altered or modified in such a way so as to adversely affect its operation, performance or durability, or has been altered or modified to change its intended use.

Non-factory installed parts and accessories are not covered under this limited warranty. Please refer to the applicable parts and accessories limited warranty text.

## **2) LIMITATIONS OF LIABILITY**

TO THE EXTENT PERMITTED BY LAW, THIS WARRANTY IS EXPRESSLY GIVEN AND ACCEPTED IN LIEU OF ANY AND ALL OTHER WARRANTIES, EXPRESSED OR IMPLIED, INCLUDING WITHOUT LIMITATION ANY WARRANTY OF MERCHANTABILITY OR FITNESS FOR A PARTICULAR PURPOSE. TO THE EXTENT THAT THEY CANNOT BE DISCLAIMED, THE IMPLIED WARRANTIES ARE LIMITED IN DURATION TO THE LIFE OF THE EXPRESS WARRANTY. INCIDENTAL AND CONSEQUENTIAL DAMAGES ARE EXCLUDED FROM COVERAGE UNDER THIS WARRANTY. SOME STATES/PROVINCES DO NOT ALLOW FOR THE DISCLAIMERS, LIMITATIONS AND EXCLUSIONS IDENTIFIED ABOVE. AS A RESULT, THEY MAY NOT APPLY TO YOU. THIS WARRANTY GIVES YOU SPECIFIC RIGHTS, AND YOU MAY ALSO HAVE OTHER LEGAL RIGHTS WHICH MAY VARY FROM COUNTRY TO COUNTRY. BRP SHALL NOT BE HELD LIABLE IF PRODUCTS OR WARRANTY PARTS ARE NOT AVAILABLE IN CERTAIN COUNTRIES FOR REASONS OUTSIDE OF BRP'S CONTROL.

For Products purchased in Australia, refer to the Australia-specific section below.

Neither the distributor, any BRP Distributor/Dealer nor any other person has been authorized to make any affirmation, representation or warranty regarding the product, other than those contained in this limited warranty, and if made, shall not be enforceable against BRP.

BRP reserves the right to modify this limited warranty at any time, being understood that such modification will not alter the warranty conditions applicable to the Products sold while this warranty is in effect.

## **3) EXCLUSIONS—ARE NOT WARRANTED**

The following are not warranted under any circumstances:

- Normal wear and tear;
- Routine maintenance items, tune ups, adjustments;
- Damage caused by negligence or failure to provide proper maintenance and/or storage, as described in the Operator's Guide;
- Damage resulting from removal of parts, improper repairs, service, maintenance, modifications or use of parts not manufactured or approved by BRP or resulting from repairs done by a person that is not an authorized servicing BRP Distributor/Dealer;
- Damage caused by abuse, abnormal use, neglect or operation of the product in a manner inconsistent with the recommended operation described in the Product's Operator's Guide;
- Damage resulting from accident, submersion, fire, theft, vandalism or any act of God;
- Operation with fuels, oils or lubricants which are not suitable for use with the Product (see the Operator's Guide);
- Damages from rust, corrosion or exposure to the elements;
- Damage resulting from water or snow ingestion;
- Incidental or consequential damages, or damages of any kind including without limitation transportation expenses, towing, storage, telephone, rental, taxi, inconvenience, insurance coverage, loan payments, loss of time, loss of income or time missed for downtime experience due to service work;
- Damages from cooling system or jet pump blockage by foreign material;
- Damages to gel coat finish including but not limited to cosmetic gel coat finish defects, blisters, starring, crazing and fiberglass delamination caused by blisters, crazing, spider or hairline cracks.

#### **4) WARRANTY COVERAGE PERIOD**

This limited warranty will be in effect from (1) the date of delivery to the first retail consumer, or (2) the date the product is first put into use, whichever occurs first and for the applicable period below:

1. TWELVE (12) consecutive months, for private use owners. For AUSTRALIA and NEW ZEALAND only, TWENTY-FOUR (24) consecutive months for private, recreational use.
2. FOUR (4) consecutive months, for commercial use owners. A Product is used commercially when it is used in connection with any work or employment that generates income during any part of the warranty period. A Product is also used commercially when, at any point during the warranty period, it is licensed for commercial use.

The repair or replacement of parts or the performance of service under this warranty does not extend the life of this warranty beyond its original expiration date.

The warranty coverage period identified above are a minimal limited warranty period which can be extended by any applicable warranty promotional program, as the case may be.

Note that the duration and any other modalities of the warranty coverage are subject to the applicable national or local legislation in the customer's country.

## FOR PRODUCTS SOLD IN AUSTRALIA ONLY

Our goods come with guarantees that cannot be excluded under the Australian Consumer Law.

You are entitled to a replacement or refund for a major failure and for compensation for any other reasonably foreseeable loss or damage.

You are also entitled to have the goods repaired or replaced if the goods fail to be of acceptable quality and the failure does not amount to a major failure.

Nothing in these Warranty terms and conditions should be taken to exclude, restrict or modify the application of any condition, warranty, guarantee, right or remedy conferred or implied under the Competition and Consumer Act 2010 (Cth), including the Australian Consumer Law or any other law, where to do so would contravene that law, or cause any part of these terms and conditions to be void. The benefits given to you under this limited warranty are in addition to other rights and remedies that you have under Australian law.

### 5) CONDITIONS TO HAVE WARRANTY COVERAGE

This warranty coverage is available **only** if **each** of the following conditions has been fulfilled:

- A) The Product must be purchased as new and unused by its first owner from a Distributor/Dealer authorized to distribute Products in the country in which the sale occurred ("Distributor/Dealer");
- B) The BRP specified pre-delivery inspection process must be completed, documented and signed by the purchaser;
- C) The Product must have undergone proper registration by an authorized Distributor/Dealer;
- D) The Product must be purchased in the country in which the purchaser resides;
- E) Routine maintenance outlined in the Operator's Guide must be timely performed in order to maintain warranty coverage. BRP reserves the right to make warranty coverage contingent upon proof of proper maintenance.

BRP will not honor this limited warranty to any private use owner or commercial use owner if one of the preceding conditions has not been met. Such limitations are necessary in order to allow BRP to preserve both the safety of its products, and also that of its consumers and the general public.

### 6) WHAT TO DO TO OBTAIN WARRANTY COVERAGE

The customer must cease using the Product upon the appearance of an anomaly, notify a servicing BRP Distributor/Dealer within two (2) months of the appearance of the anomaly and provide the Distributor/Dealer with reasonable access to the Product and reasonable opportunity to repair it.

The notification period is subject to the applicable national or local legislation in customer's country.

The customer must also present to the Distributor/Dealer, proof of purchase of the Product and must sign the repair/work order prior to starting the repair in order to validate the warranty repair.

All parts replaced under this limited warranty become the property of BRP.

## **7) WHAT BRP WILL DO**

To the extent permitted by law, BRP's obligations under this warranty are limited to, at its sole discretion, repairing or replacing parts found defective under normal use, maintenance and service without charge for parts and labor, at any authorized BRP Distributor/Dealer during the warranty coverage period under the conditions described herein. No claim of breach of warranty shall be cause for cancellation or rescission of the sale of the Product to the owner. You may have other legal rights which may vary from country to country.

In the event that service is required outside of the country of original sale, the owner will bear responsibility for any additional charges due to local practices and conditions, such as, but not limited to, freight, insurance, taxes, license fees, import duties, and any and all other financial charges, including those levied by governments, states, territories and their respective agencies.

BRP reserves the right to improve or modify products from time to time without assuming any obligation to modify products previously manufactured.

## **8) TRANSFER**

If the ownership of a Product is transferred during the warranty coverage period, this limited warranty, subject to its terms and conditions, shall also be transferred and be valid for the remaining coverage period provided BRP or an authorized Product Distributor/Dealer receives a proof that the former owner agreed to the transfer of ownership, in addition to the coordinates of the new owner.

## **9) CONSUMER ASSISTANCE**

In the event of a controversy or a dispute in connection with this limited warranty, BRP suggests that you try to resolve the issue at the dealership level. We recommend discussing the issue with the authorized Distributor/Dealer's service manager or owner.

If the matter still remains unresolved, contact BRP by filling out the customer contact form at [www.brp.com](http://www.brp.com) or contact BRP by mail at one of the addresses listed under the Contact Us section of this guide.

---

# **BRP LIMITED WARRANTY FOR THE EUROPEAN ECONOMIC AREA, THE COMMONWEALTH OF THE INDEPENDENT STATES AND TURKEY: 2024 SEA-DOO® PERSONAL WATERCRAFT**

## **1) SCOPE OF THE LIMITED WARRANTY**

Bombardier Recreational Products Inc. ("BRP") warrants its 2024 Sea-Doo personal watercraft ("Product(s)") sold by distributors or dealers authorized by BRP to distribute the Products in member states of the European Economic Area (which is comprised of the states of the European Union plus the United Kingdom, Norway, Iceland and Liechtenstein) ("EEA"), Turkey, member states of the Commonwealth of the Independent States (including Ukraine and Turkmenistan) ("CIS") ("Distributor/Dealer") from defects in material or workmanship for the period and under the conditions described below.

This limited warranty will become null and void if:

1. the Product was used for racing or any other competitive activity, at any point, even by a previous owner; or
2. the Product has been altered or modified in such a way so as to adversely affect its operation, performance or durability, or has been altered or modified to change its intended use.

Non-factory installed parts and accessories are not covered under this limited warranty. Please refer to the applicable parts and accessories limited warranty text.

## **2) LIMITATIONS OF LIABILITY**

TO THE EXTEND PERMITTED BY LAW, THIS WARRANTY IS EXPRESSLY GIVEN AND ACCEPTED IN LIEU OF ANY AND ALL OTHER WARRANTIES, EXPRESSED OR IMPLIED, INCLUDING WITHOUT LIMITATION ANY WARRANTY OF MERCHANTABILITY OR FITNESS FOR A PARTICULAR PURPOSE. TO THE EXTENT THAT THEY CANNOT BE DISCLAIMED, THE IMPLIED WARRANTIES ARE LIMITED IN DURATION TO THE LIFE OF THE EXPRESS WARRANTY. INCIDENTAL AND CONSEQUENTIAL DAMAGES ARE EXCLUDED FROM COVERAGE UNDER THIS WARRANTY. SOME STATES/PROVINCES DO NOT ALLOW FOR THE DISCLAIMERS, LIMITATIONS AND EXCLUSIONS IDENTIFIED ABOVE. AS A RESULT, THEY MAY NOT APPLY TO YOU. THIS WARRANTY GIVES YOU SPECIFIC RIGHTS, AND YOU MAY ALSO HAVE OTHER LEGAL RIGHTS WHICH MAY VARY FROM STATE TO STATE, OR PROVINCE TO PROVINCE. BRP SHALL NOT BE HELD LIABLE IF PRODUCTS OR WARRANTY PARTS ARE NOT AVAILABLE IN CERTAIN COUNTRIES FOR REASONS OUTSIDE OF BRP'S CONTROL.

For Products purchased in France, refer to the France-specific section below.

Neither the distributor, any BRP Distributor/Dealer nor any other person has been authorized to make any affirmation, representation or warranty regarding the product, other than those contained in this limited warranty, and if made, shall not be enforceable against BRP.

BRP reserves the right to modify this limited warranty at any time, being understood that such modification will not alter the warranty conditions applicable to the Products sold while this warranty is in effect.

### 3) EXCLUSIONS—ARE NOT WARRANTED

The following are not warranted under any circumstances:

- Normal wear and tear;
- Routine maintenance items, tune ups, adjustments;
- Damage caused by negligence or failure to provide proper maintenance and/or storage, as described in the Operator's Guide;
- Damage resulting from removal of parts, improper repairs, service, maintenance, modifications or use of parts not manufactured or approved by BRP or resulting from repairs done by a person that is not an authorized servicing BRP Distributor/Dealer;
- Damage caused by abuse, abnormal use, neglect or operation of the product in a manner inconsistent with the recommended operation described in the Product's Operator's Guide;
- Damage resulting from accident, submersion, fire, theft, vandalism or any act of God;
- Operation with fuels, oils or lubricants which are not suitable for use with the Product (see the Operator's Guide);
- Damages from rust, corrosion or exposure to the elements;
- Damage resulting from water or snow ingestion;
- Incidental or consequential damages, or damages of any kind including without limitation transportation expenses, towing, storage, telephone, rental, taxi, inconvenience, insurance coverage, loan payments, loss of time, loss of income or time missed for downtime experience due to service work.
- Damages from cooling system or jet pump blockage by foreign material;
- Damages to gel coat finish including but not limited to cosmetic gel coat finish defects, blisters, starring, crazing and fiberglass delamination caused by blisters, crazing, spider or hairline cracks

### 4) WARRANTY COVERAGE PERIOD

This limited warranty will be in effect from (1) the date of delivery to the first retail consumer, or (2) the date the product is first put into use, whichever occurs first and for the applicable period below:

1. TWENTY-FOUR (24) consecutive months, for private, recreational use.
2. FOUR (4) consecutive months, for commercial use owners. A Product is used commercially when it is used in connection with any work or employment that generates income during any part of the warranty period. A Product is also used commercially when, at any point during the warranty period, it is licensed for commercial use.

The repair or replacement of parts or the performance of service under this warranty does not extend the life of this warranty beyond its original expiration date.

The warranty coverage period identified above are a minimal limited warranty period which can be extended by any applicable warranty promotional program, as the case may be.

Note that the duration and any other modalities of the warranty coverage are subject to the applicable national or local legislation in the customer's country.

## 5) FOR PRODUCTS SOLD IN FRANCE ONLY

The seller shall deliver goods that are complying with the contract and shall be responsible for defects existing upon delivery. The seller shall also be responsible for defects resulting from packaging, assembling instructions or the installation when it is its responsibility per the contract or if accomplished under its responsibility. To be compliant with the contract, the good shall:

1. Be fit for normal use for goods similar thereto and, if applicable:
  - Correspond to the description provided by the seller and have the qualities presented to the buyer through sample or model;
  - Have the qualities that a buyer may legitimately expect considering the public declarations of the seller, the manufacturer of its representative, including in advertising or labeling; or
2. Have the characteristics mutually agreed upon as between the parties or be fit for the specific use intended by the buyer and brought to the attention of the seller and which accepted.

The action for failure to comply is prescribed after two years after delivery of the goods. The seller is responsible for the warranty for hidden defects of the good sold if such hidden defects are rendering the good unfit for the intended use, or if they diminish its use in such a way that the buyer would not have acquired the good or would have given a lesser price, had he known. The action for such hidden defects shall be taken by the buyer within 2 years of the discovery of the defect.

## 6) CONDITIONS TO HAVE WARRANTY COVERAGE

This warranty coverage is available **only** if **each** of the following conditions has been fulfilled:

- A) The Product must be purchased as new and unused by its first owner from a Distributor/Dealer authorized to distribute Products in the country (or in the case of the EEA, union of countries) in which the sale occurred (“Distributor/Dealer”);
- B) The BRP specified pre-delivery inspection process must be completed, documented and signed by the purchaser;
- C) The Product must have undergone proper registration by an authorized Distributor/Dealer;
- D) The Product must be purchased in the country (or in the case of the EEA, union of countries) in which the purchaser resides;
- E) Routine maintenance outlined in the Operator’s Guide must be timely performed in order to maintain warranty coverage. BRP reserves the right to make warranty coverage contingent upon proof of proper maintenance.

BRP will not honor this limited warranty to any private use owner or commercial use owner if one of the preceding conditions has not been met. Such limitations are necessary in order to allow BRP to preserve both the safety of its products, and also that of its consumers and the general public.

## **7) WHAT TO DO TO OBTAIN WARRANTY COVERAGE**

The customer must cease using the Product upon the appearance of an anomaly, notify a servicing BRP Distributor/Dealer within two (2) months of the appearance of the anomaly and provide the Distributor/Dealer with reasonable access to the Product and reasonable opportunity to repair it.

The notification period is subject to the applicable national or local legislation in customer's country.

The customer must also present to the Distributor/Dealer, proof of purchase of the Product and must sign the repair/work order prior to starting the repair in order to validate the warranty repair.

All parts replaced under this limited warranty become the property of BRP.

## **8) WHAT BRP WILL DO**

To the extent permitted by law, BRP's obligations under this warranty are limited to, at its sole discretion, repairing or replacing parts found defective under normal use, maintenance and service without charge for parts and labor, at any authorized BRP Distributor/Dealer during the warranty coverage period under the conditions described herein. No claim of breach of warranty shall be cause for cancellation or rescission of the sale of the Product to the owner. You may have other legal rights which may vary from country to country.

In the event that service is required outside of the country of original sale, or for EEA residents, if service is required outside of the EEA, the owner will bear responsibility for any additional charges due to local practices and conditions, such as, but not limited to, freight, insurance, taxes, license fees, import duties, and any and all other financial charges, including those levied by governments, states, territories and their respective agencies.

BRP reserves the right to improve or modify products from time to time without assuming any obligation to modify products previously manufactured.

## **9) TRANSFER**

If the ownership of a Product is transferred during the warranty coverage period, this limited warranty, subject to its terms and conditions, shall also be transferred and be valid for the remaining coverage period provided BRP or an authorized Product Distributor/Dealer receives a proof that the former owner agreed to the transfer of ownership, in addition to the coordinates of the new owner.

## **10) CONSUMER ASSISTANCE**

In the event of a controversy or a dispute in connection with this limited warranty, BRP suggests that you try to resolve the issue at the dealership level. We recommend discussing the issue with the authorized Distributor/Dealer's service manager or owner.

If the matter still remains unresolved, contact BRP by filling out the customer contact form at [www.brp.com](http://www.brp.com) or contact BRP by mail at one of the addresses listed under the Contact Us section of this guide.



# **CUSTOMER INFORMATION**

---

# DATA PRIVACY INFORMATION

Bombardier Recreational Products inc., its affiliates and subsidiaries (“BRP”) is committed to protecting your privacy and support a general policy of openness about how we collect, use and disclose your personal information in the course of managing our relationship with you. **More details can be found by visiting BRP’s Privacy Policy at: <https://brp.com/en/privacy-policy.html> or by scanning the QR Code below.**

Please be assured that we have appropriate security measures in place to ensure that your personal information is protected against loss and unauthorized access.

Your personal information that may be collected by BRP, directly from you or from authorized dealers or authorized third parties, includes:

- **Contact, Demographic & Registration Information** (e.g., name, full address, phone number, email, gender, ownership history, language of communication)
- **Vehicle Information** (e.g., serial number, purchase and delivery date, unit usage, vehicle location and movements)
- **Third Party Information** (e.g., information received from BRP partners, joint-marketing activities information, social media)
- **Technological Information** (e.g., IP address, type of device, operating system, browser type, webpages you view, cookies and similar technologies when you use BRP or dealers’ websites or mobile application)
- **Interaction with BRP Information** (e.g., information collected when you call BRP’s in-house sales representatives, buy items on a BRP web Site, sign up for BRP emails, participate in BRP-sponsored contests and sweepstakes or attend BRP-sponsored events)
- **Transactional Information** (e.g., information necessary to handle returns, payment information when you purchase our products or services through our websites or mobile applications and other issues related to your purchase of BRP products)

This information may be used and processed for the following purposes:

- Safety & Security
- Customer Support for Sales & After Sales (e.g., complete or follow up with you about your purchase or maintenance)
- Registration & Warranty
- Communication (e.g., sending you a BRP satisfaction survey)
- Online Behavioural Advertising, Profiling and Location-Based Services (e.g., offer customized experience)
- Compliance & Dispute Resolution
- Marketing & Advertising
- Assistance (e.g., help with any delivery issues, handle returns, and other issues related to your purchase of BRP products).

We also may use personal information to generate aggregated or statistical data that no longer identifies you personally.

**Your personal information may be disclosed to the following: BRP, BRP’s authorized dealerships, distributors, service providers, advertising & market research partners and other authorized third parties.**

We may receive information about you from diverse sources, including third parties, such as BRP’s authorized dealerships and partners, with whom we offer

services or engage in joint-marketing activities. We may also receive information about you from social media platforms such as Facebook and Twitter, when you interact with us on those platforms.

Depending on the circumstances, your personal information may be communicated outside the region where you reside. Your personal information is retained only for as long as necessary for the purpose for which we obtained it and according to our retention policies.

To exercise your data privacy rights (e.g. right of access, right of rectification), to withdraw your consent in order to be removed from the address list for marketing purposes or for the satisfaction survey or for general data privacy questions, please contact BRP's Data Protection Officer at or by mail at **privacyofficer@brp.com** or by mail at:

BRP Legal Service, 726 St-Joseph, Valcourt, Quebec, Canada, J0E 2L0.

**When BRP processes your personal information, they do so in compliance with its Privacy Policy available at: <https://www.brp.com/en/privacy-policy.html> or by using the following QR Code.**



---

# CONTACT US

*www.brp.com*

## **Asia Pacific**

### **Australia**

Level 26  
477 Pitt Street  
Sydney, NSW 2020

### **China**

上海市徐汇区衡山路10号6号楼301  
Rm 301, Building 6,  
No.10 Heng Shan Rd,  
Shanghai, China

### **Japan**

21F Shinagawa East One Tower  
2-16-1 Konan, Minato-ku-ku,  
Tokyo 108-0075

### **New Zealand**

Suite 1.6, 2-8 Osborne Street,  
Newmarket, Auckland 2013

## **Europe, Middle East and Africa**

### **Belgium**

Oktrooiplein 1  
9000 Gent

### **Czech Republic**

Stefanikova 43a  
Prague 5  
150 00

### **Germany**

Itterpark 11  
40724 Hilden

### **Finland**

Isoaavantie 7  
PL 8040  
96101 Rovaniemi

### **France**

Arteparc Bâtiment B  
Route de la côte d'Azur,  
13 590 Meyreuil

### **Norway**

Ingvald Ystgaardsvei 15  
N-7484 Trondheim

Salg, marketing, ettermarked

**Sweden**

Spinnvägen 15  
903 61 Umeå  
Sweden 90821

**Switzerland**

Avenue d'Ouchy 4-6  
1006 Lausanne

**Latin America**

**Brazil**

Av. James Clerck Maxwell, 230  
Campinas, Sao Paulo  
CEP 13069-380

**Mexico**

Av. Ferrocarril 202  
Parque Industrial Querétaro  
Santo Rosa Jauregui, Querétaro  
C.P. 76220

**North America**

**Canada**

3200A, rue King Ouest,  
Suite 300  
Sherbrooke (Québec) J1L 1C9

**United States of America**

10101 Science Drive  
Sturtevant, Wisconsin  
53177

---

## CHANGE OF ADDRESS/OWNERSHIP

If your address has changed or if you are the new owner of the boat, be sure to notify BRP by either:

- Notifying an authorized Sea-Doo dealer.
- **North America Only:** calling at 1 888 272-9222.
- Mailing one of the change of address cards on the following pages at one of the BRP addresses indicated in the *Contact Us* section of this guide.

In case of change of ownership, please join a proof that the former owner agreed to the transfer.

Notifying BRP, even after the expiration of the limited warranty, is very important as it enables BRP to reach the boat owner if necessary, like when safety recalls are initiated. It is the owner's responsibility to notify BRP.

**STOLEN UNITS:** In the event that your boat is stolen, you should notify your area's distributor warranty department of such. We will ask you to provide your name, address, phone number, Hull Identification Number and date it was stolen.



This page is  
intentionally blank



CHANGE OF ADDRESS <input type="checkbox"/>	CHANGE OF OWNERSHIP <input type="checkbox"/>	
VEHICLE IDENTIFICATION NUMBER		
Model Number	Vehicle Identification Number (V.I.N.)	
<b>OLD ADDRESS OR PREVIOUS OWNER:</b>	NAME	
	NO.	STREET APT
	CITY	STATE/PROVINCE ZIP/POSTAL CODE
	COUNTRY	TELEPHONE
<b>NEW ADDRESS OR NEW OWNER:</b>	NAME	
	NO.	STREET APT
	CITY	STATE/PROVINCE ZIP/POSTAL CODE
	COUNTRY	TELEPHONE
	E-MAIL ADDRESS	

CHANGE OF ADDRESS <input type="checkbox"/>	CHANGE OF OWNERSHIP <input type="checkbox"/>	
VEHICLE IDENTIFICATION NUMBER		
Model Number	Vehicle Identification Number (V.I.N.)	
<b>OLD ADDRESS OR PREVIOUS OWNER:</b>	NAME	
	NO.	STREET APT
	CITY	STATE/PROVINCE ZIP/POSTAL CODE
	COUNTRY	TELEPHONE
<b>NEW ADDRESS OR NEW OWNER:</b>	NAME	
	NO.	STREET APT
	CITY	STATE/PROVINCE ZIP/POSTAL CODE
	COUNTRY	TELEPHONE
	E-MAIL ADDRESS	

This page is  
intentionally blank

NOTE: \_\_\_\_\_

\_\_\_\_\_

\_\_\_\_\_

\_\_\_\_\_

\_\_\_\_\_

\_\_\_\_\_

\_\_\_\_\_

\_\_\_\_\_

\_\_\_\_\_

\_\_\_\_\_

\_\_\_\_\_

\_\_\_\_\_

\_\_\_\_\_

\_\_\_\_\_

\_\_\_\_\_

\_\_\_\_\_

\_\_\_\_\_

\_\_\_\_\_

\_\_\_\_\_

\_\_\_\_\_

\_\_\_\_\_

\_\_\_\_\_

\_\_\_\_\_

**NOTE:** \_\_\_\_\_

\_\_\_\_\_

\_\_\_\_\_

\_\_\_\_\_

\_\_\_\_\_

\_\_\_\_\_

\_\_\_\_\_

\_\_\_\_\_

\_\_\_\_\_

\_\_\_\_\_

\_\_\_\_\_

\_\_\_\_\_

\_\_\_\_\_

\_\_\_\_\_

\_\_\_\_\_

\_\_\_\_\_

\_\_\_\_\_

NOTE: \_\_\_\_\_

\_\_\_\_\_

\_\_\_\_\_

\_\_\_\_\_

\_\_\_\_\_

\_\_\_\_\_

\_\_\_\_\_

\_\_\_\_\_

\_\_\_\_\_

\_\_\_\_\_

\_\_\_\_\_

\_\_\_\_\_

\_\_\_\_\_

\_\_\_\_\_

\_\_\_\_\_

\_\_\_\_\_

\_\_\_\_\_

\_\_\_\_\_

\_\_\_\_\_

\_\_\_\_\_

\_\_\_\_\_



NOTE: \_\_\_\_\_

\_\_\_\_\_

\_\_\_\_\_

\_\_\_\_\_

\_\_\_\_\_

\_\_\_\_\_

\_\_\_\_\_

\_\_\_\_\_

\_\_\_\_\_

\_\_\_\_\_

\_\_\_\_\_

\_\_\_\_\_

\_\_\_\_\_

\_\_\_\_\_

\_\_\_\_\_

\_\_\_\_\_

\_\_\_\_\_

\_\_\_\_\_

\_\_\_\_\_

\_\_\_\_\_

\_\_\_\_\_

**NOTE:** \_\_\_\_\_

\_\_\_\_\_  
\_\_\_\_\_  
\_\_\_\_\_  
\_\_\_\_\_  
\_\_\_\_\_  
\_\_\_\_\_  
\_\_\_\_\_  
\_\_\_\_\_  
\_\_\_\_\_  
\_\_\_\_\_  
\_\_\_\_\_  
\_\_\_\_\_  
\_\_\_\_\_  
\_\_\_\_\_  
\_\_\_\_\_  
\_\_\_\_\_  
\_\_\_\_\_  
\_\_\_\_\_  
\_\_\_\_\_



**WATERCRAFT**

Model No. \_\_\_\_\_

**HULL**

Identification Number (H.I.N.) \_\_\_\_\_

**ENGINE**

Identification Number (E.I.N.) \_\_\_\_\_

**OWNER:** \_\_\_\_\_  
NAME

\_\_\_\_\_  
No. STREET APT

\_\_\_\_\_  
CITY STATE/PROVINCE ZIP/POSTAL CODE

**Purchase Date**    |    |    |  
YEAR    MONTH    DAY

**Warranty Expiry Date**    |    |    |  
YEAR    MONTH    DAY

To be completed by the authorized Sea-Doo dealer at the time of the sale.

DEALER IMPRINT AREA

## **⚠ WARNING**

Disregarding any of the safety precautions and instructions contained in the operators's guide, safety video and on product safety labels could cause injury including the possibility of death.



[www.brp.com](http://www.brp.com)

**SKI-DOO®**

**LYNX®**

**MANITOU®**

**SEA-DOO®**

**ROTAX®**

**QUINTREX®**

**CAN-AM®**

**ALUMACRAFT®**

219002353