

SEA-DOO®



TECHNICAL SERVICE PROCEDURES

DECK AND HULL REPAIR

All Surfaces



⚠ WARNING

BRP strongly recommends providing a copy of this document to your local body shop before performing a repair to obtain a good result on the acrylic surface.

219101129

Original Instructions

™® Trademarks of BRP or its affiliates.

This is a non-exhaustive list of trademarks that are the property of Bombardier Recreational Products Inc. or its affiliates.

Trademarks may not be registered in every jurisdictions:

ACETM	FISH PRO™	GTITM	GTR™
GTS®	GTX®	RXP™	RXT - X™
SEA-DOO™	SPARK®	WAKE®	XPSTM

This document contains the trademarks of the following companies:

303 AEROSPACE PROTECTANT is a trademark of GOLD EAGLE CO.

3M is a trademark of 3M

FABULOSO is a trademark of COLGATE-PALMOLIVE COMPANY.

FANTASTIK is a trademark of S.C. JOHNSON & SON, INC.

GTX is a trademark of Castrol Ltd. Used under license.

GOO GONE is a trademark of WEIMAN PRODUCTS, LLC.

KLEEN-FLO is a trademark of KLEEN-FLO TUMBLER INDUSTRIES LIMITED.

SIMPLE GREEN CLEAN FINISH is a trademark of Sunshine Makers, Inc.

Spray Nine is a trademark of Illinois Tool Work's Inc.

SUPERCLEAN is a trademark and brand of PHILLIPS 66 COMPANY.

TURTLE WAX is a trademark of Turtle Wax, Inc.

WD-40 is a trademark of WD-40 Manufacturing Company.

WINDEX is a trademark of S. C. Johnson & Son, Inc.

All rights reserved. No parts of this Manual may be reproduced in any form without the prior written permission of Bombardier Recreational Products Inc.

©Bombardier Recreational Products Inc. (BRP) 2024

BRP Inc.

TABLE OF CONTENTS

DECK AND HULL IDENTIFICATION

IDENTIFICATION CHART	8
----------------------------	---

ACRYLIC SURFACE

OVERVIEW	12
----------------	----

CARE AND PRODUCTS

SPECIAL CARE - GENERAL RECOMMENDATIONS	14
Removing Decals or Glue Residues	14
Fuel Spillage	14
Washing	14
Polishing	14
Aggressive Liquids and Solvents	14
Heat Gun	15
Storage Shrink Wrap	15
SAFE PRODUCTS ON ACRYLIC SURFACE	16
PRODUCTS TO BE USED WITH CAUTION	17
PROHIBITED PRODUCTS	18

ACRYLIC SURFACE REPAIR

MINOR SCRATCHES	20
Removing Minor Scratches	20
ACRYLIC/ABS REPAIR	21
General Recommendations	21
BASF APPROVED PAINT SYSTEMS	22
BASF PAINT PROCEDURES	24
Paint Repair Using LOW VOC Approved System	24
Paint Repair Using European Approved System	26
Paint Repair Using National Rules Approved System	28
MIPA PAINT SYSTEMS	30
MIPA PAINT PROCEDURES	31
Local touch-up process	31
Complete Repair	31
PAINT CODES	34

ACRYLIC STRUCTURAL REPAIR PROCEDURES

CM-TEC COMPOSITE REPAIRS	36
Surface Preparation	36
Patching the Repair Area	36
Sanding	37
CM-TEC HULL STRUCTURAL MEMBER AND TUNNEL COMPOSITE FRACTURE MY2018 & UP	38
Procedure	40

CM-TEC HULL COMPOSITE FRACTURE IN THE BOW AREA (ST3) MY2018 & UP	43
Procedure	44
CM-TEC BLISTERING IN ACRYLIC SURFACE	50
Procedure	51

CARBON FIBER SURFACE

OVERVIEW	56
Aesthetic Damages - Scratches	57

CARE AND PRODUCTS

SPECIAL CARE - GENERAL RECOMMENDATIONS	60
Removing Decals or Glue Residues	60
Fuel Spillage	60
Washing	60
Polishing	60
Aggressive Liquids and Solvents	60
Heat Gun	60
Storage Shrink Wrap	61
SAFE PRODUCTS ON CARBON FIBER SURFACE	62
PRODUCTS TO BE USED WITH CAUTION	63
PROHIBITED PRODUCTS	64

CARBON FIBER SURFACE REPAIR

MINOR TO MAJOR SCRATCHES	66
Removing Minor to Major Scratches	66
CARBON FIBER FINISH REPAIR	67
General Recommendations	67
Procedure	67

POLYTEC SURFACE

OVERVIEW	70
Aesthetic Damages - Scratches	70
Structural Damages	70
LOCATION OF DAMAGE	71

CARE AND PRODUCTS

SPECIAL CARE OF POLYTEC SURFACES	74
Fuel Spillage	74
Washing	74
Aggressive Liquids and Solvents	74
Heat Gun	74
Flame Treatment	74
Storage Shrink Wrap	74

PRODUCTS SAFE FOR USE ON POLYTEC SURFACES76
PRODUCTS TO BE USED WITH CAUTION ON POLYTEC77
PRODUCTS PROHIBITED FOR USE ON POLYTEC.....78

REPAIR PROCEDURES

QUICK REFERENCE GUIDE80
PLASTIC WELDING.....81
POLYTEC RESURFACING TECHNIQUE83

This page is intentionally blank

DECK AND HULL IDENTIFICATION

IDENTIFICATION CHART

YEAR	MODEL	MODEL NUMBER	HULL	DECK
ALL	All (except SPARK)	All	Polytec	Polytec
2017	GTR-X	All	Gelcoat	Acrylic/ABS
	WAKE 155	35HC, 35HD		
	GTS	25HC, 25HD	Polytec	
	GTI (900 ACE)	37HC, 37HD		
	RXP-X	21HE, 21HF	Gelcoat	
2018	GTI (900 ACE) GTI SE (900 ACE) GTS WAKE 155	All	Polytec	Gelcoat (black and white)
	GTI (except 900 ACE) GTR	All	Gelcoat	Acrylic/ABS (other colors)
	RXP-X	All	Gelcoat	Acrylic/ABS
	GTX RXT WAKE PRO	All	Acrylic/ABS	
2019	GTI WAKE 155	All	Polytec	Acrylic/ABS
	GTI SE GTI Pro GTR RXP-X	All	Gelcoat	
	GTX RXT Fish Pro Wake Pro	All	Acrylic/ABS	
2020	GTI Pro	All	Gelcoat	Acrylic/ABS

YEAR	MODEL	MODEL NUMBER	HULL	DECK
	RXP-X			
	GTI WAKE 155 GTI SE GTR	All	Polytec	
	GTX RXT Fish Pro Wake Pro	All	Acrylic/ABS	
2021	GTX Pro RXP-X	All	Polytec	Acrylic/ABS
	GTI WAKE 170 GTI SE GTR	All	Polytec	
	GTX RXT RXP Fish Pro Wake Pro	All	Acrylic/ABS	
2022	GTX Pro	All	Polytec	Acrylic/ABS
	GTI WAKE 170 GTI SE GTR	All	Polytec	
	GTX RXT RXP Fish Pro Wake Pro	All	Acrylic/ABS	
2023	GTX Pro	All	Polytec	Acrylic/ABS
	GTI WAKE 170 GTI SE	All	Polytec	

IDENTIFICATION CHART

YEAR	MODEL	MODEL NUMBER	HULL	DECK
	GTR			
	GTX RXT RXP Fish Pro Wake Pro Explorer	All	Acrylic/ABS	
	RXP-X APEX	All	Acrylic/ABS	Acrylic/ABS/ Carbon Fiber
2024	GTX Pro	All	Polytec	Acrylic/ABS
	GTI WAKE 170 GTI SE GTR	All	Polytec	
	GTX RXT Fish Pro Wake Pro Explorer	All	Acrylic/ABS	
	RXP	All	Acrylic/ABS	Acrylic/ABS/ Carbon Fiber

ACRYLIC SURFACE

OVERVIEW

Since 2017, some Sea-Doo® models have hulls and decks made of an acrylic and ABS thermoformed outer skin, and an inner layer of fiberglass and polyester resin, both compressed in a closed mold (CM-tec).

The acrylic surface can be painted and repaired. The procedure and the products are similar to those used by the automotive industry.

Follow the recommendations described in this document to obtain quality results on the acrylic surface.

NOTICE

Failing to follow the recommendations may result in a poor quality of repair or even damage to the acrylic/ABS surface.

For OPTIMUM results utilizing the service of an automotive or boat body shop is highly recommended.

IMPORTANT: BRP strongly recommends providing a copy of this document to your local body shop before performing a repair to obtain a quality result on the acrylic surface.

The results may vary depending on the affected area.

CARE AND PRODUCTS

SPECIAL CARE - GENERAL RECOMMENDATIONS

Removing Decals or Glue Residues

NOTICE

Do not use a heat gun to remove decals. BRP recommends the use of water and light detergent mixture or WD-40.

Here is an example of the damages caused by incompatible products on the acrylic surface.



Fuel Spillage

NOTICE

Make sure to thoroughly clean fuel spillage by simply wiping out the excess. Failure to clean fuel spillage may weaken the surface causing small surface damage called “crazing”.

Washing

Wash the vehicle with a solution of mild soap or detergent and lukewarm water.

Use a clean soft cloth, applying only light pressure. Rinse with clear water and dry with a damp cloth or chamois.

Polishing

Occasionally polish with a good acrylic-safe cleaner and polish. Apply a thin, even coat with a soft clean cloth and polish lightly with cotton flannel.

NOTICE

When using new products, it is good practice to test the product on a hidden surface area.

Aggressive Liquids and Solvents

If a cleaning liquid or organic solvent is used, it should be dried as soon as possible to avoid chemical attack on the acrylic surface. This time can be very short.

Occasionally, the crazing can occur up to a few hours after wiping off.

Washing the affected area with a solution of mild soap or detergent and luke-warm water may minimize and/or eliminate crazing.

Heat Gun

NOTICE

Do not use a heat gun to remove decals or while performing a repair.

- Carpet replacement
- Pump support removal
- Ride plate removal
- Etc.

Storage Shrink Wrap

When shrink wrapping a vehicle, several precautions must be followed to avoid damages to the finish surface.

1. Wash the vehicle with water and light detergent mixture.

NOTICE

Do not use a no rinse wash and shine product. This type of product may contain agents not compatible with the finish surface which could lead to acrylic crazing during the storage period.

2. Dry the vehicle thoroughly.
3. Install and shrink the wrap.
4. Install vents to allow proper ventilation under the shrink.

NOTICE

Avoid touching the acrylic surface with the torch flame during the shrinking process or heating a particular area for extended period of time.

SAFE PRODUCTS ON ACRYLIC SURFACE

While BRP cannot test every product used in each different region of the world, we have tested some common ones under a severe lab testing process.

NOTICE

If using other products, always test the product on a hidden area to test.

BRP recommends the use of the following cleaning products with acrylic hulls and decks surfaces.

- 3M Marine Cleaner and Wax
- Carnauba Meguiars Gold Wax
- Dish soap
- Fabuloso All-Purpose Cleaner Liquid Solution
- Fantastik Original All Purpose Cleaner
- KLEEN-FLO Glass Kleen
- Pre-Kleano 900
- WD-40
- XPS PRO C1 - Cleaner and Degreaser (Canada and USA only - not for retail)
- XPS PRO C2 - Cleaner Surface (Canada and USA only - not for retail)
- XPS PRO C4 - Cleaner Extra Foaming (Canada and USA only - not for retail)
- XPS All Purpose Cleaner and Degreaser (P/N 779313)
- XPS Multi-Surface and Glass Cleaner (P/N 779316)
- XPS Wash and Wax (P/N 779310)
- XPS Spray Wax with Polymer (P/N 779320)
- XPS Vinyl and Plastic UV Protectant (P/N 779317)
- XPS Sea-Doo® Hull Cleaner (P/N 779309)

PRODUCTS TO BE USED WITH CAUTION

While BRP cannot test every product used in each different region of the world, we have tested some common ones under a lab testing process.

These products are safe when:

- They are used as per manufacturer's instructions, and
- Not left for an extended period of time on the acrylic surface.

These products are also found harmful during our severe lab testing conditions exposing the raw products for an extended period of time.

NOTICE

- **Always follow recommended manufacturer's instructions.**
- **Do not leave raw product on surface for extended period of time, wipe the covered area immediately after use.**
- **Always try out the cleaning product on a hidden area to test, especially if using other products.**

Be careful when using the following cleaning products on the acrylic hulls and deck surfaces.

- 303 Products Aerospace Protectant
- Isopropyl Alcohol (Up to 50% concentration)
- Sea-Doo Anti-corrosion Spray
- Simple Green All-Purpose Cleaner
- Spray-Nine Boat Bottom Cleaner
- SuperClean Cleaner-Degreaser
- XPS All Purpose Cleaner
- XPS Boat and Watercraft Wash and Wax
- XPS Spray Cleaner and Polish

PROHIBITED PRODUCTS

While BRP cannot test every product used in each different region of the world, we have tested some common ones under a lab testing process.

NOTICE

The following products must NEVER be used on an acrylic surface.

- BRP Heavy Duty Cleaner
- Isopropyl Alcohol with a concentration over 50%
- Goo Gone Adhesive Remover
- Methylic Alcohol
- Pre-Kleano 902
- Pre-Kleano 909
- Turtle Wax Label and Sticker Remover
- Windex
- XPS Parts Cleaner
- XPS Vinyl Cleaner

Also, NEVER use cleaners or products containing the following:

- Acetone or other Ketones
- Alcohol
- Ammonia
- Chlorinated solvents
- Mineral spirits
- Paint thinners
- Petroleum based products
- Toluene or other aromatic solvents

ACRYLIC SURFACE REPAIR

MINOR SCRATCHES

Removing Minor Scratches

NOTICE

Unsuccessful operation to remove minor scratches will involve performing the <i>ACRYLIC/ABS REPAIR (PAGE 21)</i> procedure.
--

Some light scratches can often be removed by wet sanding and polishing the acrylic surface as described below.

Results may vary depending on the affected area.

Actions		Recommendations
Sanding	STEP 1	With 1500 grit wet sandpaper, hand sand with a circular motion, the affected area until the scratch is barely visible.
	STEP 2	With 2500 grit wet sandpaper, hand sand with a circular motion, the affected area until the scratch is no longer visible.
Polishing		Use standard automotive procedure.
Inspecting		If no discoloration is visible: No more action is required. If discoloration is visible or if results are not satisfactory, perform the <i>ACRYLIC/ABS REPAIR (PAGE 21) ACRYLIC/ABS REPAIR</i> procedure.

ACRYLIC/ABS REPAIR

General Recommendations

Actions	Recommendations
Preparation	Prepare the affected surface by sanding the area to eliminate the damage or imperfection. It is not necessary to remove the Acrylic/ABS surface completely.
Cleaning	Use isopropyl alcohol mixed with distilled water for a maximum concentration of 50%.
Drying	Allow the surface to dry completely.
Body filler (if necessary)	Use standard polyester based or vinyl ester-based body filler. Perform a minimum of 12:1 bevel when filling deeper damages. Apply body filler on the composite or acrylic/ABS to obtain a uniform surface.
Primer	Refer to: <i>BASF-/ or MIPA APPROVED PAINT SYSTEMS</i>
Sanding	Refer to: <i>BASF-/ or MIPA PAINT PROCEDURES</i>
Prepaint cleaning	Use isopropyl alcohol mixed with distilled water for a maximum concentration of 50%. Ensure to use proper rags and techniques to eliminate static charges on the part.
Sealer (if necessary)	Refer to: <i>BASF-/ or MIPA APPROVED PAINT SYSTEMS</i>
Base coat	Refer to: <i>BASF-/ or MIPA APPROVED PAINT SYSTEMS</i>
Pearl coat	Refer to: <i>BASF-/ or MIPA APPROVED PAINT SYSTEMS</i>
Clear coat	Refer to: <i>BASF-/ or MIPA APPROVED PAINT SYSTEMS</i>
Use of blending agent (if necessary)	Refer to: <i>BASF-/ or MIPA APPROVED PAINT SYSTEMS</i>
Polishing	Use standard automotive procedure.
Flash time (air dry)	Before: <ul style="list-style-type: none">- Polishing: Refer to: <i>BASF-/ or MIPA PAINT PROCEDURES</i>- Riding / Trailering: 10 days- Applying decals: at least 1 week

BASF APPROVED PAINT SYSTEMS

BASF and BRP have validated paint systems with detailed repair procedures specific for the acrylic/ABS surfaces.

BASF selected paint systems that would offer a worldwide availability, meeting the different regulations of various regions.

BASF VALIDATED PAINT SYSTEM				
REGULATION	NATIONAL RULES	LOW VOC		EUROPEAN
Paint System	RM Diamont Series	RM Onyx water base	RM Onyx HD solvent base	Glasurit Line 90 water base
Primer	RMP or DP Series	DP Series		Glasurit 270 Series
Clear Coat	DC5600 or DC92	RMC2400		Glasurit 923-335
Blender	UBR200			
Sealer (for spot repair)	Non applicable	Non applicable		Glasurit 285-270 (Transparent / non tinted)

IMPORTANT: BRP strongly recommends providing a copy of this document to your local body shop before performing a repair to obtain a quality result on the acrylic surface.

NOTICE

Failing to follow the recommendations described in this bulletin may result in a poor quality of repair or even damage to the acrylic surface.

MIXING RATIO AND INSTRUCTIONS

- Visit www.basrefinish.com for North American
- Visit www.Glasurit.com for EU and Australia

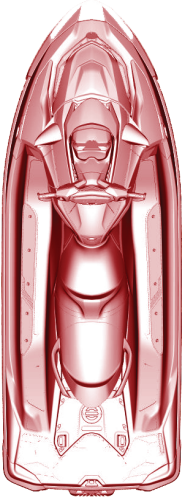

1

1. Complete repaint
2. Local touch-up

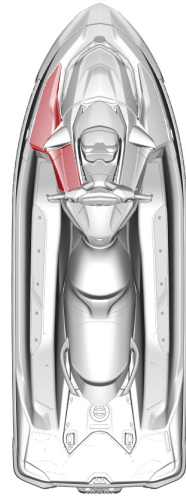

2

BASF PAINT PROCEDURES

Paint Repair Using LOW VOC Approved System

NOTICE

The directions described in this procedure must be strictly adhered to.

LOW VOC paint is not intended for touch-up. Do not perform touch-up using LOW VOC paint.

The use of LOW VOC paint must be done when performing a complete repaint only.

NOTE: A complete repaint includes the following actions: sanding, primer application, base coat application, clear coat application on the full surface of the affected area.

PAINT REPAIR - LOW VOC

PREPARATION:

1. Clean the surface using water and light detergent mixture to remove surface dirt.
2. Clean the surface with the Pre-Kleano 900 (wet / dry wipe).
3. Finish sanding all body (and repair if applicable) with P240 grit.
4. Prepare the primer for painting by sanding with P500 grit.

APPLICATION EQUIPMENT:

- Spray using a 1.3 - 1.4 mm Compliant and HVLP @ 30 PSI (full fan/feed)

MIXING RATIO AND INSTRUCTIONS:

- Visit www.basrefinish.com for North American
- Visit www.Glasurit.com for EU and Australia

PRIMER (MANDATORY):

Apply 2 full coats, allow 20 - 25 minutes flash time

- Apply 2 full coats, allow 20 - 25 minutes flash time
- Cover the complete acrylic surface

BASECOAT APPLICATION:

1. Apply 1 medium coat, allow 10 -15 minutes flash time (Check Dehydration)
2. Apply the second 1 medium/wet coat and orientation coat for Metallic
3. Allow 10 -15 minutes flash time (Check Dehydration)

CLEARCOAT APPLICATION:

1. Apply full coat, allow 5 - 10 minutes flash time
2. Apply second coat

BAKE INSTRUCTION FLASH TIME:

- Air Dry: 4 to 6 hours @ 25°C (77°F)
- Forced Bake: 30 mins @ 60°C (140°F)

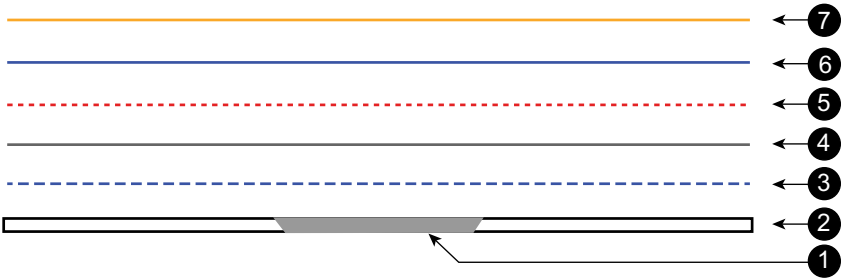

1. *Body filler (if required)*
2. *Acrylic*
3. *240 grit*
4. *Primer*
5. *500 grit*
6. *Basecoat*
7. *Clearcoat*

Paint Repair Using European Approved System

NOTICE

The directions described in this procedure must be strictly adhered to.

The use of sealer *Glasurit 285-270* is necessary when performing touch-up repairs.

PAINT REPAIR - EUROPEAN PAINT SYSTEM

PREPARATION:

1. Clean the surface using water and light detergent mixture to remove surface dirt.
2. Clean the surface with the Pre-Kleano 900 (wet / dry wipe).
3. Finish sanding all body repair with a P240 grit, then back sand surrounding areas with P500 grit.
4. In the repair area: Use a dual action orbital sander with P500 grit.
5. In the blend area: Use a dual action orbital sander with P1500 grit.
6. Clean the surface again with the Pre-Kleano 900 (wet / dry wipe).

APPLICATION EQUIPMENT:

- Spray using a 1.3 - 1.4 mm Compliant and HVLP @ 30 PSI (full fan/feed)

MIXING RATIO AND INSTRUCTIONS:

- Visit www.basrefinish.com for North American
- Visit www.Glasurit.com for EU and Australia

PRIMER REPAIR AREA (IF REQUIRED):

- Apply 2 full coats, allow 20 - 25 minutes flash time.

SEALER APPLICATION (IF REQUIRED):

Mix Ratio: Recommend Over Reducing to 6:1:4

1. Apply 1 medium coat, allow 20 - 25 minutes flash time
2. Target Film Build: .5 - .8 mils dry film (do not overbuild)

BASECOAT APPLICATION:

1. Apply 1 medium coat, allow 10 -15 minutes flash time (Check Dehydration)
2. Apply the second 1 medium/wet coat and orientation coat for Metallic
3. Allow 10 -15 minutes flash time (Check Dehydration)

CLEARCOAT APPLICATION:

1. Apply full coat, allow 5 - 10 minutes flash time
2. Apply second coat

BLENDING SOLVENT (IF REQUIRED):

Mix Ratio: 2:1 (Blender / Clearcoat)

1. Apply 1 medium coat over clearcoat overspray transition area, allow 5 minutes flash time.

2. Repeat until overspray area is melted to a smooth appearance.

BAKE INSTRUCTION FLASH TIME:

- Air Dry: 4 to 6 hours @ 25°C (77°F)
- Forced Bake: 30 mins @ 60°C (140°F)

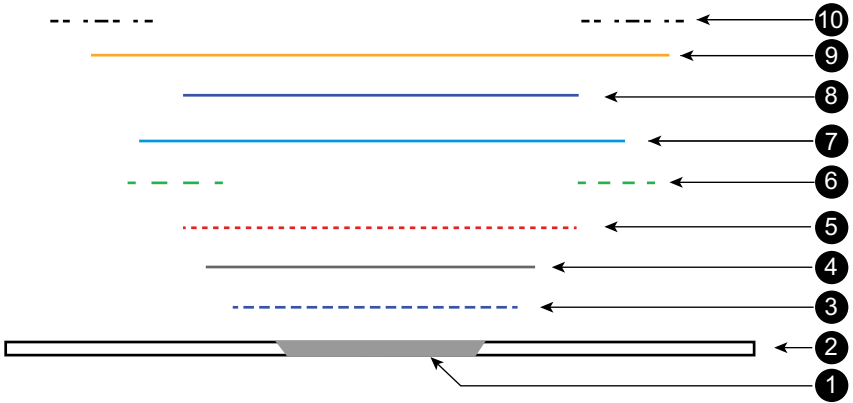

1. Body filler (if required)
2. Acrylic
3. 240 grit (only if #1 is required)
4. Primer (only if #1 is required)
5. 500 grit
6. 1500 grit
7. Sealer
8. Basecoat
9. Clearcoat
10. Blender (if required)

Paint Repair Using National Rules Approved System

PAINT REPAIR - NATIONAL RULES

PREPARATION:

1. Clean the surface using water and light detergent mixture to remove surface dirt.
2. Clean the surface with the Pre-Kleano 900 (wet / dry wipe).
3. Finish sanding all body repair with a P240 grit, then back sand surrounding areas with P500 grit.
4. In the repair area: Use a dual action orbital sander with P500 grit.
5. In the blend area: Use a dual action orbital sander with P1500 grit.
6. Clean the surface again with the Pre-Kleano 900 (wet / dry wipe).

APPLICATION EQUIPMENT:

- Spray using a 1.3 - 1.4 mm Compliant and HVLP @ 30 PSI (full fan/feed)

MIXING RATIO AND INSTRUCTIONS:

- Visit www.basrefinish.com for North American
- Visit www.Glasurit.com for EU and Australia

PRIMER APPLICATION (IF REQUIRED):

- Apply 2 full coats, allow 20 - 25 minutes flash time.

BASECOAT APPLICATION:

1. Apply 1 medium coat, allow 10 -15 minutes flash time (Check Dehydration)
2. Apply the second 1 medium/wet coat and orientation coat for Metallic
3. Allow 10 -15 minutes flash time (Check Dehydration)

CLEARCOAT APPLICATION:

1. Apply full coat, allow 5 - 10 minutes flash time
2. Apply second coat

BLENDING SOLVENT (IF REQUIRED):

Mix Ratio: 2:1 (Blender / Clearcoat)

1. Apply 1 medium coat over clearcoat overspray transition area, allow 5 minutes flash time.
2. Repeat until overspray area is melted to a smooth appearance.

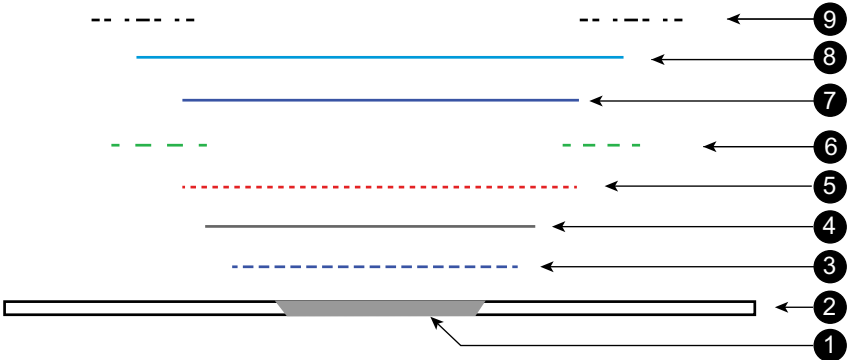

1. *Body filler (if required)*
2. *Acrylic*
3. *240 grit (only if #1 is required)*
4. *Primer (only if #1 is required)*
5. *500 grit*
6. *1500 grit (touch-up rework only)*
7. *Basecoat*
8. *Clearcoat*
9. *Blender (if required)*

MIPA PAINT SYSTEMS

MIPA selected paint systems that would offer a worldwide availability, meeting the lowest European regulations.

REGULATION	EUROPEAN
Paint System	Mipa WBC 2 Schicht-Basislack / Mipa WBC Beispritzlack
Primer	Mipa 1k Haftpromoter / Mipa P85 / Mipa P118 Ultra / Mipa PX9 / Mipa 2K-HS-Express-Filler FX4
Clear Coat	Mipa 2K-HS-Klarlack CC9
Sealer for spot repair	Mipa 2K-HS-Klarlack CC9

IMPORTANT: BRP strongly recommends providing a copy of this document to your local body shop before performing a repair to obtain a quality result on the acrylic surface.

NOTICE

Failing to follow the recommendations described in this bulletin may result in a poor quality of repair or even damage to the acrylic surface.

MIXING RATIO AND INSTRUCTIONS

– Visit www.Mipa-Paints.com for all Countries

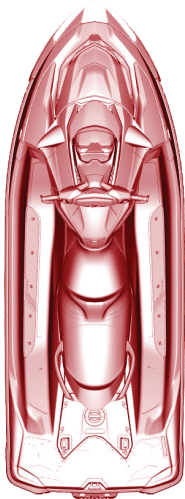

1

1. Complete repaint
2. Local touch-up

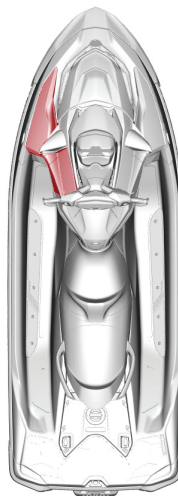

2

MIPA PAINT PROCEDURES

Local touch-up process

IMPORTANT: Pay attention! Can you perform a clean repair with enough area to blend your color properly?

This may only require a local touch-up meaning completing a paint touch-up using available swage lines (do not use the clear coat blend method) this is an unwarrantable method.

NOTICE

If performing a blend out instead of a full color repair, Use Mipa WBC Beispritzlack (blending).

Mipa WBC Beispritzlack (blending) is Designed to make fading and blending basecoats easy to be able to achieve an undetectable repair.

Mipa WBC Blending Clearcoat also can be applied directly to the repaired area and is especially suitable for silver colors, small scratches and sanding marks which can be levelled out in the transition zone.

WBC Blending Clearcoat dries absolutely colorless and guarantees a homogeneous transition.

With the use of Mipa WBC Blending Clearcoat the shade and the flop of the vehicle's paint work can be better assessed particularly in the case of silver colors.

Complete Repaint

Repainting the full top deck may require color blends in several areas or complete and clear coat application over the entire watercraft.

Preparing watercraft for full repaint process

- Prepare the watercraft by removing all decals and glue residue using Mipa Silikonentferner.
- Refer to TDS and use Mipa Silikonentferner in a well-ventilated area.
- MIPA recommends the use of Mipa Silikonentferner applied by cloth allowing to soak into decals to soften residue of decal then wipe dry with a clean dry cloth.
- Mipa Silikonentferner is a CHC-free cleaning and degreasing agent for all metallic and polymeric materials. It can be applied by paintbrush, brush, wipe, sponge or by spraying.

Sanding process

1. Sand Mipa FX4 primer using a suitable block for the area to be sanded using 320 grit sandpaper.
2. Feather out the repair using 600-800 grit sandpaper, continue sanding repair until all sanding scratches have been removed and repair area is nice and smooth.
3. Sand any non-primed flat areas using 800 grit sandpaper with an orbital sander to knock down the OEM peel.
4. Blow dust off using air blower.
5. Wet sand remaining areas using 800-1000 grit sandpaper.
6. Wash off sludge (keep watercraft and trailer clean).

7. Go over all area's dry with grey scotch brite by hand that may be hard to reach or might have been missed during sanding process.
8. Wash watercraft and trailer off.

Masking process

- Using air blower, thoroughly blow off all possible dust out of all holes and crevices.
- Use Mipa Silikonentferner (refer to TDS before use) on the entire top deck and anywhere masking is needed.
- Mask off entire watercraft leaving the top deck exposed, ensure every hole on the top deck is masked before painting to ensure no dust or overspray is created.



NOTICE

Any important decals are masked off at this point with a mixture of fine line tape and water-resistant masking tape

Painting process

IMPORTANT: Ensure you are wearing a spray suit and gloves during this process to ensure minimal dust.

1. Wax and grease the whole watercraft one last time applying with a damp cloth soaked with Mipa Silikonentferner (refer to TDS before use) and wiping dry with a clean dry cloth.
2. Blow the watercraft down 2-3 times while using Mipa Staubbindetuch (tack cloth).
3. Apply one medium coat of Mipa 1K – Haft promoter (refer to TDS before use).
4. Apply Mipa Beispritzlack (blending clearcoat) on all areas where full color coverage is not needed.
5. 1st spray pass - Apply a ½ spray pass semi-wet and flowing with a spray pressure of approx. 2 bar.
 - Dry down Mipa WBC with blower until finish is matte.
 - 2nd spray pass: Apply complete spray pass consisting of two half-wet coats ("up and down") keeping the same distance, spraying speed and spraying pressure as for the 1st spray pass.
 - Dry down Mipa WBC with blower until finish is matte.
 - Drop coat only for metallic and effect colors: the last spray pass of all effect and metallic paints is applied uniformly at a reduced spraying pressure of 1 bar. This drop coat is absolutely necessary to achieve color accuracy. In addition, this drop coat can prevent irregularities, e.g. mottling.
 - Dry down Mipa WBC with blower until finish is matte (wait a further 5 mins before clearing).
6. Remove any masking off important decals.
7. Apply 1 medium coat of Mipa Haft promoter over decals.
8. Apply 2 coats of Mipa CC9 Clear over entire top deck of watercraft (refer to TDS before use).

NOTICE

The color shade of metallic and effect colors will tend to be "lighter" after the application of the drop coat. If the shade still appears too "dark" after the first drop coating, apply at most a second drop application to further lighten the shade. Decals have been clear coated over to avoid any edges that may start to pull away over time.



PAINT CODES

To have all Model years covered here we refer to the Knowledge Center in BOSSWeb.

Please enter the following text in the search box with the year as a variable, this also works for all other BRP product lines.

Product line	Model year	Document title
SEADOO	2021	Paint Codes

NOTICE

- Paint codes are for painted parts only. Color codes for dyed panels or anodized parts are not available.
- Only on deck and hull, use variant paint codes.

Example of the color coding for the model

CORRESPONDING PAINT CODES				
BRP COLORS		VARIANT	B.A.S.F.	PPG
B-101	Can-Am Red	-	805694	937654
B-160	Deep Black	-	85366, RM 85366	DCC 95066 / DBC 9554
		M18-093	961720	953449
B-229	Bright White	-	757238	DG-DCC 917825
		M19-028	962025	975557
• B-245	Flint Grey	L21-003	978799	N/A
• B-278	Millenium Yellow	L21-001	978841	N/A
B-357	Manta Green	-	900946	935108

Example of the color coding for the model

RXT-X Model

COMPONENTS	COLOR CODE	• VARIANT
LH and RH Hood Grill Trim	B-278 B-357	=
Deck	B-278	L21-001
	B-458	L21-002
Hull	B-278	L21-001
	B-458	L21-002

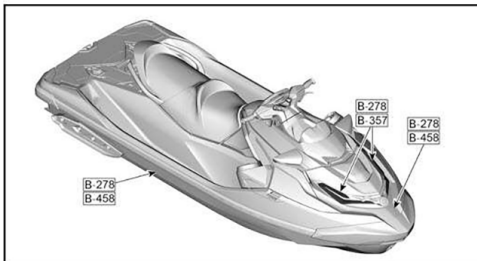

ACRYLIC STRUCTURAL REPAIR PROCEDURES

CM-TEC COMPOSITE REPAIRS

Major repairs are those that have gone past the surface finish and in through the composite structure.

Possible cause:

- Direct result of impact.

Two types of repairs have to be performed:

- The first is to restore the structural integrity of the damaged area. Fracture types can vary from a simple crack to a large hole. Usually, fiberglass reinforcement becomes necessary.
- The final part is to restore the surface finish, which cannot be done until the interior and exterior laminate surfaces were repaired.

Surface Preparation

Outside: Remove the damaged surface finish with a 24-grit disk using a power sander. Grind outward at least 2 inches from the fracture to allow the patch to bond to strong material. Cut enough pieces of fiberglass mat necessary to build up the area. The pieces should be cut so they overlap each other by at least a half inch. For a smoother finish, the last layer should be fiberglass cloth. If the fracture is small enough all you may have to do is fill the area with an epoxy filler.

Inside: For the interior repair, you can grind more. This will allow for more fiberglass material which will strengthen the area. If the fracture opening is too large after surface preparation, you may need a backing support to cover the opening. Cut alternating pieces of fiberglass mat and cloth in overlapping sizes.

Patching the Repair Area

IMPORTANT: The Outside should be repaired before the inside.

Outside:

1. Wipe clean the area with isopropyl alcohol mixed with distilled water for a maximum concentration of 50% on a cloth, then mask off area.

NOTE: For a small crack use standard polyester based or vinylester based body filler. When laying up a larger area you will use mat, cloth, and fiberglass resin and catalyst. Use a clean container to mix the resin, mix only what you will need. Follow the recommended catalyst ratio.

2. Using a clean paintbrush, brush the mixed resin on the surface. Place the smallest piece of mat over the fracture and then wet out the mat. Follow with the remaining pieces of mat and final layer of cloth.

NOTE: While wetting the pieces make sure you work the air bubbles out and saturate all the pieces evenly.

3. Wait until the repair has hardened before moving on to the interior repair.

NOTE: If the size of the opening is too large for the pieces to maintain the proper shape, you will have to use a backing support. It is a shaped piece of cardboard that fits flush to the interior surface and has a plastic layer on the repair side. It is held in place by tape or a support.

Inside:

1. Wipe down the area with isopropyl alcohol mixed with distilled water for a maximum concentration of 50% on a cloth.
2. Apply the same procedure as for outside repair when laminating the alternating pieces of fiberglass material. If a backing support was used, remove it before starting the repair.
3. After the area has hardened, remove sharp edges of material from surface. If required paint the surface.

Sanding

Outside:

This surface will have to be prepared for application of the body filler and paint repair. The size of the area will determine the surface finish procedure to be used. Refer to *Acrylic/ABS Repair*.

Inside:

This surface will have to be lightly sanded to remove sharp edges and imperfections from the repaired area and cleaned after sanding process. Refer to *Acrylic/ABS Repair*.

CM-TEC HULL STRUCTURAL MEMBER AND TUNNEL COMPOSITE FRACTURE MY2018 & UP

SITUATION

The CM-tec hulls and decks are made of fiberglass and polyester resin, both compressed in a closed mold (CM-tec).

The Acrylic surface finish, used on the latest CM-tec hulls and decks, is very flexible. This may allow a composite fracture to a structural member of the CM-tec hull to be visible only from the inside thus requiring no external repairs to the Acrylic surface finish.

PROBLEM

A fracture may be visible in the composite of a structural member of the hull or the tunnel.

Example of fracture:

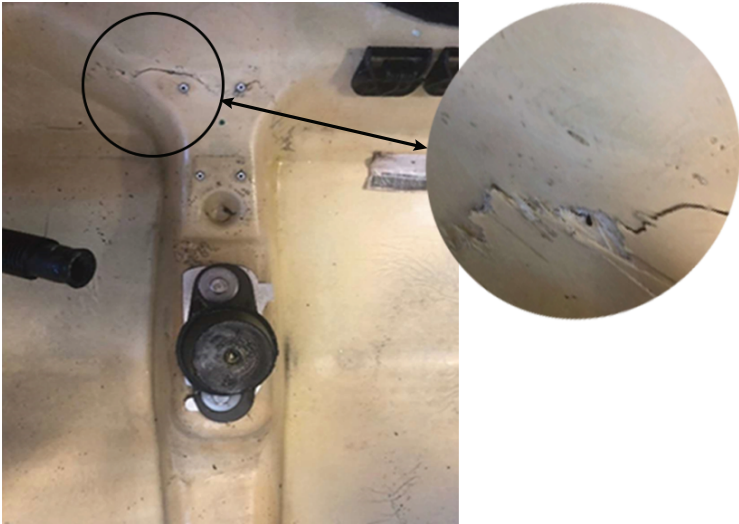

SOLUTION - Structural Member

A repair will have to be performed.

1. Restore the structural integrity of the damaged area.
2. Apply a reinforcement to the affected area.

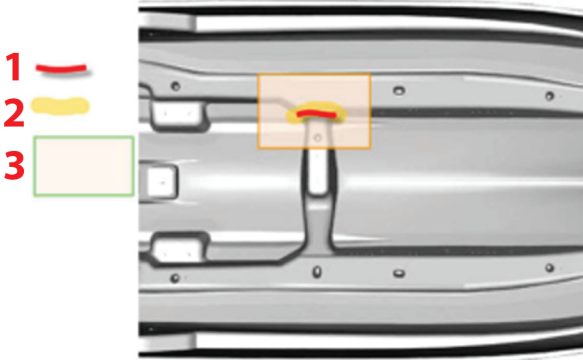

1. Fracture
2. Restore the structural integrity of the damaged area
3. Apply a reinforcement to the affected area

SOLUTION - Tunnel

The tunnel must be reinforced in the outlined area shown in the figure below. Depending on the location of the repair, the diagram is to be used as a general guideline.

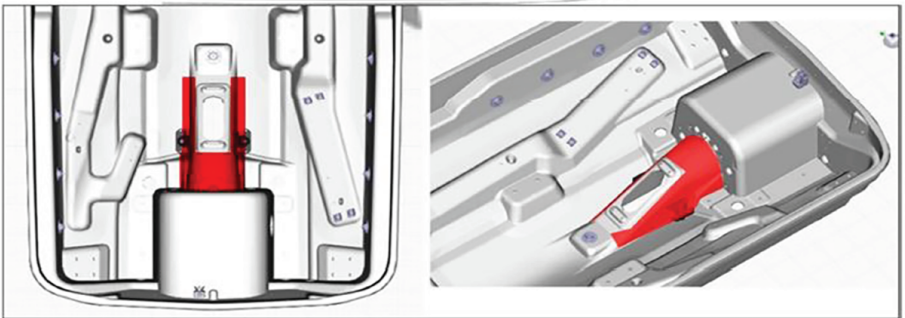

PARTS REQUIRED

Polyester / Epoxy Resin & Hardener	Purchase locally	as needed
Fiberglass mat	Purchase locally	as needed

Procedure

This procedure provides steps for repairing a hull structural member composite fracture, and tunnel repair.

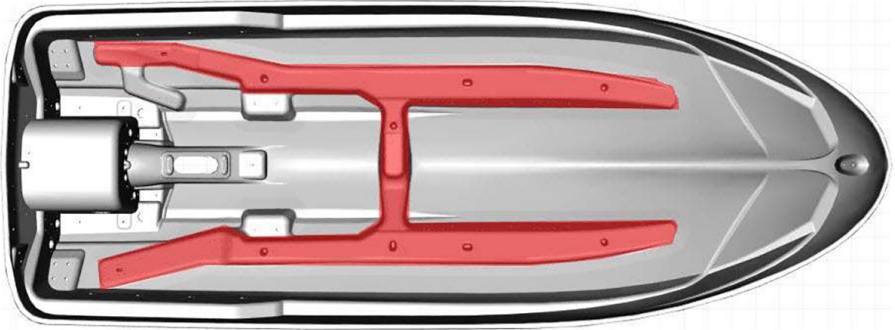

Step 1: Fracture Repair - Hull Structural Member

Surface preparation

Inside:

1. Grind the fracture almost all the way through the thickness of the hull.

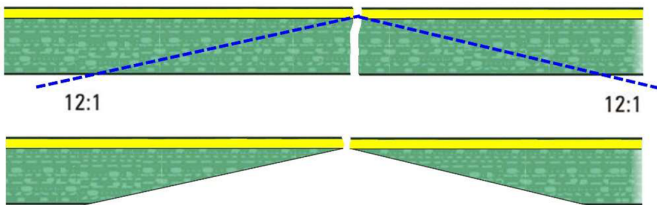

IMPORTANT: Always respect a 12:1 bevel angle to allow the patch to bond to strong material.

2. Finish the surface preparation using a power sander with a rough disk, 36 grit.
3. Wipe down the area with Isopropyl alcohol (maximum concentration of 50%) on a cloth.
4. Allow the surface to dry completely.

Patching the Repair Area

Inside:

1. Cut enough pieces of fiberglass mat necessary to build up the area.

NOTE: The pieces should be cut so they overlap each other by at least a half inch. This will allow for more fiberglass material which will strengthen the area.

2. Use a clean container to mix the resin, mix only what you will need. Follow the recommended catalyst ratio.
3. Using a clean paintbrush, brush the mixed resin on the surface.
4. Place the smallest piece of mat over the fracture and then wet out the mat.
5. Place and wet the remaining pieces of fiberglass mat to build up the repair area.

NOTE: Make sure pieces overlap each other by at least two inches. While wetting the pieces, make sure you work the air bubbles out and saturate all the pieces evenly. Try to work quickly, you may only have 15 or 20 minutes.

6. After the area has hardened, perform the *Area Reinforcement* procedure.

Step 2: Areas Reinforcement - Structural Member Repaired Area and Tunnel

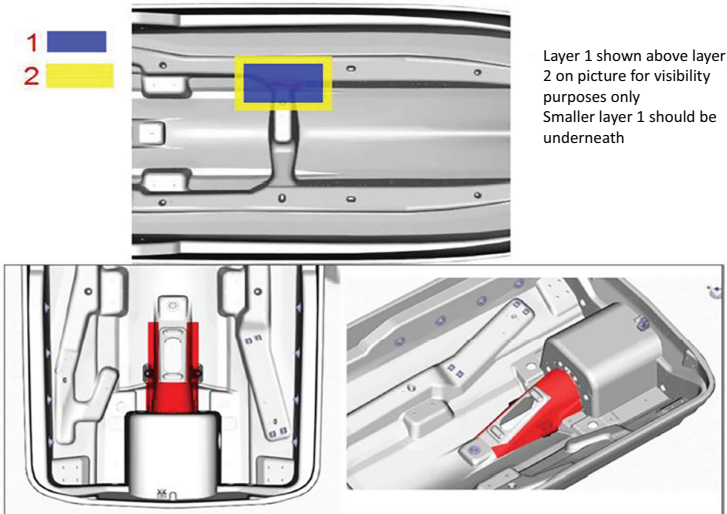

NOTICE

A smaller layer of mat must be laid beneath what is shown in red. Depending on the location, this is to be used as a general guideline using the same procedure listed below.

2 layers of fiberglass mat is the minimum recommended. More layers, or a combination of mat and woven, can be used if preferred by the repair shop.

IMPORTANT: The first, smaller layer, should extend at least 100 mm (4 in) further than the repaired area. The second layer should extend at least 25 mm (1 in) further than the first layer.

Surface Preparation

Inside:

1. Using a power sander with a 36 grit disk, scratch the surface at least the reinforcement areas shown on the image above to promote adhesion of the mat with the composite.
2. Wipe down the area with Isopropyl alcohol (maximum concentration of 50%) on a cloth.
3. Allow the surface to dry completely.

Reinforcing the Areas

Inside:

1. Cut pieces of fiberglass mat to cover each reinforcement areas with at least 2 layers of fiberglass mat as shown above.

NOTE: The pieces should be cut so they overlap each other by at least two inches. Each layer can be done by overlapping a few long strips of mat to ease the repair.

2. Apply the same procedure as for the previous patching procedure when laminating the pieces of each layer of fiberglass mat.

NOTICE

Make sure pieces of the each layer overlap each other by at least two inches and the second layer is perpendicular with the first layer. While wetting the pieces make sure you work the air bubbles out and saturate all the pieces evenly. Try to work quickly, you may only have 15 or 20 minutes.

3. After the areas have hardened, lightly sand the reinforcement areas with a fine grit to remove free fibers and obtain a smooth surface.

CM-TEC HULL COMPOSITE FRACTURE IN THE BOW AREA (ST3) MY2018 & UP

PROBLEM

Some 2018 ST3 hulls may have a weakness and develop a composite fracture in the bow area while riding in rough water conditions. The composite fractures are those that have gone past the thermoformed outer skin and in through the inner layer of fiberglass and polyester resin composite. Depending of the severity at the time of the detection, damages can vary from a simple hairline to a large crack. In both cases the repair should be handled like a composite fracture.

Example of fracture:



SOLUTION

A three-step repair will have to be performed.

1. Restore the structural integrity of the damaged area.
2. Apply the bow area reinforcement, necessary due to the weakness.
3. Painting.

PARTS REQUIRED

Polyester / Epoxy Resin & Hardener	Purchase locally	as needed
Fiberglass mat 2oz chopped strand mat is the minimum recommended	Purchase locally	as needed

Procedure

Accessing the inside of the hull:

1. Remove the storage compartment referring to the body section of the **2018 GTX, RXT, WAKE PRO - Shop Manual**
2. Move ventilation tube, steering cable, and steering harness aside.
3. Gently cut the foam blocks and remove them from the hull temporarily.
4. After the fiberglass repair is complete, the foam block must be reinstalled. Hot glue or silicone can be used to hold the foam block in place during the reassembly of the storage compartment.

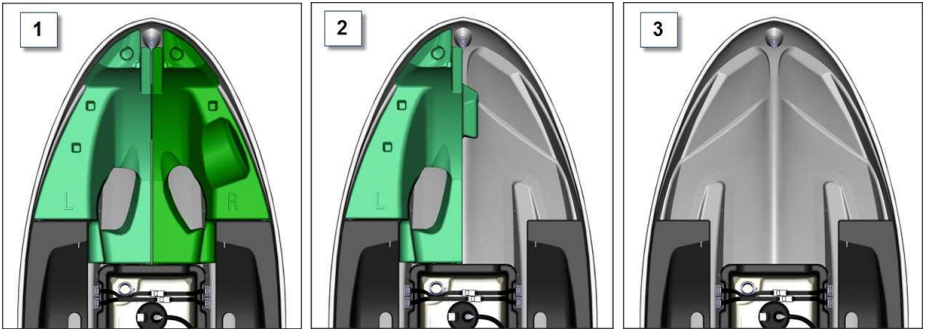

Step 1: Composite Fracture Repair



Surface preparation

Outside: If the composite is broken, straighten the hull surface first, pushing the composite back to the original shape. Drilling a small hole to use a screw with plates or washers may help.

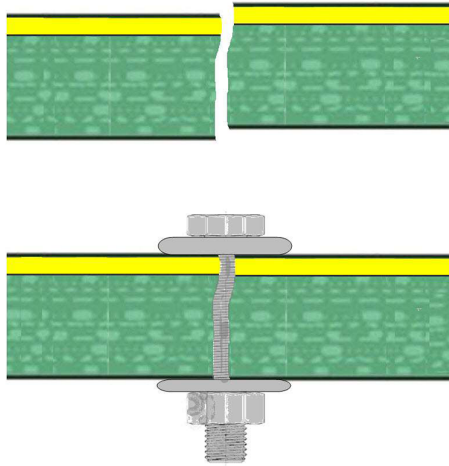

Inside:

1. Grind the fracture almost all the way through the thickness of the hull.

IMPORTANT: Always respect a 12:1 bevel angle to allow the patch to bond to strong material.

2. Finish the surface preparation using a power sander with a rough disk, 36 grit.

NOTE: Cut enough pieces of fiberglass mat necessary to build up the area. The pieces should be cut so they overlap each other by at least a half inch. This will allow for more fiberglass material which will strengthen the area.

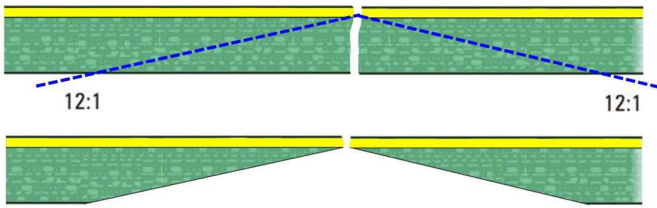

Patching the Repair Area

Outside:

NOTE: In some cases, the fracture and the bevel done on the inside may cause some openings through the hull. A temporary backing should then be put in place on the outside to properly support the patches to be applied on the inside.

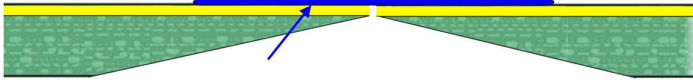

Inside:

1. Wipe down the area with Isopropyl alcohol (maximum concentration of 50%) on a cloth.

NOTE: Use a clean container to mix the resin, mix only what you will need. Follow the recommended catalyst ratio.

2. Using a clean paintbrush, brush the mixed resin on the surface. Place the smallest piece of mat over the fracture and then Wet out the mat.

NOTE: While wetting the pieces make sure you work the air bubbles out and saturate all the pieces evenly. Try to work quickly, you may only have 15 or 20 minutes.

3. After the area has hardened, perform the bow area reinforcement procedure.

Step 2: Bow Area Reinforcement

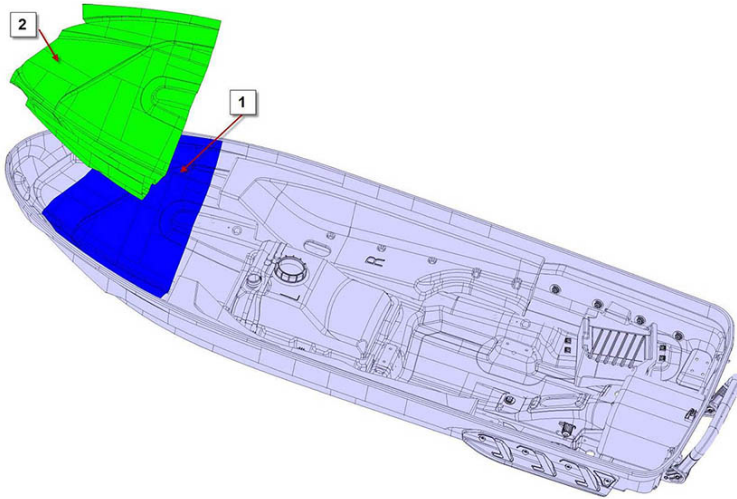

POSITION OF REINFORCEMENT LAYER 1 AND 2

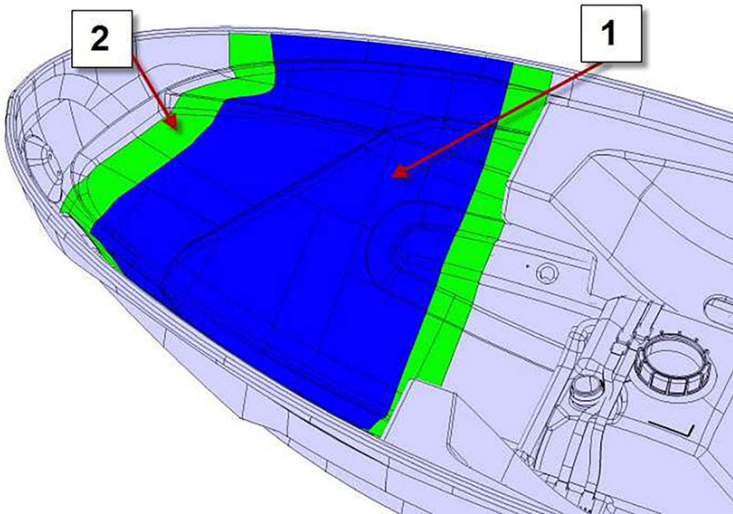

Layer 1 shown above layer 2 on picture for detailed location visibility purposes only. Smaller layer 1 should be underneath.

NOTICE

2 layers of 2oz chopped strand mat is the minimum recommended. More layers, or a combination of mat and woven, can be used if preferred by the repair shop.

Surface Preparation

Inside:

1. Using a power sander with a 36 grit disk, scratch the surface at least the area shown on the image above to promote adhesion of the mat with the composite.
2. Wipe down the area with Isopropyl alcohol (maximum concentration of 50%) on a cloth.
3. Allow the surface to dry completely.

Patching the Bow Area

Inside:

1. Cut pieces of fiberglass mat to cover each reinforcement areas with at least 2 layers of fiberglass mat as shown above.

NOTE: The pieces should be cut so they overlap each other by at least two inches. Each layer can be done by overlapping a few long strips of mat to ease the repair.

2. Apply the same procedure as for the previous patching procedure when laminating the pieces of fiberglass mat.

NOTICE

Make sure pieces of the each layer overlap each other by at least two inches and the second layer is perpendicular with the first layer. While wetting the pieces make sure you work the air bubbles out and saturate all the pieces evenly. Try to work quickly, you may only have 15 or 20 minutes.

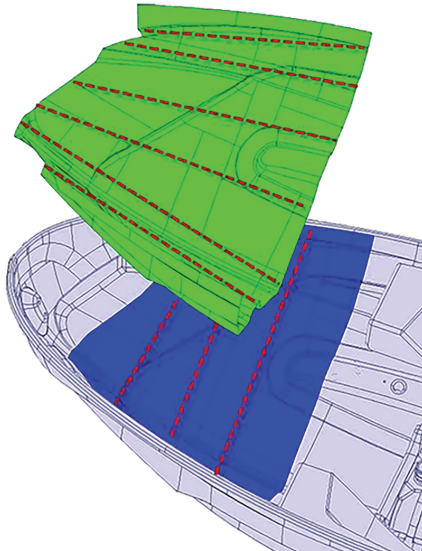

3. After the areas have hardened, lightly sand the reinforcement areas with a fine grit to remove free fibers and obtain a smooth surface.

Step 3: Painting

Outside: This surface will have to be prepared for application of body filler and paint. Refer to the BASF-/ or MIPA PAINT PROCEDURES.

CM-TEC BLISTERING IN ACRYLIC SURFACE

Major repairs are those that have gone past the surface finish and in through the composite structure.

Possible cause:

- Direct result of impact.

Two types of repairs have to be performed. The first is to restore the structural integrity of the damaged area. Fracture types can vary from a simple crack to a large hole. Usually, fiberglass reinforcement becomes necessary, especially if the fracture can be attributed to weakness.

The final part of the repair is the surface finish repair, which cannot be done until the interior and exterior laminate surfaces were repaired.

Access the damaged area to see how big or small the repair will need to be and how much of the area needs to be prepared for fiberglass.



If damage is only a small crack, sand down area using 24 grit sander or an orbital air sander then apply standard polyester-based body filler Mipa PX9.

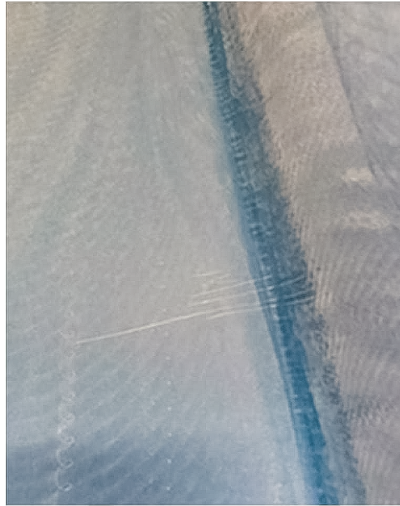

Procedure

1. Access the damaged area, if repair can be achieved without a replacement patch then sand down damaged area with an air grinder or orbital sander using 24 grit.



If the damaged area will need a replacement patch, then cut out area with sharp blade.

2. Once the damaged area has been cut out or sanded down, sand down the edges of the repair with 40 or 80 grit sandpaper. Making sure all edges have been feathered out evenly.
3. Make a cardboard template of the repaired area that has been cut out so it can be transferred onto a sheet of fiberglass matting, so you have the correct size and shape for the repair.
4. Cut out fiberglass matting to transferred size and shape.
5. Lay down 4-6 sheets of fiberglass (depending on the size of the repair).

IMPORTANT: MINIMUM OF 4 PLUS SHEETS REQUIRED. —> FOR EXTRA STRENGTH BRUSH RESIN BETWEEN SHEETS

NOTICE

The Fiberglass will require 24 hours to cure, no sanding or shaping to occur before this period.

6. Sand down and shape the fiberglass repair using 80 grit sandpaper until you have the correct shape.



7. Apply Mipa P118 body filler to even out repair and fill any pin holes or minor imperfections.



LET BODY FILLER P118 DRY UNTIL HARD

8. Sand down body filler and reshape with 120 grit sandpaper until smooth and an even finished has been achieved.
9. Feather out repair area with 240 grit sandpaper, continue sanding edges of repair until all sanding scratches have been removed and repair area is nice and smooth.
10. Sand using a dry Red scotch brite by hand in an area of 10 - 15 cms outside of the 240 grit sanding area.

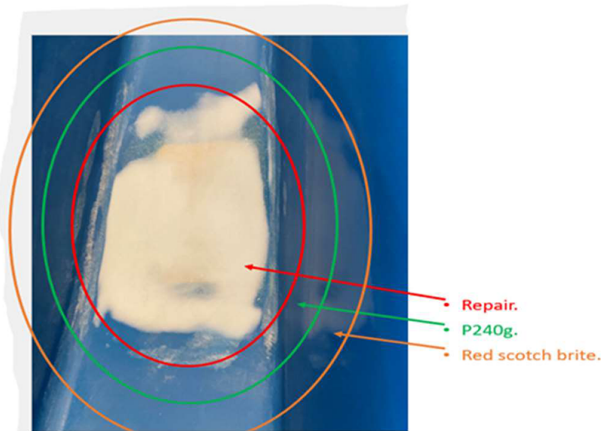

Wipe in Mipa P85 finishing filler over the whole repair to fill pinholes in the repairs that may have been missed. Applying product as smooth and even as possible will ensure a better finished result.

IMPORTANT: LET BODY FILLER P85 DRY UNTIL HARD THEN SAND WITH 240 GRIT SANDPAPER UNTIL SMOOTH.

11. Once repair is finished, blow the repair area with an air blower to remove any dust settled from repair.

Wipe around the area with Mipa Silikonentferner (refer to TDS before use) using a wet cloth and then wipe dry with a clean dry cloth.

NOTICE

Important that Mipa Silikonentferner does not come into contact with filler repair.

12. Mask repair area making sure to cover watercraft adequately to avoid any overspray on areas not requiring re-finish.

13. Apply 1 medium coat of Mipa Haft Promoter (refer to TDS before use).

14. Prime repair area using Mipa FX4 (refer to TDS before use), repair will require 2-3 coats of primer on average.

IMPORTANT: PRIMING COAT SHOULD START SMALL TO COVER THE REPAIR AND EXPAND WITH EACH COAT.



CARBON FIBER SURFACE

OVERVIEW

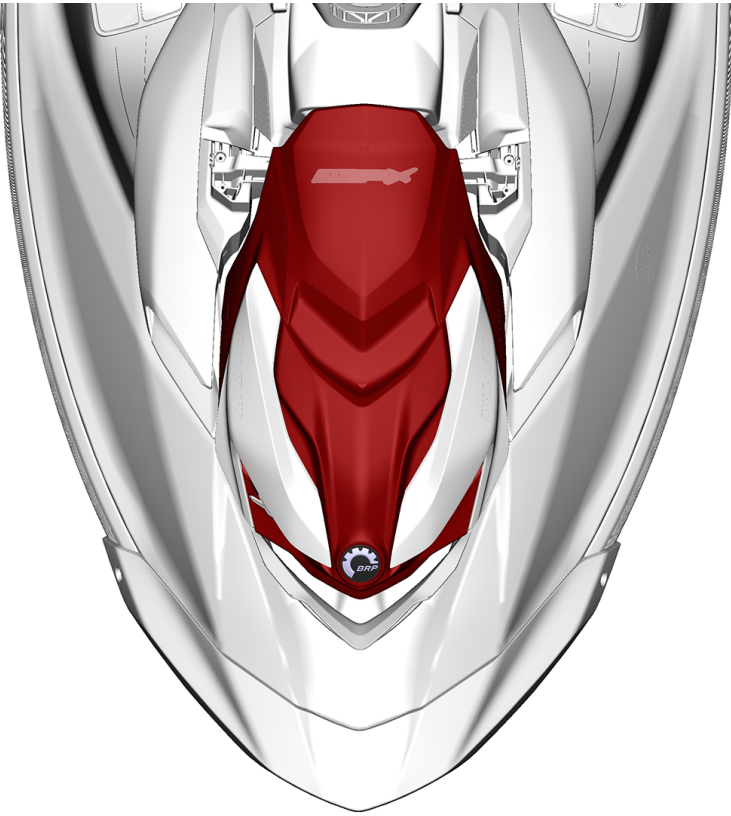

2024 RXP-X 325 MODEL SHOWN

Some Sea-Doo Watercrafts may be equipped with carbon fiber components. Refer to identification chart for specific models.

Aesthetic Damages - Scratches



EXAMPLE OF SCRATCHES

An external scratch is the result of the hull or deck surfaces rubbing against a rough or sharp object. This type of damage does not cause any operational problems.

This type of damage is exclusively aesthetic. This damage can be removed or diminished by buffing over the scratch using the carbon fiber finish repair. Refer to *Carbon Fiber Surface Repair* subsection. The results may vary, depending on the affected area.

This page is intentionally blank

CARE AND PRODUCTS

SPECIAL CARE - GENERAL RECOMMENDATIONS

Removing Decals or Glue Residues

NOTICE

Do not use a heat gun to remove decals. BRP recommends the use of water and light detergent mixture or WD-40.

BRP recommends the use of water and light detergent mixture or WD-40.

Fuel Spillage

NOTICE

Make sure to thoroughly clean fuel spillage by simply wiping out the excess. Failure to clean fuel spillage may weaken the surface causing small surface damage called "crazing".

Washing

Wash the vehicle with a solution of mild soap or detergent and lukewarm water.

Use a clean soft cloth, applying only light pressure. Rinse with clear water and dry with a damp cloth or chamois.

Polishing

Occasionally polish with a good carbon fiber-safe cleaner and polish. Apply a thin, even coat with a soft clean cloth and polish lightly with cotton flannel.

NOTICE

When using new products, it is good practice to test the product on a hidden surface area.

Aggressive Liquids and Solvents

If a cleaning liquid or organic solvent is used, it should be dried as soon as possible to avoid chemical attack on the carbon fiber surface. This time can be very short.

Occasionally, the crazing can occur up to a few hours after wiping off.

Washing the affected area with a solution of mild soap or detergent and lukewarm water may minimize and/or eliminate crazing

Heat Gun

NOTICE

Do not use a heat gun to remove decals or while performing a repair.

- Carpet replacement
- Pump support removal
- Ride plate removal
- Etc.

Storage Shrink Wrap

When shrink wrapping a vehicle, several precautions must be followed to avoid damages to the finish surface.

1. Wash the vehicle with water and light detergent mixture.

NOTICE

Do not use a no rinse wash and shine product. This type of product may contain agents not compatible with the finish surface which could lead to acrylic crazing during the storage period.

2. Dry the vehicle thoroughly.
3. Install and shrink the wrap.
4. Install vents to allow proper ventilation under the shrink.

NOTICE

Avoid touching the acrylic surface with the torch flame during the shrinking process or heating a particular area for extended period of time.

SAFE PRODUCTS ON CARBON FIBER SURFACE

While BRP cannot test every product used in each different region of the world, we have tested some common ones under a severe lab testing process.

NOTICE

If using other products, always test the product on a hidden area to test.

BRP recommends the use of the following cleaning products with acrylic hulls and decks surfaces.

- 3M Marine Cleaner and Waxtest
- Carnauba Meguiars Gold Wax
- Dish soap
- Fabuloso All-Purpose Cleaner Liquid Solution
- Fantastik Original All Purpose Cleaner
- KLEEN-FLO Glass Kleen
- Pre-Kleano 900
- WD-40
- XPS PRO C1 - Cleaner and Degreaser (Canada and USA only - not for retail)
- XPS PRO C2 - Cleaner Surface (Canada and USA only - not for retail)
- XPS PRO C4 - Cleaner Extra Foaming (Canada and USA only - not for retail)
- XPS All Purpose Cleaner and Degreaser (P/N 779313)
- XPS Multi-Surface and Glass Cleaner (P/N 779316)
- XPS Wash and Wax (P/N 779310)
- XPS Spray Wax with Polymer (P/N 779320)
- XPS Vinyl and Plastic UV Protectant (P/N 779317)
- XPS Sea-Doo® Hull Cleaner (P/N 779309)

PRODUCTS TO BE USED WITH CAUTION

While BRP cannot test every product used in each different region of the world, we have tested some common ones under a lab testing process.

These products are safe when:

- They are used as per manufacturer's instructions, and
- Not left for an extended period of time on the acrylic surface.

These products are also found harmful during our severe lab testing conditions exposing the raw products for an extended period of time.

NOTICE

- **Always follow recommended manufacturer's instructions.**
- **Do not leave raw product on surface for extended period of time, wipe the covered area immediately after use.**
- **Always try out the cleaning product on a hidden area to test, especially if using other products.**

Be careful when using the following cleaning products on the acrylic hulls and deck surfaces.

- 303 Products Aerospace Protectant
- Isopropyl Alcohol (Up to 50% concentration)
- Sea-Doo Anti-corrosion Spray
- Simple Green All-Purpose Cleaner
- Spray-Nine Boat Bottom Cleaner
- SuperClean Cleaner-Degreaser
- XPS All Purpose Cleaner
- XPS Boat and Watercraft Wash and Wax
- XPS Spray Cleaner and Polish

PROHIBITED PRODUCTS

While BRP cannot test every product used in each different region of the world, we have tested some common ones under a lab testing process.

NOTICE

The following products must NEVER be used on an acrylic surface.

- BRP Heavy Duty Cleaner
- Isopropyl Alcohol with a concentration over 50%
- Goo Gone Adhesive Remover
- Methylic Alcohol
- Pre-Kleano 902
- Pre-Kleano 909
- Turtle Wax Label and Sticker Remover
- Windex
- XPS Parts Cleaner
- XPS Vinyl Cleaner

Also, NEVER use cleaners or products containing the following:

- Acetone or other Ketones
- Alcohol
- Ammonia
- Chlorinated solvents
- Mineral spirits
- Paint thinners
- Petroleum based products
- Toluene or other aromatic solvents

CARBON FIBER SURFACE REPAIR

MINOR TO MAJOR SCRATCHES

Removing Minor to Major Scratches

Minor and medium scratches are only affecting the surface finish. A major scratch is affecting the surface finish **and** the carbon fiber surface.

Minor to major scratches can be repaired performing the *Carbon Fiber Finish Repair*. However, major scratches may remain visible after repair procedure. Replacement parts might need to be considered to restore the original aspect of the watercraft.

NOTICE

Operation to remove minor to major scratches will involve performing the *Carbon Fiber Paint Repair* procedure.

CARBON FIBER FINISH REPAIR

General Recommendations

Actions	Recommendations
Preparation	Prepare the affected surface by sanding by hand the area to eliminate the damage or imperfection. It is not necessary to remove the surface finish completely.
Prepaint cleaning	Use isopropyl alcohol mixed with distilled water for a maximum concentration of 50%. Ensure to use proper rags and techniques to eliminate static charges on the part.
Clear coat	Refer to: <i>BASF-/ or MIPA APPROVED PAINT SYSTEMS</i>
Sanding	Refer to: <i>Carbon Fiber Finish Repair Procedure</i>
Polishing	Refer to: <i>Carbon Fiber Finish Repair Procedure</i>
Flash time (air dry)	Before: <ul style="list-style-type: none">- Polishing: Refer to: BASF Paint Procedures- Riding / Trailing: 10 days- Applying decals: at least 1 week

Procedure

PREPARATION:

1. Clean the surface using water and light detergent mixture to remove surface dirt.
2. Clean the surface with the Pre-Kleano 900 (wet / dry wipe).
3. Finish sanding with 800 grit sandpaper, hand sanding with water in circular motion.

APPLICATION EQUIPMENT:

- Spray using a 1.3 - 1.4 mm Compliant and HVLP @ 30 PSI (full fan/feed).

MIXING RATIO AND INSTRUCTIONS:

- Visit www.basrefinish.com for North American.
- Visit www.Glasurit.com for EU and Australia.

CLEARCOAT APPLICATION:

1. Apply full coat, allow 5 - 10 minutes flash time.
2. Apply second coat.

POLISHING:

1. Sand by hand using 800 grit sandpaper.
2. Add 2 coats of clear coat DC92 (BASF) (same varnish as the thermofilm).
3. Hand sanding with 1200 and 1500 dry and 3000 and 5000 with water.

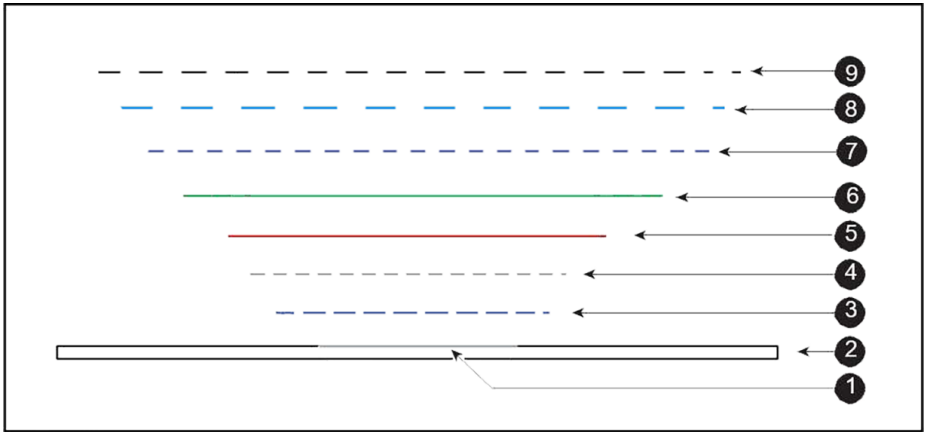

1. Touch up rework, (if applicable)
2. Carbon Fiber
3. 800 grit
4. 1500 grit, touch up rework only
5. Clear Coat
6. Clear Coat
7. 1500 grit
8. 3000 grit
9. 5000 grit

POLYTEC SURFACE

OVERVIEW

The Polytec deck and hull are made of a single thick skin of injected polypropylene reinforced with fiberglass.

IMPORTANT: BRP strongly recommends providing a copy of this document to your local body shop before it performs any repairs on a Polytec hull or deck.

NOTICE

Failure to follow the recommendations presented in this bulletin may result in a poor quality repair or damage to the Polytec surface.

Aesthetic Damages - Scratches

An external scratch is the result of the hull or deck surfaces rubbing against a rough or sharp object. This type of damage does not cause any operational problems. This type of damage is exclusively aesthetic. In most cases, this damage can be removed or diminished by buffing over the scratch using the Polytec Resurfacing Technique. Refer to *REPAIR PROCEDURES* at the end of this document. The results may vary, depending on the affected area.

Structural Damages

Structural damage is usually the result of impact. The component is cracked or pierced. The size and location of the damage are deciding factors when evaluating if the component should be repaired. For example, repairing a large area of complex damage under the engine might require as much labor as a hull replacement. An estimate of the labor cost should be used to guide the decision. The decision to repair or replace should be based on the customer's expectations regarding cost, aesthetics, resale value, and how quickly the job must be completed.

Cracks

This is the most common type of damage after scratches. A crack is a fracture which penetrates the material of a component. The opening is visible from the inside and the outside of the component.

Holes





The second type of structural damage is a hole, usually the result of an impact with an external object. A piece of the damaged component may be missing. A hole can be repaired using the original piece if it is not bent or damaged. A new piece of Polytec material, cut to size, can also be used.

LOCATION OF DAMAGE

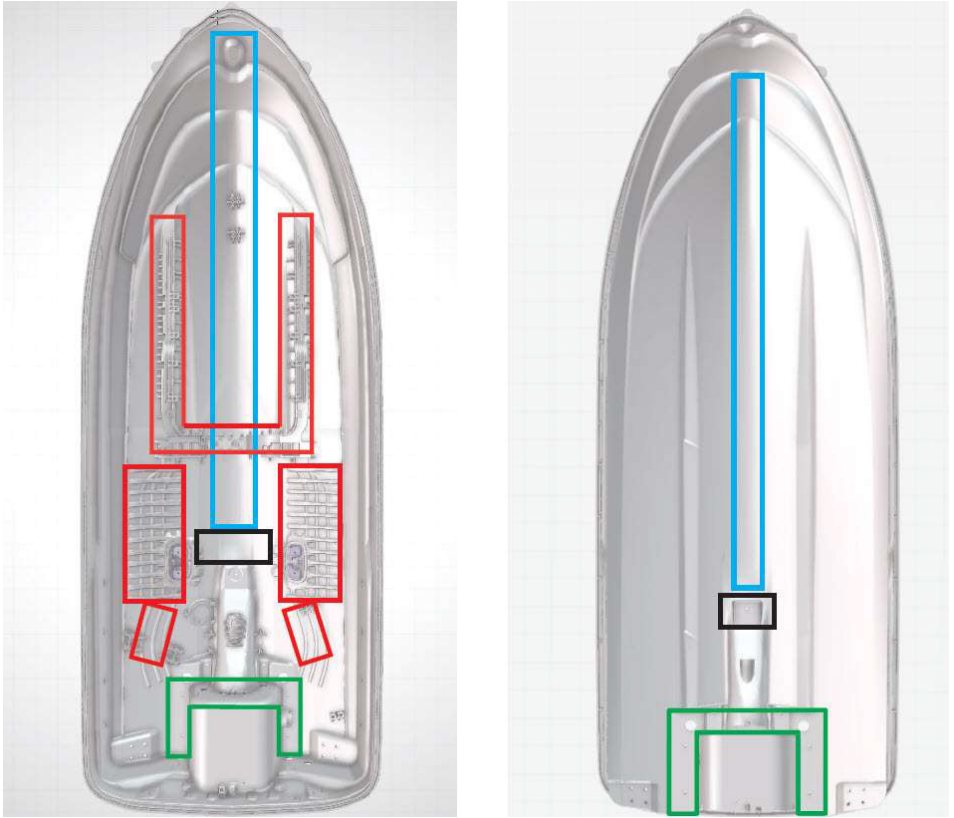
Certain areas of the hull are critically sensitive to dimensional precision and should not be repaired by plastic welding.

It is not recommended to repair structural damage at the bow and transom tow hooks as well as in the following areas:



	<i>Ribbing</i>
	<i>Pump support and ride plate mating surfaces</i>
	<i>Intake grate mating surface</i>
	<i>Keel line</i>

This page is intentionally blank

CARE AND PRODUCTS

SPECIAL CARE OF POLYTEC SURFACES

Fuel Spillage

NOTICE

Wipe up spilled fuel immediately. Failure to clean fuel spillage may weaken the surface and cause damage.

Washing

Wash the vehicle with a solution of mild soap or detergent and lukewarm water. Use a clean soft cloth, applying only light pressure. Rinse with clean water and dry with a damp cloth or chamois.

Aggressive Liquids and Solvents

If a cleaning liquid or organic solvent is used, it should be dried as soon as possible to avoid chemical attack on the surface. The time required for chemical attack to occur can be surprisingly short. Damages can be minimized and/or eliminated if no aggressive liquids or solvents are used.

Heat Gun

NOTICE

Do not use a heat gun to remove decals or while performing a repair, on:

- Decal removal
- Carpet replacement
- Pump support removal
- Ride plate removal

If heat is applied to the same area too long, the high temperature can damage the surface.

Flame Treatment

- Is a quick movement over an area or component with a blow torch.
- Should never be too intense. The part should never melt to the point that it looks polished.
- Will burn any excess plastic around the scratch.

Storage Shrink Wrap

When shrink wrapping a vehicle, several precautions must be followed to avoid damages to the surface finish.

1. Wash the vehicle with a mixture of water and light detergent.

NOTICE

Do not use a no rinse wash and shine product. This type of product may contain agents not compatible with the surface finish which could lead to acrylic crazing during the storage period.

2. Dry the vehicle thoroughly.

3. Install and shrink the wrap.

NOTICE

Avoid touching the vehicle surface with the torch flame during the shrinking process or heating a particular area for an extended period of time.

4. Install vents to allow proper ventilation under the shrink.

PRODUCTS SAFE FOR USE ON POLYTEC SURFACES

While it is impossible to test every product used in every region of the world, some common ones are known to be compatible with Polytec.

NOTICE

If using other products, always test the product on a hidden area before use.

BRP recommends the use of the following care products on Polytec hulls and decks:

XPS Care Products:

- SEA-DOO® HULL CLEANER
- WASH & WAX
- CLEANER & DEGREASER ALL PURPOSE
- MULTI-SURFACE & GLASS CLEANER
- UV PROTECTANT VINYL & PLASTIC

XPS PRO Products:

- C1 - Cleaner and Degreaser (Canada and USA only - not for retail)
- C2 - Cleaner Surface (Canada and USA only - not for retail)
- C4 - Cleaner Extra Foaming (Canada and USA only - not for retail)

PRODUCTS TO BE USED WITH CAUTION ON POLYTEC

While it is impossible to test every product used in all the different regions of the world, some common ones are known to be compatible with Polytec.

These products are safe when used under controlled conditions, as per manufacturer's instructions.

- Always follow recommended manufacturer's instructions.
- Do not leave raw product on surface for an extended period of time. Wipe the covered area immediately after application.
- If using other products, always test the product on a hidden area before use.

Be careful when using the following cleaning products on the Polytec hulls and decks.

- 3M™ Marine Cleaner and Wax
- Meguiar's® Gold Class™ Carnauba Wax
- Dish soap
- Fabuloso® All-Purpose Cleaner Liquid Solution
- Fantastik® Original All Purpose Cleaner
- Kleen-Flo Glass Kleen
- R-M® 900 Pre-Kleano
- WD-40®

PRODUCTS PROHIBITED FOR USE ON POLYTEC

While it is impossible to test every product used in all the different regions of the world, some common ones are known to cause damage.

NOTICE

NEVER use cleaners or products containing the following:

- Acetone or other ketones
- Alcohol
- Ammonia
- Chlorinated solvents
- Mineral spirits
- Paint thinners
- Petroleum-based products
- Toluene or other aromatic solvents

REPAIR PROCEDURES

QUICK REFERENCE GUIDE



This procedure was developed to be used for Polytec products using the specified materials, settings, and techniques. The use of tools, products, settings, or techniques other than those recommended may cause results to vary.

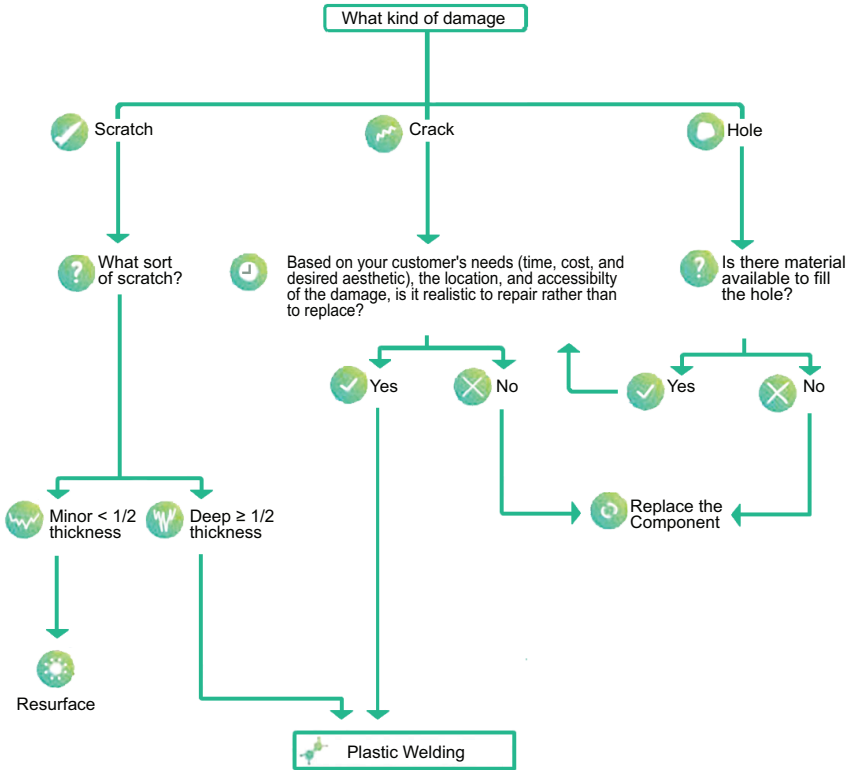
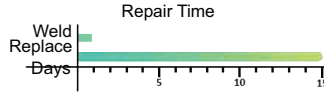

PLASTIC WELDING

Plastic Welding

Plastic welding is the process of creating a bond between two compatible polymers. There are two major stages



Heating allows a bond to form between the welding rod and the faying surface of the repaired component (melt-mixing).



Cooling, layer by layer, is necessary to solidify the newly-formed bond; this stage can have a significant effect on the strength of the finished weld.

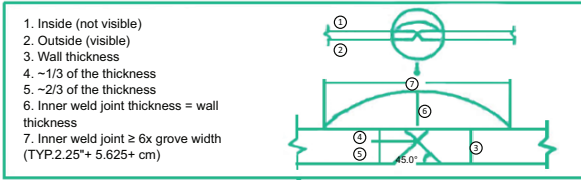

Requirements

Tools & Products	Type	Where to Buy
Hot Air Plastic Welding Tool	Leister Triac ST*	Leister.com/en/Plastic-Welding/Products/Hot-Air-Hand-Tools**
Tubular Nozzle	5 mm (1/5") 15°	**
Plastic Welding Rods	PP = GF 30% 8-9 mm (1/3") Shape: flat or triangle	PlasticSolutionsUK.com***
Flaw Repair Coating for Plastic Parts	Suggested: Per-Fix Black #7500AAA, PP TPO	Auto Supply Store
Belt Sander & Band	Finger Sander 40 to 150 grit bands	Auto Supply Store or Renovation Center
Rotary Tool & Burr Bit Set	Burr bits: plastic or wood types	Center
Rotary Wire Brush	Crimped Cup Bursh 2" (5 cm), coarse or medium, SS	
Infrared Thermometer		
Sheet Metal Snips		

* Leister Triac AT is an upgrade option and can be used with this procedure

** You can also contact your local Leister Sales and Service Center for purchase and tell them BRP Sea-Doo sent you. Leister.com/en/Plastic-Welding/Distributors.

*** BRP part no. to come; stay up to date with service publications for the latest information.

Preparation



Hot Air Plastic Welding Tool

- Install the appropriate nozzle on the tool
- Adjust the hot air welding tool to 300°C (572°F) and let it run for at least 10 minutes. If using a tool without a built-in temperature display, use an infrared thermometer gun to verify air temperature at the tip of the nozzle.
- * This temperature setting has been validated for the use of the recommended hot air welding tool and welding rods.

The complete Official Sea-Doo Polytec Hull and Deck Repair instructional video can be viewed at www.youtube.com/watch?v=eZpDowrb_rk&t=1s, or scan the QR codes to jump to select parts of the video.



Full Video

Surface Preparation



Surface Prep

- 1) Use mild detergent to remove dirt or grease from both the inside and outside surfaces of the repair area. Use a belt sander to remove the reinforcement matting from the repair area when applicable. Weld directly on Polytec surface to avoid possible delamination.
- 2) Sand the repair area on the inside surface only.

Welding

- 1) Groove the crack from the inside surface, about 1/3 of the material thickness. This groove can be made as wide as you need to work comfortably, up to 45°. Groove should be extended past crack by 1" (2.5 cm). Refer to the repair diagram above.
- 2) Remove all excess material from in or around the groove.
- 3) Cut the end of the rod at an angle to start with a clean tip. Scrape the rod with a blade to remove any dirt or oil.

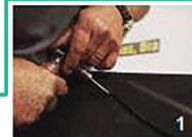

Step 1-3



DO NOT MELT THROUGH THE ROD OR REPAIR SURFACE MATERIAL!
Overheating changes the material mechanical properties.

Step 4-6



TECH TIPS

The material is hot enough when both the surface of the weld rod and the faying surface become glossy. As the rod is laid or pushed into the groove, a small weld puddle should appear.

A rod can be cut to half the width using a good pair of metal snips, and used to precisely fill the groove on the first pass or for touch-ups.

4) Place the rod end slightly beyond the beginning of the groove and apply heat to both surfaces simultaneously. The tip of the heat source should be within 1" (2.5 cm) of the weld joint.

5) While moving the heat source along the length of the rod, press the rod into the groove to fill it. Lay down the rod until slightly past the end of the groove.

6) Continue to fill the groove by adding layers. Each layer should overlap the edges of the previous one. Overlap edges of the groove as well. Wait for the material to become cool to the touch before proceeding with the next layer. The material cannot become "over cooled" if left a long time.

On the outside surface ONLY: Fill the groove until it is slightly beyond flush with the original surface.

On the inside surface ONLY: Continue until the welding joint covers 3x the groove width on each side of the crack and is the same thickness as the material itself. When in doubt, go wider.

7) Sand the weld to remove excess material. Using a fingernail, check the joint between the weld and the hull for defects. If necessary, groove the defect and apply another layer.

TECH TIP

A common defect is the formation of an air pocket somewhere in the joint. Check for these bubbles or waves between layers as you go along. When in doubt, sand away a small amount of the area in question to verify.

Note: A hole can be repaired using the technique described above. Use a piece of Polytec to block the hole; the hole and/or the piece may need to be trimmed to fit. A piece of Polytec left over from scrap part may be used if needed. Temporarily secure the piece in place using aluminum tape. Follow the procedure for Plastic Welding on a crack; treat the junction between the two parts as the crack.



Step 7

Finishing

On the outside surface, perform the *Polytech Resurfacing* technique on the repair and surrounding area. The result should be a flush surface.

POLYTEC RESURFACING TECHNIQUE

Polytec Resurfacing Technique

This technique is useful to repair a minor scuff or scratch as well as to improve the color, texture, and transition following a repair. Practice on nonvisible areas before attempting.

Using a crimped cup wire brush in a circular pattern, buff away the scuff or apparent scratch. This should be done locally at first, at a lower speed while applying some pressure. Once the scuff or scratch appears to be filled in, buff outward in a circular pattern, applying less pressure at a higher speed. A reasonably smooth transition zone should become apparent. Continue the process while increasing speed, decreasing pressure and switching from c.w. to c.c.w. until the texture of the buffed area is acceptable. Optionally, blur away the transition area with a flaw repair coating for plastics, or with spray paint for polypropylene. Spray sparingly from 12 inches (30 cm) away onto the affected area.



Transition area in work.

This page is intentionally blank

www.brp.com

ALUMACRAFT®

MANITOU®

SEA-DOO®

CAN-AM®

QUINTREX®

SKI-DOO®

LYNX®

ROTAX®

219101129