

BOMBARDIER® ATV

OPERATOR'S GUIDE

2004

INCLUDES
SAFETY, VEHICLE
AND MAINTENANCE
INFORMATION

OUTLANDER™

330 H.O. 2X4

330 H.O. 4X4

400 H.O. 2X4

400 H.O. 4X4



WARNING

Read this guide thoroughly.
It contains important safety information.

Minimum recommended operator age:
16 years.

Do not remove this *Operator's Guide* from
the vehicle.



2 1 9 0 0 0 2 9 3

This *Operator's Guide* utilizes the following symbols to emphasize particular information:



The Safety Alert Symbol indicates a potential personal injury hazard.



WARNING

Indicates a potentially hazardous situation which, if not avoided, could result in serious injury or death.

CAUTION: Denotes an instruction which if not followed, may damage the vehicle and/or components.

WARNING

YOUR VEHICLE CAN BE HAZARDOUS TO OPERATE. A collision or rollover can occur quickly, even during routine maneuvers such as turning and driving on hills or over obstacles, if you fail to take proper precautions.

For your safety, understand and follow all the warnings contained in this *Operator's Guide* and the labels on your vehicle. **Failure to follow these warnings can result in SEVERE INJURY OR DEATH.**

Keep this *Operator's Guide* with the vehicle at all times.

WARNING

Disregarding any of the safety precautions and instructions contained in this *Operator's Guide*, *Safety Videocassette* and on-product labels could cause injury including the possibility of death!

All safety documentation should remain with the vehicle at the time of sale.

All content of the *Safety Information section* should be interpreted by the reader as a warning which if not followed, may result in injury including the possibility of death.

In USA, products are distributed by Bombardier Motor Corporation of America. In Canada, products are distributed by Bombardier Inc.

The following are trademarks of Bombardier Inc. or its subsidiaries:

BOMBARDIER®

ROTAX®

Outlander™

BOMBARDIER
RECREATIONAL PRODUCTS



FOREWORD

Congratulations on your purchase of a new Bombardier® all-terrain vehicle (ATV). It is backed by the Bombardier warranty and a network of authorized Bombardier ATV dealers ready to provide the parts, service or accessories you may require.

Your dealer is committed to your satisfaction. He has taken training to perform the initial set-up and inspection of your vehicle as well as completed the final adjustment before you took possession. At delivery, your dealer would have explained the vehicle for the operation, maintenance and safety features. We trust you have taken full advantage of this! If you need more complete servicing information, please ask your dealer.

At delivery, you were also informed of the warranty coverage and completed the Warranty Registration Form which is to be sent to us for processing. In the near future you should be receiving a warranty card which will confirm our receipt of the registration as well as be used for warranty or recall purposes.

You are invited to contact our customer assistance center should you experience problems which cannot be resolved by an authorized Bombardier ATV dealer.

It is understood that this *Operator's Guide* may be translated into another language. In the event of any discrepancy, the English version shall prevail. Throughout this document, the masculine is used to denote the masculine and feminine.

The information and components/system descriptions contained in this document are correct at the time of publication. Bombardier Inc. however, maintains a policy of continuous improvement of its products without imposing upon itself any obligation to install them on products previously manufactured. Due to late changes, some differences between the manufactured product and the descriptions and/or specifications in this *Operator's Guide* may occur. Bombardier Inc. reserves the right at any time to discontinue or change specifications, designs, features, models or equipment without incurring any obligation upon itself.

The illustrations in this document show the typical construction of the different assemblies and may not reproduce the full detail or exact shape of the parts. However, they represent parts that have the same or similar function.

The use of RIGHT and LEFT indications in the text, always refers to driving position (when sitting on vehicle).

Specifications are given in the SI metric system with the SAE U.S. equivalent in parenthesis. Where precise accuracy is not required, some conversions are rounded off for easier use.

We recommend genuine Bombardier products for replacement parts and accessories. They've been especially designed for your vehicle and manufactured to meet Bombardier's demanding standards.

A *Shop Manual* can be obtained for complete service, maintenance and more repair information.

TABLE OF CONTENTS

While reading this *Operator's Guide*, remember that:

WARNING

Indicates a potential hazard that, if not avoided, could result in serious injury or death.

NOTICE	5
INTRODUCTION	6

SAFETY INFORMATION

SPECIAL SAFETY MESSAGES	8
OPERATION WARNINGS	10
SAFETY WARNING	37
RIDING TIPS	38
Clothing	39
Carrying Loads.....	40
Hauling a Trailer.....	40
Working with your ATV.....	40
Recreational Riding.....	40
Environment	41
Design Limitation.....	41
Off-Highway Operation.....	41
General Operating and Safety Precautions.....	42
Uphill Driving	42
Downhill Driving	42
Side Hilling.....	42
Drop-Offs.....	43
Riding Techniques	43
LOCATION OF THE IMPORTANT LABELS	51

VEHICLE INFORMATION

HOW TO IDENTIFY YOUR ATV	56
Engine and Vehicle Identification Number Location	56
EMISSION REQUIREMENTS	57
CONTROLS/INSTRUMENTS/EQUIPMENTS	58
1) Throttle Lever.....	60
2) 2WD/4WD Selector	60
3) Brake Lever.....	61
4) Brake Lever Lock	61

5) Transmission Lever.....	62
6) Multi-Function Switch.....	63
7) Speedometer.....	65
8) Ignition Switch.....	67
9) Fuel Tank Cap.....	67
10) Fuel Gauge.....	68
11) Fuel Valve.....	69
12) Brake Pedal.....	69
13) Footpeg.....	70
14) Access Panel.....	70
15) Rear Storage Compartment.....	70
16) Seat Latch.....	71
17) Front/Rear Cargo Rack.....	71
18) Trailer Hitch.....	72
19) Radiator Cap.....	72
20) 12-Volt Power Outlet.....	72
21) Fuses.....	72
22) Tool Box.....	73
23) Rewind Starter Handle.....	73
24) Dipstick.....	73
25) Winch.....	74
26) Winch Control Switch.....	74
27) Fairlead.....	74

LIQUIDS..... 75

Fuel.....	75
Engine/Transmission Oil.....	75
Engine Coolant.....	77
Brake Fluid.....	78
Battery.....	79

BREAK-IN PERIOD 80

Engine.....	80
Belt.....	80
10-Hour Inspection.....	80

PRE-OPERATION CHECK 81

OPERATING INSTRUCTIONS 82

General.....	82
Initial Cold Starting.....	82
Warm Engine Starting.....	83
Emergency Manual Starting.....	83
Stopping the Engine.....	83
Shifting the Transmission.....	83
2WD/4WD Selector.....	84

SPECIAL PROCEDURES	85
Flooded Engine.....	85
Engine Overheat.....	85
Post-Operation Care	85
Turn Over.....	86
ATV Immersion.....	86
Storage and Preseason Preparation	86
CARGO AND TRANSPORTATION	87
Cargo	87
Transportation.....	88

MAINTENANCE INFORMATION

MAINTENANCE CHART	90
MAINTENANCE	92
Engine/Transmission	92
Carburetor.....	96
Air Intake System	96
Electrical	97
Drive Train	98
Steering/Control Systems.....	100
Suspension	102
Brake	103
Body/Frame	103
TROUBLESHOOTING	105
SPECIFICATIONS	108
SI METRIC INFORMATION GUIDE	116

WARRANTY

BOMBARDIER LIMITED WARRANTY NORTH AMERICA: 2004 BOMBARDIER® ATV	118
BOMBARDIER INTERNATIONAL LIMITED WARRANTY: 2004 BOMBARDIER® ATV	121
FREQUENTLY ASKED QUESTIONS	124
PRIVACY OBLIGATIONS/DISCLAIMER	126
CHANGE OF ADDRESS/OWNERSHIP	127

NOTICE

This *Operator's Guide* has been prepared to acquaint the owner/operator of a new vehicle with the various vehicle controls, maintenance and safe operating instructions. It is indispensable for the proper use of the product.

This *Operator's Guide* uses the following symbols.

WARNING

Indicates a potentially hazardous situation which, if not avoided, could result in serious injury or death.

CAUTION: Denotes an instruction which, if not followed, could severely damage vehicle components.

NOTE: Indicates supplementary information needed to fully complete an instruction.

Although the mere reading of such information does not eliminate the hazard, the understanding and application of the information will promote the correct use of the all-terrain vehicle (ATV).

To fully appreciate the pleasures, enjoyment and excitement of using an ATV, there are some basic rules that **MUST** be observed and followed by any user.

INTRODUCTION

Your selling dealer should have provided you with some basic information on the particular controls and features of your new ATV. Please take the time to study this *Operator's Guide* and all on-product warning labels that came with the ATV. It more completely describes what you should know about the ATV before riding it.

Whether you are a new user or an experienced rider, it is important for your personal safety that you know the controls and features of the ATV. Equally important is knowing how to properly ride.

Regardless of your age, experience or state regulations, it is safer for you or any other person who may ride your ATV, to take an approved ATV safe riding course. Please check with your dealer or local authorities for availability in your area. If you are a completely new ATV rider, this should be done before your first ride. Your ATV instructor should be able to provide advice on local conditions and safe riding practices particular to the areas.

Riding conditions vary from place to place. Each is subject to weather conditions which may radically change from time to time and from season to season. Riding on sand is different than riding on snow or through forests or marshes. Each location may require a greater degree of awareness and skill. Always proceed with caution. Please do not take any unnecessary risks that could leave you stranded or possibly injured.

The contents of this *Operator's Guide* provide riding information which has been proven reliable by other ATV users. They are not intended as a definitive to avoid- ing accidents. How you apply this information, coupled with your mental and physical condition, the particular terrain hazard and your acceptance level to risk will have an effect on your riding experience. Have fun... and ride responsibly.

This *Operator's Guide* has been prepared to acquaint the owner/operator of a new vehicle with the various vehicle controls, maintenance and safe operating instructions. It is indispensable for the proper use of the product.

We would be pleased to receive any comments on the content and format of the *Operator's Guide*, *Safety Videocassette* or on-product warnings.

SAFETY INFORMATION

⚠ SPECIAL SAFETY MESSAGES

AN ATV IS NOT A TOY AND CAN BE HAZARDOUS TO OPERATE.

An ATV handles differently from other vehicles including motorcycles and cars. A collision or rollover can occur quickly, even during routine maneuvers such as turning and driving on hills or over obstacles, if you fail to take proper precautions.

SEVERE INJURY OR DEATH can result if you do not follow these instructions:

- ⚠ Read this *Operator's Guide* and all on-product warning labels carefully and follow the operating procedures described.
- ⚠ Never operate an ATV without proper instruction. **Take a training course.** Beginners should receive training from a certified instructor. Contact an authorized ATV dealer to find out about the training courses nearest you or call the Specialty Vehicle Institute of America (SVIA) at 1 800 887-2887 or in Canada, the Canada Safety Council (CSC) at 1 (613) 739-1535 ext. 227.
- ⚠ Always follow this age recommendation: A child under 16 years old should never operate this ATV.
- ⚠ Never carry a passenger on an ATV.
- ⚠ Never operate an ATV on any paved surfaces, including sidewalks, driveways, parking lots and streets.
- ⚠ Never operate an ATV on any public street, road or highway, even a dirt or gravel one.
- ⚠ Never operate an ATV without wearing an approved helmet that fits properly. You should also wear eye protection (goggles or face shield), gloves, boots, long sleeved shirt or jacket, and long pants.
- ⚠ Never consume alcohol or drugs before or while operating this ATV.
- ⚠ Never operate at excessive speeds. Always go at a speed that is proper for the terrain, visibility, and operating conditions, and your experience.
- ⚠ Never attempt wheelies, jumps, or other stunts.
- ⚠ Always inspect your ATV each time you use it to make sure it is in safe operating condition. Always follow the inspection and maintenance procedures and schedules described further in this *Operator's Guide*.
- ⚠ Always keep both hands on the handlebars and both feet on the footrests of the ATV during operation.
- ⚠ Always go slowly and be extra careful when operating on unfamiliar terrain. Always be alert to changing terrain conditions when operating the ATV.
- ⚠ Never operate on excessively rough, slippery or loose terrain until you have learned and practiced the skills necessary to control the ATV on such terrain. Always be especially cautious on these kinds of terrain.
- ⚠ Always follow proper procedures for turning as described further in this *Operator's Guide*. Practice turning at low speeds before attempting to turn at faster speeds. Do not turn at excessive speed.
- ⚠ Never operate the ATV on hills too steep for the ATV or for your abilities. Practice on smaller hills before attempting larger hills.

- ⚠ Always follow proper procedures for climbing hills as described further in this *Operator's Guide*. Check the terrain carefully before you start up any hill. Never climb hills with excessively slippery or loose surfaces. Shift your weight forward. Never open the throttle suddenly or make sudden gear changes. Never go over the top of any hill at high speed.
- ⚠ Always follow proper procedures for going down hills and for braking on hills as described further in this *Operator's Guide*. Check the terrain carefully before you start down any hill. Shift your weight backward. Never go down a hill at high speed. Avoid going down a hill at an angle that would cause the vehicle to lean sharply to one side. Go straight down the hill where possible.
- ⚠ Always follow proper procedures for crossing the side of a hill as described further in this *Operator's Guide*. Avoid hills with excessively slippery or loose surfaces. Shift your weight to the uphill side of the ATV. Never attempt to turn the ATV around on any hill until you have mastered the turning technique described further in this *Operator's Guide* on level ground. Avoid crossing the side of a steep hill if possible.
- ⚠ Always use proper procedures if you stall or roll backwards when climbing a hill. To avoid stalling, use proper gear and maintain a steady speed when climbing a hill. If you stall or roll backwards, follow the special procedure for braking described further in this *Operator's Guide*. Dismount on the uphill side or to a side if pointed straight uphill. Turn the ATV around and remount, following the procedure described further in this *Operator's Guide*.
- ⚠ Always check for obstacles before operating in a new area. Never attempt to operate over large obstacles, such as large rocks or fallen trees. Always follow proper procedures when operating over obstacles as described further in this *Operator's Guide*.
- ⚠ Always be careful when skidding or sliding. Learn to safely control skidding or sliding by practicing at low speeds and on level, smooth terrain. On extremely slippery surfaces, such as ice, go slowly and be very cautious in order to reduce the chance of skidding out of control.
- ⚠ Never operate an ATV in fast flowing water or in water deeper than that specified further in this *Operator's Guide*. Remember that wet brakes may have reduced stopping ability. Test your brakes after leaving water. If necessary, apply them several times for friction to dry out the pads.
- ⚠ Always be sure there are no obstacles or people behind you when you operate in reverse. When it is safe to proceed in reverse, go slowly.
- ⚠ Always use the size and type tires specified further in this *Operator's Guide*. Always maintain proper tire pressure as described further in this guide.
- ⚠ Never modify an ATV through improper installation or use of accessories.
- ⚠ Never exceed the stated load limits for an ATV. Cargo should be properly distributed and securely attached. Reduce speed and follow instructions in this *Operator's Guide* for carrying cargo or pulling a trailer. Allow greater distance for braking.
- ⚠ **FOR MORE INFORMATION ABOUT ATV SAFETY**, call the Specialty Vehicle Institute of America (SVIA) at 1 800 887-2887 or in Canada, the Canada Safety Council (CSC) at 1 (613) 739-1535 ext. 227 or contact an authorized ATV dealer to find out about the training courses nearest you.

OPERATION WARNINGS

While reading this *Operator's Guide*, remember that:

WARNING

Indicates a potential hazard that, if not avoided, could result in serious injury or death.

The following warnings and their format have been requested by the United States Consumer Product Safety Commission and are required to be in this *Operator's Guide* for all ATV's.

NOTE: The following illustrations are general representations only. Your model may differ.

WARNING



V00A0AQ

POTENTIAL HAZARD

Operating this ATV without proper instruction.

WHAT CAN HAPPEN

The risk of an accident is greatly increased if the operator does not know how to operate the ATV properly in different situations and on different types of terrain.

HOW TO AVOID THE HAZARD

Beginning and inexperienced operators should complete the certified training course offered by Bombardier Inc. They should then regularly practice the skills learned in the course and the operating techniques described further in this *Operator's Guide*.

For more information about the training course, contact an authorized ATV dealer or call Bombardier Inc. at 1 (819) 566-3366.



V00A01Q

POTENTIAL HAZARD

Failure to follow the age recommendations for this ATV.

WHAT CAN HAPPEN

Use by children of ATVs that are not recommended for their age can lead to severe injury or death of the child.

Even though a child may be within the age group for which an ATV is recommended, he or she may not have the skills, abilities, or judgment needed to operate the ATV safely and may be involved in a serious accident.

HOW TO AVOID THE HAZARD

No one under 16 should operate a Bombardier ATV.

⚠ WARNING



V00A02Q

POTENTIAL HAZARD

Carrying a passenger on this ATV.

WHAT CAN HAPPEN

Greatly reduces your ability to balance and control this ATV.

Could cause an accident, resulting in harm to you and/or your passenger.

HOW TO AVOID THE HAZARD

Never carry a passenger. The long seat is to allow the operator to shift position as needed during operation. It is not for carrying passengers.

⚠ WARNING

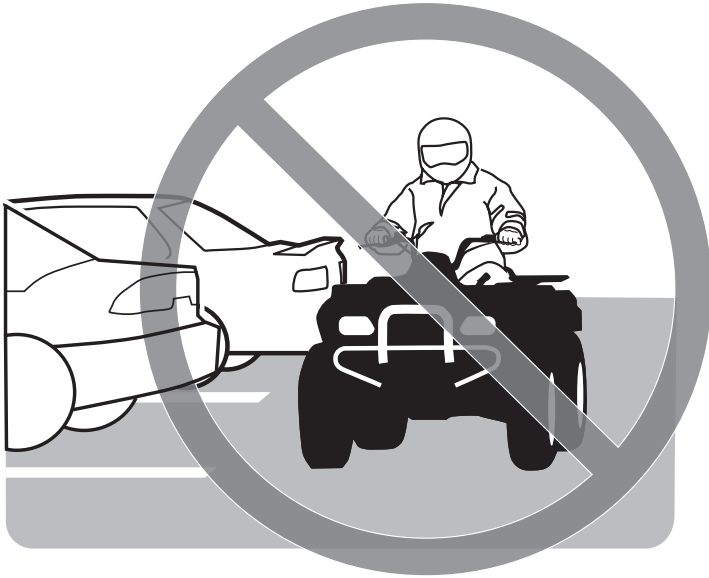

V00A03Q

POTENTIAL HAZARD

Operating this ATV on paved surfaces.

WHAT CAN HAPPEN

The ATV's tires are designed for off-road use only, not for use on pavement. Paved surfaces may seriously affect handling and control of the ATV, and may cause the vehicle to go out of control.

HOW TO AVOID THE HAZARD

Never operate the ATV on any paved surfaces, including sidewalks, drive-ways, parking lots and streets.

⚠ WARNING



V00A04Q

POTENTIAL HAZARD

Operating this ATV on public streets, roads or highways.

WHAT CAN HAPPEN

You can collide with another vehicle.

HOW TO AVOID THE HAZARD

Never operate this ATV on any public street, road or highway, even a dirt or gravel one. In many states it is illegal to operate ATVs on public streets, roads and highways.

 **WARNING**



V00A06Q

POTENTIAL HAZARD

Operating this ATV without wearing an approved helmet, eye protection and protective clothing.

WHAT CAN HAPPEN

Operating without an approved helmet increases your chances of a severe head injury or death in the event of an accident.

Operating without eye protection can result in an accident and increases your chances of a severe injury in the event of an accident.

Operating without protective clothing increases your chances of severe injury in the event of an accident.

HOW TO AVOID THE HAZARD

Always wear an approved helmet that fits properly. You should also wear:

- eye protection (goggles or face shield)
- gloves
- boots
- long sleeved shirt or jacket
- long pants.

WARNING



V00A07Q

POTENTIAL HAZARD

Operating this ATV after consuming alcohol or drugs.

WHAT CAN HAPPEN

- Could seriously affect your judgment.
- Could cause you to react more slowly.
- Could affect your balance and perception.
- Could result in an accident.

HOW TO AVOID THE HAZARD

Never consume alcohol or drugs before or while driving this ATV.

⚠ WARNING

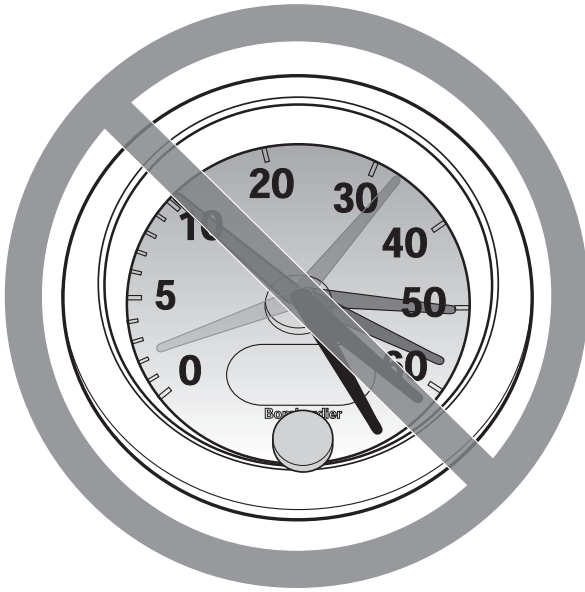

V00A08Q

POTENTIAL HAZARD

Operating this ATV at excessive speeds.

WHAT CAN HAPPEN

Increases your chances of losing control of the ATV, which can result in an accident.

HOW TO AVOID THE HAZARD

Always travel at a speed which is proper for the terrain, visibility and operating conditions, and your experience.

⚠ WARNING

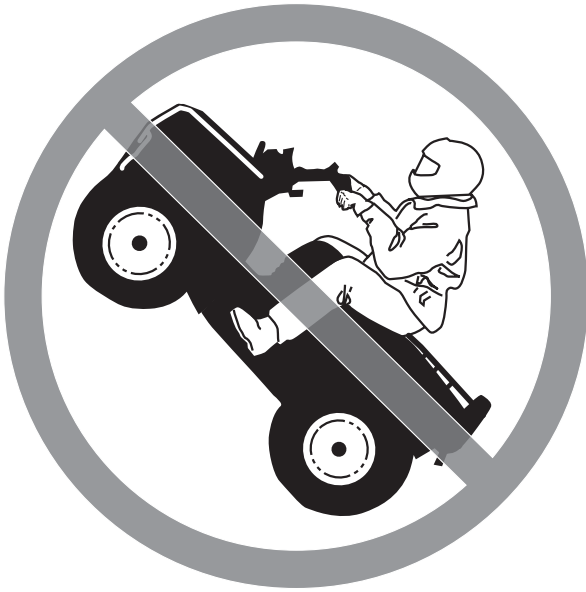

V00A09Q

POTENTIAL HAZARD

Attempting wheelies, jumps and other stunts.

WHAT CAN HAPPEN

Increases the chance of an accident, including an overturn.

HOW TO AVOID THE HAZARD

Never attempt stunts, such as wheelies or jumps. Do not try to show off.

 **WARNING**

POTENTIAL HAZARD

Failure to inspect the ATV before operating.
Failure to properly maintain the ATV.

WHAT CAN HAPPEN

Increases the possibility of an accident or equipment damage.

HOW TO AVOID THE HAZARD

Always inspect your ATV each time you use it to make sure the ATV is in safe operating condition.

Always follow the inspection and maintenance procedures and schedules described further in this *Operator's Guide*.

 **WARNING**

POTENTIAL HAZARD

Riding on frozen waterways.

WHAT CAN HAPPEN

Severe injury or death can result if the vehicle and/or operator break through the ice.

HOW TO AVOID THE HAZARD

Never ride this vehicle on a frozen surface before you are sure the ice is thick enough and sound enough to support the vehicle and its load, as well as the force that is created by a moving vehicle.

⚠ WARNING



V00A0BQ

POTENTIAL HAZARD

Removing hands from handlebars or feet from footrests during operation.

WHAT CAN HAPPEN

Removing even one hand or foot can reduce your ability to control the ATV or could cause you to lose your balance and fall off the ATV. If you remove a foot from the footrests, your foot or leg may come into contact with the rear wheels, which could injure you or cause an accident.

HOW TO AVOID THE HAZARD

Always keep both hands on the handlebars and both feet on the footrests of your ATV during operation.

⚠ WARNING

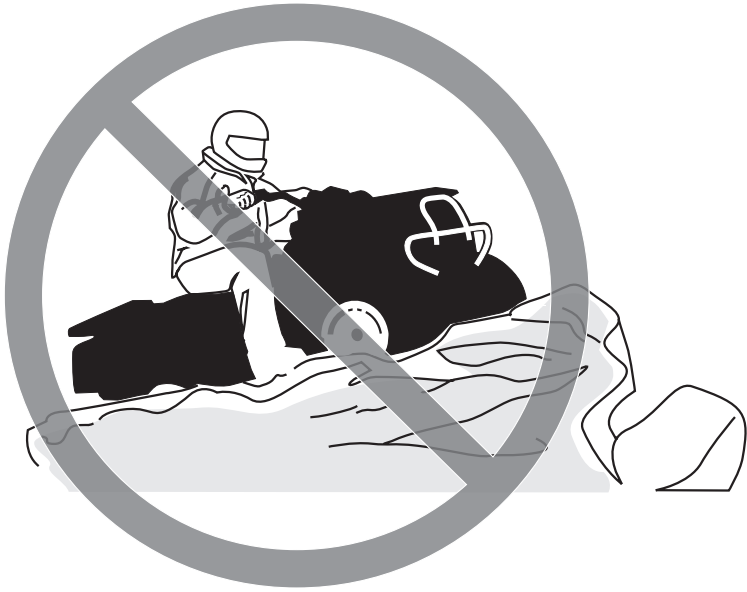

V00A0CQ

POTENTIAL HAZARD

Failure to use extra care when operating this ATV on unfamiliar terrain.

WHAT CAN HAPPEN

You can come upon hidden rocks, bumps, or holes, without enough time to react.

Could result in the ATV overturning or going out of control.

HOW TO AVOID THE HAZARD

Go slowly and be extra careful when operating on unfamiliar terrain.

Always be alert to changing terrain conditions when operating the ATV.

WARNING



V00A0D0

POTENTIAL HAZARD

Failure to use extra care when operating on excessively rough, slippery or loose terrain.

WHAT CAN HAPPEN

Could cause loss of traction or vehicle control, which could result in an accident, including an overturn.

HOW TO AVOID THE HAZARD

Do not operate on excessively rough, slippery or loose terrain until you have learned and practiced the skills necessary to control the ATV on such terrain.

Always be especially cautious on these kinds of terrain.

⚠ WARNING



V00A0EQ

POTENTIAL HAZARD

Turning improperly.

WHAT CAN HAPPEN

ATV could go out of control, causing a collision or overturn.

HOW TO AVOID THE HAZARD

Always follow proper procedures for turning as described further in this *Operator's Guide*. Practice turning at low speeds before attempting to turn at faster speeds.

Do not turn at excessive speed.

⚠ WARNING



V00A00Q

POTENTIAL HAZARD

Operating on excessively steep hills.

WHAT CAN HAPPEN

The vehicle can overturn more easily on extremely steep hills than on level surfaces or small hills.

HOW TO AVOID THE HAZARD

Never operate the ATV on hills too steep for the ATV or for your abilities. Practice on smaller hills before attempting larger hills.

⚠ WARNING



V00A0FQ

POTENTIAL HAZARD

Climbing hills improperly.

WHAT CAN HAPPEN

Could cause loss of control or cause ATV to overturn.

HOW TO AVOID THE HAZARD

Always follow proper procedures for climbing hills as described further in this *Operator's Guide*.

Always check the terrain carefully before you start up any hill.

Never climb hills with excessively slippery or loose surfaces.

Shift your weight forward.

Never open the throttle suddenly or make sudden gear changes. The ATV could flip over backwards.

Never go over the top of any hill at high speed. An obstacle, a sharp drop, or another vehicle or person could be on the other side of the hill.

⚠ WARNING



V00A0GQ

POTENTIAL HAZARD

Going down a hill improperly.

WHAT CAN HAPPEN

Could cause loss of control or cause ATV to overturn.

HOW TO AVOID THE HAZARD

Always follow proper procedures for going down hills as described further in this *Operator's Guide*. **NOTE:** A special technique is required when braking as you go down a hill.

Always check the terrain carefully before you start down any hill.

Shift your weight backward.

Never go down a hill at high speed.

Avoid going down a hill at an angle which would cause the vehicle to lean sharply to one side. Go straight down the hill where possible.

⚠ WARNING



V00A0HQ

POTENTIAL HAZARD

Improperly crossing hills or turning on hills.

WHAT CAN HAPPEN

Could cause loss of control or cause ATV to overturn.

HOW TO AVOID THE HAZARD

Never attempt to turn the ATV around on any hill until you have mastered the turning technique as described further in this *Operator's Guide* on level ground. Be very careful when turning on any hill.

Avoid crossing the side of a steep hill if possible.

When crossing the side of a hill:

Always follow proper procedures as described further in this *Operator's Guide*.

Avoid hills with excessively slippery or loose surfaces.

Shift your weight to the uphill side of the ATV.

WARNING



V00A01Q

POTENTIAL HAZARD

Stalling, rolling backwards or improperly dismounting while climbing a hill.

WHAT CAN HAPPEN

Could result in ATV overturning.

HOW TO AVOID THE HAZARD

Use proper gear and maintain steady speed when climbing a hill.

If you lose all forward speed:

Keep weight uphill.

Apply the brakes.

Lock parking brake after you are stopped.

If you begin rolling backwards:

Keep weight uphill.

Apply the brakes gradually.

When fully stopped, lock parking brake.

Dismount on uphill side, or to a side if pointed straight uphill.

Turn the ATV around and remount, following the procedure described further in this *Operator's Guide*.

⚠ WARNING



V00A0JQ

POTENTIAL HAZARD

Improperly operating over obstacles.

WHAT CAN HAPPEN

Could cause loss of control or a collision. Could cause the ATV to overturn.

HOW TO AVOID THE HAZARD

Before operating in a new area, check for obstacles.

Never attempt to ride over large obstacles, such as large rocks or fallen trees.

When you go over obstacles, always follow proper procedures as described further in this *Operator's Guide*.

WARNING



V00A0KQ

POTENTIAL HAZARD

Skidding or sliding improperly.

WHAT CAN HAPPEN

You may lose control of this ATV.

You may also regain traction unexpectedly, which may cause the ATV to overturn.

HOW TO AVOID THE HAZARD

Learn to safely control skidding or sliding by practicing at low speeds and on level, smooth terrain.

On extremely slippery surfaces, such as ice, go slowly and be very cautious in order to reduce the chance of skidding or sliding out of control.

⚠ WARNING



V00A0LQ

POTENTIAL HAZARD

Operating this ATV through deep or fast flowing water.

WHAT CAN HAPPEN

Tires may float, causing loss of traction and loss of control, which could lead to an accident.

HOW TO AVOID THE HAZARD

Never operate this ATV in fast flowing water or in water deeper than that specified further in this *Operator's Guide*.

Check water depth and current before you attempt to cross any water. Water should not go above footrests.

Remember that wet brakes may have reduced stopping ability. Test your brakes after leaving water. If necessary, apply them several times to let friction dry out the pads.

⚠ WARNING



V00A0MQ

POTENTIAL HAZARD

Improperly operating in reverse.

WHAT CAN HAPPEN

You could hit an obstacle or person behind you, resulting in serious injury.

HOW TO AVOID THE HAZARD

When you select reverse gear, make sure there are no obstacles or people behind you. When it is safe to proceed, go slowly.

 **WARNING**



V00A00Q

POTENTIAL HAZARD

Operating this ATV with improper tires, or with improper or uneven tire pressure.

WHAT CAN HAPPEN

Use of improper tires on this ATV, or operation of this ATV with improper or uneven tire pressure, may cause loss of control, and increases the risk of an accident.

HOW TO AVOID THE HAZARD

Always use tires of specified the size and type further in this *Operator's Guide* for this vehicle.

Always maintain proper tire pressure as described further in this *Operator's Guide*.

⚠ WARNING



V00A0NQ

POTENTIAL HAZARD

Operating this ATV with improper modifications.

WHAT CAN HAPPEN

Improper installation of accessories or modification of this vehicle may cause changes in handling which in some situations could lead to an accident.

HOW TO AVOID THE HAZARD

Never modify this ATV through improper installation or use of accessories. All parts and accessories added to this vehicle should be genuine Bombardier or equivalent components designed for use on this ATV and should be installed and used according to instructions. If you have questions, consult an authorized Bombardier ATV dealer.

⚠ WARNING



V00A0PQ

POTENTIAL HAZARD

Overloading this ATV or carrying or towing cargo improperly.

WHAT CAN HAPPEN

Could cause changes in vehicle handling which could lead to an accident.

HOW TO AVOID THE HAZARD

Never exceed the stated load capacity for this ATV.

Cargo should be properly distributed and securely attached.

Reduce speed when carrying cargo or pulling a trailer. Allow greater distance for braking.

Always follow the instructions in this *Operator's Guide* for carrying cargo or pulling a trailer.

⚠ WARNING



V03M01Q

POTENTIAL HAZARD

Transporting inflammable or dangerous material can lead to explosions.

WHAT CAN HAPPEN

This can cause serious injury or death.

HOW TO AVOID THE HAZARD

Never transport inflammable or dangerous material.

While reading this *Operator's Guide*, remember that:

⚠ WARNING

Indicates a potential hazard that, if not avoided, could result in serious injury or death.

SAFETY WARNING

To fully appreciate the pleasures and excitement of riding an ATV, there are some basic rules and tips that you should follow. Some may be new to you while others may be common sense or obvious. However, we ask that you take a few minutes to read this *Operator's Guide* completely before you operate the ATV.

Information in this *Operator's Guide* is limited. It is strongly recommended that you obtain further information and training from your local authorities, ATV clubs or a recognized ATV training organization such as the Specialty Vehicle Institute of America or the Canada Safety Council.

The U.S. Consumer Product Safety Commission and all ATV manufacturers do not recommend anyone under the age of 16 to ride an ATV having an engine higher than 90 cc. For the child's safety, we strongly recommend you also follow and enforce this recommendation. You are the sole judge of a rider's capability to understand the risks and operate an ATV safely.

Persons with cognitive or physical impairments or are high risk takers have an increased exposure to overturns or collisions which may result in injury including death.

Become completely familiar with the operational controls and the general operation of the ATV before venturing into off road conditions. Practice driving in a suitable area free of hazards and feel the response of each control. Drive at low speeds. Higher speeds requires greater experience, knowledge and suitable riding conditions.

Not all ATVs are the same. Each has its own unique performance characteristics, controls and features. Each will ride and handle differently.

Never assume that the ATV will go everywhere safely. Sudden changes in terrain caused by holes, depressions, banks, softer or harder "ground" plus others, may cause the ATV to topple or become unstable. To avoid this, slow down and always observe the terrain ahead. If the ATV does begin to topple or tipover, it is usually the best advice to immediately get off... AWAY from the direction of the tipover!

RIDING TIPS

While reading this *Operator's Guide*, remember that:

WARNING

Indicates a potential hazard that could result in serious injury or death.

WARNING

The pre-operation check is very important prior to operating the vehicle. Always check the proper operation of critical controls, safety features and mechanical components before starting. If not done, severe injury or death might occur.

Before using an ATV you should always:

- a) Disengage the parking device.
- b) Check the steering operation.
- c) Test throttle operation.
- d) Check brake functions.
- e) Check engine stop switch function.
- f) Verify operation and cleanliness of headlamp and taillight.
- g) Verify fuel and oil levels.
- h) Inspect tires and wheel rims for excessive wear or damage.
- i) Check tire air pressure.
- j) Secure all cargo and storage compartments.

Proceed only if all items are satisfactory.

Clothing

Actual weather conditions should help you decide how to dress. However, it is important that you always wear the appropriate protective clothing and apparel, including an approved helmet, eye protection, boots, gloves, long sleeved shirt and pants. Never wear loose clothing such as a scarf that may get entangled in the ATV or on tree shrubs and branches. Depending on conditions, a fog free visor or protective goggles may be required. This type of clothing will provide you protection from some of the minor hazards you may encounter on route. Sun glasses should only be worn during the daytime. Different colored lenses available for goggles or glasses help you distinguish terrain variations.

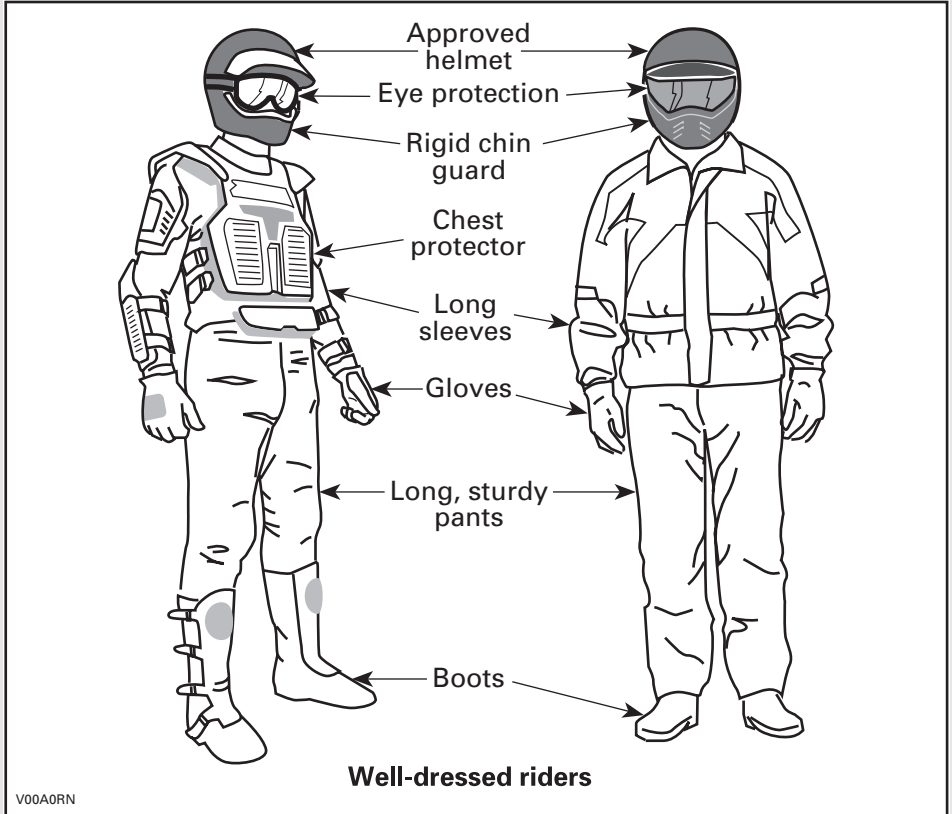

Carrying Loads

Any load carried on the ATV's carrying rack(s) will affect the stability and control of the ATV. For this reason, do not exceed the load limits of the ATV manufacturer. Always make sure the load is secured and cannot interfere with your proper control. Always be aware that the "load" may slide or fall off and create an accident. Avoid loads that may protrude sideways and get snagged or caught in brush or other obstacles. Avoid covering and obstructing the headlamp or taillights with the cargo. Always make sure any storage compartment latches are closed. If a removable compartment cover is removed to carry a load, make sure that the load is secure and that smaller objects cannot "fly out". Secure compartment cover to the rear rack.

All ATVs are intended for an operator only. Even with a long seat that provides unrestricted operator movement, they are not designed nor intended to carry passenger(s). Do not install passenger seats or use the racks or their location to carry passenger(s). Carrying a passenger (s) will affect the stability and your control of the ATV.

Hauling a Trailer

Riding an ATV with a trailer substantially increases the risk of toppling, especially on inclined slopes. If a trailer is used behind the ATV make sure that its hitch is compatible with the one on the ATV. Make sure the trailer is horizontal with the ATV. (In some instances a special extension may have to be installed on the ATV hitch). Use security chains to secure the trailer with the ATV. The ATV may require additional stopping distance if hauling heavy loads, especially on inclined surfaces. Be careful not to skid or slide. When stopped or parked, block the ATV and trailer wheels from possible movement. Always make sure load is evenly distributed on the trailer. Apply caution when disconnecting a loaded trailer, it or its load may topple on you or others. Do not turn at high speeds.

Working with your ATV

Your ATV can help you perform a number of different LIGHT tasks ranging from snow removal to pulling wood or carrying cargo. A variety of accessories are available from your ATV dealer. However, always respect the load and capacities of the ATV. Overloading of the ATV can overstress the components and cause failure. To prevent possible injury, it is equally important to follow the instructions and warnings that accompany the accessory. Avoid any physical exertion through lifting or pulling of heavy loads or manpowering the ATV. (Continue to read RECREATIONAL RIDING below).

Recreational Riding

Respect the rights and limitations of others. Stay away from areas designated for other types of off road use. This includes snowmobile trails, equestrian trails, cross country ski trails, mountain bike trails etc. Never assume there are no other users on the trail. Always stay to the complete right of the trail and do not zig zag to one side of the trail then the other. Be prepared to stop or pull off to the side if another trail user appears in front of you.

Join a local ATV club. They will provide you with a map and advice or inform you where you can ride. If a club does not exist in your area, help start one. Group riding and club activities provide a pleasurable, social experience.

Always keep a safe distance from other riders. Your judgment of speed, terrain conditions, weather, mechanical condition of your ATV and the “trust in judgment” you have in others around you will help you make a better choice of appropriate safe distance. ATVs, like any other vehicle, cannot stop “on a dime”.

Before you ride, tell someone where you are planning to travel and your expected time of return. Never consume alcohol or drugs before or while riding!

Depending on the length of your ride, carry additional tools or emergency equipment. Find out where you can get additional gasoline and oil. Be prepared for the possible conditions you may encounter. An emergency first aid kit should always be a consideration.

Environment

One of the benefits of an ATV is that it can take you off the beaten path away from most communities. However, you should always respect nature and the rights of others to enjoy it. Do not ride in environmentally sensitive areas. Do not drive over crops or tree shrubs... nor cut down trees or take down fencing... nor spin your wheels and destroy the terrain. “Tread Lightly”.

Chasing wildlife is in many areas illegal. Wildlife can die of exhaustion after being chased by an ATV. If you encounter animals on the trail, stop and observe quietly and with caution. It will be one of the better memories of your life.

Observe the rule... “what you take in, carry out”. Do not litter. Do not start campfires unless you have permission to do so... and only then... away from dry areas. The hazards you may create on the trail may cause injury to others or yourself, even at a later date.

Respect farm lands. Always obtain the permission of the landowner before riding on private land. Respect crops, farm animals and property lines. If you come to a closed gate, close it again behind you.

Finally, do not pollute streams, lakes or rivers and do not modify the engine or muffling system, or remove any of its components.

Design Limitation

The fundamental design concept is a compromise between ruggedness which call for strength and weight, and light-footedness. Although the vehicle is exceptionally rugged for its class, it is still a light vehicle by definition and its operation must be restricted to its proper purpose.

The addition of weight to any part of the vehicle changes its gravitational stability and modifies its performance.

Off-Highway Operation

The very nature of off-highway operation is dangerous. Any terrain, which has not been specially prepared to carry vehicles, presents an inherent danger where angularity, terrain substance and exact steepness are unpredictable. The terrain itself presents a continual element of danger, which must be knowingly accepted by anyone venturing over it.

An operator who takes a vehicle off-road should always exercise the utmost care in selecting the safest path and keeping close watch on the terrain ahead of him. On no account should the vehicle be operated by anyone who is not completely familiar with the driving instructions applicable to the vehicle, or should it be operated on steep or treacherous terrain.

General Operating and Safety Precautions

Care, caution, experience and driving skill are the best precautions against the hazard of ATV operation.

Whenever there is the slightest doubt that the vehicle can safely negotiate an obstacle of a particular piece of terrain, always choose an alternate route.

In off-road operation, power and traction, not speed, are important. Never drive faster than visibility and your own ability to select a safe route permits.

Constantly watch the terrain ahead for sudden changes in slopes or obstacles, such as rocks or stumps, that may cause loss of stability, resulting in tip-over or roll-over.

Never operate the vehicle if the controls do not function normally.

Uphill Driving

Due to configuration, ATVs have excellent climbing ability, so much so that tip-over is possible before traction is lost. For example, it is common to encounter terrain situations where the top of the hill has eroded to a point that the hill peak rises very sharply. The ATV can readily negotiate such a condition, however, in doing so, when the front of the vehicle is driven to a point that the vehicle's balance changes rearward tip over can occur.

The same situation may apply if an embedded object causes the front of the vehicle to climb more than desired. If such a situation occurs take an alternate route. Be aware of sidehilling dangers when doing so.

It is also wise to know the terrain condition on the other side of the hill or bank. All too often there exists a sharp drop-off that is impossible to negotiate or descend.

Downhill Driving

As a rule, ATVs can climb slopes that are steeper than they can safely descend. Therefore, it is essential to assure that a safe route exists to descend a slope before you climb it.

Decelerating while negotiating a slippery downhill slope could "toboggan" the vehicle. Maintain steady speed and/or accelerate slightly to regain control.

Side Hilling

Whenever possible, such operation should be avoided. If necessary, do so with extreme caution. Sidehilling on steep inclines could result in roll-over. In addition, slippery or unfirm surfaces could result in uncontrollable side sliding. Do not attempt to turn the vehicle downhill with the slide. Avoid all objects or depressions that will intensify the raising of one side of the vehicle higher than the other, thus causing roll-over.

Drop-Offs

An ATV will “bottom-out” and usually stop if either the front or rear wheels are driven over a drop-off. If the drop is sharp or deep, the vehicle will nose dive and tip-over.

WARNING

Avoid negotiating drop-offs. Reverse and select an alternate route.

Riding Techniques

Riding your ATV too fast for the conditions may result in injury. Apply only enough throttle to proceed safely. Statistics show that high speed turns usually result in mishaps and injury. Always remember that an ATV is heavy! It's pure weight alone may entrap you should it fall and pin you down.

ATVs are not designed for jumping nor can they, or you, absorb the energy of high impacts such as jumping. Performing “wheelies” can cause the ATV to flip over onto you. Both practices have a high risk and should be avoided at all times.

To maintain proper control it is strongly advised that you keep your hands on the handlebar and within easy reach of all controls. The same holds true for your feet. To minimize the possibility of any leg or foot injury, keep your feet on the footrests at all times. Do not direct your toes outwards nor place your foot out to assist turning as they can be hit or snagged by passing obstacles or may contact the wheels.

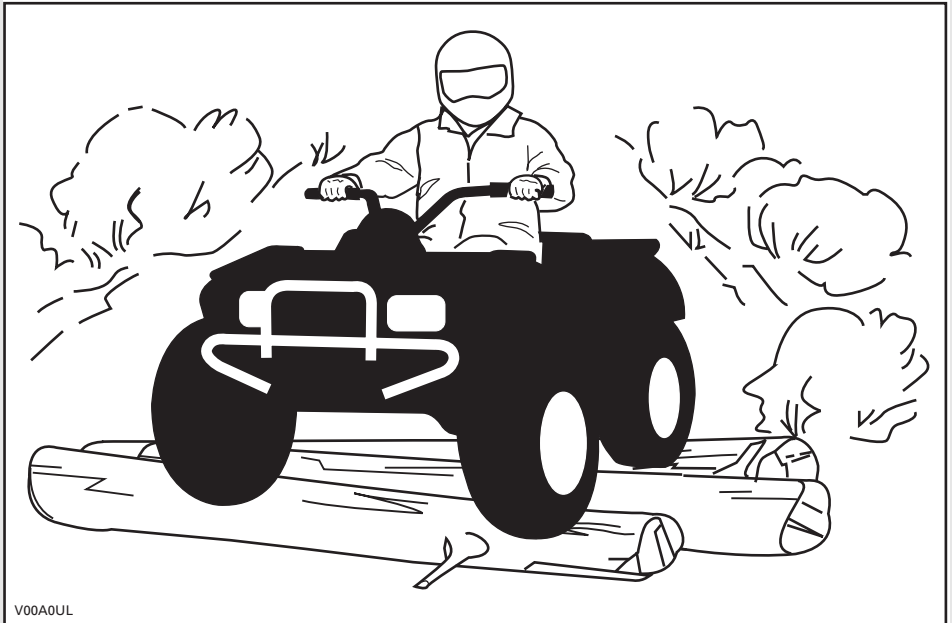

V00A0UL

Even though there is an adequate suspension system on an ATV there are “washboard” or rough terrain conditions that will make you feel uncomfortable and even cause back injury. “Posting” or riding in a crouched position will often be required. Slow down and allow your flexed legs to absorb impact.

An ATV is not designed for riding on roads or highways. (In most places it is an illegal practice). Riding your ATV on roads or highways could cause a collision to occur with another vehicle. ATV tires are not suited for paved road use. Pavement may seriously affect the handling and control of the ATV. Riding on roads or soft shoulders may confuse other road users, especially if your lights are on. If you have to cross a road, the lead driver should get off his ATV then observe and give directions to the other ATV riders. The last person after crossing then assists the lead driver to cross. Do not travel on sidewalks. They are designated for pedestrian use.

Water can be a unique hazard. If it is too deep the ATV may “float” and topple. Check the water depth and current before you attempt to cross any water. Water should not go above the footrest. Be wary of slippery surfaces such as rocks, grass, logs, etc., both in the water and on its banks. A loss of traction may occur. Do not attempt to enter the water at high speed. The water will act as a brake and could wash you away.

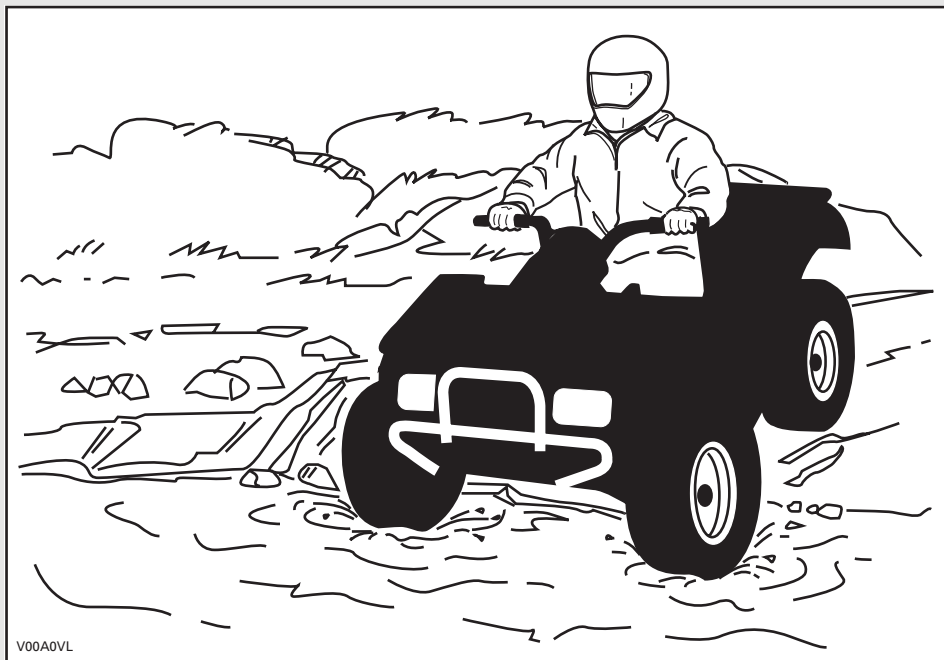

Water will affect the braking ability of your ATV. Make sure you dry the brakes by applying them several times after the ATV leaves the water.

Mud or marsh lands may be encountered near water. Be prepared for sudden “holes” or change in depth. Similarly so, be watchful of hazards such as rocks, logs, etc., partially covered by vegetation.

If your trip crosses frozen waterways, make sure the ice is thick enough to support the total weight of yourself, the ATV and its load. Be ever watchful of open ice... it is a sure indication that the thickness of the ice varies. If in doubt, do not attempt to cross.

Ice will also affect the control of an ATV. Slow down and do not "gun" the throttle. This will only result in spinning of the tires and possible tipover of the ATV. Avoid rapid braking. This again will possibly result in an uncontrolled slide and tipover of the ATV. Slush should be avoided at all times since it could block the operation or controls of the ATV.

Sand and riding on sand dunes or on snow is another unique experience but there are some basic precautions that should be observed. Wet, deep or fine sand/snow may create a loss of traction and cause the ATV to slide, drop off or become "bogged" down. If this occurs look for a firmer base. Again, the best advice is to slow down and be watchful of the conditions.

When riding in sand dunes it is advisable to equip the ATV with an antenna type safety flag. This will help make your location more visible to others over the next sand bank. Proceed carefully should you see another safety flag ahead. Since the antenna type safety flag can snag and rebound on your body if caught, do not use it in areas where there are low hanging branches or obstacles.

Riding on loose stones or gravel is very similar to riding on ice. It will affect the steering of an ATV... possibly causing it to slide and tipover, especially at high speeds. In addition, braking distance may be affected. Remember that "gunning" the throttle or sliding may cause loose stones to be ejected rearwards, into another ATV rider's way.

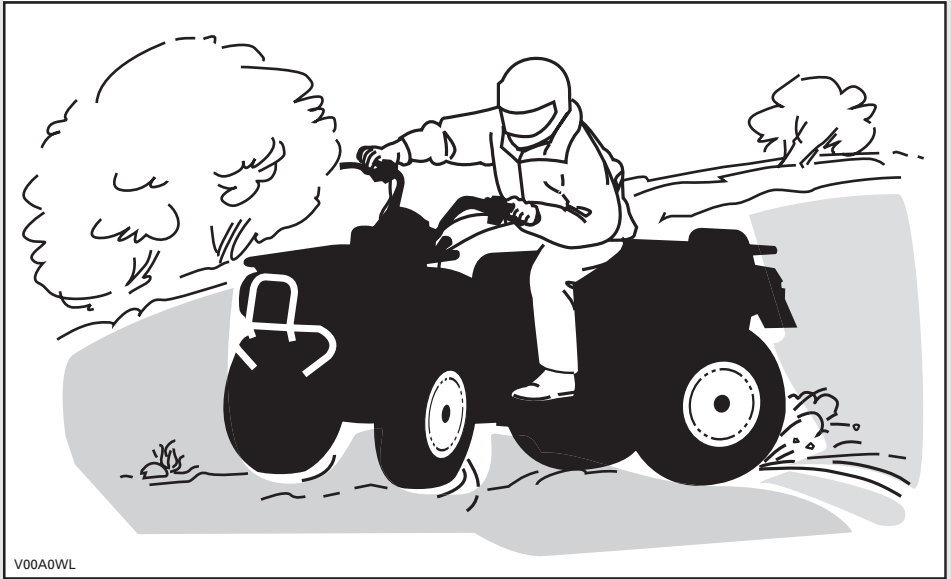

If you do get into a slide or skid, it may help to turn the handlebar into the direction of the skid until you regain control. Never jam the brakes and lock the wheels.

Respect and follow all posted trail signs. They are there to help you and others.

Obstacles on the trail should be crossed with caution. This includes loose rocks, fallen trees, slippery surfaces, fences, posts, embankments and depressions. You should avoid them whenever possible. Remember that some obstacles are too large or dangerous to cross and should be avoided. Small rocks or fallen trees may be safely crossed if approached at a 90° angle. Stand on the footrests while keeping your knees flexed. Adjust speed without losing momentum and do not “gun” the throttle. Hold handlebar firmly. Place your body weight rearwards and proceed. Do not try to lift the ATV’s front wheels off the ground. Be aware that the object may be slippery or may move while crossing.

When driving on hills or slopes two things are highly important: be prepared for slippery surfaces or terrain variations and obstacles and use proper body positioning.

While reading this *Operator’s Guide*, remember that:

 **WARNING**

Indicates a potential hazard that could result in serious injury or death.

Uphill

Keep your body weight forward towards the top of the hill. Keep your feet on the footrests and shift into low gear then accelerate and when necessary, change gear quickly as you climb. Do not over-speed since this may cause the front of the ATV to lift from the ground and fall back on you. If the hill is too steep and you cannot proceed or the ATV begins to roll backwards, apply the brake, being careful not to slide. Dismount then use the "K" turn or "U" turn (while walking back, next to the ATV on the up hill side and with a hand on the brake lever, slowly back the rear of the ATV toward the top of the hill then drive downhill). Always walk or dismount on the upside of the slope while keeping clear of the ATV and its rotating wheels. Do not try to hold on to an ATV if it begins to topple. Stay clear. Do not ride over the crest of the hill at high speed. Obstacles, including sharp drop-offs, may exist.

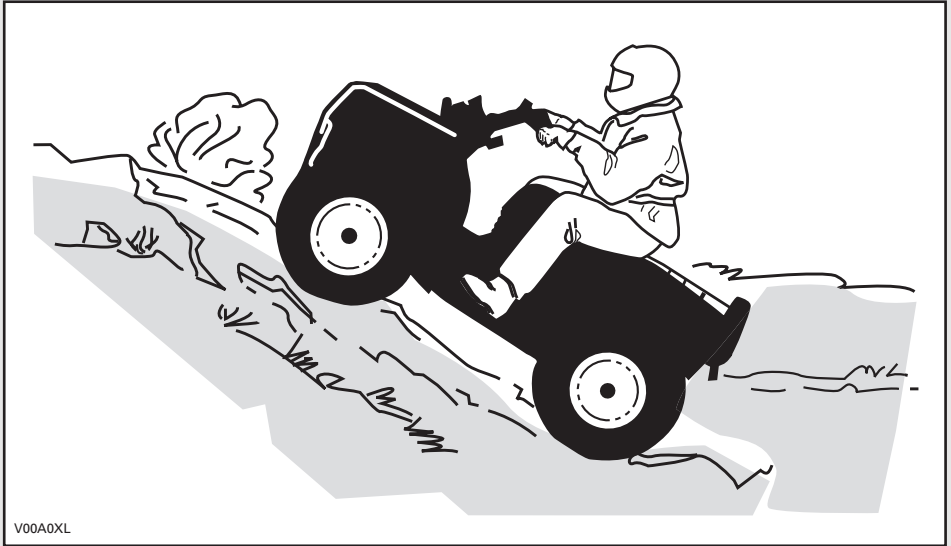

V00A0XL

Downhill

Keep your body weight rearwards. Apply the brake gradually to prevent skidding. Do not "coast" down the slope using solely engine compression or in neutral gear.

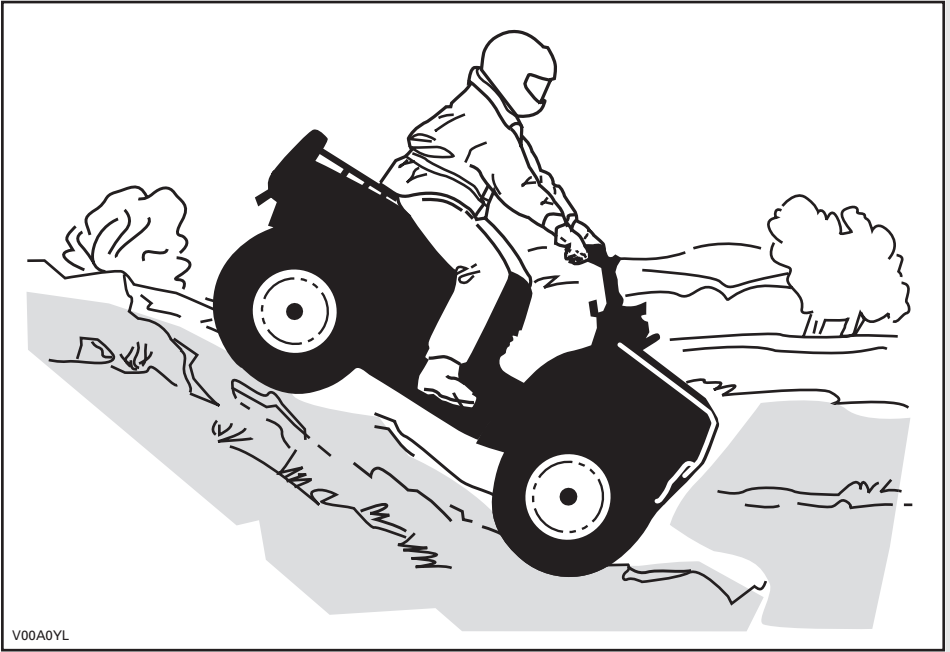

Side-Hilling

This is one of the **most risky** types of riding since it may drastically change the balance of the ATV. It should be avoided wherever possible. If it is necessary to do so however, it is important that you **ALWAYS** keep your body weight on the upside of the slope... and be prepared to dismount on that side should the ATV begin to topple. **Do not try to stop or save the ATV from damage.**



When operating in reverse, check that the path behind you is free of people or obstacles. Proceed slowly and avoid any sharp turns.

When stopped or parked always apply the parking device. This is especially important when parking on a slope. On very steep inclines or if the ATV is carrying a cargo, the wheels should be blocked using rocks or bricks. Remember to turn the fuel valve to the closed position.

Routine Maintenance

Once your ride completed it is wise to remove any build up of snow, ice, mud and grime. Not only will this help you keep the ATV longer and in good condition for resale but will eliminate potential hazards the next time you use the ATV. Wash the ATV with warm soapy water then allow it to dry. (A towel may help). Do not wash the ATV outside during freezing weather. Apply appropriate lubrication as described in the MAINTENANCE section.

Part of your responsibility towards safety is to respect the contents of this *Operator's Guide*. It provides valuable advise on how to properly take care of your ATV. If further assistance is required your authorized Bombardier ATV dealer is always willing to help.

Modification of the ATV to increase speed and performance may violate the terms and conditions of your ATV limited warranty. In addition, certain modifications including the removal of engine or exhaust components are illegal under most laws.

Changing the wheel and/or tire size may affect the stability of the ATV. Incorrect tire pressure may lead to blow outs or cause a tire to move around on its rim and become lost or damaged. Wheels or tires which are damaged should always be replaced.

LOCATION OF THE IMPORTANT LABELS

The following labels are on your ATV. If missing or damaged, they can be replaced free of charge. See an authorized Bombardier ATV dealer.

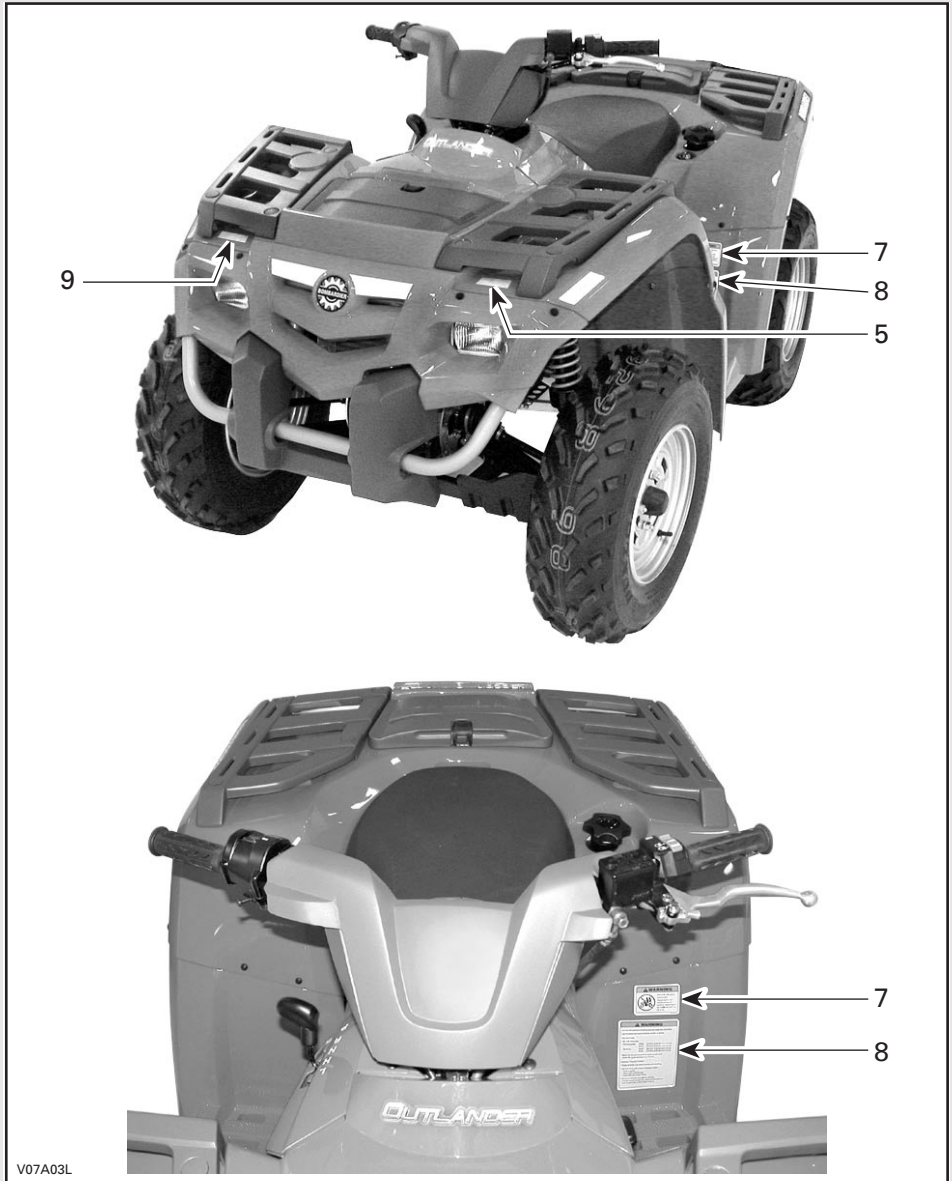

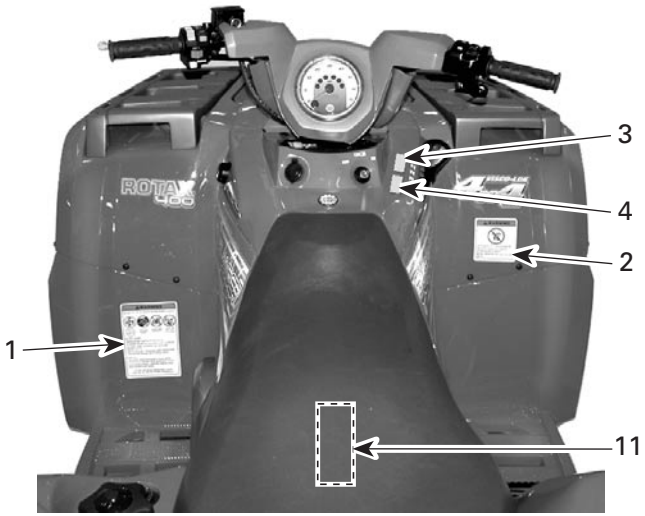

V07A06L

Label 1

⚠ WARNING

Improper ATV use can result in SEVERE INJURY or DEATH.



ALWAYS USE AN APPROVED HELMET AND PROTECTIVE GEAR.

NEVER USE ON PUBLIC ROADS.

NEVER CARRY PASSENGERS.

NEVER USE WITH DRUGS OR ALCOHOL.

NEVER operate:

- without proper training or instructions.
- at speeds too fast for your skills or the conditions.
- on public roads - a collision can occur with another vehicle.
- with a passenger - passengers affect balance and steering and increase risk of losing control.

ALWAYS:

- use proper riding techniques to avoid vehicle overturns on hills and rough terrain and in turns.
- avoid paved surfaces - pavement may seriously affect handling and control.

LOCATE AND READ OPERATOR'S GUIDE.
FOLLOW ALL INSTRUCTIONS & WARNINGS.

V01M01Z XXX XXX XXX

Label 4

CAUTION

ATV MUST be stopped to engage or disengage 4WD switch. mechanical damage may occur if switch is engaged or disengaged while driving.

704 900 471

V07M07Y

4 X 4 MODELS

Label 5

⚠ WARNING

NEVER sit here.

704 900 483

V07M05Y

Label 2

⚠ WARNING



Operating this ATV if you are under the age of 16 increases your chance of SEVERE INJURY or DEATH.

NEVER operate this ATV if you are under age 16.

704 900 011

V01M02Z

Label 6

⚠ WARNING

Improper loading of a trailer may cause loss of vehicle control.

- Maximum towing weight: 1100 lb (500 kg).
- Maximum tongue weight: 30 lb (14 kg).

704 900 009

V01M06Z

Label 3

CAUTION

- ATV MUST be stopped before shifting lever.
- Always apply foot brake to shift from Park(P) and Neutral(N).

704 900 470

V07M06Y

Label 7

⚠ WARNING



NEVER ride as a passenger. Passengers can cause a loss of control, resulting in SEVERE INJURY or DEATH.

704 900 005

V01M07Z

Label 8

WARNING

Improper tire pressure or overloading can cause loss of control.
Loss of control can result in SEVERE INJURY or DEATH.

TIRE PRESSURE

- Set with tires cold:
 - Recommended: FRONT: 27.6 kPa, (0.28 kgf/cm²), 4.0 psi.
REAR: 31.0 kPa, (0.32 kgf/cm²), 4.5 psi.
 - Minimum: FRONT: 24.1 kPa, (0.25 kgf/cm²), 3.5 psi.
REAR: 27.6 kPa, (0.28 kgf/cm²), 4.0 psi.

• Never set tire pressure below minimum. It could cause the tire to dislodge from the rim.

LOADING / TRAILER TOWING

- Cargo or trailer can affect stability and handling.
- When loading with cargo or towing a trailer:
 - Reduce speed.
 - Allow more room to stop.
 - Avoid hills and rough terrain.
- Maximum Vehicle Load: 485 lb. (220 kg).
Includes weight of operator, cargo and accessories (and if applicable, trailer tongue weight).

704 900 432

V07M03Y

Label 9

CAUTION

MAXIMUM FRONT LOAD : 90 lb (40 kg)

704 900 433

V07M04Y

Label 10

CAUTION

MAXIMUM REAR LOAD : 175 lb (80 kg)

Includes trailer tongue weight and storage tray load: 22 lbs. (10 kg)

704 900 432

V07M02Y

Label 11

VEHICLE EMISSION CONTROL INFORMATION

ENGINE FAMILY: 3BCXX.4003GC
EXHAUST EMISSION CONTROL SYSTEM: EM
DISPLACEMENT: 400cc
TUNE-UP SPECIFICATIONS:
VALVE CLEARANCE: INTAKE: 0.05-0.13 mm
OUTAKE: 0.1-0.18 mm

IDLE SPEED:
IDLE AIR/FUEL MIXTURE SETTING:
SPARK PLUG:
FUEL: (RON + MON)/2
ENGINE OIL:

1300 RPM + 100 RPM
FROM POSITION OF PILOT SCREW FOR MAXIMUM SPEED AT IDLE, UNSCREW 3/8 OF TURN
NGK DCPR8E ELECTRODE GAP → 0.6 mm - 0.7 mm
UNLEADED 87 OCTANE
SAE 5W30

BOMBARDIER
RECREATIONAL PRODUCTS



THIS VEHICLE CONFORMS TO CALIFORNIA REGULATIONS APPLICABLE TO 2003 MODEL YEAR NEW OFF-ROAD MOTORCYCLES AND ALL TERRAIN VEHICLES AND IS CERTIFIED TO 10 g/bhp-hr HC+NOx ENGINE FAMILY EXHAUST EMISSION STANDARD.

704 900 501

V07M08L

VEHICLE INFORMATION

HOW TO IDENTIFY YOUR ATV

The main components of your vehicle (engine and frame) are identified by different serial numbers. It may sometimes become necessary to locate these numbers for warranty purposes or to trace your vehicle in the event of loss. These numbers are required by the authorized Bombardier ATV dealer to complete warranty claims properly. No warranty will be allowed by Bombardier Inc. if the engine identification number (EIN) or vehicle identification number (VIN) is removed or mutilated in any way. We strongly recommend that you take note of all the serial numbers on your vehicle and supply them to your insurance company.

Engine and Vehicle Identification Number Location

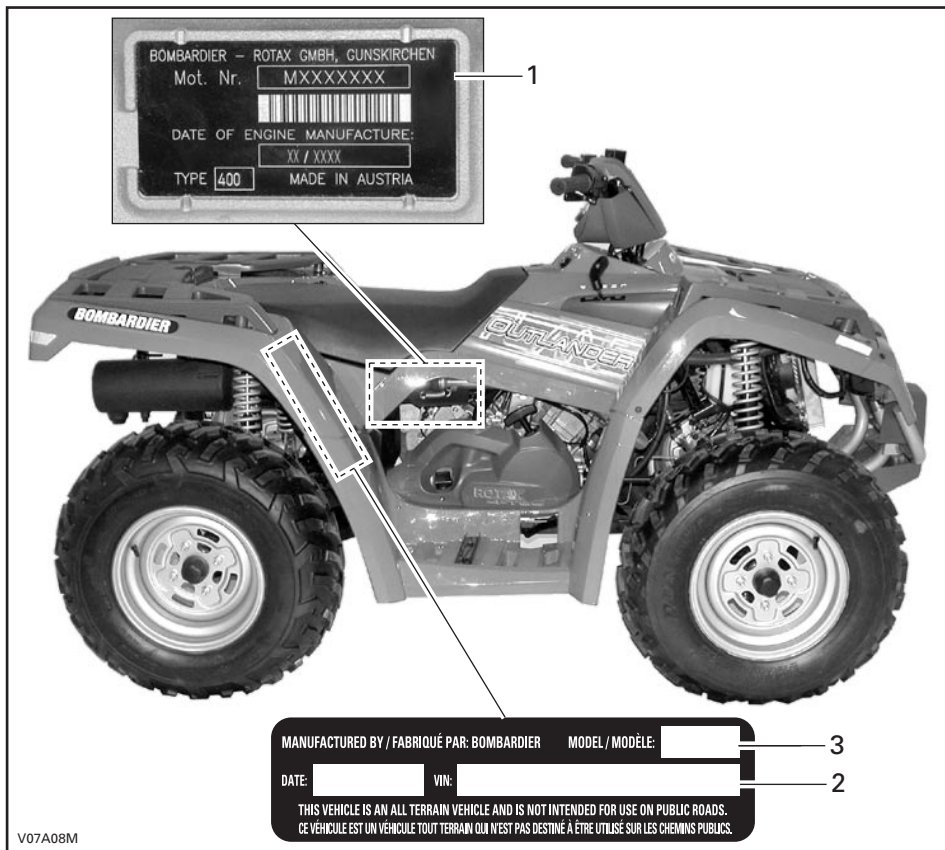

1. EIN (Engine Identification Number)
2. VIN (Vehicle Identification Number)
3. Model

EMISSION REQUIREMENTS

The California Air Resources Board (CARB) requires that your ATV complies with applicable exhaust emissions standards during its useful life, when operated and maintained according to the instructions supplied.

A non-compliance Red Label (as well as a Green Label) is obtained annually during California Vehicle registration. The appropriate label is denoted by the vehicle identification number (in the 8th character detailed herein).

VEHICLE CATEGORY	VIN 8th CHARACTER
Non-complying Red Label	Must denote a C or 3
Complying Green Label	Any alphanumeric designation other than a C or 3

CONTROLS/INSTRUMENTS/EQUIPMENTS

NOTE: Some controls/instruments/equipments are optional.

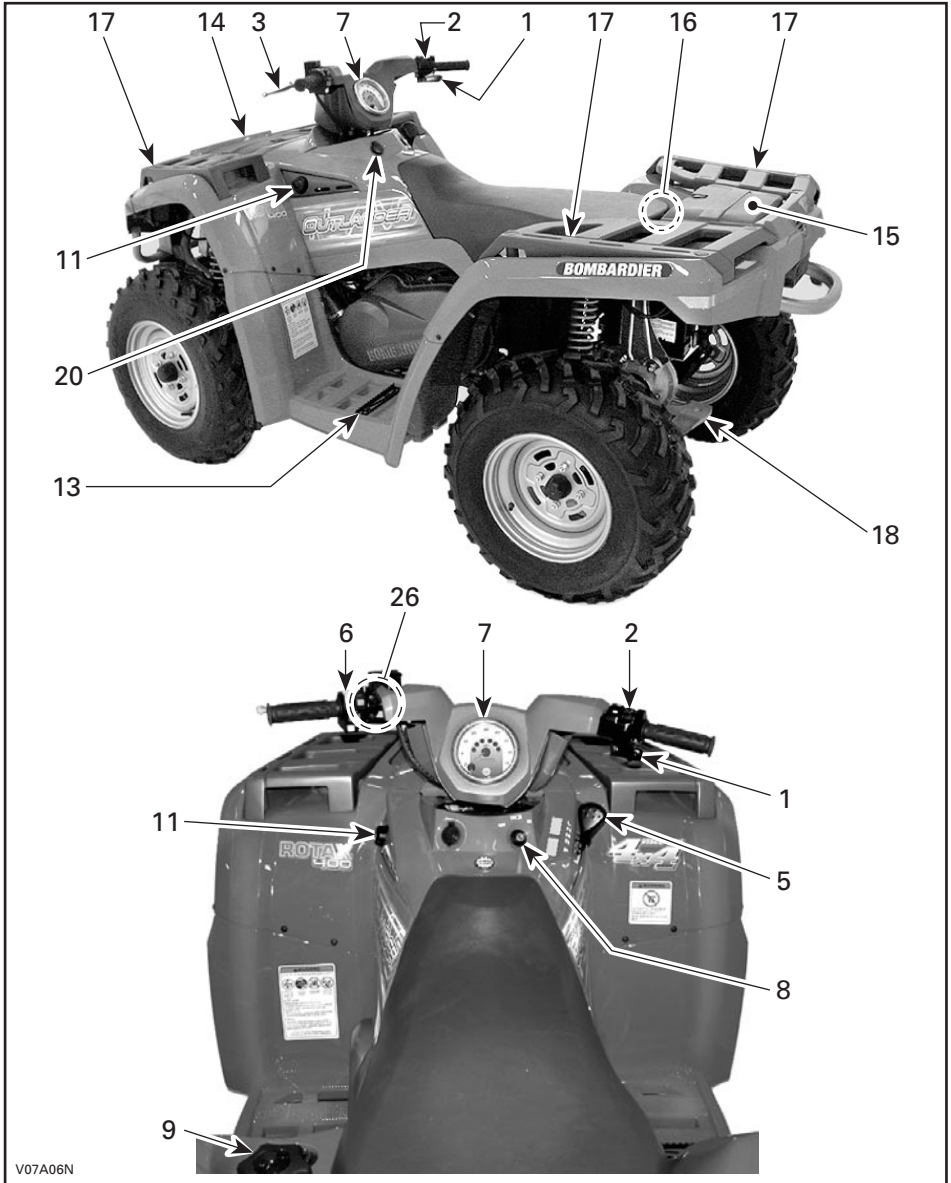

V07A06N

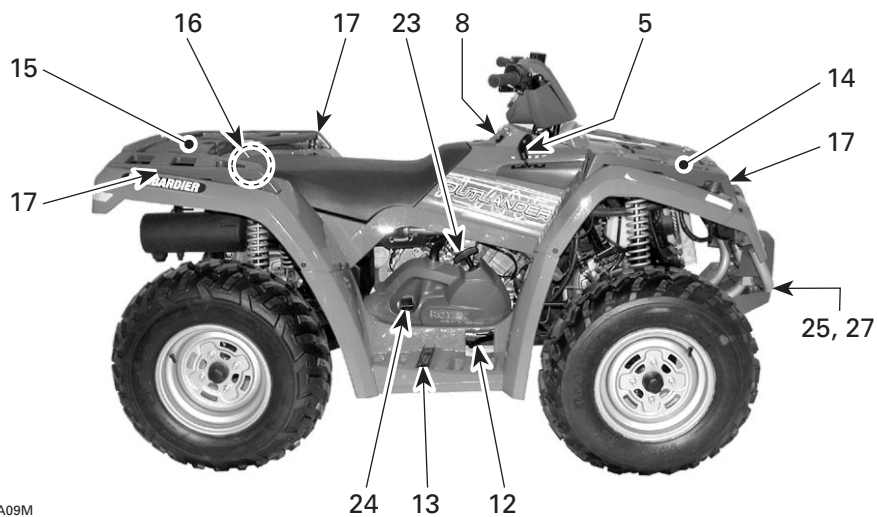
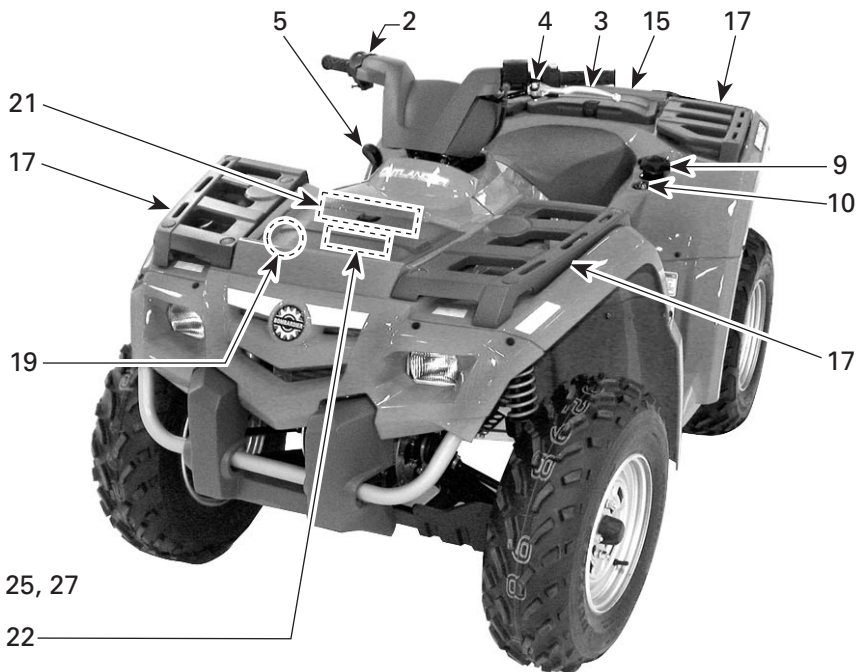

V07A09M

While reading this *Operator's Guide*, remember that:

WARNING

Indicates a potential hazard that, if not avoided, could result in serious injury or death.

NOTE: This section gives basic functions of the various controls of your ATV. For more details of how to operate one control in conjunction with some others, refer to OPERATING INSTRUCTIONS further in this section.

1) Throttle Lever

Located on the right side of handlebar. When pushed, it increases the engine speed that allows the engagement of the transmission on the selected gear.

When released, the engine speed should return automatically to idle and the vehicle will gradually slow down.

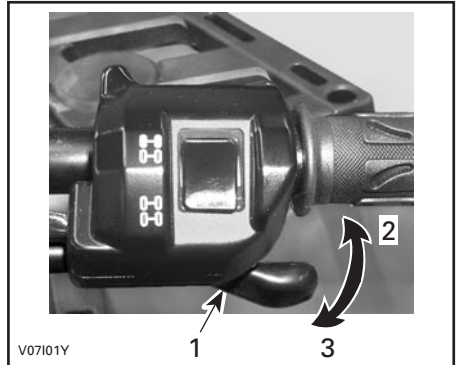

4 x 4 MODELS

1. Throttle lever
2. To accelerate
3. To decelerate

2) 2WD/4WD Selector

4 x 4 Models

Located on the top of throttle handle, this selector allows to choose between 2WD and 4WD.

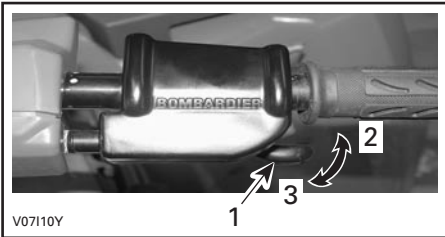

2 x 4 MODELS

1. Throttle lever
2. To accelerate
3. To decelerate

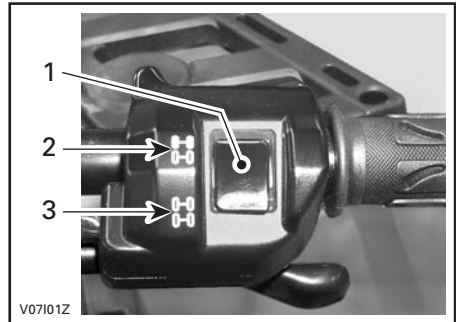

1. Selector
2. 2WD position
3. 4WD position

3) Brake Lever

Located on the left side of handlebar. When the brake lever is compressed, the front and rear brakes are applied. When released, the brake lever should automatically return to its original position. Braking effect is proportional to the force applied on the lever and to the type and condition of the terrain.

NOTE: As on other wheeled vehicles, the vehicle weight is transferred to the front wheels when braking. To obtain greater stopping efficiency, the brake system distributes more braking force to the front wheels. This will affect vehicle handling and steering control when braking vigorously. Take it into account when braking.

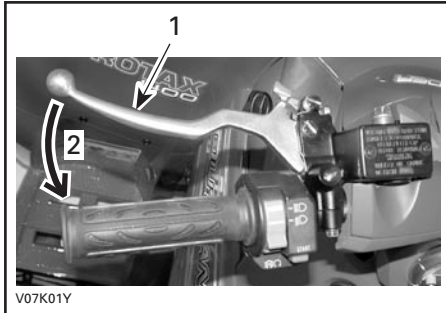

1. Brake lever
2. To apply brakes

4) Brake Lever Lock

Located on left side of handlebar on the brake lever. When applied, it prevents the vehicle from moving. Useful when the brake needs to be locked for example when doing a K-turn, during transportation or when the vehicle is not in operation.

WARNING

Always use the brake lever lock **and** engage the PARK position on the transmission lever when the vehicle is not in operation.

WARNING

Make sure brake lever lock is fully disengaged before operating the ATV.

When you ride the vehicle, brakes that are caused to drag by a continuous pressure on the lever may cause damage to the brake system and cause loss of braking capacity and/or fire.

To engage mechanism: Squeeze brake lever and maintain while moving lever lock. Brake lever is now compressed and applying all brakes.

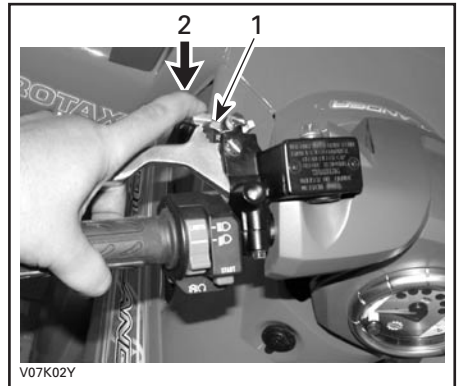

1. Brake lever lock
2. Press to apply parking brakes

To release mechanism: Squeeze brake lever. Lever lock should automatically return to its original position. Brake lever should return to rest position. Always release brake lever lock before riding.

5) Transmission Lever

Located on the right side of vehicle. A 5-position lever: P, R, N, H and L.



To change the transmission position, completely stop vehicle then move lever to the desired position. Do not force lever. If unable to shift, gently apply throttle and release it immediately, then wait until engine RPM returns to stable idle and try again.



SHIFT PATTERN

CAUTION: Always completely stop the vehicle and apply the brake prior to moving the transmission lever.

P: Park

This position locks the transmission to help prevent vehicle movement. Always use when the vehicle is not in operation. In some circumstances, it may be necessary to rock the vehicle back and forth to move the gears in the transmission to allow the park to be engaged.

R: Reverse

This allows the vehicle to go backward. The vehicle speed is limited.

WARNING

Before moving vehicle in reverse, ensure the path behind is clear of obstacles or bystanders. Remain seated.

N: Neutral

This position disengages the transmission to allow manual vehicle movement.

H: High gear

This selects the high speed range of the transmission in the gear box. It is the normal driving speed range. It allows the vehicle to reach its maximum speed.

L: Low gear

This selects the low speed range of the transmission in the gear box. It is the working position. It allows the vehicle to move slowly with the maximum traction and power.

NOTE: Use the low speed range to pull any load or to climb a steep incline.

6) Multi-Function Switch

The multi-function switch is located on the left side of handlebar.

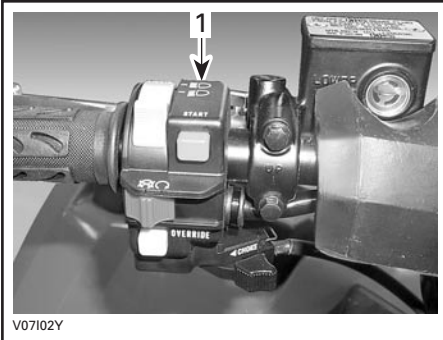

1. Multi-function switch

The controls located on this multi-function switch are:

Headlamp Switch

Located on the top of multi-function switch. Place headlamp switch to LO for the low beam and taillight. Place headlamp switch to HI for the high beam and taillight.

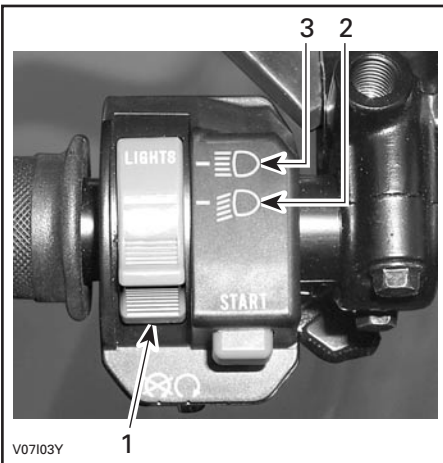

1. Headlamp switch
2. Low beam position
3. High beam position

NOTE: Place ignition switch to ON "without light" position to close the headlamp.



ON POSITION "WITHOUT LIGHT"

Engine Stop Switch

Located at the middle of multi-function switch. The engine will turn over but will not start if the engine stop switch is turned to OFF position.

This switch can be used to stop engine and as an emergency control.

NOTE: While engine can be stopped by turning ignition key OFF, we recommend the engine be stopped by the engine stop switch.



1. Engine stop switch

To stop engine, fully release throttle lever then use the engine stop switch.

Start Button

Located above engine stop switch.

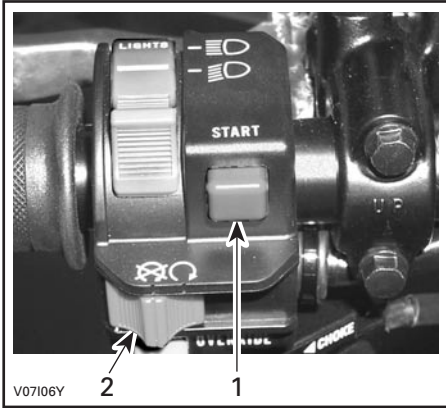

1. Start button
2. Engine stop switch

To start engine, place the engine stop switch to RUN.

Press and hold the start button. Release immediately after engine is started.

Override Button

Located below engine stop switch.

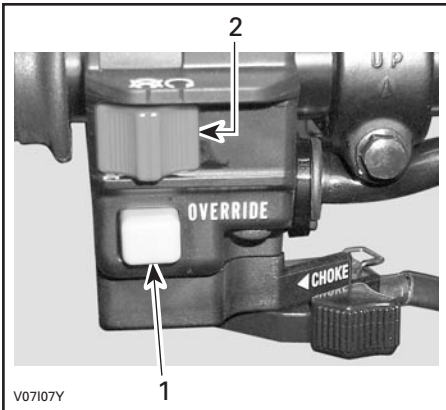

1. Override button
2. Engine stop switch

This button is used to override the reverse speed limiter system and while power backing up. To do this, press the override button.

WARNING

Never activate the override button while throttle is open as loss of control may result, causing severe personal injury or death.

Choke Lever

Located at bottom of multi-function switch. This device features a variable lever to ease cold start.

Position OFF is for normal use with a warm engine.



CHOKE LEVER IN THE OFF POSITION

The full choke position is used for lower engine temperature.



CHOKE LEVER IN THE FULL CHOKE POSITION

The other positions between OFF and FULL position, will be use depending on the engine temperature.

7) Speedometer

This vehicle is equipped with an electronic speedometer. It indicates the speed of vehicle either in MPH or km/h.

The speedometer is located at the middle of cluster and it backlit every time the ignition switch is turned ON.

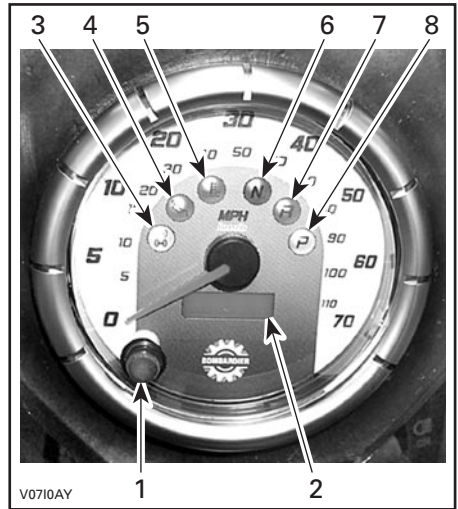

1. Display selector button
2. Display
3. 4WD indicator lamp (4 x 4 models)
4. Oil pressure indicator lamp
5. Engine temperature indicator lamp
6. Neutral position indicator lamp
7. Reverse position indicator lamp
8. Park position indicator lamp

Change from One Unit to the Other

The speedometer is factory pre-set in miles but it is possible to change it to kilometer reading.

NOTE: The unit modification is applied to the speedometer, odometer and trip meter.

Turn ignition switch OFF and open the access panel. Cut locking ties retaining the change wire to the rectifier harness.

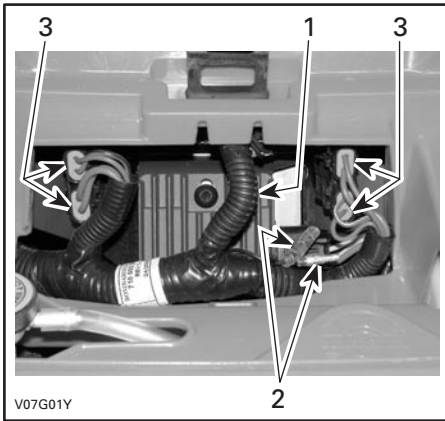

1. Rectifier harness
2. Change wire connectors
3. Fuse holders

Plug connectors to change units from miles to kilometers. Unplug to return to miles reading.

Fix the change wires to the harness with new locking ties.

Display Selector Button

The odometer always appears when turning the ignition switch ON (either ON position). To change the display to the trip meter, depress the display selector button.

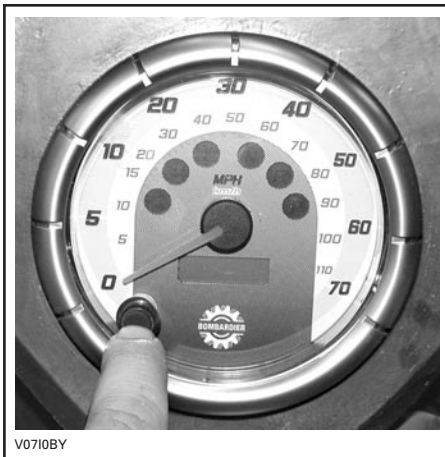

Depressing display selector button again will change display for the hour-meter. Push display selector button again to return to odometer.

Odometer

Odometer records the total distance travelled either in miles or kilometers.

Trip Meter

The trip meter records distance travelled since it has been reset. Distance travelled is displayed either in miles or kilometers.

It can be used to establish a fuel tank range or distance between 2 way points for instance.

Push and HOLD display selection button for 2 seconds to reset the trip meter.

Hourmeter

The hourmeter records engine running time in hours and minutes.

Indicator Lamps



-  4-Wheel Drive (AMBER)
-  4 x 4 Models

When this indicator light is ON, it indicates the 4WD system is activated.



Oil Pressure (RED)

When this indicator light is ON, it indicates a low oil pressure condition of the engine.

CAUTION: If the light does not turn off right after engine starting, stop engine. Check engine oil level. Refill if necessary. If the oil level is good, see an authorized Bombardier ATV dealer. Do not use the vehicle until repaired.



Engine Temperature (RED)

When this indicator light is ON, it indicates the engine is overheating.

If engine overheats, refer to ENGINE OVERHEAT in SPECIAL PROCEDURES.

CAUTION: If the light does not turn off right after engine starting, stop engine. See an authorized Bombardier ATV dealer. Do not use the vehicle until repaired.



Neutral (GREEN)

When lit, it indicates the transmission is in neutral position.



Reverse (RED)

When lit, it indicates the transmission is in reverse position.



Park (AMBER)

When lit, it indicates the transmission is in park position.

8) Ignition Switch

Located on the console.

Key-operated, 3-position switch: OFF, ON with lights and ON without lights.

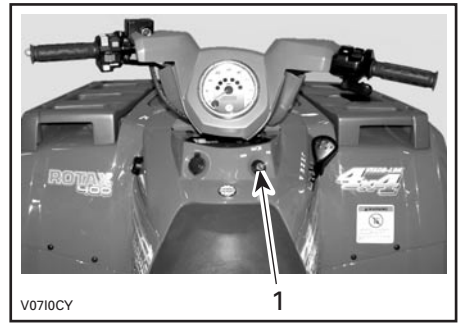

1. Ignition switch

Insert key in switch and turn to the desired position. To remove key, turn key to OFF then pull it out.

The ON with lights position, turns on all lights with either the engine running or not. Remember that having the lights on without the engine running discharges the battery. Always turn ignition to OFF after engine has been stopped.

NOTE: While engine can be stopped by turning ignition key OFF, we recommend the engine be stopped by the engine stop switch.

9) Fuel Tank Cap

The fuel tank cap is located on the left side of the rear fender.

CAUTION: Never place anything over fuel tank cap because the vent hole on the top of fuel tank cap can be blocked and the engine could misfire.

Unscrew counterclockwise and remove cap to allow fuel tank filling then fully tighten clockwise.

WARNING

Always stop engine before refueling. Open cap slowly. If a differential pressure condition is noticed (whistling sound heard when loosening fuel tank cap) have vehicle inspected and/or repaired before further operation. Fuel is flammable and explosive under certain conditions. Never use an open flame to check fuel level. Never smoke or allow flame or spark in vicinity. Always work in a well-ventilated area. Never top up the fuel tank before placing the vehicle in a warm area. As temperature increases, fuel expands and may overflow. Always wipe off any fuel spillage from the vehicle.

10) Fuel Gauge

Located on the left side of the rear fender near fuel tank cap, the gauge shows an approximate amount of the fuel in tank.

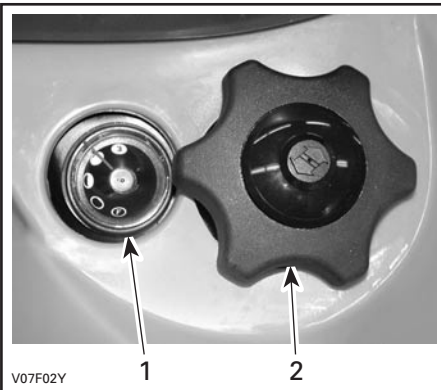

1. Fuel gauge
2. Fuel tank cap

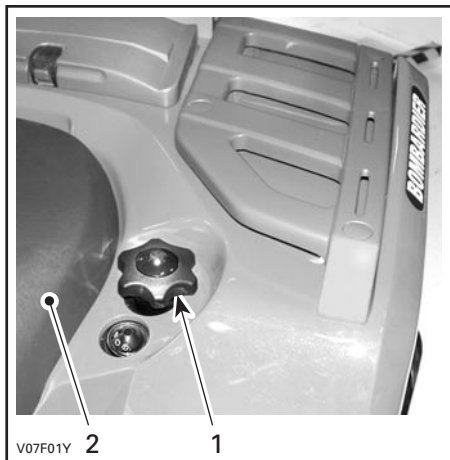

1. Fuel tank cap
2. Seat

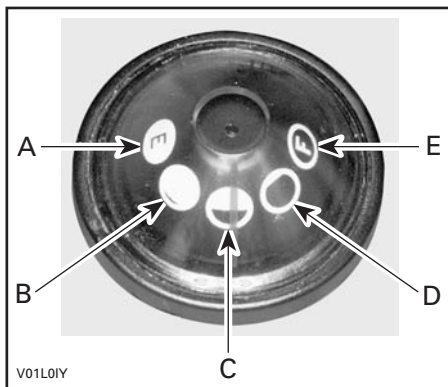

- A. Empty
- B. 1/4
- C. 1/2
- D. 3/4
- E. Full

11) Fuel Valve

Located on left side panel under console. 3-position rotary valve: OFF, ON, RES. Rotate the knob to align its pointer with ON, OFF or RES.

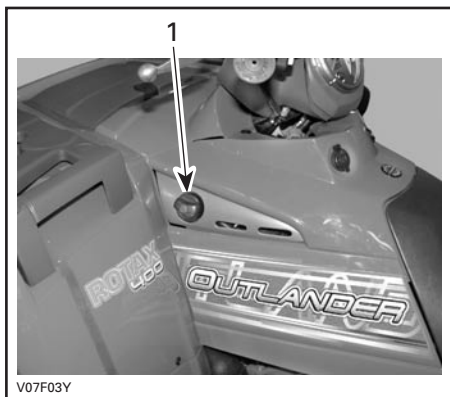

1. Align this pointer toward the desired position

OFF

Stops fuel supply to carburetor.

CAUTION: Turn valve to OFF position when ATV is not being operated or when transporting.

ON

Allows fuel to flow to carburetor. This is the normal position for operation of the vehicle.

RES (reserve)

When fuel is exhausted in the fuel tank when in the ON position, an emergency supply of fuel is available by turning the knob to RES. The reserve contains approximately 12% of the fuel tank capacity. Use this position only when the ON supply is empty.

When down to the reserve, refuel as soon as possible. Ensure to turn the valve back to the ON position after refuelling.

CAUTION: Improper opening of fuel valve will restrict the flow of fuel. Make sure valve is fully opened while running.

12) Brake Pedal

Located on the right footrest. When pressed down, the rear brake is applied. When released, the brake pedal should return to its original position. Braking effect is proportional to the force applied on the pedal and to the type and condition of the terrain.

NOTE: The brake will have also an effect on front wheels through the drive train.

The brake pedal applies the rear brake only. Should the main brake system fail, the rear brake can be activated by depressing the brake pedal.

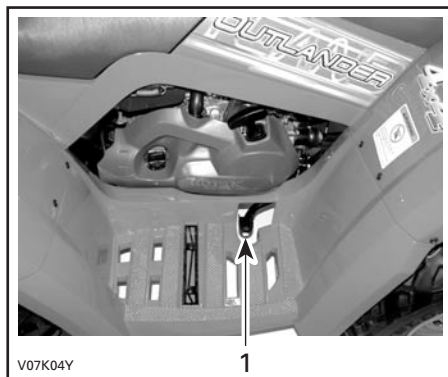

1. Brake pedal

13) Footpeg

Located on footrest. Use this area to maintain your feet stable.

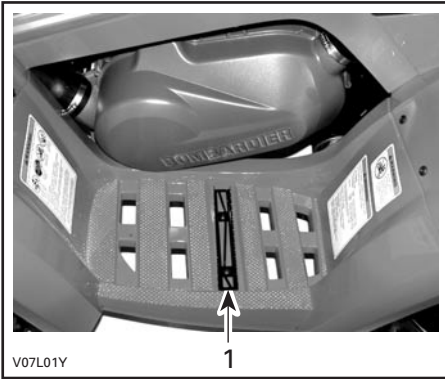

1. Footpeg

14) Access Panel

The access panel is located on the front fender, between front racks. To open the panel, unlatch, lift then remove it completely.

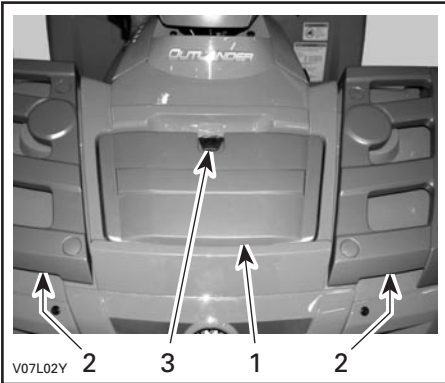

1. Access panel
2. Front racks
3. Latch

This panel allows an easier access to the service compartment. The service compartment contains different maintenance items like rear brake fluid reservoir, radiator cap, coolant reservoir and fuse holders (behind tool box).

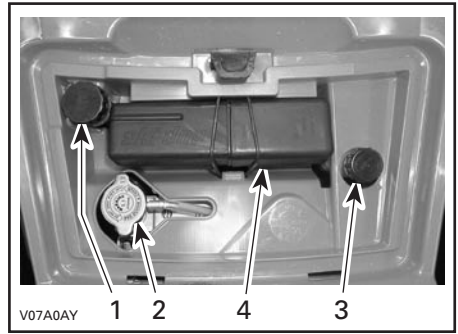

1. Rear brake fluid reservoir
2. Radiator cap
3. Coolant reservoir
4. Tool box

15) Rear Storage Compartment

Located in rear of vehicle. Convenient location to carry personal articles such as a spare spark plugs, first aid kit, etc. Unlatch cover, gently lift then remove cover.

The compartment is equipped with a drain plug. Remove plug to allow draining when necessary. Reinstall plug when finished.

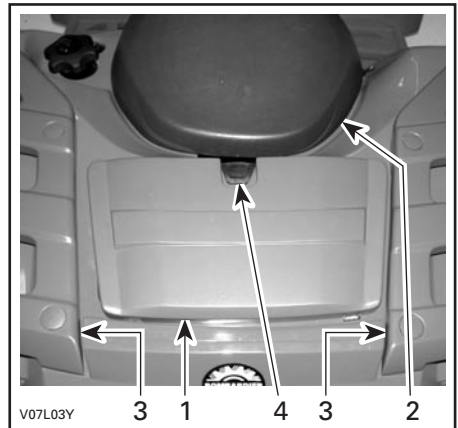

1. Rear storage compartment cover
2. Seat
3. Rear racks
4. Latch

WARNING

When engine is running, always engage the PARK position on the transmission lever before opening cover. Never leave any heavy or loose breakable objects in the storage basket. Always latch cover before riding. If storage cover is removed to provide greater carrying area, ensure that cargo is secured and will not “fly out” when riding at speed on rough terrain. Slow down.

16) Seat Latch

Located underneath the rear end of seat. It allows the removal of seat to give access to engine compartment.



1. Seat latch

Seat Removal

Push latch forward while gently lifting rear of seat. Pull seat rearward. Continue lifting movement until you can release the front retaining device then completely remove seat.

Seat Installation

Insert front tabs of seat into frame hook. When seat rests in its position, firmly push seat down to latch.

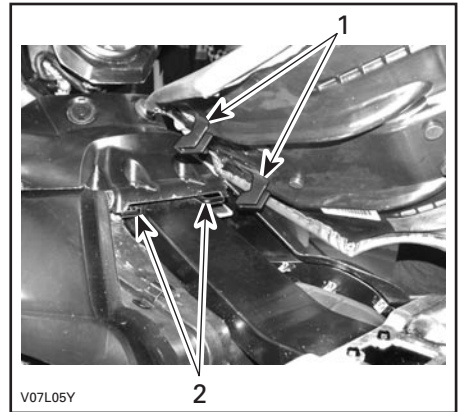

1. Insert these tabs in hooks
2. Hooks

WARNING

Periodically verify the seat lock pin and tighten if needed. Make sure seat is securely latched before riding.

17) Front/Rear Cargo Rack

Located on top of chassis at front and rear. Convenient rack to carry gear.

WARNING

Ensure to properly secure material to rack. Do not overload. Ensure load does not interfere with visibility and/or steering. Do not carry passenger(s).

Refer to SPECIFICATIONS for carrying loads and cargo weight distribution recommendations.

18) Trailer Hitch

Located near rear axle. Convenient hitch to install a ball to tow a trailer or other equipment. Install the proper ball size as per trailer manufacturer recommendations. Refer to SPECIFICATIONS for carrying loads and towing recommendations.

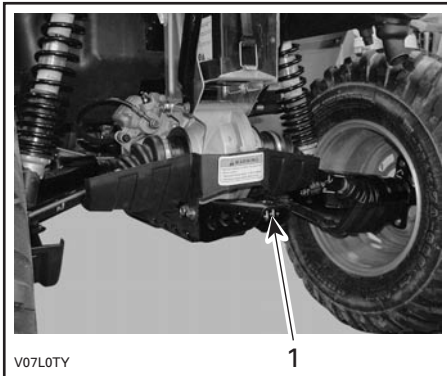

1. Trailer hitch

WARNING

Ensure to install the proper ball size that matches the equipment you will tow.

NOTE: Follow manufacturer instructions for proper attachment.

19) Radiator Cap

Located in service compartment, under access panel.

WARNING

To prevent burning yourself do not remove the radiator cap when the engine is hot.

To remove the radiator cap, press and turn it counterclockwise. Reverse the removal procedure to install.

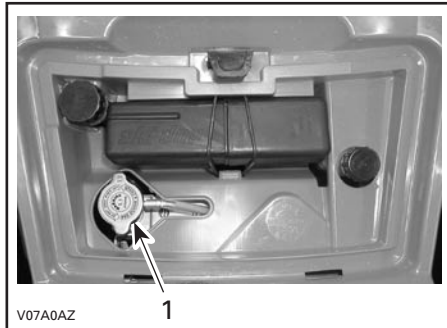

1. Radiator cap

20) 12-Volt Power Outlet

It is located on the console.

Convenient for handheld spotlight or other portable equipment.

Remove protective cap to use. Always reinstall protective cap after use to protect against weather.

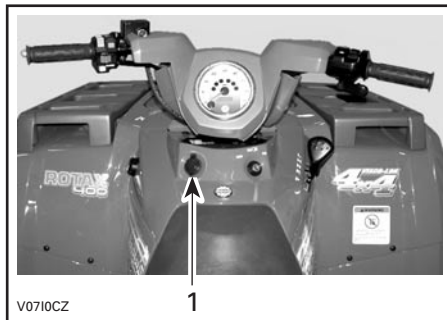

1. Power outlet

Do not exceed the rating capacity. See SPECIFICATIONS.

An auxiliary supply is available to connect additional accessories. Two wires are hidden in the wiring harness at the rear of vehicle. See an authorized Bombardier ATV dealer for more details.

21) Fuses

The electrical system is protected with fuses. Refer to MAINTENANCE for details.

The fuse holders are located in the service compartment (behind tool box).

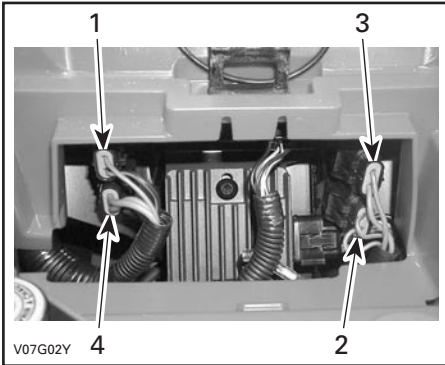

FUSES LOCATION

1. Accessories (15 A)
2. Fan (15 A)
3. Main (20 A)
4. Charging system (30 A)

22) Tool Box

The tool box is located in the service compartment. It contains tools for basic maintenance and this *Operator's Guide*.

The tools included in the tool box are:

- pliers (1)
- screwdriver (1)
- open wrench 10/13 mm (1)
- open wrench 15/17 mm (1)
- socket wrench 10/13 mm (1)
- socket wrench 16/18 mm (1)
- tire pressure gauge (1)
- Allen key 3 mm (1)
- shock absorber key (1)
- fuse 30 A (1)
- fuse 20 A (1)
- fuse 15 A (1).

23) Rewind Starter Handle

The rewind starter handle is provided as an emergency starting device.

Follow the usual starting procedure; but use the rewind starter instead of the electric starter.

Located on right side of vehicle. Auto-rewind type. To engage mechanism, pull handle slowly until a resistance is felt then continue to slowly pull the handle until the compression stroke **peak** (strong rotating resistance) is overpassed then, pull vigorously. Slowly release handle.

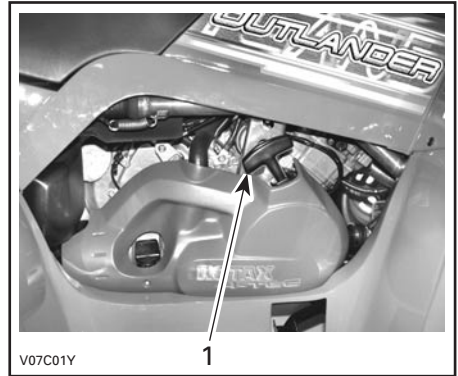

1. Rewind starter handle

24) Dipstick

Located on the right side of engine. Allow to check the oil level in the engine.



1. Dipstick

Refer to LIQUID to check the engine oil level correctly.

25) Winch

XT Models

Located behind front skid plate.

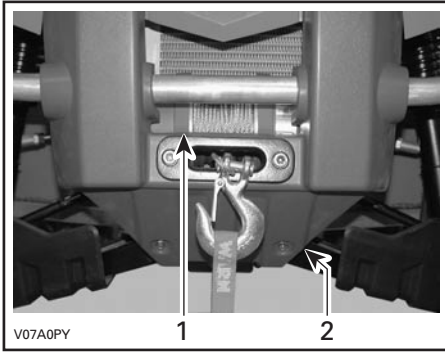

1. Winch
2. Front skid plate

26) Winch Control Switch

XT Models

Located on the left side of the handlebar.

To take out wire rope from winch, press the left side of switch.

To get wire rope into the winch, press the right side of switch.

Refer to *ATV Winch Operator's manual* for more informations.

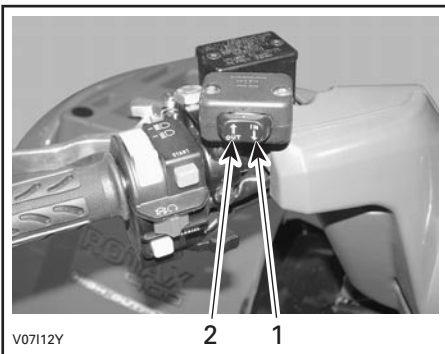

1. In
2. Out

27) Fairlead

XT Models

Located on the front of skid plate.

The fairlead is used to prevent the damages to the vehicle and guide the wire rope into the winch.

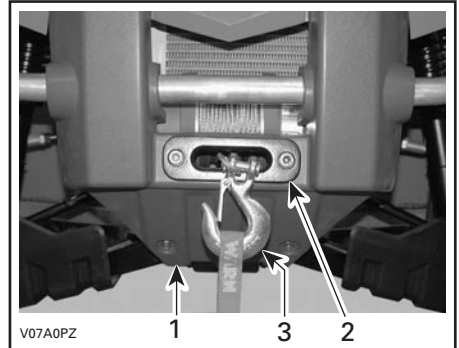

1. Front skid plate
2. Fairlead
3. Winch hook

LIQUIDS

While reading this *Operator's Guide*, remember that:

WARNING

Indicates a potential hazard that, if not avoided, could result in serious injury or death.

This section specifies the recommended liquids and procedures to check their levels. Refer to MAINTENANCE for procedures to replace the liquids.

Fuel

Recommended Fuel

Use regular unleaded gasoline or gasohol containing less than 10% of ethanol or methanol, available from most service stations. The gasoline used must have an octane number of 87 $((R + M)/2)$ or higher.

NOTE: In most service station, pump octane number corresponds to $(R + M)/2$ octane number. Usually a sticker can be found on the pump.

CAUTION: Never experiment with other fuels. The use of unrecommended fuel can result in vehicle performance deterioration and damage to critical parts in the fuel system and engine components.

CAUTION: Never mix oil with fuel. This ATV has a 4-stroke engine. Oil must be added to engine base only.

Fuel Level

WARNING

Always stop engine before refueling. Open cap slowly. If a differential pressure condition is noticed (whistling sound heard when loosening fuel tank cap) have vehicle inspected and/or repaired before further operation. Fuel is flammable and explosive under certain conditions. Never use an open flame to check fuel level. Never smoke or allow flame or spark in vicinity. Always work in a well-ventilated area. Never top up the fuel tank before placing the vehicle in a warm area. As temperature increases, fuel expands and may overflow. Always wipe off any fuel or oil spillage from the vehicle.

Engine/Transmission Oil

Recommended Oil

Use 4-stroke engine oil that meets or exceeds the requirements for API service classification SG, SH or SJ. Always check the API service label on the oil container to be sure it includes the letters SG, SH or SJ. Only use high-quality high-detergent oil.

NOTE: The same oil lubricates both engine and transmission. For improved overall performance and wear protection use Bombardier synthetic oil 5W40 (P/N 293 600 039).

Oil Viscosity

SAE 5W30 is recommended for all seasons.

However, during the hottest days of the summer and bitter cold days of the winter, refer to the following chart to select the proper viscosity.

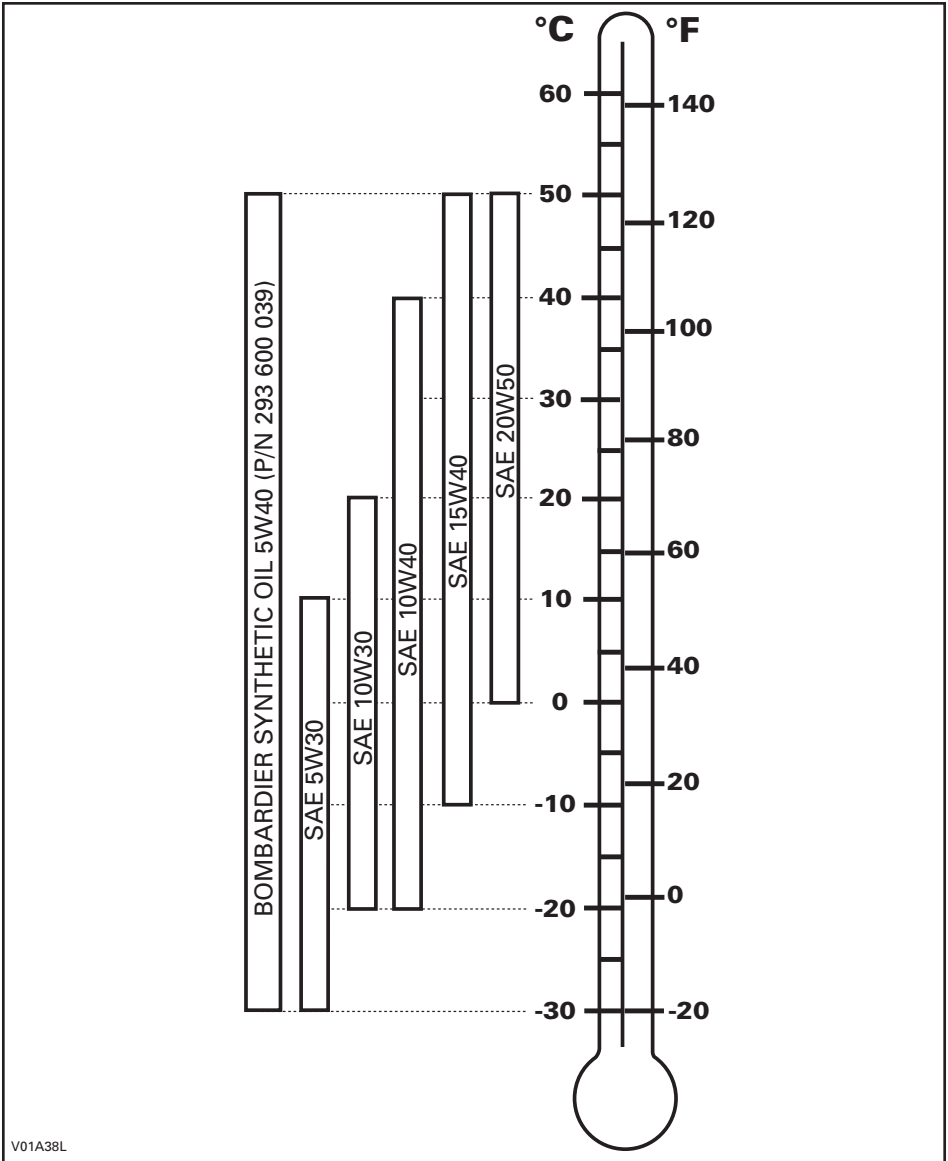

V01A38L

Oil Level

CAUTION: Check level frequently and refill if necessary. Do not overfill. Operating the engine/transmission with an improper level may severely damage engine/transmission. Wipe off any spillage.



RH SIDE OF ENGINE

1. Dipstick

With vehicle on a level surface and engine cold, not running, check the oil level as follows:

1. Unscrew dipstick then remove it and wipe clean.
2. Reinstall dipstick, screw in it completely.
3. Remove and check oil level. It should be near or equal to the upper mark.

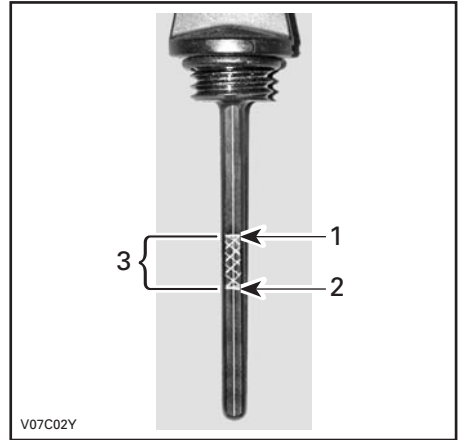

1. Full
2. Add
3. Operating range
4. To add oil, remove dipstick. Place a funnel into the dipstick tube and fill up with the recommended oil to upper mark. **Do not overfill.**
5. Properly tighten dipstick.

Engine Coolant

Recommended Coolant

Always use ethylene-glycol antifreeze containing corrosion inhibitors specifically for internal combustion aluminum engines.

Cooling system must be filled with water and antifreeze solution (50% water, 50% antifreeze) or with Bombardier premixed coolant (P/N 293 600 038).

Coolant Level

WARNING

Check coolant level with engine cold. Never add coolant in cooling system when engine is hot.

Remove access panel.

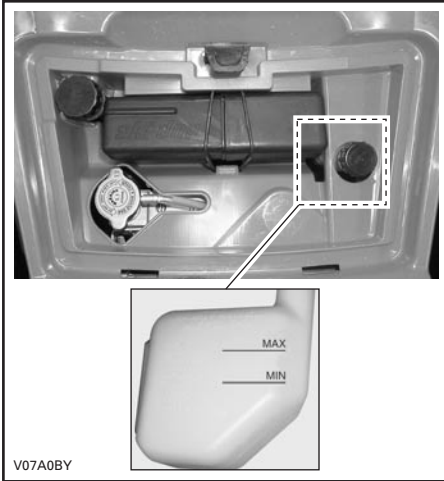

With vehicle on a level surface, liquid should be between MIN. and MAX. level marks of coolant reservoir.

NOTE: When checking level at temperature lower than 20°C (68°F), it may be slightly lower than MIN. mark.

Add coolant up to MAX. mark if required. Use a funnel to avoid spillage. **Do not overfill.**

Properly reinstall and tighten filler cap and reinstall access panel.

If the coolant is added in the coolant reservoir, check the level in the radiator too. Add coolant if necessary.

WARNING

To prevent burning yourself do not remove the radiator cap if the engine is hot.

NOTE: A cooling system that frequently requires coolant is the indication of leaks or engine problems. See an authorized Bombardier ATV dealer.

Coolant Replacement

Refer to MAINTENANCE section.

Brake Fluid

Recommended Fluid

Always use brake fluid meeting the specification DOT 4 only.

CAUTION: To avoid serious damage to the braking system, do not use fluids other than the recommended one, nor mix different fluids for topping up.

Fluid Level

With vehicle on a level surface, check brake fluid in reservoirs for proper level. They should be above MIN. mark.

Add fluid as required. **Do not overfill.**

Clean filler cap before removing.

CAUTION: Use only DOT 4 brake fluid from a sealed container. Do not use brake fluid taken from old or already opened containers.

NOTE: A low level may indicate leaks or worn brake pads. See an authorized Bombardier ATV dealer.

Brake Lever Fluid Reservoir

Turn steering in the straight-ahead position to ensure reservoir is level. Check the brake fluid level, the reservoir is full when the fluid reaches of the top of window.

Visually inspect lever boot condition. Check for cracks, tears, etc. Replace if damaged.



Brake Pedal Fluid Reservoir

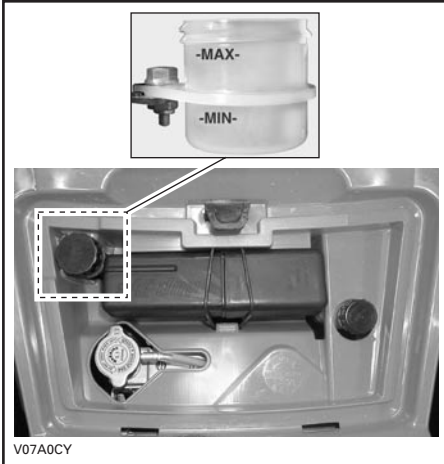

Battery

This vehicle is equipped with a dry type battery that requires no maintenance.

Cleaning

Clean battery post with a wire brush. Apply dielectric grease on post to protect against oxidation.

Removal

Disconnect BLACK (-) cable first then RED (+) cable.

WARNING

Always respect this order for disassembly; disconnect BLACK (-) cable first.

Remove the holding strap then pull the battery out of frame.

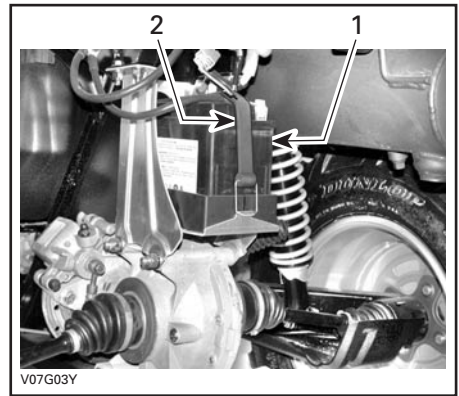

1. Battery
2. Holding strap

Installation

Reinstall battery in vehicle.

WARNING

Connect RED (+) cable first then BLACK (-) cable. Always connect RED (+) cable first.

NOTE: Place the BLACK (-) cable between holding strap and battery.

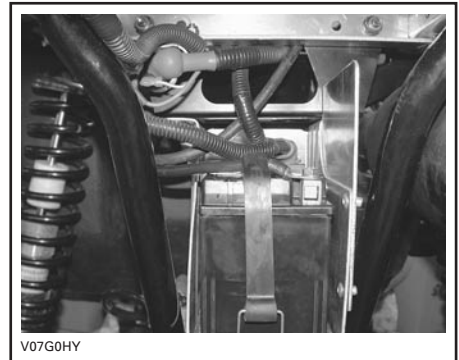

BREAK-IN PERIOD

Engine

A break-in period of 10 operating hours is required before running the vehicle at sustained full throttle.

CAUTION: Never mix oil with fuel. This vehicle has a 4-stroke engine. Oil must be added to engine base only.

During this period, maximum throttle should not exceed 3/4. **However, brief full acceleration and speed variations contribute to a good break-in.** Continued wide open throttle accelerations, prolonged cruising speeds and engine overheating are detrimental during the break-in period.

Belt

A new belt requires a break-in period of 30 miles (50 km). Avoid strong acceleration/ deceleration, pulling a load or high speed cruising.

10-Hour Inspection

As with any precision piece of mechanical equipment, we suggest that after the first 10 hours or 30 days after the purchase, whichever comes first, your vehicle be inspected by an authorized Bombardier ATV dealer. This inspection will give you the opportunity to discuss the unanswered questions you may have encountered during the first hours of operation.

The 10-hour inspection is at the expense of the vehicle owner.

While reading this *Operator's Guide*, remember that:

WARNING

Indicates a potential hazard that, if not avoided, could result in serious injury or death.

PRE-OPERATION CHECK

WARNING

The pre-operation check is very important prior to operating the vehicle. Always check the proper operation of critical controls, safety features and mechanical components before starting. If not done as specified here, severe injury or death might occur.

- Apply parking brake and check if it operates properly.
- Check tire pressure and condition.
- Check wheels and bearings for wear and damage.
- Check location of controls and ensure they work properly.
- Verify if steering operates freely.
- Activate throttle control lever several times to ensure it operates freely. It must return to idle position when released.
- Activate the brake lever and brake pedal to make sure the brakes fully apply. Lever and pedal must fully return when released.
- Ensure transmission lever is working then reset in PARK position.
- Check fuel, oil and coolant levels.
- Check for oil leaks on the engine/transmission and drive train components.
- Ensure fuel valve is in fully open position (ON).
- Clean headlamps and taillight.
- Ensure front access compartment cover and rear storage compartment cover are properly latched.
- Ensure seat is properly latched.
- If you transport cargo, respect load capacity. Ensure cargo is properly secured to the racks.
- If you are pulling a trailer or other equipment, ensure it respects the tongue capacity and towing capacity. Ensure trailer is properly secured to hitch.
- Look and feel for loose parts **while engine is off**. Check fasteners.
- Ensure the path of travel is free of persons and obstacles.
- Check operation of ignition switch, start button, engine stop switch, headlamps, taillight and indicator lights.
- Start engine and drive forward slowly a few feet and apply all brakes individually to test them.
- Check operation of 2WD/4WD selector (4 x 4 models).

Correct any problem you may have found. See an authorized Bombardier ATV dealer as necessary.

OPERATING INSTRUCTIONS

General

The transmission lever must be on PARK or NEUTRAL to allow engine to start.

NOTE: For your convenience, an override mode allows the engine to be started with the transmission lever in any position. Press and hold the brake lever or the brake pedal while pressing the start button.

To start the engine, place the engine stop switch to RUN, insert the key in the ignition switch and turn to ON, then press the start button.

Initial Cold Starting

Insert key in ignition switch and turn to ON.

NOTE: Do not forget to place the engine stop switch to RUN.

In cold weather, under 0°C (32°F), place the choke lever in full position.

Press the start button and hold until the engine starts.

CAUTION: Do not hold the start button more than 30 seconds. A rest period should be observed between the cranking cycles to let the starter cool down. Pay attention not to discharge the battery.

NOTE: The throttle can be used to help starting the engine faster. Press the throttle lever slightly; if it is pressed too much, the choke system will not be activated.

Release the start button immediately when the engine has started.

After a few seconds, move the choke lever from full choke position to an intermediate position until the best engine RPM is achieved.

NOTE: Over using the choke may flood the engine and make it hard to start. Refer to SPECIAL PROCEDURES if it occurs.

When the engine is warm, push the choke lever to OFF, and release brakes.



1. Full choke position

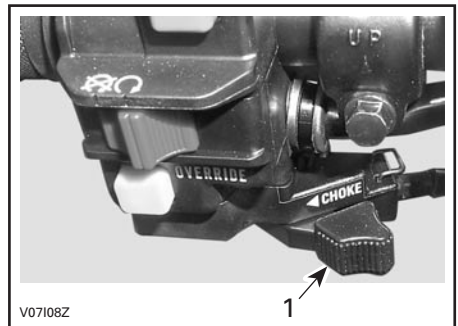

1. OFF position

Warm Engine Starting

Start the engine as explained above but without the choke. If the engine does not start after two 5-second attempts with the electric starter, pull the choke lever and place it between the ON and the OFF position. Start the engine without activating the throttle lever. After a few seconds, push the choke lever to OFF.

Emergency Manual Starting

WARNING

Always place transmission lever on PARK or NEUTRAL before starting engine manually.

Manual start is provided in the event electric start does not work.

Follow the starting procedures above but instead use the rewind starter to start.

Hold manual starter handle firmly and, slowly, crank the engine until a resistance is felt.

Pass this resistance and release the handle.

Again take the handle firmly and crank engine.

Repeat this procedure completely if necessary.

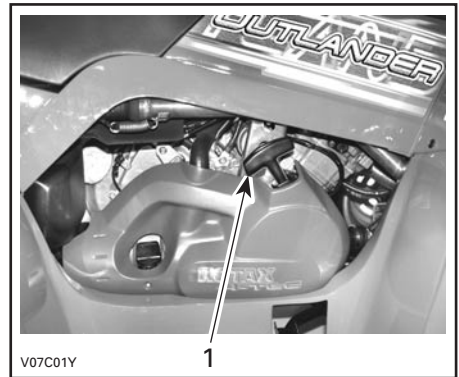

1. Hold manual starter handle firmly and crank the engine

Stopping the Engine

WARNING

Avoid parking on an incline surface.

Release throttle and completely stop the vehicle.

Apply the parking brake by using brake lever lock on brake lever.

Set transmission lever in PARK position.

Push the engine stop switch in OFF position.

Turn key in ignition switch to OFF.

Remove key from ignition switch.

Shifting the Transmission

Let engine idle to warm up.

Apply brakes and select the desired gear range H/L.

NOTE: The brake must be applied when the transmission lever is engaged in the park position.

Release brakes.

CAUTION: Make sure parking brake is fully disengaged before operating the ATV.

Gradually press the throttle lever to increase engine speed and thus engaging the continuously variable transmission (CVT).

At the opposite, when the throttle lever is released, the engine speed decreases.

Using the Reverse

CAUTION: When changing from forward to reverse, or vice-versa, always completely stop the vehicle and apply the brake prior to moving the transmission lever.

The same procedures as SHIFTING THE TRANSMISSION above apply except for the following.

Set the transmission lever in REVERSE position.

2WD/4WD Selector

4 x 4 Models

The 4WD mode may be selected or deselected when the vehicle is stopped.

CAUTION: The vehicle must be stopped to engage or disengage 2WD/4WD selector. Mechanical damage may occur if selector is engaged or disengaged while driving.

CAUTION: If the rear wheels are spinning, release the throttle and wait engine return to the idle before selecting the 4WD mode.

The 4WD mode is engaged when the selector is pushed downwards.



4WD MODE

To deselect the 4WD mode, press the selector on 2WD.



2WD MODE

When the selector is located on the 2WD, the vehicle is in 2 wheel drive at all time.

SPECIAL PROCEDURES

Flooded Engine

When the engine does not start after several attempts, the engine may be fuel flooded. Proceed as follows.

Turn ignition switch to ON and ensure choke is not applied.

Ensure the transmission lever is on PARK.

Fully press throttle lever and hold while starting the engine.

As soon as the engine starts, release throttle lever. Do not race engine.

If it does not work:

Clean the spark plug cap area then remove it. Remove the spark plug (tools are supplied in tool box).

WARNING

Always wear eye protector and gloves when cleaning the spark plug hole.

Crank engine several times. Add a small quantity of engine oil in cylinder (equivalent to a cap of oil quart). Install new spark plug if possible or clean and dry spark plug.

Start engine as explained above. If engine continues to flood, see an authorized Bombardier ATV dealer.

Engine Overheat

If engine overheats and indicator light turns on, try the following:

Check and clean radiator fins. See MAINTENANCE section.

WARNING

The radiator can be very hot, wear gloves before touching radiator.

Reduce vehicle speed but try to keep vehicle moving to supply air to radiator. If engine is still overheating after approximately one minute, stop vehicle and set transmission to PARK. Stop engine.

Place the ignition switch to ON position (**DO NOT RESTART ENGINE YET**). The radiator fan will cool the radiator.

Let engine cool down. Check coolant level and refill if possible.

WARNING

Never refill cooling system when engine is hot.

See an authorized Bombardier ATV dealer as soon as possible.

Post-Operation Care

When vehicle is used in salt-water environment (beach area, launching/loading boats etc.), rinsing the vehicle with fresh water is necessary to preserve vehicle and its components. Metallic parts lubrication is highly recommended. Use BOMBARDIER LUBE (P/N 293 600 016). This must be performed at the end of each operating day.

When vehicle is operated in muddy conditions, rinsing the vehicle is recommended to preserve vehicle and its components and to keep lights clean.

NOTE: Never use the high pressure washer to clean the vehicle **USE LOW PRESSURE ONLY** (like a garden hose). The high pressure can cause electrical or mechanical damages.

Turn Over

When vehicle is turned over or stays tilted on the side, replace the vehicle in its normal operating position (on all four wheels) and wait 3 to 5 minutes before starting engine. Before starting engine, check engine oil level and refill if necessary. If the oil pressure light stays ON after starting engine, stop engine and see an authorized Bombardier ATV dealer as soon as possible.

ATV Immersion

Should the ATV become immersed, it will be necessary to take it to an authorized Bombardier ATV dealer as soon as possible. **DO NOT START THE ENGINE!** Immersion of the ATV can cause serious damage if the correct re-start procedure is not followed.

Storage and Preseason Preparation

WARNING

Have an authorized Bombardier ATV dealer inspect fuel system integrity as specified in LUBRICATION AND MAINTENANCE CHART.

When a vehicle is not in use for more than one month, proper storage is a necessity.

See an authorized Bombardier ATV dealer for proper procedures.

When using your ATV after storage, a preparation is required. See an authorized Bombardier ATV dealer for proper procedures.

CARGO AND TRANSPORTATION

While reading this *Operator's Guide*, remember that:

WARNING

Indicates a potential hazard that, if not avoided, could result in serious injury or death.

Cargo

WARNING

The vehicle handling, stability and braking distance are affected when loading racks and using the vehicle. Correct loading and weight distribution are therefore important. Never overload, tow or carry cargo improperly. Always ensure the cargo is safely secured and properly distributed on the rack(s) before operating the vehicle. Safely reduce speed according to terrain conditions when carrying cargo or pulling a trailer. Allow greater distance for breaking. Always secure cargo as low as possible on the rack(s) to reduce the effect of a higher center of gravity. Failure to follow the recommendations here could cause changes in vehicle handling which could lead to an accident resulting in severe injuries including the possibility of death.

When cargoing vehicle, respect these maximum loads.

TOTAL LOAD ALLOWED: 230 kg (500 lb)
(includes driver, all other loads and added accessories)

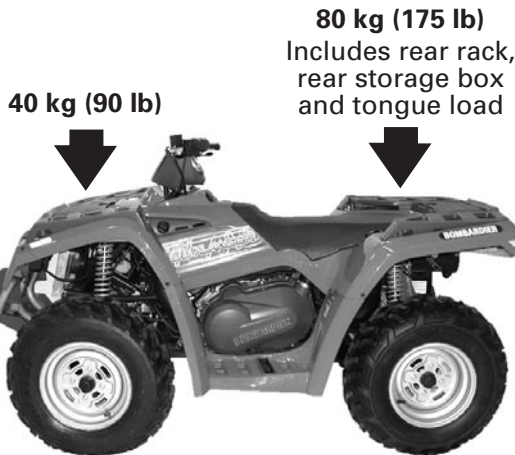

V07A0DL

Transportation

When transporting a vehicle, secure vehicle to trailer or in pickup box with suitable tie-downs. Using ordinary ropes is not recommended.

WARNING

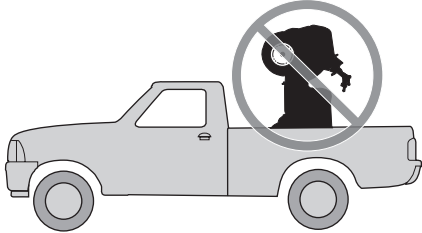

V00A174

Never tip this vehicle on end for transporting. We recommend that you carry the vehicle in its normal operating position (on all four wheels).

Place the fuel valve to OFF position.
Select the PARK position and set the parking brake.
Secure the vehicle by the front bumper and rear bumper.

CAUTION: Attaching vehicle at other locations may damage the vehicle.

Front Location



V07A0EY

Rear Location

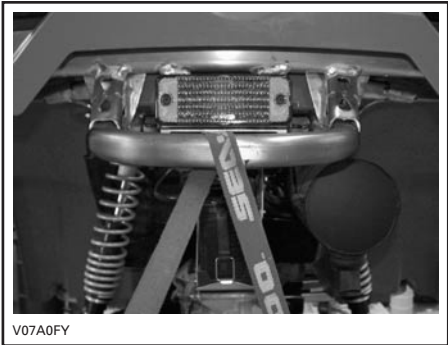

V07A0FY

WARNING

Do not tow this vehicle behind a car or other vehicle. Use a trailer.

MAINTENANCE INFORMATION

MAINTENANCE CHART

The maintenance is very important, if you are not familiar with safe service practices and adjustment procedures, see your authorized Bombardier ATV dealer.

LUBRICATION AND MAINTENANCE CHART I: Inspect, verify, clean, adjust, lubricate, replace if necessary C: Clean L: Lubricate R: Replace	INITIAL INSPECTION 10 h or 30 days OR 300 km (185 m.) ①	EVERY				TO BE PERFORMED BY
		25 h OR 750 km (470 m.)	50 h OR 1500 km (930 m.)	100 h OR 1 YEAR OR 3000 km (1865 m.)	200 h OR 2 YEARS OR 6000 km (3730 m.)	
ENGINE/TRANSMISSION						
Engine/transmission oil and filter ④	R		R			CUSTOMER
Engine/transmission oil strainer cleaning					C	DEALER
Valve adjustment	I			I		DEALER
Engine mount fasteners	I			I		DEALER
Exhaust system	I			I		DEALER
Spark arrester				C		CUSTOMER
Condition of seals	I			I		DEALER
Coolant ④	I			②	R	CUSTOMER
Radiator cap/cooling system pressure test	I				I	DEALER
Radiator condition/cleanliness (radiator fins) ③	I		I			CUSTOMER
Drive belt				I		CUSTOMER
Cleaning/condition of drive and driven pulleys				C		DEALER
CVT air inlet/outlet duct condition/cleanliness and sealing	I		I			DEALER
Rewind starter rope condition				I		DEALER
FUEL SYSTEM						
Air filter ④		C ③		R ③		CUSTOMER
Fuel lines and connections	I			I		DEALER
Fuel tank strainer					R	DEALER
Carburetor	I			I		DEALER
Carburetor valve piston				I		DEALER
ELECTRICAL SYSTEM						
Spark plug	I			R		DEALER
Battery connections	I		I			CUSTOMER
Wiring harnesses, cables and lines	I			I		DEALER
Condition of ignition switch, start button and engine stop switch ④	I			I		CUSTOMER
Condition of lighting system (HI/LO intensity, brake light, headlamp aiming, etc.) ④	I			I		CUSTOMER

LUBRICATION AND MAINTENANCE CHART	INITIAL INSPECTION 10 h or 30 days OR 300 km (185 m.) ①	EVERY				TO BE PERFORMED BY
		25 h OR 750 km (470 m.)	50 h OR 1500 km (930 m.)	100 h OR 1 YEAR OR 3000 km (1865 m.)	200 h OR 2 YEARS OR 6000 km (3730 m.)	
DRIVE TRAIN						
Front/rear drive shaft boots and protectors ④	I	I				CUSTOMER
Rear drive shaft joints			I			DEALER
Rear propeller shaft joints (grease fittings)	I		L			DEALER
Wheel bearings condition				I		CUSTOMER
Front/rear differential oil level, seals and vents	I		I		R	DEALER
STEERING/CONTROL SYSTEMS						
Handlebar fasteners				I		DEALER
Throttle/housing/cable ④	I		I			CUSTOMER
Choke condition ④	I		I			CUSTOMER
Steering system ③	I			I		DEALER
Tie rod ends			I			DEALER
Wheel nuts/studs	I		I			CUSTOMER
Wear/pressure of tires ④		EVERY RIDE				CUSTOMER
Front wheels alignment	I			I		DEALER
SUSPENSION						
Trailing arms ④				I		DEALER
Shock absorbers ④			I			DEALER
A-arms			I			CUSTOMER
BRAKE						
Brake fluid front/rear ④	I	I			R ⑤	CUSTOMER
Brake pads		I				CUSTOMER
Brake system (discs, hoses etc.)				I		CUSTOMER
BODY/FRAME						
Engine compartment	C		C			CUSTOMER
Frame				I		DEALER
Hitch/trailer ball condition (if installed)	I		I			CUSTOMER
Chassis fasteners			I			CUSTOMER
Seat fasteners		EVERY RIDE				CUSTOMER
Vehicle cleaning and protection			C			CUSTOMER

① To be performed by an authorized Bombardier ATV dealer. The initial maintenance is very important and must not be neglected.

② Every 100 hours, check coolant strength.

③ More often under severe use such dusty area, sand, snow, wet or muddy conditions.

④ Pre-ride inspection item.

⑤ To be performed by an authorized Bombardier ATV dealer.

MAINTENANCE

While reading this *Operator's Guide*, remember that:

WARNING

Indicates a potential hazard that, if not avoided, could result in serious injury or death.

WARNING

Unless otherwise specified, engine should not be running for all maintenance procedures.

WARNING

Should removal of a locking device (e.g. lock tabs, self-locking fasteners, etc.) be required when undergoing disassembly/assembly, always replace with a new one.

The following covers the maintenance items that can be performed by the customer if desired. Other items found in maintenance chart must be performed by an authorized Bombardier ATV dealer.

NOTE: Among other things, this section gives the procedures to replace the liquids. Refer to LIQUIDS for procedures to check levels and refill.

Engine/Transmission

Oil Change and Oil Filter Replacement

Oil and filter are to be replaced at the same time. Oil change should be done with a warm engine.

WARNING

The engine oil can be very hot. To prevent burning yourself, do not remove the engine drain plug or the filter cover if the engine is hot. Wait until engine oil is warm.

Ensure vehicle is on a level surface.

Remove dipstick.

Clean the oil drain plug area.

Place a drain pan under the oil drain plug area.

Unscrew oil drain plug.

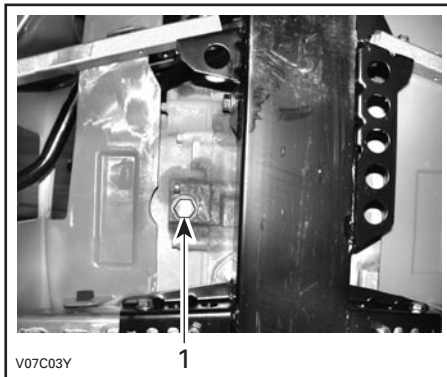

1. Oil drain plug

Allow enough time for oil to flow out of oil filter.

Remove the right engine cover.

Unscrew the oil filter cover.

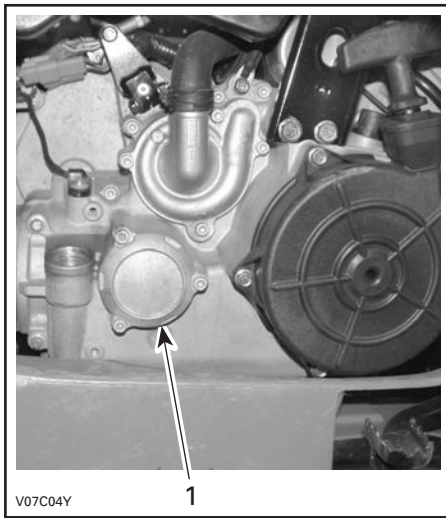

1. Oil filter cover

Remove the oil filter and replace with a new filter.

NOTE: Check the cover O-ring and change it if necessary.

Wipe out any oil spillage on engine.

Change gasket on oil drain plug. Clean gasket area on engine and oil drain plug then reinstall plug. Refill engine at the proper level with the recommended oil. Refer to SPECIFICATIONS for capacity.

Start engine and let idle for a few minutes. Ensure oil filter area and oil drain plug areas are not leaking.

Stop engine. Wait a while to allow oil to flow down to crankcase then check oil level. Refill as necessary.

Dispose of oil as per your local environmental regulations.

Oil Strainer Cleaning

The oil strainer must be cleaned every 200 hours or every 2 years or every 6000 km (3730 m.).

Contact an authorized Bombardier ATV dealer.

Coolant Replacement

WARNING

To prevent burning yourself, do not remove the radiator cap or loosen the coolant drain plug if the engine is hot.

Open the access panel and remove the radiator cap.

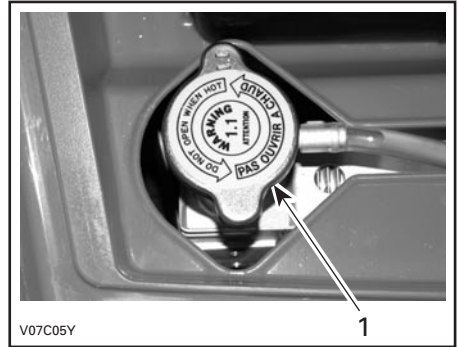

1. Radiator cap

On the right side of vehicle, remove the engine cover.

Unscrew the coolant drain plug and drain the coolant into a suitable container.

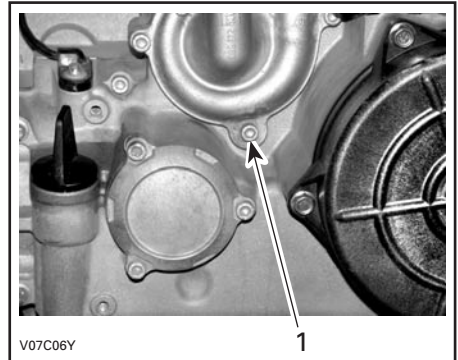

1. Coolant drain plug

NOTE: Do not unscrew the coolant drain plug completely.

Disconnect the engine temperature sensor connectors, then unscrew the bleeding screw on the top of thermostat housing.

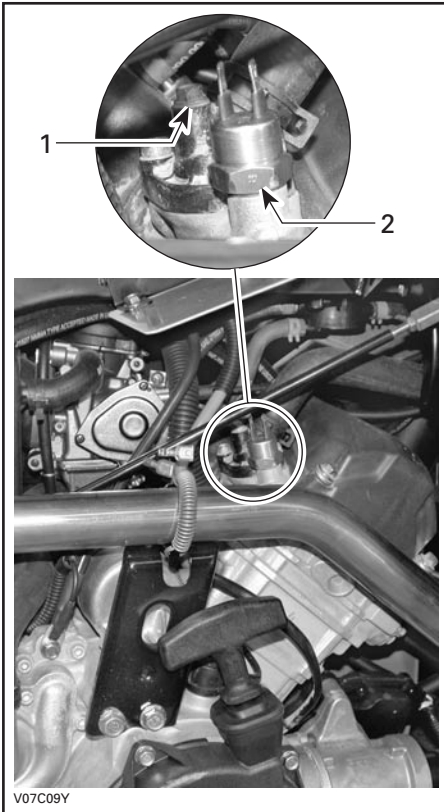

1. Bleeding screw
2. Engine temperature sensor

Drain the system completely and reinstall the coolant drain plug.

Pinch hose between radiator and thermostat housing with a large hose pincher (P/N 529 032 500).

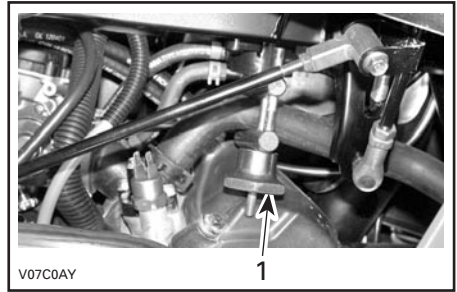

1. Hose pincher

Fill the radiator until the coolant comes out by the thermostat housing hole. Install the bleeding screw then remove the hose pincher.

Complete the radiator filling.

Check the level in the coolant reservoir and refill if necessary.

Run engine at idle with the radiator cap off. Slowly add coolant if necessary.

At this point, wait until engine reaches normal operating temperature. Depress the throttle lever two or three times; then add coolant if required.

Install radiator cap. Inspect all connections for leaks and check coolant level in the reservoir.

Drive Belt

To check the drive belt, remove the CVT cover on the left side of vehicle.

Measure and verify the drive belt. If the drive belt width is equal or narrower than 30 mm (1-3/16 in), or if flat spots, cracks or other damages are visible, see an authorized Bombardier ATV dealer to replace the drive belt.

Valve Adjustment

See an authorized Bombardier ATV dealer for valves adjustment.

Insufficient clearance will cause loss of power and possibly damage the valves. Excessive clearance will cause noise.

Spark Arrester

The muffler must be periodically purged of accumulated carbon.

WARNING

Never run engine in an enclosed area. Never perform this operation immediately after the engine has been run because exhaust system is very hot. Make sure that there are no combustible materials in the area. Wear eye protection and gloves. Never stand behind the vehicle while purging exhaust system. Respect all applicable laws and regulations.

Select a well-ventilated area and make sure the muffler is cool.

Place transmission on PARK position.

Remove the clean-out plug of the muffler.

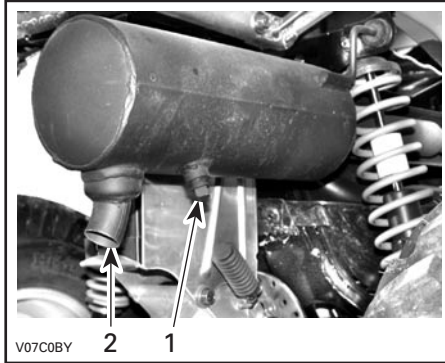

1. Clean-out plug
2. Muffler

Block the end of the muffler with a shop rag and start engine.

Momentarily increase engine RPM several times to purge accumulated carbon out of the muffler.

Stop engine and allow muffler to cool.

Reinstall the clean-out plug.

Radiator

Periodically check the radiator area for cleanliness.

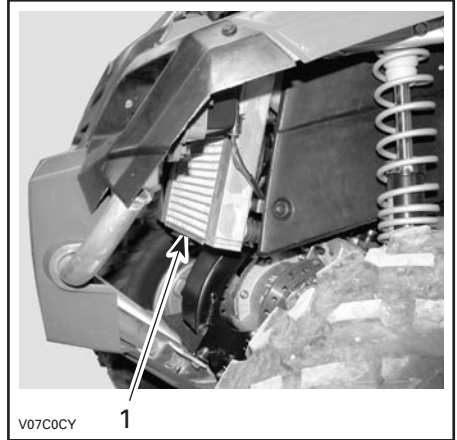

1. Radiator

Inspect radiator fins. They must be clean, free of mud, dirt, leaves and any other deposit that would prevent the radiator to cool properly.

Remove as much deposits as you can with your hands. If water is available in proximity, try rinsing the radiator fins.

If available, use a garden hose to rinse the radiator fins.

WARNING

Never clean radiator with your hands when it is hot. Let the radiator cool down before cleaning.

CAUTION: Be careful not to damage the radiator fins when cleaning. Do not use any object/tool that could damage the fins. The fins are purposely thin parts to allow efficient cooling. **WHEN HOSING, USE LOW PRESSURE ONLY, NEVER USE A HIGH PRESSURE WASHER.**

See an authorized Bombardier dealer to check the performance of the cooling system.

Carburetor

See an authorized Bombardier ATV dealer each year to verify and clean the fuel system.

Air Intake System

Air Filter Cleaning/Draining

Periodically inspect air filter box drain tube for water or deposits.

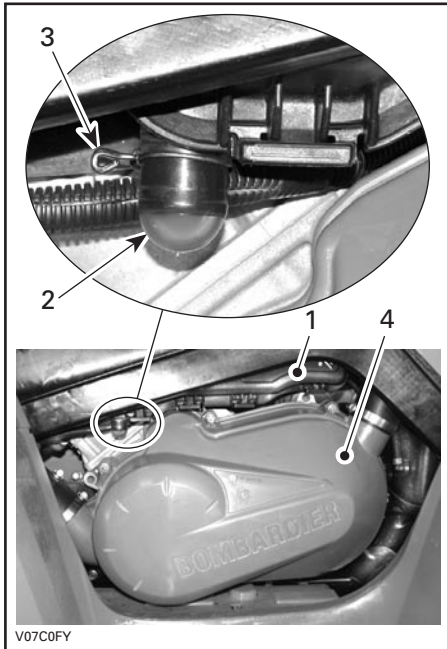

1. Air filter box
2. Drain tube
3. Clamp
4. CVT cover

NOTE: If vehicle is used in dusty area, inspect more frequently than specified in MAINTENANCE CHART.

If water/deposits are found, squeeze and remove the clamp. Pull drain tube out.

CAUTION: Do not start engine when water is found in the drain tube.

When water/deposits are found, the air filter must be inspected/dried/replaced depending on its condition.

Remove air filter as explained below.

Air Filter Removal

CAUTION: Never remove or modify any component in the air box. Otherwise, engine performance degradation or damage can occur. The engine carburation is calibrated to operate specifically with these components.

Remove seat.

Release clamps and remove air filter box cover.

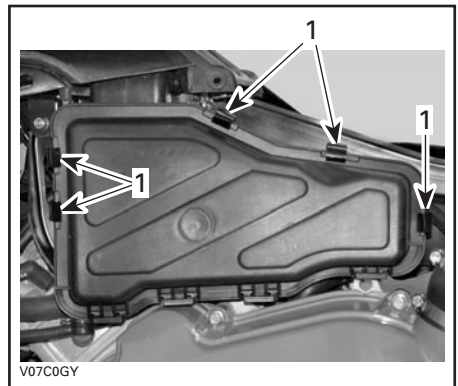

1. Release clamps

Loosen clamp and remove air filter.

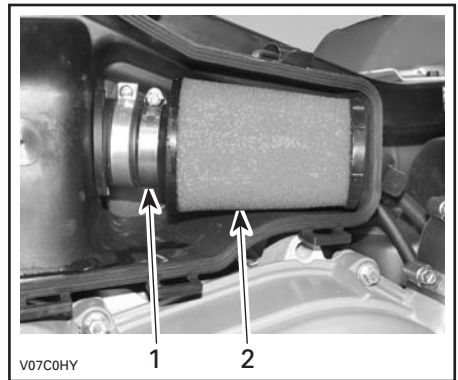

1. Clamp
2. Air filter

Pour cleaning solution (P/N 293 600 059 or an equivalent) into a bucket. Put the filter in to soak.

While filter soaks, clean inside the air box.

Rinse the filter with warm water until all cleaning solution disappears.

Then, let the filter dry completely.

When the filter is dried, re-oil with air filter oil (P/N 293 600 058 or an equivalent).

Air Filter Installation

Properly reinstall removed parts in the reverse order of their removal.

Electrical

Battery

WARNING

Never charge a battery while installed in vehicle.

Clean battery post with a wire brush. Apply dielectric grease on post to protect against oxidation.

Fuses

If a fuse is damaged, replace it by one of the same rating.

CAUTION: Do not use a higher rated fuse as this can cause severe damage.

Fuses are located in the service compartment, behind tool box.

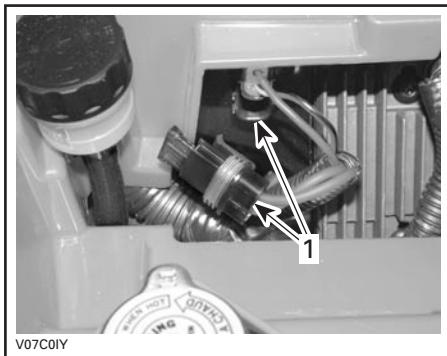

1. Fuse holders

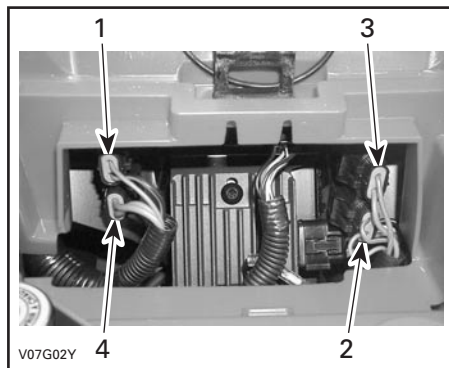

1. Accessories (15 A)
(power outlet and auxiliary supply)
2. Fan (20 A)
3. Main (20 A)
4. Charging system (30 A)

To remove fuse from holder, remove the fuse holder cover then pull fuse out. Check if filament is melted.

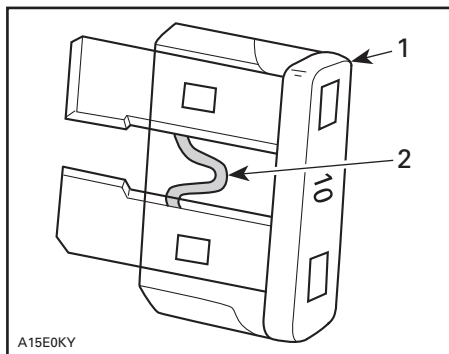

TYPICAL

1. Fuse
2. Check if melted

Bulb Replacement

Always check light operation after replacement.

Headlamps

CAUTION: Never touch glass portion of an halogen bulb with bare fingers, it shortens its operating life. If glass is touched, clean it with isopropyl alcohol which will not leave a film on the bulb.

Unplug connector from headlamp.

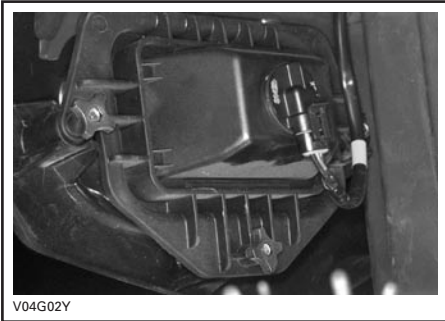

Rotate the bulb socket counterclockwise then remove headlamp.

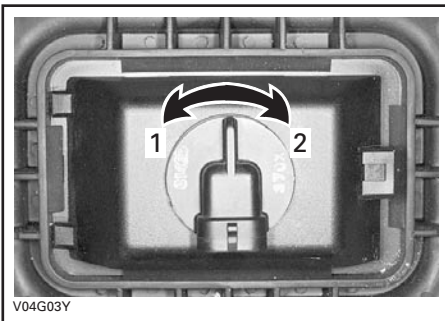

1. *Unlock*
2. *Lock*

Properly reinstall removed parts in the reverse order of their removal.

Adjust beam aiming as follows:

Turn knobs to adjust beam height and side orientation to your convenience. Adjust both headlamps evenly.

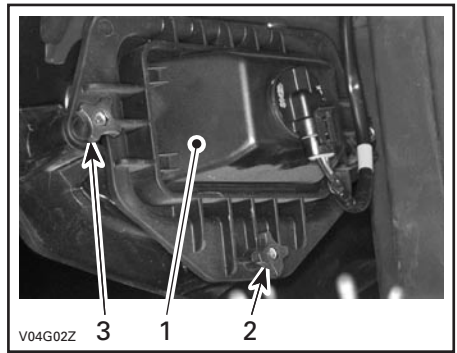

1. *Headlamp cover*
2. *Beam height adjustment*
3. *Beam side adjustment*

Taillight

Unscrew lens screws to expose bulb.

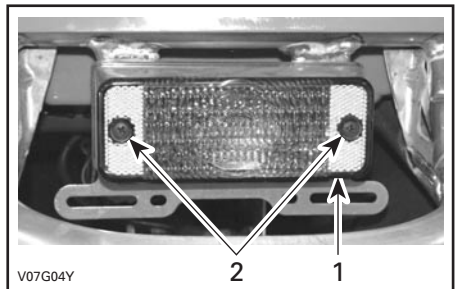

1. *Lens*
2. *Screws*

Push bulb in and hold while turning counterclockwise to release.

Install the new bulb by first pushing in while turning clockwise.

Drive Train

Drive Shaft Boot/Protector

Inspection

Visually inspect drive shaft protectors and boots conditions. Check protectors for damage or rubbing against shafts. Check boots for cracks, tears, leaking grease etc. Repair or replace damaged parts as necessary.

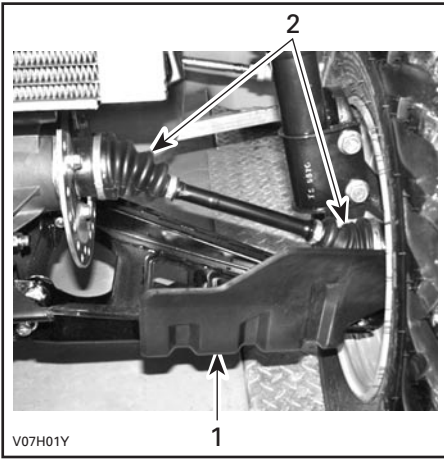

4 x 4 MODELS — FRONT OF VEHICLE

1. Drive shaft protector
2. Drive shaft boots

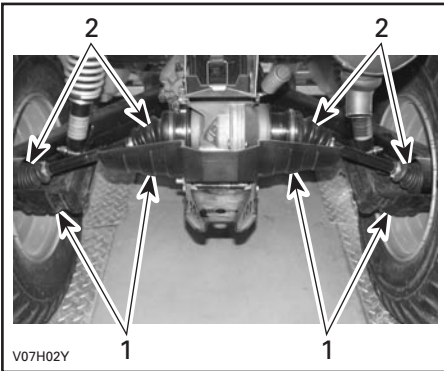

ALL MODELS — REAR OF VEHICLE

1. Drive shaft protector
2. Drive shaft boots

Wheel

Occasionally, wheel nuts should be removed to apply anti-seize lubricant on studs to ease future removal. This is particularly important when vehicle is used in salt-water environment or in mud. Remove one nut at a time, lubricate then retorque.

Wheel Bearing Condition

Push and pull the wheels from the upper edge to feel the play. See an authorized Bombardier ATV dealer if there is any play.

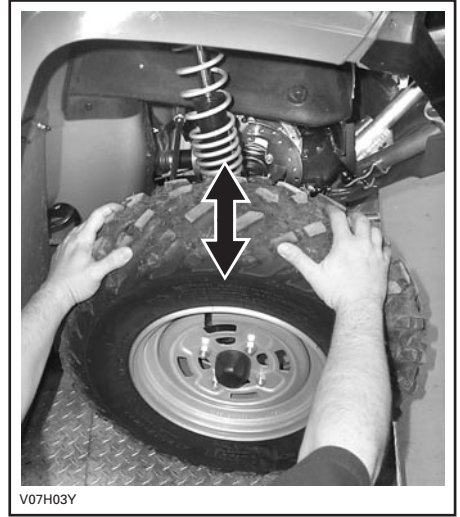

Tires/Wheels

Tire Pressure

⚠ WARNING

Tire pressure greatly affects vehicle handling and stability. Under-pressure may cause tire to deflate and rotate on wheel. Overpressure may burst the tire. Always follow recommended pressure. Since tires are low-pressure types, a manual pump should be used.

Check pressure when tires are "cold" before using the vehicle. Tire pressure changes with temperature and altitude. Recheck pressure if one of these conditions has changed.

For your convenience, a pressure gauge is supplied in tool box.

TIRE PRESSURE		
	FRONT	REAR
RECOMMENDED	28 kPa (4 PSI)	31 kPa (4.5 PSI)
MINIMUM	24 kPa (3.5 PSI)	28 kPa (4 PSI)

Although the tires are specifically designed for off-road use, a flat may still occur. Therefore, it is recommended to carry a tire pump and a repair kit.

Tire/Wheel Condition

Check tire for damage and wear. Replace if necessary.

Do not rotate tires. The front and rear tires have a different size. The tires are directional and their rotation must be kept in a specific direction for proper operation.

Wheel Removal

Loosen nuts then lift vehicle. Place a support under vehicle. Remove nuts then remove wheel.

At installation, it is recommended to apply anti-seize lubricant on threads. Gently tighten nuts in a criss-cross sequence then apply a final torque of 70 N•m (52 lbf•ft).

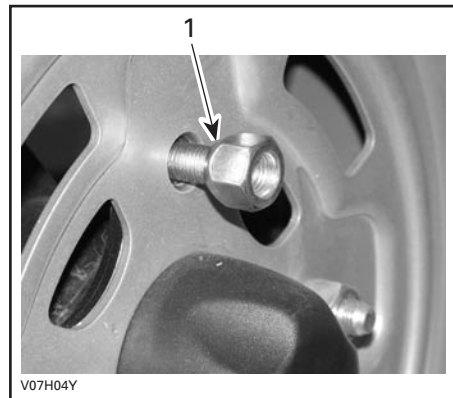

1. Taper side of nut

CAUTION: Always use the recommended wheel nuts (P/N 250 100 039). Using a different nut could cause damages to the rim.

Steering/Control Systems

Throttle Cable Lubrication

The throttle cable must be lubricated with cable lubricant (P/N 293 600 041) or an equivalent.

WARNING

Using another lubricant could cause bad working of throttle lever/cable.

Open the throttle lever housing.

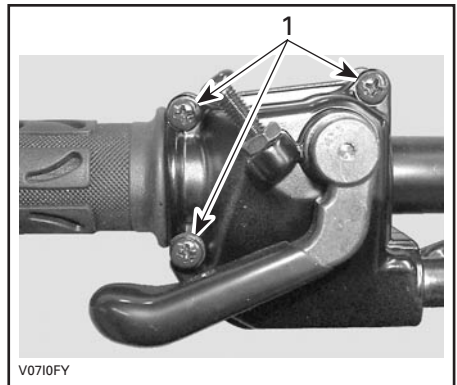

1. Remove these screws

Separate the housing. Slide rubber protector back to expose throttle cable adjuster.

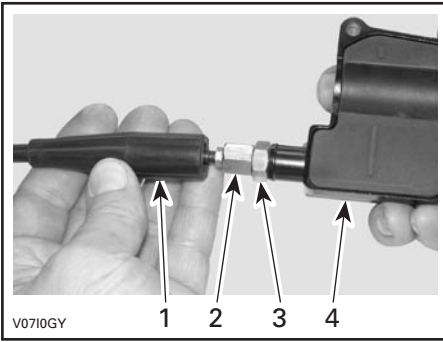

1. Cable protector
2. Throttle cable adjuster
3. Lock nut
4. Throttle lever housing

Screw in the throttle cable adjuster.

Remove:

- inner housing protector

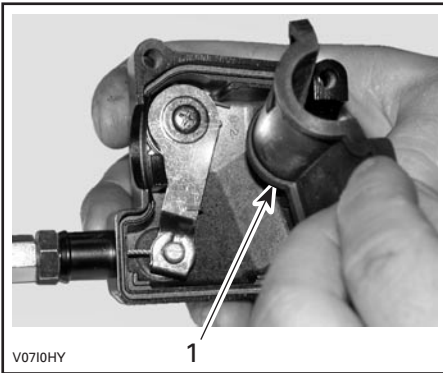

1. Inner housing protector

- the cable from the throttle lever housing.

NOTE: Slide cable in clip slot and remove the end of cable from clip.

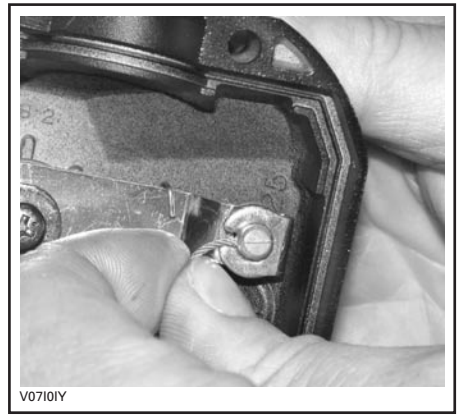

Remove the carburetor side cover.

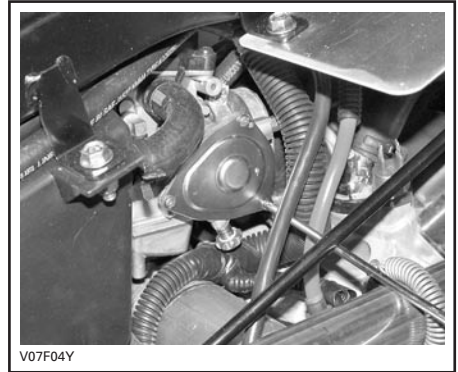

Insert the needle of lubricant can in the end of throttle cable adjuster.

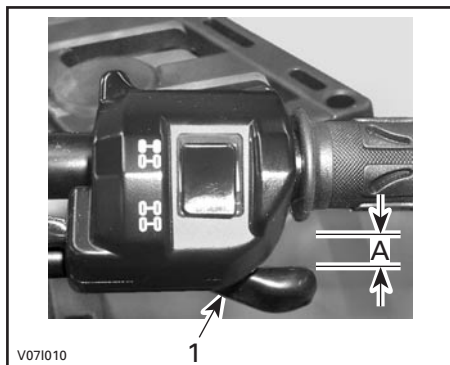

1. Throttle lever
A. 3 to 6 mm (1/8 to 7/32 in)

⚠ WARNING

Always wear eye protection and gloves when you lubricate a cable.

NOTE: Place a rag around the throttle cable adjuster to prevent the lubricant from splashing.

Add lubricant until it runs out at carburetor end of the throttle cable.

Reinstall and adjust the cable.

Throttle Lever Adjustment

Slide rubber protector back to expose throttle cable adjuster.

Loosen lock nut then turn the adjuster to obtain correct throttle lever free play.

NOTE: Measure throttle free play at the tip of throttle lever.

Tighten lock nut and reinstall protector.

With the transmission lever on PARK position, start the engine. Check if the throttle cable is adjusted correctly by turning handlebar fully right then fully left. If the engine RPM increases, re-adjust the throttle lever free play.

Suspension

Lubrication

Lubricate front A-arms. Use synthetic grease (P/N 293 550 033). There is two grease fittings on each A-arm.

Inspection

Front Suspension

Inspect the McPherson struts for oil leaks or other damages. Check tightness of fasteners. See an authorized Bombardier ATV dealer as necessary.

Rear Suspension

Inspect shock absorber for oil leaks and fasteners for tightness. See an authorized Bombardier ATV dealer as necessary.

Trailing arms

Check trailing arms for distortion, cracks or bending. See an authorized Bombardier ATV dealer if any problem is detected.

A-arms

Check A-arms for cracks, bending or other damages. See an authorized Bombardier ATV dealer as necessary.

Adjustment

Rear Shocks

WARNING

Left and right adjustment cams must always be set to the same position. Never adjust one adjusting cam only. Uneven adjustment can cause poor handling and loss of stability, which could lead to an accident.

Preload Adjustment

Adjust spring preload by turning adjusting cam accordingly, with the adjusting wrench in vehicle tool box.

Turn the adjusting cams clockwise for a firmer ride and rough road condition or when carrying cargo or pulling a trailer.

Turn the adjusting cams counterclockwise for a light load and a smooth road condition.

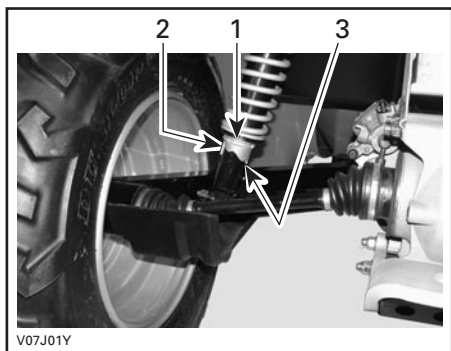

1. Adjusting cams
2. Smooth adjustment
3. Hard adjustment

Brake

Front and Rear Brakes

The front and rear brakes are hydraulic disc types. These brakes are self-adjusting and require no adjustment.

The brake lever and the brake pedal require no adjustment.

Check the following to keep the brakes in a good operating condition:

- brake system for fluid leaks
- brake for spongy feel
- brake discs for excessive wear and surface condition
- brake pads for wear, damage or looseness.

SERVICE LIMIT	
Brake pads thickness	1 mm (.040 in)
Front discs thickness	3.5 mm (.138 in)
Rear disc thickness	4.3 mm (.170 in)
Maximum discs warpage	0.3 mm (.010 in)

Brake Fluid Replacement

WARNING

The brake fluid replacement or any brake system repairs should be performed by an authorized Bombardier ATV dealer.

Body/Frame

Engine Area

Check engine area for any damage and leaks. Ensure all hose clamps are properly secured and no hose is cracked, kinked or otherwise damaged.

Inspect muffler, battery and reservoir fastening devices.

Check electrical connections for corrosion and tightness.

Replace or have damaged parts repaired.

Hitch/Trailer Ball Condition

Check tightness of fasteners and tightness/condition of trailer ball. Properly retighten as necessary and replace ball if worn.

Chassis Fasteners

Check fastener condition and tightness on the vehicle. Retighten as required.

Seat Fasteners

Remove seat and check latch mechanism and pin for wear. See an authorized Bombardier ATV dealer for parts replacement if damaged.

Vehicle Cleaning and Protection

Never use the high pressure washer to clean the vehicle **USE LOW PRESSURE ONLY (like a garden hose)**. The high pressure can cause electrical or mechanical damages.

Painted parts which are damaged should be properly repainted to prevent rust.

When required, wash the body with hot water and soap (only use mild detergent). Apply non-abrasive wax.

CAUTION: Never clean plastic parts with strong detergent, degreasing agent, paint thinner, acetone, etc.

TROUBLESHOOTING

SYMPTOM: <i>Engine does not turn</i>	
POSSIBLE CAUSES	WHAT TO DO
1. Ignition switch is in the OFF position.	Place switch to ON position.
2. Transmission is not set on the PARK or NEUTRAL.	Set transmission either in PARK or in NEUTRAL or press brake lever.
3. Burnt fuse.	Check main fuse condition.
4. Weak battery or loose connections.	Check charging system fuse. Check connections and terminals condition. Have the battery checked. Contact an authorized Bombardier ATV dealer.

SYMPTOM: <i>Engine turns over but fails to start</i>	
POSSIBLE CAUSES	WHAT TO DO
1. Burnt fuse.	Check main fuse condition.
2. Mixture not rich enough to start cold engine.	Check fuel tank level and check starting procedure, particularly use of the choke.
3. Flooded engine (spark plug wet when removed).	Refer to SPECIAL PROCEDURES.
4. No fuel to the engine (spark plug dry when removed).	Check fuel tank level; turn fuel valve to ON (also try on RES). A failure of the fuel pump or carburetor may have occurred. Contact an authorized Bombardier ATV dealer.
5. Spark plug/ignition (no spark).	Check main fuse condition. Remove spark plug then reconnect to ignition coil. Check that ignition switch and/or engine stop switch is/are at the ON position. Start engine with spark plug grounded to engine away from spark plug hole. If no spark appears, replace spark plug. If trouble persists, contact an authorized Bombardier ATV dealer.
6. Engine compression.	As the engine is pulled over with the rewind starter, "cycles" of resistance should be felt as piston goes past top dead center. If no pulsating resistance is felt, it suggests a major loss of compression. Contact an authorized Bombardier ATV dealer.

SYMPTOM: <i>Engine lacks acceleration or power</i>	
POSSIBLE CAUSES	WHAT TO DO
1. Fouled or damaged spark plug.	Check item ENGINE TURNS OVER BUT FAILS TO START.
2. Lack of fuel to engine.	Check item ENGINE TURNS OVER BUT FAILS TO START.
3. Carburetor adjustments.	Contact an authorized Bombardier ATV dealer.
4. Engine is overheating.	Check ENGINE OVERHEAT in SPECIAL PROCEDURES. If overheating persists, contact an authorized Bombardier ATV dealer.
5. Air filter/box plugged or dirty.	Check air filter and clean if necessary. Check deposits in air box drain. Check the position of the air intake tube.
6. CVT dirty or wear.	Contact an authorized Bombardier ATV dealer.

SYMPTOM: <i>Engine backfire</i>	
POSSIBLE CAUSES	WHAT TO DO
1. Exhaust system leakage.	Contact an authorized Bombardier ATV dealer.
2. Engine is running too hot.	See ENGINE LACKS ACCELERATION OR POWER.
3. Ignition timing is incorrect or there is an ignition system failure.	Contact an authorized Bombardier ATV dealer.
4. Improper carburetor setting.	Contact an authorized Bombardier ATV dealer.

SYMPTOM: <i>Engine misfire</i>	
POSSIBLE CAUSES	WHAT TO DO
1. Fouled/damaged/worn spark plug.	Clean/verify spark plug and heat range. Replace as required.
2. Water in fuel.	Drain fuel system and refill with fresh fuel.

SYMPTOM: <i>Vehicle cannot reach full speed</i>	
POSSIBLE CAUSES	WHAT TO DO
1. Engine.	See ENGINE LACKS ACCELERATION OR POWER.
2. Parking brake.	Ensure brake lever lock is completely removed.
3. Air filter/box plugged or dirty.	Check air filter and clean if necessary. Check deposits in air box drain. Check the position of the air intake tube.
4. CVT dirty or wear.	Contact an authorized Bombardier ATV dealer.

SYMPTOM: <i>Transmission lever is hard to move</i>	
POSSIBLE CAUSES	WHAT TO DO
1. Transmission gears are in a position that prevents the transmission lever to work.	Rock the vehicle back and forth to move the gears in the transmission and allow the transmission lever to be set.
2. Engine idle speed is set too high.	Adjust the idle speed. Refer to the SPECIFICATION.
3. CVT dirty or wear.	Contact an authorized Bombardier ATV dealer.

SYMPTOM: <i>The RPM increases but the vehicle does not move</i>	
POSSIBLE CAUSES	WHAT TO DO
1. The transmission is P or N position.	Select the R, HI or LO position.
2. CVT is defective.	Contact an authorized Bombardier ATV dealer.
3. Water in the CVT housing.	Contact an authorized Bombardier ATV dealer.

SPECIFICATIONS

VEHICLE MODEL		OUTLANDER™ 330 H.O.	
		2 x 4	4 x 4
ENGINE			
Type		BOMBARDIER-ROTAX® 4-TEC, 4-stroke. Over Head Camshaft (OHC), liquid cooled	
Number of cylinder		Single cylinder	
Number of valve		4 valves with mechanical lifters (adjustable)	
Displacement		325 cc (19.8 cu. in)	
Bore	Standard	82 mm (3.23 in)	
Stroke		62 mm (2-1/2 in)	
Compression ratio		10:1	
Lubrication		Wet sump with replaceable oil filter (lubrication of engine and transmission simultaneously)	
Decompressor		Automatic	
Exhaust system		Spark arrester approved U.S. Forest Service (USFS)	
Air filter		2 stage foam filter	
TRANSMISSION			
Transmission		Continuously Variable Transmission (CVT)	
COOLING			
Type		Liquid cooled	
Radiator		Front mounted with thermostatic fan	
CARBURATION			
Carburetor make and type		Mikuni BSR33. Constant velocity with manual choke and ECS (Enricher Coasting System)	
Choke plunger position		Variable	
Idle speed	± 100	1300 RPM	
Fuel pump make and type		Mikuni, external (vacuum-operated)	

VEHICLE MODEL		OUTLANDER™ 330 H.O.	
		2 x 4	4 x 4
ELECTRICAL			
Magneto generator make and type		Denso, 400 W @ 6000 RPM	
Ignition type		CDI (Capacitor Discharge Ignition)	
Ignition timing		Not adjustable	
Engine RPM limiter		8000 RPM (any gear in forward)	
Vehicle speed limiter		15 km/h (9 MPH) in reverse	
Spark plug make and type		NGK DCPR8E	
Number of spark plug		1	
Spark plug gap		0.7 mm (.027 in)	
Battery		12 V, 13 Ah (18 Ah, optional). Dry type battery	
Starting system		Electric start and manual rewind starter. Start on P, R, N, H or L position (with brake applied)	
Headlamp		2 x 30 W	
Taillight		8/27 W	
Pilot lamp cluster		LEDS, 0.7 V approx. (each)	
FUSES			
Accessories		15 A (power outlet and auxiliary supply)	
Fan		15 A	
Main		20 A	
Charging system		30 A	
DRIVE TRAIN			
Front differential		Shaft driven/single auto-lock differential (shear pump)	
Rear axle		Shaft driven	
SUSPENSION			
Front	Type	Independent suspension — McPherson type	
	Travel	178 mm (7 in)	
Rear	Type	Independent suspension — Trailing arms	
	Travel	203 mm (8 in)	
TIRES			
Pressure	Front	28 kPa (4 PSI) recommended, 24 kPa (3.5 PSI) minimum	
	Rear	31 kPa (4.5 PSI) recommended, 28 kPa (4 PSI) minimum	
Size	Front	25 x 8 - 12	
	Rear	25 x 11 - 12	

VEHICLE MODEL		OUTLANDER™ 330 H.O.	
		2 x 4	4 x 4
WHEELS			
Size	Front	12 x 6	
	Rear	12 x 7.5	
Wheel nut torque		70 N•m (52 lbf•ft)	
BRAKES			
Front		Hydraulic, 2 discs	
Rear		Hydraulic, 1 disc	
Parking		Park through transmission. LH brake lever includes a lock	
LOADING CAPACITY			
Front rack		40 kg (88 lb)	
Rear rack		80 kg (176 lb) includes tongue load	
Rear storage box		10 kg (22 lb)	
Total vehicle load allowed		227 kg (500 lb) includes driver, all other loads and added accessories	
GVWR (Gross Vehicle Weight Rating)		454 kg (1000 lb)	
Towing capacity		500 kg (1100 lb)	
Tongue capacity		14 kg (30 lb) included with rear rack	
DIMENSIONS			
Dry mass		250 kg (550 lb)	269 kg (592 lb)
Overall length		2184 mm (86 in)	
Overall width		1168 mm (46 in)	
Overall height		1143 mm (45 in)	
Seat height		877 mm (35 in)	
Wheel base		1244 mm (49 in)	
Wheel track	Front	965 mm (38 in)	
	Rear	914 mm (36 in)	
Turning radius		1829 mm (72 in)	
Ground clearance	Front and under engine	236 mm (9.3 in)	
	Rear	236 mm (9.3 in)	
Weight distribution (front/rear)		49/51%	

VEHICLE MODEL		OUTLANDER™ 330 H.O.	
		2 x 4	4 x 4
LIQUIDS			
Oil type (engine and transmission)		SAE 5W30, 4-stroke mineral-based engine oil. API classification SG, SH or SJ or Bombardier synthetic oil 5W40. Refer to OIL VISCOSITY CHART for proper grade	
Coolant		Ethylene-glycol/water mix (50% coolant, 50% water). Use coolant specifically designed for aluminum engines	
Fuel	Type	Regular unleaded gasoline	
	Octane	87 (R + M)/2 or higher	
Differential	Front and rear	Synthetic polyolester oil 75W90 (API GL-5)	
Hydraulic brake		Brake fluid, DOT 4	
Propeller shaft joint grease		Shell, Alvania EP-2 only	
CAPACITIES			
Fuel tank		16 L (4.2 U.S. gal) including approximately 2 L (0.5 U.S. gal) reserve	
Engine/transmission oil		Oil change with filter: 2.8 L (3 U.S. quarts).	
Coolant		2.5 L (2.65 U.S. quarts)	
Differential	Front	N.A.	500 mL (17 U.S. oz)
	Rear	300 mL (10 U.S. oz)	

N.A.: Not available

Because of our ongoing commitment to product quality and innovation, Bombardier reserves the right, at any time, to make changes in design and specifications and/or to make additions to, or improvements in its products without imposing any obligation upon itself to install them on its products previously manufactured.

VEHICLE MODEL		OUTLANDER™ 400 H.O.		
		2 x 4	4 x 4	XT 4 x 4
ENGINE				
Type		BOMBARDIER-ROTAX® 4-TEC, 4-stroke. Over Head Camshaft (OHC), liquid cooled		
Number of cylinder		Single cylinder		
Number of valve		4 valves with mechanical lifters (adjustable)		
Displacement		400 cc (24.4 cu. in)		
Bore	Standard	91 mm (3.58 in)		
Stroke		62 mm (2-1/2 in)		
Compression ratio		10:1		
Lubrication		Wet sump with replaceable oil filter (lubrication of engine and transmission simultaneously)		
Decompressor		Automatic		
Exhaust system		Spark arrester approved U.S. Forest Service (USFS)		
Air filter		2 stage foam filter		
TRANSMISSION				
Transmission		Continuously Variable Transmission (CVT)		
COOLING				
Type		Liquid cooled		
Radiator		Front mounted with thermostatic fan		
CARBURATION				
Carburetor make and type		Mikuni BSR33. Constant velocity with manual choke and ECS (Enrichner Coasting System)		
Choke plunger position		Variable		
Idle speed	± 100	1300 RPM		
Fuel pump make and type		Mikuni, external (vacuum-operated)		

VEHICLE MODEL		OUTLANDER™ 400 H.O.		
		2 x 4	4 x 4	XT 4 x 4
ELECTRICAL				
Magneto generator make and type		Denso, 400 W @ 6000 RPM		
Ignition type		CDI (Capacitor Discharge Ignition)		
Ignition timing		Not adjustable		
Engine RPM limiter		8000 RPM (any gear in forward)		
Vehicle speed limiter		15 km/h (9 MPH) in reverse		
Spark plug make and type		NGK DCPR8E		
Number of spark plug		1		
Spark plug gap		0.7 mm (.027 in)		
Battery		12 V, 13 Ah (18 Ah, optional). Dry type battery		
Starting system		Electric start and manual rewind starter. Start on P, R, N, H or L position (with brake applied)		
Headlamp		2 x 30 W		
Taillight		8/27 W		
Pilot lamp cluster		LEDS, 0.7 V approx. (each)		
FUSES				
Accessories		15 A (power outlet and auxiliary supply)		
Fan		15 A		
Main		20 A		
Charging system		30 A		
DRIVE TRAIN				
Front differential		Shaft driven/single auto-lock differential (shear pump)		
Rear axle		Shaft driven		
SUSPENSION				
Front	Type	Independent suspension — McPherson type		
	Travel	178 mm (7 in)		
Rear	Type	Independent suspension — Trailing arms		
	Travel	203 mm (8 in)		
TIRES				
Pressure	Front	28 kPa (4 PSI) recommended, 24 kPa (3.5 PSI) minimum		
	Rear	31 kPa (4.5 PSI) recommended, 28 kPa (4 PSI) minimum		
Size	Front	25 x 8 - 12		
	Rear	25 x 11 - 12		

VEHICLE MODEL		OUTLANDER™ 400 H.O.		
		2 x 4	4 x 4	XT 4 x 4
WHEELS				
Size	Front	12 x 6		
	Rear	12 x 7.5		
Wheel nut torque		70 N•m (52 lbf•ft)		
BRAKES				
Front		Hydraulic, 2 discs		
Rear		Hydraulic, 1 disc		
Parking		Park through transmission. LH brake lever includes a lock		
LOADING CAPACITY				
Front rack		40 kg (88 lb)		
Rear rack		80 kg (176 lb) includes tongue load		
Rear storage box		10 kg (22 lb)		
Total vehicle load allowed		227 kg (500 lb) includes driver, all other loads and added accessories		
GVWR (Gross Vehicle Weight Rating)		454 kg (1000 lb)		
Towing capacity		500 kg (1100 lb)		
Tongue capacity		14 kg (30 lb) included with rear rack		
DIMENSIONS				
Dry mass		250 kg (550 lb)	269 kg (592 lb)	
Overall length		2184 mm (86 in)		
Overall width		1168 mm (46 in)		
Overall height		1143 mm (45 in)		
Seat height		877 mm (35 in)		
Wheel base		1244 mm (49 in)		
Wheel track	Front	965 mm (38 in)		
	Rear	914 mm (36 in)		
Turning radius		1829 mm (72 in)		
Ground clearance	Front and under engine	236 mm (9.3 in)		
	Rear	236 mm (9.3 in)		
Weight distribution (front/rear)		49/51%		

VEHICLE MODEL		OUTLANDER™ 400 H.O.		
		2 x 4	4 x 4	XT 4 x 4
LIQUIDS				
Oil type (engine and transmission)		SAE 5W30, 4-stroke mineral-based engine oil. API classification SG, SH or SJ or Bombardier synthetic oil 5W40. Refer to OIL VISCOSITY CHART for proper grade		
Coolant		Ethylene-glycol/water mix (50% coolant, 50% water). Use coolant specifically designed for aluminum engines		
Fuel	Type	Regular unleaded gasoline		
	Octane	87 (R + M)/2 or higher		
Differential	Front and rear	Synthetic polyolester oil 75W90 (API GL-5)		
Hydraulic brake		Brake fluid, DOT 4		
Propeller shaft joint grease		Shell, Alvania EP-2 only		
CAPACITIES				
Fuel tank		16 L (4.2 U.S. gal) including approximately 2 L (0.5 U.S. gal) reserve		
Engine/transmission oil		Oil change with filter: 2.8 L (3 U.S. quarts).		
Coolant		2.5 L (2.65 U.S. quarts)		
Differential	Front	N.A.	500 mL (17 U.S. oz)	
	Rear	300 mL (10 U.S. oz)		

N.A.: Not available

Because of our ongoing commitment to product quality and innovation, Bombardier reserves the right, at any time, to make changes in design and specifications and/or to make additions to, or improvements in its products without imposing any obligation upon itself to install them on its products previously manufactured.

SI* METRIC INFORMATION GUIDE

BASE UNITS

DESCRIPTION	UNIT	SYMBOL
length	meter	m
mass	kilogram	kg
force	newton	N
liquid	liter	L
temperature	Celsius	°C
pressure	kilo pascal	kPa
torque	newton-meter	N•m
land velocity	kilometer per hour	km/h

PREFIXES

PREFIX	SYMBOL	MEANING	VALUE
kilo	k	one thousand	1000
centi	c	one hundredth of	0.01
milli	m	one thousandth of	0.001
micro	μ	one millionth of	0.000001

CONVERSION FACTORS

TO CONVERT	TO ①	MULTIPLY BY
in	mm	25.4
in	cm	2.54
in ²	cm ²	6.45
in ³	cm ³	16.39
ft	m	0.3
oz	g	28.35
lb	kg	0.45
lbf	N	4.4
lbf•in	N•m	0.11
lbf•ft	N•m	1.36
lbf•ft	lbf•in	12
PSI	kPa	6.89
imp. oz	U.S. oz	0.96
imp. oz	mL	28.41
imp. gal	U.S. gal	1.2
imp. gal	L	4.55
U.S. oz	mL	29.57
U.S. gal	L	3.79
MPH	km/h	1.61
Fahrenheit	Celsius	(°F - 32) ÷ 1.8
Celsius	Fahrenheit	(°C × 1.8) + 32
hp	kW75

* The international system of units abbreviates SI in all languages.

① To obtain the reverse sequence, divide by the given factor. To convert **millimeters** to **inches**, divide by 25.4.

NOTE: Conversion factors are rounded off to 2 decimals for easier use.

WARRANTY

BOMBARDIER LIMITED WARRANTY NORTH AMERICA: 2004 BOMBARDIER® ATV

1. SCOPE OF THE LIMITED WARRANTY

In Canada, BOMBARDIER INC. (hereinafter "BOMBARDIER"), and in the USA, BOMBARDIER ON BEHALF OF BOMBARDIER MOTOR CORPORATION OF AMERICA (BMCA) warrants its 2004 BOMBARDIER ATV from defects in material or workmanship for the period described below.

All genuine BOMBARDIER parts and accessories, installed by an authorized BOMBARDIER ATV dealer (as hereinafter defined) at the time of delivery of the 2004 BOMBARDIER ATV, carry the same warranty as that of the ATV.

Following tires and winches supplied as original equipment on your ATV are warranted separately by the individual tire or winch manufacturer as identified below. If an original tire or winch on your BOMBARDIER ATV has a defect in material or workmanship, please contact these manufacturers or ask your authorized BOMBARDIER dealer for assistance.

Carlisle Tire & Wheel Company
(TRAXTER AND QUEST TIRES)
23 Windham Boulevard
Aiken, SC 29805

Warn Industries Inc. (Winch)
12900 SE Capps Road
Clackamas, Oregon 97015-8903

Warranty Information:
In USA 1 800 260-7959
In Canada 1 800 265-6155
In Quebec 1 877 997-4999

Customer service :
In USA 1 800 543-9276
In Canada 1 800 668-6012
In Quebec 1 800 361-9291

Please note that for any other 2004 ATV models, unless differently specified, tires are warranted directly by BOMBARDIER and not by the manufacturer company which produce these tires.

Use of the product for racing or any other competitive activity, at any point, even by a previous owner, will render this warranty null and void.

2. WARRANTY COVERAGE PERIOD

This warranty will be in effect FROM THE DATE OF DELIVERY TO THE FIRST RETAIL CONSUMER or the date the product is first put into use, whichever occurs first and for a period of:

SIX (6) CONSECUTIVE MONTHS, for private use or commercial use owners.

The repair or replacement of parts or the performance of service under this warranty does not extend the life of this warranty beyond its original expiration date.

3. CONDITIONS TO HAVE WARRANTY COVERAGE

This warranty coverage is available only on 2004 BOMBARDIER ATV purchased as new and unused by its first owner from a BOMBARDIER dealer authorized to distribute Bombardier ATV products in the country in which the sale occurred (hereinafter "BOMBARDIER ATV dealer"), and then only after the BOMBARDIER specified pre-delivery inspection process is completed and documented. Moreover, this warranty coverage is only available if the Bombardier ATV is purchased in the country in which the purchaser resides. Bombardier will not honor this limited warranty to any personal use owner or commercial use owner where the preceding conditions have not been met. Warranty coverage only becomes available upon proper registration of the product by an authorized BOMBARDIER ATV dealer. Such limitations are necessary in order to allow BOMBARDIER to preserve both the safety of its products, and also that of its consumers and the public.

Routine maintenance outlined in the *Operator's Guide* must be timely performed in order to maintain warranty coverage. BOMBARDIER reserves the right to make warranty coverage contingent upon proof of proper maintenance.

4. WHAT TO DO TO OBTAIN WARRANTY COVERAGE

The customer must notify a servicing BOMBARDIER ATV dealer within two (2) days of the appearance of a defect, and provide it with reasonable access to the product and reasonable opportunity to repair it. The customer must also present to the authorized BOMBARDIER dealer, proof of purchase of the product and must sign the repair/work order prior to starting the repair in order to validate the warranty repair. All parts replaced under this limited warranty become the property of BOMBARDIER.

5. WHAT BOMBARDIER WILL DO

BOMBARDIER's obligations under this warranty are limited to, at its sole discretion, repairing parts found defective under normal use, maintenance and service, or replacing such parts with new genuine BOMBARDIER parts without charge for parts and labor, at any authorized BOMBARDIER ATV dealer during the warranty coverage period. BOMBARDIER reserves the right to improve or modify products from time to time without assuming any obligation to modify products previously manufactured.

6. EXCLUSIONS - ARE NOT WARRANTED

- Normal wear and tear;
- Routine maintenance items, tune ups, adjustments;
- Damage caused by failure to provide proper maintenance and/or storage, as described in the *Operator's Guide*;
- Damage resulting from removal of parts, improper repairs, service, maintenance, modifications or use of parts not manufactured or approved by BOMBARDIER or resulting from repairs done by a person that is not an authorized servicing BOMBARDIER ATV dealer;
- Damage caused by abuse, abnormal use, neglect or operation of the product in a manner inconsistent with the recommended operation described in the Bombardier ATV *Operator's Guide*;
- Damage resulting from accident, submersion, fire, theft, vandalism or any act of God;
- Operation with fuels, oils or lubricants which are not suitable for use with the product (see the *Operator's Guide*);
- Water or snow ingestion;
- Incidental or consequential damages, or damages of any kind including without limitation towing, storage, telephone, rental, taxi, inconvenience, insurance coverage, loan payments, loss of time, loss of income.

7. LIMITATIONS OF LIABILITY

THIS WARRANTY IS EXPRESSLY GIVEN AND ACCEPTED IN LIEU OF ANY AND ALL OTHER WARRANTIES, EXPRESSED OR IMPLIED, INCLUDING WITHOUT LIMITATION ANY WARRANTY OF MERCHANTABILITY OR FITNESS FOR A PARTICULAR PURPOSE. TO THE EXTENT THAT THEY CANNOT BE DISCLAIMED, THE IMPLIED WARRANTIES ARE LIMITED IN DURATION TO THE LIFE OF THE EXPRESS WARRANTY. INCIDENTAL AND CONSEQUENTIAL DAMAGES ARE EXCLUDED FROM COVERAGE UNDER THIS WARRANTY. SOME STATES/PROVINCES DO NOT ALLOW FOR THE DISCLAIMERS, LIMITATIONS AND EXCLUSIONS IDENTIFIED ABOVE, AS A RESULT, THEY MAY NOT APPLY TO YOU. THIS WARRANTY GIVES YOU SPECIFIC RIGHTS, AND YOU MAY ALSO HAVE OTHER LEGAL RIGHTS WHICH MAY VARY FROM STATE TO STATE, OR PROVINCE TO PROVINCE.

Neither the distributor, any BOMBARDIER ATV dealer nor any other person has been authorized to make any affirmation, representation or warranty regarding the product, other than those contained in this limited warranty, and if made, shall not be enforceable against BOMBARDIER.

BOMBARDIER reserves the right to modify this warranty at any time, being understood that such modification will not alter the warranty conditions applicable to the products sold while this warranty is in effect.

8. TRANSFER

If the ownership of a product is transferred during the warranty coverage period, this warranty shall also be transferred and be valid for the remaining coverage period provided that BOMBARDIER is notified of such transfer of ownership in the following way:

- a) The former owner contacts BOMBARDIER (at the phone number provided below) or an authorized BOMBARDIER ATV dealer and gives the coordinates of the new owner; or
- b) BOMBARDIER or an authorized BOMBARDIER ATV dealer receives a proof that the former owner agreed to the transfer of ownership, in addition to the coordinates of the new owner.

9. CONSUMER ASSISTANCE

- a) In the event of a controversy or a dispute in connection with this BOMBARDIER LIMITED WARRANTY, BOMBARDIER suggests that you try to resolve the issue at the dealership level. We recommend discussing the issue with the authorized dealer's service manager or owner.
- b) If the issue has not yet been resolved, please submit your complaint in writing or call the appropriate number below:

In Canada:

BOMBARDIER INC.
RECREATIONAL PRODUCTS
BOMBARDIER ATV
CUSTOMER ASSISTANCE CENTER
VALCOURT QC J0E 2L0
Tel.: (819) 566-3366

In USA:

BOMBARDIER MOTOR
CORPORATION OF AMERICA
RECREATIONAL PRODUCTS
BOMBARDIER ATV
CUSTOMER ASSISTANCE CENTER
7575 BOMBARDIER COURT
WAUSAU WI 54401
Tel.: (715) 848-4957

© 2003 Bombardier Inc. All rights reserved

® Registered trademark of Bombardier Inc. or it subsidiaries.

BOMBARDIER INTERNATIONAL LIMITED WARRANTY: 2004 BOMBARDIER® ATV

1. SCOPE OF THE LIMITED WARRANTY

BOMBARDIER INC. (hereinafter “BOMBARDIER”), warrants its 2004 BOMBARDIER ATV from defects in material or workmanship for the period described below.

All genuine BOMBARDIER parts and accessories, installed by an authorised BOMBARDIER distributor/dealer (as hereinafter defined) at the time of delivery of the 2004 BOMBARDIER ATV, carry the same warranty as that of the ATV.

Use of the product for racing or any other competitive activity, at any point, even by a previous owner; will render this warranty null and void.

2. WARRANTY COVERAGE PERIOD

This warranty will be in effect FROM THE DATE OF DELIVERY TO THE FIRST RETAIL CONSUMER or the date the product is first put into use, whichever occurs first and for a period of:

SIX (6) CONSECUTIVE MONTHS, for private use or commercial use owners.

The repair or replacement of parts or the performance of service under this warranty does not extend the life of this warranty beyond its original expiration date.

3. CONDITIONS TO HAVE WARRANTY COVERAGE

This warranty coverage is available only on 2004 BOMBARDIER ATV purchased as new and unused by its first owner from a BOMBARDIER distributor/dealer authorised to distribute BOMBARDIER ATV products in the country in which the sale occurred (hereinafter “BOMBARDIER ATV distributor/dealer”, and then only after the BOMBARDIER specified pre-delivery inspection process is completed and documented. Moreover, this warranty coverage is only available if the BOMBARDIER ATV is purchased in the country in which the purchaser resides. BOMBARDIER will not honor this limited warranty to any personal use owner or commercial use owner where the preceding conditions have not been met. Warranty coverage only becomes available upon proper registration of the product by an authorised BOMBARDIER ATV distributor/dealer. Such limitations are necessary in order to allow BOMBARDIER to preserve both the safety of its products, and also that of its consumers and the public.

Routine maintenance outlined in the *Operator's Guide* must be timely performed in order to maintain warranty coverage. BOMBARDIER reserves the right to make warranty coverage contingent upon proof of proper maintenance.

4. WHAT TO DO TO OBTAIN WARRANTY COVERAGE

The customer must notify a servicing BOMBARDIER ATV distributor/dealer within two (2) days of the appearance of a defect, and provide it with reasonable access to the product and reasonable opportunity to repair it. The customer must also present to the authorised BOMBARDIER distributor/dealer, proof of purchase of the product and must sign the repair/work order prior to starting the repair in order to validate the warranty repair. All parts replaced under this limited warranty become the property of BOMBARDIER.

5. WHAT BOMBARDIER WILL DO

BOMBARDIER's obligations under this warranty are limited to, at its sole discretion, repairing parts found defective under normal use, maintenance and service; or replacing such parts with new genuine BOMBARDIER parts without charge for parts and labour, at any authorised BOMBARDIER distributor/dealer.

BOMBARDIER reserves the right to improve or modify products from time to time without assuming any obligation to modify products previously manufactured.

6. EXCLUSIONS - ARE NOT WARRANTED

- Normal wear and tear;
- Routine maintenance items, tune ups, adjustments;
- Damage caused by failure to provide proper maintenance and/or storage, as described in the *Operator's Guide*;
- Damage resulting from removal of parts, improper repairs, service, maintenance, modifications or use of parts not manufactured or approved by BOMBARDIER or resulting from repairs done by a person that is not an authorised servicing BOMBARDIER distributor/dealer;
- Damage caused by abuse, abnormal use, neglect or operation of the product in a manner inconsistent with the recommended operation described in the *Operator's Guide*;
- Damage resulting from accident, submersion, fire, theft, vandalism or any act of God;
- Operation with fuels, oils or lubricants which are not suitable for use with the product (see the *Operator's Guide*);
- Water or snow ingestion;
- Incidental or consequential damages, or damages of any kind including without limitation towing, storage, telephone, rental, taxi, inconvenience, insurance coverage, loan payments, loss of time, loss of income.

7. LIMITATIONS OF LIABILITY

THIS WARRANTY IS EXPRESSLY GIVEN AND ACCEPTED IN LIEU OF ANY AND ALL OTHER WARRANTIES, EXPRESSED OR IMPLIED, INCLUDING WITHOUT LIMITATION ANY WARRANTY OF MERCHANTABILITY OR FITNESS FOR A PARTICULAR PURPOSE. TO THE EXTENT THAT THEY CANNOT BE DISCLAIMED, THE IMPLIED WARRANTIES ARE LIMITED IN DURATION TO THE LIFE OF THE EXPRESS WARRANTY. INCIDENTAL AND CONSEQUENTIAL DAMAGES ARE EXCLUDED FROM COVERAGE UNDER THIS WARRANTY. SOME JURISDICTIONS DO NOT ALLOW FOR THE DISCLAIMERS, LIMITATIONS AND EXCLUSIONS IDENTIFIED ABOVE, AS A RESULT, THEY MAY NOT APPLY TO YOU. THIS WARRANTY GIVES YOU SPECIFIC RIGHTS, AND YOU MAY ALSO HAVE OTHER LEGAL RIGHTS WHICH MAY VARY FROM COUNTRY TO COUNTRY.

Neither the distributor, any BOMBARDIER dealer nor any other person has been authorised to make any affirmation, representation or warranty regarding the product, other than those contained in this limited warranty, and if made, shall not be enforceable against BOMBARDIER.

BOMBARDIER reserves the right to modify this warranty at any time, being understood that such modification will not alter the warranty conditions applicable to the products sold while this warranty is in effect.

8. TRANSFER

If the ownership of a product is transferred during the warranty coverage period, this warranty shall also be transferred and be valid for the remaining coverage period provided that BOMBARDIER is notified of such transfer of ownership in the following way:

BOMBARDIER or an authorised BOMBARDIER ATV distributor/dealer receives a proof that the former owner agreed to the transfer of ownership, in addition to the co-ordinates of the new owner. The distributor will then forward this information directly to BOMBARDIER.

9. CONSUMER ASSISTANCE

- a) In the event of a controversy or a dispute in connection with this BOMBARDIER LIMITED WARRANTY, BOMBARDIER suggests that you try to resolve the issue at the dealership level. We recommend discussing the issue with the authorised dealer's service manager or owner.
- b) If further assistance is required, the distributor's service department should be contacted in order to resolve the matter.
- c) If the matter still remains unresolved then contact BOMBARDIER by writing to us at the address listed below.

BOMBARDIER INC.
RECREATIONAL PRODUCTS
BOMBARDIER ATV
CUSTOMER ASSISTANCE CENTER
VALCOURT QC JOE 2L0
Tel: (819) 566-3366

FREQUENTLY ASKED QUESTIONS

- Q: Why must my vehicle be registered with the factory? After all, I do have my original invoice as proof of when I purchased my vehicle.
- A: *Registration is very important and an authorized Bombardier ATV dealer must register your vehicle with Bombardier Inc. Make sure the registration card has been sent. All of this will allow you to:*
- Have warranty work performed at any authorized Bombardier ATV dealer in North America. Your registration card will provide the dealer with all the necessary data to complete warranty claim forms.*
 - Be advised by Bombardier Inc. should there be a safety recall or a particular warranty campaign.*
 - Be contacted much faster by the police, in the event that they find your vehicle subsequent to a theft.*
- Q: Why must my vehicle be registered with the governing body having jurisdiction over vehicle use?
- A: *Vehicle registration has two purposes: In many provinces or States, it is mandatory to register a vehicle in the same way as for a car. It allows the State or province to maintain records of existing vehicles. In some jurisdictions, governmental agencies use part of the registration fees for establishing and maintaining trails.*
- Q: Where can I find information on the lubrication and maintenance of my vehicle?
- A: *In the Operator's Guide provided with the vehicle at the time of delivery.*
- Q: Will the entire warranty be voided or cancelled, if I do not operate or maintain my new vehicle exactly as specified in the *Operator's Guide*?
- A: *The warranty of the new vehicle cannot be "Voided" or "Cancelled" if predelivered by an authorized Bombardier ATV dealer. However, if a particular failure is caused by operation or maintenance other than what is shown in the Operator's Guide, THAT failure may not be covered under warranty. This includes service work performed by the customer, oil and filter change and especially the critical adjustments such as the carburetor.*
- Q: Would you give some examples of abnormal use or strain, neglect or abuse which may affect the limited warranty coverage?
- A: *These terms are general and overlap each other in some cases. Some specific examples may include: running the engine out of oil, operating the vehicle with a broken or damaged part which causes another part to fail, and so on. If you have any specific questions on operation or maintenance, please contact an authorized Bombardier ATV dealer for advice.*
- Q: What costs are my responsibility during the warranty period?
- A: *The customer's responsibility includes all costs of normal maintenance services, non-warranty repairs, accidents and collision damage, as well as oils, and spark plugs, and incidental or consequential damages costs as explained in the warranty.*

Q: Are "Genuine" Bombardier replacement parts used in warranty repairs also covered by the limited warranty coverage?

A: *Yes. When installed by an authorized Bombardier ATV dealer, any "Genuine" Bombardier part used in warranty repairs assumes the remaining warranty that exists on the vehicle.*

Q: If I sell my vehicle within the warranty period, will the new owner qualify for the balance of the limited warranty coverage?

A: *Yes, provided the re-sale has been registered with the manufacturer.*

Q: How can I receive the best owner assistance?

A: *The satisfaction, safety and goodwill of the owners of Bombardier products are of primary concern to your ATV dealer and Bombardier Inc. Normally, any problems that arise in connection with the sales transaction or the operation of your vehicle will be handled by your Dealer's Sales or Service Departments. It is recognized, however, that despite the best intentions of everyone concerned, misunderstandings will sometimes occur. Frequently, complaints are the result of a breakdown in communications and can quickly be resolved by a member of the dealership management. If the problem already has been reviewed with the Sales Manager or Service Manager, contact the Dealer Principal himself or the General Manager.*

We are always pleased to receive your comments on this Bombardier ATV.

PRIVACY OBLIGATIONS/DISCLAIMER

We wish to inform you that your coordinates will be used for safety and warranty purposes. Sometimes, we also use the coordinates of our clients to inform them about our products and to present them offers. Should you prefer not to receive information on our products, services and offers, please let us know by writing to the address below.

Also note that, from time to time, carefully selected and trustworthy organizations may be permitted to use the coordinates of our clients to promote quality products and services. If you prefer not to have your name and address released, please let us know by writing to the address below:

Bombardier Inc.

Recreational Products

Warranty Department

75 J.A. Bombardier Street

Sherbrooke, Québec J1L 1W3

Canada

Fax Number: (819) 566-3590

CHANGE OF ADDRESS/OWNERSHIP

If your address has changed, be sure to fill out and mail the card provided on this page.

Such notification is likewise necessary for your own safety even after expiration of the original warranty, since Bombardier Inc. will be in a position to contact you if correction to your ATV becomes necessary.

NOTE: This card is strictly for change of address only.



CHANGE OF ADDRESS CHANGE OF OWNERSHIP

VEHICLE IDENTIFICATION NUMBER

--	--

Model Number Vehicle Identification Number (V.I.N.)

OLD ADDRESS: _____

NAME

NO. STREET APT

CITY STATE/PROVINCE ZIP/POSTAL CODE

COUNTRY

NEW ADDRESS: _____

NAME

NO. STREET APT

CITY STATE/PROVINCE ZIP/POSTAL CODE

COUNTRY

STOLEN UNITS

In the event that your ATV is stolen, you should notify your area's distributor warranty department of such.

Please provide your name, address, phone number, vehicle identification number and date it was stolen.

Bombardier will provide a list of stolen units to all ATV dealers on a monthly basis to aid in recovery of such units to their owners.



AFFIX
PROPER
POSTAGE

BOMBARDIER
RECREATIONAL PRODUCTS

WARRANTY DEPARTMENT
75, J.A. BOMBARDIER ST.
SHERBROOKE (QUÉBEC)
CANADA J1L 1W3

ATV MODEL No. _____

VEHICLE IDENTIFICATION NUMBER (V.I.N.) _____

ENGINE IDENTIFICATION NUMBER (E.I.N.) _____

Owner: _____
NAME

No. STREET APT

CITY STATE/PROVINCE ZIP/POSTAL CODE

Purchase Date _____
YEAR MONTH DAY

Warranty Expiry Date _____
YEAR MONTH DAY

To be completed by the dealer at the time of the sale.

DEALER IMPRINT AREA

Please verify with your selling dealer to ensure your ATV has been registered with Bombardier.

 **WARNING**

Indicates a potential hazard that, if not avoided, could result in serious injury or death.



WARNING

THIS VEHICLE CAN BE HAZARDOUS TO OPERATE.

A collision or rollover can occur quickly, even during routine maneuvers such as turning and driving on hills or over obstacles, if you fail to take proper precautions.

SEVERE INJURY OR DEATH can result if you do not follow these instructions:

- **BEFORE YOU OPERATE THIS ATV, READ THIS OPERATOR'S GUIDE AND ALL ON-PRODUCT LABELS.**
- **NEVER OPERATE THIS ATV WITHOUT PROPER INSTRUCTIONS.** Beginners should complete a certified training course.
- **NEVER CARRY A PASSENGER.** You increase your risk of losing control if you carry a passenger.
- **NEVER OPERATE THIS ATV ON A PAVED SURFACE.** You increase your risk of losing control if you operate this ATV on pavement.
- **NEVER OPERATE THIS ATV ON PUBLIC ROADS.** You can collide with another vehicle if you operate this ATV on a public road.
- **ALWAYS WEAR AN APPROVED HELMET,** eye protection, and protective clothing.
- **NEVER CONSUME ALCOHOL OR DRUGS** before or while operating this vehicle.
- **NEVER OPERATE THIS ATV AT EXCESSIVE SPEEDS.** You increase your risk of losing control if you operate this ATV at speeds too fast for the terrain, visibility conditions, or your experience.
- **NEVER ATTEMPT WHEELIES, JUMPS, OR OTHER STUNTS.**

®™ TRADEMARKS OF BOMBARDIER INC. OR ITS SUBSIDIARIES.

©2003 BOMBARDIER INC. ALL RIGHTS RESERVED

PRINTED IN CANADA

